

Glass versus MOS memories 122

\$1.00 A McGraw-Hill Publication

New approach to diff amp testing 132

September 15, 1969

Probing deep space 145

Electronics®

West
Germany,
where
linear IC's
reign

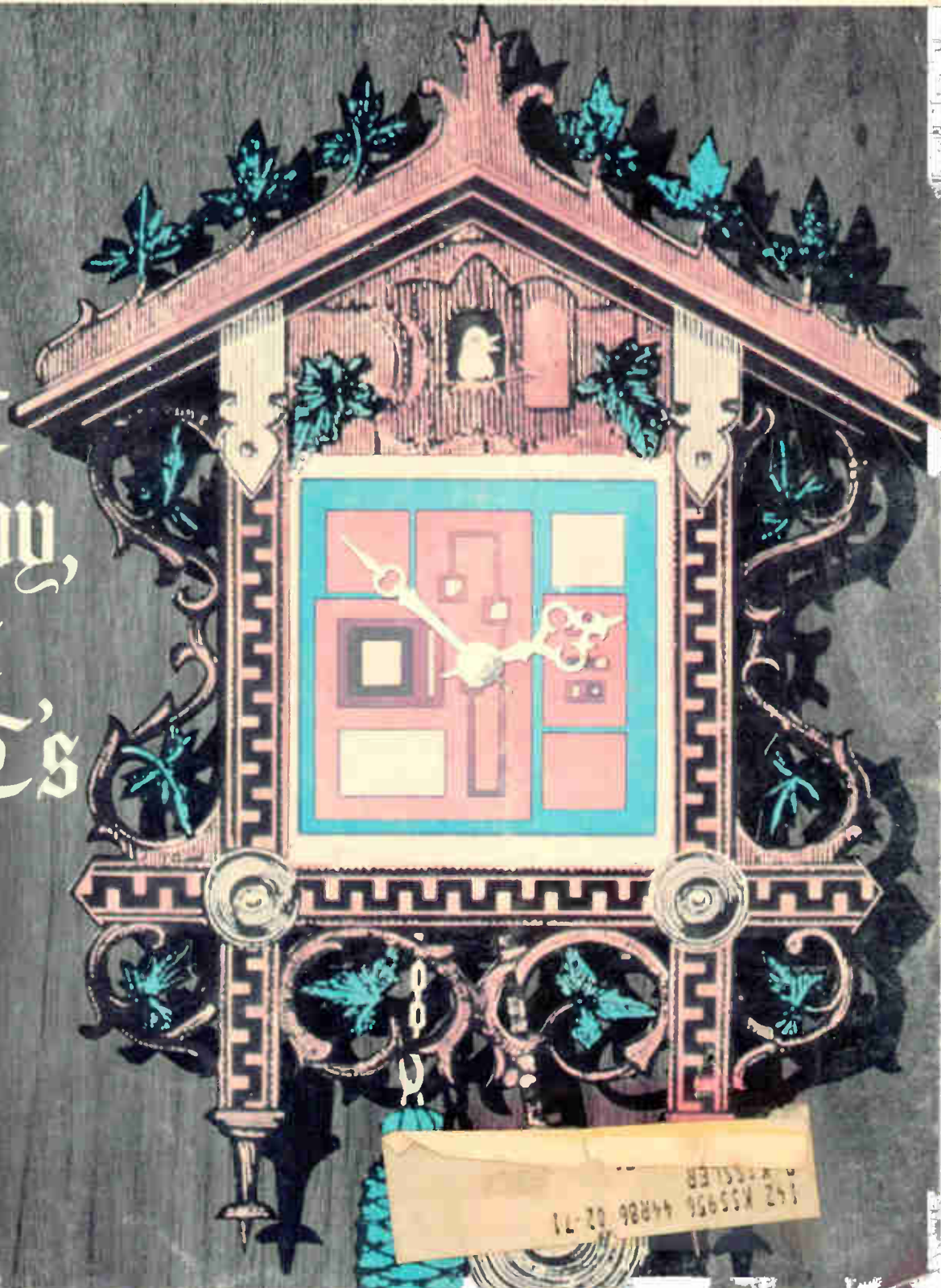

Pulsepower

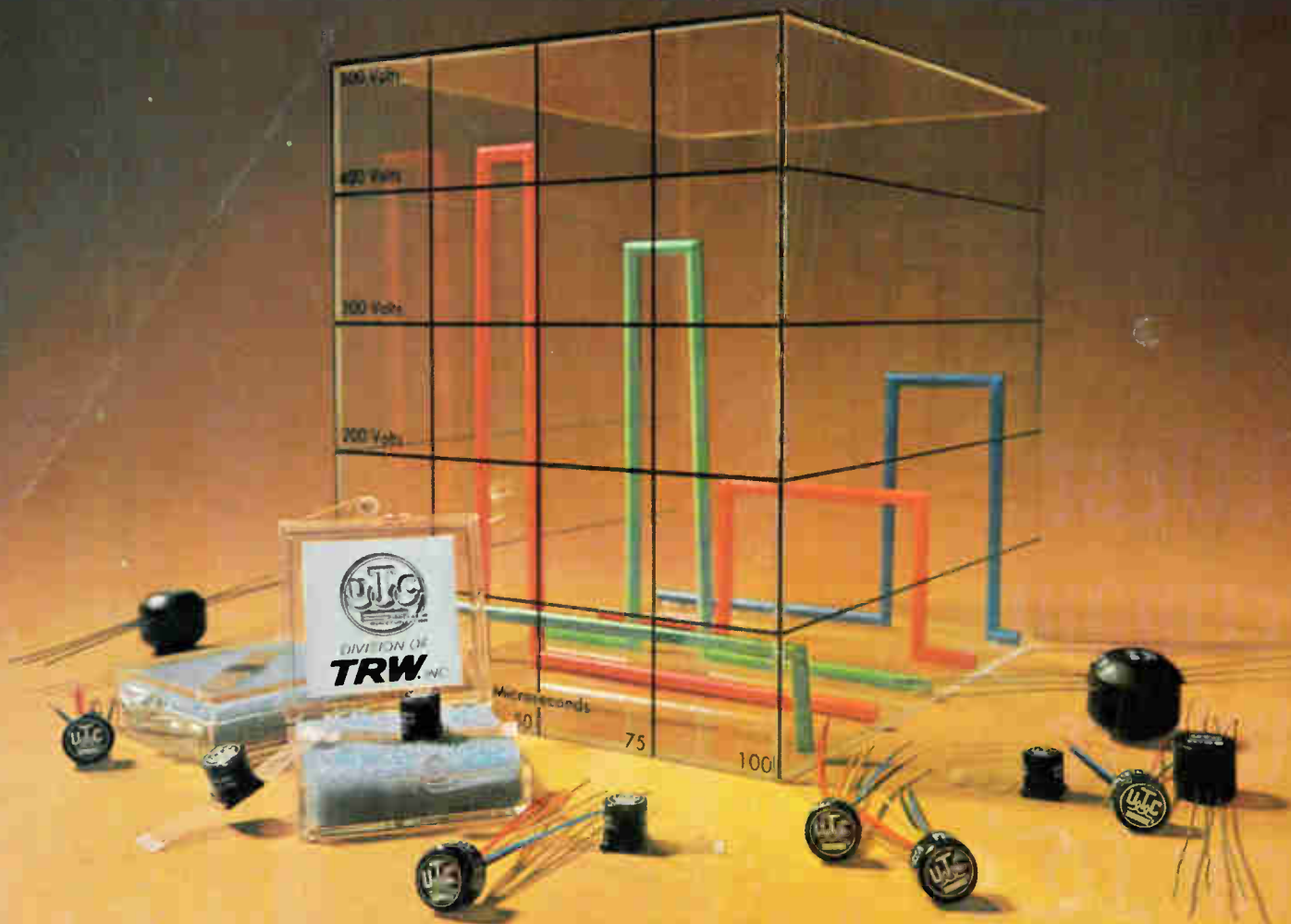

UTC miniature transformers assure high pulse integrity at ET constants exceeding 7500 volt-microseconds

The high ET constants of UTC miniature pulse transformers give you fast rise time plus low droop at highest peak-power for size in the industry. That's pulsepower.

UTC's BIT-P and PIP standard lines are the smallest metal-encased pulse transformers made. Unique structures, plus manufacturing controls, enable UTC pulse transformers to achieve high flux densities and unrivalled temperature stability. All units are individually adjusted in a standard blocking oscillator circuit, assuring parameter uniformity unavailable elsewhere.

UTC's broad lines cover most pulse applications. Note particularly: use in high-gain, low-level, high-density packaged circuits made possible by high shielding of units; SCR di/dt failure reduction due to fast rise time and high pulse-

energy capability. The units are also suitable for wide-band applications of 1 kHz to 100 MHz.

UTC's metal-encased standard lines exceed MIL Grade 6 (MIL-T-21038B). They're ruggedized, hermetically sealed, and electromagnetically shielded. Molded units to MIL Grade 7, Class S temperature (+130°C), are available with a dielectric strength of 1250 volts. Where special parameters are needed we'll tailor them to your circuits.

When your design calls for pulsepower—high pulse integrity—UTC has the answer. Check your local distributor for immediate off-the-shelf delivery, or contact United Transformer Company, Division of TRW INC., 150 Varick St., New York, New York 10013.

TRW
UNITED TRANSFORMER COMPANY

Even if your data goes from  to  you can see it all on one display.



Some of your data will barely twitch an indicator.

Some of it goes right off the scale.

No problem. The HP 7563A Voltmeter/Amplifier logarithmically compresses data with a dynamic range of 110 dB—110 dB!—and gives you a single output that includes both high and low amplitude data with constant resolution and accuracy. The 7563A accepts positive or negative signals from vibration tests, geophysical measurements, pulse height analyzers, computers and similar sources, compresses the amplitudes logarithmically and feeds the results directly to a recorder or oscilloscope. The front-panel meter gives an instant visual display in dB. And when it's not performing that job, the 7563A will double as a voltmeter (calibrated from 0.3 mV to 100 V) for

system or bench use. How's that for a voltmeter/amplifier with the modest price of \$695 and one of the widest dynamic ranges you can buy?

To add AC log conversion and voltmeter applications to DC, use the 7562A with its 80 dB dynamic range. It's the only converter on the market that can measure the true rms value of an AC voltage. Turn it loose on vibration studies, biochemical data, seismographic

studies, audio research or similar data with large asymmetrical wave forms and it will give you the most accurate log conversion you can get in AC. Or use it as an AC/DC voltmeter, calibrated directly in volts. Price is \$995.

For more information, call your local Hewlett-Packard field engineer or write Hewlett-Packard, Palo Alto, California 94304; Europe: 1217 Meyrin-Geneva, Switzerland.

HEWLETT  PACKARD



HP's new 1100 V, 110 kHz calibrator keeps it from happening.

Let's face it, anybody that works with over 1000 volts learns to keep one hand in his pocket.

But, while it will always be primarily your responsibility when working with high voltage to protect yourself — it isn't your responsibility alone.

When Hewlett-Packard engineers developed the HP 746A High Voltage Amplifier for the HP 745A calibrator they had three definite goals in mind:

1. Give you the capability to calibrate to 1100 volts at 110 kHz.
2. Do it for a reasonable price.
3. Make it the safest piece of high voltage equipment available.

How well did they succeed? Well, the 745/746 calibration system provides outputs from as low as 0.100000 mV in 1 nV steps to as high as 1099.999 V in 1 mV steps. You get 7 voltage ranges, all with 6-digit adjustability. Frequency is from 10 Hz to 110 kHz in four overlapping decade ranges. You get direct error measuring capability plus the accuracy and stability you expect from an HP working standard.

Price? \$6500 for the whole system. Or, if you already have an HP 745A add the 746A for just \$2000.

Safety? It starts by lighting the red lighting bolt (international symbol for high voltage) whenever the 1100 V output is present. An overload causes the output to be automatically removed. Two sequential steps are required to obtain the high voltage output. These and many more safety features make the HP 746 the safest piece of high voltage equipment available today!

But the best way to convince yourself is to get the complete information on this complete calibration system. For more information, call your local HP field

engineer. Or, write to Hewlett-Packard, Palo Alto, California 94304. Europe: 1217 Meyrin-Geneva, Switzerland.

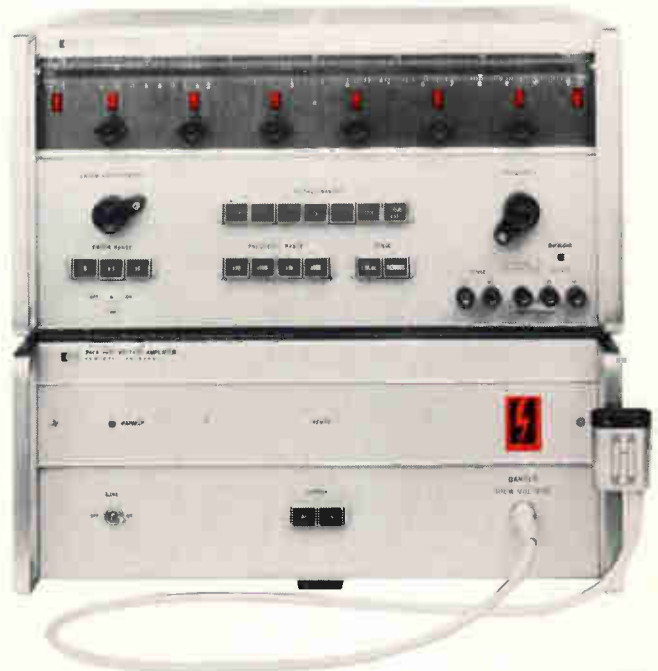

099/24

HEWLETT  PACKARD

WORKING STANDARDS

marketing manager for the PDP-8 product line, George L. Rice joined Synergistics as marketing vice president. He compares Synergistics with Digital Equipment as it was in 1958. Rice is interested in electronic money, and considers the credit card and reader made by Peripheral Data Systems a wedge into this business. Automated Systems could provide markets for the Ikon and laser recorder systems as well as, the latter to be used to store anything from inventory to credit information.

Tetrick is building a dovetailed group of divisions and men which he hopes can make a sizable dent in the electronics market of the 1970's. "There are many millions of dollars in the field," he says, "and if we're successful we should be a \$40 million company by 1974." Synergistics has grossed more than \$800,000 this year, mostly through sales of the Ikon system, and Tetrick hopes that it will become profitable by the year's end.

Who's the maverick at the staid Federal Communications Commission? The average Washington insider is likely to offer the name of Commissioner Nicholas Johnson, but if the same question were put to industry and government communications specialists the answer probably would be Bernard Strassburg. Many believe Strassburg, the 51-year-old chief of the Common Carrier Bureau, is much more effective in his own quiet way.

Strassburg, who joined the commission as an attorney 27 years ago, is considered one of the most forceful officials in an agency whose effectiveness commands limited respect—last year the Consumer's Union dubbed it the "tuned-out, turned-off FCC."

He was there. In his 5½ years in charge of the common carrier section, he is credited with influencing some of the most significant decisions in the commission's history, and with instigating investiga-

tions that could produce others. These include the Carterfone ruling that permitted use of foreign attachments—equipment not made by Bell—within the telephone network, and the more recent Microwave Communications Inc. decision allowing special-service carriers to offer commercial services in competition with telephone companies [*Electronics*, Sept. 1, p. 40]. Current investigations by Strassburg's bureau include the computer communications inquiry, and an examination of AT&T's rate structure, services, and equipment quality. He also will be conducting the upcoming FCC foreign attachment technical conferences.

Reflecting on the impact of the Microwave Communications decision, Strassburg feels that a national microwave network, dominated by data transmission with voice and facsimile capabilities, could be operating in 10 years. He concedes realistically that as applications for routes start pouring in from MCI and other microwave carriers, "a little 'Ma Bell' certainly is possible." Strassburg feels that this "could mean a change in the present industry structure," but he believes that the competition with telephone companies would be in the public interest.

The related computer communications inquiry is expected to reach a climax around October 1 with an FCC decision on regulations. Strassburg says some useful things already have come out of it—it has been a forum for an exchange between the communications and computer industries.

R&D needed. One thing Strassburg would like to see is a greater in-house research capability for Federal agencies, such as a Rand Corp. type of think tank [*Electronics*, June 9, p. 75]. The problem in setting up such facilities is convincing Congress that it's valuable, he says. Currently, "regulation does rely on industry for a good part of the raw ingredients" of decision making. But he denies that industry has any influence in policy making because "industry is not unified in its view."

hp adds

250

MHz

to the

180

Scope System

This all-solid-state plug-in system now covers 50 MHz, 100 MHz and 250 MHz Real Time, calibrated time domain reflectometry with 35 ps risetime, 12.4 GHz sampling with 28 ps risetime, storage and variable persistence...

089/10

HEWLETT  PACKARD

OSCILLOSCOPE SYSTEMS

The following 12 pages are a presentation of the complete HP 180 Scope System—including the new 183A 250 MHz Oscilloscope. If the insert is missing, you can get a copy by circling Electronics Reader Service Card Number 320.



**Bone dry...
is not dry enough for some people.**

On the surface, things that look pretty dry just aren't dry enough for some jobs. Jobs like precisely monitoring trace water in gas streams. Or finding out exactly how dry a dry box operates.

Beckman has designed, built and introduced a new line of Trace Moisture Analyzers to accomplish this critical job. They tell exactly how many parts-per-million of water are present in gas streams and atmospheres. This new generation of instruments is "industrialized" for greater durability, maintenance simplicity and reliability. The line includes porta-

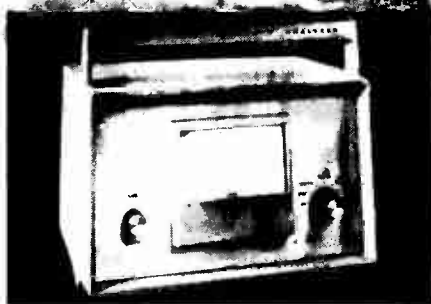

ble and semi-portable models as well as panel-mounted control units and remote analyzers. Each analyzer has a more easily replaceable cell, a temperature controlled detector, and a new heavy-duty

die-cast aluminum case. Many other standard features and options are offered like front-settable solid-state high alarm contacts, and terminals for a potentiometric or current-level recorder.

For all the facts, call your local Beckman Sales Representative or write for Data File PTM-13-170.

Beckman

INSTRUMENTS, INC.
PROCESS INSTRUMENTS DIVISION
FULLERTON, CALIFORNIA 92634

INTERNATIONAL SUBSIDIARIES: AMSTERDAM; CAPE TOWN;
GENEVA; GLENROTHES, SCOTLAND; LONDON; MEXICO
CITY; MUNICH; PARIS; STOCKHOLM; TOKYO; VIENNA

COLLISION AVOIDANCE SYSTEMS

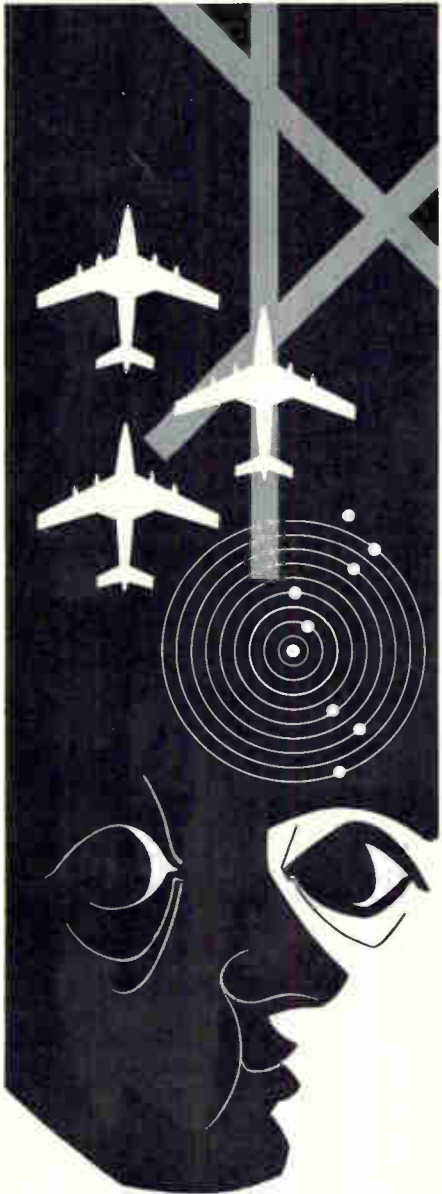

TOTAL ELECTRONIC
SYSTEMS CAPABILITY.
SPECIALISTS IN
TIME/FREQUENCY,
RADAR AND
DATA SYSTEMS
OFFERING RAPID
GROWTH.



P.O. BOX 222, BUFFALO, N.Y. 14225

Who's Who in electronics



Heavy. That's what Synergistics' Robert E. Wiltz calls himself, probably because he's the man who hunts firms to acquire.

If you can make two and two add up to five, you've achieved synergism. That's what William M. Tetrick hopes to do in the electronics business as president of Synergistics Inc. of East Natick, Mass.

During the 1950's Tetrick was president of Avis Rent-a-Car and later became president of the Farrington Manufacturing Co. But now he's starting from scratch again: "I like to build companies," he says. At Synergistics, he hopes to construct a large international organization from building blocks of small companies that are long on potential but often short on cash. When Tetrick's acquisitions of men and companies are finished, Synergistics will be a force in data processing, data communications, "electronic money," and executive information services—to name only a few areas.

On the move. Synergistics was only a corporate shell until Tetrick became president in March 1968. But with Tetrick working behind the scenes, it made its first acquisition in February—Peripheral Data Systems, a small Worcester, Mass., developer of computer-compatible credit cards and card readers, and a low-cost line of self-encoding keyboards for data entry. The keyboard price is said to be so low that even hard-nosed Viatron Computer Systems Corp. may use the product for its System 21.

Last December, Ikon Data Systems of Seattle became Synergistics' second division. Ikon

brought along a computer communications capability—a system able to interconnect up to 1,000 remote terminals at a price claimed to be about one-third that of competing systems. Tetrick says Ikon is delivering a system per month.

Last month, Synergistics bought a laser data-recorder system developed by Sylvania [*Electronics*, August 4, p. 34], and formed a third division around it.

Helping to oversee Synergistics' operations is Tetrick's three-man team. Treasurer Robert J. Gustavson handles financial matters, as well as some of the firm's acquisition activities. He's also responsible for Ikon.

Gustavson is interested in the education market as a sales area for the Ikon system, and also foresees possible acquisition of an educational software and publishing company.

Robert E. Wiltz, senior vice president for planning and development, calls himself Synergistics' "heavy." On board four months, Wiltz is largely responsible for getting the products of Peripheral Data Systems out of the lab and before potential customers. First deliveries are due this fall.

Time buying. Evaluation of acquisitions takes most of Wiltz's time; apparently the time to buy is ripe. "With money as tight as it is now, firms which otherwise could have weathered the slump aren't able to borrow."

After six years at the Digital Equipment Corp., and a year as

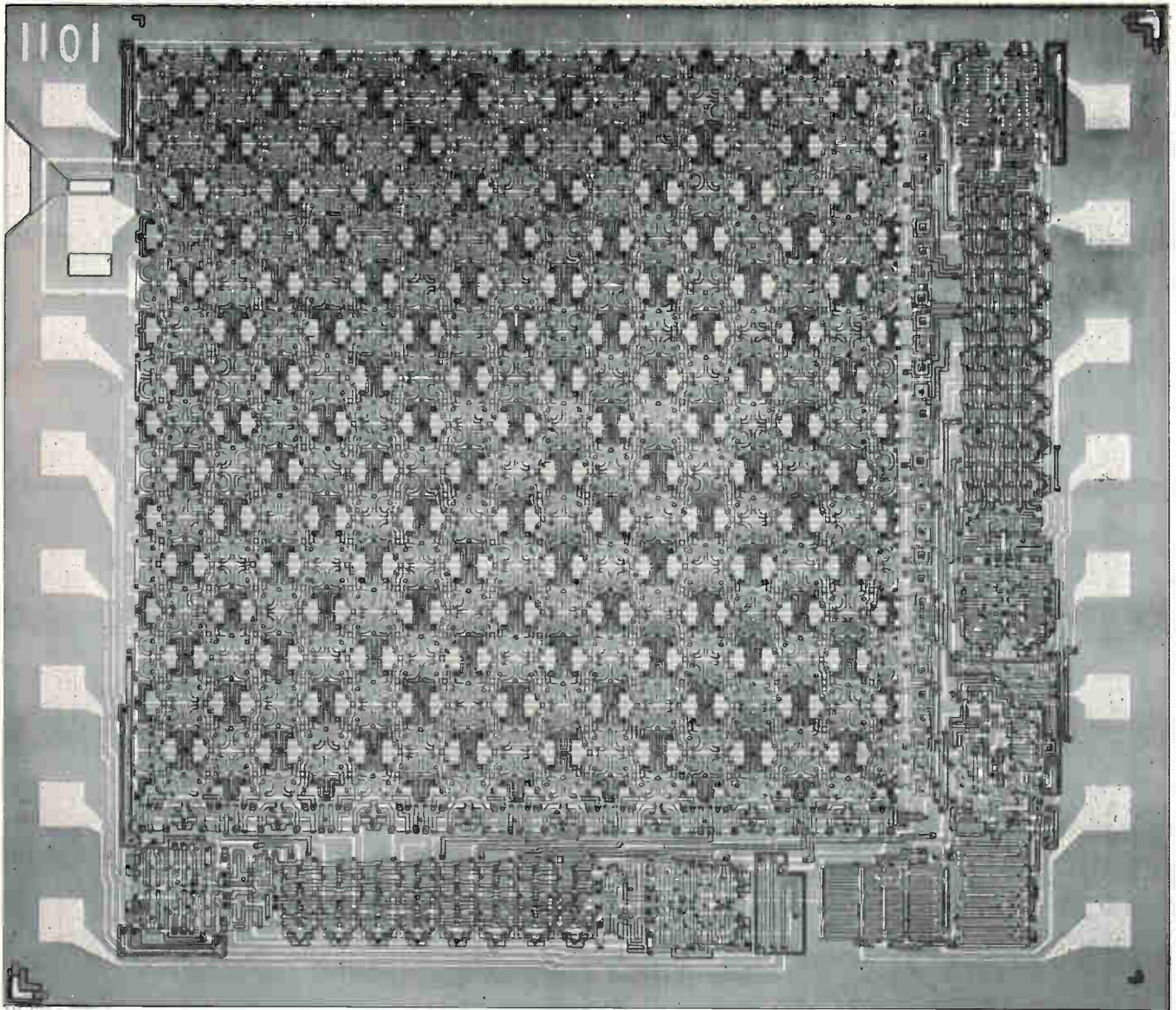

First silicon gate MOS. 256-bit random-access memory. Fully decoded.

Introducing the Intel Model i-1101 static random-access memory
□ 256 x 1 organization □ 0.1 mW per bit standby power □ 2 mW during access □ 800 nsec typical access time □ DTL and TTL compatible □ OR-tie capability □ In a 16-lead hermetic DIP.

Available now in over 40 locations. Phone your local Intel distributor: Cramer Electronics or Hamilton Electro Sales. Or phone us collect at Mountain View, California (415) 961-8080. □ Intel Corporation, 365 Middlefield Road, Mountain View, California 94040. Intel regional offices in Costa Mesa, California □ (714) 545-8541 and in Andover, Mass. (617) 536-0700.

intel

**Pick
another
winner.**

**We did.
i-1101**

Opportunity

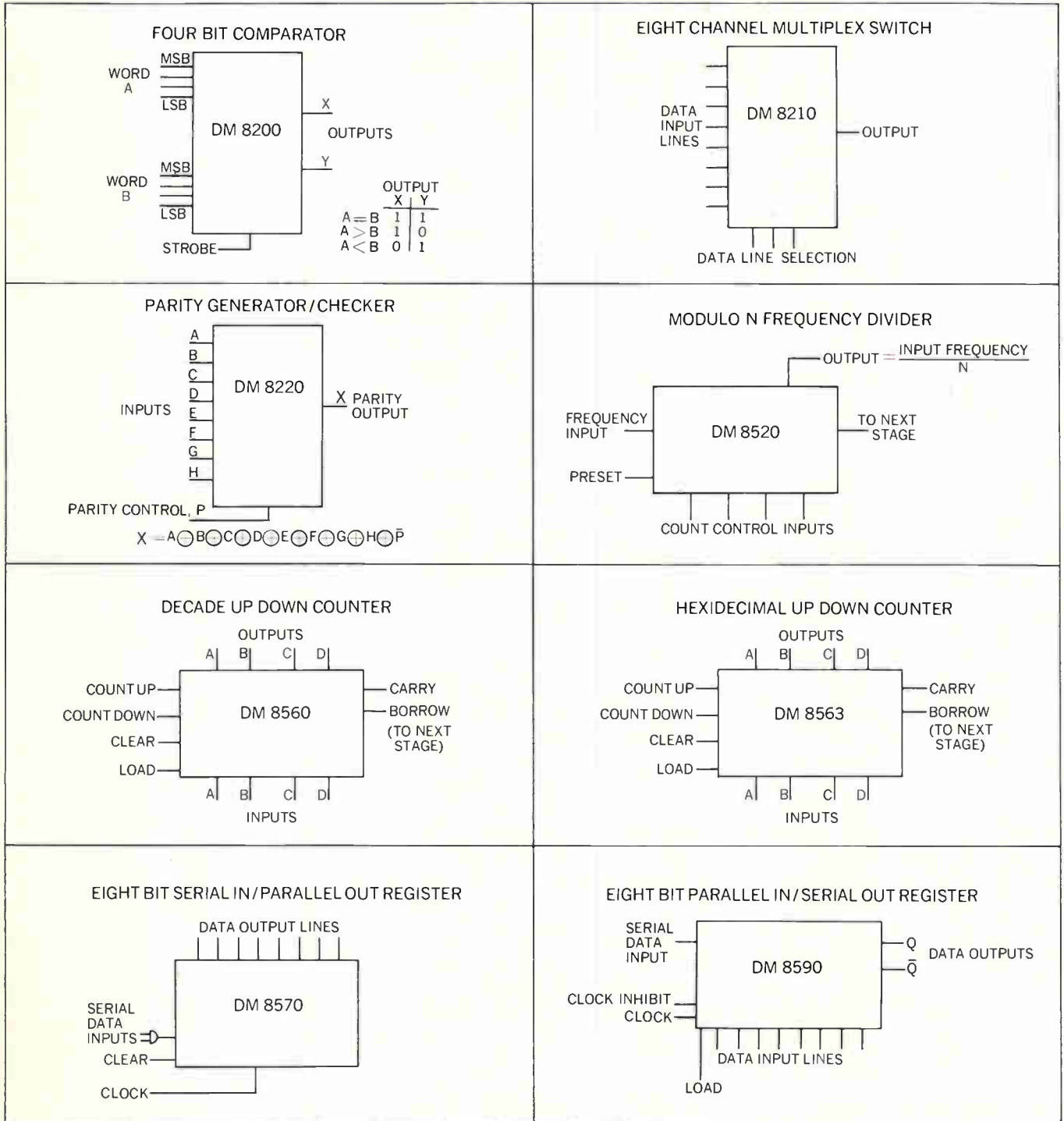

These exclusive National TTL MSI circuits offer designers increased opportunities for circuit savings in design time, board space and costs. Write or call for your free TTL Spec Guide, TTL Cross Reference Guide, and TTL Performance Tables. National Semiconductor, 2975 San Ysidro Way, Santa Clara, California 95051 (408) 245-4320 TWX: 910-339-9240 Cables: NATSEMICON

National/TTL

Equal

Gates

DM8000N (SN7400N)	Quad 2-Input, NAND gate
DM8001N (SN7401N)	Quad 2-Input, NAND gate (Open Collector)
DM8002N (SN7402N)	Quad 2-Input, NOR gate
DM8003N (SN7403N)	Quad 2-Input, NAND gate (Open Collector)
DM8004N (SN7404N)	Hex inverter
DM8010N (SN7410N)	Triple 3-Input, NAND gate
DM8020N (SN7420N)	Dual 4-Input, NAND gate
DM8030N (SN7430N)	Eight-Input, NAND gate
DM8040N (SN7440N)	Dual 4-Input, Buffer
DM8050N (SN7450N)	Expandable Dual 2-Wide, 2-Input AND-OR-INVERT gate
DM8051N (SN7451N)	Dual 2-Wide, 2-Input AND-OR-INVERT gate
DM8053N (SN7453N)	Expandable 4-Wide, 2-Input AND-OR-INVERT gate
DM8054N (SN7454N)	Four-Wide, 2-Input AND-OR-INVERT gate
DM8060N (SN7460N)	Dual 4-Input expander
DM8086N (SN7486N)	Quad Exclusive-OR-gate

Flip Flops

DM8540N (SN7472N)	MASTER-SLAVE J-K flip flop
DM8501N (SN7473N)	Dual J-K MASTER-SLAVE flip flop
DM8500N (SN7476N)	Dual J-K MASTER-SLAVE flip flop
DM8510N (SN7474N)	Dual D flip flop

Counters

DM8530N (SN7490N)	Decade Counter
DM8532N (SN7492N)	Divide-by-twelve counter
DM8533N (SN7493N)	Four-bit binary counter
DM8560N (SN74192N)	Up-down decade counter
DM8563N (SN74193N)	Up-down binary counter

Decoders

DM8840N (SN7441AN)	BCD to decimal nixie driver
DM8842N (SN7442N)	BCD to decimal decoder

Miscellaneous

DM8550N (SN7475N)	Quad latch
-------------------	------------

Spec-for-spec. Pin-for-pin. Second source on all popular 74N.

Our new retina sees red everywhere

**New photocathode responds from 300 nm to 950 nm.
Best yet for GaAs laser beam detection.**

The prosaic designation, S-25, for our new red sensitive translucent photocathode belies its exciting characteristics and usefulness.

With a spectral response that ranges from 300 nm to 950 nm, the S-25 needs no additional infrared source, sensing instead natural radiation such as moonlight and airglow. Fact is, under a night sky our new S-25 is 4 times more sensitive than S-1 or S-20.

Increased spectral range

This extreme spectral range makes possible increased contrast in detecting man-made objects versus

foliage. Obvious advantage: Extremely sensitive military night vision devices. Note, too, that because the response of the S-25 is particularly outstanding between 840 and 890 nanometers, it is ideal for gallium arsenide laser beam detection. A characteristic that should be of interest to those involved in distance measuring equipments for bridges and tunnels, or military range finders.

For those with scientific turn of mind, the S-25 operates well in high electric field gradients, is capable of high peak current output without electric field distortion or defocus-

ing, and is adaptable to multi-bounce optical trapping for even greater sensitivity.

Configurations available

You can, of course, expect to get the S-25 photocathode in a host of phototube configurations and end-on photocathode designs such as Vidisector® camera tubes, photomultipliers, image intensifiers and vacuum photodiodes.

Want more information? Write: ITT Electron Tube Division, International Telephone and Telegraph Corporation, P.O. Box 100, Easton, Pa. 18042

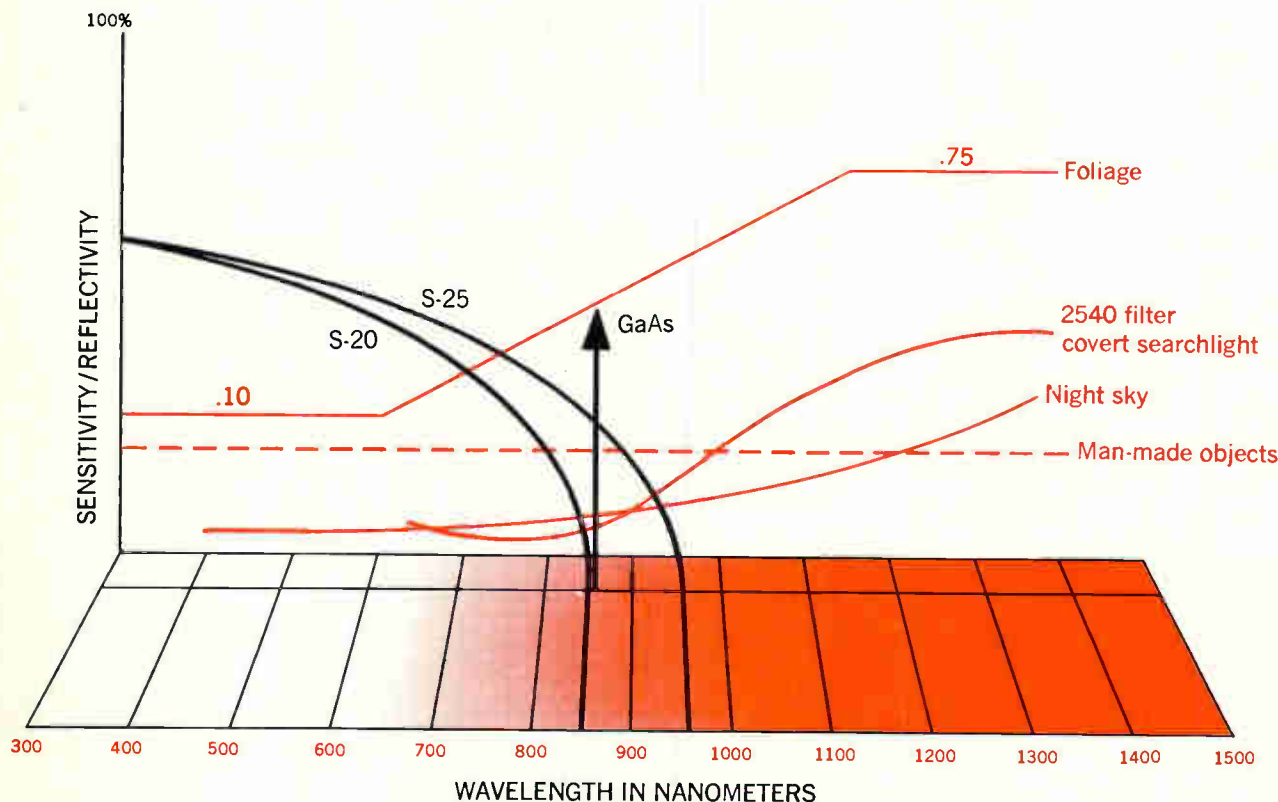

ELECTRON TUBE DIVISION ITT

Who's Who in this issue



Wittenzellner

No stranger to West Germany's electronics industry, associate editor John Gosch has been "our man in Bonn" for more than three years. Before that, Gosch—an EE graduate of New York University—was a field-service engineer in West Germany for Reeves Instruments. Both his background and skill as a reporter made him the natural selection for kicking off *Electronics'* penetrating look at West Germany's posture where IC's are concerned (p. 104). Getting down to the specifics is a quintet of German authors—Robert Suhrmann, Eckart Pech, Ernst L. Ginsberg, Werner Hoehne, and Ernst Wittenzellner. Three of the authors—Suhrmann, Pech, and Ginsberg—are circuit designers at Valvo GmbH, with Suhrmann and Pech teaming up to explain what Valvo is doing with linear IC's for color tv (p. 111). Suhrmann heads Valvo's video and picture-tube lab, while Pech designs tv circuits. Ginsberg, whose article on an IC used for shutter control in automatic cameras starts on page 113,

Writing about new ways to make measurements is nothing new to James Plumb. The author of the amplifier-testing article (p. 132) puts out plenty of instrument application notes as part of his job as a customer-service engineer at Hewlett-Packard, which he joined two years ago. Formerly, he was with RCA for eight years.



Suhrmann

Pech

has been head of Valvo's IC development since 1966. For 12 years before that, he was responsible for the design and development of discrete devices for consumer applications. On the other side of the coin—the digital side—is an article on a low-speed logic family (p. 115) authored by Hoehne and Wittenzellner, both of Siemens. Hoehne, with the company since 1964, is a specialist in circuits for telephone-exchange applications. Wittenzellner, with Siemens since 1966, is a designer of TTL and LSL.

Politics may not be Judea Pearl's game, but memories are. A native of Tel Aviv, Israel, Pearl is the author of the memories article starting on page 129. Since 1966, he has been director of advanced memory devices at Electronic Memories and Magnetics Corp. where he heads the development of plated-wire memories.



Gosch



Ginsberg



Hoehne

A six-year veteran of Corning Glass Works, David C. Uimari is the author of the memories article starting on page 122. In rapid order, Uimari went from development engineer (1963), to circuit designer (1964), to supervisor of circuit engineering (1965), to his present post as supervisor of circuit design and development (1966).

Readers Comment

causing the capacitor values to be incorrect. Since the largest capacitor in the final design should be no more than 0.1 microfarad, M is chosen to scale the largest capacitors in the frequency-scaled filters, 14,140 μf , and 18,380 μf to 0.1 μf . Hence M is 141,400 for the three-pole section and 183,800 for the two-pole section. Also, the 140 μf and 380 μf capacitors in the frequency-scaled networks should be 14,140 μf and 18,380 μf respectively. The 2,860 μf capacitor in the impedance-scaled network should be 2,860 pf. Finally, the values of M should be 141,400 for the entire three-pole section and 183,800 for the entire two-pole section.

Defends patent reforms

To the Editor:

Your patent article [Aug. 18, p. 51] creates the impression that desirable reforms were opposed by Commissioner Schuyler and others. In fact, a number of the most far reaching changes in the original bill were opposed, and removed from the bill, because they would have weakened the U.S. patent system—the strongest in the world. For instance, the former concept of issuing the patent only to the one who wins the race to the Patent Office placed a premium on premature filing, before an invention was developed and tried out. Testimony to this effect resulted in the retention of the original first-to-invent concept.

During the 1967 Geneva meeting, it was decided that the patent-cooperation treaty should not require substantive revisions of the laws of any country. The treaty was, therefore, redrafted over a year ago to accommodate both the first-to-invent and the first-to-file systems. I know of no sentiment in favor or returning to the original draft in this regard, and U.S. retention of the first-to-invent system, therefore, does not place the treaty in jeopardy.

The article also creates the impression that Commissioner Schuyler was responsible for dropping a provision for automatic publication of patent applications 18 months after filing. In fact, former Commissioner Brenner testified in January 1968 that this provision was no longer necessary, because within the near future almost all patent applications that were filed would be completely processed within that 18 month period.

It is my view that this latest revision of the bill contains a number of desirable modifications of our patent laws, and, moreover, that these modifications won't weaken the essential structure.

Edward F. McKie Jr.
Irons, Birch, Swindler & McKie
Washington

Readers' letters should be addressed:
Electronics
To the Editor
330 West 42nd Street, New York
N.Y. 10036

Applications Power*

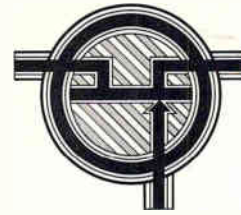

FETS IN TUNABLE FILTERS

Problem: To design a low cost, light-weight voltage tunable filter.

Solution: Use FETs as Voltage-Controlled Resistors (VCRs). Here is one approach:

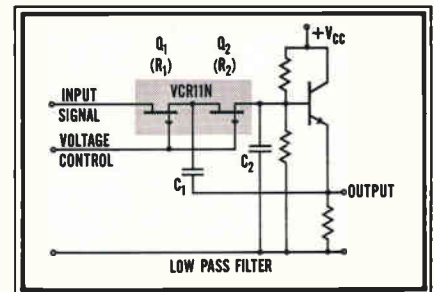

With this circuit you can have a tuning range up to 20:1 with a roll-off of 12 dB/octave. Weight is in the ounce-plus region and size is about 1½ cubic inches. Here are the design conditions and equations:

$$R_{in} > 10X C_2$$

$$R_o < 0.1X C_1$$

$$R = R_1 + R_2$$

$$M^2 = C_1/C_2$$

$$r_{ds} = \text{FET drain-source resistance,}$$

$$= \frac{r'_{ds}}{1 - V_{gs}/V_p}$$

$$r'_{ds} = r_{ds} \text{ with } V_{gs} = 0.$$

$$\omega_n = \text{Corner frequency,}$$

$$= \frac{1 - V_{gs}/V_p}{r'_{ds} M C_2}$$

* If you need a voltage tunable filter, and cost, size, weight and low power consumption are important considerations, give us a call for fast applications assistance. That's applications power: Products and service! Ask for Extension 19.

Siliconix
incorporated

1140 W. Evelyn Ave. • Sunnyvale, CA 94086
Phone (408) 245-7000 • TWX: 910-339-9216

SUBSCRIPTION SERVICE

Please include an Electronics Magazine address label to insure prompt service whenever you write us about your subscription.

Mail to: Fulfillment Manager
Electronics
P.O. Box 430
Hightstown, N.J. 08520

To subscribe mail this form with your payment and check new subscription renew my present subscription

Subscription rates: qualified subscribers in the U.S.: 1 year \$8; two years, \$12; three years, \$16. Non-qualified: 1 year \$25. Subscription rates for foreign countries available on request.

CHANGE OF ADDRESS

ATTACH LABEL HERE

If you are moving, please let us know five weeks before changing your address. Place magazine address label here, print your new address below.

name

address

city

state

zip code

The easy way to sort R-L-C components

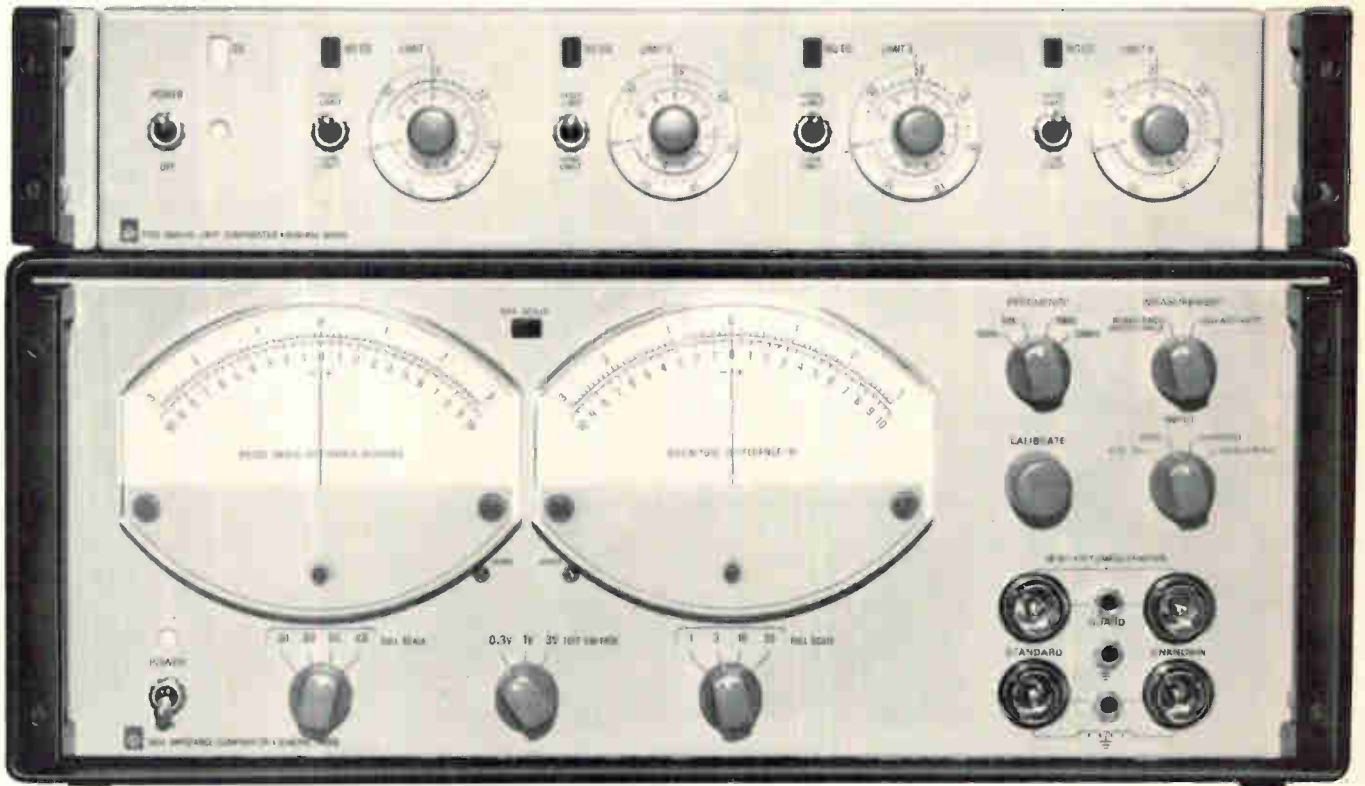

FAST

Measure and sort R-L-C components as rapidly as you can move your hands, using the new 1654 Impedance Comparator and 1782 Analog Limit Comparator. With the optional relay-equipped models of the 1782 you can attain automatic sorting rates as fast as 10,000 components per hour.

FLEXIBLE-VERSATILE

The same setup works for either R, L, or C components because the 1654 measures in terms of impedance difference. Setup is easy. Just connect your production sample or standard to one side of the bridge and your unknowns to the other side. On two large meters read the differences in magnitude and phase-angle between the sample and unknown; for relatively pure components the readout effectively is in terms of ΔR , ΔL , ΔC , ΔQ , or ΔD . Comparison precision is 30 ppm. Manual sorting decisions can be based on the 1654's meter readings or on the 1782's GO/NO GO lights. Or, you don't have to look at anything if you use the relay-equipped models with automatic sorting devices.

The 1782 has four independent limits, each settable to either a high or low limit of either $\Delta\theta$ or ΔZ . Resolution of GO/NO GO limit settings is one percent of full scale and several 1782's can be used with a 1654 for multiple-limit sorting.

LOW COST

One of the best features of this component-sorting system is the price. For \$1250 you can get the basic 1654 Impedance Comparator (rack model) for manual use where meter readout is acceptable. Analog output voltages are available to drive recorders, DVM's, or limit devices. For an additional \$570 you can add the 1782 Analog Limit Comparator and have four preset GO/NO GO limits. Or, for \$645 you can get a 1782 equipped with relays for automatic sorter control. Thus, for \$1250, \$1820, or \$1895 you get a sorting system that can't be beaten in price or performance. Prices apply only in the U. S. A.

Condensed Specifications 1654 Impedance Comparator

Measuring Ranges (dependent upon frequency and voltage): R - 2 Ω to 20 M Ω ; C - 0.1 pF to 1000 μ F; L - 20 μ H to 1000 H.

Test Voltage Across Unknown: 0.3, 1, or 3 V, switch selectable.

Internal Test Frequencies: 100 Hz, 1, 10 and 100 kHz.

For complete information, write General Radio Company, W. Concord, Massachusetts 01781; telephone (617) 369-4400. In Europe: Postfach 124, CH 8034, Zurich 34, Switzerland.

GENERAL RADIO 

...want a tantalum capacitor with proven performance?

Buy TYPE 150D TANTALEX[®] SOLID-ELECTROLYTE CAPACITORS

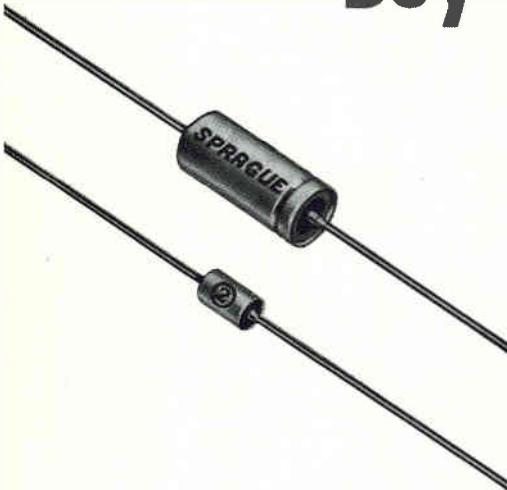

INFORMATION RETRIEVAL NO. 517

Hermetically-sealed in metal cases. Four case sizes, ranging from 1/4" to 3/4" length. Value-packed performance characteristics — low impedances at high frequencies, low dissipation factor, minimal capacitance drift with temperature, practically no change in capacitance with life. Low leakage current limits. Investigate new higher capacitance ratings.

48C-9144R1

Buy resistors with built-in dependability...

Vitreous-enamel BLUE JACKET[®] POWER WIREWOUND RESISTORS



INFORMATION RETRIEVAL NO. 518

All-welded end-cap construction eliminates moisture along the leads, also anchors leads securely to resistor body. Expansion coefficients of vitreous enamel coating, ceramic core, and end caps are closely matched. Standard wattage ratings include 1, 2, 2.5, 3, 5, 7, 10, and 11 watts. Also available with radial tab terminals in ratings from 8 to 230 watts.

For complete technical data on Type 150D Tantalex Capacitors, write for Engineering Bulletin 3520F. For information on Blue Jacket Resistors, request Bulletin 7410D. Write to: Technical Literature Service, Sprague Electric Co., 35 Marshall Street, North Adams, Massachusetts 01247.

48R-9148



Sprague and *®* are registered trademarks of the Sprague Electric Co.

THE BROAD-LINE PRODUCER OF ELECTRONIC PARTS

Electronics

Editor-in-Chief: Donald Christiansen

Senior Staff Editors

Technical: Stephen E. Scrupski

News: Robert Henkel

International: Arthur Erikson

Art director: Gerald Ferguson

Senior associate editors: Joseph Mittleman, Harry R. Karp

Assistant managing editors: H. Thomas Maguire, Howard Wolff,

William Bucci, Richard Gundlach, Frederick Corey

Special projects editor: Roger Kenneth Field; Senior staff writer: John Johnsrud

Department editors

Advanced technology: Laurence Altman

Communications: John Drummond

Computers: Wallace B. Riley, George Weiss

Design theory: Joseph Mittleman

Industrial electronics: Harry R. Karp

Instrumentation: Owen Doyle

Military/Aerospace: Alfred Rosenblatt

New products: William P. O'Brien

Solid state: George Watson, Stephen Wm. Fields

Field bureaus

Boston: James Brinton, manager; Gail Farrell

Los Angeles: Lawrence Curran, manager; Ralph Selph

New York: Peter Schuyten

San Francisco: Stephen Wm. Fields

Washington: Ray Connolly, manager; Robert Westgate, Lois Vermillion

Bonn: John Gosch

London: Michael Payne

Paris: Arthur Erikson

Tokyo: Charles Cohen

Copy editors: Edward Flinn, William S. Weiss

Assistant art director: Charles Ciatto

Production editors: Susan Hurlburt, Arthur C. Miller

Editorial research: Virginia Mundt

Editorial secretaries: Lorraine Longo, Claire Goodlin, Barbara Razulis, Vickie Green,

Bernice Pawlak, Patricia Bispham

McGraw-Hill News Service

Director: Arthur L. Moore; Atlanta: Fran Ridgway; Chicago: Robert E. Lee

Cleveland: Arthur Zimmerman; Dallas: Marvin Reid

Detroit: James Wargo; Houston: Barbara LaRoux

Los Angeles: Michael Murphy; Pittsburgh: Louis Gomolak

San Francisco: Margaret Drossel

Seattle: Ray Bloomberg; Washington: Charles Gardner, James Canan,

Herbert W. Cheshire, Seth Payne, Warren Burkett, William D. Hickman

McGraw-Hill World News Service

Bonn: Robert Dorang; Brussels: James Smith; Hong Kong: Kate Mattock

London: John Shinn; Mexico City: Gerald Parkinson; Milan: Ronald Taggiasco, Jack Star

Moscow: Jack Winkler; Paris: Robert E. Farrell, Stewart Toy

Rio de Janeiro: Leslie Warren; Tokyo: Marvin Petal

Reprints: Gail Niles

Circulation: Isaaca Siegel

Publisher: Gordon Jones

Associate Publisher: Dan McMillan

Assistant to the publisher: Wallace C. Carmichael

Electronics: September 15, 1969, Vol. 42, No. 19

Published every other Monday by McGraw-Hill, Inc. Founder: James H. McGraw 1860-1948.

Publication office 99 North Broadway, Albany, N. Y. 12202; second class postage paid at Albany, N. Y. and additional mailing offices.

Executive, editorial, circulation and advertising addresses: Electronics, McGraw-Hill Building, 330 W. 42nd Street, New York, N. Y. 10036. Telephone (212) 971-3333. Teletype TWX, N.Y., 710-581-4235. Cable address: MCGRAW-HILL N.Y.

Subscriptions solicited only from those professionally engaged in electronics technology. Subscription rates: qualified subscribers in the United States and possessions and Canada, \$8.00 one year, \$12.00 two years, \$16.00 three years; all other countries \$25.00 one year. Non-qualified subscribers in the U.S. and possessions and Canada, \$25.00 one year; all other countries \$50.00. Air freight service to Japan \$50.00 one year. Single copies: United States and possessions and Canada, \$1.00; all other countries, \$1.75.

Officers of McGraw-Hill Publications Company: Joseph Allon, President; John R. Emery, J. Elton Tuohig, Senior Vice Presidents; Gordon L. Jones, Jr., Group Vice President; Vice Presidents: John R. Callahan, Editorial; Paul F. Cowie, Circulation; John M. Holden, Marketing; David G. Jensen, Manufacturing; Jerome D. Luntz, Planning & Development; Robert F. Marshall, Administration; Robert M. Wilhelmy, Finance.

Officers of the Corporation: Shelton Fisher, President and Chief Executive Officer; John L. McGraw, Chairman; Robert E. Slaughter, Executive Vice President; Daniel F. Crowley, Donald C. McGraw, Jr., Bayard E. Sawyer, Senior Vice Presidents; John J. Cooke, Vice President & Secretary; Gordon W. McKinley, Vice President & Treasurer.

Title registered in U.S. Patent Office; © Copyright 1969 by McGraw-Hill, Inc. All rights reserved. The contents of this publication may not be reproduced either in whole or in part without the consent of copyright owner.

Subscribers: The publisher, upon written request to our New York office from any subscriber, agrees to refund that part of the subscription price applying to copies not yet mailed. Please send change of address notices or complaints to Fulfillment Manager; subscription orders to Circulation Manager, Electronics at address below. Change of address notices should provide old as well as new address, including postal zip code number. If possible, attach address label from recent issue. Allow one month for change to become effective.

Postmaster: Please send form 3579 to Fulfillment Manager, Electronics, P.O. Box 430, Hightstown, New Jersey 08520

Readers Comment

A matter of value

To the Editor:

Regarding Robert R. Shepard's article on active filters [Aug. 18, p. 82], we found the values given in the foldout chart for C_1 , C_2 , and C_3 to be quite correct for the Butterworth low-pass, three-pole case in which $w_1 = 2$, $w_2 = 2$, and $w_3 = 1$. But, due to an oversight on the part of the author, formulas 5 and 6 for C_2 and C_3 are incorrect. The correct values are $C_2 = T$, $C_3 = (1/3)(w_1 - T)$, in which T satisfies the algebraic equation: $T^3 - w_1 T^2 + 1\frac{1}{2} w_2 T - 3 w_3 = 0$. To solve for T , the quantities a and b —as defined by Shepard—may be introduced in the equation, leading to the correct expression for T . These flaws are important in designing a Chebyshev filter with $1\frac{1}{2}$ -decibel ripple.

Another aspect of Shepard's procedure is the "forced" equality of the three resistors, which introduces an additional constraint regarding the acceptable locations for the three poles.

Consider the denominator polynomial of the original transfer function, namely $w_3 s^3 + w_2 s^2 + w_1 s + 1$ and insert into it $w_1 = 6$, $w_2 = 8$ and $w_3 = 4\frac{1}{3}$. As the Hurwitz conditions ($w_1 w_2 > w_3$) are satisfied, the three poles have negative real parts. Return, now, to the given equation for T . Upon introducing the stated values for w_1 , w_2 , w_3 and solving the equation, $T = 7$. The other two solutions are complex conjugate.

Since $T = 7$, which exceeds $w_1 = 6$, capacitors C_1 and C_3 become negative.

Admittedly, Shepard's configurations (employing three equal element-values) are more than adequate for most designs.

S. Tirtoprodjo
W. Van Bokhoven
Technological University
Eindhoven
Eindhoven, Netherlands

■ Author Shepard agrees that Messrs. Tirtoprodjo and Van Bokhoven have a valid point. And at the same time, he notes that he erred in determining the value of M ,

News Features

Probing the News

- 145 **Aerospace:** Space tours tailored to the budget
151 **Computers:** SDC means business—in software

U.S. Reports

- 67 **Integrated electronics:** Silicon gates swing open
68 **Manufacturing:** New wafer divider
68 **Integrated electronics:** Parylene plastic shows promise
70 **Integrated electronics:** Hybrid breadboard technique cuts costs
71 **Automotive electronics:** Motorola voltage regulator
72 **Communications:** Improving voice links
74 **Advanced technology:** GE's thermoplastic display unit
76 **Government:** NASA inches into forbidden area
79 **Space electronics:** 30-watt laser for ATS-F
80 **Computers:** As Maryland goes
82 **For the record**

Electronics International

- 223 **Japan:** Schottky diodes found sensitive to pressure
224 **West Germany:** Transistorized Meinke antenna goes on sale
225 **Japan:** Hi-fi phono cartridge based on strain gage principle
226 **Japan:** Ion implantation process yields 7-Ghz transistors

New Products

- 167 **In the spotlight**
167 Dopant profile plotted in seconds
171 **Instruments review**
171 Pulsar is power supply, too
172 In-circuit debugging of IC's
177 **Subassemblies review**
177 200-kilobit memory is fast
179 Low-drift instrumentation amplifier
181 **Microwave review**
181 Varactors tune over wide band
185 **Data handling review**
185 Hybrid IC is total d-a converter
188 Raster display uses tv monitor
190 **Semiconductor review**
190 Memory dissipates only 315 mw
194 MOS shift register has 396 gates
196 MOS kits produce display signals

Technical Articles

- Solid state** 104 **No West German 'creativity gap' where linear IC's are concerned**
The emphasis is still on linear circuits for consumer applications, but now digital devices may be coming into their own
John Gosch, associate editor
- 111 **When it comes to color tv, the outlook is bright indeed**
Robert Suhrmann and Eckart Pech, Valvo GmbH
- 113 **IC's enter the picture for automatic cameras**
Ernst L. Ginsberg, Valvo GmbH
- 115 **For noisy environments, why not low-speed logic?**
Werner Hoehne and Ernst Wittenzellner, Siemens AG
- Circuit design** 118 **Designer's casebook**
▪ Phase comparator yields digital output
▪ Nomograph charts a fast way to build a notch filter
▪ Automatic attenuator rapidly changes signal level
- Memory technology** 122 **A choice for serial memories**
David Uimari, Corning Glass Works
- 125 **Controlling creep and skew in thin-film memories**
William M. Overn, Univac Federal Systems Division
- 129 **Packing data tightly in thin-film memories**
Judea Pearl, Electronic Memories and Magnetics Corp.
- Instrumentation** 132 **Teamwork streamlines differential amplifier tests**
A new circuit that includes a mixer and a modified sweep generator measures gain, phase shift and other parameters.
James Plumb, Hewlett-Packard Co.

Departments

- | | | | |
|----|--------------------------|--------------------------|------------------------|
| 4 | Readers Comment | 47 | Electronics Newsletter |
| 8 | Who's Who in this issue | 91 | Washington Newsletter |
| 14 | Who's Who in electronics | 198 | New Books |
| 34 | Meetings | 205 | Technical Abstracts |
| 43 | Editorial Comment | 210 | New Literature |
| | 221 | International Newsletter | |

**step forward
with the
fast-growing
scope system...**

the **hp**
180

Covers 50 MHz and 100 MHz real time,
calibrated time domain reflectometry
with 35 ps risetime,
12.4 GHz sampling with 28 ps risetime
storage *and* variable persistence
... and now

250MHz

real time !

HEWLETT **hp** PACKARD

OSCILLOSCOPE SYSTEMS

See More! Do More!

HP Adds 250 MHz Real Time to Make the 180 Scope System a Versatile Mini-Giant! Remember when a scope had to be big to be good? Not any more! No longer do you have to crowd your work space with oversize, overweight scopes to provide the measurements required by today's technology.

With the HP Mini-giant—the all-solid-state 180 Scope System—you can make accurate measurements to 50 MHz, 100 MHz, and now 250 MHz real time—or dc to 12.4 GHz sampling. The scope fits nicely on your design bench, or in your production area—and it's so light it can be carried *wherever you need it*. With plug-ins, the 180 scopes weigh only 30 to 36 pounds.

Although the 180 scopes are compact and lightweight, they give you a giant 8 x 10 cm display (6 x 10 cm on the 250 MHz mainframe)—30 to 100% larger than you get on many other scopes.

Not only does the all-solid-state circuitry of the 180 scope system give you compactness and light weight, it has many other advantages. All-solid-state components eliminate the inherent high temperature and drift associated with vacuum tube scopes—and the resulting change in performance. Frequent recalibration is eliminated. And how many times have you had to wait for a vacuum tube scope to stabilize? (A procedure not necessary with HP 180 scopes.)

Power consumption in the 180 scopes is a low 95 to 125 watts. Compare that with 500 watts required by some bulky overweight scopes.

Since the 180 scope system first appeared three years ago, the all-solid-state design has proved that service and maintenance required is minimized. Solid state components give a high reliability not found in vacuum tube scopes.

And—all-solid-state design lends itself well to the plug-in concept. Because solid state devices fit in smaller spaces, the 180 scopes are designed with only the big-picture CRT and power supply in the mainframe. All the necessary drive circuitry is contained in the plug-ins.

Check the following pages to see all the capability contained in the mainframes and the variety of interchangeable plug-ins. You'll find an extra-large measurement capability wrapped in small packages!

Where else can you get this performance and versatility? Only the HP 180 all-solid-state mini-giant provides you with a compact, lightweight, easy-to-use system complete for accurate measurements from dc to 12.4 GHz. And the HP 180 scope system has been proven by more than three years in the field!

HP 180A

Mainframe With Conventional CRT Designed for Broad-Purpose Measurements:

HP uses the post acceleration technique and a mesh-dome deflection system in the 180A CRT to provide fast writing rates, brighter traces, easier viewing, higher resolution, unmatched linearity and no compression. Add the internal graticule used in the 180A CRT and you have an accuracy limited only by the human eye.

Any of the plug-ins available (except the 250 MHz vertical and horizontal plug-ins) can be used in the 180A mainframe for measurements from dc to 12.4 GHz.

Price: HP 180A, \$825; HP 180AR (rack mount), \$900. Also military version OS-189A(P)/USM-281 (cabinet), \$1215; and OS-194(P)/USM-296 (rack), \$1205. (W/plug-ins: AN/USM-281A, FSN 6625-228-2201, \$3100.)



HP 1801A

50 MHz Dual Channel Vertical Amplifier:

For versatility in display modes, select the HP 1801A with its dual channel capability from dc to 50 MHz. You can work with channel A or channel B, A + B, or A - B. With channel A and B displayed alternately or chopped, you'll get internal triggering on channel B to maintain the time relationship between the two signals.

- 7 ns risetime
- 5 mV/cm deflection factor
- Full 50 MHz bandwidth usable on all ranges
- Price: HP 1801A, \$650; military version with X5 amplifier, PL-1186A/USM, \$800.

HP 1820A

Time Base with Variable Holdoff: For economy without a sacrifice in performance, use the 1820A time base in your 180 system. It has a variable holdoff to lock-in complex waveforms and prevent annoying multiple triggering.

- Triggers internally to >75 MHz
- Sweeps from 5 ns/cm to 2 sec/cm
- Has bright-line automatic triggering
- Price: HP 1820A, \$475; military version, PL-1213/USM, \$570.

INTENSITY



ASTIGMATISM



FOCUS



TRACE ALIGN



SCALE



POWER



CALIBRATOR
GND 250MV 10V



180A OSCILLOSCOPE

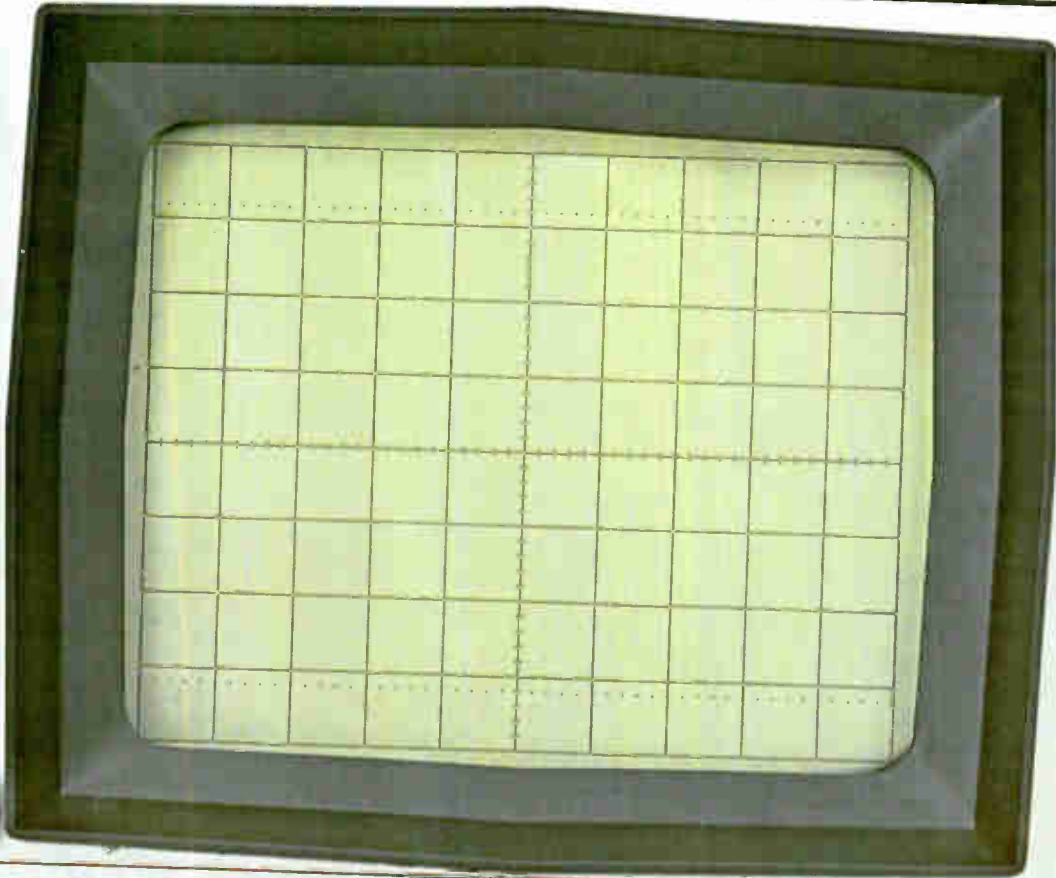

HORIZONTAL
POSITION FINE



MAGNIFIER
X1



DISPLAY
INT
EXT CAL EXT SENS



AC DC

EXT INPUT



HEWLETT • PACKARD



HP 181A

Adds Memory to Your Scope System with Storage and Variable Persistence

You can stop, store or vary your display time with the HP 181A mainframe. A wire mesh that "remembers" the electron beam trace is used next to the phosphor in the CRT. At the twist of a knob, you can adjust the

mesh memory span from 0.2 second to minutes—to hours. And the mesh doesn't forget even when you turn the power off! You get a big 8 x 10 div display in a short CRT. You can select storage and conventional

operating modes by pressing a button. And, you get full performance from the plug-ins designed for use with the 180A mainframe. Price: 181A mainframe, \$1850.



Use **variable persistence** to see clear, flicker-free displays of 3.5 ns risetime low rep rate pulses. See signal trends while making circuit adjustments. Simply adjust persistence so several traces appear on the screen simultaneously.



Use the 181A's **storage** capabilities to catch and store single shot transients. It has a writing rate of 1 cm/ μ s. Store traces side by side for later comparison. Hold traces intact for later viewing.



Use the 181A as a **conventional** scope. All the HP 180 system plug-ins give full performance in the 181A mainframe.

INTENSITY

FIND BEAM

TRACE ALIGN

ASTIG

PERSISTENCE

ERASE

MAX

MAX. W

WRITE

NORM

VIEW

STORE

FOCUS

FOCUS knob

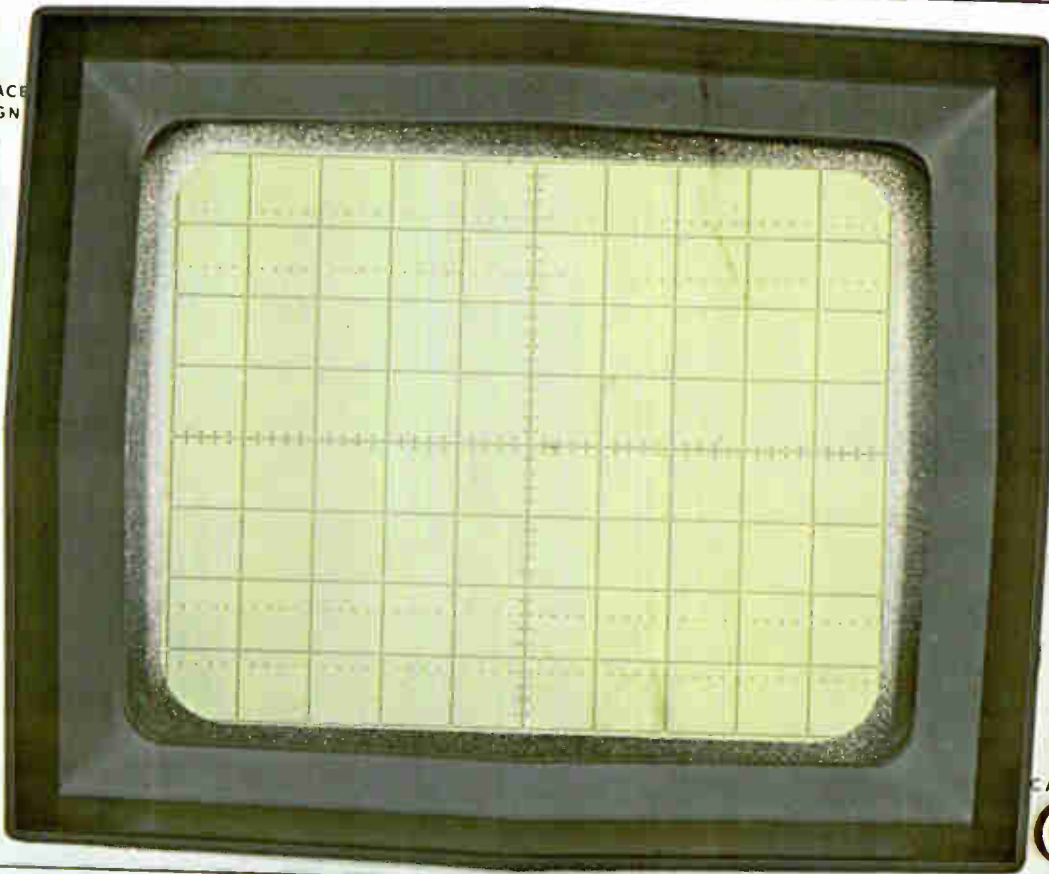

HORIZONTAL POSITION FINE

HORIZONTAL POSITION FINE knob

MAGNIFIER

X1

X5

X10

MAGNIFIER knob

DISPLAY

INT

EXT CAL

EXT SENS

DISPLAY knob

EXT INPUT

AC

EXT INPUT knob

DC

CAL 10V

PWR

PWR knob

181A OSCILLOSCOPE

HEWLETT · PACKARD

h-

HP 183A

Expands 180 Scope System Capabilities to 250 MHz Real Time!

Now, with the major breakthrough in the HP 183A CRT, you can make repetitive or single-shot real-time measurements that were possible before only with sampling oscilloscopes or special purpose low-sensitivity scopes designed for display of single-shot transients.

The HP-designed distributed deflection plate CRT in the 183A has a deflection factor of 3 V/cm. This sensitivity is compatible with solid-state circuitry allowing 6 cm of vertical display of 250 MHz input signals at 10 mV/div. This new CRT uses high driving potentials (20 kV) to give you the fast writing rate (4 cm/ns) necessary for high-frequency real time displays. (By directly driving the CRT, it is possible to achieve bandwidths above 500 MHz, real time.) And, the fast writing rate gives bright displays of low rep-rate, narrow pulses—a condition normally difficult to measure and display using sampling scopes.

To give you optimum economy and scope system flexibility, all the 180 system plug-ins can be used in the 183A mainframe. The HP 1830A vertical amplifier and the 1840A or 1841A time base plug-ins are designed for use *only* with the 183A for wide-band measurements.

For price and delivery call your HP field engineer.



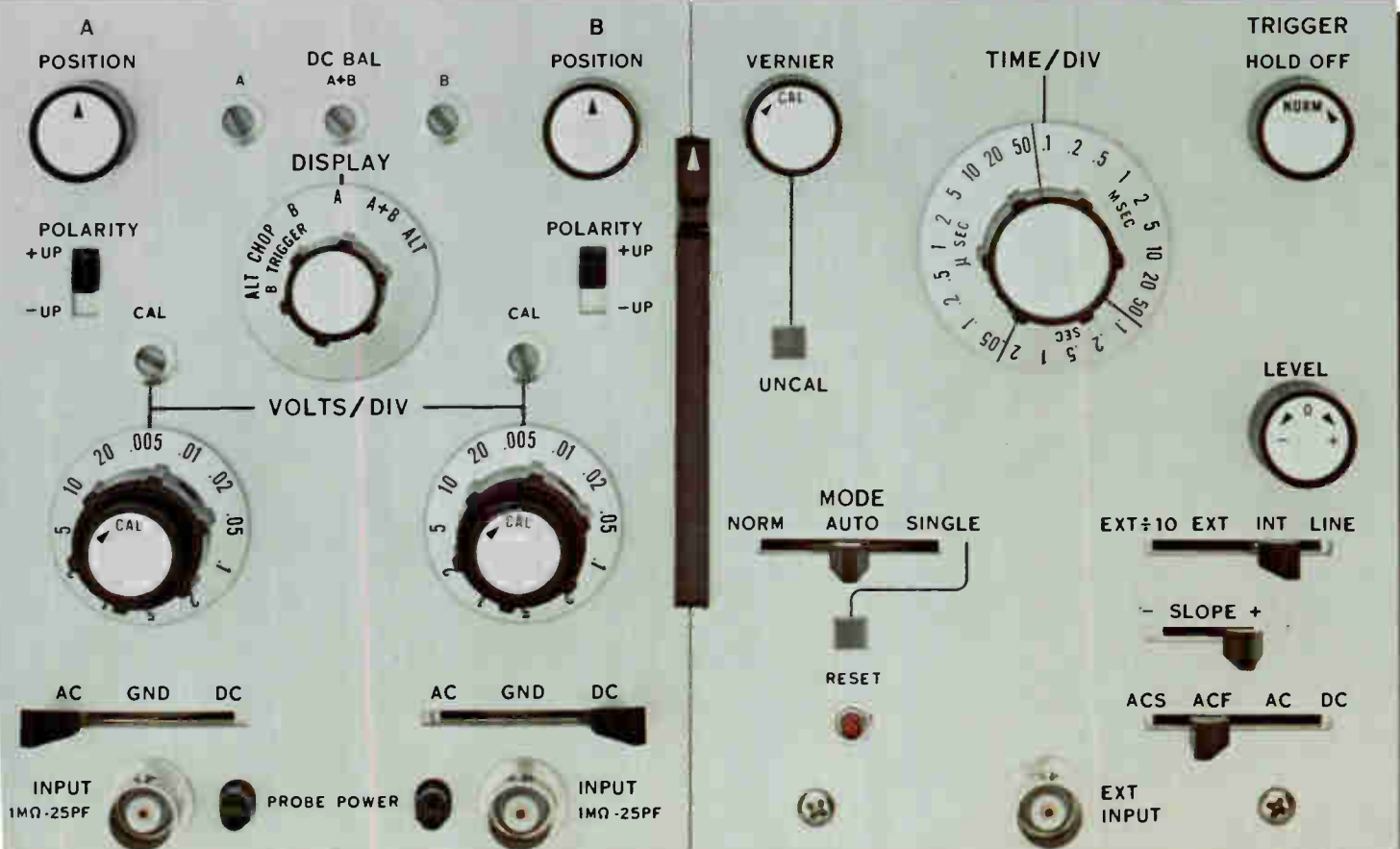

1801A DUAL CHANNEL VERTICAL AMPLIFIER (50MHz) HEWLETT · PACKARD

1820A TIME BASE

HEWLETT · PACKARD

ACTUAL SIZE

HP 1804A

50 MHz Four Channel Vertical Amplifier:

Whenever and wherever you need four-channel direct comparisons of high frequency information, the HP 1804A provides them—field, lab or production area. Each channel has 50 MHz bandwidth, 20 mV/cm deflection factor, <7 ns risetime. Each channel can be triggered individually—or you can trigger on any one channel and see the time relationship with each of the other channels. Excellent for use in designing computer logic circuitry, or checking digital logic pulse trains. Price HP 1804A, \$975.

HP 1821A

Time Base and Delay Generator: When you need a variety of sweep modes, choose the HP 1821A time base and delay generator. You get a selection of main time base, an easy-to-use delayed sweep with CM DELAY vernier control, and a mixed sweep mode for a fast/slow sweep display.

- Triggers internally to >75 MHz
- Sweeps from 10 ns/cm to 1 s/cm
- Price: HP 1821A, \$800; military version with added 2 s/cm sweep, PL-1187A/USM, \$920.

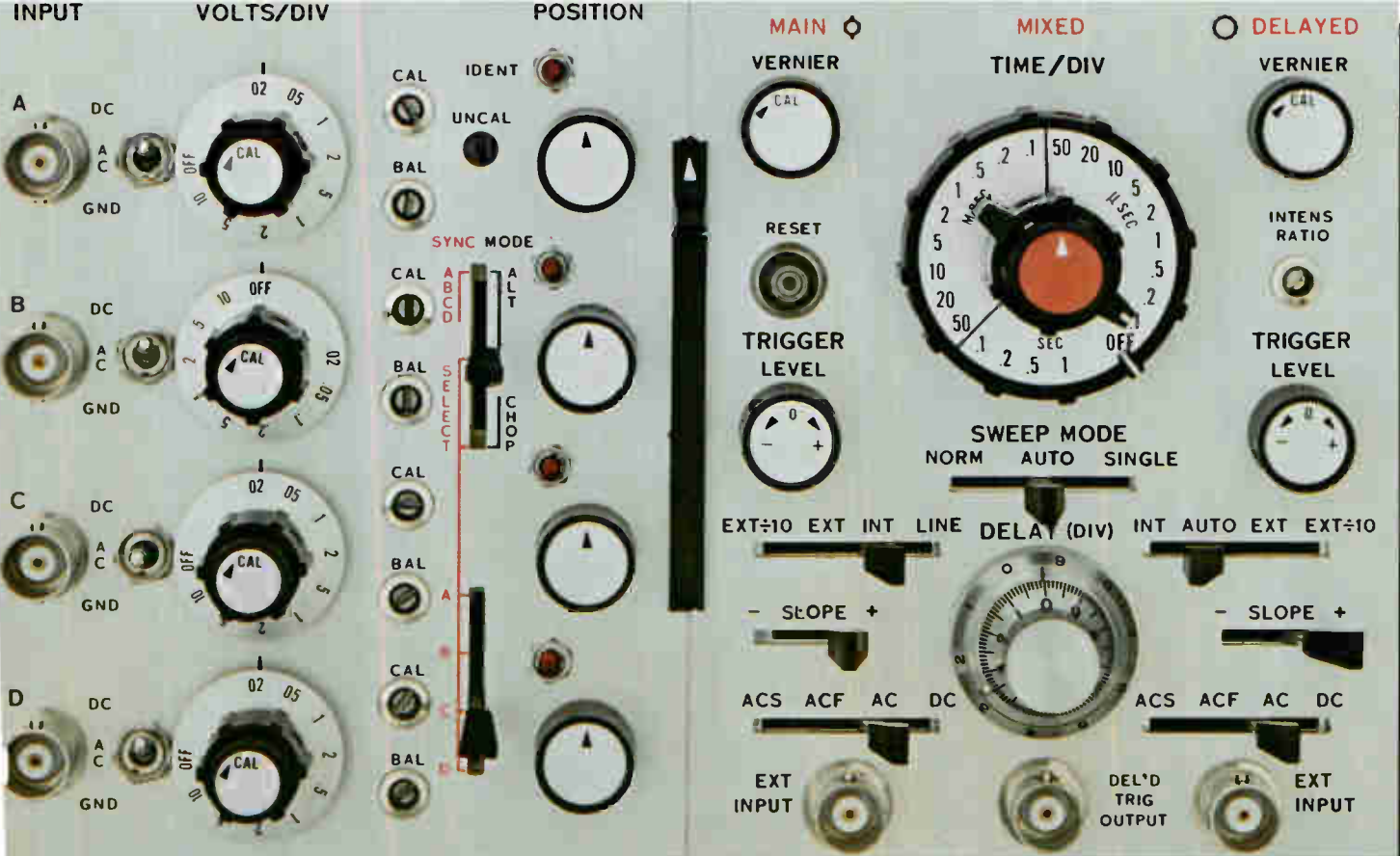

304A FOUR CHANNEL VERTICAL AMPLIFIER (50MHZ) HEWLETT · PACKARD

1821A TIME BASE AND DELAY GENERATOR

HEWLETT · PACKARD

ACTUAL SIZE

HP 1803A

Differential/DC Offset Amplifier: The 1803A adds four capabilities in one plug-in to your 180 scope system. As a **standard amplifier**, it has 1 mV/cm deflection factor with exceptionally fast overload recovery. As a **differential amplifier**, it reduces unwanted common-mode signal by a factor of 20,000 to 1. CMRR is >66 dB from dc to 100 kHz. As a **dc offset amplifier**, the 1803A lets you expand any part of your input signal for close viewing. As a **differential comparator**, the plug-in generates a very precise, stable dc voltage that can be read to four-digit resolution for comparison to the input signal. The plug-in is rugged enough to allow field use to make precise measurements. Price HP 1803A, \$950.

HP 1820B

120 MHz Time Base with Variable Hold-off: Designed for use with high frequency vertical amplifiers, the 1820B time base triggers internally to >120 MHz. The 1820B has the same variable hold-off capability as the 1820A to prevent the annoyance of multiple triggering.

- Sweeps from 5 ns/cm to 2 s/cm
- Has bright-line automatic triggering
- External triggering up to 150 MHz on 350 mV
- Price: HP 1820B, \$525.

DC OFFSET IN VOLTS (V_0)

POSITION



+ (OUT)

- (IN)



V_0 RANGES

SET V/DIV AT 20

PUSH AND TURN

0-500V
1.20V/DIV

ATTEN
BAL

0-50V
.01-20V/DIV

0-6V
.001-20V/DIV



V/DIV



UNCAL
VERNIER



V_0 AC DC GND GND DC AC V_0

+
INPUT
1M Ω -27PF

V_0 OUT
0-6V

-
INPUT
1M Ω -27PF

SWEEP VERNIER



UNCAL

TIME/DIV

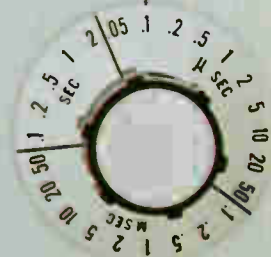

TRIGGER
HOLD OFF



TRIGGER LEVEL



SWEEP MODE
NORM AUTO SINGLE



RESET



SYNC SOURCE
EXT-10 EXT INT LINE



- SLOPE +



ACS ACF AC DC



EXT
INPUT



803A DIFFERENTIAL DC OFFSET AMPLIFIER

HEWLETT PACKARD

1820B TIME BASE

HEWLETT-PACKARD

ACTUAL SIZE

HP 1802A

100 MHz Dual Channel Vertical Amplifier: With the >100 MHz, 3.5 ns risetime 1802A amplifier in your 180 scope system, you can disregard capacitive effects when you make nanosecond risetime and high frequency real time measurements. Input capacitance of a high-quality 50 Ω system, such as the 1802A, should not be considered as a lump constant, so the 1802A input is specified as having a low reflection coefficient (< 0.05) and VSWR of 1.1:1 at 100 MHz, 20 mV/cm.

Channels may be cascaded to provide 1, 2 or 5 mV/cm deflection factor with greater than 75 MHz bandwidth.

You have near-perfect termination for your 50 Ω systems—regardless of your signal frequencies—with the 50 Ω impedance of the 180/1802A system. Increase your resistance 5, 10, 50 or 100X with resistive dividers and add only 0.7 pF capacitance—or use the HP 1123A 100 k Ω Active Probe and add only 4 pF capacitance. Price: HP 1802A, \$1200.

HP 1822A

120 MHz Time Base and Delay Generator: The HP 1822A time base and delay generator combines wide sweep mode selection with variable holdoff for high frequency applications. With the 1822A you can choose main time base, delayed sweep with easy-to-use vernier control, or mixed sweep for fast/slow sweep display.

- Triggers internally to >120 MHz
- Triggers externally to 150 MHz on 350 mV
- Sweeps from 5 ns/cm to 1 s/cm
- Price: HP 1822A, \$900

A POSITION

A+B BAL

DISPLAY

CHOP B A+B ADJ

UNCAL

VOLTS/DIV

CAL

CAL ADJ

PROBE POWER

OFF +UP -UP

VERT OUT (SYNC SOURCE)

INPUT 50Ω 6V MAX

B POSITION

UNCAL

VOLTS/DIV

CAL

CAL ADJ

OFF +UP -UP

INPUT 50Ω 6V MAX

MAIN **MIXED** **DELAYED**

SWEEP VERNIER

UNCAL

TRIG HOLDOFF

NORM

TRIG LEVEL

W STABIL

TIME/DIV

SEC OFF .05

50 20 10 5 2 1

50 20 10 5 2 1

UNCAL

INTENS RATIO

TRIG LEVEL

SWEEP MODE

NORM AUTO SINGLE-RESET

EXT ÷10 EXT INT LINE INT AUTO EXT EXT ÷10

DELAY (DIV)

— SLOPE +

ACS ACF AC DC

DEL'D TRIG OUTPUT

EXT INPUT

EXT INPUT

1802A DUAL CHANNEL VERTICAL AMPLIFIER (100MHZ) HEWLETT-PACKARD

1822A TIME BASE AND DELAY GENERATOR HEWLETT-PACKARD

ACTUAL SIZE

HP 1815A

12.4 GHz Sampling Plug-in: For 12.4 GHz (28 ps) sampling with no degradation, use the 1815A plug-in and the 1817A remote feed-through sampler in your 180 scope system. Signal averaging circuitry allows you to use the entire bandwidth capabilities of the plug-in / sampler – with lowest distortion, noise and jitter ever!

If you don't need the full 12.4 GHz capability of the 1815A, use the lower-cost, lower-frequency sampling head (1816A) for 4 GHz, 90 ps risetime sampling.

Price: HP 1815A, \$1100; 1817A 12.4 GHz Remote Sampler, \$1500; 1816A 4 GHz Remote Sampler, \$850.

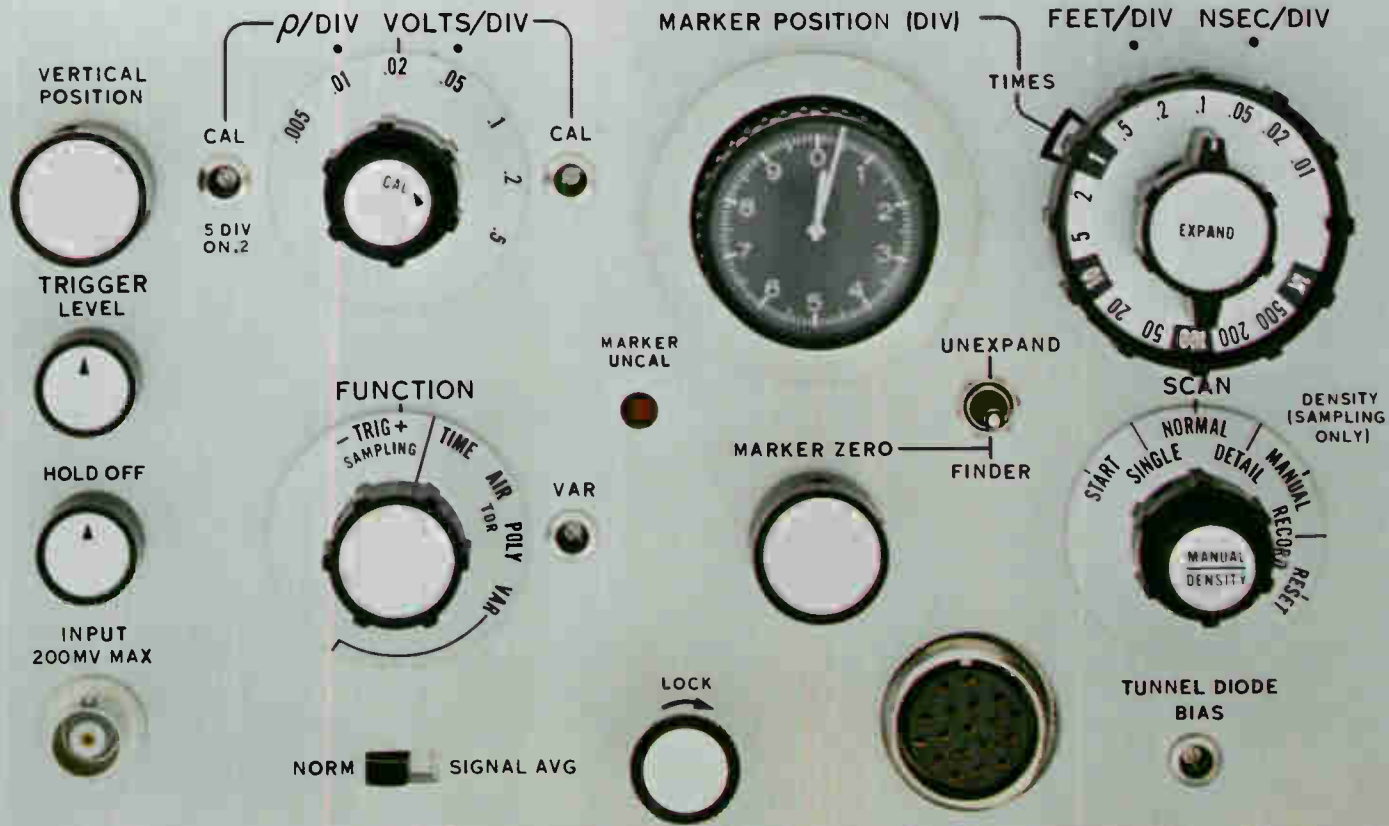

1815A TDR/SAMPLER

HEWLETT-PACKARD

ACTUAL SIZE

HP 1815A

35 ps Time Domain Reflectometer: With the 1815A, you now can make *one measurement* to find out what, where and how much—when you design connectors, circuits, antennas, strip lines or similar components. You don't have to measure around your problem, then interpolate or extrapolate.

The 1815A, used with the 1817A remote feed-through sampler and the 1106A pulse generator, provides 35 ps TDR with a capability of resolving discontinuities down to a quarter of an inch apart. New signal averaging circuitry reduces noise and jitter by a ratio of 2 to 1 or more.

If you don't need the 35 ps TDR capability, use the lower cost, lower frequency 1816A sampling head with the 1106A tunnel diode pulse generator for calibrated 110 ps TDR measurements.

Direct readouts in reflection coefficient (*rho*) and feet (meters optional) provide instant answers. Front panel controls allow direct measurements for dielectric constants of air and polyethylene, or to set the dielectric constant between $\epsilon=1$ and $\epsilon=4$.

Price: HP 1815A TDR/Sampling plug-in, \$1100; HP 1817A 28 ps Sampler, \$1500; HP 1816A 90 ps Sampler, \$850; HP 1106A 20 ps Tunnel Diode Pulse Generator, \$550; HP 1108A 60 ps Tunnel Diode Pulse Generator, \$175.

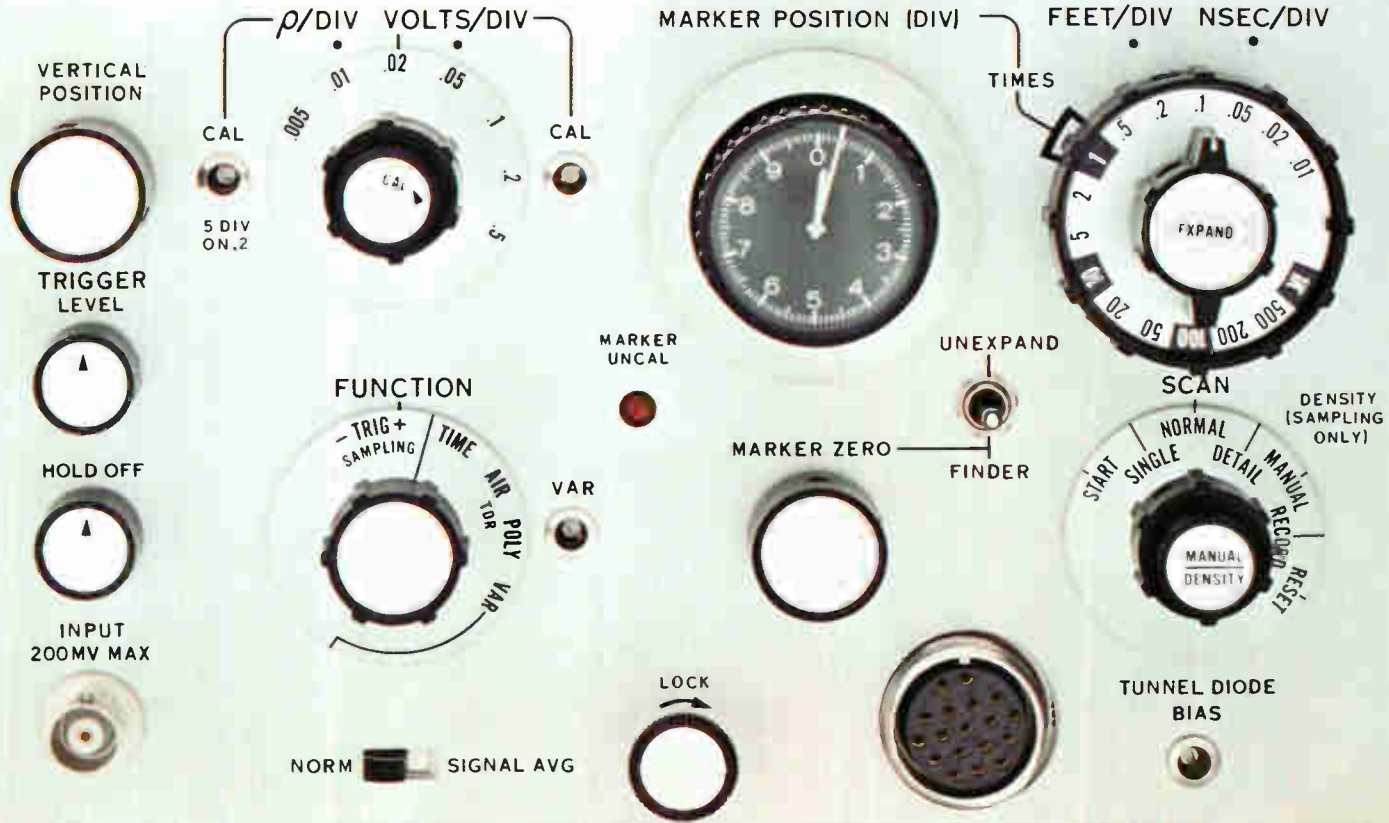

815A TDR/SAMPLER

HEWLETT-PACKARD

ACTUAL SIZE

HP 1830A

250 MHz Dual Channel Vertical Amplifier: Hybrid integrated circuits, strip-line techniques and computer-aided design based on S-parameter theory make the new HP 1830A a stable, high performance amplifier plug-in, with VSWR of 1.1:1 at 250 MHz, 20 mV/cm deflection factor.

Capacitive effects on pulse risetime and CW amplitude can greatly affect your measurements — especially at 250 MHz real time! The new HP 1830A amplifier plug-in is designed to minimize these capacitive effects. As with the high quality 50 Ω system used in the 1802A 100 MHz amplifier, the input capacitance of the 1830A is insignificant.

With the 50 Ω impedance of the 183A/1830A combination, you have a near-perfect termination for your 50 Ω systems — regardless of your signal frequencies. Resistive dividers increase resistance 5, 10, 50 or 100 times and add only 0.7 pF capacitance. Or, you can use the new HP 1120A active probe for higher resistance and a very low capacitance.

As with the 183A mainframe, the controls on the 1830A have been simplified. Display modes and trigger source controls are pushbuttons.

For price and delivery call your HP field engineer.

HP 1840A

>250 MHz Time Base: The HP 1840A triggers internally to >250 MHz, sweeps from 10 ns/cm to 0.1 s/cm. Sweep speed can be expanded by X10 magnifier on the 183A mainframe to obtain 1 ns/cm sweep for accurate time resolution. The variable holdoff capability of the 1840A prevents annoying multiple triggering by locking-in complex waveforms. The 1840A can be externally triggered to >250 MHz on 20 mV. Convenient pushbutton controls have been installed for all trigger functions.

The HP 1841A Time Base and Delay Generator (not illustrated) will also trigger internally to >250 MHz. It sweeps from 10 ns/cm to 0.1 s/cm, to 1 ns/cm with magnifier. The 1841A offers a pushbutton choice of sweep modes including time base and delayed sweep and all trigger functions.

For prices and delivery call your HP field engineer.

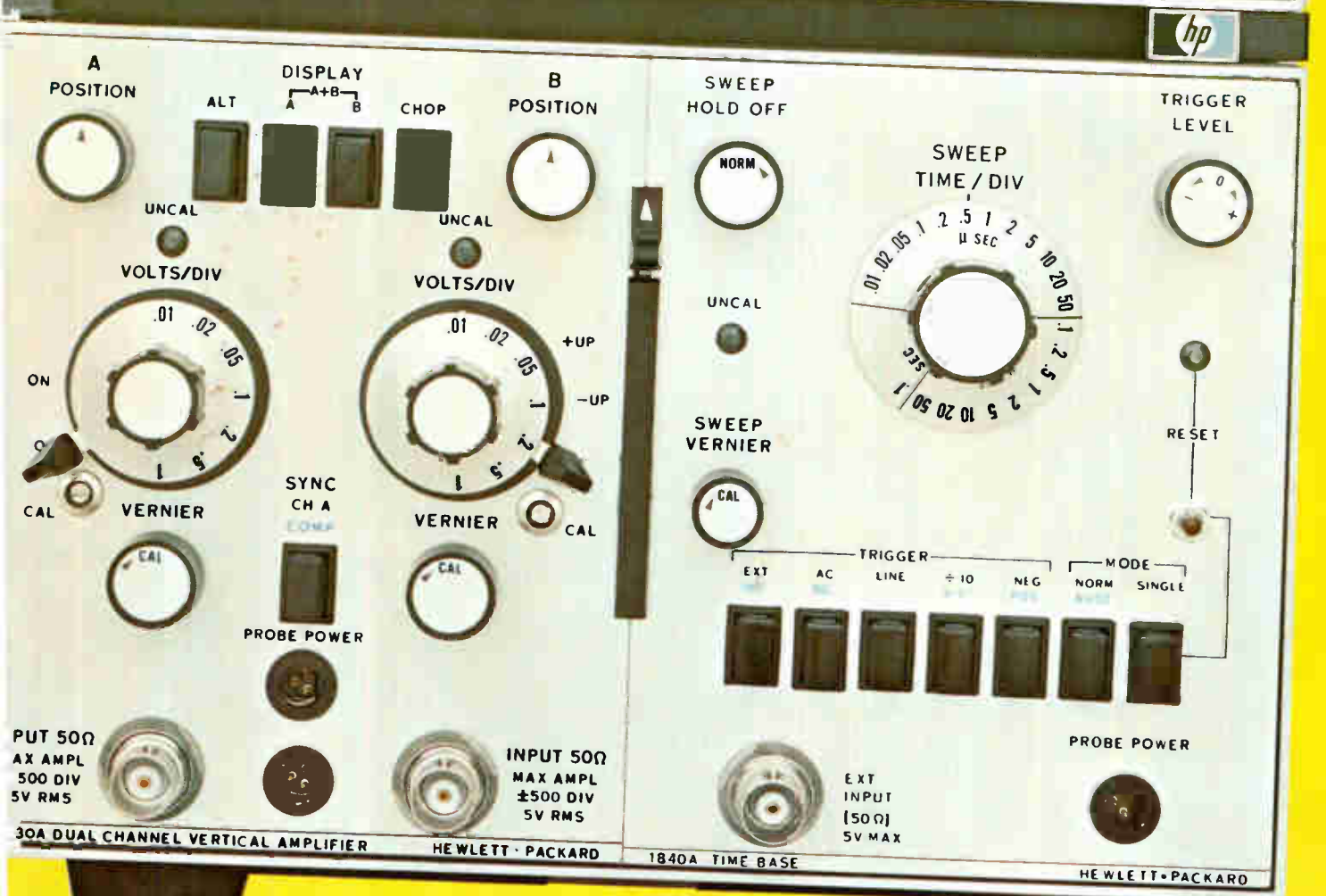
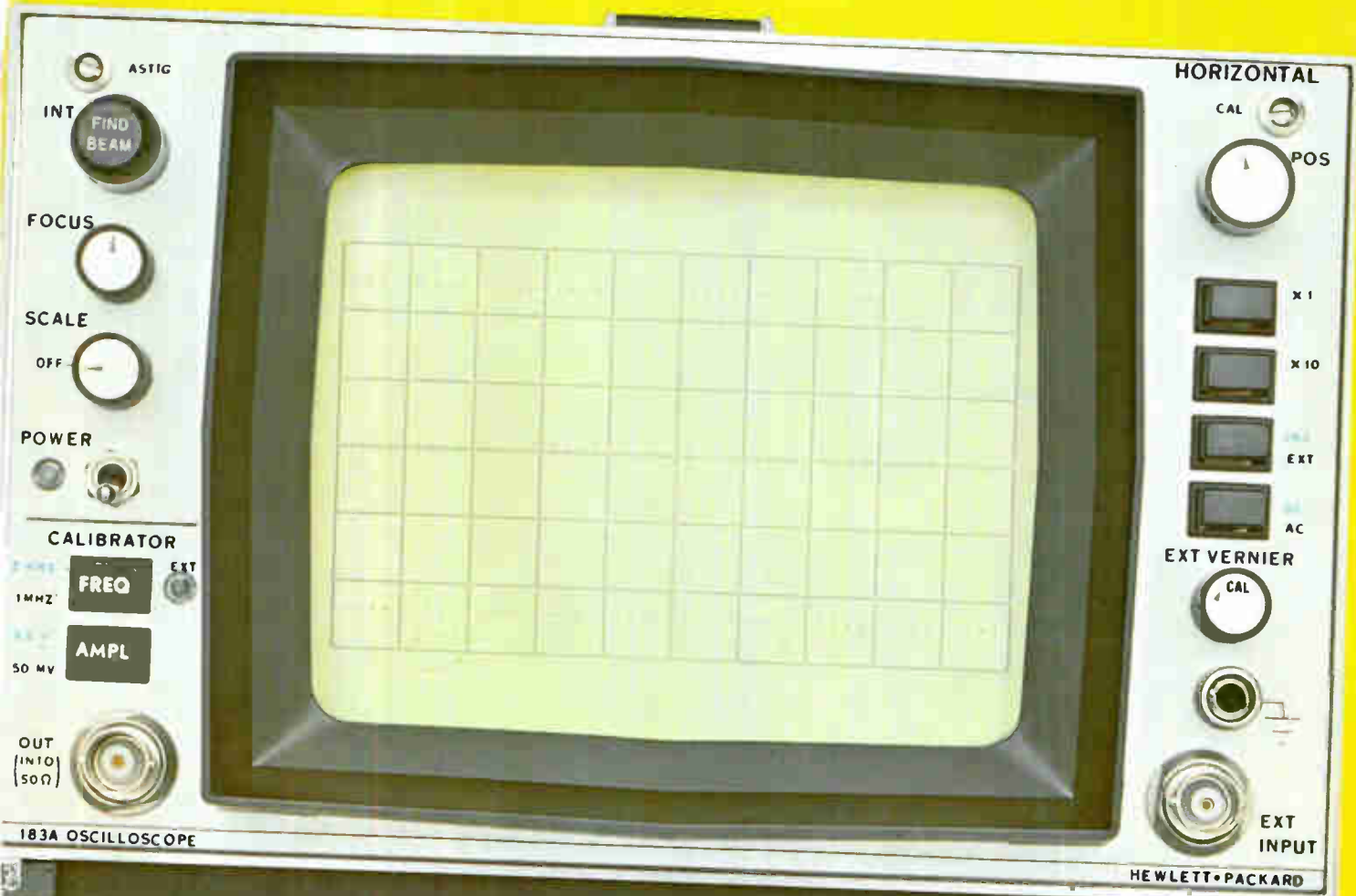

ACTUAL SIZE

STEP FORWARD With the Only Field-Proven All-Solid-State High-Frequency Plug-In OSCILLOSCOPE SYSTEM!

The engineering world is full of great ideas—but what you do with your ideas is a measure of your success. Getting a worthwhile idea is not always easy. Transforming that idea into reality—and proving it—that's where the work really begins!

At HP, we're using the best of our ideas and years of experience to design and produce the HP 180 Scope System—to help you turn your ideas into realities easier and faster.

For example, the engineering world has been plagued for years, sometimes unknowingly, with inaccuracies caused by capacitance when measuring high frequencies and nanosecond risetimes. HP design engineers battled this problem, too. Now there is a solution. HP Microwave Division's experience with high frequency 50 Ω transmission lines led to development of the 50 Ω input system used in the 1802A and 1830A amplifier plug-ins. This system gives you a near-perfect termination—regardless of your signal frequencies—and the effects of capacitance are reduced to a minimum.

A few years back, to get where you needed to be—to find out what, where and how much—you designed connectors, circuits, strip lines and antennas, by measuring all around your problem, then extrapolated or interpolated your answer. Not any more! Now you can get a direct measurement with the HP 1815A time domain reflectometry/sampling plug-in—another idea that came from experimentation with microwave circuitry.

Some scopes have a difficult time settling down to the point where accurate measurements can be made consistently—time after time. Signals often drift all over the face of the CRT! All-solid-state components (which reach operating level almost immediately) and field effect transistors in the 180 scope amplifiers virtually eliminate drift in both ac and dc measurements!

The HP 180 scope can be used as a voltmeter, frequency meter, and for a multitude of other instrument functions. But...as you well know...it is not the only instrument you need to turn your ideas into working models.

Your HP field engineer has a complete line of more than 2000 compatible instruments from which you can design your measurement system around your 180 Scope System. And, you'll find your HP field engineer is more than a scope specialist. He's a complete instrumentation analyst who can tell you about counters, voltmeters, recorders, power supplies, signal sources, oscillators, and many more.

When your job depends on your measurements, when your reputation rests on your purchases, when you want maximum performance per dollar invested, step forward with the HP 180 Scope System! Call your HP field engineer today. Or, write to Hewlett-Packard, Palo Alto, California 94304. Europe: 1217 Meyrin-Geneva, Switzerland.

the **hp**
180

Covers 50 MHz and 100 MHz real time, calibrated time domain reflectometry with 35 ps risetime, 12.4 GHz sampling with 28 ps risetime storage and variable persistence... and now

250MHz
real time!

HEWLETT  PACKARD
OSCILLOSCOPE SYSTEMS

Pick your own happy ending.

All good things, including circuit boards, must come to an end.

That's where we come in. We've got the happy ending patented.

Four times. (Pat. nos. 2,248,686; 2,294,056; 3,182,276; 3,208,026.)

In all the configurations you need. Four plug styles. Ten receptacle styles. For direct staking, or with their own insulator. With or without card guides. With or without guide pins. With any number of contacts (up to 135, on one triple-decker receptacle).

Every one meets Mil-E-5400 including the new revision "K", which makes metal-to-metal contacts mandatory.

Our Varicon™ metal-to-metal contacts are patented — and famous, in their quiet way. Because, in millions of operating hours, not one has failed.

The Varicon contacts have a unique fork-like design, with four large, coined, mating surfaces that form a firm gas-tight seal. Even after being mated for years, they remain clean and unoxidized. They have, and

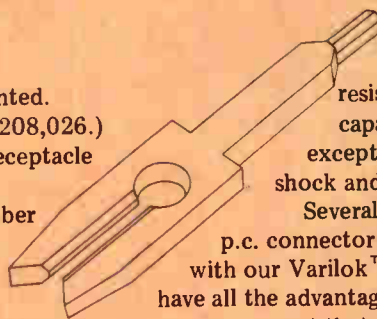

keep, a low contact resistance and high current capacity. And they're exceptionally resistant to shock and vibration.

Several members of our p.c. connector family come with our Varilok™ contact. These have all the advantages of the Varicon contacts — except that you can insert and remove them from the receptacle yourself.

They're available by the handful for small scale production and on 1800-contact reels for use with automatic crimping equipment.

They're all described in our printed circuit connector guide. To get your copy, write, wire, call or TWX us. Elco Corporation, Willow Grove, Pa. 19090. (215) 659-7000. TWX 510-665-5573.

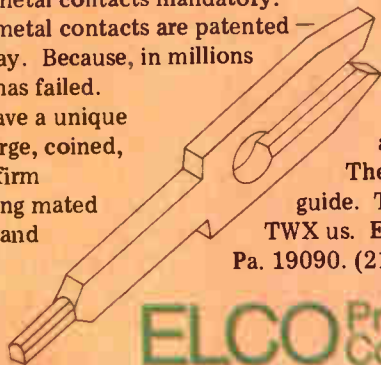

ELCO Printed Circuit
Connectors

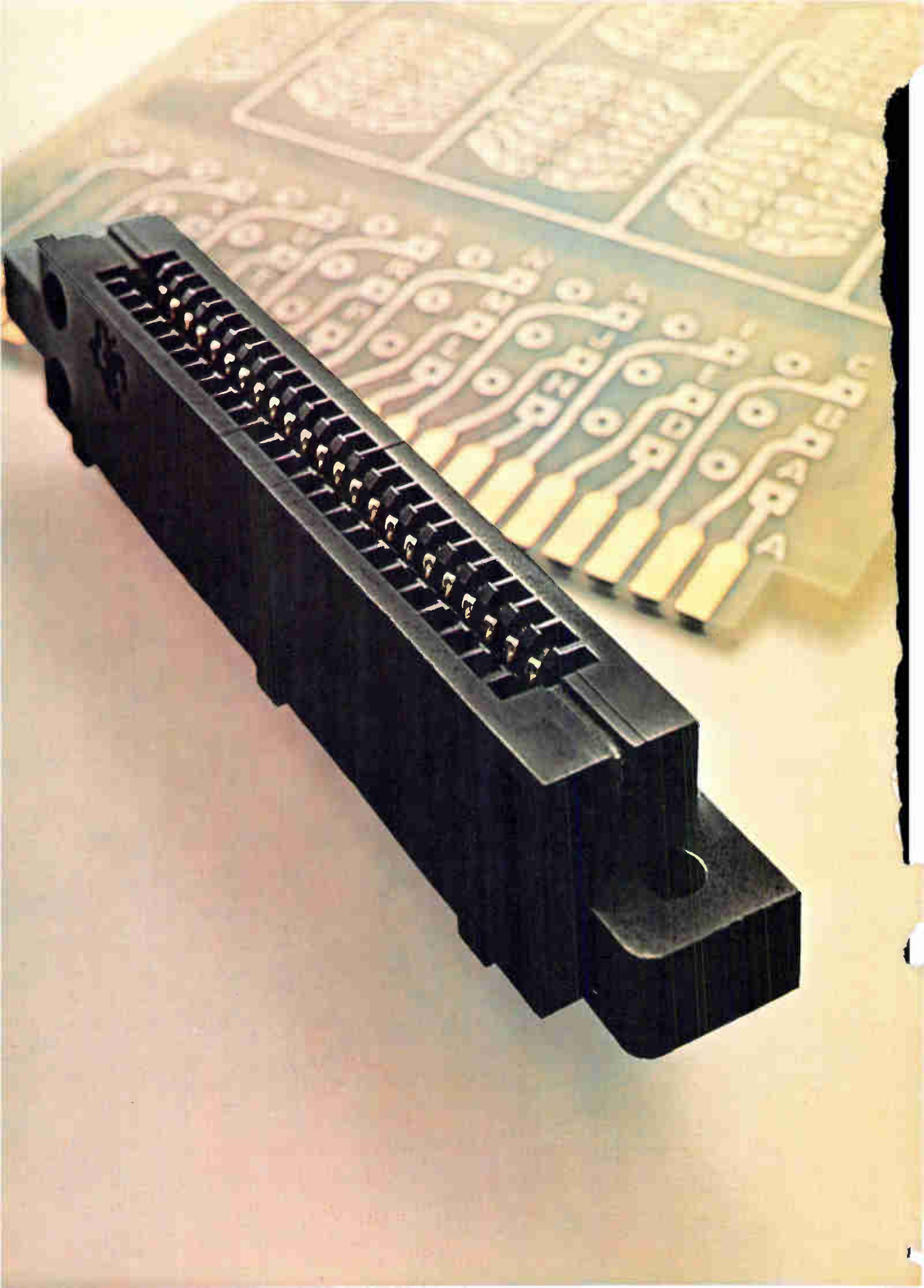

TI's new high-speed edgeboard connector

For Next-Generation Computers and RF Communications Systems

TI is ready now with a matched impedance edgeboard connector — a totally new concept in microminiature packaging. This unique device permits quick connect-disconnect of high frequency and high-speed switching circuitry. It's the only printed circuit connector we know of that combines edgeboard plug-in convenience with the impedance matching capabilities of coaxial connectors.

This new connector eliminates costly, individual coaxial connectors from your microstrip and stripline boards. Saves you as much as 80%. Gives you up to 4 times more connec-

EC-MI-9000 SERIES SPECIFICATIONS

A standard 22-position connector for switching speeds of 2 nanoseconds or faster and high frequency signals of 30 MHz or above. Rated at 3 amps dc, has 50 ohms characteristic impedance.

At 500 MHz: V.S.W.R. is 1.05:1, crosstalk is 30 db, insertion loss is 0.1 db. Its 44 contacts, made of nickel silver selectively inlaid with gold, have 0.100" spacing. Molded body is glass filled nylon.

tions in the same space.

Extremely flexible, TI's unique connector opens a whole new era for microstrip and stripline circuitry. One unit can handle various impedance levels, and RF and dc signals at the same time. This versatile device is primarily designed to termi-

nate at impedance matched mother boards. Adapters are available for coaxial cable.

For more facts about this connector breakthrough, write or call:

TI Connector Products
Attleboro, Mass. 02703.
Tel: 617-222-2800.



TEXAS INSTRUMENTS
INCORPORATED

The AMP point-to-point most versatile

One Technique Covers Widest Range Of Interconnection Requirements

Whatever your interconnection requirements, TERMI-POINT★ products can move in to fulfill them over the widest variety of applications. The components shown below are only a few of the applications now being used in industry. In addition, AMP Engineering is available to

be applied against any particular or unusual interconnection problems you may have in point-to-point wiring.

AMP Pre-Wired Panels And Component Service

If you prefer AMP to pre-wire panels or connectors, a special division in our Harrisburg plant offers complete

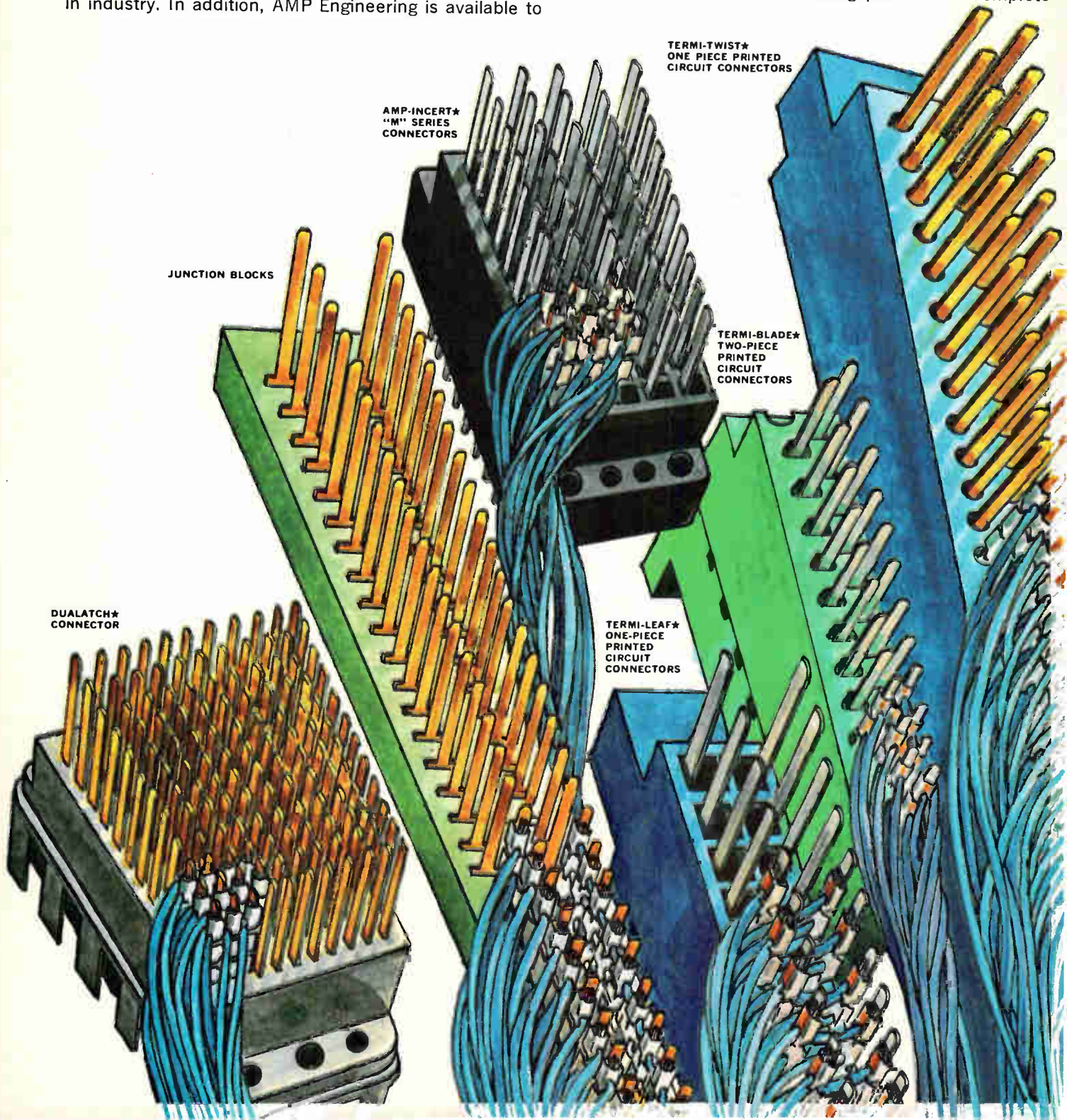

wiring technique is the in the world

facilities from taping specifications to finished product. Fully tested panels will be shipped ready for installation to give you the benefits of automated wiring at lowest applied cost. Quotes on your point-to-point wiring requirements will be supplied on request.

Write For Special Point-To-Point Wiring Report And Complete Product Information

Send for our 6-page special report, "A Stored Energy Connection for Point-to-Point Wiring" plus complete information including specifications and test data on TERMI-POINT Clips, Tools and companion products. Write
INDUSTRIAL DIVISION, AMP INCORPORATED, HARRISBURG, PA. 17105.

★Trademark of AMP Incorporated

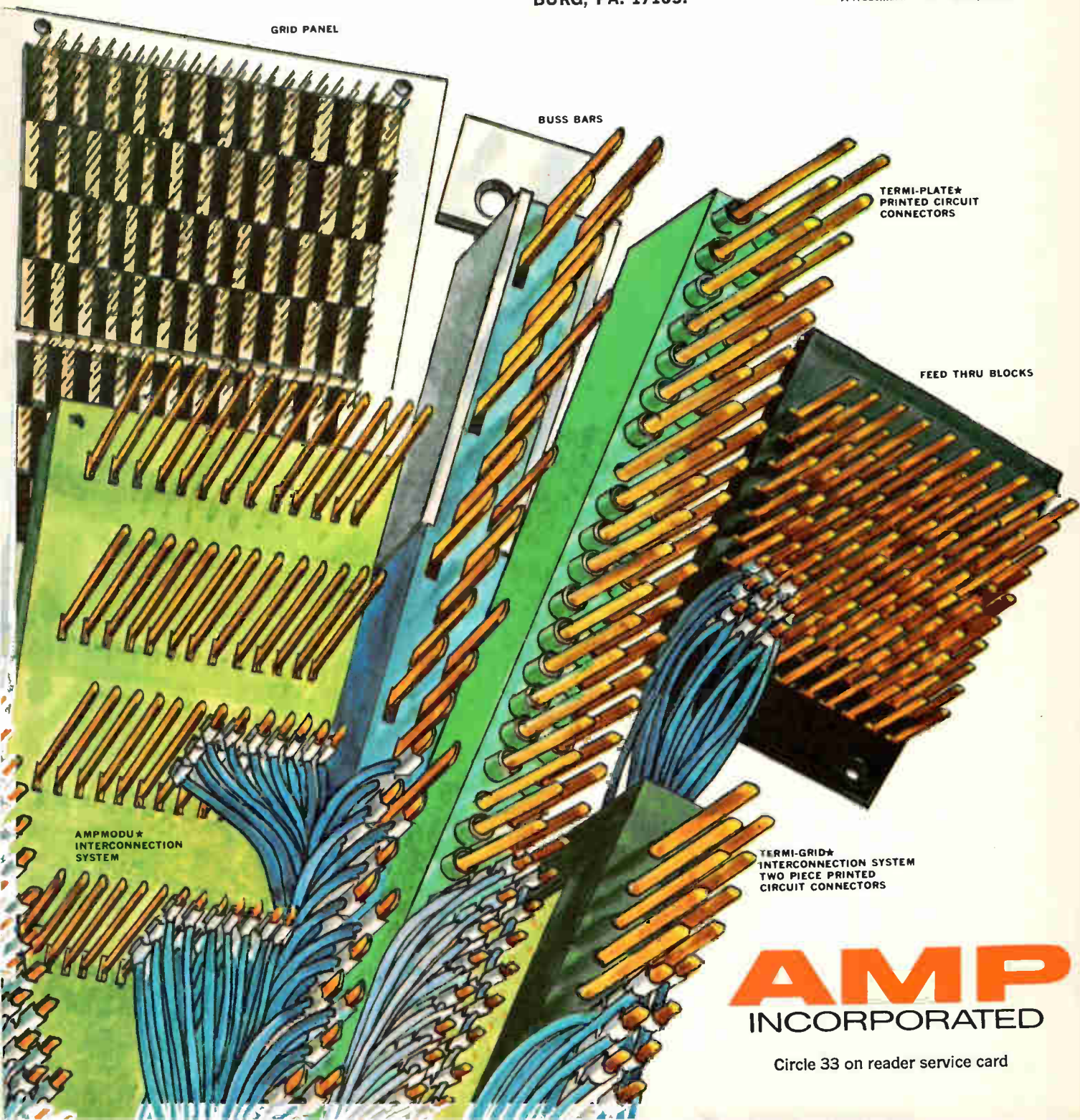

GRID PANEL

BUSS BARS

TERMI-PLATE*
PRINTED CIRCUIT
CONNECTORS

FEED THRU BLOCKS

AMPMODU*
INTERCONNECTION
SYSTEM

TERMI-GRID*
INTERCONNECTION SYSTEM
TWO PIECE PRINTED
CIRCUIT CONNECTORS

AMP

INCORPORATED

Circle 33 on reader service card



A single pair of wires, or a leased telephone line, can carry the audio signals for a complete control system.

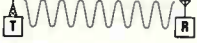

For inaccessible areas or mobile installations, a radio transmitter and receiver system can carry the signals.

REMOTE CONTROL SWITCHING WITH AUDIO SIGNALS

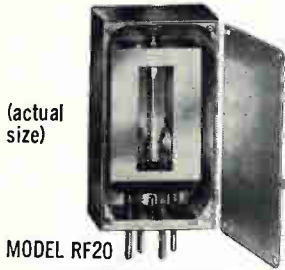

(actual size)

MODEL RF20
contactless resonant reed encoder/decoder
.395 x .620 x 1.100

An audio tone can be generated by an electronic oscillator or resonant reed encoder circuit, then transmitted by wire or radio. The tone activates a resonant reed relay to perform a control function.

Bramco reeds permit over 100 selective control frequencies within the 67 to 3000 Hz. spectrum. This is assured by: (1) the narrow response band-width of about 1% for decoders and (2) the high accuracy of Bramco reed encoders (1/10 of 1% of design frequency).

A big advantage of reeds in control switching is that they are ideally suited for simultaneous and sequential coded tone systems. The actual number of control functions possible in such a system is virtually unlimited. For example, over 3300 individual control functions are possible with only 16 frequencies coded sequentially in groups of three.

Compared to other types of tone filters, resonant reeds are small and inexpensive. They give more control functions per spectrum, per size, per dollar.

If you work with controls that select, command, regulate, or indicate, you should know how it can be done with audio signals. We custom design and stock a broad line of encoder/decoder components and modules. Bramco also custom designs LC filters from 0 to 200 KHz.

For literature write Bramco Controls Division, Ledex Inc., College and South Streets, Piqua, Ohio, or call 513-773-8271.



BRAMCO CONTROLS DIVISION
LEDEX INC.

College and South Streets, Piqua, Ohio 45356

Meetings

Eascon: by land and by air

The Department of Transportation's long-awaited report on solutions to the problems of air traffic control in the 1980's is scheduled for its first public airing at the Electronics and Aerospace Systems Convention and Exposition (Eascon) Oct. 26 through 29 in the Sheraton Park Hotel, Washington.

Dr. Lawrence Goldmuntz, consultant to the department and chairman of its air traffic control advisory committee, will review the group's findings during the afternoon of Oct. 27. Others will discuss automation of the ATC system; a new beacon system with data-link functions; averting midair collisions through intermittent positive control—a new concept in ATC—and the role of electronics in boosting airport capacity.

The impact of the Nixon Administration's proposed mass transportation act on the industry through electronics in high-speed ground transportation, and the role of electronics in reducing congestion and promoting safety on the highways, also will be covered by speakers in this technical session.

The Electronic Devices Convention will share its sessions with Eascon Tuesday and Wednesday, Oct. 28 and 29, and more than 35 manufacturers plan to exhibit at the show. The status of the Defense Department's procurement bill, and its effect on the industry, no doubt will influence the speech at the traditional military-industrial luncheon. The speaker will be a veteran backer of the military-industrial complex, Sen. Barry Goldwater.

Optical sensors. Delegates won't be able to be in two conference rooms at once, although competing with Monday's DOT session will be the first unclassified discussion of recent significant improvements in the Army's night vision systems, including new techniques in pulsed viewing and laser ranging. Competing devices, and their applications, will be analyzed.

To add more general appeal to the convention, and to emphasize

that urban problems also concern the electronics industry, one of the highlights Tuesday will be an all-day discussion in this area. The allied aerospace field will be used as an example of how industry has tried to use its knowhow to end crises in housing, transportation, and pollution.

While he may get some arguments from aerospace firms, Dr. Albert Weinstein, assistant director of research planning and coordination at the Department of Housing and Urban Development, feels that the efforts of these companies have been uneven and their success has been limited, despite their motivation and potential to make important contributions. Speakers will attempt to provide a better understanding of urban problems, will illustrate the use of aerospace resources, and will discuss their views with the audience.

On Oct. 29, NASA will put in a pitch for its earth-orbiting manned space stations. NASA officials, including Col. Frank Borman, space field director, will comment on the timetable, automatic checkout, and power source requirements for the space station and shuttle program.

Satellites won't be left out, either. At one of the four satellite sessions, the design and use of Tacsat 1, the largest communications satellite launched to date, will be examined.

For further information contact James H. Weiner, communications manager, AT&T, 2055 L St. N.W., Washington, D.C. 20036.

Calendar

Conference on Trunk Telecommunications by Guided Waves, IEE; London, England; Sept. 15-17.

Electro-Optical Systems Design Conference, Industrial and Scientific Conference Management Inc.; Chicago; Sept. 16-19.

Solid State Devices Conference, IEE; University of Exeter, Exeter, Devon, England; Sept. 16-19.

(Continued on p. 36)



The solid state numeric
is ready at Monsanto.

So are 19 other LED's.

MAN 1 shown 6x actual size.

Send a P.O.

You know we've been working on the MAN 1 visible diode numeric for several years. Well, now we're ready to take orders.

It offers all the good things you expect from microcircuits. Low power drain. Shock resistance. Happy interface with your solid-state circuitry. Plus it gives you design flexibility you've never had before. And the multi-segmented construction avoids the danger of a number being altered by a small circuit failure.

Send a P.O. and be the first designer on your block to give your

digital readout the look of the 70's.

The 19 other low-cost, long-lived LED's? Four are bright red light-emitting semiconductors that have ns switching time, diode reliability and million-hour* life.

One of our LED's emits amber light, one green light. Five put out frequencies in the infrared. One is a coupled pair, with detector and emitter in the same package to give you a light-quick switch (5 ns rise and fall) with 3 kV isolation.

Six are room temperature lasers in a variety of miniaturized configurations. Number 19 is a bunch of new

CO₂ laser modulator components.

So there's the whole line. They're all currently available from Schweber, Kierulff, K-Tronics, or Semiconductor Specialists. Or from us: Monsanto Electronic Special Products, 10131 Bubb Road, Cupertino, California 95014. Phone (408) 257-2140.

Want more information on our new numeric, the MAN 1? Circle reader service #315.

For specs on the other 19 LED's, circle #316.

* T_A = 25°C, I_F = 50ma. Result of step-stress testing with end of life projections.

Monsanto

Make a friend for life. With the guy down the hall. Or in the next building over. Someone your company hired because he is a chemist.

Take him to lunch.

Your motive: To learn about the lanthanides. The *what?*

The lanthanides. The *rare earths*, if you will. Those elements numbering from 57 to 71, from lanthanum to lutetium, in the periodic table. Plus their cousins, yttrium and thorium.

What's to learn? A lot, especially about the unique *electrochemical* properties of these elements and their compounds. Facts which can stimulate both old and new thoughts concerning the shape of IC's, TTL's, CRT's, etc. yet to come.



How's to learn? From your new-found friend—the chemist. Ask. Probe. Cajole. In any of a variety of ways:

Bluntly: "Say, tell me all you know about these rare earths."

Tactfully: "I knew you'd be the one person around here to ask. Isn't there something about the rare earths that we can use?"

Humbly: "I've heard about yttrium and gadolinium in color-TV phosphors. And about lanthanum capacitors. But there's more to rare earths than that—isn't there?"

Maybe what you don't know *can* hurt you.

Maybe what your associates (like chemists) *do* know (about rare earths) can help you.

And so can we. Write. Or call.

We'll send you—or the chemist you name—some helpful information on the rare earths.

RARE EARTH DIVISION
AMERICAN
POTASH & CHEMICAL
CORPORATION

A SUBSIDIARY OF KERR-MCGEE CORPORATION

258 Ann Street; West Chicago, Illinois 60185; Telephone: (312) 231-0760

Meetings

(Continued from p. 34)

Symposium on the Biological Effects and Health Implications of Microwave Radiation, Biophysics Department of the Virginia Commonwealth University, Bureau of Radiological Health, Environmental Control Administration, and U.S. Public Health Service; Richmond, Va.; **Sept. 17-19.**

Annual Broadcasting Symposium, IEEE; Mayflower Hotel, Washington, D.C.; **Sept. 18-20.**

Joint Power Generation Conference, IEEE, American Society for Mechanical Engineers; Charlotte, N.C.; **Sept. 21-25.**

Annual Intersociety Energy Conversion Engineering Conference, IEEE, American Society for Mechanical Engineers; Statler Hilton Hotel, Washington, D.C.; **Sept. 21-26.**

Aerospace Development Briefings and Fall Meeting, Air Force Association; Sheraton Park Hotel, Washington; **Sept. 22-24.**

Ultrasonics Symposium, IEEE; Chase Park Plaza Hotel, St. Louis, Mo.; **Sept. 24-26.**

International Electronics Conference, IEEE; Automotive Building, Exhibition Park, Toronto; **Oct. 6-8.**

Annual Conference of the American Institute of Ultrasound in Medicine; Winnipeg, Manitoba, Canada; **Oct. 6-10.**

Engineering Management Conference, IEEE; Montreal, Quebec, Canada; **Oct. 9-10.**

IGA Group Annual Meeting, IEEE; Statler Hilton Hotel, Detroit; **Oct. 12-16.**

International Symposium on Remote Sensing of Environment, The Center for Remote Sensing Information and Analysis; University of Michigan, Ann Arbor; **Oct. 14-16.**

Annual Symposium on Switching and Automata Theory, IEEE; Waterloo, Ontario, Canada; **Oct. 15-17.**

Thermionic Energy Conversion Specialist Conference, IEEE; Carmel, Calif.; **Oct. 21-23.**

Joint Materials Handling Engineering Conference, IEEE, American Society of Mechanical Engineers; Sheraton Motor Inn, Portland, Ore.; **Oct. 27-29.**

Joint Conference on Mathematical and Computer Aids to Design, Society for Industrial and Applied Mathematics, Association for Computing Machinery,

(Continued on p. 38)



Desk-type hp 9100A programmable calculator. Provides dynamic range from 10^{-98} to 10^{99} with resolution to 10 significant figures, and a memory which accommodates 196 program steps. Printed circuit board from calculator shows extensive use of Allen-Bradley hot-molded resistors.

“We specify Allen-Bradley hot-molded resistors for quality, reliability, price and delivery”

Hewlett-Packard

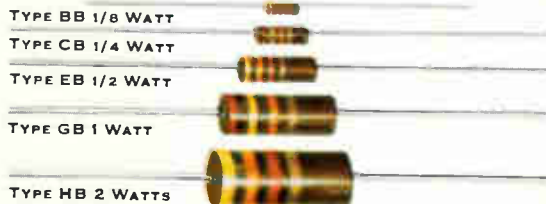

A-B hot-molded fixed resistors are available in all standard resistance values and tolerances, plus values above and below standard limits. A-B hot-molded resistors meet or exceed all applicable military specifications including the new Established Reliability Specification at the S level. Shown actual size.

The computer-like capabilities in this compact hp Model 9100A Calculator have placed severe demands on component performance. Reliability must be of the highest level.

Allen-Bradley hot-molded resistors completely meet the challenge. This is shown by the fact that they satisfy the requirements of the latest MIL-R-390008A Established Reliability Specifications at the *highest* level—the S level. This is true for all three ratings—the 1 watt, ½ watt, and ¼ watt—over the *complete* resistance range from 2.7 ohms to 22 megohms!

The unsurpassed performance of A-B resistors results from an exclusive hot molding manufacturing technique. The equipment is fully automatic—developed and used only by Allen-Bradley. The “built-in” precision control ensures the highest uniformity from resistor to resistor—year after year. Physical properties are constant. Performance is predictable.

For complete specifications on this quality line of hot-molded resistors, please write to Henry G. Rosenkranz and request Technical Bulletin 5000. Allen-Bradley Co., 1201 S. Second St., Milwaukee, Wis. 53204. Export Office: 1293 Broad Street, Bloomfield, N. J., U.S.A. 07003. In Canada: Allen-Bradley Canada Limited.



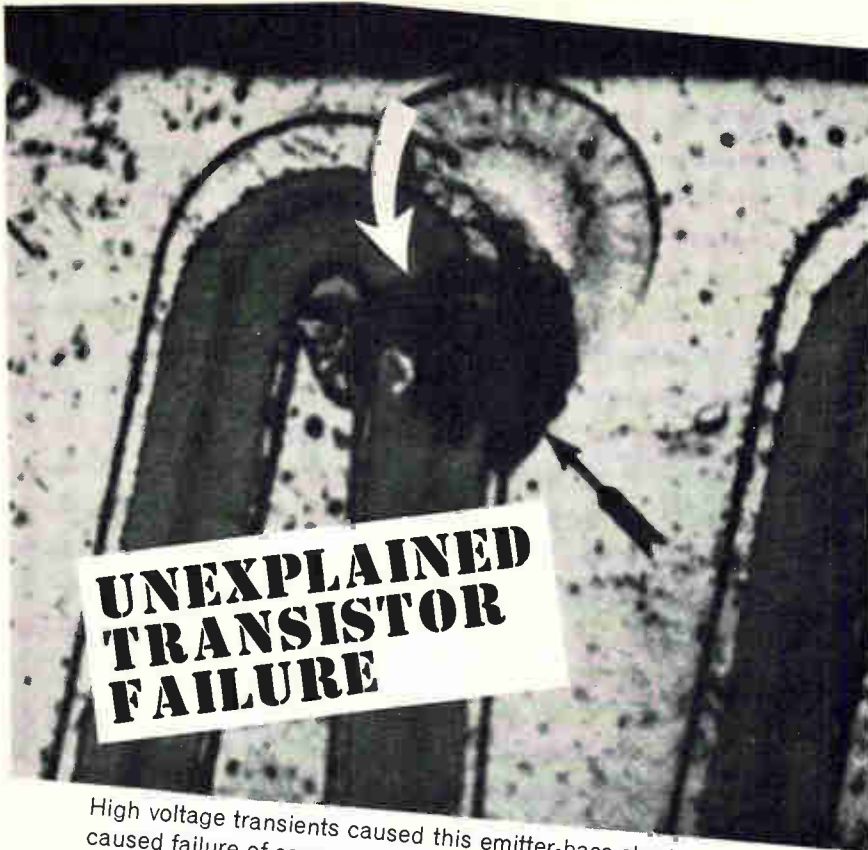

High voltage transients caused this emitter-base short which later caused failure of several power transistors.

And how you can prevent it.

Whether it was caused by a technician with a wayward probe, or a piece of heavy equipment starting up nearby, or "strays," the origin of a high-voltage transient is of no consequence.

In every case, the results are the same: immediate—or eventual—failure of costly semiconductors.

Even though it may not fail immediately, the punctured device is left with a path, analogous to scar tissue, along which subsequent failures take place.

Eventually, under thermal stress or load conditions, the semiconductor gives up. Often without apparent cause.

Protection against transients

The Heinemann JA/Q™ electronics protector prevents high voltage spikes, or overvoltages of any kind, from ever reaching your semiconductors. (JA/Q undervoltage protectors are also now available.)

The JA/Q provides protection against transients and overvoltages by sensing them before they reach the vulnerable portions of the circuit. It responds to dangerous conditions

by shunting them from the line and signaling a trip mechanism to open the line.

Transient response time of the JA/Q is within *500 nanoseconds*. Trip time is 10 milliseconds.

And overcurrent protection

Transient/overvoltage protection is combined in the JA/Q with hydraulic-magnetic overcurrent protection, which may be specified with or without time delay, depending on your circuit requirements. Time delays for typical overcurrent faults have no effect on the trip time of the protector under transient or overvoltage conditions.

To learn more about the JA/Q, write for Bulletin 3370. We're as interested in preventing failures as you are. Heinemann Electric Company, 2600 Brunswick Pike, Trenton, N.J. 06802.

HEINEMANN



Meetings

(Continued from p. 36)

IEEE; Disneyland Hotel, Anaheim, Calif., Oct. 27-30.

Nuclear Science Symposium, IEEE; Sheraton Palace Hotel, San Francisco; Oct. 29-31.

International Electron Devices Meeting, IEEE; Sheraton Park Hotel, Washington; Oct. 29-31.

Northeast Electronics Research & Engineering Meeting (NEREM), IEEE; Sheraton Boston Hotel, War Memorial Auditorium, Boston; Nov. 5-7.

University Conference on Ceramic Science, Dept. of Metallurgical and Materials Engineering, University of Florida; Nov. 10-14.

Symposium on Adaptive Processes, IEEE; Pennsylvania State University, State College; Nov. 17-19.

Short courses

Active Filter Design: Theory and Practice, University of California at Los Angeles; Sept. 22-26. \$275 fee.

Executive Technical Development, Polytechnic Institute of Brooklyn, New York; Gurney's Inn, Montauk, Long Island; Oct. 6-31. \$2,125 fee.

Interactive Production Control, Engineering and Physical Sciences Extension; University of Calif. at Los Angeles, Oct. 27-31. \$275 fee.

Call for papers

Numerical Control Society's Meeting and Technical Conference; Statler Hilton Hotel, Boston, April 8-10, 1970. Oct. 15 is deadline for submission of abstracts to program chairman, Lawrence D. Levine, Hitchiner Manufacturing Co., Milford, N. H. 03055.

International Solid-State Circuits Conference, IEEE, U. of Pa.; Sheraton Hotel, Philadelphia, Feb. 18-20, 1970. Oct. 17 is deadline for submission of abstracts and papers to L.D. Wechsler, General Electric Co., Electronics Park, Building #3, Syracuse, N.Y. 13201.

Transducer Conference, IEEE; National Bureau of Standards, Gaithersburg, Md., May 4-5, 1970. Nov. 1 is deadline for submission of summaries to Dr. Robert B. Spooner, IMPAC Instrument Service, 201 E. Carson Street, Pittsburgh, Pa. 15219.

Allen-Bradley cuts space requirements with new sealed type Z cermet trimmers

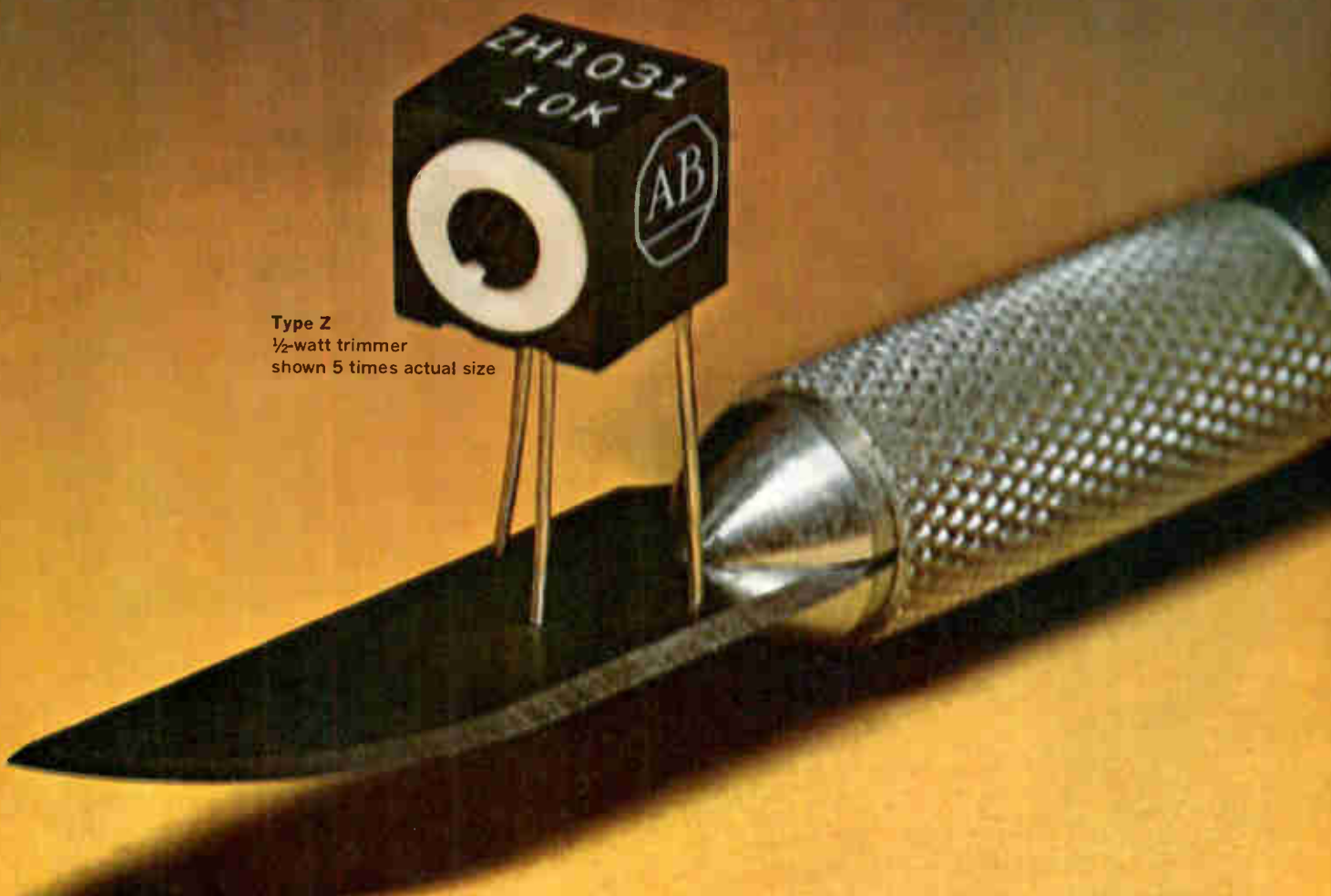

Type Z
1/2-watt trimmer
shown 5 times actual size

this latest addition to the Allen-Bradley line of cermet trimmers...the type Z...affords high performance in an especially compact package

The cermet material—an exclusive formulation developed by Allen-Bradley—provides superior load life, operating life, and electrical performance. For example, the full load operation (1/2 watt) for 1000 hours at 70°C produces less than 3% total resistance change. And the temperature coefficient is less than ± 250 PPM/°C for all resistance values and throughout the *complete* temperature range (-55°C to +125°C).

The Type Z is ruggedly constructed to withstand shock and vibration. The unique rotor design ensures smooth adjustment and complete stability under severe environments. The leads are permanently anchored and bonded. The connection exceeds the lead strength—opens cannot occur. Leads are weldable.

The enclosure is *SEALED*. It is both dust-tight as well as watertight, and can be potted. Mounting pads prevent moisture migration and also post-solder washout. For full specifications on this new spacesaving cermet trimmer, please write Henry G. Rosenkranz, Allen-Bradley Co., 1201 S. Second St., Milwaukee, Wis. 53204. Export Office: 1293 Broad Street, Bloomfield, N.J., U.S.A. 07003. In Canada: Allen-Bradley Canada Ltd.

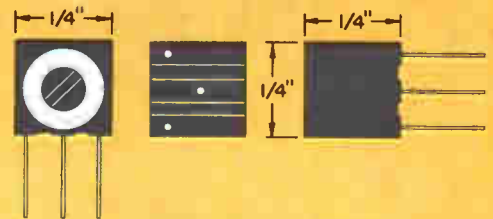

SPECIFICATIONS SUMMARY

- Adjustment:** Horizontal or vertical.
- Temperature Range:** -55°C to +125°C.
- Resistances:** 50 ohms through 1 megohm.
Lower resistances available.
- Tolerances:** $\pm 20\%$ standard, $\pm 10\%$ available.
- Resolution:** Essentially infinite.
- Rotational Life:** Less than 2% total resistance change after 200 cycles.
- Rotation:** 300° single turn.
- End Resistance:** Less than 3 ohms.



**Reliability is a spring, a wheel
and two thingamajigs.**

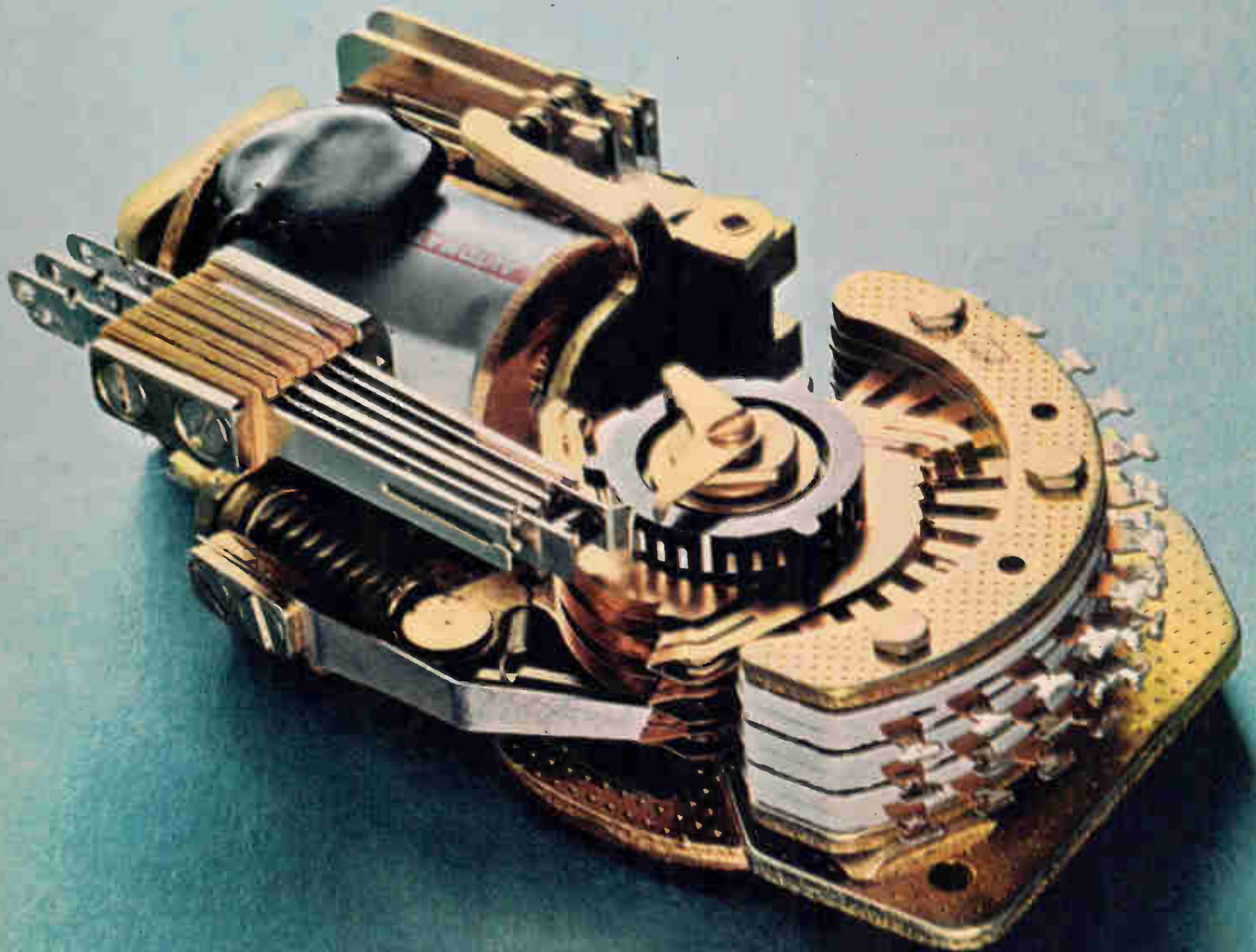



Every AE Type 44 stepping switch comes with them.

One-spring power.

The drive spring is a coil. What it does is store up power. When it comes time to switch, the spring lets loose and moves the wiper assembly forward. Each time using precisely the same pressure.

Notice our spring is tapered at one end. It's designed to perfectly match the power input. That's why you always get the best possible transfer of energy.

At one end of the drive spring is an adjusting screw. We turn it a little this way or a little that way and the tension is always perfect.

Try that with a flat spring.

We re-invented the wheel.

The ratchet wheel is a little different. The way it's made, for one thing. First, we blank it. Next, shave it. And finally, case-harden it. Then it's super strong.

Notice the big, square teeth that always provide a sure bite.

A thingamajig with teeth.

That thingamajig next to the wheel is the armature assembly. When the teeth on the end of it mesh with the teeth on the ratchet wheel, they stop the wiper assembly and position it precisely on the contact bank. Smooth as silk, every time. No jarring, no jamming, no banging.

No adjustments, either. As the teeth wear, they just drop further into the wheel. So nothing ever gets out of whack.

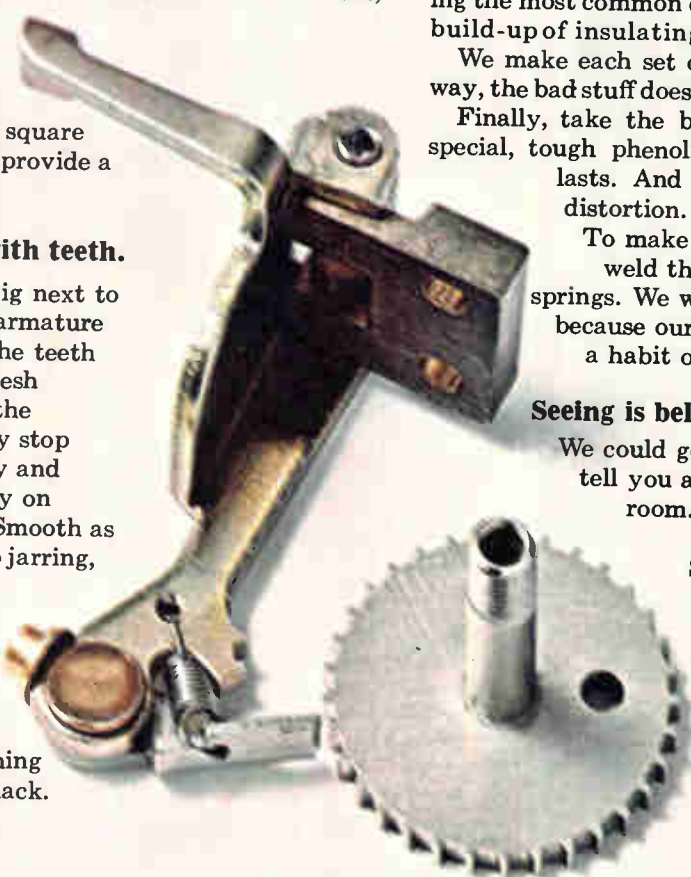

A pawl that floats.

On the end of the armature is the pawl. We made it "free floating" to eliminate the jamming and binding that go with the old style pawl stop block. And while we were at it, we stopped pawl breakage and put an end to double-stepping or overthrow.

Don't bother looking for this special set-up anywhere else. It's patented.

The other thingamajig.

It's called a contact spring. We've got some strong feelings as to what makes a contact spring strong.

In the first place, we believe there's strength in numbers. So we put two sets of contacts on each spring. This means you get a completed circuit every time. Without fail.

But some of the credit for this has to go to our solving the most common cause of contact failure—the build-up of insulating films on the contact points.

We make each set of points self-cleaning. That way, the bad stuff doesn't have a chance to build up.

Finally, take the buffers. We make ours of a special, tough phenolic material that lasts. And lasts. And lasts. All without wear or distortion.

To make sure they stay in place, we weld the buffer cups to the contact springs. We weld, rather than use rivets, because our lab found that rivets have a habit of falling off or wearing out.

Seeing is believing.

We could go on talking reliability and tell you about our testing and run-in room. There's a lot more to tell.

But we'd rather have our Sales Representative show you. And let you see first

hand the reliability that's built into every AE stepping switch. Just call or write.

Automatic Electric Company, Northlake, Illinois 60164.



AUTOMATIC ELECTRIC

SUBSIDIARY OF GENERAL TELEPHONE & ELECTRONICS

Put a MICRO SWITCH field man on your team and you've got a whole army of experts on your side.

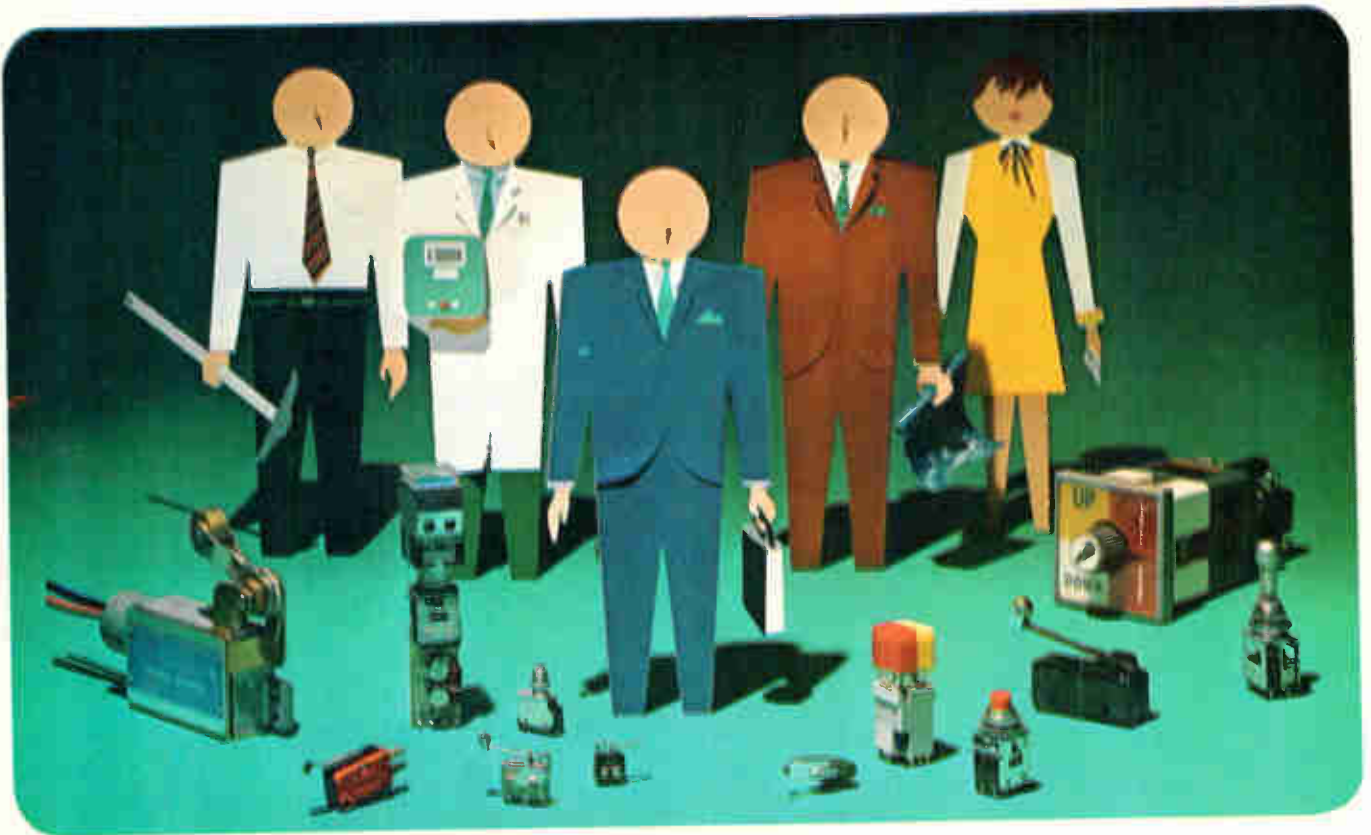

Special switching problems? MICRO SWITCH puts the largest field organization in the industry at your convenience. Our field engineers are especially trained to work on any aspect of your application requirements; from proper switch selection, including reliability and quality/cost factors, to proper switch installation and operation for maximum service.

When a field man tackles your problem, he's not working on it

alone. He is backed by a whole army of experts at the factory with many specialized talents.

For example, should you require a switch design to meet highly sophisticated specifications, he can tap the know-how of our experienced design engineering department. At the same time, he can dip into the world's largest selection of switches to find the device that's exactly suited to your needs.

Similarly, our extensive R&D facilities, advanced development

laboratories, and other engineering departments are continually developing new data and concepts to provide the most up-to-date sources of reference to serve you better.

Whatever your switching problem, large or small, call in the man who's experienced in problem solving... your MICRO SWITCH field man. You can reach him easily through a Branch Office or Authorized Distributor (Yellow Pages, "Switches, Electric").

MICRO SWITCH

FREEPORT, ILLINOIS 61032

A DIVISION OF HONEYWELL

HONEYWELL INTERNATIONAL • Sales and service offices in all principal cities of the world. Manufacturing in United States, United Kingdom, Canada, Netherlands, Germany, France, Japan.

Editorial Comment

Product planning aids West German IC effort

West Germany is gearing up to meet its goal of producing \$100 million in IC's by 1974. In spite of being less than one-fifth of the way to that goal, there are reasons to believe that it will be reached. Most important, the major IC makers use, or at least subscribe to in principle, modern methods of market evaluation and product planning. Furthermore, the progressive companies recognize their shortcomings; if there is one fly in the ointment, it is in the lack of programs to overcome some of the acknowledged problems.

At Valvo GmbH—West Germany's undisputed leader in IC production—about 80% of its new products stem from customer demand, as opposed to technical innovation from its own staff. Since Valvo is a part of Philips Gloeilampenfabrieken, all ideas for new products must first pass muster before the Philips international development committee. Philips does this to determine how the product fits into its worldwide marketing picture as well as to get a reading on the product's breadth of applicability. One of the results of this screening at the corporate level is that Valvo sells the bulk of its IC's externally rather than to other Philips divisions. When corporate approval is granted, Valvo application engineers make a system study, then provide a breadboard of the IC to the customer. If satisfactory, pricing, volume, and delivery schedules covering a period of up to three years would then be negotiated. A contract—including target specifications—may be drawn up at this stage. Valvo has initiated about a dozen new IC products per year in this way. And fewer than 10% of them failed to get into production.

AEG-Telefunken's semiconductor operations, unlike Valvo's, have targeted the in-house market. Except for specialized devices, the IC needs of all corporate divisions are met internally. Thus, the captive market may absorb as much as 90% of the IC division's output.

The division has a central product-planning committee composed of five engineers whose primary duties are to study the market for IC's. The committee sets up "working groups" that have representatives from both device and equipment departments; one such group studies IC's for color tv.

To help guide development programs, AEG-Telefunken conducts a score of studies each year that range across such fields as tv tuners, electronic switching systems, and automotive electronics. Planners at the company foresee the formation of industrial "interest groups" inside—and perhaps outside—Europe. Such groups are expected to permit more rapid development and application of West German IC technology. One such group could be based on the tv-receiver market, for example.

On the negative side of the ledger, West German industry faces a labor shortage, as well as a shortage of trained engineers. Workers needed to man the assembly lines have been imported from Spain, Italy, Portugal, South Africa, Yugoslavia, Greece, and Turkey. In some sections of the West German electronics industry, foreign workers account for 70% of the total working force. Generally, such workers are imported with government assistance and stay for periods of one or two years; they sock their earnings away and then return to their native countries. The West German companies must build housing and facilities for the workers with no expectations that they'll contribute much to the local economy. As for the shortage of engineering talent, one engineer attributes it to the West German economic and social structure which encourages bright young students to concentrate on the humanities rather than technology.

Another problem is the technology gap. Reluctant to admit it exists, West Germans nevertheless yearn to close it. Invariably, they attribute much of the gap to the "driving power" of military demand and Government support in the U.S. And they urge the West German government to put more support behind domestic technology, a demand that is being acceded to gradually, if modestly. Even at that, some West German engineers complain that much of the money spent in product development is wasted through misdirection by decision makers who are not technically competent.

Thus, while West Germany has done well in improving its posture for designing and producing IC's, it must overcome important drawbacks before it can handily reach the goals it has set. ■

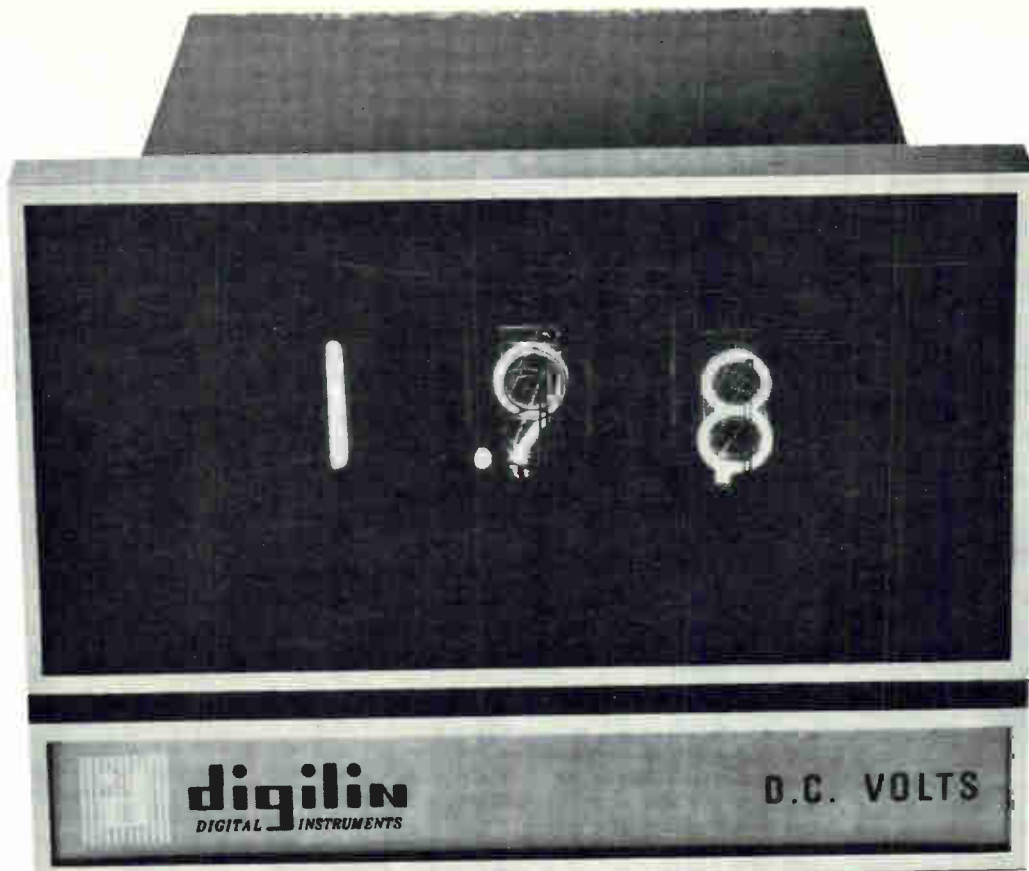

**The \$99.00
digital panel meter
you never have
to zero adjust**

Get away from quivering needles. End interpolations, extrapolations, and meter readings by conjecture. Now you can move up to digital readout with the one low cost digital panel meter with automatic zero adjust. With the new Digilin Type 250 you never worry about accuracy or unchecked drift. The 250 takes away the opportunity to make mistakes.

And while you gain day-in, day-out solid-state reliability and digital accuracy, the Type 250 — an industrial designer's masterpiece in brushed aluminum — brings an appearance of elegant precision to your system.

Now check these other important features:

Easy, external programming. With the

250, it's easy to take advantage of quantity prices. Stock one meter type. Change to a wide variety of current, voltage, or resistance ranges and change decimals all from the rear.

No internal adjustments. All ranges and functions are programmable from the rear panel. Calibration is accomplished by a single front panel vernier adjustment.

Constant high input impedance. No errors due to circuit loading.

Best visibility. Big 0.6" numbers. Parallax-free, filtered wide-angle viewing. Memory capacity gives no-blink display.

Fit-anywhere size. Just 4.38 by 3.13 inches. Only 3.12 inches behind panel.

Assured reliability. Exclusive Digilin 100-hour factory burn-in test is the most

rigorous in the industry.

How do we give you more features and better quality at the same low price? Because of Digilin innovations in circuitry, design, and manufacturing processes, the step-ahead technology that never means compromise.

At \$99.00 each in lots of 100, now you can well afford digital readout where you can't afford to make mistakes. Get in touch with Digilin today and get off the needle. Digilin, Inc., 6533 San Fernando Rd., Glendale, Calif. 91201. Telephone 213-246-8161, Ext. 401. (A division of Dura-Containers, Inc.)

Need 3-digit readout? Type 330 has same features as the 250, costs just \$129 (100-units).

digilin
DIGITAL INSTRUMENTS





You'll never get a bum wrap.

Not with a CDE wrapped tubular. For Cornell Dubilier has set the industry standard in wrap-and-fill capacitors. And we offer the most comprehensive stock in depth. Over 500 items, round and oval, covering capacities from .001 to 5 mfd, voltages from 50 to 600V DCW, and tolerances from 1% through 20%.

In polyester, polycarbonate, or polystyrene, in foil/film or metalized dielectrics—to meet every industrial or military need. And all are Sprint stock standards. SPRINT is the CDE program that assures you quick delivery of standardized components covering 98% of industry requirements.

CDE **CORNELL-DUBILIER**

50 Paris Street, Newark, New Jersey 07101

STOCK STANDARDS—WRAPPED TUBULAR CAPACITORS

TYPE WCR. General purpose, round, polycarbonate capacitor

Voltage—50 to 600V DCW
Capacitance—.001 to 2.0 mfd
Tolerance— $\pm 5\%$, 10%
Temperature— -55°C to $+125^{\circ}\text{C}$ without derating
 $\pm 1\%$, 2% , 5% , 20% available on special order over 50V

TYPE WCP. General purpose, oval polycarbonate capacitor

Voltage—50 to 600V DCW
Capacitance—.01 to 2.0 mfd
Tolerance— $\pm 10\%$
Temperature— -55°C to $+125^{\circ}\text{C}$ without derating
 $\pm 5\%$ available on special order

TYPE WPR. General purpose, round, polystyrene capacitor

Voltage—100 to 600V DCW
Capacitance—.001 to 1.0 mfd
Tolerance— $\pm 1\%$, 2%, 5%, 10%, 20%
Temperature— -55°C to $+85^{\circ}\text{C}$

TYPE MFP. General purpose, oval, polyester miniature capacitor

Voltage—50 to 600V DCW
Capacitance—.01 to 5.0 mfd
Tolerance— $\pm 10\%$, 20%
Temperature— -55°C to $+85^{\circ}\text{C}$ without derating;
 $+125^{\circ}\text{C}$ with derating
 $\pm 5\%$ tolerance available on special order

TYPE MCR. General purpose, round, metallized polycarbonate capacitor

Voltage—50 to 600V DCW
Capacitance—.01 to 5.0 mfd
Tolerance— $\pm 10\%$, 20%
Temperature— -55°C to $+125^{\circ}\text{C}$
 $\pm 5\%$, 10% tolerances available on special order over 50V

TYPE MCP. General purpose, oval metallized polycarbonate capacitor

Voltage—50 to 600V DCW
Capacitance—.1 to 5.0 mfd
Tolerance— $\pm 10\%$, 20%
Temperature— -55°C to $+125^{\circ}\text{C}$ without derating
 $\pm 5\%$, 10% available on special order over 50V

TYPE MMW. General purpose, round, metallized, polyester miniature capacitor

Voltage—50 to 600V DCW
Capacitance—.01 to 5.0 mfd
Tolerance— $\pm 1\%$, 2%, 5%, 10%, 20%
Temperature— -55°C to $+85^{\circ}\text{C}$ without derating;
 $+125^{\circ}\text{C}$ with derating
 $\pm 1\%$, 2% , 5% tolerances available on special order over 50V

TYPE MMP. General purpose, flat metallized, polyester miniature capacitor

Voltage—50 to 600V DC
Capacitance—.1 to 5.0 mfd
Tolerance— $\pm 1\%$, 2%, 5%, 10%, 20%
Temperature— -55°C to 85°C without derating;
 $+125^{\circ}\text{C}$ with derating

TYPE WMF. General purpose, round, polyester miniature capacitor

Voltage—50 to 600V DCW
Capacitance—.001 to 5.0 mfd
Tolerance— $\pm 1\%$, 2%, 5%, 10%, 20%
Temperature— -55°C without derating;
 $+125^{\circ}\text{C}$ with derating
 $\pm 1\%$, 2% , 5% tolerances available on special order over 50V.

TYPE CTM. Military round, polyester per MIL-C-27287

Voltage—50 to 100V DCW, 200V DC to 300V DC at 125°C
Capacitance—.0033 to 1.0 mfd, .001 to .15 mfd
Tolerance— $\pm 5\%$, 10%
Temperature— -55°C to $+125^{\circ}\text{C}$

Entries in red available on special order only. All other items stocked in depth at your CDE authorized distributor.

For complete descriptions, see your component selector.

CDE **CORNELL-DUBILIER**

50 Paris Street, Newark, New Jersey 07101

Electronics Newsletter

September 15, 1969

Autonetics delivering Hayakawa MOS LSI after cold summer

Autonetics is finally delivering MOS LSI circuits for Hayakawa's desk calculators after the Japanese company flatly rejected all circuits produced by the American firm during July and August. The reason: high rejection percentage among tested arrays made Hayakawa leery of using any. Autonetics considers the \$30 million order its entree into the commercial LSI business [*Electronics*, April 28, p. 103].

But shipments now are rolling in, says Hayakawa, adding that an engineer sent to Autonetics to supervise acceptance testing returned to Japan with a big batch of circuits. The problem apparently was created in going from 1.5-inch to 2-inch wafers—diffusion conditions evidently had to be changed. Hayakawa emphasizes that it's confident Autonetics has everything under control.

The bad summer deliveries, nevertheless, forced Hayakawa to delay introduction of its miniature calculator from August to October. In November, the firm says, it will receive 22,000 sets of circuits—88,000 arrays. The expectation is that Autonetics will have made up the deficit by December, and that Hayakawa will be turning out 30,000 of the machines monthly by March.

Motorola sets debut for high-performance memory system

A semiconductor memory system consisting of 8,192 bits in six packages is being prepared for introduction in the first quarter next year by Motorola Semiconductor. It will be priced competitively with comparable magnetic stores, says Wally Raisanen, Motorola's operations manager for MOS and IC memories, because it will be made with a novel beam-lead technique in which the beams are batch fabricated independent of wafer processing.

Raisanen also maintains that it is the fastest semiconductor memory of its size to date, with a cycle time of 150 nanoseconds or less, compared with core speeds of about 500 nsec in comparably sized production systems today and 250 nsec for plated-wire units now in development. The basic storage unit is a 256-bit MOS array; four of the six packages contain one array plus one bipolar chip. The other two packages contain the bipolar sense amplifier digit driver and decoding logic.

Power dissipation, 1 milliwatt per bit, is being billed as the lowest for any kind of high-performance memory. The unit is aimed at high-performance main frame applications. It is the first Motorola vehicle to incorporate the beam-lead technique.

Westinghouse shapes semiconductor shakeup

Westinghouse, in an effort to rejuvenate its ailing Semiconductor division, will make major changes in its product line. For example, rectifier diodes for automobiles—a mass market, but one on which Westinghouse has lost money for the last seven years—will be dropped.

To compensate, there will be new products incorporating a fair amount of technical sophistication. Among them: a 2,500-volt (and eventually 4,000-volt) rectifier said to have the lowest leakage current and forward voltage drop of any device in its class; a reverse-switching rectifier that can switch in 50 nanoseconds and is to replace thyratrons in radars; and a gate-controlled switch.

The switch actually was introduced unsuccessfully some years ago as

Electronics Newsletter

the GTO (for gate turn-off) silicon-controlled rectifier. Unlike conventional SCR's, it could be turned off as well as on by a signal on the gate terminal. But the GTO couldn't meet the competition of transistors. The new version has much higher voltage and current capability (the original was rated at 8 to 10 amperes), and can operate more efficiently and with greater surge capacity than transistors.

Diagnostic computer spots cancer cells

A system developed at the University of Chicago is now helping clinicians determine the difference between normal and cancerous cells in seconds instead of the minimum of hours it usually takes. What's more, because Ticas—taxonomic intracellular analytic system—is programed with information from expert cytopathologists around the world, it can identify anomalies that a single investigator, even if he were the most skilled and experienced, might never have seen. The next step in the project is direct tv transmission of diagnoses to doctors' offices.

The system, developed by Dr. George L. Wied of the university's Pritzker School of Medicine, consists of a standard fast-scan microspectrophotometer integrated with a LINC-8 biomedical computer and an IBM 360/50. Diagnostic information is fed to it and compared with stored data. Used as a consultant, Ticas is also able to describe the development and state of cells. For example, it can tell if a cell has been damaged by irradiation and, if so, how badly. It also can tell if a cell is infected by a virus or detect contamination caused by other cell populations.

MOS computer starts flight tests in '70

First flight tests of the Autonetics D-200 MOS computer could come early next year. Autonetics is teamed with the International Engineering Corp., Arlington, Va., manufacturer of loran equipment, and present plans call for the 10-lb. computer to be integrated with a loran receiver in solving navigation problems.

The avionics computer [*Electronics*, Dec. 9, 1968, p. 33] is thought to be the first such unit to use all-MOS devices in its central processor, control section, and memory. Autonetics engineers see the initial versions of the D-200 family used for navigation, guidance, and weapons-delivery applications in such aircraft as the F-14 and F-15, and possibly some of the larger helicopters, such as the CH-53. But even before this initial version has flown, plans call for shrinking the computer from its present 5 by 6 by 7 inches to about the size of a cigarette package.

Addenda

The raging dispute between NASA and the scientific community may have already reached the point at which White House science aide Lee DuBridges will be forced to arbitrate. Scientists contend that the space program is directed more toward publicity than scientific work. . . . Meanwhile, Air Force Col. Frank Borman, a Nixon favorite who was a rumored replacement for Thomas Paine as NASA administrator, has squelched the reports. As a matter of fact, he will leave the agency after the space-station study is completed. . . . RCA Laboratories has vapor-phase grown single-crystal gallium nitride. The lab hasn't yet used the material in a device, but is cautiously optimistic about its potential in semiconductor injection lasers tunable over a very wide range: visible to near infrared. The material's wavelength is about 2,000 to 3,000 angstroms and it can be p or n doped.

**Integrated
Circuit**

IDEAS

FROM
SYLVANIA

How SUHL ICs keep track of trains.

Automatic car identification system uses 28 different varieties of SUHL TTL integrated circuits.

By 1970, every freight car in the United States will be carrying a label similar to that shown at the lower right. It's all part of an automatic car identification system called KarTrak*. The KarTrak ACI system was designed and developed by Sylvania and has been adopted for use by the Association of American Railroads.

Heart of the KarTrak ACI system is an electronic scanner that reads the color coded strips on the label. The basic decoder unit utilizes 9 integrated circuit boards each containing 40 SUHL

*Trade Mark

TTL packages for a total of 360 integrated circuits. The decoder section processes the information from the labels as they are scanned on a passing train. This data includes identification of the owning railroad, and the car number. Other information such as car weight can also be included.

The SUHL integrated circuits have to work in an extreme environment. The trackside scanning units are placed in open areas all over the United States and have to bear the heat of summer

as well as the cold of winter. No special precautions were taken with the SUHL circuits. They are all standard off-the-shelf units. In addition to the basic decoder section, SUHL circuits are used in other portions of the system. A message generator that gives information on complete trains uses 60 SUHL TTL integrated circuits. A core memory storage section uses 360 SUHL TTL circuits.

Also available are five communications interface options, only one of

continued next page

This issue in capsule

IC Types

Now we have total TTL capability.

LSI

The Unicell approach to large-scale integration.

Hybrid Circuits

Hybrid shift register has many advantages.

IC Applications

Up-down counters run at speeds up to 20 MHz.

IC Developments

Sylythic beamlead ICs rival discrete components.

Manager's Corner

What does MIL-STD-883 really mean?



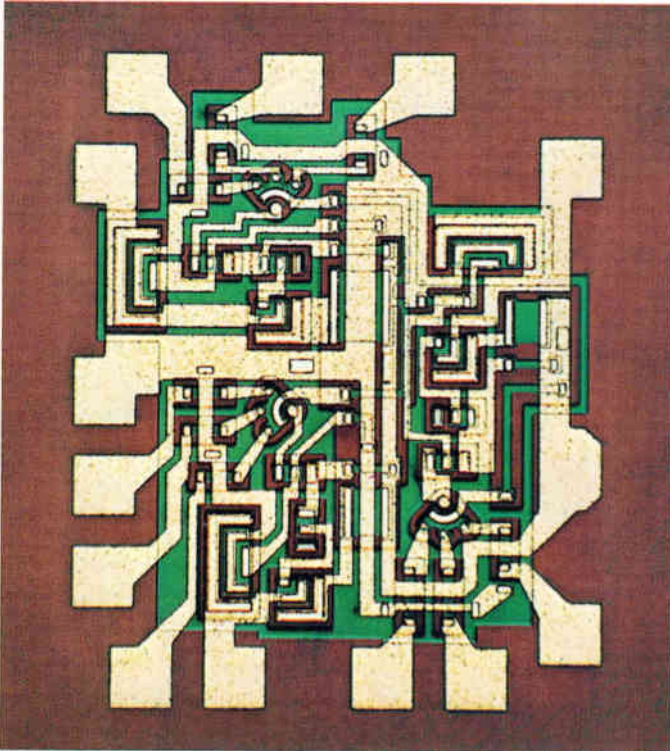

SG-190 triple 3-input NAND/NOR gate.

which is used at a time in a given system. Each interface unit consists of three circuit cards containing 40 SUHL ICs for a total of 120 circuits per system.

A read-only memory is also available as an option. This unit converts numeric input to alphanumeric output information. The read-only memory is made up of four circuit cards, each carrying 25 SUHL TTL ICs.

One of the main reasons that SUHL IC logic was selected for the KarTrak ACI system is the large numbers of logic forms available in the family. SUHL logic has the broadest line in the industry. More than 28 different types of SUHL circuits are used in the KarTrak ACI system.

This wide range of device types enabled the design engineers to tailor the system to the optimum configuration. Package count was kept to a minimum and actual design was simplified. **CIRCLE NUMBER 300**

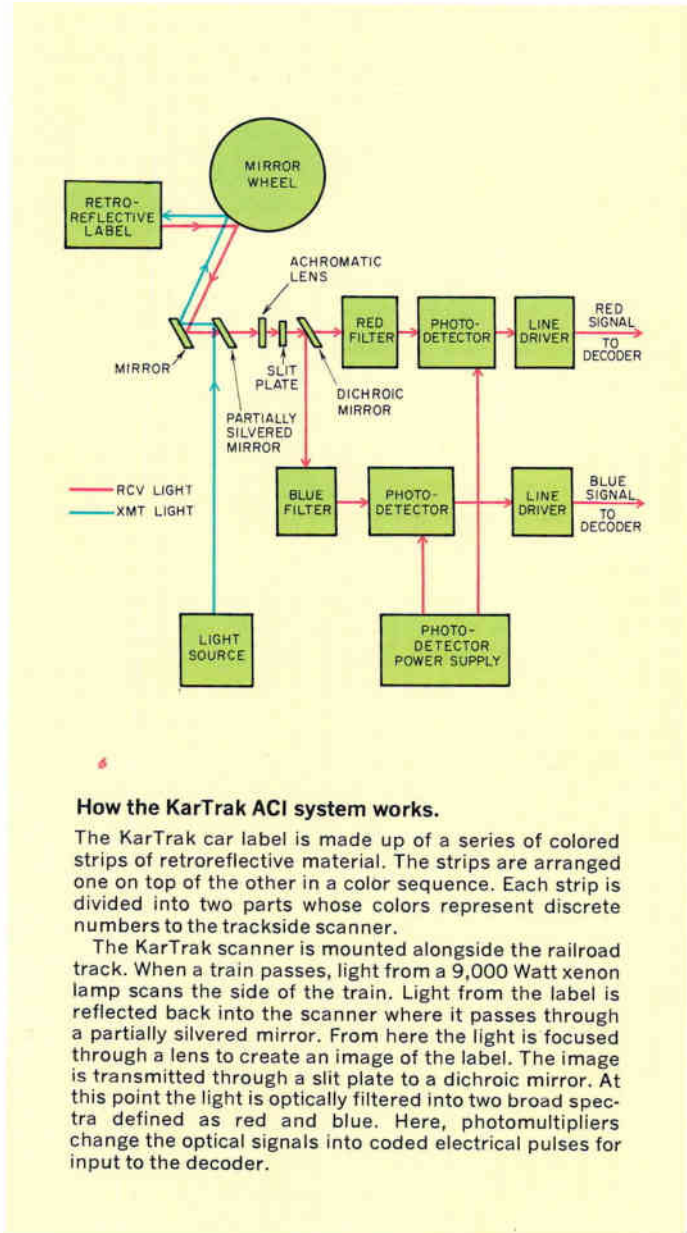

How the KarTrak ACI system works.

The KarTrak car label is made up of a series of colored strips of retroreflective material. The strips are arranged one on top of the other in a color sequence. Each strip is divided into two parts whose colors represent discrete numbers to the trackside scanner.

The KarTrak scanner is mounted alongside the railroad track. When a train passes, light from a 9,000 Watt xenon lamp scans the side of the train. Light from the label is reflected back into the scanner where it passes through a partially silvered mirror. From here the light is focused through a lens to create an image of the label. The image is transmitted through a slit plate to a dichroic mirror. At this point the light is optically filtered into two broad spectra defined as red and blue. Here, photomultipliers change the optical signals into coded electrical pulses for input to the decoder.

Now we have total TTL capability.

Addition of two new TTL product lines makes Sylvania's TTL the broadest and most diversified line available anywhere.

In today's highly selective integrated circuit market, TTL is the most popular digital logic form. And there are good reasons why. These reasons include a superior speed/power product, high noise immunity and the wide variety of functions available.

Sylvania pioneered the shift to TTL over five years ago with the introduction of SUHL (Sylvania Universal High-level Logic) integrated circuits. These products proved the superiority and practicality of the TTL technology.

Since then, the SUHL I and SUHL II families have been

constantly expanded as Sylvania continues to lead the way in TTL. A wide range of monolithic functional arrays have also been introduced to further enhance the line.

Now we've added two complete new lines of TTL logic to our constantly growing family. These new lines give you the widest choice of TTL circuits available anywhere. Now you can fill all of your TTL needs from a single reliable source—Sylvania.

CIRCLE NUMBER 301

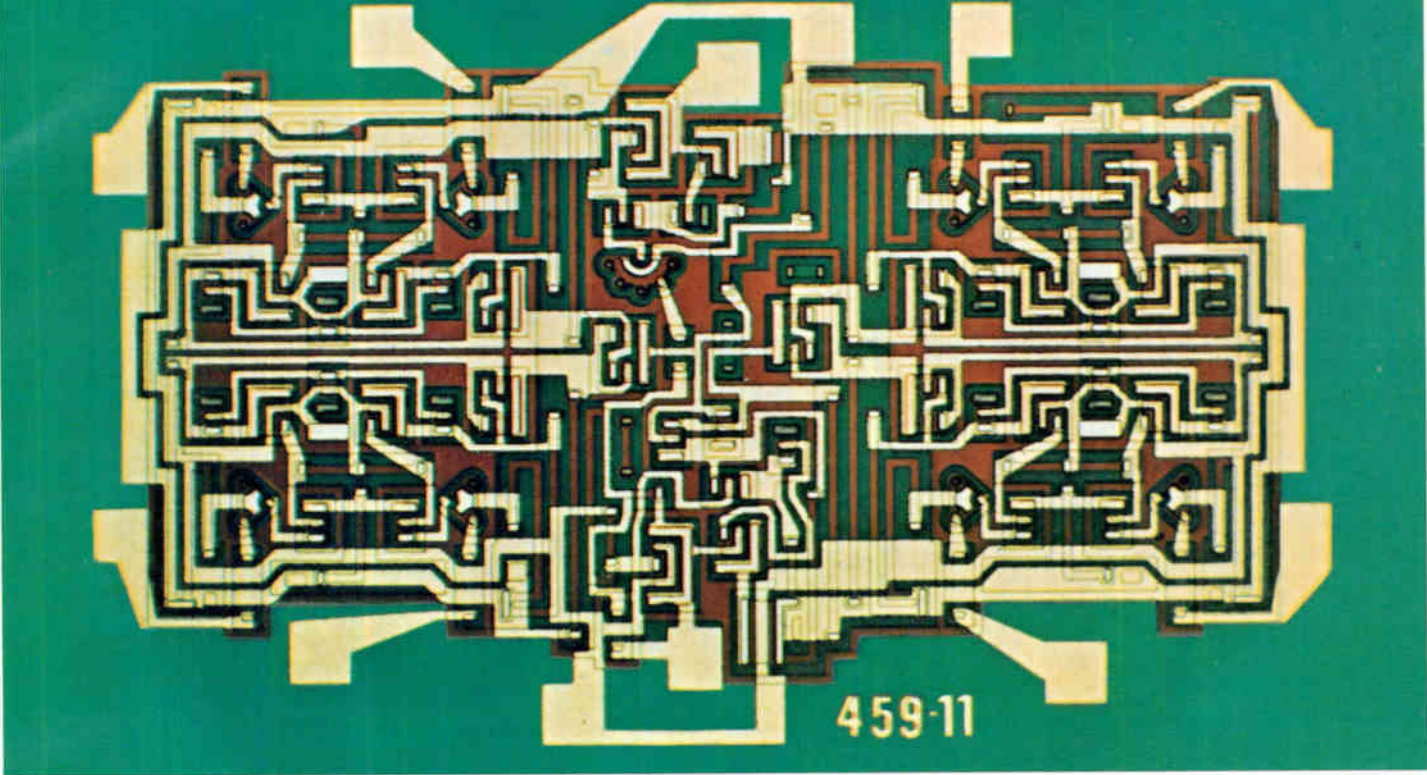

SM-120 parity generator/checker.

Sylvania TTL Integrated Circuits

Function	SUHL I	SUHL II	5400/7400	7400N
Dual 4-Input NAND/NOR Gate	SG40, 41, 42, 43	SG240, 241, 242, 243	SG5420, SG7420	SG7420N
Single 8-Input NAND/NOR Gate	SG60, 61, 62, 63	SG260, 261, 262, 263	SG5430, SG7430	SG7430N
Expandable Single 8-Input NAND/NOR Gate	SG120, 121, 122, 123	SG200, 201, 202, 203		
Dual 4-Input Positive NAND Buffer	SG130, 131, 132, 133		SG5440, SG7440	SG7440N
Quad 2-Input NAND/NOR Gate	SG140, 141, 142, 143	SG220, 221, 222, 223	SG5400, SG7400	SG7400N
Triple 2-Input Bus Driver	SG160, 161, 162, 163			
Triple 3-Input NAND NOR Gate	SG190, 191, 192, 193	SG320, 321, 322, 323	SG5410, SG7410	SG7410N
Expandable 4 Wide 2-Input AND-OR Invert Gate	SG50, 51, 52, 53	SG250, 251, 252, 253	SG5453, SG7453	SG7453N
4 Wide 2-Input AND-OR Invert Gate			SG5454, SG7454	SG7454N
Dual 2 Wide 2-Input AND-OR Invert Gate	SG70, 71, 72, 73	SG310, 311, 312, 313	SG5451, SG7451	SG7451N
Exclusive OR with Complement	SG90, 91, 92, 93			
Expandable Triple 3-Input OR Gate	SG100, 101, 102, 103	SG300, 301, 302, 303		
Expandable Dual 4-Input OR Gate	SG110, 111, 112, 113	SG210, 211, 212, 213		
Quad 2-Input Lamp Driver	SG351, 353		SG5401, SG7401	
Quad 2-Input Positive NOR Gate	SG330, 331, 332, 333	SG340, 341, 342, 343		SG7402N
Hex 1-Input Inverter	SG370, 371, 372, 373	SG380, 381, 382, 383		
Dual Pulse Shaper Delay AND Gate	SG80, 81, 82, 83			
Dual 4-Input AND-OR Gate	SG280, 281, 282, 283			
Dual 4-Input AND Expander	SG180, 181, 182, 183			
Quad 2-Input OR Expander	SG150, 151, 152, 153	SG230, 231, 232, 233		
Dual 4-Input OR Expander	SG170, 171, 172, 173	SG270, 271, 272, 273		SG7460N SG7450N
Expandable Dual 2 Wide 2-Input AND-OR Invert Gate				
Single Phase SRT Flip Flop	SF30, 31, 32, 33			
J-K Flip Flop (AND Inputs)	SF50, 51, 52, 53	SF200, 201, 202, 203		
J-K Flip Flop (OR Inputs)	SF60, 61, 62, 63	SF210, 211, 212, 213		
Dual D Flip Flop	SF80, 81, 82, 83	SF90, 91, 92, 93	SF5474, SF7474	SF7474N
Dual 35 MHz Flip Flop (Separate Clock)	SF100, 101, 102, 103	SF120, 121, 122, 123		
Dual 35 MHz Flip Flop (Common Clock)	SF110, 111, 112, 113	SF130, 131, 132, 133		
J-K Master Slave Flip Flop				SF7472N SF7473N
Dual J-K Master Slave w/Clear				

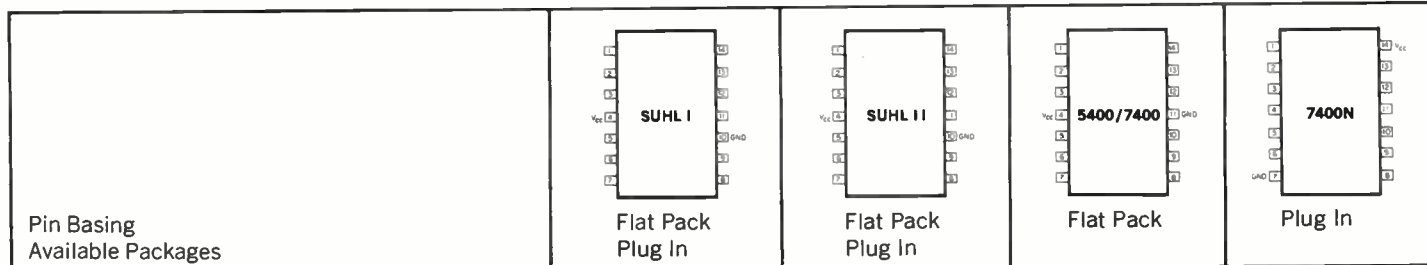

The Unicell approach to large-scale integration.

Basic cellular method gives a high degree of flexibility to design of LSI circuits.

Our research into large-scale integration has centered on a method of realizing arrays of a complexity of from 50 to 150 gates while retaining the design flexibility usually associated with less complex circuits.

We call our approach "Unicell." In our method, twenty to forty components are diffused in a fixed repetitive pattern resulting in a series of very small area cells. Cell can be made into gates, buffers, flip-flops or other logic elements simply by selecting the proper metallization pattern.

Assume you have a system requiring X number of 8-input gates, Y number of 4-input gates, and Z number of flip-flops. Further, assume that these elements must be interconnected to form a system function.

Here's how we go about it. The first step is to isolate enough cells on the wafer to provide a sufficient number to produce the needed logic elements. This group of cells becomes an array. Now the entire wafer has been divided into a series of arrays, each consisting of many cells (Fig. 1).

Next, the components in each cell are interconnected to form the required number of 8-input gates, 4-input gates, and flip-flops. The result is a series of arrays containing the required number of functional elements, but as yet the cells have not been interconnected with each other. That comes in the next series of steps.

At this point in the process, the entire wafer is covered with insulation. Then, windows are opened and the cells within each array are connected to each other in the vertical direction. Another layer of insulation is put down, windows opened, and interconnections are made in the horizontal direction (Fig. 2).

Thus, we have about one hundred identical arrays on a wafer, all internally interconnected to perform a system function. All that remains to be done is to test and package the individual arrays.

To accommodate the large number of functions built into each array, packages with 24, 36 or more leads are necessary.

Another feature of the Sylvania ap-

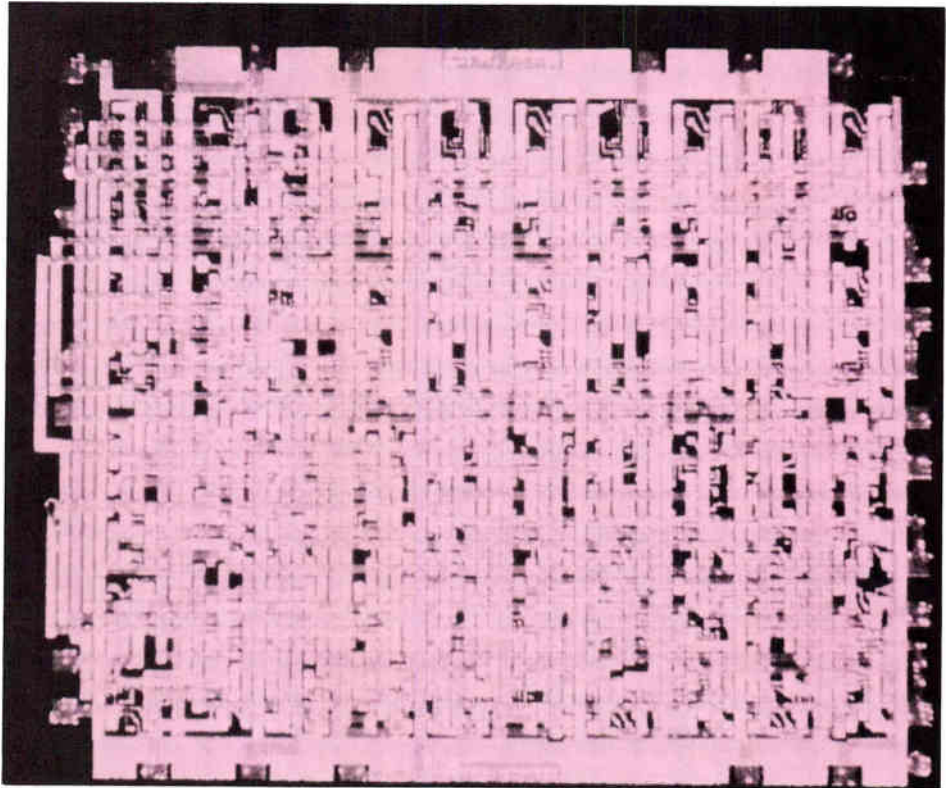

Adaptive 4-bit shift register uses 3-layer metallization.

proach to LSI is that each cell can be designed for either high speed or low power operation. Characteristics of typical circuits are shown in the table. The low power logic cells have a power dissipation of 3.5 mW and a propagation delay of 10 ns. The high speed logic cells dissipate 12 mW and have a propagation delay of 3 ns.

The finished arrays interface well with SUHL, TTL and DTL integrated

circuits having the same drive capability, loading factors and noise margins.

Some of the advantages of LSI can be seen from one logic system we designed on an experimental basis. One Unicell LSI package replaced 43 standard integrated circuits and 500 wired interconnections. The reduction in power dissipation over the IC breadboard version was a factor of three. Improve-

Unicell characteristics

	HIGH-SPEED CELL			LOW-POWER CELL		
	LOGIC GATE	DRIVER GATE	BUFFER INVERTER	LOGIC GATE	DRIVER GATE	BUFFER INVERTER
1. LOGIC (POSITIVE NAND)	$A \cdot B \cdot C \cdot D = E$	$A \cdot B \cdot C = D$	$A = \bar{A}$	$A \cdot B \cdot C \cdot D = E$	$A \cdot B \cdot C = D$	$A = \bar{A}$
2. POWER DISSIPATION	12 MW	15 MW	15 MW	3.5 MW	12 MW	15 MW
3. PROPAGATION DELAY	3 NS	8 NS	5 NS	10 NS	10 NS	5 NS
4. LOGIC FAN-IN	4 (EXP.)	3 (EXP.)	1 (EXP.)	4 (EXP.)	3 (EXP.)	1 (EXP.)
5. LOGIC FAN-OUT	10 4(W/O)	10 4(W/O)	10	10 8(W/O)	20 4(W/O)	20

Hybrid shift register has many advantages.

Monolithic MSI on ceramic substrates provides complex logic functions without problems of LSI.

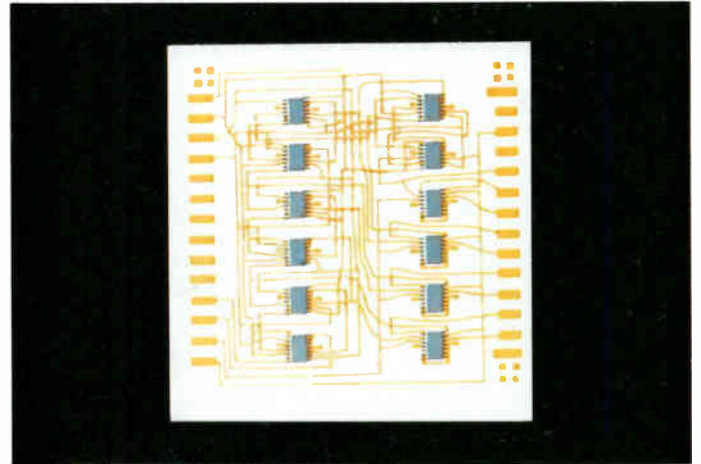

Hybrid 48-bit shift register uses 4-layer ceramic substrate.

Our new 48-bit shift register uses Sylvania MSI integrated circuits and a 4-layer ceramic substrate to obtain many advantages over large-scale integration systems and conventional printed-circuit board approaches.

The new design gives packing densities 8 to 10 times greater than can be obtained using printed circuits and flat packs. Because of the smaller size, short, narrow film conductors reduce interwiring capacitances to typically 1/5 to 1/10 that of multilayer printed circuit boards. Short lead lengths result in greater system speed.

The use of high purity alumina substrates also has advantages in thermal control. Thermal conductivity is about 100 times that of glass epoxy boards. Thermal resistance from junction to substrate is better than for conventional flat packs mounted on a printed-circuit board. The ceramic substrate is stable under prolonged exposure to temperatures up to 150°C.

The high-speed printing techniques used to make the ceramic multilayer logic arrays are inherently less expensive than photoetching, plating and laminating steps required for multilayer printed circuit board constructions.

In comparison to large-scale integrated circuit approaches our hybrid design has many advantages, too. For one thing, initial tooling cost is 1/10 to 1/100 the cost for monolithic LSI devices. Production costs are also far lower because the monolithic MSI integrated circuits used in our hybrid shift register are standard off-the-shelf items produced in high volume.

The hybrid approach also gives you design flexibility. Changes are easier to make. You can combine bipolar, MOS and other devices on the same ceramic substrate. And they can all be off-the-shelf devices.

We've also increased the reliability of our shift register by using beamlead ICs. In connections alone, use of beamleads has reduced the number from 42 man-made joints to 12 machine-made joints per IC.

With all of these advantages, wouldn't it pay you to investigate our hybrid shift register for your next application problem?

CIRCLE NUMBER 303

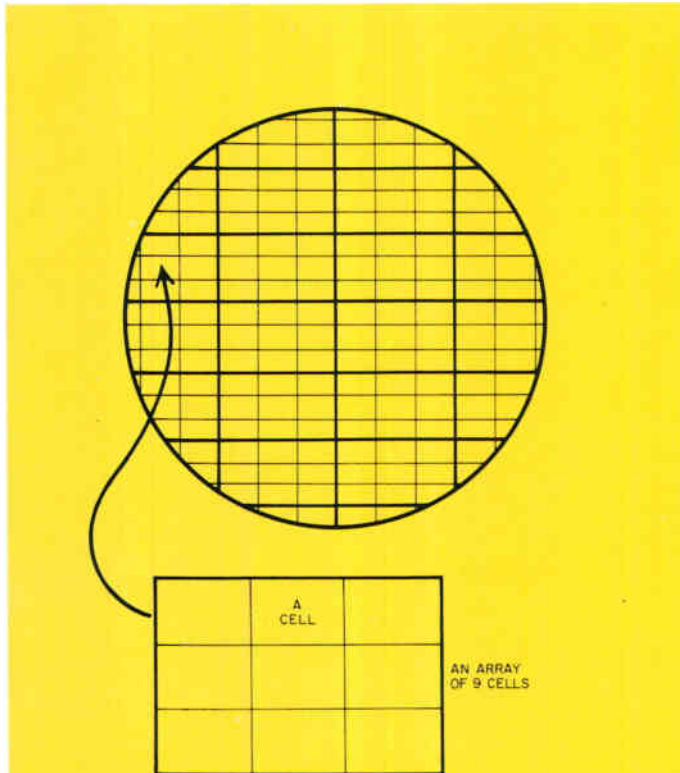

Fig. 1. Wafer is divided into a series of arrays, each consisting of many cells.

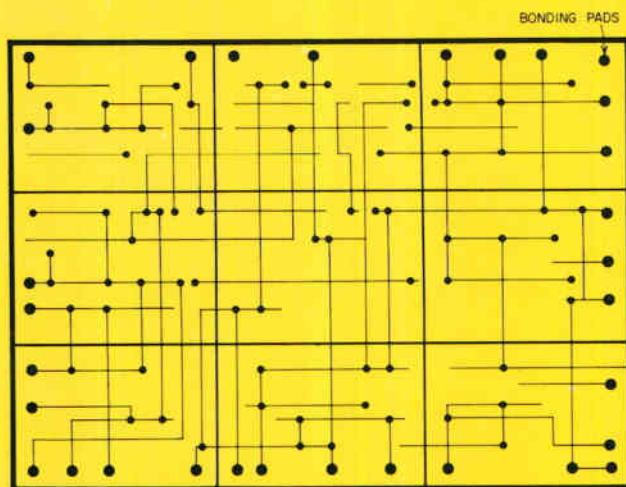

Fig. 2. Interconnections between cells are made by separate horizontal and vertical metallizations.

ment in propagation delay through the longest gate chain was a factor of two.

Improvement in speed/power product by a factor of 5 to 10 over standard integrated circuit families have been realized in other arrays that have been produced.

If you're considering LSI for your next design project, talk to Sylvania's engineers. They'll show you how to get high-level performance without losing design flexibility.

CIRCLE NUMBER 302

Up-down counters run at speeds up to 20 MHz.

High-speed devices cut package count, reduce wiring, and lower power drain.

Our new SM-183 and SM-193 up-down counters are functional arrays that contain four J-K flip-flops. Both are 4-bit synchronous up-down counters capable of speeds up to 20 MHz. The SM-183 is a binary counter and the SM-193 provides a binary coded decimal output. A mode control input switches internal gating to select up or down counting. An additional advantage that both the SM-183 and SM-193 have over conventional 4-bit counters is that appropriate flip-flop outputs are internally ANDed with the clock input. This provides a decoded clock signal for near synchronous systems operation.

The SM-183 binary up-down counter (1248 code) is designed for computer applications. Its decoded clock goes

high with the clock input when the counter is counting up and is in the "1111" state or when the counter is counting down and is in the "0000" state.

The SM-193 binary coded decimal counter is suitable for use in display devices or anywhere a coded decimal output is required. The decoded clock of the SM-193 goes high with the clock input when the counter is counting up and is in the "1001" state or when the counter is counting down and is in the "0000" state.

Each flip-flop in the counters has an external Q output, an asynchronous SET input and a common reset input. A logic "0" at the RESET input causes all four flip-flop outputs to go to a logic "0". A logic "0" at any SET input causes the corresponding output to go to a logic "1".

The SM-183 and SM-193 up-down counters are compatible with SUHL I and SUHL II integrated circuits as well as other Sylvania arrays. They are immediately available for operation over the industrial temperature range of 0°C to +75°C in your choice of 14-lead hermetic packages, flat packs or dual in-line packages.

CIRCLE NUMBER 304

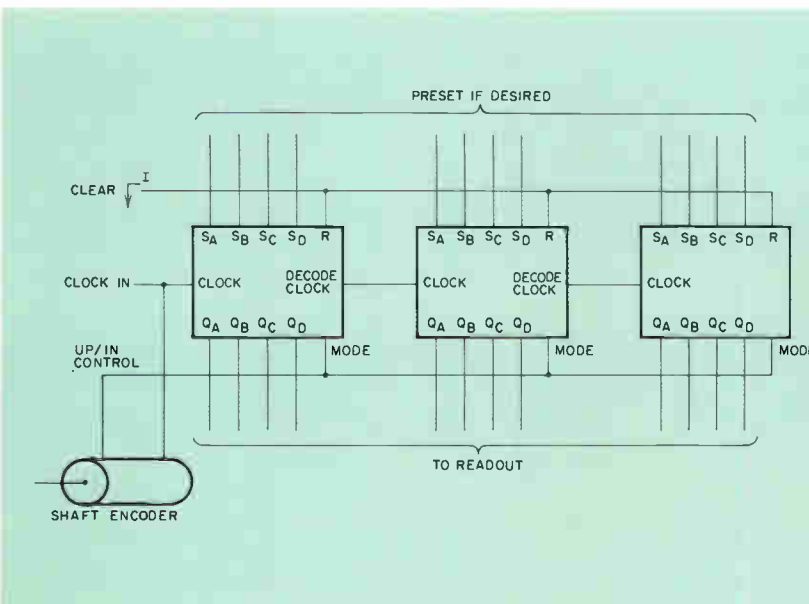
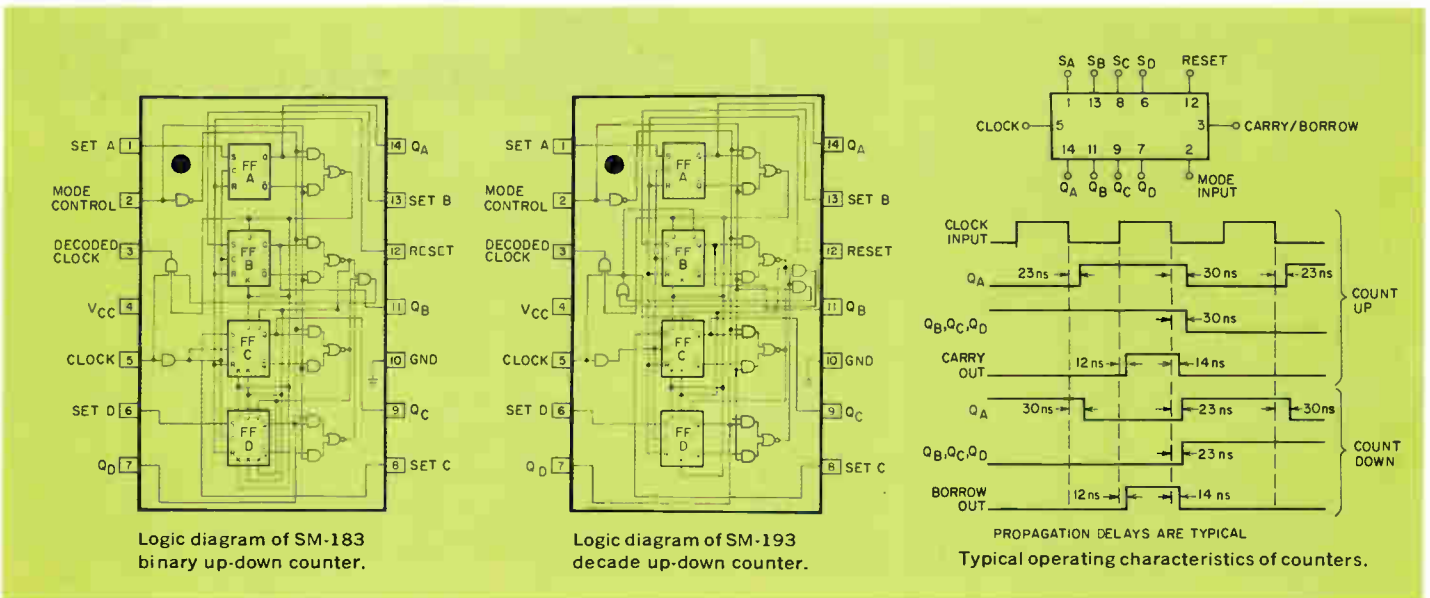

Using up-down counters with shaft encoders

Internal gating provided in the package makes the SM-183 and SM-193 especially useful in applications requiring both up and down counting. An example of this could be an X/Y plotter which would have shaft encoders on each axis. To keep track of the position of the plotter, all that is required from the encoder would be a direction of motion signal and a clock pulse for each unit distance of travel. Thus, if the Up-Down Counters were reset to zero at the 0 0 coordinates of the plotter, the counters could count up for displacement in the positive direction and count down for displacement in the negative direction.

If the encoder provided a pulse for every micron of distance traveled, the Up-Down Counters would always contain the value in microns of displacement from the 0 0 position.

Isylithic beamlead ICs rival discrete components.

Isolation process eliminates parasitic capacitances, gives 1 to 2 nanosecond switching speeds.

Sylvania is now developing an Isylithic beamlead process for making integrated circuits that are a match for the best discrete components in most respects and are even better when it comes to speed.

In Isylithic devices, circuit elements are air isolated from each other. This eliminates parasitic capacitances and permits performance equal to discrete device systems. The use of beamlead construction permits closer interconnection of components and lower lead inductance. This makes possible switching speeds in the 1 to 2 ns range.

Isylithic devices are made in a manner similar to the process for ordinary integrated circuits except that the buried layer and isolation diffusion steps are eliminated. After the diffusion processes have been completed a thin-film metallization pattern is deposited and heavy gold beamleads are electroplated on top of the metallization. Isolation of the circuit elements is obtained by selectively etching the back of the wafer to provide air isolation between the elements.

The finished integrated circuit is now ready for face bonding into film hybrid or microstrip circuits.

Sylvania has been working with beamlead devices for over three years and finds that they have definite advantages over other types of flip chip mounting.

Among the chief advantages of beamlead are the visibility of the bonds for inspection, reliability of the metallurgy, and the possibilities for low-cost assembly. The beams are about 0.5 mil thick and extend about 6 mils from the edge of the circuit. The beams can be bonded directly and simultaneously to a metallized substrate. The resulting bonds can be inspected, tested and even individually repaired if needed.

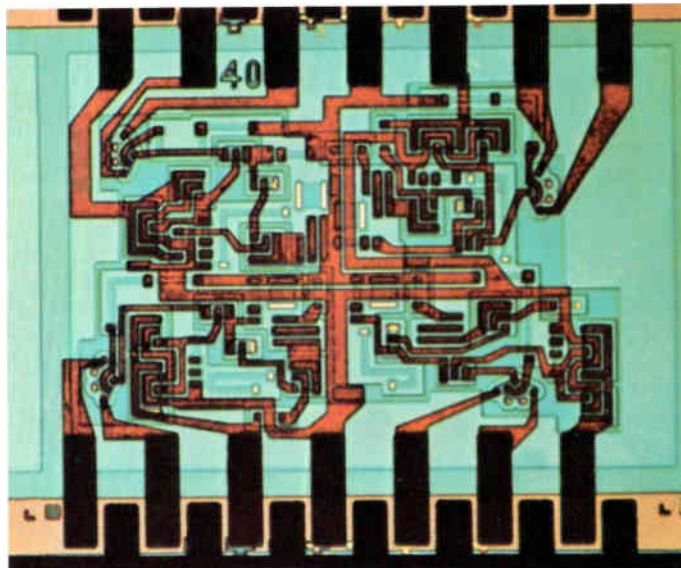

Isylithic beamlead device.

The beams, being flexible, will tolerate differences in height of the substrate metallization. This can be an important factor in their use with thick-film circuitry where silk-screened metallization always has a certain degree of irregularity.

Our Isylithic devices are passivated with silicon nitride. This provides a chip that is completely protected against ion migration and requires only mechanical protection.

For assembly of beamlead Isylithic devices, we are developing computer controlled automatic equipment that will position the substrate, position the Isylithic device on the substrate and simultaneously bond all connections. This equipment is the forerunner of a completely automated assembly line.

Although the Isylithic process is still in the development stage at Sylvania, we are producing beamlead devices for use at microwave frequencies.

CIRCLE NUMBER 305



HOT LINE INQUIRY SERVICE

Need information in a hurry? Use Sylvania's "Hot Line" inquiry service. It's easy and it's free. Just circle the reader service number(s) you're most interested in. Then fill in your name, title, company and address. We'll do the rest and see that you get further information by return mail.

You can also get information by using the publication's inquiry card elsewhere in this issue. However, using the card shown here will simplify handling and save time.



Fold and seal with tape or glue. (Do not staple.)

Fold here

FIRST CLASS
Permit No. 2833
Buffalo, N. Y.

BUSINESS REPLY MAIL
No Postage Stamp Necessary if
Mailed in the United States

POSTAGE WILL BE PAID BY

Sylvania Electric Products Inc.
Sylvania Electronic Components
1100 Main Street
Buffalo, New York 14209

Dept. D 7 7

MANAGER'S CORNER

What does MIL-STD-883 really mean?

There has been a lot of confusion surrounding MIL-STD-883 and what its purpose is and how it can be most effectively used. This publication is the first attempt at codification of a military standard for test methods and reliability specifications especially for microelectronics. It was prepared by Rome Air Development Center with suggestions and recommendations being made by major suppliers in the industry prior to publishing.

The genealogy of MIL-STD-883 can be traced through a long line of military specifications including MIL-E-1, MIL-STD-202, MIL-S-19500 and MIL-STD-750. Many of the test procedures in "883" are similar to or identical to methods previously used in these earlier specifications; often, only the method numbers being changed.

MIL-STD-883 is similar to its predecessors in that it offers a wide variety of options as to stress levels and alternate methods for performing many of the tests. Thus, the phrase often used by some customers that their ICs must be processed, in accordance with "883", is completely meaningless unless specific procedures and stress levels are called out. If the customer is not sure which procedures and stress levels he needs, assuming he has already determined that one of our standard Sylvania test plans is inadequate, he should discuss his requirements with our Field Engineering and Quality Control groups prior to requesting a quotation.

In addition to the standard types of environmental, mechanical, electrical and life tests, "883" contains some new

and relatively controversial methods on Internal Visual (Precap) Inspection (2010), Screening Procedures (T5004) and Lot Qualification Inspection (T5005). These and other procedures are often the heart of many high reliability specifications. Sylvania has developed alternative precap and screening procedures which are less costly but still provide the desired level of reliability.

For our part, we believe firmly in the concept of "building the quality in" and have tried to develop in-process Quality Control procedures that are aimed more at corrective rather than weed-out techniques. We have adopted and have been using since its inception, many of the procedures in "883". For example, our monthly life and design (Group B and C) tests are exactly the same as those specified in Method T5005 Qualification Inspection. We have also developed many of our own methods which are completely compatible and consistent with them. These procedures are generally spelled out in our Reliability Brochure (SM-1057-9P) and in detail in our Integrated Circuit Quality Control Manual.

In summary, the value of any specific procedures can be assessed only in the light of the intended application for the device; however, we at Sylvania heartily endorse "883" as a good first step in the right direction toward much needed standardization in the integrated circuit industry.



D. M. Russell
Manager, Quality Assurance and Reliability

This information in Sylvania Ideas is furnished without assuming any obligations.

SYLVANIA

GENERAL TELEPHONE & ELECTRONICS

NEW CAPABILITIES IN: ELECTRONIC TUBES • SEMICONDUCTORS • MICROWAVE DEVICES • SPECIAL COMPONENTS • DISPLAY DEVICES

I am especially interested in ICs for following application(s) _____

NAME _____

TITLE _____

COMPANY _____

ADDRESS _____

CITY _____ STATE _____ ZIP _____

Circle Numbers Corresponding to Product Item

300

301

302

303

304

305

Please have a Sales Engineer call

TODAY YOUR CLOCK IS 32 HOURS SLOW!

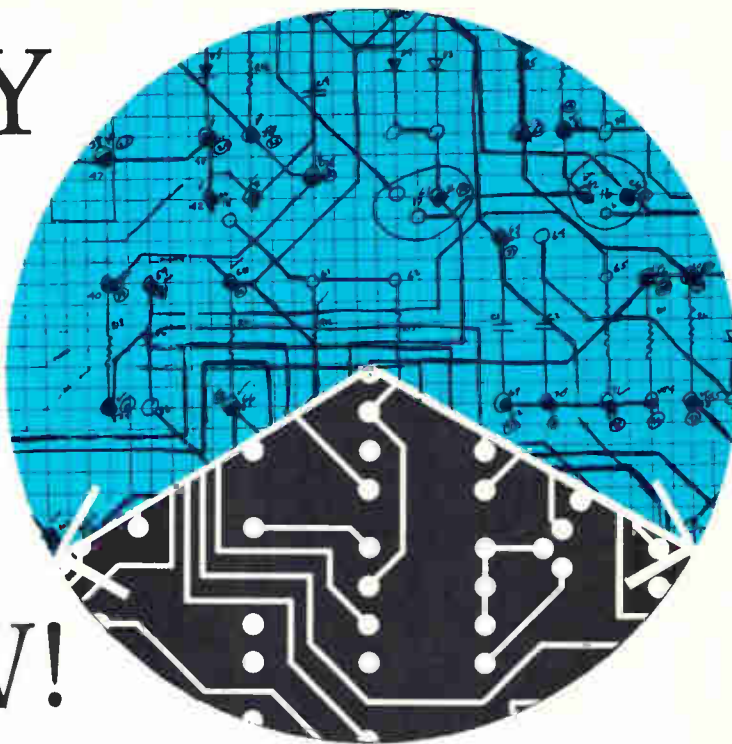

And, you can lose a valuable 32 hours on every circuit board film master you produce . . . unless, of course, you have a SLO-SYN® N/C Photo Artwork Generator to shave those 32 hours from the time it normally takes from printed circuit board sketch to finished size film master.

Then, it's *sketch to etch* in 8 short hours or less!

N/C tapes can be made directly from engineer's rough sketch and the basic program

can then be used to control drilling, eyelet and component insertion.

Time saving is your number one benefit . . . but improved accuracy, a complete manufacturing blueprint on tape and the positive production control that results are great big profit plusses.

If your clock is losing 32 hours or more on every circuit board . . .

call, write or wire:

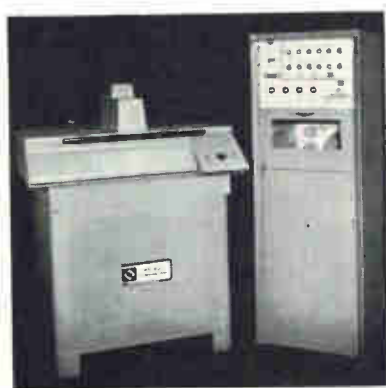

Other systems include conventional and cantilever style positioning tables and complete machines for PC board drilling, wire terminating and eyelet insertion. Request complete literature file.



**THE
SUPERIOR ELECTRIC
COMPANY**

506 Middle Street, Bristol, Connecticut 06010
203/582-9561

SALES ENGINEERING OFFICES IN PRINCIPAL CITIES

MAGNETICS BY ARNOLD

RUB-A-DUB-DUB... GOODBYE!

So who wants the hand crank on the washer and wringer?

On today's automatics you push the button and you're in business. Of course the timer requires an Arnold hard ferrite unit and so does the motor. But they get the job done with much less scrub. And a good many other appliances around the home lean on Arnold to get *their* job done.

Forward-looking manufacturers always look to Arnold for high-quality magnetic materials, design, technology and components. Magnetic cores. Powder cores. Laminations. You ask. We'll supply. The best in magnetic materials.



ARNOLD

SPECIALISTS IN MAGNETIC MATERIALS



The Arnold Engineering Company, Main Office: Marengo, Ill.
Branch Offices and Representatives in Principal Cities

Write for your free guide to the only complete line of magnetic materials.

Other Arnold products can also fit easily into the appliance industry: MPP and powdered iron cores • Tape and Bobbin Cores • Alnico and Arnox® permanent magnets • Supermendur transformer cores.

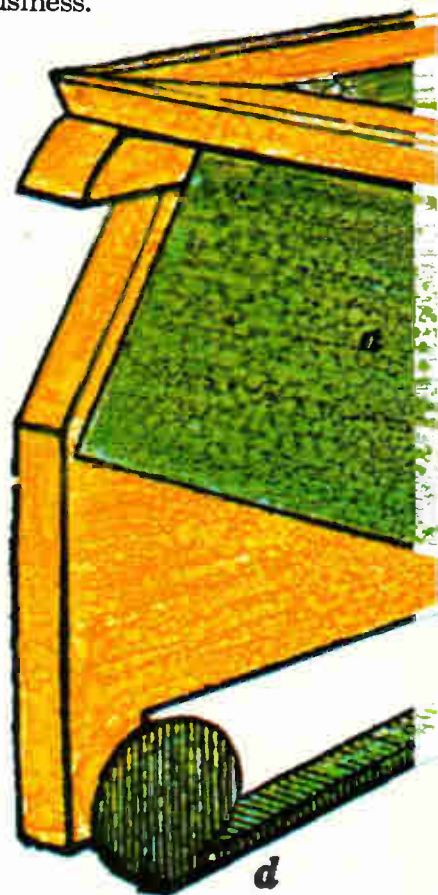

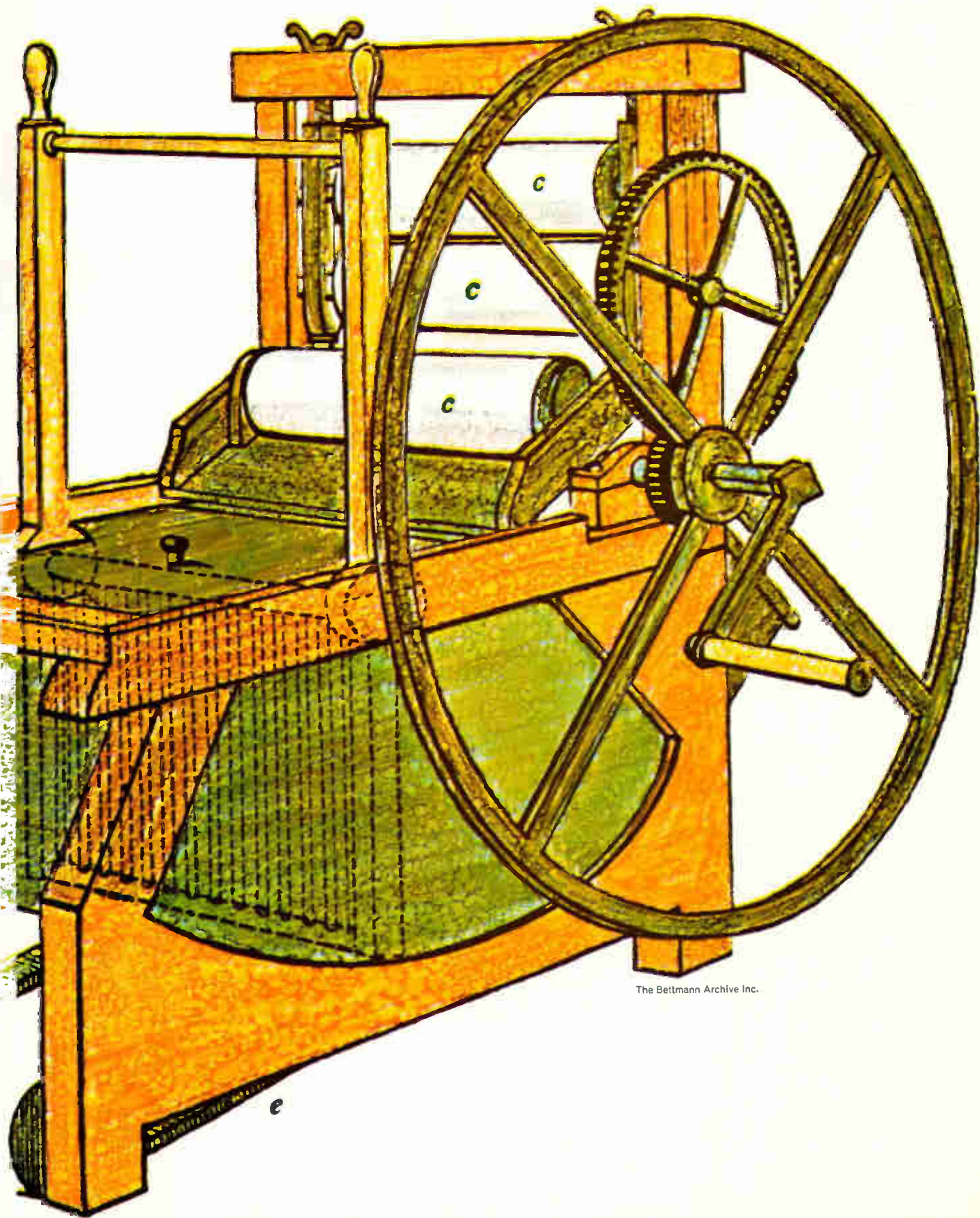

The Bettmann Archive Inc.

Circle 59 on reader service card



The Trend is TTL.

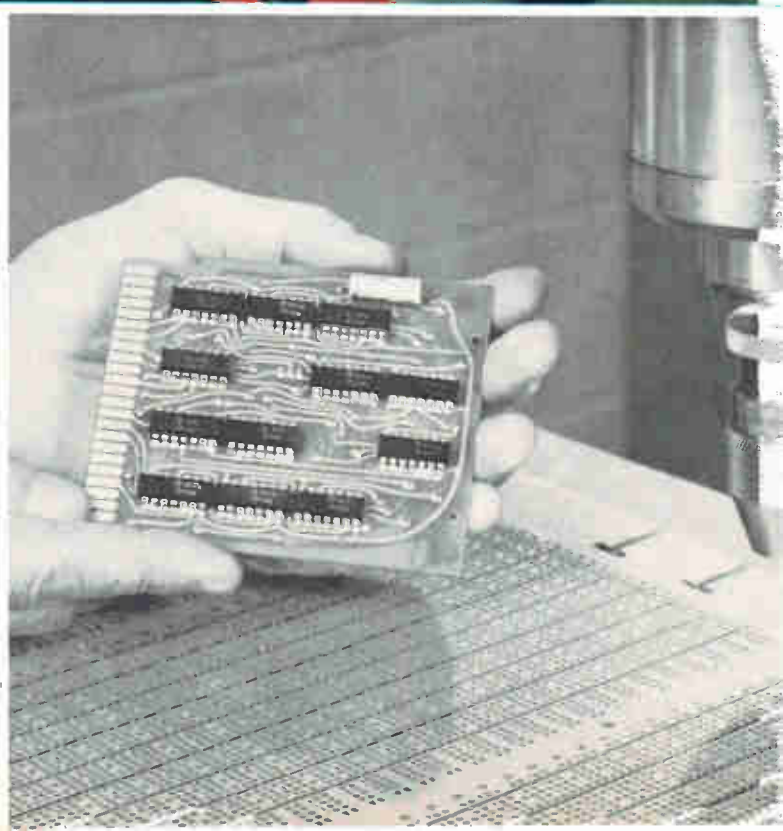

Icon all-digital numerical control helps customer cut costs and downtime.

TI integrated circuits help Icon build reliability and economy into all-digital numerical controls.

Icon Corporations' System 350 all-digital open-loop numerical control is turning in new records for reliability, economy and ease of installation.

The TI Series 74N TTL integrated circuits used in the system are giving flawless performance. About the ICs, Dr. Gordon Baty, Icon president said: "Of the more than 30,000 we have in the field, we've had almost no inexplicable

failures. We think this kind of trouble-free performance is what machine tool users want. We sink or swim on reliability and performance on the machine shop floor."

Icon's open-loop system offers far greater reliability, lower overall costs, and easier retrofit of existing machine tools.

One retrofit example: National Connector purchased a 75-year old vertical mill from a junkyard for \$250. They restored it and installed an Icon System 350 numerical controller.

Total costs ran about \$15,000 (less than one-half the cost of machines with similar capabilities). The restored mill met both tolerance and production-rate demands of National's high-precision interconnection manufacturing facility.

Retrofit went smoothly and quickly. Both mill and controller worked perfectly the first time with normal adjustments. Today, after more than a year, the system is still working perfectly.

Maintenance is simplified. High-density IC design packs instantly recognizable functions onto individual cards—allowing fast diagnosis and easy replacement.

Each Icon System 350 utilizes more than 250 TI Series 74N TTL integrated circuits in low-cost plastic packages. About twenty different types are used—including some of the latest MSI circuits.

New design aid

Integrated circuits from TI are helping many other manufacturers of industrial systems to increase reliability, improve performance, and reduce costs. Find out more from a new 80-page brochure that includes valuable design information on Series 54/74—industry's broadest TTL line. Circle 118 or write Texas Instruments Incorporated, P.O. Box 5012, M.S.308, Dallas, Texas 75222.



Upper Photo: Earl Johnson, consulting engineer for National Connector, holds one of the Icon boards containing TI TTL integrated circuits.

Lower Left: This vertical mill was purchased from a junkyard for \$250. After clean-up and restoration, an Icon numerical control was fitted smoothly and quickly. The new unit met both tolerance and production rate demands of National Connector.

Lower Right: Series 74N integrated circuits deliver command pulses to hydraulically-assisted stepping motors—positioning the mill to accuracies of ± 0.002 ".

TEXAS INSTRUMENTS
INCORPORATED

Using spot ties for wire harnessing?

HERE IS THE
**GUDEBROD
SYSTEM "S"**

—SPEEDS THE WORK—SAVES MONEY, TOO!

GUDE-TIES CUT LENGTHS—Specifically produced for spot knotting these handy cut lengths of Gudebrod Flat Braided Lacing Tape are dispenser packaged for one hand, speedy withdrawal. Available in 6", 8", 10", 12", 15", 18", 20" and 22" lengths (other lengths on order). Meet or exceed MIL-T Specs, no-slip knots hold firmly without cutting insulation.

GUDE-SNIPS—These palm-of-the-hand snips cut cleanly, easily. For right or left hand use, spring action, DuPont Teflon bearing. Allow operator to have free use of fingers without constant reaching for knife or shears. Save motion, save time.

GUDEBROD SWIVEL-TILT HARNESS BOARD MOUNT—Balanced, two dimensional action brings every section of the harness within easy reach. No stretching, no straining. Knots are tied in an easy, natural position. Cuts fatigue—speeds work.

Here you have the Gudebrod System "S" for spot tie lacing, based on the high quality, high speed Gudebrod Lacing Tape—if you're interested in saving money while speeding the harness work, get in touch with us. (For continuous tying, ask about System "C".)

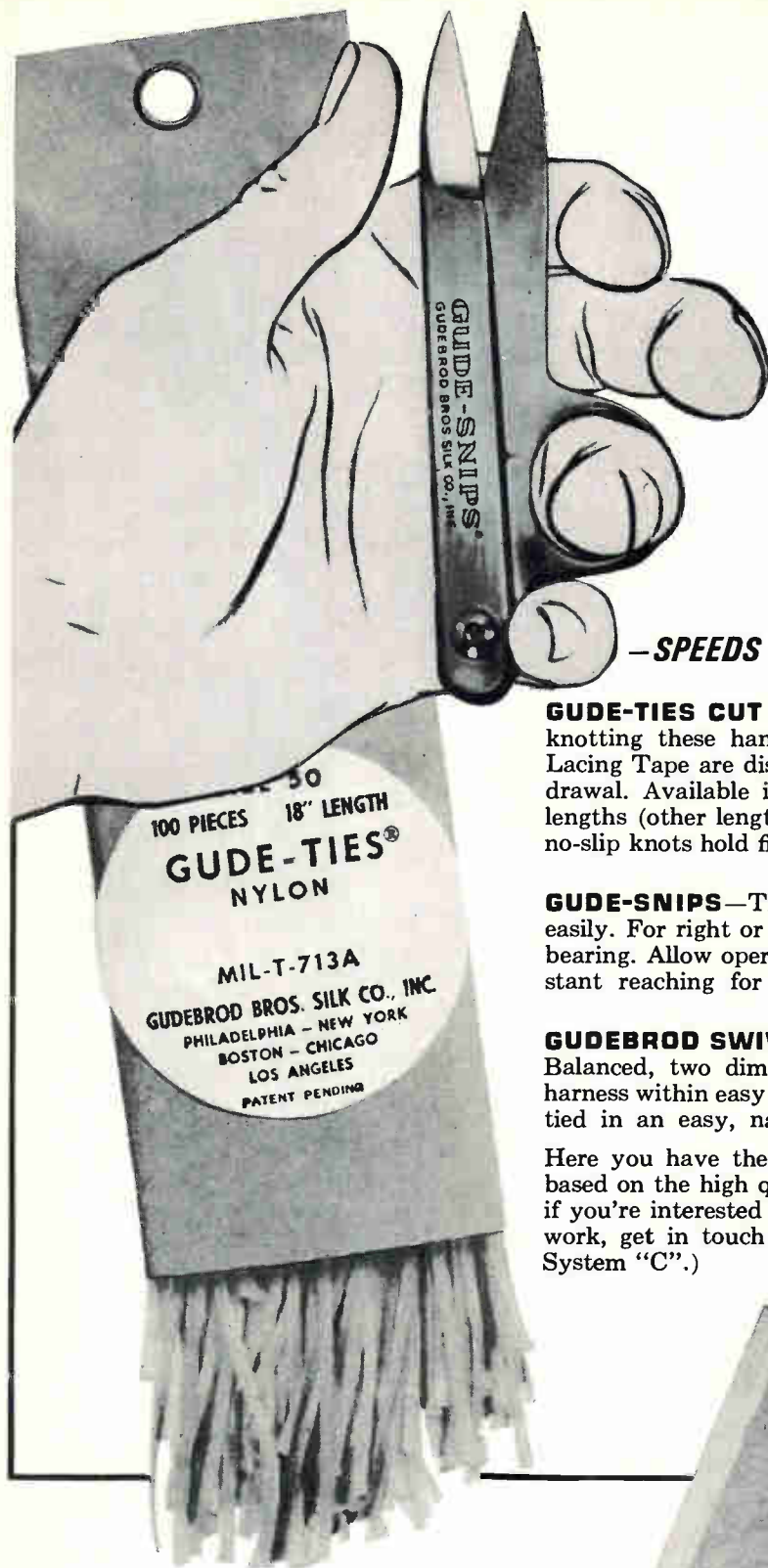

Available also in other types
of Gudebrod Lacing Tapes

GUDEBROD
Electronics Division

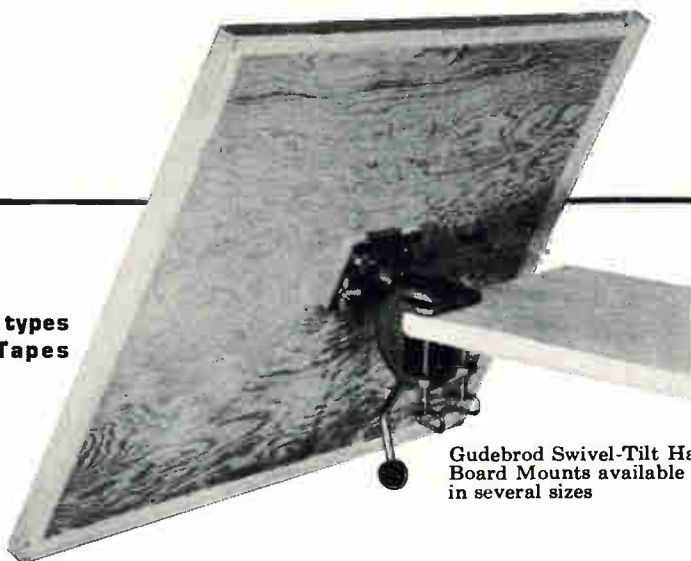

Gudebrod Swivel-Tilt Harness Board Mounts available in several sizes

GUDEBROD BROS. SILK CO., INC., Founded 1870, 12 South 12th Street, Philadelphia, Pa. 19107

Circle 62 on reader service card

Electronics | September 15, 1969



the
structure
of
excellence

The excellence of Markel electrical insulating products is composed of many elements.

● First, there is Markel's experience . . . almost fifty years of it . . . providing a thorough understanding of the electrical insulating problems of industry and the know-how to solve them. ● Then, there is the massive line of Markel products, developed one at a time to meet every conceivable requirement. More than 3,500 different types and sizes in all. ● To produce all these different insulations in large volume at competitive prices requires extensive, modern manufacturing facilities . . . probably the finest in the business. ● But all this experience, knowledge and capacity would be of little value to you without Markel's nation-wide network of sales engineers who bring Markel products and problem-solving capabilities as close to you as your telephone.



ONE SOURCE FOR EXCELLENCE
*in Insulating Tubings and Sleeveings
High Temperature Wire and Cable*



L. FRANK MARKEL & SONS, INC., NORRISTOWN, PA. 19404 • PHONE: 215/272-8960

Circle 63 on reader service card



No other multimeter gives you all this

and no one but Cimron can make a claim like that stick

Here's the first and only 4-digit instrument that you can take with you and hook up for full multimeter performance anywhere. Cimron, the Customer Concern Company, puts your needs first. That's why this new Cimron 6453 is just one more the competition will have to catch up with.

You get the most advanced MSI and IC construction plus a thin film attenuator . . . which, by the

way, eliminates 75% of the normal calibration requirements. Single plane Digivac readout tubes result in the lowest power consumption of any digital multimeter, and make full-day battery operation possible. The same amplifier used in the most costly instruments provides an input impedance ten times greater than any meter in its class.

The basic instrument gives you 5 ranges of DC voltage measurement with 5th digit overrange, autoranging in all functions, autopolarity, and pushbutton selection. Add remote control, AC,

resistance, print output and the 8-hour battery pack options, and you have full remote program-

ing capability anywhere. And it's computer compatible. The 6453 . . . just 8 pounds and 3½" x 8" x 12", sells for only \$1,125. A full multimeter is less than \$1,600. *Call us for a demonstration.* Phone (714) 276-3200 or write

Cimron, Dept. D-109, 1152 Morena Blvd., San Diego, Cal. 92110.

CIMRON
first name in measurement



LEAR SIEGLER, INC.

CIMRON DIVISION

YOU ASKED FOR IT.....

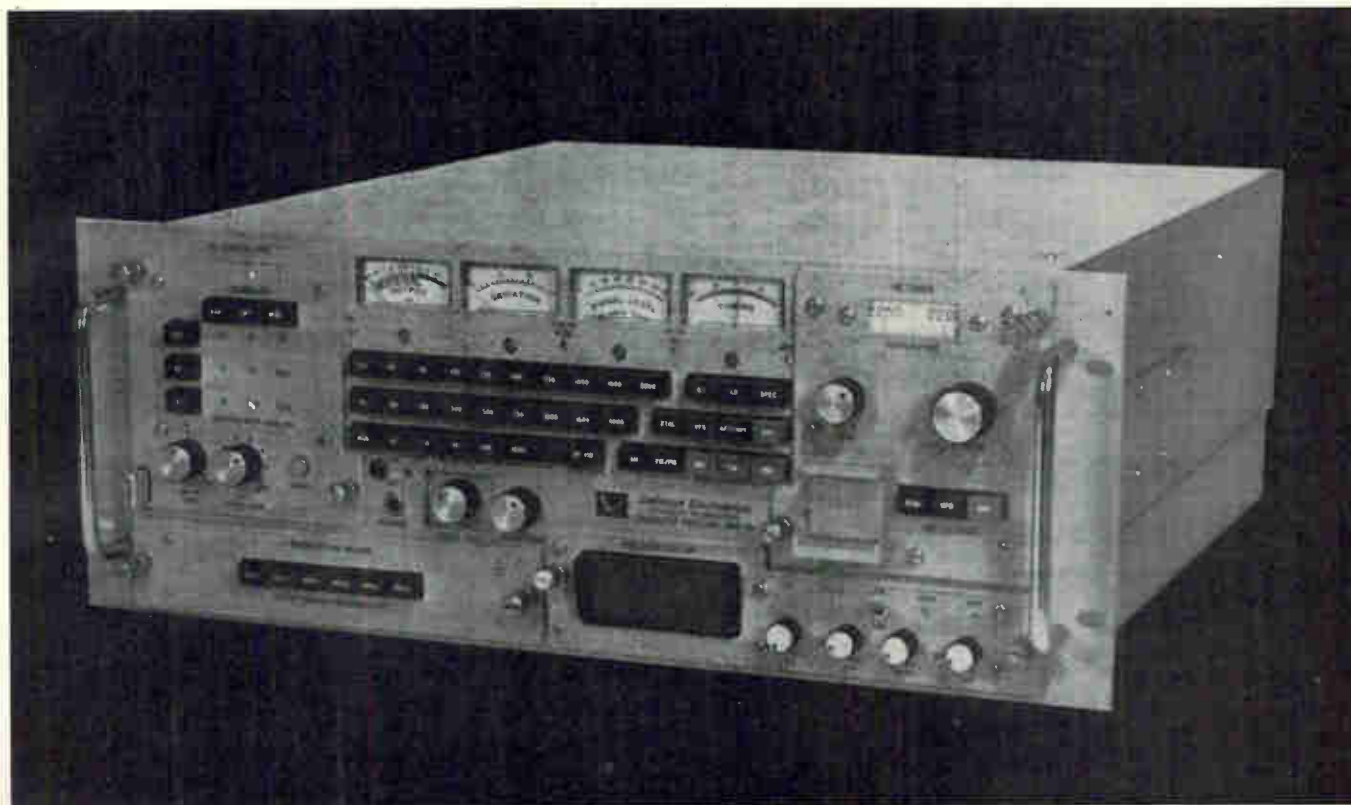

MODEL TMR-74—THE FIRST “OFF-THE-SHELF” TELEMETRY RECEIVER TO BE ACTUALLY SPECIFIED BY YOU...THE USER.

- PUSHBUTTON SELECTABLE OR COMPUTER PROGRAMMABLE LINEAR PHASE IF FILTERS AND COMPATIBLE BANDWIDTH DEMODULATORS—YOUR nine integral linear phase IF filters from 10 kHz to 6.0 MHz and four integral demodulators including AM, narrowband FM, Standard FM and wideband FM are all selectable by computer or front panel pushbuttons. Extra wide (3 MHz linear phase baseband video response) and wide angle phase demodulators also available.
 - IMPROVED AFC CIRCUITRY—YOUR drift reduction factor of 5,000:1, virtually eliminates tuning and frequency errors.
 - INDEPENDENT AND/OR COHERENT LOCAL OSCILLATORS—YOU can now use two or more standard receivers with pre-detection diversity combiners.
 - ELECTROMAGNETIC INTERFERENCE—YOUR receiver is certified to MIL-STD-461.
 - IF PHASE LINEARITY TO $\pm 3^\circ$ AND REDUCED 3RD ORDER INTERMODULATION—Assures YOU of minimum data error and distortion for All modulation formats.
 - IMPROVED ADJACENT CHANNEL RF/1ST IF SELECTIVITY—Provides YOU with increased immunity to desensitization.
 - FUTURE EXPANSION—YOUR receiver will be less susceptible to obsolescence since the standard 5½ inch panel can be replaced by a 7 or even an 8¾ inch compatible panel to accommodate additional modules.
- If YOU wish to learn how many of YOUR other ideas such as IC's and FET's were incorporated, write or call Defense Electronics, Division of DEI Industries.

Defense Electronics

PRODUCERS OF
DEI AND NEMS-CLARKE
EQUIPMENT



A DIVISION OF
DEI
INDUSTRIES

ROCKVILLE, MARYLAND 20854; (301) 762-5700; TWX: 710-828-9783; TELEX: 089602 • LOS ANGELES, CALIFORNIA 90045; (213) 670-4815
INTERNATIONAL: ROCKVILLE, MARYLAND, USA CABLE: DEI USA; INTELEX: 64102

Sales representatives in major cities throughout the world.

NEW TECHNIQUE IMPROVES LOW-LEVEL SIGNAL MEASUREMENTS

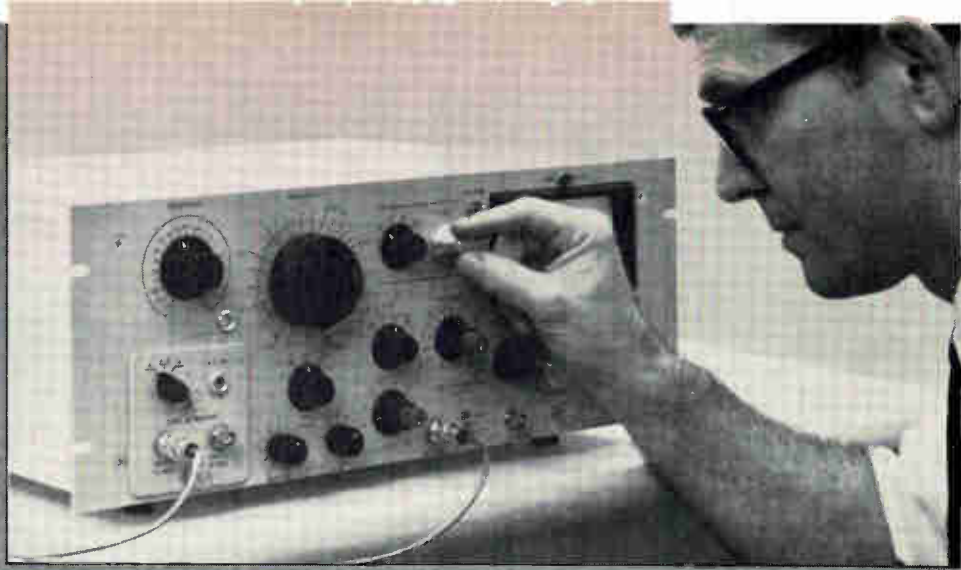

Where extremely low-level signals must be measured in the presence of obscuring noise, the use of a PARTM Lock-In Amplifier can often transform a complex and sometimes futile investigation into a routine test procedure. For example, Lock-In Amplifiers can be used to:

MEASURE AMPLIFIER CROSSTALK TO ONE NANOVOLT

Where amplifiers are in close proximity in low level data processing systems, the minimum detectable signal is frequently limited by the crosstalk or mutual interference generated. By using a Lock-In Amplifier to measure crosstalk: (1) The source of feed-through can often be identified since very low-level crosstalk can be measured over a wide frequency range. (2) Further extraneous signal coupling errors are eliminated because no instrumentation other than the Lock-In Amplifier is necessary. (3) Crosstalk levels as small as one nanovolt can be detected. (4) The phase of the crosstalk can be identified.

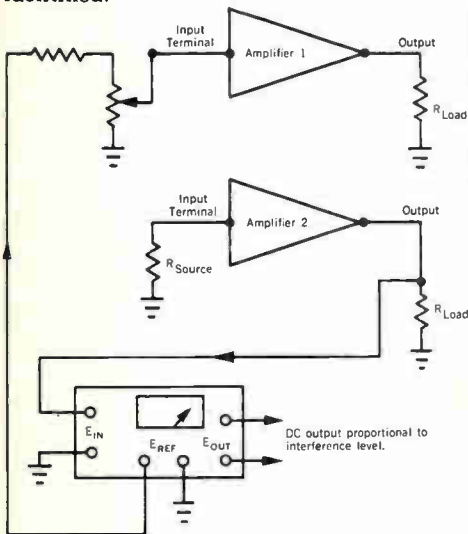

LOCK-IN AMPLIFIER
USED FOR AMPLIFIER CROSSTALK MEASUREMENT

IMPROVE BRIDGE SENSITIVITY TO ONE NANOVOLT (FS)

A Lock-In Amplifier improves bridge sensitivity without over-driving the bridge circuit. Excite the bridge with the Lock-In Amplifier's internal oscillator and connect the external null detector termination to the signal input to get: (1) Measurements over frequencies of 1.5 Hz to 150 kHz. (2) Optimum noise figures using available preamplifiers with input impedances of several ohms to 100 megohms. (3) One nanovolt full-scale sensitivity for improved null accuracy and extremely low power dissipation in critical circuits. (4) A dc signal proportional to the off-null condition for use in modifying bridge parameters or as a recorder input. (5) Detection of in-phase (resistive) and quadrature (reactive) bridge components which can be nulled independently (and simultaneously, if desired).

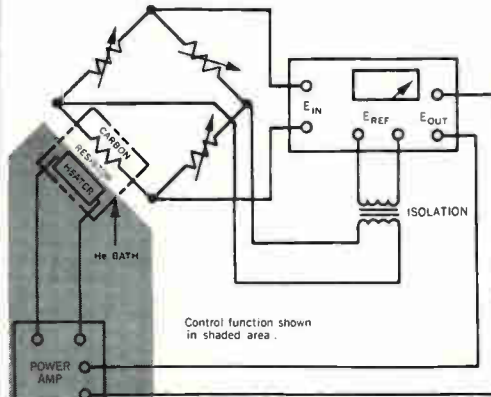

LOCK-IN AMPLIFIER
USED AS BRIDGE OSCILLATOR/NUL DETECTOR

MONITOR OP AMP SUMMING JUNCTION VOLTAGES TO 10 NANOVOLTS

The open-loop gain of op amps can be measured by monitoring the summing point voltage while operating the amplifier in its normal closed-loop configuration. The advantages of using a Lock-in Amplifier to make these measurements are: (1) Its self-contained oscillator serves as a signal source for the op amp over a wide frequency range. (2) Distortion and offset at the summing junction are minimized by the Lock-In Amplifier's high input impedance and low noise. (3) Summing junction voltages as low as 10 nanovolts can be measured and recorded to permit measurement of extremely high open-loop gains. (4) Phase shift can be measured.

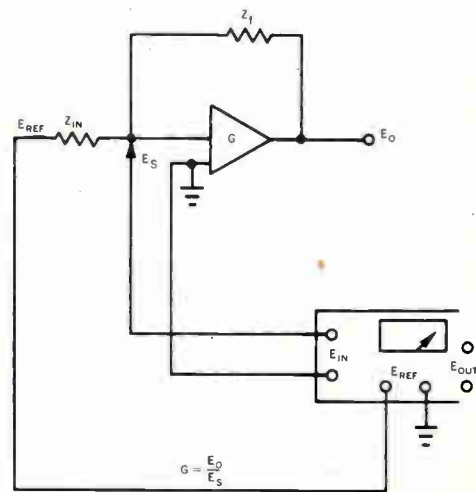

OP AMP OPEN-LOOP GAIN MEASUREMENTS
WITH LOCK-IN AMPLIFIER.

If you have a problem unearthing low-level signals buried in noise, why not call on a PAR applications specialist. He may be able to show you a better way to dig. Call him at (609) 924-6835, or write Princeton Applied Research Corporation, P.O. Box 565, Princeton, New Jersey 08540.

PAR

PRINCETON APPLIED RESEARCH CORPORATION

Silicon gates opening up for MOS

Intel's 256-bit random access memory, Fairchild's 8-channel multiplex switch feature size, speed, and threshold advantages promised in new technology.

With the introduction of products by the Intel Corp. and Fairchild Semiconductor, the promise of silicon gate technology is moving toward fulfillment. In fact, Harry Neil, Fairchild's metal oxide semiconductor product manager, says: "All of our new MOS circuits will use the silicon gate technique with the possible exception of some read-only memories. With them, it's a tradeoff between the increased speed we get with silicon gates and the increased size of the memory plane that the silicon gate requires." Each read-only design, he says, "will be judged individually."

The nature of the technique is such that threshold voltage is low, about 2 volts, and the alignment of the gate region between the source and the drain is automatic [*Electronics*, May 26, 1969, p. 49]. This means there is no overlay and more speed because there is less capacitance, also tighter tolerances give smaller geometry. And, says Bob Graham, director of marketing at Intel, there are other joys. "We get an automatic second-level interconnection scheme, since the silicon gate layer can be used to interconnect several devices on the chip, and our yields are very high. When we started making circuits about two months ago, we expected yields of about 2% but we got 10%, and we've been getting over that since." With metal gates, 5% is good.

Cuts due. Intel's first silicon gate product is a 256-bit static random access memory with decode circuits. The pricing schedule was based on yields of 2% to 5% but Graham says that "since we're getting 10% consistently, we'll soon cut prices."

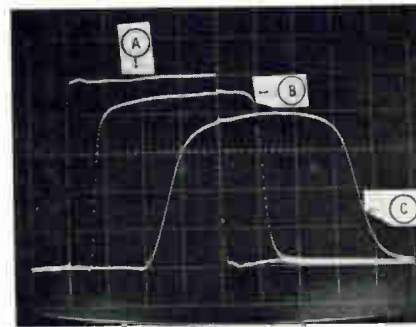
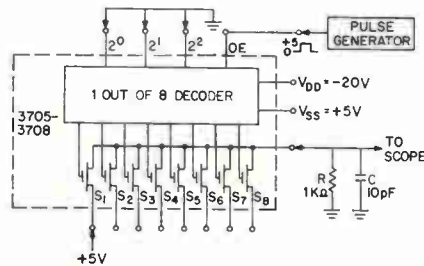

Fast. Fairchild's silicon gate entry is an eight-channel multiplex switch, the 3708, similar to its 3705. Waveform A is output enable control driven by pulse generator; B is 3708; C is 3705. Note speed of 3708.

Things weren't always so rosy at Intel. "When we first started working on the silicon gate process," says Graham, "we couldn't get it to work right and were going to give it up. But Gordon Moore [ex-Fairchild research director and one of the founders of Intel] solved the problems."

The silicon gate devices haven't been around long enough to accumulate any meaningful life test data. But according to Graham, step-stress testing—the devices are run at 400°C, 300°C, and so on until 90% of the units fail at each temperature, then the resulting data is extrapolated to 85°C—indicates that the devices will run for 10 years before significant drift, 0.5 volt, occurs.

Wafer testing and sorting also is made easier with the silicon gate process, according to Graham. "With the nitride or 100 silicon methods of lowering thresholds you have drift or inversion problems and faulty devices might not show up right away; but with the silicon gate process, there are deposition problems, and if the circuit is bad, it's bad at the sorter."

Speed. Intel's marketing plans will hinge on speed. Even though silicon gate MOS circuits are faster than conventional aluminum gate devices—1 microsecond vs. 2 μsec access times—they are still slower than bipolar circuits, so Intel will build both.

Fairchild is changing from metal-gate 100 silicon to silicon gate. Its first product is an eight-channel multiplex switch, the 3708. According to Neil, it's similar to the 3705 except that the 3705 is made with 100 silicon. Neil says that Fairchild was going to announce a 512-bit shift register, but, "at about the same time, the silicon gate process was ready for the production line, so we decided to wait until the device was redesigned for the new process."

Fairchild's silicon gate is polycrystalline silicon over silicon dioxide; Intel's is poly silicon over nitride over silicon dioxide. But both devices have similar characteristics in cell size, threshold levels, and speed, and the similarity even goes as far as the number of devices being produced each month—about 1,000 circuits each.

But at least two potential competitors are willing to let Intel and Fairchild do their thing alone—at least for the time being. Texas Instruments, says a spokesman,

U.S. Reports

doesn't believe that the advantages of the silicon gate justify its higher production cost. And General Instrument doesn't believe the gate offers enough improvement to make it a major commercial success. Speed would have to improve at least an order of magnitude before most users would consider silicon gate, says GI, so it plans to stick with nitride passivation now to drop the MOS device's threshold.

Manufacturing

Clean break

Compared to the almost antiseptic production facilities for semiconductor production, the process of dividing a scribed wafer into chips is barbaric. While a variety of schemes from air filtration to "white room" clothing keep transistors, diodes, and integrated circuits clean and yield high, the most common method for chips is to place a wafer on a thick rubber mat and run a steel roller over it in one direction, then at right angles to the first pass.

This process not only grinds the chips against one another and creates dusty contaminants, but it breaks and scratches many of

them, ruining as many as 10% to 25% of the chips. NASA's Electronic Research Center in Cambridge, Mass., is about to announce a technique that promises to make wafer division about as clean as any other semiconductor process—and one which could result in nearly 100% yields at division.

Old glove. Irving Litant, a senior scientist at the center, developed the chip-division method when he had time on his hands while waiting for some new lab equipment to be installed. Though a chemist by training, Litant worked out a simple mechanical method using such discarded items as an old rubber glove.

In Litant's approach the wafer is scribed, put in a polyethylene envelope, and placed in the chip separator. "It rests on a domed surface and is covered by a pressure fitting holding a thin rubber sheet," he says. "After clamping the assembly together, high-pressure air is let into the chamber behind the diaphragm, which flexes, pushing down on the wafer. As the wafer is forced down to conform to the shape of the hemisphere each chip is punched downward and away from its neighbors, minimizing the chance of their rubbing together."

The process takes only seconds and results in complete separation almost every time—no second tries are needed even on most gold-backed or glass-passivated IC's. The separator even divides triangular chips, a form almost all semiconductor makers have tried at least once to take advantage of silicon's natural cleavage planes—and soon dropped when it was found that most of the chips came through division in unseparated groups of two and three.

Reliability, too. Litant states that when combined with well-thought-out scribing procedures like those developed by another NASA-ERC senior scientist, Samuel M. Polcari, the new technique also could improve long-term reliability.

Polcari agrees: "Most of the contamination in packaged semiconductors is dust or grit. With the new technique, often it isn't even necessary to use a chemical rinse—the chips are that clean."

NASA's improved scribing and separation techniques also should result in fewer incipient failures, like cracks, that aren't spotted during visual inspection but propagate through an IC with temperature cycling or vibration. Caused by clumsy scribing and aggravated by present separation systems, they generally show up well into the life of an IC.

Finally, Litant notes that as integration increases, each chip lost is going to cost more. "Scribing and separation are going to become far more important as chip size grows. With large-scale integration, the chip is a larger fraction of the overall cost of a packaged device, and yields already tend to be reduced by high circuit complexity," he says.

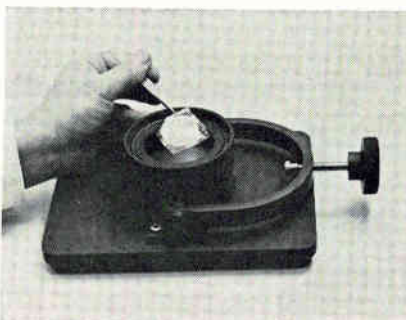
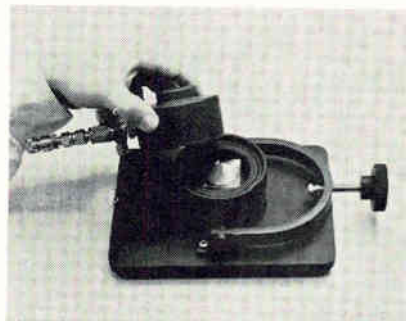
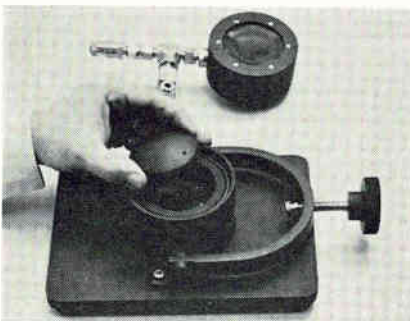

Cracker crumbles. Clockwise from above, spacer and hemisphere placed in cracker; wafer goes in and pressure fitting with diaphragm in underside placed on top; after two toggle switchings, cracked wafer is removed. Polyethylene envelope keeps chips together but keeps them from rubbing.

Integrated electronics

Attractive coat

A group of plastic films called parylenes, available since 1965 from the Union Carbide Corp., could provide the missing link to plastic-packaged semiconductor

devices that are acceptable for high-reliability applications. Although IBM and Hughes Aircraft have been quietly using parylenes to coat circuit boards and their components against moisture, the first report on the substance undoubtedly will capture the attention of semiconductor manufacturers and users alike.

Parylene C (chloro-p-xylylene), parylene D, (dichloro-p-xylylene) and parylene N (p-xylylene) have been studied for more than a year by Autonetics researchers who want them as insulation and barrier coatings over inorganic passivation layers on semiconductors. The work is sponsored by NASA's Electronics Research Center.

James Licari, one of the report's authors and group scientist in advanced chemical technology in the Autonetics research and engineering division, is restrained in discussing the potential of parylene. He says, following the first phase of the Autonetics study, "We can't say it will be a panacea, but it certainly looks promising." But he adds: "We've been looking for coatings that don't change the electrical characteristics of devices. We've studied more than 30 kinds of materials over the years and parylene is the only one that doesn't drastically change electrical parameters."

Test promising. Licari and Stuart Lee, a member of the technical staff in Licari's group and principal investigator in the ERC parylene study, have applied the films to such surfaces as component-laden circuit boards and uncapped metal oxide semiconductor devices. They've isolated threshold voltage and leakage current as the two characteristics of MOS devices most sensitive to plastic contaminants. Changes in these parameters were found to be negligible on most of the parylene-coated test devices.

Irving Litant, senior scientist at ERC and author of the initial report on parylenes with Licari and Lee, believes the early success with the material on MOS devices—which are highly finicky in the face of surface effects such as electron migra-

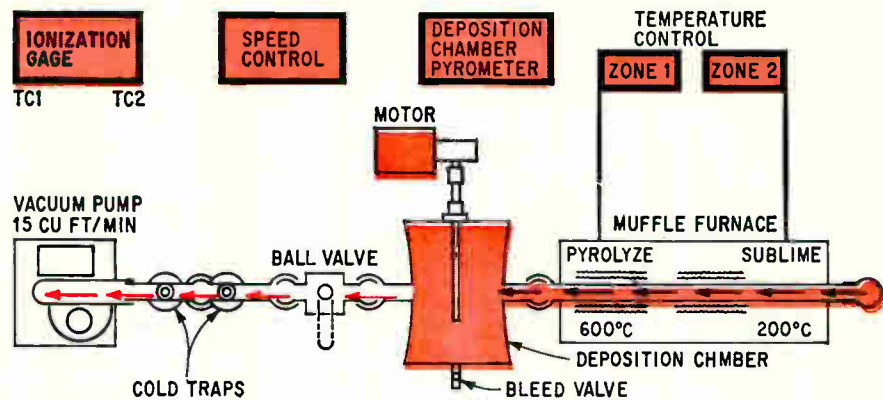

... and it comes out here. In Autonetics deposition chamber, solid parylene goes in it right, is pyrolyzed (cracked), and then deposited on devices or circuit boards spinning at 6 rpm.

tion—could lead to widespread use of large-scale-integrated, high-performance MOS arrays in plastic packages.

The MOS devices used in the Autonetics tests are 44 mils square and contain four MOS transistors of two different types; three different kinds of diodes (four diodes in all); a diffused resistor; a metal test strip; and an MOS capacitor. The devices were pretreated with a silane adhesion promoter, then parylene was deposited in a vacuum chamber.

Recombination. The solid parylene starting material is placed in the vaporization zone and held at 200°C. The vapors are conducted through the cracking area, which is heated to 600°C. Here, as Lee puts it, the material is unique in that "it falls apart into two diradicals that recombine to give the polymer." Recombination takes place at 25°C. In the deposition chamber, where the parylene solidifies again, coating the test devices with a layer of clear material, free of pinholes, which resembles cellophane. Licari says the vacuum deposition procedure averts the pinholes which often result from dipping or spraying of solvent-based coatings. The cold-deposition process, he adds, eliminates the log cures at elevated temperatures associated with other barrier coatings.

These coating agents—epoxies, silicones, and urethanes—unlike the one-component parylenes, contain catalysts and additives to control viscosity that results in sodium

and chloride ion contamination of the surfaces. Sodium ions cause leakage currents in MOS devices and chloride ions cause corrosion, especially in aluminum metalization. Licari points out that the parylenes have none of these undesirable by-products.

To date, the parylene coatings applied at Autonetics have been about 5 microns thick; Licari says layers 1 to 2 mils thick are needed to provide moisture resistance in a rugged moisture environment, so he's not prepared to say that parylenes will stand up to the stresses spelled out in such high-reliability tests as MIL-STD 883. Union Carbide guarantees a 1-micron coat.

Standing up. Autonetics tests showed that the average threshold voltage of all devices tested changed less than 0.1 volt, the breakdown voltage changed less than 1 volt, and leakage currents drifted within only a few picoamperes for all three groups of parylene-coated devices. The tests subjected the MOS devices to temperature storage ranging from 16 hours at 100°C to 128 hours at 175°C. The electrical stresses at -25°C were applied to the source and drain of the MOS transistors, with no voltage on the gate during part of the tests. Another stress of -20 volts on source and drain and +20 volts on the gate was applied.

Licari says he isn't sure parylene films can be used without further encapsulation. He maintains that in some applications in which a certain size, rigidity, and shape is required, parylenes will find prin-

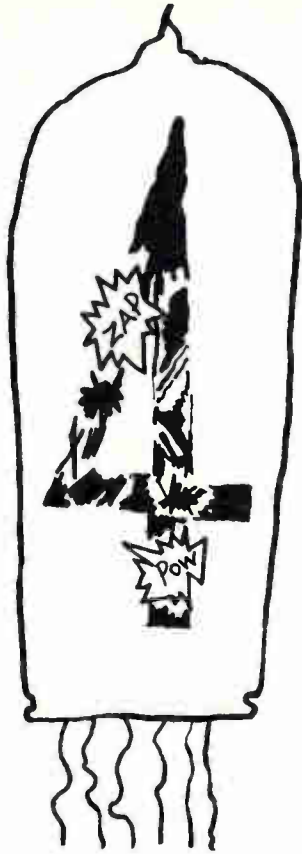

3 ways to prevent numerals from "spotting" at 55°C.

Fill with freon...
keep in shade...
or specify Datavue*
Indicator Tubes.

All Datavue tubes are rigorously tested to meet commercial and military specifications, produced for 200,000 hours of reliable operation. U.S.-made, they can cost less than \$3.95 each.

Datavue tubes feature: straight, stiff leads for fast insertion; fully formed, high-brightness characters; rated for strobing operation; wide range of alphanumeric, decimals, special characters. More than 40 different sockets, including right-angle types, are available.

Call your Raytheon distributor or sales office. *Raytheon Company, Industrial Components Operation, Quincy, Mass. 02169.*

*Trademark of Raytheon Company



U.S. Reports

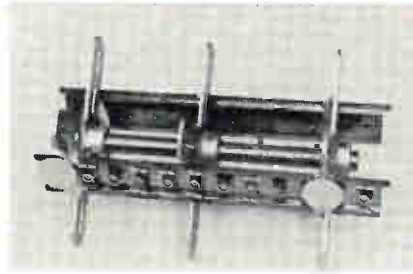

Rack 'em up. Rack holds partly packaged devices magnetically, with lead frames coated where parylene deposition isn't wanted.

principal use as the initial barrier coating, to be followed by encapsulation in epoxy or silicone. He concludes, however, that parylene is "one of the most promising polymeric materials developed in more than 10 years, with properties of extreme interest to the electronics industry."

But the material isn't without its tradeoffs—it costs about \$250 per pound, vs. \$5 to \$6 a pound for epoxies, although being vapor deposited, it goes further.

Slicing breadboard costs

Until three months ago, you breadboarded a hybrid integrated circuit by using discrete components and took your chances. Wide performance variations caused by the change from packaged to unpackaged components, and from discrete to deposited resistors, often were the result. Of course, if money were no object, you could breadboard in a hybrid format. But a change in layout, interconnection, or parts list could mean a new round of design, rubyolith cutting, photoreduction, and etching—all very expensive.

The advanced devices and techniques section at Sylvania Electronic Systems in Needham, Mass., has found a better breadboard. Joseph J. Caggiano, a department manager; Paul E. Hirtle, section head; and John R. Day, an equipment design specialist, this summer evolved a unique hybrid breadboarding approach on which they've filed for a patent; it's so convenient that the section already

is collecting customers from inside and outside Sylvania.

Discrete speed. "This method is fast," says Hirtle. "We have taken circuit designs from the backs of envelopes and reduced them to hybrid breadboards in four to eight hours. That's easily as fast as discrete component breadboarding, and faster by a couple of days than rubyolith photoreduction."

The Sylvania method uses an alumina substrate with metallized squares 10 mils on a side arrayed on it in a waffle pattern. An IC lead bonder is used to "stitch" interconnections among standard hybrid components by stringing wire from square to square, bonding the wire at each. Conductive epoxy attaches the components to the board physically and electrically.

Tinkering is easy—the epoxy, from Epoxy Technology Inc. of Watertown, Mass., makes this possible. To remove a part, the breadboard is heated to about 300°C on a hot plate. When the epoxy becomes rubbery, the component can be plucked cleanly off the board. Wiring changes are easier—tweezers pop the wires off the metallized squares, and new paths are stitched in with the bonder.

Easy switch. Since the components used are identical to those in the final product, performance is unchanged when the design is transferred to a substrate with thin film interconnections. Also, the layout of the breadboard normally is the same as that of the eventual production hybrid; this cuts time spent designing the final product. Hirtle estimates that 20% to 30% is lopped off the time needed to lay out and cut the rubyolith.

In-house, the section claims one-day turnarounds on breadboards. Stocking three substrate sizes (from 280 to 760 mils on a side), plus almost any component needed helps achieve this speed.

The system not only is fast and electrically reliable, but it's tailor made for small-quantity production of special-purpose hybrids. "We will probably make many of our short-run items this way," says Hirtle. "Although we already have made up to 40 circuits of a type, the break-even point is probably

Enter the \$6.50 SSR!

around 20 pieces—still, if time is a key factor, the breadboard is faster than rubylith.”

Extra stitch. The breadboard is about as sturdy as a conventional hybrid. Hirtle notes that once in a while the section will stitch a double set of interconnecting wires to offset possible fractures near bonds, but he says this is about the only concession to fragility needed. He adds: “the breadboards may be tough enough to become deliverable products eventually.”

If that's the case, Sylvania may have broken a price barrier. The cost of laying out a circuit, cutting a rubylith, photoreducing, exposing, and etching are all side-stepped with its breadboard process—and Hirtle estimates that they make up almost two-thirds of the cost of small-quantity hybrids. The low-cost, low-volume hybrid might have just arrived.

Automotive electronics

Regulated sales

It's unusual to find a major semiconductor manufacturing executive trying to keep his customers in the automobile industry from ordering too many voltage regulators from him, but John Welty, a Motorola vice president and director of services and operations for the Semiconductor Products division, is in an unusual position. He loses money on each hybrid integrated circuit regulator he sells to Ford and General Motors.

But then again Motorola didn't expect to show a profit on its solid state voltage regulators for some time, and there's a parallel that suggests the regulator gamble will turn into a profitable business: the division subsidized its effort in supplying the Chrysler Corp. with automotive rectifiers for two years before turning the profit corner. Says Welty, “We lost money on the rectifier traveling the learning curve, but then it became a steady, profitable business.”

The division is looking far beyond the few dollars per auto represented by semiconductors to-



Actual size 2" x 1"

We needed a solid-state relay that was

better than anybody had ever built. So we built it. With integral heat sink. Hermeticity. Virtually unlimited life. And found

we could sell it for ridiculously low money. Now. How about you? Need 2500 \$6.50 relays that will easily outlive 10,000 electro-mechanical jobs?

Ask HLS, 25 Lafayette Street, Santa Clara, California 95050. Twelve varieties. Single or double pole, to 400 V, 3 to 10 amps. Cool.



COMPACT POWER PACKS



The new Compact "M" Series Power Packs offer you:

- Rated output voltages from 1000 to 75,000 DC
- Rated output currents of 1.5, 5, and 10 milliamperes
- Input voltages of 118, 220, 230, and 240 volts AC
- Variable output from 0 to rated voltage
- Input frequency range 50 to 500 CPS
output ripple 1% RMS at rated voltage
- Hermetically sealed construction

Why pay more, and settle for less... PC's new compact power packs give more quality, more versatility, more dependability, plus smaller size, and best of all, most sizes are available in stock to meet your immediate needs.

Write for complete information and new catalog today!



Plastic Capacitors, Inc.

2620 N. Clybourn • Chicago 14, Ill.
DI 8-3735

U.S. Reports

day. Welty foresees a day when there will be \$100 worth of semiconductors in each car and truck. Auto industry spokesmen are projecting sales of 15 million cars and trucks in the U.S. and Canada by 1975, and if semiconductor or computer-like ignition systems, braking systems, and fuel-injection systems, in addition to voltage regulators, come on fast [*Electronics*, March 17, p. 84], it could mean a market of \$1.5 billion for semiconductor suppliers. "We're not reluctant to contemplate getting 50% of the market," Welty comments without a trace of braggadocio.

In a quandary. But for now, he's building up a capacity to deliver 250,000 hybrid IC voltage regulators to Ford and GM for the 1970 model year, and expects to be in full production later this month. That's the same number Welty estimates Motorola will have shipped for the 1969 model year. His quandary, however, is that the car makers like the regulator—in fact more of them want to adopt it—but Welty doesn't want to supply more since production is subsidized.

However, with the 1970-model-year device, which has been somewhat redesigned, Welty believes Motorola has a regulator that will eventually be adopted as a standard on all auto models, not just as an option for the luxury cars, as it is now on the Cadillac Eldorado, Buick Rivera, Oldsmobile Toronado, Pontiac Grand Prix, Ford Thunderbird, and Lincoln Continental Mark III. The new version employs a specially designed linear IC flip chip—bonded face down to a ceramic substrate bearing the thick-film resistors—a Darlington pair of power transistors mounted on a special heat-sink bar, and a power rectifier; all this is housed in the same kind of module used for the 1969 models. However, the 1969 versions of the linear IC chip were conventionally die bonded and wire bonded, and the power transistors were mounted differently. Both are capped and fit into the alternator housing.

Welty is confident the regulator's new design will eventually allow him to sell it to Detroit for the \$1.50 to \$2 he sees as being re-

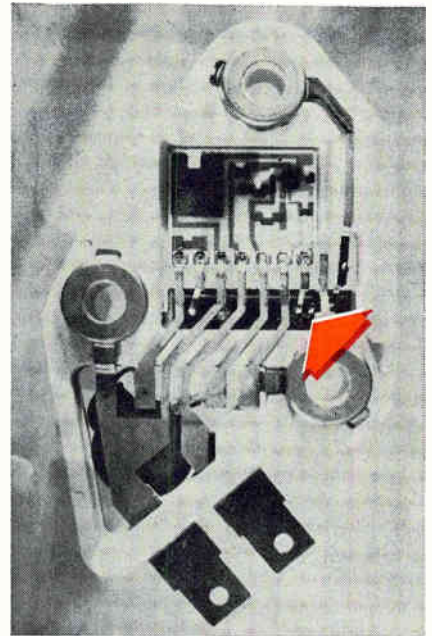

Under the hood. High-gain Darlington power amp and rectifier, on a special heat-sink bar in Motorola's auto voltage regulator, are indicated by arrow.

quired to compete with electro-mechanical regulators. Motorola is currently charging between \$2.50 and \$3 for the 1969 version. Detroit likes the hybrid IC regulator because it can be put right into the alternator housing, saving some space on the fire wall and the cost of a wiring harness. Makers still might be willing later on to pay a little more than the \$1.30 to \$1.40 it's estimated Ford pays for its electro-mechanical regulators.

Communications

Hamming it up

After almost three years of watching its proposals bounce off the military, Comdel Inc. of Beverly, Mass., suddenly finds itself with what might be called an unsolicited rfp—one that could lead to procurement of hundreds or perhaps thousands of its products.

Comdel now sells to ham radio operators. Its major product is the CSP-11, a speech processor that levels out the peaks and valleys in voice amplitude which in turn boosts average transmitter power.



ALPAC®

only
the high current
bridge rectifier
that stacks up —

**Performance
Packaging
Reliability
Price**

This power bridge rectifier is designed to out perform anything on the market. Years of reliable performance, in on-the-line operation, has proven the ALPAC concept. ALPAC is a Semtech design.

ALPAC utilizes a functional aluminum case to guarantee maximum thermal conductivity and light weight — replacing out-moded stud rectifiers and all the miscellaneous hardware associated with it.

ALPAC is easy to use. The devices are fitted with three way, universal terminals (insulated from the case) to minimize production costs.

Internally, ALPAC utilizes the Semtech high performance rectifiers — welded together for mechanical strength.

Average Output Current . . . 25 amps
Peak Inverse Voltage . . . 50 to 600 Volts
Thermal Resistance (Max.) . . . 1.5°C/watt

If you want quality "designed in" you'll buy ALPAC . . . another good idea from Semtech.

For immediate delivery see your representative:

San Francisco—941 E. Charleston, Suite 10, Palo Alto, California 94303 / (415) 328-8025
Chicago—140 N. La Grange Road, La Grange, Illinois 60525 / (312) 352-3227 / TWX: 910-683-1896
Dallas—402 Irving Bank Tower, Irving, Texas 75060 (214) 253-7644
New York—116-55 Queens Blvd., Forest Hills, New York 11375/(212) 263-3115/TWX: 710-582-2959
European Sales—Bourne A. G. Alpenstrasse 1, Zug, Switzerland / (042) 4 82 72/73

SEMTECH
CORPORATION

652 Mitchell Road, Newbury Park, California 91320
(805) 498-2111, (213) 628-5392 / TWX: 910-336-1264

© ALPAC is a registered trade-mark of the Semtech Corporation.

U.S. Reports

This means increased range and intelligibility.

Ted E. Johnson, Comdel president, had tried for some time to sell the Government on the CSP-11 idea to improve voice radio links, but had failed. Thus he was surprised when Walter M. Chase, supervisory electrical engineer at the Naval Electronics Laboratory in San Diego, suddenly flew east a month ago to talk with him about the CSP-11.

"Chase carried along a set of oscilloscope photos showing the effect the processor had on a frequency-shift-keyed teleprinter signal. He apparently had found out about it through a ham magazine and used it on a 40 kilowatt transmitter near San Diego," says Johnson.

Chase was enthusiastic; not only did the CSP-11 boost average power of teleprinter transmission by 6 decibels, it also cut adjacent channel interference from noise sidebands by about 20 db.

This could be a real lift to the high and very high frequency teleprinter communications links that carry the bulk of Naval traffic especially when plagued by ionospheric fade, dropouts, and transmission errors.

Chase and Johnson did some on-the-spot negotiating during which the Navy probably made one of the most inexpensive electronics development deals in its history. "Chase said he wanted a prototype of a militarized, miniaturized CSP-11," says Johnson, "so I told him that for a couple of thousand dollars, I could whip one up in two or three weeks."

Why Comdel. Clipping devices or automatic gain controls to increase average power have been around for years; why should the Navy suddenly become interested in the CSP-11? According to Johnson, it's partly because of the device's very low harmonic distortion when compared to other schemes, and partly because only a system like the CSP-11 could be retrofitted to single sideband transmitters.

Audio signals at 100 to 3,200 hertz enter the CSP-11, pass through an amplifier, and modulate

a local oscillator signal. The modulated signal is filtered to remove its upper sideband; it is then passed through a limiting intermediate frequency amplifier and an i-f low pass filter. Demodulated, buffered, and passed through another low pass filter, the signal is finally sent to the transmitter at the original audio frequencies. Only harmonics caused by limiting or clipping have been filtered, leaving an undistorted output.

Johnson says that the harmonics, phase additions, and cancellations common to most clippers operated solely at audio frequencies cause random sidebands in a single sideband transmission format, making the scheme useless—there's no average power boost. But by processing the signal at an intermediate frequency, the CSP-11 not only removes harmonics, but also becomes compatible with single sideband.

Johnson says that his system is the only such unit he knows of that's compatible with SSB. And even if SSB isn't a consideration, the low harmonic distortion inherent in processing at i-f allows more than double the average power boost possible with audio clippers.

Judging by Chase's enthusiasm, Johnson envisions Comdel processors in every Naval vessel and shore station.

He also feels that it may be possible to use the same basic technique to improve the quality of facsimile transmissions. In commercial use, he figures that a modified processor could lead to an inexpensive modem capable of cleaning up data transmissions.

Advanced technology

Hot colors

When researchers at General Electric in Syracuse started work on a thermoplastic technique for producing wall-size, real-time displays of color television, they had high hopes. Though they didn't know it at the time, they also needed more than their share of patience and tenacity, because it has taken 12



COMPARE
Facilities to serve
you!

Alabama Compar Southern 904 Bob Wallace Ave. Huntsville — 35801 205-539-8476	New Jersey — Southern see Pennsylvania — Eastern
Arizona Compar Rocky Mountain 84 West First St. Scottsdale — 85252 602-947-4336	New Mexico Compar Rocky Mountain 2129 San Mateo Blvd. NE Albuquerque — 87110 505-265-1020
California — Northern Compar San Francisco 820 Airport Blvd. Burlingame — 94010 415-347-5411	New York — Metropolitan and Long Island Compar New York 335 Crossways Pk. Dr. Woodbury, L.I. — 11797 516-921-9393
California — Southern Compar Los Angeles P.O. Box 7018 Burbank 213-843-5550	New York — Upstate Compar Albany 6 Highland Avenue Albany — 12205 518-489-7408
Colorado Compar Rocky Mountain 300 E. Hampden Ave. Englewood — 80110 303-781-0912	Compar Albany 319 Wells Ave. West North Syracuse 13212 315-471-3356
Connecticut Compar New England 2357 Whitney Avenue Hamden — 06500 203-288-9276	Compar Albany 42 Winding Brook Drive Fairport 14450 716-271-2230
Delaware & Dist. of Col. see Maryland	Compar Albany P.O. Box 135 Endwell — 13760 607-723-8743
Georgia see Alabama	North Carolina Compar Southern 1106 Burke Street Winston-Salem — 27101 919-724-0750
Illinois — Northern Compar Midwest 315 Laura Drive Addison — 60101 312-543-8833	Ohio Compar Ohio P.O. Box 338 Fairborn — 45324 513-878-2631
Illinois — Southern see Missouri	Compar Ohio 19500 Center Ridge Rd. Rocky River — 44116 216-333-4120
Indiana — Northern Compar Midwest 5027 No. Kemore Rd. Indianapolis 317-545-6081	Oklahoma see Texas
Indiana — Southern see Ohio	Oregon see Washington
Iowa see Illinois — Northern	Pennsylvania — Eastern Daniel & Company 231 So. Eastern Rd. Glenside — 19038 215-887-0550
Kansas Compar Midwest 6045 Mortway Suite 102 Shawnee Mission — 66202 913-432-6333	Pennsylvania — Western see Ohio
Kentucky see Ohio	Rhode Island see Massachusetts
Louisiana see Texas	South Carolina see North Carolina
Maine see Massachusetts	Tennessee see North Carolina
Maryland Daniel & Company P.O. Box 124 Lutherville — 21204 301-825-3330	Texas Compar Southwest 8609 Northwest Plaza Dr. Dallas — 75225 214-363-1526
Massachusetts Compar New England 88 Needham St. Newton Highlands — 02161 617-969-7140	Compar Southwest 5757 Bellaire Blvd. Houston — 77036 713-667-3420
Michigan Compar Midwest 21250 Civic Center Dr. Southfield — 48075 313-357-5369	Utah see Arizona
Minnesota Compar Twin Cities P.O. Box 15095 Minneapolis — 55416 612-922-7011	Vermont see Massachusetts
Missouri Compar Midwest 11734 Lackland Ind. Dr. St. Louis — 63141 314-542-3399	Virginia see Maryland
New Hampshire see Massachusetts	Washington Compar Northwest 12610 N.E. 104th St. Kirkland — 98033 206-822-4191
New Jersey — Northern See New York — Metropolitan	Wisconsin see Illinois — Northern
	Canada Kaytronics Engineering 5800 Monkland Ave. Montreal 28, Quebec 514-487-3434
	1001 Finch Ave. W. Downsview, Ont. 416-638-5511

COMPARE CORPORATION • 828 AIRPORT BLVD.
BURLINGAME, CALIF. 94010 • (415) 347-9501

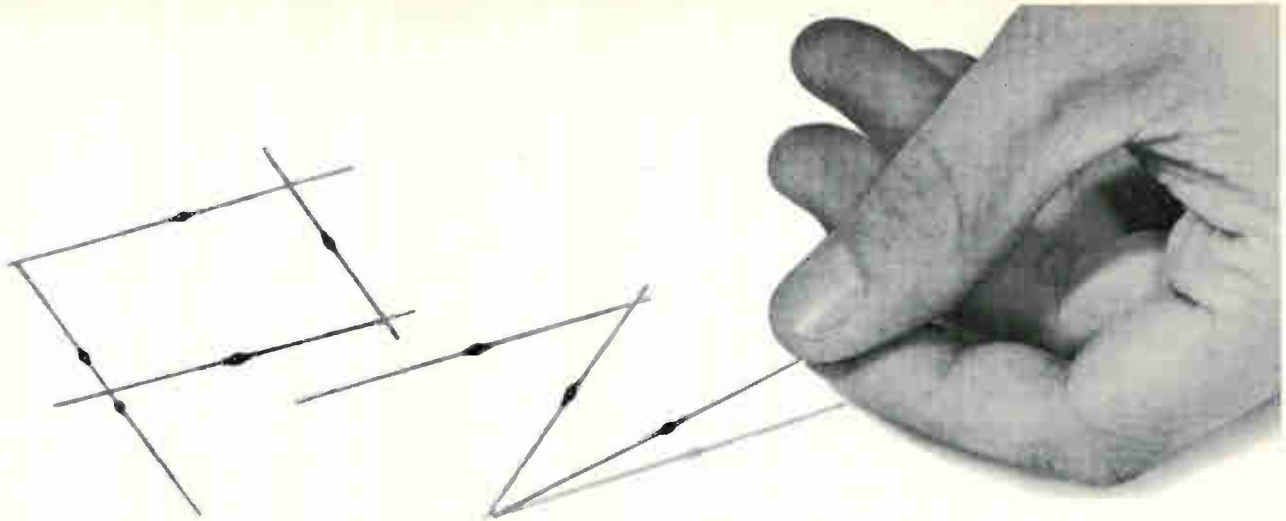

Introducing the PZ Zener

The new fused-in-glass
1 watt zener ...

Typical Unitrode fused-in-glass
stability and high-performance at
the price of an ordinary device

Order your free samples today

- Fills the bill from 400 mw thru 1 watt
- Voltages from 6.8 to 200 V
- 8 millisecond surges to 30 watts
- Low reverse current — to 500 nA
- A quarter the size of a conventional 1 watt
- Weighs less than 1/4 gram
- No plastics, epoxies, silicones, oxides, gases, or solders are used

580 Pleasant St., Watertown, Mass. 02172 • (617) 926-0404

UNITRODE

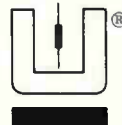

TOUGH AS ALL GET-OUT FROM THE INSIDE OUT

With the silicon die metallurgically bonded between terminal pins of the same thermal coefficient, the hard glass sleeve is fused to the entire outer silicon surface. Result — a voidless, monolithic structure.



4 EASY WAYS TO GET FREE SAMPLES AND SPECS

1. Call your Compar office, listed on the facing page.
2. Call your nearest Daniel & Co. office.
3. Call Bud Anderson COLLECT, at (617) 926-0404.
4. Check off the magazine Reply Card number.

High Voltage Silicon Rectifiers

Available in production quantities now!

HIGH VOLTAGE RECTIFIERS*					
1000V	I _O	1-99	7000V	I _O	1-99
VA 10	50mA	1.36	VC 70	1.5 A	6.82
VB 10	100mA	1.41	VF 5-7	5mA	1.71
			VF 10-7	10mA	1.89
			VF 25-7	25mA	2.08
1500V			8000V		
VA 15	50mA	1.44	VC 80	1 A	7.15
VB 15	100mA	1.51			
2000V			10,000V		
VA 20	50mA	1.55	VF 5-10	5mA	1.96
VB 20	100mA	1.59	VF 10-10	10mA	2.16
VC 20	2A	5.20	VF 25-10	25mA	2.38
2500V			12,000V		
VA 25	50mA	1.66	VF 5-12	5mA	2.22
VB 25	100mA	1.72	VF 10-12	10mA	2.44
			VF 25-12	25mA	2.68
3000V			15,000V		
VA 30	25mA	1.93	VF 5-15	5mA	2.30
VB 30	50mA	1.88	VF 10-15	10mA	2.54
VC 30	2A	5.52	VF 25-15	25mA	2.80
3500V			20,000V		
VA 35	25mA	2.70	VF 5-20	5mA	2.97
			VF 10-20	10mA	3.27
			VF 25-20	25mA	3.60
4000V			25,000V		
VB 40	50mA	2.05	VF 5-25	5mA	3.72
VC 40	2A	5.85	VF 10-25	10mA	4.09
			VF 25-25	25mA	4.51
5000V			30,000V		
VB 50	50mA	2.40	VF 5-30	5mA	4.46
VC 50	1.5A	6.18	VF 10-30	10mA	4.91
VF 5-5	5mA	1.60	VF 25-30	25mA	5.39
VF 10-5	10A	1.77			
VF 25-5	25mA	1.95			
6000V			40,000V		
VB 60	50mA	2.62	VF 5-40	5mA	5.95
VC 60	1.5A	6.50	VF 10-40	10mA	6.54
			VF 25-40	25mA	7.20

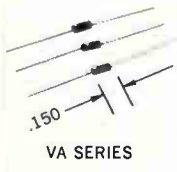

VA SERIES



VF SERIES

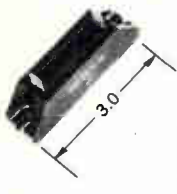

VC SERIES

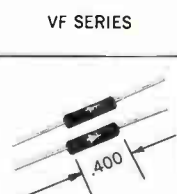

VB SERIES

*Available with fast recovery characteristic.



SEMICONDUCTOR DIVISION, 1000 N. SHILOH ROAD, GARLAND, TEXAS 75040 (214) 272-4551

U.S. Reports

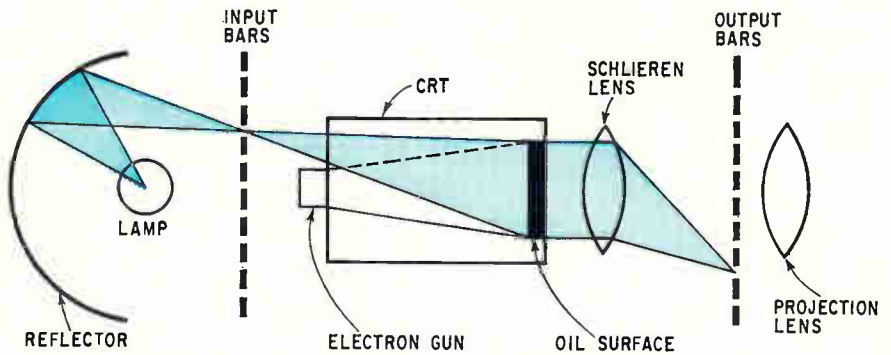

Soft pictures. GE's thermoplastic display device projects real-time, wall-size pictures in color or black and white.

years, many changes in design and marketing philosophies, and nearly \$30 million.

Now, with 100 orders for the projection system—from broadcasters, computer terminal makers, and schools, among others—GE's Visual Communication Products department is ready to tackle the job of producing a version for home entertainment, one that would carry a price tag somewhat lower than the \$30,000 (monochrome) or \$40,000 (color) now hanging on its video projector.

Melt. A picture is produced this way: an image-inscribing ion beam scans the surface of a thick-liquid thermoplastic, writing an image in the form of appropriate diffraction gratings on the liquid film. The image gratings are fixed when the thermoplastic cools. Finally, a beam from a xenon lamp passes through the transparent thermoplastic to project the image. The plastic moves in a "river" from a reservoir through the unit.

The actual size of the river being inscribed at any one time is about that of a 35-millimeter slide. And the life span of the unit is a relatively brief 3,000 hours because the thermoplastic becomes opaque and the ion beam wears out after that much use. A tv receiver tube lasts over 5,000 hours.

To produce color, the projector uses but one electron gun and one raster. Comparable systems use either three (the Eidophor) or two of each (GE's Talaria). The new projector "writes" a groove—or

diffraction grating—for each of the primary colors simultaneously so that each will contain the data needed to determine brightness and hue. To minimize interaction between gratings, the red and blue are at right angles to the green.

For red and blue, the electron spot is velocity modulated with an h-f voltage applied to the horizontal deflection plates. This causes the spot to speed or slow in sync with the h-f carrier, generating, in turn, a regularly spaced differential charge pattern on the liquid. The magnitude of the differential charge determines the groove depths and the amount of light diffracted off the bars and to the screen. Frequency for the red grating signal is 16 megahertz; another frequency is chosen for the blue. The green grating uses the grooves formed by the scan.

Government

Soldiers and spacemen

While NASA's charter clearly states that it is a civilian agency specifically established to pursue the peaceful aspects of space exploration, there is growing evidence that the agency is getting more and more involved in military business and that concern over this involvement is growing within the agency.

The major flap over the military trend is surfacing among those working in two of NASA's big proj-



When you're under pressure (8,000 psi) to get facts fast...

Composite Histogram showing 4 oceanographic parameters. Photograph by Anthony Balogh.

bring ERIE in early.

Current speeds and directions... temperatures... pressures... salinities. Essential data if Oceanography is to achieve its predicted \$9 Billion potential by 1978. Geodyne Division of EG & G International makes instruments combining multiple sensor packages... each capable of measuring up to eight such parameters. And, through new high-speed digitizing systems, all parameters are recorded almost simultaneously. From the start, Geodyne has relied on ERIE TECHNOLOGICAL for the Thick Film Hybrid Circuitry so vital to these new systems. Our unique single-source capability assures total control of substrates, precious metal formulations, components and encapsulants. Proof, once again, that it pays to bring ERIE in early.

ERIE TECHNOLOGICAL PRODUCTS, INC.

644 West 12th Street, Erie, Pennsylvania 16512
(814) 456-8592

Better solutions come from Weatherford

Try these for starters: System Interface Circuits. TTL. Light Sensors.

TI's 10 sense amplifiers simplify system circuit interfacing. Interfacing between high speed, ferrite memory cores and TTL logic systems no longer presents a "no-man's land" of problems because of TI's choice of sense amplifiers. All device types feature dual pre-amps (4K memory cores per input) with individual channel strobing and TTL compatible outputs. The SN7520N/21N pre-amps drive a single cascade-gate output, while the SN7522N/23N output is an open-collector gate. The SN7526N/27N feature the industry's first data register output for narrow strobe windows. The SN7524N/25N and SN7528N/29N have individual channels, each input having its own gate output. The pre-amp outputs in the SN7528N/29N are also available for use as test points. We can furnish an application report and data sheet on TI's 10 or circle 271 on the Service Card.

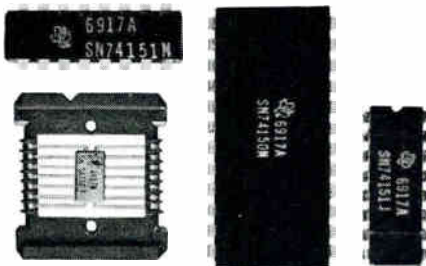
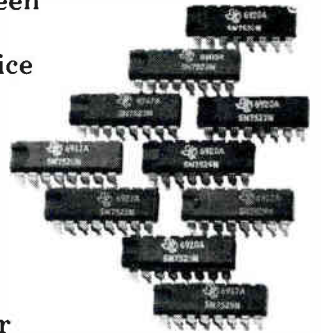

TI's 3 new MSI data selectors cool multiplexing costs. You can put the cost of multiplexing "on ice" with TI's new data selectors—each of which selects one of 16 (or eight) data sources determined by the binary address inputs. Each contains both inverter-drivers and AND-OR-INVERT gates in a single package. Result: reduced design time, inventory and circuit costs. The SN54150/SN74150 are 16-bit data selectors in 24-pin plastic packages. SN54151/SN74151 are 8-bit circuits in either the 16-pin plastic or ceramic dual-in-line packages. The SN54152/SN74152 are 8-bit selectors available in flat packs. For data sheet on this trio of data selectors, get in touch with us. Or circle 272 on the Service Card.

TI's 16 new light sensors lighten your selection burden. TI's tiny LS600 silicon planar light sensor has sired a big, new family of 16 devices, TIL601-TIL616. Now you can pick and choose what you need quickly and precisely from standard and coaxial packages, round or flat lens and four light-sensitivity ranges (0.5-3 mA, 2-5 mA, 4-8 mA, 7 mA). All are readily available and are designed for use in high-density matrix in-line readout equipment. Pick the round lens for optical arrays requiring minimum cross talk; choose the flat lens when you need a wider viewing angle. We can supply data sheets or circle 273 on the Service Card.

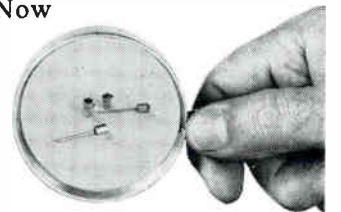

For better solutions, call your authorized TI distributor



R. V. WEATHERFORD CO.

DISTRIBUTORS OF ELECTRONIC COMPONENTS AND EQUIPMENT

ANAHEIM, CALIFORNIA
1550 Babbitt Street
714-532-6741
714-547-7521

GLENDALE, CALIFORNIA
6921 San Fernando Road
213-849-3451

PALO ALTO, CALIFORNIA
3240 Hillview Drive
Stanford Industrial Park
415-321-5373

PHOENIX, ARIZONA
1917 North 25th Drive
Carson Industrial Center
602-272-7144



POMONA, CALIFORNIA
1095 East 3rd Street
714-623-1261
213-966-8461

SALES OFFICES: San Diego, California, 714-278-7400 • Seattle, Washington, 206-762-4200 • Dallas, Texas, 214-231-6051

U.S. Reports

ects for the 1970's: the national space station and space shuttle. The work statement for the space station studies now being conducted by private contractors features this ominous stipulation: "It is anticipated that some of the data resulting from these studies will be classified. Therefore, security clearances, up to and including Secret, will be required of the contractor's and subcontractors' personnel and facilities."

Military interest. Reliable reports out of NASA indicate that the soon-to-be delivered shuttle studies will be largely classified. Those in charge are less than willing to talk about the station. According to a source in the Advanced Manned Missions Program Office, "There is no military involvement in the space station at this moment, but they are very interested in the station because their station [Manned Orbiting Laboratory] was just canceled." Military interest in the shuttle is acknowledged this way: "The Air Force is and will continue to be very active in the development of the space shuttle."

There is little doubt that the wedge is opening. Both NASA and Air Force officials have been test-ballooning the idea of "shared facilities," such as launch pads and booster development costs. Within NASA concern hinges on the fear that military money may mean a military attempt to take over either or both of the projects under the powerful labels of "national security" or "defense mission." There is, however, some pooh-poohing of such fears. As one official involved in the shuttle work says, "All the 'Restricted' stamps are going on for one reason only: to keep potential subcontractors from getting a leg up on one another when the competition starts."

The Air Force has scheduled slightly less than \$1 million for space shuttle studies in fiscal 1970. NASA is planning to supplement Air Force research on the shuttle with additional funds this year in specific areas, such as propulsion.

While it will take a while before the station and shuttle projects' exact relationship with the military

becomes clear, there is little question of involvement. Here's the evidence:

■ New testimony on defense procurement released by the House Appropriations Committee makes a reference to NASA's handling defense procurement. The project is classified flexible printer equipment for military intelligence. Most of the details on the system (called Flexscop) have been expunged from the hearing record because they are classified.

■ The director of NASA's Langley Research Center recently told the House Science and Astronautics Committee that the center has supported nearly 12 Department of Defense projects from 1961 to 1968. Included in the list were such well-known Air Force programs as F-111, Nike-Zeus, Minuteman, and COIN, the counter-insurgency program including the OV-10 aircraft.

NASA administrator Thomas Paine has stated publicly that the agency is planning to work with the Air Force and the Navy on the development of the new F-14 and F-15 fighter aircraft.

Space electronics

NASA ray

Can lasers fly? NASA's Goddard Space Flight Center thinks so, and is planning to put two of them on its applications technology satellites to provide high-data-rate transmissions for space-to-ground communications on ATS-F and intersatellite communications when ATS-G goes up.

First details of the 10.6-micrometer package—a spectral range that NASA says offers optimum channel capacity per pound of satellite weight and per watt of satellite power budget—are scheduled for disclosure this week at the International Telemetry Conference in Washington.

John H. McElroy and five colleagues at Goddard say the 30-pound, 30-watt system provides a 5-Mhz bandwidth link that could act as "a base line for future oper-

TRYGON power supplies are... a New systems grouping providing the utmost in flexibility and economy

OEM Modules; ¼ racks; ½ racks; full racks
—all compatible with ruggedly constructed
rack adapters for up to 161 VDC and 70 amps.

- Complete Systems Reliability
- Unattended Continuous Operation



TPS
Super Trypack Series
Slot range system module
from \$56.



LVW-LVS
Liberator Sub-Rack Series
Slot and wide range modules.
from \$89.



LQS
Liberator Sub-Rack Series
¼ rack slot range,
optional metering
from \$135.



LHS
Liberator Sub-Rack Series
½ rack slot range,
optional metering
from \$219.



L3R/L5R
Liberator Series full rack systems power supply
from \$450.

TRYGON MEANS POWER!

Write now for complete data and pricing
of this new systems grouping.

TRYGON POWER SUPPLIES

111 Pleasant Avenue, Roosevelt, New York 11575
Tel: 516-378-2800 TWX: 510-225-3664
Trygon GmbH 8 Munchen 60, Haidelweg 20, Germany
Write for Trygon Systems Power Supply Catalog.
Prices slightly higher in Europe.

U.S. Reports

Find it fast! in the **FREE NEW 1970 Newark industrial electronic catalog**

A \$9,000,000 INDUSTRIAL ELECTRONIC INVENTORY
720 PAGES • OVER 70,000 ITEMS; 500 MAJOR LINES

Eliminate line transients, noise and even
arrest lightning with the
WANLASS PARAFORMER™
MODEL NO. PEC-60
ONLY \$95.00
FOR 60 VA OF
WANLASS
PARAMETRIC
POWER



AND ALSO GET
0.25% AC REGULATION!
THE WANLASS PARAFORMER is the revolutionary
power transfer component that effects para-
metric transfer of power without solid-state or
mechanical elements. Standard units rated from
60 to 5000 VA in stock.

Immediate delivery from stock—factory OEM prices
—fast efficient service from 11 Newark warehouses.
One source for the products
you need, in the quantities
you need.



For your free catalog write to:

Main Office & Warehouse

NEWARK ELECTRONICS CORPORATION

500 North Pulaski Chicago, Illinois 60624
(312) 638-4411

WAREHOUSES IN

- | | | |
|--|--|---|
| • Minneapolis, Minn.
(612) 331-6350 | • Los Angeles Area
(213) 678-0441 | • |
| • Cincinnati, Ohio
(513) 421-5282 | • Grand Rapids, Michigan
(616) 452-1411 | • |
| • Denver, Colorado
(303) 757-3351 | • New Orleans, Louisiana
(504) 834-9470 | • |
| • Detroit, Michigan
(313) 548-0250 | • Dallas, Texas
(214) 271-2511 | • |
| • New York City
(212) 255-4600 | • Houston, Texas
(713) 782-4800 | • |

ational system designs" such as Data Relay Satellite. The CO₂ laser, they contend, offers an attractive alternative to microwave or millimeter wave intersatellite communications.

The parts. In addition to a 50-milliwatt laser local oscillator, the communications system will employ a 500-mw laser transmitter modulated either by a cadmium telluride or by a gallium arsenide crystal mounted in the optical resonant cavity to get the 5 Mhz band. Also in the laser subsystem are the frequency stabilization servo and laser power meters.

In the optical package are a coarse beam-pointer or slewing mirror, image motion compensator, directive mirrors, and a 6-inch Cassegrain telescope. This telescope functions as an optical antenna, focusing laser output into a high-power density beam for transmission and maximum power-gathering during reception.

The infrared mixer and radiation cooler subsystem contains a signal mixer, image motion error sensor, preamps, and radiation cooler. The lightweight coolers can be used, according to the NASA group, since the i-r mixer will be a wideband, mercury telluride detector able to operate at temperatures in excess of 100°K, eliminating the need for cumbersome cryogenics.

The signal processing unit holds the i-f post-amplifier and drive electronics for the image-motion compensator, laser frequency control, beampointer, and the command and telemetry interface; the fifth subsystem contains the power supply package.

Laser-to-laser. Although ATS-G will not fly until nearly a year after ATS-F, the system designers expect the ATS-F laser package to be operating for laser-to-laser-to-ground communications. They expect satellite lifetimes, which now average two years, to increase to 3 or 3½ years in the 1972 or 1973 period. But, until ATS-G flies, the single satellite will be used for a space-ground link that should provide much of the needed data on the experiment.

For initial acquisition of the laser beam by either the ground station

or ATS-G, the beam-pointing mirror of ATS-F is commanded to point at the appropriate target, which then turns on its laser transmitter—bypassing the 6-inch optical system—to illuminate ATS-F. Bypassing the optics produces a diffraction-limited beam with an angular divergence greater than the angular uncertainty of the satellite's position. A command then is sent to ATS-F to begin its search-scan operation; once locked on, the ATS-F transmitter is turned on as a beacon for the ground station or other satellite.

With both satellites in synchronous orbit, the laser-to-laser communications link will be "cross-strapped" to the satellite-to-ground r-f link. Similarly, the r-f signals will be put on the intersatellite laser hookup. "This cross-strapping of signals," the six men say, "will thus provide for the implementation of a real-time data-relay link for a low-orbiting satellite to ATS-G via radio, for ATS-F to -G by laser, and finally from ATS-F to a ground-based, data-acquisition facility via r-f."

Computers

As Maryland goes

Computer systems-makers are buzzing like bees around the 50 state capitals to get a taste of the budding state-level data processing market. The capital being watched most carefully is Annapolis, as Maryland moves to reorganize and streamline its data-processing activities. The program initiated by Gov. Marvin Mandel could lead to the long-awaited opening of that market.

About half of Maryland's \$11.5 million annual data-processing budget is spent on hardware, most of which is leased; the other half goes for personnel and software. At least \$1 million can be pared from this budget with reorganization, according to two studies prepared for Mandel.

Hard look. The studies, offered to the Governor as a public service, were prepared by the Computer Sciences Corp. and a group

2.5 A Triac Versatility from RCA

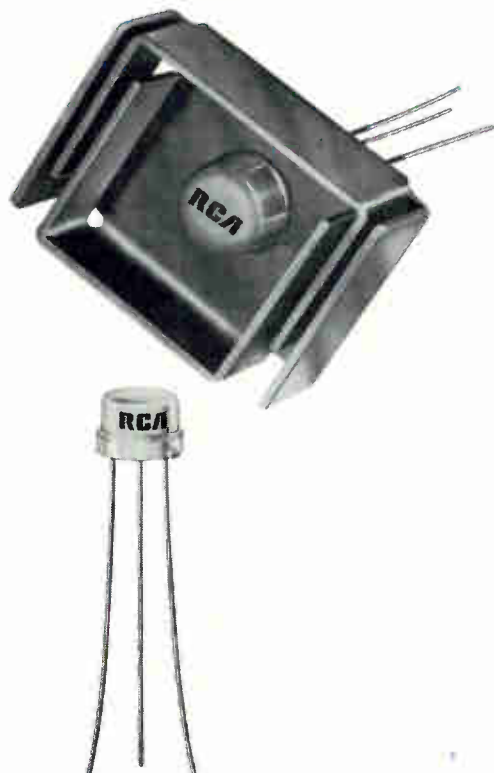

Sensitive-gate Triacs in TO-5 package
for low-power phase
control and load switching

Here's versatility *plus* in a Triac family! RCA types 2N5754, 2N5755 and 2N5756 are designed for low current circuits of either resistive or inductive loads, and for use in driving high current Triacs. All three devices feature shorted-emitter design and RMS on-state current rating of up to 2.5 A. All have gate characteristics as follows: $I_{GT} = 25$ mA max. in I^+ , III^- modes and 40 mA max. in I^- , III^+ modes. Repetitive peak off-state voltage ratings of 100, 200 and 400 volts are available to match your needs. And all three Triacs are designed to switch from off-state to on-state for either polarity of applied voltage with positive or negative gate triggering voltages.

For PC board installation, you can also obtain the

2N5754, 2N5755 and 2N5756 with factory-attached heat-radiators. Ask for RCA's 40684, 40685 and 40686, respectively.

You can also turn to RCA if you need greater gate sensitivity. The 40530-series Triacs offer you I_{GT} of 3 mA and 10 mA—for driving by integrated circuits, as shown in the following tabulation:

I_{GT}	Low Voltage (100 V)*	120-V Line (200 V)*	240-V Line (400 V)*
3 mA (all modes)	40525/40531	40526/40532	40527/40533
10 mA (all modes)	40528/40534	40529/40535	40530/40536
25 mA (I^+ , III^- modes)	2N5754/40684	2N5755/40685	2N5756/40686
40 mA (I^- , III^+ modes)			

* V_{DRM} (Repetitive peak off-state voltage)

Select the type best suited for your circuit designs. Then see your local RCA Representative or your RCA Distributor for economical pricing details. For technical data, write RCA Electronic Components, Commercial Engineering, Section RN9-2, Harrison, N. J. 07029.

RCA Thyristors

U.S. Reports

of businessmen organized as the Governor's Operating Economy Survey (GOES). Both studies are awaiting evaluation by the governor's fiscal experts. Steve Goldberg, a special assistant to the governor with the job of breaking down the Computer Sciences recommendations, says the review will take the better part of this month and possibly longer.

No specific date for completing the reorganization has been set, but Goldberg expects it to take about a year before a complete, top-level state office is set up.

Other states are looking for a model for their own reorganizations since, according to Goldberg, virtually every state has contacted Maryland about the studies, with California and Florida showing the most interest. Some large companies also have informally shown interest, he says. Among them is U.S. Steel, which he says is "having similar problems" with its operations—the main one being a proliferation of data-processing services.

De-icing. Maryland's reorganization will begin when a freeze on computer equipment purchases is lifted. The lid was put on last month until recommendations are combined, and objectives and policies are defined.

A new post, State Data Processing Administrator, is recommended by both Computer Sciences and GOES. The administrator would have control over all data processing, activities, including systems and software, purchases of new equipment, and personnel. His salary would be \$25,000 to \$30,000. GOES additionally recommends a steering committee over the administrator—both reporting to the state's budget secretary. GOES estimates setting up centralized control would cost the state \$200,000 a year, but long-range annual savings of \$2 million can be realized by eliminating duplication of effort.

Other savings would result, GOES reports, by evaluating all computer equipment and returning to the manufacturer "that which cannot be justifiably utilized." An example: two Bunker-Ramo CRT's

at the University of Maryland which aren't being used because Honeywell—the vendor—has not made programs available.

Other recommendations: set up a uniform cost-control reporting system; perform project feasibility studies before any major equipment purchases; develop written guidelines for buying equipment, such as system specifications and vendor evaluation; and establish a training program for the state's users.

For the record

MAIR starts. Hughes, Microwave Associates, and Sperry-Rand each have received \$30,000 for a six-month study of a new, high-power amplifier for the Navy's Electronics Systems Command. The work will be the initial phase of the first element to be contracted for the Navy's MAIR (for molecular airborne intercept radar) program [*Electronics*, May 12, 1968, p. 54]. The goal of the program: solid state, phased-array radar for use in the 1975-1980 time period. The amplifier for MAIR will operate at 10 gigahertz with peak power of 11 kilowatts.

Go West. If you're a systems analyst, computer programmer, or operator, and want to be paid top salary in your field, go to Los Angeles. L. A.-area electronics and aerospace companies value their computer people higher than firms in other areas to the tune of \$1,000 a year or more. A Labor Department survey of EDP occupations in 10 metropolitan areas shows this priority for systems analysts and programmers: Los Angeles, Chicago, Boston, Cleveland, Cincinnati, Dallas, St. Louis, New Orleans, Buffalo, and Jacksonville, Fla.

Max to Flax. The Institute for Defense Analyses has named Alexander H. Flax as its new president. Formerly its vice president for research, he succeeds Gen. Maxwell D. Taylor, who served as president for three years. Gen. Taylor will stay on as an IDA trustee and executive committee member. Since re-

ceiving his Ph.D. in physics from the University of Buffalo in 1958, Flax has served as Assistant Secretary of the Air Force (R&D) from 1959-1961, and president and technical director of the Cornell Aeronautical Laboratory.

Partsmanship. The Naval Supply Systems Command is buying 14 IBM 360 computers to keep track of its massive inventory of aircraft parts. Each of seven naval air stations will receive an IBM 360/50, a 360/25, and peripheral equipment over the next 18 months. The initial contract is for \$1.3 million. The Navy's billion-dollar parts inventory annually brings in 5 million requests and generates more than 2 million receipts.

On second thought . . . A supplementary check of electronics companies' capital spending plans reveals a projected increase of 21% this year, compared with a 1969 boost of 16% indicated in last spring's survey by the McGraw-Hill economics department. For 1970, 45% of the electronics firms in the recheck said they would spend more than they had planned to in last spring's projections, raising the anticipated increase for next year to 17% from the spring prediction of a 4% gain.

Little David. Another would-be giant killer is loading up his slingshot. The latest is Peter James, whose firm, Photo Magnetics Systems Inc. of Beltsville, Md., is suing several of the Goliaths in the communications/computer field for a staggering \$2 billion. The defendants, including AT&T, IBM, Western Electric, and Chesapeake & Potomac Telephone Co., are accused of infringing on James's patent covering the use of button phones and telephone lines in connection with computer systems. Both IBM and AT&T say there's no validity in the suit.

Big Boeing. An eight-engine 707 has been proposed by Boeing as the aircraft for Awacs—the airborne warning and control system—an Air Force program that is running into budget woes.



Confused by temperature coefficient and ΔV_z specification on reference elements?

Relate them with ease using your
free nomograph from Semcor.

This is the second of a series of application
nomographs offered by Semcor to help you
solve your design problems quicker and easier.
Circle our number and we'll send yours today.

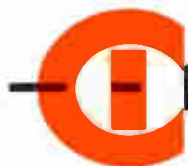

COMPONENTS, INC.
SEMCOR DIVISION

3540 W. OSBORN RD. / PHOENIX, ARIZONA 85019
PHONE 602-272-7671 / TWX 910-951-1381

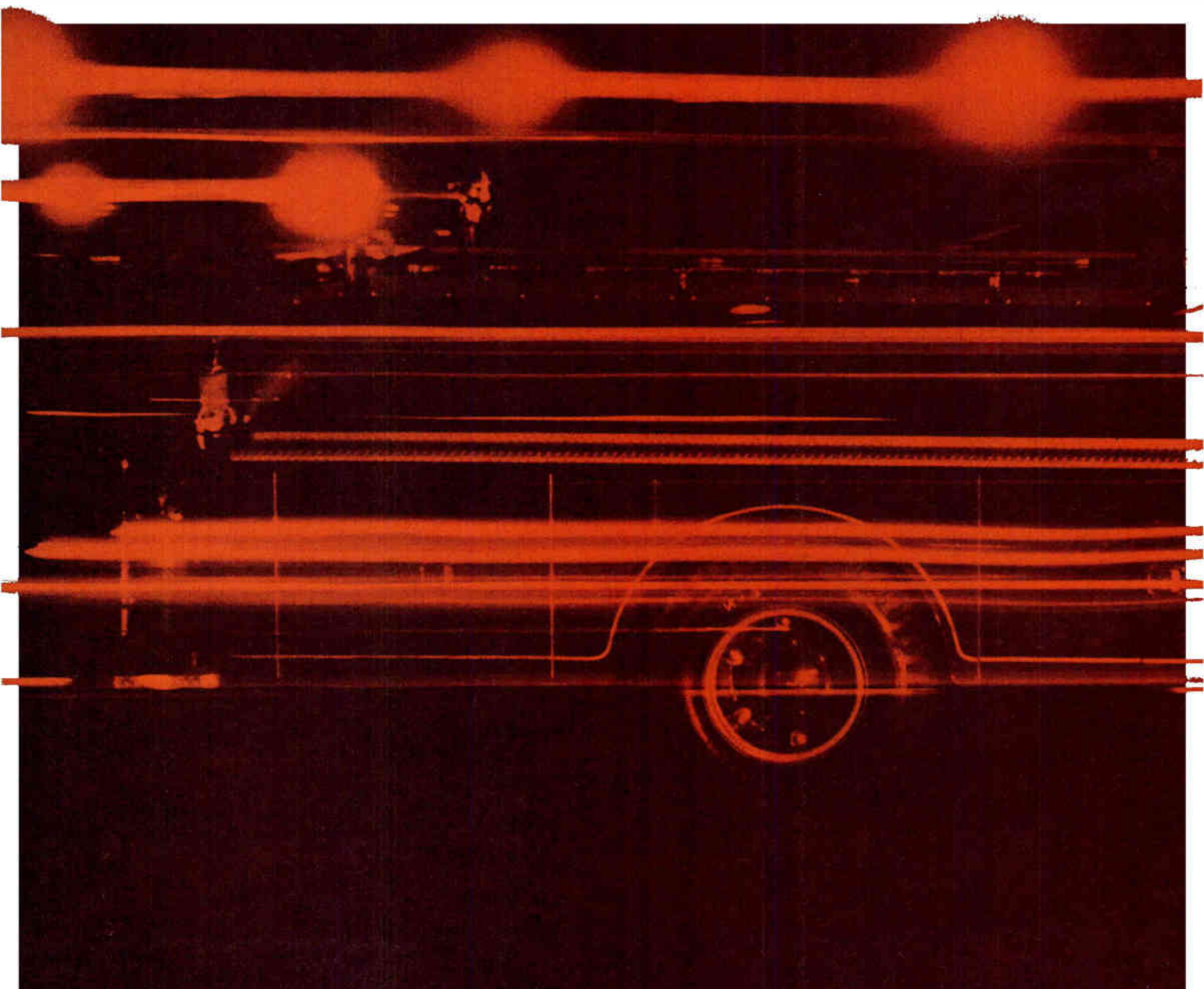

What is TRW doing at the fire?

is part of the action. We are not only on the fire truck, but the rescue squad, the police car, and the ambulance as well.

TRW power transistors help make all-solid state mobile UHF communications possible. Mobile military and ship-to-shore communications also rely on TRW fixed and variable capacitors, precision potentiometers, coils and quartz crystals. And TRW Gigahertz transistors are helping to open up totally new segments of the electromagnetic spectrum.

TRW components are used wherever dependable performance is vital. For TRW makes quality components in quantity. More than ten million components are shipped every week from TRW plants throughout the world.

TRW®

THE ELECTRONICS GROUP OF TRW INC.—
World-wide manufacturer of components for the
Government, Commercial and Industrial Markets.

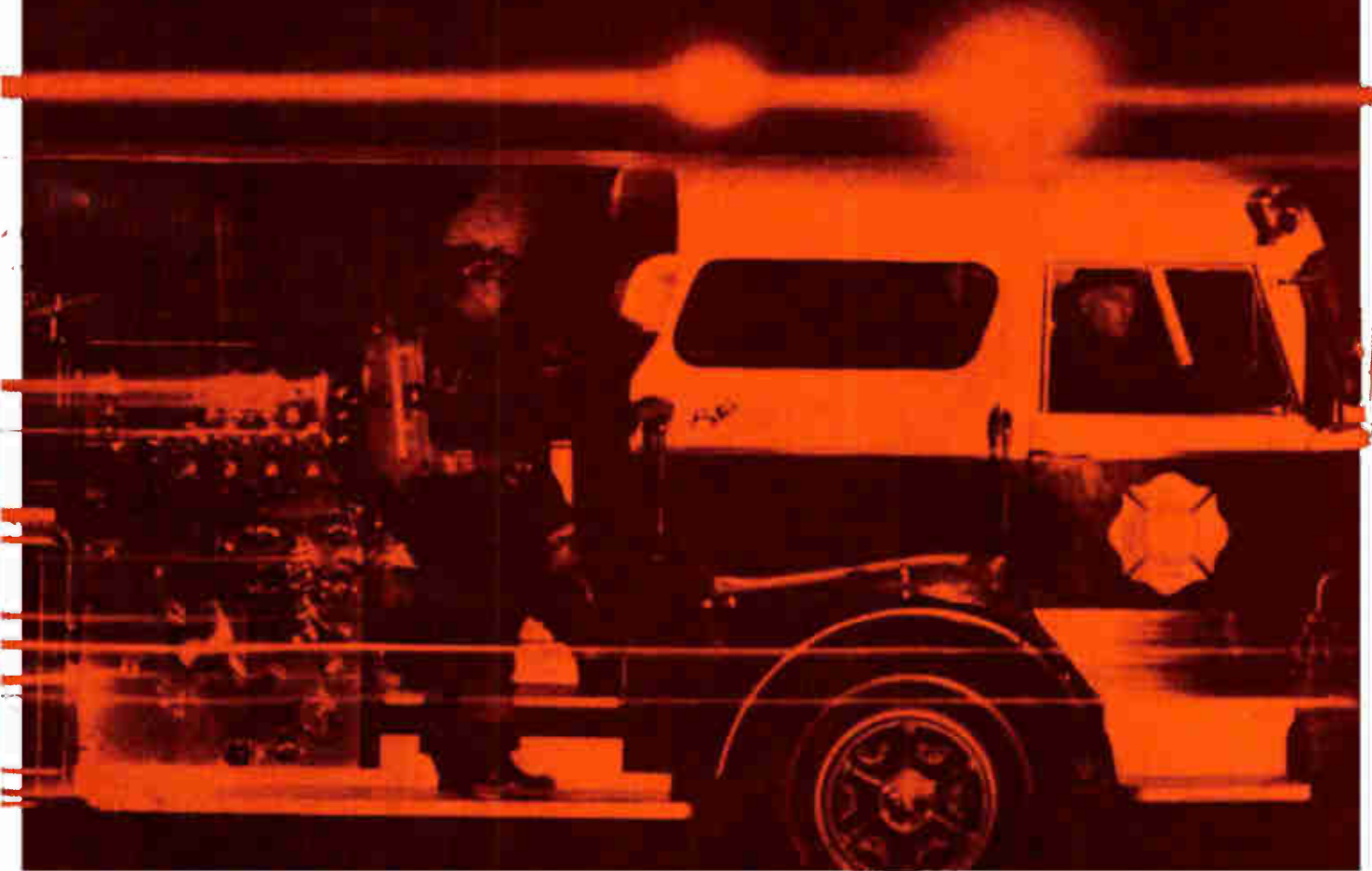

No other general purpose counter is so useful in so many ways. No other counter offers you so many accessories to fit so many measurement jobs.

First, you can get the Model 5248M with a time base that's stable to better than 5 parts in 10^{10} per day, a precision frequency standard in itself. You can measure any frequency from dc to 135 MHz to 8 places ± 1 count. Or use to 18 GHz at the same accuracy with simple plug-ins.

You can measure period, multiple period average, frequency ratio, multiple ratios, or you can scale frequencies or totalize.

With accessories that plug into the front panel you can:

Resolve time interval to 10 nano-seconds.

Measure to 18 GHz with a 1 Hz resolution in 4 seconds.

Measure CW or pulsed signals out to 18 GHz.

Prescale for direct readout to 350 MHz.

Increase sensitivity to 1 millivolt.

Make dc voltage measurement up to 1000 volts.

Normalize readings to engineering units or perform high speed batch counting or control.

And with the newest plug-in, the 5268A Frequency Multiplier, you can make high accuracy low-frequency measurements as much as 1000 times faster

You can get much more out of this counter. Because you can put much more in.

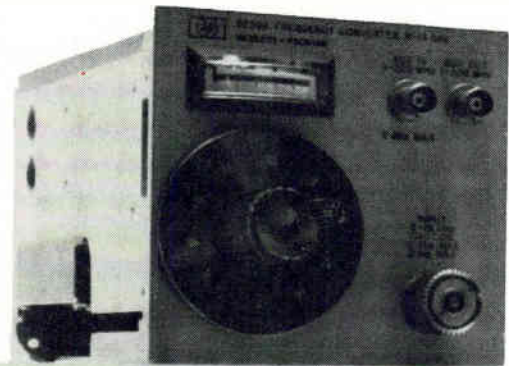

than you ever could before.

Plug-in accessory performance is unequalled. Even the 18 GHz heterodyne converter is completely free of spurious responses. And the transfer oscillator plug-in operates on a new principle which offers versatility, range (50 MHz to 18 GHz) and performance you can't get elsewhere. Add-on accessories even further extend counter usefulness by permitting manual measurements to

40 GHz or automatic measurements from 0.3 to 12.4 GHz.

The 5248M is but one member of a series of 10 closely-related models based upon the highly popular 5245L Counter. All models use the same accessories. And you'll get the same quality and field-proven design no matter whether you choose the top-of-the-line 5248M for \$3300, the original 5245L for \$2480, the economy model 5246L for \$1800 or any of the

seven other models.

For a 32-page guide to the highly versatile "5245 Series" call your local HP field engineer. Or write Hewlett-Packard, Palo Alto, California 94304; Europe: 1217 Meyrin-Geneva, Switzerland.

HEWLETT  PACKARD

ELECTRONIC COUNTERS

02908

Circle 87 on reader service card

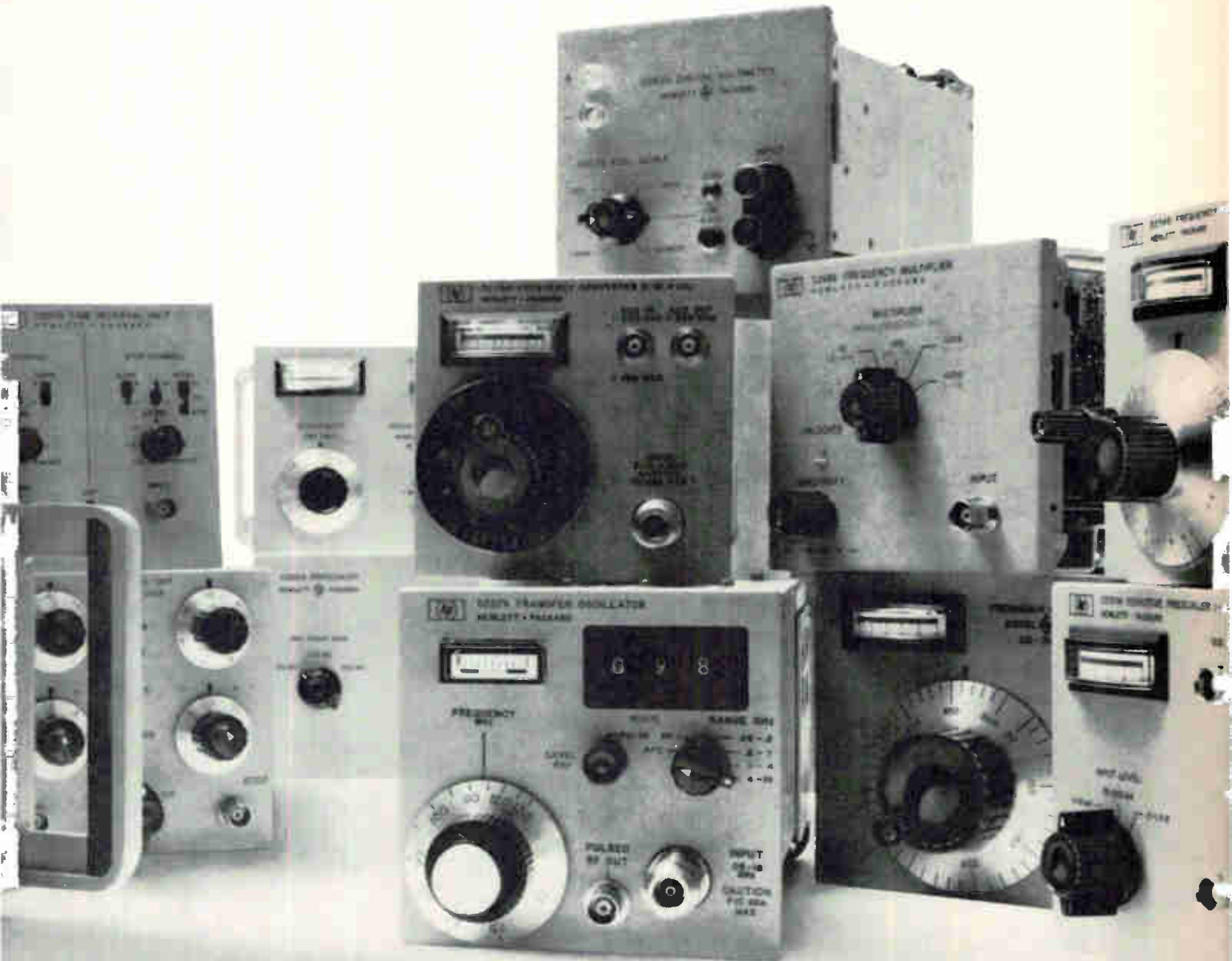

80 lines per second!

**Clevite's new
hardcopy electrostatic printer
zipped out the facing page
in 1.8 seconds flat.
That's up to seven times
faster than most printers
on the market.**

Eighty lines per second . . . 412,000 characters per minute . . . 4800 lines per minute. No matter how you figure print-out speed, dollar for dollar Clevite 4800 is far and away the fastest and most economical. It's four to seven times faster than most line printers . . . ten to twenty times faster than usual photographic hardcopy techniques. No other print-out system is even in the same ball park.

Words. And pictures.

Clevite 4800 handles both alphanumerics and graphics. Simultaneously. It will reproduce words, numbers, drawings, charts and graphs. Paper is an easy-to-file 8½" wide and page height is infinitely variable up to the full 300' length of the paper supply roll!

More of the fonts you want.

Clevite 4800 generates a wide variety of fonts from the smallest

matrix on up. In an equally wide variety of weights, sizes and styles.

Archival quality.

Clevite 4800 uses a special, high-contrast paper. The electrostatic print-out won't smear. And the paper won't curl, yellow or get brittle in storage. You can write on it with ball point pen, pencil, felt-tip or whatever.

The sound of silence.

Clevite 4800 is an electrostatic printer. So it is quiet. (Think about that next time you're trying to make yourself heard above a chorus of impact-line printers.) And no impact means less wear and tear on the printer, less maintenance and downtime.

Beyond the computer.

Clevite 4800 has uses beyond the computer. In communications it can replace banks of teletypes and prints out data transmitted by telemetry, radio microwave and/or land lines. And it prints out graphic displays from CRT's using a TV raster display memory. The Clevite 4800 whips out full pages of alphanumerics and graphics as fast as signal sources can feed it. You may have other application ideas. Let's kick them around.

A word from the sponsor.

Clevite 4800 is based on proprietary equipment and proprietary paper. There is nothing else quite like it. It's faster, more versatile, quieter and more dependable. Yet, the Clevite 4800 printer's low price will surprise you. Let's talk soon. Clevite Corporation, Graphics Dept., 37th and Perkins, Cleveland, Ohio 44114.

CLEVITE



**Clevite 4800.
The next generation
of high-speed printers.**

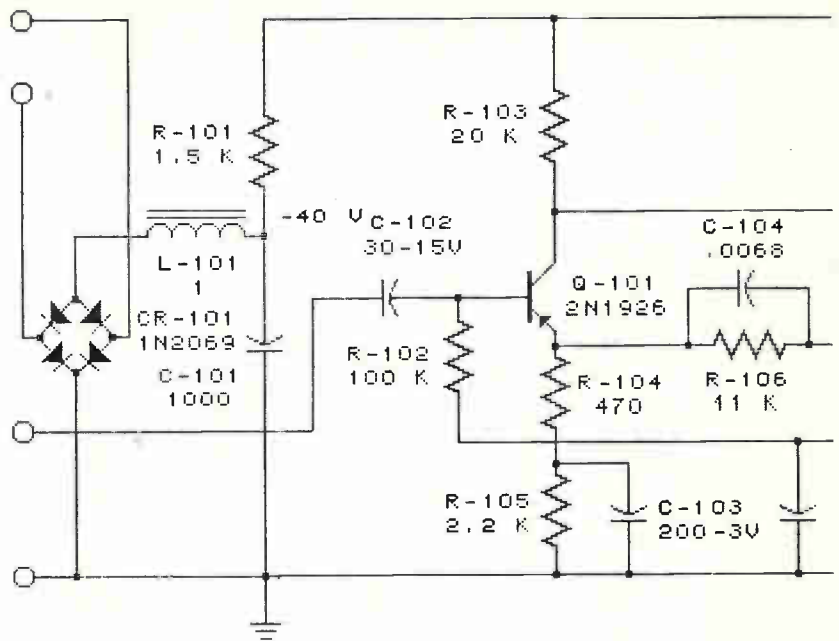
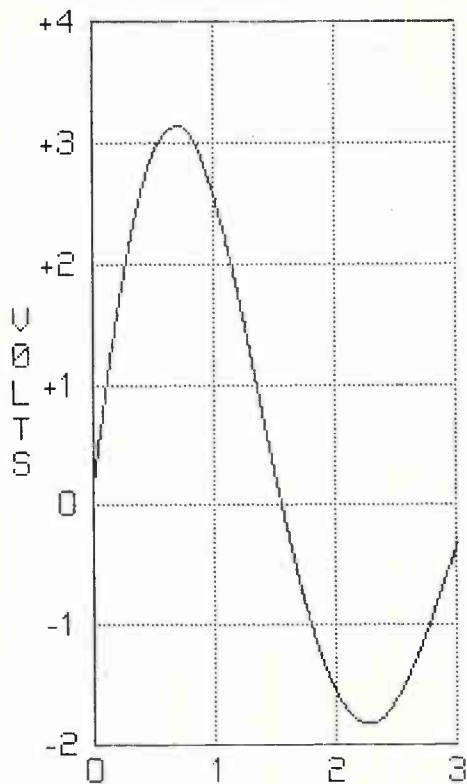

CLEVITE 4800

ABCDEFGHIJ
KLMNOPQRST
UVWXYZ
1234567890

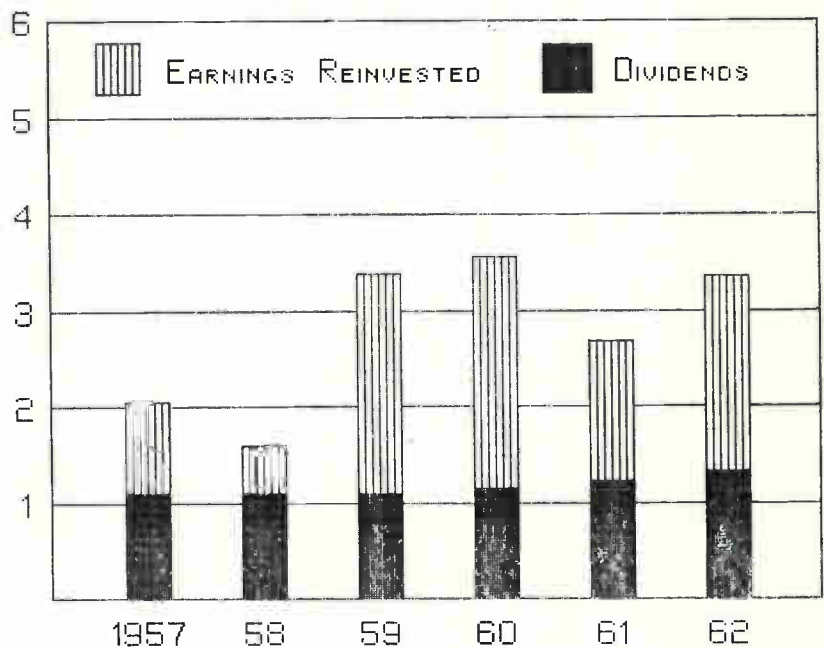

ABCDEFGHIJKLMNØPQRS
TUVWXYZ 1234567890

.,:;%()[]+~*/?=><\$#^"'"x

THESE CHARACTERS ARE NOMINALLY 10 UNITS HIGH BY 7 UNITS WIDE. SOME CHARACTERS ARE 1 UNIT WIDE AND ØTHERS ARE 9 UNITS WIDE.

abcdefghijklmnopqrstuvwxyz
1234567890

.,:;%()[]+~*/?=><\$#^"'"x

THESE CHARACTERS ARE NOMINALLY 10 UNITS HIGH BY 6 UNITS WIDE. THE HEIGHTS VARY FROM 6 TO 14 UNITS. THE WIDTHS VARY FROM 1 TO 9 UNITS.

ABCDEFGHIJKLMNØPQRSTUWVXY
1234567890

.,:;%()[]+~*/?=><\$#^"'"x

THESE CHARACTERS ARE NOMINALLY 6 UNITS HIGH BY 5 UNITS WIDE. THE WIDTHS VARY FROM 1 TO 7 UNITS.



MICROWAVE IC MODULES PROGRESS REPORT #8: PRODUCTION

Sperry Rand's PACT (Progress in Advanced Circuit Technology) program has moved microwave integrated circuits and modules out of the laboratory and onto the production line. As far as we know, Sperry Rand is the first company in the industry to take this revolutionary step.

Our functional assignment was to design the world's first radar performance analyzer for end-to-end testing of doppler radars. For a Navy program, our customer wanted a portable tester that could exercise navigation radar without radiating energy and without making any interconnection with the aircraft. Since size, weight and power consumption are critical, all the microwave functions were integrated. The result: three microwave integrated modules replacing 32 conventional microwave components.

At one time or another, Sperry Rand had produced fully integrated versions of every microwave component in the test set. Why not reduce the whole circuit to integrated modules? First, integrated modules have fewer interconnections, and are therefore more reliable. Second, integrated modules cost less to produce than present day collections of discrete components. Third, by making all of the circuit elements ourselves, we sidestepped a lot of procurement problems.

Development of the microwave integrated circuit modules for the doppler test set proved to be well within Sperry Rand's capability.

The unit works well. In the old days (last month) the microwave section would have occupied 90 cubic inches. Today it takes up 3 cubic inches. Our ferrite-

substrate modules have a low-pass filter, 6 circulators, 11 attenuators, 5 diodes, 2 mixers, 2 converters and 4 thermistors. The old way would have required 25 more flange connections than the integrated modules use. The microwave circuit functions within the same tight tolerances that it would have under the older technology.

Now that we're delivering integrated modules, you can't afford to pass up our experience. In fact, if we're not helping design your microwave system, it's probably obsolete.

A letter will start us working on your next system improvement. Write: Sperry Microwave Electronics Division, Sperry Rand Corporation, P. O. Box 4648, Clearwater, Fla. 33518 or call us at (813) 784-1461.

ABOVE RULER: The old way. Thirty-two conventional microwave components.

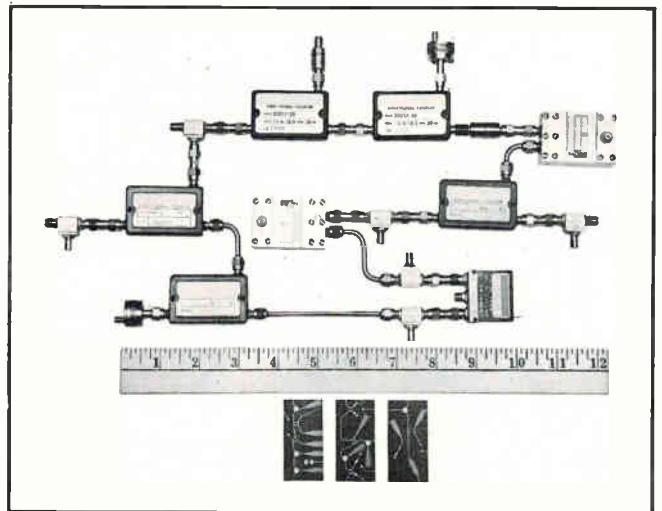

BELOW RULER: Sperry's new way. Three integrated modules. Lighter, less expensive, more reliable.

*For faster microwave progress,
make a PACT with people
who know microwaves.*

SPERRY
MICROWAVE ELECTRONICS DIVISION
CLEARWATER, FLORIDA

Washington Newsletter

September 15, 1969

Space task group steering clear of controversial goals

Don't expect President Nixon's space task group to recommend any controversial new space goals. Despite Vice President Agnew's outpouring about sending man to Mars after the Apollo 11 flight, the report will not push for anything significant and costly like the 1961 decision to put man on the moon in this decade.

The report, which won't be released publicly until after the heat over fiscal 1970 military appropriations cools in Congress, is expected to urge continued NASA efforts on the reusable space shuttle, the 12-man orbiting space station [*Electronics*, June 23, p. 143], and the nuclear engine for rocket vehicle applications (Nerva). Such programs however, certainly could lay the groundwork for a future manned mission to Mars.

Not resolved by the space task group, however, was believed to be the question of who will manage space shuttle development. Betting now is that NASA will end up with the shuttle, since the Air Force, which also would like to run the program, has too many in-house budgetary problems to take on the expensive shuttle.

EIA defense study: rocky road ahead unless firms plan alternate routes

The Electronic Industries Association has completed an ambitious, year-long study on the outlook for the defense electronics industry beyond 1972, and its conclusions spell danger for companies that don't carefully chart and predict the movements of this churning, changing market. The long-range picture for the space market is "very grim," the EIA says, while the outlook ranges from fair to very good in the defense area. The growth potential in education and training, marine sciences, and law-enforcement—likely diversification targets of defense-oriented companies—could be enormous if funding sources develop.

Forecasting the technological trends of the next 30 years, the EIA sees a period of technological evolution, rather than a period of revolution that characterized the past three decades. A review of the EIA requirements committee's 10-chapter, in-depth analysis, which includes nearly every issue and market area except for medicine and health (the section chairman failed to meet the publication deadline), provides the following highlights:

Space: 'grim'

A slowdown in the Soviet-U.S. space race is the major factor in the grim space outlook forecast by the EIA. The slowdown will come, the EIA says, when both governments realize that such efforts yield only limited economic and military benefits. Except for space communications, there are no significant public benefits foreseen to justify major increases in public outlays, the EIA asserts.

Furthermore, despite the push for a National Earth Orbiting Space Station, there will be a "real and reasonably permanent gap" in manned space flight in the post-1972 period, the EIA predicts. In the unmanned space programs, the EIA sees the industry faced with prolonged deliveries, reduced procurement of components, smaller and less costly launch vehicles, upgrading of operational reliability guarantees, and more intensive and cost-conscious competition, resulting in more competitors for fewer programs.

Defense: 'mixed'

The EIA rates probable new defense market opportunities in R&D and procurement as good for equipment, component, and material suppliers; average for associate prime system and major subsystem contractors, and

Washington Newsletter

poor for major prime systems contractors. The EIA expects only general purpose forces programs to decrease. **On the upswing, it predicts, will be spending for strategic forces, intelligence and communications, airlift and sea lift, and R&D.**

Competition is expected to be intense for new development work which will result in major new weapon systems. More teaming will be necessary due to the size and complexity of such systems, and efforts will be made to design major weapons systems so that they can be improved by only a minimal investment to update their subsystems.

The EIA says deemphasis is needed on multimission weapons and "gadgetry", which have adversely affected R&D in several tactical areas, adding that technology lead time from conception to deployment of a system needs to be compressed.

Education: 'booming'

With the cost of education running to \$80 billion a year—10% of the gross national product—the EIA predicts a burgeoning market for sophisticated electronic gear, particularly in the communications, data processing, and storage and retrieval areas. **But this can happen, the EIA says, only if a systems engineering approach is taken to counter the established and conservative education structure.** This will require large and costly development programs, and the money must come from government, the EIA says.

Most of the industry's involvement would be in this design stage and in the deployment phase in which systems would be built, sold, installed, operated, and supported.

Law enforcement: 'funds available'

With Law Enforcement Assistance Administration funding—matched by state and city funds—expected to rise from \$300 million in fiscal 1970 to \$1 billion by 1972, the police, obviously, represent a potentially large electronics market. **But the EIA warns that such hardware cannot be simply borrowed from equipment designed for other applications.**

Military communications gear, for example, could be adapted for police use if redesigned and repackaged to take into consideration such problems as receiver selectivity, rejection of images, modulation, and adjacent channels found in urban areas.

The use of helicopters should expand, along with related communications and surveillance systems including low-light-level tv and direct viewers. However, for police applications, the EIA says **existing hardware must be redesigned for greater range, lower power requirements, and simplified operation.**

Another area of growth is in police vehicle communications gear, but only if manufacturers pay heed to current law enforcement complaints of low reliability.

Marine sciences: 'major opportunity'

"Challenge and opportunity seem to be present in equal amounts," says the EIA study of the marine market. Industry is now spending about \$100 million a year in nonmilitary R&D. But if this area is to be profitable, companies will have to steer away from strictly research vehicles and chart a course toward smaller and more mundane development that hold out greater commercial promise. As for a major national program sought by the Marine Sciences Commission, the EIA believes Government response will be largely negative because of other, more pressing needs. A token approach, creation of a national advisory committee for the oceans, is likely as a starter. This probably will be followed by a national program of sorts two or three years later.

Sorensen modular power supplies

± 0.005% regulation

\$8900



- Optional 10 μ sec. overvoltage protection.
- Requires no external heat sink in ambients to 71° C.
- 29 models—voltages to 330 Vdc at power levels to 300 watts.
- Remote programming—remote sensing—series/parallel operation.
- Overload and short circuit protection.
- Meets military specifications.

Model QSA 10-1.4, shown actual size, illustrates the compactness of the Sorensen QSA Series.

These laboratory-grade, precision power sources are designed for OEM or system applications and utilize the latest solid-state regulating technology to provide a high degree of regulation and stability.

Sorensen produces 29 wide-range models, each with optional overvoltage protection. Other manufacturers require more than 100 models to cover the same area. By producing and stocking fewer models, Sorensen is able to provide better specifications, higher reliability, lower prices and "same-day shipments."

For more information contact your local Sorensen representative or; Raytheon Company, Sorensen Operation, Richards Ave., Norwalk, Conn. 06856. Tel.: 203-838-6571; TWX: 710-468-2940; TELEX: 96-5953.



RAYTHEON

THIS 100-FOOT ANTENNA CAN BE DEPLOYED FROM A 10-FOOT PACKAGE.

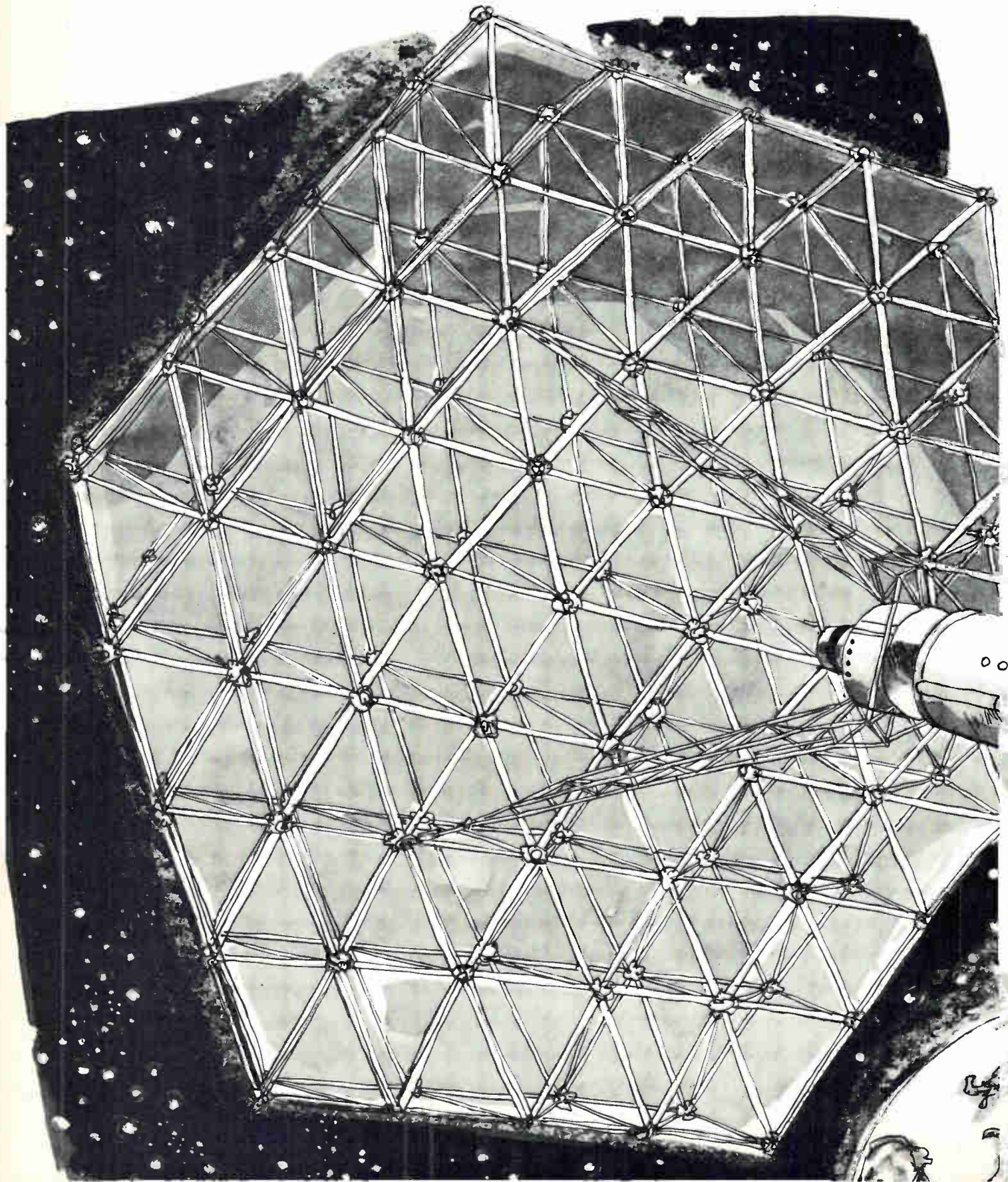

Getting a large-aperture antenna where you want it, when you want it, has become more and more of a problem in developing advanced space communications systems.

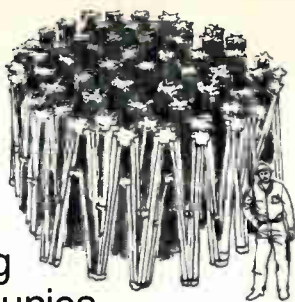

Until now, placing rigid, precision-surface antennas as large as NASA and the military would like them to be has been out of the question.

But now General Dynamics' Convair Division has conceived a geodesic truss that makes possible an antenna from five feet to 100 feet or more in diameter that folds into a package just one-tenth of its deployed size. Spring-loaded, it erects automatically on command.

Ten times the gain of today's antennas. The reason for a large-aperture is, of course, to achieve greater gain and narrower beams. The lightweight antennas we are developing for NASA are designed to provide a peak gain of more than ten times that of the largest communications satellite antennas available.

This larger gain factor means the satellite needs less power output.

Also, smaller, less-expensive ground terminals may be used.

High performance combined with design flexibility. When deployed, this antenna would have a mesh surface covering the triangular elements to form an accurate contour (diameter/surface tolerance $> 5,000$) for high performance through the upper microwave frequencies. And though conceived as a means of erecting orbital parabolic antennas, the same basic concept can be extended to a variety of other configurations — such as helical and horn arrays.

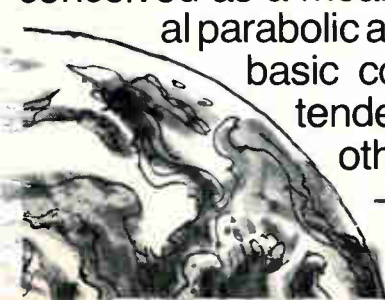

Small, lightweight package permits broad spectrum of uses. The advantages of getting an erectable antenna that folds into so small a package are obvious where launch vehicle payload is limited. For communications relays. Radio and television broadcasting. Radar. Radio astronomy and weather data acquisition. In potential military applications for protected space communications systems. And for lunar uses looking not too far into the future.

Applications foreseen in "inner space" too. We're also investigating the use of erectable antennas for portable ground terminals, and on both surface vessels and submarines. Here not only is size to be considered, but the ease and speed with which such antennas may be deployed and retracted into a housing.

This compactness also suggests use in underground silos where swift operation under changing tactical conditions would be imperative.

Erectable antennas are just one example of our continuing work on space programs. More than 370 Atlas vehicles have been launched, and the 1969 Mariner-Mars fly-bys were the tenth and eleventh operational Centaur missions. Also, in the past year, seven Convair scientific satellites have been boosted into space. Earth-bound space support projects include three Apollo Instrumentation Ships built by General Dynamics for NASA's global tracking network. They all show what technology can accomplish when it's handed a problem. At General Dynamics we put technology to work solving problems from the bottom of the sea to outer space... and a good bit in between.

GENERAL DYNAMICS

Technical information on erectable antennas is available on request. Write: General Dynamics, Dept. 850, 1 Rockefeller Plaza, New York, N.Y. 10020.

Circle 95 on reader service card

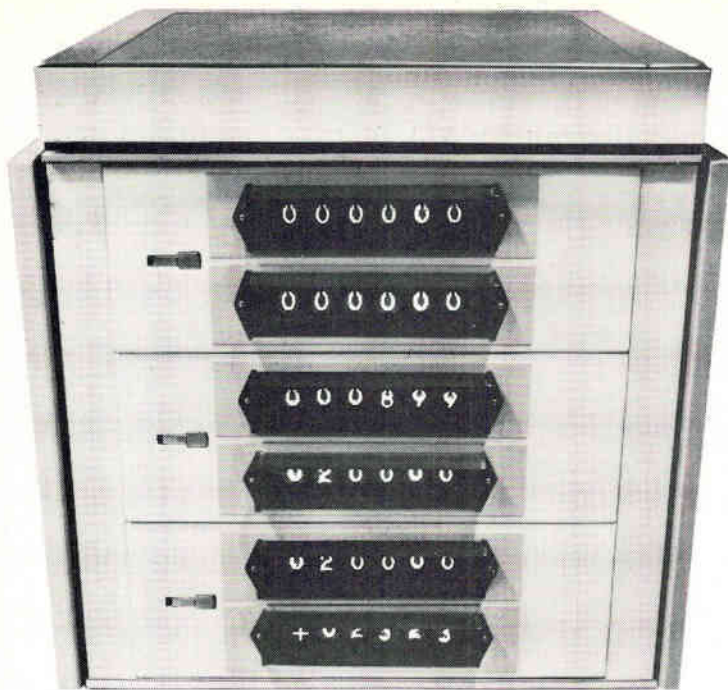

Indicator tubes—simple interfacing, limited flexibility, low in cost.



Full-scale terminals—extremely flexible, very expensive.

One way

Two way



New kind of CRT Readout—the best of two worlds.

New way

Announcing the SRD-100—a new CRT readout device with simple interfacing. Now it's practical to use CRT readout displays in place of indicator tubes. Without getting into the cost of full-scale terminals. Especially if you need remote or multiple displays. And even if you need only 5-10 digits.

The SRD-100 accepts numeric/symbolic BCD data in parallel form, converts it to a composite video signal and displays it on any 525-line TV monitor.

In any of 160 character positions. Interfacing is as simple as indicator tubes.

And you can display data at remote locations with any number of CRTs—with just a single coaxial cable.

You can blink data off and on four times per second. Use three different sizes of character display. And reverse the character and display background from black on white to white on black. All controlled independently, line by line.

Cost for the basic SRD-100, not including TV monitors, is \$995. Characters in groups of half lines, plus options, are additional.

So if you have a numerical readout problem in any application like automatic testing, process control, automation or data acquisition, you're no longer limited to indicator tubes. Now you have a choice.

From the company that specializes in innovative data communications systems.

ADDS

Applied Digital Data Systems, Inc.

Mr. Richard Kaufman
Marketing Director, Dept. 10.
Applied Digital Data Systems, Inc.
89 Marcus Boulevard
Hauppauge, New York 11787

Please send more information about the SRD-100.

Name _____
Title _____
Company _____
Address _____
City _____
State _____ Zip _____



The thinking man's filter.

We make filter pin connectors in both rectangular and circular subminiatures. Nobody else does it our way. Nobody else guarantees a 100,000 to 1 reduction of RF energy. Think about that.

HUGHES

HUGHES AIRCRAFT COMPANY
CONNECTING DEVICES



We're getting to be known as rounders.

We invented the BULLS-EYE Connector and created a reputation as circular subminiature specialists. Goes to show you what a little concentration can do. (Like 102 contacts in a #18 shell.)

HUGHES

HUGHES AIRCRAFT COMPANY
CONNECTING DEVICES

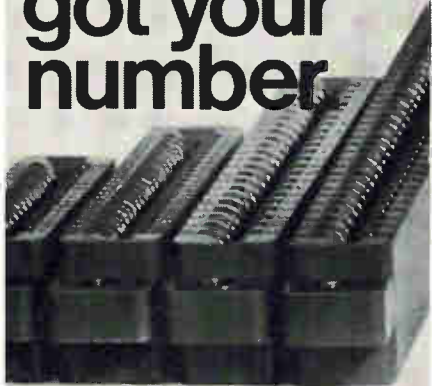

We've got your number.

Show us a spec, and we'll show you miniature and subminiature printed circuit connectors in 10 sizes with 10 to 96 contacts. We're good at the numbers game.

HUGHES

HUGHES AIRCRAFT COMPANY
CONNECTING DEVICES



We bend over backwards.

Contour Cable™ happened here first. Flexible etched flat cable. Flexible flat continuous cable. Custom cable/harness assemblies. Flexibility is a thing with us.

HUGHES

HUGHES AIRCRAFT COMPANY
CONNECTING DEVICES



We'll save your space.

The way we make subminiatures, they're more subminiature. More fully packed. Same contact size and spacing, only we get 110 contacts to the inch. Socket to 'em!

HUGHES

HUGHES AIRCRAFT COMPANY
CONNECTING DEVICES



The do-it-yourself connector kit.

With our Universal Connectors, you decide what goes where. The crimp removable contacts are interchangeable in either body. The big difference at Hughes is the positive way they get together. The PolarHex way.

HUGHES

HUGHES AIRCRAFT COMPANY
CONNECTING DEVICES

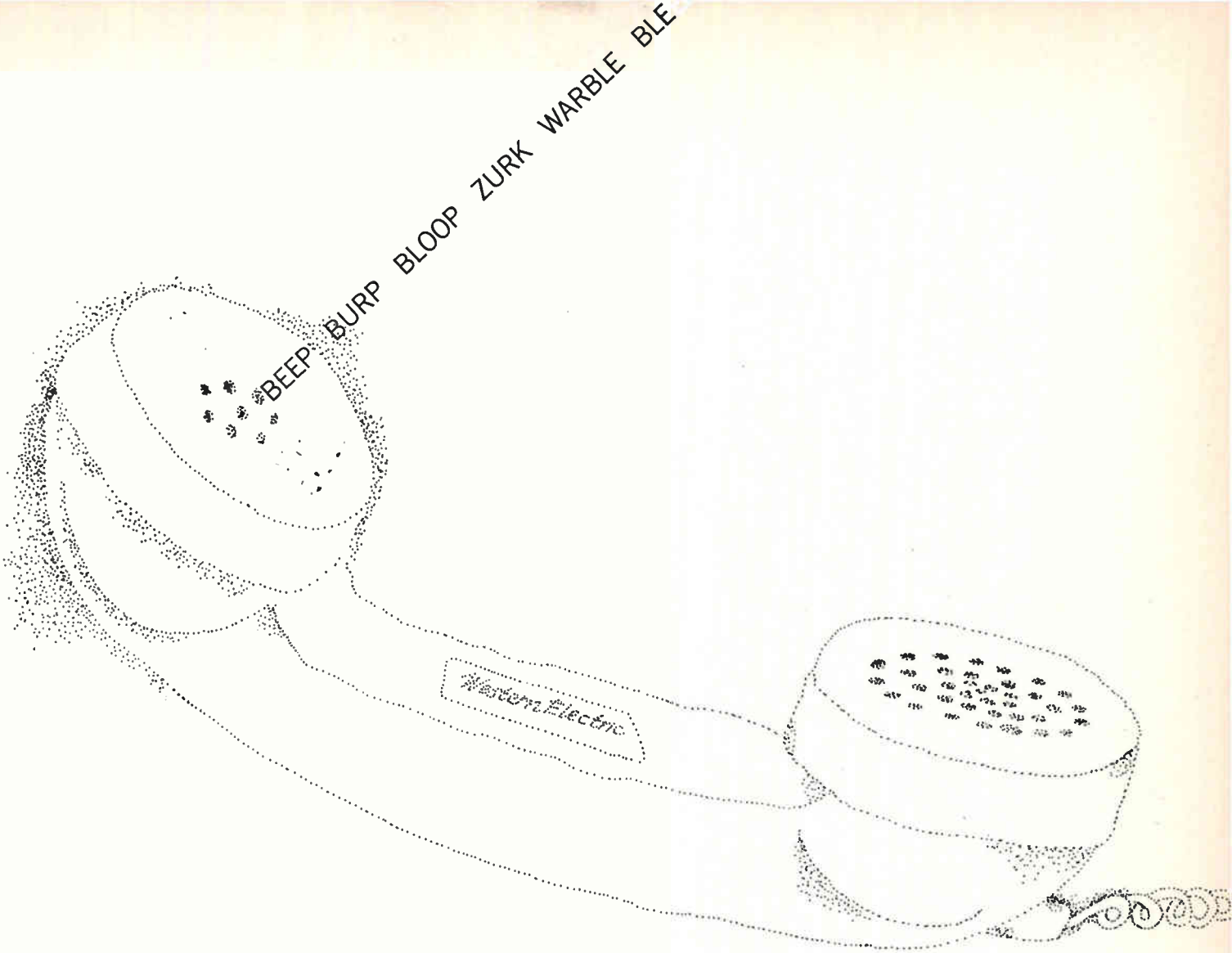

MONOTHERM® UNDERSTANDS

If you want the output of a computer fed directly into another business machine 3,000 miles away, Western Electric's Data-Phone® Data Communications Set can make the connection. Over ordinary telephone lines.

Data bits from the computer are converted to tones by a Data-Phone data set. At the receiving end a similar set changes the tones back into the signals required by the business machine.

The key component in many Data-Phone data sets is a Western Electric 3A2 Data Unit. And at the heart of the Data Unit is a Riegel

Monotherm® flexible laminate of copper and Type H Kapton® used for the printed circuits.

Why Monotherm? Because it's an extremely flexible laminate which folds like a book to compact size, thus saving valuable space. Because it eliminates the need for a color-coded wiring maze. Because it possesses high dimensional stability. Because it can be automatically (and repeatedly) soldered. Because its uniquely high heat resistance makes it easily repairable in the field.

If automated mass production, high reliability, low cost, im-

proved serviceability and small size are design requirements of your circuits, why not make a connection with Monotherm? The coupon will do it.

Synthane • Taylor Corporation
Valley Forge, Pennsylvania 19481

Please send me Kapton®/copper data sheets and the Conductor and Dielectric Guide for Riegel Monotherm.

Name _____

Company _____

Street _____ City _____

State _____ Zip _____



synthane-taylor

EXCLUSIVE U.S. DISTRIBUTOR OF RIEGEL MONOTHERM IN SHEETS AND ROLLS

Monotherm®—registered trademark of Riegel Paper Corporation for its laminations of conductive and dielectric materials. Kapton®—registered DuPont trademark for its polyimide film. Data-Phone®—registered trademark of Western Electric Co.

Circle 99 on reader service card

200 KHz to 220 MHz is standard on this FM/AM Signal Generator

... no extender required!

\$1,395



Model 995B/2

- FM to ± 75 KHz all ranges; up to ± 600 KHz on top band
- AM up to 50%
- Simultaneous FM and AM for AM rejection checks
- Crystal Calibrator
- Direct Reading Incremental Tuning
- Accepts Composite Stereo Signal

Available upon request
SIG. GEN. BOOK I

The Sig. Gen. Book I presents detailed discussions on signal generators and receiver measurements including: source impedance of feeder connected receivers, coupling to loop antennas, signal-to-noise ratio, automatic gain control, plotting response characteristics, measurement of adjacent channel suppression and spurious responses, etc.



mi **MARCONI**
INSTRUMENTS

Division of English Electric Corporation
111 CEDAR LANE • ENGLEWOOD • NEW JERSEY 07631
TELEPHONE: 201-587-0607

716



Optimizer

**Off-the-shelf
Full Capacity thyristors
balanced for all parameters
only from Westinghouse.
Try 'em for size.**

With thyristors that meet all critical design parameters — not just a couple—you get reduced equipment size... plus savings on circuit components. And only Westinghouse delivers them.

Our parameter optimization in full capacity thyristors gives you another bonus: more design security. And their compression bonded en-

capsulation (a Westinghouse first) assures low thermal impedance.

Vital statistics: 40 to 550 amps, up to 1500 volts; standard JEDEC and POW-R-DISC packs.

So optimize away! Send for SA-10205. Westinghouse Semiconductor Division, Youngwood, Pa. 15697.

You can be sure... if it's
Westinghouse



BURROUGHS DEVELOPS... SELF-SCANTM PANEL DISPLAY

the most significant development in electronic display

Burroughs, the originator of NIXIE[®] tubes, now revolutionizes display technology with the first commercially practical dot matrix display system. It took SELF-SCAN panel display, the remarkable Burroughs invention that takes the electronics out of the present electronic display ... reducing costly drive circuitry up to 90%.

With a minimum number of leads and drivers, Burroughs' system automatically scans data input into in-plane readout characters formed by glowing dots ... making possible a totally new combination of readability, minimal packaging and cost advantages.

The new flat-panel display is basically a matrix of small gas discharge cells hermetically sealed between heavy glass plates in a sandwich configuration. The matrix itself, formed of insulating material, has small grooves on its top surface to allow positioning of information anode wires which intersect each hole. Cathode conductors behind the center sheet intersect at each cavity with a second set of anode wires.



By utilizing the phenomena of preferential glow transfer and glow shifting, the initial glow caused by cathode ionization in the dot matrix may be moved through selected holes to a visible position on the top surface. A sequential flow of light is thus achieved without separate drivers for individual columns and rows.

Burroughs' alphanumeric SELF-SCAN panel displays are available with or without memory for any application requiring 16 or 18 digit readout.

Write today for descriptive brochure, Burroughs Corporation, Electronic Components Division, P. O. Box 1226, Plainfield, New Jersey 07061. Tel.: (201) 757-5000.

Burroughs 

Technical Articles

**No West German
'creativity gap' where linear
IC's are concerned**
page 109

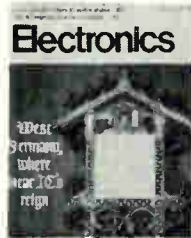

With consumer products dominating the West German scene, it's little wonder that linear circuits have upstaged digital circuits in the IC spotlight. A special report by John Gosch, *Electronics'* man in Bonn, tells how things got that way and why they may be changing. In separate articles, Valvo's "universal" approach to IC's in color tv and a shutter-control IC for automatic cameras are described. On the digital side, Siemen's efforts in promoting noise-immune-logic IC's are detailed. Upcoming articles in this new series focus on silicon on spinel, MSI for office machines, economic methods of preparing IC artwork, and other German innovations. The cover symbolizes the state of Germany's IC industry; the IC shown on the clock face—actually made by IIT's Intermetall subsidiary—is for stabilizing clock drives.

**Memories: glass-vs-MOS
tradeoff; thin-film
design criteria**
page 122

This twelfth installment of *Electronics'* memory technology series explores the tradeoffs between glass delay-line memories and MOS shift registers, showing that each has advantages that make it the choice for certain applications. Two of the articles describe the causes of one of the major problems in thin films—creep—and discuss its prevention. If creep isn't controlled, a bit can "ooze" into a neighboring position and destroy data. This problem must be considered in the design of any thin-film memory system. Controlling creep permits higher packing density in both planar and cylindrical thin films. The third article discusses this and shows there are additional factors that can increase density.

**Teamwork streamlines
differential amplifier tests**
page 132

Differential amplifiers can't be hooked directly to an oscilloscope for testing because the scope can't handle their wide dynamic range. And the logarithmic amplifiers needed to compress the diff amp's output over a wide band of frequencies are expensive and hard to come by. A novel test circuit, however, makes it possible to use an inexpensive narrowband log amplifier in a setup that tells in seconds how open-loop response, common-mode rejection ratio, or input and output impedance of a differential amplifier change with frequency. In this circuit, the differential amplifier's output is mixed, and the difference frequency is compressed by the log amp and displayed on the scope.

Coming

**Silicon gates
for fast MOS IC's**

Metal oxide semiconductor IC's in which silicon, rather than aluminum, is used as the gate electrode are faster and can be packed into half the chip area. Silicon-gate technology has so many advantages that at least one manufacturer will introduce many silicon-gate devices in the future.

No West German 'creativity gap' where linear IC's are concerned

Reporting from Bonn, associate editor *John Gosch* finds that the emphasis is still on linear circuits for consumer applications — but now digital devices may be coming into their own, as future articles in this new series will show

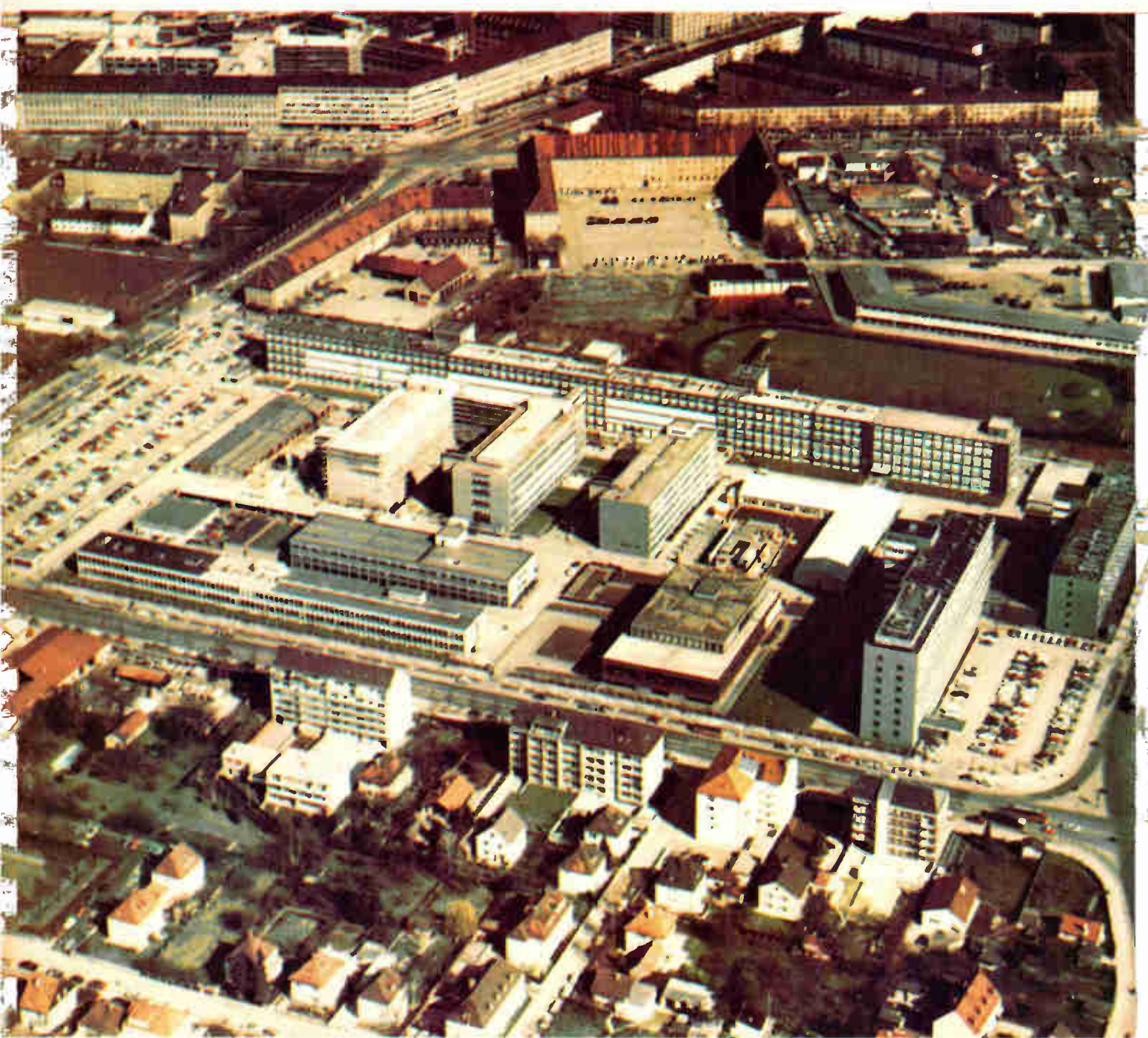

duction equipment for IC's—most gear in German plants are U.S.-made.

Lacking extensive government support and without a significant national space program, Germany's digital-development and production got off to a late start. As a result, most of digital circuits found in Germany today are either made in the U.S. or made by U.S.-owned production facilities in Europe.

To be sure, some government money is already trickling into microelectronics labs. The Bonn government only recently started to aid domestic computer development. The Ministry for Scientific Research, for example, has allocated \$20 million this year, increasing to \$100 million by '73, for R&D on computer systems. This amount may not be much, but it does represent a significant step for the Bonn government. Nevertheless, precious little will go to component makers. Some microelectronics support is also coming from the German military. But this, too, is anything but extensive.

Thus, there is little question as to why the linear IC is king in Germany. And partly because of the country's strong position in consumer electronics—production of radios and tv receivers reached \$540 million last year—and the preference for domestic IC's, four "essentially German" firms have cornered roughly half of the total market valued at \$25 million this year. Some industry people say the four companies—Valvo GmbH, Siemens AG, Intermetall Halbleiterwerk der Deutsche ITT Industries GmbH, and AEG-Telefunken—may have cornered as much as 60% of the market.

Siemens and AEG-Telefunken are German owned, while the others are members of international groups headed by foreign companies. Valvo is a subsidiary of Philips Gloeilampenfabrieken NV of the Netherlands and Intermetall is, as its full name implies, a subsidiary of the International Telephone and Telegraph Corp. of the U.S. Despite their foreign affiliations, both Valvo and Intermetall are regarded as essentially German; they maintain their own research, development, marketing, and sales operations. These activities are, however, planned, coordinated, and funded to a greater or lesser extent by their parent companies.

Combined, these four firms have annual IC output in the neighborhood of \$17 million, of which exports—primarily linear devices—account for roughly \$5 million to \$8 million.

Common to all four firms is an involvement, in varying degrees, in both digital and linear IC activities. But at both Siemens and AEG-Telefunken, digital-IC production far overshadows linear production. Both firms are major manufacturers of communications and industrial electronics equipment, and most of their devices are earmarked for in-house use.

Intermetall, a maker of semiconductor components exclusively, is on the opposite side of the spectrum. The company's major emphasis is on linear IC's, at the expense of digital circuits.

Sandwiched between Siemens and AEG-Telefunken on one side and Intermetall on the other is Valvo. A component maker in its own right, Valvo's strong suit is linear devices for consumer items—primarily in the home-entertainment sector. The company makes more voltage-stabilizer IC's for tv-receiver tuning diodes than any other single device. Not that Valvo is overlooking digital devices. It isn't. Evidence of this can be seen in

● West Germany's traditional emphasis on consumer goods—radios, televisions, automobiles, cameras, clocks, and the like—has, to a great extent, dictated the direction of the nation's integrated-circuit business. This has led to linear circuits dominating the German scene.

With little existing technology on which to fall back, German IC designers have had to develop their own concepts. And how well they've done can only be gauged by the distinctive original linear IC's that have come out of Germany. These circuits are equal to or better than anything made elsewhere. This success can be attributed, in large part, to an outpouring of research-and-development funds for linear circuits. Although the total amount is insignificant by U.S. standards, most of it had gone into linear IC's.

As a result, business is booming and German firms are feverishly expanding their IC capabilities to cope with the fast-rising demand for linear circuits. By 1974, most experts agree, Germany will be turning out \$100 million in IC's—about four times the country's present annual output. And as is the case today, the great bulk of 1974's IC production will be linear circuits.

But what about digital IC's? Accounting for less than 50% of the total German-made IC market, digital circuits are in the shadow of U.S. technology. Duplication, not originality, has been the hallmark of Germany's digital IC efforts. And the same can be said of the pro-

Construction. Growing pains afflict all German IC manufacturers. Siemens, for example, is adding a six-story 4,500-square-foot IC factory to its Munich semiconductor complex.



the growing emphasis being given diode-transistor-logic devices, for example.

Much of Valvo's production of digital devices stem from U.S. know-how. This is largely because of a technological-exchange agreement, which ended some time ago, between Valvo's parent company—Philips—and the Westinghouse Electric Corp. Valvo, as a result, was able to draw on U.S. design concepts.

By far and away, Valvo is West Germany's No. 1 IC maker, with annual output estimated \$8 million and \$9 million—about as much as the other three firms put together. The Hamburg-based firm carefully selects its markets. This has led to Valvo being the first German IC maker to come up with a device that electronically controls camera shutters. And the company is marching strongly into color tv with several new IC's.

On the digital scene, Valvo is developing a bit-line, transistor-transistor-logic circuit that incorporates 50 gates on a single chip. Like the company's DTL, the TTL is basically designed for parity control of the numerical content of two binary counters.

Siemens, which is West Germany's top-ranking electronics company, is No. 2 in IC's. Digital and linear devices will account for \$6.25 million in sales this year. Of the dollar value, digital circuits—with TTL types dominating these—account for roughly 70% of the total. Roughly 50% of these digital devices wind up in such

Siemens-made equipment as data-processing systems, communications gear, measuring and control equipment, and instruments. Telephone-exchange equipment will more than likely be an upcoming major thrust for digital IC's. Siemens also makes linear devices—operational amplifiers, for example—for in-house use. Upcoming at the company: IC's for military applications.

Although digital devices is where Siemens has its strength, it's in the linear sector that the company has made its mark as an innovator. The company has come a long way since it developed a hybrid circuit that incorporated several resistors and capacitors. The device, designed for hearing aids, was fitted with tiny sockets for miniature tubes that were developed specifically for the circuit. And a decade later—in 1962—Siemens introduced its first monolithic IC for use in hearing aids.

Three years later, the company was the first in Europe to mass-produce a linear IC for a consumer-electronics product. The device was an amplifier and the product, a tape recorder. The amplifier was the forerunner of Siemens' TAA 420, a two-stage device that has been a Siemens hallmark.

In essence, the TAA 420 consists of a low-noise, high-input-impedance preamplifier and an output amplifier. Between these stages is an external volume-control circuit that, should it be desired, can be replaced by an automatic signal-level control circuit. Thanks to a nega-

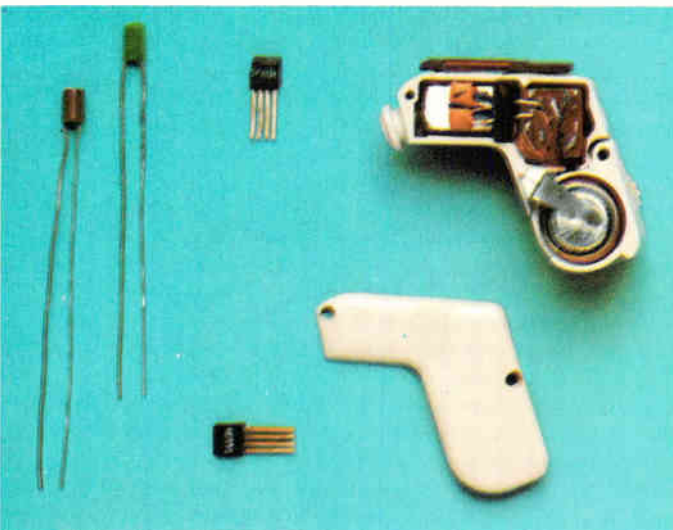

Evolution. Siemens' monolithic TAA 131 (the black rectangle) is designed for hearing aids. The IC evolved from the company's work on hybrid circuits dating as far back as 1952.

Rank and file. This large, modern, and well equipped chip-bonding facility at Siemens' plant in Munich is typical of German IC factories.

tive feedback from the output amplifier, which exhibits a high open-loop gain, an almost unlimited number of frequency-response curves can be obtained. These curves are used for equalization.

Another Siemens IC original is the SV 30, an amplifier designed to drive directly a medium-power push-pull output stage. This device, too, is for a consumer product.

Using the input stage—a differential amplifier—the operating point of the output stage can be easily set to half the value of the supply voltage, thus enabling optimum use of this voltage. High linearity can be achieved by using high value of feedback. Because the input stage features good noise characteristics, the amplifier can—if so desired—be used without an output stage.

Still another Siemens amplifier, the SV 33, fills the need for an IC-based intermediate-frequency amplifier suitable for both a-m and f-m radio receivers common to Europe. The amplifier is designed for supply voltage ranging from 4 to 12 volts.

At an operating voltage of, say, 9 volts the SV 33's current consumption is only 7 milliamperes. Depending on external circuitry, the amplifier features a voltage amplification of between 70 and 90 decibels and thus can replace at least two discrete-component amplifier stages.

In a-m operation, the range of the gain control is more than 60 db. In f-m operation, output signal limitation

becomes effective at input signals smaller than 300 microvolts. In conjunction with a ratio detector, the circuit exhibits good suppression characteristics. In all, the device employs just about 20 active and passive components, thus making it both economical and efficient.

Destined for control applications ranging from home appliances to automobiles is Siemens' TAA 861 which delivers an output current of 70 ma. Thus, direct control of relays or power stages is possible without resorting to intermediate stages.

On the digital front, duplication of U.S. designs has typified much of what Siemens has done. The company, like Valvo's parent firm—Philips—had a know-how exchange agreement with Westinghouse and other U.S. firms. As a result, Siemens' TTL circuits are compatible with and bear a strong resemblance to Texas Instruments', Siemens' emitter-coupled logic series is similar to Motorola Semiconductor's, and Siemens' metal oxide semiconductor devices resemble General Instrument's.

Of late, however, Siemens has struck out on its own in the digital field. Attesting to this fact is the company's low-speed-logic (LSL) family. These digital circuits, designed for process-control equipment and telephone-exchange systems and featuring high-static and dynamic-noise immunity, are comparable to similar devices made elsewhere, says Siemens.

Intermetall, which was founded in Düsseldorf in 1952

Tripled. By the end of this year, AEG-Telefunken's development and production capacity will be three times larger than it was in 1968. New buildings are rising at the firm's main semiconductor plant in Heilbronn, and additional space is being made available by shifting production of discrete devices to factories in West Berlin and Austria.



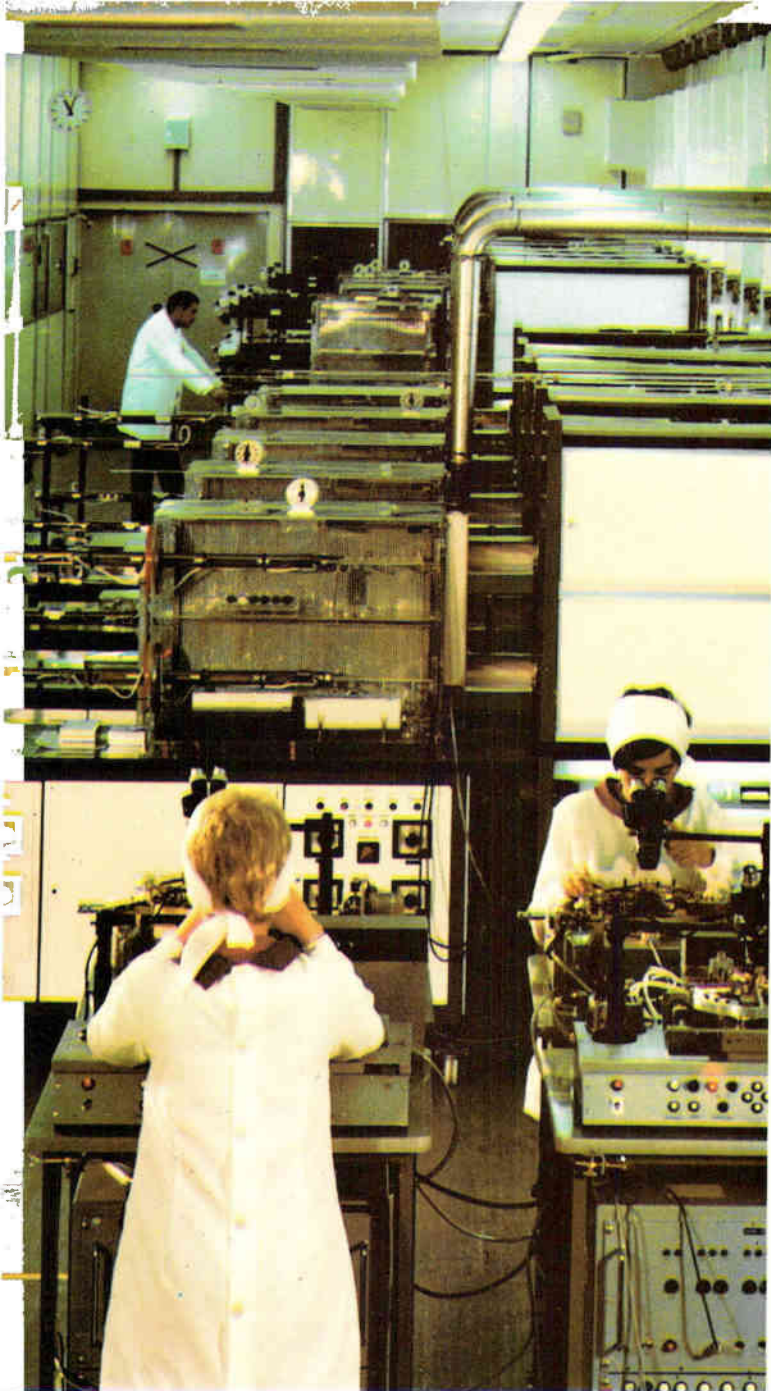

Imports. Diffusion furnaces at Siemens' diffusion center in Munich are American made, as is most IC production equipment in Germany. There is a reverse trend, however—Siemens, for one, has developed a mask-aligning technique and is marketing equipment for it abroad.

as the Gesellschaft für Metallurgie und Elektronik—company for metallurgy and electronics—began to deliver germanium diodes and transistors for simple industrial applications and laboratory use in 1953. Two years later, the company, already known as Intermetall, was affiliated with the Clevite Corp. The U.S. firm not only gave the German firm strong financial backing but provided it with U.S. semiconductor know-how as well. Five years later—in 1960—Intermetall moved to its present site at Freiburg in the Black Forest region and produced germanium and silicon diodes, and transistors for both industrial and consumer electronics. In 1965, after Clevite had gotten out of the semiconductor business, Intermetall came under the wing of ITT.

Since then, Intermetall has become ITT's leading developer of consumer IC's in Europe. More than 33% of Intermetall's total output—about \$2 million in IC's this year—is exported, primarily to other European nations, with only 5% going to other ITT firms.

For the most part, Intermetall is oriented toward large markets for its off-the-shelf and custom-made IC's. Its off-the-shelf devices, both digital and linear, are aimed primarily at three markets—home entertainment, automotive, and timepieces. Since West Germany manufactures some 37 million household clocks and 7 million wristwatches a year, the market for IC's in timepieces is anything but small.

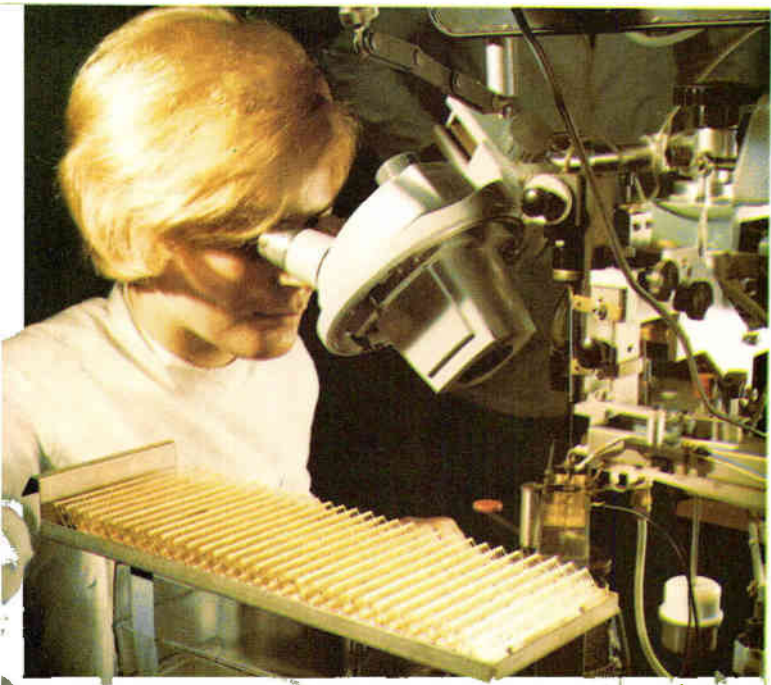

Plastic pack. Production methods closely resemble those used in the U.S. Here, a Siemens employee bonds IC chips to lead frames for subsequent plastic encapsulation.

. . . in some cases, designers of digital circuits have charted their own course. Of particular note is a noise-immune circuit for use in process computers . . .

Typical of Intermetall's linear IC effort is its TAA 771, a monolithic bipolar device designed primarily for automotive applications. The IC, incorporating more than 50 active and passive components, is essentially used as a pulse generator for direction indicators and blinking lights. The circuit, built up on a 1.2-millimeter-square chip, is housed in either a dual or a quad in-line package. (Unlike other ITT subsidiaries, which use chips diffused at the parent company's West Palm Beach, Fla., plant, Intermetall makes its own.) In conjunction with a frequency-determining resistance-capacitance circuit and a relay, the TAA 771 replaces conventional hot-wire blinking relays.

Another typical Intermetall-designed IC is the TAA780, a linear device used in electrically driven wall, table, and alarm clocks. By means of a control circuit, the output voltage in the clock's drive mechanism is kept constant at 1.1 volt so that temperature variations between -20°C and $+60^{\circ}\text{C}$ do not affect the clock's accuracy. Thus, the TAA 780 stabilizes the voltage.

The IC is epoxy-encapsulated in a pancake housing that measures roughly 5 millimeters in diameter and 2.5 mm high; it weighs about 0.02 grams.

At AEG-Telefunken, West Germany's No. 2 electronics firm, IC activities are taking up an increasing proportion of total semiconductor efforts. Of the total IC production, digital devices account for 80%. However, the output

of linear devices is expected to increase at such a rapid rate that by 1971 digital and linear production could well be split just about 50-50.

The great bulk of AEG-Telefunken's IC's are for in-house use. Between 80% and 90% of the digital devices wind up in company-made measuring and control systems, communications equipment, computers, and military hardware. Just about the same could be said for linear circuits, except that these end up in consumer products. Next year, something like 70% of the linear devices will be for in-house use, while a sizeable portion of the remainder is expected to be custom-made devices.

As is the case with other German IC producers, much of the company's strength in the digital area stems from U.S. technology. AEG-Telefunken's TTL series, for example, is strikingly similar to Texas Instrument's 74N series. And similarly the company's ECL line, developed for fast computers such as the company's TR 440, is essentially a duplication of Motorola's emitter-coupled logic.

On the other hand, designers at the company's Heilbronn plant, like those at other German firms, have in some cases charted their own course. Of particular note is zener-diode-transistor logic (DTLZ), a noise-immune circuit for use in process computers and electronic-data processing peripheral equipment. A newer version of this circuit is the DTLZ 2, which features a noise-immunity of around 5 volts and a propagation delay time of less than 100 nsec. The DTLZ 2 has the same pin configuration as the TTL 74N series.

Another noteworthy development is a special resistor-transistor-logic device that is earmarked for space application. Its power dissipation is an extremely low 500 microwatts per gate.

Presently in the development stage at Heilbronn are very fast IC's such as symmetrical emitter-coupled logic (SECL) devices that have delay times of less than 1 nsec. The company is also developing LSI circuits based on bipolar and MOS techniques.

AEG-Telefunken's linear device activities are strongly influenced by the trend toward integrated techniques in consumer electronics. Under development are such circuits as high-frequency broadband amplifiers, low-frequency amplifiers with power outputs up to 4 watts, and i-f amplifiers for tape recorders, and radio and tv receivers. Several special linear IC's such as operational

Doppelrohr. Technician adds solution to souble-tube diffusion oven at Valvo's factory in Hamburg. Like Siemens and the other major German manufacturers, Valvo must rely on U.S.-made production equipment.

amplifiers are being developed for application in industrial electronics equipment.

In addition to developing new IC's, AEG-Telefunken is concentrating much of its engineering talent on developing novel manufacturing approaches.

Spurred by the rising production costs and a critical shortage of labor, the company has started to install control equipment for a fully automated production line at its Heilbronn facility. A closed-loop system will soon be used for handling IC material flow and will take over such jobs as controlling doping and other operations involved in IC fabrication. The computer will also be used as a management information system to enable executives to reach fast decisions pertinent to overall IC operations. AEG-Telefunken is considered in the forefront of automating IC production lines.

Still another example of a new manufacturing approach is the company's optical mask aligning.

Based on this technique, machines have been developed that have been sold to most big semiconductor companies in the U.S., Japan, and Europe. In the U.S., for instance, the machines are being used to develop LSI devices and other components such as targets for silicon vidicons. And an improved version of this machine has already been prepared for the market. ●

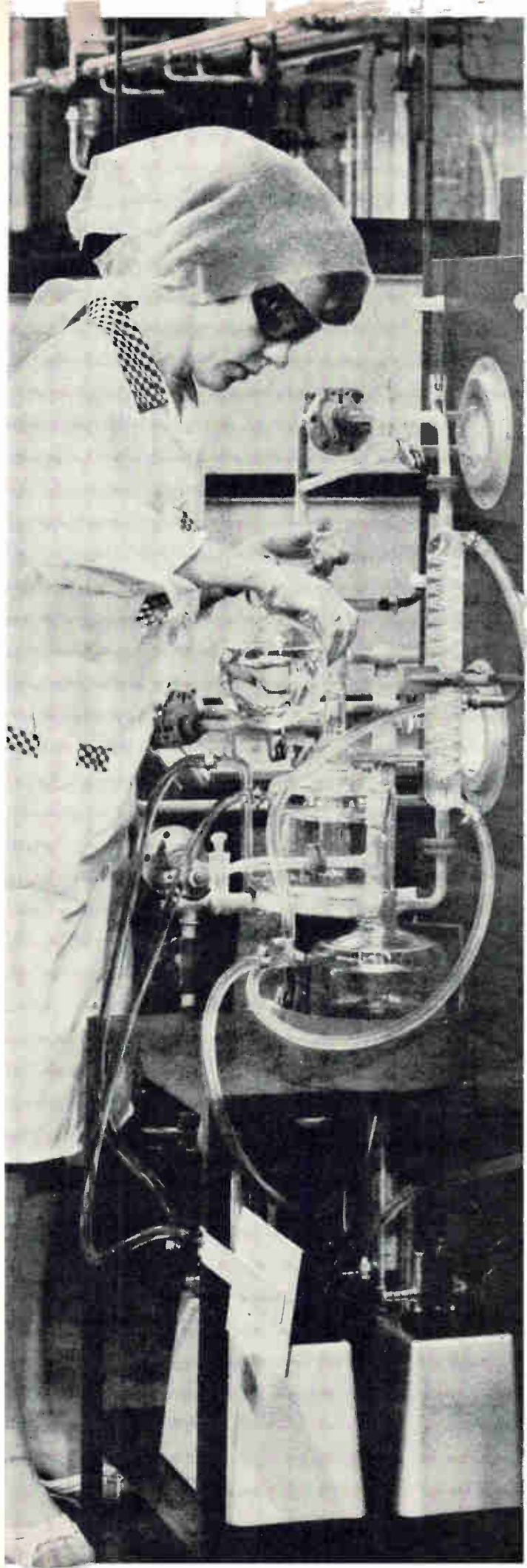

When it comes to color tv, the outlook is bright indeed

Valvo's Robert Suhrmann and Eckhart Pech point out five linear IC's that can be used with different systems—PAL, Secam, or NTSC

● Color-tv receivers, as they are built today, are a combination of transistors, tubes, and IC's. What's more, different transmission modes are used in different parts of the world. France and the Soviet Union use Secam, the sequential-with-memory system, while Britain and West Germany employ PAL, for phase-alternation line. But these make up only part of the picture. Elsewhere, in North America and Japan, the NTSC (National Television System Committee) is used.

Thus, IC makers who covet the color-tv market must take all these factors into account—the different component mixes and the different transmission systems—when they ready a product line. And this is exactly the course of action taken by Valvo GmbH.

Since cost is a major consideration in consumer products, Valvo designs its IC's so that they can replace

many discrete components in a color set. As a result, many functions are incorporated on a single chip. This has led to a family of five IC's, all of which are in the 16-pin packages that are both standard and popular. And all can interface with transistors and other IC's.

Four of the circuits—video combination, chrominance combination, synchronous demodulator, and subcarrier combination—can be connected as shown below for color difference driving in a PAL receiver. Together with the fifth IC, these circuits can be used for red-green-blue driving, as on next page. The matrix IC generates the color signals that drive output transistors directly.

A major advantage of these circuits is that each can be used singly with discrete stages. And for certain circuits, it doesn't matter which transmission mode is used—Secam, PAL, or NTSC. The matrix and video-combination IC's, for example, are compatible with Secam. The matrix's functioning doesn't depend on the type of color system employed. And, the video combination can be used in a positive-modulated system when clamped automatic-gain control (agc) is employed on the black-level signal.

In NTSC sets, the matrix, the video combination, the chrominance combination, and the subcarrier combination are suitable although they were designed specifically for PAL. Both NTSC and PAL are similar. In fact, the two systems are identical except for PAL's inversion of the polarity of the R — Y (red minus luminance) signal. This inversion compensates for phase errors that might occur in transmission.

The synchronous demodulator, although compatible with NTSC, wouldn't be economical with that system because it contains circuitry to PAL alone—a special switch and flip-flop. Another IC, one that would combine other functions with the synchronous demodulator is already in the works at Valvo and will incorporate—in addition to the demodulator—either a chrominance amplifier for direct coupling to the video detector or video combination. Or, the IC will incorporate parts of the subcarrier combination (perhaps a phase detector and a burst gate.)

The PAL synchronous-demodulator IC contains two active demodulators for the R — Y and the B — Y (blue minus luminance) signals, which are taken directly from the PAL delay line. The G — Y (green minus luminance) signal is obtained from a matrix. This IC also contains a

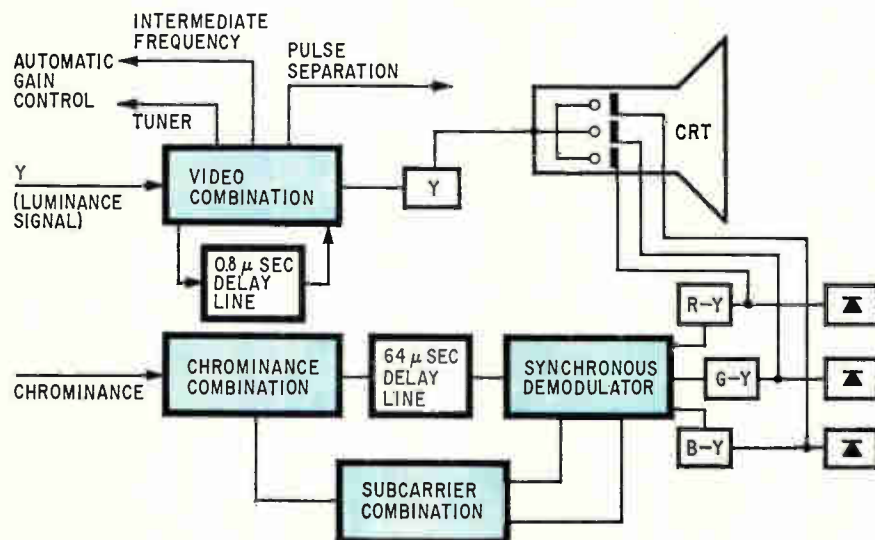

Video. In the color-difference drive mode, four IC's (indicated by the color areas) are required for the video section of a PAL tv. For maximum replacement value, many functions are combined on a chip.

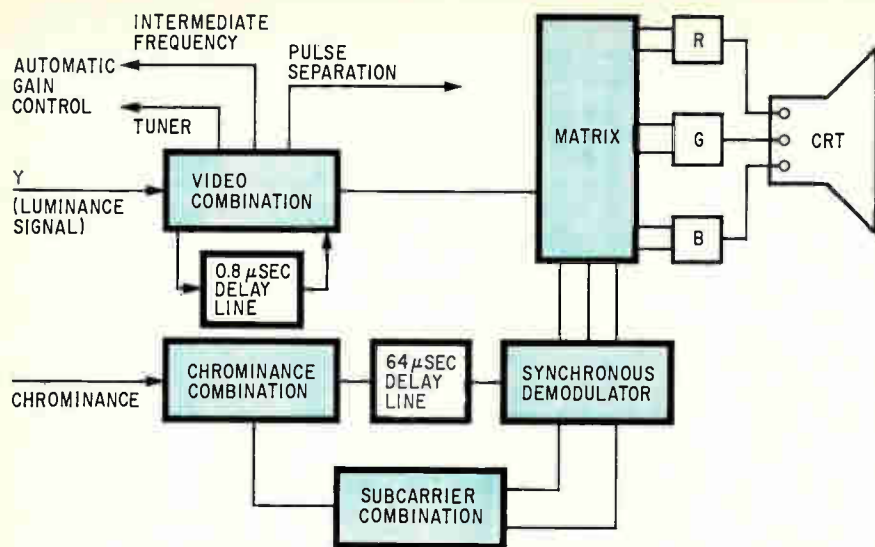

Versatile. With the addition of a matrix IC, the same four circuits used for color-difference drive can be used for red-green-blue drive. IC's are indicated by the color.

PAL switch and the flip-flop that drives it, and a color killer that can switch off the entire IC.

The video-combination IC consists of a two-stage luminance preamplifier, a stage for keyed agc, a fly-back blanking circuit, and a contrast-and-brightness-control circuit. Automatic beam-current limiting is obtained by reducing the contrast. Because an electronic potentiometer is included, this control circuit lends itself to remote control. Essentially, the electronic potentiometer is a pair of differential amplifiers in which the signal amplitude can be controlled by shifting the signal current from one amplifier to the other. The luminance preamplifier permits matching of Y-delay lines having an impedance of 1 to 3 kilohms. Its output signal can drive either the luminance output stage or the matrix IC directly.

The chrominance-combination IC contains a chrominance amplifier with a voltage-gain control range of about 30 decibels, an agc amplifier, and a driver stage that can directly drive the PAL delay line. An electronic potentiometer is built in to allow remote control of contrast and saturation. The voltage used for remote control in the video combination circuit can be used for this circuit's remote control, too. In addition, this IC has a stage for burst blanking and gating, and has a color killer as well.

The fourth circuit in the Valvo family is the subcarrier-combination IC. This circuit contains a 4.4-megahertz synchronizing circuit, a subcarrier oscillator, PAL-synchronizing stage, and a pulse shaper.

Finally, the matrix IC consists of a stabilized matrix preamplifier that directly drives three external transistors for red, green, and blue signals. Feedback from these output stages produces stable d-c levels, which lead to stable frequency response. The 3-db bandwidth is about 6 Mhz.

Typical of Valvo's IC family is the synchronous demodulator circuit, officially designated the TAA 630. This circuit illustrates the thinking that went into the IC's, for the components are essentially the same used in the entire family. Outstanding is the use of the differential amplifier to perform a variety of functions—amplification of video signals, gating of parts of those signals, amplitude control of video signals (automatic control or control by means of the electronic potentiometer), and, detection of color signals.

The TAA 630 consists of two similar demodulators of the B — Y and R — Y chrominance signals. Each demodulator is, in principle, a differential amplifier that acts as a switch controlled by a reference signal from the 4.4-Mhz quartz oscillator in the PAL receiver. Both polarities of the demodulated chrominance signals are present at the outputs of the differential amplifier, and, as a result, the G — Y signal can be obtained easily by simple resistive matrixing of the inverted B — Y and R — Y signals.

Moreover, two differential amplifiers provide good suppression of the reference signal. And, they lead to extremely good d-c stability at the outputs—different amplification factors are used for the a-c and d-c components of the output signals.

This approach requires two current sources (also arranged as differential amplifiers). These, too, are fed from a current source, with the d-c stability determined by the current source's emitter resistor. The current sources for the double-differential amplifier stage act as an input stage for the chrominance signal, while the emitter combination determines the demodulator's signal amplification.

To minimize the relative temperature drift of the demodulator's three outputs, Valvo's designers specified the same size for both the collector and emitter resistors. And to obtain equal temperature coefficients for the

IC's enter the picture for automatic cameras

Ernst L. Ginsberg, another Valvo engineer, focuses on shutter and time-delay control

base-emitter junctions of the current-source transistors, the junction areas were sized to conform to the different currents through the two demodulators.

Two identical limiting circuits are used as the input stage for the two reference signals, Ref_{B-Y} and Ref_{R-Y} . The limiters assure independence from the reference-signal amplitude, a necessity when quartz-filter circuits are used to produce the reference signals.

To convert the polarity of the inverted $R - Y$ chrominance signal, an additional double differential amplifier is incorporated into the limiter circuit for the reference $R - Y$ signal. This part of the circuit inverts the polarity of the reference $R - Y$ signal and thus cancels the inverted polarity of the $R - Y$ chrominance signal. This is the PAL switch. It is driven by a flip-flop, synchronized by a PAL identification signal. A special input terminal enables the flip-flop to be set at a specific state.

The color killer incorporated in the TAA 630 can be used to switch off the entire demodulator, thereby eliminating the influence of the chrominance and reference signals. This, too, is a necessary feature when quartz filters generate the reference signal.

Valvo has also developed a second version of the synchronous demodulator that some tv designers may prefer. It allows unclamped driving of the picture tube; the signals are so temperature stable that they can drive the RGB matrix directly. ●

● Since their inception, IC's have been subject for cameras. And now, with automatic cameras—those in which the shutters are controlled automatically—increasing in popularity, it isn't surprising to find cameras subject of IC's. This is particularly true in West Germany, where the manufacture of top-quality cameras is traditional.

The IC, with its inherent size, weight, and power advantages—particularly when compared with discrete circuitry—is a natural for this kind of an application. But the design constraints imposed on a shutter-control IC can be formidable.

Consider, for example, the performance requirements specified for a monolithic circuit sought by one camera-shutter maker, the Prontor Werk Alfred Gauthier GmbH, a subsidiary of Carl Zeiss.

Among other things, the IC had to be capable of tolerating a considerable drop in supply voltage—from 4.5 volts down to 2 volts—as battery energy is drained; it had to be capable of switching over a threshold voltage range of from 1.4 to 1.9 volts; it had to be capable of operating satisfactorily over temperatures ranging from -20°C to $+60^{\circ}\text{C}$; it had to be capable of keeping the shutter open over exposure times ranging from 10^{-3} to 20 seconds; and, since rather high current is needed to drive the solenoid that operates the shutter, the IC had to be immune to the potentially damaging transients that occur during switching.

To meet these requirements, Valvo GmbH developed the TAA 580, shown next page. A monolithic device, the TAA 580 is made up essentially of a Schmitt trigger— Q_1 , Q_2 , Q_3 , and Q_4 —in a Darlington configuration, a level-shifting pnp transistor, Q_5 , and a current amplifier, Q_7 , and Q_8 that drives the output stage, Q_6 .

Most automatic cameras use a cadmium sulfide photoresistor to convert light into electrical energy. The shutter, opened when the release button on the camera

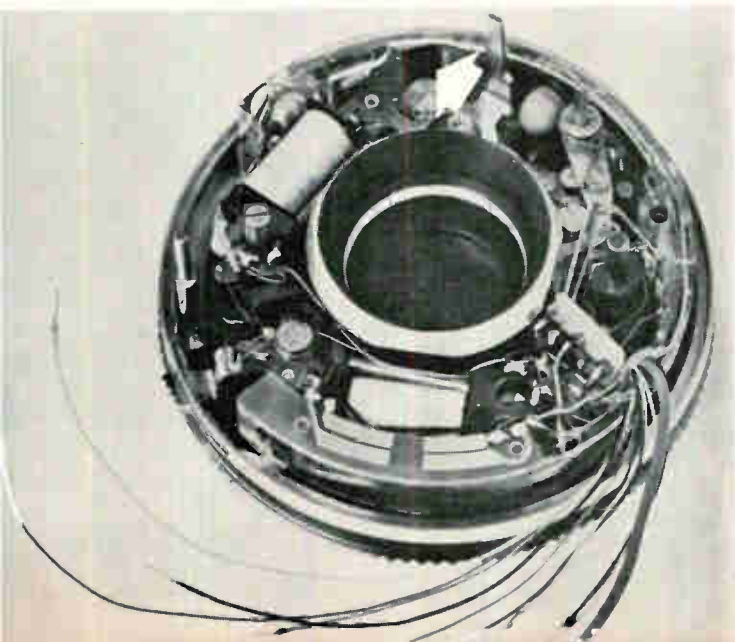

Concealed. IC for exposure-time control is mounted on a ring around the camera's lens. Addition of an identical IC would permit delayed shutter opening.

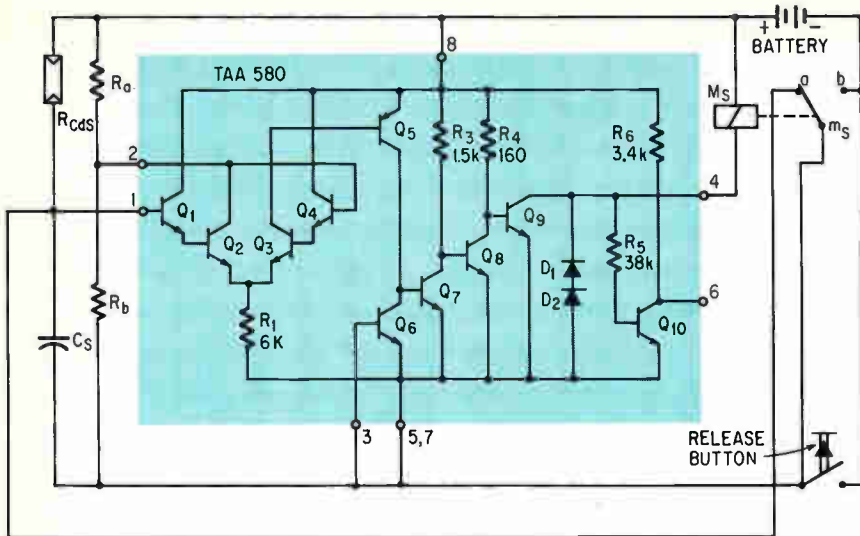

Big picture. Monolithic TAA 580 (in color) is combined with discrete components—photoresistor, storage capacitor, and relay—to control shutter speed.

is pushed, is kept open by a relay and light-dependent current—which flows through the photoresistor—charges a capacitor. When the voltage on the capacitor reaches a predetermined threshold level, a solenoid switches off and closes the shutter automatically.

With the TAA 580, a bypass contact connects the battery to the device when the camera's release button is pushed. When this occurs, both Q_1 and Q_2 are off but Q_3 , Q_4 , Q_5 , Q_7 and Q_9 are on, which means that the solenoid, M_s , is turned on and its contact is moved to position *b*, thus keeping the circuit energized. Now capacitor C_s charges through the photoresistor, R_{Cds} , until the threshold is reached. When this is reached, the Schmitt trigger switches— Q_1 and Q_2 turn on, Q_3 turns off, and the solenoid closes the shutter.

The customer's requirements for the IC were dictated by the worst-case conditions for the camera. These occur when the battery voltage is down to 2 volts, the threshold voltage is 1.9 volts, the temperature is -20°C , and the exposure time is 20 seconds (due to dim light). And under these conditions, the circuit has to operate with only 100 millivolts across R_{Cds} , and with R_{Cds} at its dim light value of 70 megohms, the input current to Q_1 will be only 1.4 nanoamperes.

The Darlington configuration was chosen for Q_1 and Q_2 because of the need to obtain a high current gain. Since Q_2 must be able to draw the base current of Q_4 —about 100 na—the combination of Q_1 and Q_2 must have a current gain of about 100. To further improve gain, narrow base widths are used for the transistors.

Because gain drops with temperature, the lowest temperature, -20°C —rather than the other extreme, $+60^\circ\text{C}$ —is the worst-case condition when both the battery power and available light is low.

To protect the IC—particularly the collector of Q_9 —from high voltages induced in the solenoid when it is switched off, two diodes, D_1 and D_2 , are included. Formed from emitter-base junctions, these diodes have a combined breakdown voltage of 14 volts.

Moreover, to prevent the solenoid from turning off when Q_9 is off, Valvo designers found it necessary to limit the base current of the solenoid drive transistor, Q_{10} . This was achieved via a buried resistor, R_5 , of about 40 kilohms.

One of the special features of the TAA 580, which is encapsulated in an eight-lead plastic flatpack, is that it

can also be used to provide an adjustable time delay before the shutter's opening. This is achieved by substituting a variable resistor for the cadmium-sulfide photoresistor. Thus two TAA 580's can be used in a camera to obtain both a time-delay and shutter-time control. In this configuration, output 6 of the time-delay IC is connected to input 3 of the shutter-time IC. When the release button has been pushed, Q_{10} of the time-delay IC blocks the shutter-time IC via Q_6 until C_s of the time-delay IC is charged.

A simpler version, the TAA 560, has been developed for cameras whose requirements are far less stringent. Operating temperature range of the TAA 560 is only 10° to 40°C . But because it cannot be used with an R_{Cds} greater than 20 megohms, the circuit isn't suitable for very-low-light-level photography.

The 560 has an external threshold adjustment which keeps the spread of threshold voltage within $\pm 7\%$. Price, of course, is critical in any component of a consumer product, and this self-adjusting feature compares favorably with external adjustment. It not only simplifies shutter production and assembly, it also limits the number of external leads to four. This, in turn, reduces IC manufacturing cost, since only four leads have to be bonded to the IC chip. The shutter manufacturer benefits because the device is cheaper and assembly is faster. ●

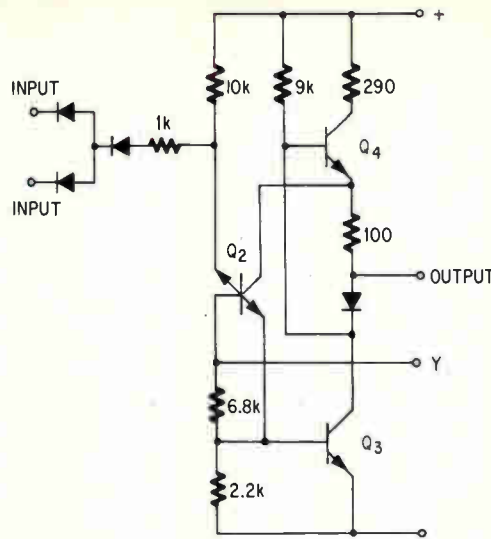

Economy model. LSL uses the Miller capacitance of transistor Q_2 to slow pulse transitions. Type 1 shown here is a simple, low-cost version.

For noisy environments, why not low-speed logic?

Werner Hoehne and Ernst Wittenzellner, both of Siemens, view the digital scene

● Susceptibility of logic circuits to noise pulses is as much a function of rise and fall times as it is of voltage levels. This is as true of "noise-immune" high-level logic as it is of standard transistor-transistor logic.

In developing logic IC's for electrically noisy environments—in automatic machine tools, for example—Siemens AG decided to slow down the pulse transitions. The result is a dynamic noise immunity as much as ten times better than that of high-level (zener diode) logic, and the improvement over standard TTL is even greater.

The key to the new low-speed logic (LSL) is the utilization of the Miller capacitance of the IC. This is the capacitance between collector and base of a transistor; to an input signal, it appears to be multiplied by the gain of the device. In LSL, certain transistors are designed to have a large Miller capacitance. Because of their large RC time constant, these transistors therefore substantially increase the rise and fall times of pulses pass-

ing through them to at least 100 nanoseconds. Noise pulses, which are usually of shorter duration, simply don't have time to affect the logic circuit.

There are two versions of LSL. Type 1 is an economy line, type 2 a premium line with higher noise immunity and fan-out. Both operate at a typical clock frequency of 100 kilohertz—high enough for most industrial applications—and over a temperature range of -30 to $+75^\circ\text{C}$. The table shown on page 117 compares the characteristics of LSL with zener-diode logic and TTL.

Both types have provisions in addition to Miller capacitance for noise immunity:

▶ The operating voltage range of 12 to 15 volts was chosen to provide a static noise margin of at least 5 volts at a threshold voltage of 6 volts, and to be compatible with the 12- to 20-volt range used for operational amplifiers. An LSL flip-flop will retain information if the voltage applied to it is between 9.5 and 18 volts.

▶ A push-pull output stage is used to give a low terminal resistance, and hence a low time constant, to signal wires. This allows capacitive crosstalk voltages to quickly drop below threshold.

▶ The IC package has a terminal for connecting an external capacitor in parallel with the internal Miller capacitance if the circuit must be used in an extremely noisy environment.

In type 1, shown above, the circuitry of the

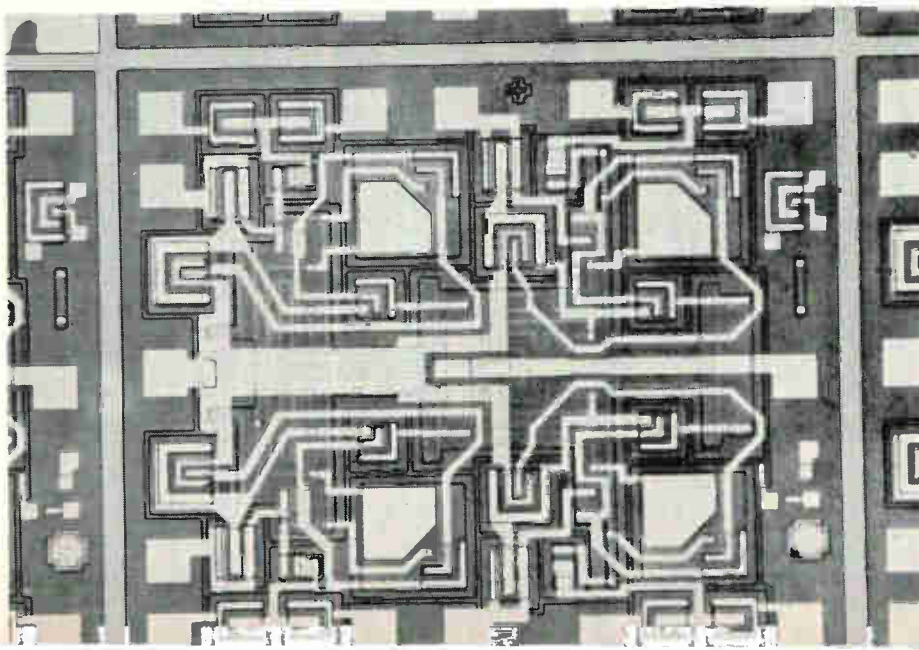

Big junctions. To maximize the Miller capacitance, the collector-base junctions have been made extremely large. This circuit is a quadruple dual-input gate, type 1.

INPUT SENSITIVITY AT LOGIC 1 LEVEL

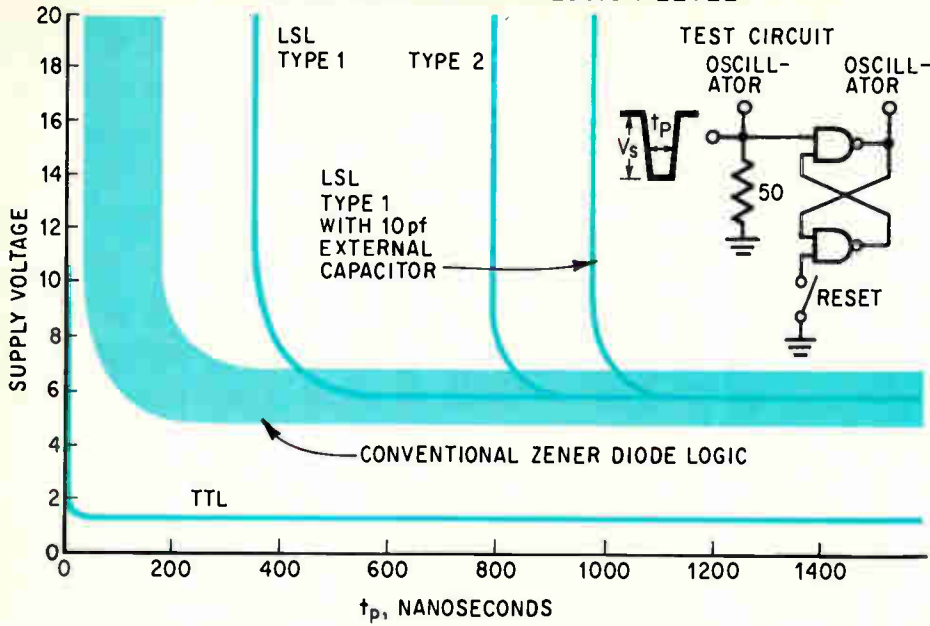

Superior. Dynamic noise immunity of types 1 and 2 LSL is considerably better than that of TTL and conventional zener-diode logic.

INPUT SENSITIVITY AT LOGIC 0 LEVEL

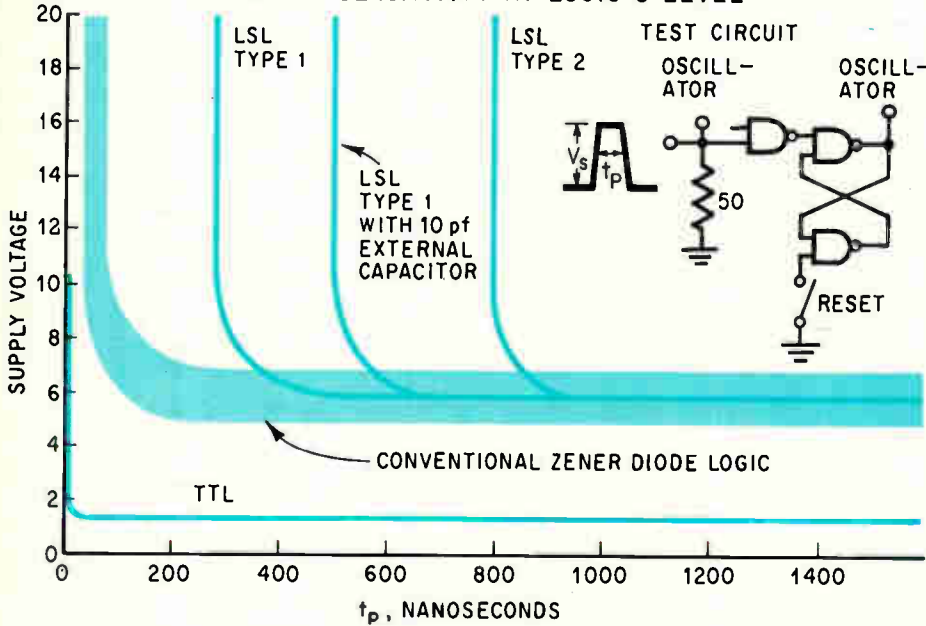

Premium model. Type 2 LSL provides nearly identical slowing of negative-going and positive-going pulse transitions.

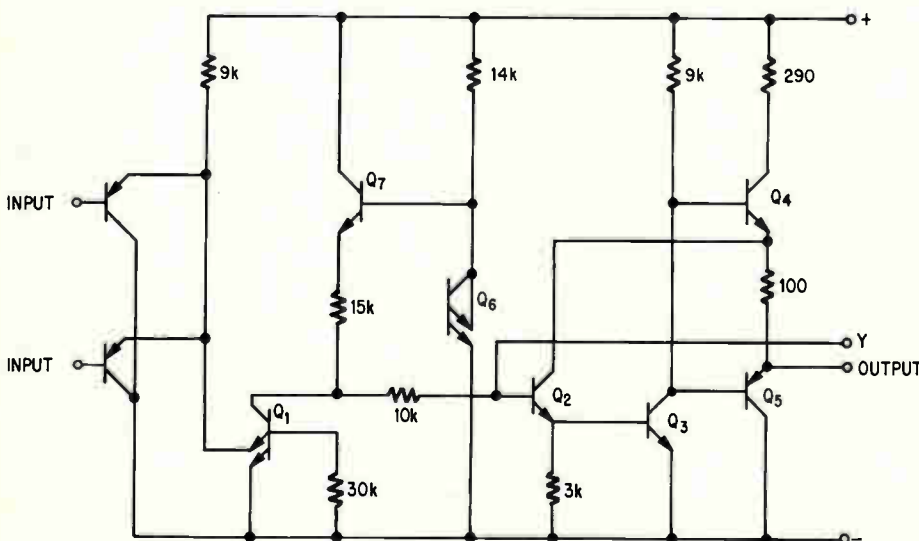

LSL vs. high-level logic vs. TTL

	LSL, type 1	LSL, type 2	High-level (zener diode) logic	TTL
Operating voltage	11.4-16.5	9.6-16.5	12 ± 1 or 15 ± 1	5 ± 5%
Power dissipation, mw (at 12 volts; TTL at 5 volts)	16	24	24 ± 48	10
Static noise immunity, volts	5	5	4.5-5.5	1
Dynamic noise immunity, nsec (at 12 volts; TTL at 5 volts)				
logic 1	350	800	120-150	15
logic 0	300	700	50-80	10
Fan out	10	40	4-10	10

gate inputs and of the output stage is of conventional design. The novel feature, of course, is the Miller-capacitance integrator formed by transistors, Q_2 and Q_3 , connected in cascade. The collector-base junction of Q_2 furnishes the Miller capacitance, therefore the junction area has been made extremely large as shown on page 115, bottom.

The slope of an output signal is $|dV_{out}/dt| = |V_o/R_M C_M|$ where V_o is the voltage step at the input to the Miller integrator, R_M is the input resistance of the Miller integrator (about 10 kilohms), and C_M is the Miller capacitance (about 10 picofarads) multiplied by the gain of the cascaded transistors. At a supply voltage of 12 volts, the negative-going slope of the output pulse lasts for 100 to 180 nsec and the positive-going slope lasts for 300 to 600 nsec.

Designed to have a low selling price, type 1 consequently had to be kept as simple as possible. But in that simplicity lies the large difference between the times for the negative-going and the positive-going slopes, and as well the dependence of the slope times on the supply voltage. (As the voltage is increased, the negative-going slope becomes steeper, relative to the positive-going slope.) Nevertheless, type 1 affords a five times improvement in noise immunity over zener-diode logic, as shown on opposite page.

The dynamic noise immunity of type 2 LSL was

improved by a factor of 2 by making the rise and fall times nearly identical at a value between 300 and 500 nsec. Moreover, these times are essentially independent of the supply voltage, so that the noise immunity increases in proportion to an increase in supply voltage. Another advantage is that temperature, too, has little effect on t_r and t_f of type 2.

The difference in rise and fall times in type 1 results from variations in the charging and discharging currents through the Miller capacitance. These variations, in turn, result from changes in the supply voltage.

The correct near-unity ratio is achieved in type 2 LSL by the constant effective resistance at the input of the Miller integrator, using Q_1 and Q_7 , as shown on opposite page, for internal voltage stabilization. And to eliminate sensitivity to supply-voltage variations, the Miller integrator is driven by a constant-voltage source.

The superior performance of type 2 shows up in a higher fan-out, also—40, versus 10 for type 1. This is brought about by using pnp transistor amplifiers at the input and output so that lower input current can be accepted and higher output current can be generated.

All of these provisions add to the complexity of the type 2 circuit, and therefore to the cost.

To build this LSL—both type 1 and type 2—Siemens' uses the same diffusion lines as for its standard TTL family. The major difference in the process is the use of an epitaxial layer of slightly higher resistivity to give a higher breakdown voltage (the collector-to-emitter breakdown voltage must be at least 18 volts in LSL.) Gold doping is lighter for LSL, since extremely high speed isn't wanted.

The circuits are packaged in a dual in-line epoxy case. The type 1 series comprises a quadruple two-input gate, a dual five-input gate, a dual five-input power-gate (this circuit has a fan-out of 30), and a J-K master-slave flip-flop. The flip-flop performs the same function and has the same truth table and pin configuration as the SN7472 and FLJ111 TTL circuits.

Type 2 is available as a dual AND/OR combination gate with inverting inputs. It's a universal gate that can be used to form RS flip-flops, D flip-flops, master-slave flip-flops, counter flip-flops, adders, and shift registers.

As additions to the LSL line, Siemens now contemplates level converters for interfacing with TTL circuits, and drivers and receivers for long transmission lines. ●

Designer's casebook

Designer's casebook is a regular feature in Electronics. Readers are invited to submit novel circuit ideas and unusual solutions to design problems. Descriptions should be short. We'll pay \$50 for each item published.

Phase comparator yields digital output

By R.H. Gruner

General Electric Co., Oklahoma City*

Two voltage comparators and a transistor-transistor logic gate combine with a digital voltmeter to yield a digital-output phase comparator with accuracies of better than 1% at 1 megahertz.

The zero-crossings of each input signal are detected by voltage comparators. The limited output of each comparator is then current amplified by the SN7400 TTL gate. The square-wave output of the gate is then differentiated, and the negative transitions are used to set and reset the latch, composed of gates 3 and 4. The ratio of the off-time to the

*now with Data General Corp., Southboro, Mass.

on-time of gate 3 is directly proportional to the phase angle between the two input signals. Transistors Q_1 , Q_2 , Q_3 , and related components form a precision analog switch. When the switch is on, the output of the emitter of Q_3 is 3.6 volts. When the switch is off, the output is at ground potential.

The latch drives the analog switch at a duty cycle determined by the phase relationship of the two input signals. The d-c component of the pulse train is extracted by a low-pass filter formed by R and C. This d-c component—the voltage analog of the phase angle in degrees—is then applied to a digital voltmeter which reads the phase angle.

Calibration is achieved with three potentiometers. Applying the same square wave to both inputs, potentiometer R_1 should be adjusted so that the negative transitions of gates 1 and 2 occur within 10 nanoseconds of each other. With no inputs applied, but with gate 3 high and gate 4 low, R_2 should be adjusted to yield 3.6 volts at the analog output. Finally, with gate 3 low and gate 4 high, R_3 should be adjusted for zero output voltage.

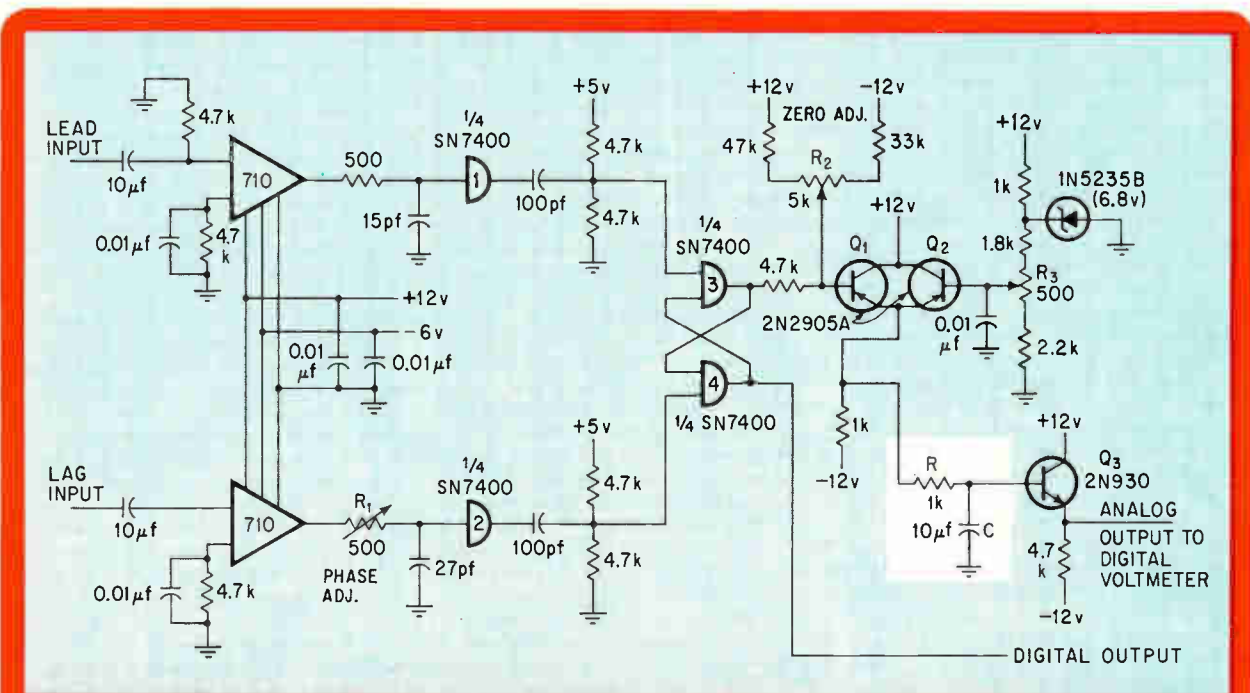

Digital output. A transistor-transistor logic gate yields a square wave output which is then differentiated and used to set and reset gates 3 and 4. The d-c component of a pulse train, a voltage analog of the phase angle, is extracted from the pulse train and applied to a digital voltmeter.

Nomograph charts a fast way to build a notch filter

By Paul V. Wanek

Warwick Electronics, Niles, Ill.

A sharp bandstop response can be achieved by using a notch filter built with resistors and capacitors only. This is especially useful at low frequencies where it is desirable to avoid using bulky inductors. The filter has a high Q which makes the amplitude response very sharp and thus produces a narrow stopband at a particular frequency. By adding an active network, the notch filter may be used as an oscillator or as a narrow bandpass filter.

The notch filter has zero transmission at one particular frequency as can be seen in the frequency response curve. The resistance R_2 is set to give zero phase shift at the center frequency and is determined by the equation $R_2 = R_1/12$. The center frequency can be calculated from the formula $f = \sqrt{3}/(2\pi R_1 C)$. The load resistance R_L should be much larger than R_1 . This will reduce the voltage drop across resistors R_1 and increase the symmetry of the over-all response.

A bandpass filter may be obtained by placing the notch filter in the feedback loop of a degenerative amplifier as shown in the diagram. In this circuit Z_f represents the notch filter, and Z_a is a resistor used to balance the input current of the positive input of the operational amplifier.

A design example is illustrated on the nomograph to help clarify its use. The desired bandstop frequency is 5,500 hertz, and the feedback resistances—the R_1 's—are 10 kilohms each. To obtain the value of the required capacitance, a line is drawn from the frequency back through the feedback resistance. The capacitance C can be read from the nomograph as 0.005 microfarad. The shunt resistance R_2 is obtained from the same line and is found to be 830 ohms. The circuit's accuracy is better than 3%.

Adjusting resistor R_3 in the filter will make the amplifier unstable and thus produce an oscillator. The frequency of oscillation is the same as the center frequency; that is $f = \sqrt{3}/(2\pi R_1 C)$.

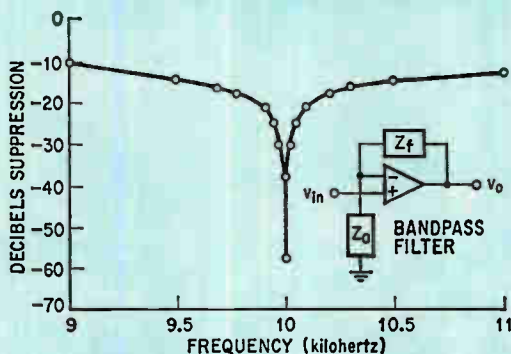

Sharp response. The notch filter can be placed in the feedback loop of a degenerative amplifier to produce a narrow bandpass filter.

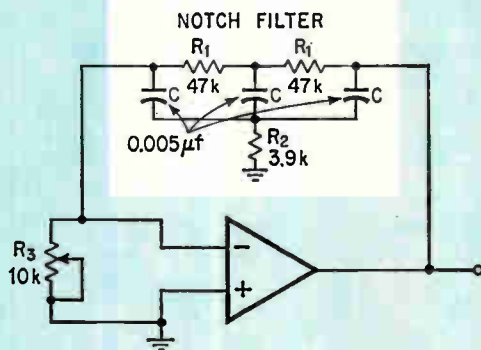

Easy oscillator. The notch filter may be used to design a simple oscillator by changing R_3 and making the amplifier unstable.

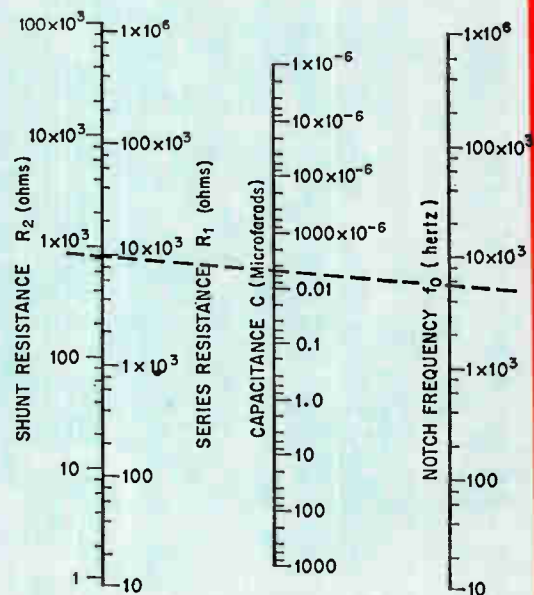

Quick and easy. A nomograph quickly and easily determines the values for all circuit components needed to design an RC notch filter.

The
Choice
is TTL.

TI introduces an MSI parity generator/checker which has no equal.

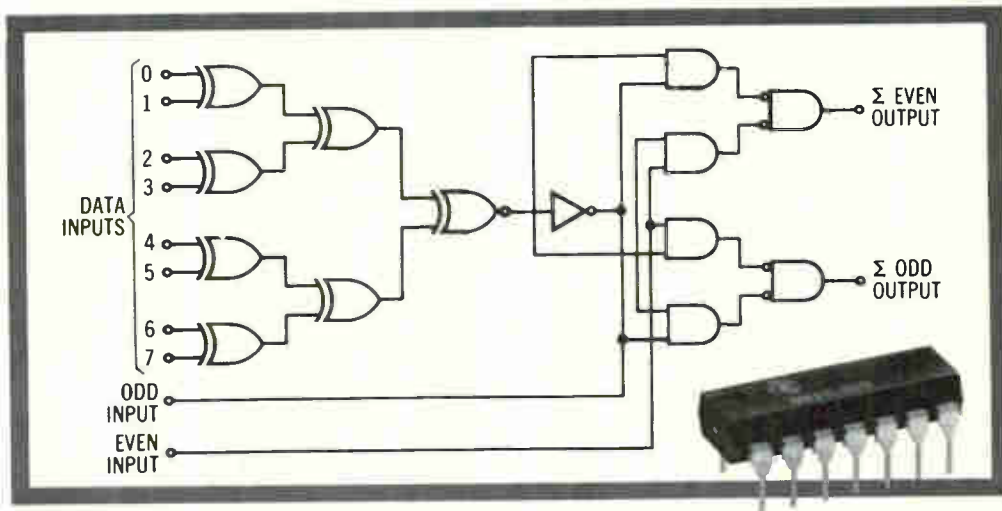

(Peerless speed and economy.)

TI's new SN54180/SN74180 MSI circuits generate ODD/EVEN parity for 8-bit words in only 32 nanoseconds. For longer word lengths, each additional 8-bits requires a mere 10 ns. Thus, parity for a 16-bit word is accomplished in a quick 42 ns.

Power dissipation: typically 170 milliwatts.

As for packages, you have an unparalleled choice of flat packs, ceramic or plastic dual-in-lines.

And you won't find the equivalent function anywhere else for

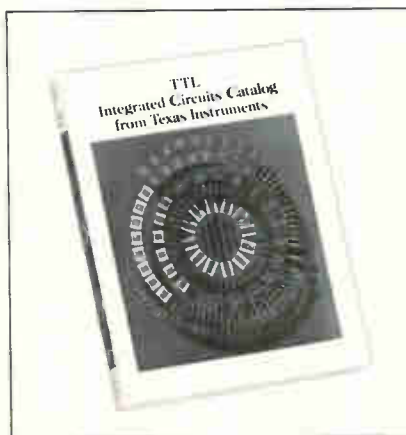

\$7.69 (plastic package, 100-999 quantities). Prompt delivery. Full compatibility with TI's other TTL and DTL circuits.

You'll want more facts, so we've put together a level-headed 424-page catalog containing the data sheets on every Series 54/74 TTL circuit from TI. Circle 113 on the Reader Service card or write Texas Instruments Incorporated, P. O. Box 5012, M.S. 308, Dallas, Texas 75222. Or check with your nearby authorized TI Distributor.



TEXAS INSTRUMENTS
INCORPORATED



A choice for serial memories

By David C. Uimari

Corning Glass Works, Raleigh, N.C.

When designing serial memories with capacities of from 100 to 20,000 bits and bit rates of from 1 to 2 megabits per second, an engineer may choose to use either glass memory modules or metal oxide semiconductor shift-register circuits. Whatever his decision may be, he will find that both glass memory modules and MOS shift registers are useful as digital delay lines of 20 microseconds to a few milliseconds, as buffers in computer systems, and as temporary storage to refresh the volatile image in a cathode-ray tube display; they are also used in digital integrators, digital differential analyzers, and serial adders. One of their more sophisticated applications is for buffering different input and output rates, using interlacing techniques in which adjacent bits in the memory arrive or depart at nonadjacent times. Either kind of serial memory can produce the desired result in any of these applications; but they differ in cost, frequency response, and other parameters.

In both approaches a data bit inserted at one end of a device appears at the other end some time later—for the case of 100 bits at 1 megabit per second, 100 microseconds later. For longer term storage, the source is disconnected from the device after the maximum number of bits has been loaded; then the output, after shaping and amplifying if necessary, is connected to the input so that all the data circulates continuously.

While glass delay lines don't work well at frequencies below 2 megahertz, their range of operation extends up to 50 Mhz. Memory modules made from these delay lines can operate at as low a bit rate as desired, with appropriate interleaving or encoding techniques. Also, the power-supply requirements of glass memory modules are simpler; they need fewer different voltages than do the MOS circuits. Furthermore, glass memories need no external bit-for-bit synchronizing and can accept signals from, and deliver them to, most standard integrated circuits without special level-shifting circuits at the interfaces. In addition, their power dissipation doesn't depend on operating frequency.

On the other hand, MOS doesn't work too well at data rates above 2 megabits per second, and over 5 megabits the circuits must be multiplexed—

several slower circuits must operate in parallel, with successive bits routed to different circuits in rotation. Below 1 megabit, MOS is usually better than glass; indeed, at these lower frequencies, the tradeoff is actually between MOS and magnetostrictive delay lines rather than between MOS and glass delay lines.

Nevertheless, the MOS approach has an advantage over the glass memory approach in terms of size and weight. While the power supplies, clocks, and level shifters required by MOS diminish this edge, adequate planning will minimize this problem. In MOS about 4,000 bits in eight flatpacks, together with associated external circuits, will fit on a 4½-by-6-inch printed circuit board weighing 8 ounces; a glass memory module of the same capacity, while occupying the same amount of space, would weigh 14 ounces. Furthermore, an MOS shift register of half the capacity would be about half the size, whereas the 2,000 bits in glass would take up the same volume as 4,000 bits.

Random access isn't possible with either technique, except on a time-dependent basis. To obtain any particular bit, one must wait, on the average, half the time required for a single bit to propagate through the memory, because the data in a serial memory is accessible only at the input or at the output. This limitation usually isn't a serious obstacle when the data is serial to begin with—as when it arrives from a telephone line or other communication channel.

These memories are also dynamic—the data is lost if it doesn't move continuously through the memory. In a glass memory, the data propagates alone through the memory once it has been launched; power and clocking are necessary only to resynchronize it when it appears at the output. But an MOS memory needs clock pulses to push the data along. While MOS static shift registers can be built, in which the clock can be stopped indefinitely

This is the twelfth installment in *Electronics'* continuing series on memory technology, which began in the Oct. 28, 1968, issue.

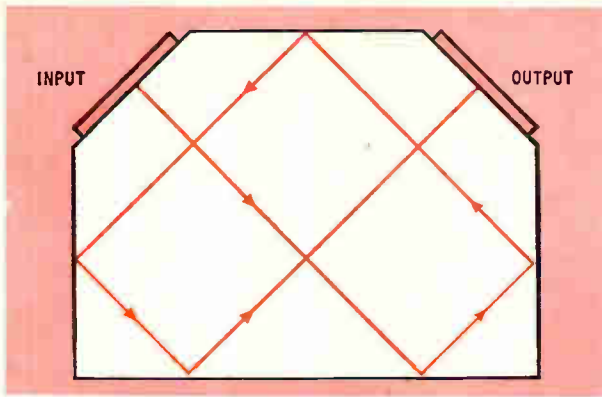

Five cushion. The shape of the delay line in a glass memory insures several reflections for the propagating sound wave, thus prolonging the delay within the glass.

without losing data, they still require continuous power—and they are intrinsically larger and more costly than dynamic MOS memories.

Serial memories are most economical—whether MOS or glass—in capacities of 100 to 20,000 bits. For fewer than 100 bits, arrays of flip-flops are feasible; integrated bipolar circuits are generally used, but MOS has made some inroads in this area. For more than 20,000 bits, ferrite cores and electro-mechanical media, such as rotating disks and drums, cost less per bit.

While the frequency tradeoffs between MOS and glass are generally found between 1 and 5 megabits per second, other considerations may be involved. The memory function can't be divorced from the rest of the system, and these frequency and capacity limits shouldn't be construed to say that it can. For example, if physical size is important, MOS may be the best choice in an application where otherwise a magnetostrictive delay line would be less expensive. Or if power dissipation is a problem, a glass memory may pay off even at an unusually low frequency. Also one can't ignore assembly cost, testing cost, or ultimate reliability.

Happy circumstance

Glass delay lines themselves have been used for many years but they are now enjoying an increase in the number and variety of applications. This is a result of the heavy emphasis on speed, and the need for frequencies that approach the resonant frequency of the glass-transducer combination. Widespread use and demand along with increased production volume have cut the cost per unit to the point where glass is now competitive in many areas where it was not before.

Quite simply, a glass delay line transmits mechanical energy from an input transducer to an output transducer. The delay arises from the relatively slow velocity of propagation, and can be as great as 350 microseconds because the path inside the glass is usually much longer than the dimensions of the glass, as shown above. A glass memory module includes the delay line with its transducers, and driving, sensing, and regenerating circuits.

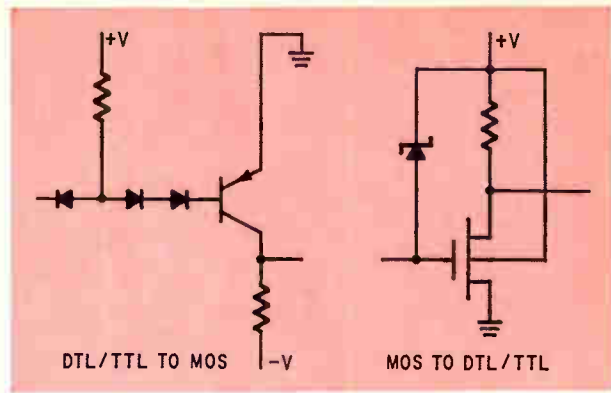

Level shift. Circuits like these are sometimes required to translate between high MOS voltage levels and the lower levels used in bipolar circuits.

The bulk glass from which a glass memory is made must have properties that permit it to be formed to the proper shape economically; it must also have a minimum temperature coefficient of velocity and a minimum frequency coefficient of attenuation.

Glass that meets the temperature coefficient requirement has a coefficient of linear expansion that is equal and opposite to the coefficient of its elastic modulus. This glass is relatively soft, as glass goes, and is easily formed into the proper shape—pentagonal, for example—usually by grinding or by pressing it in a mold when it's hot.

Close tolerance

This forming operation is quite critical. In this kind of glass the velocity of sound is about 10,000 feet per second, or a tenth of an inch per microsecond. But the tolerance on the time delay is typically ± 15 nanoseconds, which restricts the tolerance on the path length, including several reflections, to ± 0.0015 inch.

Two kinds of piezoelectric transducers are in common use—quartz crystals above 10 Mhz and lead zirconate-titanate (PZT) below that point. Sometimes both are used, although PZT is fragile at high frequencies. However, with a judicious use of both available transducer materials, a single memory can operate at any frequency in the range of 2.5 to 50 Mhz. At lower frequencies the energy beam spreads inside the glass far enough to reflect from the top and bottom of the slab as well as from the edges. These extra reflections increase the attenuation sharply, to an unacceptable level.

Either type of transducer is metallized on both sides and attached to the glass with cement or solder. Connecting wires are attached to the transducers by soldering.

Unlike the MOS memory, the cost of a glass memory is relatively insensitive to the number of bits per package, up to 5,000 bits. A larger piece of glass can store more bits; and since the fabrication cost are much greater than the material costs, the size of the glass has little effect on the price of the complete unit. In other words, a 5,000-bit mem-

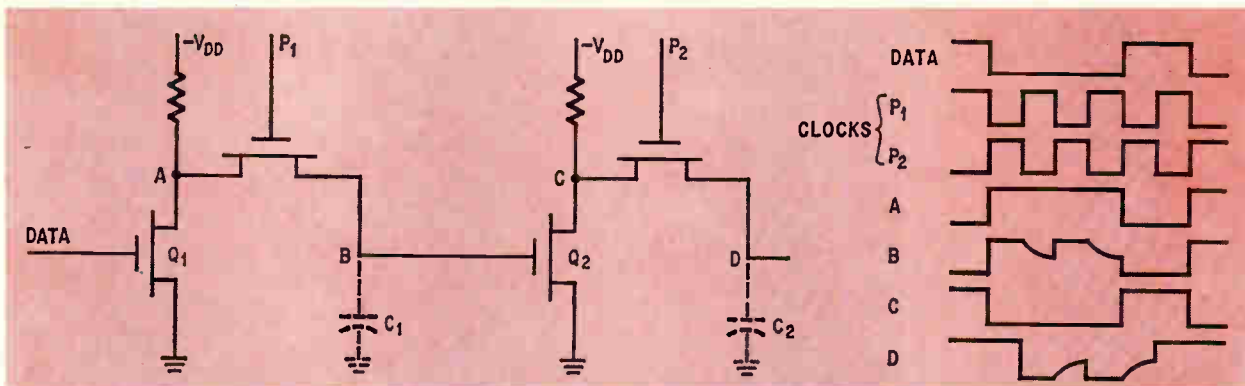

Dynamic. Gate capacitance of transistor Q_2 , shown here as C_1 , picks up the inverted data at A when P_1 is negative, retains it long enough for P_2 to transfer it to the gate capacitance of the next stage. Charging and discharging rates determine minimum and maximum frequencies of the circuit.

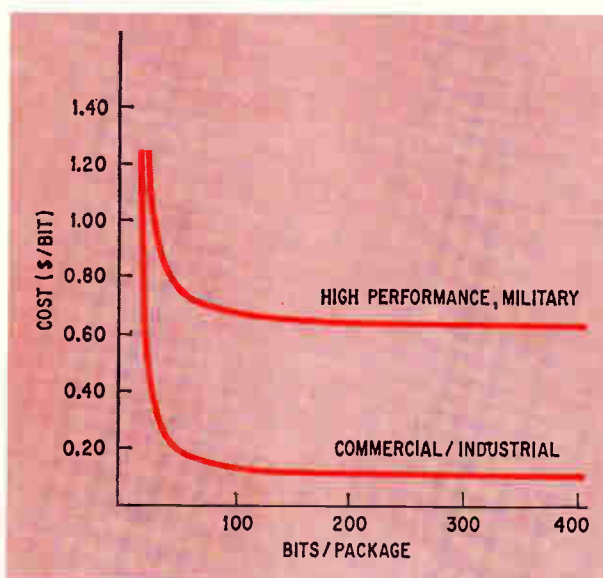

Cheaper by the hundred. MOS memories cost less per bit when large numbers of bits are squeezed into a single package. But a wide temperature range boosts costs.

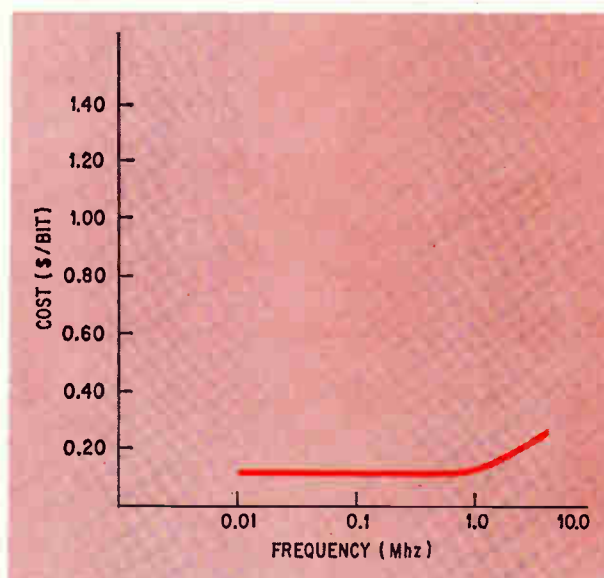

Corner plot. At higher frequencies the cost of an MOS memory suddenly rises, almost like the attenuation of an amplifier.

ory would cost only slightly more than a 50-bit memory operating at the same data rate.

As with the MOS devices, the cost per bit of a glass memory increases when the operating temperature ranges increases—typically, by 10% to 20%. But costs are almost constant as frequency increases.

The case for MOS

An MOS memory can be fabricated as a large-scale integrated circuit with several hundred bits on a single silicon chip. These capacities are possible because of the extremely small size of most MOS transistors.

The most common type of transistor used today in MOS shift registers is the p-channel field-effect transistor. This device comprises two p-type re-

gions—the source and drain—diffused into a wafer of n-type silicon, with an insulating layer of silicon oxide and a metallic layer—the gate—deposited between them. That portion of the n-type silicon directly under the gate is the channel. When the gate acquires a negative charge from an external circuit, it drives the n-type carriers from the channel, which thereby becomes p-type and establishes a low resistance between the source and drain. Thus the transistor turns on.

Most MOS shift registers use negative logic—with the binary 0 state at ground and the binary 1 at a negative voltage, somewhere between -7 and -24 volts. These levels are difficult to obtain from standard bipolar IC's; they require level-shifting circuits such as shown at the right on page 123 to translate to and from the bipolar signals, which

generally range from 1 to 5 volts.

Recently an improved manufacturing process has been developed for producing shift registers that operate directly with standard bipolar logic levels. This process eliminates the need for level shifters.

Charging the capacitance

The gate, together with the channel and the insulating oxide, forms a capacitor that charges and discharges as the transistor turns on and off. Since this charging action passes current through an external resistance, it takes time; and the time constant is the principal limiting factor on the speed of MOS circuits. This capacitance is also large enough to serve as the storage medium in a dynamic shift register; it retains charge for a long enough time to define the state of the next stage in the register.

A typical dynamic shift register stage is shown at the top of page 124.

Because the MOS transistor can be so small, many shift-register stages can be made on a single chip of silicon; and with multi-chip packaging, several chips can be packaged together. Thus a single small package could contain quite a large memory. Up to 256 bits in a single package are readily available off the shelf, and chips and packaging techniques are improving every day, indicating the availability of still larger memories in the near future.

Prices now range from 5¢ to 50¢ per bit, in quantities of 1,000 chips; the price per bit of larger chips, as well as larger quantities of chips, tends to be lower, as shown in the graph on the left directly opposite. But price tends to rise slightly for higher-frequency MOS circuits, as shown in the right-hand graph, or for wider operating temperature ranges.

Future developments

It's safe to predict that MOS costs will drop radically. Modules now priced at 5¢ per bit show every promise of dropping further before long. And their performance will improve—operating data rates will be somewhat higher, and ways will be found to use more moderate data rates with less complex clock requirements. Circuits that need lower-voltage power supplies will certainly be developed.

Glass memory modules are available now at prices as low as 2½¢ per bit. While the percentage drop in cost of these modules will probably be less than that of MOS shift registers, both devices are expected to continue to be cost competitive in the future—especially in the higher bit capacities. And the advantages of glass at high data rates, and its simple operation, will also help preserve its niche in the market. In addition, even higher data rates and longer delay times appear probable, with the development of better materials and better circuits. Longer delay times, of course, correspond to a lower cost per bit. ■

Memories XXX



Controlling creep and skew in thin-film memories

By William M. Overn

Univac Federal Systems Division, Sperry Rand Corp.
St. Paul, Minn.

It's not easy to make thin-film memory elements bistable—that is, constrained to two magnetic states corresponding to binary digits 0 and 1. To get binary operation with these elements demands careful design, precise control of the memory's external circuits and control of the film's deposition process. During deposition it's necessary to optimize anisotropy and to minimize skew. Also the film's creep threshold should be made as high as possible, and the electronic circuits designed to avoid crossing it. A mounting nearly free of strain is also important, for mechanical strain in the presence of magnetostriction increases the amount of skew.

In planar and cylindrical thin-film memories, a word field and a digit field are applied at right angles to one another in such a way that they combine at one and only one memory element. This arrangement permits a fairly large tolerance in drive currents. It permits each field to be somewhat greater than its nominal value without causing spurious switching, while permitting both fields to be somewhat less than nominal and still cause switching where they combine.

But reducing this advantage is the practice of batch-fabricating hundreds of elements on a single substrate, as discrete planar film spots or as a large continuous film on a wire. These elements have properties that differ to the extent that a current that's less than the critical value at one element may be considerably more than the critical value at another element.

A characteristic of a magnetic thin film is its anisotropy—by virtue of which each element has an easy axis of magnetization and a hard axis at right angles to it. Nominally the easy axes of all the elements are parallel, in the sense that two vectors pointing north and two vectors pointing south are all parallel to one another; the conductors carrying the word current are parallel to this easy direction of anisotropy.

When reading or writing, a current in the word line generates a magnetic field around the line. This field is thus at right angles to the easy axis of the field and of the current that generates it [see next page]. When reading data from the memory, this rotation generates a signal in the bit line; this signal is amplified and sent out as the memory's response

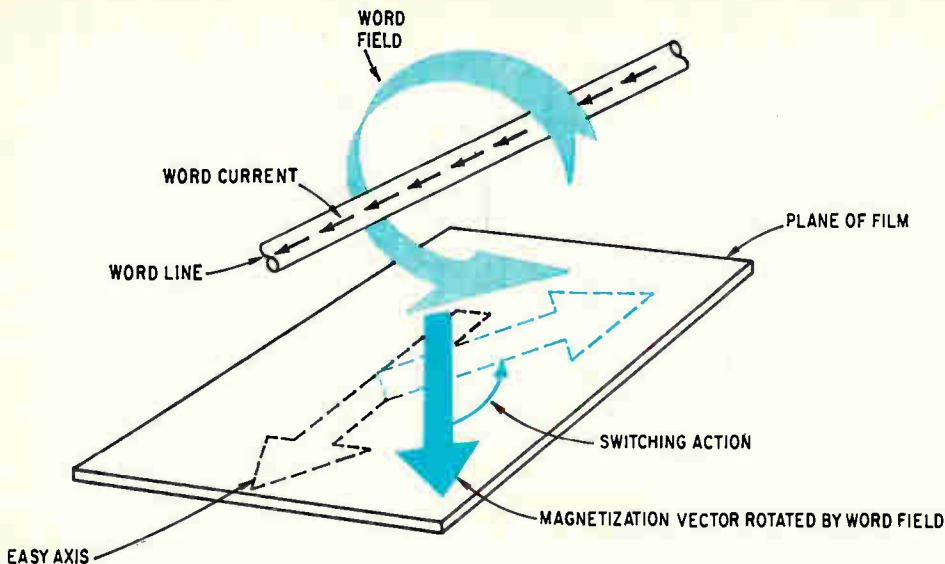

Rotation. A magnetic field surrounding the word line tends to rotate the magnetization vector in the thin film away from the easy axis of the film. Then the digit field (not shown) can, if desired, switch the vector to the opposite direction.

to the read command. When writing, there is current in both the word and bit lines; the word field rotates the magnetization, and the bit field tends either to rotate it back or to drive it over in the opposite direction, depending on whether the new bit being written is the same or opposite to the one stored previously.

Most planar thin films operate with destructive readout (DRO) to achieve speed. This means that the magnetization is switched quickly from the 1 to the 0 state to generate the readout signal; but the speed advantage is tempered by the need to regenerate the 1 state immediately after reading. On the other hand, most cylindrical thin films, or plated wires, use nondestructive readout (NDRO); the magnetization is rotated only slightly, giving a much smaller readout signal, but permitting a large memory to operate with a small number of electronic circuits that are shared among different parts of the memory.

Skew and dispersion

Unfortunately, the easy axes of all the elements are only nominally parallel. An individual element's easy axis may be at some small angle to the nominal direction—an angle called "skew". The extent of skew corresponds to the film's departure from ideal. In the analogy used above, if the compass directions of the four vectors were a degree or two away from due north and due south, they could be described as nominally parallel, yet slightly skewed.

Skew has two principal effects in thin film memories; it increases the amount of digit current required to write, and it reduces a parameter called the reversible limit.

The required digit current must be increased because skew creates a component of the word field along the easy axis, as shown on page 128—a component that should be zero, but isn't. When the digit field then tries to switch the magnetization of

the element, it's opposed by the nonzero skew component; thus considerable digit current is needed to first overcome this opposition, and then switch the magnetization.

The reversible limit is the angle to which a word field may repeatedly drive the magnetization during successive nondestructive read operations, without causing the stored bit to deteriorate. Skew reduces the reversible limit because some elements are closer to the limit than others in the absence of a word field; this situation limits the amplitude of the word current—but only in NDRO mode.

Another factor related to skew is "dispersion." Although skew is defined in terms of the actual position of an element's easy axis relative to its nominal position, skew can actually vary from point to point within a single element. Dispersion is an indication of how much it varies in an element, and by extension how much it varies across a continuous sheet containing many elements. A measure of dispersion is the angle of skew in either direction not exceeded in some standard percentage—usually 90%—of the area of film. Like skew, dispersion tends to increase the digit current and limit the amplitude of the word current—again, only in NDRO mode.

Both skew and dispersion are effects of the film's polycrystalline nature and the failure of all the crystals to line up perfectly with the magnetic field in which the film is deposited.

However, the real villain in thin-film arrays is neither skew nor dispersion but rather magnetostriction. Recent improvements in the economics of thin-film memories are, in fact, due to new ways of controlling magnetostriction. Skew and dispersion, although serious, are well under control; ways were worked out years ago to produce large thin-film arrays with suitably small values of skew and dispersion. But magnetostriction causes the skew to increase greatly when a small mechanical strain appears in the element. Strain is almost impossible

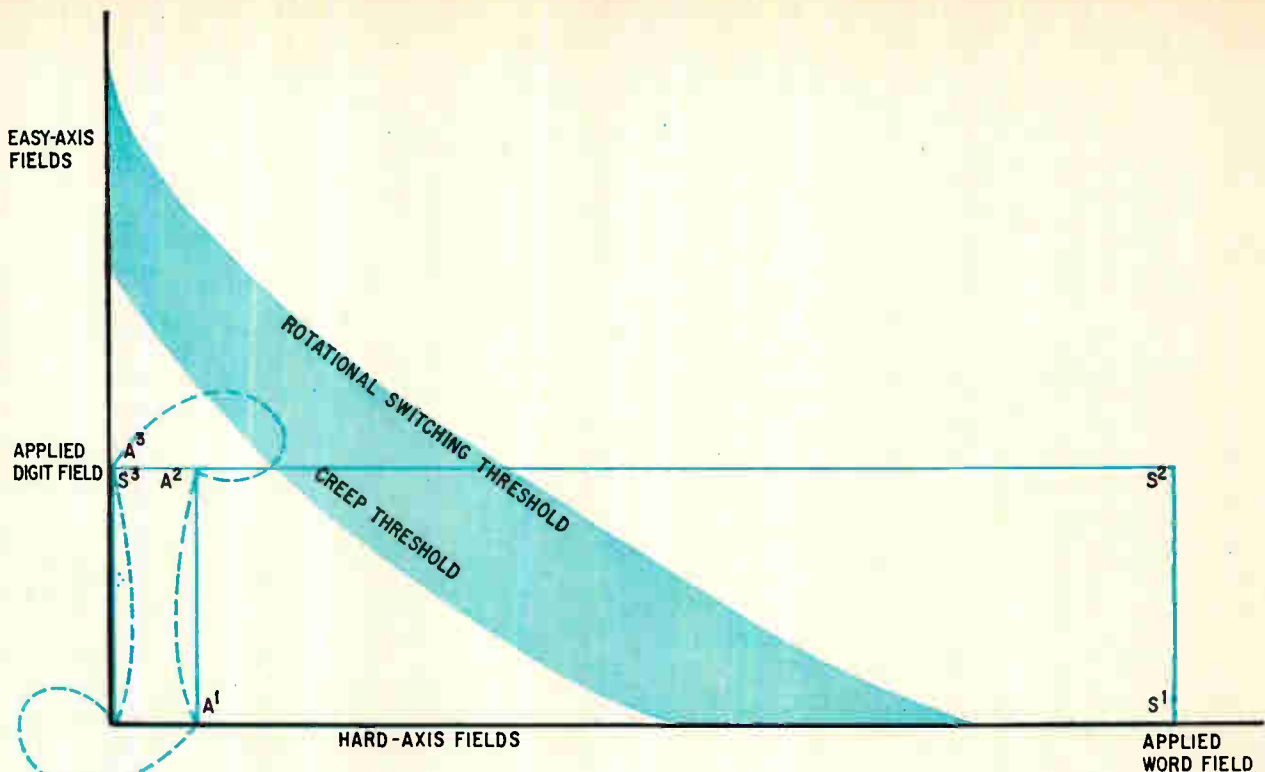

Indirect path. Transients induced in inactive digit lines can cause brief excursions of the magnetic field (color) into the creep region of an unaddressed memory element. If repeated often enough, such excursions can destroy the information stored in such an element.

to avoid completely; even if a mounting could be devised that would completely free an array of strain, the slightest external force or tremor would introduce new strains. Thus magnetostriction is the single factor that has kept film elements in the laboratory.

When a bit is written in a thin-film memory element that consists of a spot with well-defined edges, the edges of the spot don't switch along with the center unless the same bit is rewritten many times. But, when the element is part of a large continuous film and is defined only by the intersection of the word and digit fields, repeated writing of the same bit in that element can eventually cause the magnetization to creep, or to spread into an adjacent location and to disturb the bit stored there.

But when many such cycles do occur, followed by a single cycle of the opposite type—many 0's followed by a single 1, or many 1's followed by a 0—a subsequent read may produce an undesirably small output signal. This is called an adverse-history condition.

Creep also can occur in and near elements when one of the driving fields is present in normal switching magnitude and a residual field is present on the other axis. This residual field may be the fringe of a switching field for an adjacent element, or it may simply be the effect of skew. In either case it causes domain nucleation, which arises from flaws in the film and on the film's substrate.

In a perfect film deposited on an absolutely

smooth substrate, the presence of fields that are too small to affect the film's magnetization would never have any effect, no matter how often they were repeated. But near a flaw in the film or a bump in the substrate, irregularities in the film's crystal structure react to small fields more readily, and their magnetic state is likely to change. The effect is analogous to the way water vapor condenses on ions created by the passage of nuclear particles in a cloud chamber.

This change is the beginning of a magnetic domain, which is itself a larger "flaw" in the film. Other small domains are found at bit boundaries—the remnants of previously recorded information on continuous cylindrical films, and irregularities at the edges of discrete film spots. Additional small fields impinging on these domains induce them to grow and propagate across the film, thus causing the memory element to creep. Thus the creep threshold is lower than the switching threshold.

Since these stray domains arise at bit boundaries as well as at actual flaws, it's useless to strive for a perfect film or an ultrasubstrate. On the contrary, these flaws can block the growth of a domain as well as initiate it; so that the beryllium-copper wire and the initial copper layer under the magnetic plating of a plated wire are made with a controlled roughness rather than with maximum smoothness.

Difficulties caused by both creep and adverse histories, shown above, can be avoided by proper design of the word and digit lines and the elec-

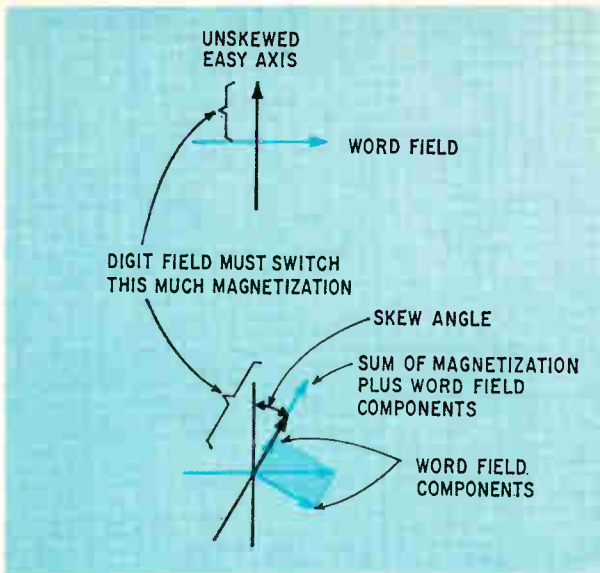

More oomph. When the thin film's easy axis has skew, the word field has a component along it, which opposes the digit field's tendency to switch the magnetization. To meet this opposition, the digit current must be greater than in the absence of skew.

tronic circuits that drive them.

In general, either a sufficiently large word field alone or a sufficiently large digit field alone can switch the magnetic state of an element. If both fields are present, their sum can switch it if the sum is represented by a point in the diagram above and to the right of the rotational switching threshold curve.

But if the sum of the two fields is just below the rotational threshold, the element's magnetization won't switch unless the driving pulses are repeated many times; the more times they are repeated, the further below the threshold they can be and still cause switching. The curve below the creep region is the theoretical limit if the pulses are repeated infinitely many times.

If the sum of the two fields is below the creep region, it has no effect on the element. The trick is to make sure that a field that should be below the creep region stays below it, even in the presence of small electrical transients.

In the absence of skew, the word field would be plotted directly along the horizontal axis as shown, and the digit field along the vertical axis. But skew causes one or the other of these fields to effectively appear at a slight angle to its axis, and thus to bring the sum point closer to the threshold of the creep region. Thus, with skew, transients become more dangerous.

Suppose that a particular element is being addressed in a thin-film array and a very large word field, as shown, is required to obtain high speed in the DRO mode. Here, the sum of the word and digit fields is represented by the point S_2 ; if the word field is turned on before the digit fields, and the two are turned off in the same order, the element will

be exposed to the four fields S_1 , S_2 , S_3 , and the origin, in that order.

Neighbors cause problem

These conditions tend to create a creep problem in the element adjacent to the one addressed. Proper design of the memory system prevents the problem from appearing; for if creep appears even in a single element the entire memory system might as well have failed.

The adjacent element is subjected to the full digit field, which is generated by a digit current in a conductor that passes over the adjacent element. Furthermore, because the word field is so large, its fringes are likely to affect adjacent elements. Thus the fields presented to the adjacent element are represented in the diagram by the four points A_1 , A_2 , A_3 , and the origin. The point A_2 is dangerously close to the creep threshold—particularly so if skew is present or if the creep threshold is lower than its nominal value.

When the word driver turns off, the word field for the addressed element decays from S_2 to S_3 . But as the current in the word line decays, in a poorly designed memory it would generate a voltage in the adjacent word line, because the two are parallel over a considerable length and inductively coupled. Although the adjacent word line isn't operating, it probably isn't a completely open circuit either; it has some high-impedance connections somewhere, and it is capacitively coupled here and there too. Therefore a current spike would accompany the induced voltage in the passive line, in the forward direction. This spike would create a transient field that is added to the fringes of the decaying field from the word line next door; the net result would be a field that as it decays from A_2 to A_3 , does so not along the solid line, but along a stray path such as that shown dotted—which crosses the creep threshold.

The mechanism described in this example is the principal mode of failure that involves creep. It could be controlled by turning off the word current slowly, so that its long fall time wouldn't generate the spike in the adjacent conductor. But this slows down the memory. Other controls can be applied that don't impose a speed penalty. Some kind of control is essential, because attempting to control the element behavior is impractical in the presence of uncontrolled transients.

Some of the recent developments that overcome creep include better film materials, better manufacturing techniques, better mechanical design, and magnetic keepers over the word lines.

Closed flux paths, as in plated wire memories and the mated-film design [*Electronics*, April 1, 1968, p. 31] effectively raise the creep threshold and reduce the digit current, which obviously makes creep less of a problem. ■

Bibliography

W.M. Overn, "Status of Planar Film Memories," *IEEE Transactions on Magnetics*, Sept. 1968, p. 308.



Packing data tightly in thin-film memories

By Judea Pearl

Electronic Memories and Magnetics Corp., Hawthorne, Calif.

High packing density in planar and cylindrical thin-film memories—the latter more popularly known as plated-wire memories—is limited more by creep than by almost any other characteristic. How creep can be overcome, therefore, is of paramount importance to designers of these systems, particularly with regard to plated wire, a growing technology.

The nature and causes of creep were discussed at length in the preceding article [see page 125]. When memory elements are packed tightly together in a flat film or along a wire, obviously, the field that switches an individual element must be relatively strong at the element, but must taper off very rapidly to avoid affecting neighboring elements—in other words, it must be strongly localized. It's easy to make small conductors capable of carrying enough current to produce the necessary field at the element, but preventing this field from dispersing is not so easy. This dispersion arises from two facts. The first is that the nature of the fabrication process requires that at least one of the conductors be slightly separated from the film. The second is

that the nonuniform magnetization in the film itself has an effect on the field around the conductor—an effect similar to that of like poles on two ordinary bar magnets, whose fields tend to push one another apart.

This effect is shown more precisely in the diagram and graph at left below. The diagram shows a cylindrical film between two narrow word straps, and the film's effect on the magnetic field created by the current in the straps. Without considering the film, the magnetic field distribution is easy to calculate from the current distribution in the straps; it's shown by the black curve in the graph. But magnetic monopoles on the film's surface create a demagnetizing field that opposes the field directly under the straps and aids it on either side, thus causing it to spread. The resultant field distribution is in color in the graph. Clearly the dispersion at points well removed from the strap is several times larger with the film than without it.

Mathematical expressions have been derived^{1,2} relating this dispersion to the film's thickness, its magnetization at saturation, and its degree of anisotropy (difference in magnetic properties in the hard and easy directions). For planar and cylindrical fields, the dispersion lengths are respectively:

$$\lambda_{pf} \approx \frac{t}{2} \frac{M_s}{H_k}$$

$$\lambda_{cf} \approx \left(rt \frac{M_s}{H_k} \right)^{1/2}$$

In these expressions, t is thickness, M_s is magnetization, H_k is anisotropy field, and r is the radius of the wire.

Clearly, to localize the field as much as possible,

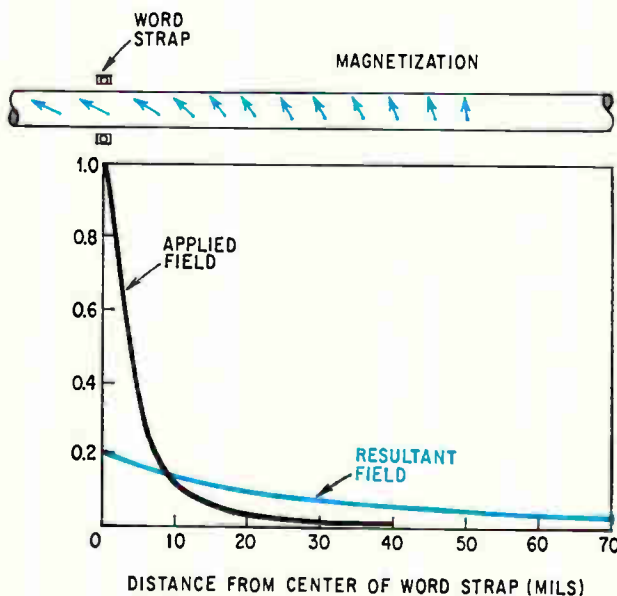

Dispersion. Magnetic film on wire reduces the magnetic field under the word strap but increases it by a large factor on each side of the strap.

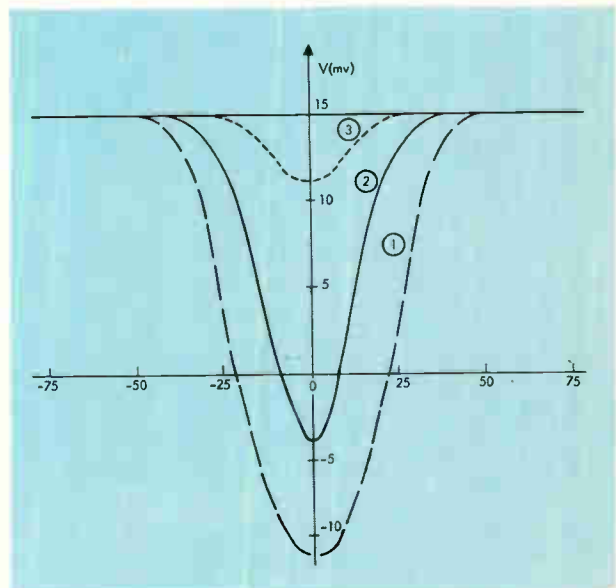

Profiles. These curves show voltage decreasing from the no-disturb case (1) when adjacent cells are 35 mils (2) and 25 mils (3) apart.

and thus to reduce interference with adjacent cells, the film should be as thin as possible, with a low magnetic saturation level and a high anisotropy. Unfortunately, these characteristics also produce lower outputs and require higher drive currents. In this respect plated wire is superior to planar films in that its dispersion can be reduced by using smaller wire without reducing output signal amplitude.

Furthermore, since wire employs a closed magnetic flux path along the easy axis, it has no demagnetizing field in that direction, and therefore no inherent minimum spacing between adjacent wires. Planar film, on the other hand, requires a minimum bit length along the easy axis to guard against self-demagnetization, especially during readout. This is one reason why planar films with several memory words on a single word line have never been successful.

Shaping the field

In a memory cell with suitably localized fields, the area interrogated during a read operation should be as large a proportion of the area switched when writing as possible. This condition is best achieved with a magnetic field whose cross-section is as nearly rectangular as possible. (A perfectly rectangular field, of course, would have no dispersion at all—an unrealizable ideal.) There are two ways to approximate such a distribution: with multiple-turn word straps and with magnetic keepers.

When the distributions of a double word strap are combined, and when the two straps are properly spaced, the resultant field distribution is nearly rectangular.

The second method requires a keeper, a piece of magnetic material that completes the magnetic circuit and prevents demagnetization. In a plated-wire memory without a keeper, the demagnetizing field opposes and disperses the applied field. But when a keeper made of a high-permeability material is placed over the word lines, both the applied field and the demagnetizing field tend to enter and exit the keeper at a 90° angle to its surface—much as if identical word lines and plated wire were behind the keeper surface, at the position of a mirror image. These image currents and image magnetic charges reduce the demagnetizing field and tend to localize the resultant field. Similar considerations apply to planar films.

However, keepers do have some disadvantages. Even though a high demagnetizing field requires higher drive currents and puts a lower ceiling on packing density, it tends to wash out nonuniformities in film properties and dimensions. For example, in the presence of a large demagnetizing field, the variations in drive line width affect the resultant field only slightly, whereas with a keeper and consequently with a small demagnetizing field, the resultant field is inversely proportional to the drive line width.

Although analytical and numerical methods of calculating magnetic field distributions can often

help the memory designer understand how the field spreads and therefore how his cell size for a given overall configuration is limited, they are based on ideal films that have never existed even in the laboratory, much less on the production line. Therefore, such methods should be complemented with experimental measurements before attempting to make a final design.

A simple technique for measuring the most important parameters of a cell on a plated wire relies on the film's nondestructive readout property. To use this method, a technician records a data pattern on the wire, and then measures it by moving it between the word straps as if it were a piece of magnetic tape passing under a read head.

The parameters measured are the cell lengths—taken after writing once with minimum current, and again after writing many times with maximum current—the length of the interrogated area during a read, and the minimum spacing between cells.

First, the wire is magnetized in one direction over a considerable length with maximum word and bit currents. (The word current is in the strap around the wire; the bit current is in the wire itself.) Then these currents are turned off; the wire is positioned with its midpoint under the strap, and then the currents in the opposite direction are turned on. This remagnetizes the wire in the opposite direction; half the entire length is remagnetized in this way. The result is a sharp transition of magnetization from one direction to the other at a short distance X_{11} from the center of the wire. Now the word current alone is turned on to read what is on the wire, and the sense voltage on the wire itself is plotted as the wire moves under the strap. This voltage has a transition similar to that of the magnetization on the wire, but less sharp because of the field dispersion. The spread of this transition is measured by the slope of the voltage profile. And this profile crosses the zero axis at a point coinciding exactly with the magnetization transition. This yields a simple measurement of X_{11} , which is half the maximum cell length. The voltage profile indicates the system's response to a unit step function of magnetization. From this response, the magnetization distribution can be reconstructed from any arbitrary voltage profile.

Measuring the minimum cell spacing initially requires that a minimum-current 1 be written in the middle of a row of maximum-current 0's, and that the voltage profile be measured using the moving-wire technique [see curves at bottom right, page 129]. Then new maximum-current 0's are written on both sides of the 1, at gradually decreasing distances, until the 1's profile begins to shrink. The curves show the amount of shrinkage at two cell spacings. ■

References

1. D.B. Dove and T.R. Lang, "Magnetization Distribution in Flat and Cylindrical Films Subject to Nonuniform Hard Direction Fields," IEEE Transactions on Magnetics, 1966, p. 194.
2. Judea Pearl, "Field Distribution of Plated-wire Memory Elements and Cylindrical Films Subject to Nonuniform Hard Direction International Conference on Magnetics, 1968.

These guys have got our numbers.

SIGNETICS STOCKING DISTRIBUTORS

ALABAMA

Huntsville 35801: *Compar Corp.*, 904 Bob Wallace Ave., Room 114
Phone: (205) 539-8476

ARIZONA

Scottsdale 85251: *Compar Corp.*, 84 West 1st Street
Phone: (602) 947-4336 TWX: (910) 950-1293

CALIFORNIA

Burlingame 94010: *Compar Corp.*, 828 Airport Blvd.
Phone: (415) 347-9501

Culver City 90230: *Hamilton Electro Sales*, 10912 W. Washington
Phone: (213) 870-7171

Burbank 91504: *Compar Corp.*, 2908 Naomi Avenue
Phone: (213) 843-1772

Los Angeles 90022: *Wesco Electronics, Inc.*, 5650 Jillson Street
Phone: (213) 685-9525 TWX: (910) 580-1980

Palo Alto 94303: *Wesco Electronics, Inc.*, 3973 E. Bayshore Road
Phone: (415) 968-3475

San Diego 92111: *G. S. Marshall*, 7990 Engineer Road, Suite 1
Phone: (714) 278-6350

El Monte 91731: *G. S. Marshall*, 9674 Telstar Avenue
Phone: (213) 579-1500 TWX: (910) 587-1565

CANADA

Downsview, Ontario: *Cesco Electronics, Ltd.*,
24 Martin Ross Avenue
Phone: (416) 638-5250

Montreal, Quebec: *Cesco Electronics, Ltd.*, 4050 Jean Talon West
Phone: (514) 735-5511

Ottawa, Ontario: *Cesco Electronics, Ltd.*, 1300 Carling Avenue
Phone: (613) 729-5118

Quebec: *Cesco Electronics, Ltd.*, 128 West Ballier Street
Phone: (418) 524-3518

COLORADO

Denver 80110: *Compar Corp.*, 300 East Hampden Avenue
Phone: (303) 781-0912 TWX: (910) 933-0183

Denver 80216: *Hamilton Electro Sales*, 1400 West 46th Street
Phone: (303) 931-0580

CONNECTICUT

Hamden 06500: *Compar Corp.*, 2357 Whitney Avenue
Phone: (203) 288-9276 TWX: (203) 772-0439

FLORIDA

Orlando 32805: *Hammond Electronics*, 911 W. Central Blvd.
Phone: (305) 241-6601

ILLINOIS

Elmhurst 60126: *Semiconductor Specialist, Inc.*,
195 Spangler Ave., Elmhurst Industrial Park
Phone: (312) 279-1000 TWX: (910) 254-0169

Addison 60101: *Compar Corp.*, 315 Laura Drive
Phone: (312) 543-8833

MARYLAND

Baltimore 21208: *Compar Corp.*, Pikesville Professional Bldg.,
7 Church Lane
Phone: (301) 484-5400 TWX: (710) 862-0860

Rockville 20850: *Pioneer Washington Electronics, Inc.*, 1037 Taft St.
Phone: (301) 427-3300

MASSACHUSETTS

Burlington 01803: *Avnet Electronics Corp. of Mass.*,
207 Cambridge Street
Phone: (617) 272-3060

Newton Highlands 02161: *Compar Corp.*, 88 Needham Street
Phone: (617) 969-7140 TWX: (710) 335-1686

Watertown 02172: *Schley Electronics Corp.*, 36 Arlington Street
Phone: (617) 926-0235

MICHIGAN

Southfield 48075: *Compar Corp.*, 21250 10 1/2 Mile Road
Phone: (313) 357-5369

Detroit 48240: *Semiconductor Specialists Inc.*,
25127 West Six Mile Road
Phone: (313) 255-0300

MINNESOTA

Minneapolis 55416: *Compar Corp.*, 3925 Monterey Avenue,
P. O. Box 16095
Phone: (612) 922-7011

Minneapolis 55423: *Semiconductor Specialists Inc.*,
7742 Morgan Avenue South
Phone: (612) 866-3434

MISSOURI

St. Louis 63141: *Compar Corp.*, 11734 Lackland Industrial Drive
Phone: (314) 542-3399

NEW JERSEY

Cherry Hill 08034: *Hamilton Electro Sales*,
1608-10 West Marlton Pike
Phone: (609) 662-9337

Haddonfield 08033: *Compar Corp.*, 15 Potter Street
Phone: (609) 429-1526

NEW MEXICO

Albuquerque 87110: *Compar Corp.*, 2129 San Mateo, N.E.
Phone: (505) 265-1020 TWX: (910) 989-1659

NEW YORK

Albany 12205: *Compar Corp.*, 6 Highland Avenue
Phone: (518) 489-7408 TWX: (710) 441-8224

Buffalo 14202: *Summit Distributors Inc.*, 916 Main Street
Phone: (716) 884-3450

New York 10011: *Terminal-Hudson Electronics*, 236 W. 17th St.
Phone: (212) 243-5200 TWX: (710) 581-3962

Woodbury 11797: *Compar Corp.*, 335 Crossways Park Drive
Phone: (516) 921-9393 TWX: (510) 221-2170

NORTH CAROLINA

Winston-Salem 27101: *Compar Corp.*, 1106 Burke Street
Phone: (919) 723-1002 TWX: (510) 931-3101

OHIO

Cleveland 44103: *Pioneer Standard Electronics*,
5403 Prospect Avenue
Phone: (216) 432-0010

Fairborn 45324: *Compar Corp.*, 16 South Broad Street
Phone: (513) 878-2631

Fairview Park 44126: *Compar Corp.*, 19500 Center Ridge,
Rocky River, or P. O. Box 4791
Phone: (216) 333-4120

PENNSYLVANIA

Philadelphia 19132: *Milgray-Delaware Valley, Inc.*,
2532 North Broad Street
Phone: (215) 228-2000 TWX: (710) 670-3400

TEXAS

Dallas 75207: *Hamilton Electro Sales*, 2344 Irving Blvd.
Phone: (214) 638-0900

Houston 77019: *Hamilton Electro Sales*, 1216 West Clay Street
Phone: (713) 526-4661 TWX: (910) 881-3721

WASHINGTON

Kirkland 98033: *Compar Corp.*, 12610 N.E. 104th Street
Phone: (206) 822-4191

Seattle 98108: *Kierulff Electronics*, 5940 6th Avenue, South
Phone: (206) 763-1550

Now you've got theirs. Signetics

Signetics Corporation / 811 E. Arques Ave., Sunnyvale, Calif. 94086 / A subsidiary of Corning Glass Works

Teamwork streamlines differential amplifier tests

New circuit built with a mixer and a modified sweep generator measures gain, phase shift, input and output impedance, and common-mode rejection ratio; point-by-point plotting is eliminated; display is immediate

By James Plumb

Hewlett-Packard Co., Loveland, Colo.

Mixing signals to a lower frequency so that they can be handled by lower-priced equipment is an approach long used by radio designers. Now engineers testing differential amplifiers are adopting the same approach to make their job easier and faster. With a sweep generator supplying the input, the output of an amplifier is mixed with a signal whose frequency differs from the sweep generator's output by a small but fixed amount. This setup tells in seconds how open-loop response, common-mode rejection ratio, or input or output impedance changes with frequency.

An engineer out to measure how an amplifier's gain changes with frequency would reach naturally for his sweep generator because its bandwidth covers the bandwidth of any differential amplifier he's likely to come across. But there would be problems if he simply hooked the amplifier's output to an oscilloscope. Commercial differential amplifiers have at least 80 decibels of dynamic range, and that's too much for a scope to show.

The way around this problem is to first compress the amplifier's output with a logarithmic amplifier. But this solution begets another problem: a log amplifier that's linear over the frequency ranges of particular differential amplifiers is expensive at best, and nonexistent at worst. Turning instead to a bank of log amplifiers may bring costs down a bit, but it'll also bring in tuning, calibration and switching problems. Besides, an engineer who also wants to measure phase shift will still have to reach for phasemeters that can either cover the amplifier's frequency range or work with log inputs.

Mixing sweeps away all of these difficulties. If the amplifier being tested has an output frequency that's both low and constant, any inexpensive log

amplifier can compress the output, regardless of how wide a range of frequencies the sweep generator is putting out. The amplitude of the log amp's output then tells what the differential amplifier's gain is. And when this output along with a reference signal turns a flip-flop off and on, the flip-flop's output is proportional to the phase shift.

The basic test circuit for making these measurements is shown on page 133. The sweep generator is modified to produce two outputs: a swept sinusoidal signal and a signal that's offset from the swept signal by a fixed amount, f_i , which is on the order of 100 kilohertz. After passing through the amplifier being tested these two signals are mixed and the difference frequency, which is equal to f_i , is selected by a bandpass filter.

The filter's output goes to a log amplifier and then to a diode rectifier whose output drives the vertical amplifier of a dual-trace oscilloscope. When the scope's horizontal amplifier is driven by a ramp signal whose magnitude at a given time is directly proportional to the sweep generator's output frequency, the scope displays gain versus frequency.

Putting in a flip-flop and a second test channel that has a reference component in place of a differential amplifier adds the capability of measuring phase. The reference component, usually just a short cable, doesn't shift the test signal; therefore, any phase difference between the outputs of the two channels is caused by the amplifier being tested. The outputs of the two log amplifiers both have a frequency of f_i ; their phase difference is proportional to the phase shift of the amplifier being tested. After being converted into square waves, one signal goes to the SET terminal of a flip-flop and the other to the RESET. If the amplifier

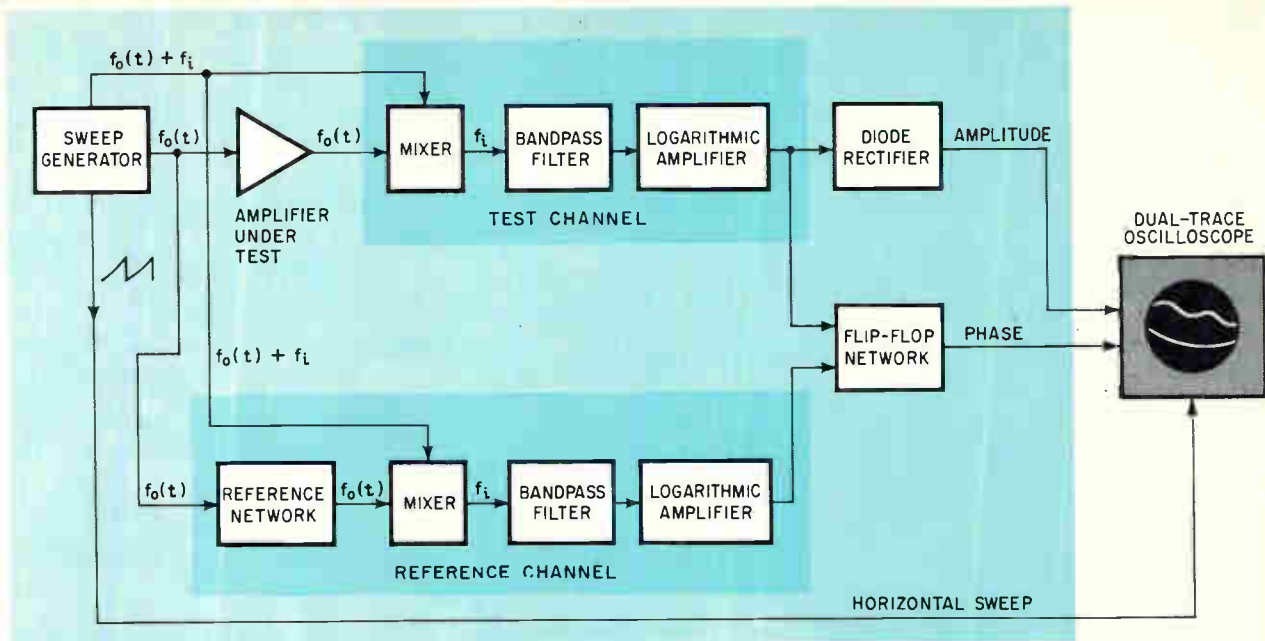

Gain and phase. The amplifier's input is the swept signal, $f_o(t)$. Its gain and phase are proportional to the rectifier's output and the flip-flop network's output, respectively. The scope plots both against $f_o(t)$.

being tested causes no phase shift, the two signals will be in phase, and the flip-flop will either be always on or always off; it's unimportant which. If the differential amplifier does shift the test signal, the test channel's square wave will go positive at a certain time, turning the flip-flop on, and some time later the reference channel's wave will go positive, turning it off. The time the flip-flop is on during a cycle is proportional to the phase shift.

The flip-flop's output, a rectangular wave whose frequency is f_i , is filtered, and the resulting d-c signal goes to the other vertical amplifier in the dual-trace scope. With the ramp from the sweep generator driving the horizontal amplifier, the scope now displays phase shift as a function of frequency.

Open and closed

Designers and users of differential amplifiers often want to know the open-loop response, but because the open-loop d-c gain of some differential amplifiers is as high as 100 db, it's difficult to test them in the open-loop configuration. Input noise can drive the amplifier out of its linear range.

But the test circuit, with minor modifications, has no trouble measuring open-loop response because it makes its tests while the amplifier is in a closed-loop configuration with its gain set near 0 db. The amplifier has a resistor in its feedback loop, and its output goes to the test channel. Instead of being connected to the sweep generator, the reference channel's input is connected to the amplifier's inverting terminal. The difference between the output of the log amplifier in the test channel and the output of the one in the reference channel is the differential amplifier's open-loop gain. The phase difference between the output of

the differential amplifier and the input to the inverting terminal is the open-loop phase shift. When the open-loop gain and phase shift are displayed by a dual-trace oscilloscope, the gain crossover frequency (the frequency at which the gain is 0 db) and the phase shift at crossover can be seen.

At times it's useful to predict an amplifier's closed-loop performance from open-loop data, particularly when the amplifier is unstable in a particular closed-loop configuration.

The test circuit can help out here by rapidly supplying a scope with the values of gain and phase needed to plot curves on a Nichols' chart, a Cartesian diagram containing contours of constant closed-loop phase and gain.

The conventional way to predict closed-loop performance from open-loop data is to plot the open-loop gain and phase shift against frequency and then determine if the phase shift is more than 180° at 0 db. Besides showing whether the network is stable, these two plots also show the network's phase margin (phase when gain is 0 db) and gain margin (gain when the phase is 0°).

This information, plus a lot more, can be obtained by plotting open-loop gain against open-loop phase on a Nichols' chart. Normally, this is a dreary point-by-point chore; but it turns into a quick job if the test circuit's gain signal drives a scope's vertical amplifier and its phase signal drives the horizontal amplifier. Then with a Nichols'-chart template placed over its face, the scope displays a gain-versus-phase plot.

The common-mode rejection ratio can also be measured with the test circuit. First the noninverting terminal of the amplifier being tested is connected to the sweep generator and the inverting

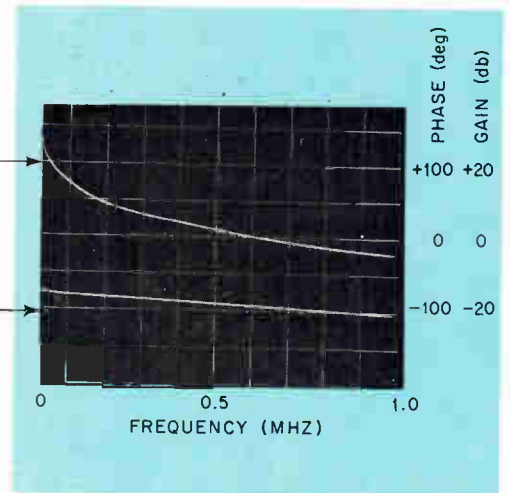
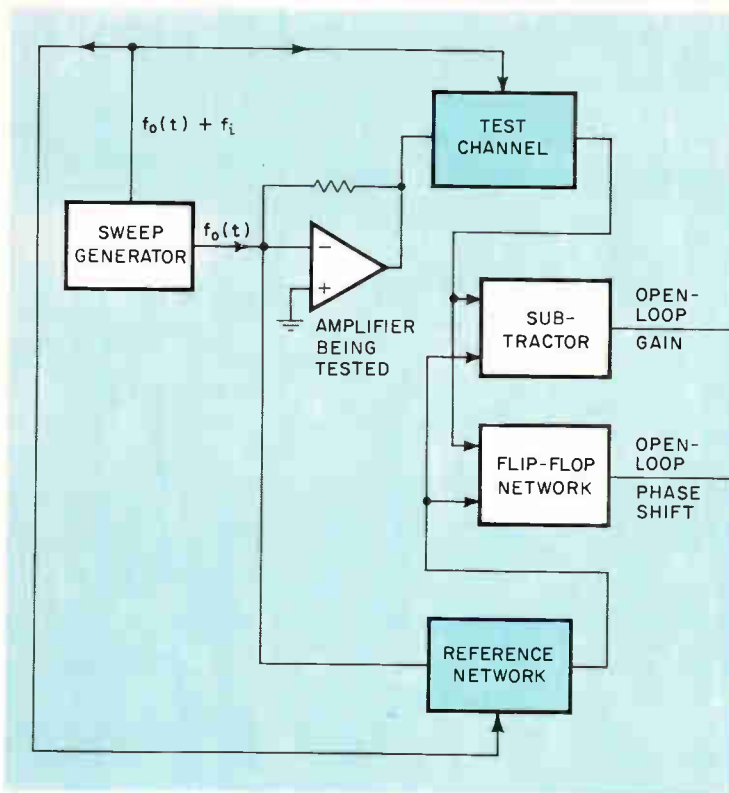

Open story. When open-loop response is being measured, the reference channel is connected to the inverting terminal. Then the difference between the outputs of the channels' log amplifiers is proportional to the open-loop gain. The phase difference between the amplifier's output and input is the open-loop phase shift.

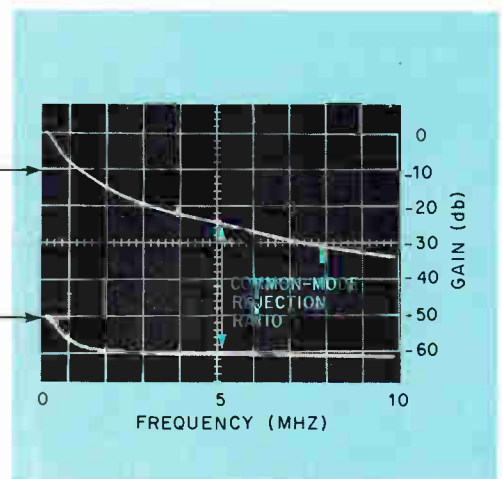
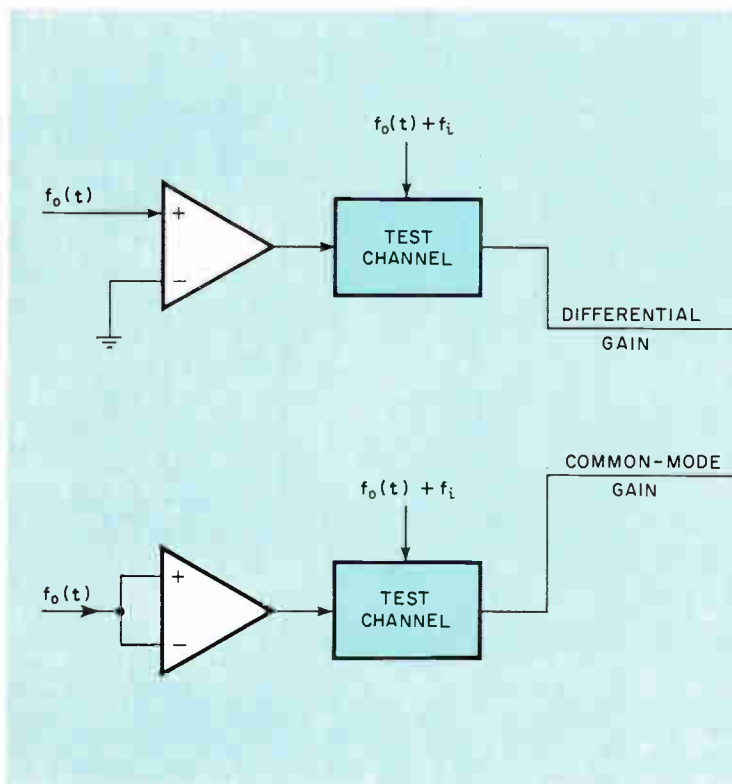

Between the lines. The top circuit sends the scope a signal proportional to the amplifier's differential gain, and the bottom one sends a signal proportional to its common-mode gain. The common-mode rejection ratio at a given frequency is the distance in db between the two curves.

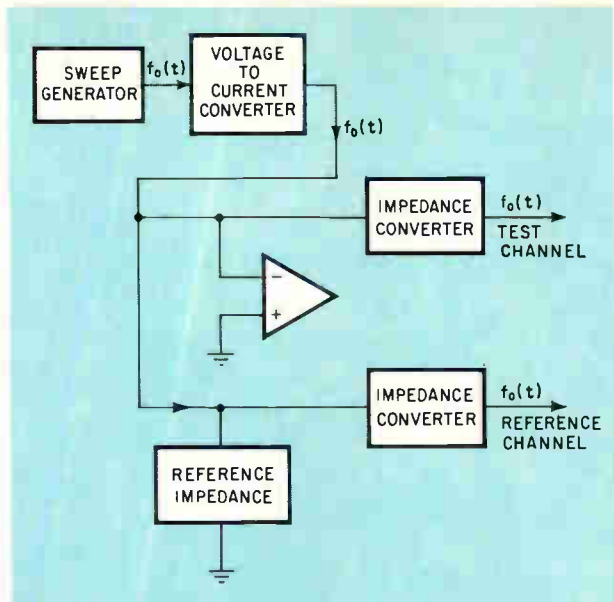

Z for all frequencies. The test circuit measures Z_i or Z_o when a swept, constant current flows through the test and the reference impedance.

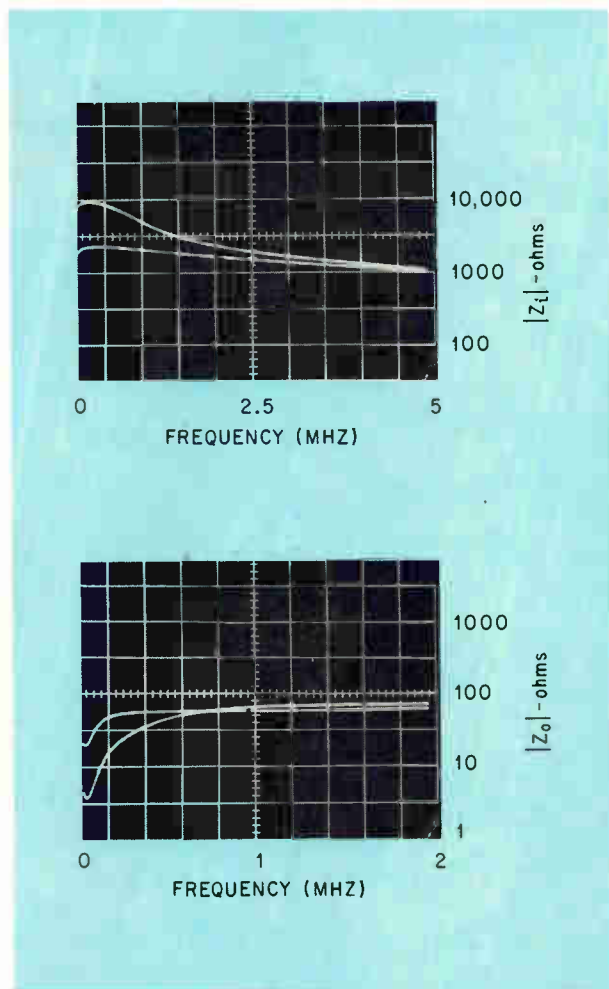

Z lines. For both Z_i (top) and Z_o the plots with the lower values at lower frequencies correspond to 0-db feedback gain, and the other traces to -20 db.

terminal is grounded. If the amplifier's output is connected to the test circuit, the circuit's output is proportional to the amplifier's differential gain. Therefore the scope displays differential gain as a function of frequency. This plot is photographed.

If the amplifier's two input terminals are now tied together and connected to the sweep generator, the test circuit's output is, by definition, proportional to the common-mode gain. The next step is to photograph the plot of common-mode gain versus frequency, and superimpose this plot onto the picture of the differential-gain curve. The amplifier's common-mode rejection ratio at a given frequency is the difference between the differential and the common-mode gain; therefore the ratio can be read directly from the composite photograph. This is quite an improvement over the situation where an engineer either accepts on faith the rejection ratio stated by the amplifier maker or measures the ratio at a few select frequencies.

Impedance

Another assumption often forced on a designer is that an amplifier's input and output impedances are constant. But by using the test circuit, the designer can tell not only how input and output impedance change with frequency but also how the gain in the feedback loop effects them.

When a differential amplifier is operating with a feedback-loop gain of β , the input and output impedances, Z_i and Z_o , are

$$Z_i = (1 + A\beta) Z_1$$

$$Z_o = \frac{Z_2}{(1 + A\beta)}$$

where Z_1 and Z_2 are the open-loop input and output impedance, and A is the open-loop gain.

When impedance is being measured, a few changes are made in the test circuit. First, instead of feeding the amplifier directly, the sweep generator sends its output to a converter which then puts out a swept signal whose current is constant. Connected between the amplifier being tested and its mixer, and also between the reference network and its mixer, are converters with high input impedance and low output impedance. These converters ensure that the currents flowing into the amplifier and into the reference network don't change.

The top trace shown on the left indicates the magnitude of the input impedance of a commercial differential amplifier for different values of β . When β is 0.1, Z_i is 10 kilohms at low frequencies, and it decreases to 1 kilohm at higher frequencies. For β equal to 1.0, Z_i is lower and more stable.

The lower display is the output impedance. The traces show that low values of Z_o can be achieved with higher values of β but only at low frequencies. At lower frequencies Z_o tends to be constant at 50 ohms, regardless of β .

In these examples, only magnitudes have been traced; however the test circuit also measures angles of these parameters. ■

“WHEN IT COMES TO REED RELAYS,

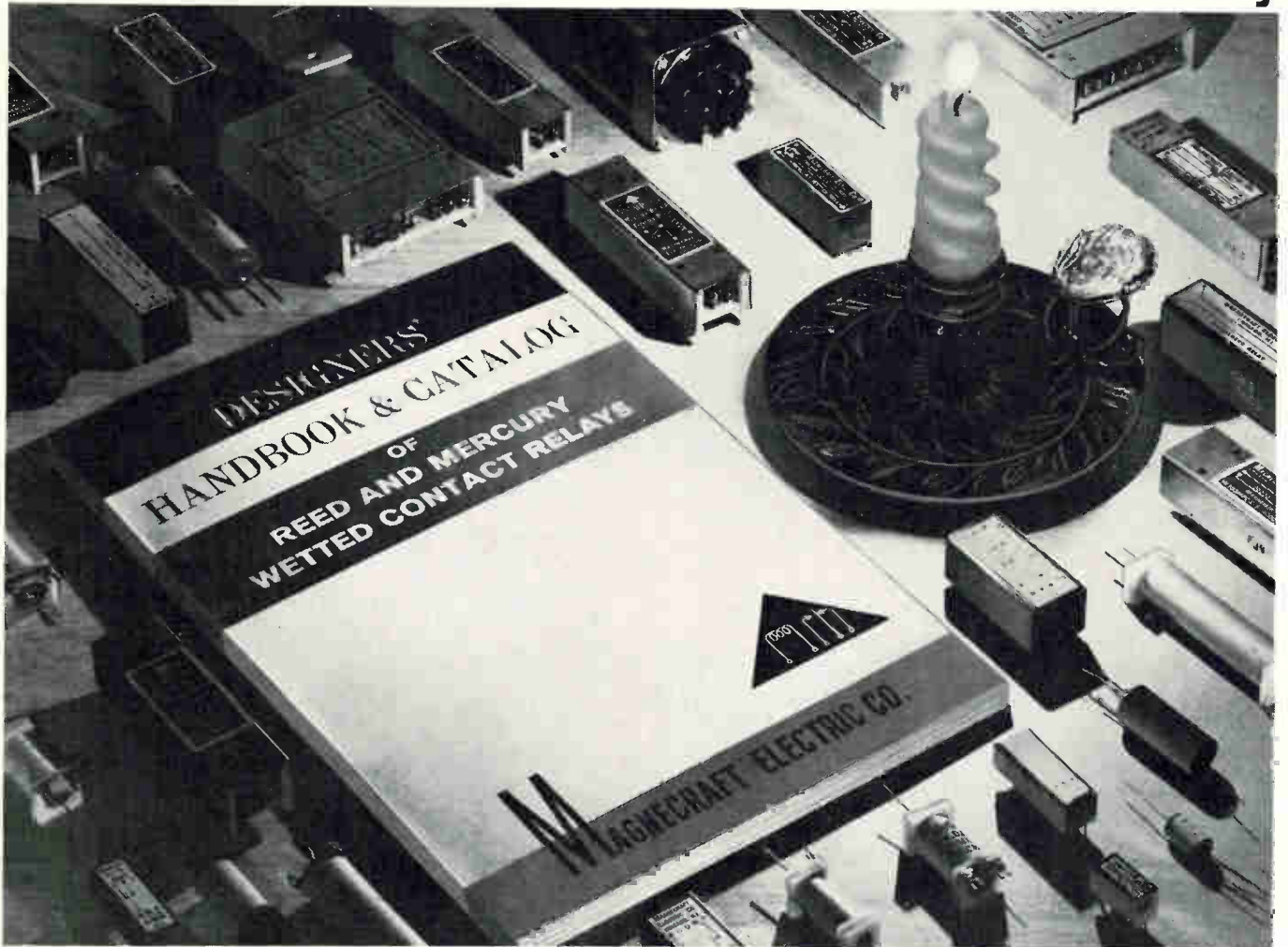

MAGNECRAFT WROTE THE BOOK”!

After developing the largest stock of dry reed and mercury-wetted relays on the market today, we had enough experience to write a book. So, we did! An 80-page handbook, in fact. It starts off with a glossary of terms and carries through to a complete product data section. In addition, there is information on applications and design considerations, how to specify relays, principles of operation and testing procedures.

Free copies are available to qualified circuit designers, engineers and others involved in the electrical or electronic fields. Write for yours. We may never win a Nobel Prize for literature, but if they ever offer one for advancements in reed relay development — well, that's another story.

Manufacturing Stock Relays for Custom Applications

Magnecraft[®] ELECTRIC CO.

5575 NORTH LYNCH AVENUE • CHICAGO, ILLINOIS 60630 • 312 • 282-5500

You get true multi-function versatility with these NEW Philbrick/Nexus Non-Linear Modules

check the function:

4350/4351 LOG OPERATOR

Log of currents, log of voltages, antilog of voltage with three built-in sensitivities plus built-in amplifier.

- RAISING TO ARBITRARY POWERS OR ROOTS
- LOG RATIO OF TWO INPUTS
- "1/X" LAW COMPUTATION
- LOG COMPRESSION
- LOG EXPANSION



4352 VECTOR OPERATOR

Find $\sqrt{X^2 + Y^2}$ of two input voltages, average of an input voltage, or true rms of input voltage in a single module.

- MULTI-COORDINATE CONVERSION
- TRUE RMS POWER MEASUREMENT
- AC TO DC CONVERSION, AVERAGE OR RMS



4353/4354 SQUARE LAW ELEMENT

Used with an external amplifier to obtain output proportional to square or square root of input.

- TWO QUADRANT SQUARING
- MEAN-SQUARE AND QUARTER-SQUARE MULTIPLIER
- RMS COMPUTATION
- COMPUTE ABSQUARE OR ABROOT
(ABSQUARE(X) = X · |X|; ABROOT (X) = X / $\sqrt{|X|}$)

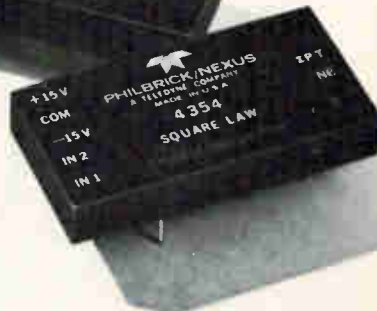

4450 FOUR QUADRANT MULTIPLIER

True four quadrant multiplier whose output represents the instantaneous product of two input signals. Built-in amplifier; only one external component required for operation.

- TRUE POWER MEASUREMENTS
- GAIN CONTROL
- MODULATION
- AUTO CORRELATION
- DIVISION

4850 GATED OPERATIONAL AMPLIFIER

Multipurpose module with operation modes such as Reset, Integrate, and Hold that may be controlled with external digital signals applied to two internal logic comparators.

- CONTROLLED INTEGRATION
- SUMMATION
- TRACKING
- HOLDING
- SWITCHING



These seven new, compact, encapsulated modules are economy-priced and available immediately. For more information contact your local Philbrick/Nexus field engineering representative, or write, Philbrick/Nexus Research, 22 Allied Drive at Route 128, Dedham, Massachusetts 02026.



PHILBRICK/NEXUS RESEARCH

A TELEDYNE COMPANY

In the beginning there was the Crystal...

... then there was BULOVA

The silicone dioxide mineral that nature created Bulova refined, shaped and put to use. Today, our expertise in crystals extends from the raw stone to the finished crystal device.

With the quartz chosen by a trained eye and cut with near-surgical precision, Bulova specialists in circuit design and thermodynamics add their talents. This knowledge is correlated with selective computer programming for optimum circuit performance.

The result is a crystal capability that should be on your side when you tackle frequency control problems.



CRYSTALS

A full line of crystal cuts and enclosures in both low and high frequencies . . . from 2KHz to 33MHz fundamental and 150-MHz overtone . . . in every type of packaging — Coldweld, Glass-sealed, Solder-seal metal holders. New Coldweld line of miniaturized packages

available in TO-5 Series, HC-6/U, HC-18/U, HC-25/U and TO-8 cans, in tolerances as close as $\pm .0005\%$ from -10°C to $+60^{\circ}\text{C}$.

CRYSTAL FILTERS

A complete capability from 4KHz to 30MHz for such typical use areas as — Band Pass / Linear Phase / Time Delay / Single Side Band. Computer Programs determine design tradeoffs quickly and economically — A staff of application and production engineers provide in-depth experience in the following crystal filter designs: 1. Butterworth, 2. Butterworth-Thompson, 3. Chebyshev, 4. Bessel, 5. Elyptic, 6. Lerner, 7. Gaussian (Transitional), 8. Image Parameter.



CRYSTAL OSCILLATORS

Choice examples of our capability are . . . PCOXO-101, a high stability crystal oscillator, with an output frequency of 1MHz or 5MHz, an aging rate of $1\text{PP}10^9$ per day, and a frequency stability of $\pm 1\text{PP}10^8$ over an ambient temperature of -55°C to $+70^{\circ}\text{C}$ and TCXO-30, a temperature compensated crystal oscillator, in a frequency range of 3 to 5MHz, has a stability of $\pm 5\text{PP}10^7$ over a temperature range of -55°C to $+85^{\circ}\text{C}$.

For further technical data on crystals, crystal filters or crystal oscillators, call (212) 335-6000, see EEM Section 2300, or write —



BULOVA FREQUENCY CONTROL PRODUCTS

Electronic Division of Bulova Watch Company, Inc.
61-20 Woodside Ave., Woodside, N. Y. 11377 (212) 335-6000

Go Bulova, and leave the designing to us!

IN THE GOOD OLD DAYS



Programming was pretty slow... Now, the Beckman 6401 is programmable to 136 MHz

In the Model 6401 Programmable Counter and Timer, Beckman offers a general purpose laboratory and production instrument that does what you want it to, at a price you can't resist...\$1375.

The 6401 provides direct frequency measurements to 136 MHz and complete programmability from contact closures. And the 6401 makes new measurements that were "unheard" of in the Good Old Days—like pulsed RF frequency or burst frequency measurements and period measurements from both channels for calibrated phase timing.

Timing measurements are a breeze with the exclusive trigger point monitor lamps in the 6401 for optimum attenuator and trigger adjustments. And maximum utilization of field replaceable IC's assures highest reliability and the lowest cost of ownership.

The 6401 is provided in a compact 3½" rackable package to conserve systems panel space, with 1-2-4-8 BCD outputs and scope markers as standard features. Options for serial input and output data, for nine digit display, and oscillator options with stabilities to 5 parts in 10¹⁰ per 24 hours are available.

Regardless of what "programmable" meant in the good old days, take advantage of what Beckman has

to offer today. For complete information, contact your local Beckman office, sales representative or the factory direct.

Specifications

Measurement Modes: Frequency: Input A, 0-136 MHz; Input B, 0-10 MHz. Burst Frequency: 0-136 MHz. Time Interval: A to B, 0.1 μ sec to 10⁹ sec. Period: Input A, 0-10 MHz. Period Average: Input A, 1 to 10⁸ in decade steps. Ratio: (F_x \div F_y) \times M with F_x = 0 to 136 MHz, F_y = 0 to 10 MHz, M = 1 to 10⁸. Totalize and Scale: Input A, 0-10 MHz scale; 136 MHz count, 1 to 10⁸ in decade steps. *Sensitivity:* Inputs A & B. 100 mV rms. *Crystal Frequency:* 10 MHz. *Stability Aging Rate:* Temperature: 2.5 \times 10⁻⁶ from 0°C to 50°C; Line Voltage: 1 \times 10⁻³ for \pm 10% line voltage change. *Oscillator Output:* 10 MHz. *External Oscillator Input:* 10 MHz. *Time Base Output:* 3 V p-p. *Display:* 8 digits with overflow indication. Storage ON-OFF. Sample Rate: fast recycle and .1 sec to 10 sec display. Gate Lamp. *Remote Programming:* by switch closure to ground; BCD data at rear panel. *Temperature:* 0-55°C. *Power:* 115/230 V \pm 10%; 50-400 Hz. *Price:* \$1375. *Options:* ACL: Laboratory Stability Oscillator, 3 parts in 10⁹ per 24 hrs; \$400. ACN: Ultra-high Stability Oscillator, fast warm up, 5 parts in 10¹⁰ per 24 hrs; \$800. 9 digits: \$100. Rear Inputs (A and B): \$50.

Beckman

INSTRUMENTS, INC.

ELECTRONIC INSTRUMENTS DIVISION

RICHMOND, CALIFORNIA • 94804

INTERNATIONAL SUBSIDIARIES: AMSTERDAM; CAPE TOWN; GENEVA; GLENROTHES, SCOTLAND; LONDON; MEXICO CITY; MUNICH; PARIS; STOCKHOLM; TOKYO; VIENNA

TELEMETRY'S
MOST
COMPATIBLE
PAIR



PC-500 IN THE FIELD

TICOR III IN THE LAB

This matched pair of Mincom Instrumentation Recorder/Reproducers are right out of the same family. Every Mincom PC-500 and every TICOR III grow up together—literally—and this proves out in their faultless cooperation in data acquisition and reduction. They are the industry's most advanced systems for their specified tasks, they share telemetry's ultimate compatibility while providing up to 2 MHz on fourteen channels. The rugged PC-500 was designed from the blackboard up to complement TICOR III's flutter suppression performance. In both systems the basic servo design thinking is identical. At the sub-assembly level, electronics and circuit design are the same. Add to this TICOR III's unmatched servo bandwidth, its low $\pm 0.4 \mu$ sec time base error, its highly successful two years of field test as Mincom's Model 32—and look no further for your complete (and compatible) data team. Write us for details and specifications.

Mincom Division **3M**
COMPANY
300 SOUTH LEWIS ROAD • CAMARILLO, CALIFORNIA 93010

7704

7504

AUTO SCALE FACTOR READOUT

A character generator senses the position of volts/div, amps/div, time/div, polarity, and uncalibrated variable controls, then accounts for probe attenuation and displays the correct scale factors for all channels directly on the CRT.

DISPLAY CONTROLS

Three intensity controls adjust "A" sweep, "B" sweep, and READOUT brightness independently. A single-focus control, a screwdriver astigmatism adjustment, and a two-position beam finder complete the control group.

CALIBRATOR

A multi-function generator usable as a "standard" for calibration of voltage and current GAIN, time/div, and probe compensation. The output is DC or AC (1 kHz or variable) voltage or current (fixed at 40 mA). The amplitude accuracy is within 1% and the time accuracy is within 0.5% at 1 kHz.

BRIGHT TRACE

The acceleration potentials are 24 kV for the 7704 and 18 kV for the 7504 for improved trace visibility. Single-shot photographic writing speed is 3300 cm/ μ s (7704) measured with the standard P31 phosphor, the new C-51 camera and 10,000 ASA film. The display area is 8 cm x 10 cm with a parallax-free illuminated graticule.

DUAL-TRACE SWITCHING

Both the vertical and horizontal mainframe amplifiers are "dual trace" providing a unique level of flexibility with plug-in combinations. A relatively small number of plug-ins can then meet a wide range of application requirements. The CHOP and ALT modes permit simultaneous displays of delaying and delayed sweep, and, through switching logic, may be "slaved" to provide a functional dual-beam type of display.

TRIGGERING

The signals from both vertical plug-ins are coupled through a mainframe logic circuit and made available to each horizontal plug-in, selectable from LEFT channel, RIGHT channel, or slaved to VERTICAL MODE. The latter frees the operator from manual source changes during single-trace operation and, in conjunction with the P-P AUTO TRIGGER MODE in the time-base units, provides true hands-off triggering during routine measurements.

FOUR PLUG-IN CHANNELS

The modular approach is the answer to instrument flexibility. With dual-trace switching in the mainframe amplifiers, each plug-in can be "specialized" in function and operate in combination with other units. Thirteen plug-ins are currently available for the 7000-Series. Together, they represent the widest range of performance options for multi-trace, differential and sampling applications available today.



7A13 Differential Comparator Amplifier

Bandwidth—DC to 100 MHz (3.5 ns tr) in the 7704; DC to 75 MHz (4.7 ns tr) in the 7504. Min deflection factor—1 mV/div at full bandwidth.

7B71/7B70 Time-Base Units for the 7704

2 ns/div maximum sweep speed. Operable singly or in combination for delaying-sweep capability.

7A16 Wide-Band Amplifier

Bandwidth—DC to 150 MHz (2.4 ns tr) in the 7704; DC to 90 MHz (3.9 ns tr) in the 7504. Min deflection factor—5 mV/div at full bandwidth.

7A22 High-Gain Differential Amplifier

Bandwidth—DC to 1 MHz with selectable upper and lower -3 dB points. Min deflection factor—10 μ V/div at full bandwidth.

7B51/7B50 Time-Base Units for the 7504

5 ns/div maximum sweep speed. Operable singly or in combination for delaying sweep capability.



7A11 Captive FET Probe Amplifier

Bandwidth—DC to 150 MHz (2.4 ns tr) in the 7704; DC to 90 MHz (3.9 ns tr) in the 7504. Min deflection factor—5 mV/div at full bandwidth.



7A12 Dual-Channel Amplifier

Bandwidth—DC to 105 MHz (3.4 ns tr) in the 7704; DC to 75 MHz (4.7 ns tr) in the 7504. Min deflection factor—5 mV/div at full bandwidth.

7A14 AC Current Probe Amplifier

Bandwidth—25 Hz to 105 MHz depending on mainframe and current probe; two probes available. Min deflection factor—1 mA/div at full bandwidth.



7M11 Delay Line Unit

Two 75 ns, 50- Ω delay lines. Trigger selection from either line.



7S11 Sampling Amplifier

Accepts the plug-in sampling heads for bandwidths to 14 GHz (25 ps tr).

7T11 Random Sampling Time Base

10 ps/div to 5 ms/div sweep range, accomplished with equivalent-time and real-time techniques.

Triggering to 12 GHz.





NEW

7000 SERIES

Plug-In Oscilloscopes

150 MHz Bandwidth . . .

USABLE performance to 150 MHz or 90 MHz. Combined mainframe and plug-in bandwidths are specified at minimum deflection factors with or without probes. With . . .

MORE Sensitivity . . .

Higher sensitivities are achieved at greater bandwidths than ever before. 5 mV/div at 150 MHz, 1 mV/div at 100 MHz and 10 μ V/div at 1 MHz. With . . .

MORE Flexibility . . .

Each mainframe accepts up to four plug-in units. Thirteen plug-ins are currently available to cover virtually all multi-trace, differential, sampling, and X-Y applications. Plus . . .

NEW Convenience . . .

Greater convenience in all areas of instrument operation. Features such as Auto Scale Factor Readout, lighted push-button switching, and true automatic triggering assure faster, more accurate, less complicated measurements.

Please turn for additional information.



C-51/C-50 Trace-Recording Cameras



Two new compact trace-recording cameras have been designed for direct compatibility with the 7000-Series Oscilloscopes. The C-51 and C-50 cameras are basically identical units, differing only in the lens system. The C-51 has an f/1.2, 1:0.5 lens; the C-50 uses an f/1.9, 1:0.7 lens. The C-51 is recommended for single-shot photography at the fastest sweep rates, the C-50 for more general purpose applications. Photographic writing speed of the two 7000-Series mainframes with the C-51 and 10,000 ASA film (without prefogging) is 3300 cm/ μ s (7704) and 2500 cm/ μ s (7504).

The cameras offer a new level of operational convenience for mistake-proof trace photography. The guess work normally associated with selection of f stop and shutter speed to match the ASA index and trace brightness is eliminated. After setting the ASA index, the built-in photometer allows a visual correlation of trace intensity to the correct f stop setting and shutter speed. After initial adjustment, a change of f stop or shutter speed will still maintain the same exposure. Focusing is accomplished by two beams of light projected on the CRT which, when superimposed, indicates optimum focus. The insert shows the photometer spot and the range-finder focusing images.

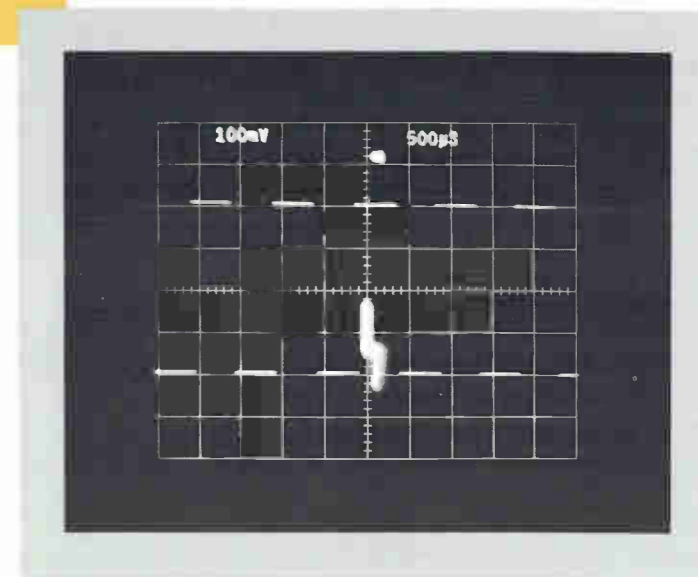

SCOPE-MOBILE® CARTS

The 204-2 Scope-Mobile® Cart is specifically designed for the 7000-Series instruments. It provides a securing mechanism for the oscilloscope, nine positions of selectable tray tilt, a large storage drawer, storage for five 7000-Series plug-ins, and large locking-type wheels.



PROBES

The P6053 is a miniature fast-rise 10X probe designed for full compatibility with the 7000-Series instruments. Input R and C is 10 M Ω , 10.3 pF. Probe risetime is 1.2 ns or less.

The P6052 is a passive dual-attenuation probe designed for measurements below 30 MHz. A sliding collar selects 1X or 10X attenuation. Input R and C is 1 M Ω or 10 M Ω , 100 pF or 13 pF. Risetimes are 60 ns (1X) and 7 ns (10X).

7704 Oscilloscope	\$2500
7504 Oscilloscope	\$2000
7A11 Amplifier Plug-In	\$850
7A12 Amplifier Plug-In	\$700
7A13 Amplifier Plug-In	\$1100
7A14 Amplifier Plug-In	\$575
7A16 Amplifier Plug-In	\$600
7A22 Amplifier Plug-In	\$500
7B71 Time-Base Plug-In	\$685
7B70 Time-Base Plug-In	\$600
7B51 Time-Base Plug-In	\$510
7B50 Time-Base Plug-In	\$450
7S11 Sampling Plug-In	\$450
7T11 Sampling Time-Base Plug-In	\$1100
7M11 Dual Delay Line Unit	\$250
204-2 Scope-Mobile® Cart	\$155
C-51 Trace-Recording Camera	\$900
C-50 Trace-Recording Camera	\$700
P6052 or P6053 Probes ea	\$50

U.S. Sales Prices FOB Beaverton, Oregon

Tektronix, Inc.

For a demonstration, call your local Tektronix field engineer or write: Tektronix, Inc., P.O. Box 500, Beaverton, Oregon 97005.

Space tours tailored to the budget

NASA's plans for unmanned planetary exploration in the 1970's are expansive; but the major challenge is getting the \$3 billion to bring them to fruition

Unmanned exploration of the entire solar system waits on Government's blessing.

Plans now being formed by space officials will see at least one U.S. probe—orbiter or lander—sent to every planet in the next decade.

Other missions could include docking a spaceship to an asteroid and collecting samples or flying a craft near Halley's Comet.

If the plans aren't approved, however, the U.S. could lose its chance to stage a "grand tour" of the outer planets, which won't again be positioned correctly for such a mission until the next century.

Chief architects of the solar system exploration plan are NASA's planetary programs directorate and the National Academy of Sciences' space science board. Part of the plan calling for exploration of the inner planets is virtually sure of acceptance; the

grand tour may be tougher to sell.

Two Mariner spacecraft will be sent to orbit Mars in 1971; a request is now being discussed in Congress for a Mariner-Mercury mission in 1973, and NASA is already starting to commit the \$400 million estimated cost for sending two Viking lander missions in 1973 and 1974.

Plans for Viking are moving quickly. Martin-Denver has been selected as prime contractor for the landers, and NASA's Jet Propulsion Laboratory will be a prime contractor for the two orbiters. Tying it all together will be NASA's Langley Research Center as program manager. The Martin contract is being negotiated now and is expected to be final in a month or so at which time subcontract awards will begin going out. JPL will be calling in quite a few contractors to help with its portion of the job—many of which will be

those who have worked on the two Mariner '69, and are working on the two 1971 missions.

Whether the President will approve the grand tour program is unknown at this point. He's now evaluating it as part of his study for space goals in the next decade. If he gives the go ahead for the tour, NASA planners think the entire program for both inner and outer planets will be approved. One strong supporter of the tour is the Space Task group, which offered suggestions to the President.

Two plans. At NASA there are two grand tour plans under consideration. One is a four-planet mission to Jupiter, Saturn, Uranus, and Neptune but not Pluto. To avoid getting caught in Saturn's rings, spacecraft would have to fly out way beyond the planet and, thus, trip time would be long—11 years. The other plan calls for four three-

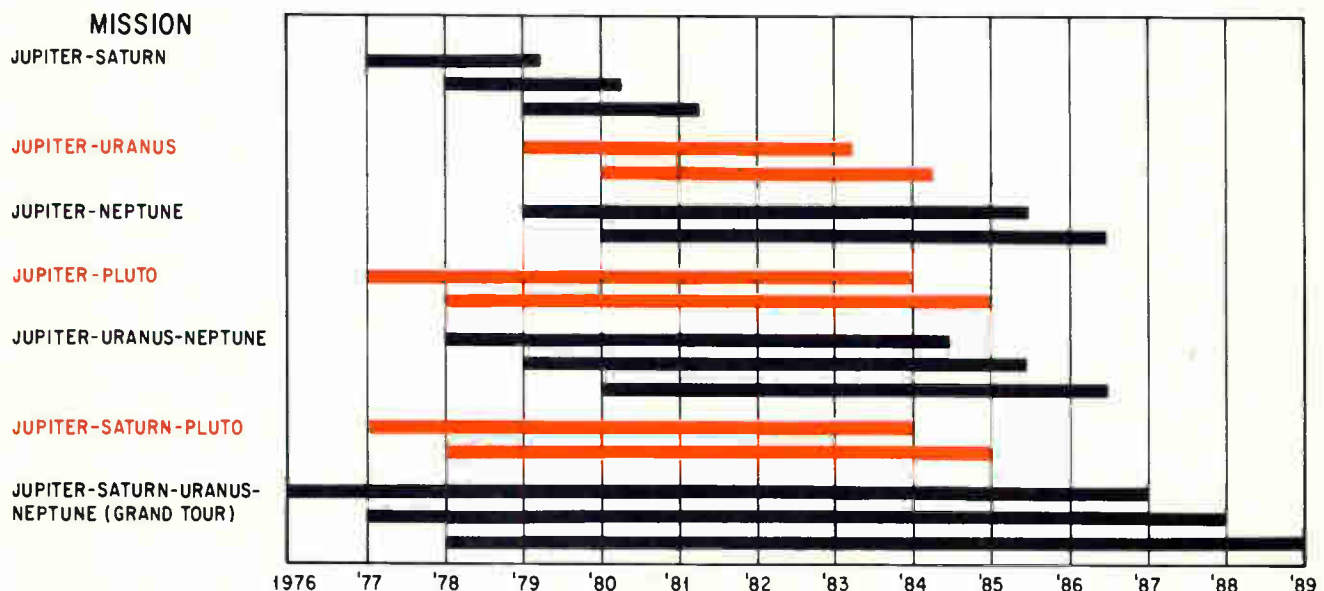

Outer limits. Estimated launch dates and trip durations are shown for spacecraft tours of outer planets. Missions are feasible in the late seventies because of alignment of planets and won't be possible after that for many years.

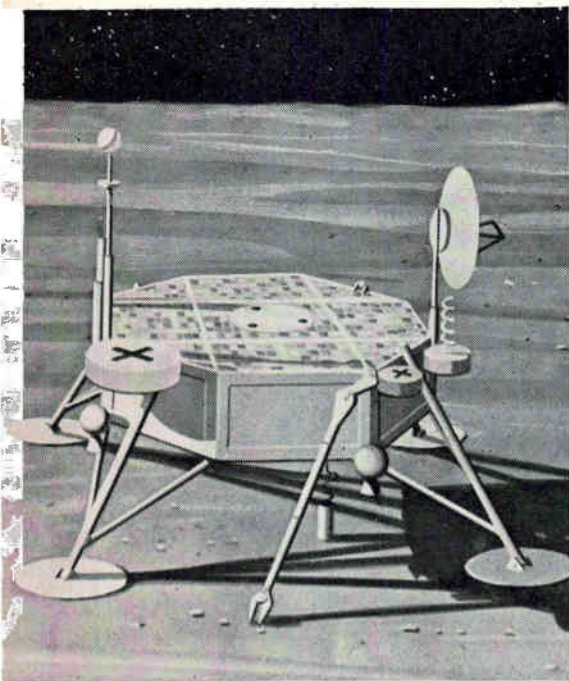

Touchdown. Viking vehicle, equipped with sensors, will attempt soft landing on Mars in 1973.

planet missions: two 7-year, 6-month tours to Jupiter, Uranus, and Neptune and two Jupiter, Saturn, and Pluto shots to take about eight years. The three-planet plan would pass the south pole of Saturn and miss the rings.

Since opportunities for the grand tour only exist in the late 1970's, NASA is putting a lot of stock and time into the missions, banking on a Presidential go-ahead.

The Jet Propulsion Lab has been working on a grand tour concept since 1965 and has been studying trajectories and developing conceptual designs for spacecraft. For the last year, Goddard Space Flight Center has worked in some of the same areas, and six months ago the Marshall Space Flight Center began studying the possible missions.

Meanwhile the Ames Research Center has just begun working on the problems of getting grand tour probes into the atmospheres of the various planets. All of these elements have been tied together at NASA headquarters, and center representatives are working on the program under the title of the Outer Planets Working Group. In short, NASA is moving on the program which is quickly pointing to the second, or two-mission plan.

Says Donald P. Hearth, director of the planetary programs office, "From what we've learned so far the two three-planet opportunities are the most attractive, and we feel probably the way to go."

New spacecraft indicated

Hearth says that the latest studies of the program call for a new spacecraft which is between 1,000 and 1,500 pounds in weight, and which would have both spin-stabilized and three-axis stabilization capability. Hearth adds that the craft would carry a Mariner class payload akin to the recent Mariner 6 and 7 missions with the added capability of planetary practical field-measuring devices. Hearth says the payload would include equipment for measuring magnetic fields and radiation belts and television pictures of the planets.

"We're in a pretty good position to move," says Hearth, because of the intensive work that's been going on in house." The next move that NASA would like to make, according to Hearth, is to get funds for a test flight of the new spacecraft into the fiscal 1971 budget. Hearth explains that the ship ought to be tested in 1974 because it will incorporate new high reliability components designed to last for years, nuclear propulsion systems, and long distance communications systems.

The test craft would go out to Jupiter. Hearth says if the test flight is approved as part of the program then heavy industry involvement would begin in fiscal 1971. Should the test be scuttled, fiscal 1971 will see lots of study money but will delay the massive hardware commitment for a year.

Present plans call for two missions in 1977 and two in 1978, with the less favored one-shot tour slated to go off during that two-year period. The optimum plan for NASA at this point is for five crafts—the four operational shots and the one experimental shot. Hearth says it's a bit early to say how much the favored plan would cost but that it would be in the area of \$400 million to \$600 million.

Going along with the recent recommendations of the National Academy of Sciences, NASA wants probes to the major planets by the

early 1980's starting with Jupiter in the 1970's. Hearth points out that the missions offer some exceedingly difficult challenges. He points out, for example, that the entry velocity to Jupiter is a minimum of 160,000 feet per second. The academy report urged a goal of putting a probe into the Jovian atmosphere in 1974, which Hearth says may be technologically questionable by that date, but NASA would like to push for as early as possible. One point Hearth is quick to make when discussing the outer planets is that one should not overlook other possibilities for the 1970's, namely atmospheric probes.

As far as the outer planets go—that is, from the asteroid belt on out—Hearth says that the position taken in the academy report includes the broadest plan NASA supports.

Broad plan wanted

The recently released report of the academy entitled "The Outer Solar System" strongly urges a broad plan for outer planet exploration. The report calls for NASA to present, in the next budget, a long-term plan for exploration of the outer reaches including not only the grand tours and major probes, but also such single items as a 1976 Jupiter orbiter mission, craft to explore the asteroid belt, and investigation of the major comets. Continuation of the pioneer program past pioneers F and G is also recommended.

The academy report also termed the following hardware developments as being necessary for the success of the plan:

- Mass spectrometers for deep entry probes with suitable sampling inlets and capable of withstanding high pressures and potentially corrosive chemical atmospheres.

- Sophisticated high-resolution visual imaging systems capable of focusing on the planet from the time the spacecraft leaves earth until it is at its closest point to the planet.

- More sophisticated thermal imaging systems covering the infrared wavelengths to map the temperatures of the planetary atmospheres.

- A planetary data system

specially designed for continuous coverage during the cruise mode and providing a higher rate of data storage and transmission during planetary encounter.

▪ A special over-all system of instruments specifically designed to operate in the hostile environment of Jupiter.

▪ Upgrading of existing radar and radio astronomy facilities, the construction of a major new facility for planetary radar astronomy, and the early development of radio-link and bistatic radar experiments.

The academy suggests an early start in these key areas as well as on design efforts for a grand tour spacecraft, probes for unique entry missions, advanced propulsion schemes, and ground related development, including a major new telescope for the Southern Hemisphere. The academy also favors a series of earth-orbiting telescopes which would look at the deep planets with high-resolution imagery and ultra-violet spectroscopy.

While the outer planets have been coming in for their share of attention lately with much talk of the grand tour and other missions, Hearth is quick to point out that his group is no less interested in the inner planets.

The 1973 Viking missions should be considered the beginning of Mars surface exploration, according to Hearth, and not the end of anything. He says, "I definitely see a continuation for a few years at least of the Viking kind of system for Mars. There will be continuations in 1975 and 1977." Hearth says that it won't be possible to specify what extensions of the Viking capability will be used in the future missions until more data is gathered on Mars over the next few years. However, the possibilities include giving mobility to the Viking lander or outfitting the orbiter for high-quality photography of the type that the Lunar orbiters yielded from the moon. Hearth also adds that a decision to put men on Mars would change everything.

Good shape. Hearth feels that the planetary program is in good shape these days with Mars missions past and future, two pioneers scheduled for Jupiter and a strong possibility of a Mercury mission.

But, he says Venus needs more attention. "The Venus atmosphere is without question one of the strangest in the solar system," he says. It's exceedingly dense with very high temperatures near the surface. "At present we've got nothing scheduled for Venus," says Hearth, "and somewhere along the line we're going to have to get a program going which will include getting down to the surface of the planet."

Hearth suggests that in 1970, NASA will try to put automated landers on Venus. He says that the Viking lander approach can't be used on Venus due to the extreme differences in temperature and pressure. The first missions to Venus will be atmospheric probes in which four simple probes at a time would be sent into the planet's atmosphere. They would be simple parachute probes which would send data as they traveled through the thick atmosphere and would be destroyed when they hit the surface.

Another concept which would be pursued in the early days of Venusian exploration is the "buoyant venus station," a balloon-borne package which would float through the atmosphere for weeks. While NASA has not yet done much investigation with Venus landers, studies thus far indicate that the lander would be able to travel by parachute and would have to be able to withstand extreme temperatures on the surface. Because of the cloud cover on the planet, it would need a power supply not dependent on solar energy.

Hearth also points out that much can be done with Venus—and other planets for that matter—from the earth with the development of sophisticated radar techniques. He says that another aspect of the envisioned planetary exploration program in the 1970's will include greater attention to earthbound techniques for solar system studies.

Big puzzle. Philosophically, Hearth looks at the grand scheme for exploration as analogous to a giant jig-saw puzzle—each planet being different but forming a part of the picture. For this reason, the keyword at the Planetary Programs Office is "balance." Hearth says that this is why NASA will

**THEY'VE
GOT
OUR
NUMBER!**

**Computer Access
Systems**

Hewlett-Packard

**International
Computer Products**

Omnitec

Sycor

Viatron

Wang

Laboratories

Westinghouse



FOR

**MINI-DIGITAL
READ / WRITE
HEADS**



YOU TOO CAN GET THE HEADS
YOU NEED FOR DESK-TOP,
INPUT/OUTPUT, TERMINAL, AND
PERIPHERAL EQUIPMENT.
BY CALLING THIS NUMBER:

(612) 545-0401

Nortronics
COMPANY, INC.

World's Largest Tape Head Manufacturer

8101 Tenth Avenue North
Minneapolis, Minnesota 55427
Phone—(612) 545-0401

Meet the Members of The Board...

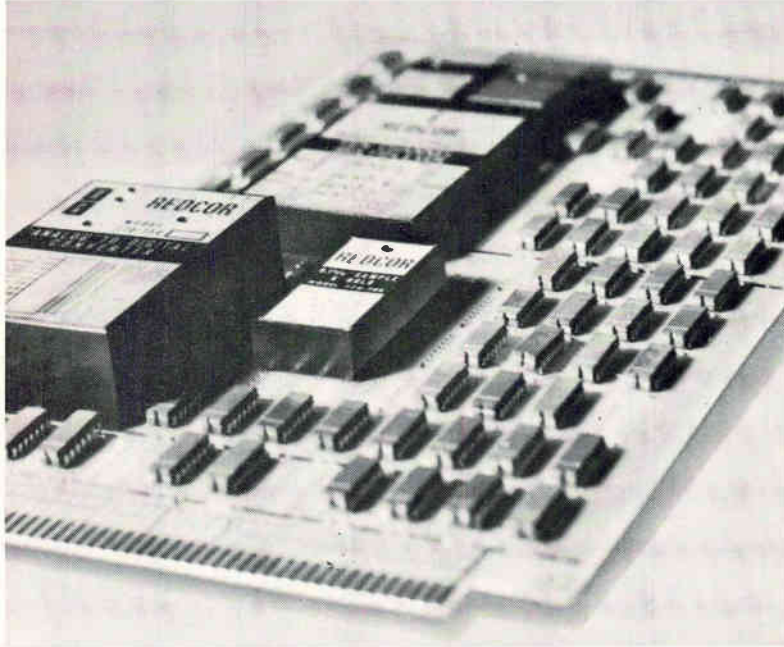

...Dual In-Line Conference

For the successful management of analog circuit design, the designer's board members must have background characteristics based upon dynamic response specifications and a proven performance with known sources and loads. The designer's board members must also have the ability to "fit in" with the others whether they be dual in-lines, discrete or flat-pack components. Our packaging configuration allows the designer this freedom.

The guaranteed performance of REDCOR's closed loop module concept frees the system designer from the concern, risk and expense normally experienced with other analog modules.

To support those special circuit and system design requirements, REDCOR can supply not only the modules, but the boards, chassis, and power supplies.

Analog-to-Digital Converters
Digital-to-Analog Converters
Multiplexers
Sample and Hold Amplifiers
TRICON Fast Settling Amplifiers

BUF-FET Ultra Fast Settling
Amplifiers
Dynamic Bridge Amplifiers
REDIREF Voltage Reference
Supplies
Comparators

REDCOR's board members come prepared to meet any situation. For a complete catalog listing specified performance, write or call:

R
C **REDCOR**
CORPORATION

Complete Systems Capability / 7800 Deering Avenue, P.O. Box 1031,
Canoga Park, California 91304—(213) 348-5892

avoid putting all its programs on any one planet. Hearsh says that getting information from comets and asteroids could also be very important pieces in this puzzle and can't be overlooked. Right now, says Hearsh, the planetary program has a "Mars tinge" to it; within a few years he claims it will have a "universal tinge" to it.

NASA's plans for the solar system are still a long way from fruition. First, the Administration and Congress are going to have to authorize the resources needed for the plan. Planetary programs will take up \$127 million of the total NASA budget for fiscal 1970—a sizeable jump from last year's \$71 million. According to Hearsh, "A balanced unmanned planetary program for the 1970's will require about 10% of the current NASA budget or about \$300 to \$400 million a year." NASA's planetary "lobby" has its work cut out for it as it will not only have to fight for funds in Congress but also within the agency as well for just about every project.

Hearsh says that after the fiscal hurdles are cleared, some tough technological challenges will still have to be dealt with. Hearsh puts "long-lifetime reliability" at the top of his list. He says, "In the 1960's we put spacecraft up for a year and sometimes they lasted longer. In the next decade we've got to be able to send up craft that will last for eight years or longer." He adds that electronic reliability is still the biggest question mark.

Long-distance communications and spacecraft control are also going to be tough to contend with according to Hearsh. "It took us about 5½ minutes to get a message to Mariner 7 when it was near Mars," says Hearsh. "To communicate with a spacecraft near Neptune will take us 3½ hours one way. This is not only a terribly difficult communications problem but it also means that we will have much less control over the craft and we will have to build more control into the spacecraft itself."

The ideas and techniques needed to get the planetary program going in the 1970's are not going to be easy to come up with, and Hearsh says that his main reason for being optimistic is that problems of relative difficulty have been mastered by and for NASA.

EAGLE

*...where the
state of the art
is the standard
of the industry*

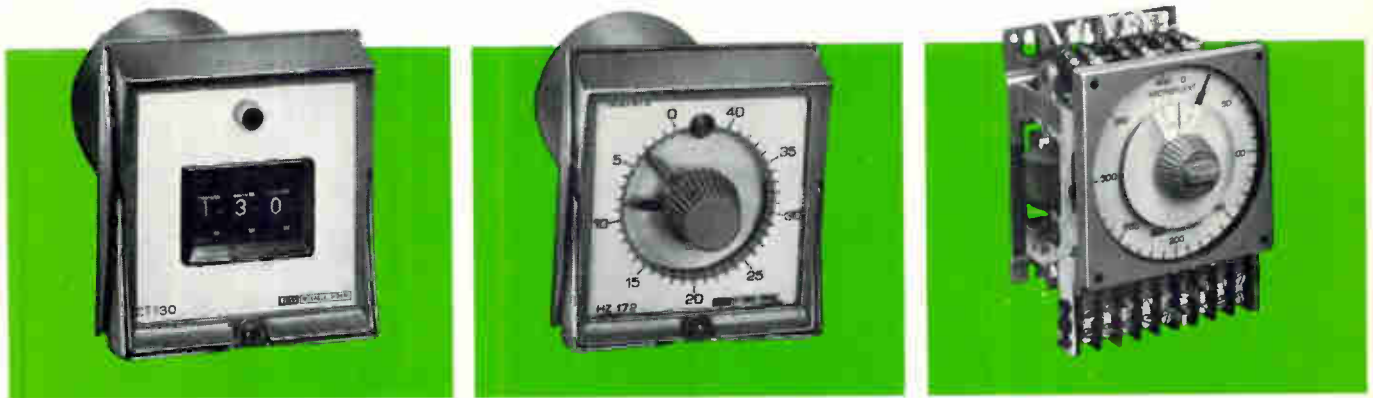

You'd need an Eagle Counter to count all the Eagle Counters!

CT Series Solid-State On/Off Counters

State-of-the-art design and components for high-speed commercial-class counters... loaded with options. Two- and three-digit models count 1200 contact closures per minute with 100% accuracy using electrical input from limit switch, photocell or other sensing device. Input filtered against effects of transients and contact bounce. Convenience of binary thumbwheel setting and plug-in interchangeability.

Send for Bulletin 743

HZ170 Series CYCL-FLEX® Counter

Most popular counter of its type in commercial use. Range of 80 counts has separate pointers for count setting and countdown. Count speed is 400/minute maximum with average mechanical life of 15 million counts. Many variations in control functions enable adaptation of the standard design to a wide variety of specific applications. Plug-in design features instant interchangeability.

Send for Bulletin 726

HZ4 MICROFLEX® Counter

One of many widely used industrial-grade Eagle counters that can be actuated from a variety of sources. Starting impulse from limit switch, timer, pushbutton or pressure switch starts countdown. Variety of 15-amp. control variations at end of count. Automatic reset. Other Microflex units count shaft revolutions or give count control between two limits, responding to add and subtract input pulses.

Send for Bulletin 720

GET THE SPECS and full details...more than \$1 million in Eagle time/count controls, control relays, precision potentiometers...waiting to serve you in 35 major areas throughout the world...including U.S.A., S.A., Europe, U.K., Canada and Australia.

GW Eagle Signal Division
A GULF + WESTERN COMPANY

Davenport, Iowa 52803

BEST SHORT-TERM STABILITY IN A RUBIDIUM FREQUENCY STANDARD...: \$7500.

That says it.



No if's, and's or but's. Just the facts. The Hewlett-Packard 5065A sets a new mark for short-term stability (rms) in a rubidium frequency standard: less than 7×10^{-12} , 1 second averaging; 2.2×10^{-12} , 10 sec. avg.; and 7×10^{-13} , 100 sec. avg.—verified against the HP hydrogen maser. Yet this 37-pound, portable atomic standard costs you only \$7500.

More facts. The 5065A has a built-in frequency synthesizer that lets you change time scales as much as 1×10^{-7} by convenient thumbwheel dialing—no extra cost. Fine frequency control resolution is 2×10^{-12} . Signal-to-noise ratio is greater than 87 dB.

Long-term stability is better than 2 parts in 10^{11} per month. And the standard has passed environmental tests for humidity, magnetism, vibration, shock and electromagnetic compatibility under military specifications.

Options featured: Option 01 is a Time Standard which has a clock pulse rate of 1 pulse/second, a rise time of less than 50 nsec and jitter of less than 20 nsec. Clock movement is 24 hours. Option 02 is a Standby Power Supply.

The price—again—of this portable, rugged Rubidium Standard is only \$7500. Option 01 costs \$1500;

Option 02, \$300. Or you can get Option 03, shown above, which combines both for \$1800.

Now you can get all three frequency standards from Hewlett-Packard—quartz, cesium or rubidium. Get more facts by calling your HP field engineer, or writing Hewlett-Packard, Palo Alto, California 94304; Europe: 54 Route des Acacias, Geneva.

HEWLETT  **PACKARD**

FREQUENCY STANDARDS

02805

SDC means business—in software

Rand's military-oriented offspring follows move into commercial sector with a commitment to the bright future of generalized data management systems

By Ralph Self

Associate editor

The computer and software worlds were still buzzing about last month's decision by System Development Corp. to become a profit-making organization, when the Santa Monica, Calif.-based firm quickly followed with another move intended to stake its claim in the commercial software market: introduction of a new data management system—a computer program that undoubtedly will further jolt the industry giants.

The impetus for SDC's switch from non-profit to for-profit status involved both economics and technology. The firm was becoming a prime target for management and technical headhunters bearing gifts of stock options. "Looking ahead, it wasn't clear that our capability could be kept together and used to best advantage as a non-profit," says Wesley S. Melahn, president of SDC. "In order to be in on the big exciting things in our industry we need to be in the commercial field; at times this kind of motivation for employees is more important than finances," he asserts. The change also signified a heavy commitment to the belief that generalized data management systems are the wave of the future.

"A generalized approach is the way the world is going over the next five to 10 years, and a lot of people in the software business have made the mistake of developing an accounting package and then trying to generalize," says Robert W. Hamer, SDC's commercial division manager. And according to Melahn, theirs is the first truly generalized, interactive, time-shared program that permits management to manipulate data and make deci-

sions, using a plain English-language approach to programming.

The phraseology is familiar, but the corporate credentials for bringing it off are impressive. They include more than 1,400 major software systems contracts successfully completed and a considerable number of employees who are senior practitioners in the infant science of software development.

Planning ahead. Although SDC only recently announced its switch from non-profit to for-profit status, a commercial systems division was formed in February, 1968 to lay the groundwork for the changeover.

The Commercial Data Management System (CDMS), and Orbit (on-line retrieval of bibliographic information), are important elements in a total Time-Shared Data Management System (TS/DMS) expected to swell SDC commercial

sales to \$30 million by 1974. The company now obtains about 80% of its \$61 million annual sales from its military-oriented air operations, space and range, and command support operations divisions. Most of the remainder comes from the public systems division, including education, transportation, public safety and government systems. Only 3% now is contributed by the fledgling commercial division.

Unlike many time-shared computer firms, SDC got into the business primarily to provide an operating environment for its data management system. One time-sharing computer center, using an IBM 360/67, has been in operation at Santa Monica since early this year. A second center at Falls Church, Va., equipped with an IBM 360/65, has just been opened. SDC officials say multiplexed lines to New York and



Close control. Operators in Santa Monica center mount tapes for the appropriate programs in use, and monitor the number of users in the system.

Dallas will be available at the centers by the end of the month.

Taking a cautious approach, the company has tested TS/DMS for several months at the Santa Monica computer center, and 15 customers already are using it. Major customers include Atlantic Richfield, Texas Instruments, Gulf & Western Industries, First National City Bank of New York, and Continental Can.

Atlantic Richfield, for example, uses the system to analyze customer sales. Gulf & Western uses it to update and maintain personnel files. For Continental Can it provides an index to the various kinds of containers the company has produced. Texas Instrument employs the system for financial and personnel data management.

"I don't know of anyone in the field who has a system comparable to ours, but others are working on it," Hamer declares. "The companies that we think are going to catch up with us the fastest are

Control Data Corp. and possibly IBM."

One of a kind. Hamer insists that SDC's system can't be compared with engineering oriented time-shared computational packages using basic, APL, Fortran or Cobol, or forms-oriented systems like Inframatics Mark 4, Computer Sciences Corp.'s Cogent 1, 2, and 3, and IBM's report generator, RPC.

The IBM Generalized Information System (GIS), while comparable in some ways with TS/DMS, operates in a batch mode, although it is eventually expected to evolve into a time-shared system, Hamer says. Another IBM approach, Information Management System (IMS), essentially is a teleprocessing system that quickly puts data into files with rapid updates, but without an interactive capability, he adds. "Because it uses batch processing, IBM's GIS tends to store a lot of programs in the memory. If you want a different set of information,

you wind up with a very large library of stored programs," explains John Lockhard, manager of commercial accounts for SDC.

By contrast, the SDC program is divided into functional parts, each of which stands alone and can be easily updated. For example, it is possible to update the compose part without causing a disruption in the remainder of the program.

"Our program is on-line, interactive, and uses both inverted and index files," says Lockhard. (In an inverted index file, data is carried only once and then referenced in all instances. On the other hand, index files are cross referenced in the ordinary manner.)

"Users can feed their inputs to the computer, query the computer, and make changes immediately. And the inverted-index organization permits faster data retrieval," he adds.

Giving its all. To retain maximum computer use and flexibility, batch updating with SDC's system is done overnight outside of time-sharing periods. The SDC approach also differs from conventional time-sharing operations in that the company sells time segments during which the entire capability of the computer is available to each user.

"Many time-sharing services, in effect, chop up the computer and sell each user a piece," says Lockhard. "On the other hand, form oriented systems such as the Mark 4 and Cogent are useful mainly in a small business or small computer environment where the data needed is more rigidly structured. There is a tendency in that kind of system to arrive at a point where the user is only getting repetitively-run reports," he asserts.

"We think selling a slice of time instead of a slice of memory is a more efficient way to go because it gives the user a larger share of the computer's resources," says Lockhard. "We can still overlap the transfer of programs and the operation of other programs, retaining the ability to manipulate large amounts of data and make real-time inquiries," he adds.

SDC concedes, however, that when IBM is able to make GIS interactive and time-sharing, the system will be somewhat similar to CDMS. Connect time, central processing unit, terminal access, and

Coming of age

Hardly anyone present at the formation of the System Development division of the Rand Corp. in 1955 could have foreseen that 14 years later a \$61 million profit-making corporation would evolve.

The division was formed in December 1955 to develop programs for the increasingly complex command and control systems required by the military. Early work by the division included programming for the U.S. Air Force's Semi-Automatic Ground Environment (SAGE) system, initial development of computer time-sharing concepts, and one of the first uses of English-language methods in computer programming.

Rand management decided in 1956 that "the tail was beginning to wag the dog" and shut off the systems development unit as an independent non-profit corporation. The Systems Development Corp. was privately started by members of the Rand board, privately financed, and until 1966 was classified a specially related non-profit corporation. Movement toward completely independent status for sdc started in 1962-63, when the company's hitherto unique software capabilities increasingly became available to competing pri-

vate firms; the final break with the Air Force occurred partly as the result of Congressional pressure for open competition in military contracts.

However, sdc continued to be handicapped in its competition with private firms by its inability to raise capital for expansion. The company increasingly became the target of personnel raids by private corporations able to offer attractive stock options and other benefits. In August, sdc became a for-profit taxpaying corporation, with 25% of the total equity and a 20% stock option going to members of an investment group headed by Lehman Brothers.

After the option is exercised, 35% of the equity will be retained by the sdc trust, and 20% will be available for employee stock options. The corporation is expected to go public within the next 18 months.

Income from the non-voting stock held in trust will be used for scientific and educational purposes in the computer field, probably for sponsorship of research in colleges and universities. It is expected that the trust will be dissolved in five to 10 years when funds are exhausted, sdc officials say.

memory storage costs for TS/DMS are competitive with other data centers using similar computer hardware, SDC says. Direct sale price for the system will be "in six figures," SDC adds.

For customers who use the Santa Monica and Falls Church data center computer facilities, the rates are: Time-sharing terminal connect, \$9 per hour; monthly minimum, \$100; central processing unit, \$12 per minute. Disk storage rates are \$9 per access hour for the first logical cylinder, and \$.0432 per access hour for each logical cylinder beyond the first; \$5.40 per access hour for magnetic tape. According to SDC, a survey of 12 time-sharing services using similar computer equipment shows it ranked sixth in per-hour-use cost.

A total capability

While CDMS and Orbit obviously will be primary selling points, SDC officials emphasize that they're selling a total data processing capability. Other elements in TS/DMS include Tint (teleprinter interpreter) and Watfor (University of Waterloo and Fortran) interactive computational packages; Cobol, Fortran, Jovial and Fortran 4 programmer packages; a jovial interactive programming support system package; and utility packages to perform specific maintenance tasks.

A time-shared executive program (TS/Exec) handles scheduling, allocation and coordination and related functions for TS/DMS users at the data centers. And in addition to typewriter and teletype terminals, the system has a cathode-ray tube display output which permits the user to form data plots and bar graphs using alpha-numeric characters. The display is an interim package that will be replaced with more advanced displays, SDC says.

Ready for action. Just how ready is SDC to take on the commercial giants? The company has a ready answer both for the skeptics, and for those software firms that are apprehensive about competition from the company's military spawned technology.

Says one official: "We have always been a doing organization, and never had a sheltered environment like Rand and Mitre, with a guaranteed level of support. The



**We're still
No. 1
in variable filters!**

There must be a reason.

Krohn-Hite, a pioneer in the initial development of variable filters, has maintained leadership by keeping pace with an ever-changing state-of-the-art. Conversion from tubes to solid state, modern packaging techniques and addition of versatile new instruments to meet new engineering parameters, add up to the most comprehensive line in the industry.

Series 3300, for example, are all silicon, solid state, low distortion, variable electronic filters that are digitally tuned over the range from 0.001 Hz to 99.9 kHz. Models 3320 (Single channel) and 3322 (Dual channel) provide 24 db per octave attenuation slopes per channel, and Models 3340 (Single channel) and 3342 (Dual channel. Illustrated) have slopes of 48 db per octave per channel.

Recent additions to the Series are Models 3341 (Single channel. Price \$995) and 3343 (Dual channel. Price \$1825). Frequency range is 0.01 Hz to 99.9 kHz. Attenuation slopes are 48 db per octave per channel.

All Models in Series 3300 feature line or battery operation, with batteries internal and rechargeable.

Write for the new 1969 Catalog containing complete specs on the entire Krohn-Hite line.

OVERSEAS SALES OFFICES: BELGIUM, C. N. Rood s. a. DENMARK, SC Metric A/S; FRANCE, Antares; GERMANY, Nucletron Vertriebs-GMBH; HOLLAND, C. N. Rood n. v.; ITALY, Dott. Ing. Mario Vianello; SWEDEN, Teleinstrument; ISRAEL, R.D.T. Elect. Eng. Ltd.; JAPAN, Shoshin Shoji Kaisha, Ltd.; AUSTRALIA, Sample Electronics (Vic.) Pty., Ltd.; G. B., B & K Inst. Ltd.

KH **KROHN-HITE**
CORPORATION

580 Massachusetts Ave., Cambridge, Mass. 02139, U.S.A.
Phone: (617) 491-3211 TWX: 710-320-6583

Oscillators / Filters / AC Power Sources / DC Power Supplies / Amplifiers

Service... Engineering... Experience

MAKE THE **BIG** DIFFERENCE
BETWEEN A YOKE SPECIALIST
AND A YOKE SUPPLIER



1" ID 12 oz. Single Gap
Shielded Dynamic/Static
Focus Coil

Syntronic Yoke Specialists have more yoke knowledge and provide more engineering assistance than anyone else in the field.

The most extensive line of deflection yokes available is offered by Syntronic... in production quantities or custom designed to special requirements. See the BIG Difference for yourself the next time you specify a yoke.

Syntronic INSTRUMENTS, INC.
100 Industrial Road, Addison, Illinois Phone 312, 543-6444

Circle 233 on reader service card

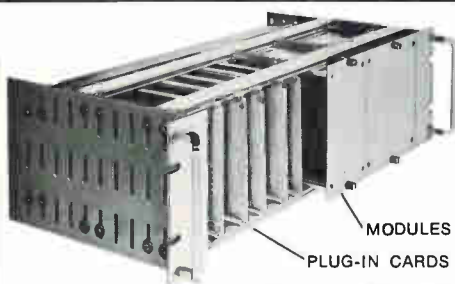

Vector-strut Cages Have Universal Adjustability

- STRENGTH
- HANDSOME APPEARANCE
- QUICK ASSEMBLY
- LOW COST

CHECK THE SPECS AND SEE:

THE VECTOR-STRUT CAGE provides an adjustable aluminum frame which through customer test has proven to be more versatile than other competitive units on the market.

- Mountable on 10", 19" or 24" racks.
- Three standard heights - 3 $\frac{1}{2}$ ", 7 $\frac{1}{2}$ ", 8 $\frac{3}{4}$ ".
- Three standard depths - 8.975", 11.975", 15.725".

● Prototype quantities shipped from stock. Production quantities in minimum time.

● Vertically slotted side walls and adjustable cross member end brackets allow universal height and depth adjustability for cards and module cases.

● Infinite adjacent positioning capability for modules, cards and connectors with extruded fastener holding ducts.

"EFP" ALUMINUM MODULE CASES" to fit Vector-Strut Cages

● Sixty (60) standard sizes for circuit cards, featuring $\frac{1}{16}$ " extruded grooves on .150" centers across case width for easy card mounting — no holes required in circuit board.

● Slide out side covers for quick access to cards.

● Front panels with captive thumb screws and rear panels either slotted or closed for user's connector design.

FOR HIGH FREQUENCY Vector Pak plug-in cases provide 90 to 100 DB of shielding with optional side panel gasketing.



EFP MODULE*

* Patented Features

Write the factory for specification data and prices.



Vector ELECTRONIC COMPANY, INC.
12460 Gladstone Ave., Sylmar, Calif. 91342

company has competed with private industry for some time on military contracts, and knows what the game is all about."

Melahn admits, however, that penetrating the commercial market will require a new approach. A first step has been to hire a 20-man sales force to conduct a direct-contact sales program.

"Military sales required a two-to-three year lead time to sell everyone concerned on the system; in the commercial area, customers are looking for quick solutions to problems, and generally won't pay development costs," says Melahn. "We obviously lack people and experience in the commercial market, and will be going outside to recruit personnel," he adds. However, changing the corporate image of SDC won't be a difficult problem, the president believes.

"My impression is that we are largely unknown in the commercial world, but we have a reputation among military customers for producing on schedule and within cost; it won't really be a disadvantage," says Melahn.

Growing up. "We expect to continue to grow in all areas, including our military and public systems divisions. However, on the military side, it appears that next year we may have to work hard just to stay even" Melahn admits. SDC wants to double its size over the next five years, but admits that the goal may be squeezed by a drying-up of money in the military sector. Cancellation of the Manned Orbiting Laboratory (MOL) and a tapering-off of air defense activities has shrunk SDC's military workload, but the company still has a \$20.1 million satellite control facilities contract with the Space and Missile Systems organization (Samso) and the Air Force Western Test Range.

The possibility of slackening military contracts is being offset by a continuing involvement in non-military systems. Charles Alders, SDC vice president, says public projects now total \$7 million per year, and may double over the next four years, depending on the national priorities assigned to public and military requirements, and the availability of funds.

Father and son. The most potent force SDC brings to its new push

for commercial markets is technology gained from developing highly complex time-shared programs for the military ancestry of TS/DMS. SDC officials say Adept-50, a time-sharing system designed with support from the Advanced Research Projects Agency (ARPA), Department of Defense "was developed parallel with the commercial version." The system is being evaluated by the National Military Command System Support Center for command and control use. A version of Adept-50 also is being built for command and control applications with a General Electric 635 computer by the Rome Air Development Center.

A direct father-son relationship also is traceable between TSS/Lucid, a time-sharing system built in 1962 for government use, and the newly introduced TS/DMS.

Missionaries. "We still have a very large missionary job to do; an understanding of generalized systems is evident in the larger corporations, but it becomes less as the corporation gets smaller," says Hamer.

Hamer expects a revolution in the way software is used and regarded. "We're paying a terrible price in computer programming; every time you want to make a change, it costs more in computer programming, and that's one thing that will push the world in the direction of generalized data management," he declares. Somehow you have to beat the rising curve in programming costs, and we think we have at least part of the answer in TS/DMS."

SDC officials agree that it would have been difficult to sell TS/DMS as recently as five years ago. Says Alders: "There were an awful lot of people disenchanted in the past over the gap between promises and utilization in practice. Only in the past two or three years has the large user really had good use from his computer. We believe TS/DMS provides a fundamental tool necessary for data management."

There are no present plans to enter the hardware business, but Alders affirms, "There might be some interest in going into graphics and communications in the future." Research in hand-written character recognition systems is now underway at SDC. ■

it's true!



StereoZoom® 7, just added to the matchless line of Bausch & Lomb Stereomicroscopes, now takes pictures. That's right, takes pictures.

There's an integrated camera system, which allows you to use a 35mm or 4" x 5" film; or 3 1/4" x 4 1/4" or 4" x 5" *Polaroid camera, and start shooting. You might call it the StereoZoom 7 Triocular Photomicrographic System, because that's what it is.

It's also a multiplex system, because visual and photographic functions in no way interfere with each other. You can look while you shoot. And you know how important that is.

This photographic potential plus the widest zoom range, clearest viewing, highest magnification, and a sufficient variety of models make StereoZoom 7 the one you surely should find out about.

Write today for Catalog 31-2185 and for our free demonstration offer. Bausch & Lomb, Scientific Instrument Division, 99721 Bausch Street, Rochester, New York 14602.

*Reg. Polaroid Corp.

BAUSCH & LOMB

SCIENTIFIC INSTRUMENT DIVISION

Circle 155 on reader service card

Visicorder--recording

When we designed our original Honeywell Model 906 Visicorder back in 1956, we didn't start with an idea of how it would work.

We started with the idea of what it should do: give you *immediate* readout of high-frequency analog data.

So instead of using a conventional recording technique (with chemicals, ink or vapor), our Model 906 was designed around a whole, new, unconventional technique . . . of recording on light-sensitive paper, which then developed on exposure

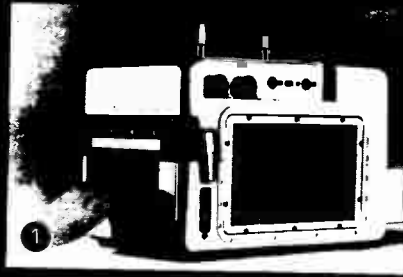

to an ambient light.

Since then, we have seen this "unconventional" technique become the most widely accepted system in

oscillography, an accomplishment that might have been enough to content most manufacturers.

But not Honeywell. We expanded this technique to fit virtually any application, by introducing Visicorder of greater capacity.

Then we introduced Visicorder with added convenience features and increased versatility, including a new fiber-optics recorder.

And then we introduced a complete range of accessories, such as our microfilm recorder accessory (that provides expanded resolution

1 Model 906: 6" compact, "handyman" Visicorder

2 Model 2206: 6" battery-powered, portable, Visicorder

3 Model 1508A: 8" Visicorder with takeup unit

4 Model 2106: 6" laboratory Visicorder

5 Model 1204: Visiprinter accessory

6 Model 2400: Microfilm recorder accessory

7 Model 1912: 12" high-performance Visicorder

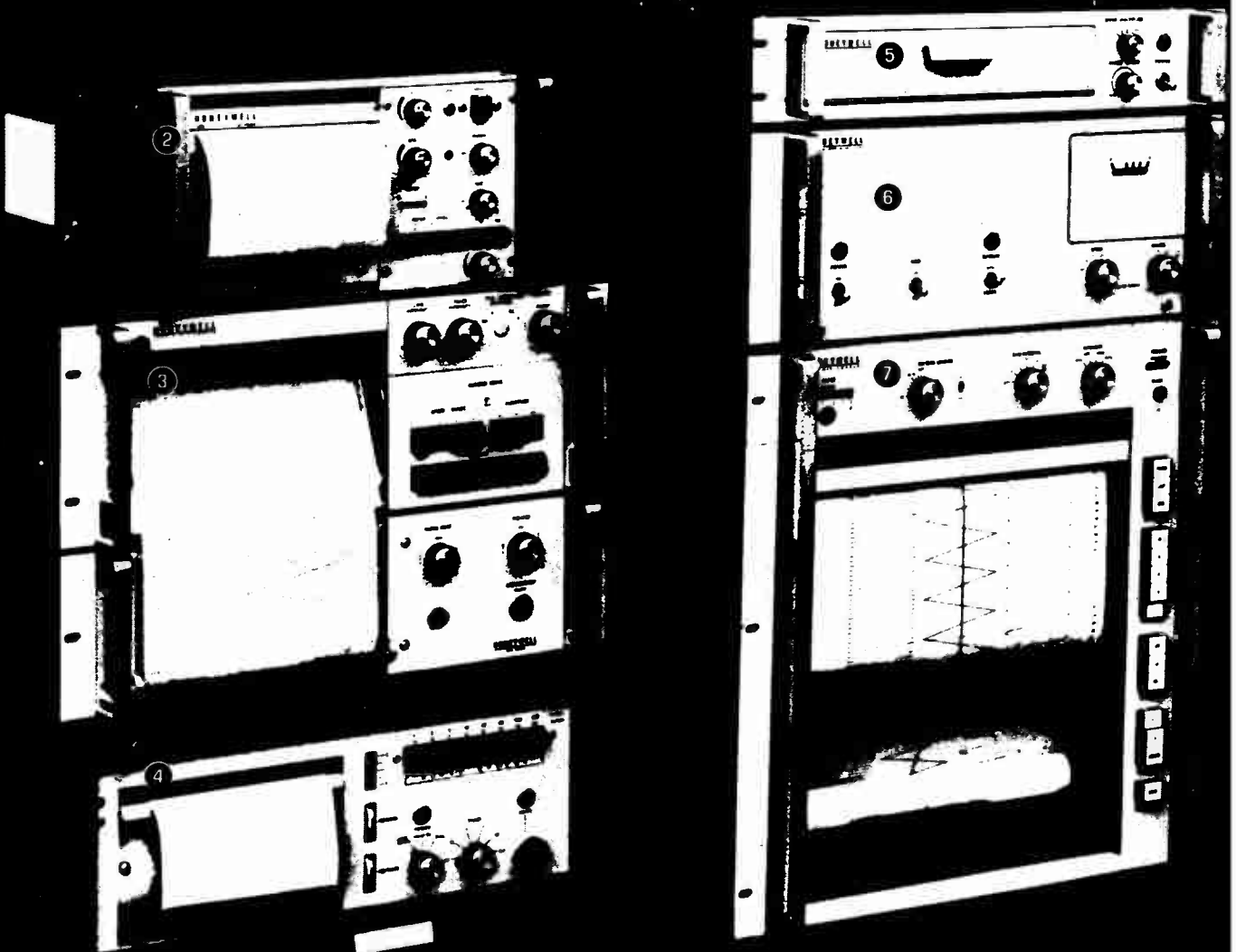

Regional Sales Offices:
Albuquerque, NM (505) 345-1656
Dave Dimick
Chicago, IL (312) 674-9770

solutions since 1956

duced record storage space, increased economy, and a permanent record); and our Visiprinter, a digital printer accessory that allows you to record digital data, along with the analog traces on any Visicorder.

And then, finally, we complemented this line with a variety of signal conditioning instruments, including amplifiers, attenuators, strain gage and thermocouple control units. Plus a wide selection of thermocouples and Statham transducers.

Until now, today, when we can

Statham Transducers
Model 1108: 8" general purpose Visicorder

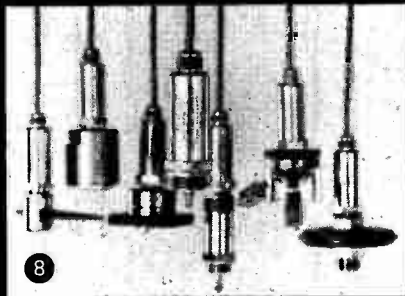

honestly say that we offer the world's finest and most complete line of direct recording light beam oscillo-

10 Model 1806: Fiber-optic recording oscillograph
11 Signal Conditioning

graphs, systems and accessories. Which means that a Honeywell engineer can provide the solution to any recording problem, no matter the size or complexity.

And that from small portables to 36-channel Visicorders, DC to 1 MHz, Honeywell can deliver, install and maintain any size system.

For more information, call your nearest regional sales manager listed below, or write: Honeywell Test Instruments Division, P.O. Box 5227, Denver, Colorado 80217 (303) 771-4700.

Honeywell

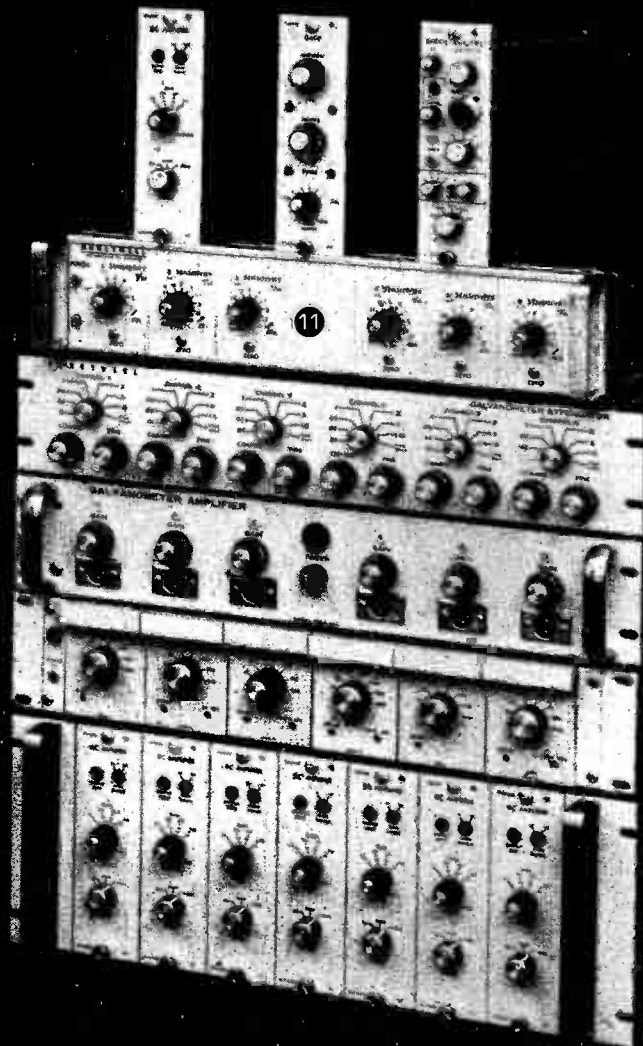
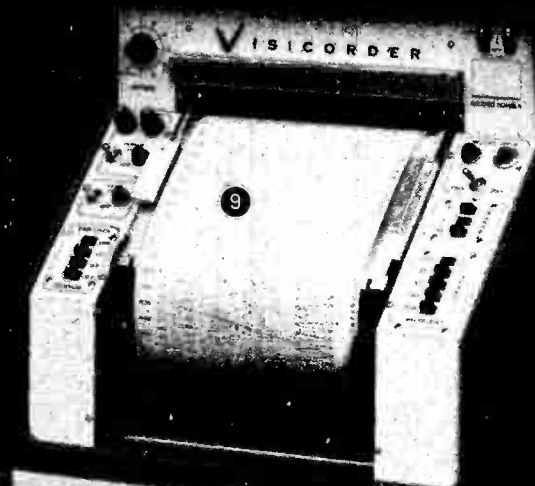

Long Island City, NY (212) 392-4300
John Paul
Los Angeles, CA (213) 724-3500
Marke Johnson
McLean, VA (703) 893-4660
Bill Schmick

Circle 157 on reader service card

PRE-ENGINEERED POWER!

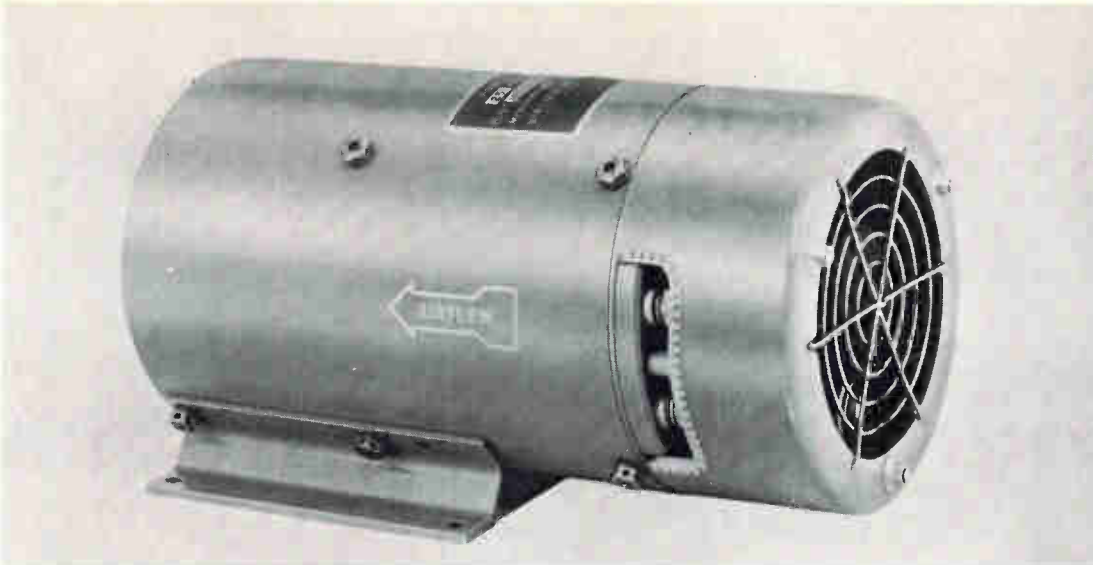

28G5P 47-65 Hz input (also style 28GP for 400 Hz), high-efficiency 28 V.D.C. output; lightest, most compact static unit

Here are two readily available ways to get dependable 28 V. D. C. high-current power

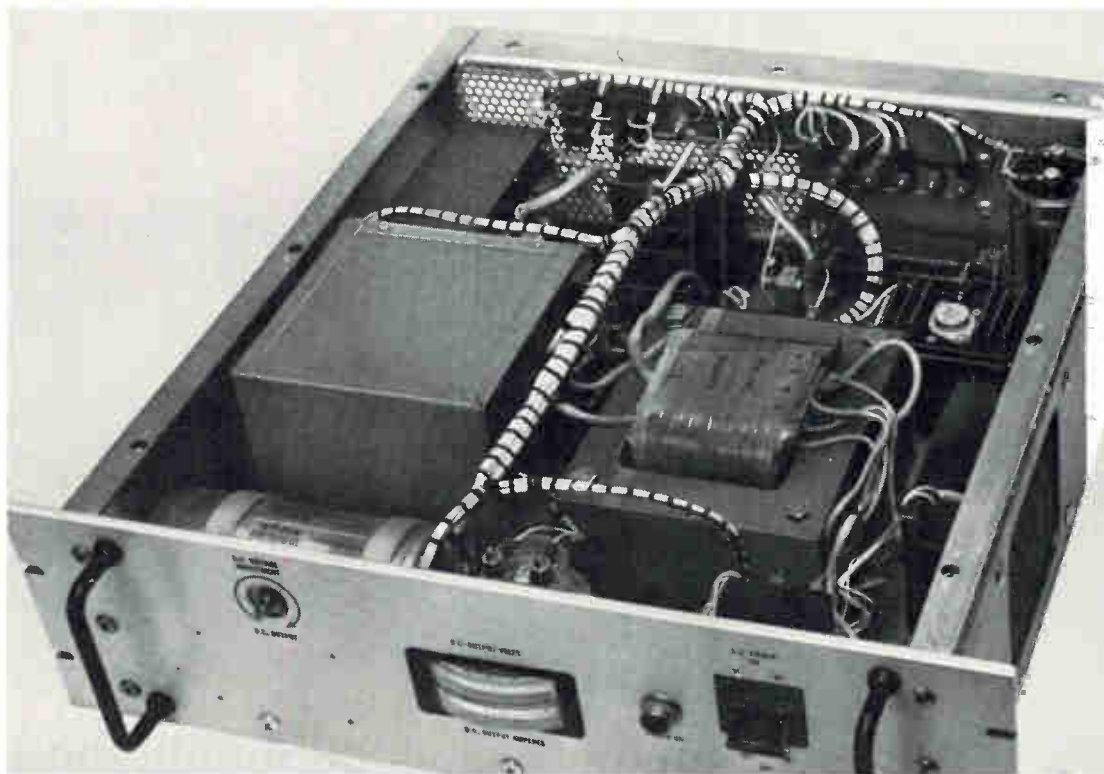

CR27.5 High-current, adjustable, 1% regulation, 28 V.D.C. output, 50-60 Hz unit. Withstands substantial overloads.

Tung-Sol pre-engineered standard power supplies meet lots of special requirements. You'll find they offer many cost/efficiency/size-weight/availability advantages. No more shoehorning in at the last minute with a make-do power unit. No more high-cost custom or do-it-yourself designs. In all likelihood, Tung-Sol's done it before ... and can meet the specific requirements of your circuitry.

Tung-Sol pre-engineered power supplies reflect unique production abilities and in-house capabilities in solid-state components, transformers and electromagnetics which contribute added performance-value to your equipment. Units meet EMI and MIL Specs.

Talk to one of our experienced factory engineers. He's backed by a versatile line of pre-engineered, readily available, standard power supplies. Tung-Sol Division, Wagner Electric Corporation, 630 West Mt. Pleasant Ave., Livingston, N.J. 07039. Telephone (201) 992-1100.

TUNG-SOL*

Helps you do more
...with less

*Registered trademark Wagner Electric Corporation

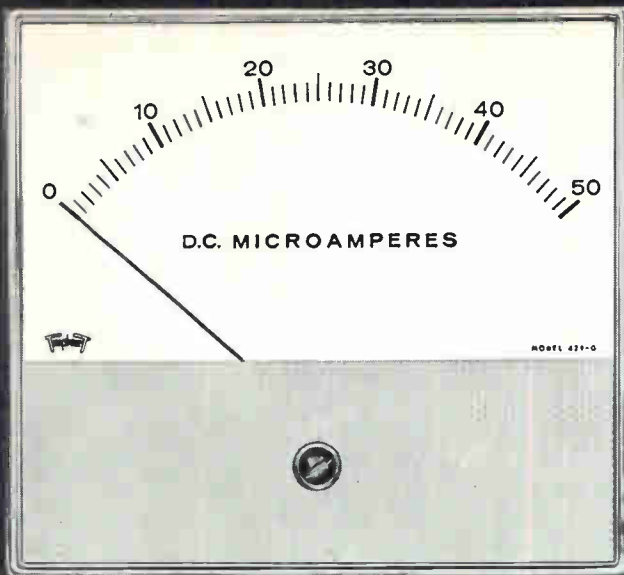

now you see it

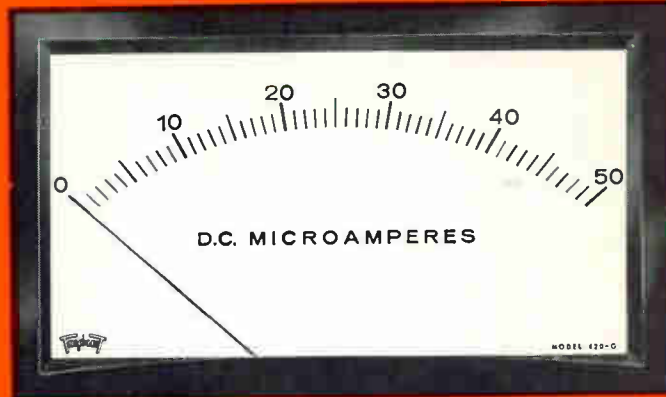

now you don't



THE PANEL INSTRUMENT WITH BUILT-IN FLEXIBILITY

TWO NEW SIZES!

5½" and 1½" (Miniature)

TRIPLET

New Triplett G-Series Panel Instruments offer a modern design that features a greater degree of flexibility and interchangeability.

1 Two types of mounting are available—conventional flush type or behind-the-panel with a bezel for modern picture window appearance. **2** The insert shield on the front of the meter can be custom painted or printed to meet customer's requirements.

3 Triplett's famous self-shielded Bar-Ring magnet, with one-piece die-cast frame, in all DC and DC suspension type instruments.

In five popular sizes: 5½" DC and AC; 4½" DC and AC; 3½" DC and AC; 2½" DC and AC; 1½" (conventional flush mounting only) DC and AC rectifier type.

NOW IN FIVE POPULAR SIZES:

1½" (Miniature); 2½"; 3½"; 4½"; & 5½".

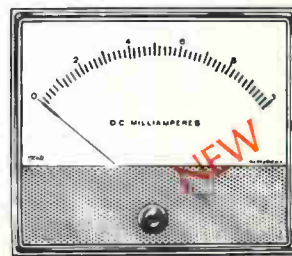
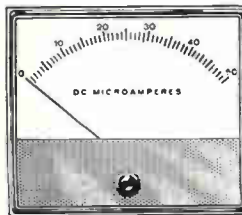
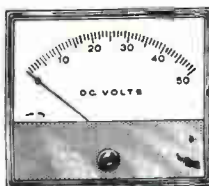

TRIPLET ELECTRICAL INSTRUMENT COMPANY, BLUFFTON, OHIO



Our new panel meter is a slim bargain. 2³/₄" deep. **\$149***

Presenting our new digital panel meter. A low-cost little package that's the perfect replacement for old-fashioned panel needle meters. This DVM measures with accuracy to 0.1% of reading ± 1 digit, 100 μ V resolution, 100 megohms impedance, auto-polarity, and numerals you can read from thirty feet away. You install it in seconds. It fits a 4" x 2³/₄" opening. And as a result of a new and unique design concept, the unit is only 2³/₄" deep. Calibrate it just

once. And save when you update every meter on every panel: *\$199 in single units. \$149 in lots of 100.* \$129 in lots of 1,000.*

This new DVM is ready to slip in now wherever panel meters are used. For detailed information and a complete set of specifications, write Tyco Instrument Division, Tyco Laboratories, Inc., Bear Hill Industrial Park, Waltham, Massachusetts 02154. Or call (617) 891-4700.

TYCO



**MSI/LSI
Circuit Seminar
For Equipment And
Systems Designers**

Presented by Electronics/Management Center. An Information Service of McGraw-Hill
New York — September 29-October 1, 1969, Statler Hilton Hotel
7th Avenue & 33rd St., New York, N.Y.
California — December 1-3, 1969, Airport Marina Hotel
8601 Lincoln Blvd., Los Angeles, Calif.

MSI/LSI Circuit Seminar

14.1 MOS Gate Capacitance

- dielectric constant and thickness
- gate dimensions and overlap capacitance

14.2 MOS Field Capacitance and Crossover Capacitance

14.3 Junction Depth, Capacitance and Resistivity

14.4 K values – t_{ox} , μ_n , ϵ_0 , W/L

14.5 Metallization Width, Spacing and Thickness

14.6 Area/Performance Optimization

- minimum length/width structures

14.7 Discussion of a Complete Set of Topological Design Rules

15. Yield Factors and Process Control

15.1 Processing Variables and Design Tolerances

- alignment uncertainties
- photoresist limitations
- working plate constraints

15.2 Threshold Control

- oxide thickness
- fixed charge (Deal's triangle) – crystal orientation and cooling ambient
- mobile charge – gettering, contamination sources

15.3 Test Devices and Patterns

- MOS capacitor (C-V evaluation)
- gate threshold device $V_{TH} = f(I_D)$
- field threshold device
- alignment marks, sizing marks and critical dimensions
- process development test vehicles

15.4 Gate Oxide Vulnerability – Protection Techniques

- MOSSAB and zener diodes

15.5 Wafer and Device Attrition

- in-process testing and rejection criteria
- probing, assembly, packaging and final testing

16. Facilities and Equipment Requirements for LSI

16.1 Requirements for a Prototype Facility

- personnel
- mask making equipment
- process equipment
- assembly, packaging and test equipment

16.2 Available Products and Services

17. Applications and Product Types Most Suited to LSI

17.1 The following examples will be discussed:

- desk calculator
- input/output peripheral equipment
- scratchpad memory
- read-only memory
- airborne computer – GP and DDA
- associate memory
- correlator applications
- multiplexers
- A/D and D/A converters
- industrial controls
- medical electronics

18. Currently Available MSI/LSI Products

18.1 Bipolar MSI

18.2 MOS MSI/LSI

19. Advanced Technology Trends

19.1 Contributors to Improved LSI Technology

- smaller geometries
- multilayer interconnect
- MOS-bipolar in same array – internal clock generation, high speed decoders
- array passivation
- multichip assembly

19.2 Contribution of Advanced Technology to Cost, Performance and Density

- memories
- delay lines
- general logic
- reliability

20. Technological Controversies

20.1 Semiconductor Developments

- complementary N and P MOS
- other MOS structures – SOS, TFT, self-aligning gate, MNS and MNOS and epitaxial
- isolation techniques – dielectric isolation, etch and back-fill

20.2 Custom vs. Standard Products

- memories
- logic
- production volume considerations

Fee

The registration fee for all sessions, a complete set of notes, and luncheons – \$385.

Registration

Register now for either the New York or Los Angeles program. Use the registration form below. Make checks payable to Electronics/Management Center. You must register in advance. We will be happy to bill you or your company, but only fully paid-up registrants will be permitted to attend the seminar.

Hotel reservations should be made directly with the hotel. A number of rooms is being held for seminar attendees. When you make your reservations, identify yourself as an attendee of the MSI/LSI seminar.

Samuel Weber, Mgr.
Electronics/Management Center
330 West 42nd Street, N.Y., N.Y. 10036

MSI/LSI Circuit Seminar for Equipment and Systems Designers

____ Please register me in your three day seminar at \$385

____ New York session ____ Los Angeles session.

____ Check enclosed

____ Bill me

____ Bill company PO# _____

Name _____ Title _____

Address _____

Company _____

City _____ State _____ Zip _____

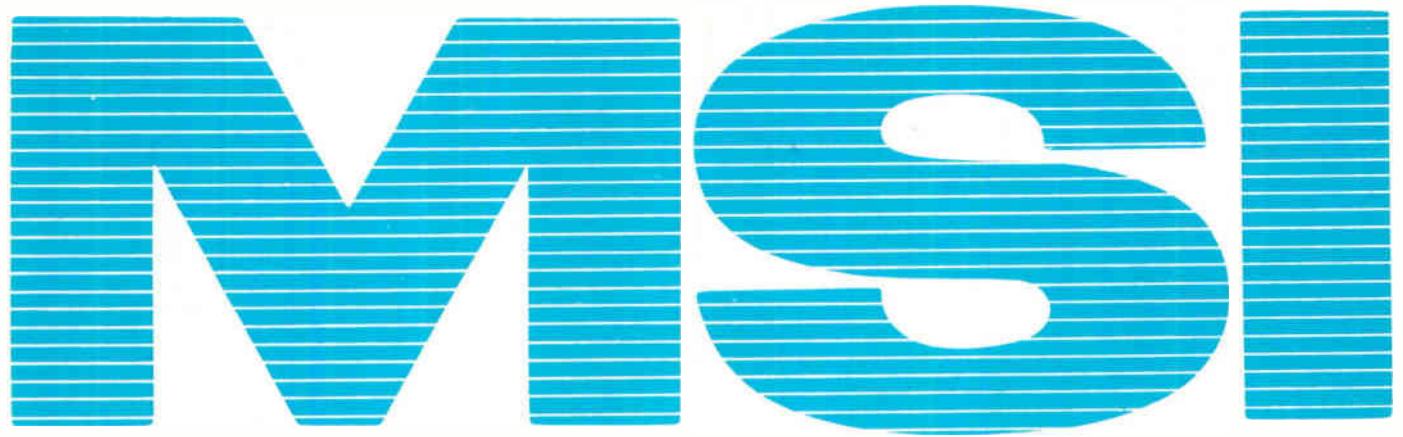

MSI



**MSI/LSI
Circuit Seminar
For Equipment And
Systems Designers**



MSI

Presented by Electronics/Management Center. An Information Service of McGraw-Hill
New York – September 29-October 1, 1969, Statler Hilton Hotel
7th Avenue & 33rd St., New York, N.Y.
California – December 1-3, 1969, Airport Marina Hotel
8601 Lincoln Blvd., Los Angeles, Calif.

Program

1. Evolution of Large Scale Integration (LSI)

1.1 Unique Properties of MOS

- self-isolation
- no voltage offset
- bilateral switching
- clocked load resistors
- temporary memory via gate storage
- design through mask topology
- second layer interconnect through diffused crossunders

1.2 Limitations of MOS

- lower speed than bipolar
- surface sensitivity – charge control, traps, radiation susceptibility
- gate oxide vulnerability
- low output current drive
- interface problems
- parasitic capacitive coupling

2. MOS Device Structure and Characterization

2.1 Basic Geometry of MOS Device

2.2 Device Design Parameters

- V_{GS} , K , body effect, BV_{OSS} , BV_{OX} , I_{OSS} , C_{GS} , C_{PN} , etc.
- parameter temperature sensitivity

2.3 Basic Device Model

- drain current in SAT and NONSAT regions
- R_{ON} and g_m
- body effect
- voltage dependent capacitive loading

3. Basic MOS Circuit Techniques

3.1 Circuit Solution Using the Basic Device Model

- DC solution with active load resistors
- clock power relationships
- transient solution – speed, power, speed-power product

4. Topological Design and Layout

4.1 Examples of Logic Gate Mask Layout

- 2ϕ ratio shift register layout
- logic gate layout
- design rule considerations and limitations

5. Advanced Circuit Techniques

5.1 Circuit Evolution

- early 4ϕ , modern 4ϕ , ratioless 2ϕ , precharged 2ϕ , capacitive pullup

- interrelationships between circuit forms
- circuit models and their solutions for each circuit form – charge, discharge, power dissipation, speed-power product, charge sharing and parasitics
- clock requirements – timing relationships, amplitudes, drive requirements

5.2 Suitability of Circuit Forms to Given Applications

- shift registers
- general logic
- memories

5.3 Use of Circuit Forms in Combination

6. LSI Artwork Generation

6.1 Design Approaches

- handcrafted layout
- standard array
- discretionary wiring
- building block (library of functions)

6.2 Comparison of Design Approaches

- development cost
- turnaround time
- error susceptibility
- chip size and yield
- performance tradeoffs

7. Logic Implementation with LSI

7.1 Advantages of Multiphase Logic

- master-slave avoidance
- ease of delay implementation
- area, power and speed advantages

7.2 Conversion of System Logic into Form Suitable for LSI Implementation

- availability of multiple AND-OR capability at a single logic node
- minimization of logic levels
- power and propagation delay minimization

7.3 Comparison of 2ϕ and 4ϕ Logic Systems (Ratio vs. Ratioless)

- timing problems and their solutions
- logic level limitations
- speed, power, area and speed-power product comparison

8. Design Examples

8.1 System Partitioning Techniques

- multiphase logic implementation

Purpose

This seminar is designed to give the systems designer the knowledge he needs to deal effectively with MSI and LSI circuits as basic subsystems.

Through lecture, panel discussion, and hands-on sessions, the systems designer will be exposed to all phases of the newest and most popular circuit techniques, their design, manufacture, and application.

He will achieve a broad, realistic, and authoritative approach to: realizing the systems parameters made possible by MSI/LSI; achieving maximum cost-performance ratio; maintaining a competitive edge; getting the most out of off-the-shelf units; improving communications with vendors; using multiple sources; developing in-house capabilities; establishing realistic schedules, and meeting production deadlines.

Faculty

Presentations, discussions, and work sessions are under the direction of the staff of Integrated Systems Technology, Inc. of Santa Clara, California. Each member of the staff has wide experience in the areas of circuit design, systems application and semiconductor research and development.

Donald E. Farina – President, Integrated Systems Technology, Inc. One of the contributors to the design of the first micrologic integrated circuit families. Served as head of the R&D department in digital circuits for Fairchild Semiconductor, responsible for both digital circuit and bipolar device structure development.

For the microelectronics division of Philco-Ford Corporation Mr. Farina served as Director of R&D and was responsible for device and research devoted to MOS large scale integration. He received his BSEE at New York University in 1953.

8.2 Artwork Generation

- composite plan – logic cell placement, minimization of interconnect length and crossunder
- chip area estimating
- computation of cell loading in order to determine device geometry
- array performance calculations

9. MOS/Bipolar Interface Techniques

9.1 Requirements for Interface Circuits

- voltage level translator bipolar ↔ MOS
- low impedance output driver MOS → MOS
- power supply compatibility
- low power dissipation on chip
- small area on chip
- minimum number of discrete components off chip

9.2 MOS Output Buffers on Chip

- scaled ratio type inverter
- push-pull driver
- push-pull with bootstrap driver
- dual load buffer
- series-sampled buffer
- diffused NPN emitter follower
- lateral PNP
- discrete load resistor

9.3 MOS Output Buffers off Chip

- NPN inverter – clamped and nonclamped
- NPN emitter follower
- PNP inverter
- complementary inverter

9.4 Input Buffer Techniques

- lateral PNP
- biased substrate
- lateral coupling device
- PNP inverter

10. Low Threshold Technology

10.1 Low Voltage Circuit Design

- speed, power, area and speed-power product of ratio circuits
- speed, power, area and speed-power product of ratioless circuits
- direct output compatibility with bipolar IC's
- direct input compatibility with bipolar IC's
- system and array power tradeoffs

11. Cost Considerations for LSI

11.1 Chip Size and Complexity vs. Cost per Function

11.2 Distribution of Fabrication Costs

- materials cost
- labor cost – process labor, sorting, dicing, packaging, testing, etc.

11.3 Array Development Costs

- handcrafted array
- standard matrix
- building block
- discretionary wiring

11.4 System Cost Factors

- system overhead – clock generation, interface circuitry, assembly cost, power supplies, etc.
- systems cost examples – discrete IC vs. LSI

12. Computer Aided Design

12.1 Logic Verification

12.2 Array Topological Design

- minimization of area, interconnect, crossunders and loading

12.3 Array Performance Prediction

- calculation of propagation delay, power dissipation, operating speed, etc.

12.4 Computer Artwork Generation

- library of standard functions
- computer controlled coordinatograph, photo exposure head, CRT

12.5 Test Sequence Generation

- test requirements
- algorithms
- test hardware

13. MOS Structures and Fabrication Techniques

13.1 Substrates and Preparation

13.2 Mask Sequences and Variations

- oxidation and diffusion
- field oxide and crossunders

13.3 Gate Structures

- surface preparation
- dielectric: homogeneous and composite
- metallization and delineation
- annealing and alloy

14. Process Constants and Minimum Design Rules

Ronald Pasqualini – Vice President, Engineering. Widely experienced in R&D on MOS memory systems for Philco-Ford Corporation. Performed initial logic design, circuit analysis, and composite layout of a monolithic read-only memory. Was responsible for the interface between R&D processing and R&D design.

Systems design experience in integrated circuits includes shared responsibility on an Air Force large scale array navigation computer, and Ranger spacecraft. Also designed a monolithic 2-MHz binary/BCD converter employing 4-phase circuit techniques.

Mr. Pasqualini holds a BS in Aeronautics from M.I.T., 1962, and an MSEE from U.S.C., 1966.

Richard Craig – Vice President, Technologies. Mr. Craig has devoted the major portion of his career to the semiconductor. With three major semiconductor manufacturers his experience includes such early developments as planar and epitaxial processes and structures. More recent experience includes responsibility for the development of advanced MOS LSI techniques, including multilayer and minimum size structures, oxide and interface charge control, and MOS circuit innovation and evaluation.

Mr. Craig received his BA in Physics from Fresno State College in 1958.

Richard Aladine Carberry – Senior Design Engineer. Presently involved in the logic and circuit design of complex MOS devices, and the design of digital equipment utilizing bipolar and MOS IC's. As a project engineer for Philco-Ford Corporation he was involved in the design of MOS memory and arithmetic chips for a guidance computer, as well as a sequencer and other control circuitry utilizing bipolar IC's.

For Lockheed Missiles and Space Company he designed analog circuits for a guidance system, switches, modulators and demodulators, active and passive filters, and various operational amplifier circuits.

Mr. Carberry holds BSEE and MSEE degrees from the University of California at Berkeley.

MSI/LSI Circuit Seminar

14.1 MOS Gate Capacitance

- dielectric constant and thickness
- gate dimensions and overlap capacitance

14.2 MOS Field Capacitance and Crossover Capacitance

14.3 Junction Depth, Capacitance and Resistivity

14.4 K values — t_{ox} , μ_n , ϵ_0 , W/L

14.5 Metallization Width, Spacing and Thickness

14.6 Area/Performance Optimization

- minimum length/width structures

14.7 Discussion of a Complete Set of Topological Design Rules

15. Yield Factors and Process Control

15.1 Processing Variables and Design Tolerances

- alignment uncertainties
- photoresist limitations
- working plate constraints

15.2 Threshold Control

- oxide thickness
- fixed charge (Deal's triangle) — crystal orientation and cooling ambient
- mobile charge — gettering, contamination sources

15.3 Test Devices and Patterns

- MOS capacitor (C-V evaluation)
- gate threshold device $V_{TH} = f(l_d)$
- field threshold device
- alignment marks, sizing marks and critical dimensions
- process development test vehicles

15.4 Gate Oxide Vulnerability — Protection Techniques

- MOSSAB and zener diodes

15.5 Wafer and Device Attrition

- in-process testing and rejection criteria
- probing, assembly, packaging and final testing

16. Facilities and Equipment Requirements for LSI

16.1 Requirements for a Prototype Facility

- personnel
- mask making equipment
- process equipment
- assembly, packaging and test equipment

16.2 Available Products and Services

17. Applications and Product Types Most Suited to LSI

17.1 The following examples will be discussed:

- desk calculator
- input/output peripheral equipment
- scratchpad memory
- read-only memory
- airborne computer — GP and DDA
- associate memory
- correlator applications
- multiplexers
- A/D and D/A converters
- industrial controls
- medical electronics

18. Currently Available MSI/LSI Products

18.1 Bipolar MSI

18.2 MOS MSI/LSI

19. Advanced Technology Trends

19.1 Contributors to Improved LSI Technology

- smaller geometries
- multilayer interconnect
- MOS-bipolar in same array — internal clock generation, high speed decoders
- array passivation
- multichip assembly

19.2 Contribution of Advanced Technology to Cost, Performance and Density

- memories
- delay lines
- general logic
- reliability

20. Technological Controversies

20.1 Semiconductor Developments

- complementary N and P MOS
- other MOS structures — SOS, TFT, self-aligning gate, MNS and MNOS and epitaxial
- isolation techniques — dielectric isolation, etch and back-fill

20.2 Custom vs. Standard Products

- memories
- logic
- production volume considerations

Fee

The registration fee for all sessions, a complete set of notes, and luncheons — \$385.

Registration

Register now for either the New York or Los Angeles program. Use the registration form below. Make checks payable to Electronics/Management Center. You must register in advance. We will be happy to bill you or your company, but only fully paid-up registrants will be permitted to attend the seminar.

Hotel reservations should be made directly with the hotel. A number of rooms is being held for seminar attendees. When you make your reservations, identify yourself as an attendee of the MSI/LSI seminar.

Samuel Weber, Mgr.
Electronics/Management Center
330 West 42nd Street, N.Y., N.Y. 10036

MSI/LSI Circuit Seminar for Equipment and Systems Designers

____ Please register me in your three day seminar at \$385

____ New York session ____ Los Angeles session.

____ Check enclosed

____ Bill me

____ Bill company PO# _____

Name _____ Title _____

Address _____

Company _____

City _____ State _____ Zip _____

Introducing the 7½ minute prototype.

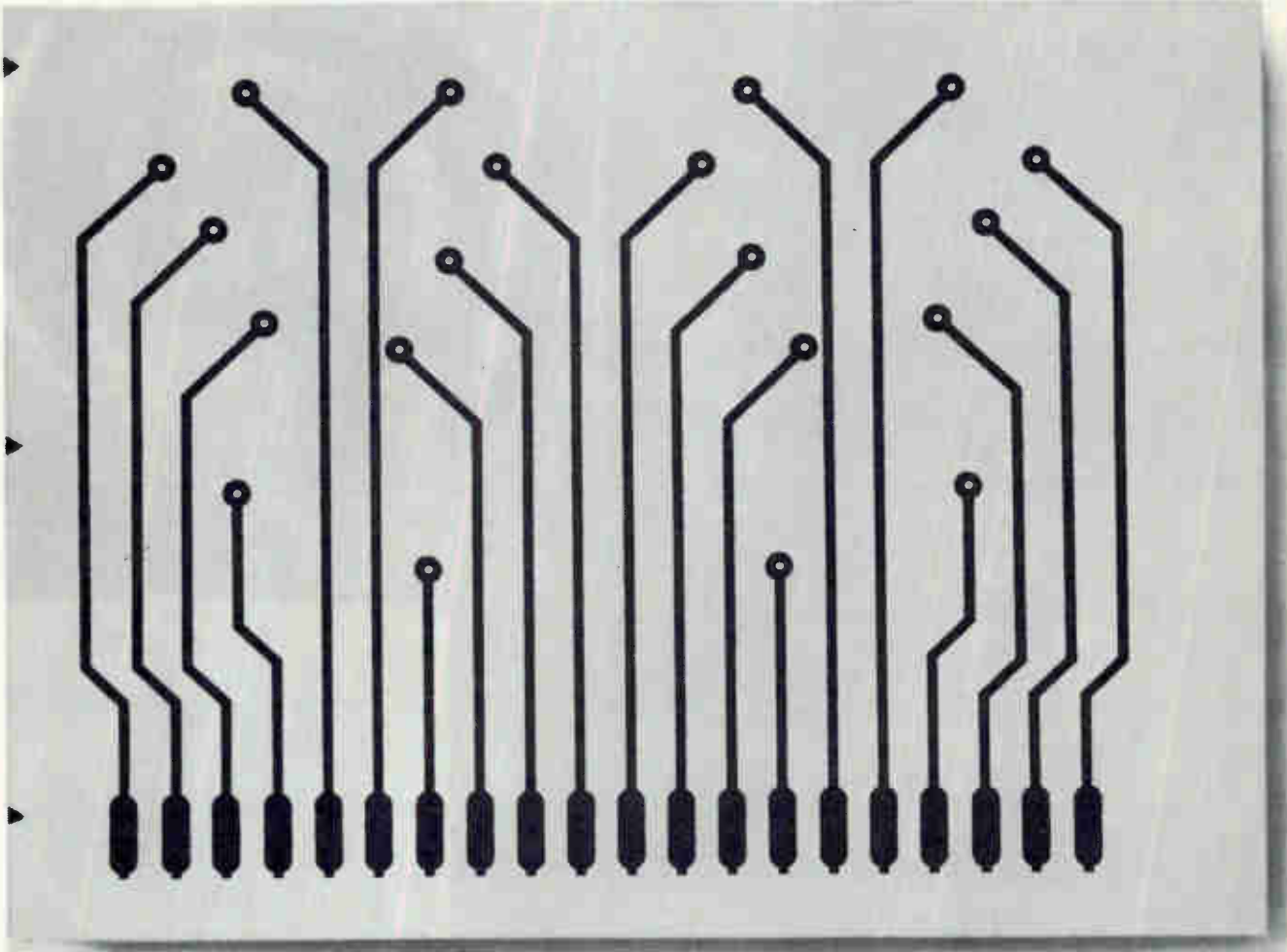

Getting prototype circuit boards used to be the biggest nuisance in design projects.

It took a lot of man-hours, expense, and a lot of space for bulky, awkward equipment.

No more. With Xerox Standard Equipment, chemical resist images can be transferred to copper-clad laminates and prepared for conventional etching—in 7½ minutes flat.

For just pennies per prototype.

And there are no wet, messy chemicals (the xerographic process is

completely dry).

No air-controlled darkroom (the Xerox equipment can be set up in a small corner almost anywhere).

No need for highly-trained technicians (most people can learn to handle it in just 60 minutes).

Of course, the 7½ minute prototype is only one of the ways you can use Xerox Standard Equipment.

If you have another 7½ minutes, we'll explain some of the others. Write Dept. BC14, Xerox Corporation, Rochester, New York 14603.

XEROX

IT HAS COME AT LAST

Part TWELVE of a Series on the State of the Chopper Art

The Integrated Circuit Metal Oxide Semiconductor Field Effect Transistor Solid State Chopper With Copper Leads

(Popularly known as ICMOSFETSSCWCL or izzmossfettssisswikell)

Izzmossfettssisswikell is otherwise known as our part number IC-1, available with reasonable price and speed from our Cambridge Division. It has offset contribution under trying conditions of around a microvolt, a conducting resistance of about 300 ohms, and an off resistance of some 1,000,000,000 ohms. (10^9 is easier to say, but we like to write all those zeros.) The zeners across the gates keep your highly charged assembly girl from blowing up our reasonably priced choppers while installing same. You need a drive of about 6.3 volts rms AC, which can be sine wave if you're not too fussy about noise and offset. Fussy types can use clipping zeners to square things. Now we know all this took quite a while, and we're sorry about that. But you'll be glad you waited. Ask for our bulletin on IC-1.

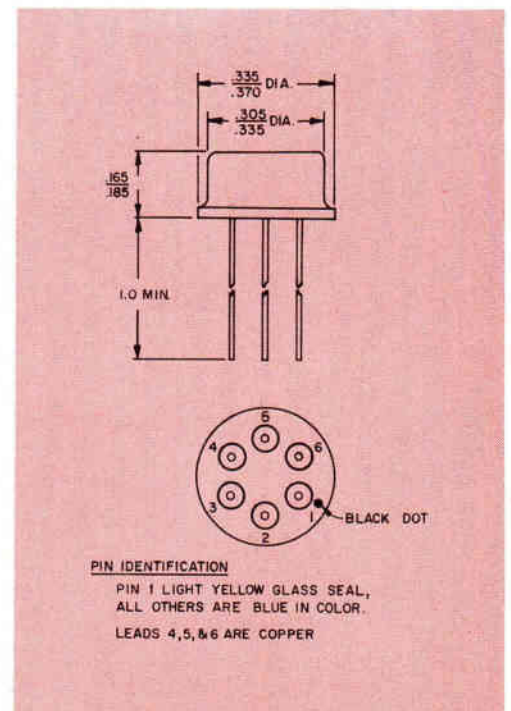
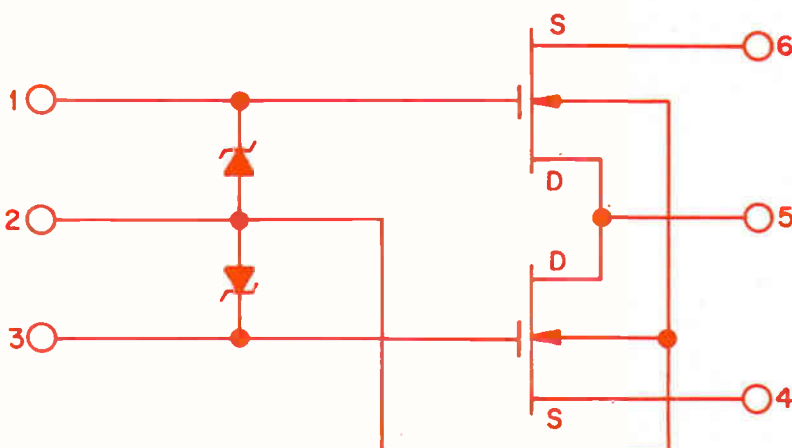
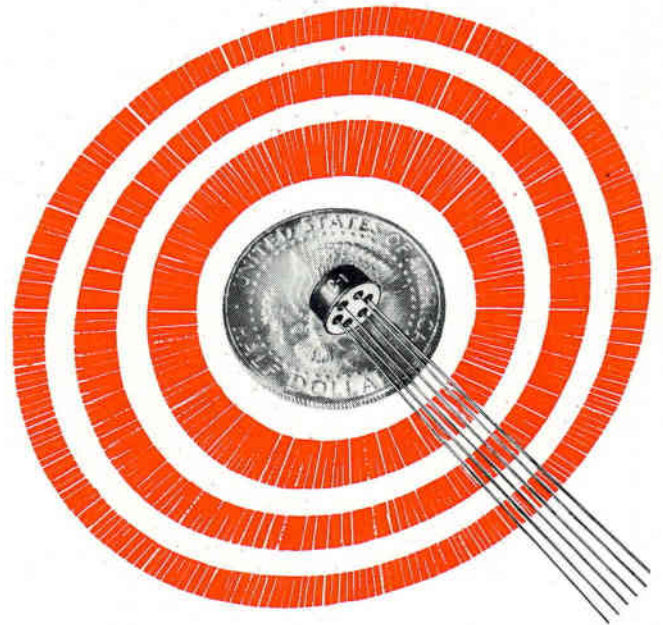

AIRPAX ELECTRONICS

166 Circle 166 on reader service card

CAMBRIDGE
DIVISION
CAMBRIDGE, MARYLAND 21613

Electronics | September 15, 1969

Dopant profile plotted in seconds

Wafer analyzer calculates impurity density as a function of depth by measuring a pair of radio-frequency voltages; price is \$10,000

Speed has characterized the era of semiconductors. Every new diode, transistor or integrated circuit, it seems, is a little faster than its predecessor. Ironically, the makers of these devices, the very people who have made a millisecond seem as if it were a millennium, have had to think in terms of weeks when making one of their most important measurements—plotting a wafer's dopant density as a function of wafer depth.

But the weeks-of-waiting days may be over. Research & Development Products Co. is offering an instrument called the Copeland Wafer Analyzer that plots these impurity profiles in seconds. More-

over, at \$10,000 the analyzer's price is at most one fifth the price of older profile-plotting equipment. And the analyzer has still another feature: it puts out continuous profiles; the plots from the older systems are connect-the-dots affairs.

Impurity profiles are a key to high device yield. Starting out with a wafer of pure semiconducting material, a device maker allows some dopant, or impurity, to diffuse into it. He tries desperately to control the dopant density in the wafer. But because diffusing is more of an art than a science, he doesn't know how well he has succeeded unless he measures the density-depth profile.

The doped wafers are then diced and used in making devices. By knowing beforehand from the profile whether a wafer is properly doped, the device maker spares himself the doomed attempt to make good devices out of bad semiconductor wafers.

Till now, plotting a profile has involved making a series of capacitance measurements, feeding these measurements to a computer which calculates dopant density at discrete depths, and finally plotting the profile. The usual turnaround time for the whole operation is four weeks, and the price of the measuring system ranges upward from \$50,000, not including computer



Plotter. The Copeland Wafer Analyzer generates impurity profiles for silicon, germanium, gallium-arsenide, and gallium-phosphide wafers. The machine uses voltage measurements to continuously calculate density and depth of impurities, and it then plots these parameters on an x-y recorder. The profiles are a key to a high yield in device manufacture.

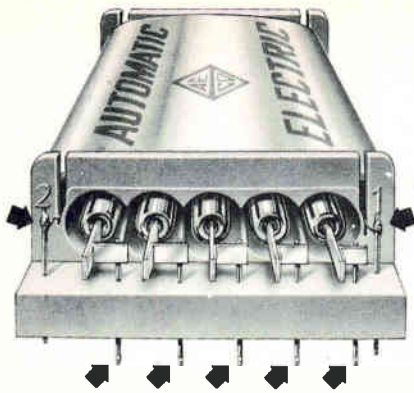

Groov-Pin[®] Terminals Are Simpler... More Reliable... Lower in Cost

Groov-Pins rather than stamped or formed press-fit terminals are used in a new line of Correeds* developed by Automatic Electric Co., Northlake, Ill., a subsidiary of General Telephone & Electronics.

Here's why they are producing important savings for AE:

- Stamped or formed terminals require end-for-end and side-for-side orientation for assembly. Groov-Pins can be inserted from either end.
- Stamped or formed terminals need soldering projections for each connection. Groov-Pins can be soldered or welded anywhere.
- Groov-Pins also permit a simpler plastic mold for nylon relay coil forms. Hard-to-remove core pins and locking slots are eliminated.

If you design or make relays, connectors, or other hardware, find out how Groov-Pins can simplify your product and dramatically cut costs. Write to Groov-Pin Corporation, 1121 Hendricks Causeway, Ridgefield, N. J. 07657. Telephone (201) WH 5-6780.

Automatic Electric uses Groov-Pin terminals in its new Correeds. They are now available to AE's telephone company customers. Correeds have as many as 14 terminals, so a cost cut here means savings for the company. Groov-Pins lock in the Correeds' coil form by a cold flow of nylon into three swaged grooves. Notches at both ends make it easy to wrap and solder leads from the Correeds.

*Automatic Electric's name for Dry Reed Switch Modules

GROOV-PIN CORP.
FASTENER DIVISION

and related costs.

The Copeland analyzer, on the other hand, measures voltages; it uses the measurements from them to continuously calculate density and depth, and then plot these parameters.

Seeing dots. The first step in using the analyzer is to deposit a metal dot, a few mils in diameter, on a wafer. Placed on the dot is a probe that both sends a 0.1-milliamp 5-megahertz current through the wafer and applies a continuously increasing d-c voltage.

By forcing free electrons and holes out of the region under the dot, the d-c voltage produces a depletion region whose depth increases as the voltage increases. There's no net charge inside the wafer; therefore the depletion region is charged because the forced-out mobile charges leave behind them the fixed charge of the exposed impurity atoms.

Also coming into the depletion region is the charge carried by the 5-Mhz current. During a single cycle, the region continuously changes its depth, trying to expose enough fixed charge to balance the charge coming in through the dot. This oscillation of the region's border generates a 10-Mhz signal. The lower the dopant density at a given depth, the more the border moves during a single cycle, and the higher the amplitude of the 10-Mhz signal. In other words, the voltage of the 10-Mhz signal is inversely proportional to the dopant density.

The metal dot acts as if it were the plate of a capacitor, and the depletion region as if it were the dielectric. The capacitance across the region decreases as the depth increases; the 5-Mhz voltage in turn increases when the capacitance decreases. Thus the 5-Mhz voltage is directly proportional to the depth of the depletion region.

The analyzer has a pair of radio-frequency voltmeters, one of which measures the 5-Mhz signal and the other the 10-Mhz signal. When these voltages drive the analyzer's x-y recorder, it plots the wafer's profile under the dot.

Inventor. John Copeland, supervisor of the bulk effect studies group at Bell Telephone Laboratories and the inventor of the analyzer, says that the accuracy of the Research & Development in-

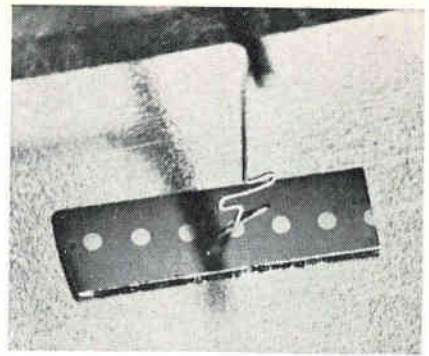

On the dot. Impurity profile is measured by probe that contacts metal dot on semiconductor wafer.

strument is on the order of a few percent. Accuracy goes down as the depletion region gets deeper, he points out. For example, if the capacitance is 2 picofarads at a depth of 5 microns, the analyzer would measure the density to within 1%; at 10 microns, the accuracy would be down to 4%.

Besides competing with older systems, Copeland's analyzer will be matched against a profile plotter introduced this year by J.A.C. Electronics Ltd [*Electronics*, March 31, p. 179], which sells for \$1,700 exclusive of x-y recorder and sample holder. Copeland's instrument is a constant-current unit, and J.A.C.'s is a constant-voltage device. When the depth is small, Copeland points out, a constant-voltage analyzer sends a large amount of current through the wafer. "What you're measuring then is an average density and not the actual density at a certain depth," he says.

Spencer Ettman, president of Research & Development, expects to find plenty of customers among makers of semiconductor devices.

And Ettman isn't worried about the possibility that big semiconductor houses will build these analyzers themselves. "There are a lot of people who would like to try," he says, "but there's so much involved in solving the development problems—not to mention component costs—that unless you're going to build a hundred of these things, it doesn't pay to research them out. A lot of companies have tried to build them and failed.

For those who don't want to try, it takes Research & Development 12 weeks to deliver an analyzer.

Research & Development Products Co., 170 Tenth St., Piscataway, N.J. [338]

This IC tester is simple-minded.

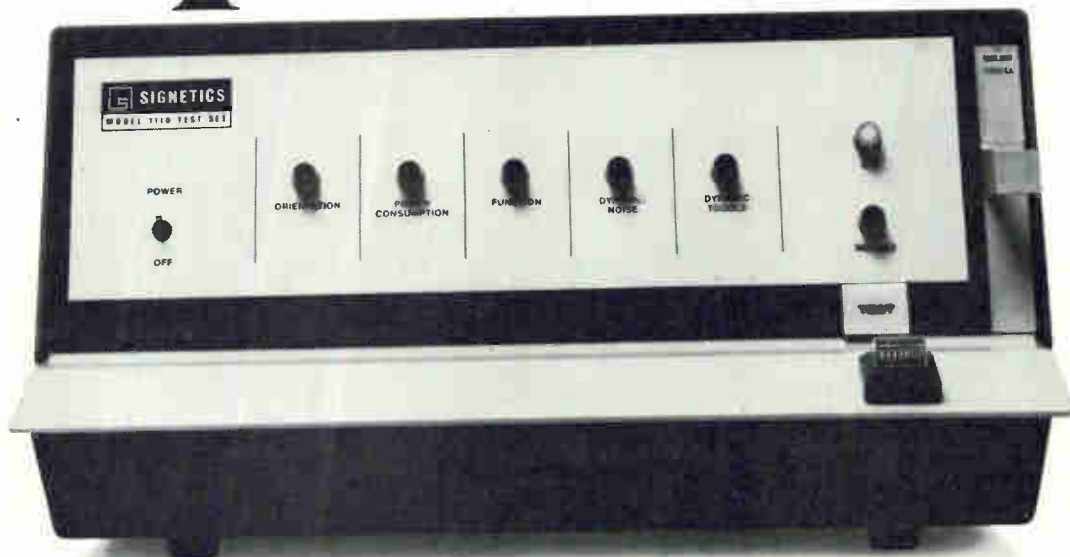

You like things uncomplicated. Streamlined. Functional.

So that's the way we built our Model 1110 Digital IC Tester.

No gauges to twiddle, no knobs to fiddle. In fact, it's so easy even your secretary can handle it.

It takes five steps:

1. Select and insert a single program board.
2. Insert IC in test socket.
3. Push test button—blink, blink, blink.
4. Go—the IC is good.
5. No go—it fails the test.*

And our model has a high accuracy rating of 1% on DC parameter tests which only seems right for a company that has years of experience in the integrated circuit field.

Simple enough? You'll find the price is too. It starts at \$4,500.

Now all you have to do is write us for a sales brochure and data sheets. Or, call Marketing, Signetics, Measurement Data (415) 961-9399 or 961-9384 for a demonstration.

It's that simple.

*Specific tests indicated... 1) orientation test, 2) power consumption test, 3) function test, 4) dynamic noise test, 5) dynamic toggle test.

Signetics

MEASUREMENT/DATA

Signetics, Measurement/Data, 341 Moffett Blvd., Mountain View, Calif. 94040 / A subsidiary of Corning Glass Works

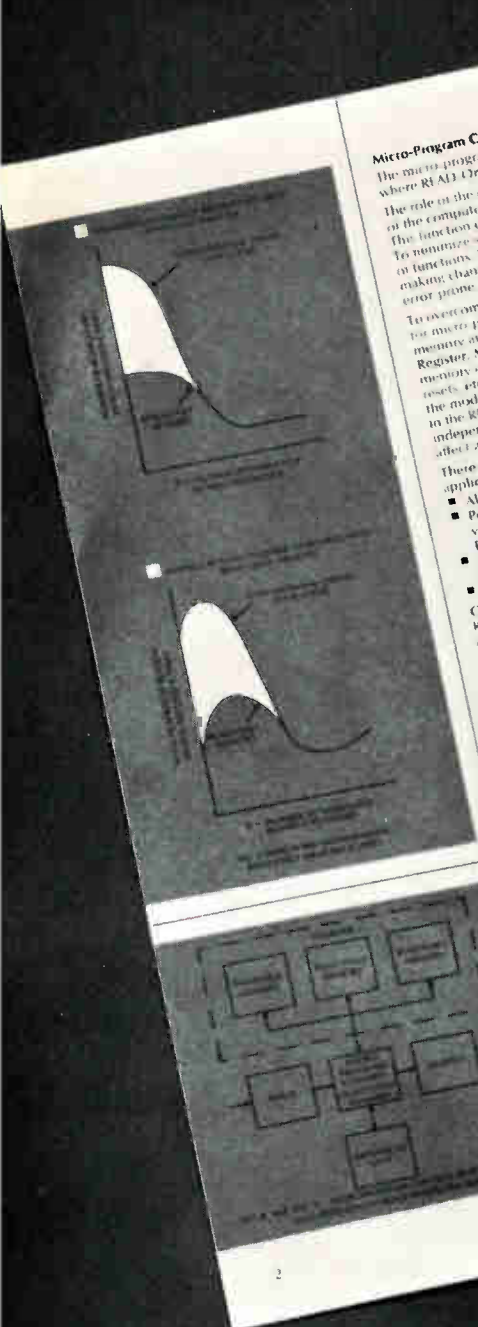

Micro-Program Control

The micro-program control application is one of several areas within a computer where READ-Only memory is used. Another area is program storage. The role of the micro-program control unit is to coordinate the internal elements of the computer so that events occur in a logical sequence and at the proper time. The function can also be accomplished with the use of conventional diode gates. To minimize system costs, each gate is designed to perform a maximum number of functions. However, since each gate is used in a multitude of functions, making changes or additions to the control logic is tedious, long, and highly error prone.

To overcome these shortcomings, READ-Only memories have been employed for micro-program control. In this application, the inputs to the READ-Only memory are the states of key elements within the computer (e.g., Instruction Register, Micro-program Counter, Overflow Flip-flop, etc.). The READ-Only memory outputs go to controlling elements such as shift controls, counters, resets, etc. Whenever a change in machine structure or an instruction is required, the modification is quickly implemented by modifying the appropriate words in the READ-Only memory. Since each micro-instruction or memory word is independent of every other micro-instruction, changing one instruction does not affect any other instruction.

There are additional advantages to using READ-Only memories in micro-program applications which are:

- Allow rapid changes in machine structure.
- Permit the offering of a family of compatible computer systems with the variable between computers being the micro-program in the READ-Only memory.
- Provide a method for directly increasing system speed by increasing READ-Only memory speed.
- Significantly reduce system costs.

One study¹ comparing READ-Only memories with conventional logic found that READ-Only memories cut the number of circuit boards in a system by 36% and the number of circuit board types by 75%. Thus, it helps to cut hardware costs by 36% overall reduction. READ-Only memories can cut hardware costs by 36%.

Program Storage

This is the second area within computers where READ-Only memories are used. Many programs, once written and debugged, are never significantly changed. For these programs, the high reliability (MIBF of 10,000 hours), low cost (\$2 to 10¢ per bit), fast speed (100-500 nanoseconds access time), and non-destructive read-out of READ-Only memory systems make them an ideal storage medium.

The READ-Only memory is used as a modular element of the computer storage, as shown (lower) left. The program is initially written and debugged using the erasable core memory. After debugging, the program is placed in the READ-Only memory for permanent storage.

- Some of the types of programs that have been stored in READ-Only memories include:
- assemblers
 - bootstrap routines
 - stored tables
 - utility programs
 - machine tool programs
 - compilers
 - debug routines
 - emulators

¹K. Ward & J. Hutton, "The Manufacturing Costs in System Design," EIT Computer Group News, March 1966, p. 5.

Character Generation

Many computer peripheral equipments, such as alphanumeric display, trap in displays and printers, need to generate characters. In virtually all of these equipments, a READ-Only memory is used in the character generator to store the information of each individual letter, character or special control.

The character can be generated in one of three possible ways: Raster, Stroke or Vector. The raster character (Fig. 6) is generated by a set of dots selected from a pre-determined grid. The stroke character (Fig. 7) is generated by a set of strokes of pre-determined length, direction and relative position of each stroke. The vector character (Fig. 8) is generated by a set of vectors, each vector being a set of pre-determined directions and a minimum of 4 possible lengths.

The major advantage of the raster and stroke methods is that only information data is required for each character. This reduces the required memory capacity and, therefore, lowers the ultimate display terminal cost. However, characters formed in this way tend to show pattern resemblances. It has been found that where displays are to be viewed for one-hour per day or longer, the smaller raster method (5 dots) tends to cause eye strain and contribute to operator fatigue. However, this shortcoming can be overcome by using larger matrices, typically 7x5 or 9x5, or by using a more comprehensive stroke matrix.

Vector generator characters can range from a few vectors per character to more than 1000 vectors per character. This form of character generator requires a large memory capacity than raster or stroke generators. However, it provides more flexibility in the formation of characters, and therefore provides eye-pleasing characters.

A unique characteristic of broad transformer memories that makes them particularly appropriate for character generators is the ability to modify memory contents (see page 19). Since the memory contents may be changed, individual character shapes or entire character repertoires may be changed during prototype design. During production, this alterability allows display system manufacturer to offer special character repertoires and symbols, customized for each application or customer. The display system manufacturer can literally offer a different character repertoire for each application (customer, or console).

Application Summary

Application Summary	READ-Only Memory Application
End Product Computers	bootstrap programs
	program storage
	micro-program control
	code converters
	stored tables
	emulators
	high-speed multiplication
	proprietary software protection
	character generation
	keyboard to code converter
	vector character generators
Displays	
Printers	micro-program control
Rotating Mass Memory Storage Systems	
Special Purpose Digital Systems	punched paper tape read
	trigonometric tables
	code converters
	keyboard to code converter
	analog waveform generator
	systems status tables
	storage of operating
Communications Systems	
Typesetting Systems	
Arabic Systems	
Status Monitoring Systems	
Machine Tool Controllers	
	*Acquisition once available upon request

READ-Only memories can cut hardware costs by 36%

The above statement comes from the Engineering Guide to READ-only Memory Systems; a basic, working text written to get you into the technology with a minimum of fuss and bother. So you'll know when to use READ-only memory. And how.

It has everything an engineer needs. From the theories behind the technology to block diagrams of specific applications like program storage, microprogram control, character generation. With lots of nice little touches in between. Sequence photos showing how you can modify the memory contents. And a huge, fold-out work sheet with all the facts you need when designing a system. Timing diagrams, interface specifications, mechanical dimensions. The works.

Spend a quiet afternoon with the Engineering Guide to READ-only Memory Systems. It's free.

Write Paul Rosenbaum, Memory Technology Inc., 83 Boston Post Road, Sudbury, Mass. 01776, (617) 443-9911.

Memory Technology
Incorporated

High-voltage source has split personality

Capable of putting out either 2-kv pulses or a d-c signal, generator can be a test instrument or a power supply

An unused switch position led a pulse generator into a double life. As is the case with many products, Instrument Research Co.'s PM-2 started out as a jury-rigged affair, built for in-house use. "We needed a high-voltage pulser to test switching tubes," says Instrument Research's president, Edward Withey. "Every time we had to run a new test, we tacked on a few

more capabilities. Finally, we decided that we had a pretty good product, so we packaged it to sell as a pulse generator. But on our selector switch we had one unused position, so we went back to the drawing board to figure out something else we could add. The generator has a good power supply anyway, so we connected the switch to that. Now the PM-2 is

both a versatile pulse generator and a real good power supply. And it sells for \$1,175, the price you usually pay for the pulser alone."

As a power supply, the PM-2 delivers up to 100 watts, and has output ranges up to 2 kilovolts and up to 50 milliamps. The rms ripple of its output at full load is 0.4%.

As a pulse generator, it delivers up to 45 watts continuously and



Digital flux-gate magnetometer model DM-2000 is for laboratory and industrial use. It displays ambient field values directly in milligauss on four non-blinking decimal readouts. A two-position switch selects ranges of either 200 milligauss, with ± 0.1 milligauss resolution; or 2,000 milligauss, with ± 1.0 milligauss resolution. Schonstedt Instrument Co., Reston, Va. 22070 [361]

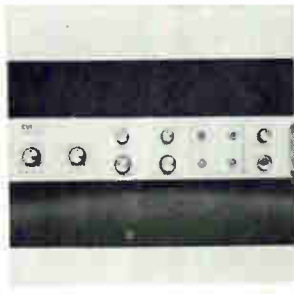

Video analyzer model 321 provides a means of utilizing the tv camera as a scientific instrument. Similar in principle to the sampling oscilloscope, it provides an interface between the camera and computer, as well as providing for low cost chart recording of video waveforms. Accuracy is better than 3%. Price is \$2,500. Colorado Video Inc., Box 928, Boulder, Colo. 80302 [362]



Transistor-diode curve tracer model 443 makes possible direct readout of semiconductor characteristics on a general-purpose oscilloscope. It features all silicon solid state p-c board construction and dual transformers for isolation and safety. It is available in kit form at \$69.95 and factory-wired at \$99.95. Eico Electronic Instrument Co., 283 Malta St., Brooklyn, N.Y. [363]

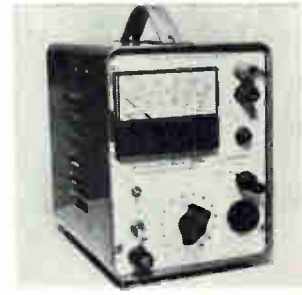

Multiple range, solid state, voltage breakdown tester, model 791, is suitable for testing both low and high voltage transistors, thyristors, diodes and rectifiers for zener breakdown levels. It has four voltage ranges: 0-50, 0-100, 0-1,000 and 0-5,000 volts. The high voltage output is continuously adjustable on every range. SVI Electronics, 48 Broadway, Albany, N.Y. [364]



Group-delay measuring set model 400-C measures rapidly the delay factors of the various frequencies in high-speed data-transmission bands from 200 hz to 600 khz in line and radio circuits, with an accuracy of ± 5 μ sec below 20 khz and ± 2 μ sec above 20 khz. Price (1-4) is \$4,995 each; delivery, 10 weeks. Advanced Technology & Systems Corp., 1143 Post Road, Riverside, Conn. [365]



Digital temperature indicator provides a digital readout of 12 independent temperatures, and an averaging position for displaying the rms average of the 12 channels. This is particularly useful for monitoring average air or fluid temperatures in large volumes. Temperature is read directly in $^{\circ}$ F with a 0.1 $^{\circ}$ F resolution. Price is \$1,350. RdF Corp., 23 Elm Ave., Hudson, N.H. 03051 [366]

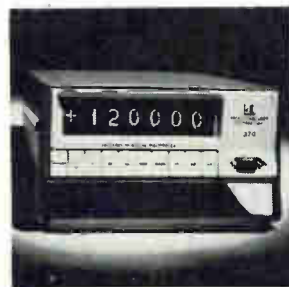

Five-digit voltmeter/multimeter model 370 features high accuracy (0.0025%) in a package 3 $\frac{1}{2}$ in. high, half rack size. The unit can also measure a-c volts (to 100 khz), ohms (to a resolution of 1 milliohm) and ratio (0.99999:1), by simply adding plug-in modules. Price is \$2,400; delivery, 60 days. Data Technology Corp., 1050 East Meadow Circle, Palo Alto, Calif. [367]



Digital frequency meter 4034 measures frequencies up to 1 Mhz and time intervals from 10 μ sec to a million seconds. Heart of the unit is a crystal oscillator that establishes time intervals to an accuracy of $\pm 0.01\%$. The instrument's four-digit display allows it to count up to 9,999 cycles or time intervals. Beckman Instruments Inc., 2400 Harbor Blvd., Fullerton, Calif. [368]

PROBLEM: EMI SUPPRESSION



SOLUTION: LUNDY 'LOSSYLINE' FLEXIBLE FILTER

The LUNDY "LossyLine" FLEXIBLE FILTER is an absorptive/dissipative low-pass microwave filter. It eliminates undesired harmonics, EMI, and other types of spurious microwave energy. Provides over 100db attenuation in the microwave ranges from 10 MHz to over 45 GHz.

- Voltage Ratings: 100 V to 100 KV
- Current Ratings: 5 to 50 Amps
- Temperature Range Available: -67° C to +250° C
- Suppression at a fraction of the usual cost
- Extremely lightweight and minimum size
- Performs without grounding
- Flexibility: minimum bend radius .50 inches

WRITE FOR TECHNICAL LITERATURE

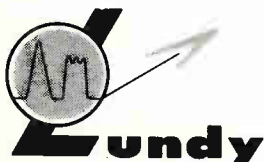

LUNDY ELECTRONICS & SYSTEMS, INC.
Glen Head, New York 11545
516-OR6-1440 TWX 510-223-0605

up to 2,250 watts peak. The peak voltage is 2 kv, at 1 amp, and the peak current is 2 amps, at 1 kv. Pulse width is variable between 0.5 microsecond and 1 millisecond.

Also variable is the rise time, between 160 volts per μsec to 20 kv per μsec when the output's amplitude is 2 kv. This feature together with the current-monitoring jack, makes the PM-2 useful for testing silicon controlled rectifiers.

Because its output can be gated by external signals, the PM-2 fits into automatic test systems.

In addition, it can put out positive and negative pulses simultaneously, a capability that comes in handy for testing high-power transistors.



Wide and fast. Both the width and rise time of PM-2's output pulse can be varied.

Among some of the generator's other applications are pulse modulating, laser pulsing and flash-tube driving, says Withey.

It bites. A monostable multivibrator connected to the power supply generates the pulses. After being amplified and passed through some protective circuitry, the pulses go to the output stage, whose main component is a power tetrode. From here the pulses go to a "tail biter", a network that forces pulses to fall off quickly even when they are feeding a capacitive load. "For example," says Withey, "if the pulser is feeding 1,000 ohms in parallel with 1,000 picofarads, the fall time is about half a μsec . Without the tail biter, it would be 6 or 7 μsec ."

The instrument draws a maximum of 375 watts. And it's 16 by 8½ by 9 inches. Delivery time is four weeks.

Instrument Research Co., P.O. Box 231,
Lincoln, Mass. 01773 [369]

New instruments

Debugger tests IC's in-circuit

Digital analyzer
detects logic errors,
power supply faults

A drawback common to most digital-IC testers is the fact that the IC must be removed from the circuit board and placed in the tester. According to Robert Kenyon, president of Testex Inc., "What was needed was an in-circuit IC analyzer, and we've got one. Too often, a good IC is damaged when it is removed for testing."

Designated the model 410, the instrument detects logic errors, input and output signal level errors, and power supply faults in resistor-, diode-, and transistor-transistor logic IC's, and it indicates if there is a signal present at each of the pins—up to a maximum of 10 pins in a circuit.

The 410 is intended for use in debugging prototype assemblies and in development of new circuits for production lines. It can also be used for troubleshooting and service work on systems and subsystems.

Each device type to be tested requires a plug-in program card board. The board is programmed to provide the proper power supply and logic levels and includes a reference IC for the logic tests. A blank board is supplied with the tester, and according to Kenyon, "perprogrammed boards for the more commonly used IC's will be available for about \$50 each."

Two modes of operation are provided. The first compares input and output levels of the device under test to those preset on the program board, and also compares the logical response of the device to that of the device on the program board. Lamps on the front panel of the 410 indicate what type of error is present and at which pin. In the second mode, the tester checks to see if a signal is present at each of the pins. The tests can

Save the ruins.

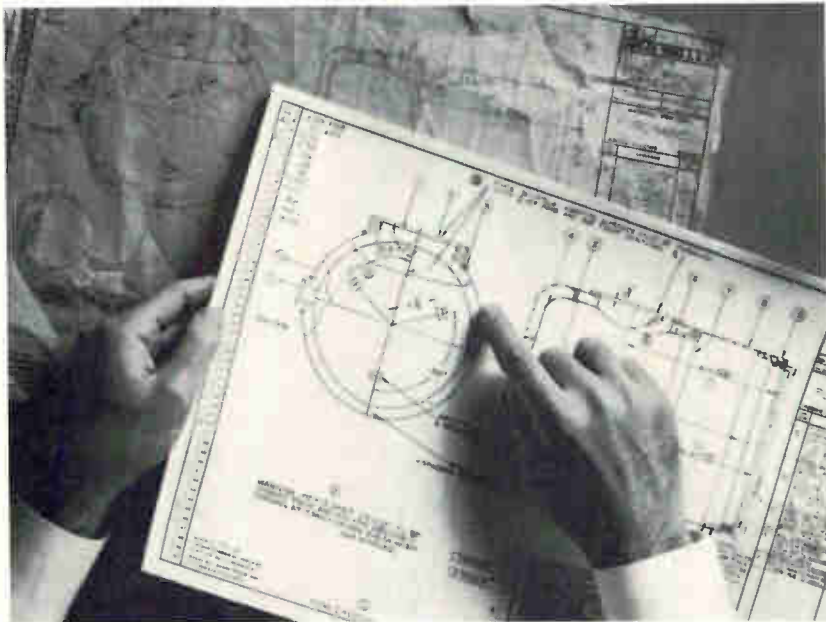

Have your second originals made on KODAGRAPH Wash-Off Film, ESTAR Base. It pays.

Next time you're confronted with a faded, wrinkled, stained, flaky, or otherwise exhausted original drawing, have it restored on KODAGRAPH Wash-Off Film, ESTAR Base.

Your reproduction department or commercial blue-printer will send you back a great second original. One that will last through years of use.

You'll get back a drawing with details in sharp blacks, on which folds and blots have been removed. This highly durable ESTAR Base Film has a fine-tooth matte drafting surface that accepts jewel- or steel-tipped pens, standard pencils—smoothly. Multiple same-area erasures are a snap. You use a drop of water and a touch or two of your eraser.

Check with your Kodak Technical Sales Representative on KODAGRAPH ESTAR Base Films and many other ways to save creative drafting time. Or write us: Eastman Kodak Company, Business Systems Markets Division, Rochester, New York 14650.

Kodak

DRAWING REPRODUCTION SYSTEMS BY KODAK

Convert any X-Y scope into a curve tracer: \$655*

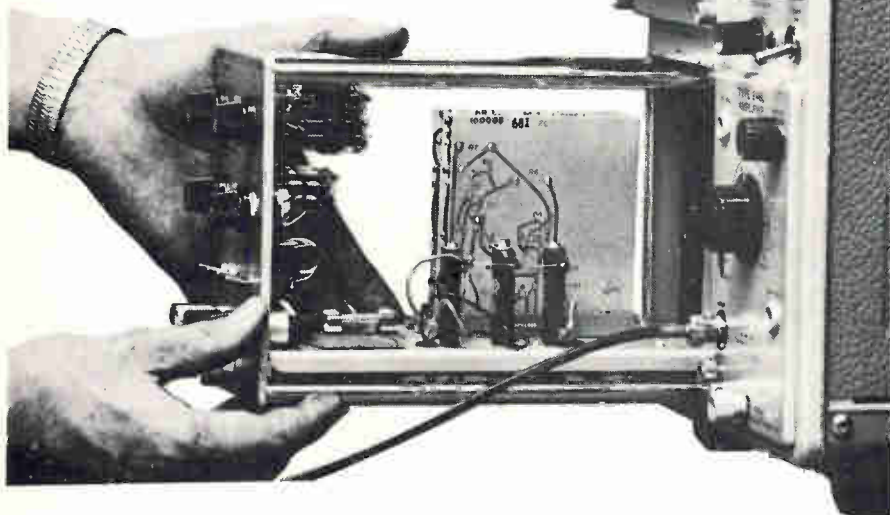

Now U-Tech's plug in and console units are all your oscilloscope needs to become a curve tracer. Save 1/2 to 1/3 the cost!

For the price of one curve tracer, you can now buy two to three of these U-Tech units that use the facilities of your present scope to display the dynamic characteristics of both NPN and PNP transistors, N Channel and P Channel junctions, FETs, MOS-FETs, bipolars, uni-junctions, diodes, tunnel diodes and SCRs.

Ask your distributor about these U-Tech curve tracer units or order direct from:

* Prices apply to purchase and shipments within U.S.A. fob Salt Lake City, Utah
 † Registered Trademark Tektronix Inc.



U-Tech plug-in Model 681: \$655.00*. For use with Tektronix† 560 series Oscilloscopes.



U-Tech plug-in Model 682: \$675.00*. For use with Tektronix† 530, 540, 550, 580 series Oscilloscopes.



U-Tech Console Model 683: \$685.00* For use with any X-Y Oscilloscope.

... test probe is key to performance ...

be performed in any sequence, and in both modes the power supply level is checked against a reference.

Kept it simple. "In the construction of the 410," says Kenyon, "we tried to use as few different circuit cards as possible, and to make them redundant so that servicing would be simplified." The result is that there are five types of cards and a mother board. These include one power supply card, one display card, two line driver cards, three output comparator cards and five input comparator cards.



Troubleshooter. Instrument tests IC's without removing them from board.

The heart of the analyzer is the test probe, which Kenyon says depends on a proprietary technique. The probe connects to a test clip that accommodates 14 or 16 pin dual in-line IC's. Other clips are available for 1/4-by-1/4-inch flat packs or 1/4-by-1/8-inch flat packs. Up to ten inputs and six outputs can be tested.

Few of the large manufacturers of integrated-circuit testers have gone into the in-circuit tester market, and Kenyon says the principal reason is that they're not interested in the service or repair market. He says Testex decided to get into this part of the tester business when it was discovered that the need for both debugging and repair is growing with the increased use of complex IC assemblies.

The 410 will sell for \$2,500 and the company quotes delivery time of 30 days.

Testex Inc., 154 San Lazaro Ave., Sunnyside, Calif. 94086 [370]

U-TECH

A Division of Industrial Physics and Electronics Company

4190 South State Street, Salt Lake City, Utah 84107 Tel. (801) 262-2663

Yes, send me curve tracer model.....

Enclosed is: Check P.O. Bill me Send literature

NAME _____ TITLE _____

COMPANY NAME _____

COMPANY ADDRESS _____ PHONE _____

CITY _____ STATE _____



When you're stuck with more wire than space...

Get around the problem, neatly, with Brand-Rex ribbon cables.

These slim space-savers bend into tight corners . . . hug contours around obstacles . . . keep wiring out of the way. They make high density interconnections easier to handle.

Brand-Rex gives you a wide choice of vinyl-insulated ribbon constructions (singles, pairs, shielded wires, coaxials) . . . with 2 to 100 conductors . . . to meet a variety of commercial and military requirements. Conductors can vary in type, size and color (striped wires also) within a given cable. They separate and strip easily, terminate in standard devices.

Write for the facts on Brand-Rex ribbon cable. And ask about any custom design you have in mind. Brand-Rex Division, American Enka Corporation, Willimantic, Conn. 06226.

Connect for tomorrow.

BRAND-REX

SCRs



20 from the tide

From the tide of 5,364 SCRs now available,* TI has selected 20 that meet 80% of low-level circuit requirements.

They're part of TI's preferred semiconductor line, selected after months of computer demand analysis to save you time and money in specifying discrete components.

TI's preferred 20 SCRs are popular, proven and readily available from TI distributor and factory stocks. Volume production assures you the most competitive prices.

Applications are many and varied in consumer and industrial equipment such as light flashers, ignition systems, appliance and stereo/TV controls. In military systems they can perform relay-

TI Preferred SCRs							
Type	Avg. Fwd. Current I_D (A)	Fwd. & Rev. Voltage BV_F/BV_R (V)	Gate Current to Fire I_{GT} (μ A)	Type	Avg. Fwd. Current I_D (A)	Fwd. & Rev. Voltage BV_F/BV_R (V)	Gate Current to Fire I_{GT} (μ A)
T1C44	.600	30	200	2N3007	.350	100	200
T1C45	.600	60	200	2N3008	.350	200	200
T1C46	.600	100	200	2N3555	1.6	30	20
T1C47	.600	200	200	2N3556	1.6	60	20
2N3001	.350	30	20	2N3557	1.6	100	20
2N3002	.350	60	20	2N3558	1.6	200	20
2N3003	.350	100	20	2N3559	1.6	30	200
2N3004	.350	200	20	2N3560	1.6	60	200
2N3005	.350	30	200	2N3561	1.6	100	200
2N3006	.350	60	200	2N3562	1.6	200	200

ing, squib firing, fuzing and read-out-tube driving functions.

If one of TI's preferred 20 SCRs doesn't fit your specific requirements, remember TI makes 111 standard and over a thousand special SCR types from which to choose.

Write for TI's brand new 1970 *Preferred Semiconductors and Components* catalog: Texas Instruments Incorporated, PO Box 5012, MS 308, Dallas, Texas 75222. Or just circle reader service card number 117.



*1969 Worldwide figure from D.A.T.A., Inc., publishers of *Electronic Data*.

TEXAS INSTRUMENTS
INCORPORATED

200-kilobit read-only memory is fast

Modular braided-wire system has 200-nanosecond access time, 500-nsec cycle time; speed achieved through TTL sensing

When program variables multiply, so must the storage capacity of the read-only memory that keeps track of them.

Memory Technology Inc. designed its series MSBS braided-wire memory system to be expandable to the largest capacity available in today's market. The top-of-the-line version stores 196,608 bits in word lengths of 24 or 48 bits. Since the

series is modular, the ROM can be adapted to the length of the user's program. It is possible to build up to that 196,608 capacity in increments of 24 kilobits.

Marketing director Paul L. Rosenbaum says the MSBS series is aimed at the broad field of control applications. "Microprogramed devices now are replacing both logic and software in this area," he says,

"especially in situations where the number of control variables is large, and where operations might have to be performed asynchronously." Industrial process control would be one example, and another would be control of computer peripherals. "The MSBS makes possible very flexible microprogramed control with a response time in the order of the machine cycle time,"



Sample and hold modules series SH-100 are for fast and medium speed data sampling and acquisition applications. They feature 0.01% accuracy, 50 nsec aperture time, 2 μ sec acquisition time and a 1,000 megohm input impedance. Units are potted, contained in less than $\frac{3}{8}$ cu in. and operate over a temperature range of 0 to 70°C. Aritech Corp., 130 Lincoln St., Brighton, Mass. [381]



Single sideband filter 6455AU(L) can upgrade the performance of existing receivers as a result of its very steep rejection characteristics. It has a carrier frequency of 1.750 Mhz with a bandpass of 3.2 khz at 2-db attenuation level. Nominal impedance is 250 ohms. Operating temperature is -30° to +75°C. Damon Engineering Inc., 115 Fourth Ave., Needham Heights, Mass. [382]



Dual output d-c regulated supply PM502 is for operational amplifier power source use. It operates directly from 115 v a-c ± 10 v a-c, 50 to 400 hz, and supplies two regulated (line-load 0.02%) d-c outputs of ± 15 v each delivering from 0 to 100 ma. Case size is 3.5 x 2.5 x 1.25 in. Weight is about 16 oz. Computer Products Inc., 2709 N. Dixie Highway, Ft. Lauderdale, Fla. [383]



Power supply for d-c use offers line regulation of $\pm 3\%$ at 105-130 v. It is lightweight, hermetically sealed and oil impregnated to offer high reliability and long life. It features 20% load regulation, ripple less than 2%, electrostatic shield, and temperature rise under 40°C. Load rating is 0 to 5 ma d-c. Chicago Condenser Corp., 3255 W. Armitage Ave., Chicago 60647 [384]



Sealed power supplies operate as a pair in character display crt systems. They operate from an input of 44 v d-c providing output voltages of 12 kv and -2.2 kv at $\pm 1\%$ and 2 kv at $\pm 5\%$. Regulation is better than 0.25% for the 12 kv and -2.2 kv outputs and 1.5% for the 2 kv output with ripple on any output less than 0.1% peak to peak. AMP Inc., Elizabethtown, Pa. [385]

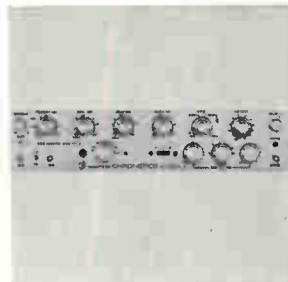

Current-driver/pulse generator model PG-13A can deliver up to ± 2 amps or ± 100 v single or double pulses from 50 to 1,000 ohms at repetition rates to 25 Mhz. Rise and fall times are less than 10 nsec to 50 msec; linear greater than 100:1 dynamic range between rise and fall; independently variable. Price is \$1,750. Chronetics Inc., 500 Nuber Ave., Mt. Vernon, N.Y. [386]



Lumped constant delay lines are low silhouette 5 to 200 nsec units for computer applications, radio and radar uses. They meet or exceed MIL-Standard 202 for moisture resistance, vibration, shock, humidity and life, and the basic requirements of MIL-D-23859. Temperature range is 55° to 125°C. Price ranges from \$3.25 to \$19.90. Valor Electronics Inc., Costa Mesa, Calif. [387]



D-c power supplies series JR weigh under $1\frac{1}{2}$ lbs. The 50-w units are designed to meet requirements where size and weight are important. Output voltages are in the 3-30 volt range. Features include 0.1% line or load regulation, 3 mv rms maximum ripple, transient response under 1 msec. Unit is $1\frac{3}{4}$ x $3\frac{1}{8}$ x $6\frac{1}{2}$ in. ACDC Electronics, N. Ontario St., Burbank, Calif. [388]

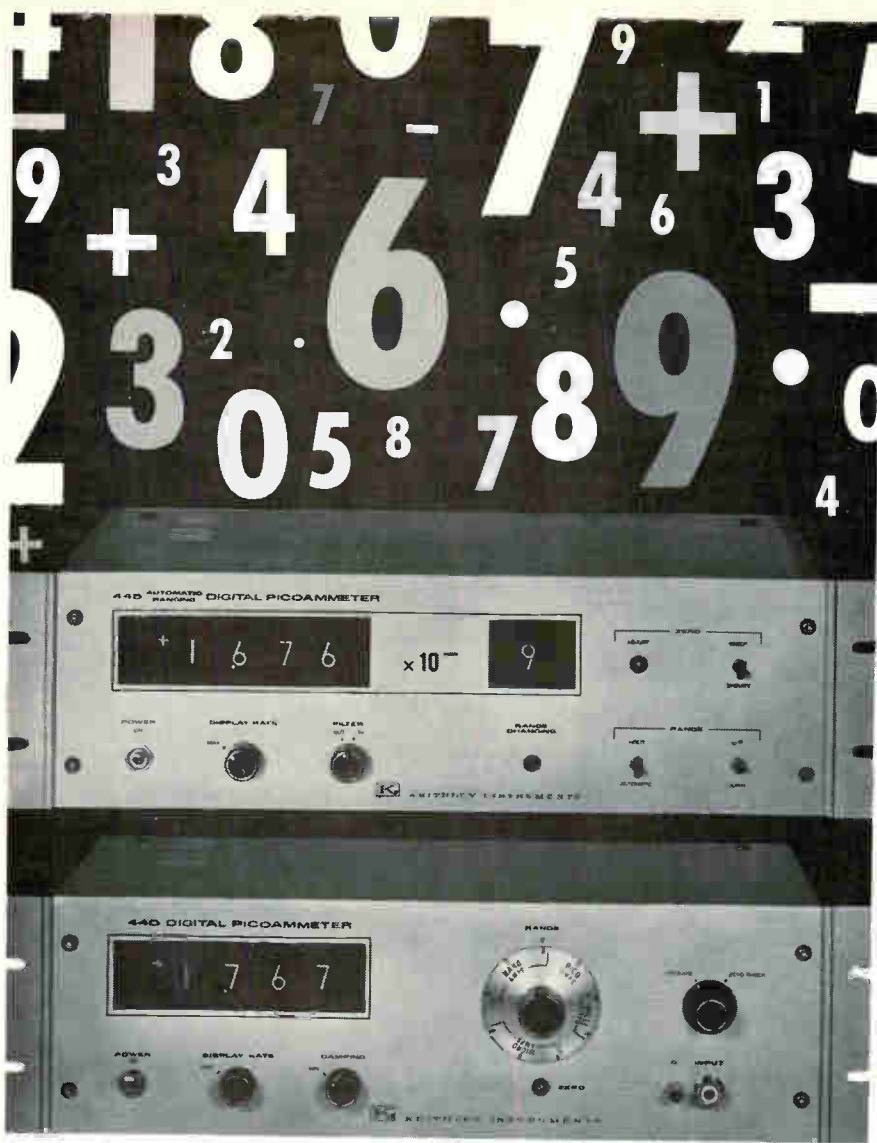

MEASURES MILLIAMPERES TO PICOAMPERES AND NARROWS THE GAP BETWEEN PRICE AND PERFORMANCE

See the first digital picoammeter above? It's our new \$1495 autoranging Model 445. It simplifies measurements from 10^{-2} ampere f.s. to 10^{-9} ampere and provides both analog and BCD outputs. The second is the Model 440, new too. At \$995, it features 10^{-2} to 10^{-10} ampere f.s. current ranges, has an analog output and an option for BCD.

Both picoammeters are packed with convenience features designed to minimize operator error and maximize performance. Stable to 0.5% of full scale per week, they make low level measurements accurate to 0.2% almost routine. And provide variable display rate to 24 readings per second. But isn't that what you'd expect from a firm with years of analog picoammeter design experience? And an industry-wide reputation for quality? Like Keithley.

See if you don't agree we have the best digital approach to picoampere level measurements. Call your Keithley Sales Engineer for demonstration and details. Or contact Keithley Instruments, Inc., 28775 Aurora Rd., Cleveland, Ohio 44139. In Europe: 14 Ave. Villardin, 1009 Pully, Suisse. Prices slightly higher outside the U. S. A. and Canada.



KEITHLEY

says MTT's Rosenbaum.

Access time in the new memory series is 200 nanoseconds, and cycle time 500 nsec; this is fast even by the standards of braided-wire memories. The speed limit went up when Memory Technology switched from sensing with diode-transistor logic to transistor-transistor logic.

"TTL made faster access possible because of its cleaner, less noisy waveshapes," says Rosenbaum. "And because there was less dispersion in turn-on time—rise times are much more abrupt and repeatable than for DTL—we were able to tighten electrical tolerances and increase speed."

Feared spikes. Memory Technology is using the 7400 series TTL, and though the designers had at first feared spike noise from the interaction of the TTL and the power supply, they solved the problem by placing a filter network at the power supply terminals.

Memory boards are connected in parallel with one another in a rack mount configuration which holds up to eight such boards plus a data register board.

Cycle and access times aren't affected by memory expansion, so the user can depend upon repeatable times, regardless of how many modules he adds to the memory.

Not only is the system easy to expand, but it should also be simple to integrate into systems design. The MSBS runs on logic-level voltages; a single ± 5 -volt supply is sufficient.

Options are available for the MSBS, among them a data register board which is equipped to handle about 95% of applications needs, says Rosenbaum. It yields flip-flop outputs and has a fanout of seven. For situations where a greater fanout is needed, an address distribution board is available which buffers input address lines so that only one unit load is presented to each address line. Rosenbaum notes that this results in "artificial fanout" and would bail out marginally powered flip-flop registers in a user's system.

Prices for MSBS series ROM's begin at less than \$1,600. The company is quoting 60-day delivery.

Memory Technology Inc., 83 Boston Post Road, Sudbury, Mass. 01776 [389]

New subassemblies

Amplifiers low in cost, drift

Instrumentation units priced as low as \$39, use IC's as submodules

Low-cost, integrated circuit operational amplifiers available for use as submodules are paving the way for development of low-drift instrumentation amplifiers in small, modular packages.

Among the most recent offerings are two diminutive, low-cost instrumentation amplifiers from Burr-Brown. The models, 3264/14 and 3263/14, are 0.4 inch high and 1.5 inches square. They can be mounted on printed-circuit cards or inserted into mating connectors. The 3264 has a maximum input voltage drift of ± 10 microvolts per $^{\circ}\text{C}$, and is priced at \$39 singly or \$29.90 each in lots of 100. For applications requiring lower drift, the 3263, with a maximum voltage drift of ± 3 $\mu\text{v}/^{\circ}\text{C}$ through the temperature range of -25°C to $+85^{\circ}\text{C}$, is priced at \$59 individually and \$45 each in 100 lots.

The amplifiers are expected to find wide applications, and will replace operational amplifier circuits in many differential-input circuits. Only one external resistor is required to set the gain to any value from 1 to 1,000; complicated operational amplifier summing networks are not needed. Unlike high-gain operational amplifier circuits, the units have high input impedance—over 100 megohms—even at high values of differential gain.

Burr-Brown Corp., International Airport Industrial Park, Tucson, Ariz. 85706 [390]

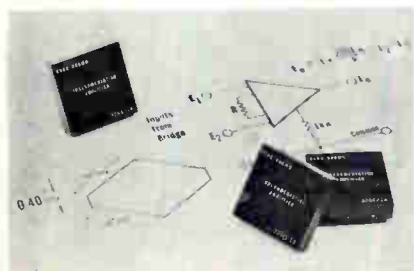

WHERE ACCURACY COUNTS!

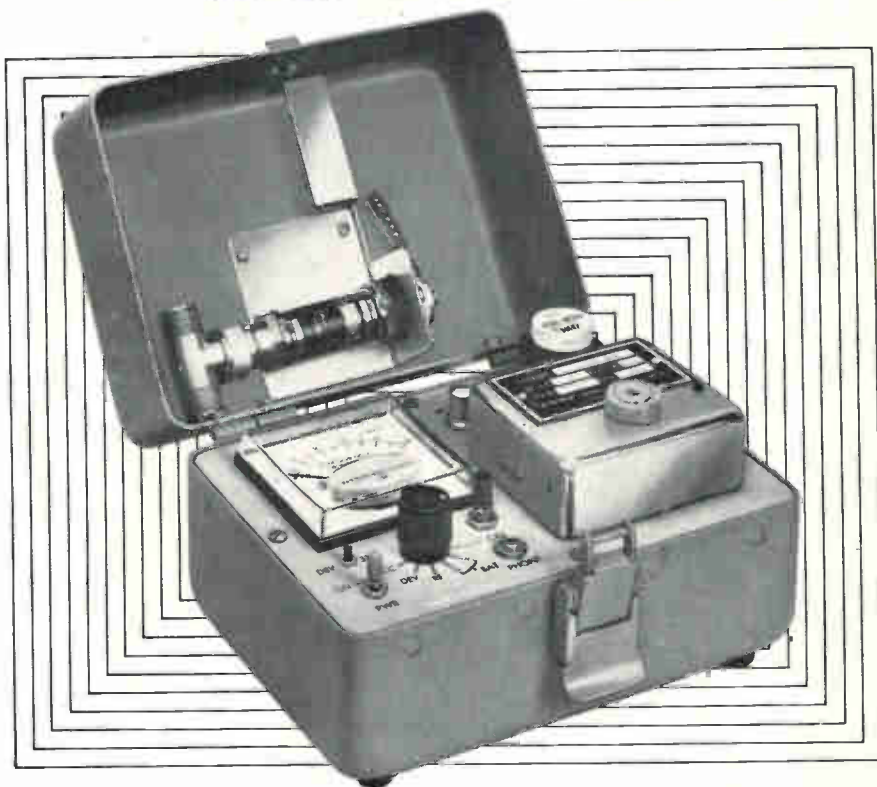

INTERNATIONAL MODEL 6000 FREQUENCY METER
measures frequencies 10 khz to 600 mhz with accuracy as close as .000125%

The Model 6000 Modular Frequency Meter will measure frequencies 10 KHz to 600 MHz with .000125% accuracy. The wide variety of plug-in oscillator accessories and range modules makes the Model 6000 adaptable to a number of jobs in the field and in the laboratory. Portable, battery operated with rechargeable batteries.

Model 6000 with 601A charger, less plug-in modules.....\$195.00



RANGE MODULES (Mixers)
\$25.00 to \$45.00 each

OSCILLATOR MODULES
(Crystal Controlled For Frequency Measurement)
\$30.00 to \$90.00 each

... For complete information write International today.



CRYSTAL MFG. CO., INC.
10 NO. LEE • OKLA. CITY, OKLA. 73102

**This portable will record
more facts in less time, at less cost
than any other 2-channel recorder
on the market.**

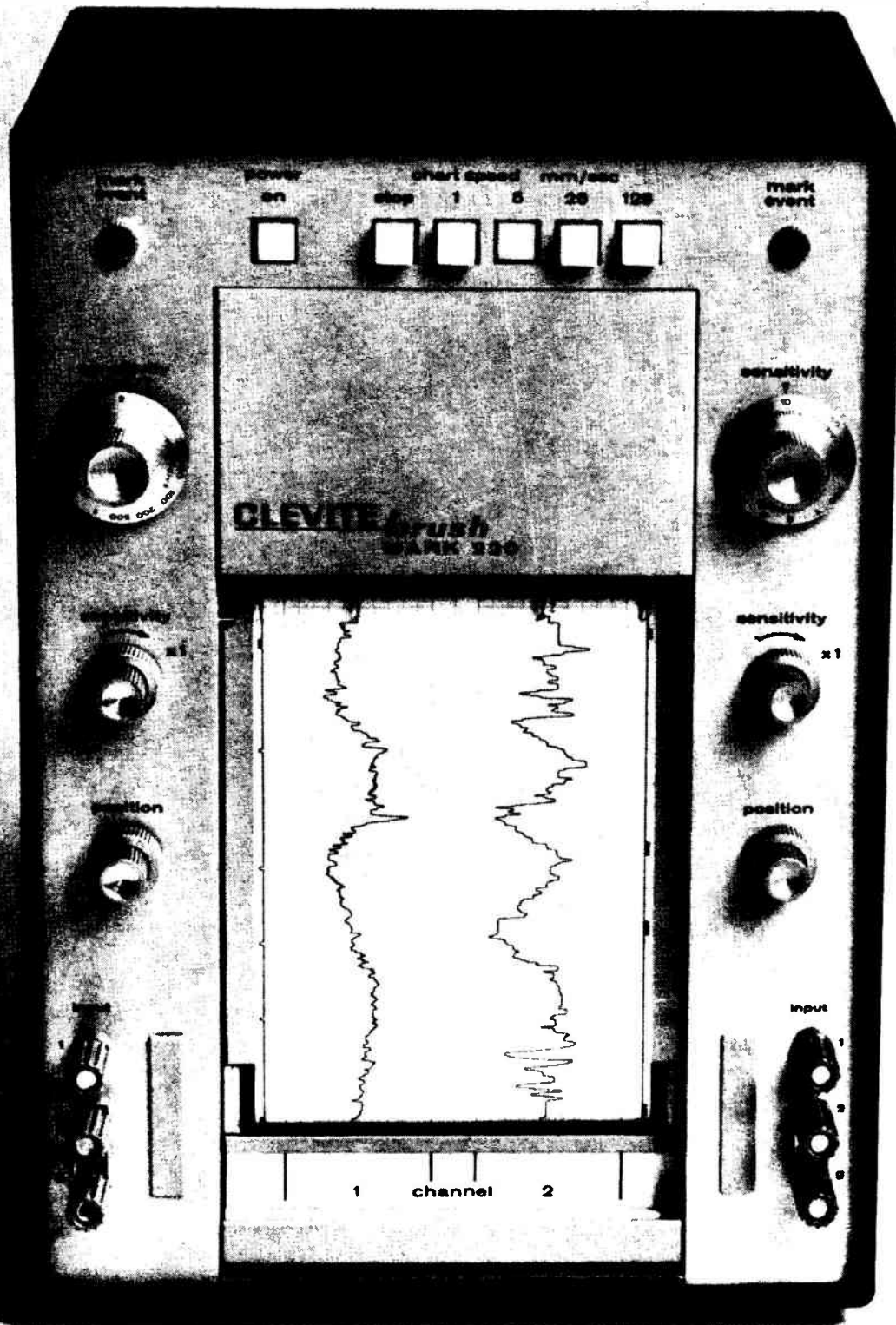

We call it the Mark 220.

And once we put it through its paces for you, you'll call it the most amazing piece of recording gear around.

To begin with, we *guarantee* the Mark 220 to be 99½% accurate. Which is a good deal better than almost anything else on the market . . . regardless of size or price. The pressurized ink-writing system is the same one you'll find in our six and eight channel systems. Instead of laying the trace on the



paper, it forces it *in*. Run your finger over it. There's no smear, no smudge. And trace crispness and uniformity is in a class by itself.

Built-in preamplifiers give you measurement range from 1 mV per division to 500 V full scale — and you never have to re-calibrate. Pushbutton controlled chart speeds. Two handy event markers. Ink supply is a disposable cartridge, good for a year.

Yes, for a 25 pound portable that's no bigger than a breadbox, the Mark 220 is quite a recorder. Ask your Brush representative for a demonstration. Or, write for complete details. Clevite Corporation, Brush Instruments Division, 37th and Perkins, Cleveland, Ohio 44114. We'll include our informative booklet "Elimination of Noise in Low-Level Circuits".

CLEVITE BRUSH

Varactor diodes tune over octave band

Silicon mesa units with Q's up to 2,000 and capacitance change ratios as high as 15:1 offer challenge to yig-tuned devices

About the only solid-state microwave oscillators with octave bandwidths until now have been yig-tuned devices. Available tuning varactors didn't sufficiently change their capacitance with bias voltage variations.

Now Parametric Industries Inc. has introduced a varactor series which challenges some yig devices. It's the PV0129 line, and its units

combine Q's of up to 2,000 with capacitance ratios of up to 15:1, using both forward and negative bias.

The high Q should keep the tuned signal a narrow one, dispersed only slightly around a particular center frequency, while the broad capacitance ratio would allow that frequency to be tuned across very wide bands.

The best previously available varactors have had Q's of about 1,700, and capacitance change ratios only 20 to 30% as great as a PV0129's. These characteristics limited the operation of varactor-tuned local oscillators to less than octave bandwidths.

The Q of 2,000 is measured at 50 megahertz and -4 volts bias; this figure falls off with frequency until



Cathode-pulsed twt VTC-5261J1 is for use as a driver or output tube in pulse-radar missile-guidance systems that operate between 5.4 and 5.9 Ghz. It produces more than 1 kw of peak output power at an 8% duty cycle from a package weighing 4.5 lbs and measures slightly more than 12 in. long, less than 3 in. high and 3 in. wide. Varian, 611 Hansen Way, Palo Alto, Calif. [401]



R-f filter model TTF-315-3-3EE is for the 210 to 420 Mhz telemetry band. It is a 3-section device having a 30-db form factor of 3. Typical insertion loss is 1.3 db at center frequency and average power rating is 30 w. If maximum stopband rejection is required the filter is also available in a 5-section version. Telonic Engineering Co., Box 277, Laguna Beach, Calif. [402]



Radar altimeter antenna 0-1-34-04530 has metallic directors within its aperture to correct the E and H plane beam instead of a dielectric lens which is susceptible to shock, vibration and other environmental hazards. Unit operates at 4,300 \pm 50 Mhz, with a gain greater than 13 db and efficiency greater than 85%. Electronic Resources Inc., 4561 Colorado Blvd., Los Angeles [403]



Four direct-reading, transmission type microwave octave wavemeters cover frequencies ranging from 970 Mhz to 12,430 Mhz. Insertion loss is 10 db max. Frequency readout is direct every 10 Mhz with accuracy of 0.1%. Spurious responses are 20 db minimum below desired response, and off resonance response is 40 db nominal. Gombos Microwave Inc., Webro Rd., Clifton, N.J. [404]



Crystal source FS-220 develops 1/2 watt at 3 Ghz with low a-m and f-m noise characteristics for communications use. It uses a 95-Mhz crystal oscillator as the base frequency followed by an amplifier/multiplier chain. Frequency stability is \pm 0.003% over 0° to +60°C. Unit meets MIL-E-5400 Class II for shock and vibration. Frequency Sources Inc., Box 159, N. Chelmsford, Mass. [405]



Tunable L-band power source model 111001V features an integrated isolator. It operates on a frequency between 1,025 Mhz and 1,150 Mhz at an operating voltage of -28 v, 150 ma maximum. Power output is 1 w minimum with a 1-db flatness over the band. The unit exceeds performance parameters of MIL-E-5400. Centilabs Corp., Old Middlefield Rd., Mtn. View, Calif. [406]



Waveguide junction circulator CSH116 is for industrial microwave heating uses. Operating at 2,450 Mhz, it can handle 10 kw c-w power with water-cooling or 5 kw without cooling. Minimum isolation is 20 db and insertion loss is 0.2 db maximum. Vswr is 1.20 maximum. It can be furnished with a dummy load at port-3 if required. Raytheon Co., Waltham, Mass. [407]



Miniature calibrated variable attenuator model 4797 has flat frequency response from 12.4 to 18 Ghz, and may be used from 2 to 20 Ghz as a variable level set attenuator. Attenuation range is from 0 to 45 db, with maximum insertion loss of 1 db, vswr of 1.30, and accuracy of \pm 1.5 db. Price is \$475; delivery, from stock. Narda Microwave Corp., Plainview, N.Y. 11803 [408]

NEW VACTEC "PLASTIC" PHOTOCELLS

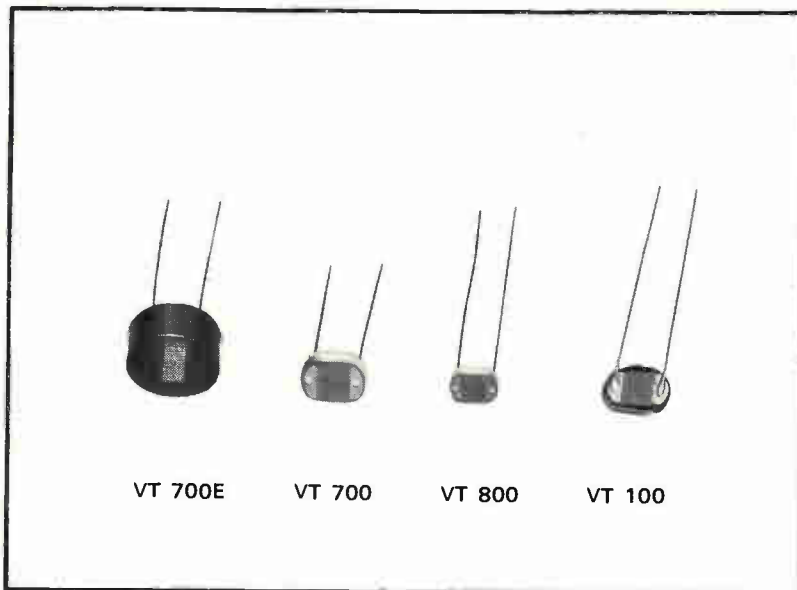

Actual size, priced as low as .29 each ($\pm 33\%$ tolerance) in 100,000 quantities.

Low Cost Way to Meet Most Photocell Requirements

Are you spending up to a dollar for photocells when Vactec can satisfy your needs for far less? Here's a complete line made the same, and with the same quality characteristics and precise tolerances as their metal cased counterparts. Yet they cost about *half* as much, because instead of sealing, they are protected by a thin transparent plastic coating.

Vactec "plastic" cells are conveniently controlled by ambient light, or from closely coupled low voltage lamps for remote control. Special processing provides resistance to humidity, making these devices suitable for indoor industrial and commercial applications like controlling relays in line voltage circuits; switching SCR's on or off; phase control in proportional circuits; or as feedback elements for motor speed controls in consumer appliances.

GENERAL SPECIFICATIONS

Material	Two Cdse and three Cds materials, including the new type 3 with exceptionally high linearity and speed.
Voltage Maximum	(dark 300V.)
Dissipation at 25°C	200 mw (VT 100) 250 mw (VT 700 and VT 700E) 125 mw (VT 800)
Ambient	-40°C up to +75°C
Resistance	Wide range as low as 600Ω at 2 F.C.

Write today for Bulletins PCD-41, 57, 57E, and 58.

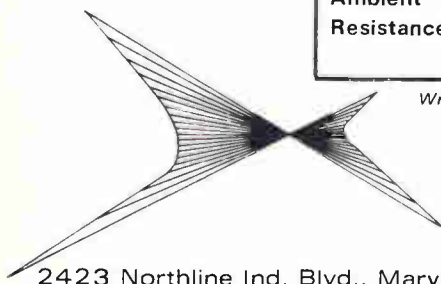

VACTEC, INC.

2423 Northline Ind. Blvd., Maryland Heights, Missouri 63042
(314) 872-8300

Specializing in standard Cds, Cdse, and Se cells. Custom engineering for every photocell need. Listed in EBG under "Semi-Conductors" and EEM Sec. 3700.

at 1,000 megahertz, Q is about 100. Still, Parametric has little hesitation about calling the PV0129's the varactors with the highest available Q for their frequency range—nominally 500 to 2,000 Mhz.

Howard B. Foster, sales manager, says the combination of virtues results from a procedure whereby the silicon mesa devices are etched after packaging. This procedure allows control of junction characteristics, increases both Q and capacitance change ratio, and also aids in compensating for parasitic capacitances in the package. PV0129's offer capacitances of 1, 2, 2.5, 5, or 7 picofarads at -4 volts bias. Variations due to packaging are only 0.1 to 0.3 pf.

Low means fast. Foster points out that low capacitance means fast tuning. "Yig devices are inductive," he says, "and compared to these small capacitance varactors, yig tunes relatively slowly and soaks up power. With these new varactors, tuning speed easily is in the gigahertz-per-second range—we may be approaching the level where power supply design may be more of a tuning speed limitation than the varactors."

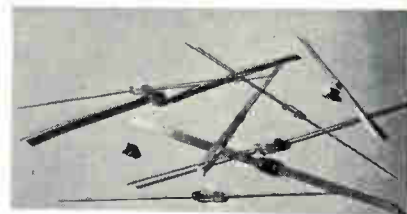

Tuners. Varactors combine high Q, high capacitance change ratio.

Though he doesn't stress the point, this speed would make the varactor very useful in electronic warfare applications, a market that makes up about a quarter of Parametric's income. Other, more overt, applications would be in sweepers, electronically controlled signal generators, and communications gear.

The semiconductors come in almost all common packages from the pill-prong types to miniaturized versions for stripline and coaxial installations. Price is \$65 in quantities of 1-10, and \$46.50 in lots of 1,000 or more.

Parametric Industries Inc., 742 Main Street, Winchester, Mass. 01890 [409]



NEW AMI/MOS FAMILY — Random Access Memory Circuits. Mass produced RAMS by AMI can be programmed in your system for various word lengths, providing complete system design versatility. The 128 bit matrix, for example, can be hooked up as a 4 x 32, 2 x 64, or 1 x 128. Available now, these low cost, solid state memories are only part of the AMI/MOS story, which includes RAMS, ROMS, Shift Registers and other standard MOS products. Send for details. Better yet, hop a jet and visit our production facility — America's largest.

NOW IN PRODUCTION
RAMS
IN HANDY MATRIX



AMERICAN MICRO-SYSTEMS, INC.

3800 Homestead Road, Santa Clara, California 95051

Telephone 408-246-0330, TWX 910-338-0018

CUSTOM & STANDARD MOS ARRAYS/MEMORIES/REGISTERS/LOGIC

Thick-film IC is total d-a converter

Speed and accuracy of low-cost hybrid unit make it suitable for feeding data to strip-chart recorders, other non-crt displays

The monolithic integrated circuit digital-to-analog converters on the market are not complete systems; discrete circuitry has to be added to make them work. On the other hand, complete systems such as potted modules of discrete devices or printed-circuit board versions of an eight-bit d-a converter can cost from \$100 to \$300, with the potted modules on the high end of the

scale. Recognizing a need and a market for a smaller and lower-cost system, engineers at the microcircuit operations of Beckman Instruments' Helipot division have designed what they're billing as the first total d-a converter in hybrid IC form. Nothing has to be added.

The model 845, an eight-bit binary unit, will sell for \$75 in quan-

ties of one to nine, about \$60 for 100 or more, and could get down to about \$40 in the 20,000 volume. Beckman was recently asked to bid on an order for 20,000 d-a converters.

George Smith, manager of research and development for the microcircuit operations, says the thick-film cermet unit is intended for commercial use in feeding data



Instrumentation disk recorder IDR-100 will record transient signal events over 20-sec real time duration and then replay the entire disk or repetitively reproduce any 25 msec "window" for hours or weeks of constant analysis. Unit has a sine wave recording bandwidth of 2 Mhz and an equivalent pulse response of 4 Mhz. Data Memory Inc., 1255 Terra Bella Ave., Mtn. View, Calif. [421]



F-m recording adaptor converts any audio tape recorder to a 4-channel data recorder. It will record and reproduce data from d-c to 30, 50, 100 and 300 hz for the 4 channels respectively. Linearity is within $\pm 1\%$; crosstalk noise is less than 1% peak-to-peak; drift is less than 0.2%/°C. Price is \$840; delivery, stock to 30 days. A.R. Vetter Co., Box 143, Rebersburg, Pa. [422]



Digital printer series 2000 can print from 4 up to 20 columns at 60 lines per minute. Input may be from -30 to +30 v d-c with 100 kilohms input impedance and is BCD parallel entry 8421, 4221, or 2421. Designed for low-speed print-out systems, the rack-mounted model measures 7 x 19 x 15 in. Price is under \$1,000. Digitron Corp., 2544 W. Main St., Norristown, Pa. 19401 [423]



Modular construction is a feature built into the 10 x 10-in. Sealectrocard badge reader SCR-1010. A "Read" light indicates that information is in position for system acquisition. A flashing light indicates "no-go" for a wrongly or improperly inserted ID badge. Units can be supplied for either 115 v a-c or 24 v d-c use. Sealectro Corp., 225 Hoyt St., Mamaroneck, N.Y. 10543. [424]



Data terminal EDX-1901 is for use in communications and data processing systems. The basic unit includes a keyboard, a page printer, a tape reader, and a tape reprocessor. It is designed for operation with the USASCII code and asynchronous operation at either 15 or 25 characters per second. General Dynamics, Electronics Division, P.D. Box 2566, Orlando, Fla. 32802 [425]

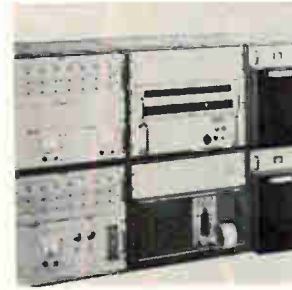

Compact data acquisition system series SY-128 accepts 400 channels of strain gage, temperature bulb, dc/dt transducer inputs. The system includes transducer excitation and calibration networks. All signal inputs are scanned and measured with the resulting data recorded simultaneously on a printer for quick assessment. B&F Instruments Inc., Cornwells Heights, Pa. 19020 [426]



Card keypunch A150 is designed as a free-standing data input preparation device for use with electronic data processing systems. It punches and interprets standard 80-column cards. It incorporates both regular and alternate stacking pockets which are operator selectable. Unit punches and interprets at up to 20 card columns/sec. Burroughs Corp., Detroit, Mich. 48232 [427]



Time code reader model 8230 is designed to translate IRIG A, B, and E modulated time code formats in terms of BCD hours, minutes, and seconds without the need for switching or code plug removal. It will find use where data must be retrieved from magnetic tape recordings for access and identification during playback. Systron-Donner Corp., 888 Galindo St., Concord, Calif. [428]

To whom
it may concern:

We'd like to
take this
opportunity
to inform you
that your
present
signal
generators
have just
become
OBSOLETE!

SINGER
INSTRUMENTATION

Data handling

Put your display on television

Raster links data source
to monitor without
complex interfacing

The design engineer seeking to use any standard 525-line tv monitor for a numeric/symbolic readout without tackling complicated interface electronics might end his search in Hauppauge, N. Y. Applied Digital Data Systems is offering a static raster display, the SRD-100, that it says can be linked to any system as easily as an indicator-tube display.

Furthermore, the company says, the SRD-100 offers unusual flexibility, due to the nature of the device itself and of its readout. The SRD-100 features background reversal, three character sizes and the ability to blink—all controlled independently on a line-by-line basis. And use of the monitor, in addition to yielding high data density and legibility, permits display at many remote locations as well as at the originating point.

Conversion. The SRD-100, using large-scale integration, accepts direct binary-coded-decimal input signals from any digital data source, converting them into a composite video signal. It then displays the data at any of 160 character positions on the monitor; the arrangement is in 10 lines, with 16 characters per line. Each character location has a four-wire binary input that's compatible with standard integrated-circuit levels or contact closures.

The company, which expects the SRD-100 to be the first of a line of display and communications products using LSI technology, is aiming the new device at users of automatic test equipment, process control, automation, and data-acquisition systems.

The basic SRD-100 is priced at \$995. The user must supply his own tv monitors.

Applied Digital Data Systems, 89 Marcus Blvd., Hauppauge, N.Y. 11787
[430]

Thick-film IC is total d-a converter

Speed and accuracy of low-cost hybrid unit make it suitable for feeding data to strip-chart recorders, other non-crt displays

The monolithic integrated circuit digital-to-analog converters on the market are not complete systems; discrete circuitry has to be added to make them work. On the other hand, complete systems such as potted modules of discrete devices or printed-circuit board versions of an eight-bit d-a converter can cost from \$100 to \$300, with the potted modules on the high end of the

scale. Recognizing a need and a market for a smaller and lower-cost system, engineers at the microcircuit operations of Beckman Instruments' Helipot division have designed what they're billing as the first total d-a converter in hybrid IC form. Nothing has to be added.

The model 845, an eight-bit binary unit, will sell for \$75 in quan-

ties of one to nine, about \$60 for 100 or more, and could get down to about \$40 in the 20,000 volume. Beckman was recently asked to bid on an order for 20,000 d-a converters.

George Smith, manager of research and development for the microcircuit operations, says the thick-film cermet unit is intended for commercial use in feeding data

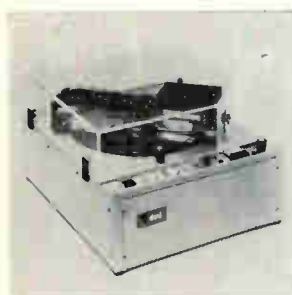

Instrumentation disk recorder IDR-100 will record transient signal events over 20-sec real time duration and then replay the entire disk or repetitively reproduce any 25 msec "window" for hours or weeks of constant analysis. Unit has a sine wave recording bandwidth of 2 Mhz and an equivalent pulse response of 4 Mhz. Data Memory Inc., 1255 Terra Bella Ave., Mtn. View, Calif. [421]



F-m recording adaptor converts any audio tape recorder to a 4-channel data recorder. It will record and reproduce data from d-c to 30, 50, 100 and 300 hz for the 4 channels respectively. Linearity is within $\pm 1\%$; crosstalk noise is less than 1% peak-to-peak; drift is less than 0.2%/°C. Price is \$840; delivery, stock to 30 days. A.R. Vetter Co., Box 143, Rebersburg, Pa. [422]



Digital printer series 2000 can print from 4 up to 20 columns at 60 lines per minute. Input may be from -30 to +30 v d-c with 100 kilohms input impedance and is BCD parallel entry 8421, 4221, or 2421. Designed for low-speed print-out systems, the rack-mounted model measures 7 x 19 x 15 in. Price is under \$1,000. Digitron Corp., 2544 W. Main St., Norristown, Pa. 19401 [423]

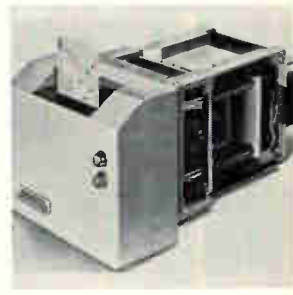

Modular construction is a feature built into the 10 x 10-in. Sealectrocard badge reader SCR-1010. A "Read" light indicates that information is in position for system acquisition. A flashing light indicates "no-go" for a wrongly or improperly inserted ID badge. Units can be supplied for either 115 v a-c or 24 v d-c use. Sealectro Corp., 225 Hoyt St., Mamaroneck, N.Y. 10543. [424]



Data terminal EDX-1901 is for use in communications and data processing systems. The basic unit includes a keyboard, a page printer, a tape reader, and a tape reprocessor. It is designed for operation with the USASCI code and asynchronous operation at either 15 or 25 characters per second. General Dynamics, Electronics Division, P.O. Box 2566, Orlando, Fla. 32802 [425]



Compact data acquisition system series SY-128 accepts 400 channels of strain gage, temperature bulb, dc/dt transducer inputs. The system includes transducer excitation and calibration networks. All signal inputs are scanned and measured with the resulting data recorded simultaneously on a printer for quick assessment. B&F Instruments Inc., Cornwells Heights, Pa. 19020 [426]



Card keypunch A150 is designed as a free-standing data input preparation device for use with electronic data processing systems. It punches and interprets standard 80-column cards. It incorporates both regular and alternate stacking pockets which are operator selectable. Unit punches and interprets at up to 20 card columns/sec. Burroughs Corp., Detroit, Mich. 48232 [427]



Time code reader model 8230 is designed to translate IRIG A, B, and E modulated time code formats in terms of BCD hours, minutes, and seconds without the need for switching or code plug removal. It will find use where data must be retrieved from magnetic tape recordings for access and identification during playback. Systron-Donner Corp., 888 Galindo St., Concord, Calif. [428]

Have a load to position?

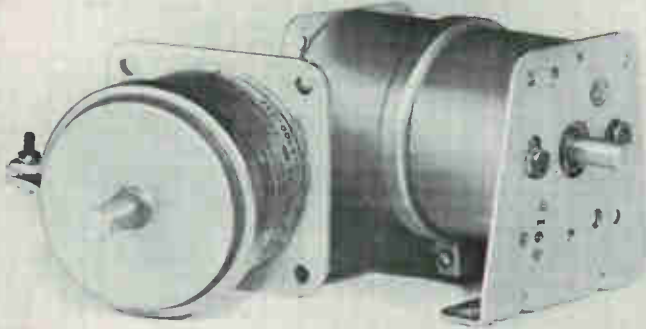

Five things you'll like about these new Ledex Stepping Motors

High torque-to-size ratio. Breakaway torque of up to 160 ounce-inches...drive a constant friction load of up to 64 ounce-inches. An exclusive new tooth clutch, with positive grip-action drive makes this high torque output possible.

Unidirectional and bidirectional models available. Choice of 18 (20°) and 12 (30°) step models for remote load driving. Bidirectional models let you position loads CW or CCW.

Minimum Life of 3 Million Steps (in both directions on bidirectional models). From design through production, they're built-to-perform. All working parts fully enclosed.

Uniform Stepping Accuracy ($\pm 1^\circ$). Entirely non-accumulative. Then consider other Ledex Series 50 stepping motor features like the ability to add rotary switches and position remotely or manually in either direction, response to simple square wave input (no expensive logic circuitry required) and their ability to meet military environmental requirements. Practical pricing too (under \$15 unidirectional; under \$21 bidirectional in 500 lots).

Twenty stock models available to help you get a quick start on your prototype.

Write for this new catalog. Or, tell us about your application and we'll recommend a solution.



Specialists in remote positioning



LEDEX DIVISION, LEDEX INC.
123 Webster Street, Dayton, Ohio 45402 • phone (513) 224-9891

to displays such as strip-chart recorders and oscillographs. Smith points out that the model 845 is not fast enough for the high resolution of cathode-ray tube displays. He adds that for strip charts and oscillographs having bandwidths of about 400 hertz, and needing less resolution than a CRT, the converter's speed and eight-bit accuracy are suitable. The unit's speed is paced by the 0.3 volt-per-microsecond slew rate of its μA 741 operational output amplifier. The converter's settling time to within 1% of the final value is 17 microseconds from zero to five volts.

Coated. In all, some 11 active devices are used in conjunction with a standard Beckman resistor ladder network. The ladder is not covered by the ceramic lid of the package. Instead, it is given a conformal polymer coating after it has been dynamically trimmed.

The switching circuitry consists of two series 930 diode-transistor logic IC's—digital devices—that perform the analog switching. In contrast, Smith explains, "When you think of the usual R-2R network, you probably have two transistors— analog devices—switching a resistor, and drive circuitry driving the two transistors pretty hard to insure base current drive, plus some kind of buffer to get the noise rejection and system compatibility with DTL and TTL inputs." The Beckman design has the DTL devices handling both this input logic interface and analog switching.

The four models of the 845 have outputs of 0 to +5 volts and 0 to +10 volts for the unipolar version, and -5 to +5 volts and -10 to +10 volts for the bipolar models of the d-a converter.

Current boost. The unit uses an eight-bit binary input word with an enable line and standard DTL input levels. The output current is 0 to 2.5 milliamperes for all models, with provision to extend this with an external power amplifier. Smith says such an arrangement, using Beckman's own model 823 amplifier, could boost the output to 200 milliamperes, which is enough to have the circuitry drive a light pen oscillograph.

The 845 is available from stock.

Beckman Instruments Inc., Helipot Division, 2500 Harbor Blvd., Fullerton, Calif. 92634 [429]

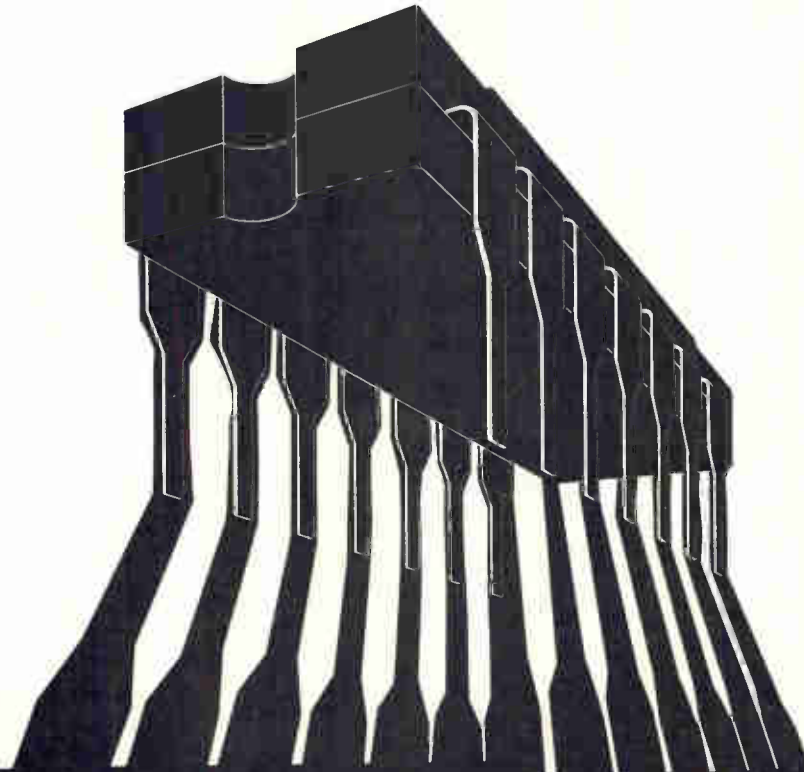

***NOW GET CERAMIC TTL
FOR THE PRICE OF PLASTIC***

**Specify ITT Series 7400
and Series 9000 Circuits**

Last time you ordered TTL circuits, you had to choose between the reliability of ceramic packaging and the economy of plastic. Now you don't have to make that choice anymore.

ITT will ship you ceramic dual in-line 7400 series and 9000 series circuits immediately—at a price competitive with plastic. Ceramic 5400 series circuits are only slightly higher than their plastic counterparts. These are top quality circuits, 100% DC and dynamically tested before shipment. They're mechanically and electrically compatible with the Series 7400 and Series 9000 circuits of other manufacturers. Don't make a trade-off between price and reliability—let your ITT salesman or stocking distributor show you how to avoid it. ITT Semiconductors is a Division of International Telephone and Telegraph Corporation, 3301 Electronics Way, West Palm Beach, Florida 33407, Phone 305/842-2411.

semiconductors **ITT**

FACTORIES IN FLORIDA • MASSACHUSETTS • ENGLAND • FRANCE • GERMANY • PORTUGAL • AUSTRALIA

To whom
it may concern:

We'd like to
take this
opportunity
to inform you
that your
present
signal
generators
have just
become
OBSOLETE!

SINGER
INSTRUMENTATION

Data handling

Put your display on television

Raster links data source
to monitor without
complex interfacing

The design engineer seeking to use any standard 525-line tv monitor for a numeric/symbolic readout without tackling complicated interface electronics might end his search in Hauppauge, N. Y. Applied Digital Data Systems is offering a static raster display, the SRD-100, that it says can be linked to any system as easily as an indicator-tube display.

Furthermore, the company says, the SRD-100 offers unusual flexibility, due to the nature of the device itself and of its readout. The SRD-100 features background reversal, three character sizes and the ability to blink—all controlled independently on a line-by-line basis. And use of the monitor, in addition to yielding high data density and legibility, permits display at many remote locations as well as at the originating point.

Conversion. The SRD-100, using large-scale integration, accepts direct binary-coded-decimal input signals from any digital data source, converting them into a composite video signal. It then displays the data at any of 160 character positions on the monitor; the arrangement is in 10 lines, with 16 characters per line. Each character location has a four-wire binary input that's compatible with standard integrated-circuit levels or contact closures.

The company, which expects the SRD-100 to be the first of a line of display and communications products using LSI technology, is aiming the new device at users of automatic test equipment, process control, automation, and data-acquisition systems.

The basic SRD-100 is priced at \$995. The user must supply his own tv monitors.

Applied Digital Data Systems, 89 Marcus Blvd., Hauppauge, N.Y. 11787 [430]

and here's the one
that replaces
them all.....*

the Singer SG-1000

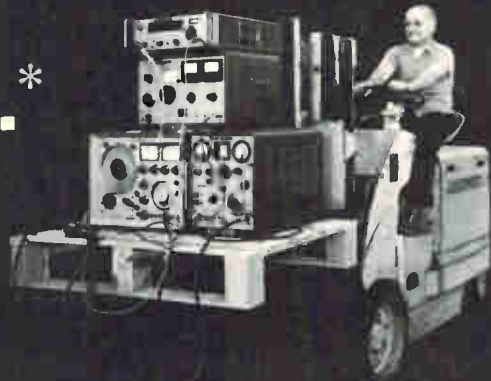

The New SG-1000 outperforms all other signal generators from LF to UHF (singly or in combination)

The new Model SG-1000 Signal Generator has obsoleted all others within its frequency range... singly or in combination. The specifications of this 5¹/₄" high instrument are unequalled... and are rarely approached.

- LF to UHF coverage... 61 kHz, to 512 MHz, extendable to 1024 MHz with simple passive doubler
- Output frequency is read directly on three digit display with two digit extension
- Unsurpassed frequency accuracy and resolution... typically 0.005%... without the commonplace problems of human error in readout.
- Unparalleled modulation capability, AM, FM, pulse, video (100 MHz bandwidth!)

simultaneous combinations such as AM/FM, FM/pulse, etc. with negligible interaction

- Automatic leveling... within ± 0.25 dB over *entire* frequency range from +20 dBm to -146 dBm
- Doubles as a frequency counter for measuring external signals between 100 Hz and 2 MHz

And if you are still not convinced that the Model SG-1000 has obsoleted most of your present signal generating equipment, consider the fact that its spectral purity approaches that of a crystal oscillator... that it has negligible warm-up drift... *no* "settling time" after band switching... and many other performance features not found in ordinary generators.

For additional technical information, or for Singer's new Application/Data Bulletin SG-10, contact your nearest Singer Field Representative or write directly to The Singer Company, Instrumentation Division, 915 Pembroke Street, Bridgeport, Conn. 06608. (203) 366-3201. *In Europe contact:* The Singer Company, Instrumentation Division, P.O. Box 301, 8034 Zurich, Switzerland, Telephone: (051) 47 25 10

SINGER

INSTRUMENTATION

*Hewlett-Packard Models 608F, 606A and 5245L/5253B. / Marconi Model 1066B/6, Pin Diode Modulator, Coaxial Switch

Read-write memory dissipates only 315 mw

Cells in 64-bit unit are kept to 40 mils square;
small geometry yields 45-nanosecond access time

Competition is hot in the semiconductor memory field, and the two leading contenders are metal oxide semiconductor arrays in the read-only camp, and bipolar arrays in the random access or read-write sector. The latest entry is a 64-bit random access memory from Raytheon Semiconductor.

The memory, designated the RR6100, initially will be packaged

by wire-bonding the chip to the can, says Mel Snyder, manager of marketing and product planning. "By December we will have beam-lead devices available," he predicts.

Bipolar memories are faster than MOS devices and are preferred for read-write units. But bipolar memories have a drawback—power dissipation. Raytheon has found a way to reduce this. "By operating

the device at $3\frac{1}{2}$ volts instead of 5 volts, power dissipation is reduced from 450 milliwatts to 315 mw," says Charles Schmitz, Raytheon's digital products development manager.

Schmitz says that the RR6100 also offers advantages over other bipolar devices, principally speed and reliability. "Because we use only one layer of metalization, our

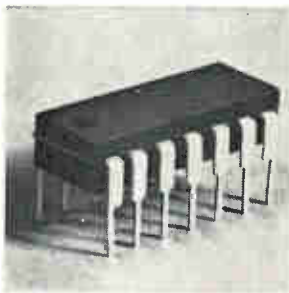

Monolithic IC TAD100 contains all the active components for a complete a-m radio receiver: oscillator, mixer, i-f amplifier, detector, agc, and audio preamp and driver stages. A-m sensitivity is 50 μ v/meter for 100 mw audio output. Agc range is 65 db for an audio output change of 10 db. Total harmonic distortion is 2%. Amperex Electronic Corp., Slatersville, R.I. 02876 [436]

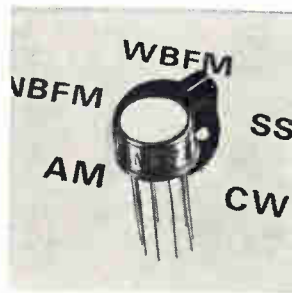

Multiple-mode, monolithic i-f strip LM373 is for a-m, f-m and ssb i-f applications as well as broad-band video amplification. It can serve nearly all radio users by incorporating those subsystem functions which may be changed with a few external connections from duties required of one mode to those of another. National Semiconductor Corp., San Ysidro Way, Santa Clara, Calif. [437]



Package outlines DO-5 and DO-3 now include 50-watt silicon zener diodes in voltage range from 6.8 to 200 v. The DO-4 package outline houses the 10-watt diffused silicon power regulator in voltage range from 6.8 to 200 v. The three devices are designed for the power supply market and meet the most stringent MIL specs. Solitron Devices Inc., 256 Oak Tree Rd., Tappan, N.Y. [438]

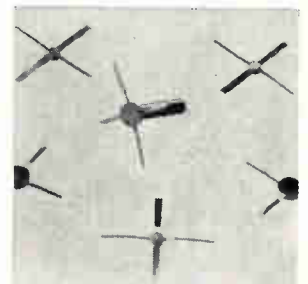

Low noise, high gain, npn epitaxial silicon microwave transistors come in three types. The input stage, model AT-101, typically provides 4 db noise figure and 10.5 db gain at 2 Ghz. The intermediate-stage AT-201 can deliver 10 dbm of linear output power at 2 Ghz. The output-stage AT-301S operates linearly at 17 dbm. Avantek, 2981 Copper Rd., Santa Clara, Calif. 95051 [439]



Megawatt avalanche rectifier types 17S04 through 24S16 can deliver $\frac{1}{4}$ million watts to a load from a single junction. The series features 170 and 240 amps and 400 to 1,600 v, hard solder construction, with forward and reverse polarity capability. Price ranges from \$10.60 to \$49.50 depending on type and quantity. Helios Semiconductor Co., 500 Dyer Rd., Santa Ana, Calif. [440]

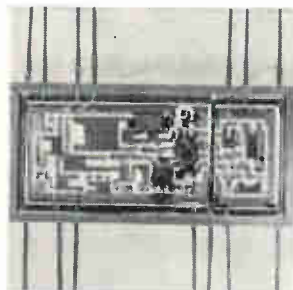

Film hybrid clock driver MS301 is a 20-Mhz device that can drive up to 15 SUHL II or equivalent-type flip-flops. It has multiple ground leads, internally connected bypass capacitors, and pin arrangement permitting convenient mounting near the flip flops to be driven. Size is 0.815 x 1.725 x 0.150 in. Sylvania Electric Products Inc., 100 First Ave., Waltham, Mass. [441]

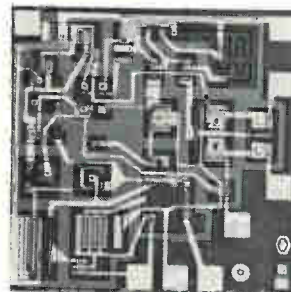

IC operational amplifier UC4101A has a guaranteed low offset current of 20 na maximum over a temperature range of -55° to $+125^{\circ}$ C. Design permits operation with ± 5 to ± 20 v power supplies. Typical applications include inverting and noninverting linear feedback amplifiers, and voltage follower stages. Union Carbide Semiconductor, 8888 Balboa Ave., San Diego, Calif. 92123. [442]

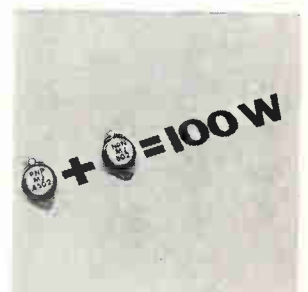

Complementary silicon transistors, the pnp MJ4502 and npn MJ802, are suitable for audio amplifiers of up to 100 w output. They have high d-c current gain of 25 to 100 at a collector current of 7.5 amps and a collector voltage of 2 v. Prices are \$5.50 for the MJ4502 and \$5.10 for the MJ802 in quantities of 100 to 999. Motorola Semiconductor Products Inc., Box 20924, Phoenix [443]

Our 5-band carbon comps are cats of a different stripe



Okay, so the other leading brand is also great on military specs. But our Speer resistors have still more to offer. □ They provide superior soldering characteristics. They're backed by the first and most sophisticated on-line computerized resistor quality control system. They're delivered in an exclusive foil pack. □ And they're accompanied by written documentation. □ Another helpful note—both our ½-watt and ¼-watt types qualify under the new Established Reliability Specification at the S level. □ Our 4-band carbon comps are something special, too—particularly now. They offer all of our traditional quality features—plus competitive prices. □ To learn more about our resistors—and the reliable customer service that backs them up—write AIRCO SPEER ELECTRONIC COMPONENTS, St. Marys, Pennsylvania 15857. □ Five "stripes" or four—you may even decide we're a whole new breed.

The passive innovators at **AIRCO** Speer

Speer resistors □ Resistor and conductor paste □ Jeffers JC precision resistors □ Jeffers JXP precision resistors and networks □ Jeffers inductors □ Jeffers capacitors □ PEC variable resistors and trimmer potentiometers.

In servo use, Waters' exclusive new MystR Conductive Plastic delivers "Second Generation" pot performance • Infinite Resolution • Resistance Ranges from 10 ohms to 5 megohms • Excellent Linearities • Output smoothness, less than 0.1% • Rotational Life upwards from 10 million cycles • Dither life in excess of 400 million cycles • Operational temperature to 150°C • Hysteresis <0.25°. From Waters now — a complete line of MIL Spec rated precision potentiometers, standard or custom, wire-wound, linear or non-linear or with MystR Conductive Plastic. Also Trimmers and Torque Measuring Devices.



WRITE FOR NEW CATALOG

Waters' MystR®

the new conductive plastic
puts muscle where it matters in Servo Pot Performance

MIL-R-39023



WATERS

WATERS MANUFACTURING, INC./ WAYLAND, MASSACHUSETTS 01778

yields are higher and the device is more reliable—there are no cross-overs. And the memory is faster—45 nanoseconds access time—because of the small geometry of the cells—40 mils square.”

Raytheon hopes the RR6100 will become an industry standard in the scratchpad memory field; they also will try to enter the main memory or main frame area by reducing the cell size to 10 mils square, which, according to Schmitz, will yield even faster operation than the present device achieves. In addition, the reduced size of the memory is expected to broaden applications.

The RR6100 is offered in a 16-pin, dual in-line package that contains the memory cells, decoding logic, and sense and write amplifiers on a monolithic chip. By the end of the year, multichip arrays with beam lead chips also will be available from the Raytheon division in Mountain View, Calif.

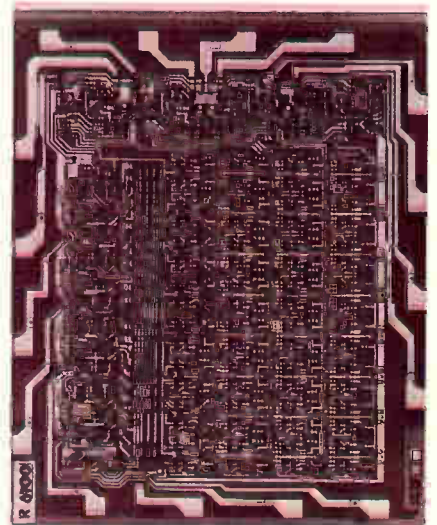

Storage chip. The 64-bit memory, now wire-bonded to a can, will be in a beam-lead package later this year.

These will include a 256-bit memory (four chips with a 64-word, four-bit capacity) and a 512-bit unit that will have 128 four-bit words. The 256-bit unit will not have a chip decoder, so an external one-out-of-four decoder is needed. The 512-bit unit will contain a one-out-of-eight decoder and for a user who wants even larger arrays, Raytheon will supply a one-out-of-16 decoder.

Product manager Schmitz ex-

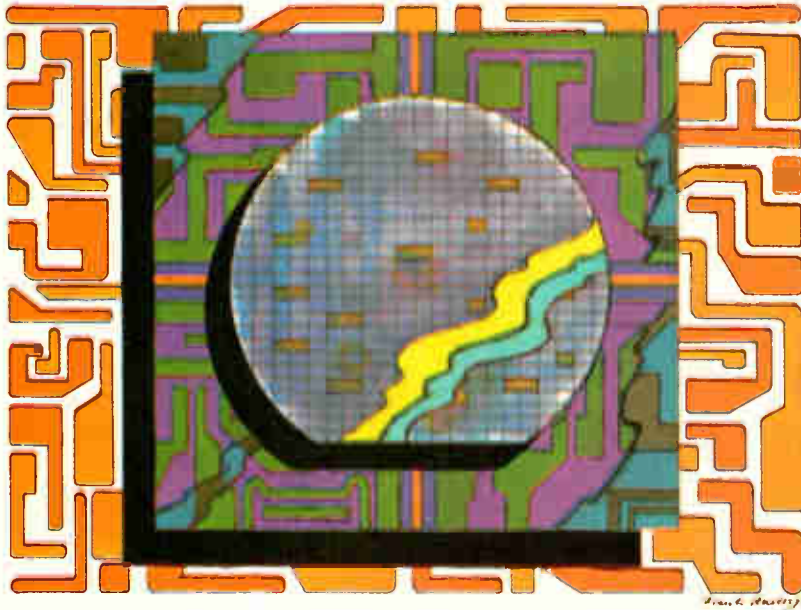

MOS / LSI WAFERS

Here's your opportunity to take advantage of MOS/LSI in new equipment designs without getting involved in lengthy negotiations, high costs, design compromises and next year deliveries!

If you're doing microelectronics design, MOS/LSI implementation can be easier than you think... without building a semiconductor facility within your plant you perform the tasks that best enable you to add value to your final product.

Cartesian's MOS/LSI lets you re-assume design responsibility and perform those manufacturing operations which you can easily handle. We take care of mask-making and wafer fabrication.

From your layout, we prepare masks and produce prototype wafers in quantities of ten for about \$100 each plus cost of mask-making... production-run quantities for less. We guarantee integrity. Turn-around time is normally five weeks, less if you provide masks. No design compromises unless you make them.

No subordination to the demands of semiconductor companies, no loss of proprietary design rights, and no staggering costs. Sound interesting? Write for a free copy of our MOS/LSI Implementation Guide and see how easily you can take advantage of the opportunities in MOS/LSI!



CARTESIAN, INC.

10432 NORTH TANTAU □ CUPERTINO, CALIF. 95014 □ PHONE (408) 257-0481

What happened when doctors and engineers got together.

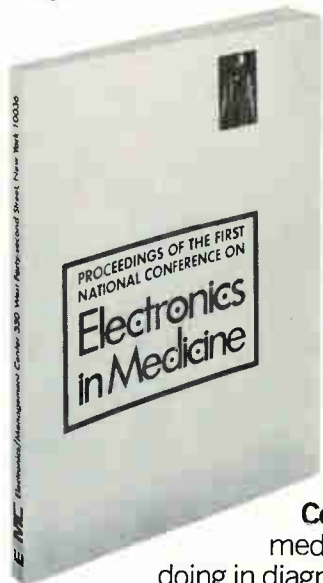

Doctors told engineers how they were using electronics and revealed their most urgent needs. Engineers described and demonstrated their newest equipment for diagnosis, treatment, and prevention. And hinted at things to come.

Their complete dialogue, with illustrations, makes pretty informative reading on a vital and growing market.

Here are some of the things it contains:

Computers: How they're joining the medical team. What computers are doing in diagnosis. In communications. The small computer as a paramedical aid.

Instrumentation: What's needed. What's available. Patient management. Protection. Standards and safety.

Electronics in the Hospital: The surgeon, the hospital, the instruments. What the administrator wants. Prescription for large-scale health care. The surgery department.

Electronics/Management Center
330 West 42nd Street, New York, N.Y. 10036

Enclosed is \$12 for a copy of the Proceedings of the First National Conference on Electronics in Medicine.

Send the Proceedings and bill me later. P.O. # _____

Name _____

Company _____

Address _____

City _____ State _____ Zip _____

plained that some customers have hybrid integrated-circuit facilities and that they might want to buy just the memory chips and the decoders (all of which will be beam-leaded) and assemble complete memories themselves. "All they have to do," says Schmitz, "is wire together all of the address lines, write inputs, write enable lines and data lines, and connect the chip enable lines to the decoder."

The RR6100's operating temperature range is 0° to 70°C and it will sell for \$38 in quantities of 100. The RR5100 operates in a range of -55°C to 125°C and costs \$51.50. Delivery is slated for the beginning of October.

Raytheon Semiconductor, 350 Ellis St., Mountain View, Calif. [444]

New semiconductors

Motorola puts its mark on MOS

Triple 66-bit shift register is first in new line of complex IC's

Seeing a chance to cut its teeth on complex MOS shift registers, Motorola accepted an invitation from the Burroughs Corp. to develop a triple 66-bit metal oxide semiconductor shift register. The invitation went to eight semiconductor manufacturers, and to date, it appears that American Micro-systems Inc. is the only firm delivering the part to Burroughs. Motorola, however, is offering its version for sale as a standard product.

The MC1141G dynamic triple 66-bit unit is the third MOS product, and the first shift register, introduced by Motorola's Semiconductor Products division. Michael Boho, a product marketer at Motorola, says the company wanted to try for greater complexity than the 25-bit and dual 25-bit devices that are now available from a number of MOS suppliers.

The MC1141G is actually a triple 64-bit unit, with two extra bits used to tag the end of a 64-bit

Parker Power

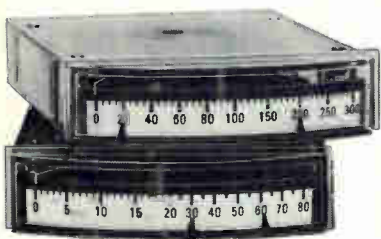

**our tough, reliable
Control Meter!!**

the ER-35

Complete control functions in minimum space, at minimum cost, retaining advantages of maximum readability and reliability. Design simplicity and standard options give you total flexibility in design and application.

the E-35

Matching indicator for use with ER-35 Control Meter when read-out only is required. Same appearance and panel cutout for uniform panel appearance.

Parker Instrument

A growth company dedicated entirely to manufacture and sale of Panel, Edgewise, and Control meters.



PARKER

INSTRUMENT CORPORATION
200 Harvard Avenue • Stamford, Connecticut 06904
Telephone (203) 325-4361 • TWX 710-474-2277

word. The circuit is designed for sequential digital applications such as buffer memories, and it requires a standard two-phase clock. Each of the three registers employs an independent input and output, with common supply and clock lines. Each register contains a single-ended output buffer. The output is delayed 66 bit times from the input and inverted.

Boho says the unit, labeled Motorola's first significant MOS product, "represents the top of the iceberg" in terms of MOS development at the division. "We chose to introduce this one because the market is there, and there aren't a dozen competitors," he adds.

Gates on the way. The MC1141G is a p-channel enhancement device. In the first quarter of next year, Motorola will introduce several gates and flip-flops using complementary MOS (p channel and n channel).

The MC1141G has 1,191 MOS FET's forming the equivalent of 396 gates and will sell for \$21 in quantities of 100 or more.

An external resistor makes the register's output compatible with diode- and transistor-transistor logic levels. It features a power dissipation of 1 milliwatt per bit at 1 megahertz, and is designed to operate from 10 kilohertz to 1 Mhz over the 0 to +75°C temperature range.

Information can be loaded at the input any time during the clock's logic one pulse. Boho says that Motorola recommends a minimum of 100 nanoseconds between clock pulses to assure the clean transfer of information from one stage to the next. The minimum clock pulse width is 230 nsec. The MC1141G uses a ratio rather than a ratioless construction. With the latter, Boho says, information can be moved faster, but the clock input capacitance goes up from the typical 80 picofarads required for the Motorola unit.

Maximum ratings for supply, clock, and data input voltages are all -30 to +0.3 volts, direct current. Maximum logic output delay is 400 nsec. The register is housed in a 10-pin, low-profile TO-5 can, and is available from stock.

Motorola Semiconductor Products Inc.,
Box 20912, Phoenix, Ariz. 85036 [445]

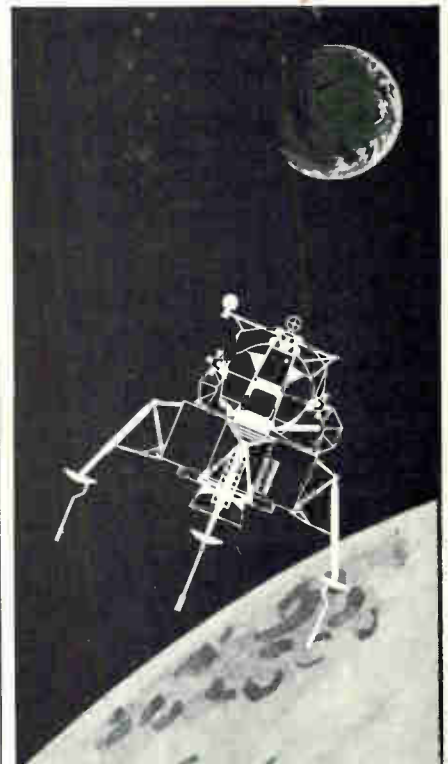

PARKER: FIRST ON THE MOON!!

**Reliable - Compact - Rugged
but above all RELIABLE!**

For the Apollo 11 moon-landing mission a Parker instrument was selected to provide oxygen quantity indication for the astronauts' Portable Life Support System.

*History's greatest demand
for absolute reliability.*



PARKER

INSTRUMENT CORPORATION
200 Harvard Avenue • Stamford, Connecticut 06904
Telephone (203) 325-4361 • TWX 710-474-2277

How Small is Big Enough?

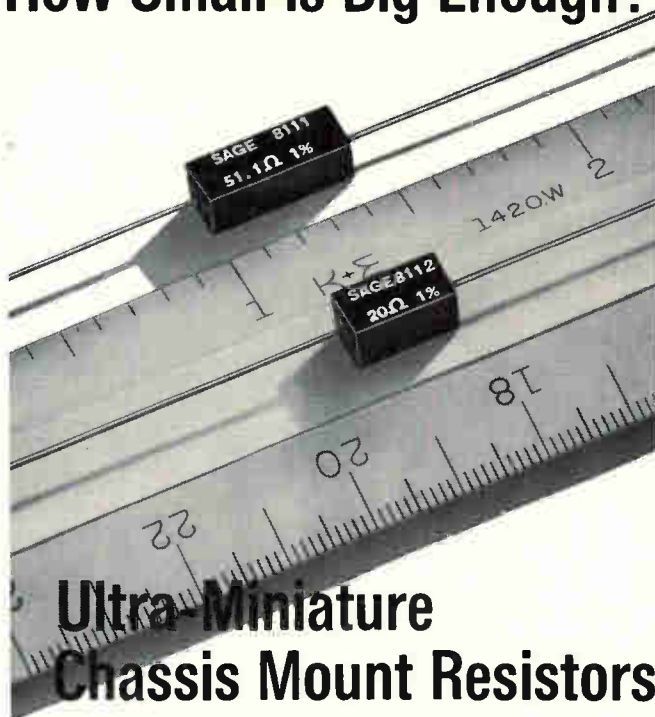

Ultra-Miniature Chassis Mount Resistors NEW from SAGE!

PROBLEM: To produce, for aerospace application, out-board resistive components for use with hybrid and/or integrated circuits which combine minimum size with maximum efficiency and reliability; also to provide mounting ease and flexibility using component clips, clamps or high temperature epoxy bonding materials

SOLUTION: The new Sage Ultra-Miniature Chassis Mount Resistors shown here!

STYLE 8111: 7 WATTS CHASSIS MOUNTED—3.5 WATTS FREE AIR—LESS THAN 0.015 IN³ VOLUME

STYLE 8112: 5 WATTS CHASSIS MOUNTED—2.5 WATTS FREE AIR—LESS THAN 0.009 IN³ VOLUME

Part	Length	Width	Height	Standard Ranges Resistance
8111	0.430" ± 0.015"	0.156" ± 0.005"	0.165" Max.	.05Ω-13KΩ
8112	0.305" ± 0.015"	0.156" ± 0.005"	0.165" Max.	.05Ω-6KΩ

ACCURACY: Tolerance to ± 0.05%

PERFORMANCE: Meet or exceed all applicable requirements of MIL-R-18546

Free air rating is based on maximum surface hot spot temperature of 275° C.

Chassis mount power rating is based on maximum surface hot spot temperature of 150° C when mounted on 4" x 4" x 0.040" aluminum chassis.

For complete engineering data on these new Sage achievements in miniaturized electronic products, write . . .

**SAGE ELECTRONICS CORP. • BOX 3926
ROCHESTER, N. Y. 14610 • Phone: (716) 586-8010**

Precision Power Resistors

SAGE
ELECTRONICS
SUBSIDIARY OF GULTON INDUSTRIES, INC.



New semiconductors

MOS kits produce display signals

Memory units can control horizontal, vertical scan, are compatible with TTL

Ready-made character generators are provided by two metal-oxide semiconductor read-only memory kits that produce control signals for digital data displays.

Marketed by National Semiconductor Corp., the three 1,024-bit monolithic memories in each kit are preprogrammed to convert standard communications code words into raster scan or vertical scan control signals.

The memories will accept inputs from transistor-transistor logic integrated circuits for high-speed display systems.

Each kit stores 64 standard 5-by-7 alphanumeric symbols. The kit designated SK0001 is programmed so that the 6-line ASCII input will select the desired symbol and generate seven 5-bit horizontal lines. The output can be used to control raster-scanned cathode-ray tubes and other horizontally scanned displays.

Kit SK0002 generates five 7-bit vertical columns suitable for crt's, tape printers, billboards, moving-light tickers, and other displays that require vertical scan techniques.

Each memory will operate in less than a microsecond on 12-volt supplies. Both kits are tested for TTL compatibility over the temperature range of 0° to 70° C. The SK0001, available in a 16-pin hermetic dual in-line package, is priced at \$120 each in lots of 1 to 24, \$96 in lots of 25-99, and \$80 each for 100-999. The SK0002, manufactured in a 24-pin hermetic dual in-line package, sells for \$150 in 1-24 lots, \$120, 25-99; and \$99, 100-999. Memories programmed to generate special symbols are available on special order.

National Semiconductor Corp., 2975 San Ysidro Way, Santa Clara, Calif. 95051 [446]



**If our new modem
lets an error
slip through,
it's one in a million.**

Now you can drastically reduce data transmission errors without sacrificing speed. With the new IBM 4872 Digital Modem.

It has an error rate of only one in a million bits when transmitted at 4800 bits per second over C2-conditioned telephone lines.

The 4872 shapes the signal so that it uses only 2400 Hertz bandwidths. It fits right in the center of the telephone channel.

No special installation is necessary with the 4872, and it has an optional voice order wire for initial tuning.

With all these features, the 4872 is still small enough to fit in the same space used by many 2400-bit-per-second data sets.

So let us tell you more about the new modem. There's about a million good reasons you'll be glad you did.

IBM®

IBM Marketing Information, 18100 Frederick Pike
Gaithersburg, Maryland 20760

- Please rush me more facts about the IBM 4872 modem.
- Please have a marketing representative call on me.

Name _____

Title _____ please print

Company _____

Address _____

City _____ State _____ Zip _____

METALIZED POLYESTER CAPACITORS

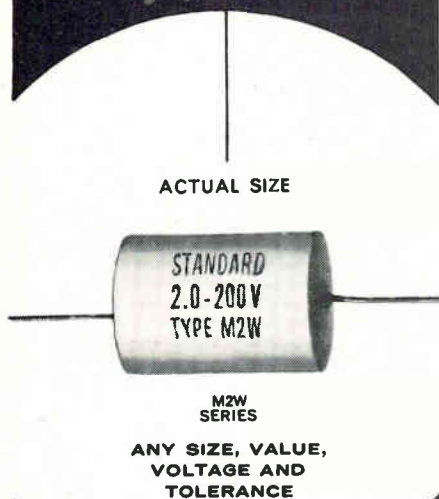

to your exact
specifications...
at stock prices

Unique, self-healing units that remain in circuit during voltage surges with little or no loss of electrical properties. Use the M2W's where size and weight are limiting factors and long life and dependability are required. The units utilize metalized Mylar* Dielectric with film wrap and custom formulated epoxy resin end fill. Available in round and flat styles.

*Du Pont Trademark for Polyester Film

Samples available on
your letterhead request



Dept. EL-9, 1065 W. Addison St.,
Chicago, Ill. 60613 • 312-327-5440

New Books

Reactor CAD

Computer-Aided Design of Magnetic Circuits
Alexander Kusko and Theodore Wroblewski
MIT Press, 114 pp., \$6.95

How accurately a designer describes a linear or nonlinear device to a computer can make the difference between a high-performance circuit and a mediocre one. Bad models often yield inaccurate results.

Some circuit elements, such as resistors, can be presented to the computer quite readily. But reactors, leakage-reactance transformers, and regulating transformers are not linear, and their reactions to temperature and frequency are difficult to describe mathematically.

The authors of this book stress the practical side of designing these components into magnetic circuits and describe how such circuits can be applied to industrial equipment. They draw on work done in Sylvania Lighting Products' magnetic components department.

The design goals are presented first, followed by a description of all necessary assumptions, equations, and accurate models for magnetic nonlinear devices. The authors offer methods for handling the interface between the various connected electrical circuits and the sequence of steps needed for computer-aided design. Finally, they show, through a series of flow diagrams, how the computer indicates the typical input and output forms in use.

The chapters are arranged so that the simplest magnetic-circuit device—the reactor—is described first, followed by leakage-reactance transformers. The final chapter covers conventional multiwinding transformers. Theory and modeling are treated for each class of device, followed by numerical examples and the approach to CAD. Many examples are oriented toward lamp ballasts, because their magnetic-circuit operation is realistically complex and because most of the programs were prepared for their design.

The computer programs presented in the book originally were developed by the authors for industrial use in reducing design time for new transformers, exploring new magnetic-circuit configurations, and obtaining more accurate designs to reduce cut-and-dry work on prototypes. To accomplish this, considerable preliminary work was necessary to develop analytical techniques and mathematical models for the magnetic and electrical circuits in which they were placed. The mere transfer of hand-design methods to computer programs would not have yielded useful and realistic CAD methods.

Overview

Computer Graphics, Techniques and Applications
R.D. Parslow, R.W. Prowse, and R. Elliot Green
Plenum Press, 247 pp., \$9.60

In July 1968, an international computer graphics symposium was held at Brunel University in Uxbridge, England. Twenty-two authors presented papers at that conference; although most of the papers were British, four were from the European Council for Nuclear Research (CERN) in Geneva, Switzerland, and five were from U.S. firms.

Collectively, the papers provide a good general review of computer graphics. However, the editors would have done well to strive for more unity and sophistication in their collection. If anything, their failure to do so is a disservice to the reader.

For example, one author describes in great detail how a cathode-ray tube works. But another rhapsodizes on ring structures in software while giving only the sketchiest definition of a ring structure. The latter author also uses an example involving the bending moment of a beam that tends to be fuzzy to all but those who are familiar with bending moments.

There's a chapter on interactive software techniques that describes the many things software can do in an interactive system, but fails



The Ultramation Machine: A real-time computer that's more than just a mainframe.

Most computers start and end with a mainframe.

The Honeywell DDP-516 just starts there.

For example, you get one of the widest choices of peripherals and subsystems offered today.

The latest: a Data Acquisition and Control Subsystem that lets laboratory operators link the computer to remote sensors, control elements, and instrumentation.

The 516 is only one member of a family of compatible 16-bit computers: Honeywell's Series 16. So if you've been working with the 116, 316, or 416, you can bring all your software along . . . and all your experience, too. (More than 500 programs developed on Series

16 computers are available for use on the 516.)

We've been working with hundreds of DDP-516 applications: Data concentration in reservation systems for almost a dozen airlines. Teamed with other Honeywell instruments in automated medical research and intensive care systems. Operating in severe environments in the ruggedized version. Time-sharing . . . Simulation . . . Data conversion . . . and many more. So we know exactly what the DDP-516 can do.

Want to know more about the computer that's more than just a mainframe? Get our new DDP-516 literature kit. Honeywell, Computer Control Division, Old Connecticut Path, Framingham, Mass. 01701.

Honeywell



Bunker-Ramo converts operational requirements to production hardware



BR-700 Information System providing off-line storage and retrieval



Militarized Automatic Map Compilation System



BR-850 Cyclic A/D Converter for video and other high speed requirements

Bunker-Ramo's Defense Systems Division has demonstrated its capability to convert operational requirements into advanced electronic equipment.

Here are significant examples:

The BR-90, combines electronic and photographic displays with stored-program control . . . BR-700, low-cost solution to source-data automation and local data management . . . UNAMACE, a computer-controlled system that automatically

prepares orthographic maps from aerial photographs . . . new techniques which provide faster data acquisition systems using high-speed cyclic analog-to-digital converters . . . new techniques leading toward low power, low cost MOS micro-electronic digital equipment.

If your project requires either special-purpose product design or large-scale systems engineering — or both — contact Bunker-Ramo.

 **THE BUNKER-RAMO CORPORATION**
DEFENSE SYSTEMS DIVISION
8433 FALLBROOK AVENUE • CANOGA PARK, CALIFORNIA 91304

AN EQUAL OPPORTUNITY EMPLOYER

New Books

to tell how software does them.

Tradeoffs are discussed in an excellent chapter that shows great insight into the variables involved in designing a display system. And a chapter on low-cost graphics is quite good; but in light of the developments over the year or so since the paper was presented, the costs quoted are largely obsolete.

One of the juiciest quotations in years is to be found in the chapter on graphical computer-aided programming systems. The author says that when preparing a job for computer solution, the initial stage, or job breakdown, isn't done by the programmer, but instead by the manager or systems analyst. Consequently, what should be the second step—a feasibility test of the initial breakdown—usually is left until the last. "Worse than that," he points out, "because the manager performs the first step and the programmer does the testing in the last step, it's a simple rule of promotion that there are no errors in the first step. Consequently changes will be made at the wrong level, resulting in the software delays and inefficiencies of which we are all too aware."

There also are chapters on computer graphics in the United States, and in the United Kingdom, and on remote display terminals. The entire second section is devoted to graphics in programming systems, management information, architectural design, research, and other topics. Finally there is a chapter on present research, a list of manufacturers, and a glossary.

Keeping up to date

Electrical Network Theory
Norman Balabanian and Theodore Bickart
John Wiley & Sons Inc., 931 pp.,
\$19.95

Those engineers who have been away from college for the last 10 years will be happy to learn that a new book is now available that presents both analysis and synthesis of electrical networks in one complete volume. The text is a thorough work that includes such

current topics as state variables, graph theory, and scattering parameters—all formerly available in separate texts.

The text evolved from a set of notes used in a beginning graduate course at Syracuse University and at the Berkeley campus of the University of California. Its level permits practicing engineers to benefit because each new subject is carefully developed.

Throughout the book, the authors stress system design by examining its internal and external structure and composition. To do so, they rely on network topology as an important tool for analyzing the internal behavior and block diagrams for the external.

Mathematics are found stressed throughout the text, with matrix algebra, linear graphs, complex variables, and Laplace transforms playing the major roles. The first two are developed within the text, whereas the last two are treated in appendixes. Also treated in an appendix, to strengthen the use of impulse functions, is the topic of generalized functions. Each appendix constitutes a relatively detailed and careful development of the subject treated.

Both analysis and synthesis of frequency and time response problems are the major topics. Both active and nonreciprocal components such as controlled sources, gyrators, and negative converters are treated as well as passive and reciprocal components. Although most of the book is limited to linear, time-invariant networks, there is an extensive chapter on time-varying and nonlinear networks.

The authors were wise not to treat matrix algebra all in one place. What they do is introduce it where it is needed and then apply it in later parts of the book for solving problems. In addition to the conventional topics such as Kirchhoff's laws and two-port networks, the authors have included graph theory, state variables, Bode and Darlington design procedures, and scattering parameters—now quite popular for designing high-frequency equipment.



Convert Your Career Goals To Realities

TECHNICAL SPECIALIST — CRT DISPLAYS

Perform conceptual design & development of future generation, computer-driven display systems and sub-systems.

ADVANCED CIRCUIT DESIGN

High-speed linear circuits including thin-film & monolithic — strong experience in A/D converters, semiconductor components & computer-aided techniques.

Call or Send Resume to:
D. T. Kalal
(213) 346-6000



THE BUNKER-RAMO CORPORATION
DEFENSE SYSTEMS DIVISION
8433 FALLBROOK AVENUE • CANOGA PARK, CALIFORNIA 91304

An Equal Opportunity Employer

**Pulling the nations
of the world
closer together...**

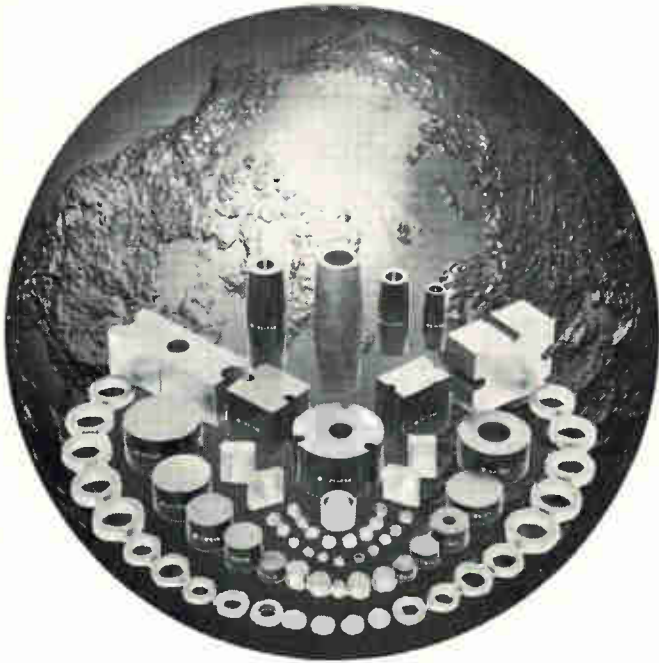

Hitachi Cast Magnets

Today's communications systems could not exist without high-grade permanent magnets. Cast magnets in particular are becoming increasingly important. Hitachi Metals produces some of the best. Cast magnets for microwave communications. Compactly designed and finished to close tolerances. Featuring high coercive force and high energy product plus magnetic field uniformity and stability.

At Hitachi Metals, magnet production is integrated. Backed by decades of experience, and a tradition of quality workmanship. Hitachi Metals makes full use of technology as modern as tomorrow.

The results speak for themselves. In communications equipment around the world.

Typical Hitachi Cast Magnets and Properties

Type	Residual Induction (Br) gauss	Coercive Force (Hc) oersteds	Energy Product (B x H) max. x10 ⁻⁶
HI-MAG I (ALNICO-5-7)	13,500~14,500	700~750	7.0~8.2
HI-MAG II (ALNICO-5-7)	13,000~14,000	680~780	6.8~8.0
YCM-8B (ALNICO-8)	8,800~9,600	1,380~1,500	4.8~5.5

Hitachi cast magnets are also used in meters, generators, motors, telephone equipment, magnetos and many other types of equipment. For further information, please contact:



HITACHI
Hitachi Metals, Ltd.

Head Office
Chiyoda Bldg., Marunouchi, Tokyo, Japan
Hitachi Metals America, Ltd.
Magnet Materials Sect.
437 Madison Ave., New York, N.Y. 10022.
U.S.A. Tel. 212-758-5255



It's never too early to start saving their hearts

Help your children form good health habits now to reduce risk of heart attack later:

- Encourage normal weight; obesity in youth may persist throughout life;
- Build body health through regular physical activity;
- Serve them foods low in saturated fats;
- Teach them that cigarette smoking is hazardous to health;
- Make medical check-ups a family routine.

Set a good example. Follow the rules yourself and guard *your* heart, too.

GIVE...
so more will live
HEART FUND



Contributed by the Publisher

Wanted design engineers by Murata to work with **MICROFORK**

Model **EFM**



Subminiature Piezoelectric Tuning Forks

As low as **\$2.00** per unit

APPLICATIONS:

Page systems; selective call systems; mobil communication; security and fire alarm systems; remote controlled tone operated systems.

SPECIFICATIONS:

Frequency: 360 to 2,900 Hz
 Freq. Accuracy:
 below 1,000 Hz: $\pm 0.5\text{Hz}$
 1,000 Hz & over: $\pm 1.0\text{Hz}$

Input/Output impedance: 300K Ω
 Insertion Loss: 10 dB max.
 TC of frequency: $3.5 \times 10^{-5}/^\circ\text{C}$ max.

DELIVERY:

Pilot run qty... from our NY shelf
 Production qty... 3 weeks

For further information call or write to:

muRata

Murata Corp. of America
 2 Westchester Plaza, Elmsford,
 New York 10523
 Telex: MURATA EMFD 13733Z
 Phone 914-592-9180

Circle 236 on reader service card

New Books

There is a total of 460 problems included in the text. In several chapters some problems are given that require preparation of a computer program even though computer programs are not covered. The authors assume that most readers have a sufficient background.

Recently Published

Logical Design of Switching Circuits, Douglas Lewin, American Elsevier, 368 pp., \$10.50

Designed as a text for courses on logical design and switching theory, this book presents, from an engineering approach, practical ways to design logic circuits. It starts with an introduction to digital numbers and set theory, and advances into the design and implementation of various circuits.

Electronic Switching Circuits—Boolean Algebra and Mapping, Matthew Mandl, Prentice-Hall, 229 pp., \$12.50

Mandl provides an excellent reference for practicing electronics or computer engineers and technicians. He discusses the principles of electronic switching circuits for both combinational and sequential systems, and explains logic circuits and parallel methods with diagrams, maps, Boolean algebra principles, practical applications, and examples.

Solenoid Magnet Design, D. Bruce Montgomery, John Wiley & Sons, 312 pp., \$13.95

A multilevel reference for all types of solenoid magnets. In addition to presenting many of the formulas and design charts needed in a majority of commonly encountered air-core magnet designs, Montgomery discusses the relative importance of design variables through graphs, and examples.

Bioelectric Phenomena, Robert Plonsey, McGraw-Hill, 380 pp., \$17.50

For graduate students with background in the physical sciences and engineering, this book discusses the electrical behavior of biological material in terms of chemical and physical properties. It covers membrane phenomena, and propagated action potential.

Digital Magnetic Logic, David R. Ben- nion, Hewitt D. Crane, David Nitzan, McGraw-Hill, 352 pp., \$15

Along with extensive coverage of its main topic, core-wire all-magnetic circuits, the authors provide a wealth of basic information on related magnetic devices and circuits.

invaluable

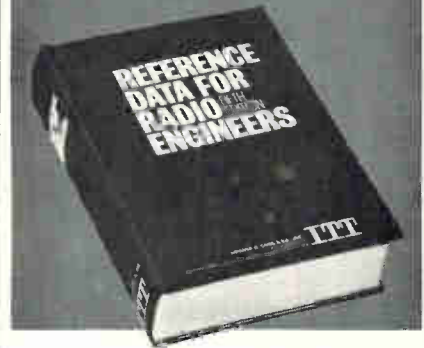

NEW 5TH EDITION OF THE WORLD-FAMOUS Reference Data for Radio Engineers

Now contains 50% MORE DATA to include major information developed over the past 12 years. Prepared by an outstanding group of practicing engineers, professors, and industry and government experts, under the direction of the International Telephone and Telegraph Corporation staff.

OVER 160,000 COPIES SOLD
IN THE FOURTH EDITION

The new FIFTH EDITION of this widely used reference work has been completely revised and updated. It provides in a single volume comprehensive data on all basic phases of electronics, including tables, formulas, standards, and circuit information—PLUS—all-new data on microminiature electronics, space communications, navigation aids, reliability and life testing, international telecommunication recommendations, switching networks and traffic concepts, and quantum electronics. 45 data-packed chapters provide invaluable information for practicing radio and electronics engineers. Includes over 1300 charts, nomographs, diagrams, tables, and illustrations. 1155 pages, plus 41-page index.

10-Day Free Examination

Howard W. Sams & Co., Inc. Dept. EL-9
 A Subsidiary of International Telephone and Telegraph Corp.
 4300 W. 62nd St., Indianapolis, Ind. 46268

Send me REFERENCE DATA FOR RADIO ENGINEERS for 10-day examination, without cost or obligation.

If I decide to keep the volume, I will send:
 \$20.00 (plus postage), or \$7.00 (plus postage) in 10 days, and \$6.50 per month for 2 months. Otherwise, I will return the book postpaid within 10 days.

\$20 payment enclosed. Send my copy postpaid with full 10-day return privilege. (Include sales tax where applicable.)

Name _____

Company _____

Address _____

City _____ State _____ Zip _____

Circle 203 on reader service card

203

SOME ENGINEERS DON'T KNOW WHEN TO QUIT

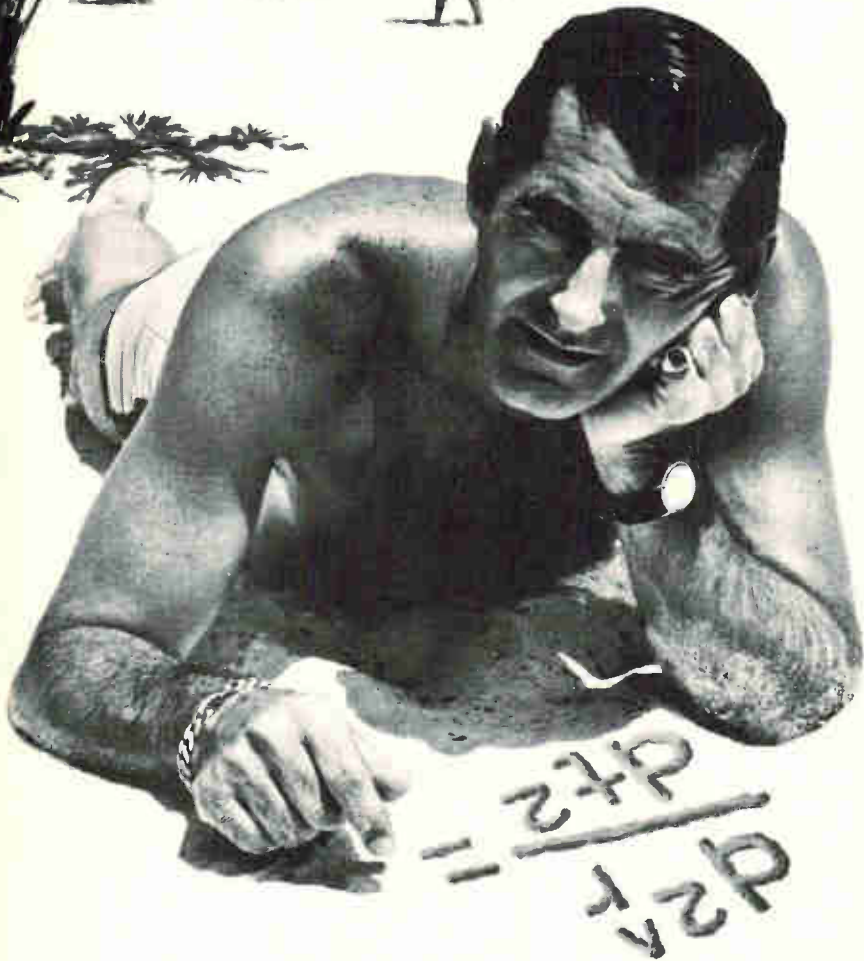

Give a guy a mile of sandy beach as a blackboard and you might find him doing equations from here to the moon . . . thinking about navigation and guidance systems.

At Honeywell-Florida we've got a lot of people who think engineering is an adventure. They create some of the world's most sophisticated equipment . . . computers . . . monolithic subsystems . . . plated wire memories . . . precision components. We give 'em room to think . . .

provide a stimulating environment and then recognize their creative individuality.

We can't promise you can do all your engineering on the beach but we can promise an atmosphere where you'll always have the engineering freedom you need to do something significant. Of course while you're relaxing on the white sand beaches of the Gulf of Mexico you may get some of your best ideas.

If you and your family fit into the Florida picture tell us about your qualifications today. We have great opportunities for engineers with experience in logic, components, integrated circuits, computer memories, circuit or programming analysis, advanced packaging, manufacturing or industrial engineering, materials or quality assurance.

Write now to Mr. Owen S. Spring, Honeywell Inc.
13350 Highway 19, St., Petersburg, Florida 33733.

Honeywell-Florida

An equal opportunity employer

To investigate professional openings in other Honeywell facilities,
send resume to F. F. Laing, Honeywell, Minneapolis, Minnesota 55408.

Technical Abstracts

Simulated inductor

Silicon monolithic gyrator using FET's
R.G. Hove and C.A. Kleingartner
Boeing Co.
Seattle, Wash.

By substituting gyrators for the inductors of an RLC network, the size and weight of a filter can be reduced considerably. Further reduction may be achieved by replacing the conventional discrete components with thin or thick film integrated networks.

The monolithic silicon gyrator provides the required high impedances by using a nonbipolar transistor and a p-channel field effect transistor, both of which are on the same chip. A configuration such as this yields a Q of 450 that can be raised as high as 1,000.

Using two voltage-controlled current sources gives the monolithic gyrator greater frequency range, better stability, and a higher simulated inductor Q than several other designs. One voltage-controlled current source has an output current in phase with its control voltage, while the other has a 180° difference between the output current and the control voltage. To achieve the desired Q, it is necessary to have very high input and output impedances. These high impedances can be achieved by using compatible p-channel FETs for the input stage of each voltage-controlled current source as well as for the collector bias current source of each nonbipolar output stage. Previous designs used npn and lateral pnp bipolar transistors that had the disadvantages of low input resistance, low beta, and large parasitics between the doped material and the substrate.

The IC used for the gyrator was originally designed for universal use in the quick response design of custom linear integrated circuits. Consequently all the components on the chip were not used and an appropriate aluminum interconnection pattern had to be designed. Because the chip isn't specifically designed for use as a gyrator, the results aren't optimum. Further work on the circuit and layout should lead to extended frequency

OPTICAL SCANNING ?

Convert Your TV Camera (or ours) into a highly Versatile computer input device with the CVI model 321 Video Analyser!

Sampling bandwidth compression allows convenient low rate digitization of wide band video signals with line or raster scanning, X-Y-Z point analysis, noise reduction, and other significant operations.



cv*i*

 COLORADO VIDEO, INCORPORATED

P O BOX 928

BOULDER, COLO. 80302

PHONE (303) 444-3972

Video Data Acquisition — Processing — Display — Transmission

Circle 237 on reader service card

Light metal fastening ...without holes



NELSON® end-welded studs are state-of-the-art fasteners for light gauge panels and enclosures. They're installed faster, simpler and at lower in-place cost than any device requiring holes. No drilling, staking, through-bolting, sealing. Locate studs wherever the best design dictates—on steel as thin as .016", .040" for aluminum.

In the example shown, Nelson studs replaced throughbolting and adhesive bonding, returning 105% on the investment in the first year.

Standard stud welders operate at a production rate of 8 welds per minute. Custom engineered, automatic systems can produce up to 45 fastenings per minute. Standard studs, to ¼" diameter, are available from stock.

Get complete design data and specifications in this new brochure.



NELSON STUD WELDING CO.
A United-Carr Div. of TRW Inc., Lorain, Ohio 44055



CANADA Ontario • WEST GERMANY: PECC Boltzschweiss, Gevelsberg, Westphalen

New free facts on "films."

Get the latest data on Mallory film resistors. A complete line. Made by the company with total capability in film resistors. Write, today.

Mallory Controls Company, a division of P. R. Mallory & Co. Inc., Box 327, Frankfort, Ind. 46401.

GENERAL SPECIFICATIONS

MALLORY TYPE	MILITARY TYPE	TEMPERATURE RATING	POWER RATING (WATTS)	RESISTANCE RANGE (OHMS)
Precision Resistors				
MAC 55	RN55	70°C & 125°C	1/8 & 1/10	10Ω-100K
MAC 60	RN60	70°C & 125°C	1/4 & 1/8	10Ω-499K
MAC 65	RN65	70°C & 125°C	1/2 & 1/4	10Ω-1 meg
MAF 55	RN55	70°C & 125°C	1/8 & 1/10	10Ω-100K
MAF 60	RN60	70°C & 125°C	1/4 & 1/8	10Ω-499K
MAF 65	RN65	70°C & 125°C	1/2 & 1/4	10Ω-1 meg
Semiprecision Resistors				
MAL 07	RL-07	70°C	1/4	10Ω-100K
MAL 20	RL-20	70°C	1/2	10Ω-470K
MAL 32	RL-32	70°C	1	10Ω-1 meg
Power Resistors				
2MOL		70°C	2	30Ω-125K
3MOL		70°C	3	40Ω-125K
4MOL		70°C	4	85Ω-125K
5MOL		70°C	5	95Ω-125K
7MOL		70°C	7	125Ω-125K

MALLORY

Circle 238 on reader service card

Technical Abstracts

range and improved temperature characteristics.

Presented at Wescon, San Francisco, Aug. 19-22.

Getting the picture

Wideband transmission of photographic data using IDCSP satellites

Walter J. Gill
Philco-Ford Corp.
Palo Alto, Calif.

Reconnaissance photographs have been sent over an Initial Defense Communication Satellite with resolution of more than 1,000 television lines. Employed was a data-transmission system called Quick Look, which consists of a vidicon camera, control electronics, a delta modulator and frequency-shift-keyed modulator, and image recorder.

In this system, a photograph—either a positive or negative transparency, or an opaque print—is illuminated in a light box and projected onto a storage-type vidicon tube via a shuttered, variable-focal-length zoom lens and a collimating lens. The vidicon's electron beam then slowly scans the image and converts it to an electrical analog wave. Next, the analog signal is passed through a delta modulator, which changes the signal to digital form before it is sent to a multiple-frequency shift keyed modem. The modem's output is a 0.5-megabit-per-second signal. The signal received at the ground terminal is converted back to analog form and displayed on a cathode-ray tube. Digital pulses are transmitted along with the signal to provide frame and line synchronization between the vidicon and the crt. The equipment, developed by the Philco-Ford Corp. transmitted pictures from Hawaii to Washington.

The vidicon's slow scan rate—16 frames per second—allows high-resolution images to be transmitted over existing data links of limited bandwidth. Standard tv rates of 30 frames per second would require a minimum analog bandwidth of 3.6 megahertz for 400-line resolution, and 33 Mhz for 1,200-line resolution. Improved resolution in the Philco-Ford system can be achieved by increasing the

DESK-TOP CIRCUIT DESIGNER

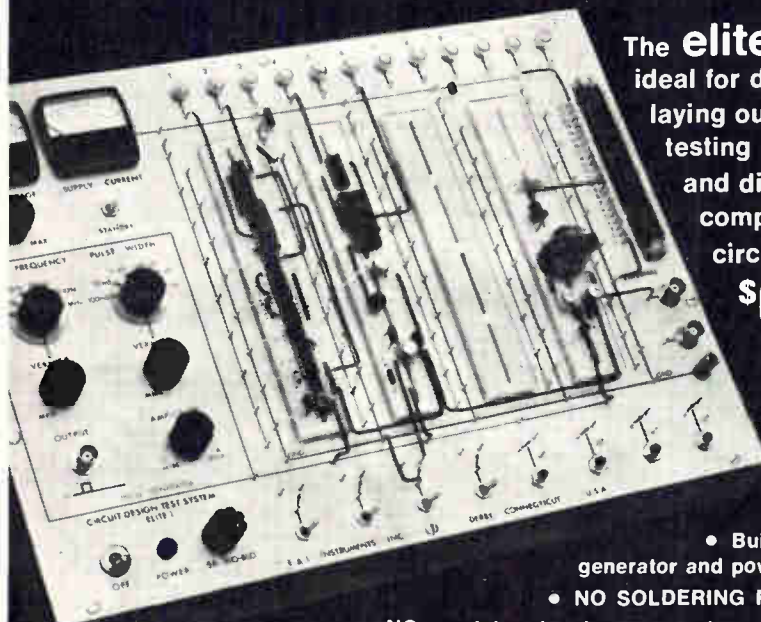

The elite 1 is ideal for designing, laying out, and testing all IC and discrete component circuitry!

\$650
complete

- Built-in pulse generator and power supply
- NO SOLDERING REQUIRED
- NO special tools, plugs or patch cords needed
- Write or phone for complete specifications and catalog



EL Instruments Incorporated

61 First Street, Derby, Conn. 06418 • Phone 203/735-8774

Tech labs 2A* Tap Switch YOU CAN'T BUY

- MORE PRECISION
- LOWER CONTACT RESISTANCE
- HIGHER CURRENT CARRYING CAPACITY
- LONGER LIFE

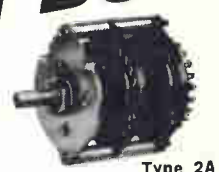

FOR THE PRICE

* Available in remote controlled versions, open or hermetically sealed. SEND FOR FREE CATALOG.

TECH LABORATORIES, INC.
Palisades Park, New Jersey

Circle 239 on reader service card

Flexible circuits

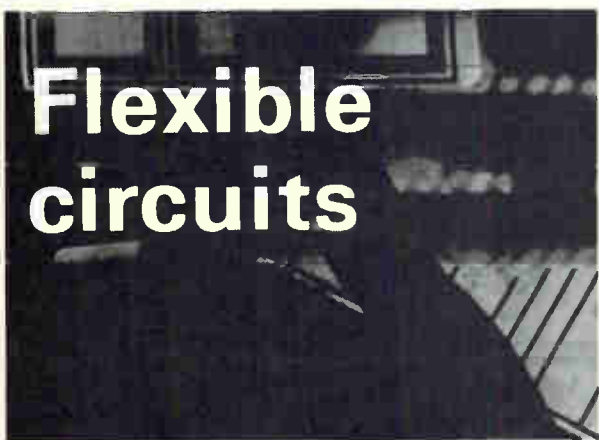

Kapton* or Mylar* flexible printed circuits are a specialty at Buckbee-Mears. We make them to standards of precision unsurpassed in the industry. We produce small wires to two mil apart on four mil centers, sizes up to five feet square. Tolerances held to $\pm .0002$ inches on wires and space, shrinkage control guaranteed.

May we tell you more? See your Buckbee-Mears technical representative, or call or write Bill Amundson, industrial sales manager.

*DuPont trademarks



BUCKBEE - MEARS COMPANY

245 E. 6th St., St. Paul, Minn. 55101 / (612) 227-6371

Circle 240 on reader service card

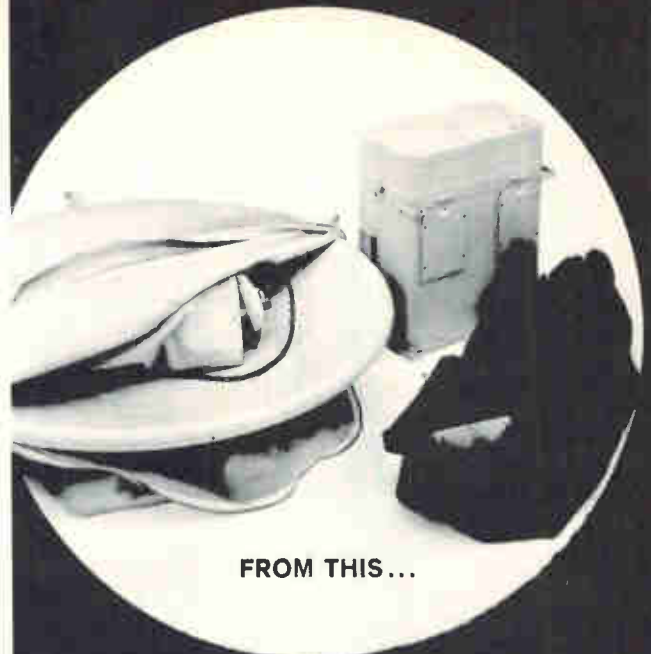

FROM THIS...

RHG OFFERS transportable microwave relay links

Used for the transmission of high speed video data or for real time high quality television, RHG wide band transportable FM relay systems are in operation today for the Navy and Air Force. The model illustrated puts out 20 watts at 7.75 GHz and has a range of 50 miles. RHG also produces Air-to-Air and Air-to-Ground systems for the military described in catalog 983. Or contact Sales Manager for details.

TO THIS
IN 5 MINUTES!

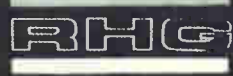
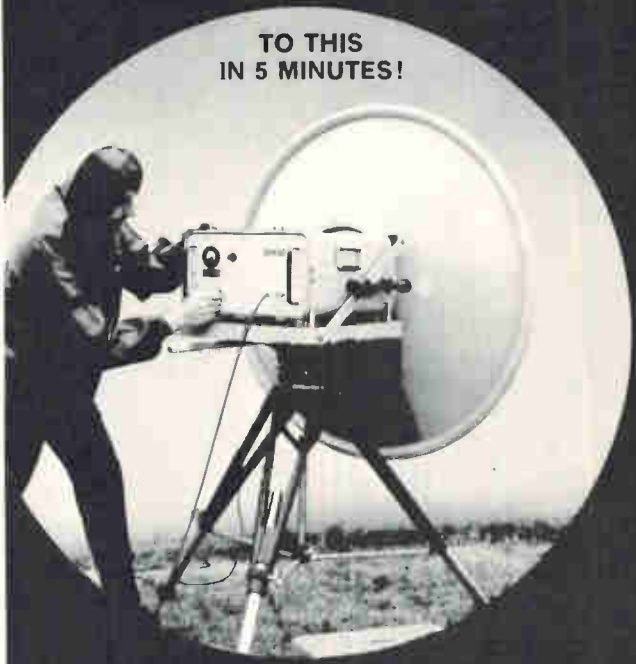

RHG ELECTRONIC LABORATORY - INC.

94 Milbar Blvd., Farmingdale 11, N.Y. 11735 (516) 694-3111

Microwave Receivers Transmitters and Components

Circle 225 on reader service card



**perfect
balance**

**technical
know-how
and
modern
design**

5282

GORDON METERS

Gordon Panel Meters are the result of more than 50 years' instrument experience, plus a combination of superior design features:

- Sparkling clear Lexan® covers
- Alnico self-shielded core magnets
- Sapphire spring-backed bearings
- Easy-to-read scales

For standard off-the-shelf meters, or custom designs tailored to your needs, order Gordon.

FREE GORDON METER CATALOG. WRITE TODAY!

PDC GORDON
A SUBSIDIARY OF

PNEUMO DYNAMICS CORPORATION
5710 KENOSHA ST., RICHMOND, ILL. 60071

Export: 2200 Shames Dr., Westbury, N.Y. 11590
Cable CHURCHIN

Technical Abstracts

zoom lens' focal length so that the 1,000 lines scan a smaller area of the photographic image.

Presented at Wescon, San Francisco, Aug. 19-22.

Variable delays

Solid state microwave acoustic variable delay devices
Ernst K. Kirchner
Microwave Electronics
Palo Alto, Calif.

The increased demand for greater range resolution and higher data rates placed on radar and communication systems will require wide-band, lossless, nondispersive, microwave variable-delay lines. These devices should be capable of variable delays of up to 150 nanoseconds with an instantaneous bandwidth of 500 megahertz in the 500 Mhz to 10 gigahertz range. This microwave variable delay can be achieved by using the interaction of a microwave acoustic wave either with a laser beam or with the magnetic spin waves of a ferrimagnetic material or by using an acoustic delay device in a repetitive pulse memory system. Alternative methods include sliding acoustic crystals relative to one another, and using the acoustic waves in a ferroelectric material.

A unit made for commercial use incorporates the magnetoelastic mechanism and provides continuously variable delay over a 10% bandwidth centered at 1.9 gigahertz. The variable delay range of the unit is from 1 to 4 microseconds with a maximum insertion loss of 65 decibels over the entire 10% bandwidth.

From what can be gathered about the performance of recent prototype units, improvements in the insertion loss of 10 to 15 decibels can be expected, operation throughout S band can be achieved, and operating bandwidths of 1 gigahertz can be approached. Variable delays exceeding the 1 to 4 μ sec range of the commercial unit are already a proven fact. Thus, many of the requirements demanded by the latest radar and communication systems have been met by the microwave variable de-

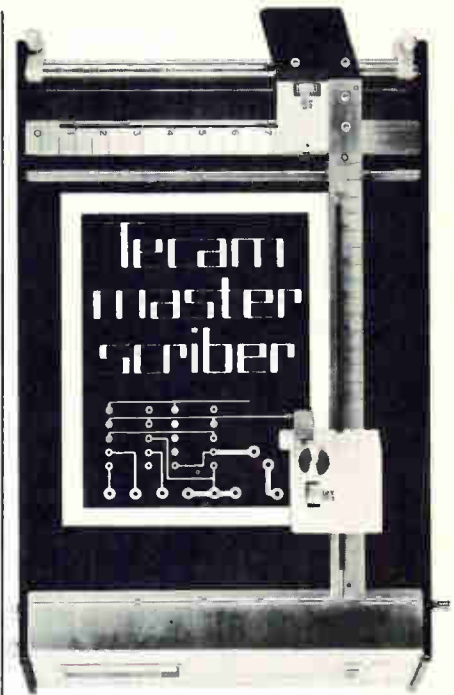

the quick way to printed circuits
for full details write to

Techno Incorporated 661 Brunswick Pike
Princeton New Jersey 08540 USA
Telephone (609) 452-9275

Circle 241 on reader service card

**CAN YOUR PRODUCTION
AND PROFITS BE
BOOSTED BY TRAINING
INNOVATION?**

**RCA INVITES YOU TO
FIND OUT.**

If you're in a field where technology is advancing, there's a good chance some of your employees have not "kept up".

That's where we can help.

We're ready to train your personnel at your place or ours, or even at home. Courses can be developed in sales, engineering, management, programming, data processing, electronics, and many other areas.

Mail coupon today for full information...

**RCA Technical
Institute**

A Service of RCA Institutes, Inc.
Bldg. 204-1, Dept. W-64
Camden, N. J. 08101
Phone: (609) 963-8000, ext. PY-5084

Please furnish information about customized training programs. We're particularly interested in
 Programmed Instruction Industrial Training

Name _____ Title _____

Company _____

Address _____

City _____ State _____ Zip _____

EG&G SILICON DIFFUSED PHOTODIODE

- HIGH QUANTUM EFFICIENCY
- WIDE SPECTRAL RANGE • FAST RESPONSE TIME • LOW NOISE

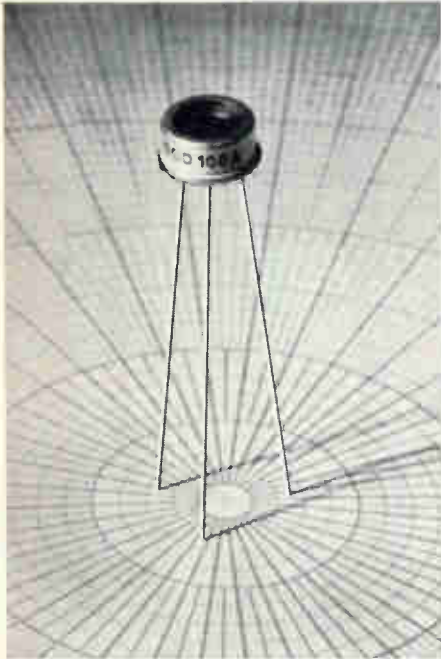

SGD-100A PHOTODIODE

The SGD-100A Silicon Photodiode provides a unique combination of wide spectral range, high sensitivity, fast speed of response, and low noise. Utilizing a planar diffused, oxide passivated, guard ring construction, the SGD-100A is suitable for applications requiring a high degree of electrical, optical, and mechanical reliability. The SGD-100A is hermetically sealed in a TO-5 package.

Sensitivity $0.5 \mu\text{A}/\mu\text{W}$ at 0.9 microns
(70% quantum efficiency)
Spectral Range 0.35 to 1.13 microns
Capacitance 7 picofarads at 90v
Rise Time 4 nanoseconds
Leakage $0.2 \mu\text{A}$ at 90v
NEP ($0.9\mu, 10^3, 1$) 7.9×10^{-13} watts
Linearity of Response over 7 decades

Applications include CW, pulsed light and laser detection and measurement, star tracking, optical navigation, communication and guidance, and range-finding systems. The new SGD-100A, also available in calibrated versions, is in quantity production for fast delivery at low price.

For information, write: EG&G Inc., 166 Brookline Avenue, Boston, Massachusetts 02215. Telephone: 617-267-9700. TWX: 617-262-9317. On west coast, telephone: 213-464-2800.



ELECTRONIC PRODUCTS DIVISION

Circle 243 on reader service card

Technical Abstracts

lay devices. Furthermore, this accomplishment serves as grounds for confidence that the increased demands of future applications won't pose much of a problem.

Presented at Wescon, San Francisco, Aug. 19-22.

EDP tests for aircraft

A computer controlled avionic test system
Frank M. Stutesman
Bendix Corp.
Teterboro, N.J.

As commercial aircraft get bigger and fly faster, periodic tests of their electronic equipment also will become more complex and will take longer unless test procedures are automated. The Bendix Corp. has developed a computer-controlled system, the 200 series, for automatically testing dozens of pieces of avionic equipment. The modular 200 can be expanded or modified easily, and is programmed in Atlas.

In designing the 200, Bendix engineers studied the electronic gear on board Boeing's 707 and its new jumbo 747, and found that one system capable of testing a plane's most complex piece of electronic equipment also would check out 80% of the remaining apparatus. The other 20% requires unusual test inputs or special instruments. Accordingly Bendix designed the 200 as a combination of an "80%" setup plus custom-built modules for testing the special cases.

In a typical 200 system program, a Bendix BDX 6200 computer sends a sequence of test inputs through a switching matrix to the first piece of equipment to be checked out. The responses, after passing through a second matrix, go to a measurement section where they're digitized and then evaluated.

Logic networks built on printed-circuit cards connect the test-input generators and the instruments to the computer, which is connected to the equipment being tested. Called device controllers, these networks can tie 256 generators and instruments to the 200's computer.

Presented at Wescon, San Francisco, Aug. 19-22.

Au! Ag! Pt! Pd!

... And other precious metal alloys for microelectronic design!

PARTIAL LIST OF AVAILABLE ALLOYS & SOLDER PREFORMS

88% Gold 12% Germanium (Eutectic Alloy)
Strip and solder preforms in all sizes
80% Gold 20% Tin (Eutectic Alloy)
Strip, wire and solder preforms in all sizes
Gold with .1 to 1.2% Antimony
Wire, strip and solder preforms all sizes
Gold - .05% Min. Phosphorous
Wire, strip and solder preforms all sizes
95% Gold 5% Nickel
Wire, strip and solder preforms all sizes
Gold and up to .5% Arsenic
Strip and solder preforms all sizes
Silver with .1 to 1.2% Antimony
Wire, strip and solder preforms all sizes
Silver - .1% Min. Phosphorous
Wire, strip and solder preforms all sizes
95% Silver 5% Nickel
Wire, strip and solder preforms all sizes
Silver and up to .5% Arsenic
Strip and solder preforms all sizes
Special alloys produced on request at minimum charge.
Precious Metals in 99.9% Pure, 99.99% Pure, and 99.999% Pure.

The most modern production techniques, the latest refining methods and the best equipped research laboratories make Williams your one best source for all precious metals and their alloys.

Available in ultra-high purity sputtering discs, preforms, foil ribbon, tape, wire, sheet and other forms.

Write for our complete Precious Metals Catalog and Specification Sheets.



WILLIAMS PRECIOUS METALS
2980 MAIN ST. BUFFALO, NEW YORK 14214
Division of Williams Gold Refining Co., Inc.

Circle 209 on reader service card 209

Space proven power supplies immediately available for avionics and industrial instrumentation

TEC off-the-shelf, miniature DC to DC power supplies still set the standards for sophisticated systems designers.

9583 Series/
1 watt*
Volume:
1.6 cu. in.
1.25 x 2.5 x 0.5

*3 and 6 watt
also available

9584 Series/
10 watt
Volume:
6.4 cu. in.
2 x 4 x 0.8

Also custom
designed, high or
low volt, single
or multi-output
power supplies
built to your
requirements.

Outputs to 5000V (custom to 20KV), totally encapsulated, operating temp. -55°C to 100°C, input 25-31 VDC, adjustable. See our ad in EBG, inside front cover and in EEM, pages 2120-2125.

P.O. Box 910
Boulder Industrial Park
Boulder, Colorado
(303) 442-3837



210 Circle 210 on reader service card

New Literature

Electronic tachometers. Dynalco Corp., 4107 N.E. Sixth Ave., Fort Lauderdale, Fla. 33308. Dynaform 7000 is a two-page bulletin discussing panel mounted, electronic tachometers. Circle 446 on reader service card.

Connector terms. Cinch Mfg. Co., 1501 Morse Ave., Elk Grove Village, Ill. 60007, has published a glossary defining nearly 150 terms that are used regularly in connector descriptions. [447]

Digital multimeter. Dana Laboratories Inc., 2401 Campus Drive, Irvine, Calif. 92664. Data sheet 981 describes the new model 5500/135 digital multimeter. [448]

Load cells. Allegany Technology Inc., P.O. Box 7293, Wilmington, Del. 19803, offers technical bulletin 301-1068 describing its series 301 and 302 load cells. [449]

Plug-in relays. Guardian Electric Mfg. Co., 1550 W. Carroll Ave., Chicago 60607, has available a brochure covering the 1310 series 4pdt-5 amp miniature plug-in relays. [450]

Data communications multiplexer. Tel-Tech Corp., 9170 Brookville Rd., Silver Spring, Md. 20910, has issued a comprehensive brochure describing the features and advantages of the TTC-1000 time division multiplexer. [451]

Hybrid circuits. Microtek-Electronics Inc., 138 Alewife Brook Parkway, Cambridge, Mass. 01922, offers a six-page brochure on a new total systems concept that allows the circuit designer to translate his breadboard or production discrete component circuitry into hybrid circuits. [452]

Data terminals. Teletype Corp., 5555 Touhy Ave., Skokie, Ill. 60076. The data communications capabilities of the new model 37 terminals are described in a 16-page, illustrated brochure. [453]

Thermistor design aid. Fenwal Electronics Inc., 63 Fountain St., Framingham, Mass. 01701. A 20-page thermistor voltage-current curve manual is designed to assist engineers in the use of thermistors operated in the self-heat mode. It is available upon a company letterhead request.

Decade pulse counter. Shelly Associates Inc., 111 Eucalyptus Dr., El Segundo, Calif. 90246. Bulletin 67-006 details information on an electronically controlled, ultraminiature decade pulse counter. [454]

Binary resistor array. Beckman Instruments Inc., 2500 Harbor Blvd., Fullerton, Calif. 92634, has released a four-

Noise Measurements? Come to the Experts!

Quan-Tech HAS BEEN MAKING EQUIPMENT FOR MEASURING ELECTRICAL NOISE IN COMPONENTS FOR TEN YEARS. NOBODY ELSE HAS.

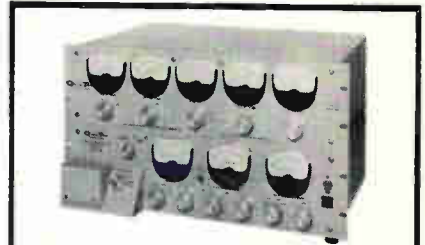

MODEL 2173C-2181 WIDE RANGE TRANSISTOR NOISE ANALYZER

Measures noise simultaneously at five frequencies in less time than it takes to read a single frequency on other equipment. Measures at 10 and 100 Hz, 1, 10 and 100 KHz on five separate meters. Collector voltage, current, and FET bias, all separately adjustable and metered. Price: Model 2173C Control Unit \$2495, Model 2181 Filter Unit \$2500.

MODEL 2283-2181 INTEGRATED CIRCUIT NOISE ANALYZER

Similar to Model 2173C-2181 except measures noise in linear IC's. Plug-in PC boards adapt the unit to different electrical and physical characteristics of various IC's. Price: Model 2283 Control Unit \$1600. Model 2181 Filter Unit \$2500.

MODEL 340 R.F. TRANSISTOR NOISE ANALYZER

Measures noise figure directly at radio frequencies. Price: \$2500. Plug-in Heads: For frequencies of 1, 2, 10.7, 45, and 60 MHz. Prices: \$1400 to \$1800.

MODEL 512 TRANSISTOR NOISE TEST SET

Measures audio broadband noise figure directly in db. Price: \$1375.

MODEL 315 RESISTOR NOISE TEST SET

Measures noise in resistors in conformance with specifications recommended by NBS and Method 308 of MIL STD 202B. Resistor Range: 100 ohms to 22 megohms. Price: \$2375.

MODEL 2136 RESISTOR NOISE TEST SET

Similar to above but measures resistors down to 10 ohms. Price: \$2550.

MODEL 327 DIODE NOISE ANALYZER

Measures noise in back-biased diodes at 10 Hz and 1 KHz simultaneously. Test Voltage manually set or automatically swept. Price: \$3250.

SEND FOR COMPLETE DETAILS
ON THE ABOVE
OR OTHER INSTRUMENTS

Quan-Tech

DIVISION OF KMS INDUSTRIES, INC.

Quan-Tech®

43 So. Jefferson Rd., Whippany, N. J. 07981
Phone: (201) 887-5508 TWX: 710-986-8251

Circle 244 on reader service card

improve MTBF with MS-180

MS-180 FREON® TF Degreaser increases the reliability of electronic equipment by removing grease and dirt. Use MS-180 on the production line or in your maintenance program to clean up assemblies, components and connections. It's safe to apply



even while equipment is operating. MS-180 is available in 16-oz. cans for plant use, convenient 6-oz. cans for field service kits. You can try it—FREE—merely by writing for a sample on your company letterhead.



miller-stephenson chemical co.,inc.

Route 7, Danbury, Conn. 06813

© Du Pont TM

Circle 245 on reader service card

Measure phase easily, directly, and accurately

ACCURACY $\pm 1^\circ$ WITH LARGE SIGNAL-TO-REFERENCE RATIOS... $\pm 0.5^\circ$ WITH SMALL SIGNAL-TO-REFERENCE RATIOS ■ CONTINUOUS 0° TO 360° READINGS ■ EXPANDED SCALES FOR ACCURATE AND EASY READING ■ ACCURACY INDEPENDENT OF ANGLE ■ DIGITAL RATIO-METRIC READOUT AVAILABLE ■ ACTON LABS' 329B PHASE METER.



BOWMAR ACTON LABORATORIES, INC.
A Subsidiary of Bowmar Instrument Corporation
531 Main Street ■ Acton, Mass. 01720 ■ (617) 263-7756

Circle 246 on reader service card

FREE! HOW TO HANDLE WAFERS, CHIPS, SUBSTRATES, MASKS

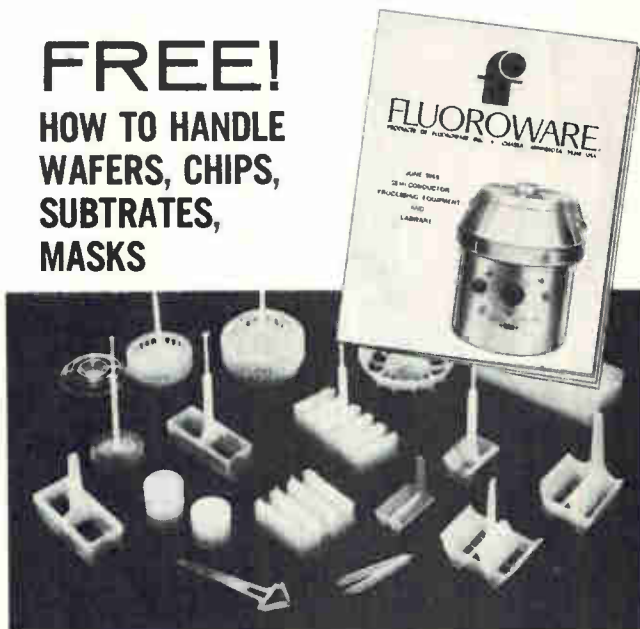

FEP Teflon* precision-molded into baskets, carriers, and trays — perfect for processing and handling semiconductor materials. The FEP material is virtually inert and useable at extreme temperatures. Hundreds of types, designs and sizes.

Write for 28-page catalog containing complete specifications and technical data.

*DuPont Trademark

f FLUOROWARE.
Chaska, Minnesota 55318 • Phone 612-448-3131

Circle 211 on reader service card

211

Equipments and Systems

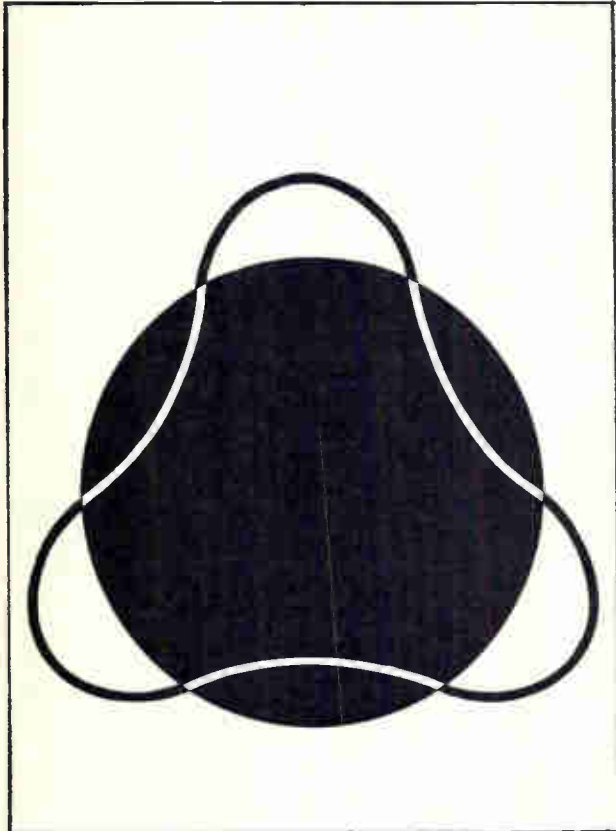

922.833

bearing the
TELEFUNKEN trademark
are symbols of
progress in the World

We manufacture and supply: Broadcasting and television transmitters • Communications transmitters • Maritime transmitters and transceivers • Professional receivers and direction finders • Radars • Radiotelephone sets and systems • Telecommunications equipment and cables • Data processing systems

Write for comprehensive documentation

ALLGEMEINE ELEKTRICITÄTS-GESELLSCHAFT
AEG-TELEFUNKEN
Export Department
79 Ulm • Elisabethenstraße 3
Germany



AEG-TELEFUNKEN

Circle 248 on reader service card



KEPCO TALKS POWER SUPPLY TECHNOLOGY:

APPROACHING THE IDEAL IN CURRENT REGULATION

For partly technical, partly historical reasons, current regulators have long played second fiddle to their voltage regulator cousins. Some of the technical problems derive from the fact current regulators have largely been mere adaptations, retaining a number of fundamental characteristics more suited to voltage than to current control.

These include: • Dynamics
• Near-zero operation
• Metering

Recent developments with voltage-agile power supplies for computer programming together with the advent of precision I-C amplifiers with controlled offsets have enabled Kepco to develop a current regulator approaching ideal more closely than any previous instrument.

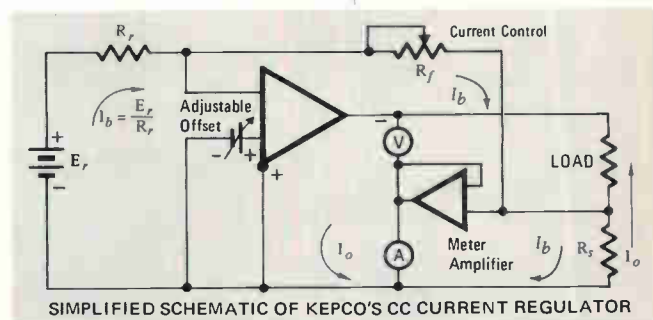

Dynamically, CC regulators are unrestrained by the usual large shunt output capacitor of conventional voltage sources. This means that a change in load resistance will produce an immediate response in the load voltage *without waiting* for a capacitor to charge! It also means that when you short the output (the proper way to idle a current source), you no longer need worry about a current surge from the output capacitor. No capacitor, no surge.

In range, most current regulators have been limited in their near-zero operation by the presence of feedback control current (I_b in the diagram) flowing through the sensing resistor. Because this current flows in the opposite direction to the load current through R_s , it's easy to see how the current in R_s can become zero while the current in your load is not. Hence, most current regulators specify a minimum value. The Kepco CC supply gets around this problem by introducing an adjustable offset across the amplifier's input. By setting this voltage to equal the $I_b R_s$ product, the power supply is fooled into going all the way to zero current.

Meters have always been a problem. How to read the load voltage accurately without shunting the output with an undesirable conductance? Another I-C amplifier to the rescue. It converts *both* meters to high impedance affairs so they don't degrade performance.

There's lots more, of course, multirange control and metering, 10-turn output control, 0.0005% line and 0.005% load regulation. Send for a copy of our new Catalog B-693 and check out the CC Plug-In Current Regulators—six models 0-2A to 0-0.2A and 0-7V to 0-100V.



Write Department CT-14

KEPCO, INC. • 131-38 SANFORD AVENUE • FLUSHING, N.Y. 11352
(212) 461-7000 • TWX # 710-582-2631

Circle 213 on reader service card 213



175 amp, 235 amp, 470 amp Regenerative Gate* SCRs

Regenerative Gate SCRs operate with lower switching losses and higher continuous di/dt than any other SCR. Low power gate drive. No sacrifice required in any other characteristic.

Continuous Rating at 60 Pulses Per Second, 90°C**

rms Current Rating	Pulse Width	Peak On-State Current
235 amp	100 μ sec.	3300 amps
470 amp	150 μ sec.	6000 amps

**Verified by long-term life test.

Also available in 55 amp and 110 amp. Request Bulletin.

NATIONAL
ELECTRONICS, INC.

a varian subsidiary
GENEVA, ILLINOIS 60134
PHONE (312) 232-4300

*A National® exclusive.
Patent Pending.

Circle 249 on reader service card

integrated circuit designer

An opportunity in our Microelectronics Research Group exists for an individual experienced in the design, debugging and testing of integrated circuits. Minimum of 2 years experience required. BSEE/MSEE, Degree Required.

We can offer excellent employee benefits and liberal starting salary.

*Please forward your resume in confidence to
Mr. R. C. Davis, Employment Mgr.*

 **SPEYRY RAND**
RESEARCH CENTER
SUDBURY, MASSACHUSETTS 01776

An Equal Opportunity Employer

214 Circle 214 on reader service card

New Literature

operation and performance of the model CEA-3086 airborne laser cooler are presented in a data sheet. [466]

Headers and receptacles. Methode Electronics Inc., 7447 W. Wilson Ave., Chicago 60656. A 16-page catalog features the complete mechanical specifications of many of the basic headers and connecting receptacles used in the Navy Standard Hardware Program. [467]

Incremental recorders. Mobark Instruments Corp., 1273 Terra Bella Ave., Mountain View, Calif. 94040, offers a four-page brochure describing low-cost digital incremental magnetic tape recorders that accept parallel or serial data. [468]

Oceanography. Texas Instruments, P.O. Box 5621, Dallas 75222. Included in bulletin SSD-OS-201-69 is a description of the company's capabilities for solving customer problems via oceanographic data collection programs. [469]

Plug and jack hardware. Pomona Electronics Co., 1500 E. Ninth St., Pomona, Calif. 91766, has released a catalog on two series of unmounted banana plug and jack hardware. [470]

Magnesium ferrite. Trans-Tech Inc., 12 Meem Ave., Gaithersburg, Md. 20760. Bulletin 110-69 discusses type TT1-3000 magnesium manganese ferrite with zinc substitution. [471]

Photocell. Vactec Inc., 2423 Northline Industrial Blvd., Maryland Heights, Mo. 63042. Bulletin PCD43/21 provides details on a photocell with two matched isolated photoconductive elements on a common ceramic substrate. [472]

Cathode-ray tubes. Westinghouse Electric Corp., P.O. Box 868, Pittsburgh, Pa. 15230. Standard and high resolution crt's for computer terminals, high resolution video displays, and medical monitoring systems are listed in a four-page booklet SA-10229. [473]

Epoxy tubing. Resdel Corp., P.O. Box 217, Rio Grande, N.J. 08242. Epoxy tubing for a variety of industrial and electronic applications is described in complete detail in bulletin 19. [474]

Spray etcher. Chemcut Corp., 500 Science Park, State College, Pa. 16801. A four-page bulletin gives operating specifications for a medium-volume conveyorized spray etcher, model 1010. [475]

Semiconductor catalog. Sprague Electric Co., Marshall St., North Adams, Mass. 01247. Forty-eight page short form catalog WR-125 gives salient information on TTL and high-speed TTL IC's as well as compatible MSI arrays,

Electronics | September 15, 1969

FOR EXCELLENCE IN ROTARY SWITCHES SPECIFY GRAYHILL

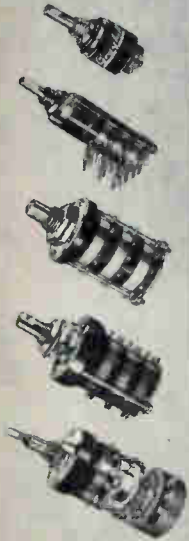

- 15°, 30°, 36°, 45°, 60° or 90° Angle Of Throw
- 2 To 24 Positions Per Pole
- Ratings Up To 15 Amps.
- 1 To 6 Poles Per Deck
- 1 To 12 Decks
- Diameters 1/2" To 2 1/4"
- Shorting Or Non-shorting Contacts
- Explosion Proof
- Military Or Commercial Styles
- Single Or Concentric Shafts
- Solder Lug Or Printed Circuit Terminals
- Switch And Potentiometer Combinations
- Key Lock Option
- Homing Rotor (Bridging And Shorting) Option
- Spring Return Option
- Power or Signal Switching
- Isolated Position (Pull-To-Turn) Option
- Adjustable Stop Option



For your Grayhill
Engineering Catalog
offering complete technical
data—contact

523 Hillgrove Avenue
LaGrange, Illinois 60525
Area Code 312, Phone 354-1040



... the Difference Between Excellent and Adequate

Circle 250 on reader service card

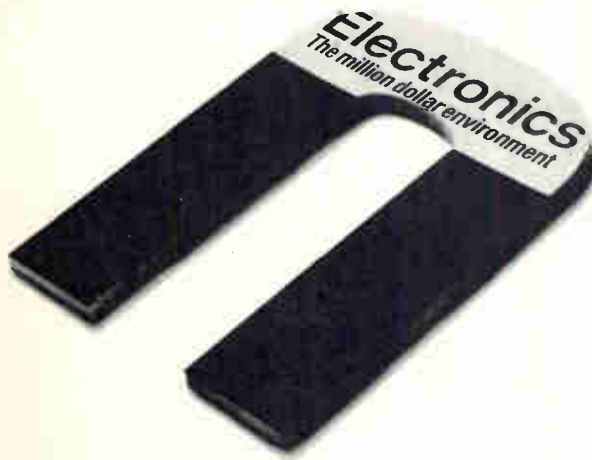

Every year, ELECTRONICS attracts requests for over 125,000 editorial reprints.

They're like interest payments on our million-dollars-a-year editorial principles.

That's how much we spend annually to produce timely, authentic, and useful articles like those listed on the reader service card as reprints currently available.

Investment and interest make both ELECTRONICS and its readers more meaningful to its advertisers.

FULLY TRANSISTORIZED

ACCURACY
RELIABILITY
LITTLE POWER CONSUMPTION
EASY OPERATION
EASY MAINTENANCE
DESIGNED FOR
INTEGRATED AUTOMATION
ELECTRONIC CONTROL SYSTEMS
DATA LOGGERS
(MANUFACTURED UNDER
HOKUSHIN LICENSE — JAPAN)

GENERAL SPECIFICATIONS

- Unified signal 2 ... 10, 4 ... 20, 0 ... 5, 0 (Input-Output) ... 10, 0 ... 20 mA etc.
- Load resistance 0 ... 3 Kohms
- Ambient -10° ... +60°C (for field instruments)
- -10°C ... +45°C (for panel instruments)
- Power supply 200 or 220 V (+10 ... -15%) A.C. or 60 c/s)

ELECTRONIC CONTROL SYSTEMS INCLUDE:

- Temperature transmitters with
 - thermoreistance (-200 ... +500°C)
 - thermocouples (0 ... +1600°C)
 - radiation pyrometer (+600 ... +2000°C)
- Pressure transmitters with
 - Bourdon tube (0 ... 350 kgf/cm²)
 - capsule (0 ... 1 kgf/cm²)
 - bellows (0 ... 1000 mm Hg)
- Differential pressure transmitters with
 - bell (0 ... 100 mm H₂O)
 - bellows (0 ... 400 mm²H₂O)
 - bellows (0 ... 35000 mm H₂O)
- Area type flow transmitters: 0, 24 ... 54, 94 m³/h
- Electromagnetic flow transmitters: 0, 41 ... 1770 m³/h
- Displacement type liquid level transmitters: 0 ... 2000 mm.
- pH transmitters: 0 ... 12 pH
- Water quality, psychrometer, mol ratio, concentration transmitters
- Miniature indicators
- 120 and 250 mm scale one and two point recorders
- Multipoint (2, 3, 6, 12) recorders
- Calculators and accessories: square root extractors, multipliers, dividers, adders-subtractors setters, program setter, integrators, signal limiters, manual control stations etc.
- Controllers
 - continuous (PI-PID) with and without indicators
 - Multipoint on-off controllers
 - Relay amplifiers
- Electro-pneumatic converters
- Computers:
 - multi-point scanner
 - data logger

MASINEXPORT

Bucuresti — România Str. Matei Millo 7
Cables: MASEXPORT — Bucuresti
Telex: 216

1st RATE 2nd SOURCE

DUAL 15 VDC



\$49⁰⁰*

OP-AMP POWER SUPPLY

Computer Products' new PM 502 power supply exhibits superior performance to and is a direct physical and electrical replacement for "Brand A's" Model 902. Contains two transformers to prevent interaction. Output impedance shows a 10-to-1 advantage, line/load regulation 5-to-1. The PM 502 is pin-compatible with other major power supplies. Operates directly from 115VAC, ± 10 VAC, 50 to 400 Hz; 230VAC also available.

We don't mind being a second source, when we can offer a better product at less cost. PM 502 is the newest member of a large family: PM 526 dual 12V

PM 528 dual 18V

PM 541 dual 24V

Other dual power supplies available... write for detailed specifications!

PM 502 SPECIFICATIONS

Input Voltage	115VAC ± 10 VAC, 50-400Hz
Output Voltage	± 15 to 15.3VDC
Output Current	0 to 100 MA each
Line-Load Reg. Each	$\pm 0.02\%$
Temp. Coeff.	0.01%/°C typical
Ripple/Noise	0.5mV RMS max.
Output Z @ 10KHz	0.2 ohms
Temp. Range	0° to 71°C
Case Size	3.5"x2.5"x1.25" plus pins

UNIT PRICES

1-4, \$53; *5-14, \$49; 15-49, \$46

SHIPMENT: 1 to 5 DAYS ARO

Computer Products, Inc.

P.O. Box 23849

Ft. Lauderdale, Fla. 33307

Phone 305/565-9565



**COMPUTER
PRODUCTS...**

FORT LAUDERDALE

New Literature

thin-film hybrid circuits, and transistors manufactured by the company. [476]

Chip capacitors. Vitramon Inc., Box 544, Bridgeport, Conn. 06601. Chip capacitor data sheet C25 covers all ten new sizes with values ranging from 10 to 470,000 pf. [477]

Capacitors and resistors. Corning Glass Works, Corning, N.Y. 14830. Short form catalog EPD DSF-1 deals with a line of capacitors and resistors. [478]

P-i-n diode applications. Hewlett-Packard Co., 1501 Page Mill Rd., Palo Alto, Calif. 94304. Application Note 922 describes the use of p-i-n diodes in micro-wave switches, attenuators, and phase shifters. [479]

Precision instrument switches. Aerovox Corp., New Bedford, Mass. 02741, has published a 24-page technical catalog describing its complete line of precision instrument switches. [480]

Transistor mounting sockets. Barnes Corp., 24 N. Landsdowne Ave., Lansdowne, Pa. Two-page bulletin PB-1005 describes sockets developed for high density mounting of TO "can" style transistors in production applications that require easy replacement of individual transistors. [481]

Pressure controller. Bell & Howell, 360 Sierra Madre Villa, Pasadena, Calif. 91109. Bulletin 6301 contains a description, features, and applications of the type 6-301 precision pressure controller. [482]

Modular program board system. Sealecetro Corp., 225 Hoyt St., Mamaroneck, N.Y. 10543. Characteristics of a completely modular Mini-Board programming system—available for as little as eight cents a crosspoint—are described in a four-page catalog. [483]

Tantalum capacitors. NCI Inc., P.O. Box 8205, West Palm Beach, Fla. 33407, has released bulletin 613B on military-type solid and wet tantalum capacitors. [484]

Volt-ohm-milliammeter. The Triplet Corp., Bluffton, Ohio 45817. A two-page technical bulletin features a battery-operated, handsized, solid state volt-ohm-milliammeter. [485]

Firewall connectors. ITT Cannon Electric, 3208 Humboldt St., Los Angeles 90031, has issued a catalog describing its new FRF environmental-resistant firewall connectors. [486]

Precision motors. McLean Engineering Laboratories, Princeton Junction, N.J. 08550, offers an eight-page catalog on computerized precision instrument motors. [487]

GRC® Intermold®



die cast ZINC ALLOY



molded PLASTICS



Coil Bobbins
Gears & Pinions

Samples Show How
**NEW MOLDING PROCESS
JOINS 2 DIFFERENT
PLASTICS IN A
SINGLE SMALL PART**

- Combine different colors, physical, chemical properties of different plastics in a single tiny component.
- Movable-element parts, separable parts, two-color parts, numbered and lettered parts, combination-of-materials parts.

- Saves assembly costs, enhances appearance, performance of your product.

Write today for "intermold" samples and detailed bulletin.



GRIES REPRODUCER CO.

Division of Coats & Clark Inc.

World's Foremost Producer of Small Die Castings

151 Beechwood Ave., New Rochelle, N.Y. • (914) 633-8600
Plants in: New Rochelle, N.Y.; Warren, R.I.; Toccoa, Ga.

Circle 251 on reader service card

MICO

NEW MODEL 885 SEVEN RATIO WIDE-RANGE ENGRAVER

NO. 885

FOR LONG AND
MULTI-LINE WORK

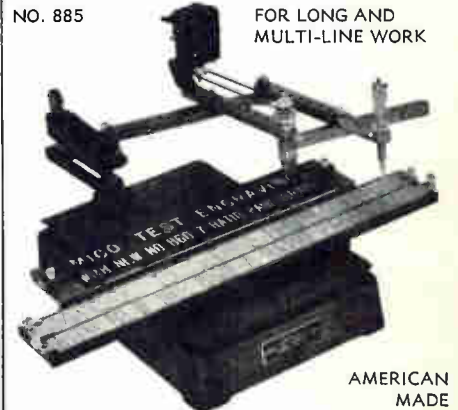

AMERICAN
MADE

- A time-saver for large plate work
- Engraves 3" x 19" area in one set-up.
- Seven pantograph ratios—from 1:5:1 to 6:1.
- Choice of 3-ball-bearing spindle assemblies for 1/8", 3/16" or taper-shank cutters.
- HSS, COBALT and Solid Carbide Cutters.
- Single and multi-line copy carriers for holding, blanks 3/4" to 3 1/2" high.
- Accommodates Mico standard accessories.

Send for bulletins and prices

MICO INSTRUMENT CO.

77 Trowbridge St. Cambridge, Mass. 02138

\$675
The ~~\$1000~~ DVM



MODEL 1820

- 0.01%
- 4 Digit
- DC Volts-Ohms-Amps
- 100% Over-Range
- Programmable Limits
- Printer Output

* also Model 1810 0.1% 3 Digit

GSA LISTED

ELDORADO

ELDORADO ELECTRODATA CORPORATION

601 CHALOMAR ROAD • CONCORD, CALIF. 94520 U.S.A. • TEL. (415) 686-4200 • TWX 910-481-9476

Circle 253 on reader service card

im-ag-i-na-tive, *adj.* creative, inventive;

syn: **mti** Video Explorer* Systems

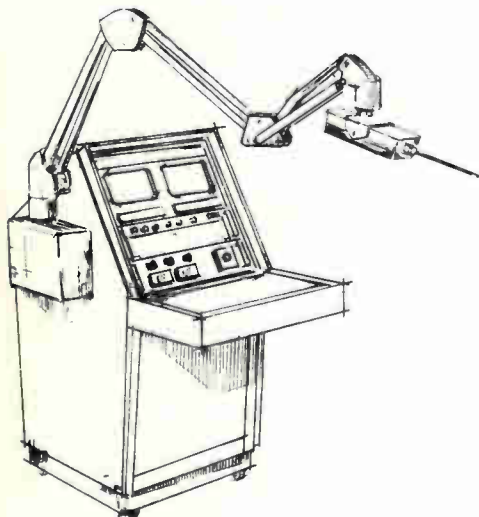

FEATURING:

- Low Light Level Image Orthicon
- Low Light Level Image Isocon Cameras
- Low Light Level Integrating Orth Systems
- High Performance Mini Head Vidicon Cameras
- Low-Lag, Non Burn Plumbicon® Cameras
- Infra-Red and Ultra-Violet Sensitive Cameras
- General Purpose Vidicon Cameras
- Broadcast Quality EIA Sync Generator
- Special and Standard Optics
- Monitors • Recorders

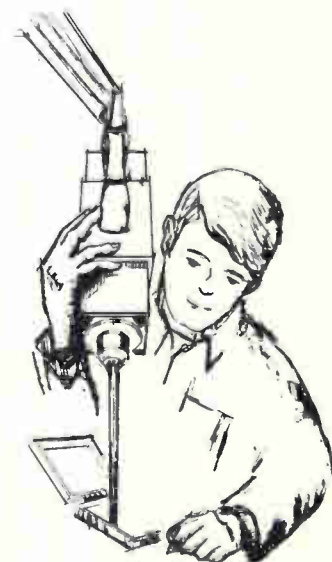

MTI and Webster define imaginative as showing a distinctive or fine command of images . . . and images are our business.

Utilizing MTI's Vidicon, Plumbicon® and Image Orthicon television (CCTV) cameras, MTI is able to offer a VIDEO EXPLORER* system tailored to your specific needs.

MTI Systems Concept includes such added features as special optics, special non-standard imaging tubes (ultra-violet, infra-red), tape recorders and a full line of accessories.

® Registered Camera tube trademark N. V. Philips of Holland

™ Trademark

MARYLAND
TELECOMMUNICATIONS
DIVISION OF KMS INDUSTRIES, INC.

10534 YORK ROAD
COCKEYSVILLE, MD. 21030
301-666-2727 • TWX 710-862-2644

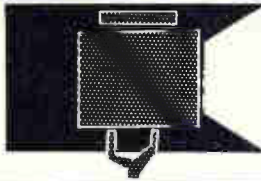

SEARCHLIGHT SECTION

- CLASSIFIED ADVERTISING • BUSINESS OPPORTUNITIES
- USED OR SURPLUS EQUIPMENT



The NEW Book on Critical Path Methods, PERT
APPLIED PRINCIPLES OF PROJECT PLANNING and CONTROL
 2nd EDITION

Library of Congress Catalog Card No. 68-22562. SBN-911590-02-1

A book that has been around since 1963, and universally accepted as a basic textbook on the fundamentals of planning, scheduling and controlling projects, has been expanded by the author to

include new concepts. There is also a perceptive analysis of current shortcomings in use that have discouraged many people from applying this powerful and practical technique.

New material includes: INVOICELESS COST CONTROL; USE OF CPM IN CLAIMS AND LITIGATION; THE DECISION TREE; VALUE ENGINEERING AND CPM; CURRENT ABUSES OF NETWORK PLANNING TECHNIQUES. A new Project Control Chart format, never before published, called the CONTINUOUS MILESTONE CHART, allows continuous project control and trend evaluation, without re-drawing the chart, regardless of how sequences of operations change from the original plan.

If you are new in Project Management, this book contains an excellent development of the fundamentals. If you are already experienced in CPM, and wonder how to improve its effectiveness, this book has the answers. In any case, APPLIED PRINCIPLES OF PROJECT PLANNING AND CONTROL will become an important adjunct to your library.

We invite you to examine this new hard cover edition for 10 days. There are 400 pages, 180 illustrations, 70 practical problems and solutions. Prepayment of the \$19.95 cost will eliminate postage and handling charges.

A. JAMES WALDRON

371 Kings Highway West
 Haddonfield, N.J. 08033

CIRCLE 966 ON READER SERVICE CARD

Why Do You Read So Slowly?

A noted publisher in Chicago reports there is a simple technique of rapid reading which should enable you to increase your reading speed and yet retain much more. Most people do not realize how much they could increase their pleasure, success and income by reading faster and more accurately.

According to this publisher, many people, regardless of their present reading skill, can use this simple technique to improve their reading ability to a remarkable degree. Whether reading stories, books, technical matter, it becomes possible to read sentences at a glance and entire pages in seconds with this method.

To acquaint the readers of this publication with the easy-to-follow rules for developing rapid reading skill, the company has printed full details of its interesting self-training method in a new booklet, "How to Read Faster and Retain More" mailed free to anyone who requests it. No obligation. Send your name, address, and zip code to: Reading, 835 Diversey Parkway, Dept. 594-019, Chicago, Ill. 60614. A postcard will do.

CIRCLE 967 ON READER SERVICE CARD

RADAR SYSTEMS GROUND AND AIRBORNE. AUTOMATIC TRACKING ANTENNA SYSTEMS. NIKE AJAX. NIKE HERCULES. M-33. MSQ-1A. MPS-19. MPS-9. SCR 584. TPS-1D. TPS-28. FAA-ASR-2. AIRBORNE SYSTEMS. APN-84. APN-102. APS-20. APS-27. APS-45. DPN-19. DIGITAL COMPUTERS. IBM 650. IBM 704.

LARGEST INVENTORY OF RADAR AND MICROWAVE EQUIPMENT IN THE WORLD.

RADIO RESEARCH INSTRUMENT CO.
 45 WEST 45TH ST. N. Y. 10036 212-JU 6-4691

CIRCLE 666 ON READER SERVICE CARD

Minifluid DISPENSER
 AIR OPERATED
 for miniature potting and encapsulating

Available in 3 sizes
 6cc - 12cc - 30cc

\$34.00 UP

PHILIP FISHMAN COMPANY
 7 CAMERON ST., WELLESLEY, MASSACHUSETTS 02181

CIRCLE 667 ON READER SERVICE CARD



EMPLOYMENT OPPORTUNITIES

POSITION VACANT

Electronic Engineer (Instrumentation) —
 Provide eng. serv. for calibration of elect. & electronic instr. & standards, perform R&D in elect & electronics measurements & instr. application, provide direct assistance to br. hd. Must have bachelor's deg. in eng. or equiv. comb. of coll. level educ., training, &/or tech. exp. not less than 4 yrs; plus 3 yrs. prof. electronic eng. exp. or exp. & educ., incl. 1 yr. various comb. res., dev., testing calibration & application problems of lab instr. or standards equiv. to GS-9 grade level. Sal. \$11,563—\$14,623. Industrial Relations Off., Long Beach Naval Shipyard, Long Beach, Calif. 90801.

SPECIAL SERVICE

Capital Contacts—Before you try Public or Private Placements to Underwriters, Investment Banking Houses, write for free helpful information to Confidential Consultant, 817 51st St., Brooklyn, N.Y.

We have been placing B.S., M.S. and Ph.D. **ELECTRONIC ENGINEERS** in fee paid positions throughout the U.S. since 1959. Send resume today or request confidential application. We are graduate engineers, working full time . . . for you.

ATOMIC PERSONNEL, INC.
 Suite L, 1518 Walnut St., Phila., Pa. 19102
 AN EMPLOYMENT AGENCY FOR ALL TECHNICAL FIELDS

CIRCLE 668 ON READER SERVICE CARD

Watch—the Employment Section for Employment Opportunities

This ad is not for men who love their jobs.

It's for the man who's found his job has become a chore.

If that man is you, then you're the man we want to talk to.

We're Management Recruiters — the matchmakers. We've got 80 offices across the country and in Canada.

Call us. And the next time you see this ad, you'll be able to pass it by.

Management Recruiters
 The matchmakers

CIRCLE 669 ON READER SERVICE CARD

The Scientists and Engineers served by Corcoran in the last year have found the difference between "a job" and "the job."

- Nationwide. Fee paid.
- Please airmail background to:

JOSEPH P. CORCORAN
 Personnel Consultants

505 B Germantown Pike
 Lafayette Hill, Pa. 19444
 (215) 825-0848

CIRCLE 672 ON READER SERVICE CARD

Don't Forget the Box Number

When answering the classified advertisements in this magazine don't forget to put the box number on your envelope. It's our only means of identifying the advertisement you are answering.

- Head-Up Display
- Scan Converter
- Vertical Situation Display
- Multiple Sensors Display

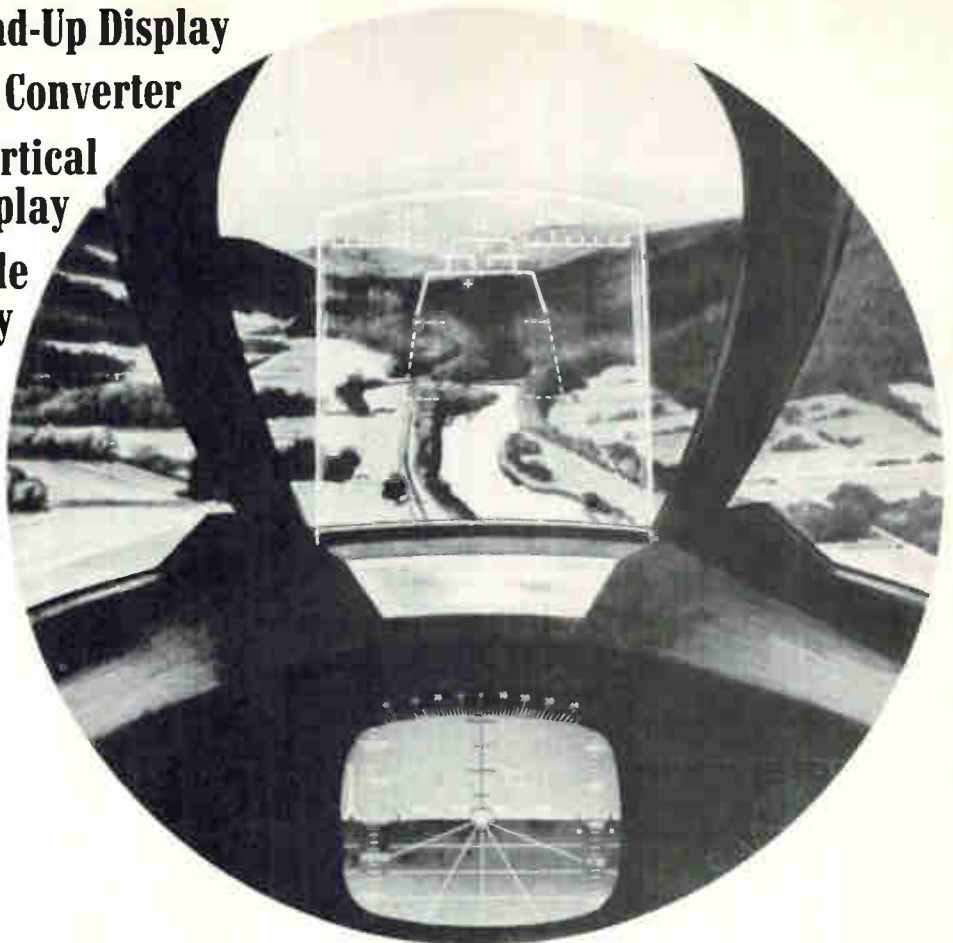

Typical of the in-depth engineering challenges you'll find at Norden

Data processing and display engineers will find a challenge in this Integrated System which improves pilot performance in weapon delivery, navigation, and terrain following. Accurately positioned command and situation symbols plus the critical flight data in alpha-numeric form are combined with an unobstructed view of the outside world to form a truly integrated flight instrumentation system.

Current Openings Include:

DATA PROCESSING AND DISPLAY ENGINEERS Experienced in TV and radar displays, analog and digital data processing, synthetic video generators, high speed function generators, scan conversion, computers. BSEE degree.

ELECTROMECHANICAL DESIGN ENGINEERS Experienced in high density electronic packaging for airborne displays and high gravity packaging of CRT and associated electronics. BSME or equivalent.

TEST EQUIPMENT ENGINEERS To design test equipment for modules, boxes and integrated display systems for production testing.

CIRCUIT DEVELOPMENT ENGINEERS Openings at all experience levels for design and development of solid state analog and digital circuits for displays. BSEE degree.

FIELD ENGINEERS To participate in field maintenance, service and flight test of integrated display systems.

To arrange a convenient interview, please forward your resume to: Mr. J. E. Fitzgerald, 308 Helen Street, Norwalk, Conn. 06852.

Norden DIVISION OF **United Aircraft**

An equal opportunity employer (M/F)

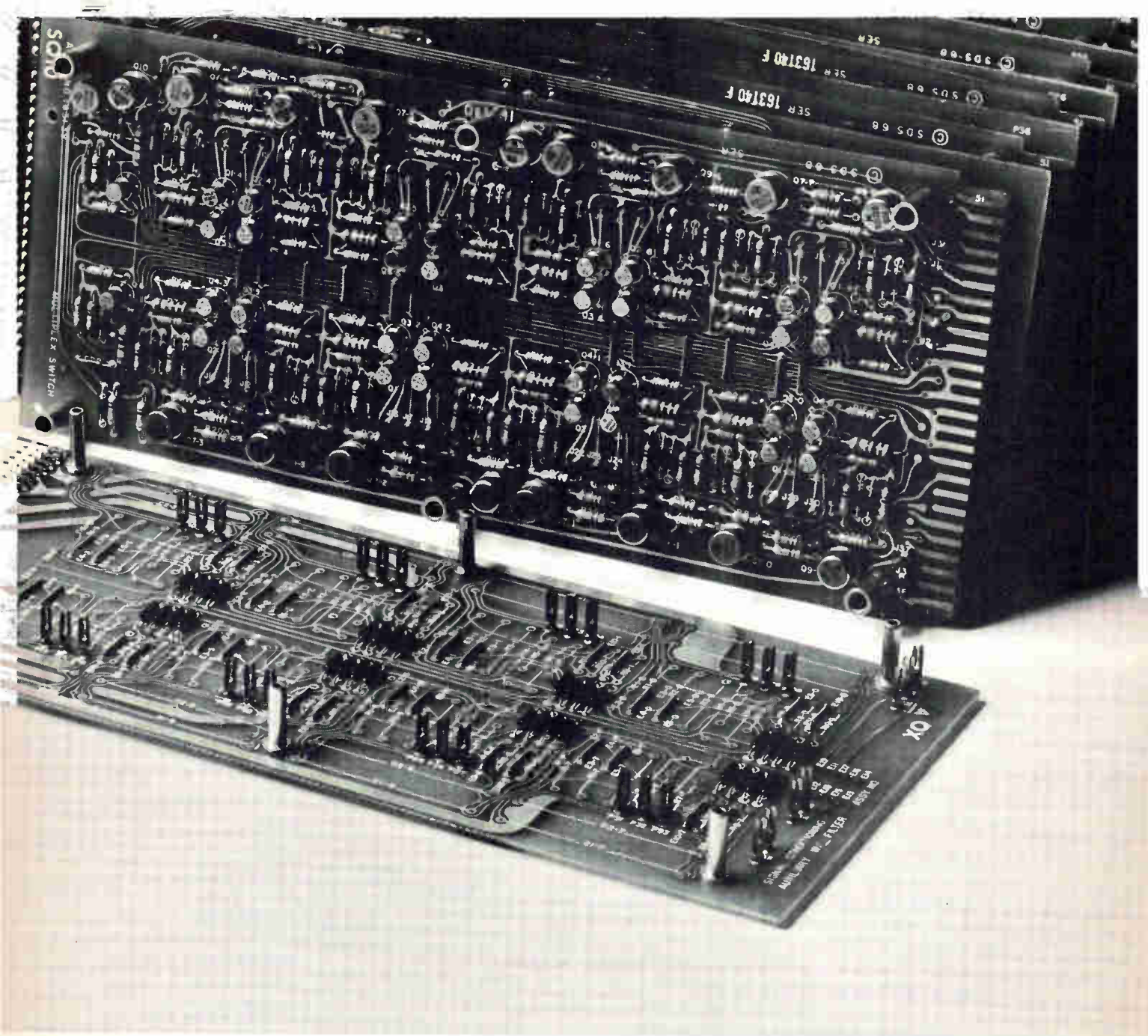

Look into our new low level multiplexer. It's good for your system.

Our DM40 solid-state differential multiplexer makes a great front-end, with amplifier per channel performance. It accepts analog signals from thermocouples, strain-gauges, resistance bridges, transducers, amplifiers and the like. It has very low noise and you don't have to worry about acquisition errors due to previous channel overload. The DM40 takes 128 input lines and you can hook eight units together for a total of 1024 inputs. It multiplexes and amplifies each signal and transmits it to your digitizer at a rate up to 10KHz. When you use it with one of our controller-digitizers you can get 13 different gain ranges.

In fact, the DM40 is even better when you get all your system components from us. This way you can be sure they'll work as a system. No interface problems to solve, no missing hardware to engineer. Our components are made to get along together.

After all, they come from a good family.

Circle 220 on reader service card

DM40 Minispecs:

Input signals:	From 2.5 millivolts full scale to 10 Volts full scale.
Gain Accuracy:	0.02% between steps.
Linearity:	0.005%
Zero Stability:	1 microvolt rti +20 microvolts rto/°C.
Crosstalk:	120db
Common Mode Rejection:	120db, DC; 100db, 60Hz.
Noise:	10 microvolts peak rti +100 microvolts peak rto.

Write for complete specifications.

Scientific Data Systems,
A Xerox Company, El Segundo, California.

SDS

International Newsletter

September 15, 1969

Japanese calculator gets U.S. circuitry

Japan's Sanyo Electric Co. is seeking government approval of a licensing arrangement reached with the General Instrument Corp. Under the agreement, Sanyo will at first import and then manufacture the U.S. firm's metal, thick-oxide nitride silicon LSI circuits for use in the Japanese company's new miniature desk calculator [*Electronics*, April 14, p. 219]. The calculator is expected to go on the market early next year.

Terms of the 10-year licensing arrangement call for General Instrument to receive an \$80,000 initial payment and a 3.25% royalty. Although Sanyo will be allowed to sell the LSI circuits separately, the company didn't win an exclusivity clause.

Sanyo is investing \$4.17 million in new production facilities to manufacture the circuits. Domestic production is expected to start in June; the company's initial goal is 70,000 circuits. The calculator itself has been redesigned so that each machine will require only four or five LSI circuits.

UK computer firm drops giant 1908A, picks up Project 52

International Computers Ltd. has dropped its development program for its 1908A giant computer [*Electronics*, Aug. 19, 1968, p. 181], originally intended for delivery in 1972. Instead, ICL says it will develop an alternative design of approximately equivalent power for delivery in 1973.

The company will not disclose its reasons for abandoning the 1908A nor the principles of its new design—for which it revived the name of a previous, defunct giant computer scheme: Project 52. However, informal talks are now going on among European computer makers. It's likely that ICL is revising design requirements in accordance with what such a consortium is likely to require. This way, ICL will have a bigger say in giant computer design. What's more, the market for very large computers has become tight in the past year, and the company probably wants to avoid freezing design and production plans for a year or two.

Italy's giants regroup for electronics push

Montecatini-Edison, Italy's largest private company, and IRI, the Italian government's major holding company in heavy industry, have both started to pull in the reins on their proliferating, sometimes wayward, electronics subsidiaries.

Montecatini-Edison's regroupment started about six months ago with the formation of Montedel, under which was put a number of electronics subsidiaries. Now that word of the reorganization has gotten out, IRI intends to follow suit and will reshuffle—probably next March—the electronics activities of companies it controls into an organization called Finelettronica, a counterpart of government-controlled Finsider in steel production and Finmeccanica in metalworking.

Britain may lose part of MRCA avionics

The next big hurdle facing the multi-role combat aircraft (MRCA) under development by Britain, Germany, and Italy is agreement on avionics. Systems definition of the avionics portion of the project, which will total nearly 1,200 planes, has just been assigned to a consortium company called Avionica Systems Engineering GmbH, Munich. Elliott-Automation from Britain, West Germany's Elektronik-System Gesellschaft, and Italy's Selenia are represented in Avionica.

By the time the definition stage is completed sometime next year, the

International Newsletter

three countries will face another round of hard bargaining over who gets what share of avionics money. The engine contract for the MRCA was given to Rolls-Royce with the provision that the work would be shared in proportion to the number of aircraft ordered. That means Germany gets 52%, Britain 32%, and Italy 16%. British avionics makers hope for a similar deal, but there had been the fear that if Britain took most of the engine work, that other countries would get the major portion of the avionics work. Now added to this is the even stronger possibility that British avionics work may be cut to allow for large orders of British auxiliary equipment—electrical systems and hydraulics.

Russians spur electronic exports to Finland

Finland may become—reluctantly—the Western showplace for Russian electronic products. A five-year trade agreement signed earlier this month between the two nations boosts electronic exports from Russia by a significant amount over the current 5-year treaty. Sources in Stockholm say the Russians evidently placed a lot of pressure on the Finns to accept some electronic items, because the Finns themselves have a well-developed industry and considerable exports trade within Scandinavia.

One reason for the Soviet electronics push is that the Russians want the world to know they are no longer just exporters of raw materials.

The new treaty calls for about \$1.35 million worth of tv receivers and radios to be exported to Finland over the five-year period, up from \$600,000 in the current treaty. The Russians will export \$2.25 million worth of measurement, testing, and control devices, a ten-fold increase.

Spanish test Swedish electronics market

The Spanish electronics export organization, Secartys, is trying to crack the Swedish market for entertainment electronics. At last week's Saint Erik's fair in Stockholm, Secartys director Ignacio Tormo said he expects no immediate breakthrough for Spanish products on the "sophisticated and very competitive" Swedish market. "But in two years we hope to be here with a good line of radios, tv receivers, and particularly hi-fi equipment," he said.

The Spanish have not been exporting electronic products in any large quantities—except to the Middle East. The Stockholm show is the first in which they have really mounted a sizeable exhibit; six of Spain's largest manufacturers were displaying.

East Germany gives itself an anniversary present—color tv

After years of grim austerity, East Germany has decided that its 20th anniversary offers an opportunity to emulate some of its East Bloc neighbors, especially Russia, and to show off consumer goods. Accordingly on October 7, East Germans will have a second black-and-white tv channel, four new transmitting stations and color broadcasts—albeit only a sprinkling at first—that will reach an area including 20% of the country's population.

Engineers at the VEB Fernsehgeraetewerk Strassfurt, one of East Europe's largest tv manufacturing plants, reportedly have turned out a transistorized color receiver—called, appropriately, Color 20—and will unveil it at anniversary time. The receiver, however, will carry a price tag of \$938, almost twice what West Germans pay for a table model. The government also has arranged to import color sets from the Soviet Union, which uses the Secam color broadcasting system, too.

Schottky barrier devices show current increase under pressure

Matsushita transistor and SCR, unlike other pressure-sensitive devices, exhibit no change in amplification factors; use in keyboards foreseen

Schottky diodes are still full of surprises. Researchers in Japan have developed two pressure-sensitive Schottky barrier devices.

Unlike pressure-sensitive transistors, where pressure applied to the emitter decreases the current amplification factor and emitter current, the new devices show an increase in current with an increase in pressure—and do not change their amplification factor. The devices were developed at the Matsushita Electronics Corp., a joint venture of Matsushita Electric Industrial Co. and Philips Gloeilampfabrieken of the Netherlands.

Twosome. Operation of the two devices is based on an empirically observed increase in current of reverse-biased Schottky barrier diodes with increase in applied pressure. In both devices the Schottky barrier consists of molybdenum deposited over n-type silicon. One of the devices is a transistor in which change in output current is a linear function of pressure applied to the molybdenum electrode. The other device is a thyristor in which pressure applied to the molybdenum electrode causes the device to switch on, in a manner similar to the gate pulse in conventional SCR's.

The transistor Matsushita used in these Schottky studies is a conventional pnp silicon planar transistor with a ring emitter in its circular base region. Contact to the emitter is made by aluminum metalization applied through a window in the silicon dioxide passivation layer, and contact is made to the collector at the bottom of the chip—both in the conventional manner. Contact is made at the center of

the base region by molybdenum metalization applied through a window in the silicon dioxide passivation layer. A stylus attached to the molybdenum transmits the pressure input to the device.

Bias circuit between emitter and base terminals of the device, with conventional polarity for a pnp transistor, forward-biases the emit-

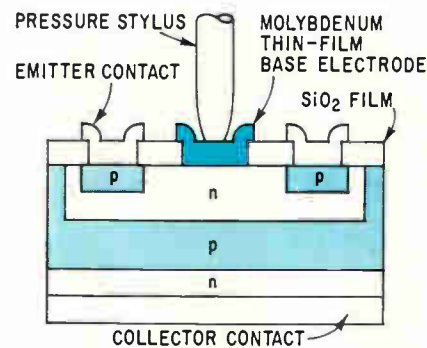

Push-pull. Pressure on the molybdenum electrode turns the SCR on and off, just like the gate pulse in conventional SCR's. In experimental transistor—which has same configuration as the SCR, but without the lower n-type layer—change in output is linear.

ter junction of the transistor. At the same time, it gives a reverse bias across the Schottky barrier between the actual base of the transistor and the molybdenum metalization that is the base contact to the external circuit. As pressure is applied to the stylus, the Schottky barrier reverse current, and thus transistor base current, increases. Transistor collector current increases proportionally.

Operation of the basic transistor and sensitivity to applied pressure

are separated in the new transistor and there is very little interaction between the two—unlike former pressure sensitive transistors in which the two are intertwined. Thus the basic transistor of the new device can be designed solely from considerations of current amplification factor, frequency response, and power handling capability desired in the finished device.

Switching. The pressure-sensitive switch is a four-layer pnpn SCR produced by planar diffusion techniques on p-type wafers. On one side of the wafer a circular n-type base and ring-shaped p-type emitter are diffused. On the other side an n-type emitter is diffused. Connection to the ring-shaped emitter is by aluminum metalization through a window in the silicon dioxide passivation layer. Connection to the n-type base, which functions as the gate, is by molybdenum metalization through another window. This device differs from most other SCR's in using an n-type base adjacent to the anode—rather than a p-type base adjacent to the cathode—as the gate.

The bias circuit used with this device is arranged so that the molybdenum-metalization-to-base bias across the Schottky barrier is reverse. An increase in pressure applied to the gate electrode effectively increases current emitted. As with conventional SCR's, this increased current causes forward breakover voltage to fall below applied terminal voltage and the device fires, staying on as long as the device current remains above holding current level. With no applied pressure the forward breakover voltage of Matsushita's ex-

perimental devices is about 80 volts.

Technology. Fabrication of Schottky diodes requires a good grasp of technology to obtain a clean semiconductor surface for intimate metal-to-semiconductor contact. Matsushita has mastered this technology for earlier devices, which now are in production and which served as stepping stones to new devices [*Electronics*, May 2, 1966, p. 167].

In addition, it is necessary to design and diffuse the devices in a manner that keeps the surface concentration of impurities where the Schottky diodes will be fabricated lower than in many other transistors or SCR's. Maximum surface impurity concentration is limited because the higher impurity concentrations bring an increased number of dislocations, which degrade characteristics and decrease reliability of Schottky diodes.

Matsushita is developing both the technology for production and applications of these devices, and hopes to bring them to market some time next year. Packaging is perhaps a worse problem than fabrication. Ideally the packages should be sealed and offer little mechanical resistance so the devices will operate at low pressures, yet protect the devices from damage caused by excessive pressure, and still be inexpensive.

Applications will include non-contact control and regulator devices, and, perhaps, units for keyboards of electronic desk calculators.

West Germany

Where's the antenna?

Imagine a car antenna that's just a few inches high, need not be extended for reception, neither rusts nor freezes up during icy weather, that vandals will have a hard time breaking off, provided they can even find it.

Well, one German electronics firm is about to put just such an antenna on the market. Fitted snugly into the supporting stem of

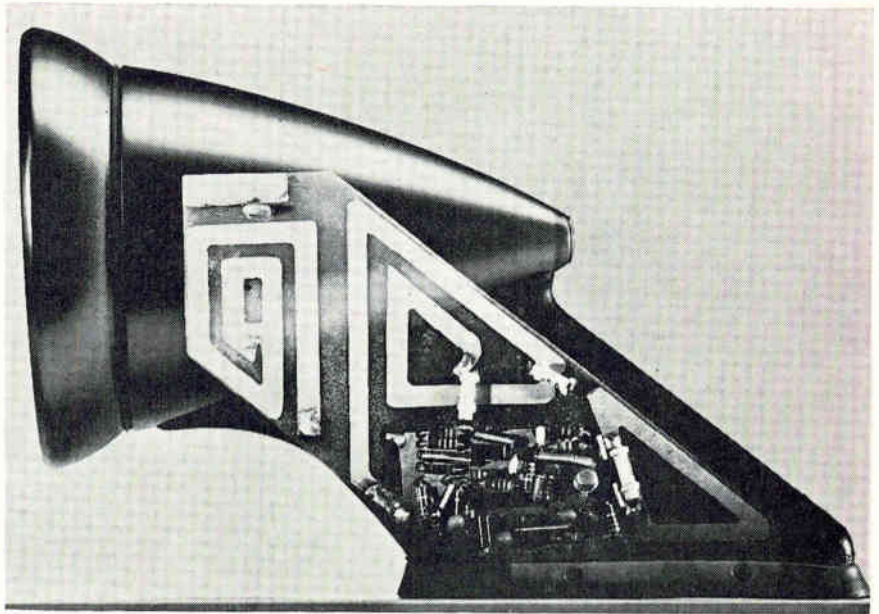

Hidden talent. Rakish rear-view mirror mounting houses the circuitry for first Meinke transistorized antenna to be sold as a consumer product. Circuit holds amplification stages for both a-m and f-m.

a fender-mounted rearview mirror, the receiving element is not only hidden but protected as well.

Active. As one might suspect, it's the controversial Meinke transistorized, or active antenna principle that makes such smallness possible. The principle was the center of argument among antenna specialists on both sides of the Atlantic two years ago [*Electronics*, June 12, 1967, p. 145].

Since then, the active antenna idea, conceived by H. H. Meinke, head of the Institute for High-Frequency Research of Munich's Technical University, has been applied in Rohde and Schwarz-developed antennas for commercial uses [*Electronics*, Aug. 4, p. 232]. Now, earlier criticism notwithstanding, active antennas are coming into their own for consumer applications.

The manufacturer of the new car antenna is Hans Kolbe & Co., commonly called Fuba, one of Europe's largest antenna makers. Unlike some other German firms, Fuba did not pooh-pooh the Meinke principle several years ago, instead it quietly went to work implementing it for automobile receiver applications. The new antenna, dubbed Alpha 3, was designed by Fuba engineers, together with specialists

of the Munich High-Frequency Institute. Alpha 3 had its public debut at last month's radio and television exhibition in Stuttgart.

Potential. Judging from the interest shown in Alpha 3, Fuba's perseverance and foresight is likely to pay off handsomely. Alpha 3 is almost certain to make a big impact on the car antenna market. Says Manfred Haenel, a Fuba marketing official, "The interest so far indicates that our new version will be the car antenna of the future."

The firm already has geared production lines for mass fabrication of the new antenna, with large-series runs starting right now. First units should hit the German market later this month; sometime in October they should show up in other European countries as well. In Germany, the Alpha 3 antenna will retail for about \$25.

To be sure, the price is about three times higher than simple telescopic versions, but Alpha 3's advantages should more than offset the extra cost. In addition to small size, inconspicuousness, and excellent performance, the antenna features some plusses: it should outlast the car and, unlike long antenna rods, presents no problems when entering low garages. What's more, Alpha 3 is about three times

less expensive than motor-driven telescopic antennas.

A-m, f-m. The antenna is designed for reception in two ranges for a-m signals from 150 kilohertz up to around 25 megahertz, and for f-m signals in the ultra-short-wave range from 87 to 104 Mhz.

The company says that test results so far indicate excellent reception qualities. In the f-m range, for example, it provides good reception—even of weak f-m stations that are difficult to pick up with telescopic rod antennas. This reception level stems from the antenna's optimum matching characteristics, from its amplifying characteristics and from its ideal physical orientation on the car body relative to the incoming wave front.

As for reception in the a-m range, Alpha 3 performs at least as well as ordinary rod antennas. If used with early-model or relatively insensitive car receivers it is superior to rod antennas thanks to its inherent amplification—from 10 to 15 decibels. Even at this level, there's no cross modulation when the antenna is used with highly sensitive receivers.

The components for the antenna's two amplifiers—one for each range—and for the associated filter circuitry are mounted on a printed circuit board installed inside the mirror's plastic stem. Optimum matching conditions are obtained by integrating the two amplifiers into the antenna structure and transforming the antenna impedance to that of the input transistors of each amplifier.

No interference. Incoming signals in the long-medium-short wave range are separated from others by a low-pass filter and then are fed to the two-transistor, broad-band a-m amplifier. High inverse feedback provides for good linearity of the amplifier's low-noise input stage. Because of the antenna's good crossmodulation levels, there's no signal interference, even at short distances from transmitting stations.

The antenna operates from a supply voltage of between 5 and 15 volts—and is therefore usable on 6-and 12-volt cars—and draws a maximum of 10 milliamperes.

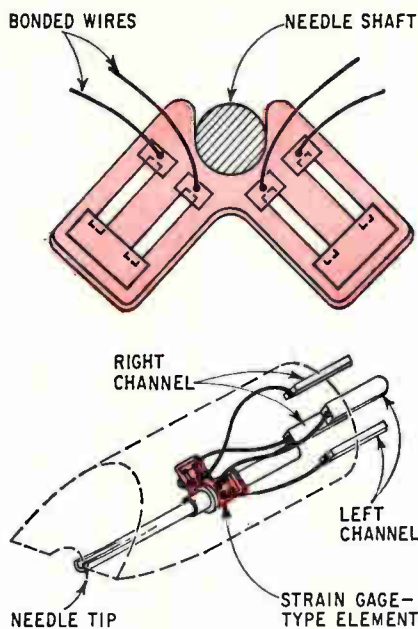

Wings of sound. Parallel strain gage elements distort to give audio signal.

Japan

Straining to hear

Magnetic phono cartridges are widely considered the most sensitive of pickups for high fidelity reproduction of recordings. While magnetic cartridges—using a moving coil, moving magnet, or induced magnetism—lead the hi-fi parade in the U.S., only one cartridge of this type is in production in Japan—mainly because U.S. manufacturers pioneered development of magnetic types and protected their designs with patents.

To get around this tight protective barrier, engineers at the Matsushita Electric Industrial Co's Acoustic Research Laboratory and Central Research Laboratory teamed up to develop a phono-graph pickup cartridge based on a new principle. It's an order of magnitude more sensitive than the best magnetic cartridge, the company says.

Straining. The new cartridge uses an evaporated semiconductor strain gage element, which the company says has never been used before in phono pickups. The strain element basically is a thin film of germanium evaporated on a polyimid plastic film about 25 microns thick.

The germanium film is polycrystalline—with a difference. Matsushita engineers say that carefully controlled deposition gives large individual crystals with proper orientation to obtain maximum resistance change with strain. With large crystals, the change in resistance is a piezoresistance effect in the bulk of the individual crystals and not at the boundaries between the crystals. Strain gage factor, or the ratio of change in resistance to change in dimension, is 65, which is much higher than that of conventional wire strain gages.

Matsushita says the new cartridge will be the smallest and lightest on the market, measuring 6 millimeters in diameter by 16 mm in length and weighing 750 milligrams. The needle tracks at 1 to 1.5 grams. Matsushita is perfecting production techniques, and next year will start sales of cartridges and preamplifier units that provide power supply for cartridge elements.

Butterfly. The cartridge element is shaped like a butterfly, with the axes of the wings at right angles from each other to obtain the proper orthogonal relationship for separation of stereo channels. A semicircular notch, whose center is at the crosspoint of the two axes, cradles the cartridge needle arm that drives the element. Because element drive is by bending, rather than displacement, the element is surrounded with grease, but the free ends of the wings are not anchored. Grease provides the equivalent of rigid support for inputs above about 20 hertz, but protects against imbalance from small, permanent deflection and from damage due to careless handling.

On each of the wings of the element are two parallel deposited strips of semiconductor material. Metalization at the ends of the wings connects the two individual strips on each wing in series. Metalization near the center provides pads for fine wire leads in the manner used for fabrication of transistors and other semiconductors.

Sensitivity. The mass of the element is 0.1 milligram, about an order of magnitude lower than even the best previous pickups. Compli-

ance of the element is in excess of 1×10^{-4} centimeter/dyne. This is large enough so that compliance of the cartridge is determined by the damping material used, and for this cartridge it is 1×10^{-5} centimeter/dyne in both horizontal and vertical axes.

Resistance of the semiconductor strips for each channel is 2,000 ohms, a convenient value for coupling to transistor preamplifiers, and low enough to minimize noise output. Current through each element is 2 milliamperes. Voltage drop through the element plus that through the load resistor requires a power supply of 10 volts. This supply can be the same used for the preamplifier because voltage is low and total current drain is only 4 milliamperes. With a standard test record, output is 3 millivolts at 1 kilohertz, and intermodulation distortion is only 1%. Stereo separation exceeds 25 decibels at 1 khz and exceeds 20 db at 10 khz. Noise output is less than 1 microvolt.

Planting bears fruit

Using ion implantation techniques, engineers at the Semiconductor Engineering department of the Tokyo Shibaura Electric Co. have produced a transistor with a gain-bandwidth product of 9 gigahertz. The highest previous figure for a Japanese transistor was 7 Ghz for a device which the Nippon Electric Co. has been making since spring.

Toshiba's new device, developed under a government subsidy [*Electronics*, Nov. 25, 1968, p. 143],

gives a power gain of 8 decibels and a noise figure of 4 db when operated at 4 Ghz.

Toshiba calls the new devices IBT transistors, for Ion-implanted Base transistor Technology. Ions are implanted into the base regions through the emitter diffusion opening in the silicon dioxide passivation layer to give a base region whose depth is accurately controlled—and which has a higher impurity concentration in the active base region than can be achieved by normal diffusion. This high impurity concentration yields the low base resistance necessary in gigahertz-frequency transistors, because base resistance is the parameter that limits gain—and also sets noise figure.

Basics. The new transistors make use of several state-of-the-art processes to achieve excellent performance and reproducibility. First, portions of the base are formed in different ways. Under the base contact metalization there is a p^+ layer about 1 micron deep that is fabricated by ordinary diffusion of boron. Between this base contact and the region that forms the intrinsic base of the transistor is a thinner connection area about 0.2 microns thick. This region is fabricated by direct diffusion from the doped silicon dioxide layer; after the window for emitter diffusion has been opened, the wafers are heated to diffuse boron contained in the oxide layer into this base connection region.

Next, the intrinsic base region is fabricated slightly overlapping the diffused connection region by implantation, through the emitter diffusion window, of boron ions accelerated to an energy of about 30,000 volts; maximum depth of this implanted layer is 0.2 microns. This layer differs from an ordinary diffused layer because high impurity density is maintained to the bottom of the layer. In ordinary diffused layers, high impurity densities are obtained only near the surface. After implantation, annealing is performed at moderate temperatures to remove implantation-induced crystal lattice imperfections.

The emitter diffusion follows

the base ion implantation. Toshiba uses arsenic for the emitter impurity, rather than the more commonly used phosphorus, because phosphorus tends to drive the base impurities under the emitter further into the chip than those in the surrounding portion of the base. However, it is hard to obtain the required high impurity density in the emitter region when arsenic is used. Toshiba has solved this problem by doping the silicon dioxide layer formed over the emitter diffusion window with both arsenic and germanium. The germanium greatly increases the diffusion constant of the arsenic through the oxide and makes it possible to diffuse higher impurity concentrations into the silicon. At the same time, the diffusion constant of germanium into silicon is small and only a negligibly small amount of germanium enters the emitter region.

Washed. Another plus of arsenic-germanium doping is that it permits using the "washed emitter" method of reopening a window over the emitter for metalization. That's because silicon dioxide with arsenic and germanium is a glass many times more soluble than the surrounding oxide; it easily dissolves away before the surrounding oxide is affected, eliminating registration problems.

For contacts, Toshiba does not use aluminum because it tends to migrate, causing opens or shorts. Aluminum also tends to alloy into the emitter, wrecking the shallow emitter junction. The noble metal system used has a lower tendency to alloy with the emitter, but still it is necessary to position the emitter junction more than 0.1 micron below the surface to obtain good characteristics.

Toshiba engineers say that in the future they expect to use this technology to fabricate higher frequency and higher power devices. Base thickness corresponds to a cutoff frequency on the order of 40 Ghz, so it should be possible to raise the frequency by better tailoring of impurity distribution, narrower emitter stripes, lower collector resistance, and similar refinements.

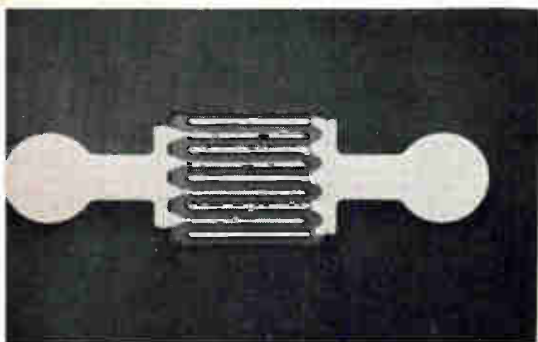

Speedy. Ion implantation technique leads to Japanese 7-Ghz transistor.

Electronics advertisers

September 15, 1969

Acton Laboratories, Inc. Impact Adv., Inc.	211	Eastman Kodak Co., Business Systems Markets Div.	173	Keithley Instruments, Inc. Bayless-Kerr Co.	178
AEG-Telefunken	213	J. Walter Thompson Co.		■ Keeco, Inc. Weiss Advertising	213
Alfco Spear Electronic Components Hazard Adv. Co., Inc.	191	E G & G, Incorporated Culver Adv., Inc.	209	Krohn-Hite Corp. L. K. Frank Co., Inc.	153
Airpax Electronics, Inc. Welch, Mirabile & Co., Inc.	166	El Instruments, Inc. Froehlich Advertising Services	206		
Allen-Bradley Co. Fensholt Adv. Agcy.	37, 39	Elco Corporation Schaefer Adv., Inc.	29		
American Microsystems Jordan Advertising	184	Eldorado Electrodata Corp. of Concord Moore-Mayhew Advertising	217		
American Potash and Chemical Corp., Rare Earth Div.	36	■ Electronics Buyers Guide Subscription Card	222A, 222B		
AMP, Inc. Garceau, Hallahan & McCullough, Inc.	32, 33	□ Electrovac Dr. Heinrich Fuchs	8E	Ledex, Inc. Yeck & Yeck, Inc.	186
□ AMP Europe Allardyce Palmer Ltd.	3E, 4E	E/MC Electronics/ Management Center	161 to 164, 194	Ledex, Inc., Bramco Controls Div. Yeck & Yeck, Inc.	34
Applied Digital Data Systems, Inc. Shaw Elliott, Inc.	96, 97	Ries Capiello Colwell, Inc.		Lockheed Missiles & Space Co. McCann-Erickson, Inc.	212
Arnold Engineering Co. Buchen Adv., Inc.	58, 59	Erie Technological Products Co., Inc. Walcker, Schmidt & Mackall, Inc.	77	□ LTT Promotion-Vente-Publicite	10E, 11E
Automatic Electric Co., Sub. of General Telephone & Electronics Corp.	40, 41			Lundy Electronics & Systems, Inc. Snow & Depew Adv., Inc.	172
Marsteller, Inc.					
		□ Ferisol Agence Domenach	30E		
		Fluoraware	211		
		Colle & McVoy Adv. Agcy., Inc.			
Bausch & Lomb, Inc. Wolff Assoc., Inc.	155	General Dynamics Corp. Young and Rubicam, Inc.	94, 95	■ Magnecraft Electric Co. Mills, Fife & MacDonald, Inc.	136
Beckman Instruments, Inc., Electronic Instrument Div.	139	General Radio Co. Horton Church & Goff, Inc.	6	■ Mallory & Co., P.R., Mfg. Div. Aitkin-Kynett Co.	206
Hixson & Jorgensen, Inc.		Gordon Co. Merrill, McEnroe & Assoc., Inc.	208	Marconi Instruments McCarthy, Scelba & DiBiasi	100
Beckman Instruments, Inc. (PID) N.W. Ayer/Jorgensen/MacDonald, Inc.	15	■ Grayhill, Inc. Carr Liggett Adv., Inc.	215	□ Marconi Instruments, Ltd. Taylor Adv., Ltd.	17E
Brand-Rex Creamer, Trowbridge, Case & Basford, Inc.	175	Gries Reproducer Co. Harold Marshall Adv.	216	Markel & Sons, L. Frank George Moll Adv., Inc.	63
■ Brush Instruments, Clevite Corp. Div.	180	Groov-Pin Corp. Feeley & Wheeler, Inc.	168	Maryland Telecommunications, Inc. Tel-Ad	217
■ Buckbee-Mears Co. Midland Assoc., Inc.	207	■ Gudebrod Brothers Silk Co., Electronics Div.	62	MasInexport Publicom Romanian International	215
■ Bulova Watch Co., Electronics Div. Caroe Marketing, Inc.	138	Ramsdell-Bickley & Co. Heinemann Electric Co.	38	Publicom Agency Memory Technology, Inc.	170
Bunker-Ramo Co. Diener & Dorskind, Inc.	200, 201	Thomas R. Sundheim, Inc.		Creamer, Trowbridge, Case & Basford, Inc.	216
■ Burroughs Corp., Electronic Components Div.	102			Mico Instrument Co.	42
By-Buk Co. Albert Frank Guenther Law Adv., Inc.	212			■ Micro Switch, Division of Honeywell N. W. Ayer & Son, Inc.	211
				Miller-Stephenson Chemical Co., Inc. Michel-Cather, Inc.	211
				Minnesota Mining & Mfg. Co. Mincom Div.	140
				Reach, McClinton & Co.	35
				■ Monsanto Co. Michel Cather, Inc.	203
				■ Murata Mfg. Co., Ltd. AMO, Inc.	
Cartesian, Inc. Miller/Stol Advertising	193	■ Hewlett Packard, Colorado Springs Div.	16, 17 to 28		
Cimron Division of Lear Siegler, Inc. Phillips Ramsey, Inc.	64	□ Hewlett Packard Europe Techno Scope	21E		
Clevite Corporation- Graphics Dept.	88, 89	■ Hewlett Packard, Frequency & Time Div.	86, 87, 150		
Carr Liggett Advertising Colorado Video, Inc.	205	■ Hewlett Packard, Loveland Div. Tallant/Yates Advertising	2	■ National Electronics, Inc. Connor-Sager Associates	214
■ Computer Products, Inc. Grenman Assoc., Inc.	216	■ Hewlett Packard, San Diego Div. Lennen & Newell, Inc.	1	National Semiconductor Corp. Hall Butler Blatherwick, Inc.	10, 11
□ Contelec Mario Willi	14E	Hitachi Metals, Ltd. Asia Adv. Agcy., Inc.	202	Nelson Stud Welding George Z. Griswold Advertising	205
Cornell-Dubilier Electronics Daniel & Charles, Inc.	45, 46	HLS Gruye, Vogt, Opperman, Inc.	71	■ Newark Electronics Corp. Stral Adv. Co.	80
□ CRC IRP	16E	Honeywell, Computer Control Div. Creamer, Trowbridge Case & Basford, Inc.	199	■ Nortronics Co., Inc., OEM Div. Stral Adv. Co., Inc.	147
		Honeywell-Florida Bradley Yeager & Assoc., Inc.	204		
		■ Honeywell Test Instruments Div. Campbell Mithun, Inc.	156, 157		
		Howard W. Sams & Co., Inc. George Brodsky Adv., Inc.	203		
		Hughes Aircraft Co. Foote, Cone & Belding	98		
Dale Electronics, Inc. Sub. of Lionel Corp.	3rd Cover			□ Omron Tatelsi Electronics Co. Dai-Ichi International, Inc.	6E, 7E
Defense Electronics, Inc. Harry I. Clarkson Associates	65	IBM—Federal Systems Div. Marsteller, Inc.	197	□ Onan Division of Studebaker Corp. Campbell Mithun, Inc.	13E
Deltron, Inc. Benn Assoc., Inc.	229	Industrial Electronic Engineers Van Der Boom, McCarron, Advertising	228		
Digilin, Inc. Van Der Boom, McCarron, Inc.	44	□ Ing. C. Olivetti & C. Spa. Studio Guiano Blei	5E		
□ Dow Corning International, Ltd. Marsteller International S.A.	18E, 19E	INTEL Bonfield Associates	12, 13	■ Parker Instrument Corp. HPM Advertising	195
		■ International Crystal Mfg. Co. Robert V. Freeland & Associates	179	■ Philbrick/Nexus Research Renaccio Adv., Inc.	137
		ITT Electron Tube Div. MacManus, John & Adams, Inc.	9	□ Phillips N.V. PIT/TMI Div. Marsteller International S'A.	2E
Eagle Signal Division of Gulf & Western Co.	149	ITT Semiconductor Div. Neals & Hlckok, Inc.	187	■ Plastic Capacitors, Inc. Sander Radkin Adv. Agcy. Ltd.	72
Feeley & Wheeler, Inc.				Princeton Applied Research Corp. Mort Barish Assoc., Inc.	66

"Speaking of lamps..."

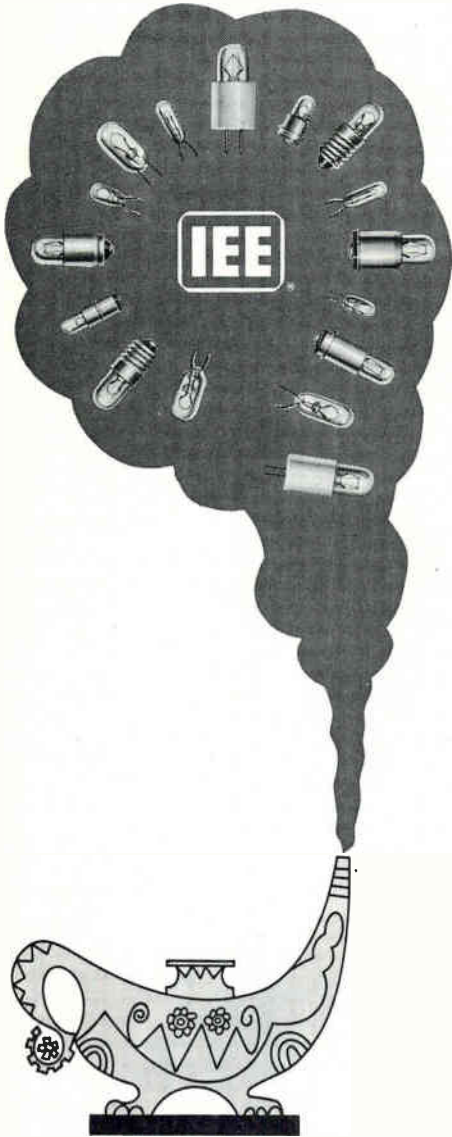

IEE builds subminiature lamps with stabilized filaments, longer life, uniform brilliance, unmatched reliability . . . at half the cost of competition. Seems like magic, but it isn't. It's extra long aging at rated voltages. (Forced aging shortens lamp life.) It's extra care in selection. It's such features as handmounted Swiss tungsten filaments and multi-point testing, all inherent in a stringent, quality assurance program for over 500 varieties. Let your IEE representative shed a little light on lamp savings for you today. (Get the rub?) Industrial Electronic Engineers, Inc., 7720 Lemona Avenue, Van Nuys, California 91405. (213) 787-0311, TWX-910-495-1707.



Quan Tech Laboratories Kniep Associates	210	■ United Transformer Co., Div. of TRW, Inc. Fuller & Smith & Ross, Inc.	2nd Cover
Radio Corporation of America Al Paul Lefton Co.	4th Cover, 81, 208	■ Unirode Corp. Silton Brothers, Inc.	74, 75
Raytheon Co., Components Div. Fuller & Smith & Ross, Inc.	70	U-Tech, Industrial Physics and Electronics Co. Div. Ross Clay Advertising	174
Redcor Corp. Management Communication Consultants, Inc.	148	■ Vactec, Inc. Coleman & Assoc. Adv.	182
Remvac Components, Inc. Caroe Marketing, Inc.	183	Varo, Inc.	76
■ RHG Electronics Laboratories, Inc. Samuel H. Goldstein, Inc.	207	Tracy-Locke, Inc. Vector Electronic Co., Inc. Buck Advertising Victoreen Instrument Division Dix & Eaton, Inc.	154 230
Sage Electronics Corp. Mathison Adv., Inc.	196	Waters Manufacturing Co. Goldman, Daniels, Inc.	192
□ Schneider R.T. Noirclerc Publicite Scientific Data Systems	22E 220	□ Watkins-Johnson Co. William C. Estler Advertising	9E 101
Semcor Division Components, Inc. Marketing & Corporate Communications, Inc.	83	■ Westinghouse Semiconductor Div. Ketchum, MacLeod and Grove, Inc.	101
■ Semtech Corp. Burruss Advertising	73	■ Williams Precious Metals, Div. of Williams Gold Refining Co. Inc.	209
□ Sercel Termonet Technique	12E 12E	Xerox Corporation Needham, Harper & Steers, Inc.	165
□ SESCOSEM □ SGS Lonsdale Italia S.P.A. Sierra Research Corp. B. P. Myer Assoc., Inc. Signetics Corp. Sub. Corning Glass Works Cunningham & Walsh, Inc.	20E 15E 14 131, 169		
□ Silec Electronique Publicite Y Ch. Lambert Siliconix, Inc. Robertson West, Inc.	29E 7		
Singer Co., The Instrumentation Div. Technical, Industrial & Scientific Marketing, Inc.	188, 189		
□ SORENSEN AG, CH-8045 Zurich ■ Sorensen Operation Raytheon Co. □ S. P. Elettronica Studio Sergio Rosata Sperry Rand Corp., Sperry Microwave Electronics Div. Neals & Hickok, Inc.	17E 93 24E, 25E 90		
Sperry Rand Corp., Research Center Allied Adv., Inc.	214 5		
Sprague Electric Co., The The Harry P. Bridge Co.	198		
■ Standard Condenser Corp. R. N. Johnson Advertising Superior Electric Co. K. C. Shenton Co.	57		
Sylvania Electric Products, Inc., Electronic Components Group Doyle Dane Bernbach, Inc.	49 to 56		
Synthane-Taylor Corp. Gary & Rogers, Inc.	99		
■ Synthetic Instruments, Inc. Burton Browne Advertising	154		
■ Tech Laboratories, Inc. Lewis Adv. Agcy. Techne (Cambridge) Limited Harrison Wright Assoc., Ltd.	207 208		
■ Tektronix, Inc. Dawson, Turner & Jenkins, Inc. Test Equipment Corp. Dean & Bain Adv., Inc.	141 to 144 229		
Texas Instruments Incorporated, Components Group Albert Frank-Guenther Law, Inc. Texas Instruments, Metallurgical Materials Division Horton, Church & Goff, Inc.	60, 61, 78, 121, 176 30, 31		
■ Transformer Electronics Co. Wolf & Weir Triplett Electrical Instrument Co. Byer & Bowman Adv. Agcy., Inc.	210 159		
TRW Electronics Fuller & Smith & Ross, Inc.	84, 85		
■ Trygon Electronics, Inc. Technical, Industrial & Scientific Marketing, Inc.	79		
■ Tung-Sol Div., Wagner Electric Corp. Feeley & Wheeler, Inc. Tyco Laboratories, Inc., Instruments Div. Kenyon & Eckhardt, Inc. Adv.	158 160		
		Classified & Employment Advertising F.J. Eberle, Manager 212-971-2557	
		EMPLOYMENT OPPORTUNITIES . . . 218-219 Atomic Personnel Inc. 218 Corcoran, J.P. 218 Management Recruiters 218 Norden, Div., of U.A.C. 219	
		EQUIPMENT (Used or Surplus New) For Sale	
		Fishman, Philip Co. 218 Markus-Campbell 218 Radio Research Instrument Co. 218	
		■ For more information on complete product line see advertisement in the latest Elec- tronics Buyer's Guide □ Advertisers in Electronics International	
		Electronics Buyers' Guide George F. Werner, Associate Publisher [212] 971-2310 Robert M. Denmead, Midwest Regional Manager [312] MO 4-5800 William A. Capuzzi, New York, New England District Manager [212] 971-3793 Regina Hers, Directory Manager [212] 971-2544 Thomas M. Egan, Production Manager [212] 971-3140 Carol Gallagher, Assistant Production Manager [212] 971-2045	
		Circulation Department Isaaca Siegel, Manager [212] 971-6057	
		Research Department David Strassler, Manager [212] 971-6058	

power
module
users:

**DON'T
ORDER
ANOTHER
POWER
MODULE**

until you've
checked Deltron's
series "N"

WE GUARANTEE

**the BEST at the
LOWEST price**

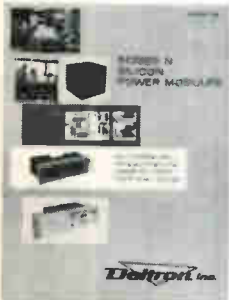

**GET
THE
FACTS**

send for
FREE
catalog

Deltron

WISSAHICKON AVE., NORTH WALES, PA. 19454
PHONE: (215) 699-9261 • TWX: (510) 661-8061

D 112

Advertising Sales Staff

Dan McMillan [212] 971-3468
Associate Publisher

Wallis Clarke [212] 971-2187
Advertising Sales Service Manager

Warren H. Gardner [215] LO 8-6161
Eastern Advertising Sales Manager

Atlanta, Ga. 30309: Michael H. Miller, 1375
Peachtree St., N.E.
[404] 892-2868

Boston, Mass. 02116: William S. Hodgkinson
McGraw-Hill Building, Copley Square
[617] CO 2-1160

Cleveland, Ohio 44113: William J. Boyle, 55
Public Square, [216] SU 1-7000

New York, N.Y. 10036
500 Fifth Avenue
James R. Pierce [212] 971-3615
John A. Garland [212] 971-3617
Michael J. Stoller [212] 971-3616

Philadelphia, Pa. 19103:

Jeffrey M. Preston
Warren H. Gardner,
6 Penn Center Plaza,
[215] LO 8-6161

Pittsburgh, Pa. 15222: Jeffrey M. Preston,
4 Gateway Center, [412] 391-1314
Rochester, N.Y. 14534: William J. Boyle,
9 Greylock Ridge, Pittsford, N.Y.
[716] 586-5040

Donald R. Furth [312] MO 4-5800
Midwest Advertising Sales Manager
Chicago, Ill. 60611: Kenneth E. Nicklas
Ralph Hanning 645 North Michigan Avenue,
[312] MO 4-5800

Dallas, Texas 75201: Richard P. Poole, 1800
Republic National Bank Tower,
[214] RI 7-9721

Houston, Texas 77002: Robert Wallin,
2270 Humble Bldg. [713] CA 4-8381

Detroit, Michigan 48226: Ralph Hanning,
856 Penobscot Building
[313] 962-1793

Minneapolis, Minn. 55402: 1104 Northstar
Center [612] 332-7425

St. Louis, Mo. 63105: Kenneth E. Nicklas,
The Clayton Tower, 7751 Carondelet Ave.
[314] PA 5-7285

James T. Hauptli [415] DO 2-4600
Western Advertising Sales Manager

Denver, Colo. 80202: David M. Watson,
Tower Bldg., 1700 Broadway
[303] 266-3863

Los Angeles, Calif. 90017: Ian C. Hill,
Bradley K. Jones, 1125 W. 6th St.,
[213] HU 2-5450

Portland, Ore. 97204: James T. Hauptli,
Don Farris, 218 Mohawk Building,
222 S.W. Morrison Street,
Phone [503] 223-5118

San Francisco, Calif. 94111: James T. Hauptli,
Don Farris, 255 California Street,
[415] DO 2-4600

Pierre Braude Tel: 225 85 88: Paris

European Director

Paris: Denis Jacob
88-90 Avenue Des Champs-Elysees, Paris 8
United Kingdom and Scandinavia

London: Oliver Ball, Tel: Hyde Park 1451
34 Dover Street, London W1

Milan: Robert Saidel, Roberto Laureri Jr.
1 via Baracchini Phone 86-90-656

Brussels: Denis Jacob
27 Rue Ducale Tel: 136503

Frankfurt/Main: Hans Haller
Elsa-Brandstroem Str. 2
Phone 72 01 81

Geneva: Denis Jacob
1 rue du Temple Phone: 31 95 60

Tokyo: McGraw-Hill
Publications Overseas Corporation,
Kasumigaseki Building 2-5, 3-chome,
Kasumigaseki, Chiyoda-Ku, Tokyo, Japan
[581] 9811

Osaka: Akihiko Kamesaka, McGraw-Hill
Publications Overseas Corporation, Kondo
Bldg., 163, Umegae-cho Kita-ku [362] 8771
Australasia: Warren E. Ball, IPO Box 5106,
Tokyo, Japan

Business Department

Stephen R. Weiss, Manager
[212] 971-2044

Thomas M. Egan,
Production Manager [212] 971-3140

Maury D'Gongora,
Assistant Production Manager [212] 971-2045

Dorothy Carmesin, Contracts and Billings
[212] 971-2908

Frances Vallone, Reader Service Manager
[212] 971-2865



Model 80 IC Tester

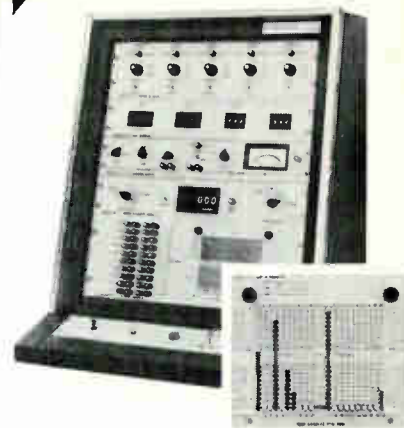

*Versatile new
low cost unit
tests all digital
and
linear IC's*

The new low cost Model 80 IC tester from Test Equipment Corporation can test all digital and linear IC's.

All signal sources and measurement devices for the Model 80 are programmed through a matrix, thus adding extreme flexibility to the type of tests performed. A unique program card (inset photo above) can provide even simpler, more rapid setup of the matrix, if desired.

An adapter converts the Model 80 to a high speed automatic GO/NO-GO programmable test system capable of complete functional logic testing of any digital IC with up to 16 leads.

The Model 80 performs all static tests on digital IC's and most dynamic tests required for linear circuits. Dynamic tests on linear IC's include open loop gain, input and output impedance, gain bandwidth, maximum output voltage swing, and others.

Low cost makes the Model 80 an excellent choice for incoming inspection, engineering evaluation or production testing. Its modular construction offers additional versatility to allow selection of specific capabilities as required.

Write today for pricing and technical information.

Test Equipment

CORPORATION
P.O. BOX 20215, DALLAS, TEXAS 75220 • 214/357-6271

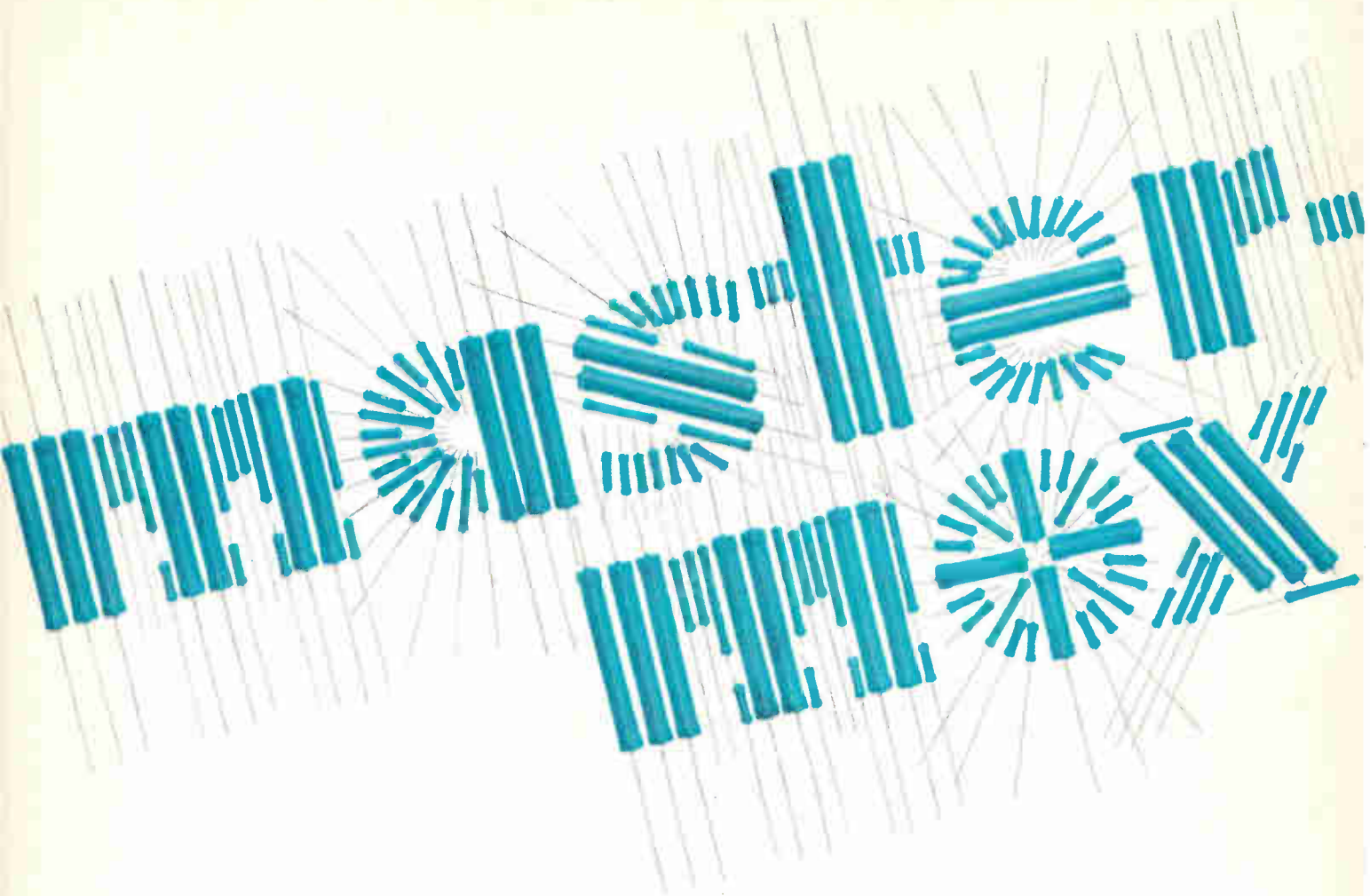

A Mastermox is something more than a metal film.

A Mastermox is a metal oxide glaze resistor. Mastermox resistors combine metal powders with molten glass to bring resistor technology to a new high. Revolutionary design creates high resistance range accuracy — 10K ohms to 10,000 Megohms. Space-savings too. Provides more watts per cubic inch.

Stability? Drift as low as 1% full-load in 2000 hours. On the shelf — less than 0.1% drift per year. Changes in voltage and temperature barely influence Mastermox performance.

Obtain Mastermox critical capability in high

voltage dividers and bleeders, meter multipliers, high voltage probes, oscilloscopes and vacuum tube voltmeters, plate load resistors, pulse forming networks, and similar applications.

Mastermox. Victoreen's master resistor.

Model	Resistance Range	Power Rating @ 70°C	*Max. Oper. Volts	Length Inches	Diameter Inches
MOX-400	1 - 2500 megs	.25W	1,000V	.420 ± .050	.130 ± .010
MOX-750	1 - 5000 megs	.50W	2,000V	.790 ± .050	.130 ± .010
MOX-1125	1 - 10000 megs	1.00W	5,000V	1.175 ± .060	.130 ± .010
MOX-1	10K - 500 megs	2.50W	7,500V	1.062 ± .060	.284 ± .010
MOX-2	20K - 1000 megs	5.00W	15,000V	2.062 ± .060	.284 ± .010
MOX-3	30K - 1500 megs	7.50W	22,500V	3.062 ± .060	.284 ± .010
MOX-4	40K - 2000 megs	10.00W	30,000V	4.062 ± .060	.284 ± .010
MOX-5	50K - 2500 megs	12.50W	37,500V	5.062 ± .060	.284 ± .010

*Applicable above critical resistance. Maximum operating temperature, 220°C. Encapsulation: Si Conformal. Additional technical data in folder form available upon request. Or telephone: (216) 795-8200.

VICTOREEN INSTRUMENT DIVISION
 10101 WOODLAND AVENUE • CLEVELAND, OHIO 44104
 EUROPE: ARNDAL HOUSE, THE PRECINCT, EGHAM, SURREY, ENGLAND • TEL: EGHAM 4887



Electronics reader service

Warning: The Post Office now requires your ZIP CODE on all mail. Please include your ZIP CODE number when filling out your reply card.

Use these handy post cards for more detailed information on: products advertised, new products, new literature.

Circle the number on the Reader Service post card that corresponds to the number at the bottom of the advertisement, new product item, or new literature in which you are interested.

Please print clearly. All written information must be legible to be efficiently processed.

If someone has beaten you to the post cards, you may obtain the needed information by writing directly to the manufacturer, or by sending your name and address, plus the Reader Service number, to Electronics Reader Service department.

All inquiries from outside the U.S. that cannot reach Electronics before the expiration dates noted on the Reader Service post card, must be mailed directly to the manufacturer. The manufacturer assumes all responsibilities for responding to inquiries. Electronics merely provides and clears requests for information from inquirer to manufacturer.

Correct amount of postage must be affixed for all mailings from outside the U.S.

To subscribe to or to renew Electronics

Fill in the "For Subscriptions" area on the card if you desire to subscribe to or renew your present subscription to Electronics. Send no money. Electronics will bill you at the address indicated on the Reader Service post card.

Multi-product advertisements

For information on specific items in multi-product advertisements which do not have a specific Reader Service number indicated write directly to manufacturer for information on precise product in which you are interested.

19 *For employment inquiries fill in home address. September 15, 1969 Card Expires November 15, 1969 14

Name _____ title _____

Company* _____

Address _____

City _____ State _____ Zip Code _____

1	20	39	58	77	96	115	134	153	172	191	210	229	248	267	286	305	324	343	362	381	400	419	438	457	476	495	514	962
2	21	40	59	78	97	116	135	154	173	192	211	230	249	268	287	306	325	344	363	382	401	420	439	458	477	496	515	963
3	22	41	60	79	98	117	136	155	174	193	212	231	250	269	288	307	326	345	364	383	402	421	440	459	478	497	516	964
4	23	42	61	80	99	118	137	156	175	194	213	232	251	270	289	308	327	346	365	384	403	422	441	460	479	498	517	965
5	24	43	62	81	100	119	138	157	176	195	214	233	252	271	290	309	328	347	366	385	404	423	442	461	480	499	518	966
6	25	44	63	82	101	120	139	158	177	196	215	234	253	272	291	310	329	348	367	386	405	424	443	462	481	500	900	967
7	26	45	64	83	102	121	140	159	178	197	216	235	254	273	292	311	330	349	368	387	406	425	444	463	482	501	901	968
8	27	46	65	84	103	122	141	160	179	198	217	236	255	274	293	312	331	350	369	388	407	426	445	464	483	502	902	969
9	28	47	66	85	104	123	142	161	180	199	218	237	256	275	294	313	332	351	370	389	408	427	446	465	484	503	951	970
10	29	48	67	86	105	124	143	162	181	200	219	238	257	276	295	314	333	352	371	390	409	428	447	466	485	504	952	971
11	30	49	68	87	106	125	144	163	182	201	220	239	258	277	296	315	334	353	372	391	410	429	448	467	486	505	953	972
12	31	50	69	88	107	126	145	164	183	202	221	240	259	278	297	316	335	354	373	392	411	430	449	468	487	506	954	973
13	32	51	70	89	108	127	146	165	184	203	222	241	260	279	298	317	336	355	374	393	412	431	450	469	488	507	955	974
14	33	52	71	90	109	128	147	166	185	204	223	242	261	280	299	318	337	356	375	394	413	432	451	470	489	508	956	975
15	34	53	72	91	110	129	148	167	186	205	224	243	262	281	300	319	338	357	376	395	414	433	452	471	490	509	957	976
16	35	54	73	92	111	130	149	168	187	206	225	244	263	282	301	320	339	358	377	396	415	434	453	472	491	510	958	977
17	36	55	74	93	112	131	150	169	188	207	226	245	264	283	302	321	340	359	378	397	416	435	454	473	492	511	959	978
18	37	56	75	94	113	132	151	170	189	208	227	246	265	284	303	322	341	360	379	398	417	436	455	474	493	512	960	979
19	38	57	76	95	114	133	152	171	190	209	228	247	266	285	304	323	342	361	380	399	418	437	456	475	494	513	961	980

19 *For employment inquiries fill in home address. September 15, 1969 Card Expires November 15, 1969 14

Name _____ title _____

Company* _____

Address _____

City _____ State _____ Zip Code _____

1	20	39	58	77	96	115	134	153	172	191	210	229	248	267	286	305	324	343	362	381	400	419	438	457	476	495	514	962
2	21	40	59	78	97	116	135	154	173	192	211	230	249	268	287	306	325	344	363	382	401	420	439	458	477	496	515	963
3	22	41	60	79	98	117	136	155	174	193	212	231	250	269	288	307	326	345	364	383	402	421	440	459	478	497	516	964
4	23	42	61	80	99	118	137	156	175	194	213	232	251	270	289	308	327	346	365	384	403	422	441	460	479	498	517	965
5	24	43	62	81	100	119	138	157	176	195	214	233	252	271	290	309	328	347	366	385	404	423	442	461	480	499	518	966
6	25	44	63	82	101	120	139	158	177	196	215	234	253	272	291	310	329	348	367	386	405	424	443	462	481	500	900	967
7	26	45	64	83	102	121	140	159	178	197	216	235	254	273	292	311	330	349	368	387	406	425	444	463	482	501	901	968
8	27	46	65	84	103	122	141	160	179	198	217	236	255	274	293	312	331	350	369	388	407	426	445	464	483	502	902	969
9	28	47	66	85	104	123	142	161	180	199	218	237	256	275	294	313	332	351	370	389	408	427	446	465	484	503	951	970
10	29	48	67	86	105	124	143	162	181	200	219	238	257	276	295	314	333	352	371	390	409	428	447	466	485	504	952	971
11	30	49	68	87	106	125	144	163	182	201	220	239	258	277	296	315	334	353	372	391	410	429	448	467	486	505	953	972
12	31	50	69	88	107	126	145	164	183	202	221	240	259	278	297	316	335	354	373	392	411	430	449	468	487	506	954	973
13	32	51	70	89	108	127	146	165	184	203	222	241	260	279	298	317	336	355	374	393	412	431	450	469	488	507	955	974
14	33	52	71	90	109	128	147	166	185	204	223	242	261	280	299	318	337	356	375	394	413	432	451	470	489	508	956	975
15	34	53	72	91	110	129	148	167	186	205	224	243	262	281	300	319	338	357	376	395	414	433	452	471	490	509	957	976
16	35	54	73	92	111	130	149	168	187	206	225	244	263	282	301	320	339	358	377	396	415	434	453	472	491	510	958	977
17	36	55	74	93	112	131	150	169	188	207	226	245	264	283	302	321	340	359	378	397	416	435	454	473	492	511	959	978
18	37	56	75	94	113	132	151	170	189	208	227	246	265	284	303	322	341	360	379	398	417	436	455	474	493	512	960	979
19	38	57	76	95	114	133	152	171	190	209	228	247	266	285	304	323	342	361	380	399	418	437	456	475	494	513	961	980

19 *For employment inquiries fill in home address. September 15, 1969 Card Expires November 15, 1969 14

Name _____ title _____

Company* _____

Address _____

City _____ State _____ Zip Code _____

1	20	39	58	77	96	115	134	153	172	191	210	229	248	267	286	305	324	343	362	381	400	419	438	457	476	495	514	962
2	21	40	59	78	97	116	135	154	173	192	211	230	249	268	287	306	325	344	363	382	401	420	439	458	477	496	515	963
3	22	41	60	79	98	117	136	155	174	193	212	231	250	269	288	307	326	345	364	383	402	421	440	459	478	497	516	964
4	23	42	61	80	99	118	137	156	175	194	213	232	251	270	289	308	327	346	365	384	403	422	441	460	479	498	517	965
5	24	43	62	81	100	119	138	157	176	195	214	233	252	271	290	309	328	347	366	385	404	423	442	461	480	499	518	966
6	25	44	63	82	101	120	139	158	177	196	215	234	253	272	291	310	329	348	367	386	405	424	443	462	481	500	900	967
7	26	45	64	83	102	121	140	159	178	197	216	235	254	273	292	311	330	349	368	387	406	425	444	463	482	501	901	968
8	27	46	65	84	103	122	141	160	179	198	217	236	255	274	293	312	331	350	369	388	407	426	445	464	483	502	902	969
9	28	47	66	85	104	123	142	161	180	199	218	237	256	275	294	313	332	351	370	389	408	427	446	465	484	503	951	970
10	29	48	67	86	105	124	143	162	181	200	219	238	257	276	295	314	333	352	371	390	409	428	447	466	485	504	952	971
11	30	49	68	87	106	125	144	163	182	201	220	239	258	277	296	315	334											

Reprint service

All Electronics editorial matter available in reprint form:

For reprints of special reports and feature articles see list on right side of this page. Send your order to Electronics Reprint Department at the address indicated. To expedite mailing of your order for single reprints please send cash, check or money order with your order. Allow 3-4 weeks for delivery.

Bulk reprints of editorial matter can be ordered from current or past issues. The minimum quantity is 100 copies. Prices quoted on request: call 212-971-2274, or write to address below.

Warning: The Post Office now requires your ZIP CODE on all mail. Please include your ZIP CODE number when filling out your reply card.

3

Business reply mail

No postage stamp necessary if mailed in the United States

Postage will be paid by

Electronics
Reader service department
Box 444
Hightstown, N. J. 08520

First class
Permit no. 42
Hightstown, N. J.



2

Business reply mail

No postage stamp necessary if mailed in the United States

Postage will be paid by

Electronics
Reader service department
Box 444
Hightstown, N.J. 08520

First class
Permit no. 42
Hightstown, N. J.

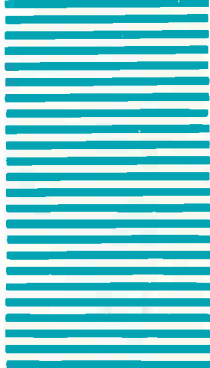

1

Business reply mail

No postage stamp necessary if mailed in the United States

Postage will be paid by

Electronics
Reader service department
Box 444
Hightstown, N.J. 08520

First class
Permit no. 42
Hightstown, N. J.



To order reprints or for further information, please write to: **Electronics Reprint Department, 330 West 42nd Street, New York, N.Y. 10036.**

To expedite mailing of your order for single reprints please enclose payment with your order.

You may order any of the below listed reprints by key number. Discounts on quantities over 10.

- Key no. R-01 **Computer-aided Design: Part I, The Man-machine Merger.** 16 pages. \$1.25.
- Key no. R-04 **Multilayer Circuit Boards: Sharpening An Imperfect Tool.** 7 pages. 50¢.
- Key no. R-05 **Topology Cuts Design Drudgery.** 12 pages. 50¢.
- Key no. R-06 **Report on Japanese Technology: Sony.** 20 pages. 50¢.
- Key no. R-010 **Special Report on Large Scale Integration.** 54 pages. \$1.50.
- Key no. R-011 **Medical Electronics (1967).** 8 part series, 44 pages. \$1.25.
- Key no. R-012 **Special Report on Gallium Arsenide** 17 parts. 32 pages. \$2.00
- Key no. R-016 **Special Report on The Transistor: Two Decades of Progress.** 48 pages. \$1.50.
- Key no. R-017 **Special Report on Ferrites.** 16 pages. \$1.00.
- Key no. R-018 **European Electronics Markets 1969** 20 page forecast report with a 6 page foldout. \$1.00
- Key no. R-019 **U.S. Electronics Markets 1969** 32 page forecast report with 4 page foldout. \$1.00
- Key no. R-020 **1968 Electronics Index to Technical Articles and Authors Free.**
- Key no. R-021 **Infrared Detector Characteristics.** 23 x 11 inch fold-out chart. 50¢
- Key no. R-022 **Active Filters: Part II, Varying the Approach.** 8 pages \$1.00
- Key no. R-79 **MOS Integrated Circuits.** 12 pages. 50¢.
- Key no. R-78 **The Overlay Transistor.** 15 pages. 50¢.
- Key no. R-75 **Biotelemetry.** 2 part series, 16 pages. 50¢.
- Key no. R-64 **Field Effect Transistors. Parts I, II, and III.** 64 pages. \$1.00.

From Dale—the pots you don't ship back...

<1% customer rejection rate!

Less than 1% customer rejection for *all* causes. That's the record established by Dale T-Pots. Consider the savings this can bring you in time, paper work. Then consider the added efficiency of consolidating more of your buys at this versatile source. Almost 50% more models added in two years. Military (RT-10, 11, 12, 22, 24), Industrial, Commercial ... wirewound and film elements. All are very competitively priced. Check today and find out. We can deliver them quickly—and you won't have to send them back.

MILITARY GRADE T-POTS

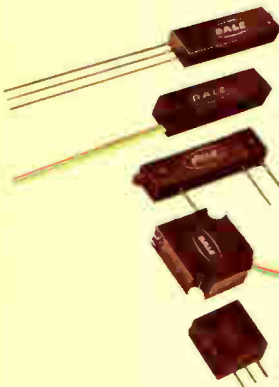

- 600 Series:** Mil. Equiv. RT-10; 10 Ω to 100K Ω , $\pm 5\%$; 1 watt at 70°C, derated to 0 at 175°C; .18 H x .32 W x 1.00 L.
- 1200 Series:** Mil. Equiv. RT-11; 10 Ω to 100K Ω , $\pm 5\%$; 1 watt at 70°C, derated to 0 at 175°C; .28 H x .31 W x 1.25 L.
- 1600 Series:** Mil. Equiv. RT-12; 10 Ω to 100K Ω , $\pm 5\%$; 1 watt at 70°C, derated to 0 at 175°C; .19 H x .32 W x 1.25 L.
- 5000 Series:** Mil. Equiv. RT-22; 10 Ω to 50K Ω , $\pm 5\%$; 1 watt at 70°C, derated to 0 at 175°C; .19 or .22 H x .50 W x .50 L.
- 5800 Series:** Mil. Equiv. RT-24; 10 Ω to 50K Ω , $\pm 5\%$; 1 watt at 70°C, derated to 0 at 175°C; .145 or .150 H x .375 W x .375 L.

COMMERCIAL GRADE ECONO-TRIM T-POTS



WIREWOUND ELEMENT

- 2300 Series:** Sealed/Unsealed; 10 Ω to 50K Ω , $\pm 10\%$; 0.5 watt at 25°C, derated to 0 at 105°C; .36 H x .28 W x 1.00 L.
- 2400 Series:** Sealed/Unsealed; 10 Ω to 50K Ω , $\pm 10\%$; 1 watt at 40°C, derated to 0 at 125°C; .31 H x .16 W x .75 L.

FILM ELEMENT

- 8300 Series:** Sealed/Unsealed; 10 Ω to 2 Meg., $\pm 10\%$ 100 Ω thru 500K, $\pm 20\%$ all other values; .75 watt at 25°C, derated to 0 at 105°C; .36 H x .28 W x 1.00 L.
- 8400 Series:** Sealed/Unsealed; 10 Ω to 2 Meg., $\pm 10\%$ 100 Ω thru 500K, $\pm 20\%$ all other values; .75 watt at 25°C, derated to 0 at 125°C; .31 H x .16 W x .75 L.

INDUSTRIAL GRADE T-POTS

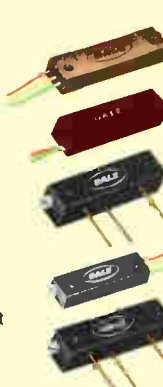

WIREWOUND ELEMENT

- 100, 200, 300 Series:** 10 Ω to 100K Ω .
- 100 Series:** $\pm 5\%$; 0.8 watt at 70°C, derated to 0 at 135°C.
- 200 Series:** $\pm 10\%$; 0.5 watt at 70°C, derated to 0 at 105°C.
- 300 Series:** $\pm 15\%$; .25 watt at 70°C, derated to 0 at 85°C. Dimensions: .22 H x .31 W x 1.25 L (also 1.32 L for 100, 200).
- 1100 Series:** 10 Ω to 100K Ω , $\pm 10\%$; 1 watt at 70°C, derated to 0 at 175°C; .28 H x .31 W x 1.25 L.
- 2100 Series:** Industrial counterpart RT-11; 10 Ω to 100K Ω , $\pm 10\%$; 1 watt at 70°C, derated to 0 at 125°C; .28 H x .31 W x 1.25 L.
- 2200 Series:** Industrial counterpart RT-10; 10 Ω to 100K Ω , $\pm 10\%$; 1 watt at 70°C, derated to 0 at 125°C; .18 H x .32 W x 1.00 L.

FILM ELEMENT

- 8100 Series:** Industrial counterpart RJ-11; 10 Ω to 2 Meg., $\pm 10\%$ 100 Ω to 500K, $\pm 20\%$ other values; .75 watt at 70°C, derated to 0 at 125°C; .28 H x .31 W x 1.25 L.

Call 402-564-3131 for complete information or write for Catalog B



DALE ELECTRONICS, INC., 1300 28th Ave., Columbus, Nebraska 68601
In Canada, Dale Electronics Canada, Ltd. • A subsidiary of The Lionel Corporation



Circle 901 on reader service card

*Exposed
RCA Coaxial
Cavities*

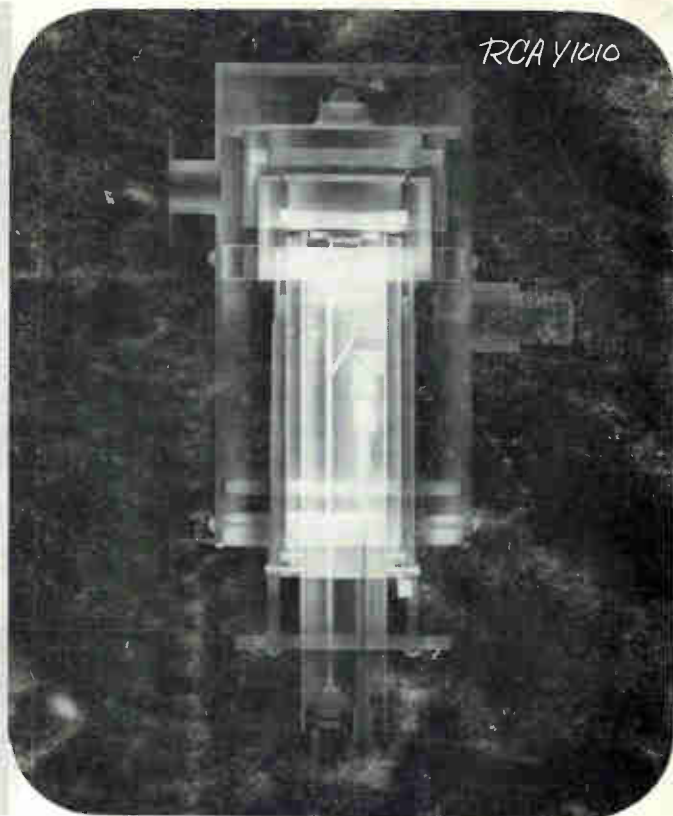

Now—continuing its leadership in the development of electronic products—RCA announces a complete range of coaxial cavities to assure optimum performance from its line of CERMOLox® Power Tubes.

Suitable for use either as complete amplifiers or as oscillators, these cavities assure specified performance with fully engineered circuitry, minimum RF losses, simplified connections, and high overall efficiency.

To fulfill your requirements, cavities are available for frequencies up to L-band and powers up to 10 kW.

The performance, reliability, and efficiency of CERMOLox tubes have been proved. This line of cavities will augment and assure these benefits. In addition, if your requirements call for special parameters, our Application Engineers will gladly modify existing cavities or develop new ones to assure you of optimum equipment performance.

For more information on RCA coaxial cavities and RCA CERMOLox Tubes, see your local RCA Representative. For technical data on specific types, write: RCA Electronic Components, Commercial Engineering Section I-19T-3, Harrison, N. J. 07029

RCA Coaxial Cavities—Available Off-the-Shelf

RCA TYPE	TUBE	POWER OUTPUT(Watts)	MODE	FREQUENCY(MHz)
Y1010	8226	100	CW	1170
Y1044	8501	10,000	pulse	400
Y1050	7651	5,000	pulse	500
Y1051	8227	450	pulse	500
Y1052	8227	400	pulse	350
Y1054A	7651	5,500	pulse	150
Y1059	7214	12,500	pulse	150
Y1070	7651	6,500	pulse	200
Y1086	7651	375	pulse	200

RCA