

Dutch fight pollution with national monitor net 78

An integrated circuit with 1 GHz bandwidth 103

Graphic display systems for minicomputers 111

# Electronics®

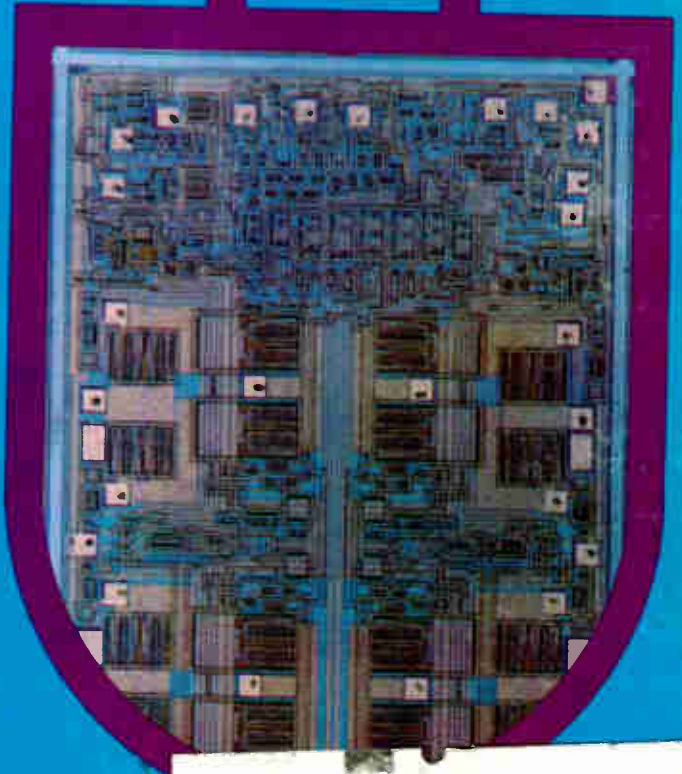
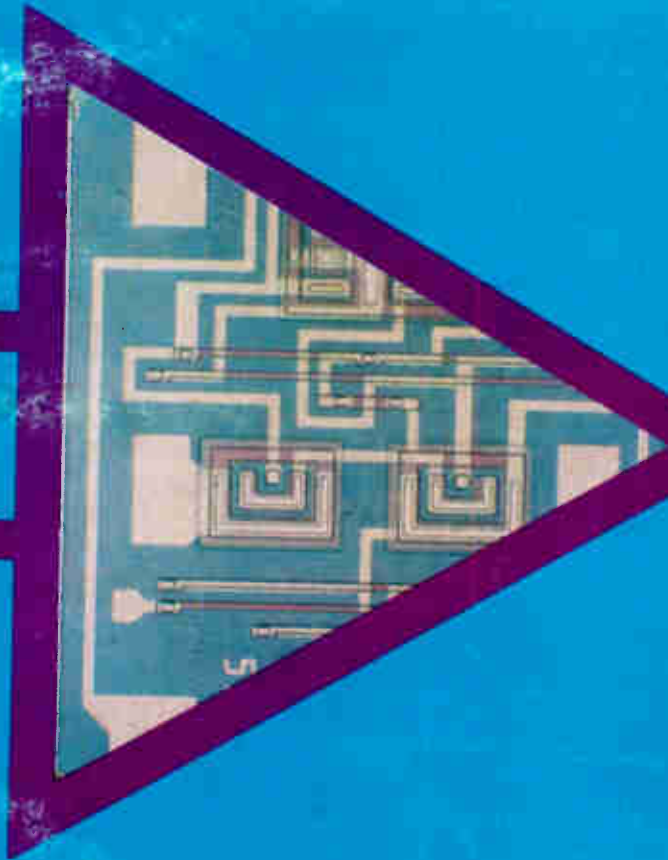

## **SPECIAL REPORT**

# Linear ICs multiply options for today's designer

1428 N. 21902 BOMAY NORTH  
MATT NEILL  
3022 NE BROADWAY  
PORTLAND OR 97232

# Sine-Cosine Function Generator



#SFG 1374-1

**Provides A Two Quadrant Sine Function**

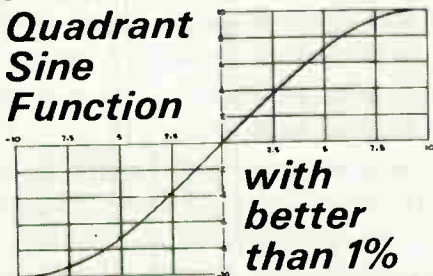

**with better than 1% Accuracy**

- Scaled for  $\pm 10V$  input and output
- Operates from conventional  $\pm 15V$  power supplies
- No external offset adjustments required
- Terminal provided to allow four quadrant operation

## Specifications Include:

- DC accuracy:  $\pm (0.1\% + 0.6\% \times E_{IN}/10V)$
- DC accuracy over the complete temperature range:  $\pm (0.25\% + 0.75\% \times E_{IN}/10V)$
- Input impedance (pin 1): 9.3K  $\Omega$
- Input voltage range (pin 1):  $\pm 10V$  DC
- Rated output-voltage:  $\pm 10V$  DC
- Rated output-current:  $\pm 5ma$
- Output impedance: 1  $\Omega$
- Frequency response for 1% accuracy: DC to 3kHz

There is No Substitute for Reliability



**GENERAL MAGNETICS, INC.**

135 Bloomfield Avenue  
Bloomfield, New Jersey 07003  
(201) 743-2700

## Precision Analog Components for Signal Manipulation and Function Generation

- Radiation Hardened Analog Multipliers and Modulators
- Linear DC to Synchro Converter
- Sine-Cosine to 3 Wire Converter
- 3 Wire to Linear DC Converter
- 3 Wire to Sine-Cosine Converter
- Sine-Cosine Generators
- Precision Modulators
- Precision Analog Multipliers
- Squaring/Square Root Modules
- Precision Analog Divider
- Precision A.C. Regulators
- Demodulators
- Transformers

## Analog Computing Applications

- Trigonometric Manipulations
- Multiplying
- Dividing
- Squaring
- Modulating
- Automatic Gain Control
- Demodulation
- RMS Computation
- Phase Measurement
- AC Amplitude Regulation and Modulation
- Linearizing
- Square Rooting
- Power Measurement
- Ratio Measurement

# 4 Quadrant Magnetic Analog Multiplier

DC x AC = AC Output



#MCM 1351-2

**Product Accuracy is  $\pm 1/2\%$  of all readings Over Full Temperature Range of  $-55^{\circ}C$  to  $+125^{\circ}C$**

- Product accuracy is specified in % of reading for all output analog voltage product points over the full military temperature range instead of % of full scale error giving superior results for small values.
- Linearity, product accuracy, and zero point virtually unaffected by temperature changes.
- All units are hermetically sealed and completely shielded from external electric or magnetic fields.

## Specifications Include:

Transfer equation:  $E = XY/3$

X & Y input signal ranges:  
0 to  $\pm 3V$  Peak

Maximum static and dynamic product error:  $1/2\%$  of point or 2 MVRMS, whichever is greater, over entire temperature range

Input impedance: X = 10K; Y = 10K

Full scale output: 3 VRMS

Minimum load resistance for full scale output: 2000 ohms

Output impedance: Less than 50 ohms

X input bandwidth:  
 $\pm 0.5db$ , 0 to 200 hertz

Y input bandwidth:  
 $\pm 0.5db$ , 20 hertz to 1000 hertz

DC power:  $\pm 15V$  unless otherwise required @ 20 ma

There is No Substitute for Reliability



**GENERAL MAGNETICS, INC.**

135 Bloomfield Avenue  
Bloomfield, New Jersey 07003  
(201) 743-2700

# Bendix printed circuit board connectors put an end to close order drilling.

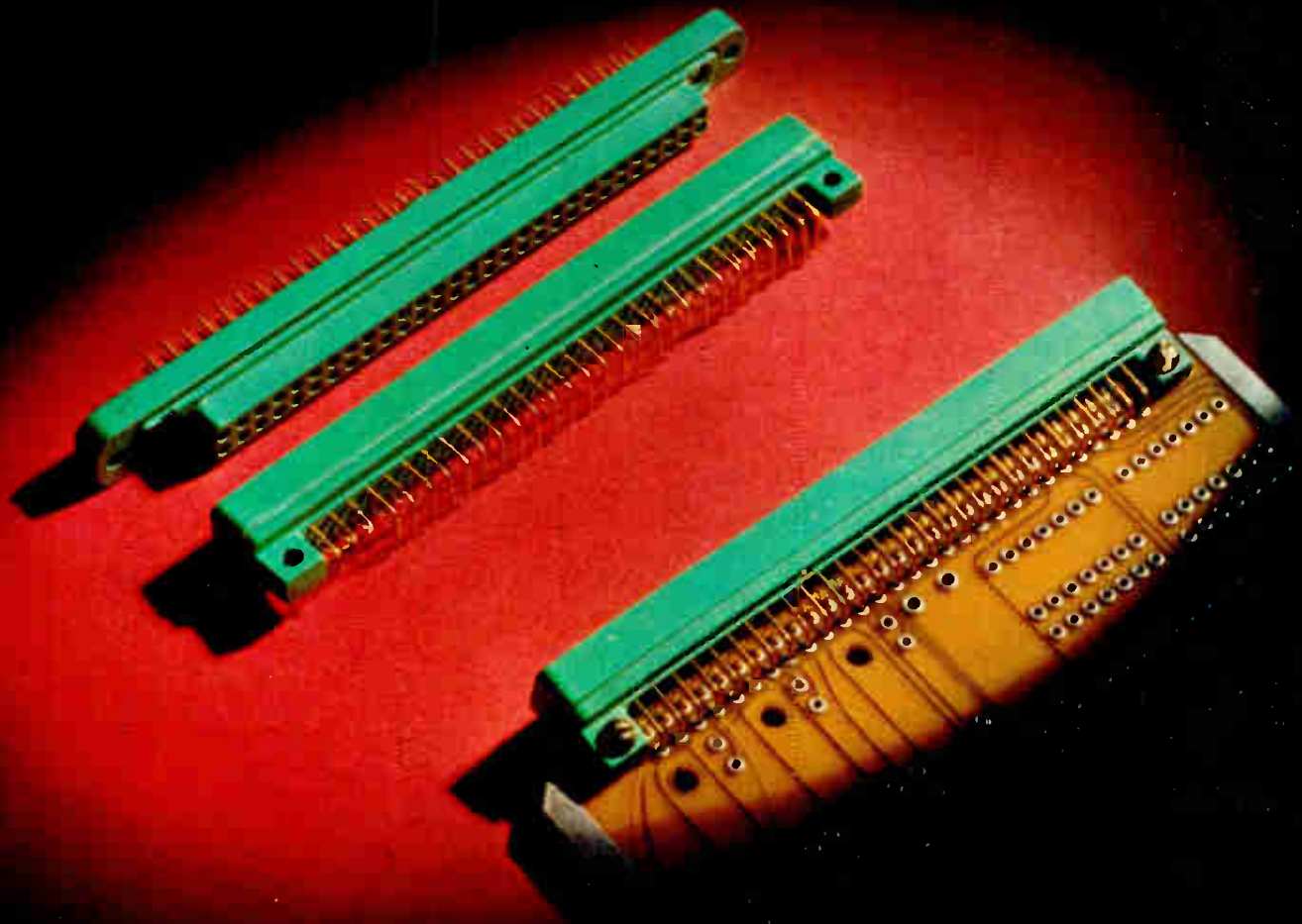

You know close order drilling. It's what's called for to produce ultraprecise hole locations in printed circuit boards. Eliminate this need and you'll cut costs for sure. Bendix P.C.B. connectors help you do precisely that. Their optional floating pin terminations "give" enough to make it easier to align pins with the printed circuit board holes.

Bendix boasts other features, too. Options like wire wrap or solder termina-

tions. Straight or right angle. Insertable crimp contacts.

Applications? Wherever printed circuit boards are used, such as switching circuits, computers, business machines, process controls, etc.

Chances are, Bendix Printed Circuit Board connectors can help you. Why not find out. The Bendix Corporation, Electrical Components Division, Sidney, New York 13838.



Circle 63 on reader service card

# it's Dana again

with a new DMM that out-classes all competition



\$650. That's the full price for complete multimeter capability: 5 DC ranges, 4 AC ranges, 5 ohm ranges.



4-DIGIT LED. 5th digit for 100% overrange, with leading zero suppression. Easy reading, reliable, cooler.



**BATTERY CHECK.** Shows operating hours remaining. When battery is low, automatic shut-off prevents wrong reading or battery damage.



**AUTOMATIC BRIGHTNESS.** The LED self-adjusts intensity to ambient light conditions.



**RUGGED.** Virtually unbreakable case. Weatherproof. Reliable for roughest field use. Won't quit.



ONLY 7½ LBS., with self-contained battery pack. Compact and lightweight for easy use . . . anywhere.



**GOOF-PROOF.** Exclusive cam-interlock absolutely prevents mis-matching of range and function.



**EASY ACCESS.** Just loosen 2 screws to remove case. Display and battery pack plug-ins for easy, fast replacement or repair.



**SPARE FUSE.** Fuse box has no-shock safety interlock. Never leaves you dead in the field.



**NO CREEP.** Non-slip-grip feet won't let this DMM slide away.

So, before you buy any old standard DMM, check out this new Dana Model 4300 Multimeter. It has all the performance specs you need . . . plus all these features designed to make your job easier and safer. Write for literature on Dana Model 4300 today. Or phone: (714) 833-1234 Collect.



**DANA**®

Dana Laboratories, Inc. 2401 Campus Drive, Irvine, California 92664

## 41 Electronics Review

MEMORIES: Fairchild unveils 1,024-bit bipolar RAM, 41  
DISPLAYS: Double layers key to tube, copier, 42  
MANUFACTURING: Plasma dry etch means thick resist, 43  
COMMUNICATIONS: Comsat's SPEC squeezes speech, 43  
COMMERCIAL ELECTRONICS: TI thermal printers, 44  
INDEX OF ACTIVITY: 44  
MARKETING: Will ICs ever sell for pennies? 46  
COMMERCIAL ELECTRONICS: Nonimpact printer, 48  
COMPUTERS: Varian 73 joins semiconductor list, 48  
LASERS: NASA blazes surveyor's trail, 49  
MEETINGS: Semicon finds right audience, 51  
AUTOMOTIVE ELECTRONICS: Crash radar uses reflector, 51  
FOR THE RECORD: 52

## 63 Electronics International

FRANCE: Report slaps government R&D policies, 63  
GREAT BRITAIN: Speech recognized without computer, 63  
WEST GERMANY: New lens for electron microscope, 63

## 73 Probing the News

MANAGEMENT: Industrial systems lead U.S. world growth, 73  
ENVIRONMENTAL ELECTRONICS: Dutch start war on air pollution, 75  
PERIPHERALS: Cashing in on IBM compatibility, 77  
CONSUMER ELECTRONICS: Cable TV sets challenge, 78

## 83 Technical Articles

SPECIAL REPORT: Linear ICs link the digital and analog worlds, 83  
DESIGNER'S CASEBOOK: Switches set synthesizer frequency, 100  
Amplitude modulator is highly linear, 101  
FETs remove transient from audio squelch circuit, 102  
SOLID STATE: Three technologies on chip make broadband amplifier, 103  
COMPUTERS: Raster scanning provides multicolor graphic displays, 111  
ENGINEER'S NOTEBOOK: Simpler settling time measurement, 119  
Logic approach to time delay uses only integrated circuits, 120

## 135 New Products

IN THE SPOTLIGHT: Multimeter 'system' is modular, 135  
5-kHz recorder handles 18 channels, 138  
COMPONENTS: SCR simplifies fusing task, 141  
INSTRUMENTS: Encoder for telemetry is programable, 146  
DATA HANDLING: Servomotors drive capstanless cassette, 151  
PACKAGING & PRODUCTION: LSI tester runs at 10 MHz, 157  
SEMICONDUCTORS: IC is modem building block, 161

## Departments

Publisher's letter, 4  
Readers comment, 6  
People, 14  
40 years ago, 30  
Meetings, 33  
Electronics newsletter, 35  
Washington newsletter, 57  
Washington commentary, 58  
International newsletter, 65  
Engineer's newsletter, 122  
New literature, 168  
Personal business, PB1

Title R registered U.S. Patent Office. Copyright 1972 McGraw-Hill Inc. All rights reserved, including the right to reproduce the contents of this publication in whole or in part. Volume 45, Number 12

## Highlights

### Dutch start air monitoring net, 75

The Netherlands is beginning to install a nationwide air-sampling network, built by Philips Gloeilampenfabrieken NV. Researchers are seeking eventual addition of water-sampling sensors to the computerized system, which will enable Belgium and West Germany to tie in their system, when built.

### Special report: linear ICs are good buys, 83

Linear and interface ICs, which have improved steadily during the past few years, now offer system and equipment designers unmatched cost-performance tradeoffs. Trends are developing for more linear functions to be placed on a chip and for both linear and digital functions to be integrated on one chip.

### 1-GHz amplifier uses 3 technologies, 103

A direct-coupled amplifier with a 1-GHz bandwidth and providing electronically controllable gain and polarity has been fabricated on one chip only 40 mils square by combining bipolar, thin-film, and MOS technologies. Nominal gain of 9 dB provides a gain-bandwidth product of 2.8 GHz.

### Raster scan is key to multicolor graphic CRTs, 111

Inexpensive computer terminal system, using conventional television CRTs refreshed by a disk drive, can also accommodate a maximum of 16 black-and-white monitors. Form overlays on one channel protect against inadvertent changes along with transient data arriving on another channel.

### Settling-time measurements simplified, 119

Time-delayed sampling technique effectively "freezes" the waveform to be measured so that any portion can be viewed repetitively on an oscilloscope. Settling time is measured by using the scope delay and dc voltmeter.

### And in the next issue. . . .

An updated report on the EE job market . . . Special report on active filters . . . Re-engineering a minicomputer to cut costs . . . Computer-aided design of C/MOS logic circuits.

### The cover.

TI's first operational amplifier, which could handle only a few milliamperes, is contrasted with TI's soon-to-be-announced core-memory driver with digital logic, analog drive, and nearly 1-ampere outputs.

# Electronics

EDITOR-IN-CHIEF: Kemp Anderson

EXECUTIVE EDITOR: Samuel Weber

MANAGING EDITORS: Lawrence Curran, *News*;  
Arthur Erikson, *International*

SENIOR EDITORS: John Johnsrud,  
H. Thomas Maguire, Stephen E. Scrupski

ART DIRECTOR: Fred Sklenar

ASSOCIATE EDITORS: Richard Gundlach,  
John N. Kessler, Howard Wolff

DEPARTMENT EDITORS

*Aerospace*: William F. Arnold  
*Circuit Design*: Lucinda Mattera  
*Communications & Microwave*:

Lyman J. Hardeman

*Computers*: Wallace B. Riley

*Consumer*: Gerald M. Walker

*Industrial*: Alfred Rosenblatt

*Instrumentation*: Michael J. Riezenman

*Military*: Ray Connolly

*New Products*: H. Thomas Maguire

*Packaging & Production*:

Stephen E. Scrupski

*Solid State*: Laurence Altman

*Special Issues*: Harry R. Karp

COPY EDITORS: Margaret Eastman,  
Everett C. Terry

ASSISTANT EDITOR: Marilyn Offenheiser

ART: Charles D. Ciatto, *Associate Director*

PRODUCTION EDITORS:

Patricia Cybulski, Arthur C. Miller

EDITORIAL SECRETARIES: Vickie Green,  
Nancy Baldasare, Julie Gorgoglione

FIELD EDITORS

*Boston*: James Brinton (Mgr.), Gail Farrell

*Dallas*: Larry Armstrong (Mgr.)

*Los Angeles*: Paul Franson (Mgr.)

*New York*: Alfred Rosenblatt (Mgr.)

*San Francisco*: Stephen Wm. Fields (Mgr.),

Roberta Schwartz

*Washington*: Ray Connolly (Mgr.),

William F. Arnold

*Frankfurt*: John Gosch

*London*: Michael Payne

*Paris*: Arthur Erikson

*Tokyo*: Charles Cohen

McGRAW-HILL WORLD NEWS

*Director*: Walter A. Stanbury; *Atlanta*: Stan

Fisher; *Chicago*: Mike Sheldrick; *Cleveland*:

Arthur Zimmerman; *Detroit*: James Wargo;

*Houston*: Robert E. Lee; *Los Angeles*: Michael

Murphy; *Gerald Parkinson*; *San Francisco*:

Margaret Drossel; *Seattle*: Ray Bloomberg,

*Washington*: James Canan, Herbert W.

Cheshire, Seth Payne, Warren Burkett, William

D. Hickman; *Bonn*: Robert Ingersoll; *Brussels*:

James Smith; *London*: Marvin Petal; *Milan*:

Peter Hoffmann, Andrew Heath; *Moscow*: Axel

Krause; *Paris*: Stewart Toy, Michael Johnson;

*Stockholm*: Robert Skole; *Tokyo*: Mike Mealey

PUBLISHER: Dan McMillan

ADVERTISING SALES MANAGER: Pierre J. Braudé

ADVERTISING SALES SERVICE MANAGER:

Wallis Clarke

BUSINESS MANAGER: Stephen R. Weiss

CIRCULATION MANAGER: George F. Werner

RESEARCH MANAGER: David Strassler

MARKETING SERVICES MANAGER:

Tomlinson Howland

## Publisher's letter

When our peripatetic solid state editor, Larry Altman, began to plan his special report on linear ICs (p.83), his outline contained entries for operational amplifiers, voltage regulators, sense amplifiers, and consumer circuit functions. He figured that, with the addition of some special linears like comparators and a fast rundown on phase-locked loops, he'd pretty much wrapped up the special. But he failed to reckon with that vaguely defined but dynamically expanding sector called "interface" circuits—the term for the circuits that mate one black box with another in a system.

"When I started," says Altman, "I had no idea just how big the scope of interface circuit design and application was. All the publicity has been hogged by the latest entries in the big-memory derby—what I call the 'memory-of-the-week syndrome'—and this has masked the fact that every memory has to interface with the rest of the system."

Two other factors that Altman says have nurtured the growth of interface ICs are: the expansion of data communications, which requires new kinds of functions to handle digital signals in an analog world, and the continuing decentralization of computers, which means more data exchange between the CPU and distant peripherals.

In the face of the unexpected richness of this editorial lode, something had to give. That's why you won't find much on consumer ICs, a topic we'll pursue soon in a follow-up report.

**Even though parochialism was evident at "Electronics 1985," with people from consumer elec-**

tronics firms talking to their counterparts at other consumer hardware producers, and industrial electronics company representatives huddling mainly with other people from industrial concerns, Ray Connolly, our Washington bureau chief, heard a number of delegates say the Electronic Industries Association or the industry should have held such a meeting at least five years ago.

The Chicago conference assessed where the electronics industries are going, how they'll get there, and what they'll be like in the mid-1980s. Connolly's story on the conference begins on page 73, and contends that growth in world markets will be greater than that in U.S. markets between now and the middle of the next decade, with industrial electronics setting the pace.

But there still aren't enough U.S. companies who realize they have to compete worldwide. "We've really got to get off our duffs and realize there are other people in the world who know something about technology," Connolly says. The Japanese are cultivating Brazil, for example. One insider at the conference told Ray that U.S. electronics firms could have exported to Japan in the '60s, and, while there would have been obstacles, the effort would have paid off. But that lesson has apparently been lost on many American electronics manufacturers, who don't realize that Brazil stands now about where Japan did in the mid-'60s, and "few American companies are trying to export to Brazil now."



June 5, 1972 Volume 45, Number 12  
89,913 copies of this issue printed

Published every other Monday by McGraw-Hill, Inc. Founder James H. McGraw 1860-1948. Publication office 1221 Avenue of the Americas, N.Y., N.Y. 10020, second class postage paid at New York, N.Y. and additional mailing offices.

Executive, editorial, circulation and advertising addresses. Electronics, McGraw-Hill Building, 1221 Avenue of the Americas, New York, N.Y. 10020. Telephone (212) 997-1221. Teletype TWX N.Y. 710-581-5234. Cable address MCGRAWHILL N.Y.

Subscriptions limited to persons with active, professional, functional responsibility in electronics technology. Publisher reserves the right to reject non-qualified requests. No subscriptions accepted without complete identification of subscriber name, title, or job function, company or organization, including product manufactured or services performed. Subscription rates: qualified subscribers in the United States and possessions and Canada, \$8.00 one year, \$12.00 two years, \$16.00 three years, all other countries \$25.00 one year except Japan \$50.00 per year including air freight. Limited quota of subscriptions available at higher-than-basic rate for persons outside of field served, as follows: U.S. and possessions and Canada, \$25.00 one year; all other countries \$50.00. Single copies: United States and possessions and Canada, \$1.00, all other countries, \$1.75.

Officers of the McGraw-Hill Publications Company: John R. Emery, President; J. Ellen Tushnet, Senior Vice President—Services; Donald B. Grady, Group Vice President, Vice Presidents: Ralph Blackburn, Circulation; John R. Callahan, Editorial; John B. Hoglund, Controller; David G. Jensen, Manufacturing; Jerome D. Luntz, Planning & Development; Joseph C. Page, Marketing.

Officers of the Corporation: Shelton Fisher, President; Joseph H. Allen, President Publications and Business Services Group; John J. Cooke, Senior Vice President and Secretary; Ralph J. Webb, Treasurer. Title registered in U.S. Patent Office, Copyright 1972 by McGraw-Hill, Inc. All rights reserved. The contents of this publication may not be reproduced either in whole or in part without the consent of copyright owner.

Subscribers: The publisher, upon written request to our New York office from any subscriber, agrees to refund that part of the subscription price applying to copies not yet mailed. Please send change of address notices or complaints to Fulfillment Manager, subscription orders to Circulation Manager, Electronics, at address below. Change of address notices should provide old as well as new address, including postal zip code number. If possible, attach address label from recent issue. Allow one month for change to become effective.

Postmaster: Please send form 3579 to Fulfillment Manager, Electronics, P.O. Box 430, Hightstown, N.J. 08520.

*low cost*

add digital control to your

# KEPCO POWER SUPPLY\*

### LINE-POWERED

Plug-in your 115/230V a-c here. The shielded transformer and feedback voltage regulators provide all the power needed.

### OPTICALLY ISOLATED

These optical couplers provide a kilovolt of isolation from the digital to the analog.

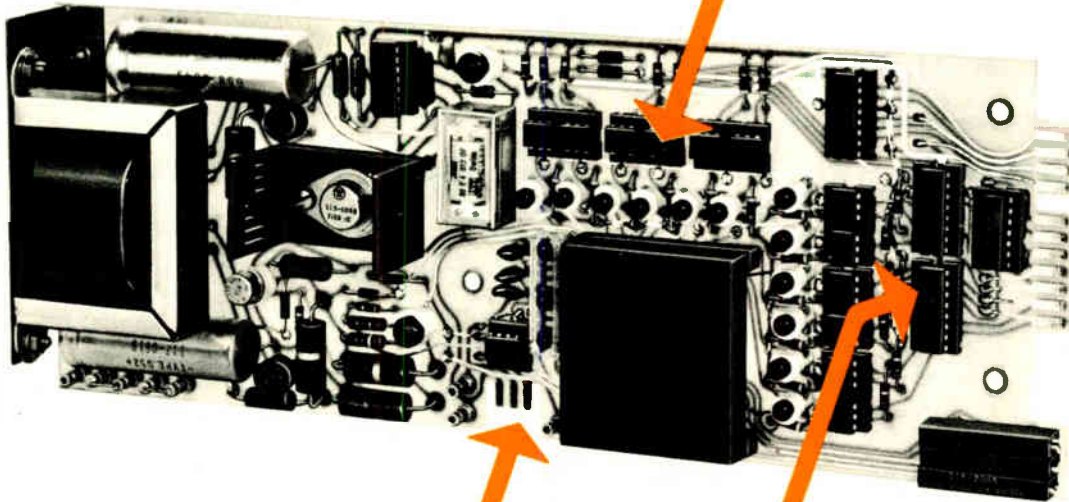

### GET YOUR OUTPUT HERE,

a 0-10V (or ±10V) analog signal that will directly program any Kepco operationally controlled power supply.

### PUT YOUR DIGITS

IN HERE:	2 digit	BCD
	3 digit	BCD
	8 bit	binary
	10 bit	binary
	12 bit	binary

### MEMORY

The buffered storage frees your signal source to do other work.

IT'S DONE WITH THE KEPCO SN... OPTICALLY ISOLATED, LINE-POWERED, DIGITAL - TO - ANALOG CONVERTERS.

\* or programmable function generator or VCO  
or active filter (frequency or "Q")  
or d-c amplifier (gain, threshold, offset)  
or comparator  
or calibrator  
or tester  
or anything you control with an analog voltage

*with* **KEPCO** *you're in control!*

For complete specifications, write Dept. EH-14

KEPCO, INC. • 131-38 SANFORD AVENUE • FLUSHING, N.Y. 11352 • (212) 461-7000 • TWX # 710-582-2631 • Telex: 12-6055 • Cable: KEPCOPOWER NEWYORK

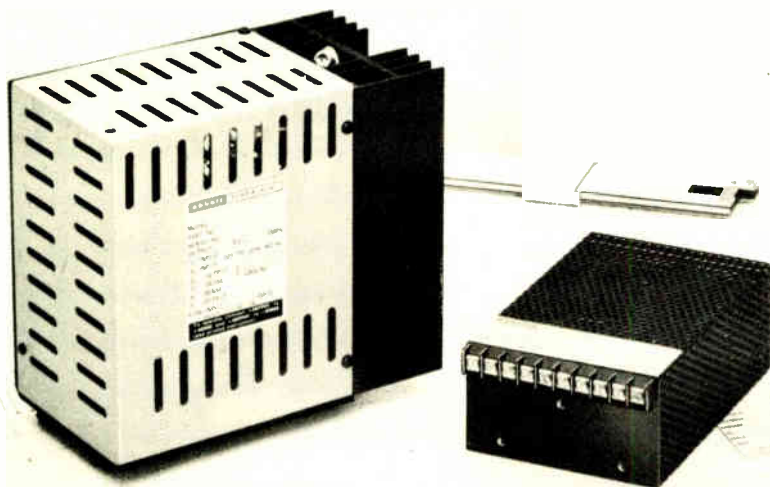

## Reduce Your Power Supply Size and Weight By 70% for \$49

A new way has been found to substantially reduce power supply size and weight. Consider the large power supply shown at left in the above photo — it uses an input transformer, into a bridge rectifier, to convert 60 Hz to 5 volts DC at 5 amperes. This unit measures 6½" x 4" x 7½" and weighs 13 pounds. It sells for \$170 in small quantities. For just \$49.00 more, Abbott's new model Z5T10, shown at right, provides the same performance with 70% less weight and volume. It measures only 2¼" x 4" x 6" and weighs just 3 pounds.

This size reduction in the Model Z5T10 is primarily accomplished by eliminating the large input transformer and instead using high voltage, high efficiency, DC to DC conversion circuits. Abbott engineers have been able to control the output ripple to less than 0.02% RMS or 50 millivolts peak-to-peak

maximum. This design approach also allows the unit to operate from 100 to 132 Volts RMS and 47 to 440 Hertz. Close regulation of 0.15% and a typical temperature coefficient of 0.01% per degree Centigrade are some of its many outstanding features. This new Model "Z" series is available in output voltages of 2.7 to 31 VDC in 9 days from receipt of order.

Abbott also manufactures 3,000 other models of power supplies with output voltages from 5 to 740 VDC and with output currents from 2 milliamps to 20 amps. They are all listed with prices in the new Abbott catalog with various inputs:

- 60  $\text{A}$  to DC, Regulated
- 400  $\text{A}$  to DC, Regulated
- 28 VDC to DC, Regulated
- 28 VDC to 400  $\text{A}$ , 1  $\phi$
- 24 VDC to 60  $\text{A}$ , 1  $\phi$

Please see pages 618 to 632 of your 1971-72 EEM (ELECTRONIC ENGINEERS MASTER Catalog) for complete information on Abbott modules.

Send for our new 56 page FREE catalog.

# abbott transistor

LABORATORIES, INCORPORATED  
general offices eastern office

5200 W. Jefferson Blvd./Los Angeles 90016  
(213) 936-8185 Telex: 69-1398

1224 Anderson Ave./Fort Lee, N.J. 07024  
(201) 224-6900 Telex: 13-5332

## Readers comment

### Death and microamps

To the Editor: C. Peter Zicko's article on "New applications open up for the versatile isolation amplifier" [March 27, p. 96] indicates in several places that 20 microamperes of current can be lethal for man. Although many other authors have made similar statements in engineering and medical literature, we can find no experimental data in scientific literature to support such statements. We believe that early data on electrically induced ventricular fibrillation thresholds in dogs<sup>1,2</sup> has been confused with later data obtained from humans<sup>2</sup>. We demonstrated in the laboratory that 60-hertz currents as low as 20 microamperes could induce ventricular fibrillation in dogs. However, data obtained from humans in the operating room<sup>2,3</sup> indicated 180  $\mu\text{A}$  to be the lowest observed 60-Hz ventricular fibrillation threshold.

We feel that this confusion in data has led in some cases to the design of very costly, super-safe devices and that much simpler solutions, such as effective equipment ground conductors, will be more than adequate against the hazards documented in references 2, 4, 5.

We have no argument against the utilization of isolation amplifiers and isolation transformers to reduce leakage currents if it is economical. We do, however, feel that using data of questionable validity as design criteria can potentially result in unnecessary increased costs of medical electronic equipment. Many of the hazards we described were the result of three primary flaws:

- Two-wire power distribution system (no equipment grounding conductor).
- Use of two-prong power cord adapters.
- Use of transformerless power supplies where shorted capacitors result in a direct connection between the powerline and device chassis.

These prime sources of trouble can be eliminated by three straightforward measures:

- Require three-wire power distribution systems in hospitals, with oversized equipment grounding wires, and revoke the grandfather



# Metal Glaze™ resistors don't drift.

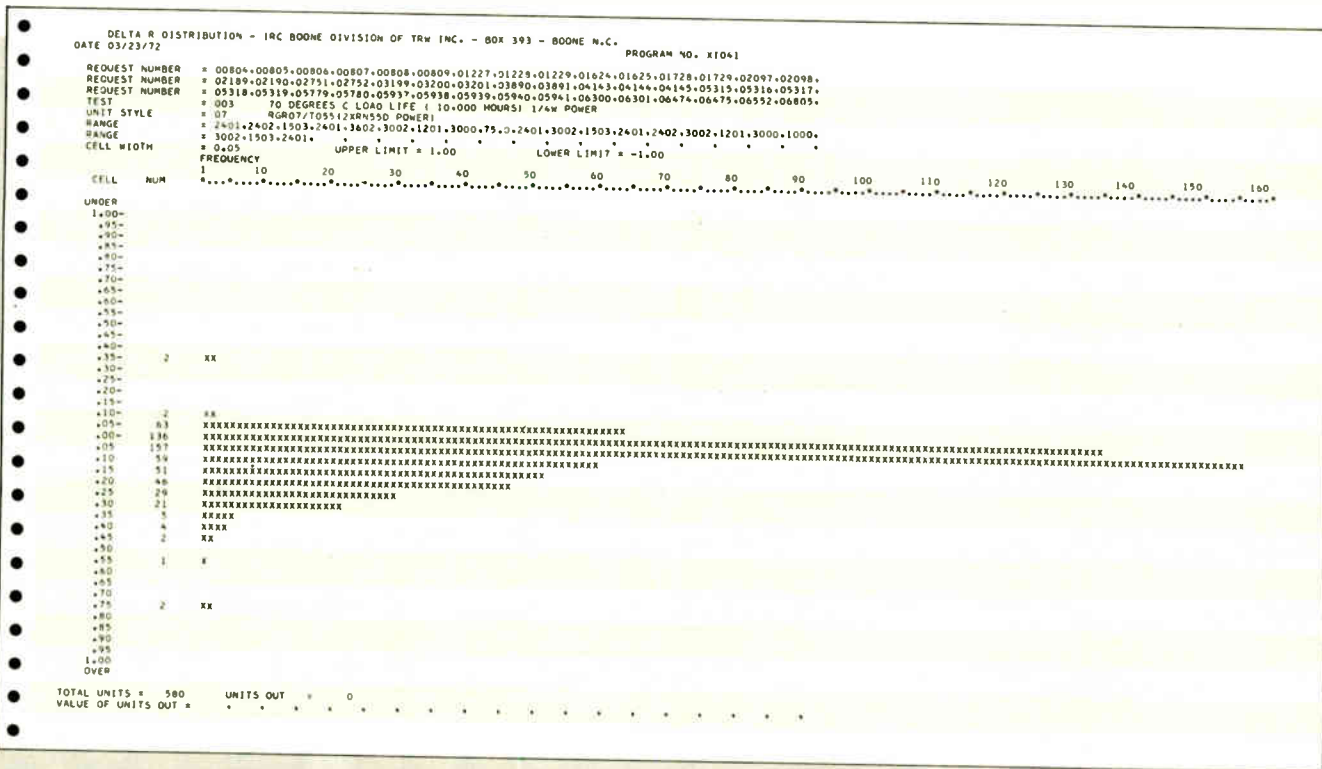

The best place to control downstream circuit drift is at the design stage. Specify IRC Metal Glaze resistors. They benefit the designer and everybody else by providing six specific kinds of protection:

- 1. Load Life.** Millions of unit hours of test data and years of field usage prove it: Metal Glaze resistors change less than 1% even after 10,000 hours—as illustrated in the computer printout above.
- 2. Overloads.** Metal Glaze thick film construction provides excellent overload and transient capabilities; e.g., 1/2 W unit can take up to 150 W for 300 μ sec.
- 3. Temperature coefficient.** Because of excellent thermal conductivity, Metal Glaze T.C. Δ R is up to 50% less than other resistors with the same temperature coefficient.

- 4. Storage life.** Metal Glaze inert characteristics cut shelf drift almost to zero. Drift of 1 to 3% per year is common in many other resistor types.
- 5. Installation.** Insertion and assembly shocks, heat, solvent and other abuses can produce instantaneous Δ Rs beyond spec limits. But Metal Glaze sets the ruggedness standard due to solder terminated subassembly and molded protective jacket.
- 6. Cost Δ \$s.** Metal Glaze resistors are most economical in universal use because they eliminate revenue drain due to field failures. Save on inventories too, due to standardizing on one resistor type.

Request Metal Glaze design data. TRW/IRC Fixed Resistors, an Operation of TRW Electronic Components, Boone, N.C. 28607. (704) 264-8861.



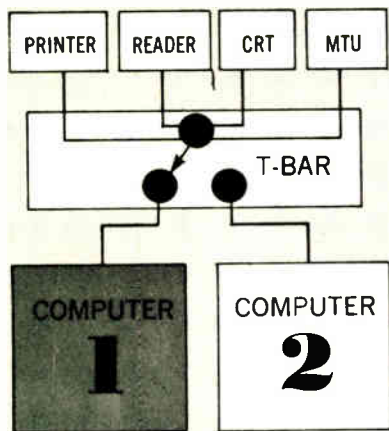

**If THIS  
computer  
FAILS...**

**...simply  
switch over  
with  
T-BARs®!**

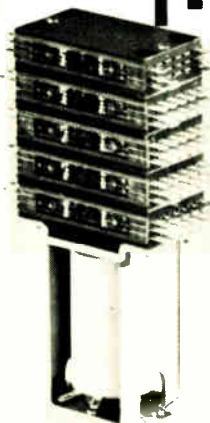

T-Bar Relays are specifically designed for switching many parallel lines either manually or remotely. 8, 12, 24, 36 and 60

pole T-Bar Relays are available in Form A and C contacts. For low level switching, specify Series 901 T-Bars with bifurcated contacts for high reliability or Series 801 for general purpose switching.

Off-the-shelf from

• NEWARK • ALLIED  
• HOLLYWOOD • CRAMER

For information, write or phone T-Bar or refer to distributor catalog or *eem*.



141 Danbury Road, Wilton, CT 06897  
phone: 203/762-8351

### Readers comment

clause which prevents implementation of this.

- Prevent the use of three-prong to two-prong power cord adapters in medical facilities.
- Require transformer-coupled power supplies in all medical equipment

C. Frank Starmer, Ph.D.  
Asst. Prof. Medicine;  
Robert E. Whalen, M.D.  
Assoc. Prof. Medicine  
Duke University Medical Center  
Durham, N.C.

#### REFERENCES

1. Weinberg, D.I., Artley, J.L., Whalen, R.E., McIntosh, H.D., and Starmer, C.F. "Electric Shock Hazard in Cardiology," IRE Trans. Biomed. Electronics, BME-9, p.244, 1962.
2. Whalen, R.E., Starmer, C.F., and McIntosh, H.D., "Electric Hazards Associated with Cardiac Pacing," Ann NY Acad. Sci., vol 111, p. 922, 1964.
3. Glen, W.W., Toole, A.L., Longo, G., Hune, M., and Gentsch, T.O., "Induced Fibrillatory Current in Open-Heart Surgery," New Eng. J. Med., vol. 262, p.852, 1960.
4. Starmer, C.F., Whalen, R.E., and McIntosh, H.D., "Hazards of Electric Shock in Cardiology," Amer. J. Cardiol, vol. 14, p.537, 1964.
5. Starmer, C.F., Whalen, R.E., and McIntosh, H.D., "Electrical Hazards and Cardiovascular Function," New Eng. J. Med., vol 284, p 181, 1971.

#### Who benefits?

**To the Editor:** In your article in the March 13th issue ["Citizens' radio called big market if FCC okays fm band," p. 31], you outline a purported "bonanza" of \$300 million should the FCC grant a portion of the 220-225-megahertz band from the present shared users of Government services and radio amateurs.

This premise is entirely false. The bulk of 2-meter fm transceivers of new manufacture used by radio amateurs in the 146-147-MHz range are made in Japan. It is a simple matter to redesign the input and output rf sections of these sets for the 224-225-MHz band, and the profit would be that of the importers and distributors of import goods, rather than the manufacturers EIA represents.

Charles E. Spitz  
Arlington, Va.

### We're moving

*Electronics* magazine is moving to the new McGraw-Hill World Headquarters Building on June 12. Our new address will be 1221 Avenue of the Americas, New York, N. Y. 10020. Our number will be (212) 997-2645.

**Switch  
12-144  
circuits  
simultaneously**

**with  
ONE  
toggle  
switch!**



24 PDT

T-Bar® Toggle Switches are specifically designed for manually switching many parallel lines. 8 — 144 pole T-Bar Toggle Switches are available in Form A and C contacts. For low level switching, specify Series 902 T-Bars with bifurcated contacts for high reliability or Series 802 for general purpose switching.

Off-the-shelf from

• CRAMER • NEWARK  
• ALLIED • HOLLYWOOD

For information, write or phone T-Bar or refer to distributor catalog or *eem*.



141 Danbury Road, Wilton, CT 06897  
phone: 203/762-8351

# "WHERE ARE THE SPEC SHEETS FOR THIS DRAWING?"

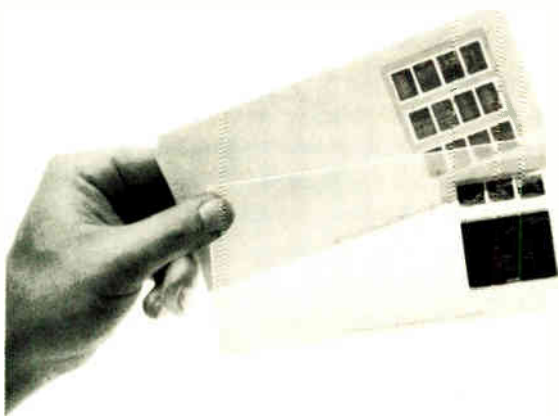

## The new **RECORDAK Aperture Cards** keep it all together.

It's a real nuisance when a drawing gets separated from its support data. But you can keep that from happening by using the new Recordak aperture cards.

Available in several formats, the new cards feature a transparent protective envelope that holds various combinations of 35mm and 16mm microfilm, for drawings and related information. A special translucent version accepts written or typed notations which reproduce, along with the film image, on tab-size diazo copies.

Other advantages of the aperture cards include fast, automated reference, simple updating, and easy, inexpensive reproduction.

Want the full story? Send in the coupon and we'll put it all together for you.

Please send me complete details on the new Recordak aperture cards.

Name \_\_\_\_\_

Position \_\_\_\_\_

Company \_\_\_\_\_

Address \_\_\_\_\_

City \_\_\_\_\_ State \_\_\_\_\_ Zip \_\_\_\_\_

Eastman Kodak Company  
Business Systems Markets Division  
Dept. DP845, Rochester, N.Y. 14650

**ENGINEERING SYSTEMS  
BY KODAK**



# Optimizing a System

Low-power circuitry—mixed with standard MSI parts—gives you speed/power successes that can't really be called trade-offs. And you get low-power reliability, too.

For example: In a 16-bit processor if all parts are standard power the typical requirement would be 8.6 watts with a cycle time of 110ns. If all parts are low power, the typical requirement would be 1.8 watts with a cycle time of 290ns.

Now, using a standard power ALU and low-power everywhere else, the typical requirement is 3.0 watts with a cycle time of 225ns.

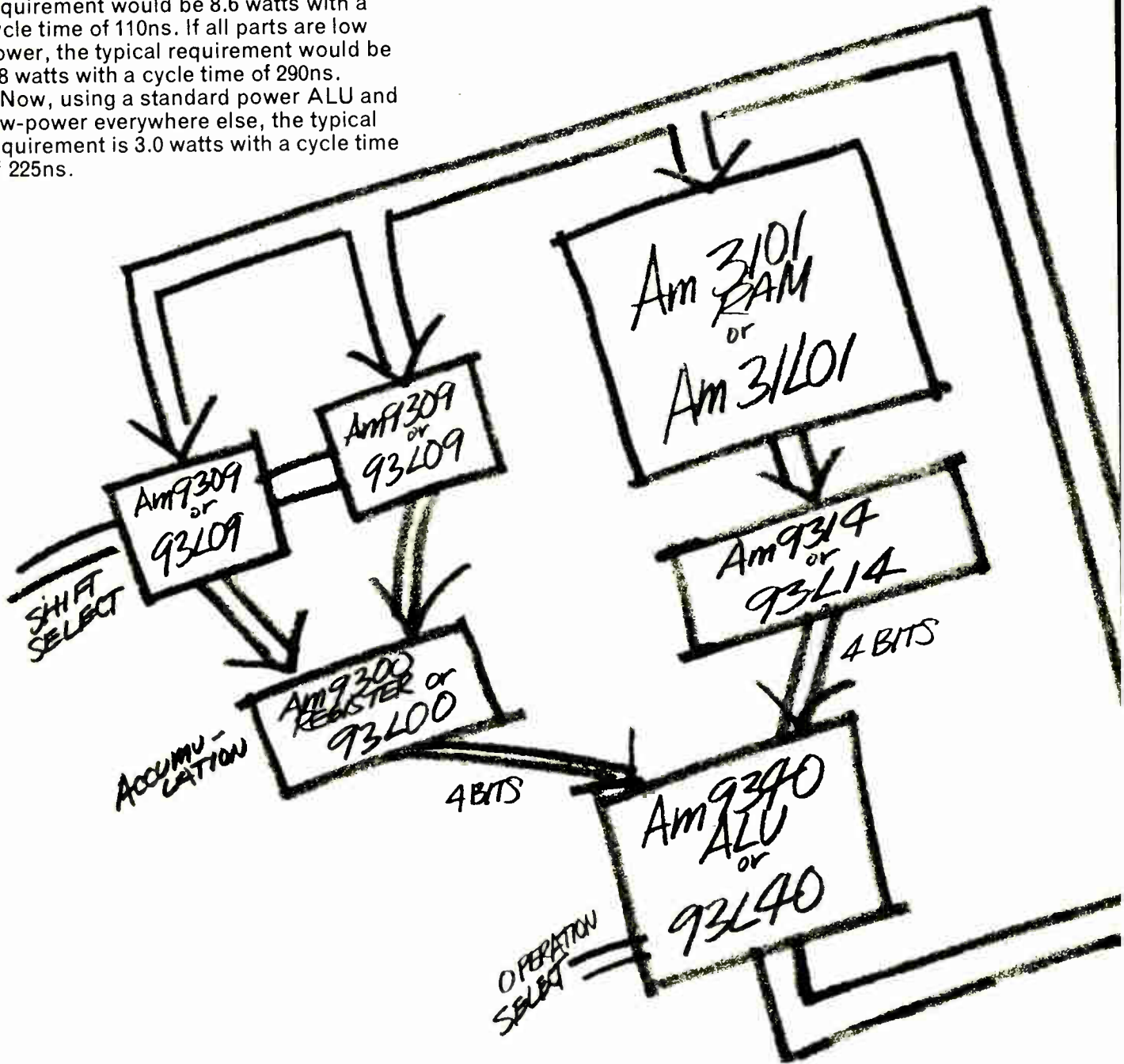

# Who has the most complete low-power MSI family anywhere?

Device	Am93L Series		Standard 9300 Series		% reduction in power using 93L
	Speed	Power	Speed	Power	
93L00 four-bit shift register	10MHz	75mW	25MHz	300mW	75% lower
93L01 one-of-ten decoder	50ns	50mW	22ns	135mW	63% lower
93L08 dual four bit latch	30ns	100mW	16ns	325mW	69% lower
93L09 dual four input multiplexer	30ns	37mW	10ns	150mW	75% lower
93L10 synchronous decade counter	13MHz	75mW	28MHz	400mW	81% lower
93L11 one-of-sixteen demultiplexer	22ns	58mW	21ns	175mW	67% lower
93L12 eight-input multiplexer	30ns	45mW	10ns	135mW	67% lower
93L14 four-bit latch	32ns	50mW	12ns	175mW	71% lower
93L16 hexadecimal counter	13MHz	75mW	28MHz	400mW	81% lower
93L18 priority encoder	29ns	75mW	16ns	275mW	73% lower
93L22 quad two-input multiplexer	31ns	45mW	10ns	150mW	70% lower
93L24 five-bit comparator	68ns	52mW	31ns	195mW	74% lower
93L28 dual 8-bit shift register	16MHz	80mW	30MHz	300mW	73% lower
93L38 multiple port memory	170ns	99mW	48ns	320mW	69% lower
93L40 four-bit arithmetic logic unit	62ns	110mW	20ns	425mW	74% lower
93L41 four bit ALU	40ns	125mW	19ns	470mW	73% lower
31L01 64-bit random access memory	75ns	130mW	31ns	450mW	71% lower
93L60 decade up/down counter	13MHz	80mW	32MHz	325mW	75% lower
93L66 hexadecimal up/down counter	13MHz	80mW	32MHz	325mW	75% lower
96L02 dual one-shot	55ns	50mW	27ns	175mW	72% lower
26L02 dual temperative stabilized one-shot	55ns	50mW	25ns	175mW	72% lower

**Who's #1? We are.**

**The #1's are adding up. That's why we're going to be the 6th largest semiconductor company in the country in the next three years.**

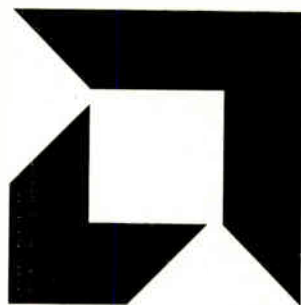

## Advanced Micro Devices, Inc.

Distributed nationally by Hamilton/Avnet and Cramer Electronics. Telephone 800-538-7904 toll free, and ask for Shel Schumaker, or in California 408-732-2400. In Los Angeles, Steve Zelencik or Russ Almand at 213-360-2102. In Mid-America, Chuck Keough at 312-297-4115. In the eastern United States, Steve Marks or Bill Seifert at 516-676-4500. In the Baltimore-Washington area, Joe Burgin at 301-788-5200. 901 Thompson Place, Sunnyvale, California 94086/TWX 910-339-9280/TLX 346306.

Circle 11 on reader service card

Delco's  
TO-66 silicon  
transistors for

# BIG POWER

Now the high-energy capability of Delco's silicon power transistors is available in the TO-66 package.

Like all the Kokomoans' silicon power transistors, they're triple diffused and built to survive the most rugged applications. Their high-voltage ratings make it practical to operate them directly from rectified 117-volt or 220-volt ac line. This allows lower weight and smaller circuit size because fewer, less bulky components are required than with low-voltage higher current systems. And, their energy capability is backed by the surest rating in the business—Pulse Energy Testing.

Use the new DTS-660 series when you need the high-voltage capability of our DTS-410, DTS-423 or DTS-425 but, in TO-213MA (TO-66) size.

They're in stock at Delco distributors now. For additional information, prices, and complete data, give yours a call or contact us at our nearest regional office.

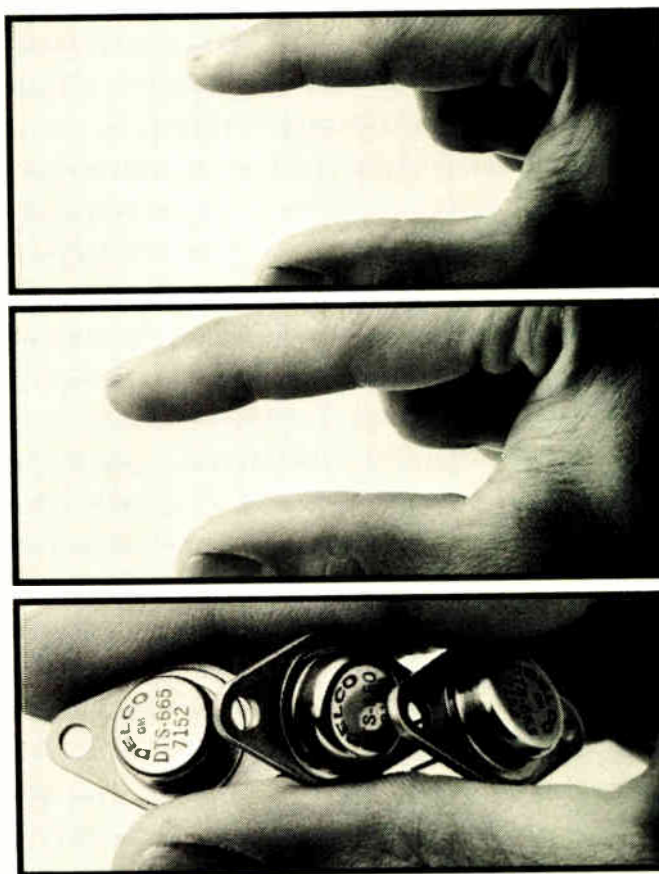

Type	$I_c$ (Cont) (Peak)	$V_{CE0}$	$h_{FE}$ @ $I_c = 1.0A$ min./max.	$V_{CE0}(sus)$ min.	$P_D$ min.	Suggested resale price 1-99 quantity
DTS-660	3.5A 10.0A	200V	30 90	200V	60W	\$5.93 ea.
DTS-663	3.5A 10.0A	400V	30 90	325V	60W	\$9.57 ea.
DTS-665	3.5A 10.0A	500V	30 90	400V	60W	\$14.94 ea.

NPN triple-diffused silicon transistors in JEDEC TD-213MA (TO-66) packages.

# IN SMALL SPACES



## Delco Electronics

DIVISION OF GENERAL MOTORS CORPORATION, KOKOMO, INDIANA

### Now available from these distributors in production quantities:

ALA., BIRMINGHAM • Forbes Distributing Co., Inc. (205)-251-4104  
ARIZ., PHOENIX • Cramer/Arizona (602)-263-1112 • Sterling Electronics (602)-258-4531  
CAL., LOS ANGELES • Kierulff Electronics, Inc. (213)-685-5511 • Radio Products Sales, Inc. (213)-748-1271  
CAL., PALO ALTO • Kierulff Electronics, Inc. (415)-968-6292  
CAL., REDWOOD CITY • Cramer/San Francisco, (415)-365-4000  
CAL., SAN DIEGO • Radio Products Sales, Inc. (714)-292-5611  
COLO., DENVER • Cramer/Denver (303)-758-2100 • Denver Walker Electronics (303)-935-2401  
CONN., NORWALK • Harvey/Connecticut (203)-853-1515  
ILL., ROSEMONT (Chicago) • Kierulff Electronics (312)-678-8560  
ILL., SKOKIE (Chicago) • Merquip Electronics (312)-282-5400  
IND., INDIANAPOLIS • Graham Electronics Supply, Inc. (317)-634-8202  
MD., BALTIMORE • Radio Electric Service Co. (301)-823-0070  
MASS., NEEDHAM HEIGHTS • Kierulff Electronics, Inc. (617)-449-3600  
MASS., NEWTON • The Greene-Shaw Co., Inc. (617)-969-8900  
MICH., ROMULUS • Harvey/Michigan (313)-729-5500  
MINN., MINNEAPOLIS • Stark Electronics Supply Co. (612)-332-1325

MO., KANSAS CITY • Walters Radio Supply, Inc. (816)-531-7015  
MO., NO. KANSAS CITY • LCOMP-Kansas City, Inc. (816)-221-2400  
MO., ST. LOUIS • LCOMP-St. Louis, Inc. (314)-647-5505  
N.J., CLIFTON • Eastern Radio Corporation (201)-365-2600, (212)-244-8930  
N.M., ALBUQUERQUE • Cramer/New Mexico (505)-265-5767 • Sterling Electronics (505)-247-2486  
N.Y., BINGHAMTON • Harvey/Federal (607)-748-8211  
N.Y., EAST SYRACUSE • Cramer/Eastern (315)-437-6671  
N.Y., ROCHESTER • Cramer/Rochester (716)-275-0300  
N.Y., WOODBURY • Harvey/New York (516)-921-8700, (212)-582-2590  
OHIO, CINCINNATI • United Radio, Inc. (513)-761-4030  
OHIO, CLEVELAND • Pattison Supply (216)-441-3000  
OHIO, DAYTON • Kierulff Electronics (513)-278-9411  
OKLA., TULSA • Radio, Inc. (918)-587-9123  
PENN., PHILADELPHIA • Almo Electronics (215)-676-6000  
PENN., PITTSBURGH • RPC Electronics (412)-782-3770  
S.C., COLUMBIA • Dixie Radio Supply Co., Inc. (803)-253-5333

TEXAS, DALLAS • Adleta Electronics Co. (214)-741-3151  
TEXAS, FORT WORTH • Adleta Electronics Co. (817)-336-7446  
TEXAS, GARLAND • Kierulff Electronics, Inc. (214)-271-2471  
TEXAS, HOUSTON • Harrison Equipment Co., Inc. (713)-224-9131  
UTAH, SALT LAKE CITY • Cramer/Utah (801)-487-3681  
VA., RICHMOND • Meridian Electronics, Inc., a Sterling Electronics Company (703)-353-6648  
WASH., SEATTLE • Kierulff Electronics, Inc. (206)-763-1550  
WASH., TACOMA • C & G Electronics Co. (206)-272-3181  
CANADA, ONT., SCARBOROUGH • Lake Engineering Co., Ltd. (416)-751-5980  
ALL OVERSEAS INQUIRIES:  
General Motors Overseas Operations  
Power and Industrial Products Dept.,  
767 Fifth Avenue, New York, N.Y.  
10022. Phone: (212)-486-3723.

**Kokomoans' Regional Headquarters.**  
Union, New Jersey 07083,  
Box 1018, Chestnut Station,  
(201) 687-3770.  
El Segundo, Calif. 90245,  
354 Coral Circle, (213)  
640-0443.  
Kokomo, Ind. 46901, 700 E.  
Firmen, (317) 459-2175  
(Home Office).



# FREE Engineering Handbook on Electromagnetic Delay Lines

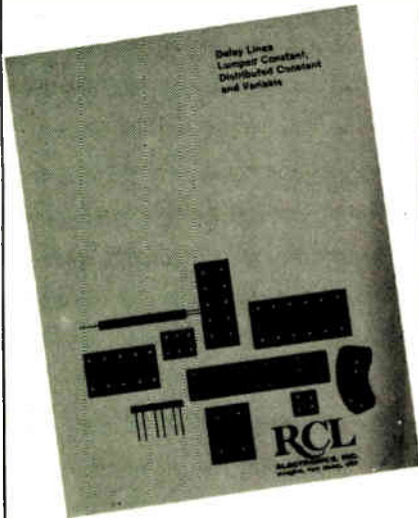

**We've reserved  
a copy  
for your desk . . .**

Terms . . . engineering definitions . . . how to specify delay lines . . . characteristics of various types . . . specifications . . . they're all included in this concise, easy-to-read handbook . . . yours for the asking.

**LUMPED CONSTANT . . .  
DISTRIBUTED CONSTANT  
. . . VARIABLE**  
all three types are covered  
in this reference  
handbook.

# RCL

**RCL ELECTRONICS, Inc.,**

General Sales Office:

Seven Hundred  
South Twenty First Street  
Irvington, New Jersey 07111

## People

Dugan puts knowhow  
behind Eurosil's pitch

"Most American semiconductor firms coming to Europe leave their knowhow behind and concentrate on selling the products of their parent company in the U.S." Those critical words come from Robert W. Dugan, vice president in charge of marketing at newly formed Eurosil GmbH in Munich, Germany. "We, on the other hand, believe in totally committing ourselves, for whoever wants to become a strong factor in the European market should not only take from it, but also contribute to that market." And that's just what Eurosil is doing.

**Doing it all.** Eurosil, a subsidiary of Intersil Inc. of Cupertino, Calif., has brought to its Munich headquarters a full staff of U.S. technicians and engineers to design custom ICs for selected customers. And once device fabrication gets started early next year, it will be wholly supported by Eurosil's own R&D efforts—independently of its parent company. This, Dugan points out, "is quite unlike operating practices of most other U.S. firms here."

Not only does the company want to make a total commitment to Europe, Dugan says, "we also want to become known primarily as a European firm." Toward that end, Eurosil is adding engineers from Germany, France, and Italy to take over from the cadre of Americans.

Eurosil's first area of concentration is in C/MOS low-threshold LSI custom circuits—devices applied mainly in the wristwatch and timing industry. During the first few months after operation began late last year, Eurosil's share of the European market for electronic quartz watch circuits has climbed to more than 50%, says the firm.

**New Yorker.** Much of that success must be credited to Dugan. He's been in the electronic watch field since the dawn of its development in 1970. Personable, energetic, and enthusiastic about his marketing job, the 45-year-old Dugan has had more than 15 years of across-the-board experience in the semicon-



**Dugan:** Taking from—and giving to—Europe.

ductor business. With a BSEE degree from Manhattan College in New York, Dugan, a native New Yorker, started in 1955 at Texas Instruments as a junior engineer. He got his feet wet in semiconductor sales in 1957, when the company sent him back East as a sales engineer in the New York metropolitan area. The following year Dugan moved west again to join Fairchild Semiconductor, eventually becoming head of product marketing.

With Jean Hoerni, inventor of the planar process, Dugan left Fairchild to join Amelco Semiconductor—now Teledyne Semiconductor—in 1962. There followed several years in marketing until finally, in mid-1968, he helped organize Intersil.

Eurosil has piled up a backlog of orders worth more than \$1.5 million—mainly from German, Swiss, and French watchmakers. And, in the preproduction stage for several West European automobile manufacturers, there's a circuit for a fuel injection system.

Allen maps thrust  
into 370 add-ons

**Competing with IBM**—and many other big companies in the data-processing business—doesn't bother Emanuel Allen, new director of engineering for Data Recall Corp. in El Segundo, Calif. Data Recall was in the news recently when IBM informed users that it would no longer service computers with Data Recall enhanced core memories. The situation was resolved after court action initiated by others. And not only does Data Recall claim to have more installations than any other company in the add-on market with



Fluke problem solvers

# The New .005% 8300A DVM: Basic Unit, \$1195; 5 Ranges DC, \$1295; 5 Ranges DC & 5 Ranges of Ohms, \$1445



Remember the original great Fluke 8300A... the first reasonably priced 5½ digit high accuracy DVM ever offered.

Now, after two years' high production and plenty of time on the learning curve, we've come up with a whole new family of 8300A's with lower prices overall and package deal prices on the most popular configurations.

There's the basic 0.005% unit with three ranges of dc (10, 100, & 1000 volts). It's the 8300A-00. It sells for a miserly \$1195. If you need millivolt dc ranges (0.1 & 1.0 v) added, we'll give you the 8300A-10 for just \$1295. For a few dollars more we'll give you the 8300A-20 with five ranges of dc volts and five ranges of ohms for \$1445.

So here's your chance to get famous Fluke quality at new low prices. And because we use single mainframe

construction throughout, you can add all the other options to make a full bench multimeter or systems box in the field an option at a time, anytime.

And remember, only Fluke can use the patented recirculating remainder A-to-D conversion technique with up to five times fewer parts than comparable DVM's for greater reliability and the best MTBF in the industry.

So, if you're looking for a very fine 5 digit DVM with 0.005% accuracy, plenty of low cost options, including ac voltage, external reference (ratio), fully isolated outputs, remote programming and complete systems compatibility including timing signals and ready indicator at package deal prices, take advantage of Fluke's great new DVM deal right away. For details, call your nearest Fluke sales engineer today or contact us directly.

Fluke, Box 7428, Seattle, Washington 98133. Phone: (206) 774-2211. TWX: 910-449-2850/In Europe, address Fluke Nederland (N.V.), P.O. Box 5053, Tilburg, Holland. Phone: (04250) 70130. Telex: 884-52337/In the U.K., address Fluke International Corp., Garnett Close, Watford, WD2, 4TT. Phone: Watford, 33066. Telex: 934583.



Circle 15 on reader service card

# Programmable 1-ns Digital Delay Generator



The Berkeley Nucleonics' Model 7040 is a new breed of time delay generator:

- It is programmable.
- It may be triggered internally or externally up to a 5-MHz rep rate.
- It is adjustable in delay from 1 ns - 999.999  $\mu$ s in 1 ns increments.
- It is accurate to 100 ps.
- And its price is \$2950.

Whenever highly precise time delays are required, the Model 7040 will do the job. It is ideally suited for the following applications: calibration of time interval counters, time-to-amplitude converters and oscilloscope sweeps; radar range simulation, cable fault location and delay line testing. The Model 7040's programmable feature gives you an important new building block for automatic test systems and production testing of IC's.

Berkeley Nucleonics has been developing and manufacturing precision pulse generators for eight years. These instruments have become standards in the nuclear research industry for testing linearity, stability and resolution of amplifiers and analog-digital converters. The Model 7040 is a product of the company's continuing interest in the development of pulse generators with precision parameters. For additional information about the Model 7040 as well as the rest of the product line, write or phone:

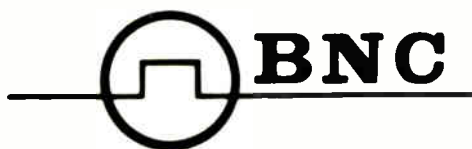

**Berkeley Nucleonics Corporation**

1198 Tenth Street • Berkeley, California 94710 • Phone: (415) 527-1121

its core memories for the IBM 360 series, but it will soon announce new add-on memories for the 370/155 and 370/165 models.

Allen's responsibility will be to continue development of existing products and engineering new products, a chore that should keep him busy what with the rapid development of technology and fierce competition in the business. Allen says that sales on the 360/30 were quiet while the suit against IBM was in the works, but they have picked up again. He adds, "1972 looks very good."

**Briton.** Allen came to the U.S. in 1962 from his native England, where he received a degree from the University of London, and went to work at Ampex. He values highly the years he spent there: "People who were at Ampex at the time populated all the major companies in the memory business." After a stint at Scantlin Electronics, plus receipt of a master's from the University of Southern California, he joined Information Control Corp., where he spent more than five years and became director of engineering.

Among the projects Allen sees in his future are products other than the replacement and enhancement core memories that now make up Data Recall's line. First, of course, might be other technologies in mainframe expansion. "We expect to have whatever it takes to compete with IBM; it's mostly core at present, of course."

And the company hopes to use some of the capital to be raised by a stock offering to finance expansion into the manufacture of other peripherals compatible with the line of its present marketing force, Computers Investors Group. Peripherals may be acquired or developed.

**Optimism on 370.** Allen is bullish about the market for 370 add-ons. "People got into the 360 market after it was a number of years old, but we're getting into 370s much earlier." He adds, "IBM is now taking us into account, so it's harder to make money. But modern technology has made it possible to get along without as much cushion as was required before."

**JUNE** edition



## in this issue

IC troubleshooting that pays for itself

The plot to simplify computer graphics

Meet our spectrum analyzer family

## NOW: an automatic sweeping synthesizer

Combines state-of-the-art frequency synthesis, precision amplitude control, and HP calculator technology.

HP's two new frequency synthesizers represent a new generation of signal sources. Besides constant resolution of 0.1 Hz up to 13 MHz, spectral purity and a stability of  $\pm 1 \times 10^{-8}$ /day, both synthesizers have read-only-memories built in to control all instrument operations. You don't need an external computer for automatic operation; both models are programmable. You merely input parameters directly on the synthesizer's pushbutton keyboard.

Solid-state displays show frequency and amplitude on the 3330B, and frequency only on the 3330A.

The A version has a manual

*(continued on page 3)*

# New waveform analyzer for automated testing

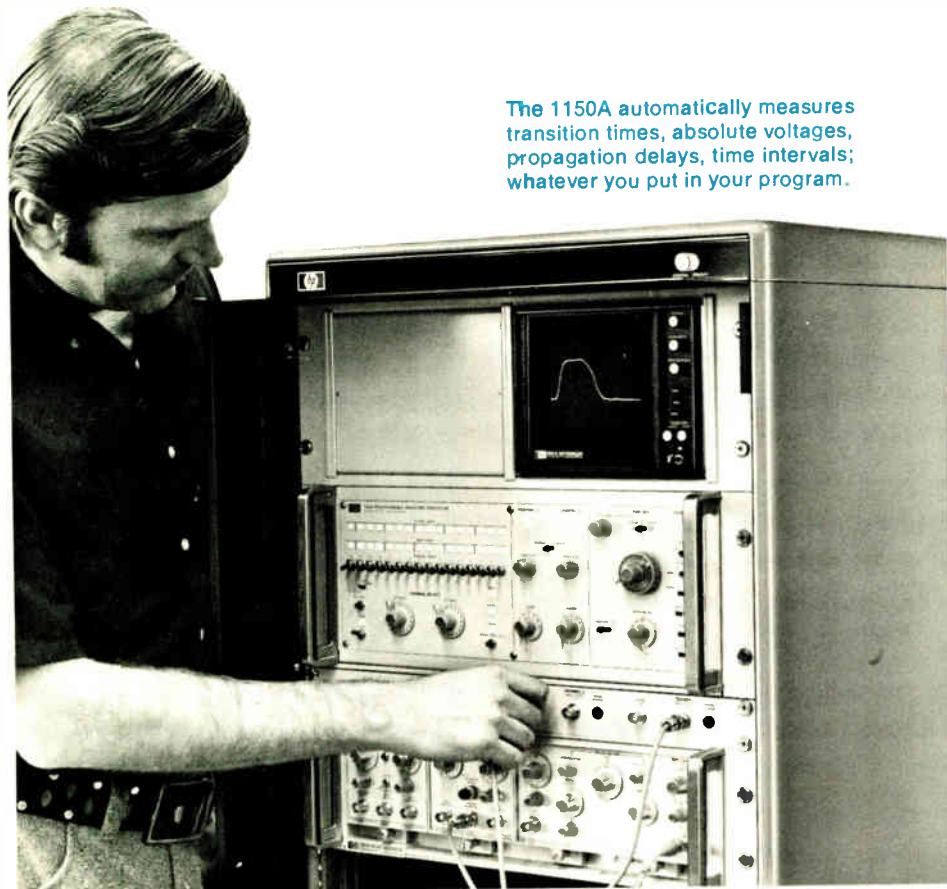

The 1150A automatically measures transition times, absolute voltages, propagation delays, time intervals; whatever you put in your program.

Automatic analysis of complex waveforms is a cinch with the new 1150A programmable waveform processor. Use it in local mode as a stand-alone oscilloscope, or link it to a minicomputer to test electronic circuits on-line.

Basically, this dual-channel, 1 GHz sampling oscilloscope-like processor digitizes incoming analog waveforms after counting the frequency down to 50 kHz or less. For sampling, there are 50-ohm inputs, a 1-2-5 sequence on attenuators and sweep times, internal triggering to 1 GHz, and signal averaging.

Plug the waveform processor into a computer or calculator. The central processor programs the ranges and settings, controls the point along the waveform where samples are taken, calibrates measurement accuracy to 1%, and calculates final results.

To help you write test programs, the 1150A has a unique pushbutton function called LEARN. Simply set

up as you would to make a manual measurement from a standard oscilloscope, then press LEARN. All front panel settings are transferred to the CPU, and automatically become parameters in the measurement program.

Price: \$12,000.

For more information, check A on the HP Reply Card.

## Cable/waveguide tests? Here's a good way

If you are testing transmission lines (coaxial and waveguide), you will want a copy of the new 8325A Microwave Test Set brochure. It describes how, using standard test instruments, you can locate discontinuities, measure insertion and return loss—all on a frequency-selective basis, 10 MHz to 18 GHz. Check K on the HP Reply Card for your free copy.

## One universal counter for all your needs

Whether you need a bench instrument or a system peripheral, try the 5326/5327 timer-counters. Moderate prices, extreme versatility, and high precision make these counters truly "universal" problem-solvers. (Just about the only thing they can't do is measure microwave frequencies.)

Your choice is almost universal, too; there are six models and many options from which to select. You buy just what you require, without paying for irrelevant extras and without compromising either your budget or your specification. For example, choose:

- Frequency range from 50 MHz to 550 MHz
- Optional seven or eight-digit display
- The simplest model measures frequency (burst or CW), period average, frequency ratio, multiple ratio, simple time interval, and totalizes.
- Or, the deluxe model that has unique time interval averaging for subnanosecond measurements, plus a built-in three-range integrating DVM for exact definition of time-interval measuring points, as well as external DC measurements.
- High-sensitivity, high-stability time bases and over 12 function-extending options.
- Complete programmability and computer interface.
- Price range from \$995 to \$2195, plus options.

For all the facts and features, check G on the HP Reply Card.



HEWLETT  PACKARD MEASUREMENT NEWS

# Delay/loss measurement made easy with new gain phase meter

Nine recorders in one—  
that's flexibility

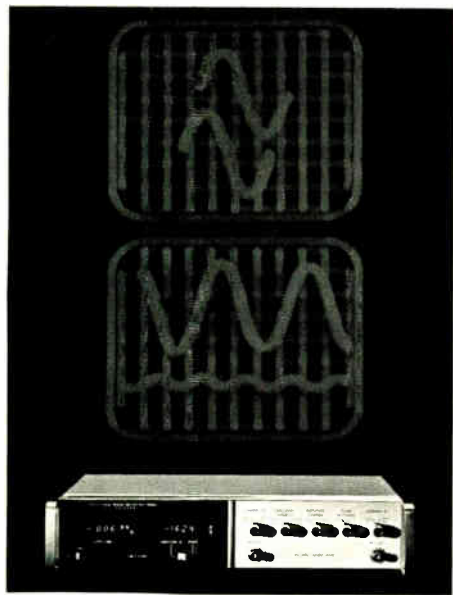

Measure signals from 0.2 mV to 200V digitally with HP's new gain phase meter.

The new 3575A Gain Phase Meter measures both amplitude and phase from 1 Hz to 13 MHz, then displays the answer on a solid-state digital readout. It takes four samples per second with a digital display resolution of  $0.1^\circ$  for phase and 0.1 dB for amplitude. The dynamic range is 80 dB.

*continued from page 1*

control of its amplitude over a 0 to +13 dB range. The B version, with precision leveled output, has a range of -86.55 dB to +13.44 dB and has amplitude sweeping capability.

Both units have spectral purity not commonly associated with frequency synthesizers. Spurious signals are greater than 70 dB below the carrier, and harmonics are greater than 60 dB to 40 dB below the carrier (depending on the frequency setting).

The two instruments use precise digital sweeping for linearity—either single or continuous sweeps. Step

Two channels are provided for phase measurements. Shape of the waveform is irrelevant; this meter measures square waves and sine waves with equal ease.

Not only can you measure the amplitude of either channel but, by merely turning a function switch, you measure the ratio of the two channels (in decibels). Ratio simplifies Q measurements and is a handy tool for engineers concerned with separation in stereo systems.

HP's logic circuitry reduces errors caused by noise, a common problem with broadband instruments. The gain phase meter filters and rejects higher frequencies, even harmonics.

This vector voltmeter is a basic instrument applicable to a variety of measurement situations. Instead of using expensive, dedicated instruments for Bode plots, employ the gain phase meter. It measures complex poles and zeros and complex impedance; or use it to test integrators and differentiators over a wide frequency range. An option is available for programming.

Prices range from \$2450 to \$3150.

*For more information, check item E on the HP Reply Card.*

size can be as small as 0.1 Hz. Parameters are entered from the keyboard; pressing a single button initiates sweep. You can even modify many parameters while the instrument is sweeping.

Whether you need a frequency synthesizer, a precision sweeper, a time-saving bench instrument, or a programmable signal source, consider the 3330 family. The 3330A costs \$5100; the 3330B, \$6000.

*Check item D on the HP Reply Card for all the facts and features.*

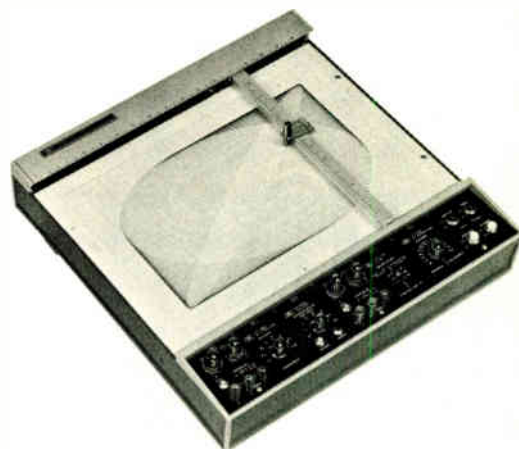

The 7004B front panel accommodates up to four option modules at a time—two per axis.

Ever wish your x-y recorder could do more than x and y? The versatile HP 7004B recorder lets you change applications merely by plugging in different function modules. You can record ac from 5 Hz to 100 kHz today, and do some high-speed point plotting tomorrow—all with the same general-purpose recorder.

The 7004B has an 11 in. by 17 in. mainframe. Acceleration is greater than 1500 in/sec<sup>2</sup>; slewing speed, greater than 30 in/sec. For high-sensitivity x-y, x-t and y-t plots, insert a module into the front panel. Plot two channels independently and extract signals superimposed on steady state dc.

There are nine modules: a dc coupler, dc pre-amplifier, time base, null detector, dc offset, filter, scanner, ac/dc converter, and dc attenuator. That's equivalent to a roomful of recorders, yet the modules store easily in your desk drawer.

The 7004B costs \$1445, and the function modules start at \$25.

*For detailed information, check item I on the HP Reply Card.*

# Diversified uses for new HP storage scopes

## Inexpensive dc supplies for lab or school

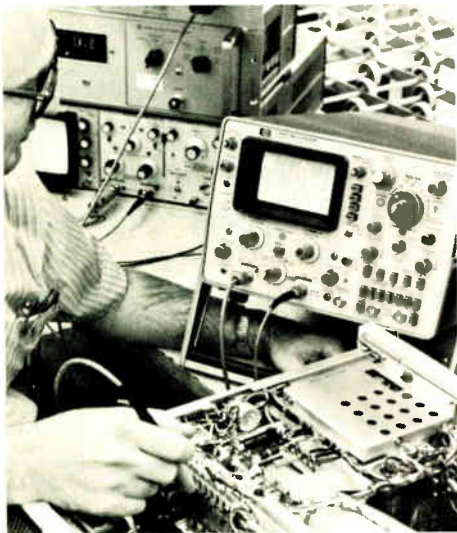

The 1703A variable persistence scope makes it easy to check slowly moving waveforms, such as in medical equipment.

The 1702/1703 portable variable persistence/storage oscilloscopes provide laboratory quality plus mobility. That's why their applications are so numerous and diversified.

A major use is in servicing digital equipment where low duty cycle pulses are encountered. The integrating feature of the CRT lets you gradually build the intensity of the pulse so that measurements can be made. This is particularly helpful for servicing peripherals and input/output devices.

A second application area is digital numerical control of industrial equipment. Although a computer is controlling the machines, measurements of the control signals often require fairly slow sweep

speeds. With variable persistence, you can eliminate annoying flicker to make the trace bright and clear for quantitative measurements.

Battery operation—a first in storage scopes—makes these ideal for outdoor use. The public utilities use them to service remote information and meteorological stations and to monitor signals transmitted from these remote stations to a central receiver. Information on weather, temperature, and humidity may be transmitted infrequently, so storage is needed to capture the information when it happens.

The 1703A (delayed sweep) sells for \$2725; and the 1702A (non-delayed), for \$2375.

*Perhaps you have an application for our new variable persistence scopes. Just check item B on the HP Reply Card.*

## New 'carefree' storage tubes for HP scopes

Tired of giving your storage oscilloscope special care to avoid damaging the CRT? Afraid to use your storage scopes at normal intensities for fear of burning the CRT? HP has solved the problem with a new storage mesh in our variable persistence cathode-ray tubes. New mesh material and processing gives the storage tube ruggedness approaching that of conventional CRTs, making the scopes



Only 5½ by 3¼ by 8 inches, these nifty little power supplies weigh only 4½ pounds each.

Need a low-cost bench supply? The 6211A (constant voltage/current limited) or the 6212A (constant voltage/constant current) solves your problem. Both power supplies are rated at 0 to 100 V, 0 to 100 mA. Compact size and bargain price make them ideal for circuit design, testing, student experiments, or even your own home laboratory in the basement.

Both models provide a 0.01% load and line regulation, 200  $\mu$ V rms/1 mV peak-to-peak ripple and noise (dc to 20 MHz), and a switchable front panel meter.

And we do mean low-cost. The 6211A sells for \$105; the 6212A, for \$130.

*To learn more, check H on the HP Reply Card.*

truly "carefree" in operation.

These 5-inch rectangular CRTs are standard equipment on all new HP storage scopes, and they retrofit earlier models without special adjustments. Don't worry about trade-offs. Writing speed, brightness, storage time and cost are unaffected.

*Interested in the new storage oscilloscopes? Just check O on the HP Reply Card.*

# HP's RF network analyzer: boon for designers

## Real-time frequency and time analysis

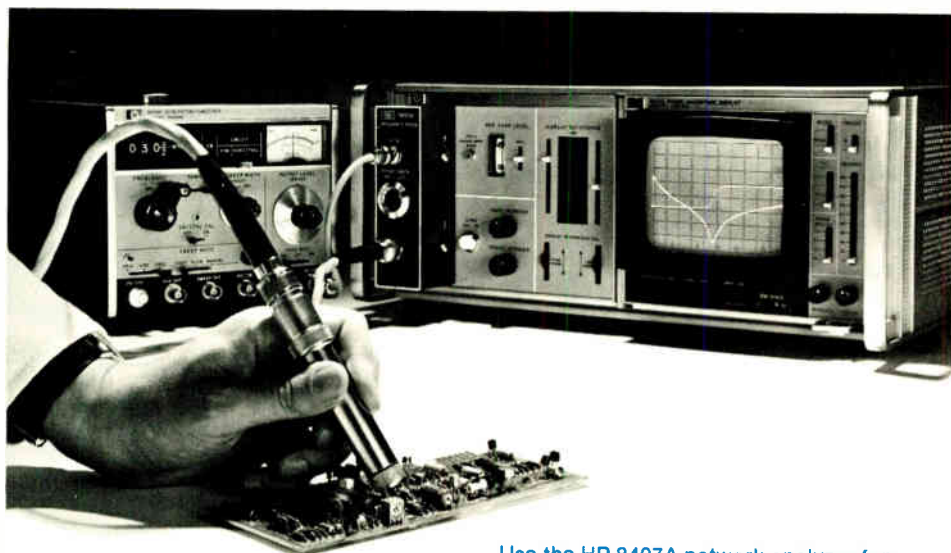

Use the HP 8407A network analyzer for "touch-and-see" swept impedance measuring in circuits.

Designing RF circuits and systems becomes easier and more certain when the elements within are fully characterized. The HP 8407A network analyzer is a "tracking detector" system that interfaces with the HP 8601A sweeper to make accurate swept measurements of network characteristics from 100 kHz to 110 MHz. Magnitude ratios exceeding 100 dB can be measured, and 0.05 dB resolution is attainable. Phase range is 360° with 0.2° phase resolution.

Use the 8407A to measure voltage and current transfer functions, gain/loss and phase shift. There are low-cost accessories for 50Ω and 75Ω

coax and probes for circuit measurements. You can also measure impedance, return loss, and reflection coefficient (magnitude and phase). The new impedance probe with 0.1Ω to 10 kΩ range is especially useful for swept impedance measurements of discrete devices or in-circuit elements.

Complete network analyzer systems (sweeper, analyzer with precision display, and full array of measuring devices) are in the \$7000 to \$8000 price range.

Check L on the HP Reply Card for more information.

The 3720A Spectrum Display provides a comprehensive and economical frequency and time analysis of complex electrical waveforms, usually those representing physical phenomena.

After receiving the auto-correlation or cross-correlation function from the HP 3721A Correlator, the 3720A Fourier transforms it and displays the resulting power spectrum or cross-power spectrum on a CRT. It also provides ensemble averaging to reduce statistical variance.

Frequency functions can be displayed in Cartesian or polar coordinates with linear or log scales, as real and imaginary parts, or as Nyquist and Bode plots.

Prices: 3720A spectrum display, \$5500; the 3721A correlator, \$7600.

For more information, check item F on the HP Reply Card.

The 3720A spectrum display converts 3721A correlator to frequency domain analyzer.



# Your computer's running mate: HP's new graphic plotter

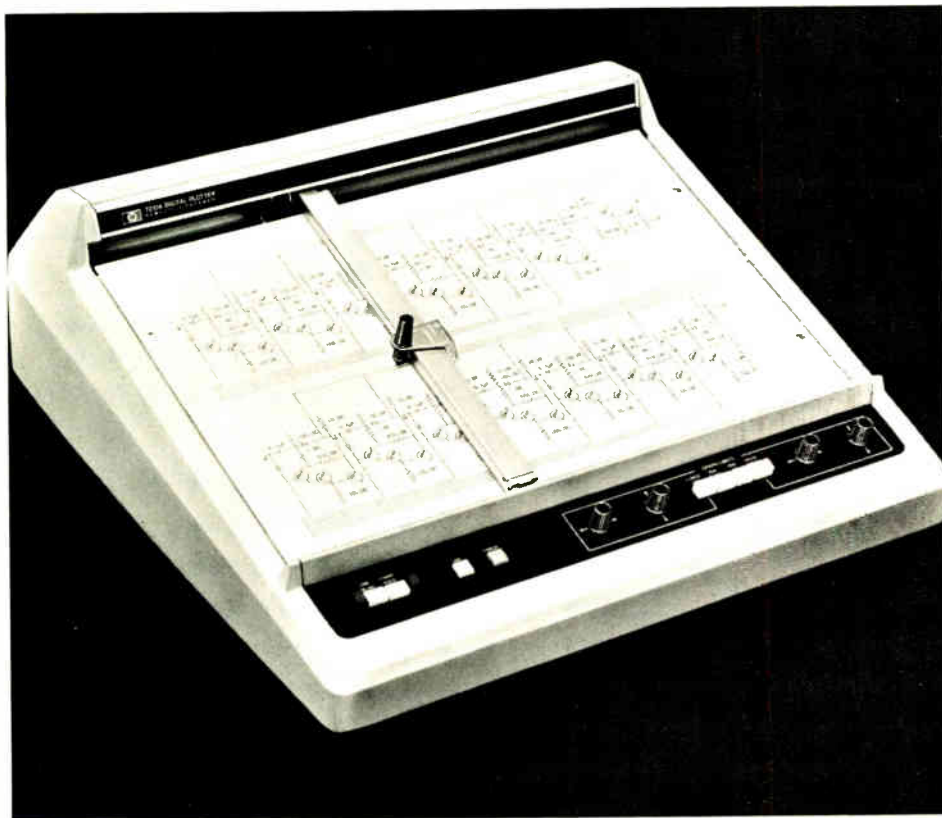

Now there is an easy inexpensive way to automatically produce hard-copy graphs. Just connect one of HP's 7200 series graphic plotters to your computer or terminal and get those charts immediately.

There are models that connect to practically any time-sharing or computer terminal operating up to 30 characters/second. A switchable-speed unit permits operation at 10, 15 and 30 characters/second. No special software is required, and the plotters can be driven using any source language such as BASIC or FORTRAN.

If you have a minicomputer, you can couple the new high-speed

**The fast, versatile 7210A graphic plotter will even draw your schematics.**

7210A directly to the computer and plot up to 20 coordinate pairs per second. It takes only 5 minutes to install a 7210A—complete with interface, I/O card and software—to any HP computer.

The 7200A costs \$3300, and the 7210A costs \$3400. Rental and lease plans are available.

*For "The Full Story of Computer Graphics," check item J on the HP Reply Card.*

## Reduce time-share costs with two new systems



**System backup for 2000E and 2000F is completely disc-based, and magnetic tapes are available for sequential files.**

Two new systems, 2000E and 2000F, make low-cost time-sharing a reality. The 2000E supports up to 16 terminals, and is expandable to the 2000F with up to 32 simultaneous terminals and dual processors.

You get proven time-sharing software; HP has installed over 200 such systems. The programming language is HP BASIC, conversational, easy-to-learn, but powerful. Two levels of libraries are maintained in mass storage: "public" programs available to any user, and "private" programs. This way, engineers can solve design problems without accessing the corporate payroll; students can program without contaminating doctoral research. And over 100 applications programs are available from HP, so your programmers don't have to write them.

Both systems use the popular 2100 computer with floating point arithmetic as the central processor. A unique HP fast moving-head disc eliminates the need for an expensive swapping disc.

The 2000E costs less than \$50K; the 2000F, less than \$110K.

*For more information, check X on HP Reply Card.*

HEWLETT  PACKARD MEASUREMENT NEWS



## Logic comparator saves up to \$50 per bad IC

No unsoldering, no adjustments—the 10529A Logic Comparator cuts trouble-shooting time to save you up to \$50 in labor cost per bad digital IC located. You merely:

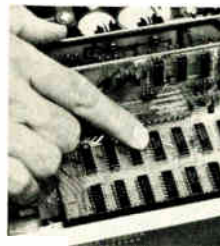

Select the IC to be tested.



Select a reference board with a good IC that has the same type number.



Insert the reference board into the logic comparator.



Attach the clip to the suspect IC and check the comparator display.



The suspect and reference ICs are compared automatically. Indicator lights signal which pins are faulty.

Because it only costs \$295, the 10529A Logic Comparator can pay for itself within a few days.

To learn more, check M on the HP Reply Card.

## The new LED leader—by 0.7 inches

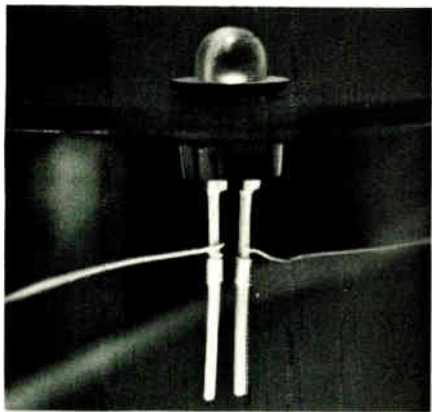

Low cost, high brightness and the convenience of wire-wrap assembly—you get all three with the 5082-4880 LED.

Designed to be wire-wrapped, the new 5082-4880 series LEDs are the first offered for solderless, socketless

assembly. Not only are they the brightest for their size in the industry, but these gallium-arsenide-phosphide lamps have a long life for permanent installations.

The long leads (0.7 inch) let you mount the lamp in a panel or printed-circuit board, then wire-wrap directly.

Select one of three light levels (0.5, 1.0 and 1.6 millicandelas), each with three different lenses. You can choose red diffused, clear diffused, or clear.

These LED lamps are available directly from stock. The price depends on quantity and light output.

For more information and prices, check T on the HP Reply Card.

## New LED display shows 0-9 and A-F

For the first time, an inexpensive LED display converts binary logic to a base 16 numbering system and displays letters A-F, as well as digits 0-9. Used in computers and test instruments, this solid-state display is suitable wherever you need to show more than 10 states.

The 5082-7340 hexadecimal indicator has built-in decoder/driver and memory. The unique blanking control lets you turn off the display, and retain or change the data stored in the on-board memory. The hexadecimal indicator is also completely DTL and TTL compatible.

Prices: \$22 (1-99), \$18 (100-499), \$15 (500-999), and \$12.25 each for 1000 or more.

To learn more, check N on the HP Reply Card.

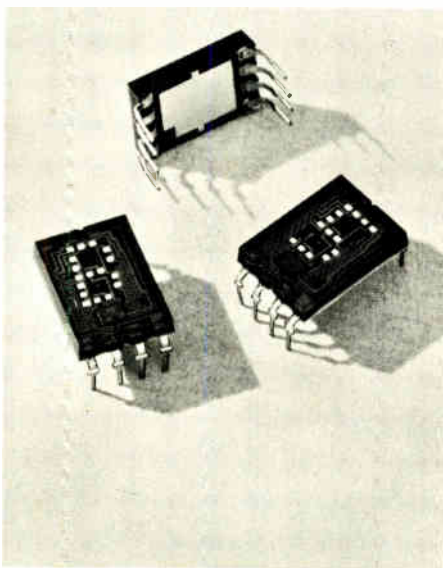

The new hexadecimal readout shows digits or letters.

# The HP spectrum analyzer family: audio to microwave

A spectrum analyzer visualizes the frequency domain as an oscilloscope displays the time domain. HP's spectrum analyzer family has an extra plus: you can custom-tailor your measurement system from 20 Hz to 40 GHz.

Each spectrum analyzer consists of a tuning section that determines frequency range:

- 8556A—20 Hz to 300 kHz
- 8553B—1 kHz to 110 MHz
- 8554L—550 kHz to 1250 MHz
- 8555A—10 MHz to 40 GHz

and an IF section that determines resolution:

- 8552B—10 Hz bandwidth
- 8552A—50 Hz bandwidth.

Both tuning and IF sections plug into a display—your choice of standard persistence, variable persistence, or large screen CRT. And you can add a tracking generator, preamplifier, or automatic preselector to extend performance range and applications. That's the convenience of our "Family Plan."

All four analyzers offer excellent signal analysis capability through features like absolute amplitude calibration, low noise and distortion, high resolution, plus wide and narrow frequency scans. Display the

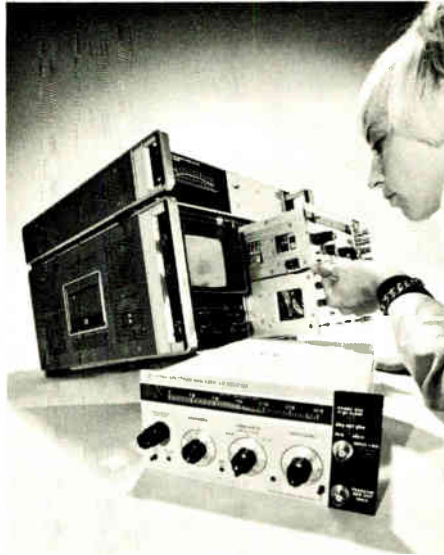

Plug-in flexibility plus versatile companion instruments make the HP spectrum analyzer family your best signal analysis value.

whole tuning range at once, then zoom down to a very narrow spectrum segment for that rigorous measurement. Measure signal amplitudes (as voltage and power) and frequency, quantity modulation levels and identify distortion products—all with one instrument. Add the tracking generator and you have

a precision swept frequency test system with 120 dB range.

With the modular spectrum analyzer family, you pay only for the capability you need. Tuning sections range from \$1690 to \$6175; the IF sections, \$2275 to \$2950; and the displays, \$950 to \$1800.

For full details on precision spectrum analyzers, check P, Q, R or S on the HP Reply Card.

## Examine modulated RF by spectrum analysis

The modern spectrum analyzer is a powerful tool for quantitative measurements of modulated RF carriers. Two new application notes cover the topic lucidly. AN150-1 treats Amplitude- and Frequency-Modulation from theory to effective measurement techniques. AN150-2 takes a similar approach with Pulsed RF signals, explaining how measurements are affected by pulse width PRF plus analyzer bandwidth and scan time.

Check U and V on the HP Reply Card for your free copies.



Measurement, Analysis, Computation

East—W 120 Century Road, Paramus, N.J. 07652, Ph. (201) 265-5000.  
South—P.O. Box 2834, Atlanta, Ga. 30328, Ph. (404) 436-6181.  
Midwest—5500 Howard Street, Skokie, Ill. 60076, Ph. (312) 677-0400.  
West—3939 Lankershim Boulevard, North Hollywood, Calif. 91604, Ph. (213) 877-1282.  
Europe—Post Office Box 85, CH-1217 Meyrin 2, Geneva, Switzerland, Ph. (022) 41 54 00.  
Canada—275 Hymus Boulevard, Pointe Claire, Quebec, Canada, Ph. (518) 561-6520.  
Japan—Ohashi Building, 59-1, Yoyogi 1-chrome, Shibuya-ku, Tokyo 151, Japan, Ph. 03-370-2281/92.

# The timer of 1001 uses.

(Priced so low it's measured in cents.)

At last. A true standard IC timer with almost universal applications. The new low-cost 555. From Signetics-Linear, of course.

And the most extraordinary advantage of 555: it's so ordinary, and so simple to use. With designed-in flexibility that's never been matched, spec for spec.

555 functions interchangeably as a time delay, oscillator, pulse detector or power modulator. Timing from microseconds through one hour. With time delays completely resettable.

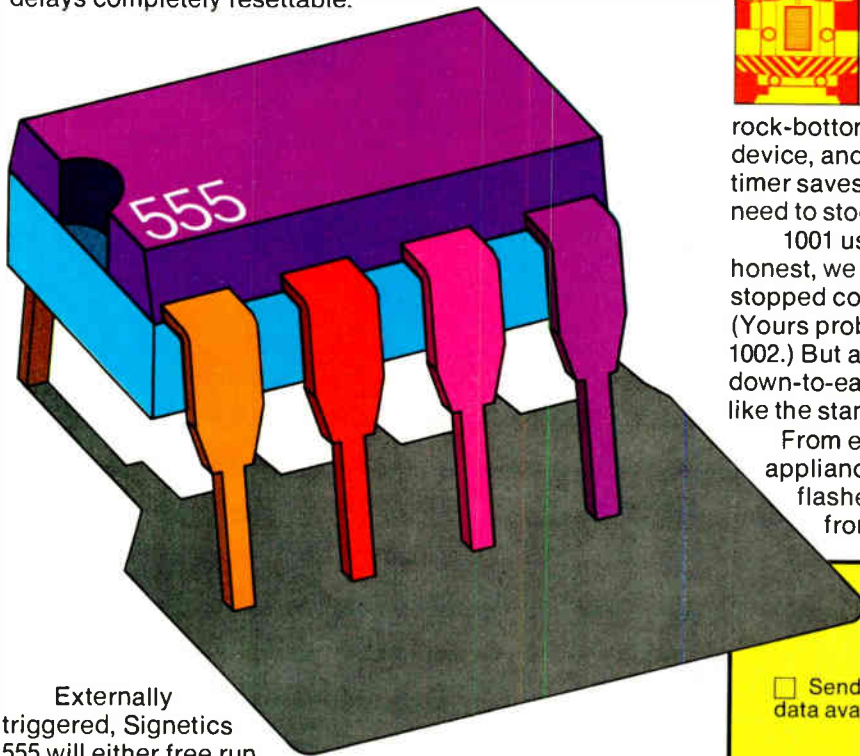

Externally triggered, Signetics 555 will either free run or latch, in adjustable duty cycles from 50% to 0.01%. Timing can be changed 10:1 with control. Operating from 5 to 15 volts with only a 1% change in timing. Output can source or sink 200mA. Temperature stability: 0.005% per °C.

And applying the adaptable 555 is practically child's play (if the kid knows basic math). Requires only a resistor and capacitor to do the job. With all kinds of options for starting the timing action. And you can operate 555 from just a single power supply.

All this, in one simple 8-pin dual in-line circuit. Available off-the-shelf now, from your distributor at



rock-bottom cost. The 100-up price is only 75¢ per device, and the multi-function capability of our 555 timer saves you still more on the parts you no longer need to stock.

1001 uses? To be honest, we haven't stopped counting yet. (Yours probably makes 1002.) But a versatile down-to-earth IC timer

like the standard 555 suggests applications unlimited.

From exotic technology to household appliances... from copying machines to barricade flashers... Start thinking. And you can take it from there.

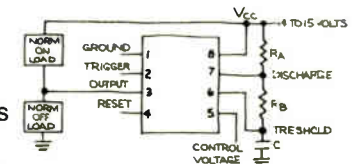

Signetics-Linear  
811 E. Arques Avenue  
Sunnyvale, California 94086

Send all the literature, specs and applications data available for the great 555 breakthrough.

Name

Title

Company

Address

City

State

Zip

Telephone

Signetics Corporation A Subsidiary of Corning Glass Works

**signetics**

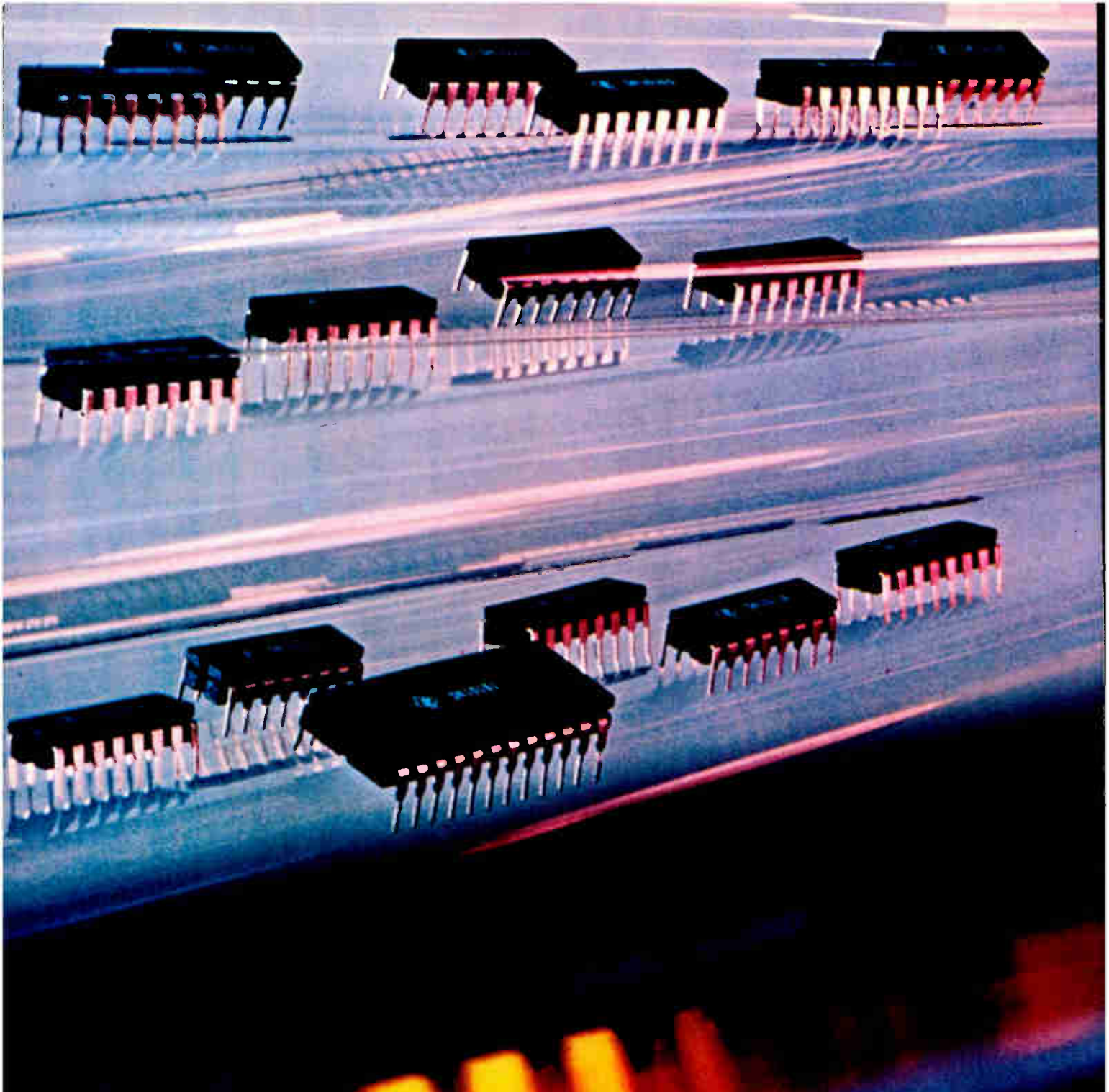

More TI integrated circuits are used in today's electronic systems than any other brand in the world. And for the reasons you'd expect: Technology. Volume. Price. Breadth. Dependability. Service. Quality. Weigh them all when you buy ECL.

# SN10000

# TI announces a new standard line of high-speed, low-power ECL: 2 ns at 25 mW SN10000.

To its capabilities as the major supplier of custom ECL circuits, TI has added a broad new standard family. Series SN10000.

Now, in weighing the long-range pros and cons of designing with emitter-coupled logic, you can add the assurance of TI's technological development and volume-production capability.

## TI can deliver now — including MSI

All SN10000 devices listed below are immediately available in evaluation quantities through authorized TI distributors or direct from factory inventories. All are in ceramic dual-inline packages — including the 24-pin ALU circuit — and are pin-for-pin equivalents to the MECL 10,000 series over the 0° to 75°C temperature range. Production quantities can be delivered 6 to 10 weeks after receipt of order.

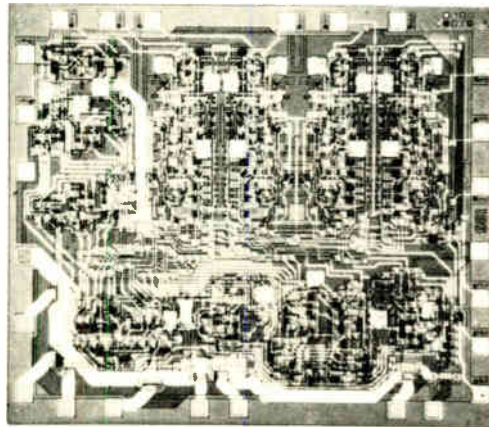

SN10181 ALU . . . 75 equivalent gates.

nal reference generator which relaxes power supply tolerances and power distribution requirements — thereby reducing overall system costs.

## Economical system design

In addition to power supply savings, you can achieve many other important design economies with Series SN10000.

Special PC boards are not required. Switching rise and fall times are slow enough so that conventional, two-sided boards can be used.

Savings in gate and package count are significant because the open emitter outputs and high impedance inputs permit wire-ORing of several gating levels. Data "bussing" and two-way data transfer are also possible with the open emitter outputs, which further make possible great flexibility in terminating schemes and logic interconnects.

Still more reductions in system gate and package count are possible because complementary outputs are readily available from ECL gates.

And now, with the availability of ECL/MSI, you can add the benefits of increased complexity — reduced package count, fewer interconnections, and smaller PC boards. All of which means lower component and system costs per gate.

## Much more to come — soon

These devices are only the beginning of a large and complete logic family . . . including memory functions as well as MSI and SSI logic circuits.

Planned, among others, are a quad 2-input AND gate, ECL/TTL level translators, a 12-bit parity checker/generator, an 8-line multiplexer, a quad latch, and a 64 x 1 RAM.

## Full specifications available now on all functions

For complete data sheets on TI's Series SN10000, circle 241 on the Reader Service Card. Or write Texas Instruments Incorporated, P. O. Box 5012, M.S. 308, Dallas, Texas 75222.



## 100-PIECE PRICE

	DESCRIPTION	100-PIECE PRICE
SN10101	Quad 2-Input OR/NOR Gate (One input common)	1.65
SN10102	Quad 2-Input Gate (3 NOR, 1 OR/NOR)	1.65
SN10103	Quad 2-Input Gate (3 OR, 1 OR/NOR)	1.65
SN10105	Triple OR/NOR Gate (2, 3, 2 inputs)	1.65
SN10106	Triple NOR Gate (4, 3, 3 inputs)	1.65
SN10107	Triple 2-Input Exclusive OR/NOR Gate	2.10
SN10109	Dual OR/NOR Gate (4, 5 inputs)	1.65
SN10115	Quad Line-Receiver	1.65
SN10116	Triple Line-Receiver (Complementary outputs)	1.65
SN10117	Dual 2-Wide 2-3 Input OR-AND/NOR-OR Gate	2.10
SN10118	Dual 2-Wide 3-Input OR-AND Gate	2.10
SN10119	4-Wide 4-3-3-3 Input OR-AND Gate	2.10
SN10130	Dual D-Type Latch	4.45
SN10131	Dual D-Type Master Slave Flip-Flop	5.65
SN10179	Carry Look-Ahead	6.80
SN10181	4-Bit Arithmetic Logic Unit/Function Generator	20.00

## Fast, cool and stable

The new Series SN10000 has a speed/power product of 50 pJ (2 ns at 25 mW per gate). You can take full advantage of the 2-ns speed without cooling problems. What's more, SN10000 offers an improved inter-

# TEXAS INSTRUMENTS

INCORPORATED

## 40 years ago

From the pages of Electronics, June 1932

Dawn, under an open sky, is a striking phenomenon to watch. Something like this is taking place right now in the engineers' battle for greater tone fidelity. Suddenly, all along the whole line of electronic devices, this matter of tone fidelity becomes of first commercial importance. A new day is breaking for greater tone accuracy.

At the Radio Show at Chicago, the new models showed a much higher degree of fidelity, made possible by the new tubes and circuits and by the trend to double loudspeakers. In phonograph recording, accuracy in reproduction out to 9,000 cycles is now achieved. The new films have sound tracks of remarkably full tone range. Last month a new theater opened at Providence, with recordings running from 40 to 8,000 cycles with complete faithfulness of tone. And in 16-mm. home talkies the effort goes on to widen the range further and further. Already the broadcasters have driven their sidebands out beyond 7,500 cycles. The new dawn of appreciation for tone is here.

Members of the Radio Manufacturers Association evidenced their confidence in the return of good times by displaying at the Eighth Annual Trade Show in Chicago, May 23-26, new sets and tubes on which \$200,000,000 will be risked within the next half year. This vast amount of money is to go for new dies, new machinery, retooling expense, raw materials, labor, and overhead, according to J. Clarke Coit, president. The fact that nearly four million sets and fifty million tubes were made in 1931, that there are several million obsolete sets in use and that there are still some thirteen million homes sans radio is cited as cause to believe a market will be found for the 1932 production.

While these new sets were being bragged up—rightfully, for they are far in advance of anything shown to the trade in the past—Radio Row in New York City was flooded with 1931 sets with as many "big names" as the movie, "Grand Hotel."

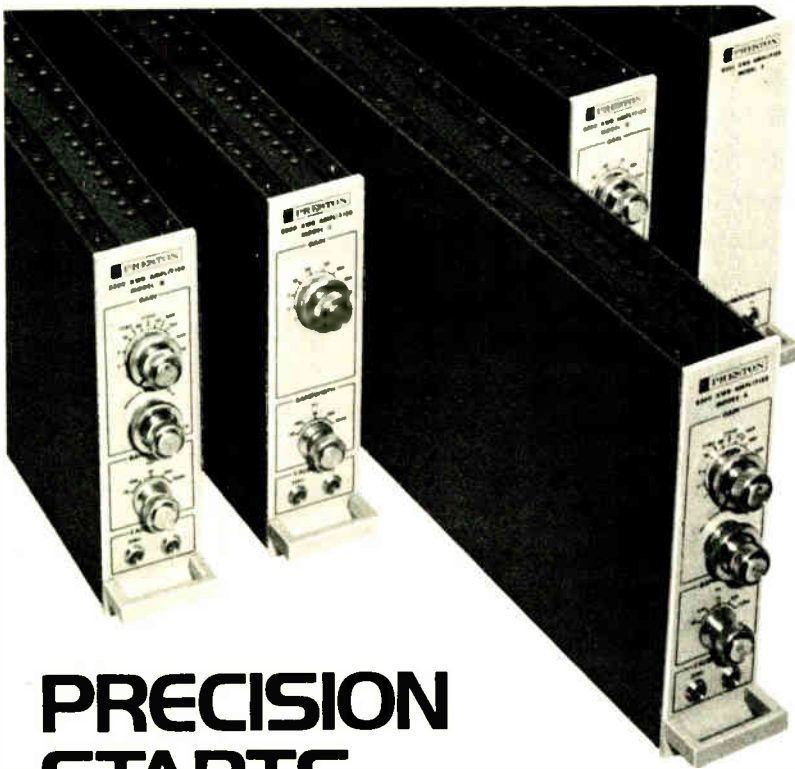

# PRECISION STARTS UP FRONT

And Preston's 8300XWB Series Amplifiers deliver *unsurpassed* front-end performance for the toughest instrumentation jobs.

The entire 8300XWB Series offers:

- Gain stability, 0.01% • Common-mode rejection at DC, 150 db; at 60 Hz, 130 db; at 100 kHz, 60 db • Common-mode voltage, 350 volts peak AC or DC • Input noise, 3  $\mu$ v rms at 100 kHz bandwidth • Settling time (100 kHz bandwidth), 30  $\mu$ sec to  $\pm 0.01\%$  full value • Slewing rate, 3 volts per  $\mu$ sec • Drift (6-month term),  $\pm 5 \mu$ v RTI,  $\pm 1$  mv RTO • Input impedance, 100 megohms • Output impedance, 1 ohm (max) • Output capability,  $\pm 10$  volts at 100 ma.

One of these outstanding models has the combination of features and capabilities to satisfy your most demanding design requirements.

PRESTON MODEL

Parameter	A*	B	C	D	E
Gain	Ten steps plus variable, to 2500x		Ten steps fixed, to 1000x		Fixed, 1x to 2000x
Gain Accuracy	$\pm 0.01\%$		$\pm 0.1\%$		$\pm 0.01\%$
Gain Linearity	$\pm 0.005\%$		$\pm 0.01\%$		
Drift ( $\mu$ v per degree C)	0.1 RTI; $\pm 20$ RTO		0.3 RTI; $\pm 100$ RTO		
Bandwidth (to 3 db point)	Selectable to 100 kHz		Preset, 100 kHz (max)		

\*Programmable gain version of model "A" is designated 8300XWBRC

If you're concerned about the Front End of your instrumentation system, contact Preston today for full details and prices on the extraordinary 8300XWB line.



SCIENTIFIC INCORPORATED

805 East Cerritos Avenue • Anaheim, California 92805 • Phone: (714) 776-6400

REPRESENTATIVES IN MAJOR CITIES THROUGHOUT THE WORLD

**PROBLEM:**  
cramming more power distribution cable into less space.

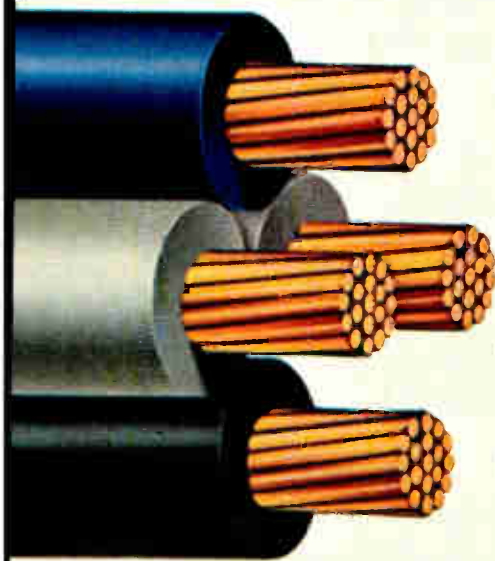

**SOLUTION:**  
a cable that's flat instead of round.

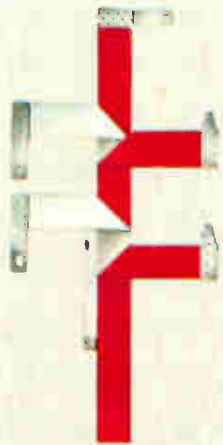

Now you can pack more power distribution cable into less space than you ever thought possible. By using Brand-Rex's new *flat* PVCA cable. A vinyl-insulated aluminum strip you can stack, run in trays or ducts, bend at any angle for branching or to follow any contour.

UL-recognized for 105°C, 100 volt operation, PVCA has passed the UL vertical flame test. And its outer jacket is highly resistant to oil and grease.

Standard terminals, including center tap, are readily available for fast, economical, air-tight, water-tight connections and splices. Yet new PVCA costs *less* than the conventional cable it replaces.

For a fact folder that outlines in detail all the special problems this new concept in flat power distribution can solve, write to Brand-Rex Company, Willimantic, Conn. 06226. Or call: 203/423-7771.

**BRAND-REX**  
4,000 solutions in search of a problem.

# If you're ready for a switch...

we're ready for you. With top-quality, competitively priced DIP switches, thumbwheel switches, rotary matrix switches, matrix slide switches, rotary BCD switches, automotive toggle switches and brake safety switches. Even proprietary-design switches, such as push-to-talk and push-button volume types.

That's a lot of switches. And they're backed by a lot of creative engineering . . . to make sure you're ready for the future.

For information and descriptive literature, write to:

**AMP Incorporated, Industrial Division, Harrisburg, Pa. 17105.**

**AMP**  
INCORPORATED

Manufacturing and direct sales facilities worldwide: Barcelona, Brussels, Buenos Aires, Frankfurt, London, Mexico City, Paris, Puerto Rico, Sao Paulo, s'Hertogenbosch (Holland), Sydney, Stockholm, Tokyo, Toronto, Turin, Vienna.

**During the NEPCON Show  
visit the AMP Booth #4301**

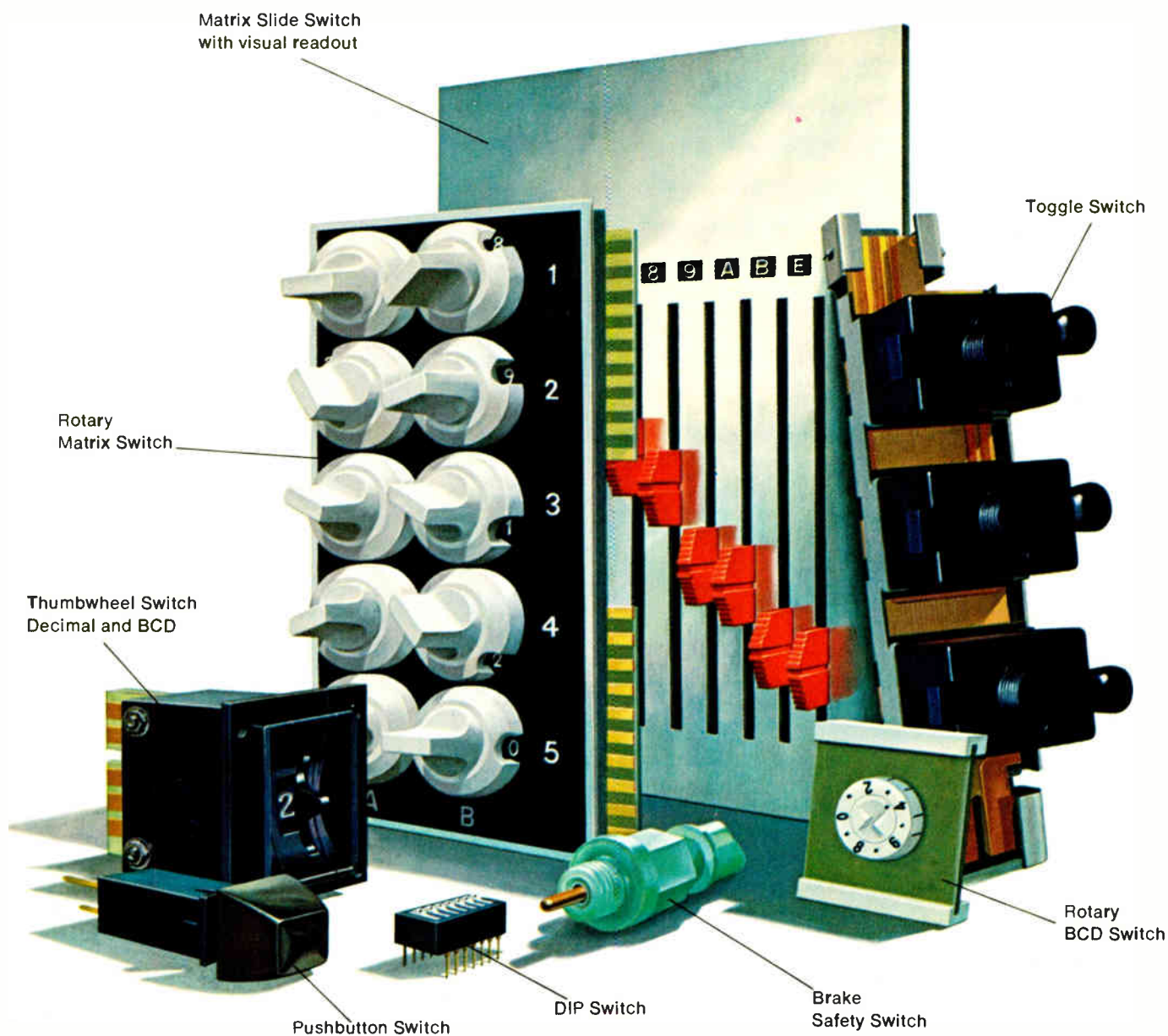



## Meetings

**Consumer Electronics Show:** EIA, McCormick Place, Chicago, June 11-14.

**Spring Conference on Broadcast & Television Receivers:** IEEE, Marriott Motor Hotel, Chicago, Ill., June 12-13.

**Air Pollution Control Assn., 65th Annual Meeting:** APCA, Fontainebleau, Miami Beach, June 18-22.

**International Conference on Communications:** IEEE, Marriott Motor Hotel, Philadelphia, June 19-21.

**Joint Measurement Conference:** ASQC, IEEE, ISA, NBS, et. al., University of Colorado, Boulder, Colo., June 21-23.

**Conf. on Precision Electromagnetic Measurements:** IEEE, NBS, U. of Colorado, Boulder, June 21-23.

**Design Automation Workshop:** ACM, IEEE, Marriott Hotel, Dallas, June 26-28.

**International Conference on Electronics in Civil Aviation:** FNIE, SEE, et al., Unesco, Paris 8, France, June 26-30.

**International Symposium on Electromagnetic Compatibility:** IEEE, Arlington Park Towers, Chicago, July 18-20.

**Western Electronic Show & Convention (Wescon):** WEMA, Convention Center, Los Angeles, Sept. 19-22.

**Engineering in Medicine and Biology:** IEEE, Americana, Bal Harbour, Fla., Oct. 1-5.

**International Symposium on Remote Sensing of the Environment:** U. of Michigan, Willow Run Labs, Ann Arbor, Oct. 2-6.

**International Conference on Cybernetics and Society:** IEEE, Sheraton, Washington, D.C. Oct. 9-12.

**Conference on Display Devices:** IEEE, United Engineering Center, New York, Oct. 11-12.

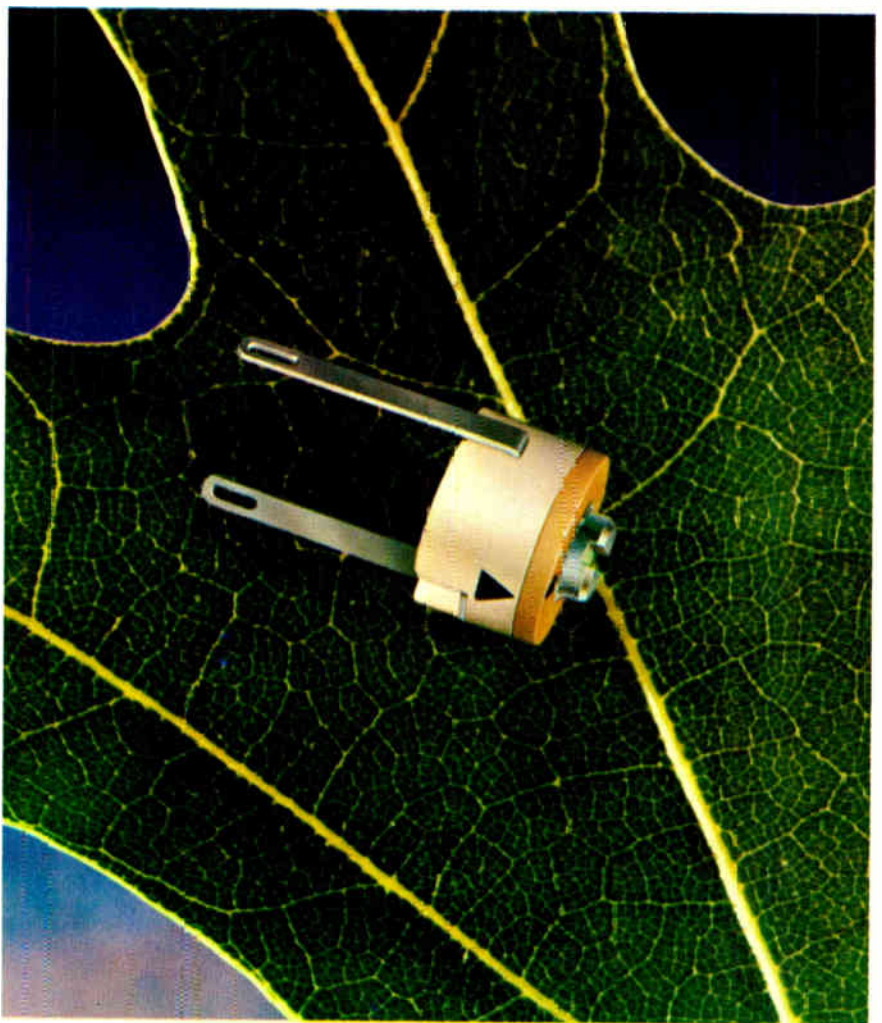

Meet the "Mite".  
Only .218" diameter. The toughest ceramic disc trimmer capacitor its size.

New from E. F. Johnson. And it's this small:   
Designed for printed circuit applications where space is at a premium. Stator of High Alumina for greater shock and vibration resistance. The rotor plate is encapsulated in ceramic for environmental stability and long life. The Q factor at 1 MHz is 500 minimum. Precision lapped bearing surfaces give you smooth linear tuning. Pick from a wide capacitance range: 1.0-3.0 pF, 2.5-9.0 pF, 3.5-20.0 pF, 5.0-25.0 pF. Designed to meet or exceed applicable requirements of MIL-C-81A.

Return the coupon today for information on Johnson's new Micro-J. And if you have a special capacitor need, we'd like to work with you. The same engineering that made our air variable capacitors the standard of excellence goes into every new Johnson product.

E. F. JOHNSON COMPANY/3003 Tenth Ave. S.W./Waseca, Minnesota 56093

- Send product specification information on new Micro-J capacitor.  
 Include information about your full capacitor line and other Johnson components.

NAME \_\_\_\_\_ TITLE \_\_\_\_\_

FIRM \_\_\_\_\_ ADDRESS \_\_\_\_\_

CITY \_\_\_\_\_ STATE \_\_\_\_\_ ZIP \_\_\_\_\_



**E. F. JOHNSON COMPANY**

# Why invest in wire-wrapping facilities,



## when you can use ours?

We can handle your complete back-panel wire-wrapping including all inventories right up to and including final inspection. You just have to bolt it in. And you can be sure of a completely tested, 100%-error-free back panel.

All your back panels can be tested with an Omnitester 900 Wiring Analyzer. This unit, pictured here in the center, has forward scan capabilities to determine, for example, whether a missing wire went to some other point. It then identifies that point.

The unit further tests for continuity resistance,

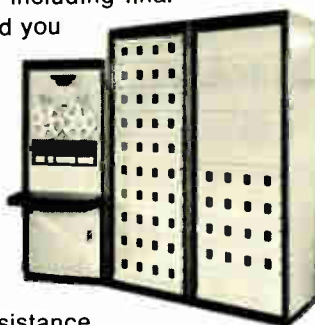

insulation resistance, DC hipot, and features programmable dwell time.

All this at a price less than in-house fabrication. No costly inventories, no capital tied to costly equipment. You can furnish the back panels or we can supply our own.

Delivery? Just 2 to 8 weeks, depending on the job and material availability. And we have two locations: Longmont, Colorado or Endicott, New York. For more details just call your nearest Amphenol sales office or write us direct. Amphenol Cadre Division, Bunker Ramo Corporation, 20 Valley St., Endicott, N.Y. 13760.

**BUNKER  
RAMO**

**AMPHENOL**

Circle 34 on reader service card

## **Hughes develops dense, low-power C/MOS process**

Hughes Aircraft, Newport Beach, Calif., has developed a complementary MOS technology that offers the **high densities of p-channel MOS with the low power requirement of C/MOS**. The new process, called C/MOS III by Hughes, offers three to five times the density of conventional MOS. It combines silicon-gate technology with oxide isolation (Planox or Isoplanar process), but requires ion implantation for doping the well, threshold shifting where necessary, and inversion control with channel stoppers.

The process can be tailored for ultra-low-voltage operation (1.5 volts) or speeds as high as 25 megahertz. Due to the critical processing, **it is not expected to be an inexpensive process, but suited for military and space applications.**

## **Process means more accurate, faster comparator**

A new high-speed linear IC process at Advanced Micro Devices Inc. of Sunnyvale, Calif., may lead to a **new generation of analog-to-digital converters that are both fast and accurate**. Now, the designer of such converters has to trade speed for accuracy in choosing a comparator for his circuit.

But with the new AMD process, which is described as an advanced npn bipolar Schottky-diode high-frequency process that offers very short propagation delays without sacrificing matching characteristics, comparators may be built with a resolution of only 0.5 millivolts; total propagation delay is only 7.5 nanoseconds for an overdrive signal 5-mV above input threshold—**at least twice as fast as anything available to date**. A comparator employing the new process is expected to be available this summer.

## **Honeywell's CAS seeks way around high costs**

Honeywell has built an airborne collision-avoidance system that it hopes will meet potential users' objections to the high price of competitive systems. Dubbed Avoids (for avionics observation of intruder danger systems), **the new CAS is derived from proximity warning indicators developed at Fort Rucker, Ala., for Army helicopters**. Honeywell has added sophisticated transponder technology, computer logic, and signal correlation techniques.

**The top price for the unit will be \$9,000, says Honeywell. Systems built by RCA and McDonnell Douglas range from \$1,000 for light planes to \$50,000 for jetliners.**

Explaining his system's comparatively low cost, Robert J. Follen, project manager in Honeywell's Radar Systems, Governmental, and Aeronautical Products division in Minneapolis, says that the philosophy behind Avoids was to keep it simple. For example, to get rid of false alarms, Avoids uses a threat-evaluation pattern that cuts to a minimum the number of interrogations needed to determine a potential threat rather than going to complicated circuitry designed to weed out false responses.

The next move is up to the Government. The airlines have been backing McDonnell Douglas' EROS system, but are interested in both RCA's Secant and Avoids. **However, they're unwilling to invest a great deal of cash in any CAS until the Government decides on a national standard.**

## **Radiant Energy builds calculators**

The latest American firm to jump into the calculator fray is Radiant Energy Systems in Newbury Park, Calif., which will make two different machines for Logic Data, a Chicago firm also buying complete calculators from NRMEC. **Radiant's calculators, one a desk model and the other a small portable, are expected to sell for about \$100.**

Size of the Logic Data deal is not known, but Radiant has given a contract to Western Digital Corp., which will supply the two silicon-gate MOS chips in the machines, for \$4 million. The calculators will use low-voltage gas display tubes from Ise Electronics of Japan [*Electronics*, May 22, p. 26].

## **Datran slices \$100 million off cash needs**

With vendor evaluation and selection for Data Transmission Co.'s nationwide digital data network "in the final throes," **the firm has managed to whittle its financial requirements to under \$200 million, says president Glenn E. Penisten.** Earlier estimates put the figure at just under \$300 million.

Penisten says the total was pared through further discussions with vendors and by implementing a new plan for initially leasing intracity facilities from existing carriers. **Decisions on vendors are due in 30 to 45 days, he says, with construction of the net to begin this year in Houston and first services scheduled for 1974.** Communications industry sources say that Nippon Electric Co. has made an offer to supply equipment with financing [*Electronics*, May 22, p. 49]. By the mid-1970s, though, Datran will introduce elements of its own solid state switching and intracity distribution facilities, as previously planned.

## **DEC's front end for 360,370 is first of new line**

Digital Equipment Corp. is bringing out **the first of a new line of data communications gear: a plug-to-plug compatible, programable front end for IBM's Systems 360 and 370.** Called the DEC 11D23, it's also software compatible and performs line control, message concentration, switching, error control, and other teleprocessing jobs.

## **Addenda**

RCA next week will reveal first details of its new color picture tube for portable TV sets. **It's said to be a slotted-mask type with a shorter neck than conventional tubes.** . . . The House Appropriations Committee has cut the research program for the TACV (tracked air-cushion vehicle) to only \$2 million from the requested \$8.5 million. **The committee said it "sees virtually no practical application for a TACV in an urban transportation system."** The funding allows the Urban Mass Transportation Administration to test its prototype, but scrubs a second vehicle. At the same time, the committee rejected a UMTA request for \$24 million to gear up for demonstration projects of people-mover systems. . . . **Qualified OEM users will have a chance to try new helium-neon laser plasma tubes free,** according to an offer from Hughes aircraft's Electron Dynamics division in Torrance, Calif. The 1- or 2-milliwatt lasers sell for only \$79.95 in thousand-piece quantity. . . . The Illinois Institute of Technology Research Institute has developed a fiber-optic matrixed camera eye for industrial robots. It displayed the device at its second industrial robot symposium in Chicago. IITRI hopes to sell the eye to a manufacturer and estimates that it would sell for less than \$1,000.



**Just when the others  
thought they were  
on to our game...**

# We Stacked

Some time ago we announced our family of everything-on-one-card core memories. Off-the-shelf. Spectacularly low prices. Fully TTL compatible with no analog or critical timing inputs required. And available in a wide range of sizes and performance characteristics.

But since then a few others have been shouting about their card memories. A pair over here. Three-of-a-kind over there.

Okay. Time to reshuffle, cut

the cards—and lay the whole new hand on the table.

First, let's look at those features common to *all* our card memories:

We use 18 mil wide temperature core throughout for top quality performance, high density and great reliability. Our unique 3 wire, 3 Dimensional planar stack design assures high density packaging. It also allows you to plug "piggy-back" style into the

electronic board via an individual pin-and-socket design. This interconnect arrangement offers several advantages. The layouts are easier. The lead lengths are shorter. The interconnections are on an integral basis. Noise is less. And performance is considerably improved.

So much for the advantages of the entire family. Now here are some individual features of the three series:

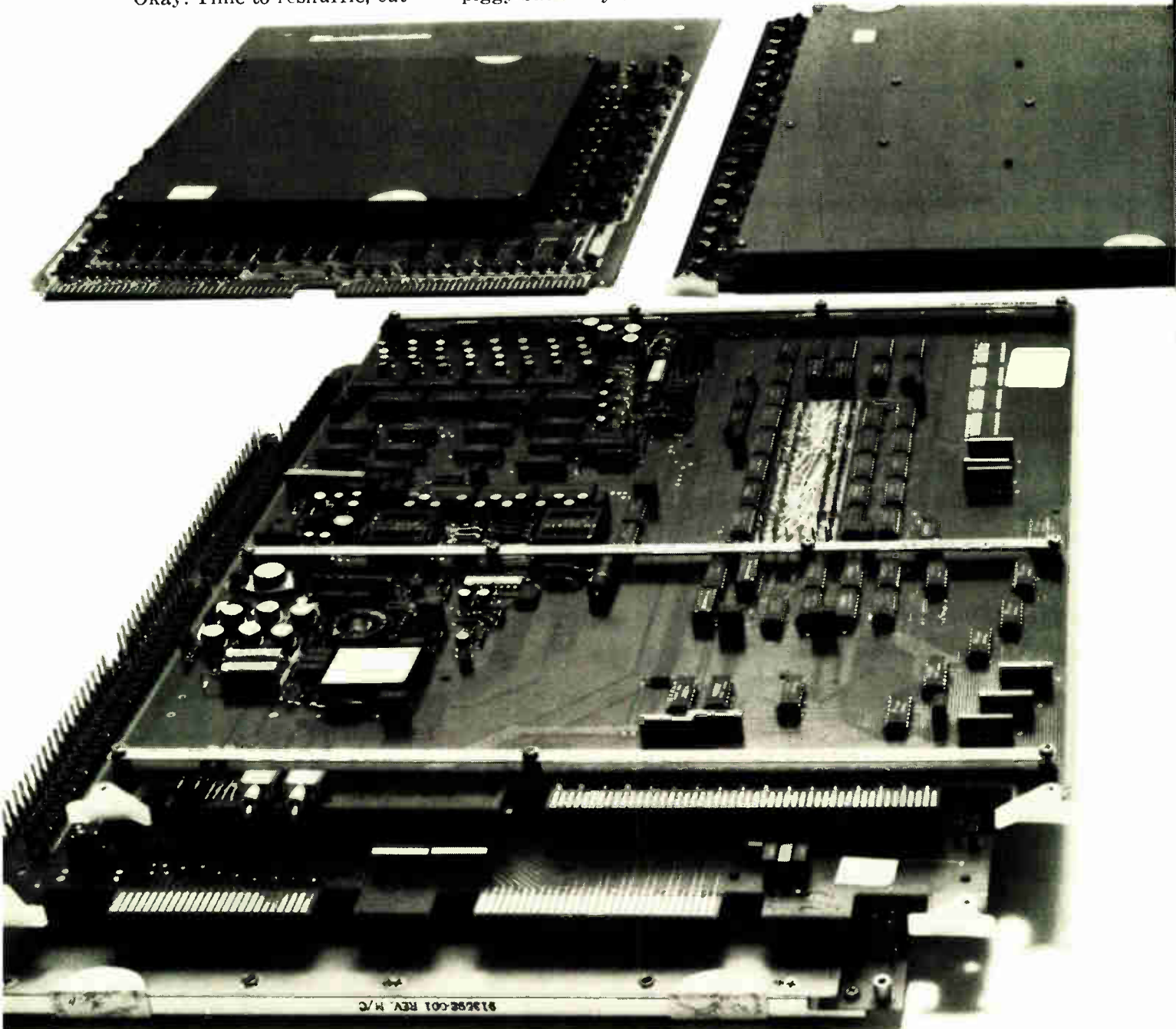

# the Deck.

## Micromemory 2000

Here you have the total system on one card with edge connections that allow the memory to be treated just like a logic circuit. With this series there are no funny voltages. The card operates from plus five volts input only.

## Micromemory 3000

This series is the high performance version of Micromemory 2000. You get high speed: 650 nanosecond



cycle time and 300 nanosecond access time. Byte control and Data Save features are included.

## Micromemory 6000

This is the newest member of the family, and in some ways the most exciting. It is a multiple board module with a 16K sense that offers you a modular concept for large mass memories. In its basic configuration of 16,384 words by 40 or 32,768 by 20, it uses only two boards. The fully expanded unit of 65,536 by 40 or 131,072 by 20 uses five PCBA's including four stack assemblies. Cycle time is 1200 nanoseconds and access time is 500 nanoseconds. Basic PCBA size is only 12.75" x 15.4". The outline width of a 16K x 40 group is only 1.7". Low drive cores are used for low power input requirements.

There you have it. The

broadest range of sizes and performance characteristics, the best list of design features—and the newest modular concept in mass memories. From the outfit that was dealing the cards before the others even learned the rules of the game.

So take another long look at our table of specs. Then give us a chance to bring a smile to your face with price and delivery quotes. It won't take us long to turn you into a card shark. Once we show you how to stack the deck.

**When you're hot, you're hot.**

♥♦♣	MICROMEMORY 2000	MICROMEMORY 3000	MICROMEMORY 6000
Configuration	4,096x9	8,192x18	16Kx40
Alterable to:	—	16,384x9	32Kx20
Full Cycle Time	1.0 $\mu$ s	650ns	1.2 $\mu$ sec
Access Time	400ns	300ns	500ns
Modes	R/R, C/W, R/M/W	R/R, C/W, R/M/W	R/R, C/W, R/M/W
Byte Control	—	X	X
Data Save	X	X	X
Required Voltages	+5V	$\pm$ 15V, +5V	+15V, +5V
# of PCBA's	1	1	1 control card + 1 per 16Kx40
PCB Size	11 $\frac{3}{4}$ x15"	11 $\frac{3}{4}$ x15.4"	12 $\frac{3}{4}$ x15.4"
Allowable PCB Spacing	1"	1"	1"
Expansion in a single chassis to:	16,384x9 8,192x18	65,536x9 32,768x18 16,384x36	65,536x160 131,072x80 262,144x40
Extended Address to:	32,768x9	65,536x18	524,288x40
In increments of:	4,096x9	16,384x9 8,192x18	16,384x40 32,768x20
Stack	3W, 3D	3W, 3D	3W, 3D
TTL Compatible	X	X	X

# electronic memories & magnetics

**NO MATTER WHERE YOU ARE . . .**

**BOURNS®**  
**ENTIRE LINE**  
**OF PRECISION POTENTIOMETERS**  
**... IS STOCKED IN DEPTH**

Bourns has 73 distributor locations; more than any other potentiometer manufacturer. One is near you... no matter where you are. Each has a complete stock of Bourns Precision Potentiometers; the industry's widest selection.

10-turns, 5-turns and 3-turns . . . in ½", ¾", 1½" and 1¾" diameters . . . with wirewound and INFINITRON® Conductive Plastic elements . . . in either bushing or servo-mount configurations.



**For complete details, or to enter your order, contact your local Bourns distributor, a Bourns sales office, representative or the factory-direct.**



**BOURNS, INC., TRIMPOT PRODUCTS DIVISION • 1200 COLUMBIA AVE., RIVERSIDE, CALIF. 92507**

**BOURNS DISTRIBUTORS —**

**ALABAMA**/Cramer/E. W. **ARIZONA**/Kierulff Elect. **CALIFORNIA**/Westates Elect. Corp. • Hamilton Electro Sales • Liberty Electronics • Elmar Elec. Inc. • Hamilton/Avnet • Electronic Supply Corp. • Western Radio **COLORADO**/Hamilton/Avnet • Kierulff **CONNECTICUT**/Conn. Electro Sales • Cramer Elect. Inc. **FLORIDA**/Cramer/E. W. • Hamilton/Avnet • Hammond Elect. Inc. **GEORGIA**/Jackson Elect. Co. **ILLINOIS**/Allied Elect. Corp. • Newark Elect. Corp. • Hamilton/Avnet **INDIANA**/Ft. Wayne Elect. Supply Inc. • Graham Elect. Supply Inc. **KANSAS**/Hall-Mark Elect. Inc. **LOUISIANA**/Southern Radic Supply Inc. **MARYLAND**/Cramer/E. W. • Pioneer/Washington Elect. Inc. **MASSACHUSETTS**/Electrical Supply Corp. • Cramer Elect. Inc. **MICHIGAN**/Harvey-Michigan **MINNESOTA**/Lew Bonn Co. • Hamilton/Avnet **MISSISSIPPI**/Ellington Electronic Supply, Inc. **MISSOURI**/Hamilton/Avnet • Hall-Mark Electronics Corp. **NEW JERSEY**/General Radio Supply Co. • Hamilton/Avnet • Eastern Radio Corp. **NEW MEXICO**/Electronic Parts Co. **NEW YORK**/Standard Electronics Inc. • Cramer/Binghamton • Cramer/Esco • Cramer/Eastern • Hamilton/Avnet • Federal Elect. Inc. • Schweber Electronics • Harvey Radio Co. **NORTH CAROLINA**/Cramer/E. W. **OHIO**/Hughes-Peters, Inc. • Pioneer **OKLAHOMA**/Hall-Mark Elect. **PENNSYLVANIA**/Pyttronics • Powell Elect. • Cameradio Co. **RHODE ISLAND**/Wm. Dandreta Co. **TEXAS**/Hall-Mark Elect. Co. • Hamilton/Avnet • Harrison Equip't Co. **UTAH**/Cramer **WASHINGTON**/Liberty Elect. **WISCONSIN**/Taylor Electric Co. **CANADA**/Varatronics • Cesco Elect. • Zentronics Ltd.



## Fairchild unveils its 1,024-bit Isoplanar memory

Static random-access device accesses in 60 nanoseconds, dissipates 500 milliwatts; Univac said to be user

The wraps are finally off what C. Lester Hogan, president of Fairchild Camera & Instrument Corp., has called the hottest thing to come out of his company since the development of the planar process—a 1,024-bit bipolar random-access memory employing Fairchild's Isoplanar process. Tom Longo, vice president

and general manager of the Fairchild Digital Products division in Mountain View, Calif., calls the fully decoded static memory—organized as 1,024 words by one bit—"the industry's first 1k bipolar memory, and it's the most complex bipolar memory to be produced to date."

Fairchild's Isoplanar process, announced a little over a year ago, employs an insulating oxide to provide isolation between active elements in an IC. Besides offering higher packing density, the technology allows smaller transistors to be built on a chip, which leads to faster circuits.

The new RAM, for example, accesses in only 60 nanoseconds; power dissipation is 500 milliwatts.

This is the same power dissipation as our 256-bit bipolar memory," says Longo, "so in effect we've been able to offer the user four times the storage capacity with no increase in power dissipation." For a transistor-transistor-logic system employing the new Isoplanar memory, Longo says total system cycle time will be on the order of 180 nanoseconds.

**Eliminated.** In comparing the bipolar 1,024-bit memory with MOS 1k parts, Longo says that, "in addition to the speed advantage of the Isoplanar part over MOS devices, our Isoplanar memory is a static device, and so we eliminate the need for drivers, sense amps, and precharge and refresh circuits."

But he is quick to point out, "We are not competing on a cost basis with MOS memories; we are looking for the performance sockets, and we will compete on a cost basis with high-performance core and plated-wire memories where the total memory system cost runs several cents per bit. These systems are in the 300-ns cycle-time category and under." And comparing the new device with existing bipolar RAMs, Longo says. "This is the device that is going to separate standard TTL parts from the high-performance Isoplanar devices."

Samples of the new device have already been shipped to a dozen companies for evaluation, and Longo says that at least one main-frame computer maker (industry in-

**Big development.** Fairchild president Hogan calls new RAM hottest thing since planar process.



## In pursuit of the bipolar RAM

It seems that everyone talks about a 1k random-access memory—and does something about it. Fairchild may be first with an announcement, but it's no secret that Texas Instruments, Motorola Semiconductor, Signetics, and Raytheon aren't far behind. A spokesman says that TI's version is in the "final stages of development."

Motorola will have a 1k RAM in both emitter-coupled logic and TTL in early 1973. The company will use the VIP (for V-groove isolation with polysilicon backfill) process, and the ECL version is to be somewhat faster and use less power than Fairchild's. Says Jack Burns, a memory product planner: "We feel that the larger-mainframe business in large RAMs will go to ECL, not TTL, due to the speed."

Burns has this to say about the Fairchild part: "It will fill a definite slot in the marketplace, and we see growth in this area in 1974. We think that the earlier market will go to 256-bit RAMs (Motorola will announce one using VIP in July) because there probably won't be other sources for the 1k until mid-1973, and the mainframe houses will likely hesitate to use a sole-source part." But Raytheon says it also has parts that are being sampled.

siders say it is Univac) has designed the part into a system scheduled for introduction in late 1973 or early 1974. And while he won't quote volume prices on the new part (samples cost \$70 each in quantities of 100), he says that "in one to two years it should not be difficult to pass the

cent-per-bit level—a 150-ns cycle-time memory system will cost about 3 cents per bit in high volume." Soon to come is an emitter-coupled-logic version. Next on the drawing board is a 4,096-bit device. Questions about availability and speed are answered with "No comment." □

## Displays

### Double layers are the key to camera tube, copier web

Ever since Bronze Age man discovered that copper and tin together made an admirable material for tools and weapons, the history of technology has been marked by fortuitous combinations. In mid-May, history once again repeated itself: two major Japanese electronics companies revealed what appear to be landmark new products, based on still another fortuitous combination—a photosensitive layer backed by a storage-charge layer.

Different. Although the same two-layer idea is crucial to both products, they cannot be considered two versions of the same thing. One is Tokyo Shibaura Electric Co.'s (Toshiba's) new TV camera tube. The other is Matsushita Electric Industrial Co.'s new web for electrostatic copying machines, a variant

that should lead to facsimile print-out on plain paper. Scientists at Matsushita's Wireless Research Laboratory expect multiple-layer devices to pop up in all sorts of new applications as people learn how to handle them.

Toshiba says that its new tube will one day supplant the Plumbicon, developed by Philips Gloeilampenfabrieken of the Netherlands—as the Plumbicon with its lead oxide/lead sulphide targets. In the Toshiba tube, the target material is cadmium selenide, long a tempting substance because of its high photosensitivity and its response curve, which rises gradually from blue through red.

The trouble is that cadmium selenide has low resistivity; among other things, that makes for high

dark currents if it's used alone as a vidicon target material. Toshiba skirted this obstacle by backing the cadmium selenide layer with a high-resistivity chalcogenide layer, but the company hasn't revealed exactly what compound it uses.

**Chalnicon.** Because the chalcogenide layer is the key, Toshiba calls the new camera tube the Chalnicon. And the company's tube men are ecstatic about its performance. It has about four times more sensitivity than a Plumbicon, they say, and much more uniform response over the visible spectrum. What's more, the gamma, or degree of contrast, of the new tube is 0.9. All told, then, the camera video circuitry can be simpler than for other vidicons.

There'll be savings in camera size, too, Toshiba adds. The first version to be marketed (18 millimeters in diameter) will have a resolution of 700 lines, despite its target size of 6.6 by 8.8 millimeters. The price is about \$1,000, and sales will start in Japan this autumn.

In Matsushita's copying web, the photosensitive material is a layer of selenium semiconductor, doped with 10% or so of tellurium. Selenium can handle both the main jobs required for an electrostatic dry copier that uses ordinary paper—generate a charged latent image of what's being copied and hold it until a toner-powder image has been picked up and then transferred to the paper. However, to do both jobs, the selenium layer has to be fairly thick; using a layer thin enough to work with a web won't do.

So Matsushita pairs a selenium layer about 0.3 micrometer thick with a 20 $\mu$ m layer of polyvinyl car-

**From Toshiba.** Camera tubes use cadmium selenide targets and are called Chalnicons.



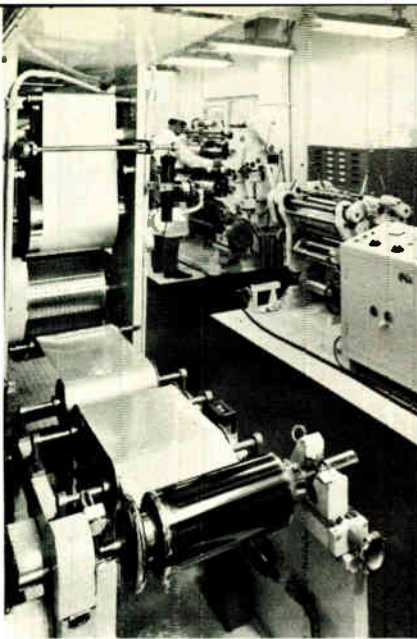

From Matsushita. New web for electrostatic copiers could use plain paper for fax.

bazole on an aluminum-coated film support. The selenium then has only to generate the charge pattern and the polyvinyl layer stores it. Because of this division of labor, tellurium doping can be boosted to increase the photosensitivity of the selenium. As the doping in a single layer of selenium is increased, poorer images will result because the resistivity of the layer drops. Matsushita maintains that its two-layer web is three to five times more sensitive than a drum coated with a single relatively thick layer of selenium.

In the new version for facsimile, the web support is made with a transparent conductive layer instead of the aluminum. □

## Manufacturing

### Plasma dry etch means thick resist

A new etching method for semiconductor production not only promises higher yields and finer geometries, but could enable device makers to cash in on some of the advantages of thick positive photoresist. Those advantages have been out of reach with chemical etching.

The plasma dry etch system has been developed by LFE Corp., Waltham, Mass. It is being used by the Shipley Co., of Newton, Mass., a maker of thick positive photoresists,

to produce etches less than a micrometer wide with walls as steep as necessary. This is in sharp contrast to the sloped side-walls characteristic of chemical etches. Shipley's experiments utilized AZ photoresist, made by Azoplate Co., of Murray Hill, N.J.

In LFE's glow discharge system, a complex fluorine hydrocarbon gas is pumped down to about 0.5 torr in a vacuum chamber. An rf current is then introduced to create a plasma that carries off exposed silicon dioxide, silicon nitride, or even pure silicon at rates between 400 and 4,000 angstroms per minute. With thick resists and chemical etching, a line or hole might widen a mil for every mil etched downward. Now taper can be controlled by varying the 13.56-megahertz rf pumped into the vacuum chamber up to its 300-watt maximum. Higher power and gas flow etch steeper sides.

**Windows.** Etching silicon dioxide is a critical step in production, since it produces the windows for diffusion of impurities; several such etches are used during the production of a device. The photoresist protects the silicon dioxide during etching, but is removed before diffusion.

While it works with thin resists, the plasma process is better suited for the thicker photoresists. Thin negative resists, despite pinholes, are popular because they adhere to silicon better than positive thick resists with their smaller molecules. But LFE's senior sales engineer, Mike P. Chumura, notes that a fast swipe of cleansing plasma across the surface of a chip solves the adhesion problem for thick resists.

With this solved, industry should warm to the advantages inherent in thick resists, says Shipley's David J. Elliott, a photoresist specialist. The reasons: no pinholes or similar coating defects, easier alignment, easier and less critical handling, scratch resistance, easy adaptation to projection masking, and—important for fine geometries—optical diffusion during exposure that is much less than that of thin resists (the thin resists' long molecules can channel light away from the desired expo-

sure areas as if they were miniature fiber-optic bundles).

Elliott emphasizes that all this translates into bigger yields. "Right now, chip yields of 17% to 20% are considered high if your designs push the art at all. With thick resists and the cool, clean processing possible with plasma etching, chip rejects might be cut by 30% to 50%—and that could be conservative."

Any system that proves it can cut rejects by that much will fast gain a following in the semiconductor business. And, as LFE's Chumura points out, the plasma system ought to gain adherents, even among those using ion implantation or beam-scanning techniques. "Most of the equipment now available uses oil-filled pumps to evacuate their work chambers, and they can leave a thin oil film that can itself cut yield or reduce performance. We can rip it right off with the plasma." Chumura reports that already companies like Raytheon, Microwave Associates, and IBM are using initial models of the device. Others close to the project say that Bell Laboratories and Western Electric also are interested. Semiconductor geometry is a continuing check on development of higher powers at higher frequencies, or advances in surface-wave devices. This places small geometries in continuing demand.

Elliott says, "Etching silicon dioxide in a standard Air Force test pattern, we have already been able to get very sharp 0.75-micron-wide lines. Though we haven't pushed the technique below this point yet, we plan to, and foresee ultra-fine geometries." □

## Communications

### Comsat's SPEC squeezes speech

Digital speech compression techniques try to achieve telephone quality at high data rates. Too often, however, voice quality suffers when traffic gets too heavy for voice channel capacity. Communications Sat-

elite Corp. researchers, however, have developed a speech predictive encoding communication (SPEC) system which it says offers two-to-one voice compression without loss of quality at high traffic loads in pulse code modulation systems.

**Inexpensive.** In addition, Comsat says SPEC is simple and would effectively double the channel capacity of large users of Intelsat or domestic satellites with installation of new ground terminal equipment. SPEC also is inexpensive—about \$400 per circuit with today's transistor-transistor-logic technology, estimates S.J. Campanella, broadband processing manager. The system, slated for field testing in the fall, would technically be ready for operation next year, he says.

For a heavy user of a 30-channel satellite segment, for example, high-quality speech compression becomes important for economical and efficient operation in increasing

traffic. Since at least 50% of a typical telephone conversation contains gaps and pauses, speech interpolation techniques can be used to sample conversations so that only the actual voice content is sent.

SPEC not only samples, it predicts. By its sampling techniques, the system deletes the gaps and also figures out what predictable parts of the conversation it needn't transmit. Thus, a transmitter-based SPEC gates out predictable samples and sends only the unpredictable ones, appropriately encoded. A receiver-based SPEC reconstructs the conversation, using the encoded tags with the unpredictable samples and what it remembers as the most recent sample transmitted through each channel. SPEC's high voice quality comes from its high sampling speed: 8,000 times per second. Thus, it reorganizes itself quickly. The system doesn't clip speech because it operates at high speed and is able to

reconstruct all samples at the receiver. A key part on the receiver end is an eight-bit "zero-order hold" memory that plays back what's stored if it doesn't get a new sample. The receiver also distributes the transmitted samples among 64 channels.

Actually, SPEC may exceed a two-to-one compression rate because only 26% to 28% of its samples are actually transmitted. □

Commercial electronics

TI 'dis-integrates' thermal printers

At first glance it's a step backward in the design of thermal printheads: Texas Instruments has removed the driver circuitry from the print chip. But that's not the case at all. In the

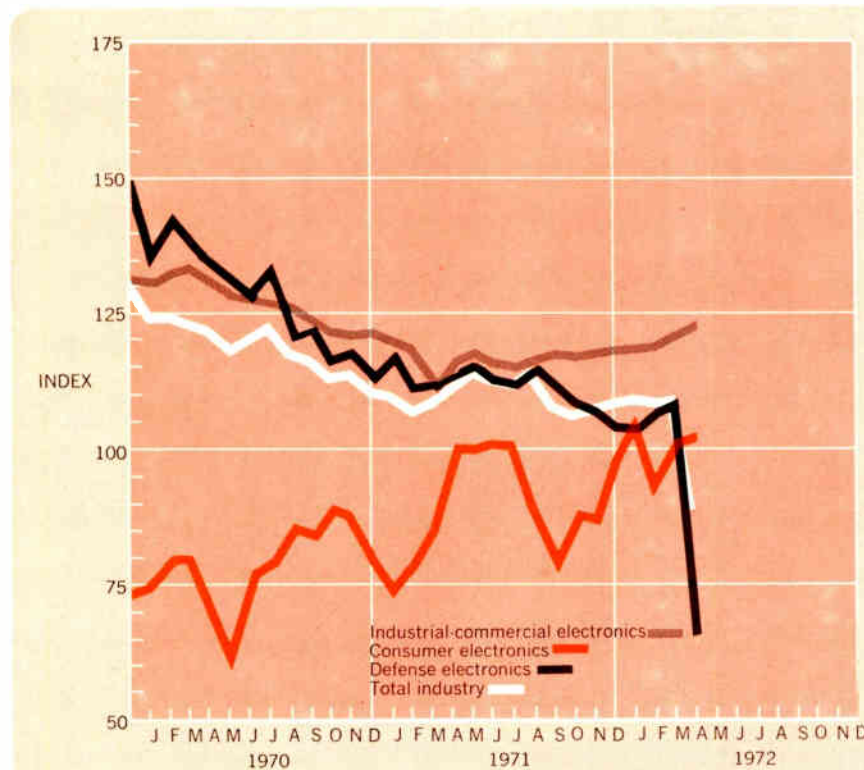

Electronics Index of Activity

June 5, 1972

The largest one-month decline in more than a year—18.6%—left the April index 21% below its April 1971 result. The prime cause of the drop was defense electronics. It was down 37.5% in April, leaving it 42.5% behind the comparable month last year.

The other two sectors increased modestly. Consumer rose 1.2% to a level 2.2% ahead of its year-ago figure, and industrial-commercial was up 1.4%, a healthy 4.9% advance over April 1971.

Segment of Industry	April '72	March '72*	April '71
Consumer electronics	102.9	101.7	100.7
Defense electronics	65.2	104.3	113.3
Industrial-commercial electronics	123.6	121.9	117.8
Total industry	88.8	109.1	112.3

Indexes chart pace of production volume for total industry and each segment. The base period, equal to 100, is the average of 1965 monthly output for each of the three parts of the industry. Index numbers are expressed as a percentage of the base period. Data is seasonally adjusted.  
\*Revised.



# TEKTRONIX® 7900 FAMILY

## 1 GHz Direct-Access Oscilloscope

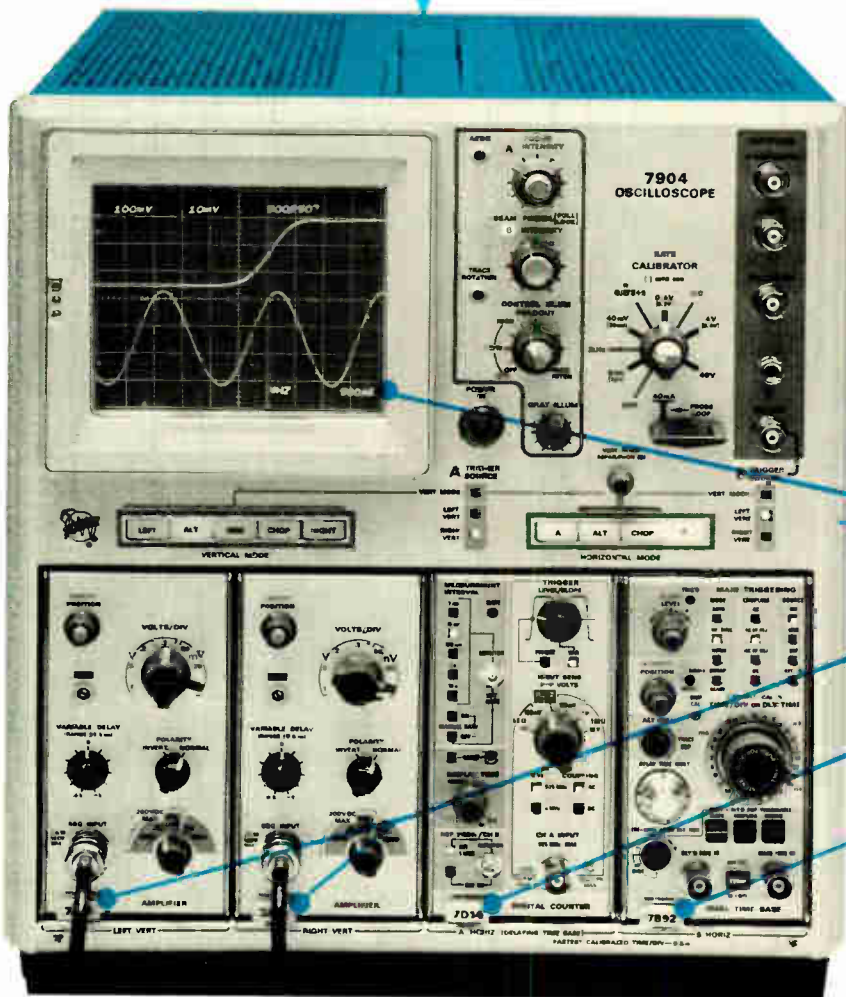

OR...

## 500 MHz real-time Oscilloscope System

- 8 x 10 cm display CRT READOUT
- 8 cm/ns writing speed
- 7A19 Amplifier 500 MHz @ 10 mV/div
- 7D14 Digital Counter 525 MHz direct counting
- 7B92 Dual Time Base 500 ps/div

OR...

choose from 24 compatible 7000-Series plug-ins for virtually any measurement

### TEKTRONIX 7904

featuring extended performance or general purpose use, from one mainframe and a family of plug-ins.

#### Extended Performance — 20 kHz to 1 GHz

Plug in the 7A21N and install a simple vertical amplifier bypass to directly access the CRT. The bandwidth — 1 GHz and risetime — 350 ps. Less than 4 V/div driving signal required — single ended or differential. Sorry — no CRT READOUT — vertical amplifier bypassed.

#### General Purpose — DC to 500 MHz

Plug in the 7A19 — 500 MHz bandwidth at 10 mV/div, 7B92 — delaying sweep rates to 500 ps/div, 7D14 — direct counting to 525 MHz. As your applications and measurement requirements change, choose from 24 plug-ins for: • sampling • TDR • spectrum analysis • curve tracing • digital multimeter • etc., etc. TEKTRONIX 7904 . . . A product of technical excellence.

For further information or a demonstration call your nearby TEKTRONIX Field Engineer or write: Tektronix, Inc., P.O. Box 500, Beaverton, Oregon 97005.

7904 Oscilloscope . . . . .	\$2900
7904 Oscilloscope, without readout	\$2500
7A19 Amplifier . . . . .	\$500
7A19 Amplifier, with variable delay	\$700
7D14 Digital Counter . . . . .	\$1400
7B92 Dual Time Base . . . . .	\$1400
7A21N Direct Access . . . . .	\$350

U.S. Sales Prices FOB Beaverton, Oregon

## Will ICs ever sell for a penny per active device? Riley says 'Yes'

IC prices in 1985 will drop to 42 cents a package—less than a penny per active device—from a current level of 54 cents, as new applications expand and U.S. domestic volume climbs to 3.2 billion units from today's 500 million. This is the judgment of James F. Riley, president of Intersil Inc., the Cupertino, Calif., semiconductor maker. Riley also forecasts increases in consumer and industrial market shares in the period to offset a declining Government share.

Growth markets of the next 13 years, in Riley's view, will be automotive, home entertainment, horologic, EDP, industrial process control, medical—" and markets A, B, and C." "I don't know what markets A, B, and C are yet," he adds, but "as the cost per device goes to one-half cent, fantastic markets will open."

The Intersil executive's vision of the future includes a semiconductor industry that "should have two firms with 50% or more of the market—who will be responsible industry leaders—so that better price stability

will ensue." Riley believes price stability an essential ingredient "so that profits will be generated to finance the necessary technical development" to maintain U.S. leadership in increasingly competitive world markets. He advanced the concept before the concluding session of "Electronics 1985," the Electronic Industries Association's mid-May management planning conference at Chicago (see p. 73).

In 1972, said Riley, "the IC industry will represent a free world market of \$752 million; consumption will be \$452 domestically, \$79 million in Japan, \$203 million in Europe, \$2 million in South America and \$15.7 million in the rest of the world." By 1985, he predicted, distribution will climb to \$1.51 billion domestically, \$340 million in Japan, \$670 million in Europe, \$20 million in South America, and \$40 million for the rest of the world.

Among a dozen other guideposts listed at the meeting for EIA's membership "from the perspective of a small company," Riley called for more intensive work with the U.S.

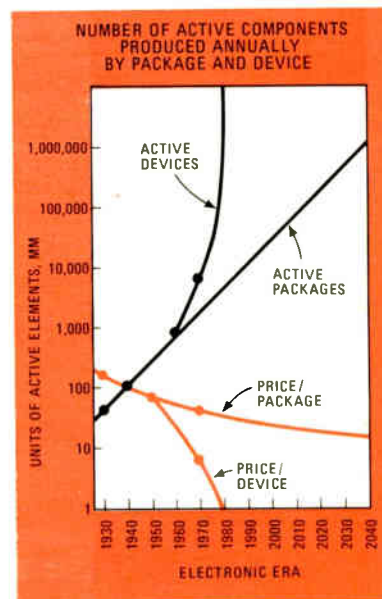

Government to "exploit foreign markets and strengthen industry's position." And he urged other U.S. manufacturers to stop bemoaning foreign competition from Japan and Europe. □

estimation of Ken Horton, an optoelectronics marketing manager, the new design increases mean time before failure about fifty-fold—to a printhead lifetime of some 50 million printed characters.

The longer lifetime is due partly to proprietary processing changes in the manufacture of the chip, Horton admits. However, he points out that splitting the logic away not only makes for a more efficient printhead, but also for more stable drive circuitry. "The logic can now be processed with the rest of our ICs, reducing costs, increasing yields, and possibly increasing the lifetime of the system."

There are two new heads: a matrix of seven rows by five columns and one that's five by four, each with ceramic substrate and heat sink and attached to a three-foot flexible cable that terminates in a printed-

circuit card. Electrical contacts on the back of the silicon print chip are connected to the metalized back of the ceramic through slots in the ceramic support. The printers, available now in production quantities, can be purchased with or without the associated decoder driver dual in-line packages.

**Obstacle.** "The only thing right now limiting the development of the thermal printhead is the tradition and history of the impact printer," says Horton. Because of the printers' silent operation and reliability, much of today's design-in of thermal printers is for military products; Horton estimates that there currently exists a multimillion-dollar market. As industry discovers the product's reliability and low power requirements, it will begin using thermal printers in portable equipment such as data terminals and

telecopiers, Horton predicts. "With the number of designs we have in development now, and the number of interfaces we have, there's no way to go but up."

The seven-by-five-dot matrix, designated EPN-2200, or 2201 with drive circuitry, is selectively energized for complete alphanumeric print capability on thermographic paper. Six watts per pulse simultaneously energize matrix elements for a maximum speed of 30 characters per second. In 100-piece quantities, the 2200 is \$72.50; it's \$80 with the five SN-21111N drivers, a seven-channel buffer amplifier designed for interfacing between an MOS character generator and the 2200.

The EPN-2300, a five-by-four-dot matrix configuration, identical with TI's earlier EPN-2100, but with logic separated from the printer chip, is

# In Answer To Your Gripes About Every Other Portable Recorder

The no jazz CPR 4010. A 7 speed, 1/2" or 1" tape, 10 1/2" reel portable recorder/reproducer.

## Old Clichés Revisited

What's so great about it? Mainly, it's the easiest machine around to use, maintain and service. (We know you've heard that before, but bear with us for a minute.)

## Operation

We've got a single knob for transport speed and electronics equalization. Automatic. Other transport functions are push-button controlled including our proprietary AUTOLOAD automatic, mistake proof tape loader that works precisely. Every time. All the electronics are in one housing. Even monitor meters, voice logger, 7 speed servo card, and all 14 record and reproduce modules. It's easy to add options because it's pre-wired. All you do is plug in.

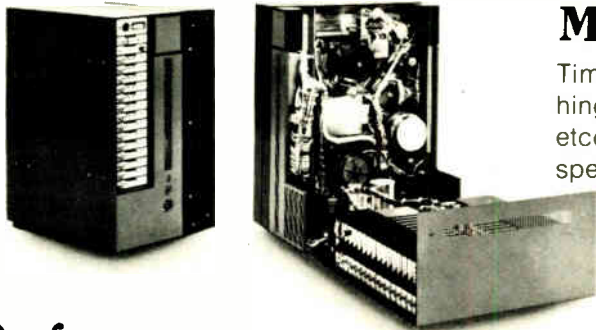
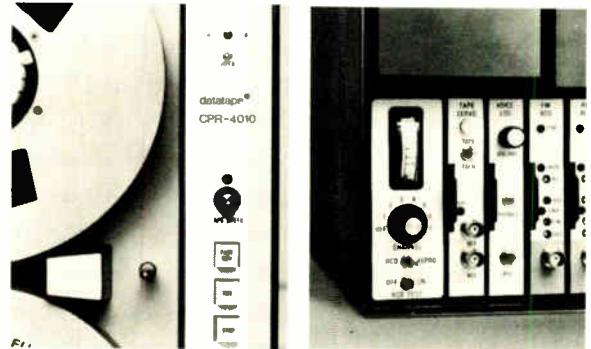

## Maintenance and Servicing

Time for the annual P.M.? It's no big deal. The back panel's hinged. Just flip it down. All motors, power supplies, electronics, etcetera, are right there. (It even runs in this position.) Nothing special needed. How's that for simplicity?

## Performance

Briefly, from the top: 7 speed transport, 15/16 to 60 ips; 7 speed direct, all automatically switched, 300 kHz at 60 ips; 7 speed FM record; 40/20 kHz, automatically switched. Any 2 speeds of FM reproduce; low tape flutter and TBE; isolation from reel perturbation via dual capstans and tension sensors. Low mass, closed loop IRIG servo system. The same electronics design as our top-of-the-line VR-3700B.

## Bell & Howell & the CPR 4010

Get all the specs. Just ask Bell & Howell, CEC/Instruments Division, 360 Sierra Madre Villa, Pasadena, California 91109.

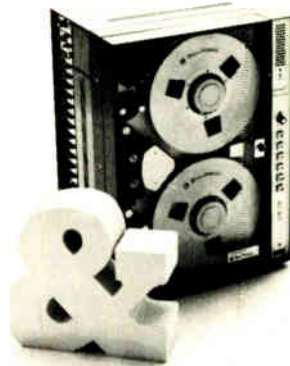

CEC/INSTRUMENTS DIVISION

 **BELL & HOWELL**

Electronics/June 5, 1972

©Copyright 1971 Bell & Howell

Circle 47 on reader service card 47

energized row by row for an average power/pulse of 1.4 watts and a maximum speed of 10 characters a second. In 100-piece quantities, it sells for \$19.50, or \$22 with an SN-21485N row driver and an SN-21484N column driver. Both print-heads incorporate a temperature-sensing diode for regulating the power supply to compensate for temperature variations of the chip.

Slated for introduction later this year are a 25-column-by-one-row line printer with a maximum speed of 300-character lines per minute, now being used by TI's equipment group on a high-speed printer designed for the Air Force, and a four-digit, seven-segment package with a 300-line-per-minute numeric print capability. Early next year, TI hopes to add a five-by-five low-power, row-strobed, device that prints 12 characters a second, and a five-by-five simultaneous printer that does 30 characters. □

## Nonimpact printer is electromagnetic

A new approach to nonimpact printing is being developed by a small new firm in Danbury, Conn. It's an electromagnetic printer, analogous to the ubiquitous Xerox machine, which prints electrostatically; its advantage is small size, low cost, and simple design. Its maker, Data Interface Corp., expects to be in production late this summer and plans to ship the first units to customers in the fall.

**Terminal.** The printer is actually a data communications terminal, rather than a copier. It translates data received on a telephone line into a pattern of dots that it records on a loop of conventional magnetic tape 1/2-inch wide and a couple of feet long; the recording head is identical to that used in large magnetic tape storage units except for the number of tracks—12—for characters printed in a 10-by-12 dot matrix. The recorded dots attract particles of a magnetic toner, which adheres to the tape in the pattern of

## Thermal isolation

Looking more for thermal, rather than electrical, isolation, Displaytek Corp. of Dallas has successfully adapted the Bell Labs air-isolated beam lead process in the fabrication of its thermal printers. The first of a series of patents assigned to the firm is issuing now, says Ed Ruggiero, president.

Displaytek's standard line now includes a five-by-seven dot matrix, and several configurations using four-digit, seven-segment chips and a Displaytek-designed function indicator. The devices are unlike the new TI chips in having the drive amps integrated.

The five-by-seven dot matrix is on a 150-by-150-mil chip that incorporates more than 200 electrical components—and 39 beam leads on 10-mil centers—on three sides of the chip. The four-digit, seven-segment chip could be the largest monolithic silicon, beam-leaded chip made—175 by 460 mils, Ruggiero says. Both have temperature compensation built in to maintain density, so Displaytek does not use metal heat sinks.

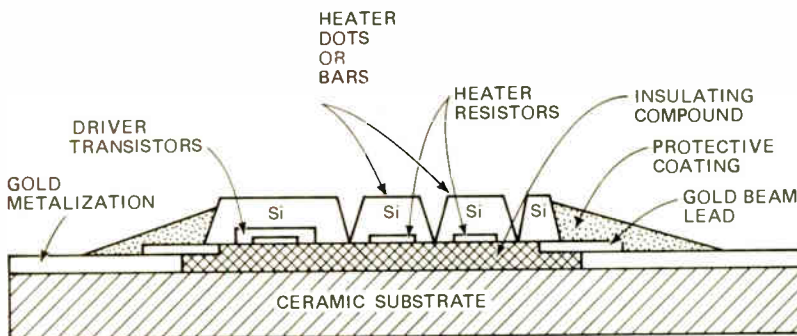

Chip. Displaytek thermal print chip doesn't use metal heat sinks.

the characters to be printed.

After a full line of data has been recorded and has picked up the toner, and when the first character on the tape is aligned with the left margin on the paper, the tape stops, and the paper is pressed gently against it, transferring the toner from the tape to the paper. The paper then moves up to accept the next line of characters, and the tape moves past an erase head where a scraper then removes any remaining traces of toner. These fall into a conveyor mechanism that returns them to the main toner bin near the recording head. As the paper moves upward, the printed line passes over a heater that fuses the toner and creates a permanent image, much like an electrostatic printer.

This idea of magnetic printing, according to M.A. Lowy, manager of market development at Data Interface, is quite old. "It goes back perhaps 100 years," he says, "but everyone who's tried it up to now

has run into serious technical difficulties—for example, a tendency for a persistent background tint to appear on the paper. We've licked the background problem, and we also have some other innovations."

At last month's Spring Joint Computer Conference in Atlantic City, the company showed a printer driven by a paper-tape reader, but said that it still needed several weeks to work out some bugs. □

## Computers

### Varian 73 joins semiconductor list

It has taken more than a year after IBM took the step, but the expected onrush of new computers sporting semiconductor memories is finally happening. And, significantly, the machines are all on the mini side—



the latest being the Varian Data Machines model 73.

The news that IBM had put its stamp of approval on semiconductor mainframe memories with the 370/145 [*Electronics*, Oct. 12, 1970, p. 125] brought predictions that 1971 would be the year that such memories would really arrive. That wasn't quite the case, and 1972 now appears to mark the dawn of the new era. Besides Varian's, other newly announced machines including the Burroughs 4700 and its soon-to-be-announced family, and the Digital Computer Corp. D-112H/SC also have semiconductor memories.

As for the Model 73, it's a highly expandable asynchronous computer that barely squeezes into the mini-computer classification. It features microprogramming accessible to the user and separate from the main memory, memory capability up to 262,000 words, data transfer rates up to three megawords per second, and a price tag of \$15,000 to \$100,000.

The 16-bit computer, says J.J. Orris, director of product management at the Irvine, Calif., company, can operate with all software and peripherals developed for Varian's 620 minicomputer. It's competitive with the Digital Equipment Corp., PDP-11/45, says Orris, but is priced about 10% lower. The 73 is not aimed at the DEM market, but at

### All in the family

Burroughs Corp. is about to announce "a new family of small-scale data processing systems" that will compete with machines like IBM's System 3 and System 360 model 20. They are said to be advanced for their size with microprogramed control, sophisticated operating systems, and at least one semiconductor memory.

The new machines will be the bottom end of the 700 line, which was announced with the introduction of the large-scale 5700, 6700, and 7700 systems [*Electronics*, Oct. 12, 1970, p. 58].

end users, including some who may now be using much larger and more expensive equipment.

All the memory is dual-port, using buses capable of handling up to 3 million words per second. For high speed, semiconductor memories operating at 330-nanosecond cycle times are available in increments of 1,024, 2,048, 4,096, and 8,192 words.

There are 16 general-purpose 16-bit registers, plus eight additional registers that can be microprogramed. The microprogramming uses wide, 64-bit words that specify diverse functions. A 512-word bipolar RAM emulates the 620 computer in 165 ns while writable increments of 512 words of 64 bits each allow users' algorithms to be executed at a 190-ns cycle time. The writable memory is separate from the main MOS or core storage. Delivery is to begin in September. □

### Lasers

## NASA blazes surveyor's trail

The U.S. Forest Service has a lot of rugged land to survey, but normal transit-and-rod methods take too much time and aren't accurate enough. So three years ago the service asked NASA to design a laser land-surveying system that could be back-packed into the forests. Now NASA has awarded RCA's Aerospace Systems division, Burlington, Mass., a \$175,000 contract to build a test unit.

The system could revolutionize surveying. Many contractors have asked NASA where they might get one, reports Louis O. Caudill of the Laser Experiments Office at NASA's Goddard Space Flight Center, and other Government agencies that have to survey land have expressed interest. The Forest Service alone could use 200 units, he says, and the Navy and Army also have shown interest in the device to lay in artillery pieces.

Confirming Caudill's impression,

reasons why  
you should  
be using

## SOLITRON P-CHANNEL FETS

- High Transductance • Low Capacitance
- Low Resistance • Low Leakage • Low Noise
- Fast Switching • High Quality
- High Reliability • Low, Low Prices

The most complete line of P-Channel FETS available. Included are:

2N2386	2N2843	2N5398
2N2497	2N2844	UC301S
2N2498	2N3329	UC400
2N2499	2N3330	UC401
2N2500	2N3331	UC420
2N2607	2N3332	UC451
2N2608	2N3376	UC452
2N2609	2N5114	UC803
2N2842	2N5115	UC805
2N2842	2N5116	UC807

Call your nearest SOLITRON representative listed below by state and telephone area code:

<b>EAST</b>	(214) 357-4576
Florida, Orlando	Houston
Hallmark Electronics	Component Spec.
(305) 855-4020	(713) 772-5127
Maryland, Baltimore	<b>WEST</b>
Radio Electric Service	Arizona, Phoenix
(301) 823-0070	Kierulff (602) 273-7331
Savage	California, Culver City
Pytronics, Inc.	Avnet (213) 836-7200
(301) 792-7000	JSH Elec. (213) 837-0177
Massachusetts, Boston	Los Angeles
DeMambo Electronics	Kierulff (213) 685-5511
(617) 787-1200	Menlo Park
Needham Heights	Bell (415) 323-9431
Kierulff/Schley	San Carlos
(617) 449-3600	Intermark Electronics
New York, Binghamton	(415) 592-1641
Federal (607) 748-8211	San Diego
Hauppauge	Intermark Electronics
Semiconductor Concepts	(714) 279-5200
(516) 273-1234	Kierulff (714) 278-2112
Hicksville	Santa Ana
Kierulff/FJR	Intermark Electronics
(516) 433-5530	(714) 540-1322
Pennsylvania, Tevose	Van Nuys
Hallmark (215) 355-7300	Intermark Electronics
<b>MIDWEST</b>	(213) 782-0362
Colorado, Denver	Washington, Bellevue
Intermark Electronics	Farwest (206) 747-1515
(303) 936-8284	Seattle
Kierulff (303) 343-7090	Intermark Electronics
Illinois, Elk Grove Village	(206) 767-3160
Lakeland (312) 595-1000	Kierulff (206) 763-1550
Ohio, Dayton	<b>CANADA</b>
Kierulff (513) 278-9411	Quebec, Montreal
Kettering	Preico Electronics, Ltd.
Arrow (513) 253-9176	(514) 389-8051
Texas, Dallas	
Component Spec.	

**Soliton** DEVICES, INC.

Give us a quick call today, and test our productivity. We also excel in CMOS, PMOS, LIC's, and Custom Circuits. Soliton Devices, Inc., P.O. Box 23157, San Diego, California 92123. Telephone (714) 278-8780 TWX 910-335-1221

# SCIENCE/SCOPE

NASA's Earth Resources Technology Satellite, scheduled for launch this summer, will carry an experimental multispectral scanner developed by Hughes. The scanner's single optical system will record signal data in four separate bands of the electromagnetic spectrum and convert the light emissions into photo-like images. The resulting "signatures" of the solar energy emitted by agricultural crops, forests, and rivers will indicate their environmental health. The scanner will "see" a swath 100 nautical miles wide during each polar orbit over the U.S.

NADGE is the first major real-time air defense system to be implemented with a high-level compiler language (JOVIAL) using two Hughes-built processors in a multi-processing mode. Hughes developed software programming for the 37 computer sites in the NADGE (for NATO Air Defense Ground Environment) system around common modules that can be adapted to solve problems peculiar to the various locations. Eighteen of the computer sites have been tested and accepted without any delay due to software programming problems. The entire NADGE system is scheduled for completion by the end of the year, except for some site work in Greece.

The first long-life hydrazine thruster systems, which Hughes developed for NASA's ATS-4 and 5 satellites, have proved superior to the conventional hydrogen peroxide thruster for making the radial and axial corrections that keep a synchronous satellite on its precise orbital station. The hydrazine thruster is safer, more reliable, longer lived, easier to restart in space, and less costly. Two new hydrazine engines, in 1- and 5-lb. thrust, are now available. Hughes is using the 1-lb. thruster on Canada's Anik 1 domestic communications satellite.

The U.S. Navy's AWG-9 weapon-control system which launches the Phoenix missile, both built by Hughes for the F-14 fighter, has a "look down" capability that enables it to pick out moving targets from the ground clutter that normally obscures conventional radar signals. A Phoenix missile demonstrated its ability to combat the anti-ship missile threat when it was launched from a test platform at 10,000 feet and hit a cruise-missile target flying at 800 feet, while another launched from 29,000 feet "killed" two targets flying close together at 10,000 feet. The AWG-9 can also launch the F-14's Sparrow and Sidewinder missiles and direct the firing of its M-61 Vulcan 20mm cannon.

Hughes needs software/programmer specialists with experience in software systems, real time applications, and technical data management systems. Also: business programmer/analysts with IBM 370/165 OS/MVT/ASP experience. U.S. citizenship required. Please write: Mr. R. S. Roth, Hughes Aircraft Company, P.O. Box 3310, Fullerton, CA 92634. An equal opportunity M/F employer.

New products from Hughes include a low-cost one-watt CW argon laser featuring the same sealed, cylindrical head as Hughes' "Hip Pocket" helium-neon lasers; the power supply is air cooled, permitting a compact 7x16x19-inch design for standard rack mounting . . . and a miniaturized scan converter designed for video data processing in a wide range of information display applications; it offers high speed and high resolution, as well as selective erasure and rewriting capability.



## Electronics review

Earl E. Corey, RCA project engineer, expresses surprise at the response: "The system has stimulated a lot of interest all over the world. There have been a lot of inquiries." Depending upon production quantities, commercial systems would cost \$10,000 to \$20,000, he estimates.

Essentially, the system replaces the surveyor's rod and transit with a vertical-firing laser beam and modified theodolite, a precision transit with telescope receiver that tells the viewer whether he is right, left, or on dead center when sighting the vertical laser beam. "The crosshairs in the scope give true bearing at each corner of the section" being surveyed, Caudill says. Also, "you can shoot over various obstacles."

Caudill says the system is designed to give 10 miles of surveying—more than a day's work—before the batteries have to be recharged, assuming it will take 20 laser firings to establish the initial azimuth bearing. Another plus that the Forest Service likes is that the system will reduce the usual four-man crews to three members, he says.

The system also is expandable from its present one-mile range to a two-mile range and could be reconfigured to give correct elevation as well, Caudill says. By firing the laser once vertically and then again at a 5° angle, a surveyor could derive altitude relative to his position through a special optical reference with simple trigonometric calculations, he explains. System accuracy would be within an acceptable few feet. □

## Meetings

### Semicon finds right audience

With Semicon II late last month at the San Mateo, Calif., Fairgrounds, Semiconductor Equipment and Materials Institute Inc. (SEMI) proved its point—exhibitors will spend money on shows only when they can be guaranteed quality traffic

through the booths. SEMI was started a little over a year and a half ago by William B. Hugle, president of Hugle International, and Frederick W. Kulicke, president of Kulicke & Soffa Industries, because many in the semiconductor equipment supply industry felt they were getting second-rate treatment at the IEEE and Wescon shows, and weren't reaching customers.

Donald C. Sutherland, a director of SEMI and marketing director of the Electronics division of the du Pont Co., complains, "At shows like the IEEE (1968 was the last year du Pont exhibited there), out of every 100 people passing through the booth, only one was of interest to us; at Nepcon, the number was better, but it was still about one out of 10. But at Semicon it's one out of two."

Last year, first for the show, about 3,500 engineers and support personnel went through the 120 exhibits; this year, over 6,000. This year, says Philip L. Gregory, SEMI vice president, "We sold out. In future shows we'll provide more booth space." The original concept for Semicon was to make it a regional show; there are plans for a Semicon in Boston, Nov. 28-30. □

## Automotive electronics

### RCA crash radar uses reflector

RCA has added its muscle to the race toward a radar collision-avoidance system for automobiles. The RCA system, unlike the Bendix Corp.'s [*Electronics*, Jan. 17, p. 54], uses a passive receiving reradiating reflector.

The radar is mounted on the auto's front end and the reflector on the rear. The device, 17 by 8 by 2.5 inches, transmits a signal of 9 gigahertz; when that signal strikes the reflector on the car ahead, it is bounced back as the second harmonic at 18 GHz. If the car gets too close an alarm is sounded.

Because the receiver accepts sig-

# Hughes is in industrial electronics, too: components, equipment and systems.



Bipolar and hybrid circuits (RS 221)



Microcircuit production equipment (RS 232)



Flat flexible cable and circuit assemblies (RS 224)

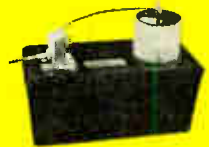

Thermal energy transfer devices (RS 237)

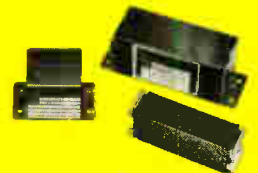

Frequency control devices (RS 227)



Numerical control systems (RS 233)

For complete information, write Bldg. 16H, Mail Station C 512, Culver City, CA 90230. Or request by Reader Service (RS) numbers.

# HUGHES

HUGHES AIRCRAFT COMPANY

## Industrial Electronic Products

# The Elegant Amplifiers



Incredibly small thick-film amps. For elegant audio and servo applications. At 15 watts, flat through 20 kHz. Through 100 kHz at 30 and up to 150 watts. Compatible with most pre-amps, they drive 3- to 8-ohm loads, use a 26-v. split/or single-ended supply. In lots of 100:

15 w. — \$ 9.05 each

30 w. — 29.00 each

Precise amplification from precise craftsmanship. Delivered economically through computer-aided design. That's the type of performance you'll find in all components by EAI. Capacitors. Active filters. Analog/digital converters plus other special function modules. Custom coils. Solenoids. Transformer kits. Molded plastic parts. And a growing list of other elegantly crafted etceteras. For details, write or call.



Electronic Associates, Inc.  
193 Monmouth Parkway  
West Long Branch, New Jersey 07764  
Tel. (201) 229-1100

nals only in the second harmonic, and has a beam width of less than 5°, it is unaffected by the radar of passing vehicles. And since the reflected signal strength is the same for all targets, the signal from a Mack truck won't swamp that of a Volkswagen, thereby eliminating false targets. Moreover, microwave data-processing circuits provide the signals, which are displayed as distance on a dashboard meter. If the car is approaching the auto ahead too fast, a blinking light and buzzer are set off. RCA engineers say they expect eventually to feed the signals into automatic equipment so that cars will be able to brake automatically.

The Bendix doppler system offers automatic control of acceleration, throttle setting, and braking, but the driver cuts off the system when he or she hits the brake. In addition, Bendix has been working with two frequencies, 16 and 36 GHz with an antenna beamwidth of 3° to 4°. The closed-loop continuous-wave system uses a Gunn oscillator and has a range cutoff of 300 feet.

RCA says the first applications probably will be for military truck convoys, but eventually reflectors could be put on dead-end barriers, wrong-way entrances, and other road hazards. In five years or so, RCA says, mass production could reduce the cost to \$50 to \$100. □

## For the record

**Surplus cut.** Sharp increases in telephone and consumer electronics imports from Japan were counterbalanced by heavy computer and test equipment exports in 1971, leaving the U.S. with a smaller but still positive electronics trade balance of \$724 million at year's end. The figure represents a decline of 35% from the \$1,114 million figure posted in 1970.

The U.S. posted its first deficit in history in telephone and telegraph equipment—\$18 million— as imports rose to \$79 million, on increases from Japan, while exports declined to \$61 million— down \$14 million from 1970. The telephone-

telegraph equipment category had a surplus of nearly \$21 million in 1970.

Japan, which now accounts for 58.9% of all U.S. electronics imports, also was cited by the U.S. as responsible for 65% of the record \$1,494 million in imports of radios, tape recorders, and television receivers. After deduction of \$173 million in U.S. exports, the trade deficit in consumer products totaled a record \$1,321 million.

**Joint technology.** . . . Computers and electronics technology are two key areas covered by the recently signed five-year cooperative treaty between the U.S. and Russia to share technological knowledge, says Presidential Science Adviser Edward E. David, who will head U.S. participation. He emphasizes that cooperation probably won't lead to production or use of computers, an area where the Russians lag.

**. . . and space treaties.** The first beneficiary of the U.S.-Soviet agreement to dock two earth orbital spacecraft will be North American Rockwell, which is expected to get an estimated \$50 million contract to build the common-docking module the manned craft will use.

**New lineup.** Significant in Texas Instruments' realignment of its organization chart is the creation of a new management level: J. Fred Bucy has been promoted to executive vice president with responsibility for TI's worldwide materials and components businesses. Other new executive vice presidents reporting directly to president Mark Shepherd Jr. are A. Ray McCord, equipment and services, and Ed O. Vetter, now chief financial officer for all corporate staff activities.

Group vice president of the newly named Semiconductor group is C. Morris Chang, former manager of the Semiconductor Circuits division of the old Components group. Underscoring TI's intention to go after the consumer products market is the creation of a new Solid State Products division, headed by Jay R. Reese. □

Give our CHIP capacitor customers something to cheer about.

DIP,  
CHIP,  
ARRAY

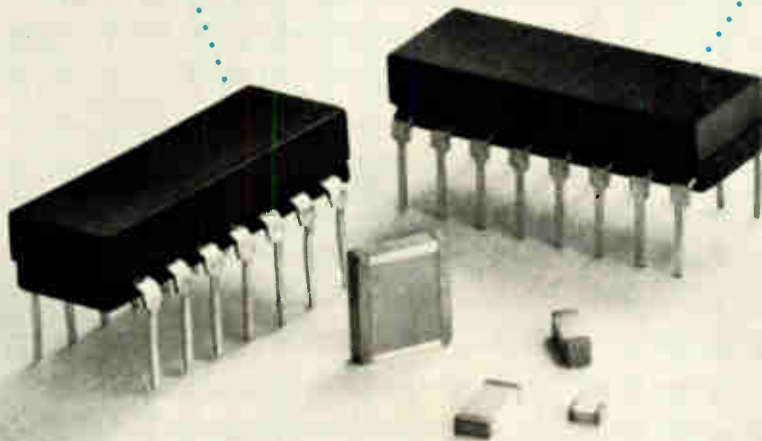

And you'll cheer too, when you learn how inexpensively you can have custom designed chip arrays to meet your specific application requirements. AVX can provide prototype quantities for your evaluation using standard chips mounted in preformed packages.

Or, for production quantities, we can fabricate the entire capacitor array as a single monolithic structure with multiple lead connections to the lead frame giving you higher component density and greater reliability at low, low cost. In addition, we offer interconnect, crossover, resistance network capabilities, both thick film and thin film.

Looking for reliable assistance in designing your multiple capacitor arrays? Cheer up, call or write Aerovox today for answers that will put a smile on your face and save you money in the bargain.

STANDARD DISCRETES AVAILABLE AS FOLLOWS:

AVX TYPE EIA STYLE	L	W	T	CAP. RANGE IN PF - 50 VDC TEMP. CHAR.			
				NPO	X7F	X7R	Z5U
ULA-11	.085	.060	.050	120 to 560	820 to 2,200	5,600 to 15,000	10,000 to 47,000
0805	.065	.040	.020				
ULA-70	.180	.070	.060	330 to 1,800	2,700 to 6,800	18,000 to 47,000	22,000 to .15 $\mu$ f
1805	.160	.050	.020				
ULA-78	.190	.090	.060	560 to 3,900	4,700 to 15,000	33,000 to .10 $\mu$ f	47,000 to .27 $\mu$ f
1808	.170	.070	.020				
ULA-60	.230	.255	.060	2,700 to 15,000	22,000 to 56,000	.15 $\mu$ f to .47 $\mu$ f	.47 $\mu$ f to 1.5 $\mu$ f
2225	.210	.235	.020				

**AVX** Aerovox®

AEROVOX CORPORATION, NEW BEDFORD, MASSACHUSETTS 02741 • TEL. 617-994-9661  
PLANTS IN: NEW BEDFORD, MA., OLEAN & FRANKLINVILLE, N.Y., MYRTLE BEACH, S.C. AND HAMILTON, ONT., CANADA

# These new additions,

## Duals 5 & 10A PNPs 20A NPNs...

New Dual 10A NPN Power Darlingtons give you twice as much in a single package. And double the space efficiency. They're ideal for full wave bridge applications such as stepper motor drivers and converters and desirable as print hammer, servo, relay and lamp drivers, and linear amplifiers. They provide inherently higher reliability through the use of monolithic planar Darlingtion chips.

The completely new PNP line beginning with 5A and 10A devices and the 20A NPN additions provide design advantages through unsurpassed performance in saturation voltage, current gain, compact packaging and voltage ratings. It adds up. We'll continue to give you more in Darlingtons because our capabilities are still growing.

For complete specifications and prices, call Sales Engineering collect at (617) 926-0404 Unitrode Corporation, Dept. 6Y, 580 Pleasant Street, Watertown, Mass. 02172



### C-LINE DUAL DARLINGTONS

Type	P <sub>D</sub> W	V <sub>CEO</sub> V	h <sub>FE</sub>	V <sub>CE (sat)</sub> V	t <sub>on</sub> μs	t <sub>off</sub> μs	Package	Price (100- 999)
PIC500	30	100	2000	1.5	0.55	2.0	TO-3 (8-pin)	\$10.00
PIC501	20	100	1000	2.0	0.65	3.6		6.50
PIC502	20	80	750	2.0	0.65	3.6		4.90

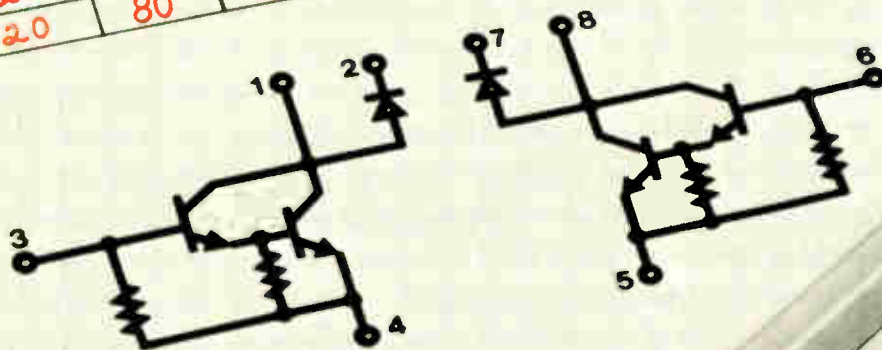

# C-LINE POWER DARLINGTONS

add to our unequalled  
Darlington capability.

**C-LINE POWER DARLINGTONS**

Peak I <sub>c</sub> A	Type	Package	V <sub>CE</sub> V	h <sub>FE</sub>	V <sub>CE</sub> (sat) V	I <sub>on</sub> ns	Price (100- 999)	
5	NPN	U2T301 TO-33	60	1000	1.5	300	\$1.25	
		U2T401 TO-66		@ 2A	@ 2A	1.50		
		U2T305 TO-33	150	1000	2.5	400	1.80	
		U2T405 TO-66		@ 2A	@ 2A	2.10		
		U2T101 TO-33	80	2000	1.5	400	2.25	
		U2T201 TO-66		@ 5A	@ 5A	2.55		
		U2T105 TO-33	150	1000	2.5	500	2.85	
		U2T205 TO-66		@ 5A	@ 5A	3.15		
	20		U2T501 TO-66	80	2000	1.5	400	4.30
			U2T601 TO-3		@ 10A	@ 10A	4.30	
			U2T505 TO-66	150	1000	2.5	500	5.40
			U2T605 TO-3		@ 10A	@ 10A	5.40	
		U2T351 TO-33	60	1000	2.0	250	1.50	
		U2T451 TO-66		@ 2A	@ 2A	1.80		
5		U2T355 TO-33	120	1000	2.5	300	2.16	
		U2T455 TO-66		@ 2A	@ 2A	2.52		
		U2T151 TO-33	80	2000	2.5	300	2.70	
		U2T251 TO-66		@ 5A	@ 5A	3.06		
10	PNP	U2T155 TO-33	80	2000	2.5	300	3.44	
		U2T255 TO-66		@ 5A	@ 5A	3.78		

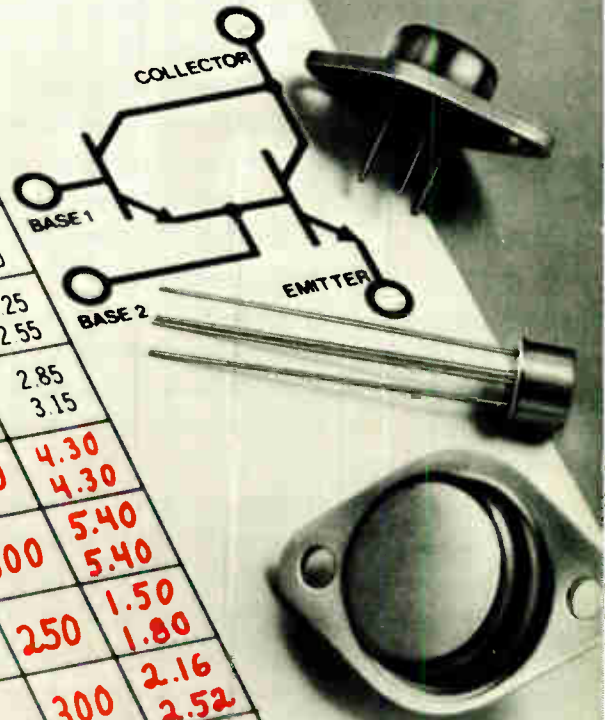

**UNITRODE**

quality takes the worry out of paying less.

Circle 55 on reader service card

# Socket-Sized Plastic Triacs:

## SMALL



0.45, 0.65 & 0.8 A RMS Triacs  
MAC92, 93, 94

— For 2 or 4 mode use in solid-state relays, T<sup>2</sup>L logic and light industrial applications

## MEDIUM

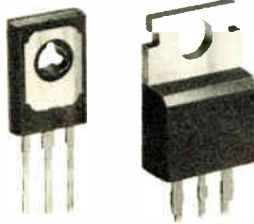

2N6068-72, 2N6342-49  
4 & 8 A RMS Triacs

— For full-wave ac control in light dimmers, motor and heating controls and power supplies

## LARGE

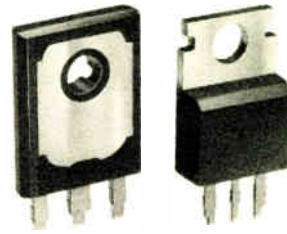

2N6151-56, 2N6342A-49A  
10 & 12 A RMS Triacs

— For demanding, higher voltage designs where up to 800 V, 9600 W full-wave control is required.

A line of low-cost plastic Triacs job-rated to fit virtually any full-wave control socket has been hard to find . . . up till now.

Now you can design in the exact Triac you need to do the job you want to do in your stepless ac control system without upgrading, downgrading, over- or under-buying. From one source.

The new MAC92/93/94 series Unibloc\* Triacs are unique — in package, performance and price. They offer less-than-1 A current capability in 30 to 400 volt blocking voltage ranges. The compact, one-piece, injection-molded case — pioneered by Motorola for volume production of small signal transistors — is ideal for automatic insertion techniques. They furnish low, 100  $\mu$ A leakage currents for minimum power drain, 4 quadrant firing (ideal for driving directly off T<sup>2</sup>L) and cost as little as 50¢, 100-up.

Two styles of medium-sized packaging are yours to choose from in the 4 to 8 A range: the new Thermowatt\* TO-220AB for direct replacement of existing types in 8 A sockets and the 4 A Thermopad\* units providing 25 to 600 V muscle in the 1,000 W control area.

And Thermowatts now handle 12 A! That's unique. And Motorola did it first. The 2N6342A-49A series 220AB types provide top power handling in this broadest plastic Triac family . . . up to 9,600 W. Still small and rugged, these new types offer low thermal resistance and high heat dissipation and durability for rugged control applications.

## Extra reliability on all...

Now you get the built-in reliability and long-term stability of glassivation on all Motorola plastic Triacs from 4 to 12 A and thermally-grown, oxide-passivation on the Unibloc types. Whichever you choose, you'll have sealed, uncontaminated junctions, higher blocking voltages and increased savings.

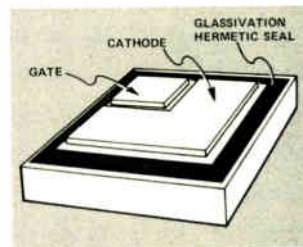

Triac Series	Plastic Package	I <sub>T</sub> (RMS) A	V <sub>BRM</sub> Range V	I <sub>TSM</sub> (SURGE) A	Price Range 100-Up
MAC92	Unibloc	0.45	30-400	6	50¢-95¢
MAC93	Unibloc	0.65	30-200	6	61¢-98¢
MAC94	Unibloc	0.8	30-200	6	67¢-\$1.05
2N6068	Thermopad Case 77	4	25-600	30	56¢- 2.10
2N6342	Thermowatt Case 220AB	8	200-800	100	95¢- 3.05
2N6151	Thermopad Case 90	10	200-600	100	1.15- 1.75
2N6342A	Thermowatt Case 220AB	12	200-800	120	1.10- 3.40

Write Box 20912, Phoenix, AZ 85036 for complete data. See your Motorola distributor or factory representative for prototype or production quantities. Size up our control capability today.

\*TRADEMARK OF MOTOROLA INC.



**MOTOROLA THYRISTORS**  
— 300 ways to get control



## Export council plans critique of U.S. policy

The communications segment of the National Export Expansion Council's forthcoming report to the Government on means of improving the U.S. trade position could prove embarrassing to the Department of Commerce. Industry leaders say the final draft of the NEEC report, scheduled for delivery by the industry council to the Government in October, strongly recommends enhancing the U.S. trade position abroad by such actions as permitting Western Electric Co. to export. At the same time the draft sharply criticizes the Federal Government's limited and inflexible financing arrangements in support of industry, as well as its excessive controls on exports of technology—a clear reference to Defense Department embargoes.

## Is Army weighing Mallard revival?

As the Army Electronics Command requests quotations for extended industry studies of its triservice tactical communications system known as Tri-Tac, communications equipment makers see two new developments evolving that could handicap the effort. For the short term, the new study awards, which are to be made by August, are expected to contain hardware exclusions that would preclude a contractor from participating in a later contract.

Looking farther ahead, sources believe the Army is contemplating a return to the original Mallard concept, which called for West European military allies to share the estimated \$20 billion cost of a post-1980 operating system and so make it acceptable to the Congress.

## Market for fingerprint I.D. systems to expand

Industry predicts a sizable market in automatic systems for fingerprint identification emerging from Federally funded development under the FBI's Project Search. KMS Industries Inc. is already turning out 15 fingerprint-activated security systems for the Air Force, and has four installed at the New York Federal Reserve Bank. The units, which substitute a print for a door key, cost \$7,500 each. On a much larger scale, McDonnell-Douglas Electronics Co. believes it can sell 350 fingerprint recognition systems to law enforcement agencies for \$250,000 each. It claims to have built the first prototype system that automatically matches a print with computerized files. Others developing systems include General Dynamics' Electro-Dynamics division, Cornell Aeronautical Lab, and North American Rockwell's Electronics group.

## Medical standards bill delayed; interim committee sought

Chances of Congress passing a medical devices standards bill this session or next are so dim that industry and standards association groups are pushing for interim measures: they're pressing the Food and Drug Administration to set up an advisory body to hammer out some preliminary agreements. Meanwhile, after a May conference the Association for the Advancement of Medical Instrumentation, the American National Standards Institute, and the American Society for Testing and Materials are seeking a national standards coordinating body.

## After you invent the future, who will engineer it?

"You don't forecast the future, you invent it."

Thus did Carl H. Madden splash cold water on what he believes is the invalidity of industrial forecasting by America's electronics industries. The criticism came as a slight shock to the participants in "Electronics 1985," the Electronic Industries Association's first coordinated attempt to peer into the future. "You can't find the future anymore by trend extrapolation," explained the U.S. Chamber of Commerce's chief economist. "Of course, you never could before, but we were all comfortable in our ignorance."

If Madden sounded like a contemporary Cassandra to his audience, his prophecy that industry persists in relying on 19th century institutions to anticipate 21st century problems came too late for the speakers who followed. Most proceeded, texts in hand, to push ahead with their projections of industry trends through 1985 (see p. 73).

### Part of the problem

After a day and a half of economic forecasts, interlarded with some introspection, industry management listened intently as J. Herbert Hollomon, director of MIT's new Center for Policy Alternatives, drew on the old law of supply and demand for the origin of today's problems in world competition.

From 1950 to 1967, he argued, the United States used an increasingly large percentage of its engineering supply to meet the sharply rising demand for defense and space systems. As a result, engineering costs soared and are now twice and three times what they are in Europe and Japan, respectively. Those costs—plus the diversion of technical resources from the private to the public sector of the economy—contributed significantly to driving many makers of components and consumer electronic products to offshore, low-cost labor markets. History is irreversible, of course, and today's engineering entrepreneurs can only hope to learn from it as they proceed to invent the future.

### What's in store

Their scenario of the future, however, is invariably premised on the view that U.S. technological superiority, combined with low-cost foreign assembly, can win entry into overseas markets that might otherwise be closed by prohibitive tariffs or quotas. But such plans fail to ask the question that Hollomon believes critical: is American technology truly better?

The question suggests an answer that sounds to many like heresy. "The United States didn't get to be better than anyone else because we were smarter," the man from Cambridge insists. The nation achieved what it did "because we were luckier"—the luck of homogeneous language, coinage, and a wealth of resources, among other essentials. And whether or not the country continues to take advantage of its luck, as it has in the past, is, for electronics at least, the heart of the matter.

It is the contention of Allen-Bradley Co.'s John Myers that too many engineers trained in the last two decades have been skilled in the exotica of space and military electronics at the expense of what he calls "the greasy-thumb end of electronics engineering: manufacturing technology" where costs receive equal consideration with performance. Thus it becomes vital for industry to concern itself with the education of tomorrow's engineers.

### Investing in inventors

Louis T. Rader, chairman of the University of Virginia's electrical engineering department, and former head of Sperry Rand's Univac division, believes industry is not concerned enough about its future source of engineering supply. "Too few industrialists have any real interest in, or concern for, engineering education and its problems," he argues, "even though these will impact not only industrial institutions but our whole way of life."

Though the U.S. retains its leadership in integrated-circuit design, for example, Rader suspects that only one in five of its design engineers employs a computer in his work for non-trivial problems. In Europe, meanwhile, "instruction in, and use of, computer-aided circuit design is spreading rapidly. We may assume that the stage is being set for a new generation of computer-designed equipment coming from those countries." As the pace of world technological development quickens, Rader warned, our present educational system is threatened by "high cost, low productivity, the general attitude of educators, and a lack of real support by industry—and I do not mean only financial support."

If industry stands aloof from this challenge, it has a great deal to lose. Most important will be the loss of the minds that will invent the future—a loss that all the foreign factories in the world cannot assuage.

—Ray Connolly

# It came in one color only

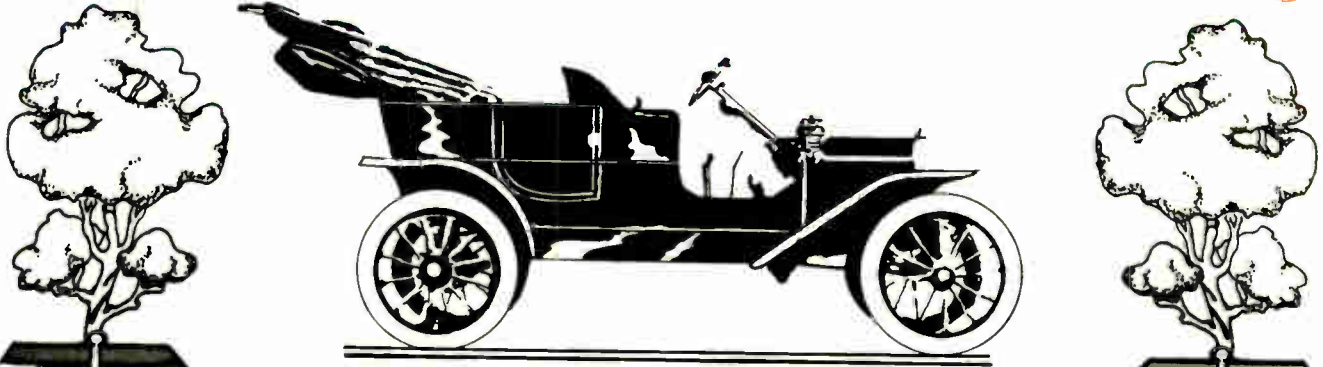

## But you don't have to buy counters that way today.

Because S-D offers you over 1,000 choices!

Frequency expandable\*

50, 200, 512 MHz, 3 GHz

4 BCD outputs

4 oscillator options

6 remote programming options

10 ns TIM, period option

7, 8, or 9 digits



\*All key features of 6150 counter/timers (including frequency range) are designed as expandable options. Add them at any time!

For details or a demo, contact your Scientific Devices office or Concord Instrument Division, 888 Galindo St., Concord, CA 94520. Phone (415) 682-6161. In Europe: Systron-Donner GmbH Munich W-Germany; Systron-Donner Ltd., Leamington Spa UK.

**SYSTRON**  **DONNER**

*Affectionately based on a 1908 Ford ad in the Saturday Evening Post.*

The Systron-Donner Instruments Group:

Alpha Scientific  Computer Systems  Concord Instruments  Datapulse  Kruse Electronics  Microwave  Trygon Electronics

Electronics/June 5, 1972

Circle 59 on reader service card 59

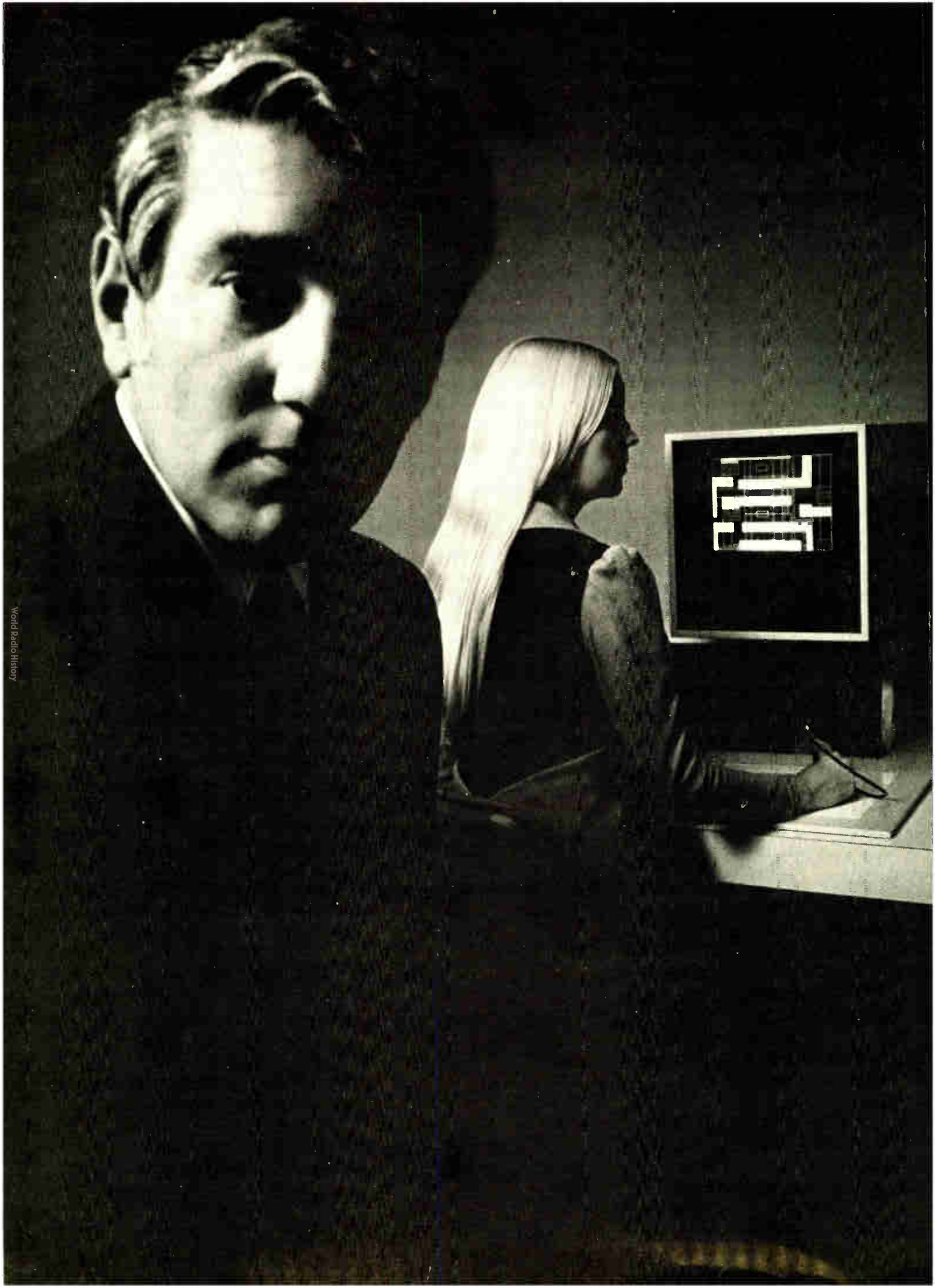

QQ We've developed an n-channel silicon gate MOS manufacturing process called COPLAMOS. Think of it as Grand Scale Integration.

Our COPLAMOS process increases density, which means we're able to put between two and four times more logic functions on each chip. And lower the cost of manufacturing.

Our COPLAMOS process also gives you MOS at bipolar speeds. It makes custom production practical even in small quantities. It reduces packaging costs. It offers TTL compatibility and allows TTL designs to be implemented in MOS. It requires less current and less expensive power supplies. It improves reliability at the chip level and insures greater reliability at the system level.

Call us. We're taking orders. In the East call Gerry Gollub (516) 231-5151. In the West call Pete Schink (415) 965-0575. Or, if you can afford to wait, send for our brochure. Then call. QQ

# STANDARD MICROSYSTEMS

Standard Microsystems Corporation, 1101 San Antonio Road, Mountain View, CA 94040

Standard Microsystems Corporation, 35 Marcus Blvd., Hauppauge, Long Island, N.Y. 11787

-----  
Standard Microsystems Corporation  
1101 San Antonio Road  
Mountain View, California 94040

Gentlemen:

Please send me the brochure about your COPLAMOS process, i.e. Grand Scale Integration.

NAME \_\_\_\_\_

TITLE \_\_\_\_\_

COMPANY \_\_\_\_\_

ADDRESS \_\_\_\_\_

CITY \_\_\_\_\_ STATE \_\_\_\_\_ ZIP \_\_\_\_\_

PHONE \_\_\_\_\_  
-----

# WE'LL SELL YOU A KEYBOARD SWITCH FOR 30¢



## ...and give you A PENNY CHANGE



**How to save silver when buying gold:** Spec Cherry Gold "Crosspoint" Contact keyboard switches. With a momentary Form A (SPST/NO) price tag of just 29¢ in 250,000 quantity . . . lower prices in higher quantities.

What do you get besides low price? Unique, proven Cherry Gold "Crosspoint" contact configuration that enhances reliability. Tested beyond 50,000,000 operations. (Test Report No. TK 10071 available on request.) You get Cherry's low profile Keyboard switch featuring rugged construction, 2½ ounce operating force and stable contact resistance (typically 25 milliohms over life). Made by the people who pioneered the Gold "Crosspoint" Contact in snap-action switches.

The result? Cherry keyboard switches are your ideal choice for computer terminals, electronic calculators and credit card validators.

**TEST A FREE SAMPLE.** Choose the 29¢ Form A switch . . . or any of Cherry's complete line of keyboard switch modules. Just TWX 910-235-1572 . . . or PHONE 312/689-7703 and ask Walt to give you facts on Keyboard Switches . . . or circle appropriate reader service number.



ACTUAL SIZE

**FORM A, MOMENTARY  
(SPST/NO)**

Circle No. 182 for Free Sample

**ALTERNATE ACTION (SPST)**

Circle No. 183 for Free Sample

**DUAL FORM A, MOMENTARY  
(DPST/NO)**

Circle No. 184 for Free Sample

# CHERRY



**CHERRY ELECTRICAL PRODUCTS CORP.**  
3608 Sunset Avenue, Waukegan, Illinois 60085

*Makers of patented Leverwheel/Thumbwheel Switches, Matrix Selector Switches, Snap-Action Switches and Keyboards.*

World Radio History

## Government report slaps official French R&D policies

The French government's research policy helps stifle development of new technology in electronics and other innovative industries. That's one conclusion of a still-secret government-funded study that digs into the psychological, cultural, and organizational barriers holding back new technology.

Insiders who have seen the report call the section covering technology transfer particularly critical. It takes to task creators of the policy that encourages companies to try to catch up with foreign competitors by hurriedly inventing equivalent projects. Rather, the report says, the state should spend more money "leapfrogging into areas where existing technology can be surpassed in one jump."

The new government study condemns the French principle of "concerted action" in research and calls for a "total review" of this approach. It proposes instead a "non-concerted" aid effort "which would by its very nature lead to originality." The report questions the effec-

tiveness of the concerted approach, as the French call it, partly because its aims are not specific enough.

The concept of concerted aid apparently is unique to France. It consists of government-sponsored research programs that tackle vast subjects, such as computer technology or space research. In the case of computers, it led to the creation of La Compagnie Internationale pour L'Informatique, the French computer company. □

consecutive series of consonant and vowel sounds occurring in a word or phrase is analyzed and the result compared with dynamic algorithms representing the words and phrases in the vocabulary. □

### West Germany

## New lens seen as atom spy

Some 2,300 years ago, Democritus theorized that all matter consisted of indivisible elementary particles, or atoms. Since the Greek philosopher came to that conclusion, a lot has been learned about the atoms and the laws that they obey. But still no one has seen the true image of one, not even with the most powerful of electron microscopes.

But seeing is believing, feels a team of researchers at West Germany's Siemens AG that is now working on a new type of electron microscopic lens with the aid of low-temperature physics. Neither higher field strengths nor higher field concentration can be obtained with conventional electron microscopes. Their magnetic lenses employ a coil system with an iron core, which won't permit the field strength to be increased beyond a certain saturation level.

The team decided to try a coreless system and, in the process, is exploiting the effects of superconductivity—the lack of resistance of certain materials at temperatures near the absolute zero. High field strengths are obtained with the coreless coil, while high field concentration is achieved by surrounding that coil with a superconducting shield. □

### Great Britain

## Speech recognized without computer

Work on electronic speech recognition has become more and more dependent on big computers. However, a team at Britain's National Physical Laboratory has developed a small system that doesn't need a computer at all.

So far, the process can recognize six phrases. Using a computer to simulate further development—not as a permanent part of the system—it has been made to recognize 27 words: the numerals 0 to 9, the months of the year, and "day," "month," "year," "yes," and "no." Brian Pay, project leader, believes the work shows that the basic recognition system can be developed to distinguished most, if not all, normal speech sounds without great expense.

**Analysis.** The NPL system depends on recognition of vowel sounds by frequency analysis and of many consonants by matching different sounds with different thresholds. Thresholds can be set in frequency, in time, or by other parameters. A

### Gap narrows

Although the report on French government research and development policies does not single it out, one prominent catch-up effort of the sort recommended in electronics is under way at Sescosem, France's only broadline native semiconductor maker. The company has received \$10 million in government research funds, specifically to try to match U.S. semiconductor technology. When the four-year catch-up effort winds up at the end of next year, Sescosem calculates it will have reduced the American headstart (estimated in 1969 at three years) by more than half.

# An Honest-to-Goodness Breakthrough in Storage Oscilloscopes

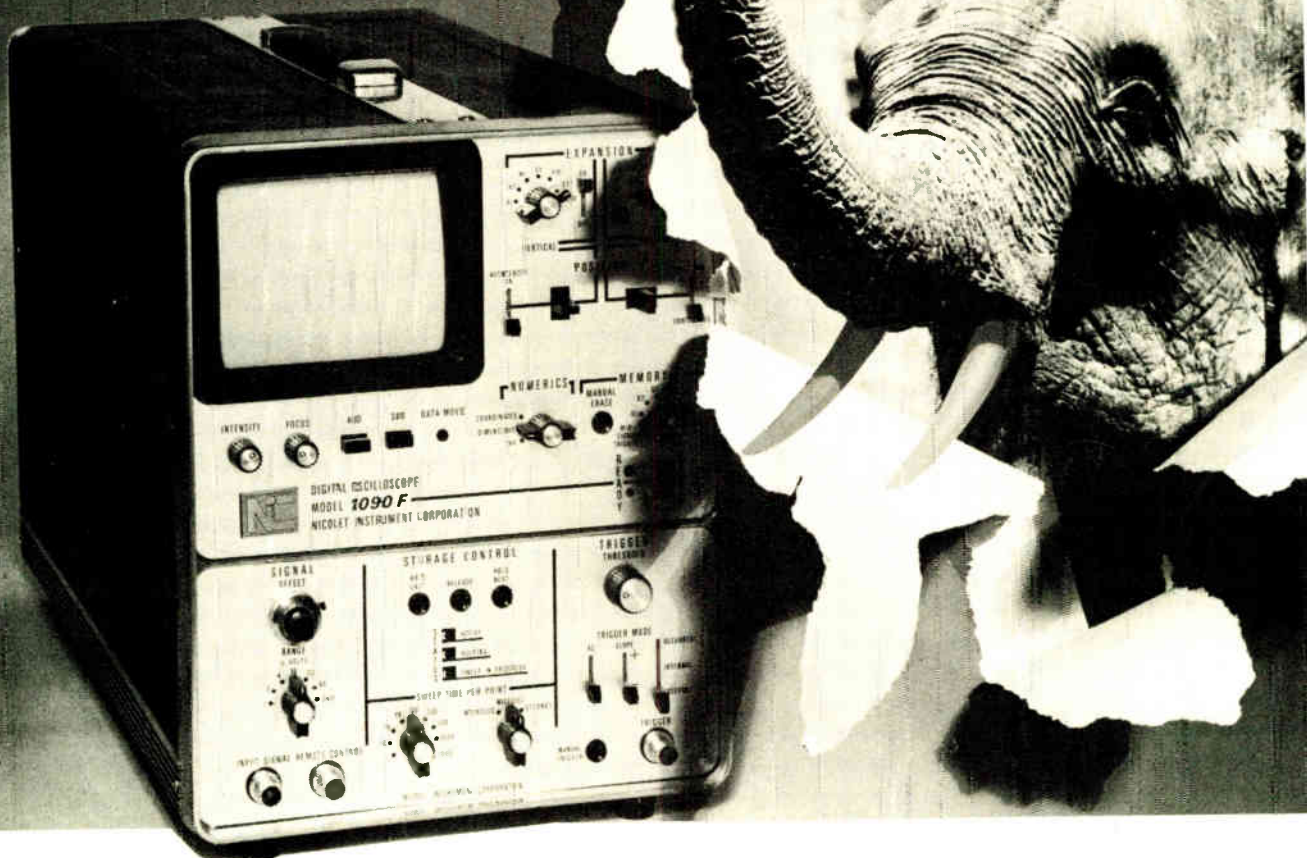

The Nicolet 1090 digital storage oscilloscope looks like a storage oscilloscope, acts like a storage oscilloscope, and is operated like a storage oscilloscope — except —

- It has about 20 times the resolution in both time and voltage. It would require hundreds of storage tubes to capture as much information about a single waveform as is recorded in the 1090's memory.
- It is about a hundred times as accurate.
- It has far greater equivalent writing speed than most storage oscilloscopes.

- It is easier, by far, to operate.
- Its stored information doesn't fade away.
- It provides normalized numerical information about any point in the waveform.
- It has sweep speeds as slow as you wish, even days in length.
- It can be told to retain a waveform before, during, or after the signal occurrence, with local or remote control.
- It can provide accurate voltages for operating a pen recorder.

Other than these exceptions, it is like an ordinary storage oscilloscope. If you know how to operate an oscilloscope, you don't even need to look at an operator's manual to make the 1090 serve your needs. Bandwidth 100 KHz ( $2 \times 10^5$  samples/second). Resolution 4096x4096. Price, with model 90-1 single channel plug-in unit: \$4500. (Pen recorder drive and binary output are extra cost options.)

## NICOLET INSTRUMENT CORPORATION

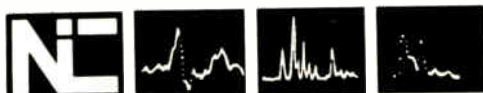

5225 Verona Road, Madison, Wisconsin 53711  
Phone 608/271-3333 TWX: 910-286-2713

Write for complete information or to arrange a demonstration.



## **Nippon to build Intelsat station in Switzerland**

Nippon Electric Co. has become a strong contender in Europe's telecommunications markets. The Tokyo company in late May picked up a **\$3 million-plus contract to build an Intelsat earth station** for the government-operated Swiss telecommunications network. The contract pushes NEC's total European business past the \$15 million mark.

The Swiss station, to start operation late in 1973, will have a 29.6-meter antenna. Initially the Swiss will use the station only for telephone and documentary traffic. But they plan eventually to add television capability. Services may also be expanded—**with two antennas for Intelsat long-haul traffic and two for operation with future European regional communications satellites.**

## **Ericsson grabs switching center pact in Britain**

Sweden's LM Ericsson has made a major breakthrough into the British market by winning a **\$34 million order from the British Post Office Corp. for crossbar equipment to equip an international switching center** in London—the largest order the Swedish firm has ever received for a single exchange. The Swedish company acknowledges that **the order could spur protests in Parliament, especially since the British press reports that the order will cost the jobs of an estimated 2,000 British workers.**

An Ericsson spokesman said the contract was won on the basis of both price and reliability in delivery against bidders that included Plessey of Britain and the Italian subsidiary of ITT. The equipment, scheduled to begin operation late in 1974, is part of a plan to increase Britain's international telephone traffic facilities four-fold by the end of the decade. Ericsson's sales in the British market—entirely for private exchanges—totaled \$7.9 million last year.

## **British firms mix phosphors for 2-color CRTs**

The main snag of two-color single-gun cathode-ray tubes—the high cost of evenly superimposing two layers of different phosphors, separated by an inert layer—**may be overcome by a technique being developed by two UK firms.** Levy-West Laboratories Ltd., a phosphor specialist, and Smith's Industries Ltd., an avionics manufacturer, have developed a mixture of two phosphors that can be applied as a single layer.

The red component glows at 5 kilovolts; the green component, at 10 kV. The inert layer is eliminated by arranging the phosphor proportions so that the green glow swamps the red at 10 kV. **The penalty is dilution of the red glow by unexcited green particles** at 5 kV, which Levy-West is trying to overcome by raising the voltage thresholds of both components so that the red glows more brightly, although the switching threshold is maintained.

## **Telefunken grants PAL TV license to Matsushita**

West Germany's AEG-Telefunken has reversed its previous policy and **licensed Matsushita Electrical Industrial Co to build color TV sets for export to countries using the Telefunken-developed PAL (Phase-Alternating Line) transmission norm,** and similar licensing deals are being negotiated with other Japanese set makers. Previously, PAL licenses had been issued to manufacturers only in those countries that had opted for the PAL television norm. An exception was Hitachi Ltd.,

which, under a 1970 patent and information exchange agreement on entertainment electronic products, was allowed to build a limited number of sets for distribution in PAL territory.

AEG-Telefunken officials decided to change their policy in order to uphold the quality standards inherent in the PAL norm, adopted thus far by 21 countries. Attempts by foreign firms to market sets designed to bypass the basic PAL patents jeopardized those quality standards, the company says. Like the Hitachi deal, the Matsushita license restricts the number of PAL sets the Osaka firm is allowed to market. Screen size has been restricted to 18 inches. The contract becomes effective upon approval by the Japanese government.

## Foreigners await Aeroflot decision on reservation net

Computer and telecommunications companies in at least four countries are anxiously awaiting Moscow's decision on bids for a \$10 million contract to install a computerized reservation system for the domestic network of Aeroflot, the Soviet airline. The largest contract ever considered for Western firms, the eventual award will depend on how many terminals the Russians decide to install.

The French ITT subsidiary **Compagnie Générale des Constructions Téléphoniques (CGCT)** hopes to have the inside track on the deal because of its sale of a \$1.2 million data switching system, delivered early this year to Aeroflot for internal traffic control. Among the other bidders are IBM, Siemens, and a Japanese firm. CGCT is clearing the way for more contracts by organizing a September conference in Moscow to present its telecommunications products to managers of the Soviet electricity, gas, marine, aviation, postal, and telephone authorities.

## Telefunken video tube integration gains sensitivity

AEG-Telefunken has started to market a video pickup tube with an integrated light amplifier that is highly sensitive. **The new XQ 1320 tube responds to illumination values between 1 and 1/10 millilux—a sensitivity that the company says has been achieved thus far only in pickup tubes having separate light amplifiers.** With a sensitivity extending from the blue to the infrared portion of the spectrum, the XQ 1320 consists of an electrostatically focused tetrode light amplifier and an electromagnetically focused and deflected vidicon system. The conversion layer between the amplifier and pickup portions is a multi-element silicon diode target that is directly excited by highly accelerated electrons from the amplifier. The tube sells for \$3,700 to \$6,200, depending on the silicon target quality.

## Addenda

Olivetti has a multimillion-dollar deal in the works to automate freight operations for Italy's nationalized rail lines. **More than 500 terminals—the first increment of the project—**will be connected to several central computers to control rolling stock and the railroad's fleet of delivery trucks. The terminals will be placed in 250 rail stations. . . . **Plessey Ltd. says it is shelving plans to build a \$25 million electronics and electrical manufacturing complex in Singapore.** No reason was given for the reversal, but Singapore workers have recently received a round of wage increases, and 60,000 unskilled workers have been imported from neighboring Malaysia. The project, to have started next August, was to have employed about 4,500 when completed in 1977.

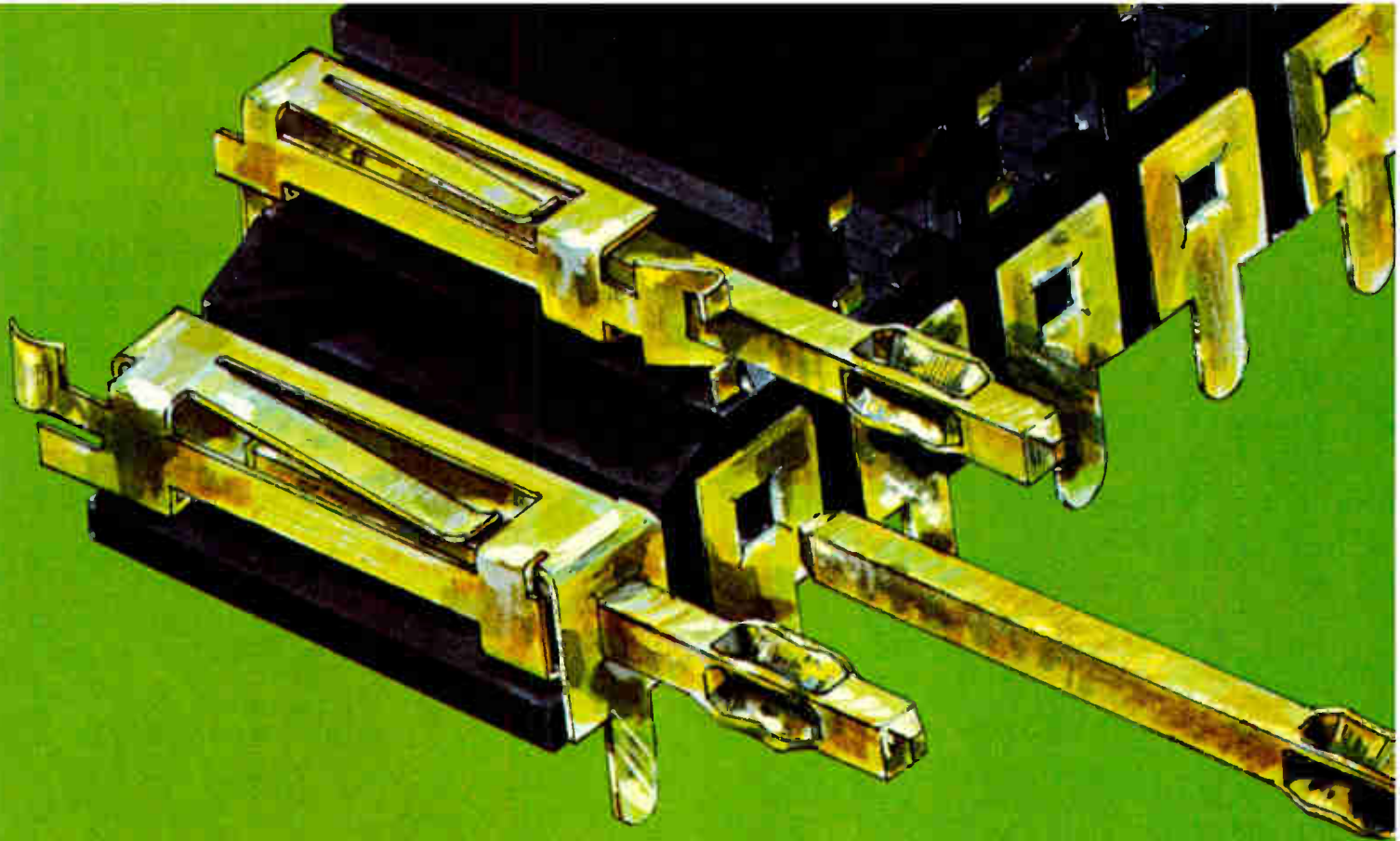

# THE PERFECT MATING

Any .025" square post, yours or ours. And Elco's Varipost Box™ connector. For true togetherness in board-to-board and cable-to-board connections. Our new single row (Series 8243) and dual row (Series 8242), connectors will mate with any .025" square posts on the market, even if they're wire-wrapped one level. Which means you can hold with your existing design and still make the connections you need.

Let's peek inside one of our Varipost Box™ connectors and see why they're so receptive.

First, the contact surfaces of the spring members are parallel to the surface of the p.c. board, and thus can span post-to-post tolerance deviations in your board. This compensates for misalignment between posts and contacts, so you get a perfect mating every time. Competi-

tive box connectors—on the other hand—have perpendicular contact surfaces that demand tighter post-to-post tolerances to insure the mating of every contact with its corresponding post.

The spring contacts in our Varipost Box™ connector are longer, deflect farther and provide a longer wiping action than competitive connectors. Our contacts extend all the way to the entrance of the connector, so they'll mate with shorter-than-standard posts. And if your posts are longer than standard, a built-in stop prevents the posts from extending out the rear of the connector and shorting out with the upper row of contacts in the dual row version.

There's more. Our contacts can be removed from the housing and replaced without deformation. And sequential mating in dual row con-

nectors—first one row, then the other—reduces insertion forces by half.

A wide range of models is now available . . . right off the shelf. Cable-to-board units with contact spacing on .100" and .125" centers in single row (with up to 25 contacts) and dual row with up to 50. Board-to-board (.100" centers) versions with up to 50 contacts, and dual row (.100" by .100") with up to 100 contacts.

As companion pieces, we offer our new .025" square posts, Elco Variposts™. And we've the insertion equipment to stake these posts into the board. So we can supply your p.c. board with posts already inserted, ready for mating.

Leave it to Elco, the Matchmaker. Another service in keeping with CONNECTRONICS, Elco's Total Connector Capability.



Elco, Willow Grove Division,  
Willow Grove, Pa. 19090  
(215) 659-7000

Elco, Pacific Division, 2200 Park Place,  
El Segundo, Calif. 90245  
(213) 675-3311



Operations in USA, Australia, Belgium, Canada, Denmark, England, France, Germany, Israel and Japan. Sales offices throughout the world. In Europe, Elco Belge, 77 Blancfloerlaan, Antwerp, Belgium, Tel. 03-190064. In the Far East, Elco International, TBR Building, 2-10-2 Nagata-cho, Chiyoda-ku, Tokyo 100, Japan, Tel. 580-2711/5.

Circle 67 on reader service card  
World Radio History

Copyright © 1971 Elco Corp. All rights reserved.

**You can teach our stepping switch  
all the newest tricks.**

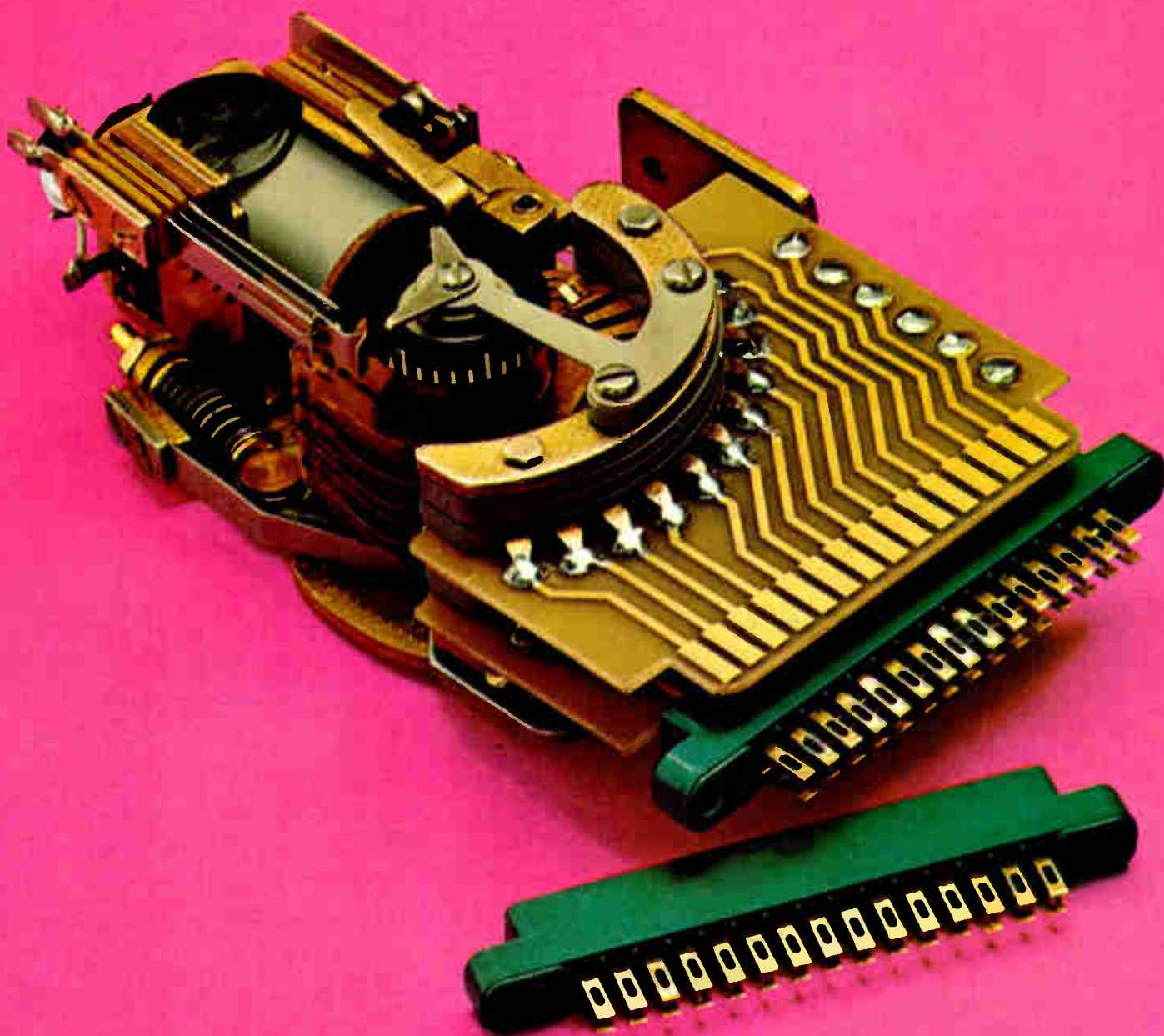

You can make a rotary stepping switch do just about anything solid state devices can do. Control. Time. Count. Program. Hunt. Test. Monitor. Indicate. Select. Yet with all that talent, a lot of people overlook it when they have a problem. That's too bad because it's often the most practical solution.

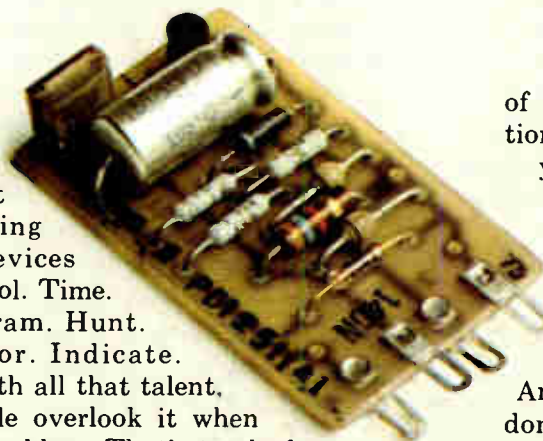

**Think of the stepping switch as a time machine.**

It conserves what you have the least of. Time. That's because most of the logic you need is built right in. It's part of the mechanical construction, not something you have to create. And by adding our Series 300 Time Delay module, you'll practically have a complete control system in the palm of your hand. Lots of people have created exotic solid state circuits only to discover they could have done the same thing faster and easier with a stepping switch.

**Ten cents a contact.**

That same exotic circuit probably costs three to five times more than a stepping switch, too. For example, a type 45 with 8 levels of 52 contacts will cost you about a dime a contact. We don't know of any switching method that costs so little.

**A better memory than an elephant.  
And just as tough.**

A stepping switch never forgets after a power outage. When the juice comes back on, it starts up right where it left off. And it shrugs off doses

of 1250 volts because of inherently high insulation resistance and dielectric strength. This gives you a system reliability that can't be matched by solid state. Should the day ever come when maintenance is necessary, a plug-in style, like the type 44 in the picture, can be removed or installed in minutes.

**10 million laps around the track.**

And maybe 10 million more. We've yanked random units off our production line and worked them to death. Many have lasted twice as long as their rated 10 million wiper sweeps across the bank. One reason is our "free floating" pawl. It can't possibly bind or overthrow because we don't use pawl or armature stops.

**Sometimes a stepping switch isn't the answer.**

If you need to switch in microseconds, or squeeze your system into a TO-5 can, forget it. But if you're looking for a simple, economical, reliable, easy-to-design solution to a switching problem, consider the stepping switch. We'll be happy to help you do it. If you want a head start, write today for a copy of our 40-page manual. GTE Automatic Electric, Industrial Sales Division, Northlake, Illinois 60164.



**GTE AUTOMATIC ELECTRIC**

Circle 69 on reader service card

# DATA COMM

**A lot of people have been saying Data  
Digital is putting**

We now have a group of people whose sole purpose is to advance the cause of data communications. The DECcomm Group. They already have communications interfaces, software packages and computers. And

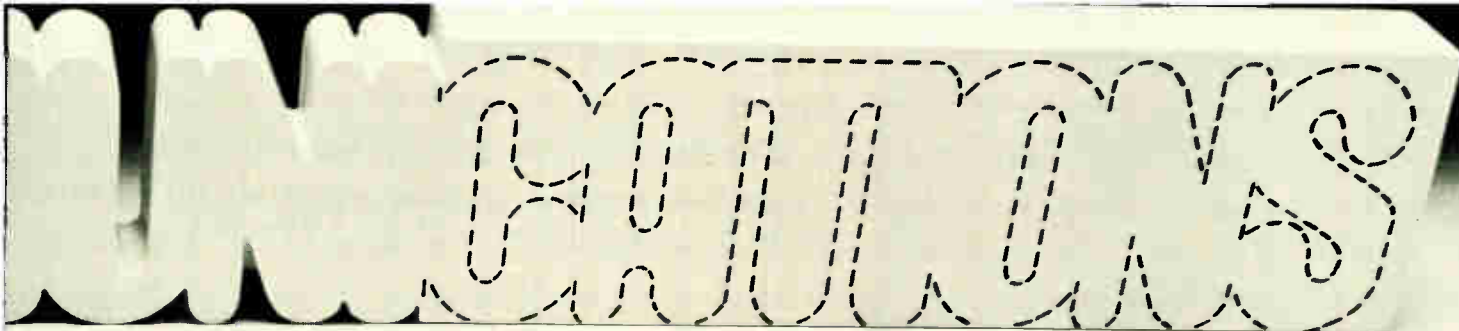

# Communications has a long way to go. an end to that.

there's a lot more to come. From the world's  
largest maker of minicomputers. Write.  
Digital Equipment Corporation, Maynard, Mass.  
01754 (617) 897-5111. European headquarters:  
81, route de l'Aire, 1211 Geneva 26.

**digital**

Circle 71 on reader service card



# Crystalonics solid state relays in a TV studio?

## That's right.

## The best doesn't cost any more anymore.

Our TV studio customers formerly used reed relays to switch video signals from various cameras during recording sessions. The reed relays weren't fast enough to operate during the blanking times, so dead spots and image carry-over resulted. *Our* solid state relays switch video signals 1000 times faster than the reed relays, as well as adding solid state reliability at comparable cost.

Crystalonics solid state relays are also upping performance and holding the line on costs in process controls, telephone multiplexers, automatic testers, oceanographic research equipment, programmed lighting controls, input/output multiplexers for computers, medical electronic equipment, music synthesizers, and audio recording studios.

Let our applications engineers help you to apply today's solid state technology to *your* needs. Crystalonics' 13 years of technological leadership in solid state switches, fotofets, and varactors is available *now*, off the shelf, and the best doesn't cost any more anymore.

Send now for information on our solid state relays to  
Teledyne Crystalonics • 147 Sherman Street • Cambridge,  
Mass. 02140 • Telephone: 617-491-1670.

 **TELEDYNE**  
**CRYSTALONICS**

**CRYSTALONICS SALES REPS AND AGENTS**

U.S. & CANADA: (201) 835-0332 / (203) 932-5656 / (205) 883-0140 / (206) 454-7422  
(213) 466-6201 / (213) 469-5871 / (214) 231-6891 / (216) 221-0450 / (219) 485-0805  
(301) 823-3603 / (303) 771-4920 / (305) 622-1383 / (312) 359-9599 / (314) 542-3657  
(315) 458-4775 / (319) 363-6425 / (415) 964-5454 / (505) 268-0928 / (513) 299-4144  
(514) 684-7755 / (516) 593-2628 / (602) 273-7387 / (609) 983-6660 / (612) 488-0201  
(617) 731-0858 / (716) 342-1413

OVERSEAS: AUSTRALIA - 790-22846 / BELGIUM - 846-21169  
DENMARK - 855-5052 / ENGLAND - 851-23894 / FINLAND - 857-121676  
FRANCE - 842-62193 / GERMANY - 841-524506 / HOLLAND - 844-54512  
ITALY - 843-34424 / JAPAN - 781-4419 / NORWAY - 856-18625  
SWEDEN - 854-10338 / SWITZERLAND - 845-52042

Circle 72 on reader service card



## Industrial sector to pace growth

Multinational operations are seen as U.S. key to exploitation of rising European, Pacific, and Latin American electronics markets

by Ray Connolly, Washington bureau manager

Leaders of America's electronics industries have completed their first intensive look at the future of global electronics and concluded that industrial systems constitute the wave of the future. In a 1985 world market expected to expand 3.6 times from the 1970 level to \$204.8 billion, industrial electronics is projected to account for more than half the world and U.S. market shares, trailed by consumer and government products. The forecast by the Electronic Industries Association was placed before 325 industry executives at "Electronics 1985," a two-day mid-May planning conference in Chicago.

Pinpointing major growth markets for electronics in Europe, the Pacific Basin and Latin America, industry leaders agreed that exploiting those markets will require multinational operations having manufacturing facilities widely distributed around the globe in or near countries with market potential [*Electronics*, May 8, p. 65]. But the more than 40 industry executives who addressed the conference concurred that they had no hard answers to the less quantifiable questions raised concerning the responsibilities of corporations and technology to the U.S. domestic society, where social values are rapidly changing.

Following an opening session in which Carl H. Madden, chief economist of the U.S. Chamber of Commerce, posed multiple questions about the corporation's role in the future—and later sharply criticized the selfish motivation and the competence of corporate representation in Washington, most participants conceded they had not seriously

considered the societal issues affecting their business. One puzzled executive asked: "How can I relate all this to a P&L statement?" Signetics Corp. executive Jack Halter summarized the reaction of most of those attending with a post-session observation that, "I'm going to have to think about this. What are these changes [in society] going to mean to our company, any company? And what can we do about it?"

**Stretched.** Donn L. Williams, conference chairman and president of North American Rockwell Corp.'s Electronics group, said he envisioned the meeting as industry's first "mind-stretching exercise." Williams conceded that he had hoped for a freer and broader exchange of views at "Electronics 1985," but he echoed the wide praise of the meeting's 301-page economic forecast put together under the direction of Sprague Electric Co.'s president, Bruce Carlson.

The new document, a meeting highlight, breaks out world con-

sumption of components, consumer, industrial and government end-products in five-year increments from 1960 through 1985. The forecast shows the highest annual growth rates occurring from 1970 to 1975 for electronic equipment throughout the world (see table). Components consumption, on the other hand, is foreseen as achieving its peak growth rate from 1975 to 1980, with an annual rate of 8.2% for all types, led by an 18.1% growth rate for monolithic integrated circuits—slightly higher than the 16.9% level forecast for 1970-75.

**Industrial.** A \$46.5 billion world industrial electronics equipment market in 1975 will account for roughly half the output of the whole industry, assuming an average annual growth rate of 14% between 1970 and 1975. American consumption of industrial electronics is forecast at \$20 billion of 1975's total \$41.5 billion domestic market, and by 1985 it will increase its market share to 56% of the U.S. total, or \$45.5 billion of

**Leaders.** North American Rockwell's Donn Williams (left) chaired the "Electronics 1985" conference in Chicago in which Sprague Electric's chief Bruce Carlson explained the EIA's new economic forecast to attendees.



## Probing the news

\$80.9 billion. U.S. consumer electronics markets are expected to double to \$12.9 billion in the same decade, but EIA's forecast of Government market growth from \$15 billion to \$22.5 billion is one or two percentage points greater than its annual inflation factors of 2% to 3%.

"If we have assumed that our entire electronic original equipment market is all there is, we had better change our thinking fast," warned Belden Corp. group vice president Warren M. Stuart. "The industrial market has emerged as the future market. Toys, musical instruments, white goods, office equipment, industrial process controls, and materials handling equipment are some examples of where electronic components are used outside of the OEM market."

**Multinational.** Numerous speakers at "Electronics 1985" concurred that multinational operations probably will be required for successful world competition by U.S. and foreign manufacturers in 1985. Bruce Henderson, president of the Boston Consulting Group Inc., warned that international business strategy is changing as rapidly and has become as complex as the changes in electronics technology. Although the U.S. is still "temporarily" the world's largest market, he said that this "is also the slowest growing industrialized country on earth."

The European Community "will be a bigger market than the U.S. in the foreseeable future," Henderson predicted, adding that "Japan will soon approach the U.S. in size of market." And he urged the industry leaders to make the necessary effort to overcome the multiple obstacles facing development of new small markets before they are shut out. "Many companies could have exported to Japan successfully during the 1960s if they had just made the effort," he noted. "Few of these are trying to export to Brazil which now is beginning to match the early phases of Japan's growth."

Other panelists touched on the South American electronics potential, including Hewlett-Packard Co.'s Carl J. Cottrell, deputy director for the International group.

FULL WORLD SUMMARY, ELECTRONICS END EQUIPMENT CONSUMPTION (MILLION \$)				
	1970	1975	1980	1985
TOTAL	56,786.8	91,314.4	137,397.4	204,802.8
<b>CONSUMER</b>	11,762.7	17,379.0	24,715.0	35,630.0
ENTERTAINMENT	11,406.0	16,130.0	22,233.0	30,470.0
AUTOMOTIVE	166.0	700.0	1,700.0	4,100.0
OTHER CONSUMER	190.7	549.0	782.0	1,060.0
<b>INDUSTRIAL</b>	24,224.1	46,535.4	75,882.4	121,172.8
DATA PROCESSING	9,628.7	20,456.6	32,585.5	51,422.4
OTHER OFFICE & STORE	810.0	3,300.0	5,700.0	9,100.0
TELEPHONE & TELEGRAPH	1,738.5	3,420.9	6,918.5	13,418.9
OTHER COMMUNICATION	5,218.1	7,307.3	10,260.7	14,818.8
TEST & MEASUREMENT	2,026.3	3,147.2	4,748.5	7,439.3
LAB & MEDICAL INST.	1,929.5	3,754.8	6,967.8	11,068.8
PROCESS CONTROL	2,873.0	5,148.6	8,701.4	13,904.6
<b>GOVERNMENT</b>	20,800.0	27,400.0	36,800.0	48,000.0
MILITARY	19,000.0	24,900.0	33,800.0	44,000.0
CIVIL AGENCIES	—	—	—	—

"Latin America is somewhat similar to the Far East in that European and U.S. competition will be there looking for new markets as they develop," Cottrell said. "Brazil and Mexico offer promise of becoming quite sophisticated markets for industrial products, as well as competitors for a share of the total Latin American market."

But, said the H-P executive, "those who expect to gain in Latin America must be prepared to establish one or more marketing and manufacturing facilities on the scene." Cottrell also noted that companies anxious to share in a world industrial electronics market—"growing at a faster rate than the world's gross national product"—must have the freedom to tap the labor supply in developing countries. Cottrell regards a low-cost labor supply as critical in U.S. competition against European and Japanese multinationals for "a share of the \$17.7 billion Japanese home market (in 1985) and for a foothold in the \$2.1 billion market in the Pacific Basin."

To compete effectively in the developing Pacific region—where reliability, ease of maintenance, and product quality have priority over complex technology—Cottrell suggested that U.S. manufacturers use their advanced production know-how, "particularly in the IC field, to provide the price-performance ra-

tios needed to beat the Japanese and others right in their own backyard."

As for the U.S. Government role in supporting industry expansion, Henderson expressed the view of most EIA members in calling for formulation of "a hard-headed realistic trade policy" that would sharply restrict imports of fast-growing products in the domestic market. "Such restrictions should be bargained away only in return for equally valuable access to foreign markets." But, in an oblique reference to the inability of EIA's membership to come up with an industry-wide trade policy of its own, Henderson urged industry leaders to "arrive at a consensus on their policy preferences and make themselves heard in Washington."

One EIA speaker, Intersil Inc. president James F. Riley, also urged more effort by the association in Washington. At a concluding session on components and subsystems, Riley projected sharp declines in costs and rapidly expanding applications for active devices through 1980. To capitalize on these advantages in world markets, Riley called on EIA to drop its "parochial views" in favor of more industry-wide positions for strong presentation to the Congress and more intensive industry-Government cooperation in developing overseas markets. □

Environmental electronics

# Dutch start air pollution war

The Netherlands is installing nationwide detection system, designed eventually to test water purity and link with neighboring countries

by John Gosch, Frankfurt bureau manager

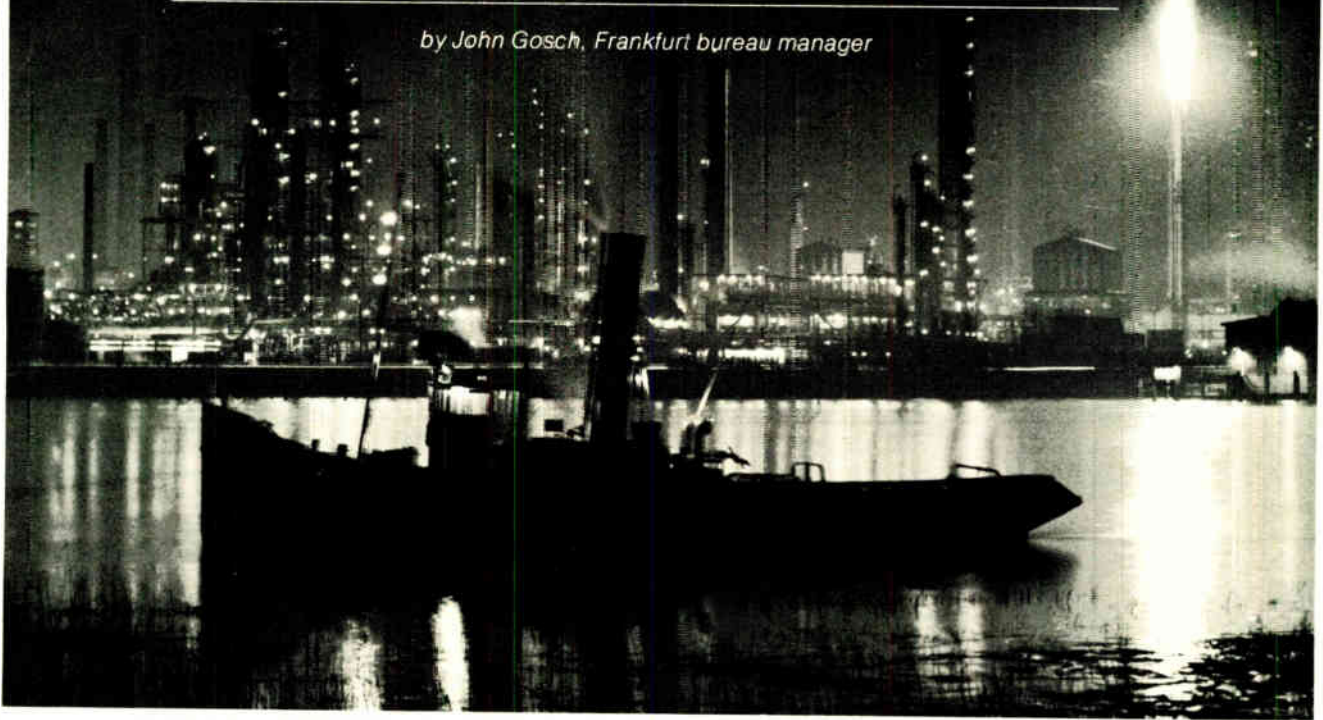

Delegates meeting in Stockholm this week for the United Nations Conference on the Human Environment may find a practical answer to one aspect of environmental problems by walking to the nearby local showrooms of the Dutch firm Philips Gloeilampenfabrieken NV. Here, Philips is exhibiting air-pollution-detecting equipment to be used in the world's first national air pollution monitoring network.

Philips is installing this automated network in the Netherlands under contract from the National Institute of Public Health. The system will consist of about 250 monitoring stations tied in with nine or 10 regional measuring centers. These, in turn, will link up with a central control station—the national measuring center—near Utrecht. Eventually, the Dutch system will be linked to similar networks that are being planned in West Germany and Belgium.

In addition to monitoring pollution in local areas, the network will keep track of cross-country polluted-air movements caused by winds and unfavorable weather conditions. For that, the network will include about 50 pick-up stations for wind direction, wind speed, and air-temperature data.

Initially, only sulphur dioxide will be monitored, but by 1974, the system will be able to detect and monitor a wide range of other pollutants, as well. It's also possible that water pollution monitors eventually will be tied in with the system. Studies on how to mesh such monitors with the network's data-processing equipment are already under way at Philips.

**How much?** Dr. Ton Schneider, head of the Holland Public Health Institute's Air, Water, and Soil Laboratory and one of the principal government officials involved in the project, estimates the network's ini-

tial cost at about \$4 million. This includes the cost of hardware, the transmission gear at the monitors and at regional and national measuring centers, and the data processing equipment at these centers. Once the detectors for other air pollutants are installed, network costs could top \$8 million, Schneider says.

The network's monitor stations are 4-foot-high cabinets, with room for eight different detectors because eventually the network may be used to monitor—in addition to sulphur dioxide—ozone, carbon monoxide, and the nitrogen oxides, as well as such components as reactive hydrocarbons, dust, tar, and soot. A 12-ft. sniffer pole is used to suck the air into the cabinet.

These units are remotely controllable and can operate unattended for as long as three months. Each consists of two modules, one for the electronics and telemetry gear and

the other for the chemical analysis equipment.

The sulphur-dioxide concentration is determined by continuous titration of the air with bromine in the measuring cell. A feedback network controls the bromine-generating current so that the net rate of bromine production equals the sulphur-dioxide absorption rate. This creates a small current that is proportional to the quantity of sulphur dioxide in the air coming into the detector per unit of time. The detector's final output is a 0- to 20-milliampere dc signal that is sent to the regional center via the Philips-designed data-transmission system.

**No choke from smoke.** The data arriving at the regional center is processed by a Philips P-2200 series minicomputer. The machine interrogates each monitor in the region once a minute and establishes from that data the mean hourly averages and daily averages of sulphur-dioxide concentration in the air. The equipment in each regional center also signals the condition when a preset limit value of sulphur dioxide concentration is exceeded. When that happens, operating personnel will then request nearby industries to defer particular pollution-causing activities.

During stagnant weather periods, factories may be asked to postpone burning waste products until winds and vertical convection currents disperse the contaminated air. The center may request that industry burn fuels with low sulphur content during periods of atmospheric stability. These measures are to be taken on a voluntary basis—anti-pollution laws are not yet in force in the Netherlands. The regional center stores and also transmits the continuous measurements made at the national measuring center.

The country's all-out drive for pollution monitoring is not accidental. In Holland, with 13 million people crowded into an area about the size of Maryland, the side effects of industrial growth have become a subject of deep public concern. Heavily industrialized, the country faces beyond its borders a high concentration of industry in neighbor-

ing Belgium and West Germany. Aggravating the pollution problem is Holland's location at the estuaries of some of Europe's major waterways, which carry pollutants from as far away as Switzerland.

**Network traces movements.** The prime function of the Dutch national network, says Schneider, is to determine the degree of air pollution in the various regions of the Netherlands, its origin, and its path across the country. The data will be used to establish year-to-year trends in levels for long-term prediction of air pollution.

The network is being laid out in a checkerboard pattern of monitoring stations. Each of the network's nine or 10 regional centers will be linked by phone lines to 20 to 30 monitors. The centers will also tie in with the meteorological data pick-up stations so that the movement of pollution and its increase due to unfavorable weather conditions can be determined and forecast. Meteorological measurements will be made near the earth's surface and from the roofs of tall buildings.

The first regional center and its associated monitor stations will be installed and equipped by August. After that, regional networks will be put up at the rate of one every six

weeks or so. The regional centers will hook up via telegraph lines with the national measuring center at the Public Health Institute at Bilthoven, outside of Utrecht. There, a Philips 9202 computer will collect and process all data coming from the regional centers. The computer can bypass regional centers and request monitored data directly from 10 stations at a time so that a check can be made on how polluted air is moving across the country. A time-shared Control Data Corp. 6600 computer will be used to calculate long-term trends.

**Future links to spot pollution.** The network will link up with the one planned in the West German state of North Rhine-Westphalia. The networks being considered for Belgium and in Germany outside of North Rhine-Westphalia will also tie in with the Dutch system. And eventually, there will be a grid of monitoring stations covering the whole area of the Benelux countries and much of West Germany. In the Netherlands, the basic pattern will be supplemented by monitors installed in big cities, around large industrial areas, and along the borders to keep track of pollution coming from neighboring countries. Mobile stations will also be added. □

### Portentous market

"The Dutch network portends what we think will be a tremendous market for instrumentation elsewhere," says S.M. de Veer, product manager for Electro Analytical Equipment at Philips' Professional Instruments division in Eindhoven. Just how big that market will be depends, of course, on how far other countries go in setting up pollution monitoring networks. "But even if they settle on regional systems only, as most countries are likely to do, the demand for instruments will mean big business for electronics companies active in the field," de Veer points out.

For France and West Germany together, de Veer foresees an initial need for some \$60 million worth of monitoring devices. For Italy, he puts the demand at around \$25 million.

Philips, producer of instruments, data processing, and transmission equipment, can supply complete systems, and is a top contender in that market, whereas such other firms as West Germany's Hartmann und Braun, are manufacturers of monitors only.

Thus far, the Eindhoven firm has sold small networks with five to 12 monitors to Germany, France, Switzerland, Italy, and the United States. Philips has also chalked up big sales of single monitors as well: 500 sulphur-dioxide detectors, each worth about \$6,000 have been sold worldwide—more than 180 of them in North America.

In the U. S., Philips has already sold about 40 air pollution monitoring installations to state air pollution control agencies and to chemical and power generating companies. Most have been sold in the past year, reports Robert Deichert, marketing director for Philips Electronic Instruments, a division of PEPI, owned by North American Philips Corp.

Peripherals

## Cashing in on IBM compatibility

The independent peripheral equipment companies have experienced great leaps in sales, and they keep plugging away at the market

by Wallace B. Riley, Computers Editor

It was the best of times in the worst of times—at least for the independent peripherals manufacturers. During the recent recession, the makers of disk storage units, magnetic tape drives and the like, increased their business tremendously even as sales were shrinking in much of the rest of the electronics industries. And the boomlet is expected to continue this year despite the fact that IBM is beginning to take notice of the independents in its own peripherals pricing.

Memorex Corp., Santa Clara, Calif., enjoyed a revenue increase in 1971 of more than 400% (\$9 million to \$46 million) over the previous year. At Potter Instrument Co., Plainview, N.Y., William P. Sharpe, vice president of marketing, says business more than doubled during the same period. A small manufacturer of card readers in the Philadelphia area says its sales jumped 600% or more in the fiscal year ending this month. And, although Mohawk Data Services, Herkimer, N.Y., would not quote a percentage estimate, officials admit experiencing “a big increase.”

Confirming this growth is a report issued last month by International Data Corp., a Boston, Mass., market research firm, which states that peripherals makers altogether did 104% better in 1971 than in 1970. IDC predicts further that the independents should boost sales by 53% this year. All of which leads up to the question: how did the independents—renting equipment plug-to-plug compatible with that sold by International Business Machines Corp.—not just hang on in a recession year but more than double their sales?

Much of the expansion is attributable to suddenly cost-conscious users shopping for equipment that performs as well as IBM's but costs less. But some of the independents are doing well by offering units that top IBM peripherals in performance, even though they cost more. Still others are prospering by offering peripheral gear that supplements, rather than competes with, IBM's, such as digital plotters.

The market may be expanding fast, but it is also fiercely competitive. James L. Pyle, assistant to the president of California Computer Products Inc. (Calcomp), Anaheim, Calif., says, “IBM made two price cuts and one threat last year, so that new independently made peripherals that were 20% to 40% below IBM in price are now only 10% to 20% lower.” But it's still possible to make a “nice profit,” he adds, if you are “equal to or better than IBM, able to convince the user that he should leave IBM peripherals, and better than most of the independents.”

That's a tall order. To satisfy it, the smaller companies find they must respond—and respond quickly—to the data processing customer's needs. Fortunately, as Richard J. Egan, marketing vice president of Cambridge Memories Inc., Newton, Mass., points out, “the data processing manager is a lot more knowledgeable today than he was a couple of years ago: he's learned he doesn't have to rely solely on IBM—he can buy equipment in bits and pieces, and a company like ours, which specializes in bits and pieces, can sell to him.”

Some of these bits and pieces compete directly with IBM products. At the Spring Joint Computer Con-

ference last month, for example, Data Disc Inc. of Sunnyvale, Calif., unveiled its Anagraph, the company's first IBM-compatible product [*Electronics*, May 8, p. 144]. Designed to operate with IBM 360 or 370 computer systems, this terminal provides display graphs and interactive alphanumeric characters at a significantly lower cost than the IBM 2260 it replaces, says Data Disc's president, Andrew O'Sullivan.

Another course, however, is to avoid a direct confrontation on just price by throwing in extra performance factors. Ian T. Ebel, product manager for end-user data storage products at Lockheed Electronics' Data Products division, Los Angeles, says his company competes

**Complementing IBM.** Double-density disk drive from Memorex.



basically by offering lower-price and higher-performance equipment than IBM. "We add some features that IBM doesn't have, such as an exerciser panel for testing each system."

A slightly different "better-than-IBM" approach is followed by Storage Technology Corp., Louisville, Colo. Thomas Kavanagh, director of special programs says, "Our dollar cost per box is higher than IBM's, but our box has higher performance. So on a cost-performance basis, we're lower than they are." For example, last fall, STC announced a magnetic tape transport that moves tape at 250 inches per second but costs more than IBM's fastest model, a 200-ips machine.

Calcomp, on the other hand, aims specifically at supplementing IBM's range. For instance, its computer output microfilm and digital plotters are peripherals compatible with IBM computers but not directly competitive with specific IBM products. When IBM took the giant step of increasing the capacity of its new disks to four times that of earlier equipment, Calcomp brought out a system with only half the new capacity—and with a reduced price, because many users don't need the greater capacity.

The larger independents, like Ampex Corp.'s Computer Products division, Marina del Rey, Calif., often make a complete line of IBM compatible equipment—ferrite core systems, disk storage units, and magnetic tape drives. "We have always leased at a price higher than IBM on some products, but our equipment isn't equivalent to theirs," says Thomas W. Harleman, manager of marketing. "For instance, our core memory might be four times as fast, and provide a 20% increase in throughput.

"Since a user may be spending \$50,000 a month to rent his computer system," Harleman continues, "the 20% increase is equivalent to a \$10,000 saving each month."

Thanks to the broad range of products Ampex makes for the computer industry, Harleman's attitude about IBM on occasion achieves the ultimate in independence. In discussing compatibility, he says with a wink, "We sometimes use the term Ampex-compatible CPU." □

## Consumer electronics

# CATV sparks challenge, but makers mark time

Designing receivers for CATV has become an issue between manufacturers and cablecasters; lack of standards is obstacle

by Gerald M. Walker, Consumer Editor

A quiet controversy has developed between television receiver manufacturers and cable TV operators over how to design and introduce sets for CATV. Manufacturers are reluctant to add to the costs of receivers and hesitate to go out on a marketing limb by making receivers dedicated to cable only.

As a result, design work at RCA Corp., Magnavox Co., GTE Sylvania Inc., and other set builders has been directed toward a combination over-the-air and cable receiver.

This approach, they hope, will keep skittish dealers happy about being able to sell the receivers for conventional reception and yet be ready to shove a foot into the cable door as soon as its expected growth spurt begins. However, set designers don't even know what frequencies to use for cable because the standards have not yet been set. Neither have the performance standards.

Cable operators want cable-only receivers, not merely the "cable-ready" sets being planned by the manufacturers. Cable has had to live with the existing receiver for 20 years, even though it is designed for over-the-air reception. Now, cable is moving from simple 12-channel transmission to 24 channels and more. This will require converters to be installed in homes to expand receiver capacities.

Additional channels will also intensify problems with cross-modulation, especially from the second 12 channels used to carry such special services as weather, news, and stock market information, as well as the uhf channels not now accommodated in the first group of 12.

Other problems experienced by cable receivers include oscillator instability and interference.

Cable television interests feel that they can influence manufacturers. While only 9% of the viewing public is now wired, industry estimates of 35% to 45% national penetration by the end of the decade encourage cablecasters to flex their muscles at set builders. In some cases, CATV transmission hardware manufacturers are affiliates or subsidiaries of companies that also make sets, thus turning the controversy into internal family affairs. The cable side says, "Build a set with the converter inside the cabinet, rather than with a nuisance add-on." The receiver side, mindful of the marketplace, says, "Over-the-air viewers must not be abandoned."

**Compromises.** No one seriously expects the cable industry to design its own receivers to lease or sell to cable subscribers because this type of investment would put a strain on finances needed to expand and modernize transmission systems. What most observers expect eventually from the bruhaha is a receiver with a multichannel selector available at the front end, but with the facility to use the selector—a converter—provided as a retrofit behind the set.

This compromise might answer the cablecaster's criticism about cluttering the subscriber's home with the set-top converter. Another long-range goal along this line might be a system of "block" conversion—that is, a switch on the outside of the set that a CATV installer could connect to an outside con-



## DIGITAL MEASUREMENT AND DISPLAY



## Best buys Better specs Bigger digits

More than 50 standard models of **api** digital measurement/display devices get your measurements up front with excellent readability, clean styling and the stable, reliable performance of MOS/LSI circuitry. DTL/TTL compatible BCD outputs . . . autopolarity . . . display hold, print command, polarity and overrange outputs . . . programmable decimal points . . . 0.1% accuracy . . . 100 db common mode rejection . . . 1000 meg. input impedance — are features common to most models.

For premium performance in a small size at low cost, the new 2½- and 3½-digit **api** 4350 Series offers remarkable brilliance and clarity in ½" planar 7-segment digits. Rugged, low voltage electrofluorescent tubes rated for 100,000 hours produce intense blue, green or turquoise display. Only 2.1" high x 4" wide.

For readability from 40 feet, the **api** 4300 Series units have ⅞" high, 7-segment planar displays of four digits. Panel space only 3" x 4.5"; separable power supplies save depth behind panel. DPM std. ranges to 19.99 mv and 1000 V, 19.99 ua and 199.9 ma. The **api** 4320 *Digital Temperature Indicator* also features isolated BCD output, 0.15% accuracy, 1°F. resolution. The **api** 4310 *Comparator* algebraically compares BCD input to a preset limit, for indication and on-off control. For complete specs and application help, write LFE, Process Control Division, 1601 Trapelo Road, Waltham, Mass. 02154. Tel. (617) 890-2000.



CORPORATION

Process Control Division

Circle 79 on reader service card

verter serving several homes. Again, the set maker could facilitate the process by providing the contacts so that the set would not need to be opened in the field.

Meanwhile, both sides of the issue agree that a lack of standards in frequency allocations for cable channels is the major stumbling block. A 22-man subcommittee of the IEEE's Coordinating Committee on Cable Communication is presently hashing out frequency allocation standards. In the past, only the cable operators worried about channel allocation, but now, set makers are involved. They point out that a truly cable-ready set tuner cannot be designed until the cablecasters get their house in order by establishing standard frequencies.

**Standards first.** Dr. Robert Powers, Office of Telecommunications for the Commerce Department, who heads the subcommittee, suggests, "Looking at the whole system—receiver and cable—it is critical to get standard frequency allocations first. When this is done, all other problems can be solved."

There is general agreement that lack of standards will hold up cable-ready receivers. Wilfred L. Hand, development engineer for GTE-Sylvania Commercial Electronics division, Batavia, N.Y., points out that there are not even standards for testing a receiver's performance on cable. This partially explains why set manufacturers and cablecasters have often come up with conflicting test data in the past.

"Until specifications are developed for a direct pick-up test, there will be no way to verify findings. We can only experiment with unqualified test sites, for there are no uniform rules. For example, how should we define the test field? Should the receiver be cable-terminated? Whether the receiver is turned toward or away from the transmitter can make a 10 dB difference in findings," Hand complains. He adds that an EIA committee is also working on these test standards. However, like the channel-allocation work, it will be some time before set manufacturers, the cable industry, and the public can expect

the best possible receiver for cable.

The Federal Communications Commission is in the act now, thanks to a maneuver by the National Cable Television Association, which petitioned the commission to rule in favor of a cable receiver. EIA, representing receiver manufacturers through its Consumer Electronics Group, felt compelled to reply that the NCTA position was overly restrictive, particularly in its requirements for tuner shielding and band-pass filter performance.

On the positive side, EIA has requested representation by set manufacturers' engineers on the technical committee of the FCC's new CATV advisory committee. And the association has recently added a cable transmission committee internally to induce cross-pollination of information between cable hardware manufacturers and set makers belonging to EIA.

But the standards-setters are looking 10 years down the road, while the contending industries are trying to work out their differences today. The result is tentative steps. For example, the RCA Consumer Electronics division, Indianapolis, Ind., has just announced a new 25-inch, solid-state color set with a "shielded system." Taking advantage of easy shielding of solid-state tuners, RCA engineers plan to expand this feature to other solid-state sets.

As for the future, Gordon Bricker, manager of cable TV development for the company states, "If the public becomes aware of cable, and if they are convinced they want the extra services promised by operators, and if the operators expand, there will be a potent situation. This would lead to a cable-only receiver, but there are a lot of 'ifs.'"

Magnavox provides a good example of how a manufacturer shifted interest away from a cable set. A year ago, its CATV division in Manlius, N.Y. (formerly Magnavox Craftsman) announced a cable-only receiver, called the 101. When the 101 was shown to the Consumer Products division, Fort Wayne, Ind., it was put on a back burner in favor of a cable/over-the-air design. A spokesman for the CATV division states that the 101 is not dead—only waiting for the rest of the industry to catch up with it. On the other

hand, a Consumer division engineer points out that part of the reason for abandoning the 101 was the difficulty in servicing the set. Meanwhile, Magnavox's Industrial division, also in Fort Wayne, is developing a new solid-state filter that has its transfer characteristics fixed by the solid-state substrate and never requires adjustment.

**How to do it.** The required rejection ratios for the adjacent sound carriers and adjacent picture carriers can be achieved by the use of lumped-constant traps. But these traps require accurate adjustment, says T. Parker Ellsworth of Magnavox; therefore, the solid-state filter designed specifically for adjacent-channel suppression should meet both the cablecaster's desire for interference-free tuning and the set makers' need to reduce service cost.

In Canada, where cable TV has achieved far greater percentage of penetration in major cities than in the U.S., set manufacturer Electrohome Ltd., Kitchener, Ont., has designed a prototype color TV receiver built around a varactor tuner. The special vhf tuner is extended in the high band so that it will cover seven channels below Channel 7 and five channels above Channel 13, requiring a frequency range of 132 megahertz to 246 MHz.

If a two-cable system is used, for example, a tuner selector can be arranged to identify the standard channels on one cable and the special channels on the second one. A band-switch selects the appropriate cable. The band-switch operates a dc-controlled diode rf switch to channel the rf signals for two cables to a single standard vhf tuner.

This tuner could be built into a module and installed as an add-on, according to the Canadian manufacturer. It could also mean elimination of the added cost of a uhf tuner; however, this step would require repeal of the so-called "all-channel law" which requires that each receiver have both a vhf and a uhf tuner.

Commenting on the cable TV receiver, Electrohome's A.T. Muma states, "It is important, for economic reasons, that a standard approach be proposed very shortly. It is also important to re-examine present legislation on all-channel tuners." □



# For built-in reliability, design with "Scotchflex" Flat Cable/Connector Systems.

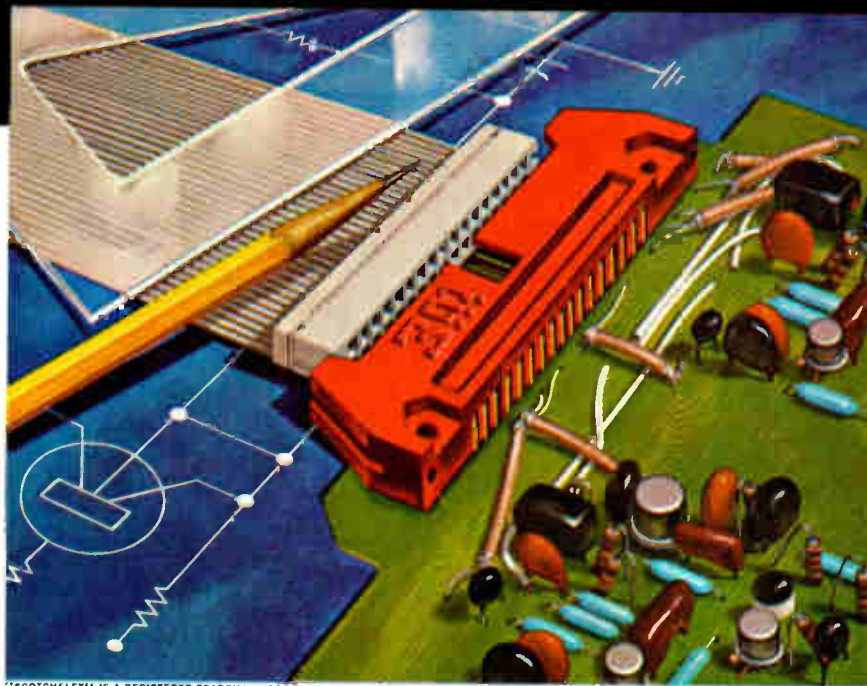

"SCOTCHFLEX" IS A REGISTERED TRADEMARK OF 3M CO.

"Scotchflex" Flat Cable and Connectors can offer you trouble-free packaging for your next generation equipment.

There's built-in reliability for your circuit inter-connects. Our flat, flexible PVC Cable has up to 50 precisely spaced conductors. The gold plated U-contacts are set into a plastic body to provide positive alignment. They strip through the insulation, capture the conductor, and provide a gas-tight pressure connection.

Assembly cost reductions are built-in, too. "Scotchflex" Connectors make up to 50 simultaneous connections without stripping or soldering. No special training or

costly assembly equipment is needed.

Off-the-shelf stock offers you flat cable in a choice of lengths and number of conductors from 14 to 50. Connector models interface with standard DIP sockets, wrap posts on .100 x .100 in. grid, or printed circuit boards. Headers are available to provide a de-pluggable inter-connection between cable jumpers and printed circuit boards (as shown). Custom assemblies are also available on request.

For full information on the "Scotchflex" systems approach to circuitry, write to Dept. EAH-1, 3M Center, St. Paul, Minn. 55101.

**3M**  
COMPANY

**Nobody  
can match  
Allen-Bradley's  
resistor cost**

**...on the board.**

**If you're really  
serious about cost,  
be serious about quality.**

Paying the lowest price doesn't mean you're getting the lowest cost. Many fixed resistor brands lose their identification in the PC board cleaning process. Some don't have true colors to begin with. Or the color bands darken and become illegible from the heat produced in normal

usage. The result is costly identification errors. Contrast this with the bright, crisp identification of Allen-Bradley's specially formulated paints. Baked on to resist aging, rough handling and solvents. Why gamble with questionable quality that can lead to unforeseen costs?

Learn the facts. Ask your nearest A-B distributor for our free booklet, "7 ways to tell the difference in fixed resistors." Or write Allen-Bradley Electronics Division, 1201 S. Second St., Milwaukee, WI 53204. Export: Bloomfield, N. J. 07003. Canada: Galt, Ont. U.K.: Bletchley, Bucks.

Circle 82 on reader service card

**ALLEN-BRADLEY**  
QUALITY ELECTRONIC COMPONENTS



# Bridging the analog and digital worlds with linear ICs

**General advances in linear integrated circuit processes, plus the existence of multiple sources for every popular circuit type, give the system designer an unusual abundance of performance and cost options**

by Laurence Altman, Solid State Editor

□ Although digital integrated circuits get most of the attention, linear and interface ICs have been coming on fast in their own right. Today they offer the system designer a cost-performance tradeoff unmatched by any other segment in the semiconductor industry.

The linear IC growth has been steady—not the digital stampede witnessed during the last few years, but a solid continuing increase in total circuit activity. Unit consumption is now growing at an annual 12%, and purchases by equipment manufacturers are expected to reach \$110 million by yearend.

Feeding this growth is a linear technology that is becoming ever more powerful. Each year innovations are added to the manufacturer's arsenal: high-breakdown transistor junctions, low-biased field-effect transistors, high-resistance epitaxial layers, lateral and vertical npns, more uniformly diffused resistor ladders, gold-doped emitters, and high-power heat sinks. It all adds up to more circuits from more suppliers providing more options to the equipment designer.

Look at the products available:

- Standard operational amplifiers selling for 25 cents a chip, low-cost high-gain duals and quads for the industrial and auto industry; super-beta and FET-input amplifiers with internal compensation, subnanosecond offset current, and slew rates as high as 50 to 100 volts per microsecond, for use in instrumentation and analog-to-digital conversion.
- Voltage regulators ranging from complex ICs that handle the power for an entire memory subsystem to

single 5-v card types for distributed supply systems.

- Digital-to-analog converters, from the cheap six-bit low-accuracy variety, suitable for simple panel meters, to eight- and 10-bit DACs with on-board voltage references and diffused resistor ladders, to be used in sophisticated process control.
- Phase-locked loop for a variety of uses—fm/i-f strip circuits, data synchronizers, tracking filters.
- Low-cost line-driver interface circuits that can drive 100 feet of transmission line from a single 5-v supply; multi-supply circuits capable of driving party lines of several thousand feet; new modem drivers conforming to the Electronic Industries Association interface standard for high-speed data transmission.

The first four of these groups will be discussed in Part 1 of this article, and the last—and most diverse—in Part 2. Then, too, there are all the varieties made for the booming consumer market, but these will be covered in a later issue.

---

### Part 1: Op amps and other linears

---

The first standard linear IC product, the operational amplifier, was offered in 1963, and is widely considered to have started the trend toward monolithic linear circuits. As Fig. 1 shows, it had all the essential features of today's circuits—low input parameters, high-gain structure, and high output slew rate. These same features, vastly improved, make op amps the most versatile components presently in the linear catalog and the work-

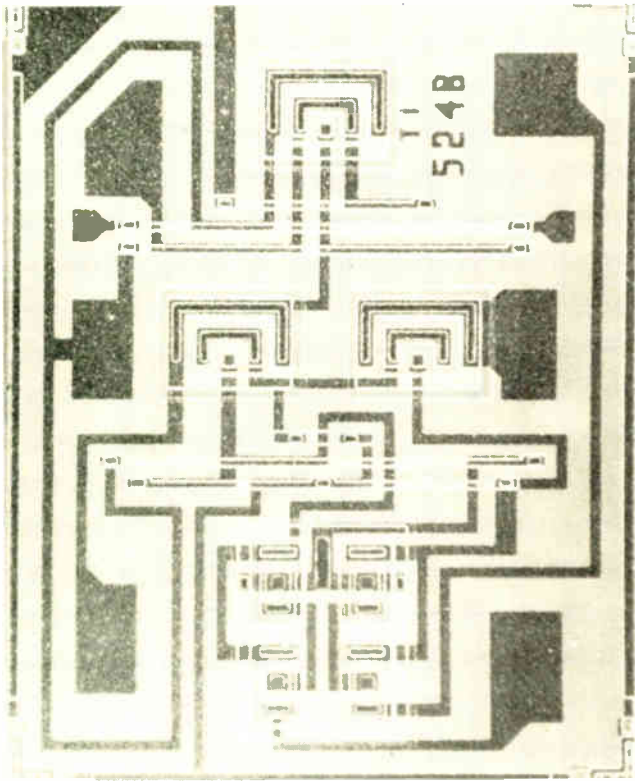

**1. Growing sophistication.** The first op amp introduced by TI (above) had transistors capable of handling only a few milliamperes. Below, a soon-to-be-announced core memory driver, also from TI, has digital logic, analog drive capabilities, and almost 1-A outputs.

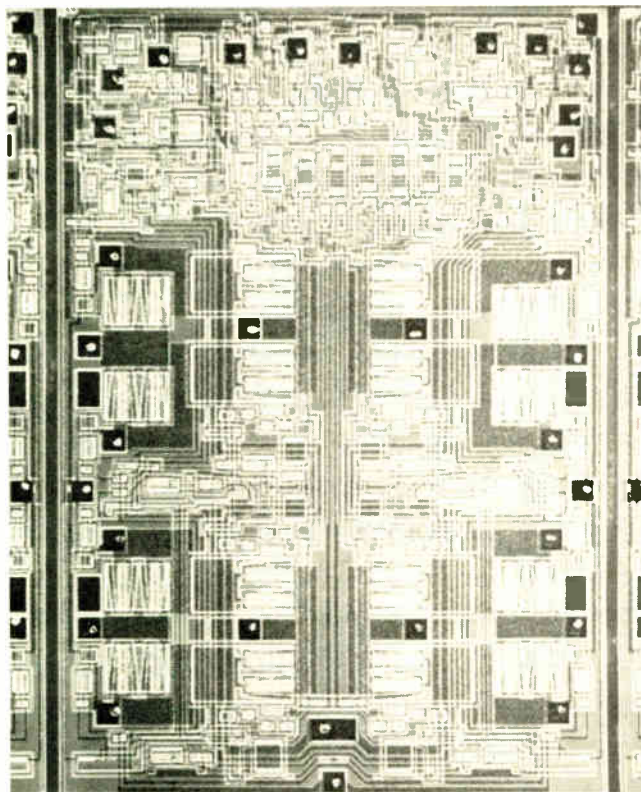

horse of the industrial market, which accounts for more than half the total of linear sales—\$50 million.

The op amp's utility derives from its role in feedback loops, the requirements for which determine its feed-forward characteristics. For this purpose, the ideal operational amplifier would have infinite input impedance, zero output impedance, infinite gain, and an open-loop 3-decibel point at infinite frequency rolling off at 6 dB per octave.

Clearly no such animal exists. But all sorts of approximations and tradeoffs of one parameter against the others are available to designers, generally offering them at least one device that can do the job—from simple unity buffers to complex generators, waveshaping circuits, and digital-to-analog converters.

### Op amps—multifarious and versatile

Table 1 compares typical op amps available today. From this table an equipment designer can pick a device to fit almost any general specification he has. For example, if it's low offset current that he requires for use at room temperature in an instrument, he might choose the type 108 or 108A. It offers 0.5-millivolt offset voltage and 0.2-nanoampere offset current, but at a sacrifice in speed—the 108's slew rate is only 0.2 V/μs. Type 741, on the other hand, although providing only moderately low input currents—1-mV offset voltage and 10-nA offset current—offers both the high gain (50 dB) and high slew speed (5 V/μs).

With op amps, it's always been a question of tradeoffs. An increase in the performance of the input has to be paid for in the output. In fact, many people feel the general-purpose amplifier has gone about as far as it can go in over-all performance. All that's left is trading off for a specific purpose.

Like many op amp manufacturers, Jack Gifford, product manager of Intersil Inc., Cupertino, Calif., feels that the new activity in the industry is to the realization of special-purpose op amps, aimed at specific applications, and away from the attempt to design a single device that can do everything. One such product is Intersil's new FET-input (type 8007) op amp that boasts exceptionally low input current: 0.5 picoampere typical, and 1 pA maximum (Fig. 3).

Nevertheless, it still retains reasonable performance in other parameters: slew rate—6V/μs; input impedance—1,000,000 megohms; internal compensation, and pin-for-pin interchangeability with the 741, the most commonly used op amp in today's designs.

Explains Intersil's manager of circuit development, Dave Fullagar: "During the past decade, the FET has become the accepted way of amplifying low-voltage currents. But you couldn't get monolithic FET-input ICs that didn't have stability problems over the full temperature range, and the best you could do was go to the expensive module or discrete device. The problem," he continues, "was that the FET-input op amps ran excessive gate currents at high common-mode voltage, drastically limiting their usefulness. So what we did was to use a bootstrap circuit to insure the good common-mode rejection."

Fairchild Semiconductor division, Mountain View, Calif., is another major semiconductor manufacturer

TABLE 1: SOME TYPICAL OP AMP SPEC COMPARISONS

25°C	Device Type									
	709	709A	741	748	101A	777	770	660	108	108A
Input offset voltage (mV)	< 5	< 2	< 5	< 5	< 2	< 2	< 4	< 3	< 2	< 0.5
Input offset current (nA)	< 200	< 50	< 30	< 200	< 10	< 3	< 2	< 5	< 0.2	< 0.2
Input bias current (nA)	< 500	< 200	< 200	< 500	< 75	< 25	< 15	< 15	< 2	< 2
Input resistance (MΩ)	> 0.040	> 0.085	> 1	> 0.5	> 1.5	> 2	100 typ	> 4	> 30	> 30
Large-signal voltage gain*	45,000	45,000	> 50,000	> 50,000	> 50,000	> 50,000	> 50,000	> 25,000 R <sub>L</sub> = 10 kΩ	> 50,000 R <sub>L</sub> = 10 kΩ	> 50,000 R <sub>L</sub> = 10 kΩ
Full-temperature										
Input offset voltage (mV)	< 6	< 3	< 5	< 6	< 3	< 3	< 7	< 5	< 3	< 1
Input offset voltage (μV/°C)	NS	< 25	< 20	NS	< 15	< 15	NS	< 25	< 15	< 5
Input offset current (nA)	< 500	< 250	< 500	< 500	< 20	< 10	< 5	< 5	< 0.4	< 0.4
Input offset current (pA/°C)	NS	< 500	< 200	NS	< 200	< 150	NS	< 40	< 2.5	< 2.5
Input bias current (nA)	< 1,500	< 600	< 800	< 1,500	< 100	< 75	< 35	< 25	< 3	< 3
Large-signal voltage gain*	25,000 to 70,000	25,000 to 70,000	50,000	> 25,000	> 25,000	> 25,000	> 25,000	> 25,000 R <sub>L</sub> = 10 kΩ	> 25,000 R <sub>L</sub> = 10 kΩ	> 40,000 R <sub>L</sub> = 10 kΩ
Output voltage swing* (V <sub>p,pk</sub> )	> 20	> 20	20	> 20	> 24 R <sub>L</sub> = 10 kΩ	> 24 R <sub>L</sub> = 10 kΩ	> 24	> 26 R <sub>L</sub> = 10 kΩ	> 26 R <sub>L</sub> = 10 kΩ	> 26 R <sub>L</sub> = 10 kΩ
Input voltage range (±V)	> 8	> 8	> 10	> 12	> 15	> 12	> 12	> 13.5	> 13.5	> 13.5
CMRR (dB)	> 70	> 80	> 70	> 70	> 80	> 80	> 80	> 80	> 85	> 96
Supply current (mA)	NS	< 4.5	< 4.5	< 3.3	< 2.5	< 3.3	< 2	< 1	NS	NS
Unity-gain slew rate (V/μS)	NS	NS	0.5 typ	0.5 typ	0.5 typ	0.5 typ	2.5 typ	> 0.1	0.2 typ	0.2 typ
Operating temp range (°C)	-55 to +125	-55 to +125	-55 to +125	-55 to +125	-55 to +125	-55 to +125	-55 to +125	-55 to +125	-55 to +125	-55 to +125
Operating supply voltage (±V)	9 - 15	9 - 15	9 - 15	15	20	15	15	20	20	20

\*R<sub>L</sub> = 2 kΩ unless otherwise specified

supplying monolithic FET-input op amps. Will Steffe, Fairchild's manager of design and development, analog products, feels that the low-input-current op amps are destined to have a significant impact on many common op-amp applications, and he cites log and antilog circuits (Fig. 3), photocell amplifiers, peak detectors, and sample-and-hold circuits as primary applications.

**The quad op amp: and the price is right**

Another tack recently taken by op amp designers works the lower end of both the performance and the price spectrum—multi-unit devices. Motorola Semiconductor Products Inc., Phoenix, Ariz., the first to pick up on this approach, has just announced a quad op amp—four devices on one chip (Fig. 4)—priced at \$1.75 per package. Type MC3401 is intended principally for industrial control systems and active filters in communications systems. Planners at Motorola feel a need exists for a low-cost, modest-performance op amp for industrial and automotive uses.

Ron Campo, Motorola's manager of linear IC product planning, points out that "at this price the automakers should also take a look"—for example, for fuel injection controls. With a gain of about 70 dB, Motorola's device costs about 2 cents per dB, a price that's difficult to beat.

The new device, which comes in a single plastic package, operates from supply voltages of 5 to 18 vdc, without the common-mode input voltage problems usually encountered when conventional op amps are operated from a single power supply.

The op amp is internally compensated (a feature not

usually found at this price), and uses a "current mirror" circuit rather than the usual differential amplifier to obtain a non-inverting input. This lets the user employ a conventional common-emitter input stage, which can be biased more easily from a single power supply. And despite the simplicity of the circuit, input bias current is only about 50 nA, while unity gain bandwidth is 5 megahertz, adequate for many gain block purposes. Output voltage swing is approximately 1 v less than the power supply voltage, showing the efficiency of the quad configuration.

Following Motorola, National Semiconductor Corp., Santa Clara, Calif., has recently announced a similar device—the LM3900—a quad op amp that is priced at 75 cents per chip. Offering essentially the same performance, the National chip, with its low price, should spark an even greater interest in multi-device, single-supply op-amp designs. Watch for other semiconductor manufacturers to follow suit.

Another growing demand among system designers is for fast op amps and comparators to interface with increasingly fast digital systems. Specifically, a comparator with a propagation delay of less than 10 ns would be a godsend to ECL and Schottky TTL systems—popular comparators today have delays greater than 40 ns.

To this end, Advanced Micro Devices, Sunnyvale, Calif., is developing a 10-μs precision comparator to interface the input of ECL logic systems. Possible applications include analog-to-digital converters, data acquisition systems, optical isolators, and processing of high-speed signals. With its ECL outputs, it could also be used

## SPECIAL REPORT

as a sensitive line receiver or sense amplifier—in 100-MHz sample-and-hold circuits, for example, and in high-frequency voltage-controlled oscillators.

Dielectric isolation is another method of obtaining fast linear circuits. Harris Semiconductor, Melbourne, Fla., one of the most active of the major semiconductor manufacturers in this technology, offers the HA2500 family of high-speed op amps that range in speed from 30  $v/\mu s$  up to 120  $v/\mu s$ . These internally compensated devices have low input parameters as well—typically 10-nA offset current, for example—and offer very fast settling time—200 ns to within 0.1%. And with their wide bandwidth and high gain (typically 18 MHz), these devices are becoming increasingly popular in d-a and a-d converters, pulse amplifiers, and high-frequency buffer amplifiers. In addition, they are radiation-hardened and meet Mil Std 883.

### Voltage regulators: going local

With voltage regulators, the big question is whether to stay with the centrally located regulator or go to on-card regulation. The option was given to digital system designers when National Semiconductor announced its type 109 device, an inexpensive single 5-v regulator, which comes in a three-terminal plastic package that can be put directly on a circuit card, and which offers regulation to within 1%.

Many digital designers like on-card regulation because it offers them the chance to deal with supply regu-

lation at the same time as they are partitioning the card, making the function an integral part of the circuit instead of an afterthought.

Perhaps more important, on-card regulation addresses fundamental problems peculiar to digital systems. Because of the relatively low-voltage, high-current requirements of these systems, heavy power buses must also be used with a centrally located regulator in order to distribute the voltage. Indeed, because of the high currents, voltage drops in connectors and conductors can cause an appreciable percentage change in the voltage delivered to the load. And this is made worse when TTL is used because during switching it draws transient currents much higher than the steady-stage current.

The 109 solves these problems by providing regulation where it is needed—right on the card. Actually, rough regulation is first employed to distribute the power without excessive concern for line drops. Then the local regulators smooth out the voltage variations due to the line drops and also absorb the transients.

The 109 also has the virtue of being quite simple to use requiring no external components. It has three active leads—input, output, and ground—and comes in standard TO-3 and TO-5 packages (1 ampere and 200 milliamperes, respectively). The device employs internal current-limiting, thermal shutdown, and safe-area compensation, rendering it practically blowout proof. And because of its growing popularity, many semiconductor manufacturers are developing a  $-5$ -v companion supply, which will probably surface in the market in the third quarter of this year.

As for the centrally-located regulator, there are types

**2. The integrated FET.** Today's monolithic FET-input op amps offer the same low offset currents as the hybrids but at a generally lower price. These Intersil devices (ICL8007)—hybrid (left) and monolithic (right)—come in TO-5 packages.

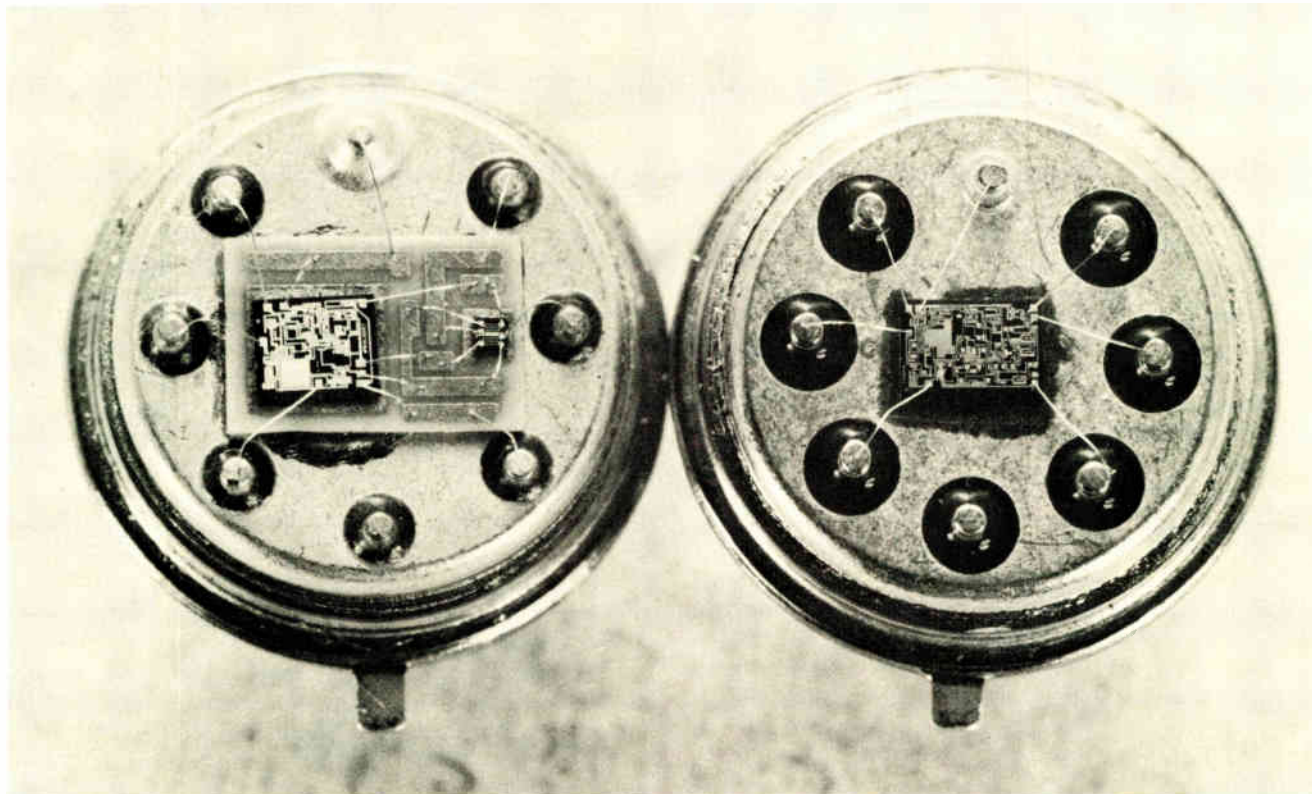

to fit almost any application. An example of the precision voltage regulators is the Fairchild  $\mu$ A723C, which gives 0.01% regulation for both load and line. This device has an output voltage adjustable from 2 to 37 v and an output current of 150 mA, and can supply +40v. It's useful in laboratory power supplies, or as an isolation regulator in low-level data systems.

For high-power applications, Motorola's MC1560 is available, which because of its large power transistors can handle current loads as high as 500 mA and powers up to 17.5 w. And if a single external transistor is added, load currents over 10 A can be accommodated.

A sampling of the voltage regulators that either are available or soon to become available is pictured on page 93.

### The new DAC game: 10 bits on a chip

Digital-to-analog monolithic circuits that were previously impossible to build with acceptable yield are by now becoming production realities. The 10-bit digital-to-analog monolithic converter (model DAC02) developed by Precision Monolithics, Santa Clara, Calif., is a case in point. Until it came along, only 6-bit monolithic DACs were available. But with its advent, data conversion is no longer the sole province of expensive and hard-to-implement hybrid and discrete modules.

Although several manufacturers currently provide monolithic DACs in four- and six-bit varieties, these chips often require additional circuitry for complete voltage-output d-a conversion. Most difficult to integrate have been stable voltage references, resistor ladders, and high-speed internally compensated op amps. Some chips provide current sources, current switches, and ladder network minus the voltage reference. Others provide the voltage reference, current sources, and switches, but not the resistor ladder.

With these DACs, the omitted circuit elements must be added by equipment designers, resulting in a larger package count, taking up more board space, and increasing the cost of assembly.

The first linear version to qualify as a LSI chip, the Precision Monolithics DAC, is built on an 82- by 148-mil chip (Fig. 5a), in an 18-pin dual in-line package. It achieves linearity guaranteed to within 0.05% plus 1- $\mu$ s settling time over the entire 0°C to 70°C range.

The circuit is not only a complete 10-bit-plus-sign DAC unit—it also incorporates a high-stability voltage reference and an internally compensated high-speed output op amp, a reference-buffer amp, a temperature-compensated current-source driver amp, a polarity-inverting amp, matched current sources, Schottky-clamped current switches, and a diffused R-2R resistor ladder. The noninverted positive logic decoding provides resolution equal to a conventional 11-bit offset binary converter.

In operation, an internal voltage reference sets up a regulator amplifier which drives the bases of 10 transistors used as constant current sources (Fig. 5b). The binary-scaled currents are generated by connecting each current source's emitter to a tap on a R-2R ladder. Current-steering logic switches each bit current either to ground or to an output sum line. A logic-controlled current-polarity-inverting amplifier drives the internally

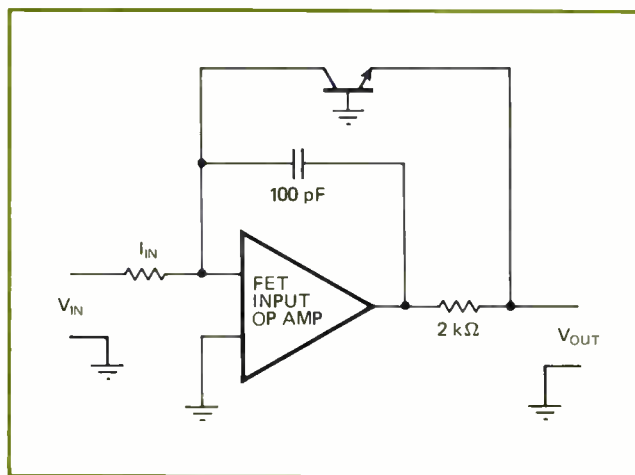

3. Basic log amp. Because of the extremely low-offset current, FET-input op amps make good log amplifiers. Inputs below 1 pA and slew rates of 6 V per microsecond are available from today's monolithic FET op amps for instrument and laboratory applications.

compensated high-speed output op amp, which converts the summed currents to a low-impedance output voltage.

A buffered reference-voltage input pin lets the user select the internal reference or apply an optional external reference, giving him extra flexibility in applications where several DACs must be slaved, or in closed-loop servo systems where the feedback potentiometer's reference sense must track the DAC reference. Full-scale output is adjusted by dividing the reference voltage with a potentiometer—the temperature coefficient of the pot is unimportant, provided that it's the same on either side of the pot. If so, the DAC will perform linearly with reference voltages varying from +6.7 v down to nearly 0 v, allowing operation as a moderate-speed two-quadrant multiplying DAC if desired.

Significantly, the device provides positive logic for both the magnitude bits and the sign switch; that is, an input of all logic 1s produces a full-scale output of positive polarity, while an input code of (0)1111111111 produces a negative full-scale output. The logic input levels of 2.0 v and 0.8 v respectively are compatible with TTL and DTL operation with full noise immunity. Because logic input current is only 10  $\mu$ A at any logic level and because logic levels of +15 v to -5 v are available, direct interface with MOS and C/MOS elements is an additional advantage.

Precision's DAC has many advantages over older six-bit voltage-switching techniques. It is faster because it uses Schottky-clamped, nonsaturating logic. The current-steering method obviates on-off switching of the individual bit current sources, preventing transients from propagating on the R-2R ladder, yet providing constant loading on the current-source baseline driver amplifier. Then, too, the bit currents are summed in the current-source output line, and are switched alternatively, depending on the state of the sign bit, between the inputs of a current-inverting amplifier. The polarity-controlled currents are then converted into a voltage by an internally compensated fast-inverting op amp. Significantly, no loss in speed results from this conversion, as is the case whenever external operational amplifiers are used

## SPECIAL REPORT

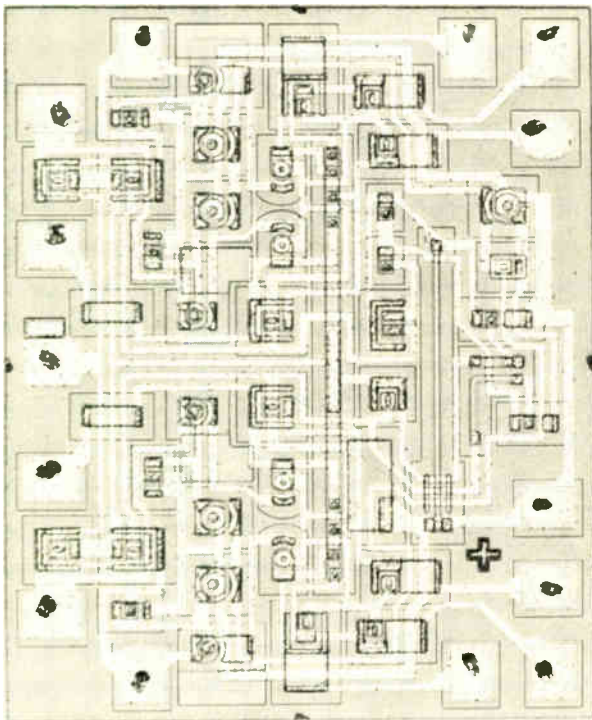

4. **Four score.** Motorola's MC3401 quad op amp (four on a chip) operates from a single 5-V supply. Its low price makes it attractive for safety and pollution control devices in automobiles, as well as for industrial process control, where only 5-V supplies are available.

along with the four- and six-bit DACs.

Such a high-resolution monolithic DAC provides extreme flexibility for the user. He may choose between the internal reference and a variable external reference to track other system elements, obtain even greater temperature stability, or allow it to operate as a two-quadrant-multiplying DAC. The sign-magnitude coding provided by this kind of device has natural application for voice and music reconstruction, servo controls, and instrumentation applications, or the DAC can be used directly in any 10-bit unipolar coding application.

### Varying the coding

The chip's layout is tailored so that minor masking changes will produce a variety of other coding schemes, including offset binary and true two's complement codes. Another code easily provided is three-digit BCD output: the layout actually includes 12 individual current sources and has provision for built-in scaling resistors over decades. These two popular codings will be made available shortly by Precision Monolithics.

Another option that can be produced from basic DAC design is a very-high-speed, high-compliance current output device for displays and fast a-d converters. Complementary (inverted) input logic is yet another easily realized option. It is evident that almost endless combinations of codings and outputs can be provided by simple metalization changes, providing a flexibility rarely found in integrated circuits.

The Motorola DAC (model MC1406), although only

sporting six-bit resolution, is also an innovative circuit, for it uses diffused resistor ladders where the more costly hybrids resort to Nichrome resistors (Fig. 6). It also features a constant-current-steering network, controlled by digital inputs, for switching current either to the output or to the positive supply. This is an important feature, since it maintains the constant current in the diffused ladder resistors that is necessary to reduce the parasitic capacitances associated with them. Also, the speed of the current-steering network makes it possible for the converter to settle to within one-half of the least-significant bit in 200 ns, opening up many speed applications in digital communications, instrumentation, cathode-ray tube displays and a-d conversion. Finally, the price is attractive—\$3.95 in quantities of 100.

One point should be noted when the MC1406 is used for high-speed purposes: unlike the Precision Monolithics unit, current-mode output was preferred to a voltage-mode output so as to boost speed. Consequently, if a user obtains a voltage output by adding an external op amp, he pays the price of a speed reduction caused by the slew rate limitation of most such amplifiers.

### Frequency stability: try a phase-locked loop

The phase-locked loop is a long-established method of obtaining error-free tracking of frequencies in signal processing. It is only recently, however, that linear chip processing has progressed to the point where all the elements of the phase-locked loop (PLL) could be integrated—voltage-controlled oscillator (VCO), phase comparator, amplifier, and low-pass filter.

Signetics Corp., Sunnyvale, Calif., was first to develop a family of monolithic PLL circuitry. But close behind were National, Motorola, Fairchild, Advanced Micro Devices, and now Texas Instruments and RCA Corp.

The Signetics standard product family, which is the largest, includes five general circuits: signal conditioner and demodulator systems (560, 561, and 562); an adaptable filter and demodulator (565), for the frequency range from 0.001 hertz to 500 kHz; and a tape decoder (567) with the same wide frequency range. These PLL circuits are found in a variety of communications equipment—tone decoders, and fm/i-f strips, telemetry decoders, data synchronizers for signal reconstruction, signal generators, modems, tracking filters, and frequency-shift-keying (FSK) receivers.

Gary Kelson, section head and linear circuit R&D specialist for Signetics' PLL design group, says, "Two outstanding uses of PLL circuits we've seen in the last few months have been in fm demodulation, FSK systems, and frequency multiplication. For example, the 565 phase-locked loop is now being used for highly linear fm demodulation."

In these systems, the average dc level of the phase comparator output signal is directly proportional to the frequency of the input signal. As the input frequency shifts, it is this output signal which causes the voltage-controlled oscillator to shift its frequency to match that of the input. Consequently, the linearity of the phase comparator output with frequency is determined by the voltage-to-frequency transfer function of the VCO. Thus, because of its unique and highly linear VCO, the 565 can lock on and track an input signal over a very wide range



**Comparing comparators.** Pioneered by National, this LM111 comparator is less susceptible to spurious oscillations than comparators like the 106 or 710. This wafer is from Advanced Micro Devices Inc., Sunnyvale, Calif.

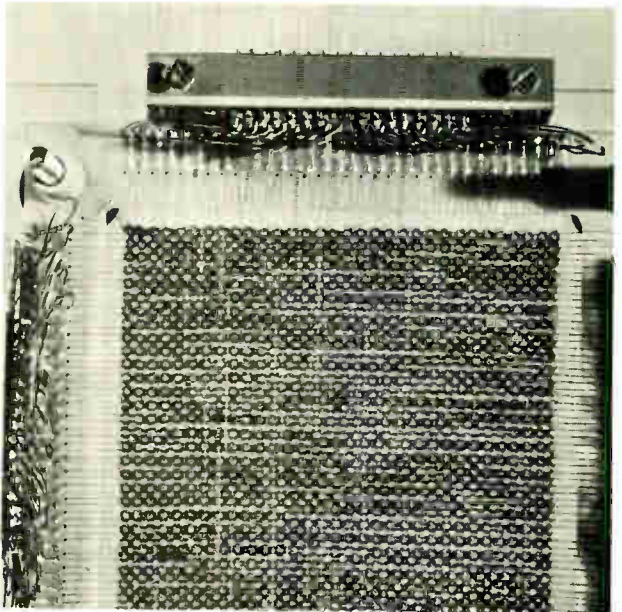
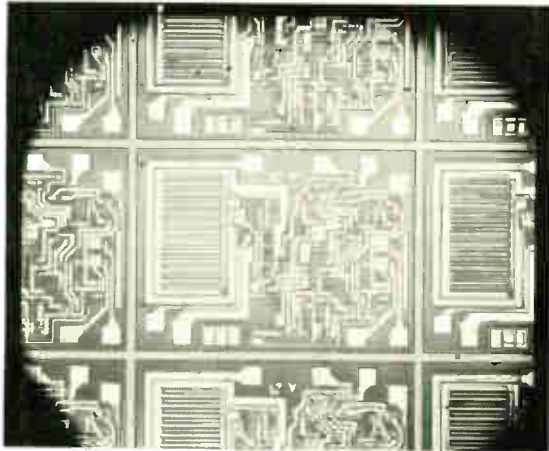

**The core of things.** Core memories require very advanced processing in the linear and interface segments. The driver (above) interfaces with complex core memories (below). Soon to be announced by TI, the chip contains logic and driver.

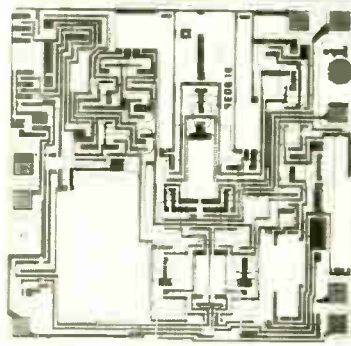
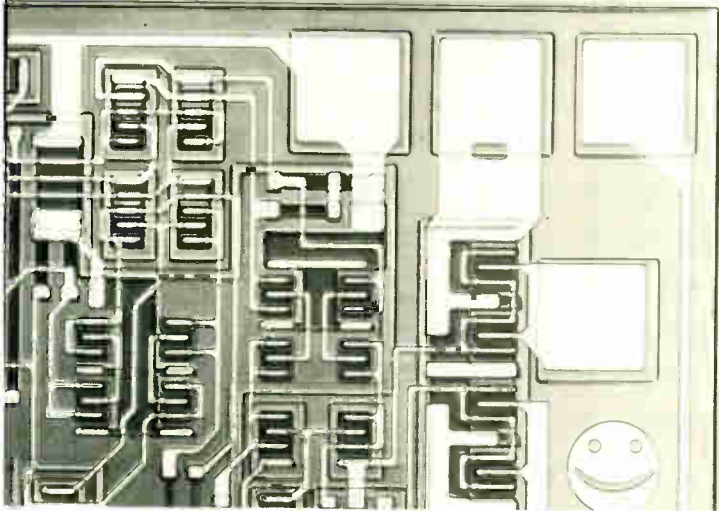

**Making a quick comparator.**

The first in a new family of high-frequency linears is this comparator from AMD. With a propagation delay of less than 10 ns, it's ideal for a-d converters, isolators, sense amps, and VCOs.

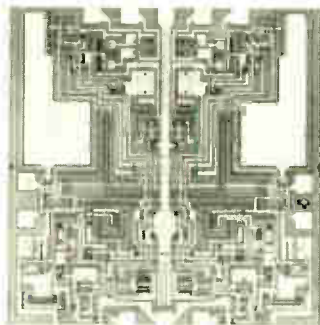

**It's fast.** Designers needing high speed often turn to dielectric-isolated op amps, like this Intersil device (2520). It has a slew rate of 120 V/μs, a settling time of 200 ns to 0.1%, a gain bandwidth product of 30 MHz.

**Double it.** High gain and wide range of operating voltages make Motorola's dual 741 (MC1553), a pair of matched op amps, particularly useful for summing and integrating.

# SPECIAL REPORT

(typically +60%) with very high linearity (typically, within 0.5%).

Frequency-shift keying, a common method of carrier transmission, refers to data transmission by means of carrier which is shifted between two preset frequencies. This shift is usually accomplished by driving a VCO with

the binary data signal so that the two resulting output frequencies correspond to the 0 and 1 states (commonly called space and mark) of the binary data signal. The use of a VCO makes phase-locking the ideal method for stabilizing the frequency involved.

A simple scheme using the Signetics 565 to receive FSK signals of 1,070 and 1,270 Hz is shown in Fig. 10. As the signal appears at the input, the loop locks to the input frequency and tracks it between the two frequencies

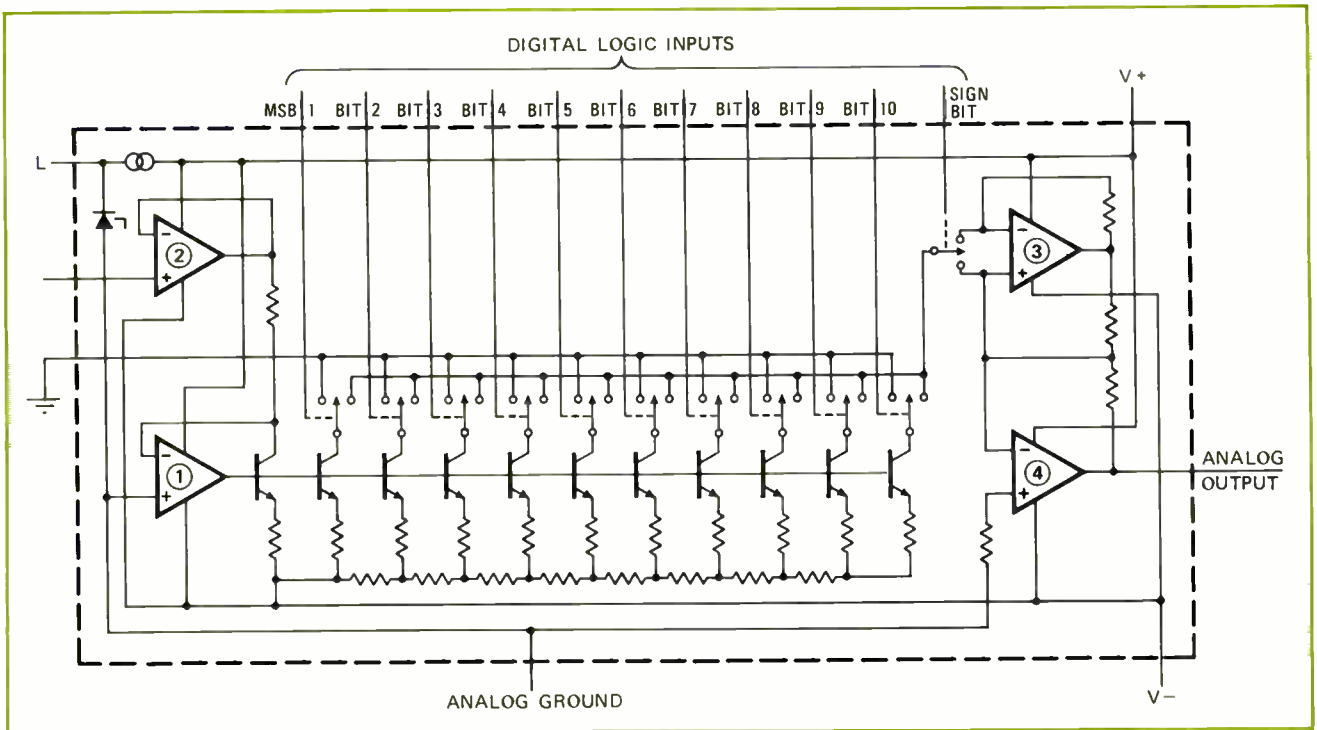
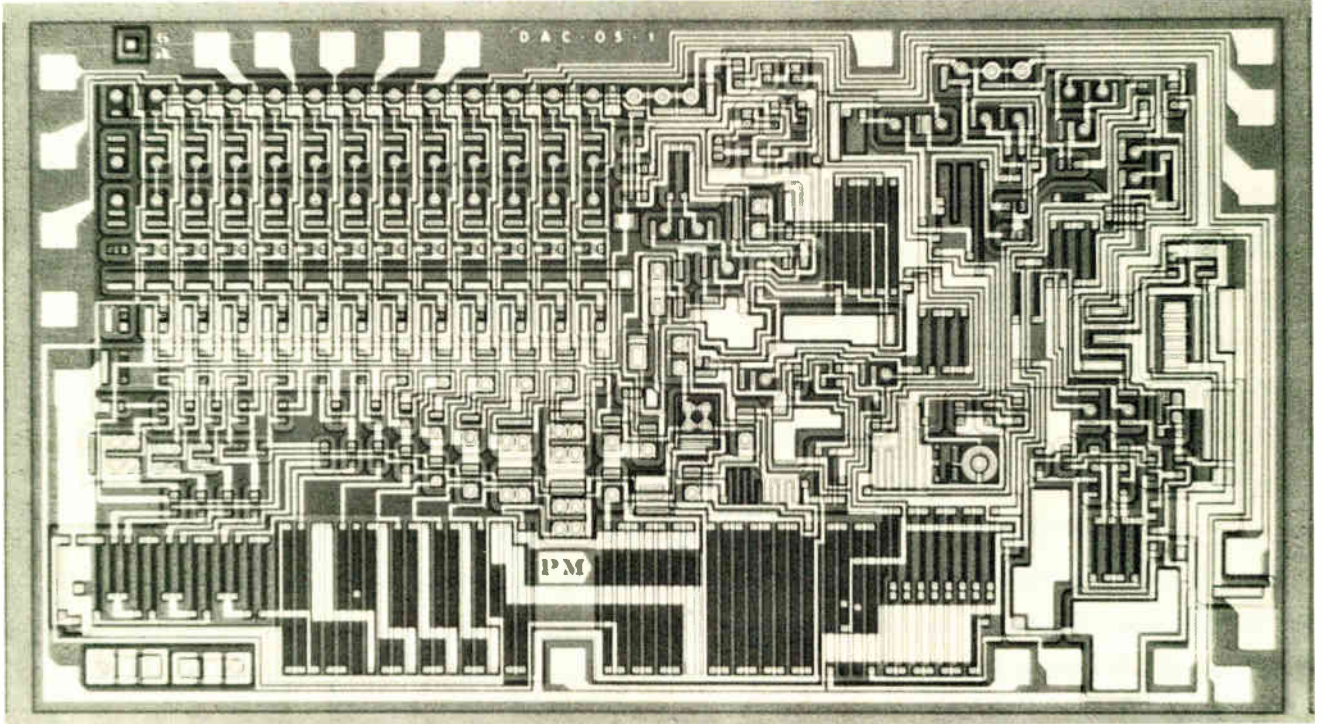

5. **The bit game.** Precision Monolithics is the first to put the full 10-bits-plus-sign on a single (82-by-148-mil) chip. The DAC02 has all the elements needed for 10-bit conversion—stable voltage reference, resistor ladder, and op amp output. The resistor ladder is diffused.

with a corresponding dc shift at the output.

In this setup, the loop filter capacitor is made smaller than  $C_1$  to eliminate overshoot on the output pulse, and a three-stage RC ladder filter removes the carrier component from the output. The band edge of the ladder filter is chosen to fall approximately halfway between the maximum keying rate (in this case 300 baud or 150 Hz) and twice the input frequency (approximately 2,200 Hz). The output signal is made logic-compatible by connecting a voltage comparator between the output and input of the loop. The free-running frequency is adjusted with  $R_1$  so as to result in a slightly positive voltage at the output at  $f_{in} = 1,070$  Hz.

The input connection is typical for cases where a dc voltage is present at the source, and therefore a direct connection is not desirable. Both input terminals are returned to ground with identical resistors (these values were chosen to effect a 600-ohm input impedance).

A phase-locked-loop circuit recently made available is the XR210, designed specifically for modem applications—decoding or encoding frequency-shift-keyed signals into binary data rates for transmission over telephone lines. Its principal feature is that it can handle data rates up to 1,800 bits per second, as well as data rates in the 300-bit-per-second range. Other PPL modems usually can handle only the lower rates.

Equally important, the 210 is TTL-compatible, a feature not included in competing modem chips, which require an additional IC to achieve compatibility. The 210 can operate from a single power supply (5 to 26 v) instead of the  $\pm 6$  to  $\pm 12$  v required by the others. The device, which comes in a 16-pin dual in-line package, can be used to interface teletypewriter or computer terminals with voice-grade telephone lines.

## Part 2: Interface circuits

One of the fastest growing sections in the linear IC catalog is the one listing interface circuits. Providing the junction between two pieces of equipment in a system, these ICs can be either all-analog, all-digital, or more usually a mixture of analog and digital elements. But they are considered part of the linear IC product line by most semiconductor manufacturers (National is an exception) because they invariably require the same high-current transistor outputs or low-input-sensitivity processing that are the hallmarks of linear ICs.

Interface circuits are used wherever data must be passed between two points—between computer and nearby terminal (all digital), between computer and remote terminal (front-end digital, output analog), or between sensing and recording equipment, such as thermo coupled and recorder (all analog).

Altogether, there are four major categories—line drivers, memory drivers, sense amps, and peripheral drivers—with most of the action occurring in the first three. TI, the world's largest manufacturer in the field, is bullish about their prospects.

Of the four types, line drivers were the first interface circuits to be developed. Figure 6 shows the three types of data transmission systems that employ line (including modem) drivers. Table 2 gives a list of circuits used in these systems, plus the catalog designation and supplier

that first announced the device (linear circuits are widely second-sourced throughout the industry).

As shown in the table, line drivers and receivers are further divisible into three varieties: circuits operating from a single 5-v supply, circuits operating from multiple power supplies, and circuits that conform to the EIA RS-232 modem interface specification, including the largely developmental tri-state output circuits for party-line use.

The single-supply line driver and receiver circuits are used in medium performance twisted-pair transmission (Fig. 8a). These are short data transmission lines for low data rates/say, up to 100 feet at less than 20 MHz.

In these systems, the transmitted data takes the form of a voltage level operating at fairly high currents—for most 5-v families, currents as high as 40 to 50 mA can be produced at standard TTL drive levels. The high power is needed to overcome line losses. If the line losses are low enough, the output capability can be relaxed—a few milliwatts will do in most cases. In addition, the receivers can have sensitivities in the 1-mV range. "These are strictly for cheap and dirty transmission line requirements," says TI's line circuit product manager, Bill Whittekin, "and that's why we can get away with the single +5-v power supply."

The higher-performing line drivers and receivers, requiring the multiple-supply circuits, are used on transmission lines up to several hundreds of feet at data rates

**6. A d-a bargain.** This 6-bit monolithic DAC from Motorola (MC1506) costs less than \$4 in 100-lot quantities. It, too, uses a diffused-resistor ladder, instead of wire film, offering conversion at a price unattainable with hybrids.

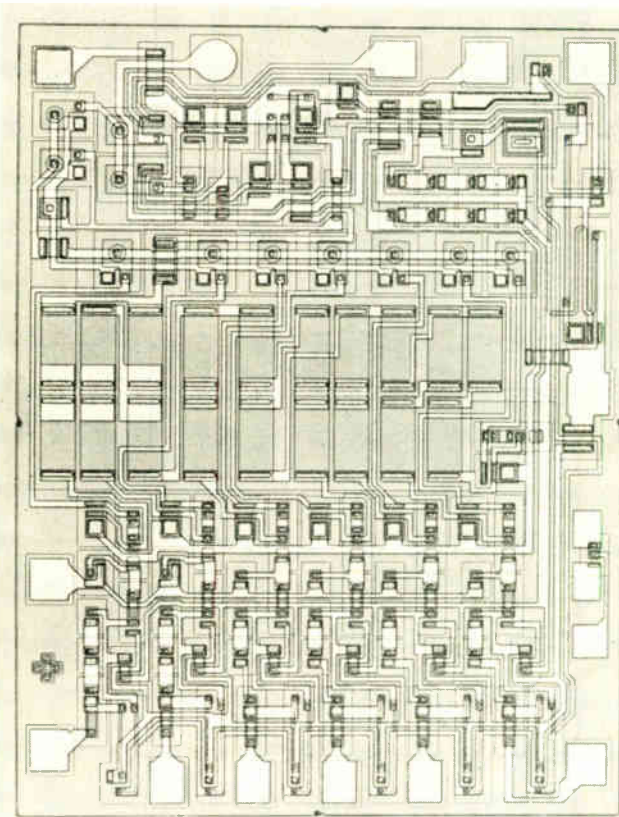

## SPECIAL REPORT

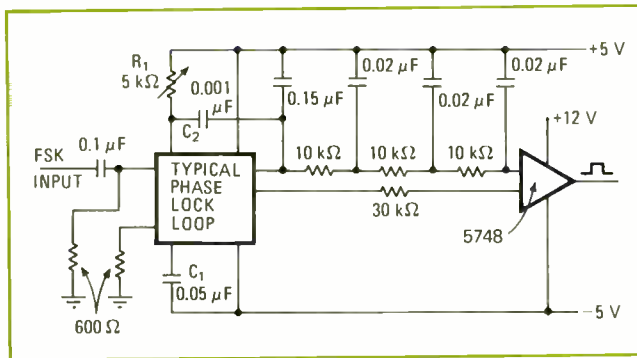

7. **Locked in.** For frequency shift keying, a phase-locked-loop circuit should have a filter capacitor ( $C_2$ ) of less than  $0.05 \mu\text{F}$  in order to eliminate overshoot on the output pulse. The RC ladder filter removes carrier component from output.

often exceeding 20 MHz. However, says Whittekin, "the tradeoff between line length and frequency must be made. If you want to go down low enough in data rate—say, into the kilohertz region—you can drive a transmission line a few thousand feet long: the telephone company does this every day."

The multiple-supply circuits are more complex, capable of outputs up to 100 mV, and with receivers capable of detecting signals as low as 1 mV. This performance is possible because the transmitted data takes the form of a constant current, generally kept at a low level of about 10 milliamperes so that line losses can be minimized and line length maximized.

The line is terminated in its characteristic impedance, and because current and impedance both are low, its output voltage levels are small, and it requires a more sensitive receiver. This means that the receivers need more than just the normal logic gate in the input. Often the same type of low-sensitivity front end that is built into many op amps is required here.

The third variety of line drivers and receivers—those meeting the EIA RS-232 specifications—is used as shown in Fig. 8b to transmit data between terminal equipment such as teletypewriters and line printers. The RS-232 specification was developed when telephone users won the right in court to use their own peripheral driver and receiver equipment on a telephone company's lines.

All RS-232 circuits operate in conjunction with a modem—a modulator-demodulator unit that processes data for transmission over telephone lines. In effect, the modem set, usually the size of an office typewriter, works with data-processing equipment and converts bipolar (digital) signals to acoustic signals at the transmit end and then re-converts acoustic signals to bipolar at the receiving end, where another modem is located. Receiving and transmitting are normally accomplished over communication lines which require interface circuits that meet the EIA RS-232C specification.

The EIA specification defines the interface on the digital portion of the modem. Essentially this means that the RS-232 drivers must be capable of driving 50 to 100 feet of cable, while withstanding output short-circuit conditions of 25 V. An RS-232 receiver, in turn, must

withstand +25-v signals excursions on the input.

To meet the +25-v input condition, the receivers have a cascaded input structure with an attenuator on the front end. To meet the short-circuit condition, the driver incorporates high-voltage-breakdown transistors in a collapsing-circuit technique that shuts off the output current when a certain voltage level is exceeded.

Two of the newest line circuits to be developed are TI's dual line driver, the SN75150, and its companion receiver, the SN75152. The driver has a dual power supply, so that it can be operated either from a +12-v supply, normally used for telephone lines, or from a +5-v supply, normally used with TTL or DTL systems. In addition, the receiver has a 3- to 7-kilohm input resistance over the RS-232C voltage range, high enough for most peripheral applications, plus an active "pull-up" on output for more symmetrical switching speeds.

Again, to meet the EIA RS-232 specification, outputs for the driver are current-limited for short-circuit protection to +25 v. Output voltage levels are nominally +6 v and are designed to drive capacitive loads greater than 2,500 picofarads, enabling the device to interface with all commercially available modems.

Because most modem sets use two receivers for each driver, the driver units are supplied as duals and the receivers as quads. This arrangement reduces the number of IC packages required in a modem design. According to TI's Whittekin, major applications for these types of drivers and receivers are computer time-sharing services, data-processing equipment, and other uses that call for relatively short single-line point-to-point data transmission and for level translators.

The 150 driver, which dissipates only 200 to 300 mW, normally comes in an eight-pin dual in-line package, but is also available in 14-pin ceramic and plastic dual in-line packages. The 154 quad line receiver comes in 16-pin ceramic and plastic dual in-line packages.

### The third state: another option for the user

Being ideal for party line applications, line drivers and receivers with three-state outputs are growing in popularity. The basic party line or data bus differential transmission line, where six parties share a common transmission line, is shown in Fig. 8c. By providing a high-impedance output state, in addition to the conventional low-impedance, high- and low-current states, equipment at any location can be switched into the high-impedance (off) state when not in operation.

National Semiconductor has pioneered in three-state output devices, for digital as well as linear applications. Quad drivers that are rapidly becoming the industry standard are National's DM7831/DM8831. Although intended primarily for computer logic manipulation, they can also drive transmission lines in a party line application. (A typical three-state party line configuration developed by the company for its 7831/8831 pair is illustrated in Figs. 10a and 10b.)

In addition, Dale Peppinger, applications specialist at TI, has designed a new circuit (Fig. 11), which tells the party line user when the line is open. Essentially, the circuit monitors the transmission line and provides an inhibit control to the local driver when the line is busy. When no data is being received from the line, the re-

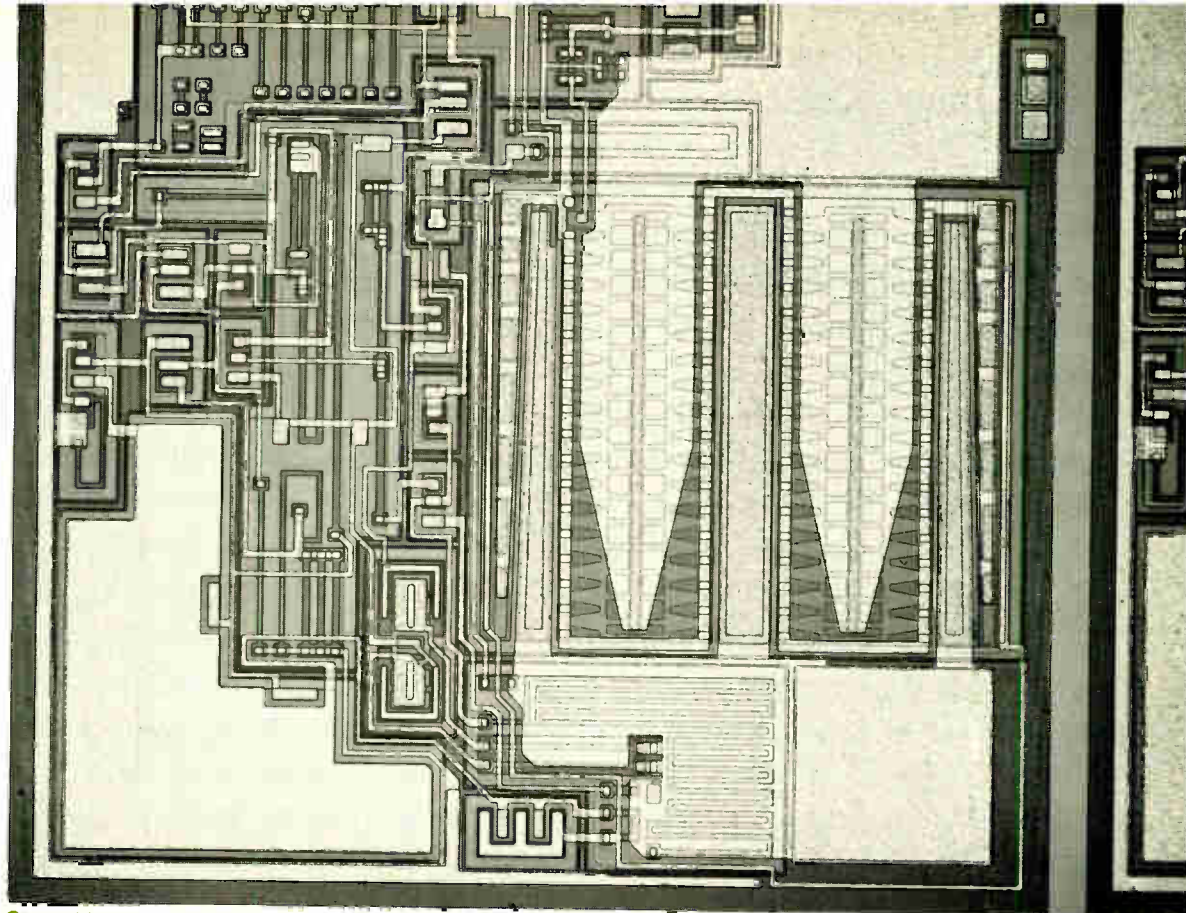

**Current to burn.** Fairchild's 7800 series of voltage regulators offers the user high current outputs, as well as pre-set voltage outputs. It's rated at 1 ampere for devices step-ranged from 5 to 24 volts.

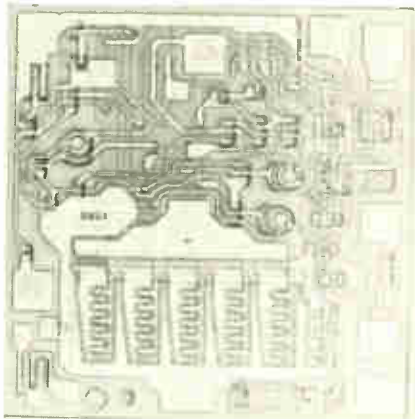

**Regulated power.** At left, Motorola's MC1560 regulator can deliver continuous current: up to 500 mA (17.5 W) without external transistor. Notice large transistors on chip.

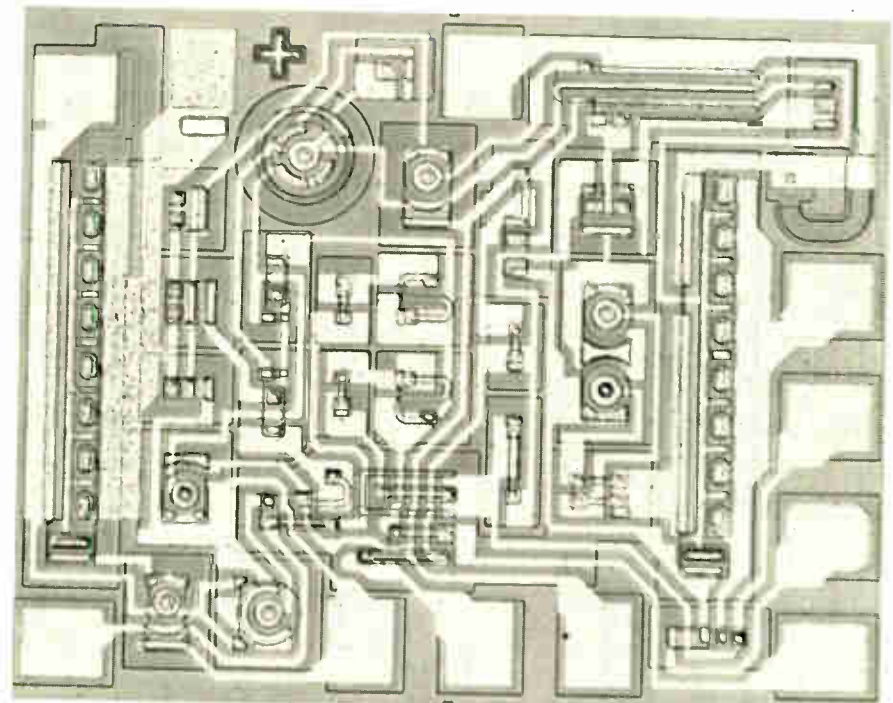
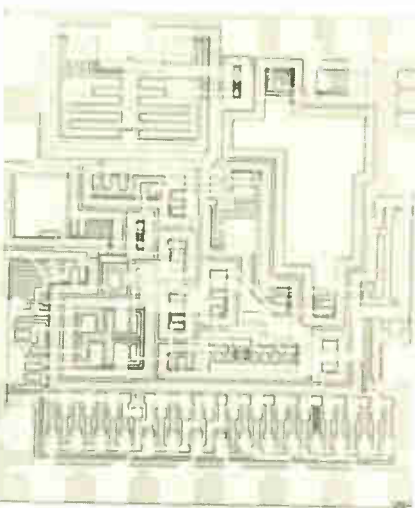

**Covering the range.** Designed for systems requiring both a positive and a negative voltage regulator, this device has a  $\pm 15$ -V regulation. Motorola will soon announce it (the MC1568).

**It's programmable.** Voltage regulators that can be pre-set through a range of voltages solve the regulation problem of multi-supply systems. TI's 401 chip on left provides 2.5–37.5 V.

# SPECIAL REPORT

triggerable one-shot releases the line driver for operation. Before data is fed to the driver input, the local enable control input is set in its high-voltage state. The line-sense amplifier is then inhibited to prevent interference with local driver. The local driver may then transmit on the line.

## Computers: demanding more interfacing

Computers and peripheral equipment are prime consumers of line drivers. This is because low-power logic circuits can transmit data only over very short distances—at most a few inches—and a system designer must go to independent line circuits if error-free data transmission over longer lines is required. Add to this the burden of noisy computer environments, and the problem of selecting suitable transmission line drivers and receivers becomes formidable. This is especially true when data is transmitted between computer consoles or between a computer and distant peripherals.

A typical computer interface system is diagramed in Fig. 12. A balanced, twisted-pair transmission line is terminated in its characteristic impedance so that both lines are biased at a few hundred millivolts. When the driver converts input logic levels to voltage levels that

control a current switch, the switch unbalances the voltage on the transmission lines, resulting in a difference voltage at the receiver input.

Usually the input of the receiver has a differential-input stage that exhibits high rejection of common-mode input signals. Intermediate stages convert the polarity of the input signal to the desired logic levels at the receiver output. Moreover, the driver output is capable of rejecting common-mode signals induced on the line, which also aids recovery of data.

An important feature of the system of Fig. 12 is that provision can be made for removing the driver output current from both lines. Again, this is the party line application, since in this inhibit mode another driver may be used to transmit data over the line.

Adding strobes or gates to the receivers, moreover, will allow any driver to communicate with any or all enabled receivers, while other drivers are inhibited and other receivers are strobed off. This version of the system is shown in Fig. 13. Line receivers and drivers may be connected anywhere along the line, so that a single transmission line can be made to serve several computer or peripheral-equipment consoles.

In most transmission systems, each line driver accepts TTL input levels and converts them into an output current that is supplied to one of the lines of the two-wire system. To select the correct line to be driven, systems

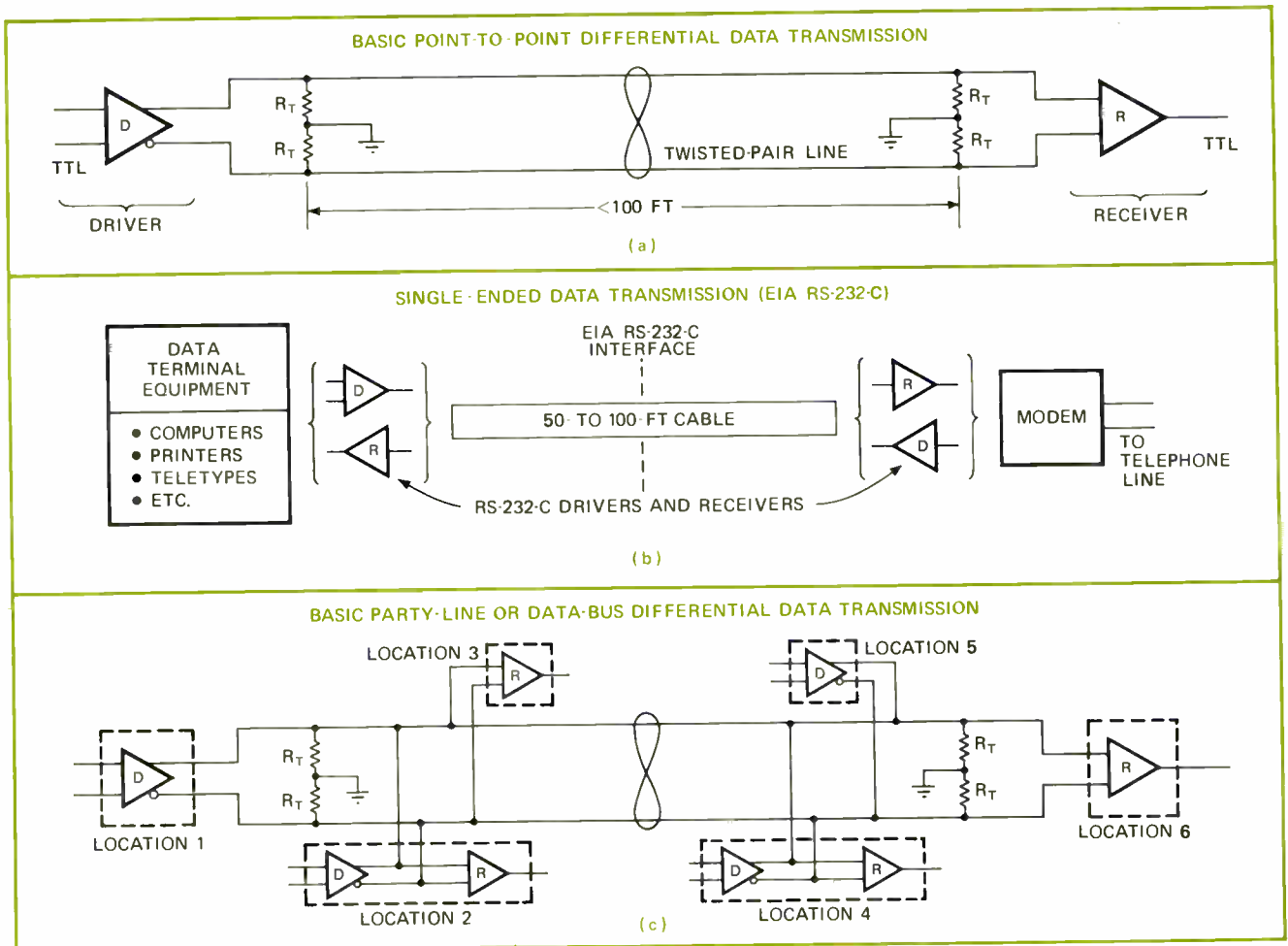

8. Lining up. Single-supply line drivers are used in simple twisted-pair transmission systems of under 100 feet (a), while more complex multi-supply units drive lines thousands of feet long. Modem drivers (b) with three-state outputs are suitable for party lines (c).

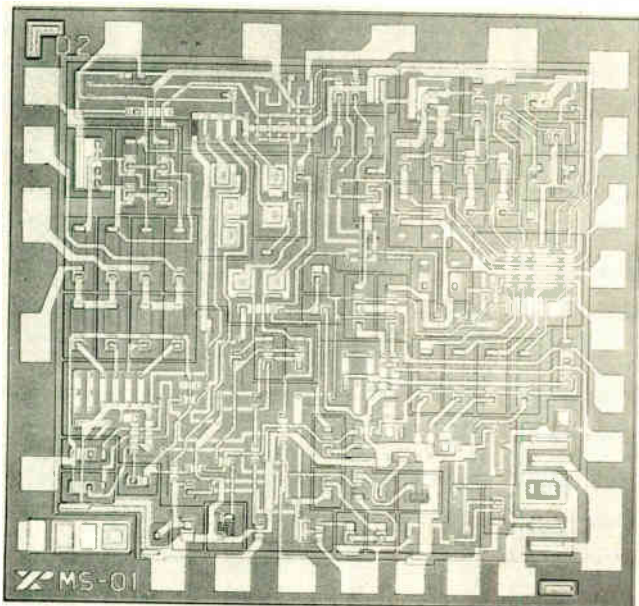

**9. New phase for modems.** Using a phase-locked-loop circuit to decode/encode frequency-shift-keyed signals, Exar's modem (XR210) can handle data rates of 1,800 bits per second, compared to 300 b/s for most other phase-locked modems.

have been using a simple gated current switch. Then a gate or inhibit input allows the output current to be removed from both lines for party line operation.

For high transmission rates, drive circuits must have low propagation delays (9 ns). Such devices are now readily available from a host of IC manufacturers. With these drivers, typical output current of 12 mA allows very long, balanced transmission lines to be driven at normal line impedances of 50 to 200 ohms. This low-level differential signal minimizes power dissipation.

A typical circuit for this application is TI's 75109 dual

driver. The device comes in standard 14-pin dual in-line packages and operates from standard supplies of +5 v. Device specifications apply over the temperature range of -55° to +125°C. Most IC manufacturers supply similar circuits.

Dual line receivers are available to complement such drivers. A typical example is TI's 75107, which is designed to detect differential input signals as low as 20 mv in the presence of common-mode input noise in the range of ±3 v. The polarity of the low-level differential input signal is then translated into high-level output logic levels compatible with TTL systems. Each receiver circuit also has TTL-compatible inputs used for strobing the receiver. One input allows independent strobing of the selected receiver, and the other, being common to both receivers in the package, allows simultaneous strobing of both receivers for increased logic versatility.

Most receivers have a nominal propagation delay of less than 20 ns, making them ideal for use in high-speed systems and almost completely insensitive to overdrive voltages greater than 10 mv. Typically, circuits respond to input signals with repetition rates to 20 MHz.

The common-mode input-voltage range of most of these receivers is a high +3 v, making them useful in all but the noisiest environments. In extremely noisy applications, input attenuators may be used to limit the system common-mode noise to a tolerable level—the excellent input sensitivity of today's receivers permits their use and, in fact, they could be included in the circuit design, but are usually omitted to increase the circuit versatility. The difficulty is that the use of such attenuators also adversely affects propagation delay, power dissipation, and input impedance. The input circuit of most receivers meets the requirements for low input currents (30 μA typical) and high input impedance (5 kilohms typical) for loading on the lines—important considerations for party-line applications.

TABLE 2: SAMPLE OF LINE CIRCUITS AVAILABLE

Description	Initial Manufacturer's Part Number	Voltage Supplies	Comments
Dual differential	TI: SN55/75109	±5 V	Constant current output (6 mA)
Dual differential	TI: SN55/75110	±5 V	Constant current output (12 mA)
Dual differential	Fairchild: 9614	+5 V	Single supply
Dual differential	National: DM7830	+5 V	Single supply
Dual EIA RS-232C	TI: SN75150	±12 V	±25 volt output short-circuit protection
Dual differential	TI: SN55/75107	±5 V	±25 mV input sensitivity, totem pole output
Dual differential	TI: SN55/75108	±5 V	±25 mV input sensitivity, open col. output
Dual differential	Fairchild: 9615	+5 V	Single supply
Dual differential	National: DM7820	+5 V	Single supply
Dual single-ended	TI: SN75140	+5 V	Adjustable $V_{REF}$ (1.5 V to 3.5 V)
Dual EIA RS-232C/Mil-Std 188	TI: SN75152	±12 V	Continuously adjustable hysteresis
Quad EIA RS-232C	TI: SN75154	+5 V or +12 V	No external components required

# SPECIAL REPORT

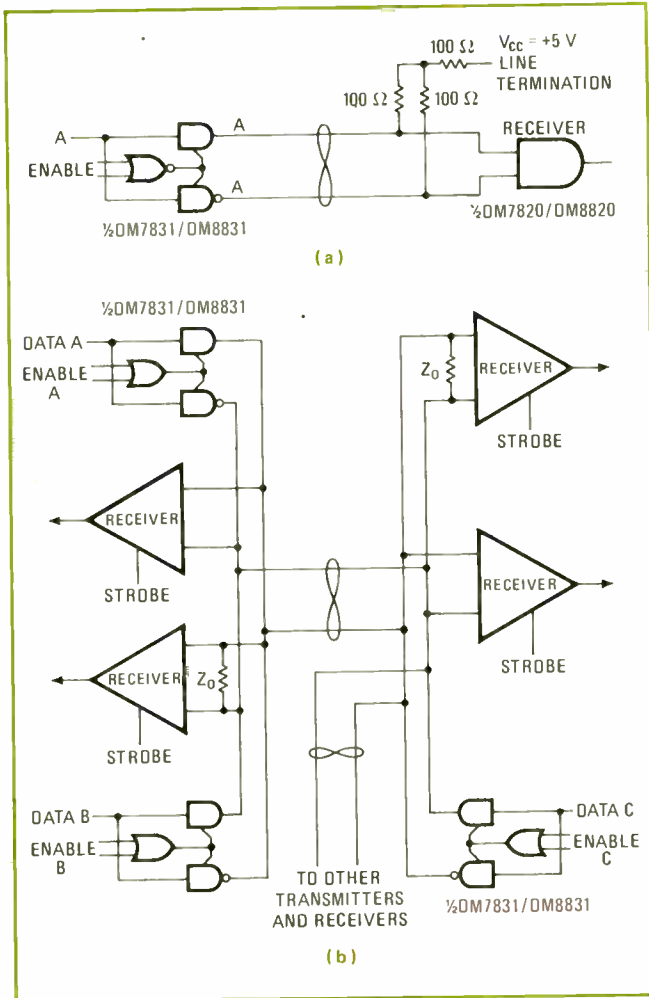

**10. Having a party.** If a three-state driver like National's DM7831 is used, many parties can be accommodated on a single transmission line. Line terminations shown in (a) have 100-ohm resistor networks. The 7831 also can be used for computer-logic manipulation.

The proliferation of computer core memories with greater and greater capacity has brought with it an increased demand on memory drivers. Indeed, this form of interface circuit has the most complex array of circuit functions of any chip in the linear product line with the possible exception of DACs. Today's memory drivers with on-chip decoders—often custom designs that are fed into the standard catalog periodically—generally contain both digital logic inputs and high-current linear transistor outputs.

### Complex chips to drive core memories

Two types of integrated core memory drivers are available to serve this market. Both are aimed primarily at thin-film memories—plated wire and flat film—organized in the two-dimensional (2-d) or linear-select-configuration. (A 2-d memory has as many drive lines as it has words; a 2½-d memory has only half as many drive lines as words, and requires a bidirectional drive.)

The simplest connection of a memory driver transistor array results in a one-to-one correspondence be-

tween transistor and memory word line. One transistor is chosen by appropriate activation of one base-select line and one emitter-select line. The collector of the selected transistor drives a memory word line. Since the word current in the 2-d system is always of one polarity, the state of stored data is determined by polarity of the bit current, which overlaps the trailing edge of the word current.

Collector-current amplitude and breakdown-voltage requirements of the transistors vary somewhat with the applications, but in general, word currents of memory drivers are in the 300-to-600-mA range, with breakdown-voltage requirements in the 10-to-30-v range. Integrated bit-current drivers require bipolar drive capability and usually do not utilize large transistor arrays. Also, the number of bit drivers, being proportional to the word length, is much smaller than the number of word drivers.

While memory driver chips without decoding are simply arrays of, say, eight high-current transistors, memory drivers with decoding on the chips are far more complex, and their designs are only now finding their way into monolithic circuits. Increasingly, these drive-decode interface circuits are replacing traditional discrete-transistor transfer circuits in magnetic memory systems.

A typical memory driver with decode has the logic diagram shown in Fig. 14. This device contains two 400-mA source/sink switch pairs, with decoding from four address lines. Two of the address inputs (B and C) are used for mode selection, that is, source or sink. The remaining address inputs (A and D) are used for switch-pair selection (W-X or Y-Z). Only one sink or source at a time may be selected in each package, to prevent excessive package power dissipation. Package selection and/or timing is performed at three additional logic inputs (E, F and G), called the timing inputs.

When coupled with external diode line-selection matrices, memory drivers with decode can provide the complete drive function for the memory. Typically, each address line is selected by a unique combination of drive and bus-line source/sink pairs, thereby supplying one coordinate of current to the memory planes in the 2-d or 3-d system.

An example is TI's 75324, which is used in the ICM-500 memory system being produced by the Computer Control division of Honeywell. This system provides a 600-ns cycle time with a 370-ns access time, has a capacity of 8.192 words of 36 bits, and is organized in 2½-d.

The most advanced memory driver to date is an as yet unannounced custom product for a computer manufacturer, which will soon, however, become an industry standard. It is an eight-bit chip designed to drive core memories (Fig. 1b), and contains eight identical bipolar tri-state drivers (transistors capable of 800-mA outputs). In addition, all logic requirements are included on the chip—a three-to-eight-line decoder, power control and selection logic.

Another big demand in computer design is for sense-amp circuits. They are widely used with magnetic memories—ferrite cores, plated wire, and planar films—and also with the new semiconductor memories (1103). They all need to be able to detect low-level differential-



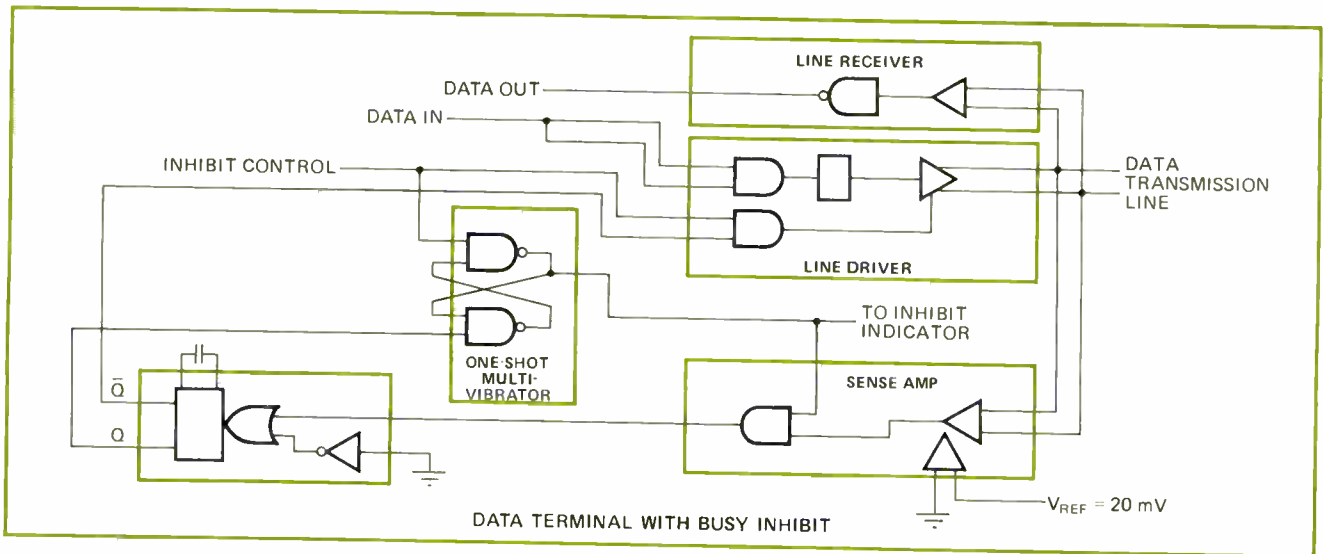

**11. Getting the busy signal.** This circuit monitors the transmission line to determine whether it's open for transmission. When line is busy, local driver is inhibited; when it is open, the driver is enabled. The design is from Texas Instruments.

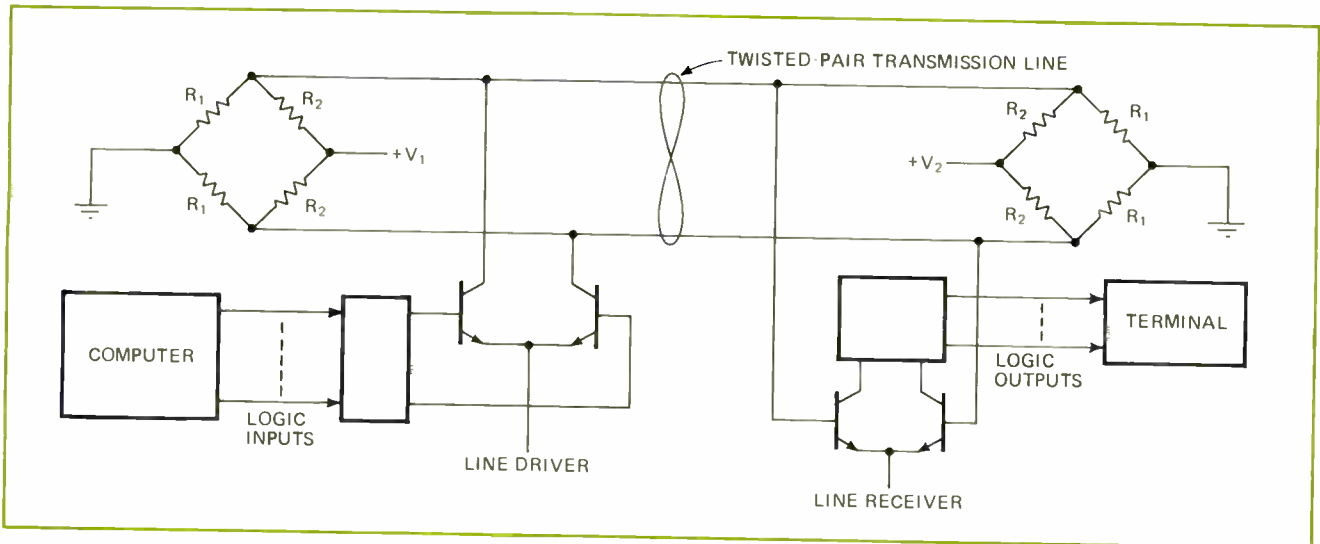

**12. Joiner.** This computer interface system has a twisted-pair transmission line with both lines biased at a few hundred millivolts. The logic inputs control the driver which activates a switch to unbalance the two voltages and cause a voltage difference at the receiver.

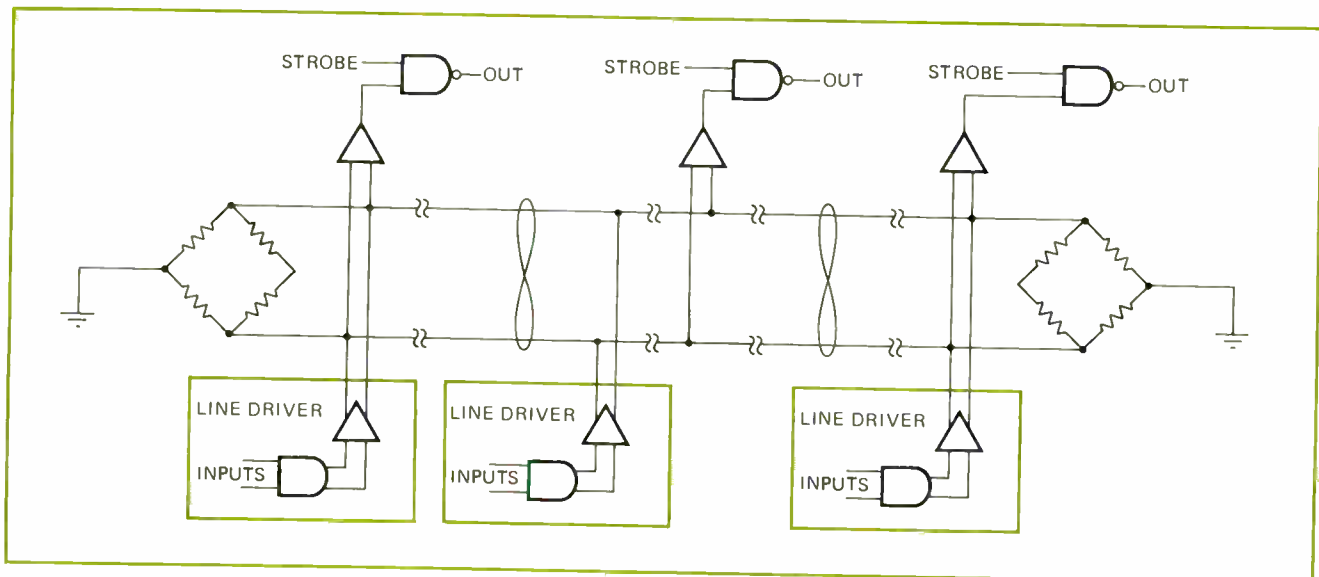

## SPECIAL REPORT

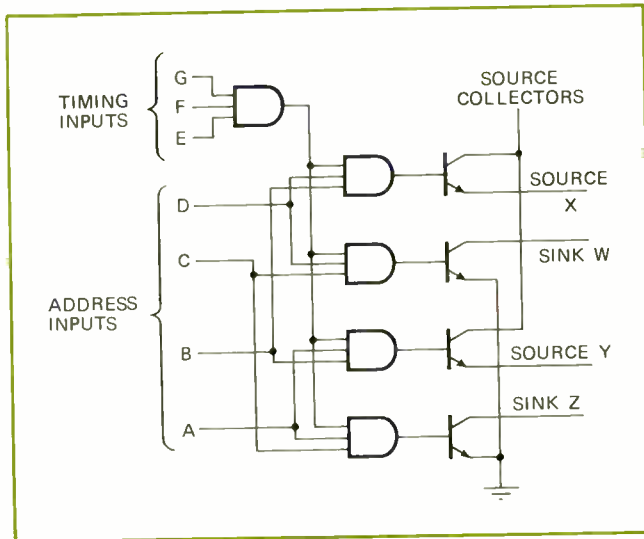

**14. Check your memory.** This memory driver with decode has two source/sink pairs; decoding is from four address lines. Mode selection is made through B and C, and pair selection is made through A and B. Logic inputs E, F, and G perform the timing functions.

input signals in the presence of common-mode noise, because the sense signals usually follow a burst of high-amplitude differential noise generated by drive currents. Integrated versions have been available to serve the core memory market since 1964, but recent circuit designs have made possible advances in both the performance and economy of these types of circuits.

One of the most popular series of sense amplifiers now available uses the "matched-amplifier" concept. It is well known that components of similar geometries built in close proximity on a monolithic circuit chip exhibit excellent thermal and electrical matching and tracking characteristics. The matched-amp type of circuit puts this IC characteristic to use by including several identical amplifiers on the same chip so that all exhibit almost identical performance. Moreover, by now, models exist for almost every coincident-current (2½-d or 3-d) core memory now in production or design.

In a typical family of matched-amp circuits, the parent device is a dual-preamplifier circuit useful for applications in memories with capacities of 8,000 or more words. To provide complementary TTL-compatible output levels, it has outputs of cascaded gates, which may also be connected as a latch to provide a simple memory data register function. The device features independent TTL-compatible strobe inputs for each sense preamplifier.

Also supplied are dual-preamplifier devices with open-collector outputs, allowing a level of logic to be implemented without additional logic delay. Added to this are circuits which feature dual preamplifiers and a complete output register with set and clear capabilities.

Thin-film memories have special sense-amp requirements. The data stored in thin-film memory elements, whether wire or planar film, is sensed by the polarity of the output signal rather than by the amplitude as in the 2½-d or 3-d core memories. Film memories are usually

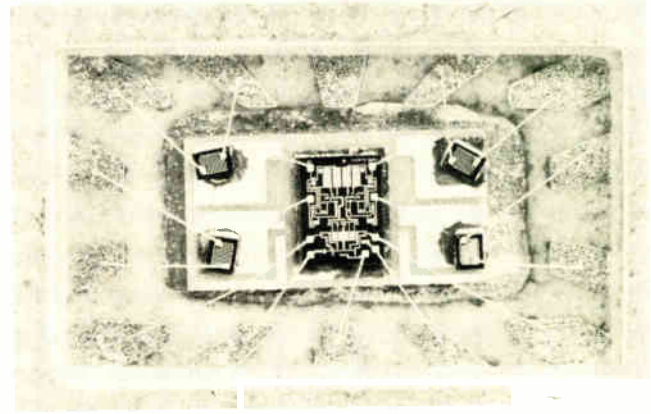
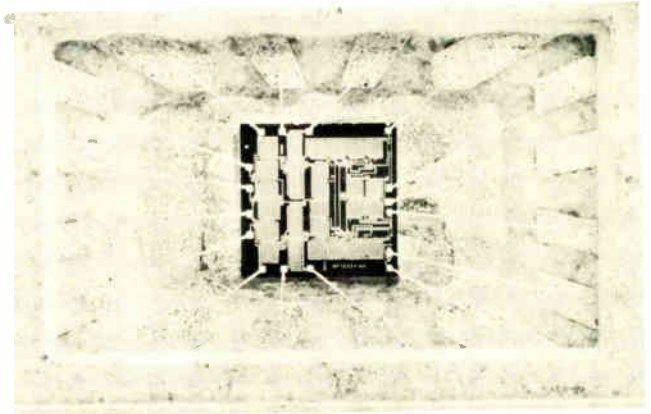

**15. New switch.** The monolithic C/MOS analog switch from Intersil (IH5043), top, consumes 300  $\mu$ W, has 0.4- $\mu$ s on-speed and 0.15- $\mu$ s off-speed. The functionally equivalent hybrid (DG142) consumes 90 mW, has 0.2- $\mu$ s on-speed and 0.6- $\mu$ s off-speed.

built in word-oriented or 2-d type organizations. Because of the low level of the sense signals, particularly those from planar films, it is necessary to amplify the signals before they can be applied to a detector. In addition, an ac-coupled stage is necessary to get rid of dc-offset problems. Furthermore, high-speed transistor-transistor logic or emitter-coupled logic is desirable to take advantage of the high speeds of the memories.

TI is one of the IC manufacturers that supplies an integrated linear wideband amplifier designed specifically for use as a sense preamplifier in thin-film memory systems. An example is the TI model 5510, which has a highly suitable 40-MHz bandwidth and 40-dB gain.

### Off-the-shelf subsystems

The prognosis for the future of linear circuits is a good one. Two trends are emerging: more linear functions on a chip, and more integration of both linear and digital functions on the same chip. Several semiconductor laboratories are already working on processing digital MOS devices alongside of linear bipolar circuits—a development that could add up to subsystems of extremely high density. By now, in fact, the day is near when a single chip will contain logic, memory, and analog drive functions—will be, in effect, a one-chip, multi-circuit, off-the-shelf subsystem. □

Reprints will be available at \$4.00 each. Write to Electronics Reprint Dept., P.O. Box 669, Hightstown, N.J. Copyright 1972 Electronics, a McGraw-Hill publication

# Sweet.



# And low.

The Economy Line. A to D and D to A converters.

From the leader, Philbrick. A complete selection of the most wanted data converter modules. Especially designed to meet the combined requirements of high performance and low cost.

Digital to Analog. The Model 4020 series features 8, 10, and 12-bit or 3 digit BCD with either voltage or current output.

The ultimate in high speed, accurate, adjustment-free data conversion capability. In a completely self-contained low profile, low cost module.

High performance D/A converters that are priced as low as \$18 for the 8-bit module in 100's.

Analog to Digital. The Model 4112 series features 8, 10, or 12-bit resolution and  $\pm 1/2$  LSB linearity. Offering speed, precision, and stability, with no external trimming.

Unusual high performance priced as low as \$49 for the 8-bit module in 100's.

Ask your local Philbrick representative for complete details. Or write, Teledyne Philbrick, Allied Drive at Route 128, Dedham, Massachusetts 02026. For toll-free ready data dial (800) 225-7883. In Massachusetts (617) 329-1600.

## Philbrick Data Converters. The good ones.

## Thumbwheel switches set synthesizer output frequency

by Jerrold L. Foote  
University of Utah College of Medicine, Salt Lake City, Utah

Two binary-coded thumbwheel switches can set the output of a two-decade frequency synthesizer that includes the two switches, a single crystal oscillator, and two decade counters. Synthesizer output accuracy and long-term frequency stability are the same as that of the crystal used as the reference frequency source. Whatever pulse-to-pulse time variation occurs is minimized to an acceptable level by a chain of binary counters.

The synthesis technique involves generating a series of pulses and blank spaces, divided by as many binary counters (N) as needed to yield the desired output frequency ( $f_o$ ). The frequency-selection circuit consists of thumbwheel switches,  $S_1$  and  $S_2$ , two banks of diodes

and their corresponding decade counters, and a flip-flop formed by gates  $G_1$  and  $G_2$ . More decades of frequency control can be added easily.

The number of oscillator pulses passed by the flip-flop-controlled NOR gate,  $G_3$ , is determined by the thumbwheel switch setting (S). Blank spaces occur while the decade counters are counting beyond the switch setting (M), the flip-flop resets, and the oscillator pulses pass through gate  $G_3$  to the binary countdown string. The output frequency is given by:

$$f_o = f_i S / MN$$

where  $f_i$  is the crystal frequency.

The output of gate  $G_3$  is a train of pulses and blank spaces that must be time-averaged to reduce the pulse-to-pulse time variation ( $\Delta T$ ) in the output frequency. This time-averaging is performed by the binary countdown string. The closer the tolerance that must be held on  $\Delta T$ , the larger is the number of binary counters required. Maximum pulse-to-pulse time variation is:

$$\Delta T = S / f_o N$$

Crystal frequency can be as high as 10 megahertz. □

**Dialing frequency.** Thumbwheel switches determine number of output decades for frequency synthesizer. Single crystal oscillator serves as frequency source. Decade counters generate pulse train that is divided by binary counter chain to obtain frequency set by switches. When switch-fixed decade count is reached, flip-flop formed by gates  $G_1$  and  $G_2$  resets, enabling gate  $G_3$  so that pulses pass to binary counters.

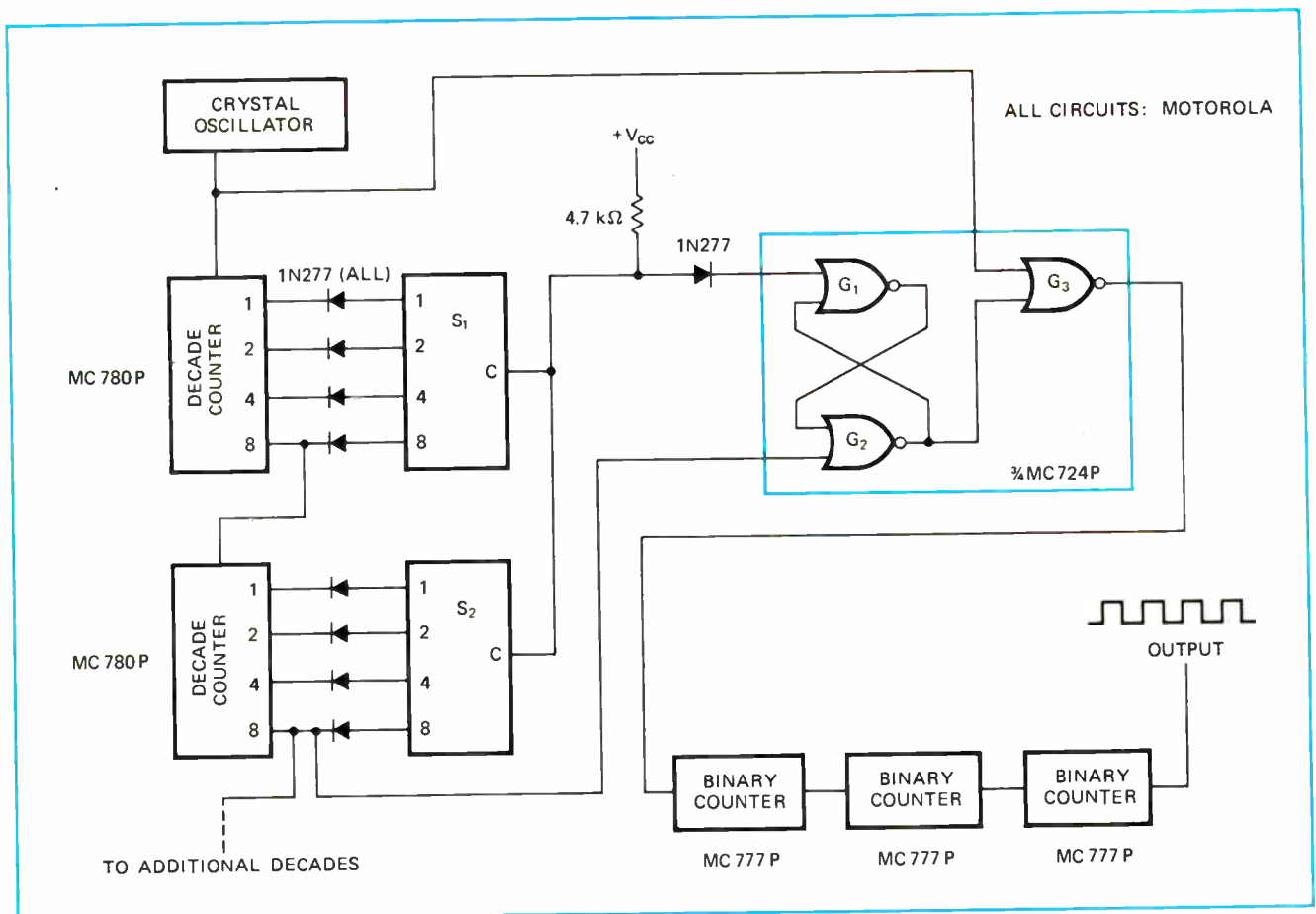

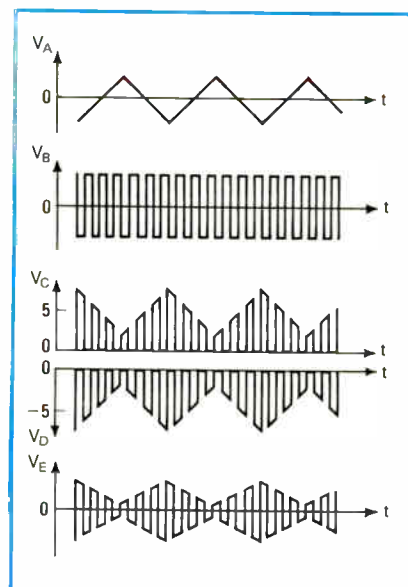
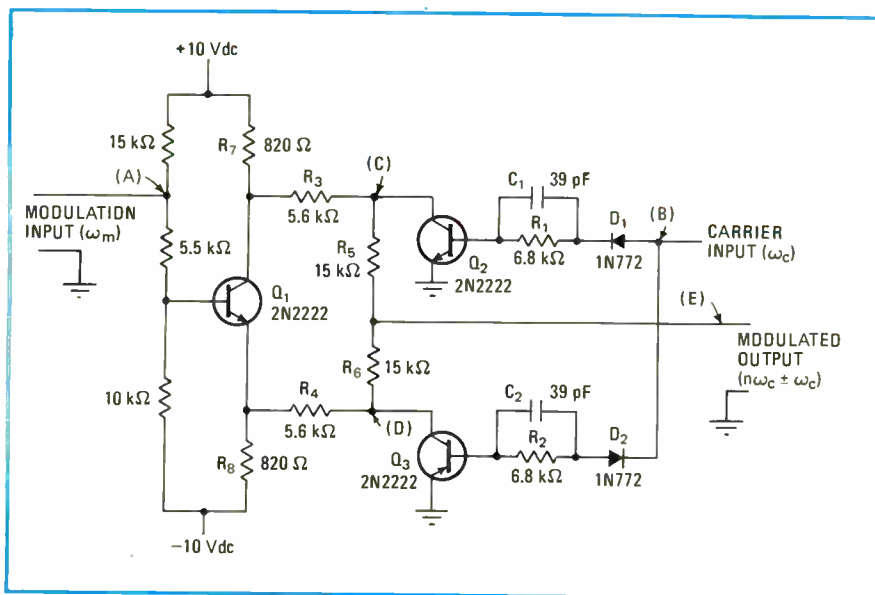

**Splitting and chopping.** Highly linear amplitude modulator theoretically can operate at half the carrier frequency. Transistor  $Q_1$  splits modulation input into two equal signals that are opposite in polarity and phase. Switch  $Q_2$  passes positive half-cycles of square-wave carrier, while switch  $Q_3$  passes negative half cycles. Chopped modulated signals (points C and D) are then summed by resistors  $R_5$  and  $R_6$ .

## Amplitude modulator is highly linear

by Donald DeKold  
Santa Fe Junior College, Gainesville, Fla.

Besides offering good linearity, an amplitude-modulation circuit can operate at modulation signal frequencies ranging from dc to half of the carrier frequency. At modulation levels as high as 97.5%, the circuit retains its linearity. All signals are directly coupled without inductive or large capacitive elements.

Transistor  $Q_1$  performs as a phase splitter for the modulation signal, which appears at  $Q_1$ 's emitter with  $0^\circ$  phase shift and somewhat attenuated from its input level. The dc level of the modulation is approximately  $-5$  v dc at  $Q_1$ 's emitter and  $+5$  v dc at the collector, where the signal is  $180^\circ$  out of phase with the input.

Transistors  $Q_2$  and  $Q_3$  are high-speed switches, driven alternately from saturation to cutoff by the carrier input. This signal, preferably a square wave, is applied to the bases of  $Q_2$  and  $Q_3$  through resistors  $R_1$  and  $R_2$  and diodes  $D_1$  and  $D_2$ , respectively. The diodes protect the transistors from excessive reverse base-emitter voltage generated by possible overdrive from the carrier signal. Capacitors  $C_1$  and  $C_2$  speed up  $Q_2$ - $Q_3$  switching times.

The collectors of  $Q_2$  and  $Q_3$  are coupled to the two outputs of phase-splitter  $Q_1$  through resistors  $R_3$  and  $R_4$ . These isolate the modulation frequency portion of the circuit from the carrier frequency portion.

The modulation signal appearing at  $Q_1$ 's collector is switched from its average 5-v dc level to ground by  $Q_2$  on each positive half-cycle of the carrier. A chopped version of the modulation signal then appears at  $Q_2$ 's collector. Similarly, the modulation signal at  $Q_1$ 's emitter is chopped by  $Q_3$ ;  $Q_3$ 's cutoff-to-saturation transition

occurs at each negative half-cycle of the carrier.

Positive and negative chopped modulation signals are then combined by a simple summing network composed of resistors  $R_5$  and  $R_6$ . Signal components of the chopped outputs that occur at modulation frequencies are summed to zero. Therefore, under perfectly balanced conditions, the modulated output is spectrally devoid of modulation-frequency components but, of course, contains the modulation sidebands. Theoretically, this permits modulating to an upper frequency limit of one-half the carrier frequency without troublesome filtering problems. The modulation envelope, in this case, is  $180^\circ$  out of phase with the input modulation signal.

The circuit's output is an amplitude-modulated square wave containing harmonics principally at odd multiples of the carrier frequency. (Spectral content is  $n\omega_c \pm \omega_m$ , where  $\omega_c$  = carrier frequency,  $\omega_m$  = modulation frequency, and  $n = 1, 3, 5, \dots$ ) If a sinusoidal carrier is wanted, the output must be filtered. Since modulation frequency components are absent from the output spectrum, a low-pass filter can be employed to select the fundamental carrier frequency and its sidebands. However, a bandpass filter must be used if the output is to be some multiple of  $\omega_c$ .

Modulator high-frequency performance depends largely on the speed of the switching transistors. For the transistors shown, useful modulated output extends to 1 megahertz. The modulator itself is essentially flat and linear to 250 kilohertz, with visually apparent distortion occurring in the modulation envelope above this frequency. At a carrier frequency of 100 kHz and modulation frequency of 1 kHz, good linear modulation can be obtained to a modulation depth of 95%.

For a modulation input signal of 14 v peak-to-peak, the maximum modulated output level will be 7.4 v peak-to-peak into an open circuit. The minimum carrier input level for a square-wave drive is 2.8 v peak-to-peak. And overdriving does not produce any unde-

sirable effects. The modulation can be any waveform.

A sine wave can be used as the carrier input, but chopping action will not be as good. Minimum sine-wave drive level is 4 v pk-pk. A linear modulation depth of 97.5% can be obtained at a carrier frequency of 10 kHz and a modulation input level of 14 v pk-pk.

Minimum carrier input drive levels remain essentially unchanged at a lower carrier frequency. Modulator performance, however, degrades somewhat at higher output frequencies—maximum linear modulation becomes only 94% at 500 kHz and 88% at 1 MHz. Output level

also drops at higher frequencies, but can be improved by using faster switching transistors and lower impedance levels throughout the circuit.

Higher supply voltages offer an alternate method for improving circuit output level. The saturation voltage of the chopping transistors represents the theoretical limit of maximum modulation depth; this voltage becomes less significant when higher supply levels are used. Furthermore, using precision resistor pairs ( $R_3$ - $R_4$ ,  $R_5$ - $R_6$ , and  $R_7$ - $R_8$ ) assures that positive and negative peak modulation signals are identical at the output. □

## FETs remove transients from audio squelch circuit

by Glen Coers  
Texas Instruments Components Group, Dallas, Texas

Using field-effect transistors instead of bipolar transistors for an audio squelch circuit eliminates switching transients without sacrificing switching time. Moreover, because there are no transients, the circuit's frequency response can be as low as desired.

In a typical audio squelch circuit (a), bipolar transistor  $Q_1$  acts as the control device for bipolar transistor  $Q_2$ , which serves as the amplifier. When  $Q_1$  turns off  $Q_2$ , the base voltage of  $Q_2$  switches from a dc level (in this case, 2.8 volts) to ground, causing a large transient output voltage spike to be generated.

The problem can be minimized by slowing the

switching speed of  $Q_1$  or raising the low end of the amplifier's frequency response. However, this method is not practical in applications requiring a broad frequency response, such as high-fidelity audio equipment.

Building the circuit with FETs (b) provides a better solution. Again, transistor  $Q_1$  is the control, while transistor  $Q_2$  is the amplifier. Only ac voltage is present at the gate of  $Q_2$ ; its dc level is at ground potential so that there is no transient generated when  $Q_2$  is switched off.

When  $Q_1$ 's gate is at zero volts, the device itself conducts, bypassing the audio signal to ground. Transistor  $Q_1$  and resistor  $R_1$  form a voltage divider that attenuates the signal by about 60 decibels. The "on" resistance of the FET is approximately 100 ohms.

To pass the audio input, a negative voltage must be applied to  $Q_1$ 's gate to turn the device off. The audio signal at the gate of  $Q_2$  can then reach the output devoid of any switching transients. □

Designer's casebook is a regular feature in Electronics. We invite readers to submit original and unpublished circuit ideas and solutions to design problems. Explain briefly but thoroughly the circuit's operating principle and purpose. We'll pay \$50 for each item published.

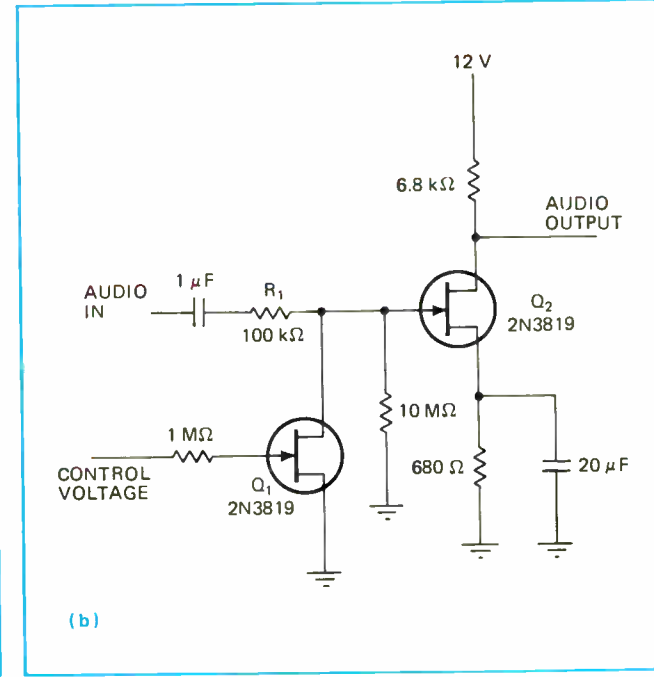
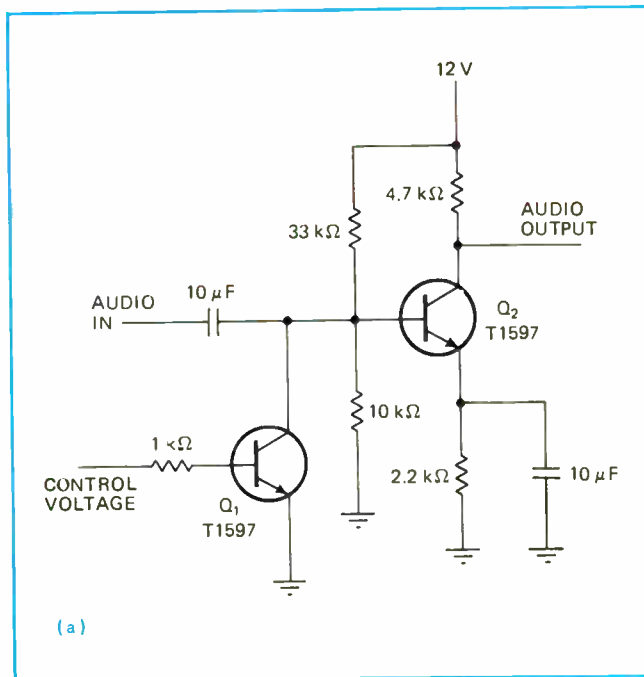

**FETs replace bipolars.** In bipolar-transistor audio squelch circuit (a), large output transient is generated when  $Q_2$  turns off, because dc voltage at  $Q_2$ 's base is grounded. Substituting FET circuit (b) eliminates transients without limiting switching speed. Control FET  $Q_1$  turns off for negative gate voltage, allowing amplifier  $Q_2$  to pass audio signal to output. Only ac voltage is present at  $Q_2$ 's gate.

# Three technologies on one chip make a broadband amplifier

Bipolar transistors, an MOS capacitor, and a thin-film resistor combine to eliminate the bugaboo of emitter-lead inductance; even the package lead inductance is utilized, as a tee-coil for interstage peaking

by John Addis, Tektronix Inc., Beaverton, Ore.

□ The latest in bipolar, thin-film and metal-oxide-semiconductor technologies complement each other to pack a gigahertz-bandwidth, direct-coupled amplifier, with electronically controllable gain and polarity, onto a single chip just 40 mils square. The circuit is mounted in a new high-dissipation package, and uses parasitic lead inductances and etched-circuit-board capacitances to provide broad bandwidth and resistive input impedance at low cost. The nominal gain of 9 decibels provides a gain-bandwidth product of 2.8 GHz.

Until recently, linear bipolar integrated transistors were so much slower than their discrete counterparts that the discrete approach was always used for high-speed amplifiers. The fastest of such amplifiers still use discrete devices. This approach, however, is prohibitively expensive where a large number of stages is involved in a high-volume, highly competitive field such as commercial instrumentation.

Obviously, a fully integrated approach to broad-band multistage amplifiers would be economically the most attractive, but it has several technical drawbacks:

■ If two or more stages are integrated onto a single chip, there is no possibility of interstage inductive peak-

ing—which can afford a three-fold improvement in gain-bandwidth product.

■ Adjustment of transient response is difficult, if not impossible.

■ The package imposes an unnecessary power limitation on the circuit.

■ Circuit yields will be low because of the very tight tolerances required to fabricate the fastest transistors.

If a single-integrated-stage approach is taken instead, another difficulty arises. The lead inductance entering and leaving the package limits the bandwidth unless it can also be used for needed interstage peaking. Even so, inductance in series with the emitter's gain-setting resistor and the peaking capacitor is the most serious limitation on circuit bandwidth, because of the low impedance level of the emitter circuit. If, however, both the resistor and capacitor can be integrated onto the IC chip, this limitation can be removed along with the cost of a miniature resistor and capacitor. This is the approach taken here. It has proved high in performance as well as economical.

The configuration of the circuit (Fig. 1) is that of a cascode amplifier utilizing one of the Gilbert multiplier

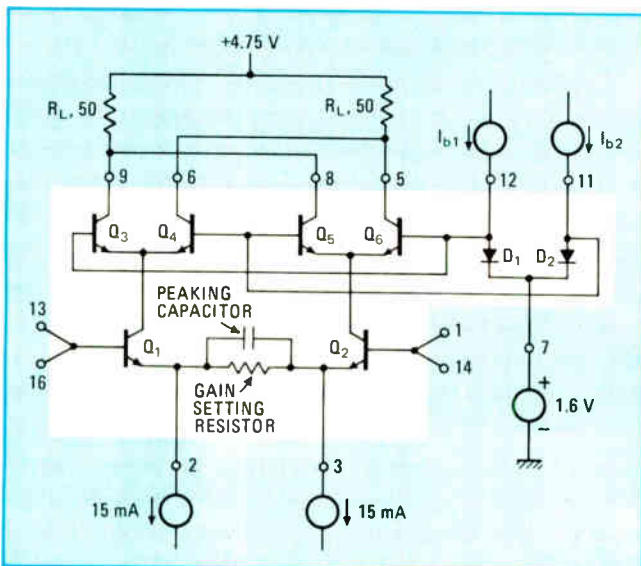

1. **Broadband.** Basic IC is a cascode amplifier in a Gilbert multiplier configuration. Because gain-setting resistor and peaking capacitor are integrated onto chip, emitter lead inductance is minimized, and bandwidth is greatly increased.

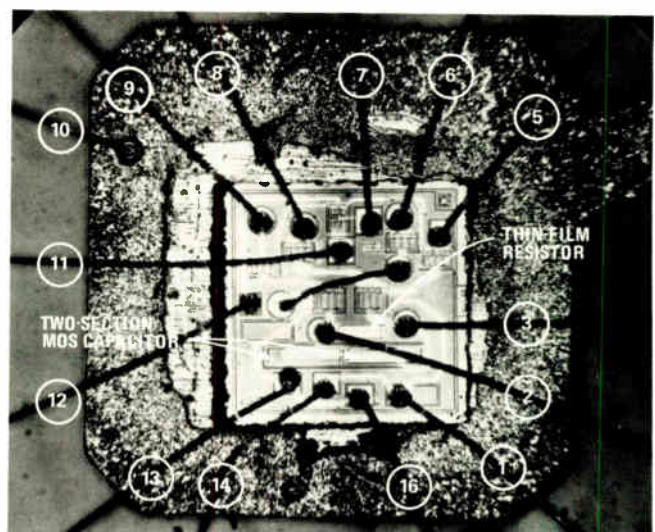

2. **Three in one.** Bipolar amplifier chip includes MOS capacitor and stable thin-film Nichrome resistor. Note that input signals applied to pins 1 and 13 loop through both package and circuit and come out at pins 14 and 16, respectively.

## The Gilbert multiplier

The Gilbert multiplier shown here exploits the known logarithmic voltage-current characteristics of one semiconductor junction-current so as to linearize the current flow in another junction. Transistors  $Q_3$  and  $Q_4$  may be considered as being voltage-driven by current-driven transistors  $Q_1$  and  $Q_2$ .

Starting with the equation  $V_{be} = (m k T / q) \ln(I_c / I_s)$ , where  $I_s$  is a characteristic of the transistor, Gilbert<sup>1</sup> shows, by summing the voltages around the  $Q_1$ - $Q_2$  loop, that  $(I_{c3} / I_{b1}) = (I_{c4} / I_{b2}) = (I_e / I_b)$ .

When  $Q_1$  and  $Q_2$  control two pairs of transistors which are themselves differentially driven, as in Fig. 1 in the accompanying text, then the over-all stage gain can be completely controlled by the two bias currents ( $I_{b1}$  and  $I_{b2}$  of Fig. 1). For example, when the two currents are equal, signals from  $Q_1$  and  $Q_2$  cancel in the output, and the gain is zero.

If the currents constitute a push-pull signal source applied to the control bases (pins 11 and 12 of Fig. 1) and a voltage applied between  $Q_1$  and  $Q_2$  is a second signal source, the output voltage between pins 5 and 9 is the product of the two signals. This circuit is the basis of most of the multipliers on the market today.

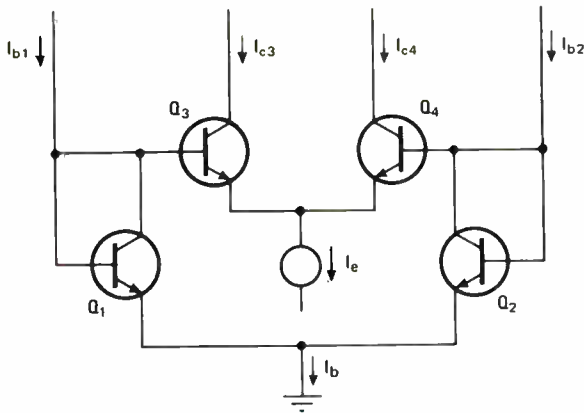

schemes.<sup>1</sup> In normal operation, pin 12 (known as a control base) is connected to current source  $I_{b1}$ .  $I_{b2}$  is zero. The input is connected between pins 1 and 13, and the output is taken between pins 5 and 9. Under these conditions, transistors  $Q_4$  and  $Q_5$  and diode  $D_2$  are off, and may be ignored. The resulting configuration is the standard cascode amplifier, with  $Q_3$  and  $Q_6$  acting as the common-base output transistors.

If  $I_{b1}$  is off and  $I_{b2}$  is on, signal current from  $Q_1$  and  $Q_2$  flows in  $Q_4$  and  $Q_5$  respectively. The configuration is still that of the cascode, but the signal polarity is now reversed. Similarly, if  $I_{b1} = I_{b2}$ , there is exact cancellation of signal currents in the output without any change in the output common-mode voltage level. It can be seen that the relation between  $I_{b1}$  and  $I_{b2}$  determines the gain in continuous and linear manner according to:

$$G = G_{\max} \left[ 1 - \frac{2I_{b2}}{I_{b1} + I_{b2}} \right]$$

The cascode configuration is inherently broad-band because the signal voltage swing at the collectors of the

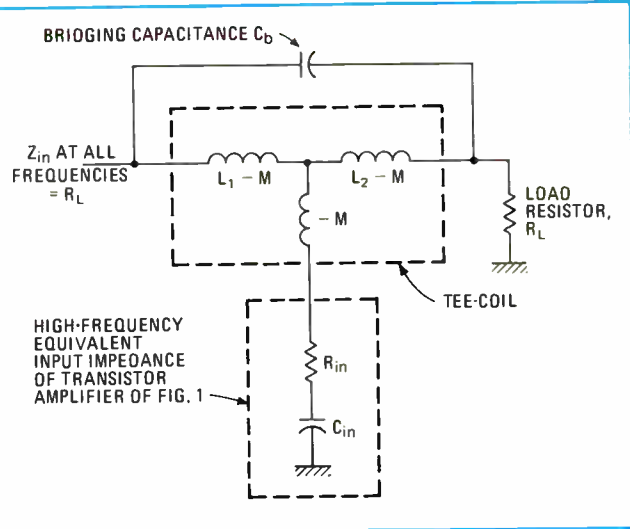

**3. Peaking.** Tee-coil interstage peaking circuit improves bandwidth by factor of 2.74 when driving R-C load. Bridging capacitance is chosen to make  $Z_{in} = R_L$  at all frequencies.

input devices ( $Q_1$  and  $Q_2$ ) is small. Any impedance in the collectors of these devices reduces the input impedance at high frequencies because it increases the voltage swing across the collector-to-base capacitance of the transistor. Thus, the absence of inductance in the collector leads of  $Q_1$  and  $Q_2$  is an inherent advantage of the integrated approach. The Gilbert multiplier of Fig. 1 retains the advantages of the cascode configuration independent of gain or polarity control.

### Speeding up the transistors

The transistors are biased at a current somewhat below their  $F_T$  peak and operate at only 2.4 volts collector-to-emitter to save power. Still, the  $F_T$  at this operating point is 3 gigahertz. To obtain this high  $F_T$  with low base resistance, the emitter width is held down to only 0.1 mil. Two base diffusions are used to maintain low base resistance without any sacrifice in beta or  $C_{cb}$ .

Integrated devices are slower than their discrete counterparts because of the large series resistance between the collector contact on top of the device and the collector region on the bottom. To reduce that resistance, a low-resistivity (deep collector) diffusion makes contact to a buried-layer collector.

To reduce capacitance between nearby devices, the isolation walls surrounding each collector region must be separated from each other. However, differential pairs of transistors must not be separated too far or temperature differences may result. While the small additional dc drift that this would cause is probably not significant, signal-related thermal effects are. Applying an input signal changes the power dissipated in  $Q_1$  by an amount generally different from the power change in  $Q_2$ . This results in a temperature difference between  $Q_1$  and  $Q_2$  which is proportional to the input signal voltage (not the square of the voltage). The temperature difference changes the  $V_{BE}$  of both  $Q_1$  and  $Q_2$ , giving rise to a new equivalent input signal. The effect is linear and not as small or as slow as one might expect—as much as 5% increase in gain at dc and a noticeable change in gain well above 1 megahertz.



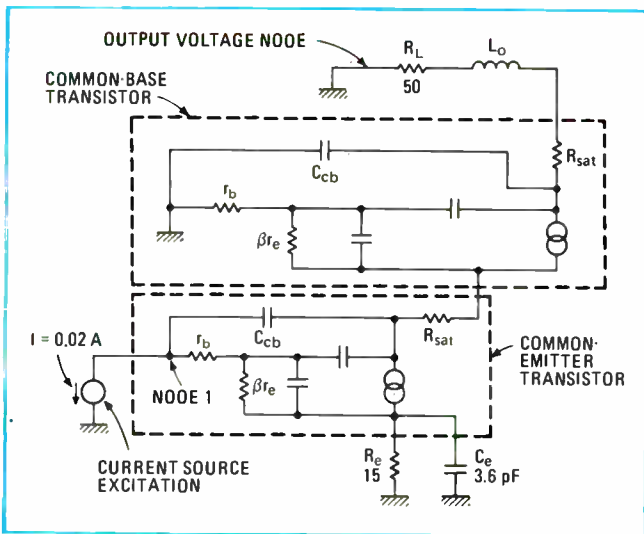

**4. Computer model.** Model of cascode circuit is used in ECAP analysis of IC amplifier.  $L_o$ , inductance of the package's output lead, causes some overshoot in transient response (see Fig. 6).

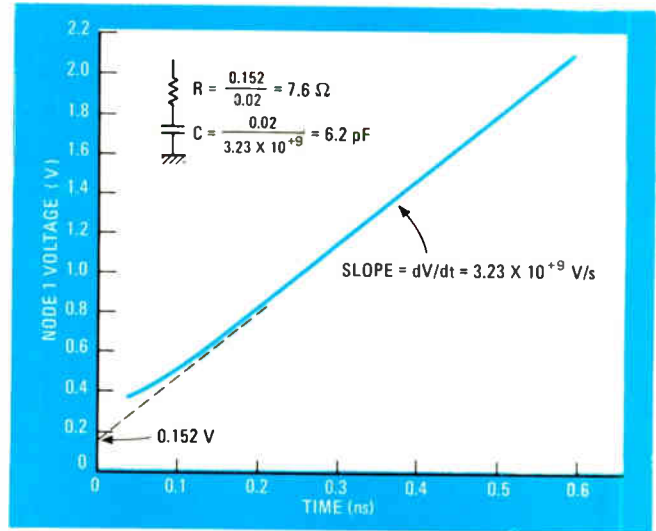

**5. Computer analysis.** This is the calculated voltage response at node 1 of Fig. 4 to a 20-mA current-step input. For time frame of interest, input impedance looks like a series R-C circuit.

Actually, it is possible to bias a differential pair so that a condition called "thermal balance" prevails. At this point, defined by the equation

$$2I_s R_L = V_s + V_{BE} - (I_s R_E)/2,$$

there are no temperature-induced input signals. The equation is derived by setting the power-difference between  $Q_1$  and  $Q_2$  equal to zero for a non-zero differential signal input. In the equation,  $V_s$  is the collector supply voltage,  $I_s$  is the emitter supply current,  $R_E$  is the emitter gain-setting resistance, and  $R_L$  is the collector load resistance.

While most oscilloscope amplifiers are biased in this way, IC units usually cannot be made to satisfy the equation. Instead, they rely on close thermal coupling to keep the magnitude of the effects down to about 1% per stage, and the multiple time constants below about 10 ms—a manageable number. Nevertheless, between five and 10 compensation networks may still be required to flatten the remaining effects of thermal imbalance.

### The ungrounded MOS capacitor

The MOS peaking capacitor is unlike many such integrated capacitors in that neither side is grounded. In both cases, the top plate is a large area of metal under which a thin layer of oxide serves as a dielectric. The bottom plate is the substrate, usually a negative power supply. Capacitors of 30 picofarads are quite commonly made in this fashion.

The configuration of Fig. 1 requires each plate to be connected to an emitter. Using two independent capacitors, one from each emitter to the substrate, is an unsatisfactory solution. The common-mode impedance at the emitter is lowered at high frequencies, and common-mode input signals couple through the substrate to the control bases. The common-mode gain is increased substantially and can easily exceed differential gain under these conditions. Oscillation is then possible in a multistage amplifier.

Fortunately, the buried-layer diffusion has low enough resistivity to serve as the bottom plate of a ca-

pacitor isolated from the substrate. The top plate and dielectric are the metal and underlying oxide as before. This materially reduces substrate excitation.

As might be expected, however, the buried layer has substantially more parasitic capacitance to the substrate than the metal, so that the emitter connected to that layer will also have greater capacitance to the substrate. Because of this imbalance, the substrate is now excited by differential as well as the remaining common-mode signals. The solution is to split the capacitor into two equal parallel capacitors. Each emitter is connected to one bottom plate and one top plate, preventing net substrate excitation. A photomicrograph of the chip and bonding is shown in Fig. 2.

To implement interstage inductive peaking, it is desirable to integrate only the emitter gain-setting resistor. However, since the gain actually depends upon the ratio of the gain-setting resistor to the load resistor,  $R_L$ , both resistors must have the same temperature coefficient of resistance. Since metal-film resistors are used for  $R_L$ , a diffused resistor, which has a temperature coefficient of about +1,600 parts per million per degree centigrade, is an unsuitable choice for the gain-setting function.

Furthermore, it is important that the tolerance be good—especially in multistage amplifiers using the same chip repeatedly. A 10% gain error in each of five cascaded stages results in a 61% over-all gain error.

An excellent solution is to deposit a thin-film resistor directly onto the chip. Nichrome is used in preference to other metal systems, such as chromium silicides and tantalum, because the etchants usually used with these other systems are not compatible with silicon dioxide or aluminum. Additionally, it has a temperature coefficient of resistance of less than 100 ppm/°C and can be made with the low sheet resistivity (10 ohms/square) required for an emitter resistor of only 30 ohms.

Large bandwidth and smooth frequency response depend heavily upon a good system of interstage peaking. One of the best of such systems is the tee-coil circuit (Fig. 3), in which the tee-coil is actually a pair of mutually coupled inductances. The use of a tee-coil to con-

nect an RC load to a source, such as the output of one stage of a multi-stage amplifier, improves the bandwidth by a factor of 2.74 while adding only 0.4% of overshoot. The 3-dB bandwidth of a tee-coil peaked amplifier is given by  $\Delta f = 2.74/2\pi(R_L + R_{in})C_{in}$ , where the circuit is assumed to be tuned for a maximally flat envelope delay response.

Adding  $C_b$ , the bridging capacitor, transforms the circuit into a "bridged tee-coil" and gives it another extremely useful property: if  $C_b = (C_{in}/12)[(R_L + R_{in})/R_L]^2$ , then the driving-point impedance,  $Z_{in}$ , is real and equal to  $R_L$  at all frequencies.<sup>2</sup>

Having a constant, real, driving-point impedance makes it possible to use etched-circuit-board transmission lines for interstage coupling, without any need for reverse terminations—that is, no collector loads are required in the driving stage. In principle, one could doubly terminate an interstage transmission line of twice the impedance and use simple inductive peaking at each end without any loss of gain or bandwidth. However, the tee-coil does a better job of preventing signal reflections between stages.

Before implementing tee-coil peaking, one must know accurately the input impedance of the stage to be peaked. This may entail considerable work by any method, but the method used here—computer analysis based on a well-tested transistor model—is fast and intuitively appealing. The analysis is carried out with IBM's well-known electronic circuit analysis program

(ECAP) using the circuit model of Fig. 4. The value of  $R_e$  is derived from a dc analysis of the required gain.  $C_e$  is given by  $C_e = 1/2^p F_t R_e$ .

A mathematical time-domain reflectometry analysis is performed with the computer; a 20-milliampere current-step input excitation is programed, and the voltage at node 1 (Fig. 5) is observed.

Since the voltage starts out at 0.152 volt, it is clear that the input at  $t=0$  looks like a resistance of value  $R = 0.152 \text{ V}/20 \text{ mA} = 7.6 \text{ ohms}$ . The constant slope of  $dv/dt = 3.23 \times 10^9 \text{ V/second}$ , for values of  $t$  greater than 0, corresponds to a series capacitance of  $C = 20 \text{ mA}/3.23 \times 10^9 \text{ V/s} = 6.2 \text{ pF}$ . Thus the input impedance looks like a simple series RC circuit.

Simple theory which neglects the Miller effect and  $R_{sat}$  predicts that  $C_{cb}$  is in parallel with the series combination of  $r_b$  and  $C_e$ . Actually, the Miller effect operates on  $r_b$  and  $C_{cb}$  to reduce the resistive component below  $r_b$  and to raise the capacitive component to a value greater than  $C_{cb} + C_e$ . The surprising fact remains that, within the time of interest (the amplifier risetime), a single series combination of resistance and capacitance adequately describes the circuit input impedance.

The proper tee-coil is then designed and interposed between the current source and the amplifier input. Another computer TDR analysis and, this time, a transient-response calculation, as well, are performed as a check. The overshoot in the transient response (Fig. 6) is caused by the package lead inductance at the output ( $L_o$

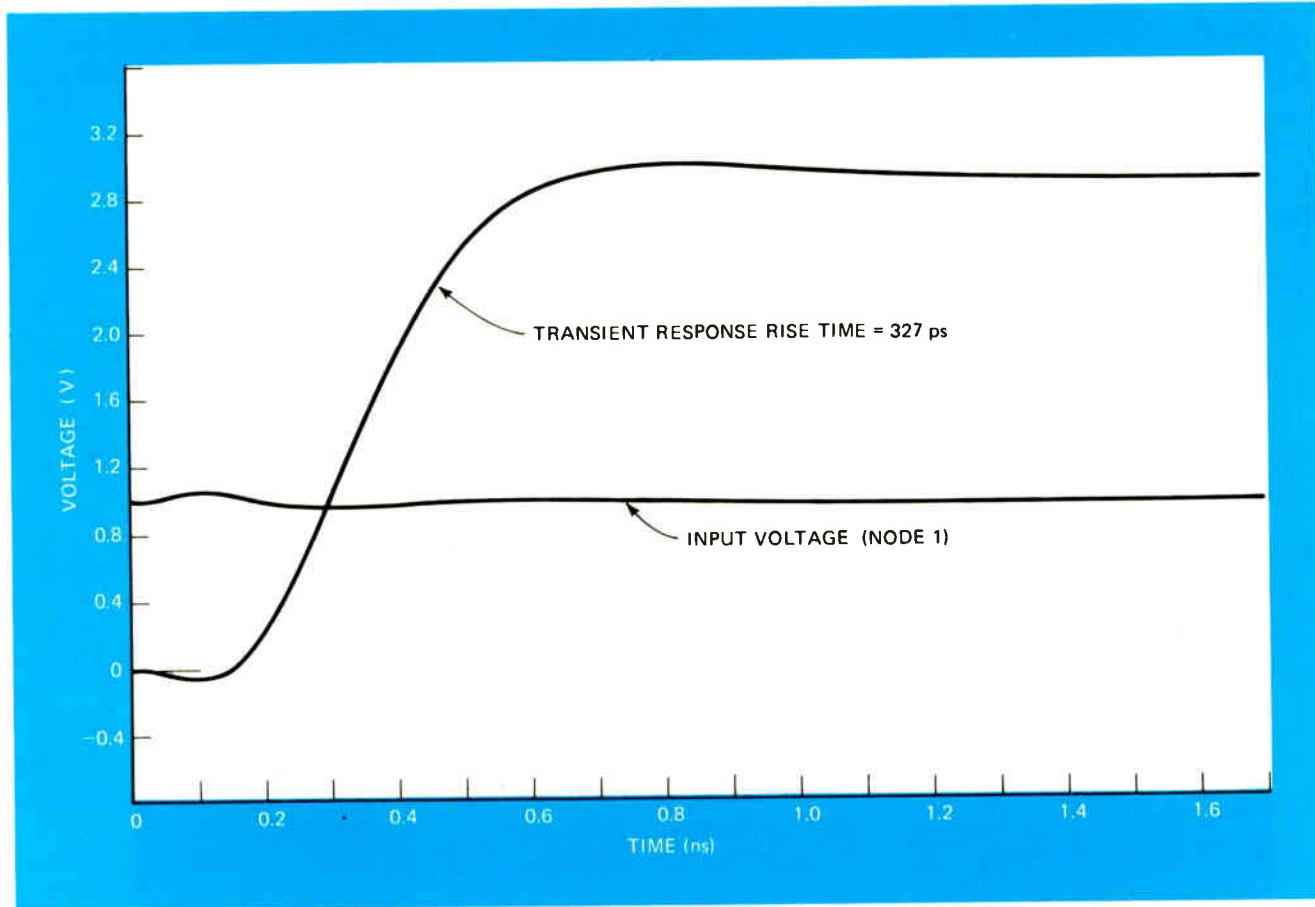

**6. Double check.** Again the computer calculates amplifier's response to a current step input, but this time with a tee-coil between the current source and the amplifier. In addition to the node 1 input voltage, the amplifier's output is plotted.

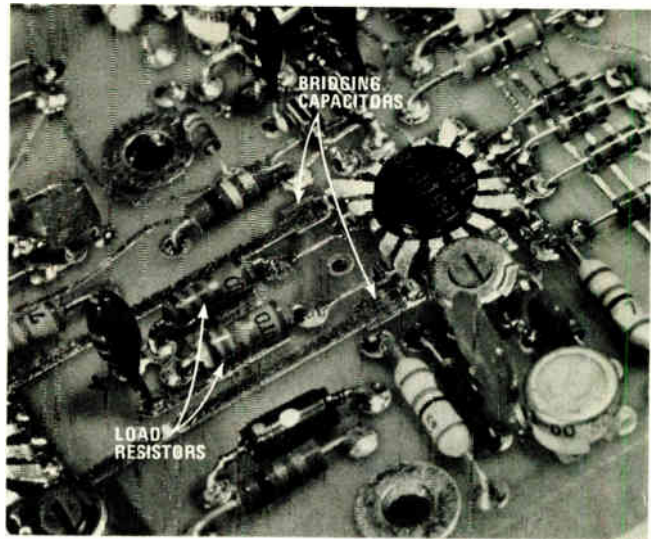
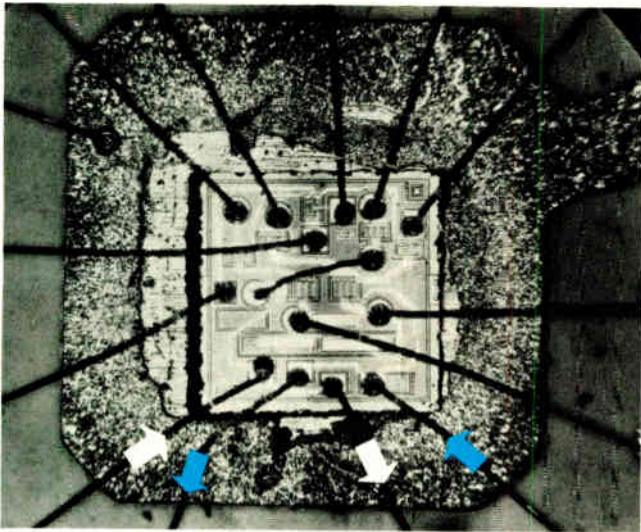

**7. A chip trick.** Tee-coil is realized by looping the input signals through the IC package as indicated by arrows on photograph of the chip. Small run of metal between load resistors and the IC adds extra inductance required by the output leads. Top plates of the bridging capacitors are seen as large square metalization areas at the corner input pins of the IC package.

in Fig. 4). It is interesting to note that the risetime is within a few percent of the value predicted from consideration of the tee-coil alone. This means that only the input impedance limits the bandwidth and that interstage peaking is very important.

To make use of the package lead inductance, the input signal is "looped through" the package. Each of the push-pull inputs enters a corner pin, leaves one of the inner pins on the same edge, and terminates in a 50-ohm load resistor,  $R_L$ . Fortunately the value of  $L_1$ , the tee-coil input inductance, is just that contained in the corner pin of the IC package (Fig. 7). The adjacent pin has slightly less inductance than required for  $L_2$ , and additional inductance is obtained with a narrow etched-circuit-board run between the pin and the load resistor.

The bridging capacitance,  $C_b$ , is obtained by using a three-layer etched-circuit-board capacitor, the top plate of which may be seen as a wide area next to the corner

package pin in the photograph of the etched-circuit-board in Fig. 7. The required 0.68 pF is obtained with just 0.01 square inch of board area.

#### A cool package

A new inexpensive epoxy package design was chosen for the IC. Because the leads are both short and roughly equal in length, power dissipation exceeds that of a 16-pin dual-in-line package and is rated at 400 milliwatts. The IC actually dissipates less than 150 mw typically and therefore runs very cool. The package may be plugged into the circuit board for easy removal. □

#### REFERENCES

1. Earle Gilbert, "A New Wide-Band Amplifier Technique," IEEE Journal of Solid State Circuits, Vol. SC-3, No. 4, December 1968, p.353.
2. Robert I. Poss, unpublished Tektronix paper, Feb. 19, 1969.

#### ACKNOWLEDGEMENTS

The author wishes to thank Wirt Cross, now at MIT, and Gene Andrews for their essential contributions to the project.

## The first practical application

The first commercial use of the new integrated circuit is in Tektronix's Type 485 350-megahertz portable oscilloscope. A total of 17 of the ICs is used—eight in the vertical and internal trigger amplifiers, two in the main vertical amplifier, six in the A and B trigger amplifiers, and one in the A external trigger display. The high gain-bandwidth product of the IC is largely responsible for the scope's 5-millivolt sensitivity at 350 MHz. The oscilloscope's input impedance can be switched from 1 megohm to 50 ohms at the touch of a front-panel button.

The entire unit weighs just 20½ pounds without accessories. This extremely light weight is traceable, at least partially, to the new IC, because it keeps the scope's power consumption to a mere 60 watts overall. Low power consumption requires only a small, lightweight power supply, which means that heavy cast parts are not needed for structural strength.



# Westinghouse Delivers!

## Fastest high-power semiconductor delivery in the industry

Only one kind of delivery counts. The kind that's on time . . . on target. Yet with the unpredictability that used to surround power semiconductors, on-time delivery was more the exception than the rule.

Now, the new Westinghouse breakthrough in power semiconductors has changed all this.

We seal and stabilize the semiconductor element by passivating it with a unique Westinghouse process. This prevents degradation, even in assembly, and permits element stocking indefinitely.

We also use special and exclusive test devices and procedures like the concurrent tester, spreading resistance probe, HV test lab, and computer models to predict characteristics.

Then we assemble the element into a package with our exclusive compression-bonded encapsulation (CBE) process. This prevents thermal fatigue by eliminating the need for solder.

And our pace-conveyor assembly system enables us to assemble high-power rectifiers and thyristors (and special assemblies) faster than anyone else in the industry.

Advantages: For a start, a prearranged delivery schedule of more than 1500 different types of high-power semiconductors in our catalog. This includes customizing the package to your form factor and voltage rating. You can forget costly power semiconductor inventory, excessive lead time on orders, and plant downtime.

We'll also stock *your* power semiconductor elements for you. With your order, we'll give you your own storage area and maintain your inventory. In case of an emergency, we'll deliver on a guaranteed shipment basis.

Our "breakthrough" in high-power semiconductors is just the start. Ask about the benefits of Westinghouse research and development leadership in high-power semiconductors. For more information about "breakthrough," phone 412 925-7272 or write Paul E. Lego, General Manager, Westinghouse Semiconductor Division, Youngwood, Pa. 15697.

75-17-72

You can be sure...if it's Westinghouse



Circle 108 on reader service card

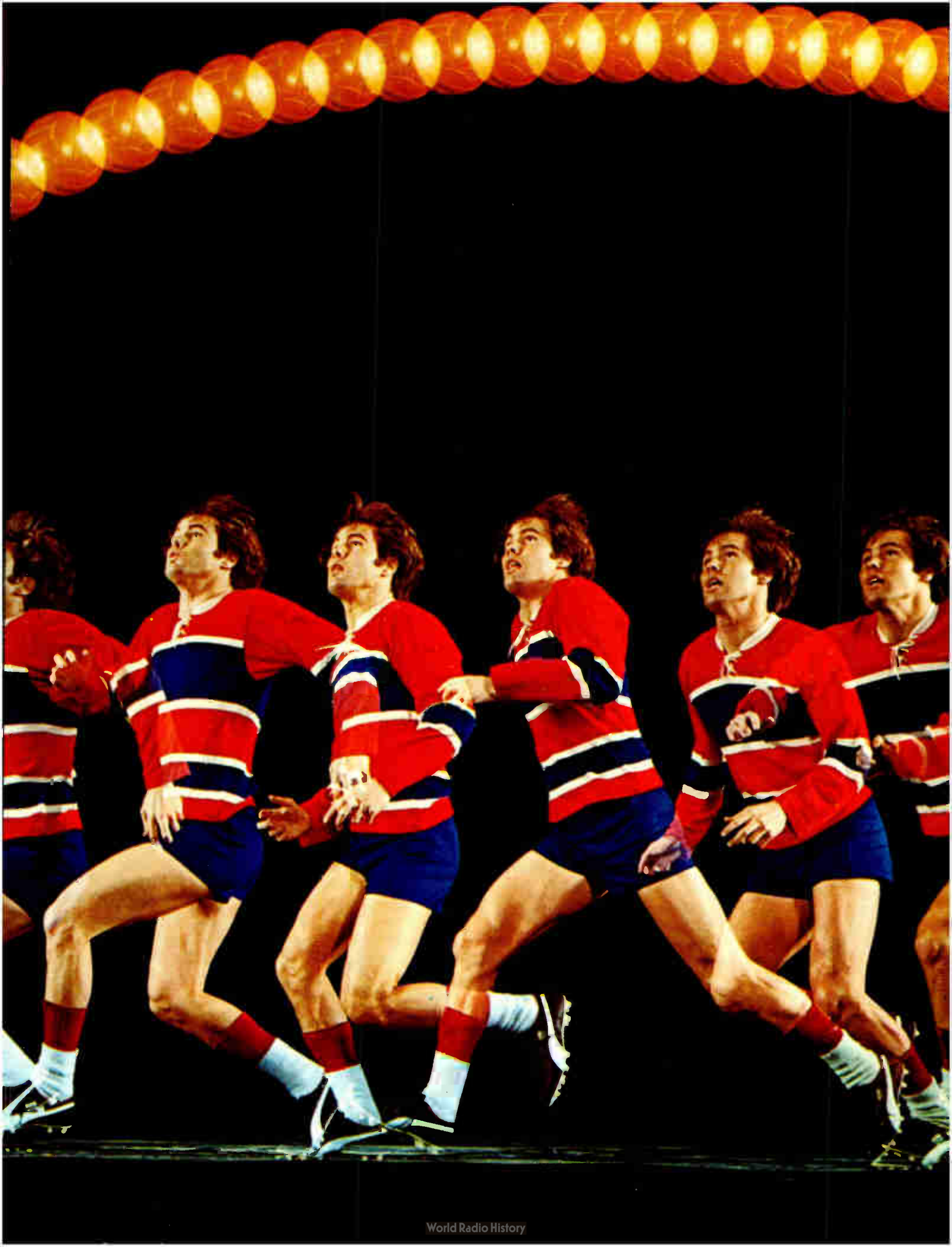

# our new High-Current power supplies pack a big jolt.



A 100 amp, 5 volt power supply for only \$315. That's the big one. The little one is 16 amps at 28 volts for \$245. In between, there are eight other models. All have comparable high current and shockingly low prices. Plus a bonus. All ten models have passed the cool operation and safety tests to earn a UL listing.

Of course, if you don't need all the power we've packed into this HCM Series, there are about 300 other models

to choose from. Single and dual output; from 2 to 400 volts; from .26 to 100 amps. Miniature versions, card types and our UL listed OEM Series. They all carry ACDC's "guaranteed forever" warranty and most are ready for off-the-shelf delivery at lightning speed.

So, next time your power supply requirements have you swimming upstream against the current, give us a call. Collect. (714) 757-1880.

## acdc electronics inc.

Oceanside Industrial Center, Oceanside, California 92054, (714) 757-1880

Circle 110 on readerservice card

# Raster scan technique provides multicolor graphic displays

Computer terminal system, using conventional television CRTs refreshed by a disk drive, can also accommodate a maximum of 16 black-and-white monitors; form overlays protect data entered through separate channels

by Lawrence R. Lovercheck, *Data Disc Inc., Sunnyvale, Calif.*

□ Analysis of computer output can often be simplified greatly when data is presented in several colors and in graphic form—particularly in applications requiring quick comparisons of value relationships. And now that minicomputers have brought many new applications within the range of electronic data processing, the need for graphic displays has been increased.

But there's a wide price gap between the simplest stand-alone cathode-ray tube display and the sophisticated interactive graphics terminal. For those applications requiring more capability than the simplest terminals, relatively sophisticated systems have been built by using the conventional television raster scan, a standard TV monitor tube, and disk storage to provide display refresh signals. Some system configurations cost no more than the least expensive graphics terminals. Yet they can provide color graphics or form overlays when needed, and as many as 16 black-and-white terminals can operate in a single system.

Among the systems built by this technique are an intensive-care monitoring system at the Massachusetts General Hospital in Boston; a process-control system at the Stanford Linear Accelerator Center, Palo Alto, Calif.; a computer-aided instruction system at the University of California; a command-and-control system for the Mariner and Pioneer space exploration projects;

and a data-base management system at the First National Bank of Chicago.

The raster scan display carries image patterns on a series of closely spaced horizontal lines of varying brightness. These lines can make up a television picture or can constitute a graphic or alphanumeric display for a computer. A vertical raster scan is advantageous in some applications. In the United States, the standard horizontal raster, which contains 525 lines, makes a display having a width four-thirds its height.

The raster scan concept is implemented (see Fig. 1) by a display generator, which receives information from the central processor, reorganizes it into a format for display, stores it on a magnetic disk for refreshing the volatile image, and displays it on a standard television monitor such as those used in broadcasting studios and closed-circuit systems.

Because the display is refreshed from the disk, the central processor generates the information for a particular display frame only once. The system shown, using standard hardware, can drive up to 16 terminals with a different display on each one; all these displays share a common display generator and refresh disk, so that the cost per terminal is low.

The number of terminals can be doubled by operating each terminal at half-resolution, further reducing

**1. Raster system.** Display generator is the heart of the system; it accepts data from the central processor, formats the data, and stores it on the magnetic disk, then reads it from the disk and displays it on the monitor. Processor, disk, and monitor are all standard.

**2. Form overlay.** A way of combining fixed and variable data on a single display requires two channels. Only the channel with the variable data is accessible to the keyboard operator or other data source, so fixed data—the form in this example—remains inviolable.

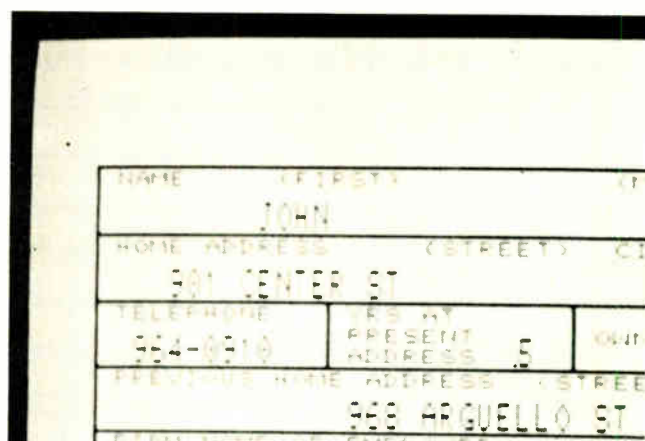
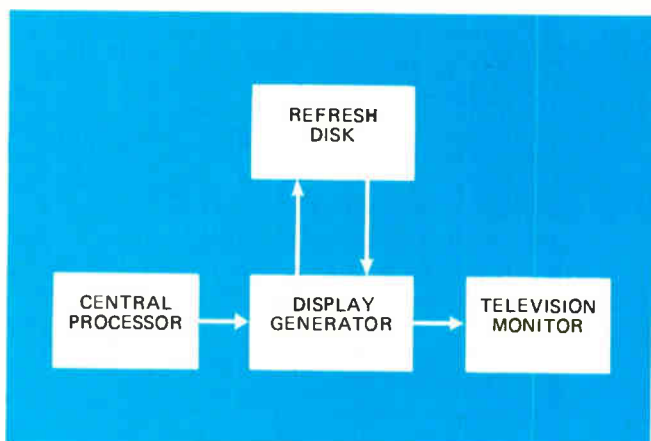

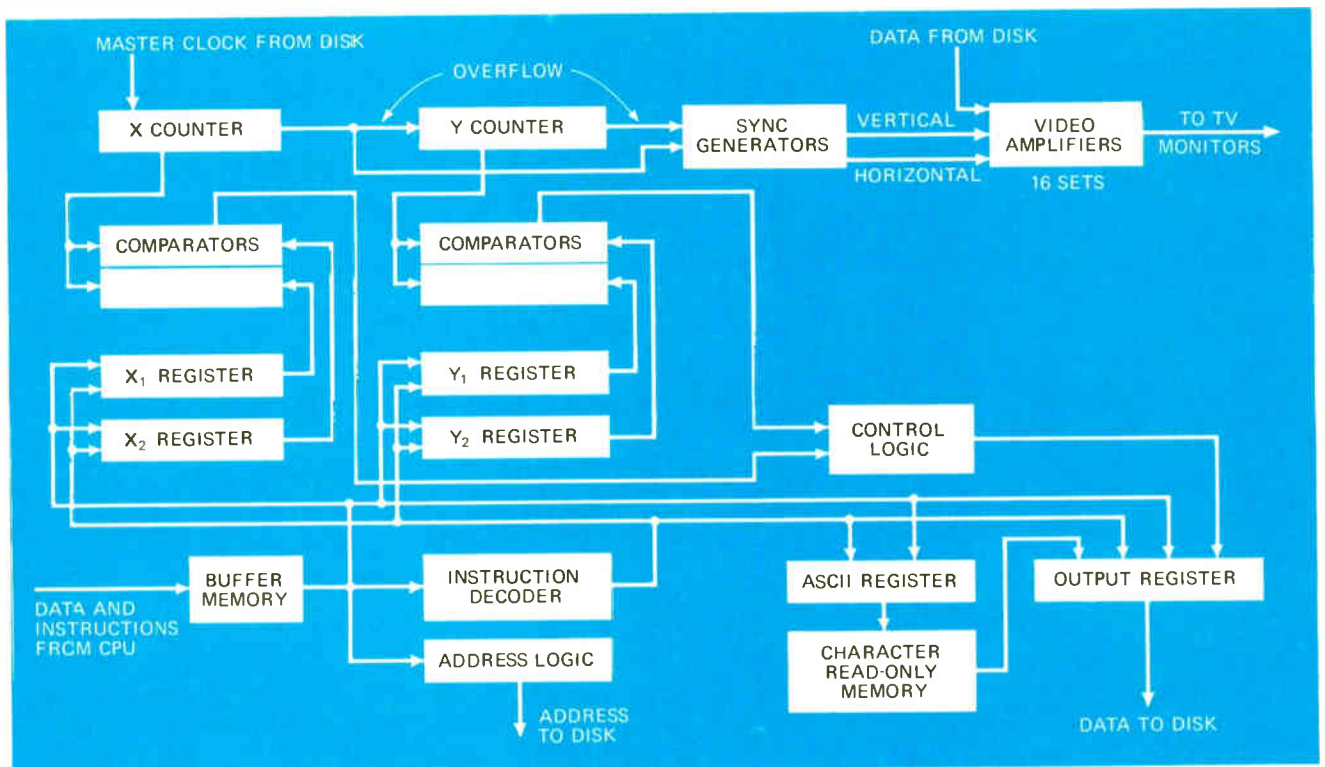

**3. Display generator.** Capable of being driven by a minicomputer, this generator puts together all images from a series of small rectangles having placement on the screen defined by the contents of the  $X_1$  and  $Y_1$  registers and size defined by the differences between these numbers and the corresponding numbers in  $X_2$  and  $Y_2$ . Images go from computer to disk, then to monitor for display.

the cost per terminal. Such a display is only half the height of a monitor screen, but some monitors have height adjustments that can compensate for this.

Color displays are easily provided by the display generator at a cost of reducing the number of channels. Three of the basic 16 can be connected to the three electron guns in a standard color television monitor, each generating its own display independently of the others. Of course, the three guns wouldn't actually be independent, but would carry the individual color components of a display of up to six colors and white—the three primary colors and their various combinations. Examples of color displays in various applications are in the photos on page 113.

If channels are combined in this way with a monochrome monitor, the same information can be made to appear as gray-scale levels corresponding to the various colors.

Channels can also be combined to provide form overlays. A standard form can be transmitted by the display generator through one channel to a monitor, and transient data to be processed on the form goes through another channel; a composite display combines the two channels (Fig. 2). This is a useful technique in routine applications where an unskilled operator works with the data. His input device—a keyboard or a light pen—would be connected only to the channel carrying the transient data so that he could not inadvertently modify the form. The same technique can be used where some of the data in a display must be protected from alteration; the protected data goes on a separate channel from transient data.

Although the same result can be achieved with a

single-channel display, that channel requires more complex software. With the selective-erase capability, the form need not be disturbed, but it is often easier to erase both the data and the form, then regenerate a new blank form, as required, than to erase selectively.

Hard copy can be obtained easily by plugging an interface card for an electrostatic printer into the display generator.

### System hardware

All CRT displays, except those using storage tubes, require the image to be refreshed periodically. If the computer is not to be tied up transmitting the image information repeatedly, the refreshing requirement means that the display system must include a local memory, with a capacity of 250,000 to 400,000 bits per image, depending on the details of the system's operation. Any of several memory technologies can be used—delay lines, shift registers, ferrite core stacks, and magnetic disks are examples. Of these, the magnetic disk is the least expensive for systems using many terminals because it can store the most data at the least cost per bit.

A disk storage unit designed to refresh a raster scan CRT must have a separate head for each data track, a high recording density, and a rotation rate that is highly stable and fast enough to refresh properly.

The head-per-track design is necessary to permit the disk to refresh several independent displays simultaneously. These heads must have individual read/write amplifiers and they must be electrically isolated from one another to prevent crosstalk.

A standard television monitor requires just over 300,000 bits to display a single frame; additional disk



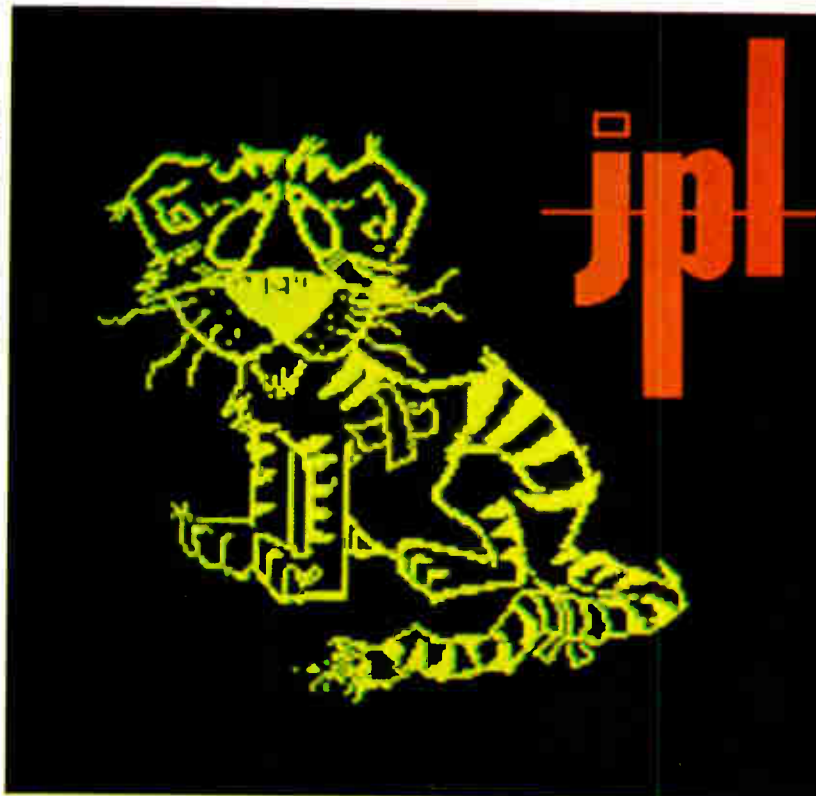
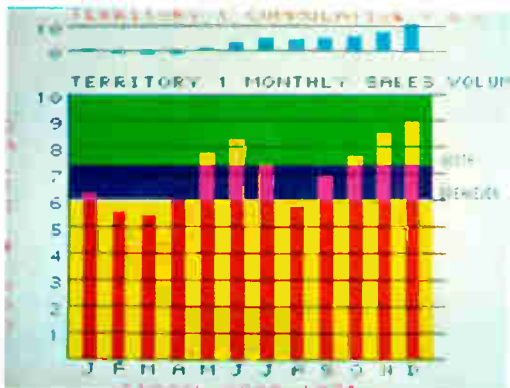
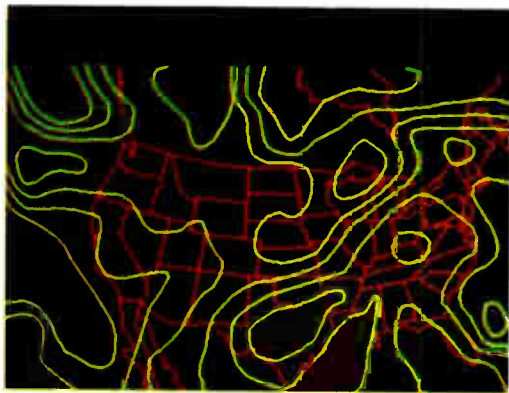
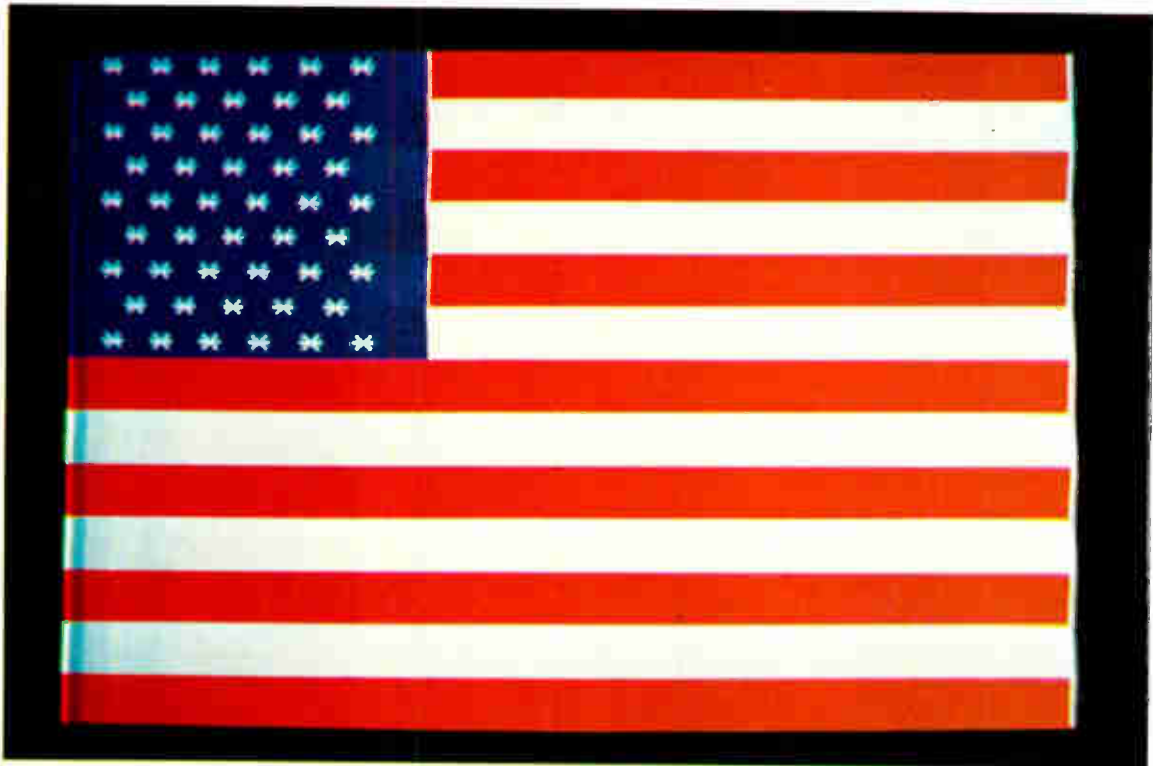

**Colorful and flexible.** These examples of color images on a disk-refreshed raster-scan display illustrate the system's flexibility as well as its color capabilities. The flag is made in line-drawing mode from only the stripes' corner coordinates; its stars, for simple programming, are alphanumeric asterisks. Similarly the bar chart is a simple series of rectangles with alphanumeric data superimposed. But the tiger and the weather map are in graphic-data mode; the images were created in the computer's memory and transmitted bit by bit to the display system. The JPL logotype combines line-drawing mode for the rectangular portions of the letters and graphic-data mode for the curved parts.

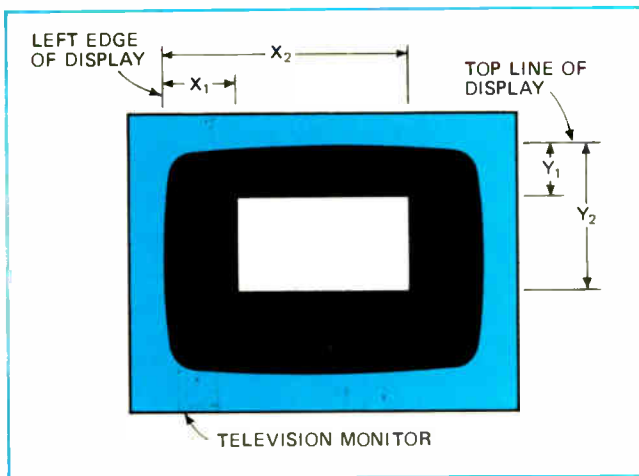

**4. Simplest image.** Solid rectangle's position and size are related to contents of four registers in display generator. Dark rectangle on white background is shown by reversing the recording polarity.

capacity, beyond that required for these displayed bits, is consumed during the horizontal and vertical retraces. Although the total could fit on three tracks of an ordinary magnetic disk, four tracks are used for simplicity in the control logic; thus the images on 16 independent displays require 64 tracks.

(The number of bits displayed per frame is determined for a horizontal scan from the standard 525 lines per frame, of which 480 lines are generally visible, and from the standard 4:3 aspect ratio, which yields 640 visible elements per line. Each element requires a single bit of storage; the number of lines times the number of elements per line is the number of bits.)

This stored information must be delivered at a speed that will permit the refresh rate to match that in standard television scanning. To achieve this rate, data is taken from the four tracks in parallel and shifted serially to the display monitor at four times the disk data rate. Thus, for the standard 30 frames per second, the

disk speed is 30 revolutions per second or 1,800 rpm.

This speed must be precisely locked in; either a synchronous motor running directly on the 60-hertz power or a servo-controlled dc motor will do. The servomotor can lock the disk rotation within  $\pm 50$  nanoseconds of an external reference per revolution. The more expensive servo control is used in complex systems that combine data from several disks, or from external sources such as television cameras or videotapes, on a single monitor.

The disk can be made to perform double duty, especially when fewer than 16 display units are to be connected to the display generator. First, regardless of the number of displays, the image must be assembled in the central processor's memory—which could require over 300,000 bits if the image is assembled directly bit for bit. But at the cost of a small expenditure in time, the processor can assemble the image on the disk a few bits at a time. When using this approach, the processor needs less internal memory, but it requires software with which the processor can work directly with stored data on the disk.

With this software, the other half of the double-duty operation becomes available when fewer than 16 display units are used. Since the disk has the capacity to refresh a full load of CRTs, capacity not needed for fewer CRTs may be used as bulk memory for the processor. This can be extremely advantageous, especially for a minicomputer with limited memory capacity.

The display generator, which is the interface between the processor and the disk unit, can be either simple or complex. Of course, the simpler its hardware, the less expensive it is; but a penalty is paid in terms of added complexity in the processor software.

One display generator design that can be driven by a minicomputer is shown in Fig. 3. Its X counter is stepped by a prerecorded 3-megahertz master clock signal from the disk; when the X counter overflows, it steps the Y counter, and when the Y counter overflows, the disk has completed one revolution. Together the X and

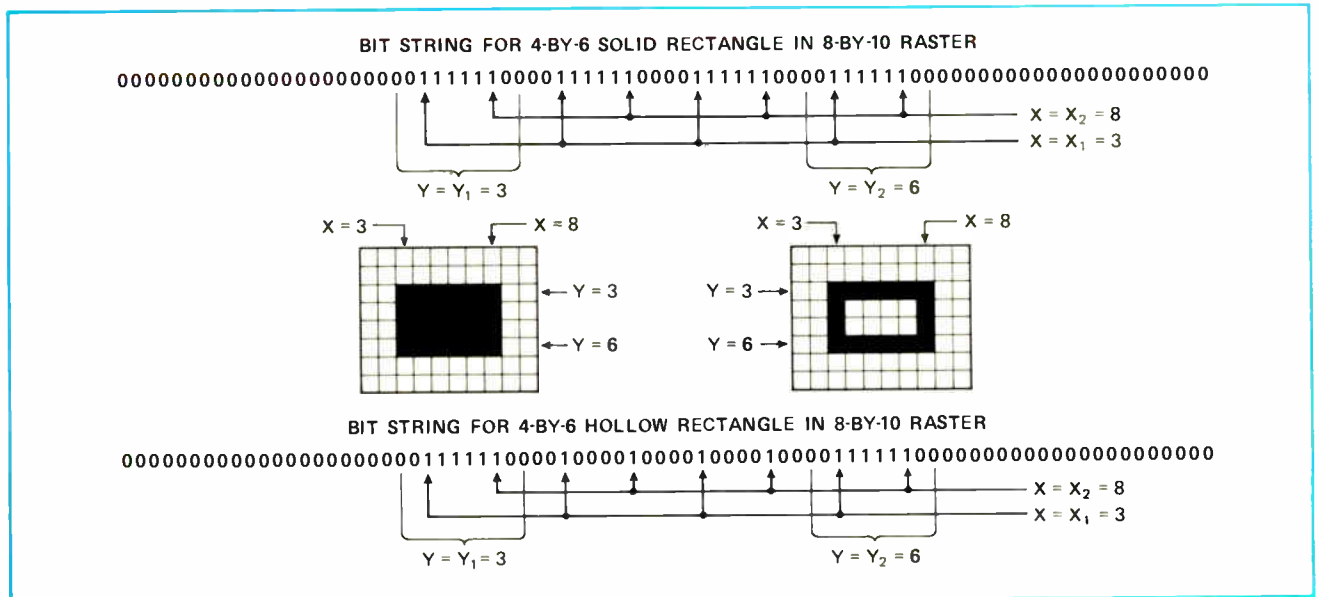

**5. Bit strings.** In small 8-by-10 raster, solid 4-by-6 rectangle is painted by binary 1s stored on disk, corresponding to each point in the raster within the boundaries of the rectangle. Hollow rectangle requires only 1s for points on the boundaries. In actual display, lines would be much narrower, relative to size of raster, and would look like lines, not stripes. 0s show suppressed writing, not recorded data.

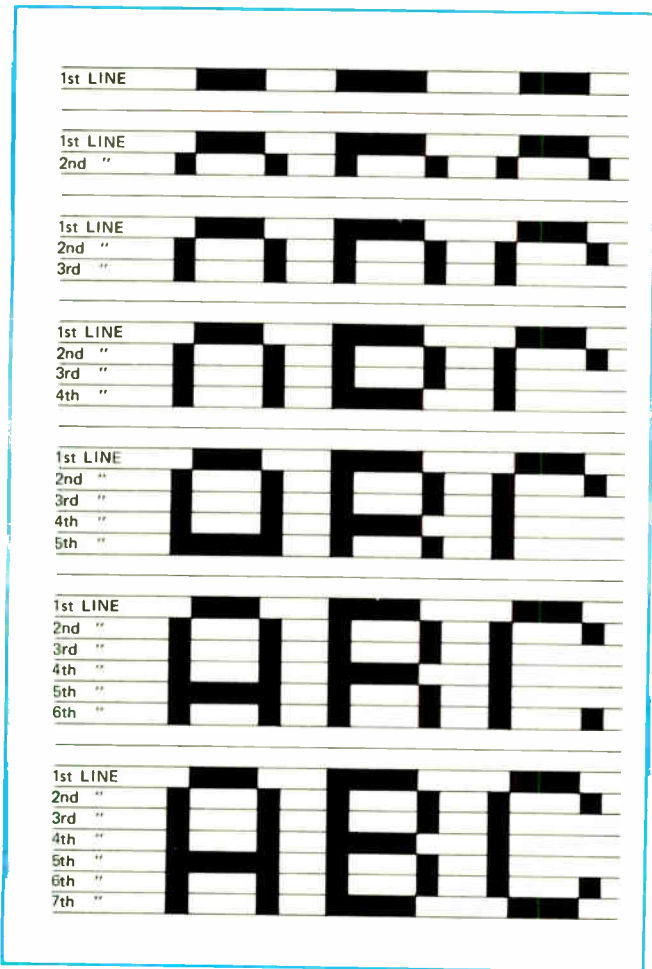

**6. Alphanumerics with horizontal scan.** Row of three characters, ABC, in 5-by-7 dot matrix form, is traced out by horizontal raster scan. Each sweep traces out part of each character; seven sweeps trace out all characters in the whole row.

**7. Graph with vertical scan.** Value of independent variable increases step by step as successively vertical scan lines are made; with each step, only one point in single-value graph need be plotted, making the entire display easy to create.

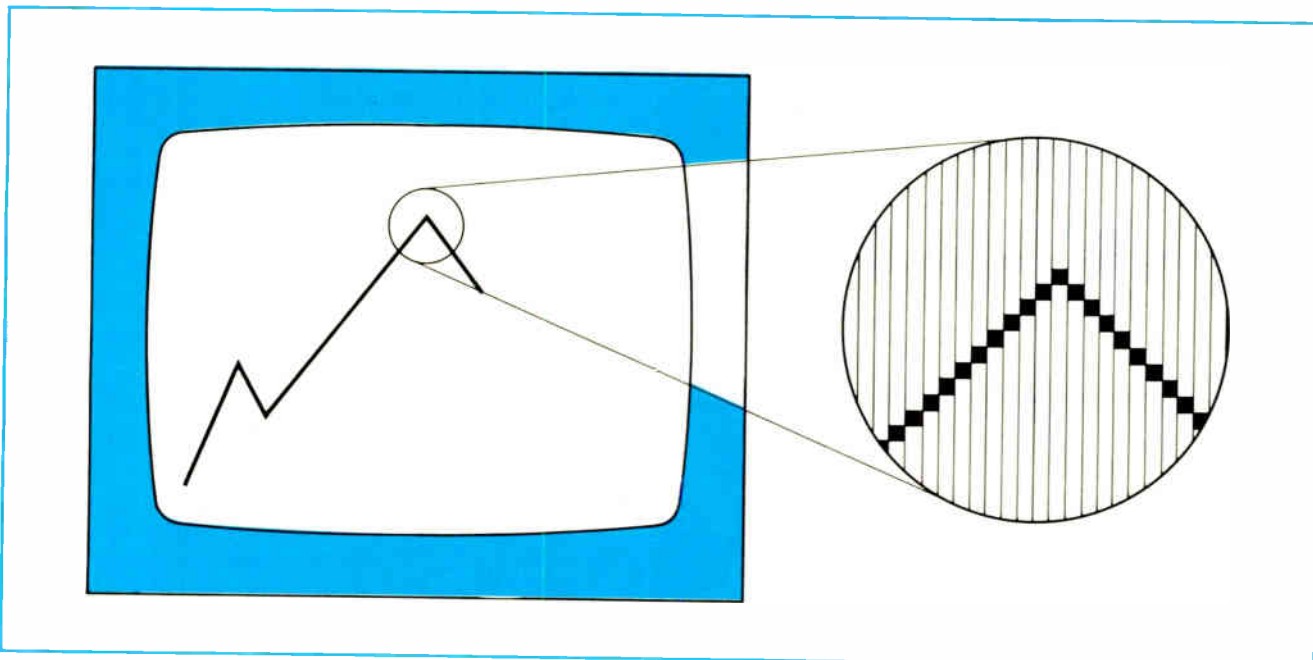

Y counters indicate the disk's instantaneous position, and by analogy, the position of the electron beam scanning the CRT screen in a horizontal-line raster (the X counter indicates the position of the beam along a line, and the Y counter the particular one of 525 lines). The overflow from the X counter generates the horizontal synchronizing signal for the CRT, and the Y counter overflow generates the vertical sync.

To this display generator the processor specifies channel addresses, X and Y coordinate positions, and data; the CPU may also specify at the start of an operation whether the data to follow constitutes a graphic display or an alphanumeric one. The data path from the processor to the generator is 16 bits wide; all instructions and data received are stored temporarily in the buffer memory before being routed to their destinations in or through the generator.

For example, to draw a simple solid rectangle in white against a dark background (Fig. 4), the processor first specifies line-drawing mode, rather than alphanumeric mode, and gives the address of the monitor on which the rectangle is to appear, corresponding to the set of four tracks on the disk from which the display is to be refreshed. Then the processor sends four numbers that are stored in the four registers,  $X_1$ ,  $X_2$ ,  $Y_1$ , and  $Y_2$ . These define the boundaries of the rectangle. As the disk turns and the X and Y counters count from 0 upward, the X and Y counters are compared with the  $X_1$  and  $Y_1$  registers. At first, no data is written on the disk; it may already carry displayed data upon which the rectangle is to be superimposed. But when the counters reach the register values, binary 1s are written on the disk and continue until the rapidly counting X reaches  $X_2$ .

This is repeated on all scan lines until  $Y = Y_2$ . On subsequent revolutions of the disk, the data is read and forwarded to the display, where the scanning beam,

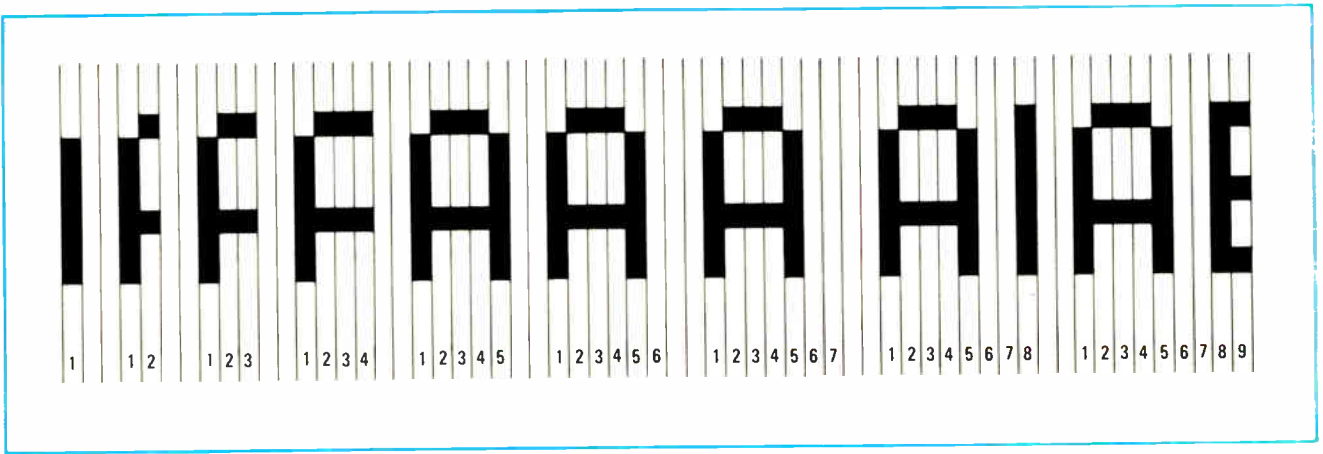

**8. Alphanumerics with vertical scan.** Part of a row of characters, A and the beginning of B, is traced out by a vertical raster scan. Each sweep traces out part of a character; five sweeps trace out the entire character, and two more mark the space between characters.

synchronized with the disk, paints a "window" on the screen.

In Fig. 5, the bit-string for the 4-by-6 solid rectangle is shown for four groups of 1s corresponding to four adjacent horizontal lines—actually narrow stripes—painted by the electron beam; these stripes, properly aligned and abutted, make up the solid rectangle.

If desired, the computer can specify a black rectangle against a white background by reversing the recording polarity of the information—that is, defining a logic 1 as black instead of white. Or the outline of the rectangle can be drawn in either white-on-black or black-on-white, with an appropriate computer instruction that sets up the controls in the display generator.

To draw the outline rectangle, the top edge is drawn as a solid line, just as in making the solid figure, when  $Y = Y_1$  and while  $X$  is between  $X_1$  and  $X_2$ . Thereafter, while  $Y$  lies between the two  $Y$ -register values, only one bit is stored at the moments when  $X$  equals one or the other of the two  $X$ -register values, drawing the two sides one point at a time, so to speak, adding points alternately to one vertical side and then the other. Finally, when  $Y = Y_2$ , another solid line is drawn to form the rectangle's bottom edge. The bit-string for the hollow rectangle contains two groups of 1s corresponding to the two horizontal lines that form the top and bottom of the rectangle. Isolated 1s elsewhere in the string form the two vertical sides of the rectangle one point at a time as the electron beam sweeps horizontally across the screen.

In alphanumeric mode, the computer can specify the position of a single character on the screen by giving the coordinates of the upper left corner of a rectangular space just big enough to contain the character, in the form of a dot matrix. Then the computer loads the character into the ASCII register shown in Fig. 3; this effectively addresses the read-only memory, which supplies the bit pattern for the character.

All images on this display are made up of standard alphanumerics generated as just described, special alphanumerics created in graphic mode, graphics built up as arrays of small solid or outline rectangles drawn as previously described, or patterns of individual points added to the display at the moment when both  $X$  and  $Y$  counters equal their respective registers. For this last mode, the computer loads the necessary data directly

into the output register after having specified the proper  $X$  and  $Y$  coordinates, bypassing the generator's rectangle-drawing controls and alphanumeric character circuits. This direct display requires the most detailed programming of all the various modes of operation.

Most of the preceding discussion has applied to horizontally scanned raster displays, as in standard television. But a vertical scan can be made to work as well; each direction has its advantages and disadvantages.

In horizontal scan, the buffer can be loaded with a full row of characters. A single sweep of the electron beam then displays a portion of every character in the row; as shown in Fig. 6, seven sweeps or scan lines display the whole row of characters in 5-by-7 dot matrix form, completing each character one segment at a time from top to bottom. The display actually uses the more complex 8-by-12 matrix. If the computer keeps up with the disk, enough characters to fill the entire screen of the CRT can be recorded and displayed in one raster frame, or one revolution of the disk.

### Vertical scan

But single-valued graphs are easier to plot with vertical scanning, because the value of the dependent variable,  $Y$ , is provided directly for each increment of  $X$ , which increases as the line count increases (Fig. 7). And in alphanumeric mode, the system need not have the buffer shown in the block diagram; the computer can feed the data directly to the generator, one character at a time. A single sweep of the electron beam displays one segment of that character, as shown in Fig. 8; five sweeps or scan lines display the character completely, and in the figure, two more lines show the space between adjacent characters. The display uses a one-line space. Without the buffer, the system costs less; but without it, the computer must wait for the display and therefore runs more slowly, while the display can write only one row of characters per scan.

Standard television monitors can be used nominally only with horizontal scan. However, special monitors need not be built for use with vertical scan; a standard monitor turned on its side works perfectly well, as does a standard monitor in a right-side-up cabinet but with the deflection yoke on the CRT turned at right angles to its usual position. □

# This is what you have to know to know everything about converters.

## Table of Contents

Analog-Digital Conversion Handbook

### I. Converters at Work

Data System Components  
Data Acquisition & Distribution  
Circuit Tricks with Components

### II. Applications of Converter Systems

Automatic Testing  
Communications and Signal Analysis  
Displays  
Commerce and Industry

### III. Converters

Understanding Converters  
Converter Design & Testing  
Specifying & Applying Converters Successfully

### IV. System Accessories

Operational Amplifiers  
Instrumentation Amplifiers  
Multiplexers  
Sample-Holds

### V. What To Do When Things Don't Seem To Work Right

Basic Questions People Always Ask  
and Where to Find the Answers  
The 10 Mistakes Users Most Commonly Make  
If All Else Fails

### Appendix

Glossary & Definitions  
Some Useful Tables

## Analog-Digital Conversion Handbook 312 pages. \$3.95

Since you make more kinds of A-D and D-A converters than anyone else, I wouldn't pass up your handbook for anything. Enclosed is my check for \$\_\_\_\_\_ for \_\_\_\_\_ copies.

Name \_\_\_\_\_ Title \_\_\_\_\_

Company \_\_\_\_\_ Street \_\_\_\_\_

City \_\_\_\_\_ State \_\_\_\_\_ Zip \_\_\_\_\_

Please allow 4-6 weeks for delivery.

Mail to: Analog Devices, Inc., Box 796, Norwood, Mass. 02062



E

# automate wire preparation the proven way!

Delivers wire cut to size, stripped one end or both ends. Ready to be used. N/C operated Wire Preparation Unit profits from a full decade of Gardner-Denver experience in processing all types of insulated wire. Millions of feet and more!

Unit operates as an on-stand-alone bench production volume details on this electronic economies

line system with terminal locator wiring equipment, or as a unit. Solid state reliability. Ideal for high or low volume. Utmost precision and flexibility. Write for details and our whole family of Wire-Wrap\* and related production equipment. Get in on major production economies enjoyed by the leading electronic manufacturers.



Automatically  
measures,  
cuts, strips.



**GARDNER-DENVER**  
Gardner-Denver Company, Quincy, Illinois 62301

\*Wire-Wrap is a registered trademark of Gardner-Denver Company

118 Circle 118 on reader service card

Electronics/June 5, 1972

## Time-delay sampling simplifies settling-time measurements

by Robert E. Gagnon  
Raytheon Co., Sudbury, Mass.

Problems arise when the settling time of large-magnitude nanosecond step functions has to be measured to within  $\pm 1$  millivolt, regardless of the driving source. A differential comparator amplifier plug-in for commercially available oscilloscopes can measure settling time directly, but the scope's overload-recovery capability limits resolution to microseconds. This method falls short when faster settling times must be measured, because the scope may be showing its own settling time, rather than that of the device under test.

One way around these problems is to use a time-delayed sampling technique that effectively "freezes" the waveform to be measured. This allows viewing any

portion of the waveform with the oscilloscope on a repetitive basis and measuring the settling time by simply using the scope delay and a dc voltmeter. Although a digital type can be used, a differential voltmeter gives more accurate results.

To measure the settling time of a digital-to-analog converter, the DAC under test is cycled periodically between the voltage levels; the level of interest is then sampled at the same rate, but with a fixed amount of delay (provided by the scope). The resultant output of the sample-and-hold circuit is a dc level equal to the amplitude of the step at that point in time. When the amount of delay is varied, the meter, having been zeroed at the level of interest, will move back and forth around zero, in effect tracing the DAC's settling-time waveform.

The timing and cyclic logic circuits are set so that the DAC's output alternates between the two levels at which settling-time measurements are to be made. The cycling period should be at least 10 times longer than the DAC's expected settling time. This assures that the DAC output will have completely settled at the final value before the

**Measuring settling times** with good resolution and accuracy requires a fast one-shot and a sample-and-hold with small aperture time.

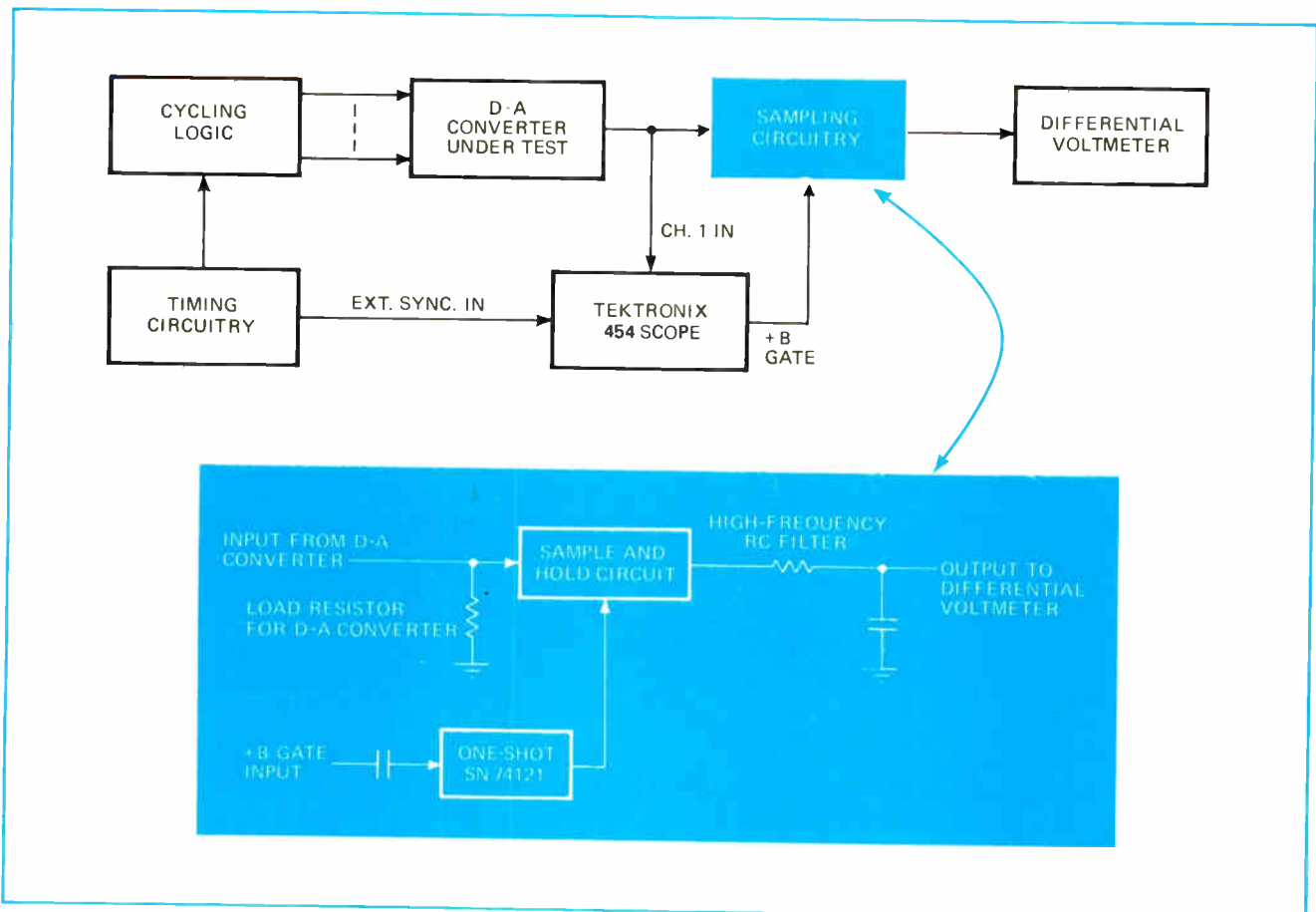

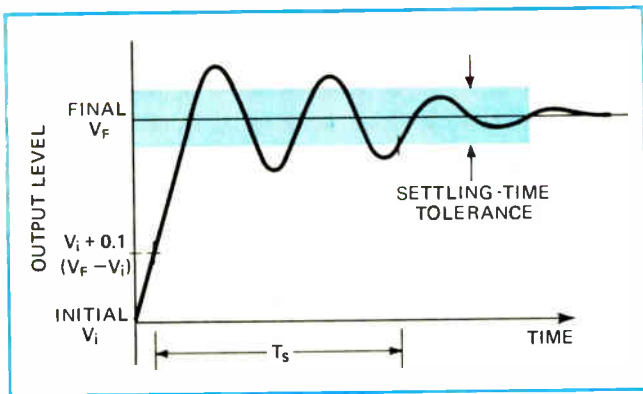

Settling-time characteristics of a typical waveform.

testing sequence is repeated.

The oscilloscope used to view the waveform is set for "A-intensified-by-B" operation; the B sweep is triggered by the timing circuitry after a fixed amount of delay, controlled by the scope. What is seen on the scope is a source wave with a small spot or section of it intensified. The scope delay is then adjusted so that the intensified spot is positioned almost at the final-voltage level end of

the waveform. The dc differential voltmeter is then zeroed at that level, and the scale set to handle the value of settling-time voltage tolerance. The scope delay is then reduced until the voltmeter reading deviates from the zero setting by an amount equal to the settling-time voltage tolerance. This value of delay is recorded. The amount of delay is further reduced (with an appropriate increase of voltmeter scale to avoid pegging the meter) until the intensified spot is at a level equal to the initial voltage level plus 10% of the total change in voltage between the initial and final voltage step. This can be done with good accuracy by observing the wave-form.

Measurement resolution and accuracy depend on the minimum width of the sampling pulse. This is determined by the output pulse width of the one-shot and the aperture time of the sample-and-hold circuit. To handle very fast settling-time measurements, an ECL one-shot can be substituted for the SN74121 (which is capable of providing 40-nanosecond pulses).

As long as the delay of the scope + B gate remains constant, the sample-and-hold circuit samples only a dc level. Switching transients are minimized by a simple RC filter. □

## Logic approach to time delay uses only integrated circuits

by John J. Carroll  
U.S. Naval Avionics Facility, Indianapolis, Ind.

The checking of systems that use linear pseudo-random pulse sequences usually requires delayed sequences, as well. Often the delayed signals are simulated by conventional delay lines, but this approach is bulky and expensive to implement, and changing the length of the delay requires switching several delay lines or using a tapped delay line.

In a more compact and less expensive approach, several logic gates can delay the pulse sequence, which is produced in the conventional way by a modified shift register, and a second shift register varies the delay in much smaller increments than are practicable with conventional delay lines.

For example, the pulse sequence may represent the output of a radar or sonar transmitter; the delayed sequence would represent the echo. In the simulation, the original sequence and the delayed sequence can be processed in the same way as the signal and its echo in an actual system.

In general, a pseudo-random pulse sequence is a cyclic group of  $2^n - 1$  pulses containing all possible binary combinations of  $n$  pulses except the all-Os combination. The cyclic characteristic of the sequence is the distinction between a pseudo-random and a truly random one.

Nevertheless, the sequence can almost arbitrarily ap-

proach true randomness. For example, if  $n = 20$ , the sequence contains more than a million pulses without repetition. When these are produced at a clock rate of 1 megahertz, the cycling rate is less than 1 hertz. Therefore, if the 1-MHz sequence is fed through a high-pass filter with a 10-kHz cutoff, the filter output closely approximates true random noise.

The pseudo-random pulse sequences are generated by a shift register (the sequence generator in the figure) in which the output of the last stage ( $A_5$ ) is combined with the output of one or more other stages in an exclusive-OR circuit. The shift register can be Fairchild's 9300 or equivalent. The output of the exclusive-OR is the pseudo-random sequence, which is fed back to the first stage of the register for recycling.

The exclusive-OR stages can be connected in many different ways, particularly in long shift registers. One connection that works particularly well for  $n = 5$  appears in the figure.

To produce the delayed sequence, the stages of the shift register are connected through AND gates to a network of exclusive-OR circuits—the sequence delay network shown at the right side of the figure. This can be a quad exclusive-OR gate—for example Fairchild's 9014 or equivalent.

The delayed output  $A_k$  of the exclusive-OR network is identical to the original sequence, except that it is delayed by a number of clock pulses—the number depending on the particular gates that are enabled. The enabling of these gates is done by the delay control, as described later. (The circuit delay through the shift register and exclusive-OR network is assumed to be negligible relative to the intervals between clock pulses, and therefore, to the minimum delay resolution.)



At any given time, the output of stage  $A_1$  of the shift register equals the output of the sequence generator delayed by one pulse period. Likewise, the outputs of other stages of the shift register represent the sequence generator output, delayed by two, three, or more clock pulses (depending on the number of stages). Any of these delays can be made available at the  $A_k$  delayed output by enabling the corresponding gate between the shift register and the sequence delay network. The circuit shown provides for delays of as many as five clock-pulse periods.

The output  $A_k$  can also produce zero delay by enabling gates  $B_3$  and  $B_5$ , which produce  $A_0$  through the exclusive-OR network from the same stages that produced the original undelayed signal.

Delays of from five to 31 clock pulses for the circuit shown (or, in general, up to  $2^n - 1$ ) are available by enabling other combinations of the gates. Thus, just as  $A_0$  is the exclusive-OR of  $A_3$  and  $A_5$ ,  $A_1$  is the exclusive-OR of  $A_4$  and a hypothetical  $A_6$ ,  $A_2$  is the exclusive-OR of  $A_5$  and  $A_7$ , and so on.

These relationships can be inverted, thanks to the peculiar mathematical properties of the exclusive-OR function, to express the longer delays in terms of the outputs of two or more real stages. Thus,  $A_6$ , or the sequence delayed by six clock times, is the exclusive-OR of  $A_1$  and

$A_4$ ,  $A_7$  is the exclusive-OR of  $A_2$  and  $A_5$ , and so on. For the higher-numbered subscripts, several substitutions may be required, yielding, for example, the fact that  $A_{12}$  is the combined exclusive-OR, or odd parity, of  $A_1$ ,  $A_2$ ,  $A_3$ , and  $A_4$ .

The delay control that enables the AND gates consists of the same number of shift register stages that are used for the sequence generator. Any delay from 1 to  $2^n - 1$  clock times can be generated by pulsing this control shift register the corresponding number of times. With this arrangement, several different delay configurations are possible.

For example, swept delay can begin at some initial value, gradually increase to a maximum, and then reset to its initial delay. This is easy to implement by using the delay control shift register, simply by clocking it at the appropriate sweep rate.

A more complex generator can be loaded in parallel with a binary number from an external source that sets the delay to some arbitrary level without stepping through a number of intervening values. When the shift register is long, producing a long pseudo-random sequence, this parallel-loading capability can save a lot of time and trouble. □

Engineer's Notebook is a regular feature in Electronics. We invite readers to submit original design, applications, and measurement ideas. We'll pay \$50 for each item published.

**Network of exclusive-ORs** (right) produces delayed pulse sequence; length of delay is set by delay control, similar to sequence generator.

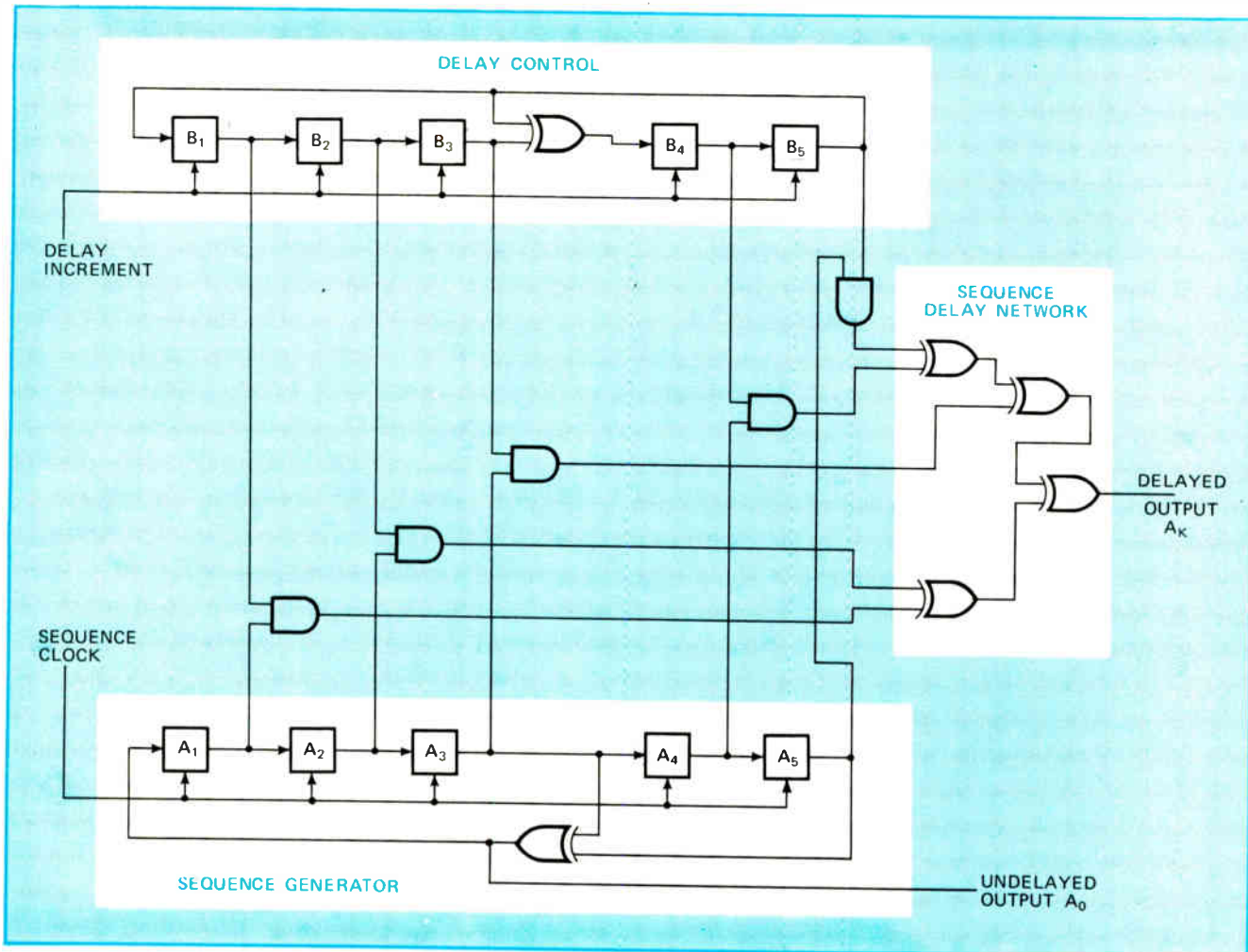

## Gentler switching gets more from power devices

Soft commutation isn't a ride to and from work in a plush railroad car. **It's a way to make a 1-kilohertz power transistor or thyristor do the job of a 5-kHz device** by softening the leading and trailing edges while reducing the peak-to-average current ratios. The design technique is especially well suited to higher-power, silicon-controlled-rectifier types. A typical hard commutation circuit, for example, requiring SCRs with turnoff times of 20 microseconds can be replaced by a soft-commutation circuit using less-expensive 30-microsecond devices. Soft commutation is not new, but David Cooper, sales and engineering vice president for the International Rectifier Corp. Semiconductor division, says **it hasn't been used much because the circuits are harder to understand and to design.** If you write to Cooper at IR, 233 Kansas St., El Segundo, Calif. 90245, he'll send you sections of a recent symposium paper dealing with soft commutation.

## Consumer market alters job patterns

If you're working for a company that's getting more deeply involved in the consumer electronics field, **don't be surprised if you find yourself taking vacations at different times** than you've been accustomed to or putting in overtime at certain seasons. Seasonality of the market generally hasn't been widespread in electronics, but it's already becoming apparent in electronic calculator manufacturing, for example, where heavy pushes are expected to get goods on store shelves for graduation and Christmas gifts.

## Mono regulators to give choice of output voltage

Monolithic voltage regulators intended for handling the power for individual printed-circuit cards have been available for a long time but **they have only supplied the normal +5 volts required by digital logic.** It is apparent that they haven't made much of an impact, since most cards carry other circuitry that requires at least one other voltage. Now, several IC makers (National Semiconductor, Motorola, and Silicon General, to name just a few) are pushing to provide regulators that will first convert the +5 V to -5 V and then regulate this voltage. When housed in TO-3 packages, they will deliver about 1 ampere, while in TO-5 cans, they'll give about 200 milliamps. **Future units will handle a wide variety of output voltages.**

## Meter movements damping out?

**"The d'Arsonval meter movement's days are numbered."** Such a statement wouldn't be surprising if it had come from someone at one of the many newer digital panel meter companies, but since we heard it from a man at Weston Instruments, we're inclined to consider it more seriously. Jack Stegenga, new products manager, says **he doesn't base his prediction strictly on the rise of the digital panel meters,** since there still are many applications where analog readouts are preferable. He thinks that low-cost digital processing circuits and solid-state displays such as arrays of light-emitting diodes will eventually displace the moving-coil movements, except for some specialized cases, where the electro-mechanical design of the meter movement can be easily tailored directly to provide simple nonlinear-to-linear conversions of electrical quantities.

# cablebility



CABLEBILITY — "The specialized skill of designing and producing quality electrical and electronic cables to meet the sophisticated requirements of today's industry."

Our word yes, and our definition — but we think it aptly describes our ability to provide the best possible solution to your multi-conductor cable problems. But CABLEBILITY is even more than that. It's a blend of experience and technical know-how combined with the virtually unlimited resources and facilities of Cities Service . . . your assurance of dependable and practical cable constructions to fulfill your most exacting requirements.

## **CITIES SERVICE COMPANY**

CHESTER CABLE OPERATIONS  
CHESTER, NEW YORK 10918



# cablebility

## proven by performance

Leading manufacturers in such fields as electronics, automation, nucleonics, communications and electronic data processing have learned to depend on Cities Service quality cables. This industry-wide acceptance has resulted in four expansion programs since 1945 to keep pace with increasing customer demands. Thanks to enlarged research and development facilities, exceptional technical manpower and the latest production equipment, we furnished more than 1,000,000 miles of insulated cables and wires to our customers last year.

Today, our CABLEBILITY is your assurance that Cities Service CITCO brand cables will meet your specifications . . . be competitively priced and will be delivered to you on time. No matter what your requirements . . . check first with Cities Service . . . we know you'll be glad you did.

- A CITCO AUDIO SOUND CABLE:** 25 shielded pairs, stranded copper conductors, low loss insulation, twisted with uninsulated drain wire, isolated aluminum tape shields, cabled PVC jacket.
- B CITCO TV CAMERA CONTROL CABLE:** Camera control cable for Audio and Video signals: a composite of PVC and polyethylene insulated conductors, cabled, overall braid shield, PVC jacket.
- C CITCO AIRCRAFT CONTROL CABLE:** 12 triples shielded jacketed, stranded copper conductors, PVC insulated, individual shield jacket color coded, cabled overall PVC jacket.
- D CITCO ELEVATOR CONTROL CABLE:** 35 conductors, stranded copper, PVC insulated, conductors coded by colors and printed numbers, cabled with open binder; individual conductors U/L listed.
- E CITCO INTEROFFICE COMMUNICATION CABLE:** 250 conductor interoffice communication and signaling cable: solid bare copper, PVC insulation, paired, cabled, PVC jacket; U/L listed.
- F CITCO STATION CONTROL CABLE:** 37 conductors, stranded polyethylene and PVC insulated, color coded, cabled, overall tough PVC jacket; per NEMA/IPCEA Specifications.
- G CITCO MUNICIPAL COMMUNICATION CABLE:** 50 pairs, polyethylene insulated, cabled, continuous layer of copper shielding tape, PVC jacket; per spec. IMSA-19-2, 600 volts.
- H CITCO SHIPBOARD CABLE:** Stranded conductors, nylon-jacketed PVC insulation, pairs shielded and jacketed, cabled, PVC jacket, and aluminum braid armor overall; per spec. MIL-C-915.
- I CITCO COAXIAL CABLE:** Type RG-218/U, solid copper conductor, polyethylene insulated, copper braid shield, PVC jacket; per spec. MIL-C-17/79.
- J CITCO REMOTE CONTROL BROADCASTING CABLE:** Stranded conductors, polyethylene insulation, pairs and triples shielded and jacketed, cabled, PVC jacket overall.
- K CITCO COMPUTER CONTROL CABLE:** 55 conductors, stranded copper conductors, PVC insulated, formed into 7 groups of 7 conductors, cabled, PVC jacket; U/L listed.
- L CITCO BUS DROP CABLE:** 3 PVC insulated stranded conductors, with split uninsulated grounding conductor, cabled, overall PVC jacket; U/L listed; per NEC.

### OTHER CITIES SERVICE WIRE & CABLE PRODUCTS

APPLIANCE WIRE • BUILDING WIRE • FLEXIBLE CORDS • FIXTURE WIRE  
GAS TUBE SIGN CABLE • HIGH VOLTAGE CABLE • HOOK-UP WIRE  
LEAD-IN CABLE • MACHINE TOOL WIRE & CABLE • SHIELDED WIRES  
WEATHER-PROOF WIRE • DEEP-WELL SUBMERSIBLE WATER PUMP CABLE  
LOW ENERGY CIRCUIT CONTROL CABLE • GASOLINE & OIL RESISTANT WIRE

## CITIES SERVICE COMPANY

CHESTER CABLE OPERATIONS

CHESTER, NEW YORK 10918

Phone: (914) 469-2141 TWX (914) 469-9801



# It took us years to develop the best stereo microscope.

## Now give us a few minutes to prove it.

Let us compare our StereoStar/ZOOM to any stereoscopic microscope in your lab.

Our microscope offers high resolution, larger fields of view, greater working distance. We have as wide a magnification range as you're likely to need: a full 6 to 1 zoom range with magnifications from 3.5 X through 210 X. The zoom control knob is coupled—so that it's conveniently located on both sides, for either left or right-hand operation. And the entire head is easily rotatable through 360°.

135 years of optical excellence went into the AO StereoStar/ZOOM. Let us compare it to any stereo microscope in your lab. After all, if it's worth your money, it's worth your time.

Call your AO Representative. Or write for our convincing 24-page brochure.



**AMERICAN OPTICAL  
CORPORATION**

SCIENTIFIC INSTRUMENT DIVISION • BUFFALO, N.Y. 14215

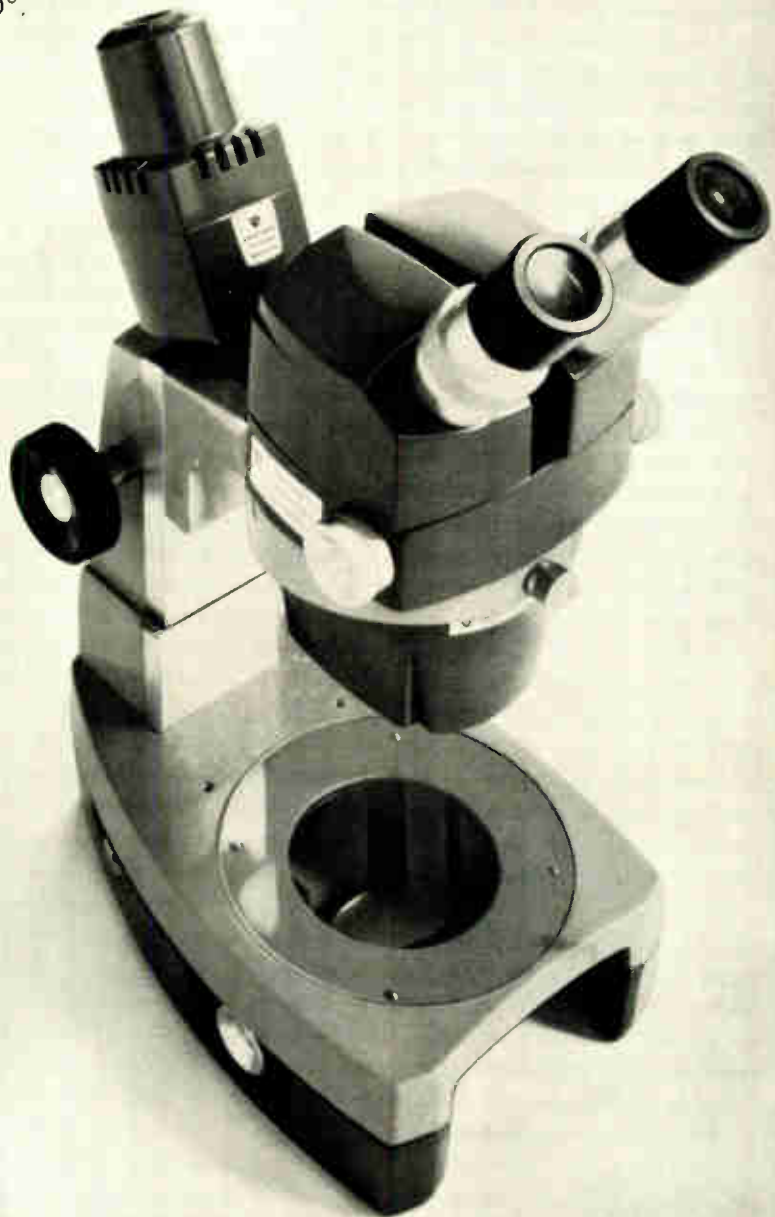

# A digital multimeter that measures true RMS and dBm directly.

Look what you can measure with the Hickok 3310 Universal Multimeter: true RMS voltage and current like these —

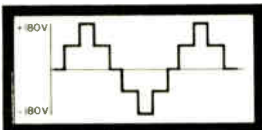

Sine wave synthesis by voltage switching  
ERMS = 110.2 Volts; 43.1 dBm

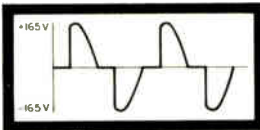

Load voltage using full-wave SCR phase control  
ERMS = 98.6 Volts; 42.1 dBm

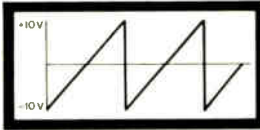

Sawtooth waveform  
ERMS = 5.77 Volts; 17.4 dBm

For just **\$845<sup>00</sup>**

You save money and receive performance with the Hickok 3310. Here are some of its RMS specs — 100- $\mu$ V resolution, 4:1 crest factor, bandwidth from 20 Hz to 50 kHz, RMS current capability from 100 nA to 2 A plus all-solid-state circuits for reliability and ruggedness.

But keep going. The 3310 reads from -40 dB to +60 dB with 0.1-dB resolution directly; no conversion or mental additions are necessary. You can choose between a 600 and 900-ohm internal reference with a front panel switch.

And don't forget the "multi." The 3310 measures DC voltage from 100  $\mu$ V to 1.5 kV, DC current from 100 nA to 2 A, and resistance from 100 milliohms to 200 megohms.

Then, there are the extras. You can add an internal rechargeable battery option with 20 hours consecutive operation or you can add a BCD-output option. Accessories extend ranges to 30 kV or 100 A, and one converts the 3310 to a 20-MHz counter. All accessories will fit into a convenient carrying case along with the 3310.

Try the 3310 for yourself. Call Hickok or your nearest Hickok field engineer for a demonstration and see RMS for yourself.

**HICKOK**  
the value innovator

Instrumentation & Controls Division  
10514 Dupont Ave. Cleveland, OH 44108  
(216) 541-8060



shown  
 $\frac{2}{3}$  actual size



# Once maps were made by hand.

## But why today?

Once, a man told another of what he'd seen and that man drew a map that all others could follow.

All of that was done by hand. That was then.

Today, a man takes a picture from an airplane of what he sees. And a second man prepares a manuscript from these photos. And then, this manuscript is transferred to film.

And then—incredibly—all of the lines that will make up the map (the rivers, the mountains, roads and streets) are *scribed* onto a negative master. By hand.

Finally, a swivel knife is used to cut outlines of specified areas. By hand. In

the seventies of the twentieth century.

Someone doesn't trust someone.

We, CalComp, have told cartographers that our 745 flatbed plotter will scribe lines equal to the tolerances and standards of the most skilled mapmaker's hand.

Cartographers have told us that they tried plotters once. And the lines were not accurate. And they were uneven. And wiggly.

The CalComp 745 Plotter is accurate to a rate of plus or minus .001 inch. The lines it scribes or cuts are smooth and even. (Their step size is only .0001 inch.)

And our 745 plots at a

speed of 4.2 inches per second. No hand alive can do that accurately.

If you make maps by hand, call us. We'll help you get from here to there.

Write us at California Computer Products, Inc., Dept. EM-M6-72, 2411 West La Palma Avenue, Anaheim, California 92801. Or call (714) 821-2011.



**CALCOMP**

Circle 127 on reader service card

# The FUJITSU quality for sale in Ultra-Mini Relays

## Relays Type 151 and 473 Series



- Small and light in weight.
- High sensitivity and reliability.
- Dust-proof, vibration-proof and shock-proof construction.

	Contact Form	Contact Rating	Voltage Rating	Pick-up Current (Voltage)	Stray Capacity	Pull-in Time	Drop-out Time	Initial Contact Resistance	Dielectric Strength	Shock	Life	Dimensions (mm)	Weight (gr)
151, 156 (Single contact)	DPDT 4PDT	100V DC 0.3A 100V AC 1A	6-48V DC	5-58mA DC	Max. 1PF	10mS	8-15mS	Max. 50mΩ (Gold plated) Max. 150mΩ (Silver, No. 1 alloy)	500V AC for one minute	10G for 11mS duration without relay damage	5 x 10 <sup>7</sup>	32.5 x 29.5 x 18.8 (4PDT)	25 (4PDT)
151X (Small stray capacity)	DPDT	100V DC 0.1A 100V AC 0.3A		11-58mA DC			8mS	Max. 400mΩ				27.1 x 28.8 x 18.5	20
473D, 474D (Twin contact)	DPDT 4PDT 6PDT	100V DC 0.3A 100V AC 1A	6-100V DC	6-130mA DC	20mS		6mS	Max. 50mΩ (Gold plated) Max. 150mΩ (Gold flashed)				32.5 x 35.0 x 18.8 (6PDT)	40 (6PDT)
473A, 474A (Twin contact)	DPDT	115V AC 1A	6-115V AC	4.8-92V AC			32.5 x 23.7 x 18.8	30					

\* 151: Screw/solder terminal 154 Printed circuit board ( 151 relay remodelled)  
 153, 473 Plug-in with socket 155 Printed circuit board ( 153 relay remodelled)  
 156 Stud-screw/solder terminal 474 Printed circuit board ( 473 relay remodelled)

**FUJITSU LIMITED**  
 Communications and Electronics  
 Marunouchi, Tokyo, Japan

MAIN PRODUCTS □ Telephone Exchange Equipment □ Carrier Transmission Equipment □ Radio Communication Equipment □ Space Electronics Systems □ Auto Radios & Car Stereos (TEN) □ Electronic Computers & Peripheral Equipment (FACOM) □ Telegraph & Data Communication Equipment □ Numerical Control Equipment (FANUC) □ Remote Control & Telemetering Equipment □ Electronic Components



Polaroid designed the CR-9 Land camera just for oscilloscope trace recording.

Snap the shutter and remove the film from the camera. Fifteen seconds later you have a fully developed, distortion-free print of the cathode ray tube display.

And the CR-9 is inexpensive. It costs less than \$180. (Other cameras that take pictures of comparable quality, start at around \$500.)

One person can easily make permanent records of the displays shown on several oscilloscopes. The portable CR-9 weighs less than 24 ounces. So, if you have more than one oscilloscope, you can quickly move the camera from one to another.

Focusing is unnecessary because the hood automatically holds the camera at the correct distance from the display. There are 8 interchangeable, light-tight hoods

from which to choose. They fit almost all oscilloscopes with 6x8, 6x10, and 8x10 cm graticules. The first hood comes with the camera. You pay a little more for additional hoods.

Buy the CR-9. And aim for the perfect wave.

For more information write: Polaroid Corporation, Dept. 35-239, 549 Technology Square, Cambridge, Mass. 02139. (In Canada: 350 Carlingview Dr., Rexdale, Ont.)



## The Polaroid CR-9 Oscilloscope Camera

# Now a low cost camera that develops pictures like these in only 15 seconds.

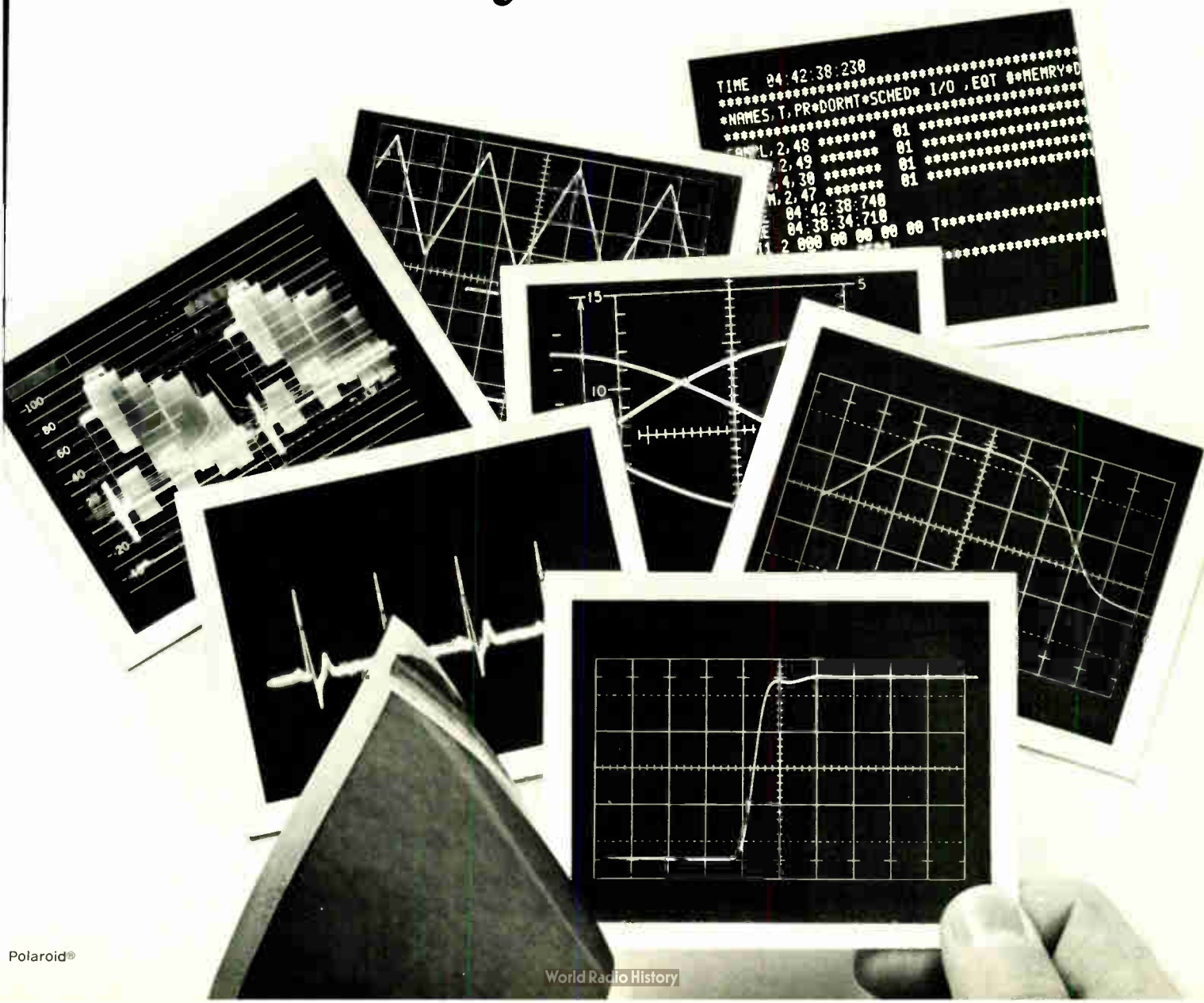

# transfer program sequence

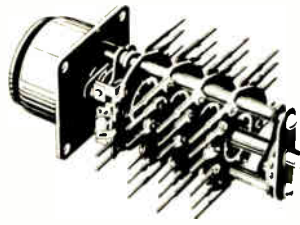

To transfer, program, or sequence multi-pole circuits, Ledex concepts in rotary switching give you practically limitless flexibility.

## The next time you have circuits to switch... consider Ledex manual and solenoid powered switches

The combination of rotary segments, tabs, notches, and short or long contacts makes it possible to come up with almost any electrical pattern you need. Decks gang easily, to increase switching capacity.

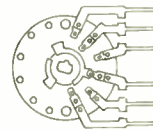

PC leg terminals give you even more flexibility. With perpendicular mounting, you increase the number of circuits you can switch on the same board. (We also supply rotary switches that mount parallel to boards.)

Then, for remote control, you can have your whole switching solution sandwiched between two PC boards.

When you bring your switching problem to Ledex, all you need to bring along is your schematic. Our switching technology people work out all the details for you. And because they're good at finding ways to simplify circuitry, don't be surprised if you end up with a lot less switch than you thought you needed.

The next time you have circuits to switch, manual or remote, simple or complex, talk to our switching technology people.



*the total technology people*

**LEDEX INC.**  
123 Webster Street  
Dayton, Ohio 45401  
(513) 224-9891

POSITIONING · SWITCHING · MICROELECTRONICS

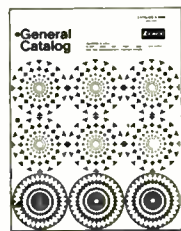

Over 400 ways to turn... push... pull... index... step... and switch, plus new microelectronic interface circuits. All from the shelf.

Ask for Catalog A-9500

*new things  
keep  
happening  
at Ledex*

... the LMD-1,  
a versatile  
universal  
control circuit  
—now on the shelf

### Shape, stretch, squeeze, and program pulses

Vary repetition from 1 ms to 10 minutes, or get independent ON-OFF pulses from 0.1% to 99.9%. You can also use the LMD-1 as a power driver and control 10A 50V loads at continuous duty.

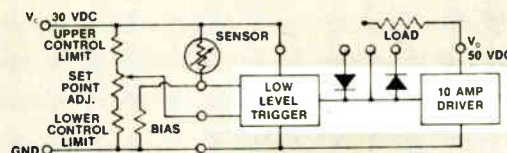

As an ON-OFF controller, LMD-1 can control any parameter convertible into resistance change. A 0.5 kW load can be controlled with only 80 nA typical bias input from the sensor. Schematics are available for applications at right.

### ten LMD-1 applications

- Pulsar, programmable rate
- Pulsar, programmable on & off time
- Pulsar, programmable duty factor
- Schmitt Trigger
- Proportional pulse modulating controller
- Time delay on power application
- Time delay on switch opening
- Time delay/hold-in circuit
- One-shot, trigger on plus slope
- One-shot, trigger on minus slope

# If you're not an engineer, scientist or technician, don't read this page.

Model 1666. Available everywhere in the USA and Canada. Call (800) 631-1971 free for the Monroe office nearest you. In New Jersey call (800) 962-2804.

Programming: Choose either 128 or 256-step models.

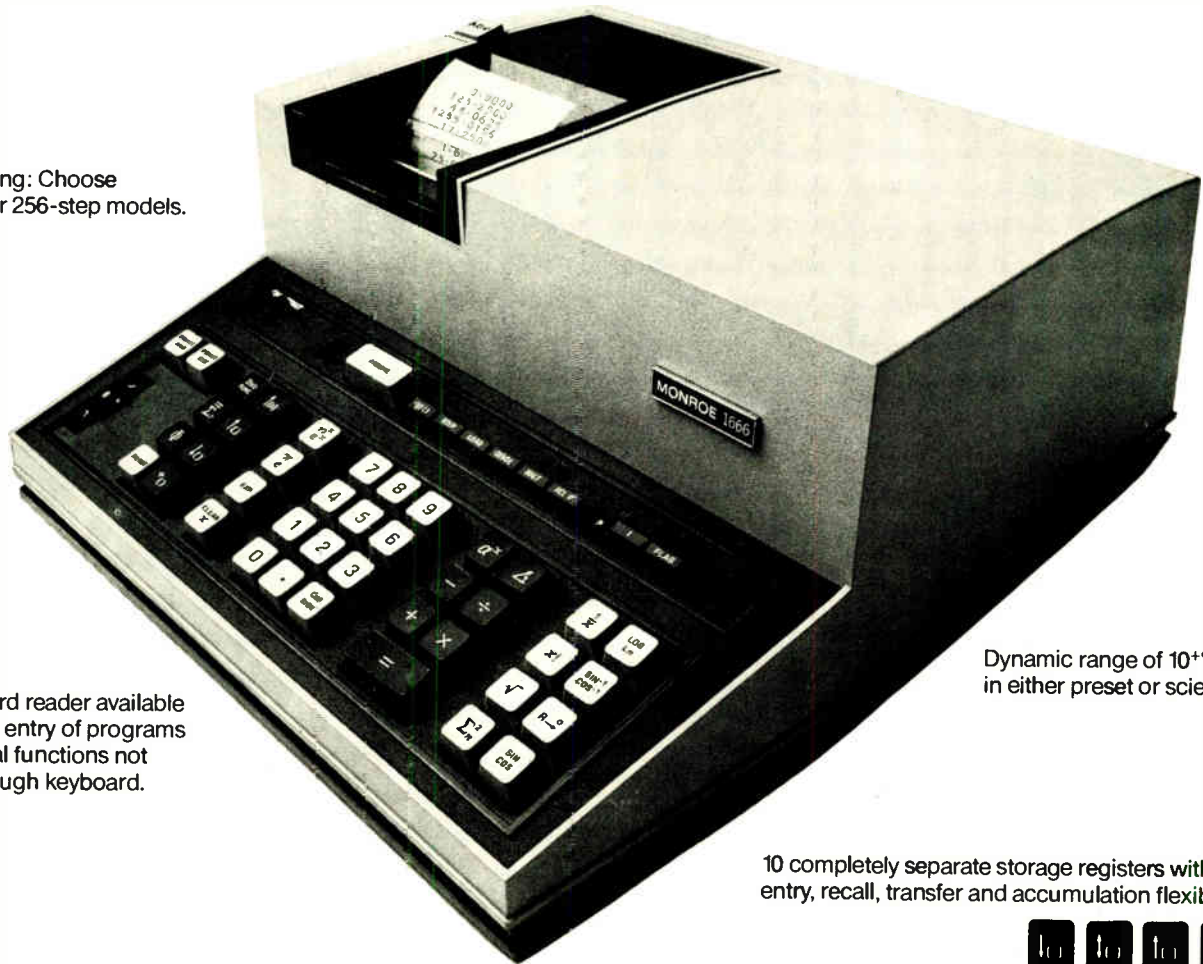

Accessory card reader available for automatic entry of programs and additional functions not available through keyboard.

Dynamic range of  $10^{+99}$  to  $10^{-98}$  in either preset or scientific notation.

10 completely separate storage registers with complete entry, recall, transfer and accumulation flexibility.



Automatic special functions for:



Complete program library covering every scientific and engineering discipline available to Monroe users.

 **Monroe. The Calculator Company.**

550 Central Avenue, Orange, New Jersey 07051  
81 Advance Road, Toronto 18, Ontario, Canada

# By Any Measure...

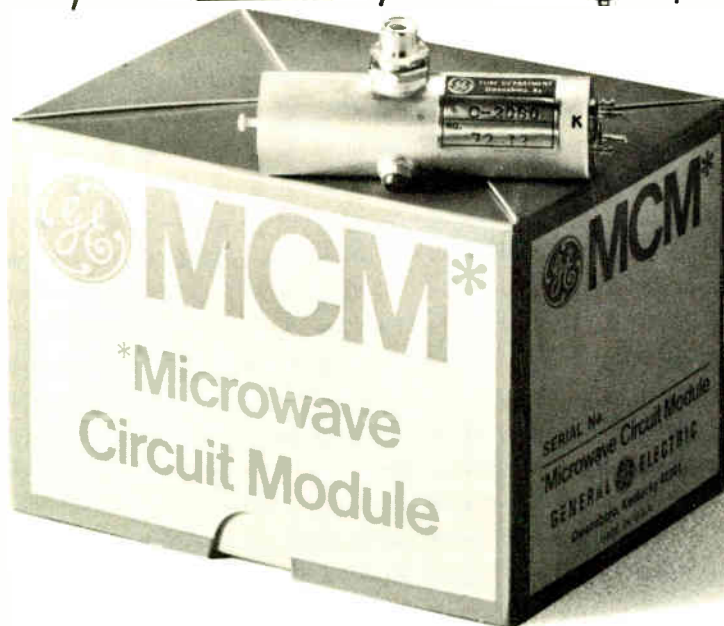
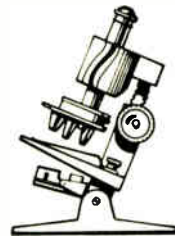
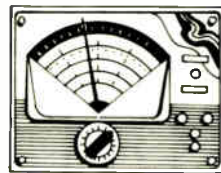
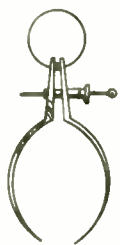

## GE MCM's and Ceramic Triodes Are Your Best Buy!

High quality is what you've become accustomed to from General Electric Ceramic Triodes and Microwave Circuit Modules (MCM's). Now, with the GE "Best Buy" program, you can expect even *more*. It's our No. 1 goal to make General Electric your best buy in quality, service and value. So...no matter how you make purchasing decisions, make General Electric *your* best buy in microwave devices!

Tube Products Department  
316 East Ninth Street  
Owensboro, Ky. 42301



**GENERAL**  **ELECTRIC**

Burndy Fingrip® terminals mate easily and grab hard. But the real grabber is the lower installed costs you get when you combine the terminals with our tooling.

Fingrip terminals save at both ends because they install faster and mate easier. Closed barrel Fingrips have an easy-entry tapered barrel for smooth, quick wire insertion. Mating is easier because a unique funneled lead-in on Fingrip open barrel terminals aligns the terminal with the male tab to prevent deforming. And a reinforced transition area resists bending and provides a tab stop to prevent over-insertion.



But we don't stop at terminals. Burndy tooling offers a system for everyone. Loose terminals can be crimped with a wide variety of hand tools. For larger production runs, terminals on continuous strips are crimped with rapid cycling bench presses that can install as fast as your operators can insert the wires. And for even larger runs, choose a Burndy fully automated system that measures, cuts, strips and crimps up to 6,000/hour.

With our terminals and tooling, you can cut costs by coming to grips

with your production problems. Fingrips!

# Fingrip is a grabber.

 **BURNDY**  
Norwalk Connecticut 06856



# BURNDY CONNECTS

International Sales Headquarters & Manufacturing Facilities: Canada/England/Belgium/Mexico/Brazil/Australia/Japan/Sales Offices in Major Cities  
World Radio History Circle 133 on reader service card

Model 2001 \$1,695

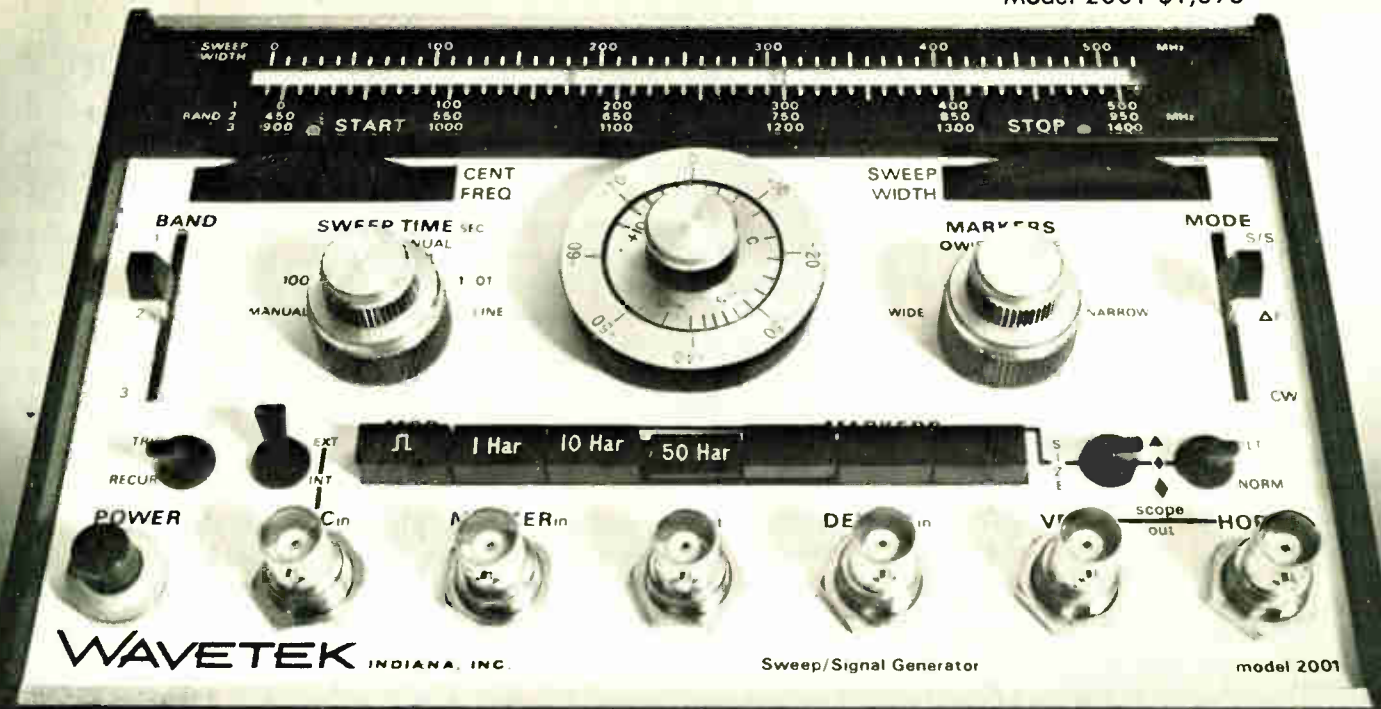

The brand new Model 2000 Sweep/Signal Generator costs \$320 less than the 2001 (our top-of-the-line sweeper). Yet the two instruments are remarkably alike—especially in the specifications, which are identical. Both have solid-state varactor-tuned and swept oscillators from CW to full-band sweep width. They share a frequency range of 1 MHz to 1.4 GHz with P.I.N. diode attenuation and P.I.N. diode internal or external leveling. Both are programmable with remote control of frequency, bandwidth, output level, and FM, AM or pulse modulation. The only real differences are the ones you can see—the controls on the front panel and the price. So, if you can't tell why the 2001 should cost \$320 more, buy the 2000. After all, that's why we built it.

# We just came down with a new sweeper.

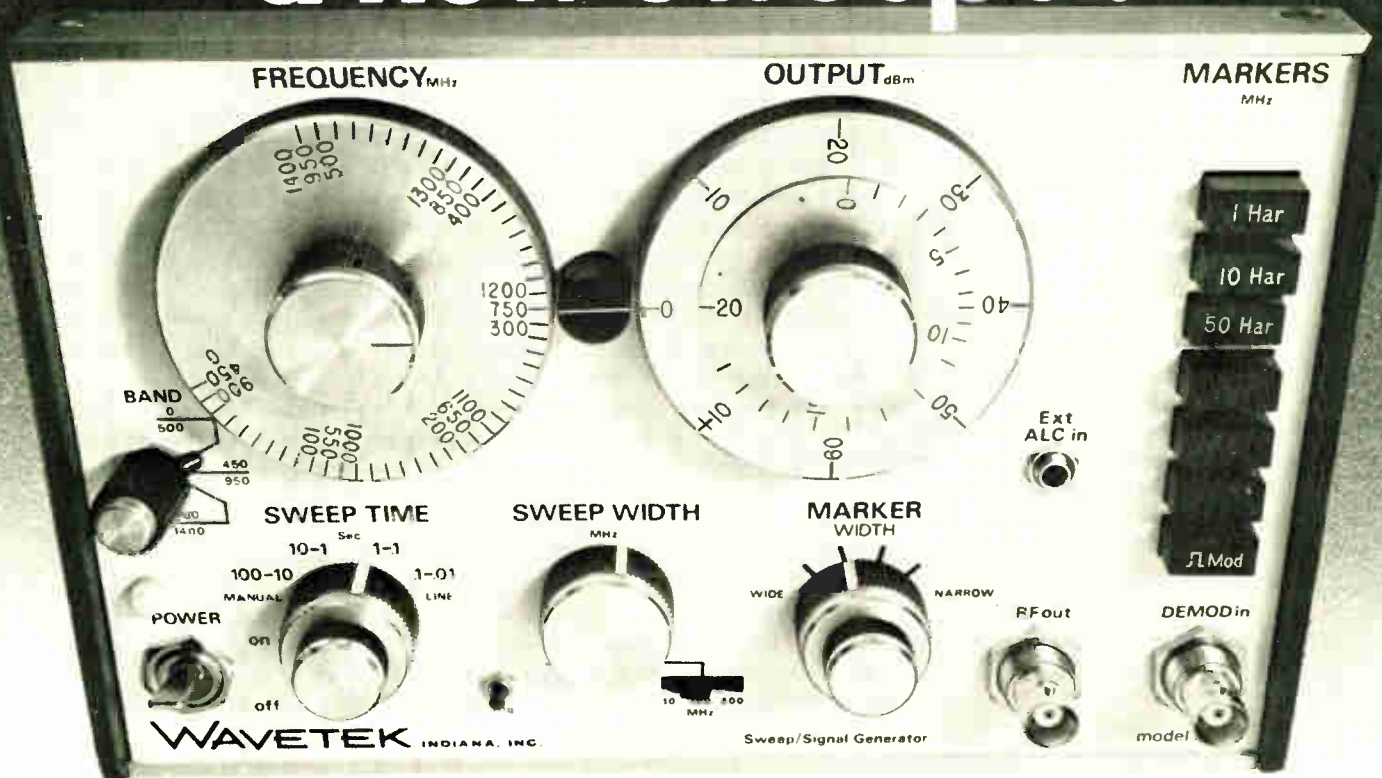

P.O. Box 190, 66 North First Avenue  
 Beech Grove, Indiana 46107  
 Ph. (317) 783-3221 TWX 810-341-3226

World Radio History

Model 2000 \$1,375

## New Products

# Multimeter 'system' is modular

Low-priced instrument is built around 4½-digit readout and power unit; plug-ons include dc voltmeter, multimeter, battery, and BCD module

by Michael J. Riezenman, Instrumentation Editor

**Back in the days** when cost was not always the primary consideration, instrument makers tended to put as much capability into their equipment as they could. Nowadays, however, the customer wants to pay only for the capability he needs. So it is not surprising that Hewlett-Packard's latest entry in the digital multimeter field is not an expensive superperformance unit, but rather a no-nonsense 4½-digit meter with the attractive selling price of \$600.

The instrument is not a single unit, but a collection of snap-together modules known as the 3470 measurement system. The heart of the system is the model 34740A display module, which contains the system's power supply and light-emitting diode readout. This module—which must be included in every 3470 system—is priced at \$325.

Initially, four additional modules will be available:

■ 34701A dc voltmeter plug-on—a

\$150 unit that measures 1 volt to 1 kilovolt in four ranges.

■ 34702A multimeter plug-on—a \$275 instrument that measures four ranges of ac and dc voltage and six ranges of ohms, from 100 ohms full-scale to 10 megohms full-scale.

■ 34720A battery module—a \$200 option that converts the 3470 into a portable instrument with rechargeable batteries.

■ 34721A BCD module—a \$175 accessory that provides a nonisolated BCD output for operating printers and other devices.

Thus, the system price can vary from a low of \$475 for the simple dc voltmeter to a high of \$975 for the portable (battery operated) multimeter with BCD output.

**Flexible.** The price-capability structure of the 3470 system reflects H-P's assessment of today's marketplace. The multimeter plug-on, for example, does not include autoranging or current-measuring capability

because H-P feels that most users would be unwilling to pay for these "extras." The 3470 system concept, however, allows for change. Future plug-ons may well include these more-costly options. And additional plug-ons will be available in the near future, says Ken Jessen, one of the 3470 developers. Since the display module is essentially a 1-v digital voltmeter, plug-ons can be developed to measure any quantity that can be converted into a value between 1 millivolt and 1 volt.

All of the modules in the 3470 system have been designed for quick and simple servicing. Simple two-sided mother boards are used instead of a complex multilayer board or a tightly spaced array of vertical boards. The instruments can be almost completely disassembled without tools. The exception is a single screw in the display section which is included to comply with an IEC safety standard that requires

**All in the family.** Display module is head of the 3470 family. Added modules might be a BCD or battery unit and a voltmeter or multimeter.



# NEW SIMPSON

## 6-digit electronic counter/timer



**AGING  
RATE:  
1 ppm  
per  
year**

**model 2726A  
only \$575**

- Direct measurement to 32 MHz
- Period averaging, single or multiple
- Frequency ratio, single or multiple
- Time interval and count totalization
- Switch-selectable sensitivity control
- Solid state . . . integrated circuits
- 7 time bases, crystal controlled
- Automatic overrange indication
- 9 digit resolution
- Also available with 10 ppm Aging Rate and same features as above: 6-digit Model 2726 only \$475, and 5-digit Model 2725A only \$425

*For further information or demonstration, see your local instrumentation products distributor or write for Catalog 369.*



**SIMPSON ELECTRIC COMPANY**  
5200 W. Kinzie St., Chicago, Illinois 60644  
(312) 379-1121



DIVISION

### New products

that a tool be used to expose power-line voltages. A test card is available for the display module.

**Rugged.** The 3470 uses the same tough cast-aluminum case that has proven itself with the 5300A counter system. While very strong, these cases are relatively light in weight. Thus, the display module weighs only 3 pounds, and the multimeter plug-on weighs only 2 lb.

The 3470 will operate on 100, 120, 220, or 240 v -10%, +5% switchable, and at any line frequency between 48 and 440 Hz. Since the display uses a dual-slope integrator, however, it is subject to noise pickup

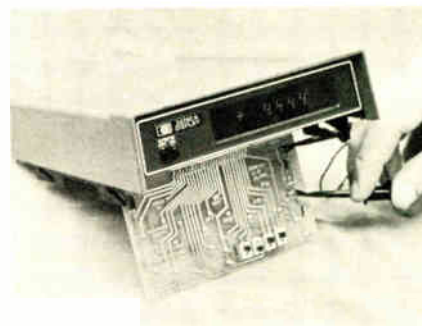

**Self-check.** Board includes switches for testing readout, brings out key voltages

at the lower power-line frequencies. For this reason, the 3-MHz crystal that controls the integrator's gate interval can be replaced by a 5-MHz crystal if the instrument is to be operated from a 50-Hz line instead of 60 Hz. Either the 50- or 60-Hz option is available at no additional charge. At 400 Hz, power-line noise is not a problem, so either crystal will do.

Inquiries Manager, Hewlett-Packard Co., 1601 California Ave., Palo Alto, Calif. 94304 [338]

#### KEY SPECIFICATIONS

(All accuracy specifications are at 23 C ±5 C)

**Maximum dc error (both voltmeter and multimeter):** 1-V range ±(0.03% of reading + 0.01% of range) All other ranges ±(0.04% of reading + 0.01% of range)

**Maximum ac error:** 45 Hz to 20 kHz ±(0.4% of reading + 0.05% of range) 20 kHz to 100 kHz: ±(1.0% of reading + 0.1% of range)

**Maximum ohmmeter error:** 10-megohm range: ±(0.25% of reading + 0.02% of range) All other ranges ±(0.065% of reading + 0.02% of range)

**Dc input resistance (both voltmeter and multimeter):** 10 megohms ±0.1% Ac input impedance 10 megohms ±10% in parallel with 75 pF

**Ohmmeter input characteristics:** Current through unknown is 10 mA on 100-ohm range decreasing one decade per range to a minimum of 0.1 µA on the 10-megohm range. Maximum voltage across unknown is -7 V Maximum voltage that can be applied safely to the input terminals is ±350 V on all ranges.

**Over-ranging:** 100% for all functions and ranges except 20% for ac and dc 1,000-V ranges.



# Look at that dude go!

## 85 nsec 1024 Bit RAM

The all new EA1500 sets the pace for RAMs—high speed, low cost—using N-Channel Silicon Gate Technology. 85nsec access time! Yes sir, and that's worst case guaranteed. Price is a low \$25 bucks in 100 quantities. And then there's *Automatic Refresh*. Memory timing and control are simplified by the elimination of precharge and refresh addressing. A single write pulse does the job. The EA1500 RAM allows the memory system to be refreshed "invisibly," and that means no more memory busy signals.

In active operation, the EA 1500 dissipates only 160mW while standby is typically 11mW. It can be logically turned off between accesses, reducing standby dissipation to a few milliwatts.

The EA1500 interfaces easily with bipolar logic, operates on +15V and -15V supplies. For other good things about the Dude, write for our data pack and your free Dude pin.



 **electronic arrays, inc.**

501 ELLIS STREET, MOUNTAIN VIEW, CALIFORNIA 94040, (415) 964-4321 TWX: 910-379-6985

**Stocking distributors:** Intermark, Cramer, Computer Components, Burstein-Applebee Company.

# 5-kHz recorder handles 18 channels

Each trace can cover full 8-inch record width in compact instrument; channels share fiber-optic CRT that writes on photosensitive paper

**How does one build** an 18-channel chart recorder with dc to 5,000-hertz response and a height of only 8.75 inches—including the 18 signal-conditioning modules? Honeywell's answer is to avoid using individual recording elements—pens or styli—for each channel, and instead to have all the channels time-share a single fiber-optic cathode-ray tube that writes directly on photosensitive paper. Actually, the recorder produces a latent image that emerges as a visible trace when the paper is exposed to light.

The signal-conditioning modules draw all their power from the recorder's mainframe, eliminating the need for individual power supplies and their associated extra size, weight, and cost. The resulting instrument, which is called the model 1858 Graphic Data Acquisition System, is said to be the first fully integrated data acquisition system contained in a single compact unit.

To avoid the "dotted-line" appearance of other time-shared systems like fixed-stylus electrostatic recorders, the 1858 uses a technique called connected-dot sampling. With this arrangement, the system remembers the value of the last data sample and keeps the CRT beam unblanked as it moves from the previous data point to the succeeding one. The result is a continuous trace on the recording paper.

**Full width.** With many mechanical chart recorders, the specified frequency response is strictly a small-signal figure. Because the 1858 uses inertialess recording, its frequency response specifications apply to trace amplitudes of up to 7.4 inches (out of a maximum record width of 8 inches). The frequency response of the recorder depends upon the signal-conditioning module that is used. For example, with the model 1883-MPD medium-performance differential-amplifier module, the

frequency response is down a maximum of 0.5% at 1 kHz, 1.3% at 2 kHz, 3% at 3 kHz, and 8% at 5 kHz. However, when the model 1881-HGD high-gain differential-amplifier module is employed, the response can be down as much as 3% at 2 kHz, 5% at 3 kHz, and 12% at 5 kHz.

Recording accuracy, sensitivity, linearity, etc., depend upon the choice of signal-conditioning module. Maximum sensitivity is 1 millivolt per division; minimum linearity error is 0.4% of full scale relative to the grid lines; accuracies are adjustable to within 0.5% of full scale; and maximum input impedance is 10 megohms shunted by less than 120 picofarads.

At present, there are five signal-conditioning modules available for the new recorder. These are high-, medium-, and low-gain differential amplifiers, an interfacing unit for connecting low-impedance sources to the recorder, and a strain-gage control unit that includes gage excitation and balance functions, as well as amplification. They vary in price from \$200 to \$600, and the mainframe carries a price tag of \$5,000. A full-blown 18-channel system could go as high as \$15,800, not counting the chart paper which costs \$14.55 per 100-foot roll.

Honeywell, Test Instruments Div., P.O. Box 5227, Denver Colo. 80217 [339]

#### SELECTED SPECIFICATIONS

**Record width:** 8 inches  
**Record length:** 100 feet with standard-weight paper, 200 feet with extra-thin paper

**Power requirements:** 200 to 350 watts (depending upon number of channels and options) at 50 to 400 hertz from either 107 to 127 volts or 214 to 254 v. Additional transformer taps permit operation down to 100 or 200 v

**Record drive speeds:** 0.1 inch per second to 120 in /s in 42 discrete steps.

**Record drive accuracy:** Maximum error is 7% over full voltage and environmental range, typical error at nominal voltage and environment is less than 3%.

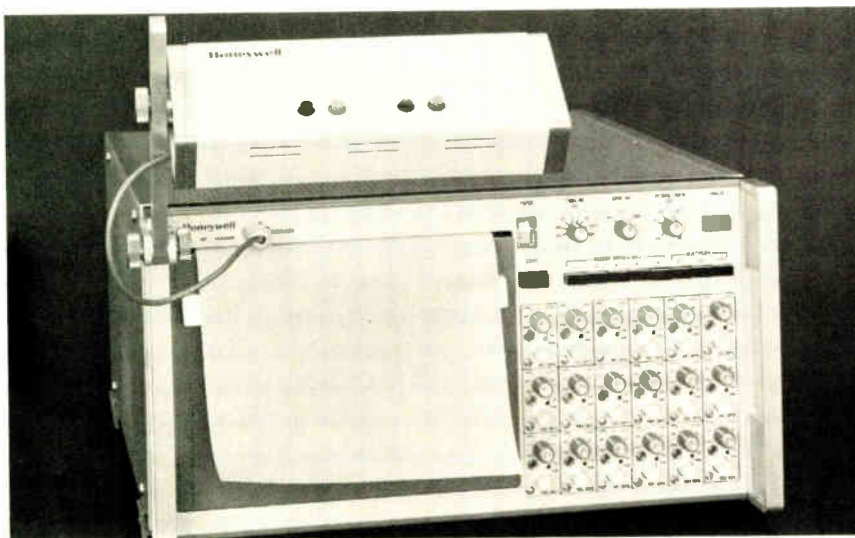

**Fast readout.** Latensifier on top of recorder makes image visible almost immediately. Room lighting will also develop traces, but this takes a longer period of time.

# SUPERDIGIT\*



Now available as a  $\frac{1}{4}$ " LED display for instrument, terminal and industrial control applications, the Fairchild FND 70 represents a three-way breakthrough that enables you to design tomorrow's displays today.

## **SUPERIOR PRICES**

**\$3.95 (100 up)**—A low price made possible by a breakthrough in manufacturing technology which uses low cost plastic package assembly techniques.

Inherent high costs of conventional displays, which require extensive hand fabrication and

large amounts of gallium arsenide phosphide materials, have been eliminated. The small-quantity price is also indicative of the low prices that will accompany large-scale production.

## **SUPERIOR STACKING DENSITY**

**More Packages Per Inch**—The FND 70 has the smallest ratio (2:1) of total package to digit size. Four digits, each 300 mils wide X 500 mils, occupy less space than three conventional units, and, because of the straight leads, can be stacked both vertically and horizontally.

## **SUPERIOR APPEARANCE**

**Advanced Optics Technology**—Provides bright, bold digits with a pleasing uniform appearance for viewing convenience up to a full  $140^\circ$ .

**Seeing is Believing**—You only have to see the Superdigit to realize why it is so superior to any other display on the market, whether it be Nixie tubes, LEDs or what have you. Your Fairchild Semiconductor sales engineer or distributor salesmen can give you a visual demonstration.

\***SUPERDIGIT** is a trademark of Fairchild Camera & Instrument Corp.

**MADE IN  
FAIRCHILD**

FAIRCHILD MICROWAVE AND OPTOELECTRONICS DIVISION 4001 MIRANDA AVENUE, PALO ALTO, CA 94304

# before you specify your next minicomputer you should know this about minicomputer applications

Cincinnati Milacron offers complete adaptive aid in applying minicomputers to your product or process. Cincinnati has helped to design and apply minicomputers to such operations as machine controls, inventory control, chemical processing, electric power generation, commercial scale and batching, insurance data handling, medical data processing, radio and television communications, fast food business operation, commercial printing, and scientific education.

A full line of minicomputers is available from Cincinnati to fit your particular application requirements. A new "Strippable CIP" minimum hardware unit is also available for about \$1600.00. You can custom-tailor your own if you like. Full software is available for standard and special applications. Call (513) 494-5444 and ask for Minicomputer Applications Support . . . we'll help you get the most for your minicomputer dollar. Or send for our brochure, MINICOMPUTERS AND THEIR APPLICATIONS. Cincinnati Milacron, Process Controls Division, Lebanon, Ohio 45036.



Cincinnati Milacron's CIP/2200 minicomputer is the high-speed reliable heart of this concrete batching system.



minicomputers



Machine Tools  
Process Controls  
Chemicals  
Plastics  
Plastics Processing Machinery  
Abrasives

Components

## SCR simplifies fusing task

Unit with 20,000-ampere surge rating can replace high-power ignitron tubes

An exceptionally high surge rating built into a silicon controlled rectifier gives promise of simplifying fault-protection practices, particularly in resistance welding and phase-controlled power rectifiers.

The device, developed by International Rectifier and designated the 1000A, can operate at 1,600 amperes rms and 1,200 volts. Its maximum peak, one-cycle, nonrepetitive surge current is 20,000 A, which IR believes is the highest in the industry for an SCR of this size. For fusing, the maximum  $I^2t$  value over 5 to 8.3 milliseconds is 1,650,000 amperes-squared seconds. In many applications, such a high surge rating as this could make it possible to do without the costly fuses used against overloads, states David Cooper, IR vice president for sales and engineering.

"In high-power supplies, the device would 'ride through' a fault, providing sufficient time for the SCR trigger pulse to be removed," he explains. "Or, with the proper circuit design, the device could withstand three or four cycles during a fault condition, until a circuit breaker opened." The solid-state device is capable of replacing the highest-power ignitron tubes used in the welding industry, Cooper adds.

The 1000A is available in versions with maximum repetitive peak reverse voltage ratings from 500 to 1,200 v. Maximum average on-state current at 180° conduction is 1,000 A. The  $dv/dt$  is 200 v per microsecond minimum. Thermal resistance is 0.02°C per watt. The unit is made with a high-voltage epitaxial construction pioneered by IR.

In contactor applications, two of the SCRs in antiparallel in an IR

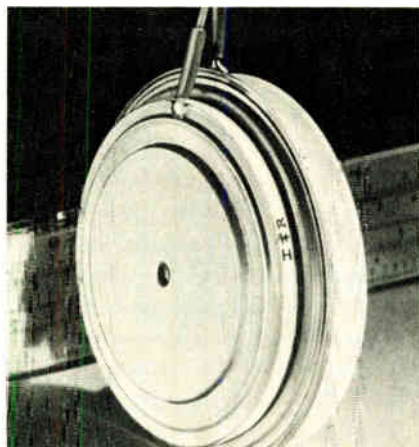

liquid-cooled heat exchanger could supply 2,200 A rms. For welding at 22 cycles (60 Hz, 35°C water temperature and 2 g/m flow rate), the assembly could be utilized at 4,500 A rms. The device can be supplied by IR in liquid- or air-cooled heat exchangers.

The SCR is 0.976 inch high, has a diameter of 2.750 in., and weighs 15 ounces.

The 1,200-v version is priced at \$281 in 10-99 quantities.

International Rectifier Corp., Semiconductor Div., 233 Kansas St., El Segundo, Calif. 90245 [341]

### Potentiometer is compatible with automated equipment

One-watt, 18-turn wirewound capability is offered by the model 3095 Trimpot potentiometer. The unit is packaged in a TO-116 dual in-line integrated-circuit package and is compatible with automatic insertion equipment. Specifications include power dissipation of 1.0 watt at 70°C, operating temperature range of -65 to +150°C, temperature coefficient of 50 parts per million per degree centigrade, and a resistance

### We're moving

Effective immediately, please send all product information to: New Products Editor, Electronics, McGraw-Hill Publications Co., 1221 Avenue of the Americas, New York, N.Y. 10020.

range from 10 to 50,000 ohms. Resolution is 0.16 to 1.54%. Price in quantities of 1,000 to 1,999 is \$2.25.

Bourns, Trimpot Products Div., 1200 Columbia Ave., Riverside, Calif. [344]

### Low-priced encoder allows interchangeability of parts

A motor-mounted encoder, the Trim-step 225, allows replacement of the active portions of the encoder, and by using a hollow drum instead of a disk, eliminates the effect of axial play of the motor shaft. The device also allows complete interchangeability of parts. The unit pro-

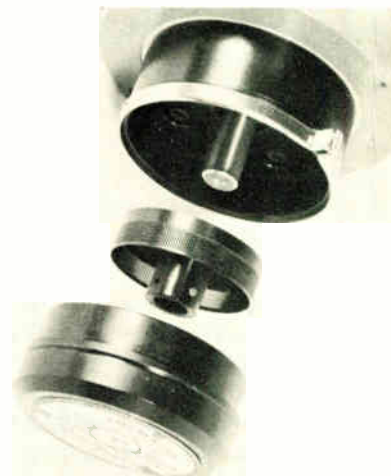

vides square-wave output signals in quadrature and complementary outputs. Typical applications include enhancement of stepping motor performance by closing the loop to insure positional information, or allow rapid acceleration. Price is \$100 in quantities of 1 to 9 for the single-channel version and \$125 for the dual-channel version.

Trump-Ross Industrial Controls Inc., 265 Boston Rd., North Billerica, Mass. 01862 [345]

### Crystal oscillator measures 1½ by 1½ by 3 inches

A crystal oscillator model CO-217D provides a stability (aging rate) of better than  $1 \times 10^3$  parts per million in a 1½-by-1½-by-3-inch pack-

# AEL'S engineering know-how in Hybrid Microcircuits<sup>®</sup> helps you...

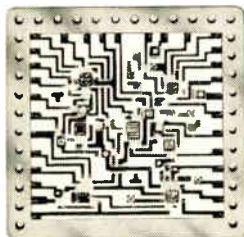

“think small”

## more efficiently!

Others can reduce printed circuits to a hybrid state, but only AEL can step in to make the suggestions you need for better circuitry, economies and efficiency. Only AEL produces Hy-

brid Microelectronic Circuits (HMC<sup>®</sup>) providing all the things you may not be aware are missing from your present circuits. See for yourself by letting AEL work with you on your next project.



**A**ERICAN **E**LECTRONIC **L**ABORATORIES, INC.

P. O. Box 552, Lansdale, Pa. 19446 • (215) 822-2929 • TWX: 510-661-4976, Cable: AMERLAB

142 Circle 142 on reader service card

### New products

age. An integrated-circuit proportional oven control system provides 100,000 hours mean time between failures, and temperature stability is better than  $1 \times 10^2$  parts per million over 0 to 50°C. Sine or logic outputs are 1, 5, or 10 megahertz, and a wide range of other frequencies is available.

Vectron Laboratories Inc., 121 Water St., Norwalk, Conn. 06854 [346]

Pushbutton switch offers compact size, long life

A butt-contact single-pole single-throw momentary pushbutton switch is designated the model 8632. The unit measures 0.754 inch in length by 0.252 in. in width, and the mounting hole diameter is 11/64 in. Contacts are coin silver, and contact rating is 0.5-ampere resistive load at 115 volts ac or 28 vdc. Also available is a rating of 0.25 ampere at 250 vac. The 8632 has an insulation resistance of 10,000 megohms minimum, and dielectric strength is 500 volts rms at sea level. Electric life is 100,000 make-and-break cycles. Initial contact resistance is 10 milliohms.

C & K components Inc., 103 Morse St., Wattertown, Maine 02172 [347]

Pushbutton switch uses light-emitting diodes

A light-emitting diode has been added to the model 01-700 pushbutton switch. Since the diodes have an almost infinite life, they eliminate failure and replacement. They are compatible with integrated circuits, while offering rapid response and negligible operating current at low voltage. The double-break butterfly switch minimizes any mechanical bounce and eliminates contact weld-

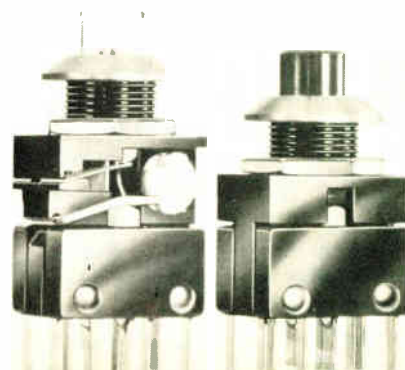

# Instrumentation Amplifiers. We only make five. But they're the only five you need.



In addition to simplifying your choice, we made it a better choice. So you can do more with less and spend less doing it.

Just look at our line-up.

Our model 605 gives you the best premium performance of any instrumentation amplifier. It's available with three drift options including the industry's lowest drift,

to  $0.5\mu\text{V}/^\circ\text{C}$ . It also has the best non-linearity, 0.005%. All without compromising its 120dB of CMR. Starting at \$59, it's a first choice.

Our 604 is a higher speed version of our high accuracy 605. Giving full power bandwidth to 50 kHz and settling time of  $20\mu\text{s}$  to 0.01%. At \$155, it gives you performance comparable to rack and panel devices.

Our 520 is the world's first I.C. instrumentation amplifier at the world's lowest price. Only \$18.

For general purpose applications, choose our 603 FET input model at \$39. Or our 602 with fixed gain and an active shield drive terminal for \$55.

When you know even more about our line of instrumentation amplifiers, you'll see why our five are the only five to look at.

We can send you data sheets on all five. As well as our 1972 Product Guide which shows all the other things we make to solve more of your problems better than anyone else.

Analog Devices, Inc., Norwood, Mass.  
02062, (617) 329-4700.



# Your problems stimulated this breakthrough of Coaxial Illumination

Bausch & Lomb StereoZoom 7 Microscope with Coaxial Illuminator is the answer to your need for full field, full aperture illumination; full color, high contrast imaging and better resolution of micro-miniature detail.

This unique form of incident illumination eliminates surface glare from highly reflective surfaces and also effectively illuminates low contrast objects.

With full optical equipment you can use a range of magnification from 15X to 280X and anywhere in between. Field diameter ranges from 0.55 in. to 0.03 in. Unlike conventional vertical illuminators, you still get full working distance from 3.0 in. to 0.56 in.

The design of the integral illuminator provides for light from a

single source being beamed down through each side of the microscope, focused sharply on the specimen and from it reflected back up the other optical axis. This provides true three-dimensional viewing in the incident light mode.

While these statements, because of past problems, may seem exaggerated, we assure you that a demonstration in your own lab, with your own most difficult objects will prove their complete validity. We want you to try a StereoZoom 7 Microscope with Coaxial Illuminator, preferably side by side with the conventional stereomicroscopes you are now using. Then, you be the judge.

**Write for our catalog 31-2368 and free demonstration offer.**



StereoZoom. Reg. T.M. Bausch & Lomb.

**BAUSCH & LOMB**   
SCIENTIFIC INSTRUMENT DIVISION  
61406 Bausch Street, Rochester, N. Y. 14602

Circle 144 on reader service card

## New products

ing. Two isolated circuits can be controlled with one switch.

Licon, Div. Illinois Tool Works Inc. 6615 W. Irving Park Rd., Chicago, Ill. 60634 [348]

Thermal cutoff is aimed  
at heating applications

The Microtemp 4D safety thermal cutoffs, which are ceramic-base cur-



rent-limiting packages, can be used on heating elements to furnish upper-limit temperature cutoff. The units can handle up to 30 amperes at 300 volts, and temperature ratings are from 136 to 468°F and 58 to 240°C. Price is as low as 21.2 cents. Delivery is from stock.

Micro Devices Corp., 1881 Southtown Blvd., Dayton, Ohio 45439 [349]

Power modules for switches  
are rated at 11 amperes

Power modules for use in heavy current switches feature 11-ampere, 125/250-volt ac, ¼-horsepower-rated snap-action switching. Applications are in on-off power switching, motor control, solenoid switching, and other types of high current

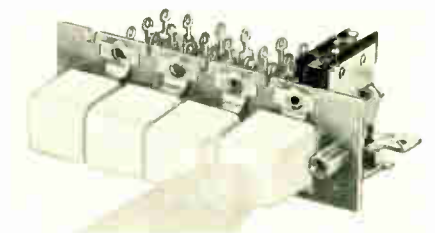

switching in industrial, commercial, and consumer equipment and systems. The DW series units have a height of ¾-inch above centerline of the complete switch frame assembly.

Switchcraft Inc., 5555 North Elston Ave., Chicago, Ill. 60630 [350]





**We deliver.**

**Our 250-nanosecond core memory leaves semiconductors way behind.**

Sure, the semis talk a good game. But they can't beat our new Store/336 core memory system for speed, reliability, low cost and capacity *altogether* in one compact system.

Access time is 250 nanoseconds. Cycle time is 650 nanoseconds. (If that's not fast enough, we've got a Store/336A that does it in 600.) You get over 8K words by 18 bits in a 2"x8"x11" module. Don't stop there, though. You can build as much memory as you need by ordering modules stacked in our compact chassis. For example, you can have a

65K-x-18 system in a chassis only 8 3/4" high. That's a lot of memory in a little space.

We deliver core quality, too. Our own roll-cut process produces more uniform cores at a lower cost. We make them all sizes. You can buy the cores, or you can buy our stacks and systems full of them. Cores and memories are our business. We want yours.

So we'll meet any memory competitor head-on for price, performance and quality. And we'll just let the semiconductor people keep on talking while we deliver. Call today.



**OEM National Marketing:** Boston (617) 237-1950; Bethesda, Md. (301) 652-8120; Cherry Hill, N. J. (609) 667-7555; Dallas (214) 231-2240; Detroit (313) 354-5858; Los Altos, Ca. (415) 941-5485; Los Angeles (213) 474-1596; Minneapolis (612) 927-8747. **U.S. Representatives:** Burlingame, Ca., W. J. Purdy Co. (415) 347-7701; Chicago, L-TEC, Inc. (312) 296-1500; Orlando, Gentry Assoc., Inc. (305) 894-4401. **OEM International Marketing:** Amsterdam 020-452-457; Tokyo 493-645; London 01-579-2917; Munich 08-106-5766; Vienna 34 53 61, 34 44 16. **International Representative:** Tokyo, Marubeni 501-7421. **Home Office:** 6219 De Soto Avenue, Woodland Hills, Calif. 91364 (213) 887-8000.

## Instruments

**Encoder is programable**

---

Modular design permits PCM unit for aircraft telemetry to be tailored to system

---

Most telemetry encoders are custom-made, hard-wired types that are limited in their handling of telemetry formats, bandwidths, and types and quantities of data. A pulse-code-modulation encoder developed by Spacetac, on the other hand, is designed for a variety of applications in aircraft telemetry.

The IRIG-compatible unit, designated the series 2100, consists of a control unit with as many as eight analog and eight digital signal multiplexer-expanders stacked on top. It offers up to eight output codes and four parities.

Control-unit functions are divided into modular subassemblies, one an electrically programable read-only memory (EPROM) with 2,048 bits of storage holding one to eight telemetry formats. Format length is a maximum 2,048 bits per frame, with from 2 to 128 frames per format, and 2 to 128 sub-frames per frame. "Competitive systems are limited in that they cannot switch sub-frame length easily because they are hard-wired," says Armin F. Spiegel, engineering manager at Spacetac. "We can just change the memory."

A frame synchronization code memory consists of 2 EPROMs with a total of 8 words of 10 bits each, selected according to the program in the format storage. Sub-frame synchronization is obtained by programming the frame counter state into the telemetry format or by using an inverted frame sync code.

System bit rate can be customer-specified up to 256 kilohertz per second, and bit stability is  $\pm 50$  ppm. By changing the crystal of the internal oscillator, virtually any bit rate is possible, or it can be supplied by an

external source. And 6-to 11-bit word lengths can be selected, allowing data sampling at different accuracies.

Input power consumption is low: less than 2.3 watts for the control unit, 25 milliwatts on standby; 200 mW maximum for each analog multiplexer, and 30 mW for each digital multiplexer. Noise is less than 100 millivolts on a 1-ohm power source, because of filtering of power supply lines.

Price depends on the number of expanders, but an encoder generally runs between \$10,000 and \$15,000.

Spacetac Inc., a subsidiary of Corning Glass Works, Burlington Rd., Bedford, Mass. 01730 [351]

---

**X-Y recorder is for medical applications**

Medical measurements are the main application of the model 7041A X-Y recorder, which provides digital system outputs and wave analysis displays. Acceleration on the Y axis is 3,000 inches per second squared and 2,000 in./s<sup>2</sup> on the X axis. This, coupled with comparable deceleration, results in low overshoot. Slewing rate is 30 in./s, and accuracy is to within  $\pm 0.2\%$  of full scale. Options include front-wheel controls, English or metric scaling, a wide variety of calibrated X and Y ranges, sweep rates, and an event marker. Price is \$1,050.

Hewlett Packard Co., San Diego Div., 16399 W. Bernardo Dr., San Diego, Calif. [354]

---

**Swept signal generator covers 1 to 18 gigahertz**

An extended-range microwave sweeper, the model 404-A, covers the frequency range from 1 to 18 gigahertz and provides 5 milliwatts  $\pm 1$  decibel of internally leveled power. The unit uses sequentially four discrete oscillators that cover 1 to 2 GHz, 2 to 4 GHz, 4 to 8 GHz, and 8 to 18 GHz. It may be operated in single-octave, straddle-band, or multiband configurations in any

part or all of the instruments range. Sweep time from 1 to 18 GHz is 50 milliseconds, eliminating the need for storage or high-persistence oscilloscopes.

Servo Corp. of America, 111 New South Rd., Hicksville, N.Y. 11802 [355]

---

**Frequency-sensitive meter can resolve 3 microvolts**

A frequency-sensitive rf voltmeter measures absolute voltages over the range from 30 to 100 megahertz. The type USU-1 measures voltages from 3 microvolts to 3 volts at bandwidths of 200 kilohertz or 2 megahertz. Two built-in sources provide 50-MHz calibration points for digital frequency indication and level calibration. Applications include selective attenuation and frequency-response measurements, antenna pattern plotting, reflection coefficient and impedance measurements, sensitive null indication, and loss-gain measurements on two-port networks. Price is \$6,950. Delivery is from stock.

Rohde & Schwartz Sales Inc., 111 Lexington Ave., Passaic, N.J. 07055 [356]

---

**Transmission test set operates in transparent mode**

Transmission problems can be pinpointed with the model 221 on-line transmission test set. The device operates in a transparent mode between the terminal and modem.

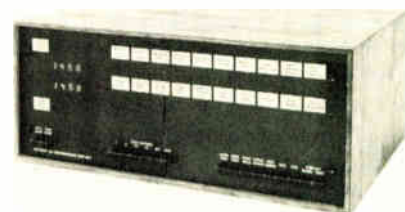

When transmission stops, the unit automatically steps through tests on the local modem, the line, and the remote modem, indicating when a test fails. Two digital meters monitor send and receive lines, and the



## Take the risk out of buying a Logic-Circuit Tester

Buying a tester can be risky. You know it all depends on the supplier, but who can you trust? Your own staff, for one, of course. They know what you need and may find the time to design and build your system. So why not them?

Because General Radio has already done it for you — solved the design and programming problems that your staff has yet to face. In three years, GR has sold twice as many logic-circuit testers as our three closest competitors. Our designs and test programs are proven in 100 years of field operating time, yet you'll pay only a small

fraction of their cost. And, GR assumes full system responsibility. Honestly, now, can you do the job for \$20,000? We can.

### Special Needs?

Our modular subsystems and programs are easy to add later as you need them. Let present needs dictate initial specs and cost with the assurance that later expansion will be both possible and economical.

So, who can you count on for a logic-circuit analyzer at least as good as you could make yourself? GR, of course.

### Try Us

Our 1790, 1792, or 1793 can do your job. Outline your requirements or ask for a demonstration from the GR office nearest you or from GR in Concord, Mass. In Europe, write Postfach, CH 8034, Zurich, Switzerland.



**General Radio**

NEW YORK (N.Y.) 212 364-2722 (N.J.) 201 791-8990 • BOSTON 617 646-0550  
CHICAGO 312 992-0800 • WASHINGTON, D.C. 301 881-5333 • LOS ANGELES 714 540-9830  
TORONTO 416 252-3395 • ZURICH (01) 55 24 20  
GRASON-STADLER 617 369-3787 • TIME/DATA 415 327-8322

Circle 147 on reader service card

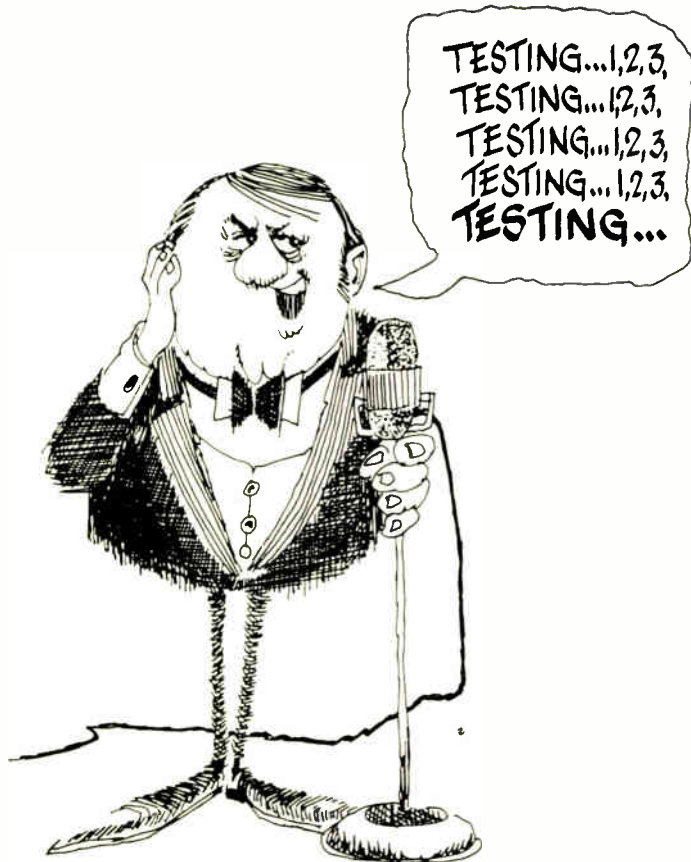

For the past few years we've been announcing to anyone who will listen that, "We make things you can use in your work." A few of you haven't heard us.  Can you use solders or solder preforms? We make nearly 2 billion preforms a year... preforms of guaranteed purities, guaranteed tolerances, guaranteed configurations according to your specs. Our solders are also available in rod, bar, tube, ingot, ribbon, wire, foil or whatever form you need. If you can use our solders or solder preforms, then pay attention to this: *we'll deliver what you need, when you need it, at a price you can't ignore.*  Are you listening? Call or write for our comprehensive Solder Preform Selector.



## INDIUM CORPORATION OF AMERICA

### SOLDER FABRICATION DEPARTMENT

1676 Lincoln Ave. • Utica, N. Y. 13502 • Telephone (315) 797-1666 • TWX 510-242-0288

High quality solders and solder preforms of Lead, Tin, Silver, Indium, Cadmium, Gallium, Antimony, Bismuth, Copper, Aluminum, Nickel, Zinc and Germanium.

## New products

operator can instantly determine when the performance of the system is satisfactory before transmitting data.

Antekna Data Comm Div., 625 Clyde Ave., Mountain View, Calif. 94040 [357]

### Electrostatic voltmeter measures from $\pm 0.05$ V

An electrostatic voltmeter model 300 is used to make noncontacting measurements in the range from  $\pm 0.05$  to  $\pm 3,000$  volts ac or dc. The electrostatic probe is placed in close proximity to the object or surface to



be measured, and the output indicates, without drift, the unknown voltage to an accuracy within  $\pm 0.05\%$ . Input impedance is  $10^{20}$  ohms in parallel with  $10^{18}$  farads, and bandwidth is 200 hertz.

Trek Inc., 8460 Ridge Rd., Gasport, N.Y. 14067 [358]

### Multipurpose tester is for communications applications

The rack-mounted model 2051 combines a signal distortion analyzer, data test pattern and character generator, a character recognizer, and a bit-error rate test set. The unit is aimed at communications center data processing, and telegraph and computer-language communications traffic. Specific applications are in modems, frequency-division multiplexers, video terminals, tape repeaters and other peripherals using Baudot and ASCII codes.

Digitech Data Industries Inc., 66 Grove St., Ridgefield, Conn. 06877 [359]

# Safety in numbers.

Some DPM's are small and inexpensive. Others are small, inexpensive, and high-performance. Still others are small, inexpensive, high-performance, and engineered to last for years. Our new AN2544 is in the latter class.

In a case no larger than most 3½-digit meters, and at a price of only \$350, the AN2544 packs so much performance and reliability it represents a major advance in the DPM art. The full specs will tell you that. What they don't tell you is how, from design concept to the last bakeout, we make this meter to last. When you ship an instrument with our meter on the front panel, we want it to stay shipped.

---

Sample specifications of the AN2544 line-powered meter  
Accuracy 0.01% — 40,000 counts  
Stability 8ppm/°C  
3-wire differential guarded input  
Completely isolated analog and digital sections  
( > 600v CMV)  
Automatic zero — no offset  
3-phase, dual slope integration  
BCD output standard  
Dimensions: 2" h x 3.5" w x 2.75" d (mounting surfaces)

---

Ask for the full specifications. Along with them we'll send you a very interesting 28-page free booklet on the theory, operation, and applications of DPM's in general. It's very helpful and refreshingly impartial. From the manufacturers of the largest line of DPM's in the world. Analogic Corp., Wakefield, Mass. 01880, (617) 246-0300.

**ANALOGIC** ■



*Northeast*  
617-235-2330  
203-966-2580  
315-446-0220

*Mid Atlantic*  
201-652-7055  
212-947-0379  
215-272-1444  
301-587-3910

*Midwest*  
314-837-0597  
216-267-0445  
513-434-7500  
313-892-2500

312-283-0713  
913-648-4173  
412-892-2953

*South*  
713-785-0581  
817-268-3505  
305-647-3498  
305-622-2770

205-881-5031  
404-351-3654  
803-576-7462

*West*  
303-744-3301  
505-523-0601  
602-946-4215  
505-296-8303

714-540-7160  
408-374-5220  
206-762-7664  
503-646-6064

*Canada*  
613-836-4411  
604-688-2619  
416-444-9111  
514-861-1375

Circle 149 on reader service card

# NEW! PHASE-LOCKED LOOPS.

For greater V.C.O. stability, frequency range, and functional capability.

## HA-2800 for guaranteed frequencies up to 25 MHz.

For use in frequency synthesizers. As an I.F. amplifier detector for F.M. Or phase modulation receivers. Operation guaranteed up to 25 MHz. V.C.O. output: compatible with both TTL and ECL and provides improved temperature coefficient and supply regulation. Supply voltage range: 12V to 30V.

Supplied: 16-pin 100-999 units hermetic DIP

HA-2800 -55°C to +125°C \$22.65  
HA-2805 0°C to +75°C \$9.85

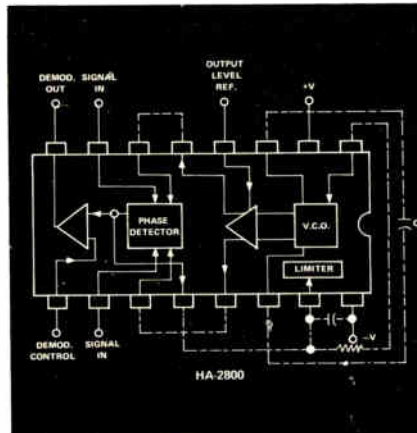

## HA-2820 for frequencies from 0.1 Hz to 3 MHz.

For use as amplifier/detectors, audio tone generators/detectors, and precision motor speed controls. V.C.O. output drives DTL/TTL and provides greatly improved stability. Supply voltage:  $\pm 6V$  to  $\pm 12V$ .

Supplied: 14-pin 100-999 units hermetic DIP

HA-2820 -55°C to +125°C \$13.35  
HA-2825 0°C to +75°C \$6.35

### NO OTHER PHASE-LOCKED LOOPS COMBINE THESE FEATURES.

In addition to greater stability, frequency range and application versatility both devices feature:

Independent phase detector and voltage controlled oscillator in the same package.

Broken loop between the phase detector and the V.C.O., permitting inclusion within the loop of amplifiers, active filters, sweep circuits and other acquisition aids.

Isolated phase detector output, which allows adjustment of demodulated output gain and filtering without affecting the loop's characteristics.

For details see your Harris distributor, representative, or write direct.

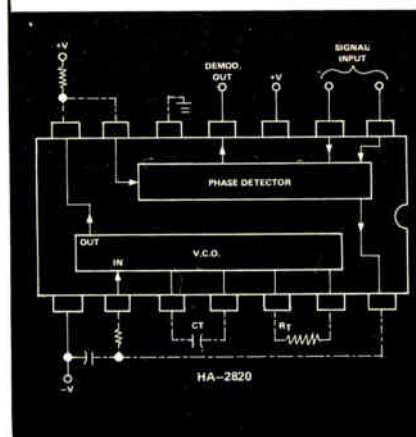

**HARRIS**  
**SEMICONDUCTOR**

A DIVISION OF HARRIS-INTERTYPE CORPORATION

P.O. Box 883, Melbourne, Florida 32901  
(305) 727-5430

**DISTRIBUTORS:** Schweber Electronics: Westbury, New York (516) 334-7474; Rockville, Maryland (301) 881-2970; Hollywood, Florida (305) 927-0511 / Harvey/R & D Electronics: Lexington, Massachusetts (617) 861-9200 / Semiconductor Specialists, Inc.: Chicago (312) 279-1000; Detroit (313) 255-0300; Minneapolis (612) 884-8132; Kansas City (816) 452-3900; St. Louis (314) 428-6100; Dallas (214) 358-5211; Indianapolis (317) 243-8271; Pittsburgh (412) 781-8120; Dayton (513) 278-9455 / R.V. Weatherford Co.: Albuquerque (505) 265-5671; Anaheim (714) 547-0891; Austin (512) Enterprise 1443; Dallas (214) 231-6051; Denver (303) 427-3736; Glendale (213) 849-3451; Houston (713) Enterprise 1443; Palo Alto (415) 321-5373; Phoenix (602) 272-7144; Pomona (714) 623-1261; San Diego (714) 278-7400; Seattle (206) 762-4200. **HARRIS SALES OFFICES:** Wellesley, Massachusetts (617) 237-5430; Wayne, Pennsylvania (215) 687-6680; Palos Heights, Illinois (312) 597-7510; Melbourne, Florida (305) 727-5430; Palo Alto, California (415) 321-2280; Melville, New York (516) 249-4500; Syracuse, New York (315) 463-3373; Washington, D.C. (202) 337-4914; Dallas, Texas (214) 231-9031; Scottsdale, Arizona (602) 946-3556; Long Beach, California (213) 426-7687.

Data handling

### Servos drive tape cassette

Motors provide constant speed without a capstan in simple, compact unit

Many woes of the designers (and users) of magnetic-tape cassette drives stem from a common design assumption: that the only way to move the tape at constant speed is to pinch it between a constant-speed

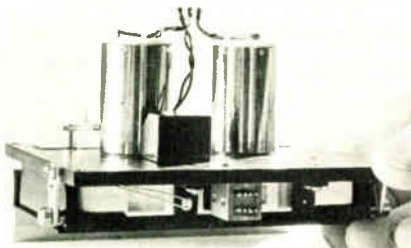

capstan and a rubber idler. That adds a mechanical complication—the need to back the idler away from the tape when the cassette is to be removed—and the pinching action also tends to distort the tape and to embed dust particles in the oxide surface, creating a potential for errors in the recording.

A solution to these difficulties has been incorporated into a cassette drive that is both simpler in design and much smaller than most competing products. It's Ross Controls Corp.'s series 1000 recorder, which uses two reversible servomotors to drive the tape reels directly, without a capstan. These motors are the only moving parts in the drive, not counting the cassette holder or the latch that keeps it shut.

These motors provide constant tape speed through an arrangement that gradually slows the motor driving the take-up reel and speeds the motor driving the other reel. The input to this control circuitry is simply the relative speeds of the two motors, measured through their back emf. No separate tachometers or tape clock signals are necessary.

Like other drives for standard

cassettes, the series 1000 stores 1.5 million bits in a standard Philips-type cassette, which contains 300 feet of tape 0.15 inch wide. This tape moves in either direction at 20 in. per second, transferring data at 10,000 bits per second. The servo-controlled drive maintains this velocity within 2.5%; its start time is 3 milliseconds from start command to readable signal, and 35 ms to stabilized speed; stop time is 50 ms. High-speed rewind and tape search are possible in either direction at 120 in. per second. Yet during all these operations the tape tension is maintained constant.

The basic cassette deck, with drive motors, measures 4½ by 4 by 3¼ in. and includes a dual-track read/write head, signals for indicating beginning and end of tape, and interlocks for cassette-in-place and file-protect (writing inhibited). A complete recorder is also available, the model 1111, including the basic deck plus servo and read/write amplifiers, interface circuits, formatting logic, power supply, and enclosure; it measures 10 by 6¾ by 9¼ in. The model 1000 specifically omits all belts, clutches, friction drives, pulleys, and solenoids.

The basic model 1000 deck sells for \$225 singly; the complete model 1111 recorder is priced at \$850. Quantity discounts are available to OEMs, who may also order parts of the system.

Ross Controls Corp., 381 Elliot Street, Newton, Mass., 02164 [362]

Printer operates at 125 lines per minute

The model 102B line printer uses a 9-by-7 dot matrix and forms characters at 125 lines per minute for 132-character lines. The unit uses two printing heads that operate in unison and print in both directions. Features include paper runaway control, manual line spacing, hardware code selector, 64-character input, and transmission of up to 75,000 characters per second in parallel mode. The 102B can be linked with most minicomputers. Unit

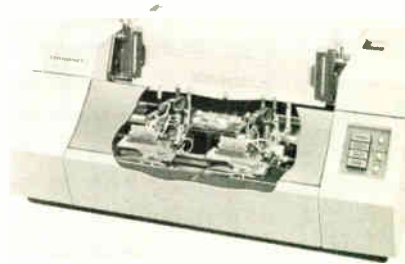

price is \$5,390.

Centronics Data Computer Corp., One Wall St., Hudson, N.H. 03051 [363]

Coupler converts BCD output to computer language

An instrument coupler, the model 410, converts decimal or binary-coded-decimal output directly into computer, terminal, or teletypewriter language. The unit is connected to the instrument's output and to the computer or terminal. Programable line formulating speed ranges up to 10 digits per word and 10 words per line. Options permit expanded input and output capabilities. Input level is compatible with TTL and DTL. Price is \$995.

Ambient Systems Inc., 3020 Scott Blvd., Santa Clara, Calif. 95050 [364]

Paper-tape reader detects 400 characters a second

A paper-tape reader, the model PR-1, can detect as many as 400 characters per second with roll tape and 300 characters per second with fanfold tape input. The 19-inch rack-mounted unit can read a wide

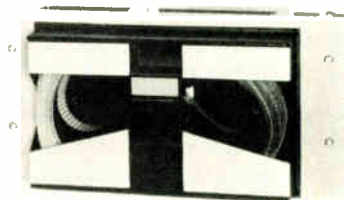

range of commercial tape widths without electrical or mechanical adjustment. Interfacing circuitry occupies about an eighth of an optional printed-circuit board located in the computer console, permitting

## Megohmmeter and Hipot?

**YES!** For true integrity in HV bench-testing of electrical or electronic equipment —you need both! Megohmmeter to test insulation resistance (IR) . . . Hipot to test dielectric strength.

### HIPOTRONICS OFFERS

a full line of high resistance megohmmeters — sixteen models with ranges to 20,000,000 megohms and high current capability for testing insulation resistance to ASTM specification D-257, MIL, and UL standards.

### HIPOTRONICS ALSO OFFERS

a full line of AC/DC hipots — twenty-seven models with ranges to 10KV AC and 25 KV DC for non-destructive measurement of leakage current, corona discharge, AC and DC insulation strength.

### HIPOTRONICS GUARANTEES

complete high voltage — high resistance capability for thorough testing of switches . . . motors . . . coils . . . chokes . . . insulation . . . transformers . . . cables . . . electrical/electronic assemblies . . . harnesses . . . and more.

For more information write or call our marketing department for brochures HP7101 and HP7107.

**HIPOTRONICS**®

BREWSTER, N. Y. 10509  
Phone: (914) 279-8091



Circle 152 on reader service card

## New products

other internal circuitry to be mounted on the same board.

Digital Computer Controls Inc., 12 Industrial Rd., Fairfield, New Jersey 07006 [365]

### Core memory offers

fail-soft circuit

An expansion magnetic core memory is designed for the PDP-11 computer. The random-access memory, the DC-38-11, can be applied as a peripheral and be plugged into the computer's Unibus cable. Two features offered are parity generate and a fail-soft circuit. Cycle speeds are 650, 750, and 900 nanoseconds, and the three-wire, 3-d coincident-current unit is available as a 4,096-word read/write module. Price is \$2,600 in quantity.

Datacraft, P.O. Box 23550, Ft. Lauderdale, Fla. 33307 [366]

### Alphanumeric printers handle

25 characters per second

A nominal rate of 25 characters per second is offered by the model DP-750 series of alphanumeric printers. The self-contained unit has a drum-type print mechanism with a total of 42 alphanumeric characters that can be printed in 21 columns. Four basic ASCII-compatible input systems are available: serial



asynchronous data is accepted at rates to 3,200 baud in the model 751; serial asynchronous data at 10 characters per second in the 752; parallel-bit, serial-character format at maximum closed-loop rate of 500 characters per second in the 753; and ASCII parallel-bit, serial-character input continuously where maximum closed loop does not exceed

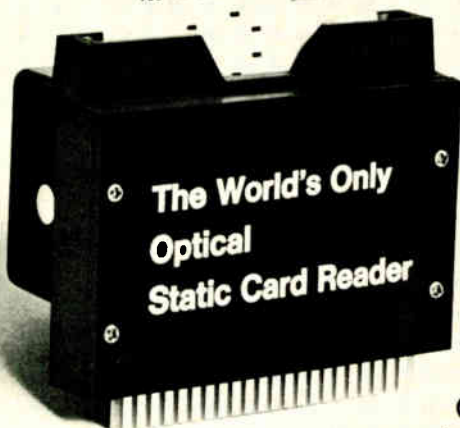

Accepts Hollerith cards or badges.

Extremely reliable, compact.

Easy to operate.

Uses diode-isolated light sensors.

Available from 10x10 to 12x80 matrix.

Prevents improper card insertion.

Plugs into standard connectors.

Horizontal or vertical card insert.

Optional solenoid card ejector.

For further information contact  
Ken Terasaki, Panasonic Industrial Division,  
200 Park Avenue, New York, N.Y. 10017 (212) 973-8907

**Panasonic**®  
just slightly ahead of our time

Circle 194 on reader service card



# What's all this noise about noise?

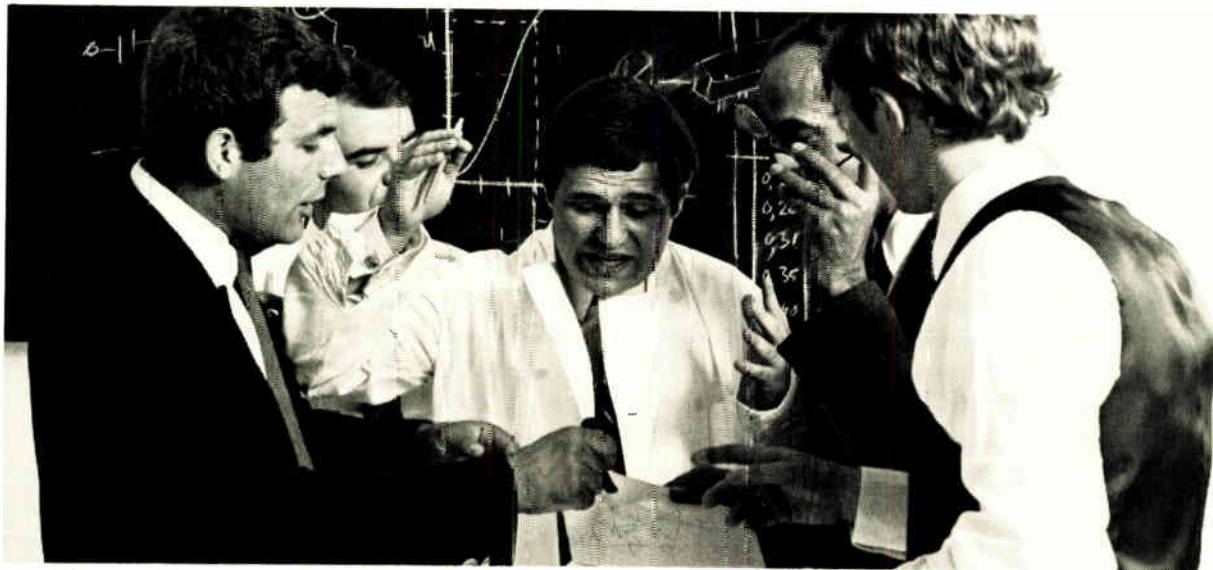

Philips' 30-series high noise-immunity logic modules solve noise problems instantly, right on the circuit design.

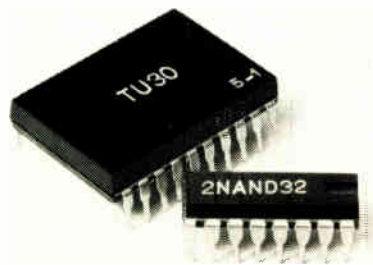

How to eliminate the effects of self-induced and externally generated a.c. and d.c. noise in logic circuits... there's a subject to keep earnest circuit designers debating into the night.

But it's time to call time, gentlemen. All this noise about noise is just valuable energy going to waste.

Philips' new 30-series high noise-immunity logic modules provide an instant solution, not only to problems caused by so-called d.c. noise, but to the more troublesome spurious a.c. pulses that can cause a logic system to go all illogical.

The trick is in matching up the relationship between noise-immunity and speed-of-system response. With a 30-series module you simply add, where necessary, a slow-down capacitor in the circuit... selected, of course, to fit the situation... and there's no more noise problem left to talk about!

Don't leave yet. The 30-series includes not only logic elements, but timers, power amplifiers, lamp/relay drivers, interface modules, p.c. boards, connectors, mounting racks... everything you need to build a complete system.

Modules come in 16 and 20 pin dual-in-line packages ready to insert. Philips provides full application support... we'll even design a prototype for you. Not that we want to take all the noise out of life... just the part that costs you needless time and money. After all, there are still plenty of other things to argue about...

Order your copy of "Noise behaviour of the 30-series".

N.V. Philips' Gloeilampenfabrieken  
Electronic Components and  
Materials Division  
Eindhoven - The Netherlands

Distributed and sold in the U.S. by:  
Amperex Electronic Corporation  
Solid State and  
Active Devices Division  
Providence Pike,  
SLATERSVILLE R.I. 02876

In Canada: Philips Electron Devices  
a division of Philips Electronics  
Industries Ltd. 116, Vanderhoof Avenue  
TORONTO 17 - Ontario



Electronic  
components  
and materials

# PHILIPS

HIGH

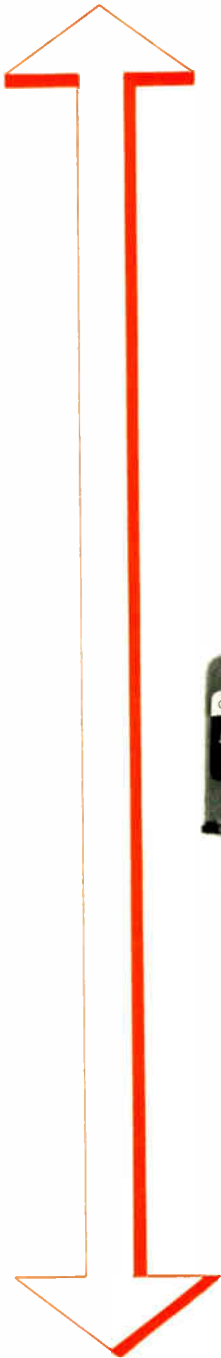

LOW

# ADLAKE

**has solid-state and hybrid timing and switching components for:**

- ... high and low current switching
- ... high and low impedance circuits
- ... high and low switching speeds
- ... high and low temperature environments
- ... high and low engineering budgets

*New circuit design problems call for innovation . . . and ADLAKE has economical, highly reliable semiconductor and hybrid timing and switching components for process control, multiplex, instrumentation, EDP, motor/load control and other critical applications. ADLAKE offers brand new answers to brand new problems.*

Here are just two of many versatile, economical and highly reliable components to solve a wide range of critical specifying problems.



**PULSE LATCH** Precise control of DC loads . . . All solid state, completely encapsulated . . . internal transient suppression . . . immune to shock and vibration . . . capacity up to 2 amperes at 100% duty cycle . . . Accurate switching up to 20HZ from input pulses as narrow as 100  $\mu$ seconds, depending on load. Ideal for the control of lamps, solenoids, delay circuits, fractional hp motors.



**TRANSFER TIMER** DC-DC Transfer Timer delays input before transfer to the output. Adjustable time delay from 20 milliseconds to 2.0 minutes. Accuracy  $\pm$  2.5%

over temperature range of  $-30^{\circ}$  to  $+170^{\circ}$  F. Operates on standard voltages from 12 to 115 DC. Will provide half-wave rectified output when operated from 110 volt, 60 Hz input. Optional solid-state AC or input/output isolation. Rated 1 ampere continuous. A precise timing device for process and control circuits or systems.

\*AC Pulse latch or transfer timers available on special order.

*Specify ultra-reliable solid-state ADLAKE timers and control components for critical timing and switching applications.*

USE READER SERVICE NUMBER FOR COMPLETE INFORMATION

## THE ADAMS & WESTLAKE COMPANY



ELKHART, INDIANA 46514  
219 - 264-1141  
TELEX 25-8458  
CABLE ADLAKE

### New products

25 characters per second in the 754. Price of each is \$975.

Anadex Instruments Inc., 7833 Haskell Ave., Van Nuys, Calif. 91406 [367]

Terminal built for remote job entry

A communications terminal can be used for remote job entry and to make inquiries into a computer's data base. The programable unit, the model 2922, is also designed for teleprocessing applications. The terminal includes a 500-line-per-minute printer. Data is entered through a punched-card reader and then transmitted to the central computer at speeds up to 7,200 bits per second. After processing the jobs, the central computer transmits reports and listings back to the terminal. Price is \$43,525, and rental plans are available.

IBM Data Processing Div., 113 Westchester Ave., White Plains, N.Y. 10604 [368]

On-line test set pinpoints data transmission problems

Operating in a transparent mode between terminal and modem, the Antekna model 221 on-line transmission test set pinpoints the cause of data transmission problems. It automatically steps through tests of the local modem, indicating which

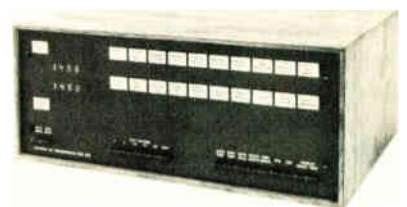

test fails. Using simplified pushbutton controls, the user can perform tests from either end of the system, eliminating the need for assistance at a remote location. Two digital meters in the tabletop device monitor send and receive lines and provide a readout of error rates.

Antekna Data Comm Division, 625 Clyde Ave., Mountain View, Calif. 94040 [369]

# The mini-maxi machine. Kearfott SKC-2000 Airborne Digital Computer has a new number—AN/AYK-13.

Floating point arithmetic eliminates scaling problems and permits use of Fortran IV compiler.

Existing, working hardware designed to accommodate tomorrow's technology, today.

Large machine architecture used in compact airborne digital computer is readily expandable.

True modularity. Machine architecture and mechanical design permit virtually unlimited addition of CPU and memory modules.

Unique mechanical design provides for adequate cooling of MSI/LSI devices used.

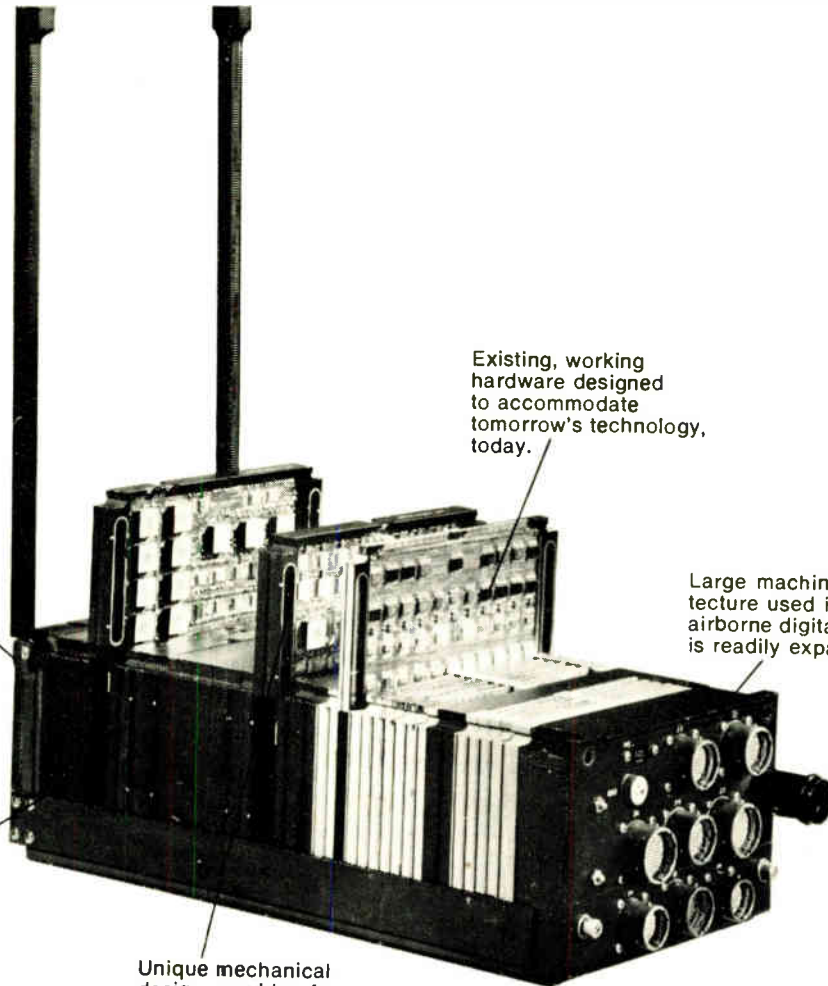

Here's a general purpose, high performance digital computer based on a single data and control bus, and an interconnecting series of modules. Modules that can be combined to form a simplex central computer, a multi-computer or a multi-processor—simply, quickly, efficiently.

But there's more. Through the use of asynchronous module operation, a complete spectrum of input/output capabilities is made possible. Because the SKC-2000 modules can be mixed and matched, and even replaced as new technological advancements are made.

We can provide you with a whole family of compatible modules for our SKC-2000. And one of our experts can help you put together a winning combination, from a mini-machine all the way up to a maxi-machine.

For more information, and a detailed new brochure, write The Singer Company, Kearfott Division, 1150 McBride Ave., Little Falls, N.J. 07424. Or call (201) 256-4000.

**SINGER**  
AEROSPACE & MARINE SYSTEMS

#### Typical Characteristics (CPU)

Number Systems	Binary, floating point and two's complement fixed point
Data words, Floating Point	24 bit mantissa, 8 bit exponents
Data words, Fixed Point	32 bits including sign
Instruction Words	16 bits short, 32 bits long
Instructions	99 total long & short
Address Modes	Direct, indirect, relative, immediate
Average Execution Times For 1.9 $\mu$ sec memory (LSI)	Add-2.125 $\mu$ sec, multiply -5.875 $\mu$ sec, Divide -5.875 $\mu$ sec
Memory words directly addressable	131,072

# New from Helipot: the lowest trimmer profile in the business.

SHOWN ACTUAL SIZE

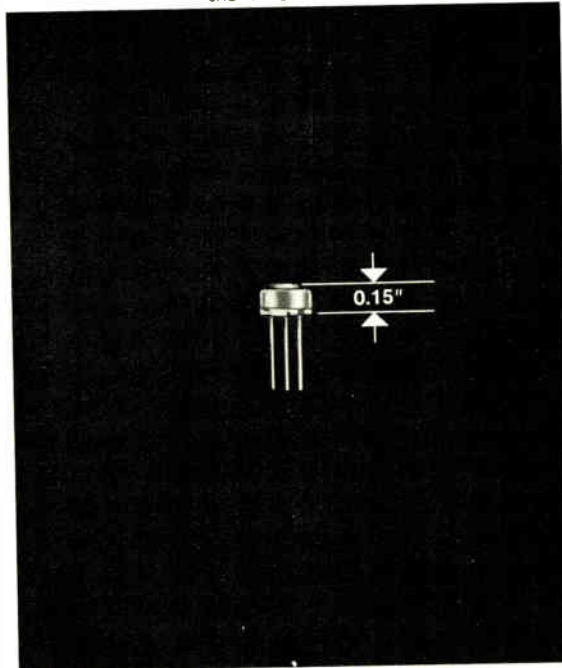

You can't do better than our Series 82 Trimmers for small size and low cost . . . and, of course, Helipot dependability. These  $\frac{1}{4}$ " single-turn, general-purpose cermet models have the lowest profile in the industry with a proven cermet resistance element that can be set to any voltage ratio within 0.05% of full scale. Sealed metal housings, solid stops, and essentially infinite resolution. They'll save you space—they'll save you money. (Our prices start at \$1.40 list.) Two good reasons to write for specs and prices today.

**Beckman**® INSTRUMENTS, INC.

**HELIPOT DIVISION**

2500 Harbor Blvd., Fullerton, Calif. 92634

HELPING SCIENCE AND INDUSTRY IMPROVE THE QUALITY OF LIFE

### Packaging and production **LSI tester runs at 10 MHz**

Unit checks RAMs, ROMs, registers, and both MOS and bipolar random logic

When Macrodata decided to upgrade its MD-100 metal oxide semiconductor memory tester from 5 to 10 megahertz in response to demands from users of bipolar devices, company engineers discovered that new technology would also permit them to expand capability for testing nonrepetitive parts at little additional cost. The result is the MD-104 LSI tester [*Electronics*, May 22, p.26]. It checks random-access memories, read-only memories, shift registers, and random logic in both MOS and bipolar designs. The price of \$24,950 is about \$5,000 more than for an MD-100 with paper tape, which is standard on the MD-104. Frank Chase, marketing vice president at Macrodata, claims that it's the first such tester to operate at 10 MHz.

The higher speed, in itself, is of little consequence to most MOS users, since typical MOS large-scale integrated circuits operate at frequencies as low as 200 kHz, and few hit 2 MHz. But speedy emitter-coupled logic and transistor-transistor logic devices at 10 MHz are popular in many applications; in fact, the MD-104 makes use of such devices in a large high-speed RAM module that accounts for part of its expanded capability. The MD-100 used a combination of RAMs programmed by switches (or optionally, paper tape or computer) to determine patterns for specific devices, plus a programmable ROM supplied by Macrodata that guides the general testing through such programs as galloping 1s and 0s (Galpat). The new machine sticks to a high-speed bipolar RAM, and stores both types of programs after loading from the integral paper tape reader.

A huge RAM will be available to store patterns for general LSI testing, which cannot be categorized into simple patterns as memories can. The instrument also includes improved diagnostic capability.

The MD-104, like the MD-100, is strictly a functional tester. It consists of a high-speed TTL processor that generates the patterns in real time, plus a test deck with personality cards that interface to different classes of devices. The MD-104 will be ready for delivery in September.

Macrodata Co., 20440 Corisco St., Chatsworth, Calif. 91311 [391]

### Circuit card has wire-wrap, IC connections on same side

A low-profile integrated-circuit card that can be wire-wrapped and then converted to all-printed-circuit connections is designated the Slim-Wrap. The wire-wrap and integrated-circuit connections are on the same side, allowing the cards to be placed closer together than other types of wire-wrapped cards. The board provides a 0.6-inch card center-to-center mounting, and it can accommodate 44 ICs in a combina-

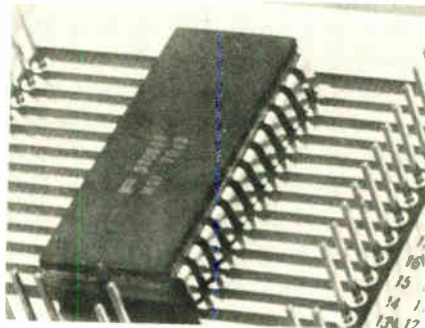

tion of 14-, 16-, and 24-pin devices. Price is \$39.30 in lots of 100.

Interdyne, 14761 Califa St., Van Nuys, Calif. 91401 [396]

### Boat retractor operates up to 30 inches a minute

The model 721 boat retractor is used to control the insertion, dwell, and retraction portions of the diffusion process performed on silicon

wafers. Stroke is adjustable over a 34-inch range and can be programmed to provide different speeds in the ramp and flat-zone areas of the diffusion tube. The units provide dwell-mode oscillation as required, and speed ranges from 0.1 inch per minute to 30 in./min in nine discrete steps. An override control permits emergency retraction at 30 in./min on demand.

Process Sciences Inc., Main St., Pleasant Valley, N. Y. 12569 [397]

### Miniature DIP provides seal without damage

High-temperature hermetic sealing of ceramic DIPs—at about 520°C—often causes degradation of MOS linear and digital circuits. However, a low-temperature sealing process called Cerdip II eliminates this problem. The graded-viscosity glass system consists of a preassembled header so that only a die has to be attached before bonding. The subassembly is then sealed at 450°C, using the company's clips instead of conventional boats.

Diacon Inc., 4812 Kearny Mesa Rd., San Diego, Calif. 92111 [399]

### Lightweight dispensing gun applies viscous materials

All types of viscous materials can be applied with the model 910 dispensing gun. Method of application is through standard collapsible metal tubes with tapered plastic nozzles at the ends of the tubes. The operator removes the twist-lock cap on the back of the gun barrel, inserts the tube downward to make a seal

## We're moving

Effective immediately, please send all product information to:  
New Products Editor, Electronics, McGraw-Hill Publications Co., 1221 Avenue of the Americas, New York, N.Y. 10020.

**This  
Sweet  
MICROVOLT  
MULTIMETER** is  
**SENSITIVE** to  $1\mu\text{V}$ ,  
**STABLE** within  $2\mu\text{V}/\text{day}$   
and easy on the budget at  
**\$560**

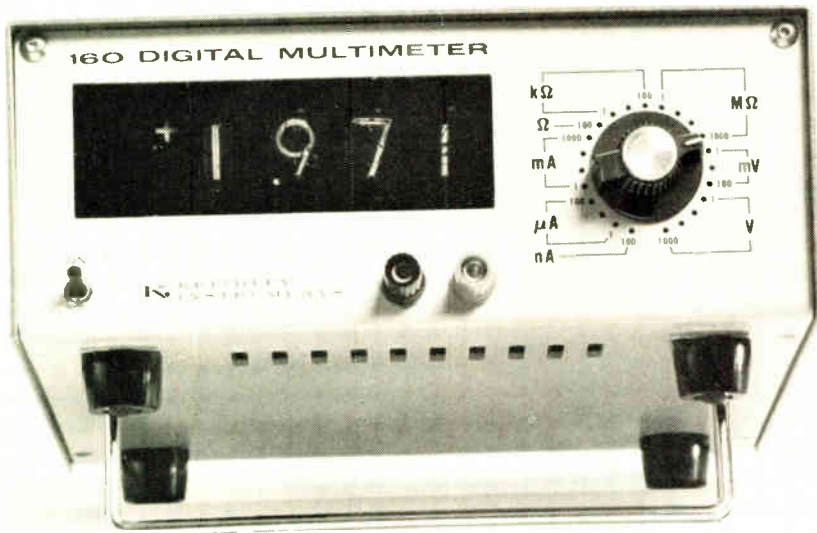

Users call it "the-how-sweet-it-is-meter".  
But it's really the Model 160 that...

- MEASURES WITH DIGITAL ACCURACY
  - Voltage** —  $1\mu\text{V}$  to 1000V
  - Current** — 0.1 nA to 2A
  - Resistance** —  $0.1\Omega$  to 2000 MΩ
- 100% OVERRANGING
- ANALOG and OPTIONAL BCD OUTPUT
- AC/DC PROBE ACCESSORY
- MANY MORE SWEET PERFORMANCE FEATURES



**KEITHLEY  
INSTRUMENTS**

U. S. A.: 28775 Aurora Road, Cleveland, Ohio 44139  
Europe: 14, Ave. Villardin, 1009 Pully, Suisse

SEND FOR FULL DETAILS AND YOUR FREE "HOW SWEET IT IS" BUTTON

## New products

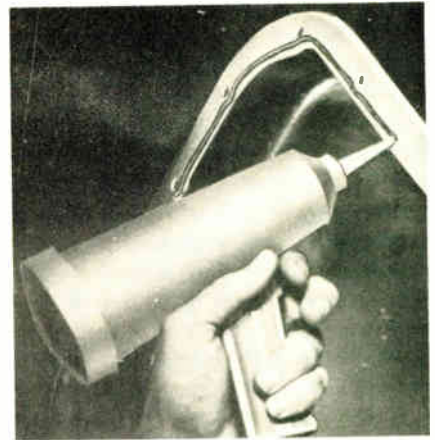

around the nozzle, and replaces the barrel cap. Once the desired air pressure of the gun has been determined, the operator pulls the trigger, which allows the air to apply pressure evenly around the entire tube. The gun accepts 2-, 3-, and 5-ounce tubes.

Techon Systems Inc., 4738 W. 156th St.,  
Lawndale, Calif. 90260 [398]

## Vibration tester verifies integrity of printed circuits

A tabletop vibration testing system is designed mainly to verify the integrity of printed circuits but can be used also for plugboards, memory boards, and any component weighing up to 20 pounds. By hand-

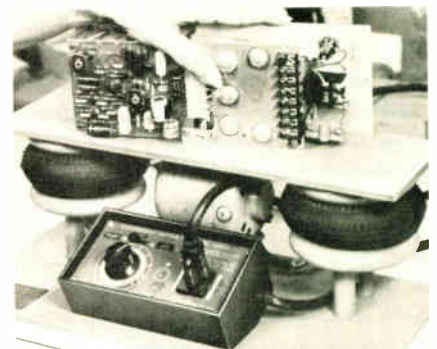

holding the component being tested and buzzing it for 3 to 5 seconds, the operator can find marginal and faulty solder- and wire-wrap connections, as well as remove debris. Range is up to 10,000 vibrations per minute and force output is 60 pounds.

Branford Vibrator Co., 160 Whiting St., New  
Britain, Conn. [400]

# New plug-in transformers have bounce to the ounce(r)

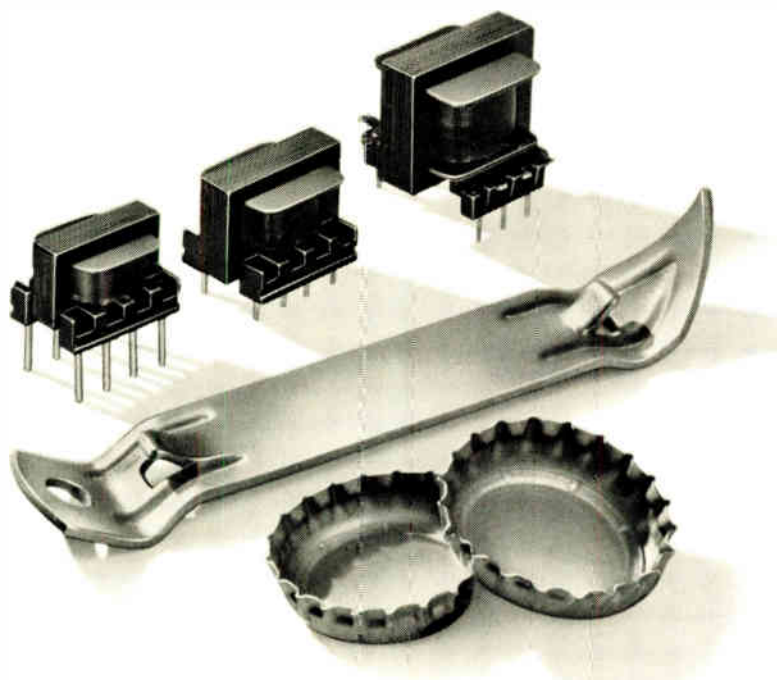

TRW/UTC can help you open up some refreshing solutions to your printed circuit board audio transformer problems. Our Ouncer, Subouncer and Sub-subouncer lines, the quality standards for years, are now available with plug-in pin terminals for labor—and cost—saving board mounting. Leads are designed for wave soldering.

These plug-in units offer all the quality, reliability and utility of the famous UTC ounce line with insulated leads. Nothing has been compromised.

Special Subouncer and Sub-subouncer molded units can be furnished in place of any open frame model. Metal encased types to MIL grade 4 are available from stock or can be made to your specs.

This is the transformer line that couples highest performance and reliability with plug-in economy and the shortest delivery cycles. Write for catalog data. TRW/UTC Transformers, an Operation of TRW Electronic Components, 150 Varick Street, New York, N. Y. 10013. Tel: (212) 255-3500.

**TRW**  
UTC TRANSFORMERS

# motion detector



The CVI Motion Detector 304 used with conventional CCTV cameras and systems provides a unique automatic alarm triggered by variations in brightness.

#### Security

the 304 allows free movement of personnel until a restricted area is entered

#### Production Monitoring

the 304 automatically monitors status boards, meters, level gauges, conveyor belts, traffic

#### Fire Protection

the 304 detects most types of smoke, giving added fire protection to secure areas

#### Indoor/Outdoor

the 304 is ideally suited for outdoor use because it does not respond to slow variations in light level

#### Fail Safe

alarm and latch detect loss of power, loss of video or abrupt changes in light level

If you're moved by the 304 story so far, circle our reader service number, drop us a line or call for more specifics.

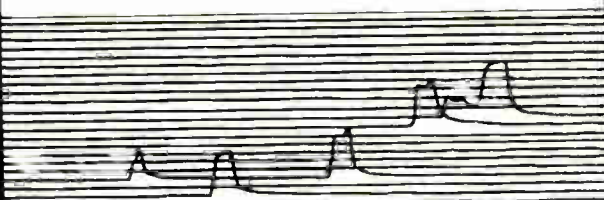

Typical vehicular/pedestrian traffic log

Colorado Video Inc. **cvi**  
P.O. Box 928 Boulder, Colorado 80302 (303) 444-3972



Use it **FREE**  
for 5 days!

Design, test, layout and build circuits with any combination of components and modules... **FREE!**

This advanced concept circuit design test system features built-in independent circuit monitor lights, built-in isolated pushbuttons, toggle arrays, universal acceptance with ELI's SK-10, common hook-up wire interconnection and unlimited fan in/fan out capability. Try it absolutely **FREE** for 5 days. If not satisfied, return it and you won't be billed. Trying is believing! How can you go wrong?

Don't use the **BINGO** card... **order now!**



**ELI INSTRUMENTS, INCORPORATED**  
61 First Street, Derby, Conn. 06418  
Telephone: 203/735-8774

Circle 197 on reader service card



**YOU'RE WHISTLING IN THE DARK...**

if you think that heart disease and stroke hit only the other fellow's family.

**GIVE...** so more will live  
**HEART FUND**



Contributed by the Publisher



## New products

Semiconductors

# IC is modem building block

Design permits phase-locked loop in chip built for data networks, telemetry

The basic analog functions of a frequency-shift-keyed modem are contained in the XR-210, a monolithic chip developed by Exar. The 16-pin integrated-circuit package can be wired to demodulate FSK signals into binary outputs. In other configurations, the same IC can function as an FSK modulator with discrete frequency-tone outputs.

The unit can handle both low-speed (300 bits per second) and medium-speed data rates (up to 1,800 bits per second) and it is compatible with Bell type 103 and 202 data sets. The monolithic circuit has four sections—a phase detector, a voltage-controlled oscillator (VCO), a voltage comparator, and a logic driver.

As shown, the differential outputs of the phase-detector (pins 2 and 3) are internally connected to the analog control terminals of the VCO section. These phase-detector and VCO sections can be interconnected, therefore, as a monolithic phase-

locked loop simply by ac coupling the VCO output (pin 15) to either one of the phase-detector inputs (pins 4 or 6).

The voltage comparator section converts the voltage polarity changes across the phase detector terminals into binary logic pulses. The dc level at pin 3 also serves as a voltage reference for the voltage comparator. The logic driver section is a power transistor internally connected to the comparator output and can "source" or "sink" up to 100 milliamperes of load current.

The frequency of the VCO section is determined by an external timing capacitor connected between pins 13 and 14. The nominal value of the VCO frequency,  $f_o$ , can be expressed as:

$$f_o = \left( \frac{200}{C_o} \right) \left( 1 + \frac{0.6}{R_x} \right) \text{Hz}$$

where  $R_x$  (in kilohms) is an optional resistor used to extend the circuit's operating frequency, and  $C_o$  is the timing capacitor (in microfarads). The VCO voltage-to-frequency conversion gain is inversely proportional to the external resistor,  $R_o$ , connected across pins 11 and 12.

The circuit can operate with a single power supply in the range of 5 to 26 volts, and accommodate input frequencies between 0.5 hertz and 20 megahertz. It will be available from stock starting this month. Price of the XR-210 chip is \$6.50

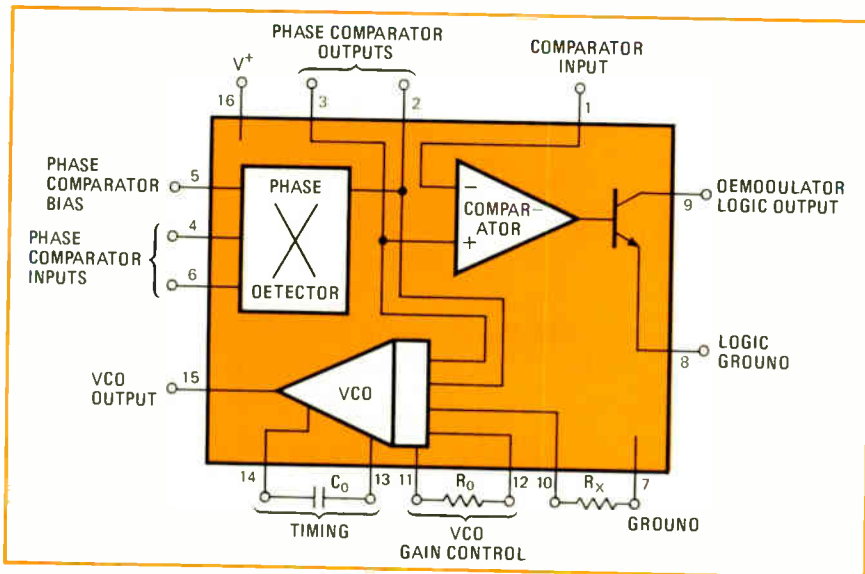

FSK modem. New 16-pin IC modulates or demodulates at up to 1,800 bits per second

**DON'T  
DOUBLE  
CROSS  
YOUR LOADS**

**ZERO  
CROSS**  
them with

## Jewell GOLD LINE SOLID STATE RELAYS



- ZERO CROSSING TYPES FOR CONTAMINATED, EXPLOSIVE OR CRITICAL APPLICATIONS

8 amp. standard duty. 15 and 30 amp. heavy duty in single, two and three pole. Miniature style -2, 3 and 4 amp.

They keep your loads at full power without noise. Switching is smooth, waver-free, noise immune—even under extreme high inrush exposure. Other features include: Wide frequency range. Complete encapsulation. All solid state construction. No moving parts for maintenance-free operation . . . and other advantages not found in other units.

- PROPORTIONAL CONTROLLER RELAY TYPES ARE IDEAL FOR AC MOTOR CONTROL
- VARIATIONS TO ORDER

*Write or phone for pricing and technical information.*

**Jewell**

JEWELL ELECTRICAL INSTRUMENTS, INC.  
Grenier Field, Manchester, NH 03105  
Phone: (603) 669-6400 • Telex: 94-3435

# Join now

Eastman 910<sup>®</sup> adhesive joins virtually any combination of smooth, clean materials instantaneously, with shear strengths up to 5000 p.s.i.



For details, call or write:  
Eastman Chemical Products, Inc.  
Kingsport, Tenn. 37662



Circle 162 on reader service card

## Get the facts on the boom in Georgia. And get them free.

There's a reason Georgia has been industrializing and urbanizing itself faster than any other state in the dynamic South.

In fact, there's a whole bookful of reasons, with corresponding profit opportunities for companies of every description.

Write Georgia  
Department of Industry  
& Trade, Industry Division,  
Dept. EL-12, Post Office  
Box 38097, Atlanta,  
Georgia 30334, for your  
free copy of the 1972  
Georgia Industrial Survey.

It could start a boom of  
your own.  
**Georgia, the unspoiled.**

162 Circle 198 on reader service card

### New products

each in quantities of 100 and more.  
Exar Integrated Systems Inc., 733 N. Pas-  
toria Ave., Sunnyvale, Calif. 94086 [411]

Medium-scale integrated  
devices use ECL technology

Four medium-scale integrated de-  
vices in the 95H400 series of tem-  
perature-compensated ECL products

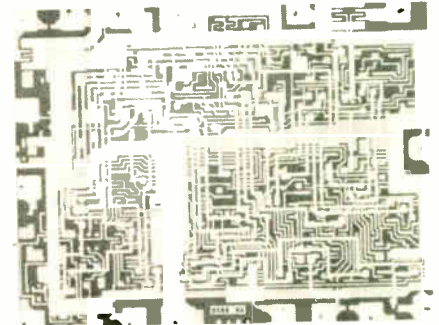

include a four-bit universal shift register, a five-bit comparator, a triple two-input multiplexer, and a high-speed version of the model 9528 dual-D flip-flop. The first three are aimed at high-speed data processing, and the flip-flop is for radio-frequency generating and measuring equipment and other jobs. Price of the 95H00 200-megahertz shift register is \$12.50. The 9580 2.6-nanosecond multiplexer is \$5.20. The 95H55 6-ns comparator is \$5.20, and the 95H28 260-MHz flip-flop is \$13.60.

Fairchild Camera & Instrument Corp., Semi-  
conductor Components Group, 464 Ellis St.,  
Mountain View, Calif. 94040 [413]

LED/sensor/amplifier system  
is for tape, card reading

An LED/sensor/amplifier subsystem  
for tape and card reading combines  
matched emitters and sensors into a

### We're moving

Effective immediately, please  
send all product information to:  
New Products Editor, Electron-  
ics, McGraw-Hill Publications  
Co., 1221 Avenue of the Amer-  
icas, New York, N.Y. 10020.

Electronics/June 5, 1972

FOR IC & MOS DRIVERS



# 3 AMP SENSITIVE GATE TRIACs

- 3mA, 4mA, 5mA, 10mA & 25mA ( $I_{GT}$ ).
- All quadrant gating
- 50V to 600V ( $V_{DROM}$ )
- Glass-passivated chips
- Di-Mesa\* Construction  
For improved operational reliability

Also from Hutson:  
4 Amp Sensitive Gate  
SCR's. 200 $\mu$ A & 1mA  
( $I_{GT}$ ). 50V to 600V ( $V_{DROM}$ )

Hutson's complete line includes:

- Ratings to 40 Amp [ $I_{T(RMS)}$ ]
- All popular packages plus chip form TRIAC's & SCR's.
- Center-gate, shorted-emitter design
- Void-free, glass-passivated chips

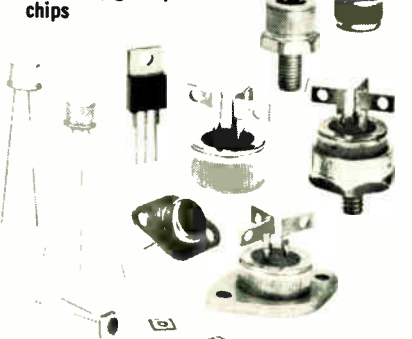

\*T.M. HUTSON INDUSTRIES

## HUTSON INDUSTRIES

BOX 34235 • 2019 W. VALLEY VIEW  
DALLAS, TEXAS 75234 (214) 241-3511  
TWX 910-860-5537

### Distributed by:

BODELLE CO., INC., Chicago, Ill. 312/468-1016  
Detroit, Mi. 313/273-6920 ■ NEWARK ELECTRONICS  
CORP., Inglewood, Cal. 213/678-0441  
THOR ELECTRONICS, Elizabeth, N.J. 201/354-2420  
Canada: WEBER-SEMAD ELECTRONICS, Downsview, Ont.

### European Marketing Director:

30 Rue Pierre Semard, Yerres, 91 France  
Tel: Paris 925-8258 TELEX 21-311

### Distributed in Europe by:

Switzerland: D. LEITGEB, Dubendorf  
Sweden: ELEKTROFLEX, Sundbyberg  
Spain: BELPORT, Madrid  
Holland: RODELCO, Den Haag

## New products

single package that is ready to install. Called the PP900, the unit has nine channels, and is compatible with transistor-transistor logic and diode-transistor logic. Operating speed is in excess of 1,000 characters per second, and the units can read translucent tape with a transmissivity of 50%. Price for 1 to 9 devices is \$100.

Centralab Semiconductor, 4501 North Arden Dr., El Monte, Calif. 91734 [414]

Transistor measures 2.8 by 1.5 by 1.1 millimeters

A transistor called the Mini Mold measures 2.8 millimeters in length, 1.5 mm in width, and 1.1 mm in depth. Applications are in uhf and vhf receivers, and low-noise ampli-

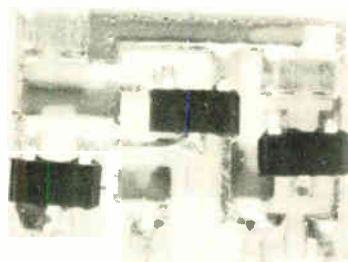

fiers that require high frequency for the driving parts of the display tubes. The transistor will allow reduction in the size of a hybrid integrated circuit by about 30%, and handling is made easier because the transistor is a complete package.

NEC America Inc., Pan Am Building, Suite 4321, 200 Park Ave., New York, N.Y. 10017 [415]

Buffer simultaneously drives 3 or 6 lamps

A hybrid hex buffer circuit is designated the model 20330. The unit can simultaneously drive three 300-milliamper or six 150-mA incandescent lamps, and a maximum of two packages is all that is required. The device is housed in a 14-pin dual in-line plastic package. Features include 300-mA sink current, 5-volt logic supply, and six drivers

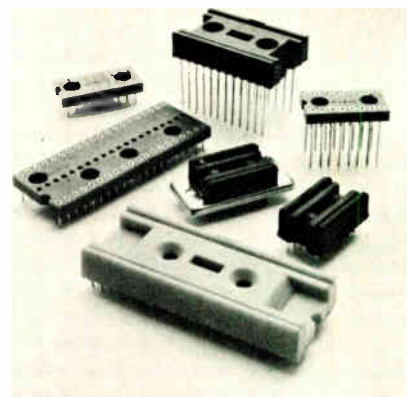

## If you've got the circuit, we've got the socket.

We ought to.

After all, Augat conceived and pioneered the socket panel for dual-in-line IC's. So why wouldn't we make other sockets for printed circuit boards as well?

We do. Low profile types, ultra-low profile types, MSI and LSI types, even LED sockets. More important, Augat design and quality standards provide for longer life, better retention and greater reliability.

There's more to Augat than sockets. As the leader in electronic interconnection, we also offer a broad selection of accessories. For quick information on price and delivery, call us at (617) 222-2202. Or write for our catalog. Augat Inc., 33 Perry Ave., Attleboro, Mass. 02703. Our representation and distribution is nationwide and international.

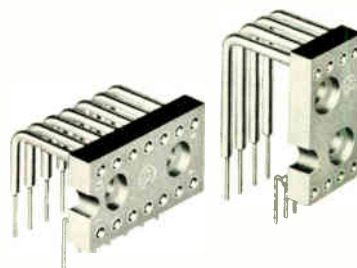

## Plug into Augat®

See our new packaging developments at  
The NEPCON EAST Show, New York,  
Booths 4521-4523.

# NEW LOW PROFILE. NEW LOW COST.

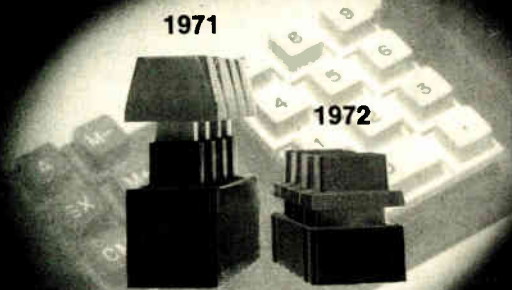

The switch is called BI-PAC Phase 2. It saves space... only 0.580" behind the panel with 0.150" stroke and 0.075" overtravel. Our latest 2-shot Keycap is low profile too. Even the touch is low... 2½ ounces.

It saves money... less than 25c per key for 500,000 positions. That's because it's simple. Dual cross-wire gold contacts with wiping action provide high reliability.

Want more savings? Buy CRC completely assembled Keyboards. A dozen leading U.S. calculator manufacturers are already using BI-PAC Keyboards in high volume.

To get all the Phase 2 savings, write or call.



**Controls Research Corporation**

2100 S. Fairview, Santa Ana, Calif., 92704  
Phone: (714) 557-7161

Circle 164 on reader service card

## tones to CONTROL ALERT SIGNAL



over phone lines,  
P.A. systems & radio channels

- **HIGH STABILITY ENCODER** generates precision control tone for transmission on audio channel.
- **VOICE IMMUNE DECODER** detects control tone on audio channel and energizes output relay. Highly selective audio filter plus tone timing circuit prevents false response to voice or music signals.
- **BRAMCO GIVES YOU FLEXIBILITY** with complete tone systems, building-block modules, and custom sub-assemblies for O.E.M. use. Ask for Catalog 303.



**BRAMCO CONTROLS**  
DIVISION OF LEDEX INC.

COLLEGE AND SOUTH STREETS, PIQUA, OHIO 45356  
513-773-8271 - the tone technology people

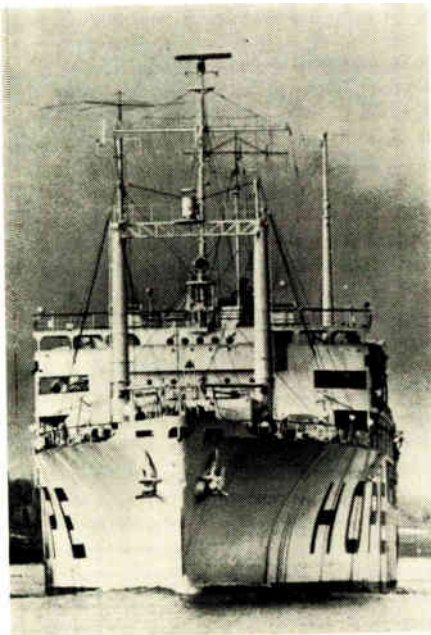

## S.S. HOPE, M.D.

Doctor... teacher... friend to millions on four continents—this floating hospital is a symbol of America's concern for the world's disadvantaged. Keep HOPE sailing.



Dept. A, Washington, D.C. 20007

## New products

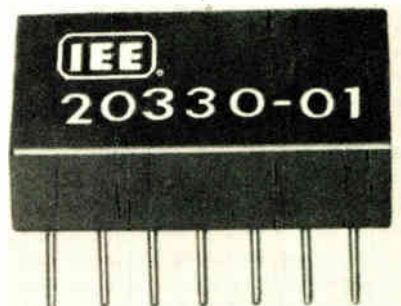

to a package. Price in quantity is \$5.45.

Industrial Electronic Engineers Inc., 7720-40  
Lemona Ave., Van Nuys, Calif. 91405 [417]

## Serial IC memory stores 200,000 bits per card

A serial semiconductor memory system stores 200,000 bits per card configured in 20,000 words of six to 10 bits on one 8-by-10½-inch printed-circuit card. Larger storage systems may be made by interconnecting many cards. The system operates at clock rates from 1 megahertz to 25 kilohertz, and has an access time of 500 nanoseconds at maximum clock rate. Each card has 10 input terminals, 10 output terminals, and one clock terminal—all single-ended lines. Power required per card is 5 volts ±5% at 7 amperes. Price is less than ½ cent per bit in OEM quantities.

Intel Corp., Memory Systems Operation,  
3065 Bowers Ave., Santa Clara, Calif. 95051  
[418]

## Display driver provides BCD data outputs

A bipolar monolithic four-bit latch-decoder-display driver offers binary coded decimal outputs. The HD-0140 uses junction-isolated technology and provides high-speed, high-current data-handling capability for light-emitting diodes and other types of numerical displays. In data handling and communications applications, the unit is compatible with transistor-transistor logic on the strobe, reset, data input, and data output circuits. The circuit de-

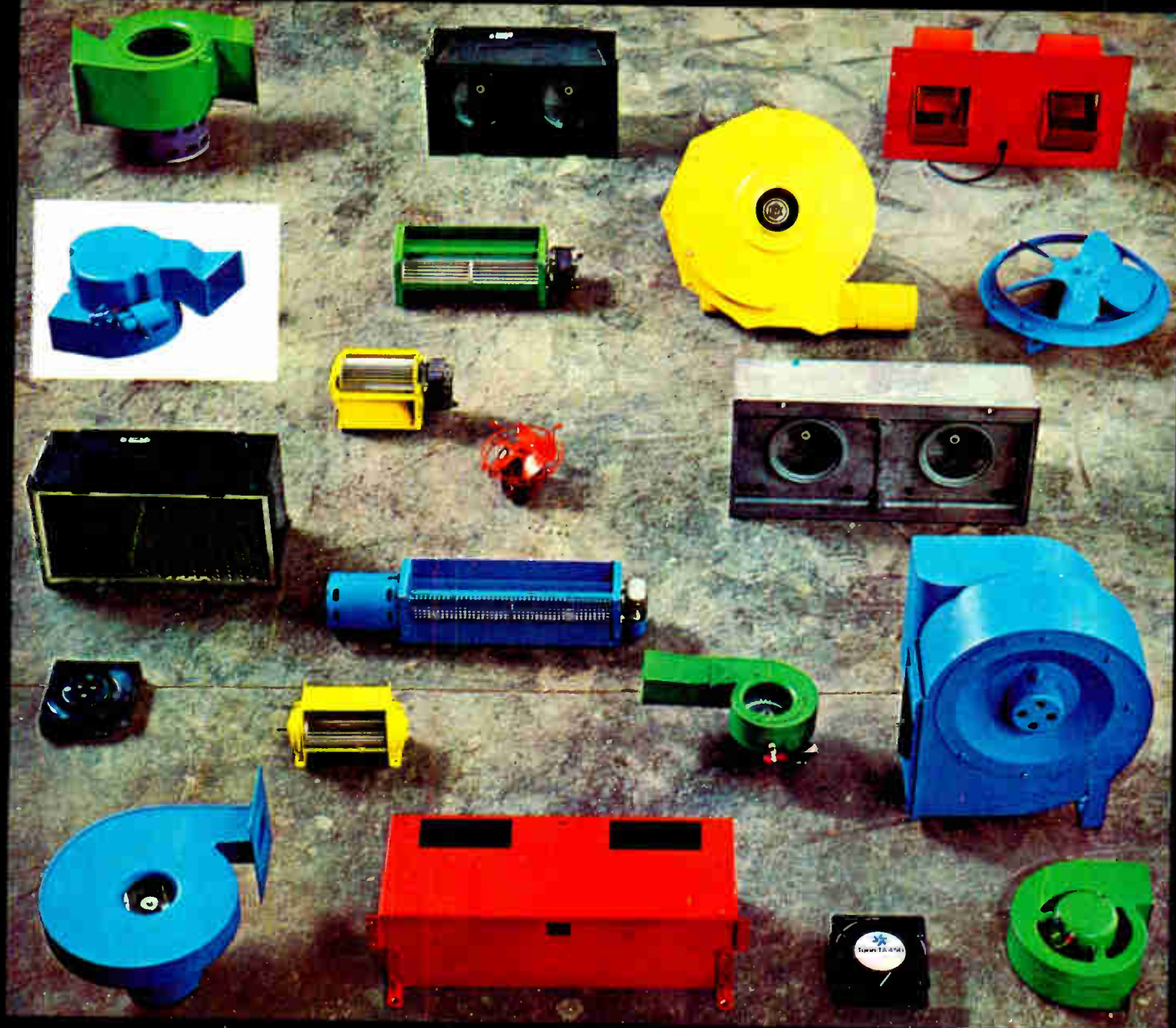

**This one  
does a job  
for your  
competitor.  
It might  
not be  
for you.**

**Torin Flexibility**

**Problem:** Late in the development stage of a new product, one of our computer customers discovered an unforeseen contamination problem that could only be corrected by an air supply. No space allowance had been made for a blower unit. Air flow and pressure requirements that required a good sized centrifugal impeller presented further difficulty. Space tolerances were tight and rigid.

**Solution:** Our engineers used a specially-designed motor with an end bell that, in order to fit, had to meet a critical limitation within 20 thousandths of an inch. To save space the motor was set into the inlet end of the centrifugal wheel. The forward-curved inlet duct was given special configuration to get around hardware already existing within the computer. Although the wheel housing was originally conceived in sheet metal, experimentation revealed that plastic would not only reduce costs considerably, but would also allow better scroll development. Design to prototype was accomplished within three weeks. 90,000 units are now in actual use, only 50 have proved less than satisfactory.

Your competitor's air-moving problems are his. Yours are yours. And both are firmly dictated by optimum product performance. Often we can produce exactly what you require through modifications of existing units. But if custom design is called for we can turn that out too. More than 500,000 square feet of modern production space results in competitive pricing and realistic deliveries.

You see here just one example of our flexible problem-solving experience. There's so much more to the Torin story. Get it first hand from one of our twenty Technical Sales Representatives. Or, write or phone for our tells-it-all booklet.

**Torin Corporation**

**United States:** Torrington Conn  
Van Nuys, Calif  
Rochester Ind, Elgin, Ill  
**Canada:** Oakville, Ont  
**England:** Swindon, Wilts  
**Belgium:** Nivelles  
**Australia:** Sydney

 **Torin**

Circle 165 on reader service card

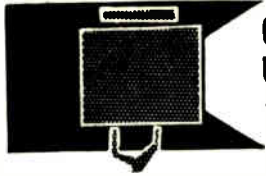

# SEARCHLIGHT SECTION

• CLASSIFIED ADVERTISING • BUSINESS OPPORTUNITIES  
• USED OR SURPLUS EQUIPMENT

## AUTOTRACK MOUNT



### AUTOTRACK SCR-584 RADARS

360 degree azimuth, 210 degree elevation sweep with better than 1 mil accuracy. Missile velocity acceleration and slewing rates. Amplidyne and servo control. Will handle up to 20 ft. dish. Supplied complete with control chassis. ALSO in stock — 10 cm. van mounted radar system. Conical scan. PPI. 6 ft. dish. Ideal for S band telemetry, weather, balloon trk., missile trk., rocket trk., ECM range. Write for complete data 600 pg instr bk avail at \$25 ea.

### HAWK MISSILE DOPPLER RADAR

CW low power illuminator. AN / MPQ-33. Dual antenna on single mount. Van mounted. Complete X band doppler tracker.

### PATH LOSS MEAS. FACILITY

Mfg. REL. For establishing max. xsmn paths for tropo and microwave links. 2 heli-hut vans. Covers 1-2.5ghz bands. 20 to 120 watts CW output.

### PHOENIX MISSILE SYSTEM

10" PPI, 5" B and C displays, and complete digital computer consoles.

### IBM 704 SCIENTIFIC COMPUTER

w/ peripherals & programs. Cost \$2,000,000. Our price \$10,000.

### MIT MODEL 9 PULSER 1 MW—HARD TUBE

Output 25kv 40 amp., 30kv 40 amp max. Duty cy .002. 25 to 2 microsec. Also 5 to 5 microsec. and 1 to 5 microsec. Uses 6C21. Input 115v 60 cycle AC. Mfg. GE. Complete with driver and high voltage power supply. Ref. MIT Rad. Lab. Series, Vol 5, p. 152.

### 2 MEGAWATT PULSER

Output 30 kv at 70 amp. Duty cycle .001. Rep. rates: 1 microsec 600 pps 1 or 2 msec 300 pps. Uses 5948 hydrogen thyratron. Input 120 / 208 VAC 60 cycle. Mfr. GE. Complete with high voltage power supply.

### 2 MEGAWATT HARD TUBE PULSER

Output 40kv at 50 Amps. Duty cy .0038. Var. pulse width. Compl. with driver and HV power supply. Input 208V 60hz.

## RECON DRONE CONTROL RADARS

X Band systems autotrack and search complete with plotting boards. Fully mobile van mounted. Gives PPI, slant range, altitude data. Ground to air control links and beacons also in stock. AN / MPQ-29 & AN / UPW-1.

## AUTOMATIC TRACKING SYSTEM

SCL. ATL. MOD. 3101-J70 Antenna Pedestal. AZ-EL. 15 deg. per second rated speed. 23 inch dia. bearing. Complete w / control console & mag. amplifiers.

## SPARE PARTS IN STOCK

Nike Ajax, Nike Hercules, M-33, MPS-19, TPS-1D, TPS-10D, FPS-6, SPS-8, SCR-584, HIPAR.

## RADAR & RF PKGS.

34ghz 40kw Pulse RF pkg  
24ghz 40kw Pulse bomb loss system  
16ghz 130 kw Pulse B-58 search radar system

X BAND AUTOTRACK 250KW PULSE M-33

compl w / plot boards

X BAND AUTOTRACK 50KW PULSE B-47

fire control complete

C BAND 5 MEGAWATT PULSED KLYST.

AN / FPS-26 Ht. Finder

C BAND 1 MEGAWATT AUTOTRACK

10ft dish mortar locator MPQ-21

C BAND 285KW PULSE Search AN / SPS-5 / 10

S BAND 1 MEGAWATT COHERENT AN / TPS-18

S BAND 1 MEGAWATT PULSE NIKE ACQ.

L BAND 1 MEGAWATT PULSE AN / UPS-1

L BAND 500KW PULSE AN / TPS-1D / E

L BAND 5 to 20KW PULSE

400mhz 1KW CW AN / FPS-23

225mhz 1 MEGAWATT PULSE AN / SPS-28

2-30mhz 100KW PULSE

CW 950-5ghz 150 WATTS

CW 1.5mhz-10.5ghz 5 WATTS

CW S & X BANDS 300-600 WATTS

## AN / GPG-1 SKYSWEEP TRACKER

3 cm. auto tracking radar system. Comp. pkg. w / indicator sys. Full target acquisition & auto. tracking. Input 115v 60 cy. new.

In stock for immed. del. Entire sys 6' x 3' x 10'. Ideal for infrared tracker, drone tracker, missile tracker. R & D.

## CATV-COLOR MICROWAVE LINKS

Rathen type KTR-1000. Fullcolor bandwidth as well as studio audio. Rack mounted. Complete trans-receiv racks in stock.

HUNDREDS MORE IN STOCK  
LARGEST RADAR  
INVENTORY  
IN WORLD.  
WRITE  
FOR  
CATALOG  
ON YOUR  
LETTERHEAD

# Radio-Research Instrument Co. INC.

3 Quincy St., Norwalk, Conn. 06850 • 203-853-2600

CIRCLE 951 ON READER SERVICE CARD

**New** **VACUUM PENCIL**

for picking up miniature parts

**PHILIP FISHMAN COMPANY**  
7 CAMERON ST. WELLESLEY, MASSACHUSETTS

CIRCLE 955 ON READER SERVICE CARD

**Radiation Devices Co.**

DEM'S — BROADCASTERS  
UNIVERSITIES — SERVICE COMPANIES

Review Our Economical Line of Instruments, Accessories, and Signal Processing Components Spanning The Frequency Range From D.C. to 2 GHz. To Get Best Value For Your Electronics Dollar. Brochures and Application Notes Are Available Upon Your Request.

RADIATION DEVICES CO., BOX 8450, BALTIMORE, MD. 21234

CIRCLE 952 ON READER SERVICE CARD

Government & Commercial Surplus  
**TEST-COMMUNICATIONS-DIGITAL EQUIPMENT**

Write for our latest bulletins  
**DATA/INSTRUMENTATION ASSOCIATES**  
208 S. Pulaski St. • Balto., Md. 21223

CIRCLE 953 ON READER SERVICE CARD

**FREE CATALOG**  
**HARD-TO-FIND PRECISION TOOLS**

Lists more than 1700 items—pliers, tweezers, wire strippers, vacuum systems, relay tools, optical equipment, tool kits and cases. Also includes four pages of useful "Tool Tips" to aid in tool selection.

**JENSEN TOOLS and ALLOYS**  
4117 N. 44th Street, Phoenix, Arizona 85018

CIRCLE 954 ON READER SERVICE CARD

## New products

livers 40-milliampere outputs to drive a single seven-segment numeric display, and four additional outputs are included that supply the

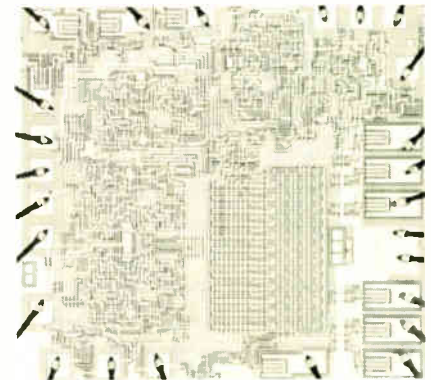

BCD data stored in the latch. The commercial version in 100-lots is priced at \$7.55, and the military model at \$11.25.

Harris Semiconductor, Melbourne, Fla. 32901 [416]

Dual op amps are for analog applications

Two monolithic operational amplifiers, constructed on a silicon chip, are intended for analog applications where board space and weight are important. The model  $\mu$ A747 offers a high common-mode voltage range



and absence of latchup, suiting the device for use as a voltage follower. The unit is short-circuit-protected and requires no external components for frequency compensation. An internal 6-decibel/octave roll-off insures stability in closed-loop applications. Signetics, 811 East Arques Ave., Sunnyvale, Calif. 94086 [419]

## HELP!

Q. How do I reply to a box number ad?

A. Address an envelope with the box number indicated in the ad, c/o Electronics, Class. Adv. Dept., P.O. Box 900, NY, NY 10020

Q. Who do I contact or call to renew my classified ad or make corrections?

A. Write Electronics, Class. Adv. Dept., P.O. Box 900, NY, NY 10020 or call: (212) 997-6585 or 6586. Give full company name, size of ad, & date or dates it is scheduled to appear.

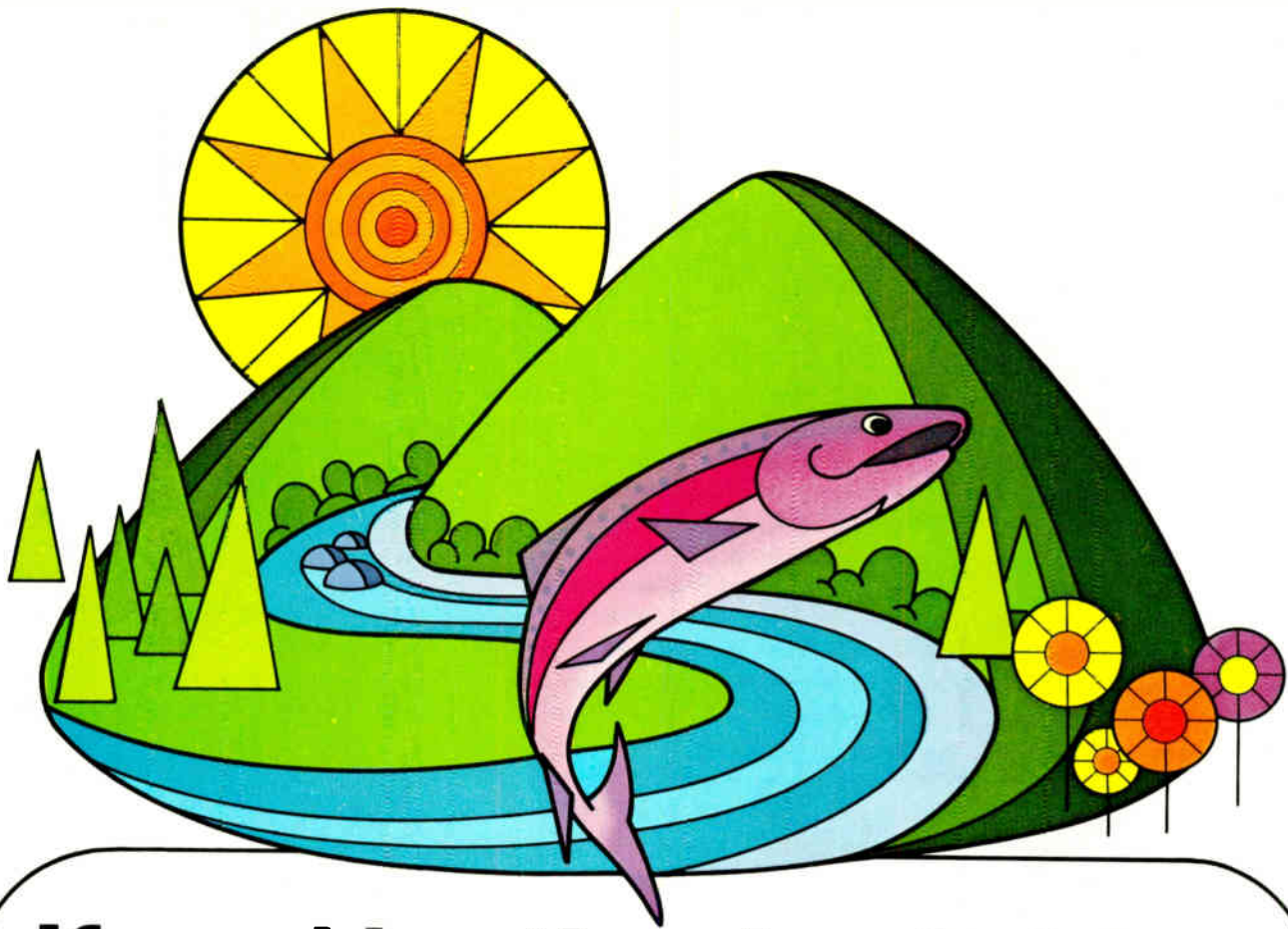

# If you'd rather be fishing

Let SAE solve your packaging problems.

Wouldn't you rather be up to your hip boots in a trout stream than up to your neck in packaging problems? Then turn over component selection, packaging, and systems assembly to us. You go chasing the Rainbow.

Only SAE provides a complete packaging service in your choice of three systems: Plug-in, Planer, and Dipstik™.

We manufacture all the hardware for card cage plug-in systems, including PC cards, card files, card guides, connectors, sockets, enclosures, mounting and bussing.

Rather go planer with logic panels? We have everything: panels, mounting hardware, sockets, peripheral items.

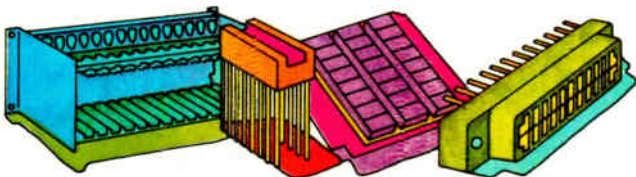

Or try our unique Dipstik. It gives twice the IC density as PC methods, and eliminates a lot of hardware.

Whichever method you select, we can supply the components for you to assemble yourself. Or, we'll pick the parts, do the assembly, and let you do the wiring. Or, we'll provide everything: components, assembly, and Wire-Wrap®. So, call us in . . . and you can go out fishing!

**Free bumper sticker for your desk.** Tell the world you're a fisherman. If not, tell us what you are. Maybe we have a bumper sticker to match. Anyway, we'll send a new brochure showing how we can relieve you of systems packaging snarls. Write us:



**I'd rather be fishing**

## Stanford Applied Engineering Inc.

340 Martin Avenue, Santa Clara, California 95050 Telephone (408) 243-9200 — (714) 540-9256 — TWX 910-338-0132

Electronics/June 5, 1972

Circle 167 on reader service card 167

# When your machine has more to say...



## IEE Readouts provide the vocabulary.

When your machine has more to say, IEE rear projection readouts let it speak out with an eloquence that make other display systems seem taciturn.

For instance, just one IEE rear projection readout will improve the vocabulary of your machine with up to 64 new phrases expressed in any combination of alphanumeric, in any language, accompanied by the symbols of any discipline, all displayed in a variety of colors and in the type styles that go best with your panel decor.

No gas discharge tube, or LED or what have you, can make that statement.

### IEE units communicate — loud and clear!

Our big Series 80 rear projection readout lets your machine shout in huge 3 $\frac{3}{8}$ -inch characters. Or we can say things discretely

with our fit-anywhere  $\frac{1}{2}$  x  $\frac{3}{4}$ -inch Series 345 model.

All with single-plane viewing, variable brilliance, and the capability to change vocabularies right in the field. To assist, we have a powerful new low-cost hybrid driver/decoder for any of the readouts. Plus a host of other driver/decoders... all, competitively priced... purchased separately or customer mounted.

Rear projection readouts give you an order of display versatility a world apart from other techniques, and IEE builds more of them than anybody. Send today for our Short-Form Catalog on units that are long on talk. Industrial Electronic Engineers, Inc., 7740 Lemona Ave., Van Nuys, California 91405. Telephone: (213) 787-0311 • TWX 910-495-1707

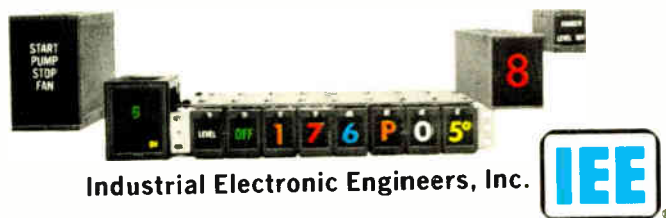

Industrial Electronic Engineers, Inc.



## New literature

**Telemetry modules.** Solid State Electronics Corp., 15321 Rayen St., Sepulveda Calif. 91343. A 52-page catalog describes a line of fm-fm telemetry modules, including voltage-controlled oscillators, dc amplifiers, dc signal isolators, frequency-to-dc converters, and tone oscillators. Circle 421 on reader service card.

**Chip resistors.** Semi-Films Technology Corp., Box 188, West Hurley, N.Y. 12491. A four-page brochure describes a line of thin-film tantalum nitride chip resistors for hybrid integrated-circuit applications. The bulletin contains technical specs for standard units, and discusses capabilities for custom designing. [422]

**Transistor chips.** Teledyne Crystals, 147 Sherman St., Cambridge, Mass. 02140. A catalog lists a line of semiconductor chips used in hybrid circuits. They include FETs, pnp and npn switching transistors, integrated choppers, and monolithic interface circuits. [423]

**Oscillographs.** An eight-page bulletin from the Scientific Measuring Instruments Div., Siemens Corp., 186 Wood Ave. South, Iselin, N.J. 08830, describes the four models of Oscillomink ink-jet oscillographs. The brochure illustrates the various features of the line, besides giving technical data on each of the four instruments and their plug-in amplifiers. [424]

**Angle-to-digital converters.** A series of angle-to-digital converters and plug-in modules is described in an eight-page brochure from Singer Instrumentation, Los Angeles Operation, 3211 S. La Cienega Blvd., Los Angeles, Calif. 90016. [425]

**Computer interface.** Systems Engineering Laboratories, 6901 W. Sunrise Blvd., Fort Lauderdale, Fla. 33313, has published a 30-page booklet on MACS, a universal computer-to-process interface, aimed at the scientific and industrial computer user. Data sheets are also included. [426]



# 24,940 KEY PEOPLE WHO DON'T READ THESE,



# READ THIS.

That's a lot of people to be putting all their faith in just one magazine. Especially when there are so many others to choose from.

Yet all these important customers would rather go to The Source than read any of the next five electronics magazines.

That's a lot of readers. And that's a lot of trust.

We get so much unduplicated readership simply because we can't be duplicated.

So once they've read Electronics, they've read it all. And if you're advertising everywhere else, nearly 25,000 prospective buyers will never see it.

These readers are so loyal, they'd rather

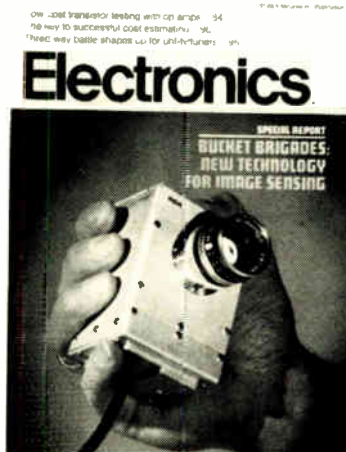

pay from \$8 to \$25 to read our magazine than get all the others free. And their loyalty is just part of our story.

58,000 (67%) Electronics subscribers are managers.  
70,000 (81%) have engineering job functions.  
74,000 (85%) decide who their companies will buy from. And a third of them decide on purchases of over \$100,000 a year.

These crucial buying influences believe in Electronics. And they'll believe in you when you advertise in Electronics.

With our kind of readership, you can't afford not to go to The Source.

**Electronics** *MS Grow*  
**THE SOURCE.**



# PDP-8. PDP-11. For OEM's

A few months ago, we came out with new low cost versions of our PDP-8 and PDP-11 families for the OEM.

With prices as low as \$2436. In quantities of 50.

We made sure they'd have the features, architecture and compatibility that make PDP-11 and PDP-8 the most popular, most imitated minis ever.

We must have hit on the right combination. We've been mixing it up with some of the toughest OEM's around. And coming away with their business.

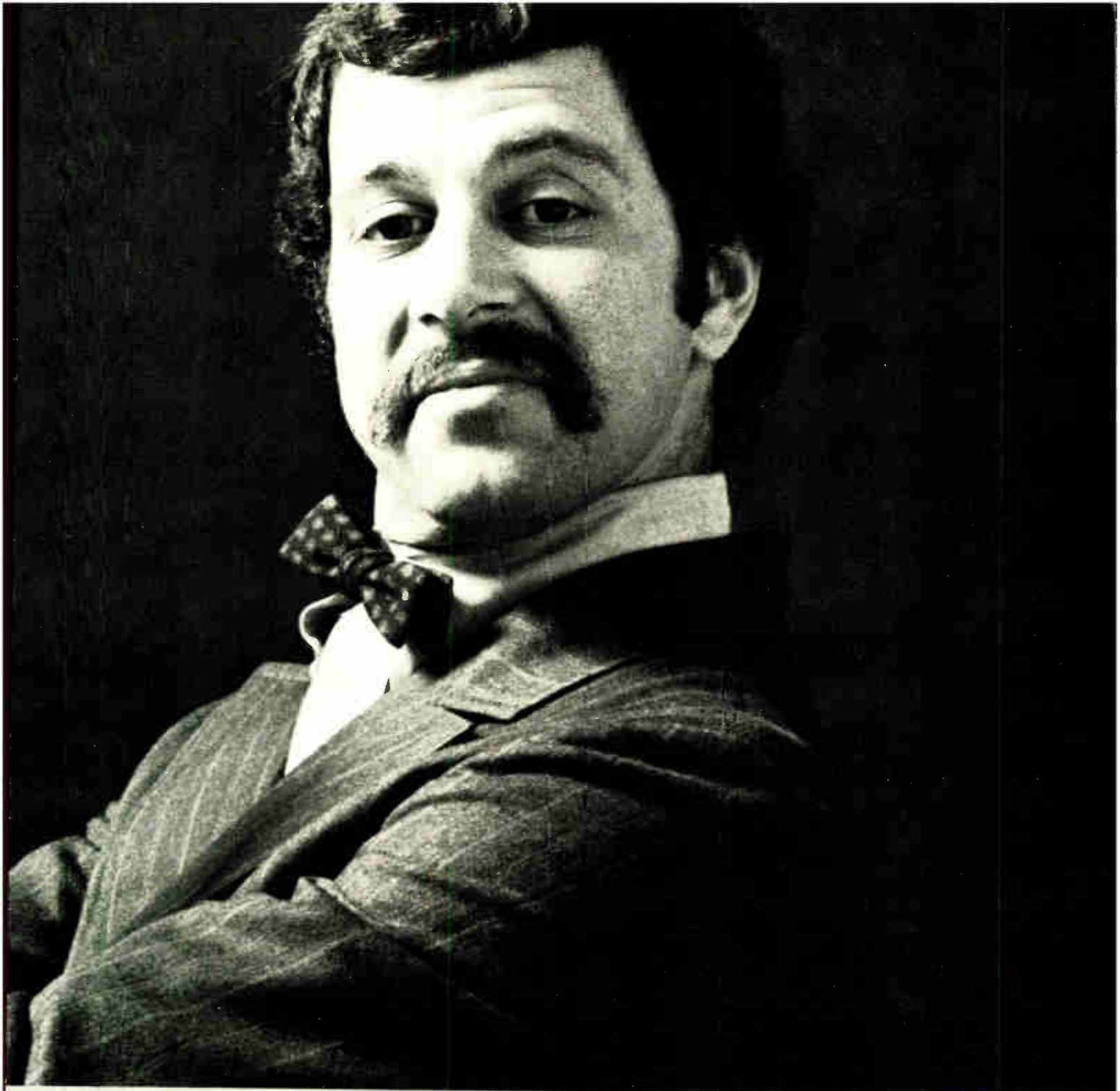

# who hate to spend money.

We're after your business, too.  
Because now we have the right  
computers. At the right prices.  
From the right company.  
Come and get 'em.

Digital Equipment Corporation,  
146 Main Street, Maynard, Mass.  
01754. (617) 897-5111.

**digital**

# Who shot Santa Claus?

**S**anta Claus is dead! He died last year, when price and wage controls were imposed, the dollar was devalued and the whole trend of American economic policy and thought was abruptly reversed.

He died when the dreams died. The dream of something for nothing. The illusion that everything—prices, wages, profits, benefits, everything—could go forever up, without ever coming down. The fantasy of an endless and effortless expansion of output, with no increase in input. The vision of permanent, ordained U.S. domination of world markets.

What happened? Who killed Santa Claus?

A lot of things happened, all at once. But what principally happened was that the most productive economy in the history of the world became steadily less productive, and less competitive.

U.S. productivity in terms of total output declined. For over two decades, the gross national product increased at an average rate of about 4% per year. For 1970 and 1971, the rate dropped by almost three fourths—to 1.0%. The loss in output for the two years was \$60 billion.

Productivity in terms of output per man-hour declined.

From an average annual increase of 3.1%, 1950-1968, to an average 1.7%, 1968-1971.

Productivity in terms of cost efficiency declined. While output per man-hour was increas-

ing less than 2% a year, compensation per man-hour was increasing 7.4% a year.

Meanwhile, other changes were occurring.

The structure of the U.S. economy was changing. Services accounted for 30% of the GNP in 1950—37% in 1960—42% in 1970.

Demands on the shrinking producing base were increasing. The military burden, the burden of public needs, the tax burden, all grew heavier.

Competition in the world marketplace was increasing. Our major competitors became more productive.

West Germany continued to increase GNP and output per man-hour both at an average annual rate of 6%—and to increase exports 7% a year.

Japan increased GNP by an amazing 9% a year—output per man-hour 12%—exports 15%.

The U.S., in contrast, increased exports a bare 2% in 1971, and for the first time in this century imported more than it exported, by about \$2 billion.

What, or who, caused the decline in U.S. productivity?

What, and who, did not?

The measurements of output, of output per man-hour, or of cost efficiency do not measure

the effectiveness of labor alone, or of management alone, or of government alone. They measure and reflect on the efficiency of labor *and* of management *and* of government—and of the system that links all three in a functioning whole.

The decline in productivity is a result of the attitudes and actions of labor, and of management, and of government, and of the American people. It is the final result of a national attitude, and of the sum total of 200 million actions and inactions.

**B**ecause the decline is, above all, the result of waste. Waste of time, waste of money, waste of materials, waste of effort, and waste of spirit. And the truth is, this is an extravagantly, almost proudly, wasteful society.

So who is to blame? Nobody. And everybody. In the immortal words of Pogo: "We have met the enemy, and he is us." Who shot Santa Claus? We did.

And it doesn't matter. What matters is that, for whatever reason, we are all in the same boat. Neither labor nor management nor government can prosper, and most assuredly the American public cannot prosper in an unproductive and noncompetitive America.

It is time to stop fixing the blame and start fixing the boat. And the place to start is with the waste.

One way or another, we have got to reduce the waste of time—on or off the job. Due to the attitudes or actions of labor, or of management, or of government.

The waste of money—squandered, misspent or lost down a multitude of ratholes by careless labor, careless management and magnificently careless government.

The waste of materials—due to heedless consumption and needless neglect—by labor, management, government and the public.

The waste of effort—in meaningless, misdirected, mismanaged work. The fault of management, and of labor, and of government.

And the waste of spirit, energy and goodwill—in endless confrontation between labor, management, government and the myriad other groupings in a contentious society.

**Q**uite an order! To make America productive again, all we have to do is reform the attitudes and redirect the actions of a nation.

But all great endeavors begin with a single idea.

And in this case the idea is simple, stark and direct—

—we can no longer *afford* the waste. The richest nation on earth is no longer so rich or so abundantly wealthy as to be able to ignore reality.

Santa Claus is dead!

We had best learn to live without him. Starting now.

---

*We at McGraw-Hill believe in the interdependence of American society. We believe that, particularly among the major groups—business, professions, labor and government—there is too little recognition of our mutual dependence, and of our respective contributions. And we believe that it is the responsibility of the media to improve this recognition.*

*This is the second of a series of editorial messages on a variety of significant subjects that we hope will contribute to a broader understanding.*

*Permission is freely granted to individuals and organizations to reprint or republish these messages.*

*John R. Emery*  
John R. Emery, President  
McGraw-Hill Publications Co.



# Electronics advertisers

June 5, 1972

■ <b>Abbott Transistor Labs., Inc.</b> Technical Adv. Agency	6	<b>Electronic Arrays, Inc.</b> Regis McKenna, Inc.	137	• <b>Racal Thermionic Limited</b> Nicklin Advertising Ltd.	23E
<b>ACDC Electronics, Inc.</b> Rose Associates Advertising & Public Relations	110	■ <b>Electronic Associates, Inc.</b> Gerald Clarke, Inc.	52	• <b>RCA Ltd.</b> Marsteller, Ltd.	68-69
<b>The Adams &amp; Westlake Company - Relay Division</b> Adwest Advertising	154	<b>Electronic Memories, Inc.</b> Gumpertz, Bentley & Dolan Adv.	37-39	<b>RCA (Mobile Communications Systems)</b> J. Walter Thompson Co.	PB 5
<b>Advanced Micro Devices</b> Keye/Donna/Pearlstein	10-11	• <b>English Electric Valve Co.-Ltd.</b> C. R. Casson Ltd.	8E-9E	■ <b>RCL Electronics, Inc.</b> Morvay Advertising Agency	14
<b>Allen-Bradley Company</b> Hoffman-York, Inc.	82	• <b>Fairchild GMBH</b> Evan Steadman Services Ltd.	21E	• <b>Schneider R. T.</b> Intermedia	15E
<b>American Electronic Laboratories, Inc.</b> Ernest William Greenfield, Inc.	142	<b>Fairchild MOD</b> Allen Snyder Advertising	139	<b>Schweber Electronics</b> Herman & Associates, Inc.	176A-176B
<b>American Optical Corporation, Scientific Instrument Div.</b> Fuller & Smith & Ross, Inc.	125	■ <b>Fluke Manufacturing Co., John</b> Bonfield Associates	15	• <b>Selenia</b> Tilligraf	62
<b>American Telephone and Telegraph Co.</b> N. W. Ayer & Sons	PB 11	<b>Fujitsu Limited</b> Asian Advertisers, Inc.	128	• <b>Sescosem</b> Perez Publicite	1E
<b>AMP, Incorporated</b> Aitkin-Kynett Co., Inc.	32	<b>Gardner-Denver Company</b> Buchen Adv., Inc.	118	<b>Sheraton-Boston Hotel</b> Needham & Grohman, Inc.	PB 7
■ <b>Amphenol Cadre Division, Bunker Ramo Corp.</b> Marsteller, Inc.	34	■ <b>General Electric Company, Tube Products Department</b> Robert S. Cragin, Inc.	132	<b>Signetics Corp., Sub. of Corning Glass Works</b> Hall Butler Blatherwick, Inc.	27
<b>Analog Devices, Inc.</b> Schneider Parker Guy, Inc.	117, 143	<b>General Magnetics</b> McCarthy/Scelba/DeBiasi Adv. Agcy., Inc	2nd cover	<b>Simpson Electric Co.</b> Amerad Advertising Services, Inc.	136
<b>Analogic Corporation</b> Grover and Erickson, Inc.	149	<b>General Radio Co.</b> Grad Associates	147	<b>Singer Company, Kearfott Div.</b> Gaynor & Ducas, Inc.	155
■ <b>Augat</b> Creamer, Trowbridge, Case & Basford, Inc.	163	<b>Georgia Department of Industry &amp; Trade</b> Cargill, Wilson & Acree, Inc. Adv.	162	<b>Snelling &amp; Snelling</b> Evo & Mattern Adv. & PR	PB 2
‡ <b>Automatic Electric Co., Sub. of General Telephone &amp; Electronics Corp.</b> Marsteller, Inc.	68-69	■ <b>Grayhill, Inc.</b> Carr Liggett Advertising, Inc.	176	<b>Solitron Devices, Inc.</b> Sol Advertising Agency	49
■ <b>AVX/Aerovox Corporation</b> Lescarboura Advertising, Inc.	53	<b>Harris Semiconductor</b> Tucker Wayne & Company	150	<b>Sony Superscope</b> Audio Advertising Assoc.	PB 13
<b>Bausch &amp; Lomb, Inc.</b> Wolff Assoc., Inc.	144	■ <b>Hewlett-Packard, Electronics Products Group</b> Corporate Marketing Communications	17-26	‡ <b>Standard Microsystems Corporation</b> Robert A. Schloffeldt Advertising	60-61
‡ <b>Beckman Instruments, Inc., Hellpot Division</b> N. W. Ayer/Jorgensen/MacDonald, Inc.	156	<b>Hickok Electrical Instrument Company</b> Key Marketing Associates	126	<b>Stanford Applied Engineering</b> Rose Associates Advertising & Public Relations	167
<b>Bell &amp; Howell - Electronics &amp; Instruments Group</b> Coordinated Communications, Inc.	47	■ <b>Hipotronics, Inc.</b> Kenmarc Advertising, Inc.	152	<b>Sunoco Products Co.</b> Cargill, Wilson & Acree	PB12
■ <b>Bendix Corporation, Electrical Components Div.</b> D'Arcy-MacManus-Intermarco, Inc.	1	<b>Hughes Aircraft Company</b> Foote, Cone & Belding	50-51	■ <b>Syatron Donner Concord Instruments</b> Bonfield Associates	59
<b>Berkeley Nuclonics</b> Bonfield Associates	16	<b>Hutson Industries</b> Warren-Guid	163	<b>T-Bar, Inc.</b> The Robert A. Paul Advertising Agency, Inc.	8
<b>Bourns, Inc.</b> Marlborough Assoc., Inc.	40	■ <b>Indium Corporation of America</b> Evans Garber Ligas & Paige	148	■ <b>Tektronix, Inc.</b> Dawson, Inc.	45
<b>Brand-Rex</b> Creamer, Trowbridge, Case & Basford, Inc.	31	<b>Industrial Electronic Engineers, Inc.</b> Van Der Boom, McCarron Advertising	168	<b>Teledyne Crystalonics</b> Gerard J. Gormley Advertising, Inc.	72
<b>Burndy Components</b> Ketchum, MacLeod & Grove, Inc.	133	<b>Jewell Electrical Instruments, Inc.</b> Amerad Advertising Services, Inc.	161	■ <b>Teledyne Philbrick</b> Ingalls Associates, Inc. Advertising	99
<b>California Computer Products</b> Dailey & Associates Advertising	127	■ <b>Johnson Company, E. F.</b> Martin Williams Advertising	33	<b>Teledyne Post</b> Sperry-Boom, Inc.	PB 7
■ <b>Cambridge Thermionic Corporation</b> Chirurg & Cairns, Inc.	176	<b>Keithley Instruments, Inc.</b> Bayless-Kerr Company	158	• <b>Teradyne U. K. Ltd.</b> John Collings & Partners Ltd.	67
<b>Champion Spark Plug Co.</b> J. Walter Thompson Co.	PB 3	■ <b>Keppo, Inc.</b> Weiss Advertising	5	■ <b>Texas Instruments Incorporated, Components Group</b> Albert Frank Guenther Law, Inc	28-29
‡ <b>Cherry Electrical Products Corp.</b> Kolb/Tookey and Assoc., Inc.	62	■ <b>Lambda Electronics Corporation</b> Michel-Cather, Inc.	3rd cover	• <b>Thomson CSF</b> Bazaine Publicite	5E
<b>Chester Cable Operations, Cities Service Company</b> Lewis Advertising Agency	123-124	<b>Ledex, Inc.</b> Advertising/Mervar	130	<b>Torin Corporation</b> Viscom International, Inc.	165
• <b>C. I. I.</b> Interplans-Publi Action	16E	<b>Ledex, Inc., Branco Controls Division</b> Advertising/Mervar	164	<b>Travelodge</b> Daily & Assoc. Advertising	PB 4
‡ <b>Cincinnati Milacron, Process Controls Division</b> David K. Burnap Advertising	140	<b>LFE Corporation, Process Control Division</b> Culver Advertising, Inc.	79	■ <b>TRW Electronics, IRC Boone Division</b> Odiome Industrial Advertising, Inc.	7
■ <b>Clalrex Corporation</b> Michel-Cather, Inc.	4th cover	• <b>LTT</b> Publibel	17E	■ <b>TRW Electronic Components, UTC Transformers</b> Odiome Industrial Advertising, Inc.	159
■ <b>Colorado Video, Inc.</b> O'Connell-Colburn, Inc. Creative Business Communications	160	<b>Lyon Metal Products, Inc.</b> Reincke, Meyer & Finn	PB 15	<b>UniCom Systems, Inc.</b> Stanbro, Smallwood & Drummond	PB 16
<b>Combustion Engineering</b> Coordinated Communications	PB 9	‡ <b>3M Electro Products Division</b> Batten, Barton, Durstine & Osborn, Inc.	81	■ <b>Uniltrade Corporation</b> Impact Advertising	54-55
<b>The Connecticut Hard Rubber Company</b> Cohar Associates	175	<b>McGraw-Hill Magazines</b> Hall Advertising Ltd.	172-173	• <b>Victoreen Instrument Division</b> Dix & Eaton, Inc.	18E
<b>Controls Research Corp.</b> Ron Jenner & Company	164	• <b>Microwave &amp; Electronic Systems Ltd.</b> Hall Advertising Ltd.	60-61	• <b>Vidar Corporation, Instrumentation Div.</b> Lincoln Associates	19E
<b>Dana Laboratories</b> Rose Associates Advertising & Public Relations	2	• <b>Miller Stephenson Chemical Co., Inc.</b> A. B. W. Toft and Co.	13E	• <b>V/O Techmashexport</b> V/O Vneshtorgreklama	14E
<b>Data Products</b> Farrell-Bergmann Advertising	145	<b>Monroe, The Calculator Company, Division of Litton Industries</b> Baker & Hartel, Inc.	131	• <b>Wandel Und Goltermann</b> Werbeagentur	20E
<b>Delco Electronics Division, General Motors Corp</b> Campbell-Ewald Company	12-13	<b>Motorola Semiconductor Products, Inc.</b> E. B. Lane & Associates, Inc.	56	■ <b>Wang Laboratories, Inc.</b> W. L. I. Associates	PB 10
■ <b>Digital Equipment Corporation</b> Creamer, Trowbridge, Case & Basford, Inc.	70-71, 170-171	‡ <b>Nicotel Instruments Corp.</b> Hagen Advertising, Inc.	64	<b>Wavetek</b> Chapman Michetti Advertising	134
• <b>The Digitran Company</b> Jansson Advertising, Inc.	156	• <b>Nippon Kogaku K. K.</b> K & L Advertising Agency	140	<b>Westinghouse Semiconductor</b> Ketchum, MacLeod & Grove, Inc.	108-109
■ <b>Eastman Chemical Products, Inc., Industrial Chemicals</b> J. Walter Thompson Company	162	• <b>D. Olivetti &amp; C. Spa</b> Studio ECO	10E	<b>Xentec, Inc.</b> Grafico	176
<b>Eastman Kodak Company, Business Systems Markets Div.</b> J. Walter Thompson Co.	9	• <b>Oscilloquartz SA, Neuchatel</b> M. R. Holer Werbeagentur BSR/EAAA Bern	7E		
■ <b>EL Instruments, Inc.</b> The Robert A. Paul Advertising Agency, Inc.	160	<b>Panasonic Industrial Div.</b> Dentsu Corporation of America	152		
‡ <b>Elco Corporation</b> Mori Barish Associates, Inc.	67	<b>Pennsylvania Grade Crude Oil Association</b> Meldrum & Fewsmith, Inc.	PB 11		
• <b>Electro Scientific Industries</b> Com/Mark Communications Group	81	<b>Philips Elcoma</b> Tag-Intermarco delaMar	153		
		• <b>Philips Gad Elcoma</b> Tag-Intermarco delaMar	2E, 12E, 24E		
		• <b>Philips N. V. PH/T &amp; M Division</b> Marsteller International S. A.	64		
		<b>Pitney Bowes Multi Products</b> deGarmo, Inc.	PB 6		
		<b>Polaroid Corp.</b> Doyle Dane Bernbach, Inc.	129		
		<b>Preston Scientific, Inc.</b> Donald S. Smith Associates	30		

## Classified & Employment Advertising

F. J. Eberle, Manager 212-971-2557

<b>EQUIPMENT (used or Surplus New) For Sale</b>	
<b>Data/Instrumentation Associates</b> .....	166
<b>P. Fishman Company</b> .....	166
<b>Jensen Tools &amp; Alloys</b> .....	166
<b>Radiation Devices Company</b> .....	166
<b>Radio Research Instrument Company</b> .....	166

■ For more information on complete product line see advertisement in the latest Electronics Buyer's Guide  
 • Advertisers in Electronics International  
 ‡ Advertisers in Electronics domestic edition



Photo: O'Neill

Miss Raquel Welch

Learn the seven warning signals of cancer. You'll be in good company.

1. Unusual bleeding or discharge.
2. A lump or thickening in the breast or elsewhere.
3. A sore that does not heal.
4. Change in bowel or bladder habits.
5. Hoarseness or cough.
6. Indigestion or difficulty in swallowing.
7. Change in size or color of a wart or mole.

If a signal lasts longer than two weeks, see your doctor without delay.

And be sure to have a health checkup once a year, no matter how well you may feel.

**Fight Cancer with a checkup and a check**

American Cancer Society



**Advertising Sales Staff**

**Pierre J. Braudé** [212] 971-3485  
Advertising Sales Manager

**Atlanta, Ga. 30309:** Joseph Lane  
100 Colony Square, 1175 Peachtree St., N.E.  
[404] 892-2868

**Boston, Mass. 02116:** James R. Pierce  
607 Boylston St. [617] 262-1160

**Chicago, Ill. 60611:** Robert W. Bartlett  
Kenneth E. Nicklas, 645 North Michigan  
Avenue, [312] MO 4-5800

**Cleveland, Ohio 44113:** William J. Boyle  
[716] 586-5040

**Dallas, Texas 75201:** Richard P. Poole  
1340 Republic National Bank Building  
[214] RI 7-9721

**Denver, Colo. 80202:** Harry B. Doyle, Jr.  
Tower Bldg., 1700 Broadway  
[303] 266-3863

**Detroit, Michigan 48226:** Robert W. Bartlett  
2600 Penobscot Building  
[313] 962-1793

**Houston, Texas 77002:** Richard P. Poole  
2270 Humble Bldg [713] CA 4-8381

**Los Angeles, Calif. 90010:** Robert J. Rielly  
Bradley K. Jones, 3200 Wilshire Blvd., South Tower  
[213] 487-1160

**New York, N.Y. 10020**  
1221 Avenue of the Americas  
Warren H. Gardner [212] 997-3617  
Michael J. Stoller [212] 997-3616

**Philadelphia, Pa. 19103:** Warren H. Gardner  
6 Penn Center Plaza.  
[212] 971-3617

**Pittsburgh, Pa. 15222:** Warren H. Gardner  
4 Gateway Center, [212-971-3617

**Rochester, N.Y. 14534:** William J. Boyle  
9 Greylock Ridge, Pittsford, N.Y.  
[716] 586-5040

**San Francisco, Calif. 94111:** Don Farris  
Robert J. Rielly, 425 Battery Street,  
[415] 362-4600

**Paris:** Alain Offergeld  
17 Rue-Georges Bizet, 75 Paris 16, France  
Tel: 720-73-01

**Geneva:** Alain Offergeld  
1 rue du Temple, Geneva, Switzerland  
Tel: 32-35-63

**United Kingdom:** Keith Mantle  
Tel 01-493-1451, 34 Dover Street, London W1

**Milan:** Robert Saidel  
1 via Baracchini Phone 86-90-656

**Brussels:** Alain Offergeld  
23 Chaussee de Wavre  
Brussels 1040, Belgium  
Tel 13-65-03

**Stockholm:** Brian Bowes  
Office 17, Kontor-Center AB, Hagagarten 29,  
113 47 Stockholm Tel: 24 72 00

**Frankfurt/Main:** Fritz Krusebecker  
Liebigstrasse 27c  
Phone 72 01 81

**Tokyo:** Masaru Wakeshima, McGraw-Hill  
Publications Overseas Corporation,  
Kasumigaseki Building 2-5, 3-chome,  
Kasumigaseki, Chiyoda-Ku, Tokyo, Japan  
[581] 9811

**Osaka:** Ryji Kobayashi, McGraw-Hill  
Publications Overseas Corporation, Kondo  
Bldg., 163, Umegae-cho Kita-ku [362] 8771

**Australasia:** Warren E. Ball, IPO Box 5106,  
Tokyo, Japan

**Business Department**

**Stephen R. Weiss, Manager**  
[212] 997-2044

**Thomas M. Egan,**  
Production Manager [212] 997-3140

**Carol Gallagher**  
Assistant Production Manager [212] 997-2045

**Dorothy Carter,** Contracts and Billings  
[212] 997-2908

**Frances Vallone,** Reader Service Manager  
[212] 997-6057

**Electronics Buyers' Guide**

**George F. Werner,** Associate Publisher  
[212] 997-3139

**Regina Hera,** Directory Manager  
[212] 997-2544

# TEMP-R-TAPE: GREAT ELECTRICAL PROPERTIES PLUS MOST ANYTHING ELSE YOU MIGHT WANT IN A TAPE.

Like high tensile or tear strength; excellent abrasion, thermal, and chemical resistance; exceptional dimensional stability; excellent conformability; and a low-friction, easy-release surface. Because Temp-R-Tape® is a complete tape "family" available in a variety of materials like polyester, polyester/rope paper laminate, Teflon\*, Kapton\*, and fiberglass. Supplied with thermosetting, silicone, or acrylic pressure-sensitive adhesive.

Find your CHR distributor in the Yellow Pages under "Tapes, Industrial" or in industrial directories. Or write for details and sample. The Connecticut Hard Rubber Company, New Haven, Connecticut 06509.

\*T.M. of DuPont

a HITCO company

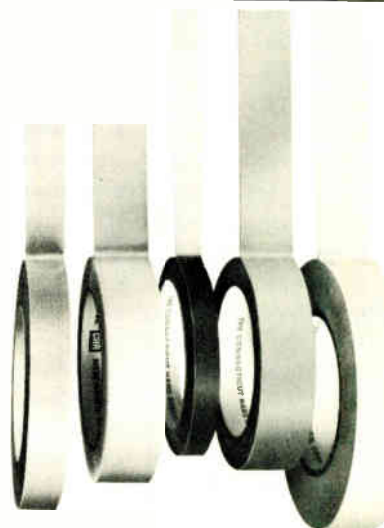

## A CAMBION® Double "QQ" Product Line

Not every design engineer will opt for putting his IC's in separate sockets, but an increasing number are doing it every day.

And for three good reasons.

First, serviceability. IC's are easier to service and replace.

Second, protection. A DIP should not be subjected to elevated temperatures of pin soldering.

Third, reliability. Wire-wrapping requires true position and precisely formed contacts for hand or automatic wiring.

You know the reasons for socketing. Now, let's tell you why the CAMBION Double "QQ" line of sockets will serve you better.

First, quality. In both design and manufacture, CAMBION controls the body design and materials, contact plating, contact retention, profile and durability.

Second, quantity. In body design and variety, CAMBION has 8, 14, 16, 18, 22, 24, 28, 36 and 40 pin sockets, either Wire-Wrap\* or solder.

These add up to the CAMBION Double "QQ" approach: traditional CAMBION quality in quantity. With CAMBION Sockets, the quality stands up as the quantity goes on.

To be plugged in, get the full CAMBION Socket story by asking for our Callout and latest Catalog #99. They're both free. Cambridge Thermionic Corporation, 445 Concord Avenue, Cambridge, Massachusetts 02138. Phone: (617) 491-5400. In Los Angeles, 8703 La Tijera Blvd. 90045. Phone: (213) 776-0472.

## Three basic reasons for socketing IC's



176 Circle 176 on reader service card

## SPECIAL OFFER

only

**\$19<sup>95</sup>**



5 Vdc @ 3 Amp  
Quality Power Supply  
1 to 100 Units

**compare:** .1% Reg .1% Ripple & Noise

- Input: 120/240 VAC ±10% 60Hz
- Remote Sensing Capabilities
- Foldback Current Limiting
- Overvoltage Protection\*
- 50 Hz Input\*\*
- Mechanical Size 4" x 4½" x 2¾"
- OEM Contracts Available
- Off-the-Shelf Units Available
- Electrostatically Shielded Transformer

\*Overvoltage Crowbar Option \$6.00 \*\*50 Hz Input Option \$2.00  
Offer good until Aug. 1, 1972 Regular Price \$24.95

**XENTEK INC.**

Call (213) 944-4417  
10912 South Painter Avenue  
Santa Fe Springs, California 90670

Circle 201 on reader service card

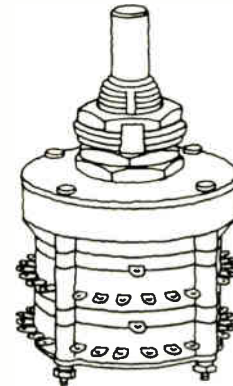

## Mini rotary switches 16-20-24 pos., 1-12 Decks

Unprecedented size/capacity ratios with Grayhill's Series 53, 57, 59 rotary switches... up to 24 positions per pole in diameters from only 1.125" to 1.281"... behind panel depths range from a scant .916" (1 deck) to 4.829" (12 decks).

Enclosed. Molded-in terminals. Fixed stop or continuous rotation. Raised contacts to prevent arcing across insulation.

For our latest Engineering Catalog write or phone:  
Grayhill, Inc., 523 Hillgrove Ave.,  
La Grange, Illinois 60525.  
(312) 354-1040.

**Grayhill**  
INC.

Circle 202 on reader service card





Betsy Ray

JUNE 1972

REAL ESTATE

The outlook for people on the move

INVESTMENT

Over-the-counter market grows up

EDUCATION

A look at three-year college programs

TRAVEL

Vacationing on rented wheels

HEALTHY, WEALTHY AND WISE

REAL ESTATE

**A bouncier market in housing awaits people on the move**

The corporate nomad is on the move again. After a lull for two lean years, American business has resumed its practice of moving people and offices around the country. Also, managers and technicians displaced by recession cutbacks are going where the jobs are. So the game of musical chairs has put new zip in the housing market.

Anyone moving this year is finding a scene markedly different from the one that might have confronted him three years ago. Then, mortgage money was hard to find, expensive—over 9% in some areas—and available only to people with large down payments. Good

houses were scarce, and new construction had slowed to a crawl.

Today, home-building activity is setting records. And though sales prices are on the up side, mortgage money is plentiful. Rates are generally reasonable—7% and lower in some spots—and terms are more liberal. "We're getting back to the days of the 90% mortgage," observes Shirley deLima of Homerica, Inc., one of the largest of the national home-finding services transferees can turn to. "For three years, you were lucky to get 75%." Even 95% conventional mortgages are now available in some areas, although these usually involve a "piggyback" type of mortgage provided by such firms as Home Capital Funds, Inc., or Mortgage Guarantee Insurance Corp. (If your cash is short, those are names to remember.)

This year's transferees also face a wide diversity of housing markets in dif-

By RESA W. KING

ferent parts of the country that can mean a marked difference in lifestyle, depending on where they are going. Atlanta, Denver, Chicago, Washington and the

New York City suburbs are—still—seller's markets. Listings are few and prices high. In Houston and Southern California, however, the home buyer can now get a lot more house for his money.

In Atlanta, realtors report that, despite abundant mortgage money, rates are headed upward to 8% this summer. In San Francisco's select suburbs good listings don't last long, but mortgages may be had for 7% to 7¼%, largely due to an oversupply of cash among California savings and loan associations. Mortgage money is available at comparable rates in many northeastern suburbs, but listings in the popular-priced ranges are scarce, and prices generally have begun to firm up.

The rental and condominium markets in Houston, Denver and Southern California—despite heavy use of recreational amenities as attractions—are softening; that's due to building close to the saturation point. Condominiums in the northeast, however, are strong (from the seller's point of view), although they offer fewer frills, and maintenance charges are higher.

If easy-maintenance condominium living appeals to you, be sure to check carefully into the management and the

# At least there's one problem you can stop worrying about.

## Finding the right employees.

Through Snelling and Snelling.

All you need is a telephone and the acumen to call us. For we may have immediately available the people you need. If not, we'll find them.

Quickly. Efficiently.

And with measurable savings to you in time, aggravation and in another vital area—money.

Look us up in the White Pages. You have nothing to lose except problems.

Make that telephone call. And watch Snelling and Snelling magic.



# Snelling AND Snelling

The World's Largest Employment Service  
with 540 offices coast to coast

availability of financing. Some lenders are still skittish about condominiums, unless they have been in on the development from the start. Says a Homeric officer, "Some banks that will lend 90% on a single-family home won't go above 75% on a condominium."

There is a new and more generous look this year, too, to what many employers are willing to do for their transplants. "They're becoming more realistic about picking up direct expenses," says Nancy Balthus, executive secretary of the Employee Relocation Real Estate Advisory Council (ERREAC) in Chicago.

Take closing costs. An ERREAC survey of 273 companies reveals that 33 recently began reimbursing the closing costs on both purchases and sales. This can be a surprising chunk of money. Charges like \$500 to \$750 are typical, and they can easily go higher.

Increasingly companies are picking up the entire tab for what the relocation specialists call "making the employee whole" in his new location. These include costs of selling a house (or unloading an apartment) and buying a new one. At least part of this reimbursement is taxable, so Standard Oil of California, among others, pays for increases in income taxes resulting from the move.

One major midwestern oil company picks up any continuing expenses on an unsold home for up to six months—in addition to guaranteeing a loan for the down payment on a new one. And it recently added automatic payment of half a month's salary for miscellaneous expenses. Shell Oil employees moving to Houston from New York got two-thirds of a month's salary as a resettlement allowance. American Can Co. paid relocation bonuses of from \$560 to \$2,600 when it shifted from New York to Greenwich, Conn., although the move meant no change of residence for many. The tab came to \$3-million-plus.

One bit of advice which companies have gleaned from experience is well worth taking, even if you are picking up the tab yourself. That is: Hire an independent building inspector to assess the structural and mechanical features of a new home. They can be particularly helpful during construction in evaluating the builder's specifications and materials. They are easy to find—usually in the Yellow Pages under "Building inspection services"—and fees range from \$40 to \$100 for homes up to \$80,000.

A note of caution, though: Be sure the person who inspects your home is a professional engineer, licensed by the state. Too many of the services hire former construction workers, who are not really professionally equipped to detect serious potential faults.

RESA W. KING, former Contributing Editor specializing on real estate subjects for Business Week, has recently been undergoing the "relocation" process—to a new home in Connecticut.



## There's been a change in Power City.

Noyes Rogers, lawyer and recent candidate for the Nebraska state legislature, grew up in Columbus.

"This is farm country ... great farm country. People like to know just what they're getting for their money ...

whether it's taxes, or the price of eggs.

"Now I've always felt that Fords are a good car for the money. And my '71 Ford LTD is no exception.

"I've now had Champions in the car for a good many miles...

and they're fine. So far. You boys can quote me on that."



Toledo, Oh. © 4360

**6 million Ford owners have switched to Champion Spark Plugs.**

PERSONAL BUSINESS like the rest of this magazine is written to help you. It is devoted to the personal interests you share with other successful people, and is intended to guide you in the management of your leisure time and money.

## want more information on these advertisers?

Check the advertisers' names, fill out coupon below and return.

- |   |   |
|---|---|
| <input type="checkbox"/> American Telephone & Telegraph     | <input type="checkbox"/> Sheraton Boston Hotel          |
| <input type="checkbox"/> Combustion Engineering, Inc.       | <input type="checkbox"/> Sonoco Products Company        |
| <input type="checkbox"/> Lyon Metal Products, Inc.          | <input type="checkbox"/> Sony Superscope                |
| <input type="checkbox"/> Pennsylvania Grade Crude Oil Assn. | <input type="checkbox"/> Teledyne Post                  |
| <input type="checkbox"/> Pitney Bowes                       | <input type="checkbox"/> Travelodge International, Inc. |
| <input type="checkbox"/> RCA Mobile Communications Systems  | <input type="checkbox"/> Unicom Systems, Inc.           |
|   | <input type="checkbox"/> Wang Laboratories, Inc.        |

Send information on advertiser(s) checked above.

Name \_\_\_\_\_

Company \_\_\_\_\_

Title \_\_\_\_\_

Street \_\_\_\_\_

City, State \_\_\_\_\_ Zip \_\_\_\_\_

Mail coupon and advertiser list to:

**Personal Business Dept.  
McGraw-Hill/ 29th Floor  
330 West 42nd Street  
New York, N.Y. 10036**

# Cut travel costs

Do you travel on business? Then TraveLodge has special rates for you. Pre-set and guaranteed. Just fill in the coupon below. Clip it to your letterhead and send it to Director of Sales, TraveLodge, Box 308FO, El Cajon, California 92022. You'll have your TLC card by return mail. Use it. You'll save your company money. You can save trouble for yourself, too, by calling (800) 255-3050.\*

One toll-free number for more than 450 TraveLodges across the continent.

# here.

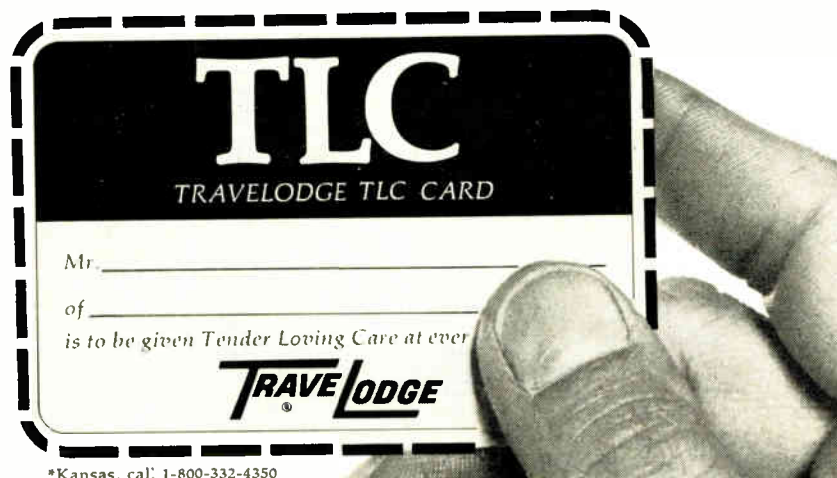

\*Kansas, cal: 1-800-332-4350

## INVESTMENTS

### The OTC Market: A minor league is coming of age

The over-the-counter (OTC) market encompasses every security not listed on a formal exchange, and occasionally—when large blocks are distributed—some that are. It's a market where perhaps 40,000 corporate common stocks are traded, plus most corporate, state, municipal and U. S. government bonds, not to mention mutual funds, most bank and insurance company stocks, and Canadian and other foreign issues.

Yet the drawbacks of dealing in this giant of markets have been phenomenal. OTC securities have largely been bought

By GERALD M. LOEB

and sold by some 4,000 dealers across the U. S. who are connected only by telephone or telegraph. To close a trade it has sometimes been necessary to contact as many as five dealers. The process has been slow, and cost to the client high. Information has been scarce.

All this started to change for the better in February of last year. This was the start of what is known as "NASDAQ," the abbreviation by which the new automated quotation system of the National Assn. of Securities Dealers is known. Something exceeding 3,000 securities are now quoted by NASDAQ, which will ultimately handle up to 20,000 different issues.

In a sense, the OTC market still resembles the minor leagues in baseball. New issues start over-the-counter, and now, if important enough, within the NASDAQ system. The current requirements are that the issuer have \$1-million or more in assets, 500 or more shareholders, and a minimum of 100,000 outstanding shares. Already the NASDAQ portion of the OTC list is a major market in itself.

The great bulk of OTC securities, of course, are still handled over the phone and by telegraph. The National Daily Quotation Service publishes what are known as "pink sheets," and Standard & Poor's has its "blue sheets." Together

## How RCA specialist Bill Margiotta separated the chickens from the trucks.

It happened to Match Corporation, a heavy construction outfit in California.

Whenever they tried to reach their equipment operators by radio, they ended up talking with a chicken farmer 3,000 miles away.

Expert after expert was called in. No improvement.

Then RCA's communications consultant Bill Margiotta took over. He designed a new system around RCA capabilities. It worked perfectly. Exit chicken farmer.

RCA Mobile Communications is a team of leaders within the leader, RCA. And Bill Margiotta is a member of that team. A specialist. He gives his customers the kind of attention we think every RCA customer deserves.

That's why we hire men like Bill Margiotta. We want you to get the best possible communications performance out of your system. Whether you have two mobile radios or a hundred.

For further information on reliable mobile communications, contact Harold A. Jones, Division Vice President, RCA Mobile Communications Systems, Dept. PB3, Meadow Lands, Pa. 15347.

# RCA

Mobile Communications  
Systems



# The Specialists

For the RCA office nearest you, call toll free, 800-243-6000. In Connecticut, 1-800-882-6500.

# Business travels at the speed of paper.

## How does your performance compare with ours?

YOURS		OURS	
	Average time for average secretary to open average mail = 10 minutes. Or 50 minutes per week. Or 41½ hours per year. While you sit waiting.	<b>Mail Opening</b>	Our MailOpeners work as part of the sorting process. By 9 a.m., your mail is open, ready for work. No waiting. 
	Most offices need a copier in action on the premises. But all too often, breakdowns and service delays bring it to a standstill.	<b>Copying</b>	Our electrostatic copiers range up to 30 dry copies a minute. Built to resist breakdown conditions. Quick service from 2400 servicemen if required. 
	Human counters go fast or slow depending on how flexible their fingers are — minus time lost to boredom and re-counting (due to human error).	<b>Counting</b>	Our mistake-proof Tickometers count up to 1,000 paper items a minute, (simultaneously) endorsing and cancelling. Use for money, tickets, labels, food stamps, etc. 
	Human collators get bored, take coffee breaks, mix up pages, turn them upside down and use up expensive time that should be used for secretarial work.	<b>Collating</b>	Our machines feed single sheets into sets, staple them, stack them, non-stop, no mistakes, at up to 500 sheets a minute. 
	If you're still using the human hand folder-inserter, you have the slowest, most expensive machine on the market. (Think of invoice time!)	<b>Folding Inserting</b>	Our folder-inserters feed, insert, count and stack up to 65 envelopes a minute. Or the folder and inserter can be separated to work independently. 
	Days of every secretary's month go in typing and re-typing the same old addresses on invoices, envelopes, payroll, government forms, orders, etc., etc.	<b>Addressing</b>	Our Addresser-Printers can do all of these things and more, doing the work of up to eight girls—with 100% accuracy. 
	If your postage scale is ¼ of an ounce off, you could be overpaying ... at 8¢ an ounce! Or sending prestige mail out with the stigma of "postage due."	<b>Weighing</b>	Our scales have cam mechanisms, lifetime prelubricated bearings and iso-elastic components to keep your records straight both ways. 
	Adhesive stamps waste waiting time in the post office, licking and sticking time in the mailroom and processing time during delivery.	<b>Mailing</b>	Our postage meters save all that time ... besides printing postage with little ads alongside, keeping tax records, sealing envelopes. And making mail look professional. 



**Pitney Bowes**

Because business travels  
at the speed of paper.

If you'd like to hear more about these business procedures and systems, we'll gladly send over one of our experts. Write Pitney Bowes, 0178 Pacific Street, Stamford, Conn. 06904, or call one of our 190 offices throughout the U.S. and Canada. Postage Meters, Mailing Equipment, Copiers, Counters and Imprinters, Addresser-Printers, Labeling and Marking Systems.

these still list the bulk of OTC securities not on NASDAQ.

But with NASDAQ now at his disposal, the investor can ask his broker for a quotation on a NASDAQ stock and get an immediate answer. The individual broker has a "Level 1" machine on his desk, which consists of some buttons and a video screen. By pressing the symbols for the security in question, a quote that fairly reflects the existing bid and offer immediately appears on the screen. There is a "Level 2" service for the dealer which gives all the current quotations and the names of the dealers making bids and offers. And over 600 market-making dealers use the "Level 3" machine, which enables them to enter and change their own bids and offers.

The individual investor benefits in many ways. His orders are usually filled to his best advantage. The difference between the bid price and the offered price is narrowed. And for the first time, the volume of trading in unlisted stocks is tabulated.

Buying or selling securities in the NASDAQ system is sometimes on the broker's ordinary commission basis and sometimes on the net basis used by dealers. Most exchange brokers tend to charge the New York Stock Exchange scale. The smaller retail securities dealers mostly deal at net prices as they have in the past. These prices include a built-in profit factor. That amount is not disclosed, but the mark-ups permitted have been declining. They will undoubtedly decline further and come closer to the broker's standard commissions. The average is perhaps 2% to 3%. There is a NASDAQ policy that calls for surveillance when a mark-up comes into the 5% range. Buying and selling on a commission basis is usually the best way for the investor. He knows the price at which his security changed hands and the fee he is being charged.

The NASDAQ System has greatly expanded the sources of information for investors. Leading financial papers have enlarged their quotation tables. *The Media General Financial Weekly* includes an over-the-counter section carrying all NASDAQ quotations (P. O. Box 26565, Dept. 082, Richmond, Va. 23261, \$50.00 annually). Standard & Poor's has a variety of services. From an individual investor's standpoint, their most useful publications are their OTC and regional exchange stock reports. (The service is expensive, but it is generally available for checking in most brokers' offices.)

The *OTC Market Chronicle* gives complete OTC news and quotes coverage (25 Park Place, New York 10007,

\$20.00 a year). John S. Herold has a quarterly over-the-counter review of growth stocks. The price of an annual subscription is \$30 (35 Mason Street, Greenwich, Conn. 06830). R. W. Mansfield Co. (26 Journal Square, Jersey City, N. J. 07306) has a weekly OTC edition of its well-known stock chart service (\$275 per year). The Select Information Exchange's 86-page *Investment Sources & Ideas Bulletin* (obtainable from SIE, 2095 Broadway, New York, 10023) lists eight various OTC services. The *Value Line Special Situations Service* covers mostly OTC stocks weekly, and costs \$145 a year if taken with the regular *Value Line Investment Survey* (5 East 44th St., New York, 10017).

Investors who formerly dealt only in listed stocks have many new names to learn, although a number of blue chips such as American Express, Anheuser-Busch, Cannon Mills, Inland Container, and Kaiser Steel, among others, have been traded OTC. Bankamerica Corp., as of the close of last year, was the most active of all of the over-the-counter listings.

The New York Stock Exchange is feeling the competition. Robert W. Haack, the Big Board president, points out that recent and upcoming changes make it clear that a "New" NYSE will emerge before the end of the current year. The old NYSE has reason to be concerned. NASDAQ is being tested as a direct competitor. One indication: General Motors' New York Stock Exchange ticker symbol is "GM." It now also has a NASDAQ ticker symbol—"GMOT."

Being new, the NASDAQ system and the OTC market in general still have many problems. One is what is known in the trade as "backing away." It simply means not taking stock or selling it in accordance with the bids and offers put into the system. There have also been questions about the accuracy of the volume figures, and there is concern over certain wild rises that occasionally have occurred in exotic new issues. Perhaps sharpest of all among NASDAQ's growing pains is the need for a national clearing network and quicker delivery of securities to buyers. This is now underway.

NASDAQ and similar systems are only the beginning of automation. There is strong support for the development of a national central market system that will bring all buyers and sellers together on the video screen. When this happens, the differences between listed and unlisted stocks will markedly shrink in importance.

GERALD M. LOEB, now senior consultant for E.F. Hutton & Co., writes and lectures widely on investment. His *The Battle for Investment Survival* is considered a Wall Street classic.

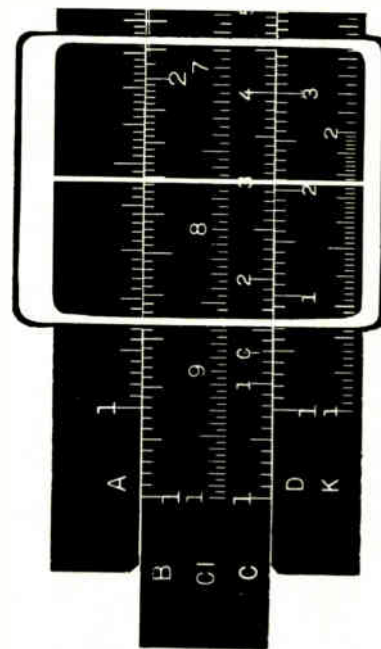

From slide rules to erasing machines, microfilms to French curves—no one offers a better selection of quality graphic/engineering supplies, equipment, services. Expect the most.

 **TELEDYNE  
POST**

DES PLAINES, ILLINOIS



**In Boston,  
stay at the  
Sheraton Towers.**

**And find out  
how the other  
1% lives.**

For reservations call  
**800-325-3535**

Overlooking the city atop the

**Sheraton-Boston  
Hotel**

SHERATON HOTELS AND MOTOR INNS  
A WORLDWIDE SERVICE OF ITT  
PRUDENTIAL CENTER

## Need college consume four costly years?

### BILLS AND BOREDOM ARE TAKING A CUT IN THREE-YEAR PLANS

Four long years of college can flatten a parent's wallet. They can just as surely flatten a student's enthusiasm for education. Recognizing these two realities, many colleges and universities are taking a logical (if radical) step—they are shortening the time it takes to get an academic degree.

Says Alden Dunham of Carnegie Corporation, which has funded many such change-overs: "Four years is just an arbitrary number. Way back, Harvard chose it, following the Cambridge and Oxford models, and the four years just stuck." Curiously, the English themselves shortly switched to a three-year degree. Now Harvard—like both Yale and Princeton—is considering a three-year degree, and all sorts of schools are exploring the idea.

Already Northwestern has switched to allowing about one-fourth of its students to take a three-year degree. Small colleges like Illinois' Shimer and Wisconsin's Ripon, private universities like St. Louis, and the nation's two biggest state systems, the California State Colleges and the State University of New York (SUNY) all offer the opportunity to get a degree in shorter time. The point, says SUNY Chancellor Ernest Boyer, is that "an education should not be equated with a five-day-a-week, four-year ritual. We are trying to establish a program that is educationally and fiscally sound."

A big push toward a speeded-up degree is the financial reprieve it can give

parents. Scholarships nowadays are going only to students with real financial need. The middle-class parent is almost always excluded from such help. Costs are not just going up, they are going up at a higher yearly clip. A cut of one-quarter of college time can save a parent anywhere from \$3,000 to \$5,000.

Last year in Utah, for instance, parents probably saved \$3.5-million when 1,278 students trimmed a full year off their college stay. And in Wisconsin, Ripon's president, Bernard Adams, points out: "A young person graduating a year early gains a year's salary as well."

The economic argument is almost as strong for the schools. Says one Ivy League administrator, "It's one way to avoid pricing ourselves out of the middle-class market."

But time saving is not just money saving. It can save students as well. For many, graduate study is a necessity, and graduate school can stretch on and on. A would-be medical doctor, for instance, may not emerge from the cocoon until his thirtieth birthday. The prolonged schooling itself is a deterrent to such study. So, close to 20 medical schools

#### By BARBARA RADLOFF

now are trying to compress study to three years. Many, like Boston University, are working with undergraduate colleges to combine a course that will span only six years for both a B. A. and M. D. Colleges from New York Medical College to the University of the Pacific Dentistry School have just put in three-year programs, as well. The University of Chicago, which pioneered in early graduation back in the 1930's, has several programs in which students can get both a B. A. and M. A. in just four years. So does Northwestern.

Princeton professor Marvin Bressler, who has strongly recommended that his university consider a three-year program, admits that many of his reasons are simply psychological. "Kids know more today," he says. "They're more

mature and have been exposed to more things. Four years of college is just too long a period of psychological dependence. It results in alienation, the 'generation gap', or what have you." Harvard, for instance, finds the so-called "sophomore slump" such a grim reality that it is thinking of giving everyone the sophomore year off for travel or work in the "real" world.

While the pressure to introduce a speeded-up degree may be generalized, the ways of accomplishing it differ. A parent who is convinced that such a program would benefit a student in his family will have some options to consider. For instance, Dartmouth is initiating year-round schooling. This means a student could graduate in three years—but not everyone could stand that pace. What's more, income from a summer job would have to be forfeited, and the total cost would be roughly the same as for a traditional four years.

Pre-collegiate who know what they are aiming for also are looking for ways to cut schooling time. In response, SUNY is starting three different plans this year. One will take students from the junior year in high school and enter them in college. Another will send professors into high schools, and a third will offer an intermediate year between the 11th grade and the college sophomore year. Among private colleges, Shimer is doing the same thing. President Robert Long says, "More than 30% of our students are enrolled in a full-scale college program after completing no more than their junior year in high school, and 40% will graduate in three years."

A parent intrigued by the advantages of a shortened degree should also be aware of the pitfalls. While some state schools firmly believe that the "fast degree" is possible and even desirable for everyone, other educators are more cautious. Northwestern maintains that such a program is only beneficial for those who know what they want in the way of a career. "If you're intellectually shopping around," says a Northwestern spokesman, "that's what four years are for." A student should also make sure a time-shortened degree will not make it difficult to enter a particular graduate school of his choice.

Some consideration, too, should be given the social needs of the collegiate. But most data indicates that the big personal changes in a student's life come during the first year of college; whether he remains two or three years more is not significant. Says Princeton's Bressler, "Generally we're not saying the three-year degree is for everyone . . . but at least we're loosening up the alternatives."

On Yale's Old Campus—where some think three years is long enough for a B.A.

Dick Wolters







## Our fight against air pollution begins 15,000 feet underground.

If we wait until air pollution gets into the air, we've already lost the battle.

So C-E starts fighting on the ground floor, by cleaning sulfur from crude oil, right at the well site.

That way, the oil's clean enough to make sense ecologically, and we help turn Florida's new Jay Field into one of America's biggest oil finds in twenty years.

C-E's Natco Division has

teamed up with Sun Oil to build a multi-million dollar facility at Jay Field, that takes a ton of sulfur from every 150 barrels of crude oil.

And that sulfur isn't just thrown away. Every ton of it goes into something useful, instead of going up in smoke.

What's more, we've equipped this new plant with the latest in anti-pollution controls, so while we're fighting one form of pollution, we don't create another.

What Natco is doing in Florida is just part of what C-E is doing world-wide, helping business answer environmental questions, before they turn into environmental problems.

And we find those answers, even if we have to dig for them.

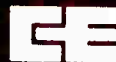

**COMBUSTION ENGINEERING, INC**

990 Long Ridge Road, Stamford, Conn. 06902

**Our name in oil production processing... C-E Natco.**

Other C-E Names • C-E Combustion Division • C-E Lummus • C-E Industrial Group • C-E Cermatec • C-E Canada

in calculating & typewriting  
**real  
productivity  
is near...**

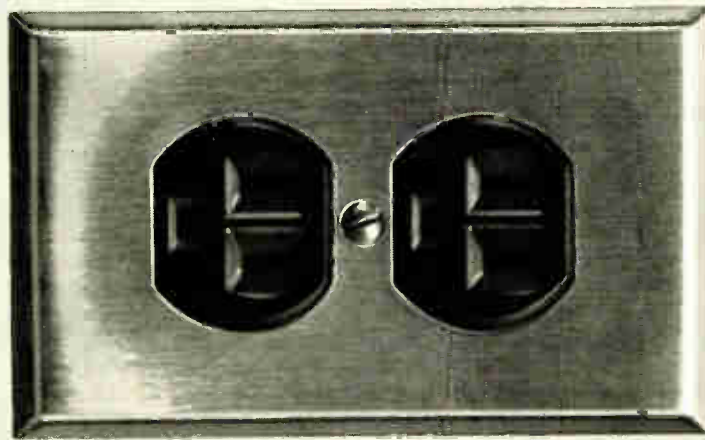

**THIS near**

Just plug in one of our calculators or word processing systems and watch productivity soar. Large shop, small shop — at any level.

We can offer you a simple programmable calculator that will double a clerk's output. Or a full-blown calculating system that rivals a computer's power but carries a bite-sized price tag. Or an automatic typing system that thinks.

During the past few years, we've increased the productivity of many, many organizations and we can do the same for you. Inexpensively. Just give us a call.

We're in the Yellow Pages under "ADDING & CALCULATING MACHINES."

Wang Laboratories, Inc.  
Tewksbury,  
Massachusetts 01876  
PB-6

**WANG**



## Hitting the road in rented comfort

A New Jersey family recently returned from a two-week trip to Disney World in Florida. With five children to accommodate, they rented a 24-foot and luxuriously-appointed motor home. Their bill came to \$1,113. Gas, oil, food, and tolls, of course, were extra. A neighboring family of four made the same trip for a rental fee of \$150. They used a folding tent-type trailer.

The figures roughly indicate the range of possibilities open to the summer tourist who wants to take his family on the road for a couple of weeks of camper life, but doesn't want to tie up his cash in hardware. The motor home that the New Jersey family rented for \$1,113—as high as that sounds—costs close to \$20,000 to purchase. It came equipped with TV, radio, 8-track stereo, and even an automatic dishwasher.

This is just about tops for this sort of rental equipment. At a typical East Coast agency, New Horizons, Inc., Lodi, N.J., the rental is \$350 a week plus 12-cents a mile. As in most other locales, money is paid in advance. This includes the rental fee, estimated mileage charges, taxes and a "security" deposit. On longer rentals, most agencies will shave the weekly fee—a Mt. Kisco, N.Y., outfit, for instance, asks \$1,200 a month for a comparable deluxe vehicle, a saving of \$300 from the weekly basis. There are regional variations, too. In Cleveland, \$300 a week is tops.

Fees naturally drop as the accommodations become more spartan. A small, sleep-four tent-type trailer can usually be had for about \$75 a week. A sleep-six model may cost \$100 or better. The most modest of self-propelled vehicles, such as the so-called "van-conversions" of Volkswagen, start at \$100 a week, plus mileage charges. The least of the real motor homes, such as a 17-footer with modest accommodations for four, will cost \$150 to \$225 a week.

Motor homes, too, offer some problems for untutored drivers. Big ones are 7.5-foot wide and carry complex machinery and equipment. Thus, anyone renting one is best advised to take whatever training the agency has to offer. It may mean as much as two or three hours' drill before setting out.

# quality speaks for itself



1911 Stevens-Duryea Tauring Car  
Frederick C. Crawford  
Auto-Aviation Museum

## MOTOR OIL REFINED FROM 100% PURE PENNSYLVANIA GRADE CRUDE OIL — THE CLASSIC OIL FOR MORE THAN 63 YEARS

What makes a car a classic? Like this 1911 Stevens-Duryea? Design, performance, craftsmanship, integrity, age, and a lot of tender loving care.

Regular use of a brand of Pennsylvania Grade motor oils is one tender loving care you can give any car—vintage, brand-new or in-between.

All of these superior motor oils start with the world's finest crude found only in the abundant Pennsylvania region. It's been proved to have the highest natural

viscosity index, highest natural oiliness, highest natural lubricating qualities.

Pennsylvania Grade motor oils start richer, protect better naturally. Which is why they are the most asked-for brands coast to coast.

Pennsylvania Grade, the classic oil. Its quality speaks for itself.

Free booklet gives helpful car care information. Write Dept. PB 26.

**PENNSYLVANIA GRADE CRUDE OIL ASSOCIATION**  
P. O. Box 250, Oil City, Pennsylvania 16301

"Pride of  
Performance."

## ANNOUNCING A SERIES OF COMMUNICATIONS UPDATES FOR EXECUTIVES AND MANAGERS.

**Today's management depends more and more on good communications.**

**Because so many of your decisions involve information carried over telephone lines in some way, the Bell System is scheduling a series of day-long conferences planned especially for executives and managers.**

**The sessions will cover such matters as Management Information Systems, computer time-sharing, and the use of modeling in management.**

**We will bring you up to date on services we offer today and plan for tomorrow. You can learn, through the latest in multimedia presentations, how others are using the newest communications tools. And you will have ample time to exchange ideas with fellow executives, both in discussion sessions and informally at lunch.**

**There is no charge for attending one of these conferences. The Bell System Communications**

**Consultant who works with your company can supply further details. Or mail us the coupon below.**

Bell System Seminar  
Department D  
866 Third Avenue  
New York, New York 10022

I am interested in your Communications Updates for Executives.

Please have a representative call me.

Please send a brochure and a schedule.

Name \_\_\_\_\_

Title \_\_\_\_\_

Company \_\_\_\_\_

Address \_\_\_\_\_

Telephone \_\_\_\_\_

City \_\_\_\_\_ State \_\_\_\_\_ Zip \_\_\_\_\_



# The father of our country should not be the mother of invention.



Many companies find George Washington so inspiring, they develop new products mainly to collect his portrait.

On currency.

Which results in many new products that are neither genuinely new nor genuinely helpful.

So we feel there's a better reason to invent things:

To solve problems for our customers.

We've followed that philosophy since 1899, when we developed the first inexpensive paper cone for textile

machines.

And we've continued to follow it in developing other significant products. Such as fibre paper mill cores to replace more costly wooden and metal cores. And composite cans for liquids like oils and citrus concentrates that replace expensive metal cans. And folding cartons and hundreds of other products that improve efficiency in virtually every major industry.

If you'll write Dept. PB, Harts-ville, S.C. 29550 for our booklet — and the booklet is free — you can

learn more about the unique products we've developed. (Which, incidentally, do not include the gas and oil products from Sunoco, another company.)

The booklet will also tell you something else. How we've grown to a \$135 million business. Which proves that necessity is not only the true mother of invention, but that she is very good to her children.

Sonoco Products Company.  
Innovators in paper  
and plastics.



SO571

# Sony takes the microphone off your hands.

Sony put the microphone where it belongs. Inside the tape recorder. Now you can gesture, wave, or walk around while you dictate. There's no mike to lug, clutch, or give you "mike fright." Because the microphone is out of sight—as well as out of mind.

Sony's revolutionary new condenser microphone is built right into the case. Cleverly concealed, it can scarcely be seen. Yet it picks up voices with crystal clarity from anywhere in the room.

You'll find Sony's built-in condenser microphone adds more convenience than ever to our compact, simple-to-use Sony solid-state Cassette-Corders.<sup>®</sup>

Ideal for businessmen on the go, executives at their desk, scholars in the field—professionals of every stripe. Choose a new Sony Cassette-Corder<sup>®</sup> with the amazing built-in microphone. TC-90—\$99.95; TC-40—\$99.95; TC-95—\$119.95; TC-45—\$119.95; TC-110A—\$129.95; TC-55—\$139.95; TC-140—\$139.95.

Consult the Yellow Pages for your nearest Sony/Superscope dealer.

At last your hands are free!

**SONY** **SUPERSCOPE**

You never heard it so good.<sup>®</sup>

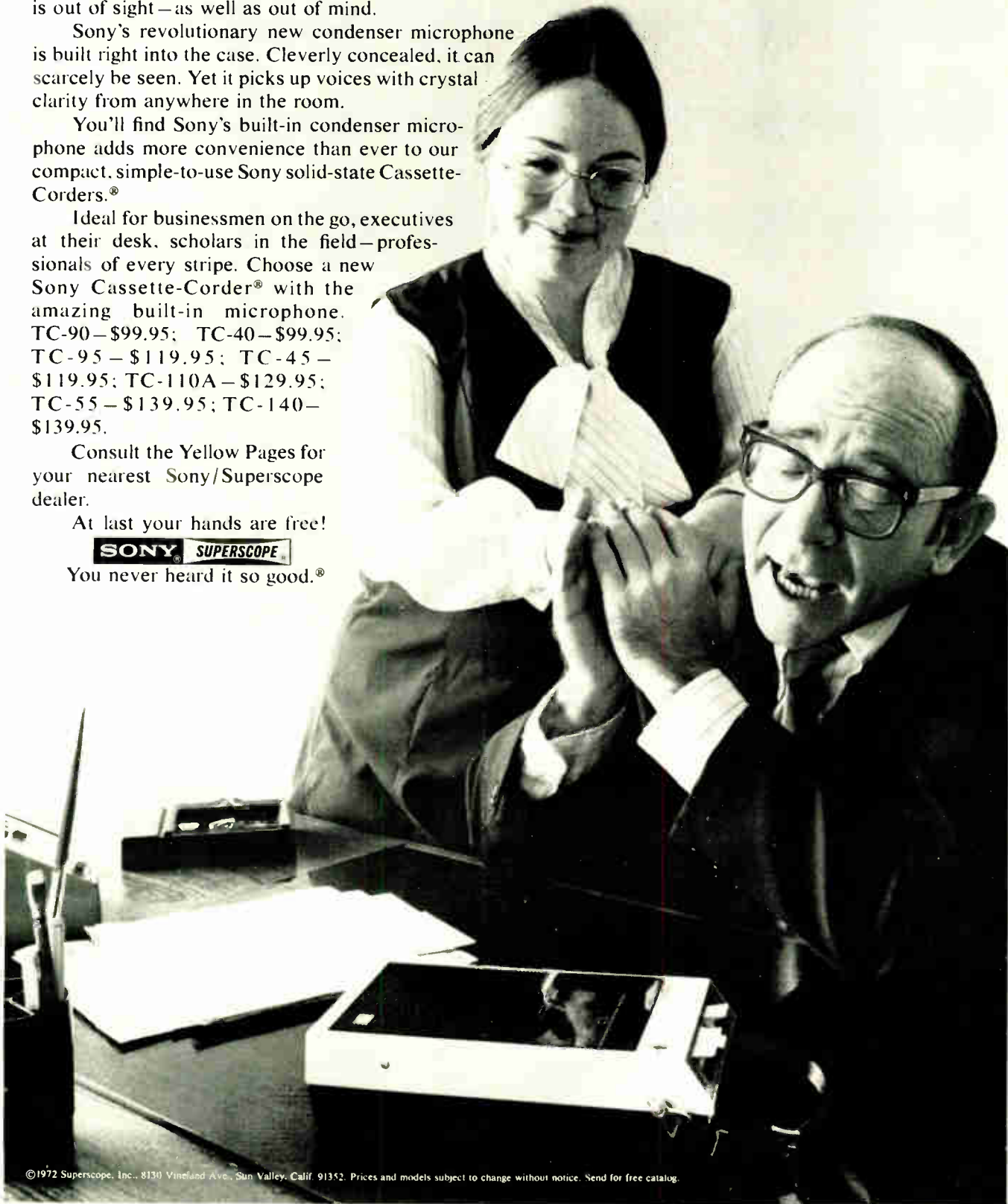

©1972 Superscope, Inc., 8130 Vineland Ave., Sun Valley, Calif. 91352. Prices and models subject to change without notice. Send for free catalog.



### Tax scene: campaign coffers, battling IRS, weed killer woes

The doorbell dollar: New 1972 rules on tax deductions for political gifts keep on creating confusion. Boiling it down: You can deduct up to \$50 of *your total gifts* (\$100 on a joint return); or, take a tax credit for 50% of your total gifts, up to \$12.50 (\$25 jointly). But you may *not* get both. . . . You can't, as some think, take separate deductions (or credits) for gifts to various candidates or groups. You can, though, take a deduction even if your candidate has since dropped out of the race. And it can be *any* race, from White House to school board.

The tax audit season has arrived. "Getting called in by IRS is bad news," says a top New York tax lawyer, "but not quite so bad as people think." This year the typical businessman faces longer odds on a 1040 audit or partial examination (1-chance-in-over-50). He also faces improved odds on coming away with his bankroll intact if he goes over the head of the IRS examiner and appeals to higher IRS authority. Last year's cases that were pushed to the top level within IRS were settled for a *third* of the extra \$1.4-billion that had been claimed by tax agents. And IRS got only 40% in the U.S. Tax Court.

Gardening note: A taxpayer sprayed *weed killer* and ruined his grass, shrubs and trees. He had believed the chemical to be selective. The damage, said the Tax Court, amounted to a deductible casualty loss. The case (*Farber*) becomes an arguing point, in case you come up with similar botanical blunders.

### Manners & money: halls of ivy, bikes, new 35mms

*A student still seeking a college berth for September* may garner a late admission if he's willing to reset sights and focus on a smaller, lesser known campus. Two clearing houses brush away a lot of paperwork and strain for a family. For a \$20 fee, they supply member colleges with profiles of student applicants; the colleges, in turn, contact those students who seem best to fulfill their requirements. ASK US, sponsored by the National Assn. of College Admissions Counselors (9933 Lawler Ave., Skokie, Ill. 60076) maintains contact with 1,050 colleges—and claims 90% success. The College Admissions Assistance Center (461 Park Ave. South, New York 10016) has 300 on its list. *The hand-holders*: Some private consultants charge fees well over \$100—and do little more than point out the very same colleges.

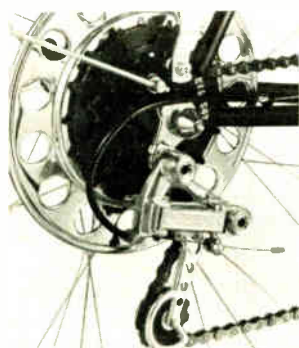

*Countless cyclists have been pulling charley horses* pumping uphill or against the wind—even with \$300 or \$400 bikes that have turned-down bars and 10 speeds. The strain may come from the gearing, since the professional-type bikes now in favor are made for cyclists with legs of iron. The not-so-professional rider may want to have the local bike shop replace the rearwheel gear cluster with one having an easier hill-climbing capacity. Among new kits on the market is a cluster-derailleur by Shimano American Corp.—\$27.

*New style 35 mm cameras* give the novice's picture-taking a professional touch. At \$125-150, they demand some skill, but not enough to scare anybody away. Easiest-to-operate models include the Electro-35GT Yashica (\$150), the Olympus 35SP (\$135), and the Minolta HiMatic (\$125); they automatically indicate proper opening and set shutter speed. Semi-automatics that let you set shutter speed include Konica Auto S2 (\$150), and Canon Canonet QL17 (\$140). Note: In this price range, Kodak's fine Instamatic X-90 (\$145) is fully electronic. Shop and compare.

### High spirits

Robert J. Misch, the food and drink man, has a cheery, fast-reading course in hard liquor: *Quick Guide to Spirits* (Doubleday); it's compact, informative. An excellent and not-too-sweet drink noted is the Bobaroo, from the bartender at Manhattan's Four Seasons: Shake with ice 2¼ oz. Canadian whiskey, ¼ oz. each white creme de menthe and dry vermouth. The Four Seasons, incidentally, has just been picked for five-star listing by Mobil Travel Guides (one of 11 restaurants in the U. S.).

We know that when you get plenty of help in the planning stages, better workmanship and on-time delivery, you're not likely to try other sources. So we put more manpower in the field; operate three strategically located plants and provide the largest dealer network. That way, you can

always count on timely personal help from a Lyon Dealer salesman, a factory representative, or both.

You have a lot more going for you when you take full advantage of Lyon leadership. Proven quality. The best selection—more than 1600 stock items. The easiest

ordering system. The best packaging. All of our products are unit packaged and shipped as shown in the catalog. And most orders are rolling in 24 to 72 hours.

Next time, spare yourself: enjoy the kind of service that made us No. 1. Call your Lyon Dealer.

## We know what it takes to stay Number 1: more personal service

LYON METAL PRODUCTS, Inc.  
75 Monroe Avenue, Aurora, Illinois 60507

Please send me a copy of catalog No. 100

Name \_\_\_\_\_

Firm \_\_\_\_\_

Address \_\_\_\_\_

City \_\_\_\_\_ State \_\_\_\_\_ Zip \_\_\_\_\_

Look for us in the Yellow Pages under LYON  
"STEEL SHELVING," "LOCKERS" or "SHOP EQUIPMENT"



LYON METAL PRODUCTS, INC.  
General Offices: 75 Monroe Ave., Aurora, Ill. 60507  
Plants in Aurora, Ill., York, Pa., Los Angeles  
Dealers and Branches in All Principal Cities

**LYON**

METAL<sup>®</sup>  
PRODUCTS

# HERE'S THE NEW UNICOM 1215: THE ONE WITH THE CRAZY % KEY.

Our new compact 1215 has features galore. Ho hum. But among them is a crazy little % key—for people who like to get correct answers in fewer steps. And for those who find decimal points confusing when working with percentages. Here's how it works. Say you want to add 5% tax to a total. Touch the times key. Enter the percentage as a whole number. Touch the crazy % key. Voila. You have the tax, decimally correct. Don't go away, the best is yet to come. Touch the % key again, and you have the net amount, decimally correct. You can work discounts just as easily. And the crazy % key works as swiftly in division to give you decimally correct percentages! Our "ho hum" features include automatic constants, automatic chaining, flip-flop exchange key, separate memory, round-off and truncate, and a powerful dual decimal system. The 1215 weighs less than five pounds and takes up less space than your letterhead. And the price is unbeatable. Call your nearest UniCom representative now. Or write UniCom, 10670 North Tantau Avenue, Cupertino, California 95014.

**UniCom**  
Systems, Inc.

**THOSE CRAZY GUYS  
FROM UNICOM HAVE  
DONE IT AGAIN!**





Do you face a make or buy decision on power supplies?

# BUY LAMBDA LX SERIES

Now 39 models in 7 package sizes...  
single, dual & triple outputs

**new**  
dual output model  
in "CC" package



**DUAL OUTPUT**

LXD-CC-152:  $\pm 15V$  to  $\pm 12V$ , 4.0A, \$235

**new**  
dual and triple output  
models in "D" package

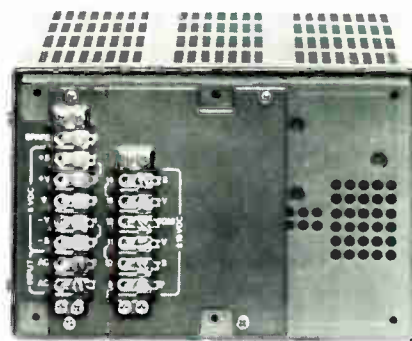

**DUAL OUTPUT**

LXD-D-152:  $\pm 15V$  to  $\pm 12V$ , 6.2A, \$280

**TRIPLE OUTPUT**

LXT-D-5152:  $\pm 15V$  to  $\pm 12V$ , 3.1A, \$375  
5 $\pm$ 5% VOLTS 12.0 AMPS (WITH O.V.)

**all listed in Underwriters'  
Recognized Components Index\***

**all designed to meet MIL  
environmental specifications**

**all in stock for 1-day delivery**

**all guaranteed 5 years**

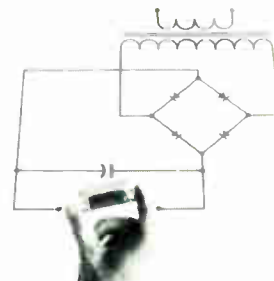

**WHETHER  
YOU MAKE  
OR BUY...**  
**LAMBDA**  
ELECTRONICS CORP.

A **Vaco** Company

\*Dual and triple models presently undergoing qualifying tests.

MELVILLE, NEW YORK 11746 515 Broad Hollow Road Tel. 516-694-4200 ARLINGTON HEIGHTS, (CHICAGO) ILL. 60005 2420 East Oakton St., Unit Q Tel. 312-593-2550  
NORTH HOLLYWOOD, CALIF. 91605 7316 Varco Ave. Tel. 213-875-2744 MONTREAL, QUEBEC 100C Hymus Blvd., Pointe-Claire, Quebec-730 Tel. 514-697-6520

Circle 901 on reader service card

# Clairex phototransistors give you higher sensitivity at extremely low illumination levels...and they cost no more.

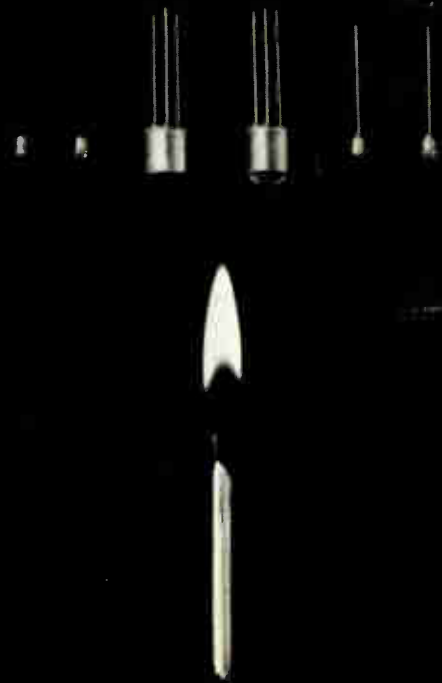
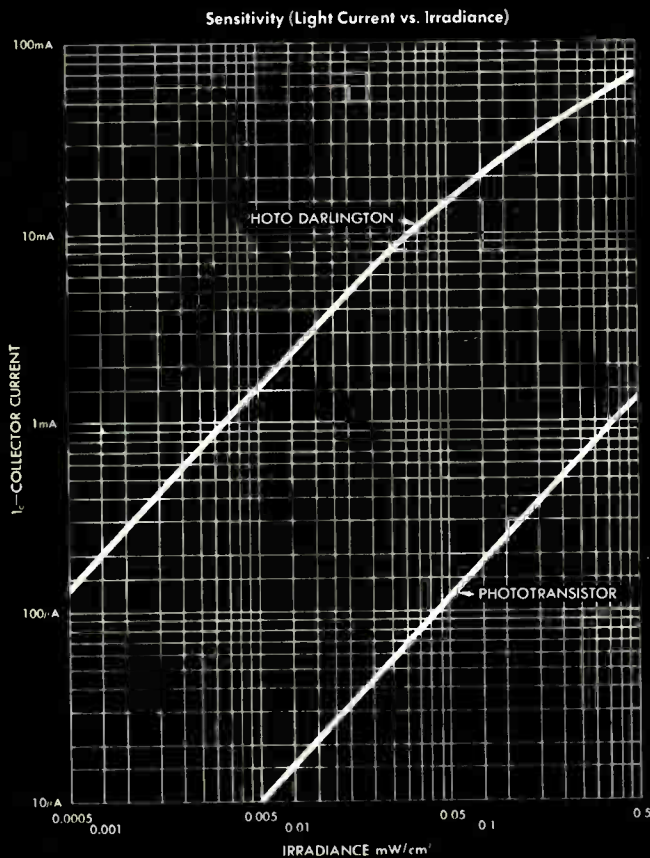

One of our customers is using our phototransistors to detect signals from an LED at distances up to 60 feet.

If you need phototransistors to give you more current at lower light levels, call (914) 664-6602, or write Clairex<sup>®</sup>, 560 South Third Avenue, Mount Vernon, New York 10550.

## CLAIREX ELECTRONICS

A DIVISION OF CLAIREX CORPORATION

Circle 902 on reader service card