

- 67 How long will the business boom last?
- 116 Low-frequency analyzer has digital storage
- 121 New tricks in laser trimming

# Electronics®

**Buckling up for the  
bumpy road to Detroit**



1420 N11302 80MAY NOV74  
MATT NEVILL  
3022 NE BROADWAY  
PORTLAND OR 97232



# ENGINEER POWER

Engineering is the big difference in Power Supplies from Electronic Measurements . . . more power per cubic inch, more power per pound, higher efficiency (and less heat), ripple as low as 0.5 mV.

The table shows the 0.1%-regulation SCR models and 1%-regulation EM models, but Electronic Measurements has a full line, bench-type and modular, with single and multiple outputs, from 5V to 500V and from 2.5A to 650A.

And there's more: remote sensing and programming, automatic E/I crossover, stability within 0.05%, full overload protection, rugged construction that's easy to service, and a five-year guarantee.

In Power Supplies, the best is Engineer Power, from Electronic Measurements. For a short-form catalog, use the Reader Service card, or contact Electronic Measurements.

| Rating    | Price   |         |
|-----------|---------|---------|
|           | EM      | SCR     |
| 6V-600A   | \$1,600 | \$2,000 |
| 7.5V-300A | 1,200   | 1,400   |
| 10V-250A  | 1,200   | 1,400   |
| 10V-500A  | 1,600   | 2,000   |
| 20V-125A  | 1,050   | 1,200   |
| 20V-250A  | 1,275   | 1,500   |
| 20V-500A  | 2,050   | 2,650   |
| 30V-100A  | 1,050   | 1,200   |
| 30V-200A  | 1,450   | 1,800   |
| 40V-60A   | 950     | 1,100   |

| Rating    | Price   |         |
|-----------|---------|---------|
|           | EM      | SCR     |
| 40V-125A  | \$1,300 | \$1,600 |
| 40V-250A  | 1,975   | 2,500   |
| 50V-200A  | 1,975   | 2,500   |
| 80V-30A   | 950     | 1,110   |
| 80V-60A   | 1,200   | 1,500   |
| 100V-100A | 1,975   | 2,500   |
| 120V-20A  | 975     | 1,300   |
| 120V-40A  | 1,200   | 1,500   |

| Rating   | Price  |         |
|----------|--------|---------|
|          | EM     | SCR     |
| 160V-15A | \$ 950 | \$1,100 |
| 160V-30A | 1,300  | 1,600   |
| 160V-60A | 1,975  | 2,500   |
| 250V-10A | 950    | 1,100   |
| 250V-20A | 1,300  | 1,600   |
| 250V-40A | 1,975  | 2,500   |
| 500V-5A  | 1,300  | 1,500   |
| 500V-10A | 1,600  | 2,000   |

19" Rack, 20" depth. Voltage and current adjustable over wide range.

See EEM Vol.1-791, 1-792, 1-793 for additional information.



## ELECTRONIC MEASUREMENTS INC.

405 Essex Road, Neptune, N. J. 07753

Phone: (New Jersey) 201 - 922-9300 • (Toll-Free) 800 - 631-4298

Specialists in Power Conversion Equipment

HP: WE DELIVER COMPUTER SOLUTIONS - NOT JUST COMPUTERS



**DESIGNED ESPECIALLY FOR THE SYSTEMS USER,** everything is in a single, pretested unit. Just plug it in and you're in business. The HP 2100S lets you come up with a whole new range of minicomputer systems solutions.

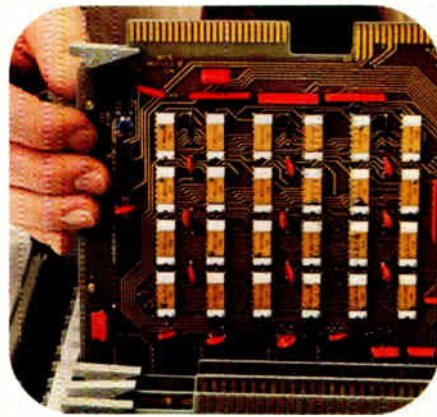

**THE COMPUTER WITHIN A COMPUTER:** A plug-in card lets you microprogram, to speed up subroutine execution of important applications. Frees valuable memory space for added problem-solving capacity.

- EXTENDED ARITHMETIC INSTRUCTIONS
- FLOATING POINT HARDWARE
- DUAL-CHANNEL DIRECT MEMORY ACCESS
- CRYSTAL-CONTROLLED PROGRAMMABLE TIME-BASE
- PARITY CHECK WITH INTERRUPT
- POWER-FAIL PROTECT WITH AUTOMATIC RE-START
- MEMORY PROTECT
- TWELVE I/O CHANNELS
- COMMUNICATIONS CONTROL INTERFACE
- A 16K, 16-BIT MEMORY (EXPANDABLE TO 32K)

**THE SYSTEMS FEATURES YOU WANT MOST** are standard on the HP 2100S. Combine these with microprogrammability, powerful peripherals and a complete selection of software.

## Meet the HP 2100S computer. Specifically designed for solving system problems.

Here's the top-of-the-line HP computer. Specially designed for systems use, the basic package meets most system needs as it is. Yet, its well-thought-out options and peripherals let you customize your HP 2100S for efficiency. Proven software includes Assembly Language, FORTRAN, BASIC, and ALGOL compilers, plus a complete microprogramming software package. Operating systems are available for batch processing, real-time and time-sharing. Send for our new brochure that tells it all.

22305

HEWLETT  PACKARD

Sales, service and support in 172 centers in 65 countries. Palo Alto, California 94304. Offices in principal cities throughout the U.S.

# GREATEST YIELD IN THE ELECTRICAL FIELD

## ALLEGHENY LUDLUM STEEL GIVES YOU MORE FOR YOUR MONEY

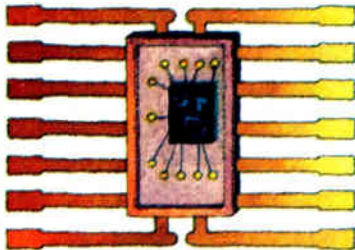

Critical demands for leadframes in semiconductors are more than satisfied by Allegheny Ludlum. Our product range and consistently high quality fill numerous needs.



We can earn your seal of approval . . . with special steels for glass-to-metal seals: AL 42 and 4750. Sealmet 1 and 4. AL 430Ti. And others. All meet tightest tolerance requirements . . . for sealed-beam headlights, fluorescent lights, electronic tubes.



Wider strip? In widths up to 25 inches, our electrical alloy strip yields more good parts faster to cut costs. Sheet? Plate? Bar? Get the best . . . for laminations and shavings. Motors. Transformers. Generators. Relays. Solenoids. Vibrators. Cores. Check our Sealmet alloys. Or Ohmaloy. Mumetal. Moly Permalloy, etc.: all products of strict A-L quality control . . . from computerized melting to final shipment . . . for consistently superior characteristics.

A pioneer in developing magnetic shielding materials, we stock Mumetal and Moly Permalloy for prompt delivery. Our Research Center, most elaborate in stainless and specialty alloys, helps solve special shielding problems.



For more on how America's leading producer of stainless and specialty alloys can help you in the electrical field, write: Allegheny Ludlum Steel, Dept. 331, Oliver Building, Pittsburgh, Pa. 15222.

**AL Allegheny Ludlum Steel**  
Division of Allegheny Ludlum Industries

## 31 Electronics review

MEMORIES: Core makers study multibit concept, 31  
Domain-tip memory edges toward market, 32  
NAVIGATION: Small radar aimed at small boats, 32  
INSTRUMENTS: Wanted: portable X-ray checker, 33  
PRODUCTION: Automated cabler uses linear motor, 33  
COMPONENTS: Tough connector to rough it in cars, 34  
DISPLAYS: Gas display goes in IC package, 34  
CONSUMER ELECTRONICS: Bowmar adds to its calculators, 36  
GOVERNMENT ELECTRONICS: Customs eyes big computer net, 36  
MEDICAL ELECTRONICS: A timer for dental brace wearers, 38  
COMMERCIAL ELECTRONICS: Electronic lock needs no key, 38  
NEWS BRIEFS: 40  
COMPUTERS: AFIPS' new policy attracts industry, 40  
Optical character-recognition systems drop in price, 42

## 54 Electronics International

JAPAN: Semiconductor laser heads for 10,000-hour goal, 54  
GREAT BRITAIN: Models—scale and mathematical—check radar, 54  
AROUND THE WORLD, 55

## 67 Probing the News

ECONOMICS: The boom will come down gently, 67  
COMMERCIAL ELECTRONICS: Lasers seek larger markets, 70  
COMMUNICATIONS: WU still leads domsat derby, 72  
COMMUNICATIONS: Germans add electronics to pay phone, 78

## 93 Technical Articles

SPECIAL REPORT: Buckling up for the bumpy road to Detroit, 93  
DESIGNER'S CASEBOOK: Crystal oscillator has high stability, 112  
Varistor voltage divider improves receiver agc, 113  
Regulating high voltages with low-voltage zeners, 113  
Mord applications for the 741-type op amp, 114  
INSTRUMENTATION: Digital store aids in low-frequency analysis, 116  
PACKAGING & PRODUCTION: Laser trimming: an art to be learned, 121  
ENGINEER'S NOTEBOOK: Timer, thermistor control temperature, 128  
IC timer's duty cycle can stretch over 99%, 129  
Timer plus resistor can produce square waves, 130  
Versatile timing circuit monitors battery voltage, 130  
Pair of IC timers sounds auto burglar alarm, 131  
Timer converts temperature to frequency, 131  
IC timer can function as low-cost line receiver, 132

## 142 New Products

IN THE SPOTLIGHT: IC timers make the most of delay, 142  
SEMICONDUCTORS: Hybrid buffer supplies 50 milliamperes, 144  
PACKAGING & PRODUCTION: Tester built for semiconductor units, 153  
SUBASSEMBLIES: Hermetic supplies offer efficiency to 77%, 163  
MICROWAVE: Rf connectors are low-priced, 170  
MATERIALS: 179

## Departments

Publisher's letter, 4  
Readers comment, 6  
40 years ago, 8  
People, 14  
Meetings, 22  
Electronics newsletter, 27  
Washington newsletter, 51  
Washington commentary, 52  
International newsletter, 57  
Engineer's newsletter, 134  
New literature, 180

## Highlights

### The cover: Automotive electronics hits the road, 93

Government demands for new safety systems, backed by some years of device development by electronics manufacturers, are guaranteeing that 1974 model cars will all carry a markedly increased complement of electronic components and systems—and this will be only a beginning. Man in driver's seat on the cover is by illustrator William Shields.

### Not much of a bump after the boom, 67

Sales cannot maintain their present pace forever, but both Wall Street and top management in the electronics industries generally expect that this time the inevitable slowdown will be relatively short and not too serious. The mix of markets is healthier than it was in 1971, and new markets are opening up.

### Digital analysis of low-frequency signals, 116

A spectrum analyzer that stores low-frequency signals in a digital memory achieves high resolution with a low-cost cathode-ray tube. Further, measurement time can be reduced by an adaptive sweep, which accelerates whenever the signal stays below a given threshold.

### The art of laser trimming, 121

A powerful tool in the fabrication of hybrid circuits, laser trimming is a process that demands care in the choice of resistor materials and geometries, as well as highly skilled use of the laser beam.

### And in the next issue . . .

Special report on flat cable . . . evaluating the epitaxial deposition process by computer: fifth article in the series, "Mini-computers in action."

EDITOR-IN-CHIEF: Kemp Anderson

EXECUTIVE EDITOR: Samuel Weber

MANAGING EDITORS: Lawrence Curran, *News*;  
Arthur Erikson, *International*

SENIOR EDITORS: John Johnsrud,  
H. Thomas Maguire, Laurence Altman  
Ray Connolly

ART DIRECTOR: Fred Sklenar

ASSOCIATE EDITORS: John N. Kessler,  
Howard Wolff, Gerald M. Walker

### DEPARTMENT EDITORS

*Aerospace*: William F. Arnold  
*Circuit Design*: Lucinda Mattera  
*Communications & Microwave*:  
Lyman J. Hardeman  
*Computers*: Wallace B. Riley  
*Consumer*: Gerald M. Walker  
*Industrial*: Alfred Rosenblatt  
*Instrumentation*: Michael J. Riezenman  
*Military*: Ray Connolly  
*New Products*: H. Thomas Maguire  
*Packaging & Production*: Stephen E. Grossman  
*Solid State*: Laurence Altman  
*Special Issues*: Harry R. Karp

COPY EDITORS: Margaret Eastman,  
Everett C. Terry

ASSISTANT EDITOR: Marilyn Offenheiser

ART: Charles D. Ciatto, *Associate Director*  
Patricia Cybulski, *Assistant Director*

PRODUCTION EDITOR: Arthur C. Miller

EDITORIAL SECRETARIES: Janet Annunziata,  
Julie Gorgoglione, Penny Roberts

### FIELD EDITORS

*Boston*: Gail Farrell  
*Los Angeles*: Paul Franson (Mgr.)  
*Midwest*: Larry Armstrong (Mgr.)  
*New York*: Alfred Rosenblatt (Mgr.)  
*San Francisco*: George Sideris (Mgr.),  
Judith Curtis  
*Washington*: Ray Connolly (Mgr.),  
William F. Arnold  
*Frankfurt*: John Gosch  
*London*: Michael Payne  
*Paris*: Arthur Erikson  
*Tokyo*: Charles Cohen

### McGRAW-HILL WORLD NEWS

*Director*: Walter A. Stanbury  
*Bonn*: Robert Ingersoll;  
*Brussels*: James Smith;  
*London*: Marvin Petal;  
*Milan*: Peter Hoffmann, Andrew Heath;  
*Moscow*: Axel Krause;  
*Paris*: Stewart Toy, Michael Johnson;  
*Stockholm*: Robert Skole;  
*Tokyo*: Mike Mealey

PUBLISHER: Dan McMillan

ADVERTISING SALES MANAGER: Pierre J. Braudé

ADVERTISING SALES SERVICE MANAGER:  
Wallis Clarke

BUSINESS MANAGER: Stephen R. Weiss

CIRCULATION MANAGER: George F. Werner

MARKETING SERVICES MANAGER:  
Tomlinson Howland

**D**uring the preparation of the special report on automotive electronics (see p. 93), Consumer Editor Jerry Walker became more sensitive than ever about the buckling up of seat belts, a fall-out from talking with auto makers about the electronically controlled seat-belt systems due on the 1974 model cars.

While driving around Detroit for a week of reporting, Walker decided to take an informal survey of how many Detroit-area drivers buckle their shoulder harnesses. He figured that would give him an indication of how motorists will react to the new electronic systems that will require use of the lap and shoulder harness in order to get the car started.

"It looks as though electronics and Government requirements will change at least one driving habit," he reports. "In a week of keeping an eye out for shoulder harnesses, during which I must have passed hundreds of cars, I saw just one in use. And that was on a student driver.

But once sensitized to keeping his belt fastened, he then had a reverse experience during his call on Delco Electronics in Kokomo, Ind. There Walker rode around in one of the 1,000 or so cars that GM has put on the road to test electronically triggered air cushions. "Since the air-bag car has no seat belts, I felt uncomfortable, like Linus without his security blanket. What's more, you wonder if the bag is suddenly going to blow up in your face, but the Delco man using the test car told me that you get over that after awhile.

**W**hile electronics is slow to enter the average car, Wall Street would come to a halt without electronics. The securities industry uses

a wide range of electronic technology—from telecommunications to voice-response computers—to meet the need for up-to-the-second information.

While putting together the Probing the News story that looks beyond the current business boom (see p. 67), Associate Editor Howard Wolff checked in with some Wall Street securities analysts. "It happened with every analyst I visited. He or she would talk for a while, then suddenly push some buttons on the desktop terminal and solemnly inform me that the market was up or down. The ubiquitous little displays have become as necessary and accepted an adjunct of the securities business as the Dow-Jones average itself."

"Not only that," adds Wolff, "but hand-held calculators are getting a big reception there, too. One analyst I interviewed had two—plus a desktop model—and said he needed them all.

**I**f you think the op amp is a versatile device, take a look at the integrated-circuit timer. As Circuit Design Editor Lucinda Mattera points out in presenting a series of timer applications in Engineer's Notebook (see p. 128), monolithic timing circuits may well replace the general-purpose op amp as the most versatile linear IC. And on page 142, you'll find a product wrap-up on who's doing what and what's available in IC timers.



June 21, 1973 Volume 46, Number 13  
91,799 copies of this issue printed

Published every other Thursday by McGraw-Hill, Inc. Founder: James H. McGraw 1860-1948. Publication office 1221 Avenue of the Americas, N.Y., N.Y. 10020; second class postage paid at New York, N.Y. and additional mailing offices.

Executive, editorial, circulation and advertising addresses: Electronics, McGraw-Hill Building, 1221 Avenue of the Americas, New York, N.Y. 10020. Telephone (212) 997-1221. Teletype TWX N.Y. 710-581-5234. Cable address: MCGRAWHILL N.Y.

Subscriptions limited to persons with active, professional, functional responsibility in electronics technology. Publisher reserves the right to reject non-qualified requests. No subscriptions accepted without complete identification of subscriber name, title, or job function, company or organization, including product manufactured or services performed. Subscription rates: qualified subscribers in the United States and possessions, Canada, and Mexico \$8.00 one year, \$12.00 two years, \$16.00 three years; all other countries \$25.00 per year, except Japan \$50.00 per year and Brazil \$40.00 per year, including air freight. Limited quota of subscriptions available at higher-than-basic rate for persons outside of field served, as follows: U.S. and possessions and Canada, \$25.00 one year; all other countries \$50.00. Single copies: United States and possessions and Canada, \$1.00; all other countries, \$1.75.

Officers of the McGraw-Hill Publications Company: John R. Emery, President; J. Elton Tuohig, Executive Vice President-Administration; Gene W. Simpson, Group Publisher-Vice President; Senior Vice Presidents: Ralph Blackburn, Circulation; John R. Callahan, Editorial; John B. Hoglund, Controller; David G. Jensen, Manufacturing; Gordon L. Jones, Marketing; Jerome D. Luntz, Planning & Development.

Officers of the Corporation: Shelton Fisher, President; Wallace F. Traendly, Group President, McGraw-Hill Publications Company and McGraw-Hill Information Systems Company; John J. Cooke, Senior Vice President and Secretary; Ralph J. Webb, Treasurer.

Title registered in U.S. Patent Office; Copyright © 1973 by McGraw-Hill, Inc. All rights reserved. The contents of this publication may not be reproduced either in whole or in part without the consent of copyright owner.

Subscribers: The publisher, upon written request to our New York office from any subscriber, agrees to refund that part of the subscription price applying to copies not yet mailed. Please send change of address notices or complaints to Fulfillment Manager; subscription orders to Circulation Manager, Electronics, at address below. Change of address notices should provide old as well as new address, including postal zip code number. If possible, attach address label from recent issue. Allow one month for change to become effective.

Postmaster: Please send form 3579 to Fulfillment Manager, Electronics, P.O. Box 430, Hightstown, N.J. 08520.

# The filter that stands by itself.

Model 3550 multifunction filter has no competition. For just \$590, this instrument provides band-pass, band-reject, low-pass or high-pass operation — instantly selected by a single front panel switch. The 3550 minimizes circuit loading with high input impedance and overcomes load sensitivity with low output impedance. Cut-off frequency is continuously adjustable from 2Hz to 200kHz — covering the entire

audio range and well beyond. Model 3550 also offers a choice of Butterworth response or Low Q for transient-free performance. It's features like these that leave all other filters without a leg to stand on. For fast action, call The Wavemakers at (617) 491-3211, TWX 710-320-6583 Krohn-Hite Corporation, 580 Mass. Ave., Cambridge, Mass. 02139.



**KH** KROHN-HITE  
CORPORATION

SALES OFFICES: ALA., Huntsville (205) 534-9771; CAL., Santa Clara (408) 243-2891, Inglewood (213) 674-6850; COLO., Littleton (303) 795-0250; CONN., Glastonbury (203) 633-0777; FLA., Orlando (305) 894-4401; HAWAII, Honolulu (808) 941-1574; ILL., Des Plaines (312) 298-3600; IND., Indianapolis (317) 244-2456; MASS., Lexington (617) 861-8620; MICH., Detroit (313) 526-8800; MINN., Minneapolis (612) 884-4336; MO., St. Louis (314) 423-1234; N.C., Burlington (919) 227-2581; N.J., Bordertown (609) 298-6700; N.M., Albuquerque (505) 255-2440; N.Y., E. Syracuse (315) 437-6666, Rochester (716) 328-2230, Wappingers Falls (914) 297-7777, Vestal (607) 785-9947, Elmont (516) 488-2100; OHIO, Cleveland (216) 261-5440, Dayton (513) 426-5551; PA., Pittsburgh (412) 371-9449; TEX., Houston (713) 468-3877, Dallas (214) 356-3704; VA., Springfield (703) 321-8630; WASH., Seattle (206) 762-2310; CANADA, Montreal, Quebec (514) 636-4411, Toronto, Ontario (416) 444-9111, Stittsville, Ontario (613) 836-4411, Vancouver, British Columbia (604) 688-2619.

No matter  
what shape  
your waves  
are in . . .

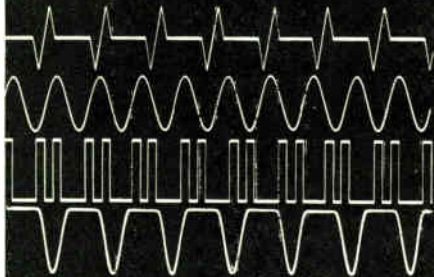

Intronics gives  
you their true  
RMS value.

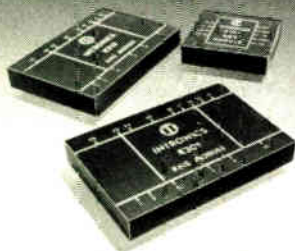

$$E_1(\text{RMS}) = \sqrt{\frac{1}{T} \int_0^T (E_1)^2 dt}$$

And you'll get to keep more than two thirds of what you would expect to pay for true Root Mean Square measurements. Intronics' RMS Operator Modules accept any arbitrary input waveforms—sine, distorted sine, square, random and complex. They perform the actual operations of squaring, averaging and square rooting. And they provide an output which is a smooth, continuous function of the input without breakpoint type non-linearities. Intronics' RMS Modules provide accuracies to 0.05%, precise measurements from DC to 1 MHz, response time as fast as 2 msec, and DC calibration.

You no longer need to settle for the insufficient accuracies of averaging and peak value devices, or the high cost of a true RMS voltmeter. Specify Intronics' RMS Modules. It's the best way to avoid worries about the shape of things.

  
**intronics**

57 Chapel Street, Newton, Massachusetts 02158 U.S.A.  
617-332-7350, TWX 710-335-6835

Overseas Call:  
Brussels, Belgium 35-97-91 Tel-Aviv, Israel 53459  
Helsinki, Finland 11-123 Milan, Italy 719-518  
Paris, France 9077844 The Hague, Holland 678380  
Munich, Germany 524181 Maldstone, England 54224

## Readers comment

### Product line

**To the Editor:** In Electronics Newsletter in the May 10 issue, I was quoted as saying that GI will announce eight 4000-type C-MOS products by the end of the year.

While it is true that we now have available our MEM4016, an equivalent to the RCA CD4016 C-MOS quad bilateral switch, the other C-MOS products planned by General Instrument are not 4000-type devices. New C-MOS products from GI include an interface C-MOS driver used to control MOS and C-MOS multiplexers and analog switches requiring 15 volts from transistor-transistor-logic levels, an eight-channel C-MOS multiplexer, and a dual eight-channel and a 16-channel multiplexer all with TTL-compatible inputs.

E. J. Kramer  
Product marketing manager  
for MOSFETS  
General Instrument Corp.  
Hicksville, N. Y.

### More on numbers

**To the Editor:** The "calculator puzzle" in Readers Comment in the April 26 issue is what I consider a calculator joke instead of puzzle. Because everyone knows the commutative and associative laws in elementary algebra,  $(a \times b) \times c = c \times (a \times b) = (c \times a) \times b$ . If  $a = 15873$ ,  $b = N$  ( $N = 1, 2 \dots 9$ ), and  $c = 7$ , then  $c \times a = 7 \times 15873 = 111111$ . It is evident that this number multiplied by  $N$  equals  $NNNNNN$ .

I have something more interesting than this. I found that there exist infinite numbers which have a property similar to a ring counter. For example, 142857, shift right and end carry to the left, becomes 714285, which equals  $142857 \times 5$ . On a calculator with 16-digit display, try this number: 0588235294117647. Or on an "octal calculator" (no such calculator is on the market right now) try the number 0564272135<sub>8</sub>. Should anybody want to know how to generate this kind of number and why it behaves this way, I would be happy to hear from him.

Shing F. Lin  
Design engineer  
Mostek Corp.  
Carrollton, Texas

**For bonding  
metal-  
to-metal-  
to-glass-  
to-glass-to-  
plastics-  
to-plastics-  
to-rubber-to-  
rubber-to-  
metal-to-etc-  
to-etc.**



One drop goes a long way in fastening almost anything to almost anything.

Eastman 910<sup>®</sup> adhesive bonds fast, too. Almost instantaneously. With only contact pressure.

Tensile strength? Up to 5000 psi at room temperature.

New Eastman 910 MHT and THT/Grades hold when the heat's on. Even over 400° F.

For further data and technical literature, write: Eastman Chemical Products, Inc., Kingsport, Tennessee 37662.





# Introducing the first American fuseholder to meet Europe's IEC standards.



## The "shock-safe" 3AG fuseholder.

Our new fuseholder isn't really red, white and blue. Its standard color is black, just like all other fuseholders.

But there the similarity ends.

For this Littelfuse fuseholder is the only American-made holder designed to meet current International Electrotechnic Commission standards.

IEC's Publication No. 65, accepted by all European countries, requires fuseholders to offer absolute protection against electric shock, even under fault conditions.

And that's exactly what our new 3AG "Shock-Safe" fuseholder does! Several safety features have been incorporated into the fuseholder design to protect the user from any possibility of touching live parts.

In addition, our "Shock-Safe" fuseholder offers another important form of protection by

assuring your acceptance in European markets. For if the fuseholder used in your product doesn't meet IEC standards, that product could be rejected by European testing and approval boards, which refer to Publication No. 65 for the purchase of equipment.

The "Shock-Safe" fuseholder #345001 has been designed to retrofit existing panel mounting holes and is the **only** 3AG fuseholder currently available for continuous operation to **20 amperes and 300 volts.**

"Shock-Safe" fuseholders from Littelfuse.

A basic necessity if you're selling the European market.

For more information, send for Product Bulletin #1000 or contact your local Littelfuse distributor.

# LITTELFUSE

Subsidiary of Tracor

800 E. Northwest Highway • (312) 824-1188 • Des Plaines, Illinois 60016

Cut package count . . . Simplify board layout . . .  
Reduce equipment size . . . with

# DIP MULTI-COMP<sup>®</sup> RESISTOR-CAPACITOR NETWORKS



(Metanel<sup>®</sup> Film Resistors, Monolythic<sup>®</sup> Ceramic Capacitors)

**STANDARDIZED DESIGNS\* FOR BETTER AVAILABILITY, BETTER PRICES**

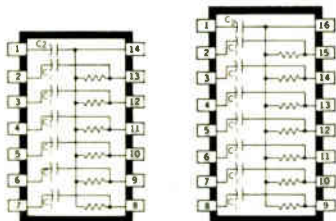

**BYPASSED PULL-UP AND R-C COUPLING NETWORKS**

| R (Ω) |      |      | C 1        |
|-------|------|------|------------|
| 100   | 470  | 2000 | 100pF      |
| 150   | 500  | 2200 | 330pF      |
| 200   | 680  | 3300 | 0.01μF     |
| 220   | 1000 | 4700 | <b>C 2</b> |
| 330   | 1500 | 6800 | 0.05μF     |

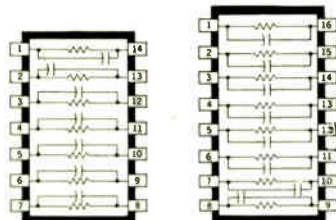

**SPEED-UP NETWORKS**

| R (Ω) |      |      | C      |
|-------|------|------|--------|
| 100   | 470  | 2000 | 1000pF |
| 150   | 500  | 2200 | 3300pF |
| 200   | 680  | 3300 | 0.01μF |
| 220   | 1000 | 4700 |        |
| 330   | 1500 | 6800 |        |

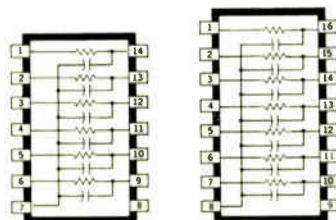

**ACTIVE TERMINATOR NETWORKS**

| R (Ω) |      |      | C (pF) |
|-------|------|------|--------|
| 100   | 470  | 2000 | 100    |
| 150   | 500  | 2200 | 330    |
| 200   | 680  | 3300 |        |
| 220   | 1000 | 4700 |        |
| 330   | 1500 | 6800 |        |

\* OTHER PACKAGES, CIRCUIT CONFIGURATIONS, AND RATINGS AVAILABLE ON SPECIAL ORDER

**Sprague puts more passive component families into dual in-line packages than any other manufacturer:**

- TANTALUM CAPACITORS
- CERAMIC CAPACITORS
- TANTALUM-CERAMIC NETWORKS
- RESISTOR-CAPACITOR NETWORKS
- PULSE TRANSFORMERS
- TOROIDAL INDUCTORS
- HYBRID CIRCUITS
- TAPPED DELAY LINES
- SPECIAL COMPONENT COMBINATIONS
- THICK-FILM RESISTOR NETWORKS
- THIN-FILM RESISTOR NETWORKS
- ION-IMPLANTED RESISTOR NETWORKS

For more information on Sprague DIP components, write or call Ed Geissler, Manager, Specialty Components Marketing, Sprague Electric Co., 509 Marshall St., North Adams, Mass. 01247. Tel. 413/664-4411.

THE BROAD-LINE PRODUCER OF ELECTRONIC PARTS



## 40 years ago

From the pages of Electronics, June 1933

The Chicago World's Fair of 1933 is an all-electronic exposition.

It was opened by electronics; it is lighted by electronics; in large measure it is being operated by electronics; and electronic phenomena and apparatus are among the outstanding features of its many exhibits.

And if the feet of the great American public are not so tired from tramping up and down 85 miles of exhibit aisles and corridors as to drive any other consideration than that of aching "dogs" out of its collective mind, that great American public is going to have a much enlarged and improved understanding of the electronic arts when it gets home from "A Century of Progress" exposition in Chicago this coming summer. The g.A.p. can save a lot of shoe leather if it will allow its electronic interest to be satisfied with explanations and demonstrations of basic phenomena, for these are shown in a most illuminating series of educational exhibits in the Hall of Science. But this is highly improbable, for undoubtedly the public will investigate thoroughly all parts of the Fair exhibits and everywhere will see or hear evidences and examples of electronic application.

The opening of the Fair, with its employment of a quantum of light energy from the star Arcturus caught by a photocell, was a triumphant gesture of electronics. That struck a keynote that continues its tone throughout the period and over the whole area of the Exposition. As on the opening night the big searchlight atop the west Skyride tower, nearly 700 feet in the air, picked out each major group of buildings with its beam and in response, by photo-electric cell control, each spectacular lighting display sprang into brilliance against the dark, so every night of the coming summer will the crowds gasp their "Oh's" and "Ah's" when the electronic lamplighter makes its appointed round. Man has never made a more impressive demonstration than this of the cosmic imperative, "Let there be light."

# The first at this price!

$\pm 1\mu\text{V}$  resolution / 5 full functions / 26 ranges  
Lead-compensated ohms



For immediate information on Systron-Donner's new Model 7205 5½-digit Multimeter, call us collect on our *Quick Reaction* line: (415) 682-6471. Or you may contact your Scientific Devices office or S-D Concord Instruments Division, 10 Systron Drive, Concord, CA 94518. Europe: Systron-Donner GmbH, Munich, W. Germany; Systron-Donner Ltd., Leamington Spa, U.K.; Systron-Donner S.A., Paris (Le Port Marly) France. Australia: Systron-Donner Pty. Ltd. Melbourne.

SYSTRON  DONNER

# The following is a bl the 64-bit RAM

## Super high speed RAMs

We've got 3101A's and 75/8599's.

We've also got the new Am27S02 (a mil temp, open collector version of the 3101A) and the new Am27S03 (a faster, plug-in replacement for the 75/8599).

So you've got plenty of choices: Military or commercial temperature ranges, with open collector or three-state outputs, and any kind of package you want.

There are a couple of things you won't be able to choose: One is that every single 64-bit RAM we sell is built to MIL-STD-883. The other is that we guarantee our specs (including switching times) over the full temperature range.

## High speed RAMs

We've got 3101's, 54/7489's and 93403's.

We second source the whole kit and kaboodle: The temperature ranges, the outputs and all the packages you can name.

Which, for many companies, would be enough.

But not for us.

And so we build every single device—military and commercial—to MIL-STD-883.

And we guarantee the specs of every single device (including switching times) over its full temperature range.

Advanced Micro Devices, Inc., 901 Thompson Place, Sunnyvale, California 94086/TWX 910-339-9280/TLX 346306.  
For product or sales information, call the AMD sales representative nearest you. In Sunnyvale, Shel Schumaker at (800) 538-7904 (toll free from outside California) or (408) 732-2400; in the eastern United States, Steve Marks or Bill Seifert at (516) 676-4500; in Washington/Baltimore, Ken Smyth at (301) 744-8233; in Mid-America, Chuck Keough at (312) 297-4115; in the Los Angeles area, Steve Zelencik or Russ Almand at (213) 360-2102 or Larry Strong at (213) 870-9191; in the United Kingdom, Des Candy at Herne Bay (Kent) 61611; and in Germany, Hermann Lichotka at (0811) 594-680.  
Advanced Micro Devices is distributed nationally by Cramer and Hamilton/Avnet Electronics.

# tant attempt to get all business we can:

## Low power RAM

We've got a great low power 64-bit RAM, too.

Our very own Am31L01.

It offers all the advantages of low power (185 milliwatts, maximum) while maintaining a respectable 105 nanosecond maximum access time.

The Am31L01 comes in both military and commercial temperature versions with open collector outputs and is available in any kind of package you can name.

And while it goes without saying that the Am31L01 is built to MIL-STD-883 and that we guarantee its specs over the full temperature range, we'll say it anyway.

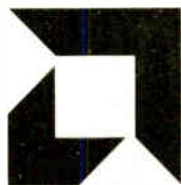
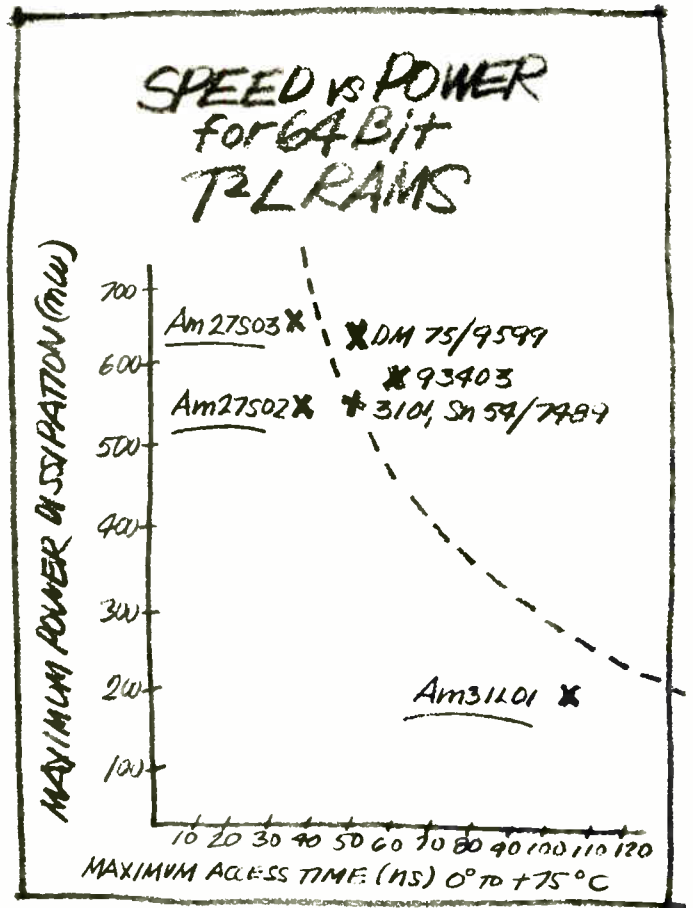

# Advanced Micro Devices, Inc.

(We're going to be #6.)

Circle Bingo card #209

# All Panel Meters are not created equal.



## We try to build an edge into General Electric panel meters.

For instance, you won't see a GE panel meter turn yellow, because we use a special white paint that stays white. You won't get eyestrain either. GE panel meters come with extra-wide scales, big numerals, tapered pointers, and shadow-free cover plates for quick, sure readings. We're fussy about things like that.

## Once you've installed them, forget 'em.

GE's famous reliability just doesn't happen, we *build* it in! We designed-out a lot of extra parts that might fail, just to give you extra instrument reliability. To make sure, we added a 20% overload capability to our voltmeters and ammeters. Still not satisfied, we decided to measure instrument quality from parts to finished product in order to screen out anything marginal. Now, it's just too tough for a lemon to squeeze through.



## GE panel meters come from a good family.

They look good individually and they look good together. Choose the rounded BIG LOOK® design for unique style and wide-eyed readability. Or choose the

clean HORIZON LINE® case for its

behind-panel mounting flexibility (*without* the usual bezel), and its snap-off mask available in six colors. GE makes panel meters to suit you and to add snap to your application.

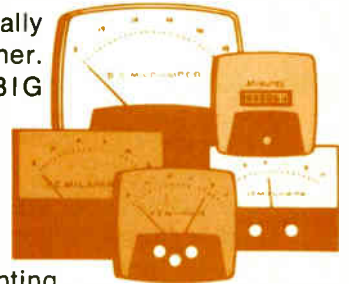

## You can count on General Electric panel meters.

They're built to help you do a better job. At GE, we're not interested in product equality. We want ours to be *better* than the rest.



For a complete catalog of competitively priced and readily available GE panel meters, see your nearby authorized GE distributor. Or write to General Electric Company, Section 592-43, One River Road, Schenectady, N. Y. 12345.

592-43

## Specify General Electric... just for good measure.

Circle 12 on reader service card

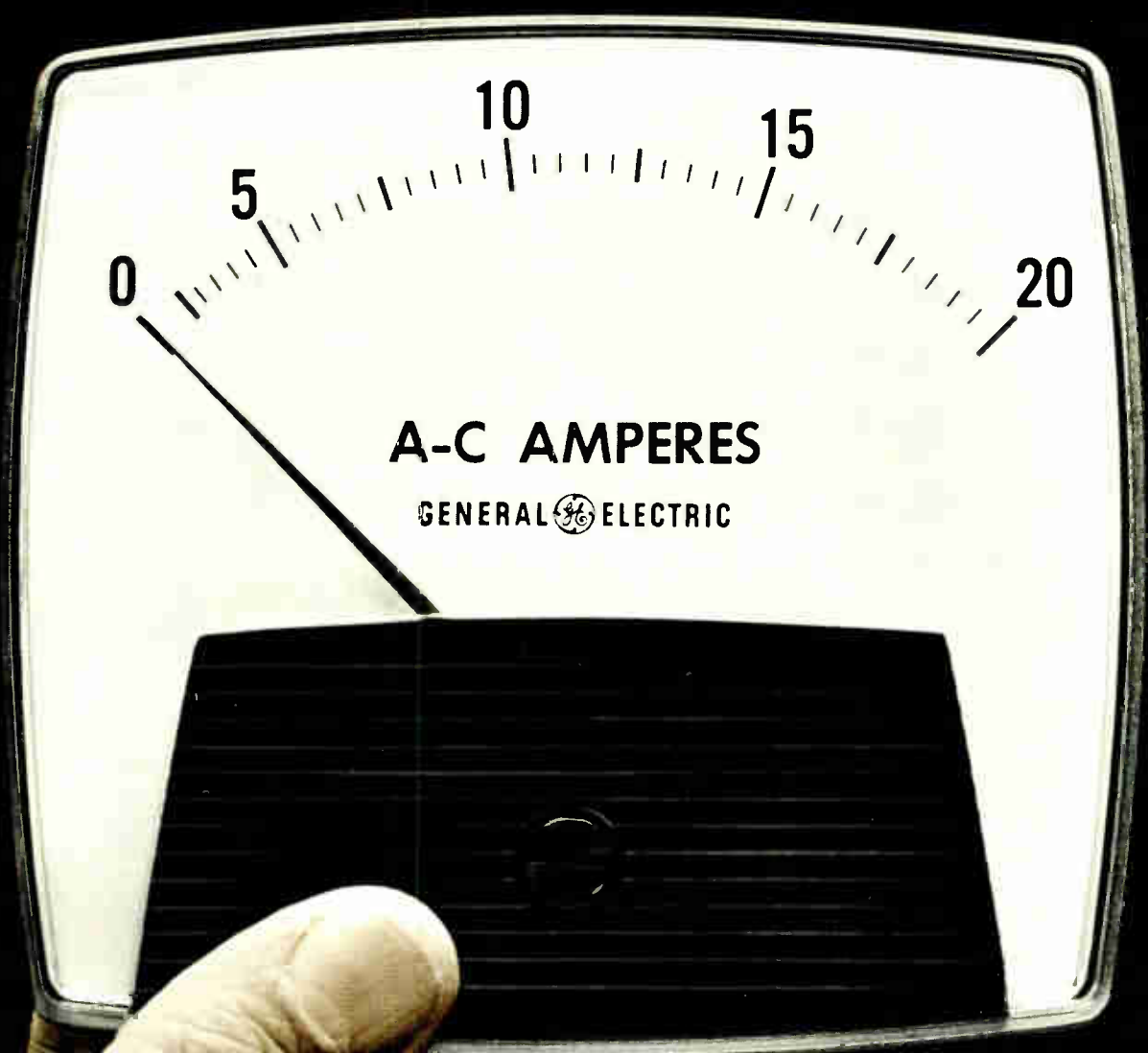

**A-C AMPERES**

GENERAL  ELECTRIC

**GENERAL  ELECTRIC**

**Tubes?  
Forget them.**

**HERE'S 100  
WATTS OF  
SOLID-STATE  
RF POWER!**



**A state-of-the-art amplifier.**

ENI's new Model 3100L *all-solid-state* power amplifier provides more than 100 watts of linear power and up to 180 watts of pulse power from 250 kHz to 105 MHz. This state-of-the-art class A unit supplies over 50 watts at frequencies up to 120 MHz and down to 120 kHz. All this capability is packaged in a case as small as an oscilloscope, and it's just as portable.

**Extraordinary performance.**

Featuring a flat 50 dB gain, the Model 3100L is driven to full power by any signal generator, synthesizer or sweeper. AM, FM, SSB, TV and pulse modulations are faithfully reproduced by the highly linear output circuitry. Immune to damage due to load mismatch or overdrive, the 3100L delivers constant forward power to loads ranging from an open to a short circuit.

Solid-state reliability is here.

The price? \$5,690.

Write for complete information: ENI, 3000 Winton Road South, Rochester, N. Y. 14623  
Call (716)-473-6900 or TELEX 97-8283  
Dept. E 524

**ELECTRONIC  
NAVIGATION  
INDUSTRIES**

**ENI . . . The world's leader  
in solid-state power amplifiers.**

## People

David, the White House's loss  
and Gould Inc.'s gain

Edward E. David Jr., formerly the President's Science Adviser and head of the late Office of Science and Technology, has been hailed as the first—and maybe the last—modern science adviser. Lauded for his extraordinary perception of the role of civilian technology in world affairs, David now is comfortably and enthusiastically settled as executive vice president of Gould Inc. and president of Gould Laboratories, the \$13 million R&D arm of the Chicago-based electronic, electro-mechanical, electrochemical, and metallurgical complex that bills itself as “the integrated technology company.”

Gould's research work in auto emission control systems and electrical propulsion for transportation undoubtedly provided the lure for David, one of the country's leading proponents of energy R&D—what he calls “the Apollo of the '70s and '80s.” But he also cites the company's work in new techniques for energy storage, new information displays, new and automated instruments for measurement and control, and new kinds of medical instrumentation as part of the firm's “irresistible offer to take an effective role in taking civilian technology to a level we haven't had before, but that we can achieve,” David says. “Gould is unique in that it has a very broad base of technology, and that kind of base can spawn many business opportunities.”

**What Gould's got going.** Although he admits that Gould doesn't have the unrestricted use of funds “that we had in the case of NASA and DOD,” David is relying on American industry's ingenuity, excellence, and productivity as he shepherds new technologies through Gould Laboratories. These include, he says, a new ink-on-demand printer based on the firm's ink jet technology, new techniques of very thin foil electroplating at high speeds, vehicular electronics work with Dana Corp. that will result in electronically controlled automatic



**Former OST chief.** Ed David, now at Gould Inc., has been called the first and maybe last modern science adviser to a President.

transmissions, and new forms of actuators for driving such things as automatically locking car doors—this in addition to catalysts for emission control, Wankel engine parts, energy-absorbing devices for collision resistance, and new primary batteries, including a zinc-air battery with 10 times the capability of carbon-zinc cells, and others, with emphasis on peak saving in power systems, and electric propulsion.

**Washington days.** Despite the relative financial limitations of private industry compared with the Government, David likely has more opportunity now than would be the case if he had remained in Washington and the Office of Science and Technology had not been abolished. “Ed David,” a Washington wag once quipped, “is a bartender to a teetotaler.”

David agrees that President Nixon has not exactly been on a science and technology binge—“he's more like a social drinker, who likes his wine and an occasional light aperitif,” he says. But certainly, with David's departure and the demise of the OST and the President's Science Advisory Committee, the science and engineering community has lost its defender, and its visibility, at the



# MOSTEK WILL WORK WITH YOU. ASK DATAPPOINT.

DATAPPOINT Systems have literally streamlined data handling operations for various industries throughout the nation. But it didn't "just happen", according to Bill Bramlett, Manager of Support Engineering for DATAPPOINT. "We wanted to utilize the full advantages of the state-of-the-art.

Specifically, we wanted to get away from the serial memory system and put MOS technology to work in order to achieve a faster, more reliable, space-saving processor. While searching the industry for someone who could come up with a 1K RAM, we met MOSTEK. They accepted our problem and met

the challenge with a 1K RAM that doubled our memory size and increased our speed by a factor of 100. What really impressed us was MOSTEK's willingness to keep refining the design and production of their 1K RAM; today, we enjoy trouble-free operation across the country."

DATAPPOINT exemplifies what we do best: analyze the problem, formulate the solution, produce the result, and work closely with our customer. But don't take our word for it; ask DATAPPOINT. Then call MOSTEK: we'll work with you.



On the Datapoint assembly line, San Antonio, Texas: Dave West, Mostek Sales Manager examining the MK 4008 P Memory System (1 K RAM); on the right, Bill Bramlett, Manager of Support Engineering, Datapoint Corporation.

## MOSTEK®

1215 West Crosby Road  
Carrollton, Texas 75006  
(214) 242-0444  
TWX 910-860-5975  
TELEX 73-0423

© Copyright 1973 by MOSTEK Corporation

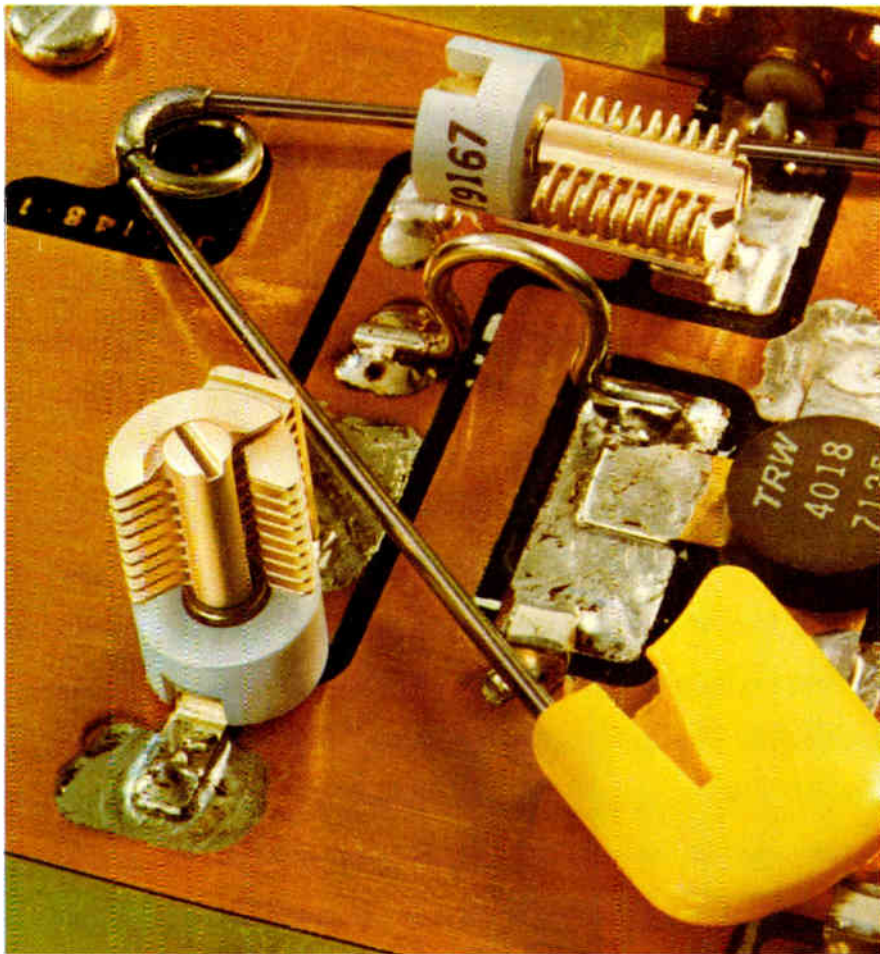

## The smallest 180° tuning air variable capacitors just had babies!

Right. Johnson's exclusive subminiature type "T" air variable capacitors (PC mounts) now come with stripline terminals for microwave applications, either vertical or horizontal tuning.

These space-savers are only about 1/3 the volume of a "U" capacitor, but they offer extraordinarily high mechanical and electrical performance for critical applications.

Rotors and stators are as stable and uniform as precision machining from solid brass extrusion can make them. A high 1 1/2 to 8 ounce-inches torque holds the rotor securely under vibration.

Temperature coefficient is very low plus 30 ± 15 ppm/° C. Q is high, typically 1800 at 200 MHz. Three capacitance ranges span from 1.3 pF to 15.7 pF.

Our 45 years of experience really shows up in these new capacitors. But why take our word for it when a stamp will get you a couple of freebees and you can check them out for yourself.



E. F. JOHNSON COMPANY/3005 Tenth Ave. S.W./Waseca, Minnesota 56093

| Check type and range of sample(s) needed. | Capacitance range | 1.3 to 5.4               | 1.7 to 11.0              | 1.9 to 15.7              |
|---|-------------------|--------------------------|--------------------------|--------------------------|
| Horizontal tuning                         |                   | <input type="checkbox"/> | <input type="checkbox"/> | <input type="checkbox"/> |
| Vertical tuning                           |                   | <input type="checkbox"/> | <input type="checkbox"/> | <input type="checkbox"/> |

Name \_\_\_\_\_ Phone \_\_\_\_\_

Firm \_\_\_\_\_ Title \_\_\_\_\_

Address \_\_\_\_\_

City \_\_\_\_\_ State \_\_\_\_\_ Zip \_\_\_\_\_



**E. F. JOHNSON COMPANY**

highest level. David, however, doesn't think that's all bad.

He characteristically underplays his role in doubling the Federal science budget and his efforts for a new and expanded air-traffic control system, new technology in mass transit, conversion of military centers to cancer and toxicological research, the civilian-oriented space shuttle, the breeder reactor program, intensified research into fossil fuels, and reactor safety, to name a few—which "all sort of happened," he says, during his 28-month tenure in Washington. Instead, the focus of science and technology has been blurred—decentralized into each Government agency and department. "I think it's not all a bad thing," he says. "I think we've reached a point that we need to get operating people to stand on their own feet for the R&D they need."

**No longer heroes.** The loss of a White House-level ombudsman is an indication that the influence of the scientific community has waned, David observes. "Science and engineering are no longer the heroes they once were, at least in the public's eye. Basically, I think that while OST itself was a highly prestigious, favored force by the scientific community—because it indicated that science had an influence beyond science itself—it was the prestige of the office that was lost more than any tangible impact on Government departments," he says. "It's a reflection of a real decline in the public's receptivity to science and engineering talking about the affairs of mankind."

A graduate of Georgia Tech with advanced degrees from the Massachusetts Institute of Technology, David joined the Nixon Administration from his post as executive director of research in communications systems at Bell Telephone Laboratories. Besides having what has been called an "annihilative" tennis skill, he is an avid skier and spends part of the summer horsebackpacking. More sedentary interests include geology, mineralogy, and writing, and "my wife says I have too much camera equipment," he adds.

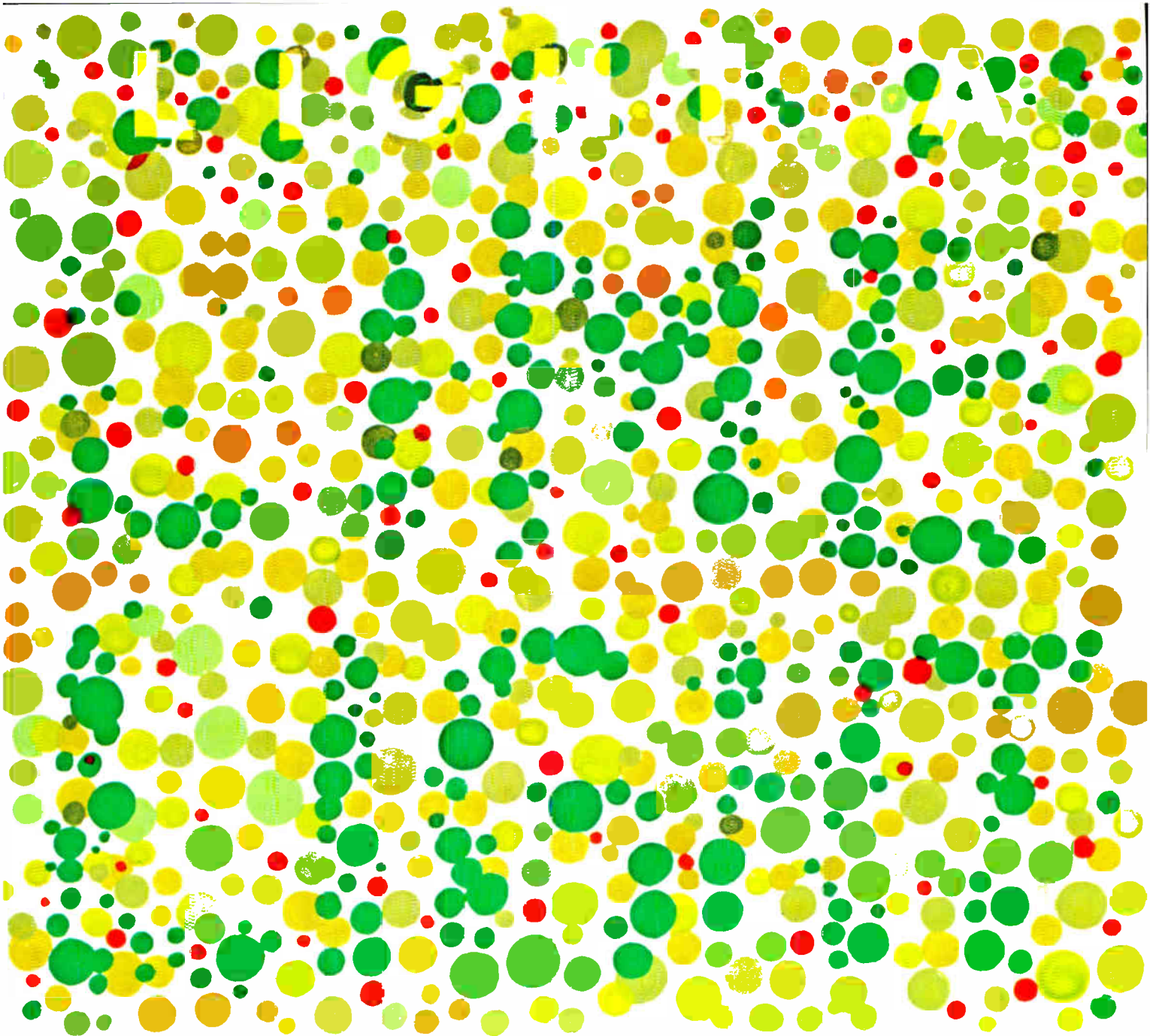

READ THIS PAGE FROM 10 FEET AWAY.

It'll tell you what to do when you want a state-of-the-art green LED indicator that's human-engineered to be seen from a considerably greater distance than possible with present industry offerings.

It'll give you a name to remember when you want the lowest-cost green LED in the industry: the MLED750 that costs just 99¢, 100-up . . . more than a nickel less than dimmer devices.

It'll indicate what green device goes on like this: 0.5 millicandellas brightness at 25 mA, 2 volts  $V_F$  and a 90° viewing angle. And stays on — evergreen.

It'll reveal who's got the technical competence to offer a brighter-packaged LED.

It'll show you you should specify green. . .

From Motorola, the  LED Producer.

# Maximum switching performance comes in two sizes: small and smaller.

MICRO SWITCH SM and 1SX subminiatures offer electrical capacity normally found only in much larger switches. The result is big switch performance in a smaller package.

Since both devices are extremely versatile, they can be used whenever space and weight are critical.

Choose from hundreds of versions, including some that meet MIL-S-8805. Our small

SM (up to 11 amp capacity) and the smaller 1SX (up to 7 amp capacity) are both available with a variety of actuator and terminal styles. There's even a screw-terminal

SM as well as a sealed-plunger version for wet or dirty applications. UL and CSA listings are standard. Low operating force, bifurcated gold contact and low differential travel types are available for your application.

For more information, contact your MICRO SWITCH Branch Office or Authorized Distributor (Yellow Pages, "Switches, Electric"). No request is too small for them to handle.

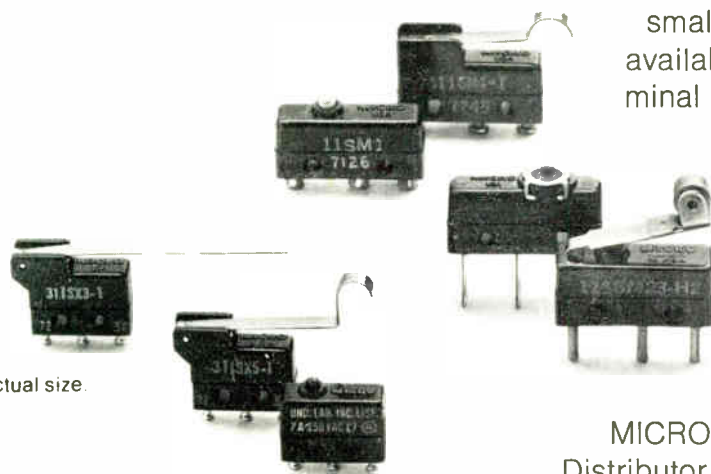

Shown actual size.

MICRO SWITCH makes your ideas work.

MICRO SWITCH products are available worldwide through Honeywell International.

18 Circle 18 on reader service card

**MICRO SWITCH**  
FREEPORT ILLINOIS 61032  
A DIVISION OF HONEYWELL

# New Tool New Board New Method

**it's part of the TY-RAP® System**

**Now tie quicker than ever before...**

Our new high speed tool does it all . . . feeds a TY-RAP tie around bundle, cinches to a preset tension, locks securely and trims evenly . . . all in  $\frac{8}{10}$  of a second. There is no tool adjustment needed regardless of bundle diameter from  $\frac{1}{32}$ " to  $\frac{3}{8}$ ".

The off-the-board harnessing method allows the tool optimum use. This technique utilizes our new harness board and harnessing aids. The board is reusable and reversible. It's modular too . . . snaps together for larger work areas. It's constructed of poly-ethene foam sandwiched between two metal screens — nails are pushed in by hand. It's all part of the TY-RAP System to lower your costs of harness fabrication.

Write for new catalog, The Thomas & Betts Company, Elizabeth, New Jersey 07207 (201) 345-4321. In Canada, Thomas & Betts Ltd., P. Q.

**Sold Only Through Authorized T&B Distributors**

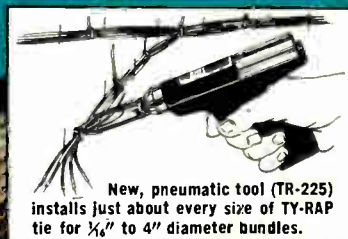

New, pneumatic tool (TR-225) installs just about every size of TY-RAP tie for  $\frac{1}{32}$ " to 4" diameter bundles.



**THOMAS & BETTS**

Division of Thomas & Betts Corporation

517

Circle 19 on reader service card

# Siemens introduces the lowest profile in PC-board EMR's.

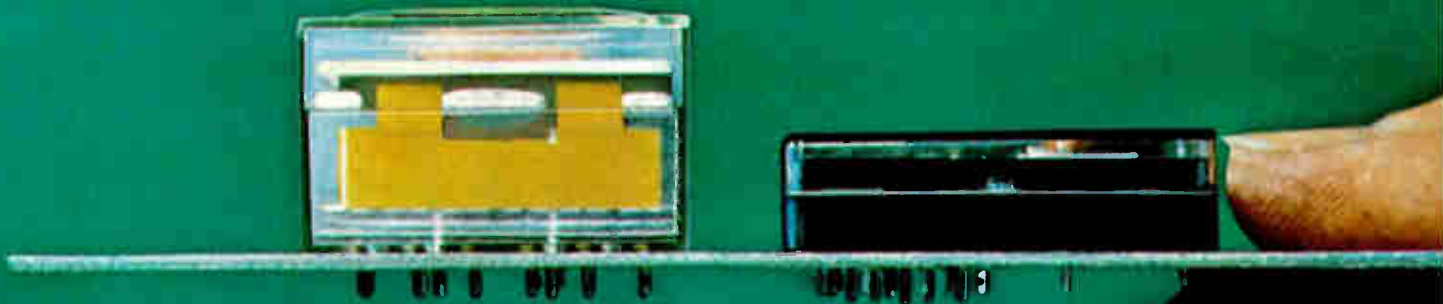

Common  
low profile

Siemens  
low profile

6PDT

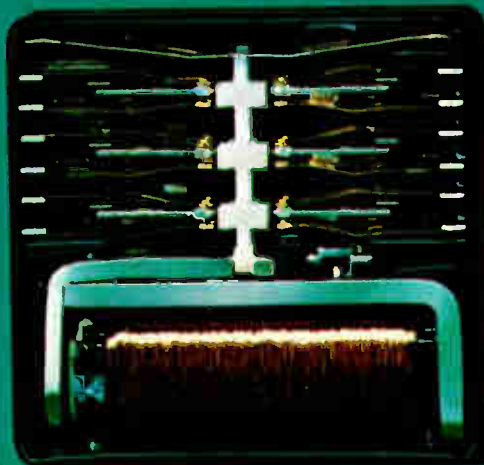

4PDT

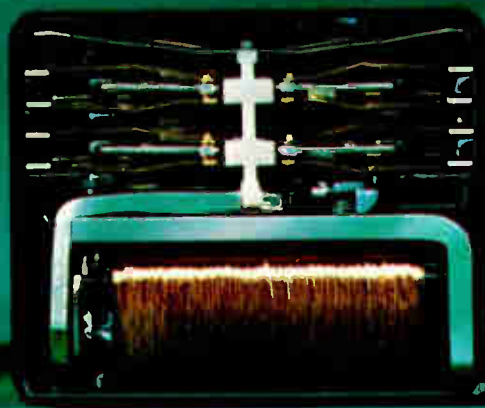

DPDT

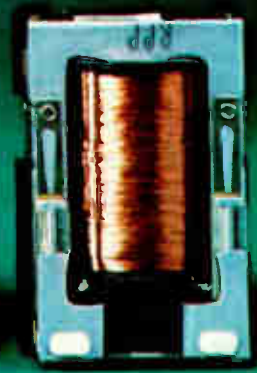

**These new low profile relays with only 0.4" height let you put twice as many PC boards in a rack yet give you over twice the current rating.**

Siemens, one of the world's leading relay manufacturers, has come up with another major relay innovation. This time it's a complete family of general-purpose Electro-Mechanical Relays with a lower profile combined with higher current rating than has been possible with any available design.

The new Siemens family consists of DPDT, 4PDT, and 6PDT models which have uniformly the same 0.4 inch height above the PC-board face and have contact ratings of 1 A at 24VDC (0.3 A at 115 VAC).

No longer need the relay be a limiting design factor. You can use Siemens low profiles on racks with 0.5" center-to-center PC-board spacing instead of up to one inch spacing. Thus you can pack up to twice the circuitry in the same space.

It also means you can design to switch twice the current you had been limited to by earlier PC-board relay types. Or if you don't need more current, you have a much higher safety margin.

The new Siemens relays have bifurcated contacts for high reliability, and a sealed base that keeps flux or solder from from contaminating the contacts.

Siemens has many additional high-reliability, general-purpose relays. Write or call us for more information on the new low profile line or for relays for other applications.

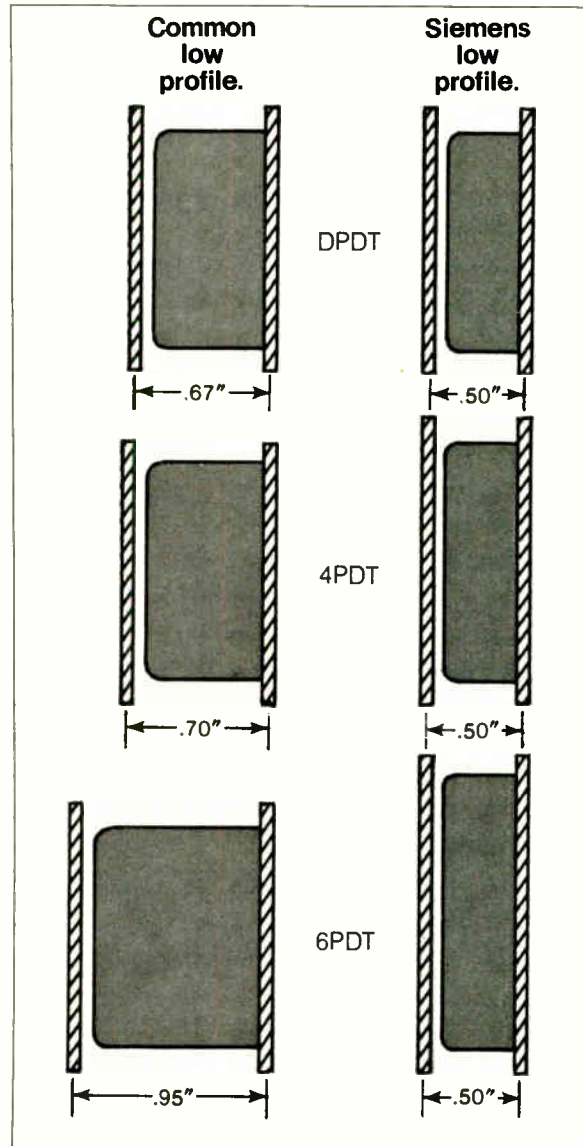

Siemens low-profile relays are easily mounted in racks with 0.5" center-to-center PC-board spacing.

Siemens Corporation, Special Components Department, 186 Wood Avenue South, Iselin, New Jersey 08830. (201) 494-1000.

At left, the first complete family of low-profile relays.

# WHY CHOOSE RENTAL ELECTRONICS WHEN YOU RENT, LEASE, OR RENTAL-PURCHASE?

Because REI is the recognized leader when it comes to supplying you the most complete selection of electronic/scientific test equipment—to rent, to lease, or to rental-purchase—at the most attractive costs.

Now, more than ever, you must expand along with the pace of economic and technological development. To avoid the handicap of obsolete equipment, to help you maintain a flexible budget, to keep abreast of the competition, to assure growth with increased production and sales—Rental Electronics offers you the instruments you need, when you need them, for as long as you need them.

REI offers you precisely the right instruments—everything from amplifiers to oscilloscopes to synthesizers—with a plan custom-designed to meet your specific requirements!

Our staff of sophisticated financial planners is ready to help you choose the rental, lease, or rental-purchase package that best fits your situation.

And your needed equipment is ready for almost instantaneous delivery, direct from one of nine strategically-located "Instant Inventory" Centers across the U.S. and Canada.

Every Rental Electronics customer is our *very special* customer, receiving the service he needs under a rental, lease, or rental-purchase plan custom-tailored especially for him. The results are increased *PROFITS* for you!

**Ask for our full catalog today! Write or call:**



## Rental Electronics, Inc.

A **PEPSICO** LEASING COMPANY

99 Hartwell Avenue, P. O. Box 223  
Lexington, Massachusetts 02173 Tel. 617/862-6905

Gaithersburg, Maryland 301/948-0620 / Lexington, Massachusetts 617/861-0667 / Anaheim, California 714/879-0561 / Rosemont, Illinois 312/671-2464 / Fort Lauderdale, Florida 305/771-3500 / Dallas, Texas 214/638-4180 / Oakland, New Jersey 201/337-3757 / Ontario, Canada 416/677-7513 / Palo Alto, California 415/328-4525

## Meetings

**Design Automation Workshop:** ACM, IEEE, Sheraton, Portland, Ore., June 25-27.

**International Symposium on Information Theory:** IEEE, Ashkelon, Israel, June 25-29.

**International IEEE G/AP Symposium and USNC/URSI Meeting:** IEEE, U. of Colorado, Boulder, Aug. 21-24.

**17th Annual Meeting and Equipment Display:** SPIE, Town and Country, San Diego, Calif., Aug. 27-29.

**European Microwave Conference:** IEEE, IEE, Brussels University, Belgium, Sept. 4-7.

**Western Electronic Show & Convention (Wescon):** Wema, Hilton and Cow Palace, San Francisco, Sept. 11-14.

**Third European Solid-State Device Research Conference:** IEEE et al., Munich Technical University, West Germany, Sept. 18-21.

**International Conference on Engineering in the Ocean Environment:** IEEE, Washington Plaza, Seattle, Sept. 25-28.

**International Exhibition of Industrial Electronics (Elettronica 2):** Turin, Italy, Sept. 29-Oct. 8.

**International Electron Devices Meeting:** IEEE, Sheraton Park, Washington, D.C., Oct. 7-10.

**Electronic and Aerospace Systems Convention (Eascon):** IEEE, Sheraton, Washington, Oct. 8-10.

**Optical Society of America Annual Meeting:** OSA, Holiday Inn—Downtown, Rochester, N.Y., Oct. 9-12.

**International Telemetry Conference/USA:** ITC, Sheraton Northeast, Washington, D.C., Oct. 9-11.

**Canadian Computer Show & Conference:** CIPS, Exhibition Park, Toronto, Oct. 16-18.



CERAMIC  
AIR  
GLASS  
QUARTZ  
PLASTIC

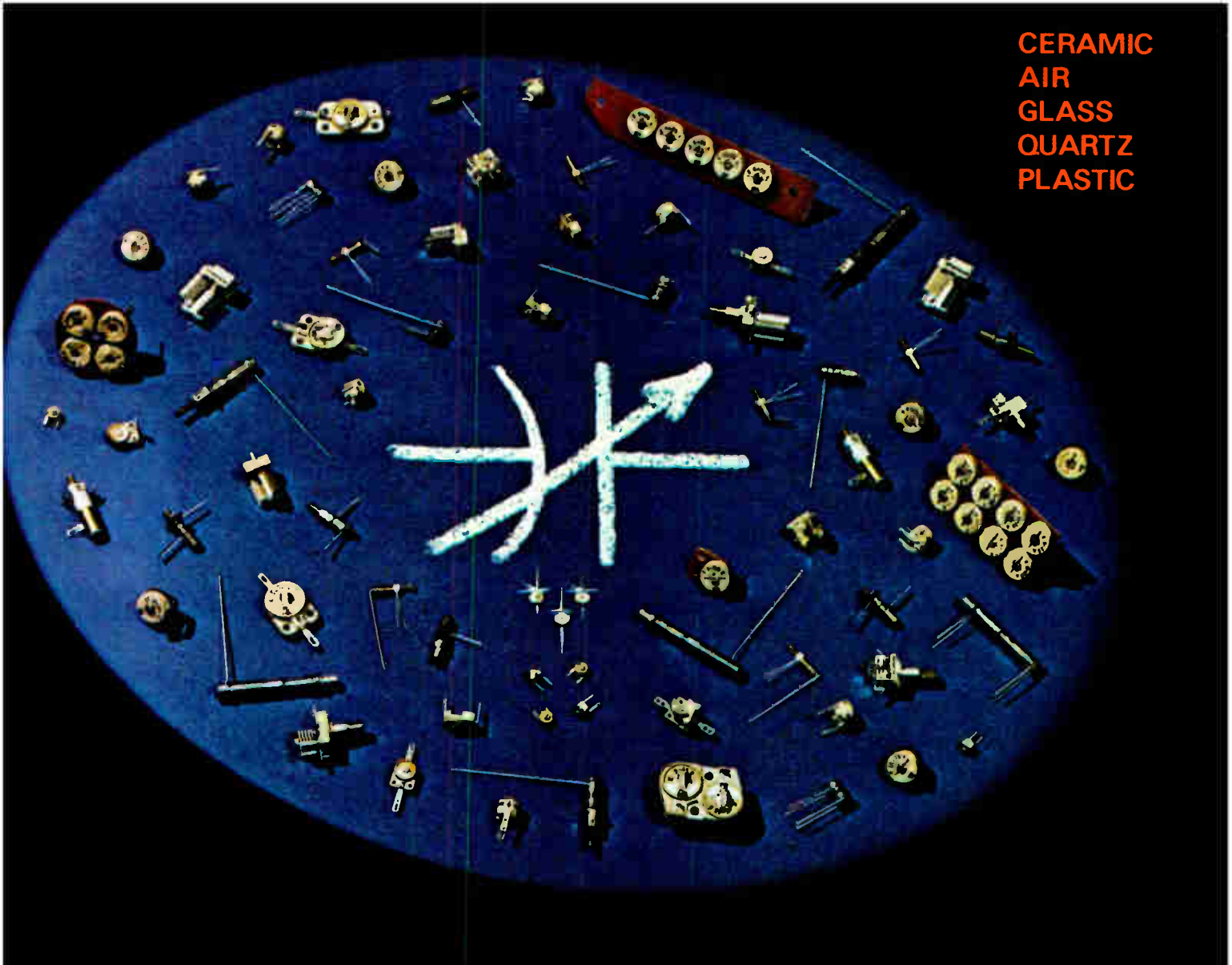

## THE TRIMMER CAPACITOR YOU NEED APPEARS SOMEWHERE IN THIS SPOTLIGHT

**MORE THAN 1,000 VARIATIONS TO CHOOSE  
FROM . . . AND ERIE DELIVERS ON TIME**

When engineering and purchasing people need Trimmer Capacitors, most look to ERIE first. And for good reason. It's easy to find the trimmers they need. The price is right . . . the quality is typically ERIE . . . and they know ERIE delivers on time to meet production schedules.

ERIE Trimmer Capacitors range in size from the tiny new "Vari-Thin" 515 Ceramic Trimmer for quartz watches and other miniature circuits . . . up to a variety of larger sizes and assemblies. Whether you need ceramic, air, glass, quartz or plastic, we have the dielectric, capacitance range and mounting arrangement to meet your requirements. If you have the application . . . ERIE has the Trimmer Capacitor. In the spotlight above, can you find the Trimmer best suited to your current bread-board circuit?

Let ERIE serve as your one-stop source for quality Trimmer Capacitors.

**WRITE TODAY FOR OUR  
TRIMMER CAPACITOR  
CATALOG . . . 500  
OR CALL 814/453-5611**

**ERIE TECHNOLOGICAL PRODUCTS, INC.**

Erie, Pennsylvania 16512

Circle 23 on reader service card

# ERIE

# How Would You Like To Get Answers Like These In Seconds?

It took only 27 seconds for HP's 3042A Automated Network Analyzer System to perform this complete low-pass elliptic filter analysis. Note the detailed plot of amplitude response as well as the tabulated printout of all the important filter characteristics. HP's 50 Hz to 13 MHz network analyzer systems are truly state-of-the-art. They can free you from countless hours of point-by-point measuring and plotting—and they're equally valuable on the production line and in the lab.

**The Most-Powerful 3042A System** not only can perform your entire testing process, but it lets you make measurements that you never could do before. It's a fully-automatic two-channel analyzer that will completely characterize any two-port linear device. Because it's automated, you get outstanding

ELLIPTIC FILTER  
TEST

FILTER NO. = 25003

INSERTION LOSS  
PASS  
0.15 DB

PASSBAND RIPPLE  
PASS  
≤ 0.3 DB

STOPBAND REJ.  
PASS  
> 50DB

1600 HZ REJ.  
-65.87 DB

2400 HZ REJ.  
-91.97 DB

3DB FREQUENCY  
1066.9 HZ

PASSBAND DELAY  
PASS  
≤ 0.4 MSEC

data repeatability along with the dramatic speedup in testing rate. Use it to fully test such time-takers as active filters, crystals or op amps. You can do them in seconds or minutes instead of the usual hours or days.

The system is comprised of three standard HP products—a synthesizer source, a tracking detector, and a calculator. This powerful combination applies equally to one-of-a-kind lab tests, or to repetitive production line testing. And, in addition to being able to make such tests as group delay, limit testing and offset measurements automatically, you also gain the capabilities of data reduction and decision making. You can have this fast, capable 3042A System for \$22,300—ready to operate.

**Semi-Automatic 3041A System** brings you the advantages of partial automation for significantly less money than full automation would cost. It incorporates the same synthesizer source and tracking detector used in the fully-automated system, but is controlled by a more economical marked card programmer (instead of the calculator). You can even make group delay, limit test and offset measurements with the 3041A. At \$14,000, it's modestly priced but does the work of systems costing much more.

**Basic 3040A System** teams the tracking detector with one of four automatic synthesizer sources. It's a budget-priced combination that provides you with many of the capabilities of a dedicated automated system, but at much lower cost. When you select the top-of-the-line automatic synthesizer you get a lab-in-a-box with a "brain." It combines the performance of a synthesizer, a sweeper, a marker generator, a counter, a programmable attenuator, a precision level generator, and a controller in one instrument. Depending on

the synthesizer you choose, these high-capability systems cost from \$6,900 to \$11,000.

All three of the Network Analyzer systems help you do more work in less time and with less labor. With them you can telescope what formerly took hours, or even days, into only minutes or seconds. Optional accessories let you select and pay for only the exact capability you need. For full details on these network analyzer systems call your local HP field engineer. Or, write Hewlett-Packard, Palo Alto, California 94304. In Europe: HPSA, P.O. Box 85, CH-1217 Meyrin 2, Geneva, Switzerland. In Japan: Yokogawa-Hewlett-Packard, 1-59-1, Yoyogi, Shibuya-Ku, Tokyo, 151.

093/40

**HEWLETT**  **PACKARD**

**NETWORK ANALYZERS**

Circle 25 on reader service card

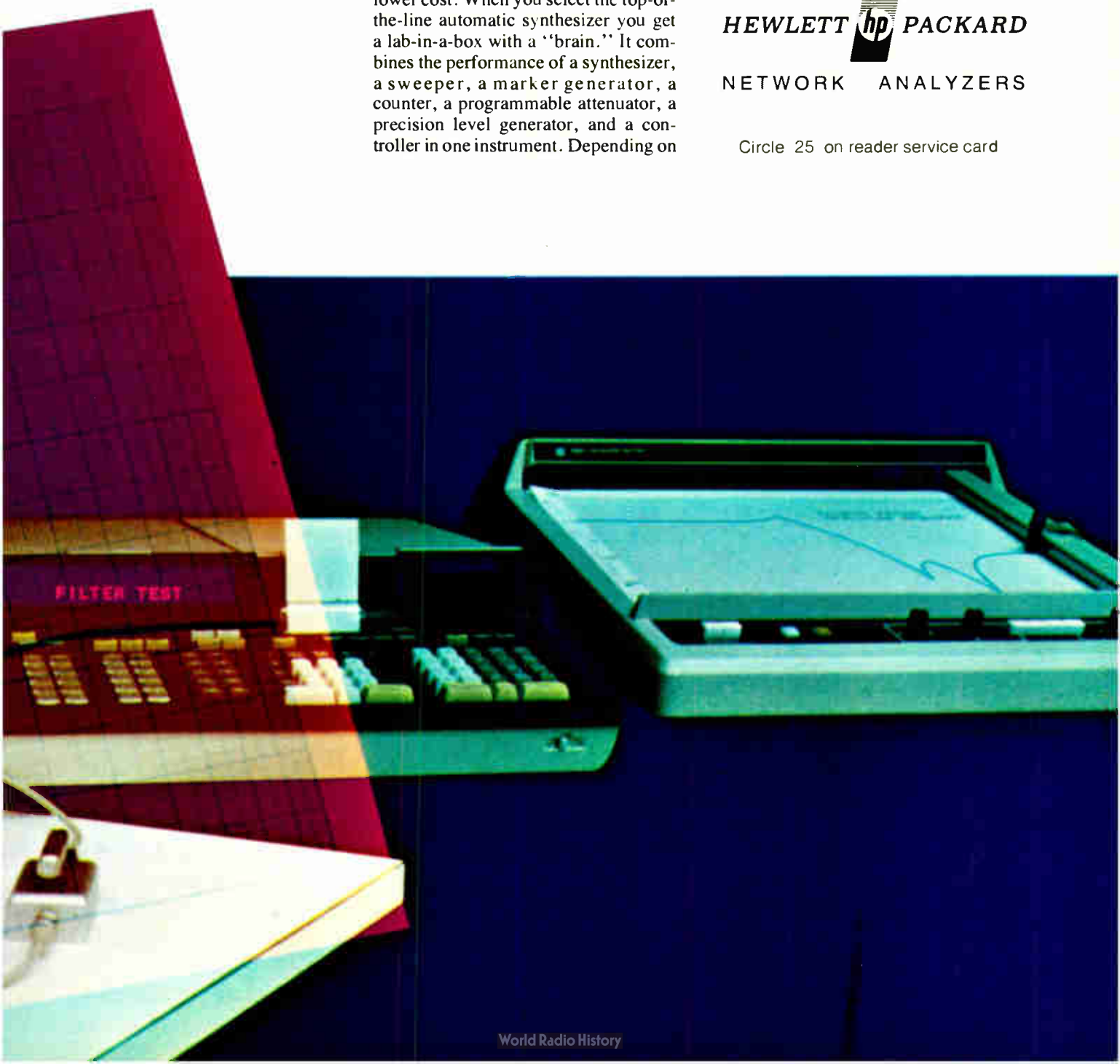

**Quality  
resistor networks  
now available  
off-the-shelf.**

**Pull ups or  
terminators,  
in popular  
values.**

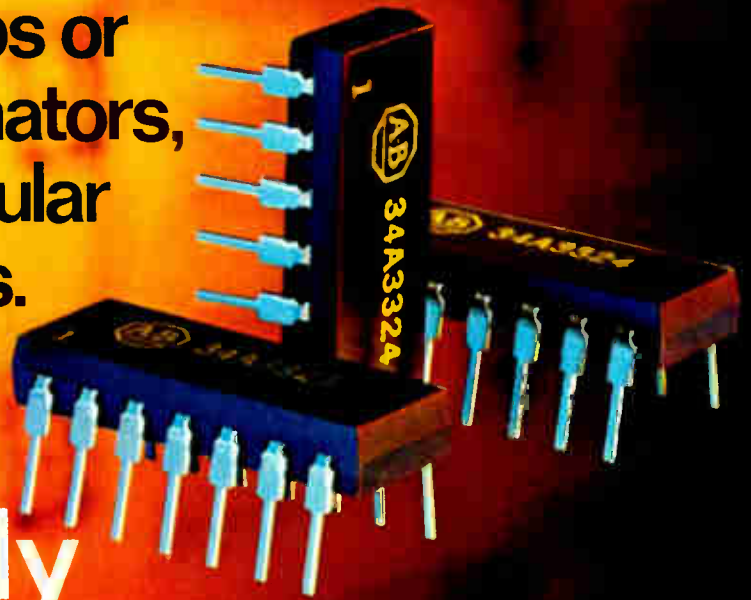

**If you're really  
serious about cost,  
be serious about quality.**

Now our most popular thick-film resistor networks are ready and waiting, in quantity, at your A-B electronics distributor. Pull-up networks and terminator networks with tolerances of  $\pm 2\%$  in popular values from 68 ohms to 22K ohms. All in compatible

14 lead .300 series DIP's. Or if you need something special we'll quickly custom design any circuit that'll fit into a 14 or 16 lead DIP. And we mean quickly. Overall specs include: absolute tolerances to  $\pm .5\%$ . Tracking  $\pm 50$  ppm/ $^{\circ}\text{C}$  (and lower). TCR to

$\pm 100$  ppm/ $^{\circ}\text{C}$ . Write for free technical publications 5850 and 5851. Allen-Bradley Electronics Division, 1201 S. Second St., Milwaukee, WI 53204. Export: Bloomfield, NJ 07003. Canada: Cambridge, Ontario. United Kingdom: Jarrow, Co. Durham NE32 3EN.

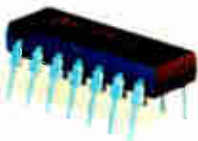

Actual Size

EC73-3 © Allen-Bradley 1973



**Allen-Bradley**  
Milwaukee, Wisconsin 53204

Circle 26 on reader service card

## Impatt diodes reach frequency-power product high

The highest frequency-power product for Impatt-diode oscillators has been achieved at Hughes Aircraft Co., Torrance, Calif., reports the company. Using single- and double-drift diodes and conventional and ion-implantation methods, **Hughes researchers have obtained outputs of 120 milliwatts at 140 gigahertz.** Moreover, they expect to obtain over 100 mW at 150–170 GHz and lower power outputs at 200 GHz. **These devices could be of particular importance as solid-state pump sources for parametric amplifiers and local oscillators in millimeter-wave systems.** Interest in the region above 100 GHz is growing rapidly because of projected applications in wideband communications and high-resolution radar.

## Motorola varactors to tune car radios

Varactor tuning is coming to a-m automobile radios. Motorola's Semiconductor Products division has unveiled the MVAM-1 tuner unit, consisting of three matched discrete varactor diodes in a single package. **The Phoenix division has priced the unit in the \$1.50 range for now,** and is aiming to have the same function in monolithic form at \$1 for the 1977 model year radios, which are already in design. Samples of the discrete version, which will help shrink the space required behind the dashboard by replacing the bulkier mechanical tuner, will be available by the third quarter. **Diode matching, critical for precise tuning, is  $\pm 1\%$ , achieved at least in part by using ion implantation** to get better device uniformity.

## Pulsing light cuts rear-end collisions by 60%

The California Highway Patrol has approved the operational concept of cyberlites—yellow flashing lights, actuated by a monolithic circuit. Cyberlites have cut rear-end collisions by 60% in an experiment in San Francisco. The new auto electronics device, invented by John Voevodsky of the San Francisco Bay area, increases the number of times a rear light pulses as the rate of deceleration increases—**the faster the car slows down, the faster the light pulses.** The test was based on accident reports of 250 cabs that had the cyberlites installed and 250 cabs that had standard braking lights.

In its report to the California state legislature, the Highway Patrol disapproved of the brightness and false signals the light may give off if a driver rides his brakes. But developer Voevodsky says an auditory warning system would solve the latter problem. **If the lights were used nationwide, Voevodsky says they could save about 1,440 out of the 2,400 persons who are killed each year in rear-end collisions.**

## Deflection circuits for TV will be packaged in plastic

Texas Instruments, Dallas, is currently sampling high-voltage TV horizontal deflection transistors in plastic packs, with collector-emitter voltage ratings of 1,200 and 1,400 volts. This is considered the highest voltage achieved in plastic packages for consumer applications. The company expects that the plastic TO-3 packaging will save users of comparable metal-can devices about 20%, when production quantities are available in September. **The devices feature low saturation voltages and typical switching speeds of 0.6 microsecond at 2 amperes.**

Power dissipation is not critical for cathode-ray-tube deflection tran-

sistors because of their intermittent use, and TI has packaged chips as large as 170 by 170 mils before. But **the trick for these 130-mil-square chips was to develop passivation techniques good for up to 1,400 v.** The devices, designed for U.S. and Japanese small color and black-and-white sets, will complement a line of metal-can units offered by TI Ltd., Bedford, England, and from Delco and several Japanese suppliers.

## **Market in new general-aviation gear put at \$534 million**

Proposed and impending avionics regulations by the Federal Aviation Administration will mean \$534 million in new general-aviation equipment over the next several years, says J. B. Hartranft, president of the Aircraft Owners and Pilots Association. His estimate breaks down as \$14 million for emergency locator transmitter beacons required by the end of the year, **\$420 million for new equipment to accommodate new 25- and 50-kilohertz spacing for communication and navigation equipment,** and \$100 million for new altitude-encoding transponders required for large terminals and altitudes of 12,500 feet and over. **Current annual avionics market is estimated at about \$160 million.**

## **Industry asked to propose parameters for laser safety**

The quantum mechanics division at the National Bureau of Standards laboratories in Boulder, Colo., is attempting to coordinate the laser industry's efforts to come up with laser standards, particularly in view of recent laser safety standards proposed by the U.S. Bureau of Radiological Health. **The NBS group is asking for industry comments** for a special program on the subject at the Sept. 1 meeting of the American Society for Testing Materials in San Francisco. Both laser producers and instrumentation houses will be invited to participate.

## **Modular modems to come from Intertel this month**

A new line of modem communication systems aimed at the end-user market will soon be announced by Intertel, Inc., Burlington, Mass., which until now has sold mainly to the OEM modem market. **With the new modular line, systems—including modems, and diagnostic equipment for pinpointing problems in communications networks—can be custom built** by adding accessories and options. Intertel expects a "tremendous market" for the systems approach, a concept it says has not been used by other modem makers. **The aim of the system is to eliminate communications downtime and provide greater use of the telephone system.**

## **CCDs go commercial with 4,096-bit unit now and 8,192-bit design later**

Charge-coupled-device technology, discovered only three years ago, is already entering the commercial world. Bell Northern Research Ltd., the Ottawa-based research arm of Bell Canada, has **developed a 4,096-bit CCD shift register and is close to completing development of an 8,192-bit shift register** that the company says could result in systems 30 times faster than comparable rotating disks. Bell Northern is willing to license or engage in a joint venture for the production of either device.

The 4,096-bit unit operates from a 2-megahertz clock and its fabrication with a double-level polysilicon process uses "existing production technology." **The chip, which measures 156 mils square, is designed for two-phase operation. A 10-volt clock with n-channel MOS logic is on the same chip.**

# C-LINE PIN DIODES

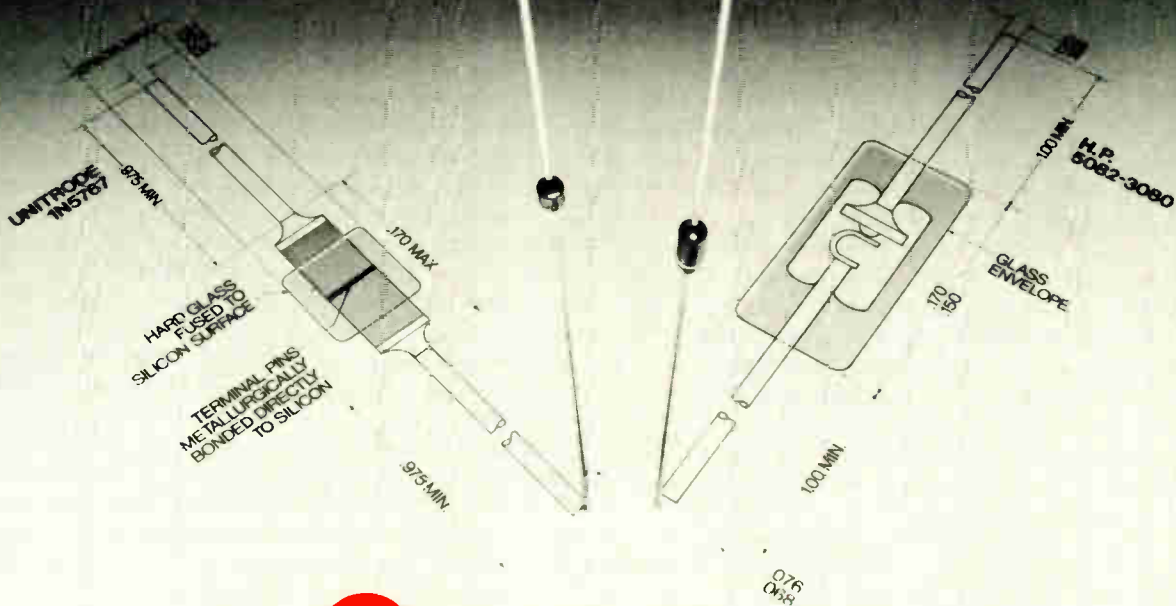

## Compare Unitrode's 1N5767 with H.P.'s 5082-3080

The 1N5767 is HP's EIA Registration of the 5082-3080. Both Unitrode and HP meet the same specs. Both are competitively priced. The difference is in how they're made. Unitrode's fused-in-glass process results in a monolithic structure with the lowest possible thermal and series resistance available. The silicon chip is metallurgically bonded directly to the terminal pins and a hard glass sleeve is then fused to the pins. The result is unmatched peak and average power dissipation. And the normal parasitic inductance and capacitance is far less than in conventional diodes with straps, springs, whiskers, or ceramic packages. Unitrode's 1N5767 can withstand thermal cycling from

-195°C to +300°C and it exceeds all military environmental specs for shock, vibration, acceleration, moisture resistance and solderability. They're ideal for use in general purpose PIN diode applications such as CATV attenuators and switches and simple series switches for transceivers, radar, etc. As to HP's diode construction, we think it only fair that they should tell you about it. For samples, call Howard Kaepplein at (617) 926-0404 collect, Unitrode Corporation, Dept. No. 8 Y, 580 Pleasant St., Watertown, Mass. 02172. For the name of your local Unitrode distributor or representative, dial (800) 645-9200 toll free, or in New York State (516) 294-0990 collect.

### ELECTRICAL SPECIFICATIONS (25°C)

| Unitrode Series | $C_T$ Total Capacitance @ 50V, 1MHz pF | RF Resistance @ 10 $\mu$ A, 100MHz $\Omega$ | RF Resistance @ 20mA, 100MHz $\Omega$ | RF Resistance @ 100mA, 100MHz $\Omega$ |
|-----------------|--|---|---------------------------------------|--|
| 1N5767          | 0.4 max.                               | 1000 min.<br>3000 typ.                      | 8 max.<br>4 typ.                      | 25 max.<br>1.5 typ.                    |

See EEM Section 4800 and EBG Semiconductors Section for more complete product listing.

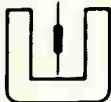

**UNITRODE** quality takes the worry out of paying less.

# GE-MOV™ VARISTORS

## CLAMP VOLTAGE TRANSIENTS

GE-MOV™ Varistors are voltage dependent resistors employing new zinc oxide technology.

At rated voltage, impedance is high, dissipation is negligible, and circuit performance unaffected.

Under surge conditions, impedance falls abruptly, surge energy is absorbed and destructive voltage transients eliminated by the conducting GE-MOV™ Varistor.

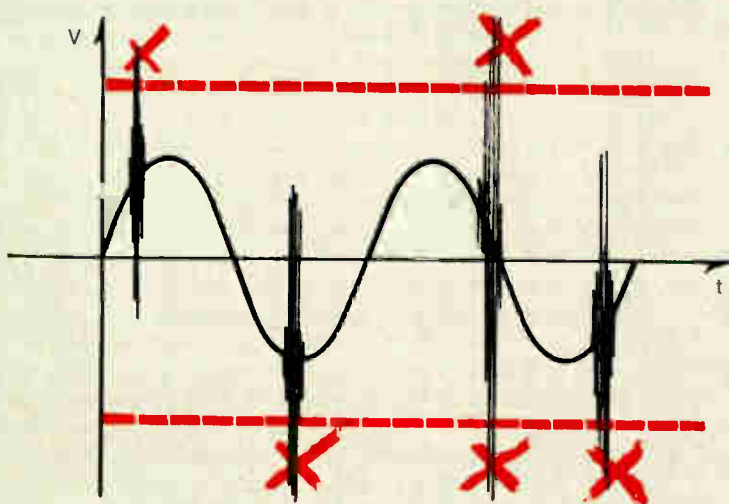

### 92 MODELS OFFER:

- Operating voltages 95 to 1000 V RMS.
- Pk. clamping voltages 286 to 2,500 V at 10A.
- Pk. current ratings to 2000A.
- 50 nanosecond response time.
- Energy absorption 1 to 160 joules.
- Average power dissipation .25 to 15 watts.

Economical for new designs; improved protection for designs now using selenium, silicon carbide, spark gap or zener diodes.

Free GE-MOV™ DESIGN KIT available from any authorized General Electric Electronic Components distributor, or writing on company letterhead to:

General Electric Semiconductor  
Building #7, Electronics Park, Mail Drop #49  
Syracuse, New York 13201

GENERAL  ELECTRIC



## Ferrite core makers seek competitive edge with multibit concept

By controlling the current pulse, a ferrite core might hold as many as 8 bits—or so core makers hope

**Manufacturers of ferrite cores**, faced with the increasing inroads into their markets by semiconductor memory makers, are re-examining an old concept—storage of more than one bit in a core—as a means of prolonging the life of their products. That was the consensus of core makers at the National Computer Conference held in New York City earlier this month (see p. 40). All of them are working on the concept and talking about it, albeit guardedly.

Their ranks include Ampex Computer Products division, Lockheed Electronics Co.'s Data Products division, Data Products Corp.'s Core Memories Inc., the Electronic Memories division of Electronic Memories and Magnetics, and Fabri-Tek Inc.

The idea is to increase storage density, yet add minimally to core-stringing and peripheral-electronics costs, and thereby to further reduce systems costs. The scheme isn't new but is getting serious consideration for the first time. If as many as 8 bits can be stored, the core can hold a complete character coded in American Standard Code for Information Interchange ASCII or Extended Binary Coded Decimal Interchange Code EBCDIC—the two most common computer codes for data.

**Prolonging core life.** One approach is to use partial switching. In a conventional core threaded with

selection wires, a current pulse of sufficient amplitude in the wires switches the magnetic state of the core; but the switching begins at the inside surface of the hole and progresses outward. With sufficient control over the amplitude and duration of the current pulse, and with sufficiently uniform material in the core, this partial switching might be controlled so it could be stopped at a predetermined level in the core. Then the number of distinguishable levels would establish the number of bits in the core.

The switching would always start from the inside and go out. Thus if the core had eight levels, the fifth level couldn't be switched independently of the four inside it. Ampex and Data Products seem to be taking this partial-switching approach to achieve multibit storage in single cores.

According to Victor Sell, manager

of the Ampex Computer Products division's core and stack products in Marina del Rey, Calif., Ampex is looking at the multibit phenomenon not only to increase density but to make "smarter" memories that can store alphanumeric. Sell expects to have a character-oriented core system based on two cores per character by the year's end. Sell believes telephone numbers and complete words could be contained in cores with this type of alphanumeric capability.

**Doubling up.** Ralph Gabai, marketing manager for Lockheed Electronics Co.'s Data Products division in Los Angeles, describes multibit or multistate cores as "a minor loop phenomenon that's been around for years. The core isn't basically changed, but it switches on the minor loop, not the major loop," to get multistates. With perhaps only a 10% increase in electronic-compo-

**More store in the core.** Major core manufacturers are studying techniques for making cores such as this one hold a complete character in ASCII or EBCDIC code.

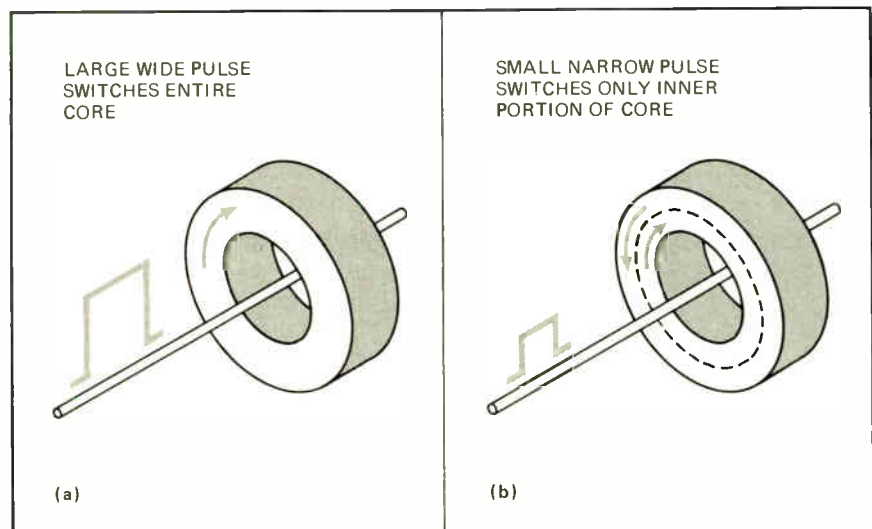

nent costs and with the same number of cores, a core system's capacity might be doubled.

Gabai characterizes his division's effort as at the development stage. He'll say little about the work other than that Lockheed is working on winding techniques, core characteristics, material compositions, and sensing electronics.

Data Products Corp. recently began an effort in multibit core storage. Bill Rumble, systems engineering department manager, Core Memories Inc., Mountain View, Calif., says the work involves partial switching. On the basis of preliminary results, he says, "We're pretty confident two bits can be stored in a core, and maybe more," but he stresses that it's too early to speculate about single-core capacity.

Electronic Memories is different. Though it is also actively working on the multibit concept and claims to have applied for a patent on one or more aspects of it, an EM&M spokesman insists that his company's approach does not involve partial switching. But, when asked if a new material or a new formulation was involved, he merely says, "It might, and it might not."

Finally, a Fabri-Tek spokesman points out that the firm examined multibit storage at least three years ago and decided not to pursue it then, but he adds that the company is taking a new look at the technique now. □

---

## Memories

---

### Domain technology edges toward market

Domain-tip propagation (DOT) memory technology went into hibernation last summer when IBM introduced virtual memory into its System 370 computers. But soon DOT memories will reappear in the form of large backing memories needed by virtual-memory systems.

Originally intended for general-purpose applications, DOT memories were returned to the laboratory

shortly after they were announced because the developers, Cambridge Memories Inc., Concord, Mass., foresaw a larger market if the system design were reworked so that it could replace the high-speed disks and drums that virtual memory requires. Cambridge Memories president, Joseph F. Kruey, expects to ship the first 40-million-bit unit to a large computer installation in the fall.

The first unit will have a data transfer rate of about 10 million bits per second; this is much faster than today's disk units. The DOT registers themselves are much slower, but parallel transfers from the registers through peripheral electronic circuits boost the speed.

**Helps stop "thrashing."** As most disk storage units go, 40 million bits is small, but larger capacities will be forthcoming in 1974; and even with the small capacity, the DOT's access time of a microsecond or so is so much faster than the several milliseconds in disks and drums that it is less likely to get involved in "thrashing"—excessive transferring of data back and forth between the main memory and the backing memory in a virtual machine, at the expense of useful computation. Thrashing is a serious difficulty in some installations.

The technology, developed first at Laboratory for Electronics, Inc., Boston, Mass., and then acquired by Cambridge Memories [*Electronics*, March 20, 1967, p. 48; May 8, 1972, p. 141] stores data in the form of small magnetic domains. These domains are propelled through a serpentine film by the magnetic field associated with a two-phase electric current in an adjacent winding. (There is a resemblance here to magnetic bubble technology originally developed at Bell Telephone Laboratories, but it is only superficial—bubbles propagate through a continuous substrate, propelled by an external rotating magnetic field and guided by the magnetic properties of metal patterns on the substrate.)

Cambridge Memories used the technology in a small commercial product called DOTram, announced

at last year's Spring Joint Computer Conference; but IBM's announcement altered the market for mass memories, opening up the new possibilities for DOT. □

---

## Navigation

---

### Small radar aimed at small boats

Homing in on light weight and low cost, Bonzer Inc. has designed a short-range, high-resolution navigation radar for recreational vessels. The Overland Park, Kans., firm of radar altimeters for general aviation has cut the weight to 22 lb and price to less than \$1,500—a reduction of a third in both cases.

The result is the SR-20 radar that pumps out only 40 watts of peak power instead of the low kilowatts of its competitors. It provides close-in "seeing" ability—down to 10 yards on a full-scale range of just 50 yards and with 1-yard resolution.

The SR-20 design is unusual for its basic system concept as well as its use of a pencil tube for its power source. Only a pencil tube, supplied by RCA's Electronic Components division, Harrison, N.J., will provide the clean 30-50-nanosecond-wide pulses required for the system's short range, says W.F. "Bud" Wiley, Bonzer's president. Apparently, a magnetron is not only too expensive, but it is much larger and produces very noisy pulses, while solid-state devices can't reach the power output that is needed. Planar tubes could meet the requirements, but they don't have the reliability of the pencil tubes, Wiley says.

The radar operates between 2.9 and 3.1 megahertz. It has a fixed 100-to-2,500-yard range and a continuously variable one from 10 to 250 yards down to 10 to 50 yards. To cover them, it uses a swept receiver gate that looks for target reflections in 30- to 40-nanosecond windows between transmitter pulses. The receiver gate is swept over the range in 20 milliseconds regardless of which ranges are being cov-



**Resolution.** Bonzer's radar for leisure craft offers high resolution over short ranges. The SR-20 has a peak output of just 40 watts, but that's enough for close-in detection.

ered. Hence, the trace on the radar's 5-inch plan position indicator scope takes 20 ms to move from its inner to outer points, slow enough for the display to be quite bright.

The gated technique yields a "huge" increase in sensitivity, Wiley asserts. The signal-to-noise ratio improves as well because the receiver is shut off and not open to interfering signals.

By contrast, in a conventional radar the receiver is left on between pulses so that it will pick up reflected signals as they return. Thus, video signals must be sent from the antenna and receiver to the display in synchronization, requiring cumbersome rotating waveguide joints. In the Bonzer unit, the signals are passed through simple slip rings. And since low-frequency information need not be passed, an eight-conductor cable, rather than waveguide or coax, suffices.

**Omitted.** In addition, the new radar uses the same cavity for both transmission and reception, with the cavity primed by the received signal. Thus, the unit doesn't need a local oscillator and, because the video is recovered from the cavity modulator, an i-f strip is omitted as well.

With such simplification, as well as its low-power design, the topside power supply, transmitter, receiver, an array of four helical antennas and rotator weigh only 17 pounds, roughly one third that of competi-

tive units, according to Wiley. The PPI scope, with electrostatic rather than electromagnetic deflection, weighs an additional 4½ lb. The SR-20 sells for \$1,495, a third less than competing units, Wiley says. □

---

## Instruments

---

### Wanted: portable X-ray checker

X-ray diagnostic equipment must be checked for compliance with Federal performance standards, and a variety of measuring devices are now required. The Bureau of Radiological Health wants a single portable instrument to do the job. BRH plans to issue requests for proposals early next month for a six-month effort to design a prototype, pick the winning design within a month, and to make its first buy of 185 units next year.

"That wouldn't be the end of our purchasing," says Robert Jacobs, acting chief of the ionizing radiation branch. Other potential buyers are X-ray-equipment manufacturers, hospitals, and state health departments, he says.

The unit must measure timer accuracies and radiation exposure from diagnostic X-ray equipment. Although there are various devices

already on the market, the bureau says they are not simple, compact, accurate, fast or cheap enough.

The bureau has already designed a breadboard model that weighs a few pounds and measures 6 inches square by 8 in. deep, Jacobs says. It wants manufacturers to "bring it out of the laboratory and into the real world."

The instrument has three main parts: an ionization chamber, a charge digitizer, and an autoranging counter-timer with an electronic X-ray sensor. To measure total X-ray exposure or rate of exposure, the user places the ionization chamber directly into the beam which detects the radiation and converts it to a charge. The digitizer receives the charge and changes it to digital pulses, which are then fed to the counter-timer and displayed as milliroentgens or milliroentgens per minute.

To determine a diagnostic X-ray machine's timer accuracy, the autoranging counter-timer measures the duration of the X-ray machine's radiation pulse and displays it digitally also. The prototype unit carries out all the measurements required by the Federal standard.

Upon requests by manufacturers and state health departments for more time, the Government has extended the effective date of the X-ray standard to Aug. 15, 1974. The extension will not affect development of the portable instrument, Jacobs says. □

---

## Production

---

### Automated cabler uses linear motor

An automated system for forming cable harnesses recently delivered to a Western Electric plant in Mesquite, Texas, could go a long way toward eliminating a big bottleneck in electronic production. According to Robert N. Nanninga, vice president of Wayne Engineering, Ltd., the new machine developed by his company operates six times as fast as a manual operator.

"It's the only truly functional, automatic, cable-forming system in

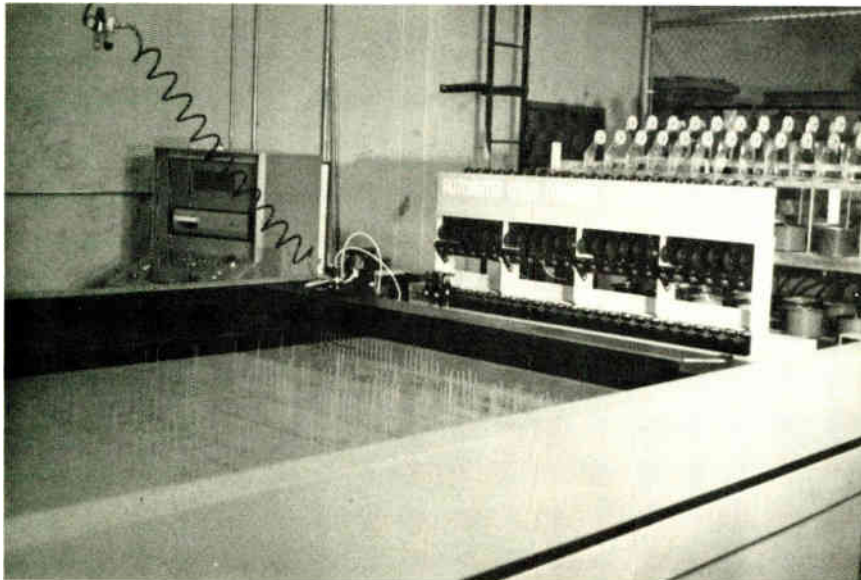

**Harness maker.** Wayne's Formatic 2400 automatically produces cable harnesses at a rate of 1,500 inches per minute, accommodating 24 wire sizes from size 30 to 14.

existence," he says, adding that although the industry has been trying to develop automated systems for 15 years, 95% of all cables are still formed by hand. Consequently, he looks forward to \$16 million in sales of the machines in the next two years, mostly to large users of cables such as IBM, Western Electric, and automobile and aerospace manufacturers. The Chatsworth, Calif., company also hopes to establish a service bureau for other users.

The Wayne system, called the Formatic 2400, uses the Sawyer principle linear induction motor. In this motor, which was developed and marketed by Xynetics Corp., Canoga Park, Calif., the active parts float on a cushion of air. The system uses a Wayne-developed tape-driven controller and a dispensing cart for the 24 wire spools.

The basic appeal of the \$150,000 stripped-down machine is its speed. The Formatic operates at 1,500 in./min. Another major benefit is reduced errors and reworking. "Every cable produced is a carbon copy of the first," says Nanninga.

The linear motors and the head are air-operated, with no electric wires on the head. Even the drill is pneumatic. The X and Y positions are controlled by the Xynetics linear motors; the cable-laying Z-axis head is a Wayne design. Pre-

threaded heads for up to 24 wires from size 30 to 14, including twisted pairs and shield cables, are automatically selected and routed, then returned to rest.

The head automatically stops if the wire runs out or breaks (not likely at the 2-lb laying pressure), if it hits a pin, or if tension on the wire is too great.

The controller for the system uses magnetic- or paper-tape drive, but an optional computer interface will drive more than one table at once. Cable tying and wire cutting are manual in the first system, but automatic wire terminating and stripping are options, as are automatic pin insertion and automatic verification.

Wayne Engineering has an exclusive license on the Xynetics motor for wire laying, pin setting and photo/facsimile applications and has other equipment in design. □

### Components

## Tough connector to rough it in cars

Because more and more electronic systems are being used in automobiles—for electronic fuel injection,

antiskid control, seat-belt interlocks, and air bags—Amphenol Connector has designed a low-cost, environmentally sealed electronic connector that can handle millivolt signal circuits as well as power circuits up to 300 volts rms.

"We think we've found a need for a connector that performs better over a longer time in tougher environments," says W. D. Wilson, market manager for transportation products at the Chicago-based division of Bunker Ramo Corp.

Amphenol's series 44 connector is simply two molded neoprene parts with several crimp-removable contacts. It is priced competitively with the splash-proof, molded polyvinyl chloride connectors currently used.

**The material is important.** Neoprene was chosen "to give acceptable performance at minimum cost," Wilson says. The material rapidly recovers its original dimensions and thus offers a better environmental seal than the PVC or similar thermoplastics which depend on the adherence of the material to the wire, he says.

Wilson estimates the cost at about 50 cents or less per mated pair for a two-contact connector in quantities of 200,000. □

### Displays

## Gas display goes in IC package

A late entry in the gas-discharge-display stakes, running against the Burroughs Panaplex and Sperry Information display units, is a multidigit display that offers simplified packaging and mounting, plus a sharp resolution that makes it especially attractive for small, handheld calculators and instruments.

Developed by Diacon Inc., a San Diego, Calif., packaging house, the new display uses a perforated metal anode bonded to a glass faceplate rather than the transparent tin-oxide conductive anode of the Burroughs and Sperry readouts. The cathodes are similar etched metal

# Critical Path™ test fixturing

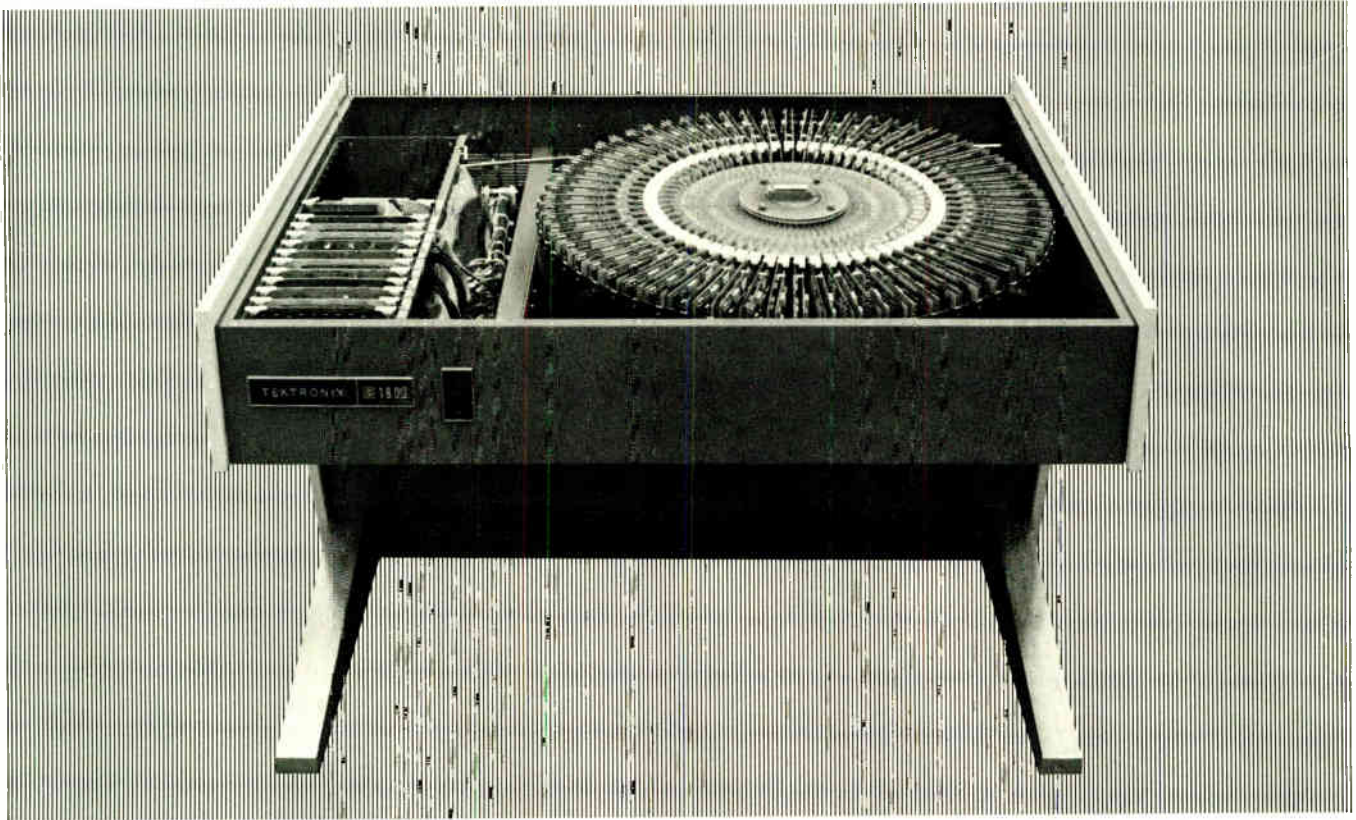

## The lower cost answer to the test system fixture problem

Users of modern high-speed function testers find that fixturing is one of the most critical and expensive parts of their systems. The 1803 Test Station, a part of our S-3260 Super Test System, using Critical Path™ fixture design solves the problems.

Connection of a Device Under Test (DUT) to a high speed (up to 20 MHz) function tester demands that the signal environment be free from leakage, aberrations and reflections, yet it must be flexible enough to accommodate many different devices. Most often in the past, the only practical fixtures have been dedicated, expensive custom-built assemblies. The owners of such fixtures have found that inordinate amounts of capital are invested in them.

The 1803 Test Station presents the first practical high-speed test fixture scheme. It uses pin electronic cards to bring signal generation and detection devices as close to the DUT as possible. Critical Path design permits clear signal paths to and from the device. To change DUTs on an 1803, the user need only change a small inexpensive socket board.

The S-3260 is the ultra-modern test system designed to test modules, discrete components, IC's of all types, and p.c. boards. Capable of performing DC, Timing and Function testing, it accesses up to 64 I/O pins. Built around a powerful minicomputer, seven-phase clock generator, and power supplies, the S-3260 is capable of applying test patterns up to 64 bits wide at rates from 600 Hz to as high as 20 MHz.

Not being a special purpose, limited usage machine, the S-3260 will not become obsolete as your testing requirements change. Already delivered systems are being used in R/D, manufacturing and QC environments. To learn more about the system designed to solve your testing needs, contact your Tektronix field engineer, or write to Tektronix, Inc., P. O. Box 500A, Beaverton, Oregon 97005.

**AUTOMATED  
TEST  
EQUIPMENT**



**TEKTRONIX®**

committed to  
technical excellence

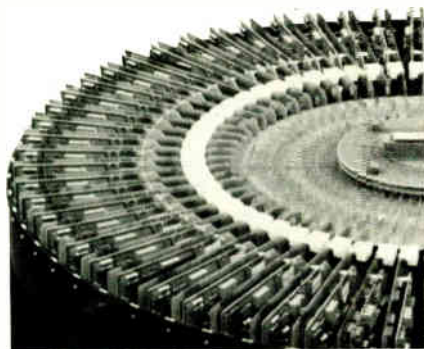

For a demonstration circle 34 on reader service card

Circle 35 on reader service card 35

## Bowmar expects every home will soon have two calculators

The way Joseph J. Casale sees it, we'll be a nation of two-calculator families before too many more years. Casale, the first president of Bowmar/Ali Inc.'s newly formed Consumer Products division and former marketing vice president of the Admiral Corp.'s Electronic division, speaks with the zeal of a born marketer. And now Bowmar, which claims half the consumer calculator sales in America, has put a new gleam in the eye of the youthful 46-year-old executive by showing 11 new calculators—including five desktop models—at the Consumer Electronics Show in Chicago this month. There is also a diversification move afoot into other consumer products.

Among the calculators are several with memories, a first for Bowmar. Designed to compete with Hewlett-Packard's HP-35 will be a scientific-engineering type calculator probably available later this year for "around \$200."

Other products displayed in prototype form included: a radio receiver with varactor tuner and a digital frequency display using large LEDs, a cable digital clock with alarm and timer-electrical outlet to control appliances, and a digital travel clock with an alarm.

All of these products use MOS technology. According to Craig Balchunas, product manager, the last three products have not yet been priced and are being shown primarily to give Bowmar an early indication of dealer interest.

Two of the calculators are desktops, including the top model, the TX1200, which has a 12-digit display and a floating decimal. The top of the new pocket calculator line is an eight-digit memory machine, the MX70, with four functions, a

floating decimal, and either ac or battery operation. Another change is color. Several of the Bowmar calculators come in red and yellow cases, as well as black and gray.

**Copying the Japanese.** Casale is giving Bowmar the new look in consumer marketing, one actually introduced in this country about five years ago by Japanese firms and used by them with great success. Simply put, it is the use of specialist representatives rather than the distributors to move their goods. Distributors with their big inventories and sales staffs had very often "become almost as big as the manufacturers and had to be included in product decisions and the like. Reps, on the other hand, are just that—representatives, says Casale.

Another Casale touch is the addition of dealers around the world. Bowmar had 150 in January and about 8,000 as of the end of May. "Our goal," says Casale, "is to have 10,000 dealers by the end of the year."

**Calculator chief.** Joseph Casale is giving Bowmar a new look in marketing.



preforms that, like the anode, extend past the package edge to form terminals, as in DIP integrated circuits (not too surprising a design since Diacon president Bryant C. "Buck" Rogers invented the DIP

configuration.)

The gas discharge occurs between the cathode segments and the anode, appearing in and defined by the slots in the anode. Unwanted glow is blanked by the anode; di-

electric layers over segments of the cathode prevent additional unwanted discharge or shorting.

**Soldered directly.** Up to eight digits can be placed in a package, and the anode can be split into separate units for multiplexing. A big advantage of the construction is its similarity to conventional IC packages. For the user, this means that it can be soldered directly to a circuit board, whereas other gas discharge displays require sockets.

Early versions will have a seal on the side, but Duane Manning, manager of displays at Diacon, feels that even this can be eliminated if hot cap sealing is used in an evacuated atmosphere containing the proper neon gas mixture. The gas is the same as that used in other gas displays and emits the same orange-red color. It also requires the same 170- to 200-volt drive. □

## Government electronics

### Customs eyes bigger communications net

The U.S. Customs Service is testing its anti-smuggling computer network at several airports this summer with an eye toward expanding the system to cover air travelers. Should the result prove satisfactory—and it looks as if it will—the agency is expected to ask Congress for money to buy more terminals in order to increase its war against drug smugglers.

The system, called the Treasury Enforcement and Communications System (TECS), is an outgrowth of an earlier customs system that is now run jointly by it and Treasury Department alcohol, tobacco, and firearms enforcement agencies, plus the Internal Revenue Service. In that earlier system, terminals at agent and inspector locations are connected to data banks in two Burroughs 5500 computers, San Diego, Calif., and to the FBI's National Criminal Information Center index.

The system is working along the Mexican border and is being in-

# If you need a 1-GHz oscilloscope...

...with conventional scope operation, try the 7S14 Sampler.

Trigger level, variable holdoff, and auto-triggering are familiar conventional scope features. Now you have them with the 7S14 Dual Trace Delayed Sweep Sampler. This Tektronix sampler has "hands off" triggering, simplified operating controls, calibrated sweep delay, and a unique "two-dot" time measurement feature. These features bring you a simple-to-use sampling scope which can do a better job more accurately.

How? You can now see the leading edge of an internally triggered signal at *any* time per division setting. This lets you check the width of wide, low-duty cycle pulses on the same sampling scope used to measure risetime—a new assist for you. The calibrated sweep delay not only brings you more time-interval measurement accuracy, but offers a delay-zero adjustment which lets you select time-zero and identify it with a bright dot in the trace. Then a second dot can be placed with the Delay Time Multiplier dial. The time interval between these dots is then determined by the dial reading and the Delaying Sweep (sec/div) setting, resulting in an accurate and unique method of "two-dot" time measurements.

Performance! The 7S14 Sampler in your choice of a 7000-Series mainframe has it. Its a DC-to-1 GHz sampling scope having dual-channel vertical with risetimes of 350 ps and sensitivities from .5 V/div to 2 mV/div.

These features, with the well known 7000-Series CRT READOUT complete an easy-to-use, and inexpensive sampling scope.

Order the 7S14 Dual Trace Delayed Sweep Sampler for \$1850, or for more information write:

Tektronix, Inc., P. O. Box 500, Beaverton, Oregon 97005. In Europe write Tektronix LTD., P. O. Box 36, St. Peter Port, Guernsey, C. I., U. K.

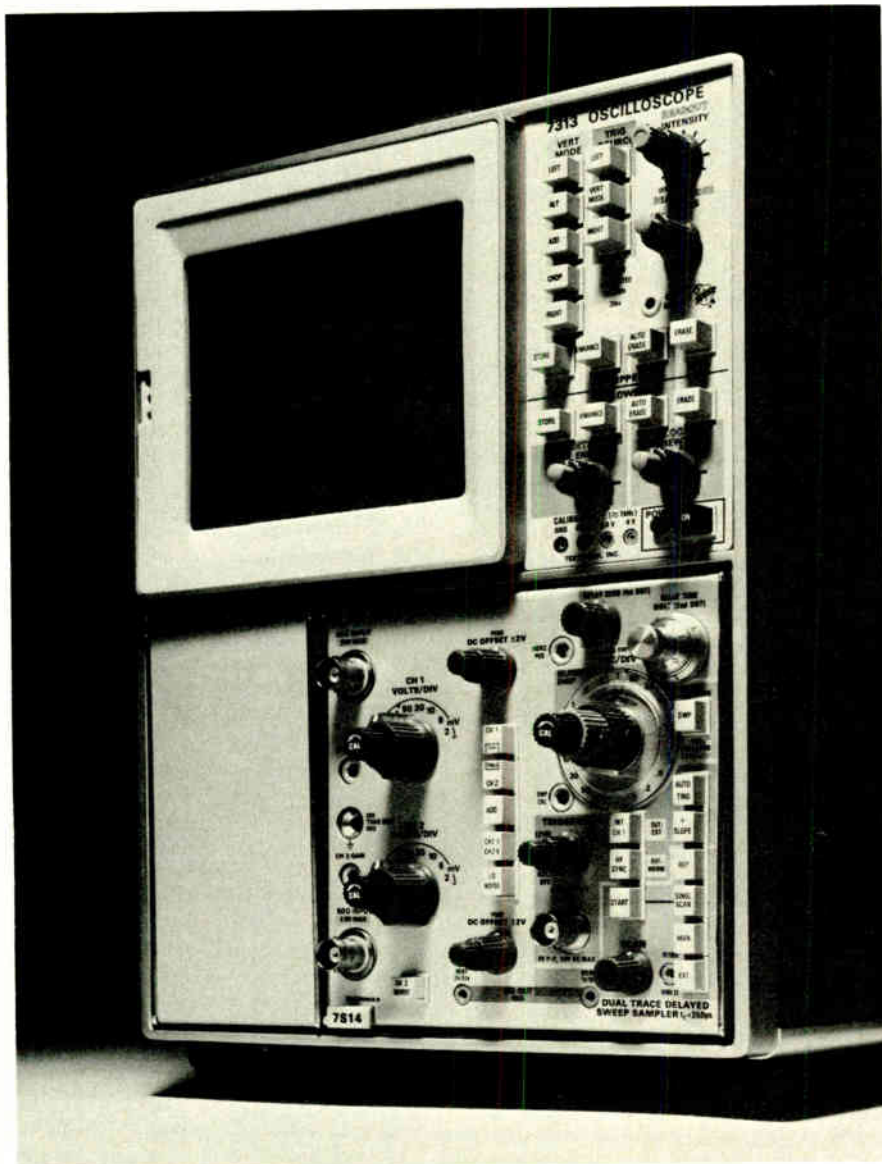

For a demonstration circle 36 on reader service card

  
**TEKTRONIX®**  
committed to  
technical excellence

Circle 37 on reader service card 37

stalled along the Canadian border where it is aimed at checking tourists in cars. An agent spots a license number of a car in line at a checkpoint, queries the system, and in less than three seconds gets information on whether the car has been involved in a previous offense.

While customs intelligence division officials are reluctant to talk too much about TECS, it is known that the system will handle other queries

besides license numbers and accept tipoffs from foreign informants relayed stateside. Reportedly, the \$4 million system contains some 180,000 records, handles an average of 500,000 queries a week and will operate at more than 300 locations when the Canadian border stretch is completed.

The airport tests are producing five "productive hits" (arrests) a day, while the rest of the system re-

sults in 700 arrests a year. Moreover, 100% of the passengers are checked with no delays.

The present system uses 396 teletypewriter terminals, manufactured by Frederick Electronics, Frederick, Md. Should customs not get funds for airport terminals, it is considering relocating existing terminals at more airports. □

### Timer may stiffen morale of dental-brace wearers

Almost everyone submitting to strict discipline to achieve a goal seeks recognition and approval—from weight watchers to the members of Alcoholics Anonymous. Now every teenager going through the throes of orthodontia can have a little more incentive, too, thanks to electronics and a Mountain View, Calif., orthodontist.

An integrated circuit and a few sensors built into the neck strap of today's bulkier dental braces will count the hours the braces are worn and store the number in memory, to be read out by an instrument at the dentist's office. The inventor of the timer, Dr. Michael Northcutt, says the device isn't aimed at catching "cheaters," but is intended to give a child the same kind of psychological lift that a dieter gets when he has lost another pound.

Northcutt showed his design a few weeks ago at the National Orthodontists Conference in Dallas, Texas, and was immediately swamped with orders from other doctors.

The orders—some 50,000 already—will be filled by a company that Northcutt set up, Orthoplastics Corp. He has already placed an initial order for 100,000 sensor-timer circuits with Magic Dot Inc., of Minneapolis, which developed the prototypes. Orthoplastics has applied for patents in a dozen countries.

The design was worked out by Northcutt with the aid of Peter Buckeley, dean of engineering at Bradley University, Peoria, Ill., who also serves as chief engineer for Orthoplastics.

At first they planned to have the circuits made by one of the semiconductor companies in the San Francisco Bay area, since the design called for an MOS clock and memory. However, they eventually chose Magic Dot, Northcutt says, because they decided sensor performance is critical, and one of Magic Dot's specialties is making extremely sensitive biomedical switches such as breath-operated switches used by paraplegics to control wheelchairs.

A series of models will be produced for Orthoplastics by Magic Dot. Pressure switches, capacitive skin sensors, or thermistors will be used, depending on how the neck strap is to be worn. Magic Dot designed three custom TTL circuits for the unit and assembles the chips and sensor circuitry as a thick-film hybrid circuit. A mercury cell is the power supply.

Northcutt estimates sales will be about 20% of the total neckstrap market, which amounts to some 500,000 units per year in the United States alone. They will sell for about \$12.50 each, and the readout instrument will be leased for \$12.50 a month. Considering that an orthodontist's bill might run to \$1,000, it's a small price to pay to get junior to keep his brace on in school.

## Commercial electronics

### Electronic lock needs no key

A company whose business is based on the keyhole is now trying to make it obsolete. The Schlage Lock Co., San Francisco, Calif., has introduced an electronic lock that eliminates any visible form of security on a door.

The system consists of a central control unit housing the circuitry and a reference card key; a transformer; and a sensor that is actually an inefficient radio antenna. A second key, similar to a credit card, activates the lock. The card is coded with copper on a dielectric and has a single discrete combination of radio frequencies that must correspond to those in the reference key. The sensor continually emits a cascade of radio frequencies and is connected to the control unit, which operates from the house current via

**New age for Schlage.** Electronic lock has no keyhole. A coded card opens the door.

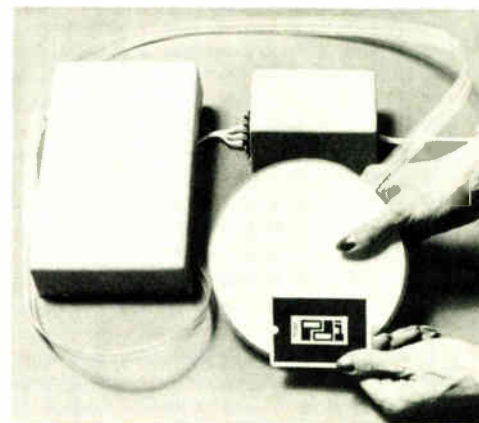



General purpose 12-bit  
A-D converter  
TC = 30ppm/°C,  
speed = 40μsec

\$ 75

100s

General purpose  
12-bit DAC  
TC = 30ppm/°C,  
speed = 5μsec

\$ 39

100s

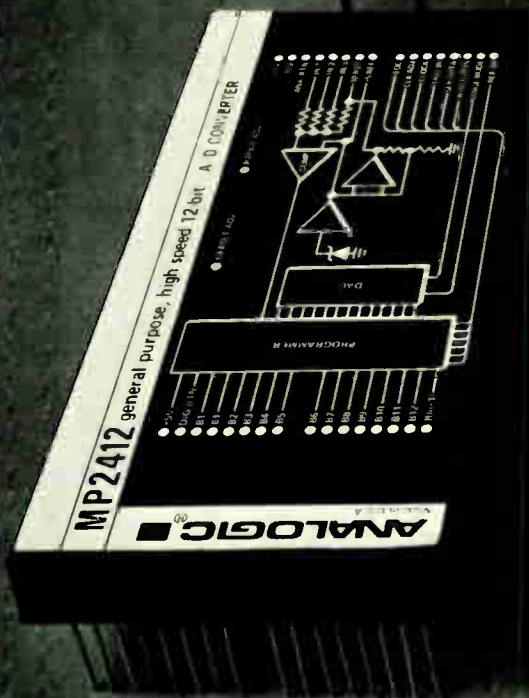

## Pass it on

Pass the saving on to your customers and go to market more competitively with Analogic's new low-cost converters. Both use MSI components extensively to keep the parts count down and the reliability up. Both are backed by the industry's most experienced team of data conversion engineers — people who know instrumentation and like to help their customers solve problems.

And keep in mind our high performance modules too. Like the MP2912 A-D converter with a 4μsec conversion time, a TC of 7ppm/°C, and a price of \$375 in 100s. Allowing system throughput rates much higher than 100KHz, it is the fastest 12-bit unit around. Or the MP1812 12-bit DAC with a maximum settling time of 10μsec, a TC of 10ppm/°C, and price of \$77 in

100s: It features all wire-wound resistors for utmost stability and month-to-month repeatability.

Send for complete specifications and our new complete catalog of over 70 data conversion products. We'll include our handy A-D/D-A Design Reference Guide free. Analogic Corporation, Wakefield, Mass. 01880 (617) 246-0300.

*Northeast, 617 235-2330, 203-966-2580, 315-446-0220, 201-652-7055, 212-947-0579  
Mid Atlantic, 215-272-1444, 703-790-5666  
Midwest, 412-892-2953 216-267-0445, 513-434-7500, 313-892-2500, 913-362-0919, 314-395-4100, 312-283-0713, 414-476-1500  
South, 713-785-0581, 214-620-1551, 305-894-4401, 919-227-3639, 205-534-9771, 305-773-3411, 813-867-7820  
West, 303-744-3301, 505-523-0601, 602-946-4215, 505-296-8303, 714-540-7160, 408-374-5220, 206-762-7664, 503-646-6064  
Canada, 613-836-4411, 604-688-2619, 416-444-9111, 514-861-1375*

**ANALOGIC** ■

Circle 39 on reader service card

## News briefs

### Expansion of citizen's radio sought

Congested citizen radio bands will be expanded and equipment makers may be near a \$300 million-plus annual market when the Federal Communications Commission's proposal to establish a new Class E service in the 224-to-225-megahertz band is realized. The unanimous FCC decision came in a combined notice of inquiry and rulemaking following more than a year of inaction [*Electronics*, March 13, p. 31].

In its proposal to divide the band into 40 channels at 25-kilohertz spacing, the commission requested comments by Sept. 20 and replies by Oct. 22, 1973. Unless delays occur, equipment makers expect to get the service on the air by early 1974.

### Magnets, silicone jelly may be a cancer hope

The key to a cancer cure may be found in small, superconducting magnets and ferrosilicone jelly. The jelly is injected in a blood vessel and held in place in front of a tumor with a magnet. Starved of nutrition, the tumor or cancer shrinks. The magnet, niobium-tin alloy with an iron core, developed at Stanford University's linear accelerator center, has a magnetic field adjustable up to 20,000 gauss. The technique has been used in several successful operations at UCLA.

### WEMA broadens membership, names new president

WEMA's directors are broadening the organization's membership by accepting Government and university research organizations as associate members. WEMA already claims to be the largest U.S. electronics trade association, with 735 member companies and 89 associate members from the financial world.

In another move, the 35 directors of WEMA, in line with new bylaws making the elected industry representative head of the organization, has upped Alan J. Grant to board chairman. The board then made E.E. Ferrey, sala-

ried head of the WEMA staff since 1960, president. Grant, who is executive vice president of Aerojet-General Corp., was elected WEMA president last November.

### Hughes' laser improves power on target . . .

A phased-array, optical tracking, radar-type laser system called COAT, for coherent optical adaptive technique, uses a self-adaptive mode to increase the power reaching the target. Developed at Hughes Research Laboratories, Malibu, Calif., the system overcomes the inherent loss of phase coherence caused by atmospheric turbulence, thereby minimizing either beam spreading in a transmitter or image distortion in an imaging system.

### . . . while company produces watch modules

The latest and biggest supplier of LED display watch modules is Hughes Aircraft Co., Newport Beach, Calif. The company is making complete watch modules for the Elgin Watch Co. and for mail-order company, Hudson-Harris Corp., Great Neck, N.Y. Hughes makes the C-MOS circuit, substrate and crystal, a unit rated at 700 kHz, seven times the frequency of an earlier watch crystal. Two conventional bipolar ICs and Fairchild LEDs are also used. Hughes, no stranger to the watch industry, has been supplying Timex with low-voltage C-MOS dividers for dial watches and had made a limited number of modules for the Uranus Watch Co.

### NASA told shuttle too expensive

Congress' General Accounting Office, in a report critical of NASA's cost estimates justifying the \$5 billion space-shuttle program, recommends that the Hill examine carefully the number and nature of the missions for which NASA says the shuttle will be used. "It may be appropriate to direct NASA to re-estimate the costs," GAO says. NASA insists that the shuttle is cost-effective.

the transformer. If the house current fails, however, the alarm is dead.

The sensor is located near the door at a location known only to the home owner. If the code is correct the door is released, usually by an electric door strike or solenoid-actuated bolt. If the codes do not match, the system locks and an alarm is set off. According to the company, the lock is pickproof and secure from physical assault. Operating range is four inches.

The system, which costs about \$300 is designed for use on a single door, but the company says a system for use on up to four doors will be available in September and another system geared to small business requirements will debut later this year. □

## Computers

### AFIPS' new show policy attracts industry support

By virtually any measure, the National Computer Conference held this month in New York City was a success. The attendance figure of 32,414 was the largest for any American Federation for Information Processing Societies convention since the 1969 Spring Joint Computer Conference in Boston, which attracted 34,000.

Budgeted for 600 booths, the conference sold 615 spaces to roughly 215 companies. The booth figure

didn't quite measure up to the 700 hoped for by AFIPS convention manager, Jerry Van Dijk, but the conference was definitely a moneymaker for the society. "I couldn't be more satisfied," says Van Dijk.

The companies must have been just as satisfied. Van Dijk reports he has already signed contracts for the 1974 conference in Chicago covering 550 booths from about half of the firms who exhibited.

The event was helped by what a

# 3 interchangeable CPUs. That's modularity.



SUE's basic CPU gives you a minicomputer that's high in flexibility yet low in cost. A second CPU provides decimal arithmetic functions. And the third meets the requirements of scientific or industrial applications that call for improved math capability.

These all slide easily in and out of the chassis. Without any wiring. In fact, you can change CPUs at your plant (or even in the field if need be) in about 60 seconds. So a SUE system can change and grow as fast as your customer's needs change and grow.

**The component computer.** And you're not limited to one CPU at a time. SUE's multiprocessor capability lets you hook up as many as four on a single Infibus. Just choose the combination of processors that suits the system best.

That's because SUE (the System User Engineered minicomputer) is the first of its kind:

a component computer for systems. Its modular processors, memories and controllers all plug together in almost any combination to solve your application problems.



That includes I/O controllers, but you'll never need more than two basic types with SUE: one bit serial, one word parallel. These will adapt to any I/O device.

**Wider choice of peripherals.** We offer a full line of peripherals to go with SUE: IBM compatible 5440 disk drives, CRT/keyboards, printers from 100 cps to 600 lpm, magnetic tapes, cassettes, punched card devices and paper tapes. Anything your system needs.



**Complete software tools.** To make your programming burden lighter, we offer a full set of software tools: sort/merge, DOS, assemblers, utilities and RPG/SUE. That last item is 98% compatible with RPG II, by the way.

And we're the only company we know of that unconditionally warrants all our software for a full year.

**Built for systems builders.** SUE's built-in flexibility makes it fit your systems now, makes it easily changeable later on.

You can be sure we'll be here later on, too. Which is one more advantage of dealing with an established, reputable company like Lockheed Electronics.

Let's talk. Call (213) 722-6810, collect, or write us at 6201 E.

Randolph St.,  
Los Angeles,  
California  
90040.

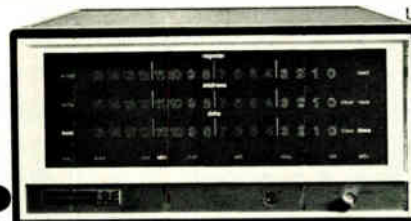

# That's SUE.

**Lockheed Electronics**  
Data Products Division

Circle 41 on reader service card

spokesman for General Automation Inc., Anaheim, Calif., terms "a good strong solid industry," and AFIPS' decision to go to a once-a-year conference.

**Moveable show.** Moreover, AFIPS has decided to rotate the show from the East Coast, to the Midwest, to West Coast. "Keeping the conference in one place would turn it into a regional show," says Robin Adler, product manager at Hewlett-Packard Co., Cupertino, Calif. Adds Ted Smith, vice president of marketing at Sycor Inc., Ann Arbor, Mich., "As long as the show sticks to major markets, not, for example, Seattle or Houston, it will more than likely succeed."

Some exhibitors, however, are reserving judgment and are not willing to take this first conference as an indication of success, not only because it is a first, but because it occurred when the Spring Joint Conference would have taken place anyway. "Next year's show," says Gerald W. Larsen, director of OEM marketing at Fabri-Tek Inc., Minneapolis, Minn., "will be the true measure of success or failure."

This first NCC also marks the re-entry of giants IBM Corp., Armonk, N.Y., and Control Data Corp., Minneapolis, Minn., into the AFIPS fold after an absence of several years. "Having the big companies back in the show is a decided plus," says a General Automation spokesman. "It makes for a well-rounded show—mainframers, peripheral companies, component houses, and so on. This attracts high-quality people, and the result is that we have end users here as well as OEM people."

**Sales on floor.** Another change was AFIPS' official sanction of sales at the show. "This show is, after all, a marketing function," says William Sewalk, director of worldwide sales for Electronic Memories and Magnetics Corp., Hawthorne, Calif. Sums up Norman G. Compton, vice president, sales systems division, Standard Logic Inc., Santa Ana, Calif., "Five days is too long. But it has been worth it. I came very negative and I'm leaving feeling that the show has been even better than Wescon." □



**It reads.** Decision Inc.'s unit reads standard fonts and other input.

## OCR drops dramatically in price as applications stimulate the market

The computer show also revealed that the high prices of optical character recognition systems, long a deterrent to the technology's broad application, are being slashed. Two companies were operating prototypes at the show that were being quoted at prices under \$50,000. Also on display was IBM's 3886 optical character reader. With a price tag of about \$98,000, this machine is pegged at less than half the price of earlier OCR units from IBM.

Optical Scanning's new OCR unit, the OpScan 37, is quoted by the Newtown, Pa., company at \$42,500. It reads standard OCR-A font and, for an additional \$7,000, it will read hand-printed numerals and marks as well. By comparison, the IBM 3886 reads both OCR-A and -B, numeric handprinting, and pre-printed Gothic numerals. The unit contains a built-in cathode-ray tube for displaying text which, because of smudges or other defects, the machine finds impossible to read. An operator then types in the correct letter on keyboard, and the unit resumes reading.

Perhaps even more startling in price than the Optical Scanning machine is the one from Decision Inc. of Oakland, Calif. In large enough quantities, it is being quoted at \$30,000, says Jared Anderson, board chairman. It reads OCR-A and -B fonts, data in a variety of additional fonts, including Courier, upper and lower cases, and data from typewriters, preprinted forms, computer printing, and numeric handprinting. The unit is also fast—at 600 characters per second it is at least twice as fast as the IBM machine.

Whereas the IBM and Optical Scanning machines use combinations of light-emitting diodes and a photocell to read characters, the OCR-7600 uses a "page reader on a chip" from Reticon Corp., Mountain View, Calif.—a linear 128-element array of photodiodes. All three machines, however, will output the data on either 7- or 9-track-compatible magnetic tape, or even directly into a computer. And they will read documents ranging in size somewhere between 2 by 4 to 9 by 12 inches. IBM says it will ship its first units in August. Deliveries of the OpScan 37 and OCR 7600 begin late this year or early next.

It was the announcement of the IBM 3886 last fall that served notice that "optical character recognition was an economically valid method of doing business," points out Frank A. Kirby, marketing vice president of Optical Scanning. And the lower prices now indicate that such page scanners may soon be replacing key punch operators as a means of translating alphanumeric data into computer-compatible codes.

Decision Inc. says it already has a \$3 million purchase agreement for its new machine. It will go to Cummins-Allison Corp., Glenview, Ill., for the company's "multimedia" data entry system.

Still another application being considered, according to Kirby, is the use of OCR in the input terminal of a message-switching system. Here, a message could be read into the system directly, again by a human operator, without it having to be converted, into the punched tape required by a teletypewriter.

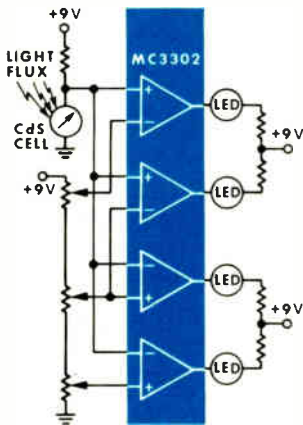

Quad Comparator simplifies light level indicator system.

# Quad Comparator sees the light.

Showing Motorola's MC3302P in a handy light level detector system\* only hints at the broad range of applications where

this *new* comparator development can conserve space and reduce costs.

We're not talking about situations where one of the excellent single or dual comparators formerly available is still adequate or even required. We're talking about system applications where the use of multiple comparators makes maximum cost reduction and high density design significant.

There are certainly other recommendations for the MC3302P, as well. For example, it is specifically designed for positive single supply operation over a wide +2 to +28 V range. The differential

inputs can handle a broad range of voltage levels, from a full  $V_{CC}$  down to ground potential. The output of each comparator is TTL compatible, and can be connected to the other outputs to give the Implied AND function. It has a wider than usual operating temperature range for plastic packaged units, from  $-40^{\circ}$  to  $+85^{\circ}$  C.

If you buy from 100 to 999 of these quads, the price is only \$1.50 each — less than 38¢ per comparator. And the MC3302P is the first quad comparator readily available. Just ask your franchised Motorola Distributor or Motorola Sales Office. \*By the way, in this specific type of application, one of Motorola's panel mount LEDs would be ideal: either the MLED650 or the MLED655. For additional information on the Quad, write to Motorola Semiconductor Products Inc., P.O. Box 20912, Phoenix, AZ 85036 or circle the reader service number.



## Practical innovations for systems design.

# THE BELL & HOWELL TRANSDUCER ENCYCLOPEDIA.

240 B.C. – 1973 A.D.

**Transducer**, trans-dóo ser, a device or component capable of receiving energy of one form and delivering an output of energy of another form.

## THE FIRST TRANSDUCER?

While on a dig in Egypt, French engineers of the late 19th Century unearthed a puzzling mystery.

In an antechamber of one of the great pyramids, they came across the tomb of a man hieroglyphics identified as "The Wizard of Ra." Next to his sarcophagus were several primitive stone and copper gadgets, one of which may have been history's first transducer. The device resembled a wash basin with a swollen trumpet protruding from it. At the bottom of the basin was a hole. Over the hole was secured a piece of highly elastic animal membrane. Running from the hole in the basin was a pipe which bulged out at one point and ended in a horn. In the bulge in the pipe were found the remains of a Mynah bird.

According to tomb writing, the unit fit snugly into the side of a large conduit which carried water from the river to Pharaoh's private bathing pools.

It was the wizard's job to monitor the water pressure and prevent it from rupturing the conduit. His monitoring device (transducer) worked like this:

As pressure built up in the conduit, the elastic diaphragm would swell inward into the tube which housed the Mynah bird. At the sight of his living quarters shrinking, the bird's salty Egyptian expressions alerted the wizard to send a runner to the river to close the sluice gates. Crude though it was, it showed that early Egyptians were able to convert mechanical energy, pressure, into acoustical energy.

## FORERUNNERS OF TODAY.

During the early years of Bell & Howell's CEC/Instruments Division existence, its oscillograph was acknowledged as the state-of-the-art in geophysical and oil exploration fields. So it was but a natural extension into modern day sensors (transducers to be used with recording oscillographs).

Development in these fields led to CEC pro-

ducing the first vibration transducers for industrial machinery requiring low frequency vibration measurement.

## PATENT #2636964.

The product of these humble beginnings paid off on April 28, 1953, when patent #2636964 was issued to CEC Division engineers Joseph H. Lancor Jr. and Julian Delmonte on an improved pressure transducer.

Capable of 5 to 150 psig pressure ranges, AC or DC excitation, wide temperature range, negligible sensitivity to both vibration and acceleration, and with a flush-type diaphragm, this advanced transducer catapulted the company into the front ranks of this highly specialized field.

By 1955, the first Mach II aircraft, Convair's B-58 HUSTLER, required 1200 sensors (capable of withstanding temperatures up to 600° F.) As the temperature environment requirements climbed, the total requirement for pressure measurement entered a new era.



Soon CEC was developing transducers capable of measuring pressure at even higher temperatures. Unfortunately, cable insulation of the time was incapable of long life at elevated temperatures.

We created CERAMICITE® seals and coatings, a high dielectric and high temperature insulator, and became one of the first users of TEFLON® fluorocarbon resin in high temperature sensor applications.

Without question, Bell & Howell/CEC was committed to a leadership position, destined to be identified by the development of the first modern-day transducer.

## A GIANT LEAP FORWARD ONE WEEKEND IN APRIL, 1959.

The first 4-300 type transducer was the CEC "Type 20" unit, conceived in conjunction with our work for Convair's ATLAS Missile.

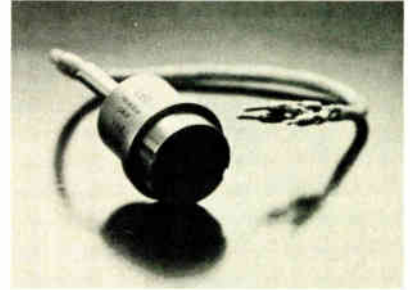

Many problems were encountered as is typical in advancing the state-of-the-art, and six CEC engineers were given the assignment to solve them. Unfortunately, for them, the assignment was made one late Friday afternoon.

That weekend Archie Carroll (the white-haired fellow at the blackboard) and five of his associates worked around the clock. They machined a variety of parts, welding, shaping and reshaping sensing elements. Their work embodied the principal design of the general pressure transducer known today as the 4-326, *still* a standard of the industry.



Today, Bell & Howell engineers are refining the state-of-the-art in all types of transducers, with special emphasis on pressure types. We work closely with test engineers in all industries to provide the most economical transducers for the application.

Bell & Howell also manufactures signal conditioning equipment, amplifiers, and both laboratory

grade oscillographs and magnetic tape recorders/reproducers. Our engineers, therefore, are keenly aware of both the sensing capabilities and output requirements of all transducers. Thus, we are in the

### 1963 TECHNOLOGY: ENTER BONDED TRANSDUCERS.

The application of new technology evolved into Bell & Howell's CEC bonded 4-454. In the early '60s bonded transducers were not satisfactory in many aerospace applications due to the high mass in the sensing element, which limited both frequency response and the ability to provide measurement readings at low pressures.

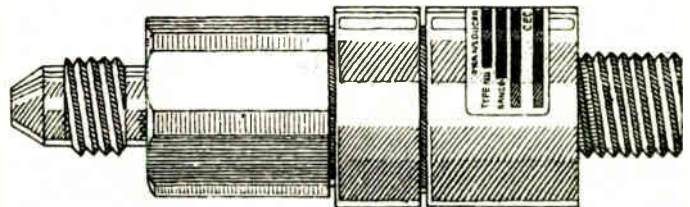

unique position of having knowledge and relating to entire testing or measurement systems required by our customers.

### OTHER TRANSDUCERS ARE MEASURED BY US.

New technology, since the Wizard of Ra, has blossomed into a field of transducer related equipment.

The equipment used to calibrate transducers was developed by Bell & Howell's CEC/Instruments Division. (A primary standard is the 6-201 Air Deadweight tester. A secondary standard is the 4-462 Digital Manometer.)

#### OTHER PROVEN BELL & HOWELL PRODUCTS.

|                                    |
|------------------------------------|
| VR-3700B—Laboratory Tape Recorders |
| CPR-4010—Portable Tape Recorders   |
| Recording Oscillographs            |
| Signal Conditioning Equipment      |
| Vibration Monitors                 |
| Digital Transducers                |

#### THE ENVIRONMENTAL RANGE



OVER 125 STANDARD RANGES IN 23 MODELS  
FROM 0 TO 0.5 UP TO 0 TO 10,000



COMPENSATED RANGES FROM -325°F TO 600°F

However, because of the inherent ruggedness of the bonded transducer design, CEC bonded units soon found use in industrial testing and process control where measurement parameters were not as stringent. Today, Bell & Howell bonded products are found in oil production automation applications, and in the manufacturing and process industries.

### PROBLEM SOLVING TODAY.

Now, test engineers in every field strive to further refine pressure measurement beyond the state-of-the-art. An example of this is the use of the Bell & Howell 4-395 transducer in the MINUTEMAN program.

Solid state technology has led Bell & Howell into the use of diffused semiconductor type diaphragm for process control in low pressure conditions.

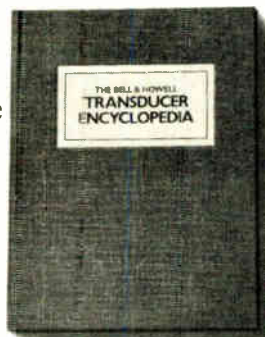

### WE'RE REWRITING THE BOOK.

It's true. *We are* rewriting the book, the Bell & Howell Transducer Encyclopedia. To be published this fall, it will be the most comprehensive study *ever*. Want to be a contributing editor? We'll pay \$25 for every article, case history, or personal experience accepted by the editor by August 31, 1973. Write: Editor, Bell & Howell Transducer Encyclopedia, CEC/Instruments Division, 360 Sierra Madre Villa, Pasadena, Ca 91109.



**BELL & HOWELL**

WE'RE REWRITING THE BOOK.

# LITRONIX 1973<sup>1</sup>/<sub>2</sub>

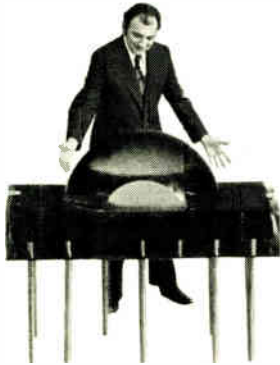

**The Beautiful Bugs:** This is the year of the DL-4 line of high brightness, low power 0.19 inch digit displays. Its integrated magnifier construction provides a handsome, clear, readable digit. It's bright: 500 ft-L at 10 mA per segment and carries many optional features; electrically isolated decimal point, left or right, pin for pin compatibility with either the MAN-1 or MAN-4. Priced at \$3.90 in 100 quantities.

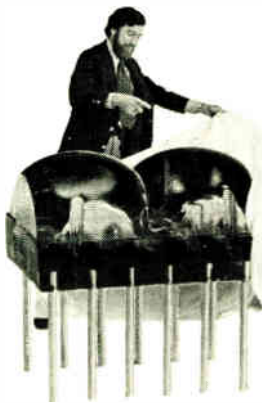

**The Two-Seater Coupe:** DL-44 is a matching two digit display in a single package. The integrated magnifier construction provides a 0.19 inch economy digit. Designed for multiplexing,

the desired digit is displayed by selecting the appropriate cathode. Offers 500 ft-L high brightness at a low power of 10 mA and shipments are categorized for uniform brightness. Priced at \$6.80 in 100 to 999 quantities.

**This is no ordinary disguised man, it's the Superman Digit.** The new Data-Lit 707 second generation LED display has all the qualities you want in a Superman digit: Low cost, low

## the bright guys

power, full solid segments with minimum gaps, availability, standard pins and high reliability.

The Data-Lit 707 is designed in the standard 14 pin dual-in-



line package. It's pin-for-pin identical with the MAN-1 and DL-10. The Data-Lit 704 is pin-for-pin identical to the MAN-4 and DL-4.

Here's the whole new Superman Data-Lit 700 family:

|         |                                     |
|---------|-------------------------------------|
| DL-707  | Common anode, left decimal          |
| DL-707R | Common anode, right decimal         |
| DL-701  | Common anode, polarity and overflow |
| DL-704  | Common cathode, right decimal       |

So step into a phone booth and call one of our distributors. The Data-Lit 700 Series is going at \$3.25 in 100-999 quantities.



**Lights Mounted Where You Can See Them:** The RL-4403/4440 have a viewing area that extends .140 inch beyond the face of the mounting clip. Its full flood 0.2 inch diameter viewing area allows extra wide, off-angle viewing. And it's bright, .8 mcd (minimum) at 20 mA on only 1.7 volts. It can be easily soldered directly to the PC board, or mounted from the front of a panel with a snap-in clip. Direct replacement for the 5082-4403/4440. Priced at \$.49 to \$.65 in 1,000 quantities.

Litronix, Inc. • 19000 Homestead Road • Cupertino, California 95014 • (408) 257-7910 TWX: 910-338-0022

#### Distributors

**Arizona:** Hamilton/Avnet, Phoenix (602) 269-1391  
**Kierulff, Phoenix** (602) 273-7331  
**California:** Hamilton/Avnet, Mountain View (415) 967-7000  
 San Diego (714) 279-2421  
**Hamilton Electro,** Culver City (213) 870-7171

**Kierulff, Palo Alto** (415) 968-6292  
**San Diego** (714) 278-2112  
**Wesco Electronics,** Los Angeles (213) 685-9525  
**Colorado:** Hamilton/Avnet, Denver (303) 534-1212  
**Kierulff, Denver** (303) 343-7090  
**Florida:** Hamilton/Avnet, Hollywood (305) 925-5401

**Georgia:** Hamilton/Avnet, Norcross (404) 448-0800  
**Illinois:** Allied, Chicago (312) 421-2400  
 Hamilton/Avnet, Schiller Park (Chicago) (312) 678-6310  
**Kierulff, Rosemont** (Chicago) (312) 678-8560  
**Kansas:** Hamilton/Avnet, Prairie Village (Kansas City) (913) 362-3250

**Maryland:** Hamilton/Avnet, Hanover (Baltimore) (301) 796-5000  
**Pioneer, Rockville** (301) 427-3300  
**Massachusetts:** Electrical Supply, Cambridge (617) 491-3300  
**Gerber, Dedham** (617) 329-2400  
 Hamilton/Avnet, Burlington (617) 273-2120

**Kierulff, Needham Heights** (617) 449-3600  
**Michigan:** Hamilton/Avnet, Livonia (313) 522-4700  
**Minnesota:** Hamilton/Avnet, Bloomington (612) 854-4800  
**Missouri:** Hamilton/Avnet, Hazelwood (St. Louis) (314) 731-1144



# MODELS SALE

**The Little Old Lady from Burbank** loves her tiny T1 solid-state lamp. It will last forever, requires no gas, it flashes, and is IC compatible. Such a little thing giving off .5 mcd at 20 mA, imagine! Has standard 1 inch leads. Options: red clear, white diffused, water clear. Priced low at \$.33 to \$.42 in 1,000 quantities.



**The Ugly Bugs:** They sure don't look like it, but our phototransistor opto-isolators can handle up to 2,500 volts of isolation with minimum CTR's from 2% to 50%. Now you can rid yourself of those Model-T relays and transformers with sleek solid-state opto-isolators. The new IL-74 is optimized for easy steering in and out of TTL. It's especially useful for elimination of noise and ground loop problems. Prices from \$1.19 to \$1.75 in 1,000 quantities.

drive for power relays, solenoids, triacs, SCR gates and power transistors. They turn on in 10 $\mu$ s, stop in 35 $\mu$ s. Solid-state reliability with 2500 volts of isolation. Second source for MCA2-30/MCA2-50 models. Prices from \$1.70 to \$1.95 in 1,000 quantities.



## litronix

**No Hassle Delivery on Calculator Displays:** If you're building calculators, and you want the standard of excellence, the DL-33 three digit display will allow you to extend battery life, reduce pin count and cost per digit. It draws less than 1 mA (average) at 1.6 volts per segment. Comes in standard 12-pin DIP package designed for multiplexing. Many options available. Prices you gotta hear to believe!

**The Swiss Had a Word for it,** but we can't print that here because watchmakers are now turning to LED displays. Litronix has a line of low power, high brightness compact digits specifically designed for carrying around on your wrist. Call the factory for timely details.



**Overdrive Models:** The ILCA2-30 and ILCA2-55 photo-Darlingtons can drive up to 100 mA DC load current—plenty of

**Pencil Beam Headlights:** The sharpest solid-state indicator light you can buy is the new RL-5054. You can select a high brightness beam at low currents—1 mcd at 10 mA or 2 mcd at 10 mA. It projects a 0.25 spot of light that is super for back-lighting applications. Priced at \$.65 to \$.85 cents in 1,000 quantities.

**Test Drive Before You Buy:** LED solid-state displays, lamps and circuit components will give you years and years of driving pleasure, no gas problems and no maintenance bills. And don't be fooled by the cheapee models, kick the tires.

**Nationwide "Honest John" Dealers:** We've got the best. Give them a call for your free test drive or write for our new 1973 catalog and your free Bright Guys bumper sticker.

Litronix, Inc. • 19000 Homestead Road • Cupertino, California 95014 • (408) 257-7910 TWX: 910-338-0022

**New Jersey:** Arrow, Saddlebrook (201) 256-7331  
Hamilton/Avnet, Cherry Hill (609) 662-9337  
Cedar Grove (201) 239-0800  
Haddonfield (609) 429-1526  
**New Mexico:**  
Century, Albuquerque (505) 265-7837  
Kierulff, Albuquerque (505) 247-1055

**New York:** Semiconductor Concepts, Hauppauge (516) 273-1234  
Hamilton/Avnet, Syracuse (315) 437-2642  
Westbury, L.I. (516) 333-5812  
Arrow, Farmingdale (516) 694-6800  
Summit, Buffalo (716) 884-3450

**North Carolina:** Pioneer, Greensboro (919) 273-4441  
**Ohio:** Arrow, Dayton (513) 253-9176  
Kierulff, Dayton (513) 278-9411  
**Texas:** Hamilton/Avnet, Dallas (214) 638-2850  
Houston (713) 526-4661

Kierulff, Garland (Dallas) (214) 271-2471  
**Utah:** Hamilton/Avnet, Salt Lake City (801) 262-8451  
**Washington:** Hamilton/Avnet, Seattle (206) 624-5930  
Kierulff, Seattle (206) 763-1550  
**Canada:** Prelco, Montreal (514) 389-8051

Ottawa (613) 237-6150  
Electro Sonic Ind. Sales, Toronto (416) 924-9301  
Hamilton/Avnet, Montreal (514) 735-6393  
Toronto (416) 677-7432  
Ottawa (613) 725-3071  
L. A. Varah, Vancouver, B.C. (604) 736-6411

# Harris CM

Here are the eight latest additions to our DI/CMOS family-- the fastest low-power logic devices on the market. And they're completely free of SCR latch-up problems.

Last fall we introduced our first eight DI/CMOS logic devices. \* Now, through our continuing development program, we've added eight more. Like the first group, these offer speeds twice as fast as any comparable IC's (typically 10ns with 10-volt power supplies) and extremely low power dissipation. Power dissipation for each of the eight new devices is typically  $I_nW$ . These units also permit a wide power supply range (3VDC to 18VDC), while providing large noise immunity—typically 45% of supply voltage. And because of our dielectric isolation process, SCR latch-up problems are completely eliminated.

Chip reliability is currently reported at more than 325,000 device hours at +125°C without failure.

The first six devices diagrammed here (HD-4000 series) are pin for pin compatible with the CD-4000A series. The last two are Harris proprietary devices (HD-4800 series). All are available in 14-pin DIP's except the HD-4814, which comes in a 16-pin package. For details see your Harris distributor or representative.

## 9

**HD-4002**  
Dual 4 NOR Gate

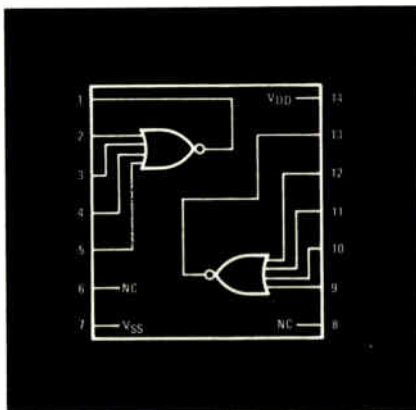

Pin for pin compatible with CD-4002A.  
100-999 units  
-40°C to +85°C \$1.00  
-55°C to +125°C \$3.40

## 10

**HD-4007**  
Dual Complementary Pair Plus Inverter

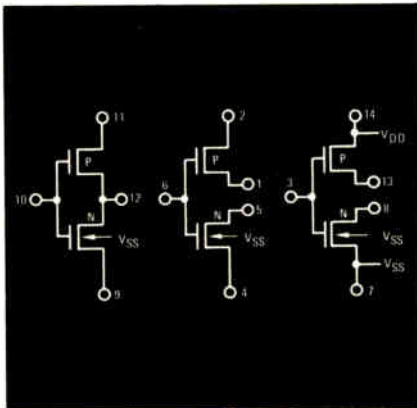

Pin for pin compatible with CD-4007A.  
100-999 units  
-40°C to +85°C \$1.00  
-55°C to +125°C \$2.65

## 11

**HD-4019**  
Quad AND/OR Gate

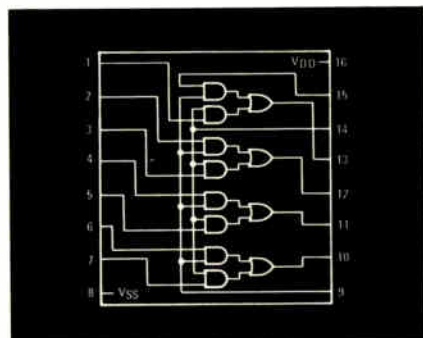

Pin for pin compatible with CD-4019A.  
100-999 units  
-40°C to +85°C \$2.45  
-55°C to +125°C \$5.05

## 12

**HD-4023**  
Triple 3 NAND Gate

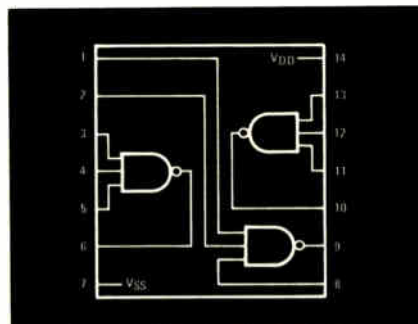

Pin for pin compatible with CD-4023A.  
100-999 units  
-40°C to +85°C \$1.00  
-55°C to +125°C \$3.40

## 13

**HD-4025**  
Triple 3 NOR Gate

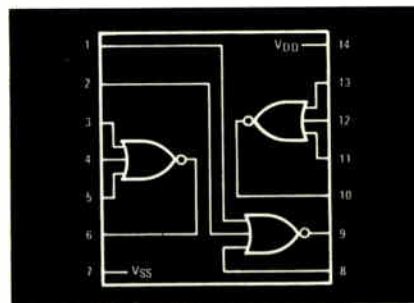

# OS cont'd:

Pin for pin compatible with CD-4025A.

100-999 units  
 -40°C to +85°C **\$1.00**  
 -55°C to +125°C **\$3.40**

## 14

**HD-4030**  
 Quad Exclusive OR Gate

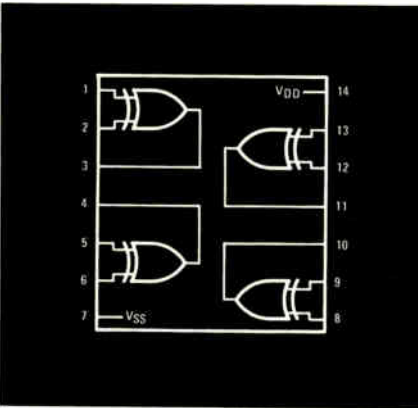

Pin for pin compatible with CD-4030A.

100-999 units  
 -40°C to +85°C **\$2.10**  
 -55°C to +125°C **\$3.80**

## 15

**HD-4811**  
 Quad Exclusive NOR Gate

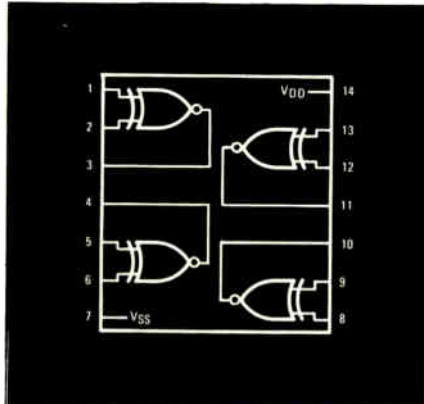

A Harris proprietary device.

100-999 units  
 -40°C to +85°C **\$2.10**  
 -55°C to +125°C **\$3.80**

## 16

**HD-4814**  
 Hex Inverter

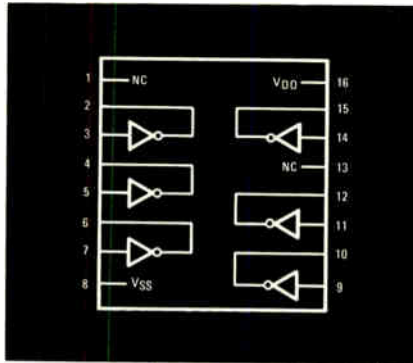

A Harris proprietary device.  
 Replaces HD-4009 in applications  
 requiring only the inverting function.  
 100-999 units  
 -40°C to +85°C **\$2.10**  
 -55°C to +125°C **\$3.80**

## \* 1 thru 8

In case you missed the ad describing our first eight CMOS devices, here they are again. All are high-speed, low-power units. The HD-4000 series is pin for pin compatible with the CD-4000A series. The HD-4809 is a Harris proprietary device.

|  | 100-999 units  |                 |
|--|----------------|-----------------|
|  | -40°C to +85°C | -55°C to +125°C |
| 1. HD-4000 Dual 3 NOR Gate               | \$1.00         | \$3.10          |
| 2. HD-4001 Quad 2 NOR Gate               | \$1.00         | \$3.30          |
| 3. HD-4009 HEX Inverter                  | \$2.20         | \$5.25          |
| 4. HD-4010 HEX Buffer                    | \$2.20         | \$5.25          |
| 5. HD-4011 Quad 2 NAND Gate              | \$1.00         | \$3.30          |
| 6. HD-4012 Dual 4 NAND Gate              | \$1.00         | \$3.45          |
| 7. HD-4013 Dual "D" Flip Flop            | \$2.10         | \$4.75          |
| 8. HD-4809 Triple/True Complement Buffer | \$2.25         | \$5.30          |



**HARRIS**  
**SEMICONDUCTOR**  
 A DIVISION OF HARRIS-INTERTYPE CORPORATION

P.O. Box 883, Melbourne, Fla. 32901  
 (305) 727-5430

**WHERE TO BUY THEM:** ARIZONA: Phoenix—Liberty, Weatherford, Scottsdale—HAR (602) 946-3556  
 CALIFORNIA: Anaheim—Weatherford, El Segundo—Liberty; Glendale—Weatherford; Long Beach—HAR (213) 426-7687; Mountain View—Elmar; Palo Alto—Weatherford, HAR (415) 964-6443; Pomona—Weatherford; San Diego—Weatherford, Western  
 COLORADO: Denver—Elmar, Weatherford  
 WASHINGTON, D.C.: HAR (202) 337-3170  
 FLORIDA: Hollywood—Schweber, Melbourne—HAR (305) 727-5430  
 GEORGIA: Atlanta—Schweber  
 ILLINOIS: Chicago—Semi-Specs, Schweber, Palos Heights—HAR (312) 597-7510  
 INDIANA: Indianapolis—Semi-Specs  
 MARYLAND: Rockville—Schweber  
 MASSACHUSETTS: Lexington—R&D; Waltham—Schweber; Wellesley—HAR (617) 727-5430  
 MICHIGAN: Detroit—Semi-Specs  
 MINNESOTA: Minneapolis—Semi-Specs  
 MISSOURI: Kansas City—Semi-Specs, St. Louis—Semi-Specs  
 NEW MEXICO: Albuquerque—Weatherford  
 NEW YORK: Melville—HAR (516) 249-4500; Syracuse—HAR (315) 463-3373; Rochester—Schweber, Westbury—Schweber  
 OHIO: Beachwood—Schweber, Dayton—Semi-Specs  
 PENNSYLVANIA: Pittsburgh—Semi-Specs, Wayne—HAR (215) 687-6680  
 TEXAS: Dallas—Weatherford, Semi-Specs, HAR (214) 231-9031  
 WASHINGTON: Seattle—Liberty, Weatherford  
 WISCONSIN: Wauwatosa—Semi-Specs  
**LEGEND FOR HARRIS SALES OFFICES & DISTRIBUTORS:** Harris Semiconductor (HAR), Elmar Electronics (Elmar), Harvey/R&D Electronics (R&D), Liberty Electronics (Liberty), Schweber Electronics (Schweber), Semiconductor Specialists, Inc (Semi-Specs), R. V. Weatherford Co (Weatherford), Western Radio (Western)

# 0.0005Hz to 10MHz

Variable positive  
& negative ramps;  
variable positive &  
negative pulses.

Sine, square,  
triangle  
and pulse  
waveforms.

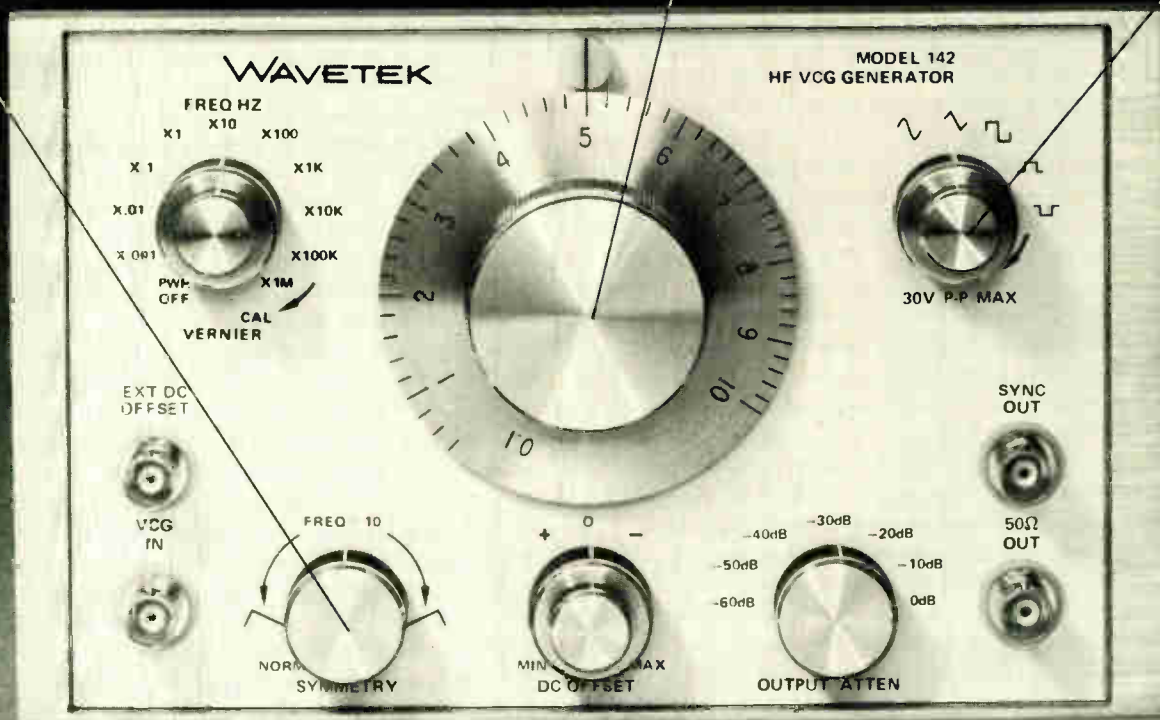

**\$595** **WAVETEK®**  
P.O. BOX 651, SAN DIEGO, CALIFORNIA 92112  
PHONE (714) 279-2200 TWX 910-335-2007

Circle 50 on reader service card

## Foreigners hold most U.S. patents in growth markets

The U.S. Government is worried about Patent Office data showing that, in electronics and other technologies identified as growth markets, an increasing share of U.S. patents is being awarded to foreign nationals. The Commerce Department's newly formed Office of Technology Assessment and Forecast says citizens of other countries now own **61% of U.S. patents for electronic fuel-injection systems for internal combustion engines**, and it expects that figure "to rise to 75% in the next few years." In the same period, foreign nationals are expected to increase their share of patents on electronic musical instrument controls from 30 to 85%. They now hold, and are expected to continue to receive, **74% of all patents for photoelectric control systems for still cameras**, are forecast as increasing their share of recording cartridge changer system patents from 46% to 75%, and are expected to boost their share in magnetohydrodynamic power-generation hardware from 49% to 80%.

## Cost ceiling set in August award of B-1 countermeasures

The Air Force has put a \$1.4 million "design-to-cost" unit price ceiling on 240 production models of the electronic defensive countermeasures subsystem designed to go into the new Air Force B-1 bomber being developed by Rockwell International Corp. **The radio-frequency surveillance package, with its \$336 million potential**, is scheduled to be awarded in August by the Aeronautical Systems division, Dayton, Ohio, following evaluation of final responses due in July from Cutler-Hammer's AIL division and Raytheon Co.

## The FAA's specs for interim MLS upset industry

How much is the design of a multimillion-dollar proprietary system worth? **The Federal Aviation Administration thinks \$25,000 is enough for a complete set of manufacturing drawings and the right to license other manufacturers** of the interim Microwave Landing System it expects to approve by mid-September [*Electronics*, Jan. 4, p. 53]. Competing companies, jumpy about the FAA's protracted deliberation over the MLS, are angry with the requirement contained in the agency's RFP, and the FAA has therefore extended the RFP deadline by two weeks to July 3. **The agency says it wants to prevent a monopoly in a market worth potentially \$50 million.** Competing are Cutler-Hammer's AIL division, Boeing, Singer-Kearfott, Texas Instruments using the French Thomson-CSF design, and Tull Aviation Corp.

## Congress wants more ERTS, but OMB must decide

Congress is trying to bolster the successful Earth Resources Technology Satellite program after cuts demanded by the Office of Management and Budget caused NASA to delay the launch of follow-on ERTS B until 1976 [*Electronics*, Feb. 15, p. 73] and killed the Interior Department's fiscal 1974 request to start an ERTS C [*Electronics*, Dec. 18, 1972, p. 49]. **The Senate and House space committees put in \$8 million to bring ERTS B up to pre-launch readiness**, so that NASA and Interior might switch their spacecraft this way: Since NASA wants to add a thermal-sensing channel on ERTS, which would take development time, Interior could take over B while NASA pursued C. **The catch is that OMB must still okay the project.** General Electric is prime contractor for the first two ERTS.



## Good design doesn't change.

Ten years ago, Acopian came out with a line of plug-in D.C. power supplies, which were conservatively designed and built to last. It's the same basic line of power modules which electronic engineers specify today in their product designs.

This stability is a rarity in the electronics industry, where the life expectancy of a product design seldom goes beyond three years. Where, during the past decade, other companies, styles, and trends have come and gone.

Today, as in 1963, the Acopian plug-in power supply design continues to be valid. No change just for the sake of change. Only to improve the product. No sacrifices just to achieve arbitrary size reduction or a contemporary appearance. Or to stretch their operating environment

These concepts are confirmed by the reliability and consistent performance of Acopian plug-in power modules proven by their field use during the past decade.

Additionally, Acopian plug-in power supplies offer many inherent advantages.

Consider how they could simplify your product design. With thousands of models available to precisely fit your requirements. Single and dual output. Regulated and unregulated (for economically driving lights and relays). Special high-isolation types for powering strain gauges and other transducers. A range of power ratings from 1 to 200 volts... from 100 ma. to 5.0 amps. A choice of performance levels. Models tested to military specifications.

Consider further how our octal base power modules could reduce your assembly costs. With the input and output connections simply pre-wired to an octal socket on the chassis, installation and removal of the power supply become one second operations. There's no need for a wire harness. No need for brackets or special connectors. No need in most applications even for mounting screws.

Send or phone for a current catalog of Acopian power modules and accessories. They're backed by a firm five-year warranty, which includes the cost of both parts and labor. And by a promise which we have never failed to keep: manufacture and shipping in three days after your order is received. Acopian Corp., Easton, Pa. 18042. Phone (215) 258-5441. TWX (510) 651-4919. Telex 847-493.



## Philips, Siemens, and CII near computer partnership

Philips Gloeilampenfabrieken, Siemens AG, and Compagnie Internationale pour l'Informatique expect to sign a pact making them partners in computers within a month. Officials of the three companies aren't talking freely about their deal, but **it's a good bet that the trio will pool computer capabilities—minus excepted—in a new "European" company.**

Aim for the long term is a new line of machines and enough market strength to nibble off some of IBM's overwhelming market share in Europe. At the outset, though, the combined offering will be put together from existing machines. **Philips' hardware will dominate in the lower end of the line, Siemens' in the middle range, and CII's the upper end.**

At the moment, Philips, Siemens and CII together are doing some \$750 million annually in computers. That gives them a combined market share of some 12% in Europe, compared to something like 65% for IBM. Teamed up, the three figure they can easily boost their share to at least 20% before too long.

## France pushes digital battlefield communications system

France is currently the front runner in a race to develop a new generation of battlefield digital telecommunications systems. **The major French electronics companies have reached the prototype stage with a pulse-code-modulation system known as RITA, which can handle communications with fixed or moving units and features an automatic call-up system enabling any unit to be contacted immediately even when its location is unknown.** Automatic commutation technology has been developed by ITT subsidiary Laboratoire Central de Télécommunications, and hardware is also being turned out by another ITT company, Le Material Téléphonique. **The RITA system, on show at a Paris military hardware show last week, is to undergo tactical trials in 1975.** Production is scheduled to begin in 1977. Contracts will be shared between the two ITT companies and five others.

**ITT is also riding the other contender in the race—the U.S. Tritac system, codenamed AMT CC39.** ITT military divisions are working on this delta-modulated digital system, but only got a go-ahead from the armed forces last year.

## Japanese combine to produce minicomputers

Panafacom, a joint venture in the minicomputer field, will reduce by one the number of minicomputer manufacturers in Japan. And it will start out as the No. 1 in market share. **The new company will be founded with an investment of 1 billion yen, in the percentages given, by Fujitsu Ltd., with 35%; Fuji Electric Co., with 15%; Matsushita Electric Industrial Co., with 20%; Matsushita Communication Industrial Co., with 25%; and Matsushita Graphic Communication Systems, with 5%.** The company will be located in Fujitsu's Kawasaki plant just outside Tokyo.

**Fujitsu's present 20% share and Matsushita's 10% share of the mini market will make the joint venture No. 1 with 30%.** No. 2 will be Hitachi with about 20% of the market. Market share won't change suddenly because the two companies intend to go on making present products for perhaps the next year while they plan the next generation of machines.

## **Britain funds prototype of doppler-scanning ILS**

The British government has authorized construction of a full prototype microwave instrument-landing system using doppler-scanning techniques as part of the British proposals for the next generation of international aircraft-landing aids. **If the system works successfully, it will be submitted to the International Civil Aviation Organization, which will examine proposals from many countries before defining the final mandatory international system.** Prime British contractor is Plessey Co., which will use a doppler technique invented in 1968 at Standard Telecommunication Laboratories Ltd., ITT's British research subsidiary. Plessey has manufacturing licenses, but STL will develop most of the equipment for the initial installation.

**The new system will be a development of the experimental STL-built 5-gigahertz doppler ILS installation at the Royal Aircraft Establishment.** This has transmitter and antenna arrays for forward azimuth and elevation only. In the new system a back azimuth array, azimuth field monitors, and new airborne receivers will be added. Scheduled system completion date is early next year. STL claims that the RAE installation has already demonstrated accuracies of  $0.02^\circ$  rms through an azimuth arc of  $\pm 60^\circ$  and through an elevation angle from  $0.7^\circ$  up to  $9^\circ$ . **STL maintains that this performance gives the UK program a lead of about a year over rival microwave landing systems.**

## **Bosch readies auto-electronics plant in U.S.**

Robert Bosch GmbH, a heavyweight in the automobile-accessory field, is out to bolster its already strong position on the North American market. Apparently in a move **to get around the U.S. tariffs on imported goods and to be closer to its American customers,** the German company has begun construction of a \$5 million manufacturing plant near Charleston, S.C. Starting next year, an initial work force of 300 people will build electromechanical accessories for commercial vehicles. **The size of the construction site—it compares with the firm's 13,000-man facility near Stuttgart—suggests, however, that Bosch's plans in the U.S. go far beyond manufacturing truck equipment only.** In fact, a company spokesman says that the firm may get active in electronic systems for trucks and passenger cars—"if the American market calls for it."

## **Addenda**

**Siemens AG has negotiated an agreement with Corning Glass Works** under which the two firms will cooperate in the field of glass-fiber waveguides for communications. In this area, Corning until now has made available its expertise only to U.S. companies, making Siemens the first non-U.S. firm with which Corning has made a glass-fiber cooperative deal. . . . **A new entrant in the light-emitting diode business is Thorn Lighting Ltd.,** a division of the giant Thorn Electrical Industries group. Thorn will shortly launch matched single-diode indicator lamps in red, yellow, and green. The diodes are designed to give 1.5 millilumens from 20 milliamperes of current at between 2 and 3 volts, so that different colors can be used side by side without complication. . . . **Data Precision Corp.'s digital instruments will be sold in Britain by SE Laboratories Ltd.** Biggest seller will be the DP 245 multimeter, which at the sterling equivalent of \$375 will undercut its nearest rival, the Solartron 7040 by more than \$100. Solartron includes auto-ranging, not in the DP instrument, but the DP price includes batteries, which are extra on the Solartron.



# MEET FCC SPECS ON RADIATION, SPURIOUS, HARMONICS AND INTERMODS

## TYPE HFV VHF FIELD-STRENGTH METER 25 to 300 MHz

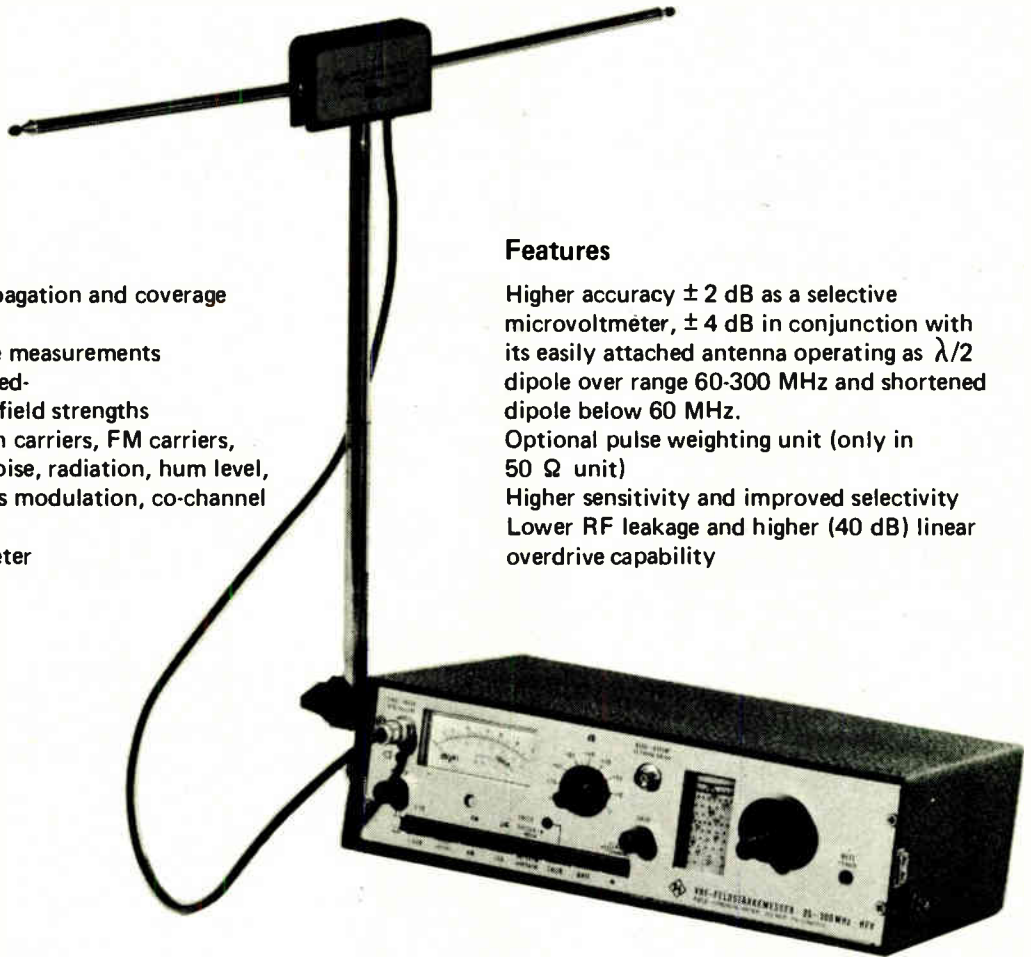

### Applications

Measurements of propagation and coverage  
Radio monitoring  
and radio interference measurements  
Measurement of wanted-  
and interfering-signal field strengths  
Measurement of vision carriers, FM carriers,  
AF carriers, system noise, radiation, hum level,  
intermodulation, cross modulation, co-channel  
interference  
Selective microvoltmeter

### Features

Higher accuracy  $\pm 2$  dB as a selective  
microvoltmeter,  $\pm 4$  dB in conjunction with  
its easily attached antenna operating as  $\lambda/2$   
dipole over range 60-300 MHz and shortened  
dipole below 60 MHz.  
Optional pulse weighting unit (only in  
50  $\Omega$  unit)  
Higher sensitivity and improved selectivity  
Lower RF leakage and higher (40 dB) linear  
overdrive capability

- Continuous tuning without band switching
- Direct voltage calibration in dB ( $\mu$ V)
- Measurement range 100 dB (log. 130 dB)
- Internal calibration at any frequency with pulse generator
- Available in 50 and 75  $\Omega$

- Linear (20 dB) and logarithmic (60 dB) indication
- Peak- and average-value measurements
- Rotatable and tiltable dipole
- AC supply and 8 hour Ni-Cad battery operation

Get The Extra Capability,  
Greater Reliability, and  
Longer Useful Life Of . . .



## ROHDE & SCHWARZ

111 LEXINGTON AVENUE, PASSAIC, N. J. 07055 • (201) 773-8010

**“We subjected the Augat plug-in socket panel to an accelerated-life test in order to induce contact failure.**

**“We failed.”**

Dave Fillio  
Principal Engineer, Component & Materials Engineering  
Honeywell Information Systems

"We needed an interconnection system for controllers on the H716 minicomputer that could help us meet four basic requirements:

"High density to get as much as possible into a small package and still meet the increasing customer demand for a broad range of peripherals, each requiring a separate controller.

"The capability of automatically wiring, with a minimum of two-levels.

"Flexibility to permit anticipated design changes and still allow us to meet a very tight schedule.

"And finally, all these features had to be available in a standard product.

"The most logical approach seemed to be printed wiring boards. But to accommodate all our controllers could have required as many as eight boards. And we couldn't afford the room. Also, when recycling changes are taken into consideration, the design cycle of printed wiring boards becomes too long and, consequently, too costly.

"Multi-layering offered a minimum of flexibility, and it, too, was rejected.

"The only practical solution was the plug-in socket panel. And of all the vendors, Augat was the only manufacturer that could provide a completely uniform, broad range of standardized products, the lowest possible profile and maximum reliability.

"The reliability tests we conducted on the Augat machined sockets included environmental exposures, accelerated-life, vibration, thermal shock, and durability. All tests with the Augat system were positive.

"From a field service standpoint, a key consideration with increasingly complex and flexible systems like the H716 is keeping them on the air at all times. Because of the reliability of the Augat interconnection system, we've had no reports of machine down-time associated with the Augat product since the introduction of the H716 eight months ago."

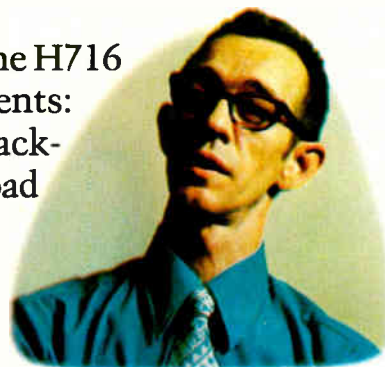

Dave Filio

More and more companies like Honeywell are realizing that Augat socket-panels are an economical, reliable and totally flexible solution to interconnection problems, including development, production and field service requirements.

Augat's precision-machined tapered entry contact has made Augat the reliability standard for the industry. As the world's leading manufacturer of socket panels and other IC interconnection products, Augat is ready to help you solve your interconnection problems.

Call or write today for a free brochure and complete product information. Augat, Inc., 33 Perry Avenue, Attleboro, Massachusetts 02703. Represented and distributed internationally.



The H716

**Plug into Augat®. Honeywell did.**

CONTROL DATA  
CYBER 70



5

# Think Twice:

## Control Data Did

Control Data's reputation was built on providing computers with high throughput/dollar capabilities. That capability must be protected by assuring their customers ultra-reliable computers. Therefore, when Control Data assigns a scope to a computer, that scope must be as reliable as their computer. This makes reliability equally as important a consideration as performance—In both categories, H-P's portable is a scope that meets Control Data's rigid requirements.

### It Pays To Compare.

Before choosing any scope—from the smallest portable to the most sophisticated lab model—make a careful evaluation and comparison. **If you need a portable**, remember that HP portables with self-contained batteries give you go-anywhere capability to meet your most demanding field service requirements. A sealed case with no fan or vent holes frees you from worry about dust and moisture. **For a lab system**, compare the flexibility offered by the broad range of compatible plug-ins. Then call us for a hands-on demonstration of the combination that best fits your needs.

### Look Into Price.

Analyze your total measurement

needs, then ask both manufacturers to submit prices. On currently available models, you'll find that HP can save you money—lots of it in most cases. Check carefully on all aspects of cost and performance. Whether you are comparing real-time systems with or without delayed sweep, or sampling units, you'll find that HP still offers a cost/performance advantage.

### Check Ease-of-Use.

Compare simplicity of controls, display size and error-prevention devices. Does the scope have useful, time-saving features; like selectable input impedance, variable-persistence storage and simplified sampling? Check writing speed; HP's new burn-resistant storage scopes are brighter than scopes have ever been, and write at a speed up to 400 cm/ $\mu$ sec. This means you no longer need to bury your head under a scope hood to view fast-risetime, low-rep rate signals.

### Don't Neglect Calibration And Service.

Compare calibration time needed for each manufacturer's unit. You'll find it takes less time with an HP scope. In fact, some companies bought HP scopes because of this one fact alone. You'll also

discover that HP scopes are backed by video tapes which cut the time you spend training your calibration people.

### Think Twice: Like Control Data.

You owe it to yourself to make these comparisons before you choose your next scope. To help you compose the check list for the scope that meets your personal needs, send for our "No-Nonsense Guide to Oscilloscope Selection." Or, contact your local HP field engineer for a demonstration. Think twice and check before you choose. Hewlett-Packard, Palo Alto, California 94304. In Japan: Yokogawa — Hewlett-Packard, 1-59-1, Yoyogi, Shibuya-Ku, Tokyo 151, Japan. In Europe: HPSA, P.O. Box 85, CH-1217 Meyrin 2, Geneva, Switzerland.

Scopes Are Changing;  
Think Twice.

083/2



OSCILLOSCOPE SYSTEMS

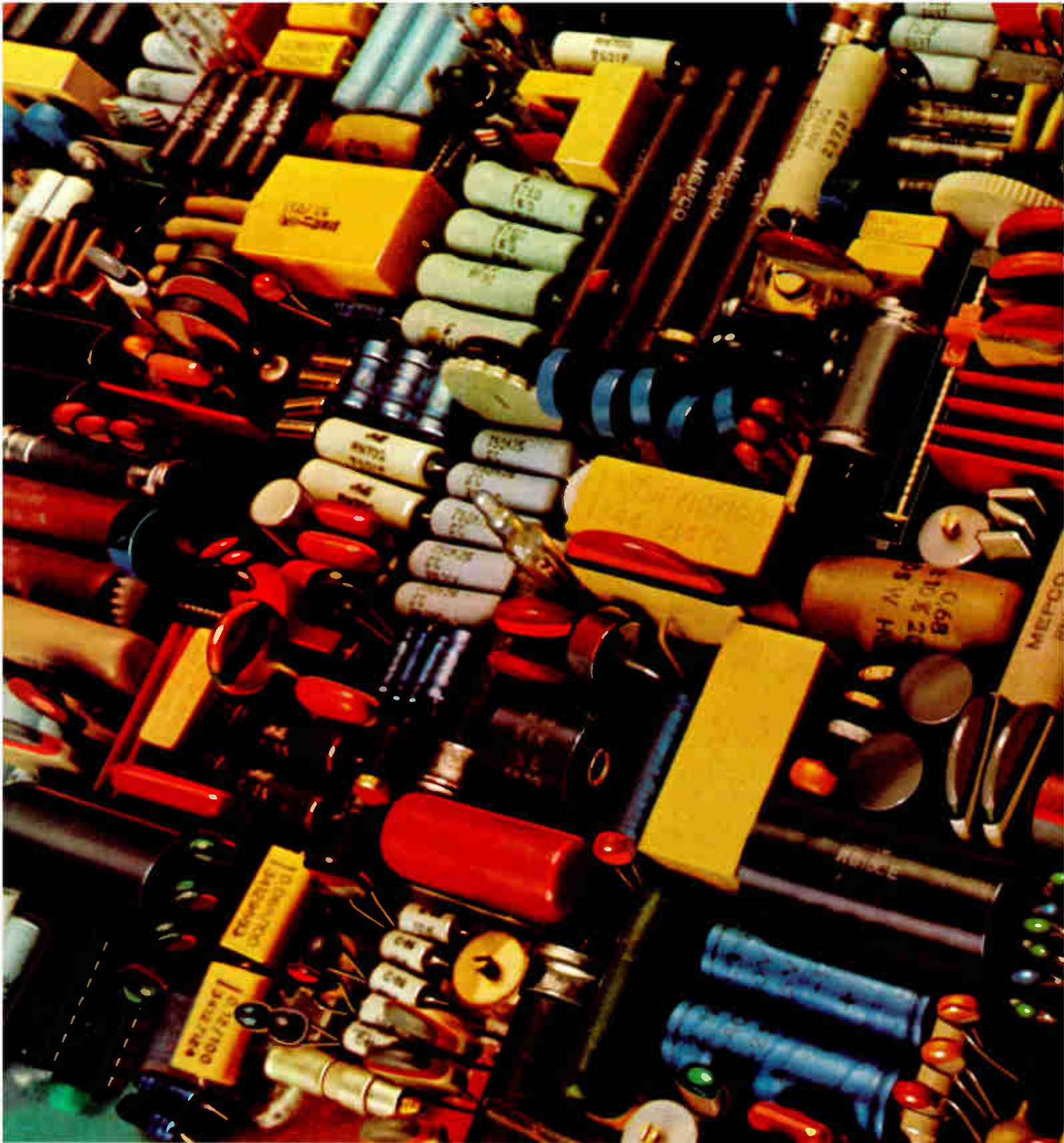

## Capacitors and resistors for home entertainment a

At MEPCO/ELECTRA, we've got 'em all. We can supply passive components to almost any military or industrial specification or for the less critical high-volume application. ER... it's here. Commercial/ industrial... here too.

Delivery? In quantity, fast. From a shelf inventory of

better than 50,000,000 pieces. Standard components from 10 worldwide plant locations.

Complete? Everything from ceramic and electrolytic capacitors to metal and carbon film resistors. From carbon and cermet trimmers to DIP networks, hybrid microcircuits and thermistors.

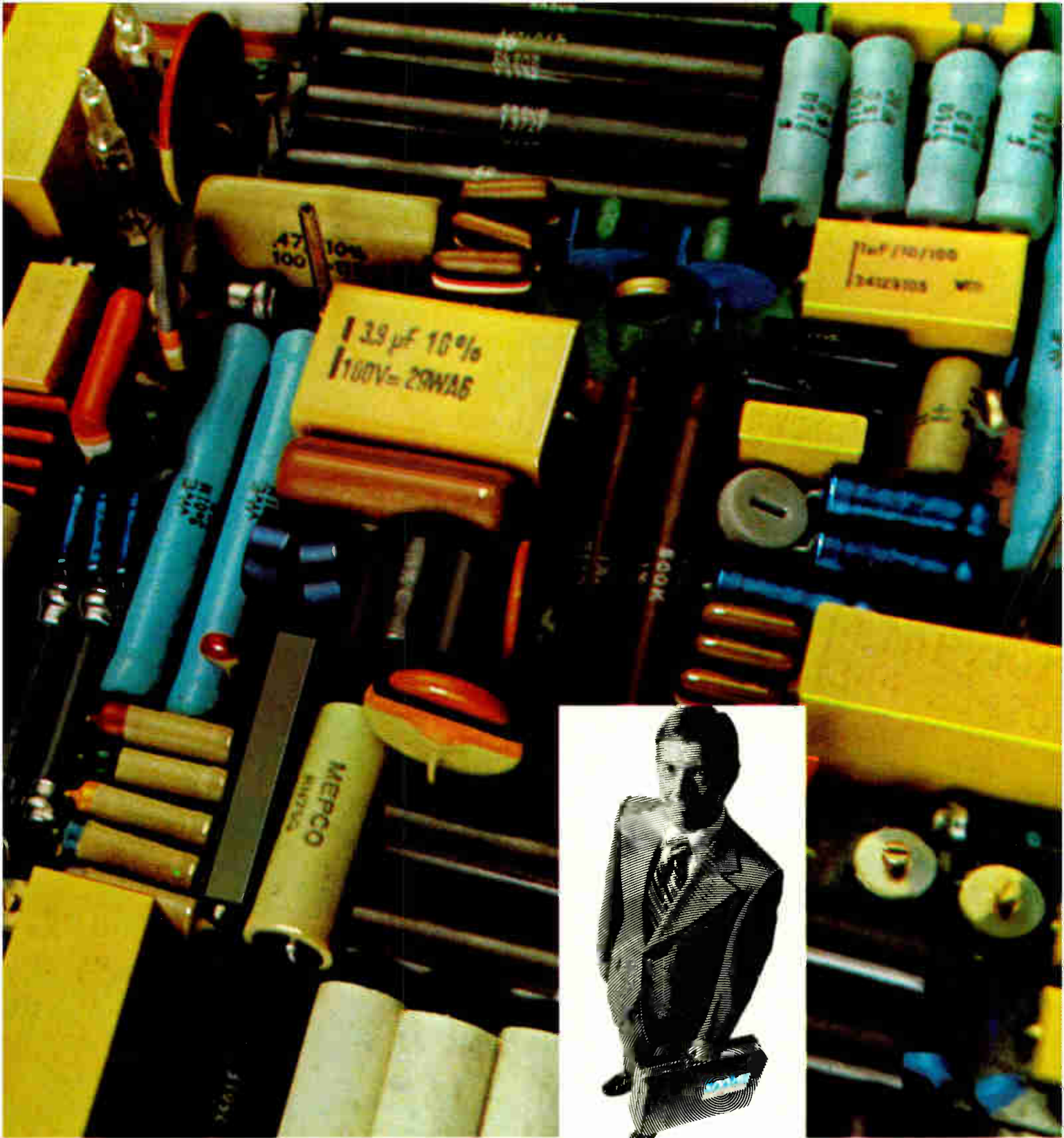

**aerospace, all in our bag!**

Our point is this... if you need high production or short runs for EDP, instrumentation, communications, entertainment or military application check with us. It pays. The best buys are in our bag.

Sold through North American Philips Electronic Component Corporation

**Talk to the man from  
MEPCO/ELECTRA**



MEPCO/ELECTRA, INC.  
A NORTH AMERICAN PHILIPS COMPANY

**FACTORY LOCATIONS:**

Columbia Road, Mcristown, New Jersey 07960,  
11468 Sorrento Valley Road, San Diego, California 92121,  
P.O. Box 760, Mineral Wells, Texas 76267

Circle 65 on reader service card

# Make the assumption: Cinch makes the connector



When you need a connector—any connector—and you're not sure who can supply it, make the assumption that Cinch can. You're on pretty safe ground, because Cinch probably makes more types of interconnection devices, for more applications, than any other manufacturer in the world.

Among the categories we cover thoroughly are

- Printed circuit connectors
- Rack and panel connectors
- Cylindrical connectors
- Component and IC sockets
- Back panel assemblies
- Barrier terminal blocks
- Telephone system connectors

Here's another assumption you can safely make: If you're looking for any reasonably standard connector type, it's probably available from your Cinch distributor, since Cinch offers more types of interconnection devices for immediate delivery through distributors than any other supplier.

So when you're trying to fill a hole in your connector procurement, make the assumption that Cinch has it . . . and that your Cinch distributor can supply it off-the-shelf. Meanwhile, write Cinch for a complete list of available product catalogs describing our products and capabilities. TRW/Cinch Connectors, an Electronic Components Division of TRW Inc., 1501 Morse Avenue, Elk Grove Village, Illinois 60007. Phone (312) 439-8800.

CM-7301

**TRW** CINCH CONNECTORS



# Probing the news

Analysis of technology and business developments

## The boom will come down gently

That's what most Wall Streeters expect will happen when curve flattens by next year; big questions are about markets and too much capacity

by Howard Wolff, Associate Editor

**The business boom** in the semiconductor industry—and electronics in general—can't continue at its present level, but when the curve flattens at the end of this year or beginning of 1974, the slowdown won't be a major one. That's the consensus of a cross section of Wall Street securities analysts and top industry officials who on the one hand are watching the use of semiconductors spread and production capacity climb and on the other hand are mindful of past slumps.

However, as can be expected, some Wall Street spirits are making rather less blithe projections from their readings of past boom-and-bust cycles. They point to the dangers of overcapacity and an historic reliance on new markets that don't seem to reach the dramatic heights expected of them.

But the bulls are definitely in the ascendency. That giant of Wall Street, Merrill Lynch, Pierce, Fenner & Smith Inc., says in a research report issued earlier this month: "Some concern over a slowdown is understandable, but we do not agree that the semiconductor industry's growth will slow materially or that overcapacity will be a serious

problem in 1974. We have, in fact, just revised upward our projections for semiconductor sales for both 1973 and 1974. . . . Our new projections indicate that U.S. consumption will grow 22.9% in 1973 and 17% in 1974 compared with our earlier thoughts of 18.6% and 14.3%."

If that report shows nothing else, it's that a sure way to get all the semiconductor watchers talking at once is to drop the word "overcapacity." Good years in the past, like 1969, saw breakneck building

followed by bad years with silent production lines. But Benjamin M. Rosen, director of research and electronics analyst at Coleman and Co., says the semiconductor industry is no longer the cyclical creature it once was. Rosen, who has a BSEE from Caltech and an MSEE from Stanford, points out that it no longer is dependent on a single mature market—computers. In 1969, computer makers accounted for three times the purchases of consumer product manufacturers. "The



**Aharon Orlansky:** "I see 1974 as a flat year, but 1975 will be a good one."



**Michael M. Senti:** "New products have the lowest profit because of the learning curve."

**Susan Robbins:** "The auto industry alone wants 20 to 30 items in each car."



**Benjamin M. Rosen:** "The mix is healthier now"—not just computers as in 1969.



mix is healthier now," says Rosen, among computers, government, industrial, and consumer customers. Adds Rosen, the semiconductor industry will do what a high-technology industry should—it will act independently of economic cycles.

There might be a short, shallow downturn in 1974, says Aharon Or-lansky, senior analyst at the Anchor Corp., but a lot of the new capacity will be ready to go on line late in 1974, just in time for the new recovery. Capital outlay for the semiconductor industry was 12% to 15% even in bad years, notes Or-lansky, so that the 27% in 1973 that alarms some observers isn't startling when 15% is just staying even.

**Profits holding.** He doesn't see capacity building to the point where prices will drop faster than the learning curve dictates, so he expects profit margins to hold. If the Gross National Product next year is "flat to moderately up, there'll be no problem," he says. "I see 1974 as a flat year, but 1975 will be good."

Optimism about the semiconductor industry's chances of breaking out of its cyclical behavior is expressed by Susan Robbins, a vice president at Heine, Fishbein & Co. "We're getting closer to the time when the electronics industries—led by the semiconductor industry—will be as omnipresent as the electrical-equipment companies were."

Ms. Robbins, like Rosen and Or-lansky, feels that the promise of new markets will come true. "The auto industry alone would like to have 20 or 30 items in each car."

**Spring bear.** The first of the bearish voices to be heard on Wall Street this spring was that of Michael M. Senft, a general partner at Andresen & Co. Senft wrote a pessimistic report on semiconductor stocks in April that caused a shiver on the street and some harsh words in the semiconductor industry.

Senft is undeterred, however. He says, "The semiconductor industry builds capacity so rapidly that as soon as there is a softening in the economy, earnings plummet. Time has proven that any slowdown in the growth of the rate of demand—which always happens when capital

## The key is in the ignition

From Wall Street to Mountain View, eyes are on the burgeoning auto market for semiconductors. But is the industry pinning to much of its hopes on the new market? What effect is Detroit having on production? And what's the effect on over-all sales? Here are the capsule views of three semiconductor chief executives.

C. Lester Hogan, Fairchild: the industry is not building capacity earmarked specifically for the auto industry. The production facilities being added now are already "sold out." He doesn't expect the auto market to fluctuate. "It won't be a sawtooth—it will rise monotonically."

Thomas J. Connors, Motorola: "The automobile industry is already having a big effect on the semiconductor industry. The volumes are so large—and in new products—that they swamp almost everything in the system."

Charles Sporck, National: So far, the auto companies have had little effect on semiconductor industry sales, since large orders have only been placed recently. He expects that the auto market will build without the fluctuations—sometimes as high as 30% to 40%—of orders from other industries.

spending is accelerating—weighs down on prices." Senft also is singularly unimpressed by all the talk of new markets. His figures show that in previous boom years, 1966 and 1969, new products accounted for around 20% of the industry's sales. This means, he says, that 80% is old products, sales of which drop when the economy softens. "New products," he says, "have the lowest profit because of the learning curve."

**No disaster.** Senft believes that the automotive and other new markets will keep the decline from duplicating what he calls the disaster of 1969 and 1970. "It will be slight, more like 1966 and 1967," he says. "Profits are too high; I see 1974 earnings flat to down."

Though industry leaders also see a cooling off of the growth rate, they are predictably optimistic. The prospect leaves C. Lester Hogan, president of Fairchild Camera & Instrument Corp., unworried. For one thing, he says, it might give the semiconductor industry a chance to catch up with order backlogs, which are at record levels and climbing.

Fairchild's own first-quarter sales rose some 47% to a volume of \$75 million, three quarters of which was in semiconductor sales. Profits increased sixfold over the first quarter of 1972—after-tax income rocketed to \$4,374,000. At the same time, Hogan says, "the industry cannot pile up two boom years in a row."

Fairchild is predicting U.S. factory sales for 1973 will be \$1.83 billion, up 25% over 1972, and that worldwide semiconductor consump-

tion will be \$3.3 billion, up 23%.

Production capacity is being added throughout the industry "at a measured and judicial rate," Hogan says. Gambles are being taken on technical developments—for example, Fairchild's expenditure of over \$1 million on developing charge-coupled devices—but not on new plants.

Thomas J. Connors, vice president of Motorola Inc. and general manager of the Semiconductor Products division in Phoenix, Ariz., says, "We think the semiconductor industry will have a slower growth next year than this, about 12% compared to the 29% we expect this year. We've already planned for this. But I don't see any slowdown for the rest of this year. It's not possible—barring a real fluke."

Connors doesn't expect an over-capacity problem. "We're now running at a rate in excess of capacity, say 115%, with three shifts and seven-day operation. So the new capacity we're adding will only bring us back to a more normal work schedule."

**Top rate.** At National Semiconductor, production capacity is being expanded at "the maximum rate," says Charles Sporck, president. "We haven't been cautious about plant expansion for 18 months." When the accountants complete the annual report for National's 1973 fiscal year, just ending, it will show that National went well over its initial capital expenditures budget of \$11 million, Sporck hints. "We'll spend more than \$11 million in 1974, too," he adds. □

# Anyone can find fault with the Teradyne L100.



If you're testing a fair number of digital circuit boards without benefit of automatic fault isolation, you're probably spending much more money on troubleshooting than you have to. Consider:

Board testing usually ends and board troubleshooting begins once you know that an output pin is in the wrong logic state. Automatic fault isolation, available with Teradyne's L100, picks up the trail at that point, automatically telling the operator where to probe, step by step, until the source of trouble is reached. Instructions are in plain English, in terms of specific pins of specific ICs. The whole procedure might take less than a minute, even with

a complex board. Best of all, it requires no special technical skills.

Maybe you think all this diagnostic power adds up to one big programming headache. Not at all. *The same probe you troubleshoot with, you program with* — simply by letting the system learn the logic on a known good board.

To learn how you can find fault with the L100 Automatic Digital Circuit Test System, write: Teradyne, 183 Essex Street, Boston, Massachusetts 02111. In Europe: Teradyne Europe S.A., 11 bis, rue Roquépine, 75 Paris 8<sup>e</sup>.

## TERADYNE

CHICAGO (312) 298-8610 / DALLAS (214) 231-5384 / NEW ENGLAND (617) 458-1256 / NEW YORK (201) 471-4052 / SUNNYSVALE (408) 732-8770  
LONDON (093-28) 61111 / PARIS 265 72 62 / ROME 59 47 62 / MUNICH (0811) 33 50 61 / TOKYO (03) 263-9354

Commercial electronics

## Lasers seek wider markets

CLEA session in Washington emphasizes industrial, communications, and energy uses and displays strong international flavor

"It's like a healthy baby. It has learned to walk and talk, and it's getting better every day. But it is still a long way to maturity." That conclusion by a Government laser researcher following the fourth biennial Conference on Laser Engineering and Applications seemed particularly apt for the robust three-day meeting at the end of May in Washington. Officials declared attendance soared by 55% from 1971, while the number of exhibitors doubled, and approximately 1,400 registrants packed 21 sessions to hear more than 200 papers delivered nonstop under the rigid timetable set by the sponsors, the IEEE Quantum Electronics Council and the Optical Society of America.

Emphasis on expanding laser applications for industrial, communications, and energy markets was strong throughout the conference, which also featured high-power and Q-switching systems for military users. But CLEA took on a markedly international flavor, largely as a result of special Japanese and Russian program committees, with foreign speakers and exhibitors stressing the industrial potential of laser R&D programs in their countries.

**Salesmen.** While researchers from Nippon Electric Co. and Nippon Sheet Glass Co. were detailing in a technical session the characteristics of their recently developed optical fiber called Selfloc [*Electronics*, April 26, p. 53], company representatives were taking orders at the Nippon booth for 100-meter lengths at \$2,490 and quoting 60 to 90 days delivery. As if in response to reports from Bell Laboratories and Corning Glass Works of the development of fiber-optic waveguides with losses as low as 5 and 2 decibels per kilome-

ter [*Electronics*, May 24, p. 33], Nippon said it "positively promised that the loss will be decreased below 20 dB per kilometer in the near future" for its Selfloc fiber "because the work to purify bulk materials is in progress." Losses in the Selfloc cable now are guaranteed to be less than 40 dB per kilometer.

Noting that Japan's government-supported effort in pattern information processing, called PIP [*Electronics*, Feb. 1, p. 60], "is now at a quite important stage," the Ministry of International Trade and Industry's Kenjiro Sakurai outlined programs on optical information processing in Japan. In an invited paper written with Hitachi's Yasutsugu Takeda, Sakurai reported:

- Several Japanese laboratories have developed holographic memories for digital data, including Fujitsu laboratories which has built a  $10^7$ -bit system. Others in the field include: Musashino Electrical Communication Laboratory, Hitachi Central Research Laboratory, and Tokyo Shibaura.

- Sanyo Electric Co. has developed an inexpensive and compact credit identification system using six holograms attached to a card, with every

alphanumeric character of a key code written as a hologram.

Hitachi's Center Research Laboratory and the NHK technical research laboratories are expanding on their jointly developed wide-screen and high-resolution laser color television display with 1,125 scanning lines.

Sakurai also indicated strong Japanese interest in applying lasers to high-speed facsimile transmission and reproduction systems, citing work in progress at several companies, notably Matsushita in Tokyo and also at Matsushita Facsimile Corp. On the U.S. side, Zenith Radio Corp. demonstrated its model 150R laser system designed for facsimile use. Officials of the Optical Systems Group, Melrose Park, Ill., said that the system, still in the R&D stage, is able to generate 64 lines of 128 alphanumeric characters each on magnetically sensitive paper in 0.07 second. The paper is then treated in a toner bath in which carbon particles are attracted to the area scanned.

High-speed facsimile and other recording systems are also the target of RCA Corp., which introduced a helium-cadmium laser developed at

**Roll out the orders.** This is Nippon Electric's Selfloc optical fiber. The company was taking orders at CLEA, quoting 60-90 days delivery, for 100-meter lengths of the new material.

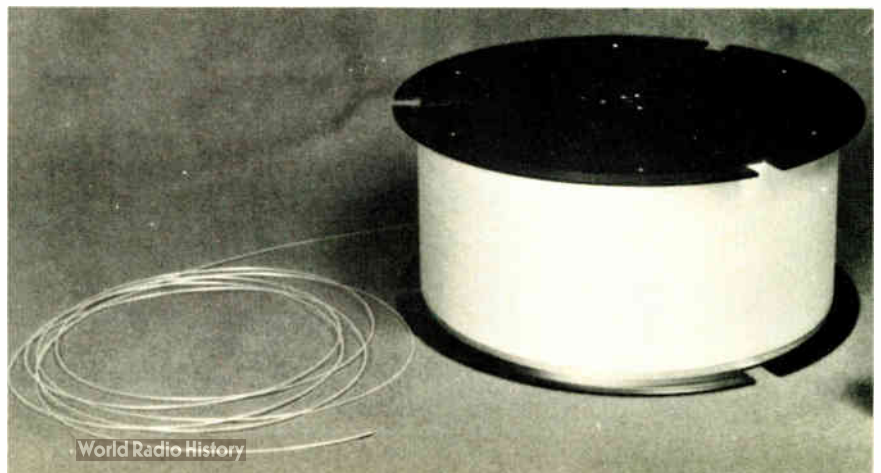

its Princeton, N.J., laboratories and marketed as model LD2186 by its Industrial Tube division, Lancaster, Pa. Priced at \$2,450, the He-Cd system puts out 15 milliwatts and operates at 442 and 325 nanometers.

For semiconductor manufacturers, researchers at Bell Laboratories, Allentown, Pa., described two laser systems for automated inspection of polished silicon wafers and patterns in both masks and processed wafers. Bell's D.F. Munro detailed one system able to scan a 5-centimeter wafer and resolve defects as small as 1 micrometer. In another paper, Bell's Delmer Fehrs outlined an automatic pattern inspector that, like the wafer scanner, uses a scanner laser beam to examine a surface. Instead of simply looking for defects, however, the pattern inspector compares the pattern under test with a known reference pattern. But Fehrs told the conference that the inspection technique has been shelved by the laboratories in favor of an alternative approach that doesn't require the use of a comparator.

**Radar.** Applications with promise for both commercial and military use—and the subject of a heavily attended CLEA session—include optical radar systems which give angular resolution and detection sensitivity that far outperforms conventional microwave radar for some targets. Eye-safe ceilometers to measure cloud-base heights at airports and monopulse satellite tracking systems are among applications under consideration.

For example, Cutler-Hammer Inc.'s AIL division, Melville, N.Y., has developed a monopulse 10.6-micrometer laser radar receiver following established microwave monopulse technology. In the system, received signals in each of four beams are processed coherently by using a local oscillator tuned near the transmitter frequency.

Another radar that seems closer to commercial use is a 1.54-micrometer erbium-glass laser transmitter designed by American Optical Corp., Framingham, Mass. The wavelength is less dangerous to the human eye, for a given power output, than either 10.6-micrometer conventional carbon dioxide lasers or 0.7-micrometer ruby lasers, ac-

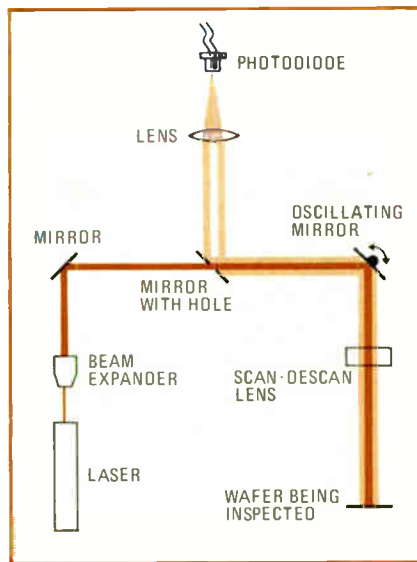

**Bounce.** Defects in wafer cause laser beam to broaden. Additional width of beam is deflected by mirror with hole, it is focused on photodiode, and defects are "read."

cording to AO engineer Norman Truscott. The 35-nanosecond pulse of 1 megawatt produces a beam with an output density that is about an order of magnitude lower than safe limits proposed by the American National Standards Institute, Truscott contends.

**Energy.** Use of lasers to produce fusion in nuclear power plants generated strong interest at CLEA. This year's conference devoted an entire session to laser fusion—12 papers plus a late item—compared to a single entry at the 1971 conference. The immediate challenge facing laser fusion researchers is development of a system that can put out between 1 and 10 kilojoules of energy in 100 picoseconds or less. And, since the targets used in laser fusion tend to reflect a high proportion of incident light back into the laser—in excess of 40% in some cases—the laser must be capable of firing directly into a mirror without damage.

Some \$20 million in capital funds plus another \$25 million annually to support fusion research is in the Atomic Energy Commission budget now before the Congress. The capital spending—spread over two fiscal years—calls for construction of a laser target facility at AEC's Lawrence Radiation Laboratory, Livermore, Calif. Construction of the system containing 10 neodymium-glass lasers that spherically irradiate the

target is expected to be completed in three years, following which three to five years will be required to investigate the physics of coupling laser radiation to dense plasmas.

**High power.** Carbon dioxide systems popularly known as TEA lasers—an acronym for transversely-excited atmospheric-pressure—continued to attract high interest at CLEA as an approach to generating high power. For example, U.S. military interest proved strong in the exhibit of Canada's Gen-Tec Inc., which made its first display of its model DD-250, a TEA laser with peak powers in excess of 5 MW and an average power output of 400 w. The Dalton, Que., company says it operates under a license of the Canadian Patent and Development Corp. to produce and market TEA lasers developed at the Defense Research Establishment in Valcartier, Que. Gen-Tec's director of R&D, A. Jacques Beaulieu, worked at the Canadian Defense Research Board before joining the company in 1971.

While Gen-Tec and others were demonstrating CO<sub>2</sub> TEA lasers, Westinghouse Electric Co. introduced another high-energy, atmospheric-pressure laser using carbon dioxide, to which it assigned the acronym Coffee—for continuously operating, fast-flow, electrically excited. Westinghouse says its system operates at about 10% efficiency with a continuous-wave output of 6 kilowatts. Stability is achieved by circulating the CO<sub>2</sub> gas at 130 mph.

Interest in high-energy lasers for weapons, however, centered around carbon monoxide systems, several of which were described in a session devoted to high-energy lasers. Avco Corp.'s Everett, Mass., research laboratory, citing research supported by the Advanced Research Projects Agency, said low-pressure electrically excited CO lasers have been operated at efficiencies of approximately 50%, indicating possible development of efficient high-power lasers. Other carbon monoxide laser efforts were outlined in papers from Westinghouse Research Laboratories, Pittsburgh, and the Air Force Weapons Laboratory. □

This article was written in Washington by Ray Connolly, Senior Editor, with reporting by Lyman J. Hardeman, Communications and Microwave Editor, and Michael J. Riezenman, Instrumentation Editor.

Communications

# Domsat a year later: tight race

Comsat-MCI-Lockheed team livens competition with plans for three satellites and construction of 10 earth terminals to start with

by William Arnold, Aerospace Editor

When the Federal Communications Commission opened the starting gates for the lucrative domestic communications satellite stakes [*Electronics*, July 3, 1972, p. 72], most eyes followed the progress of AT&T and Communications Satellite Corp. (Comsat) among the field. A year later, however, Western Union clearly is in the lead toward an operating system, followed by American Satellite Corp. (owned by Fairchild Industries and Western Union International on an 80-20 basis), RCA, and the Comsat-MCI Communications Corp.-Lockheed entry. Off to a slow start are AT&T, teamed with Comsat, and Hughes-GTE—partly because the FCC is deciding some of the rules of the race as it goes along.

**Three birds.** Latest to reveal plans is Comsat-MCI-Lockheed (CML), which envisions a system using two satellites launched in late 1975 with a third later, and “an initial build of 10 earth terminals,” according to Kenneth H. Crandell, development planning director. It expects to issue requests for proposals this fall and to award a contract for the satellites by the end of the year. Undecided is whether the spacecraft will be spin-or body-stabilized. That’s not unexpected considering the company’s parentage—Comsat manages Hughes spin-stabilized birds for Intelsat, whereas Lockheed has considerable experience with three-axis-stabilized military reconnaissance satellites.

For its system, CML will use the newer untried 12- and 14-gigahertz frequencies and the tested 6-GHz uplink and 4-GHz downlink channels. Each satellite will have six transponders at the lower fre-

quencies and from four to six at the higher ones, Crandell says. The 10 earth stations will be split between the two sets of transmitting frequencies. CML will separately ask for bids on its earth stations and may even split those between the two sets of transmitting frequencies.

CML chooses the 12- and 14-GHz channels so that satellite signals can be beamed, without interference, directly to urban rooftop receivers, which removes “the costly dependency on interconnections,” Crandell says. “Our motto is: ‘don’t fight the interconnection problem, avoid it,’” he jokes, explaining that small, video-bandwidth terminals should let CML place the terminals for clear, economic service. Its customers are expected to be corporate and Government users, commercial and public networks, and specialized common carriers that will use the system as augmentation and for coast-to-coast traffic so as not to tie up the point-to-point routes.

The various companies’ positions show the results of their differing strategies. Western Union, in filing with the FCC first to get the first approved application [*Electronics*, Jan. 18, p. 110], broke to the rail and has been running hard ever since to get its \$70 million system operating by mid-1974. American Satellite (ASC) and RCA decided to piggyback onto Canada’s Domsat (see “Good neighbor,” below) while they get their multiphase systems under way. CML was delayed when Comsat joined it after the FCC decided that Comsat could both supply a wholesale system for AT&T and be part owner in an end-to-end retail business.

**Fairness.** FCC deliberation on how to assure fair competition with AT&T’s interconnections and whether to let GTE into the switched telephone business is slowing the AT&T and Hughes-GTE applications.

However, as the domsat marketplace only has room for three or

## Good neighbor

The Canadian domsat that American Satellite and RCA want to use is the Hughes-built Anik 2, the satellite launched in April as a backup to the Anik 1 sent up last year [*Electronics*, Nov. 6, 1972, p. 33]. The 12-transponder Anik 1 serves various telecommunications functions through manager Telesat Canada, a Comsat-like corporation, in an attempt to link far-flung and sparsely populated communities through a network of 42 earth stations, of which 37 exist now and seven more will be added by year’s end.

The system could be enlarged when the government finishes deliberating over a controversial but secret plan by the Canadian Broadcasting Corp. identifying 300 communities of more than 500 persons now without radio or TV coverage. Telesat itself is watching talks about the alternative trans-Canada pipeline, which could add 35 to 40 earth stations along the 2,800-mile Canadian part of the Alaska-to-U.S. transmission.

Under a Canada-first policy, Telesat earth stations have been built by Raytheon Canada and RCA Ltd., with Philco-Ford supplying the main command and control station.

**ASSURE  
PRECISE  
OUTPUT  
CONTROL**  
for  
**EVERY  
APPLICATION**

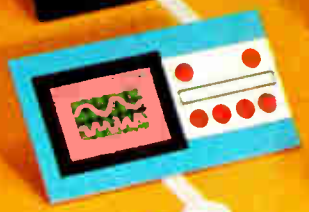

**SPECIFY  
BOURNS®  
PRECISION  
POTENTIOMETERS**

10, 5, 3, and Single Turns

1 1/16" • 1 1/16" • 1/8" • 3/4" • 1/2" Diameters

Less than 0.5% Return Rate

Wirewound and Nonwirewound Types

Exclusive SILVERWELD®  
Termination

Competitive Pricing

Bourns matchless precision potentiometers are stocked in-depth at your local Bourns Distributor. Contact the one nearest you for price and fast delivery.



BOURNS, INC., TRIMPOT PRODUCTS DIVISION • 1200 COLUMBIA AVE., RIVERSIDE, CALIF. 92507

Circle 73 on reader service card



## Now there is a choice.

DuPont calls their trichlorotrifluoroethane "FREON" TF. We call ours "BLACO-TRON" TF. So now you have a choice.

That's why BLACO-TRON precision cleaning solvent cleans the same as FREON: Their chemical formulas are identical.

If they're identical, why should you try BLACO-TRON? Service. The

service you get only from Baron-Blakeslee—for 38 years the accepted leader in advanced design precision cleaning equipment and the solvents to go in them.

### **BLACO-TRON**

FLUORINATED SOLVENTS—NOW THERE IS A CHOICE

Give BLACO-TRON—the new kid on the block—a fighting chance. Especially since the machines you are now using to clean with FREON were more than likely developed by Baron-Blakeslee in the first place. Pick up the phone and contact your BLACO-TRON Distributor now—he offers a full line of BLACO-TRON fluorosolvents.



**Baron-Blakeslee**

1620 South Laramie Ave., Dept. 0000, Chicago, Ill. 60650—Offices in All Principal Cities.

\*FREON is DuPont's registered trademark for its fluorocarbon cleaning agents.

\*\*BLACO-TRON is Baron-Blakeslee's registered trademark for its fluorocarbon cleaning agents.

Circle 74 on reader service card

World Radio History





**Call your nearest  
Baron-Blakeslee "BLACO"  
SERVICE CENTER  
for prompt Solvent Service**

- New England**  
General Chemical Corp., Boston, Mass.  
(617) 872-1202  
The Hubbard-Hall Chemical Co.  
Waterbury, Connecticut  
(203) 756-5521
- Metro New York City, Northern New Jersey,  
Long Island**  
Baron-Blakeslee, Garden City, N.Y.  
(212) LE9-8680  
(201) 687-7383  
(516) 747-8460
- South New Jersey, Eastern Pennsylvania,  
Maryland, Delaware**  
Tri-State Chemicals, Inc.  
Blackwood, N.J. (Philadelphia)  
(215) LO3-5071
- Southeastern United States**  
Moreland Chemical Co. Inc.  
Spartanburg, S.C.  
(803) 583-8481  
Moreland Chemical Co. Inc.  
Greenville, S.C.  
(803) 242-3727  
Moreland Chemical Co. Inc.  
Augusta, Ga.  
(404) 722-3751  
Moreland Chemical Co. Inc.  
Atlanta, Ga.  
(404) 457-4485  
Moreland Chemical Co. Inc.  
Kingsport, Tenn.  
(615) 247-7149  
Moreland Chemical Co. Inc.  
Charlotte, N.C.  
(704) 392-4301  
Moreland Chemical Co. Inc.  
Greensboro, N.C.  
(919) 292-0624
- Upstate New York, Northwest Pennsylvania**  
Inland Chemical Corp., Syracuse, N.Y.  
(800) 348-4661
- Indiana, Ohio, Michigan**  
Inland Chemical Corp.  
Ft. Wayne, Indiana  
(800) 552-4605  
Inland Chemical Corp., Toledo, Ohio  
(800) 348-4611  
Inland Chemical Corp.  
South Bend, Indiana  
(800) 552-4605  
Inland Chemical Corp., Cleveland, Ohio  
(800) 348-4611  
Inland Chemical Corp., Lima, Ohio  
(800) 348-4611
- Illinois, Wisconsin, Minnesota, Iowa,  
Missouri, Nebraska**  
Baron-Blakeslee, Chicago, Illinois  
(312) 656-7300  
Baron-Blakeslee, Milwaukee, Wisc.  
(414) 762-6850
- No. California, Nevada**  
Baron-Blakeslee, San Francisco, Calif.  
(415) 591-8237
- Oregon, Washington**  
Baron-Blakeslee, Portland, Oregon  
(503) 252-3468
- Southern California, Arizona**  
Baron-Blakeslee, Los Angeles, Calif.  
(213) 532-0730
- San Diego Area**  
Baron-Blakeslee, San Diego, Calif.  
(714) 295-0041

**Probing the news**

four systems besides AT&T's, according to FCC and industry estimates, the commission is being very careful in its role as traffic cop. Only Western Union's applications for construction permits for satellites and the New York City earth station have been approved, with the others in various stages of processing, except that of Western Tele-Communications Inc., which is dormant. A domsat can be operational about two years after FCC approval.

**Demonstrations.** The commission is encouraging experimentation by authorizing demonstration projects to RCA Globecom, General Electric to test digital techniques, RCA for an experiment with IBM, TelePrompter to test its portable earth station, and to American Satellite to transmit to TelePrompter on a temporary basis. Part of the ASC-TelePrompter satellite-cable hookup is scheduled for the week of June 18, when several broadcasts will be made from Washington to the National Cable Television Association convention in Anaheim, Calif.

In fact, the cable industry is becoming very active. An NCTA-arranged meeting scheduled June 17 is designed to set up a consortium of cable companies to operate a domsat-type system using Telesat's Anik on an interim basis. To be tied in with ASC, the consortium would use two of ASC's transponders on Anik, and either buy or lease the necessary ground terminals.

General Electric, which as the country's largest industrial user of telecommunications pays AT&T more than \$100 million yearly for private line services, is asking FCC permission to experiment for one year on Anik for its \$3 million PIC system. Using one or two channels, the system would employ an earth station in the San Francisco area and another in Philadelphia to provide interplant service similar to the Federal telephone service.

Ever mindful of the economic uncertainties, company pronouncements are a mixture of confident expectations and reluctance to disclose their customers for fear of having them wooed away. ASC's president Emanuel Fthenakis asserts that of

the "seven serious applicants," only "two in fact (Western Union and ASC) have taken the positive steps in starting a program that provides services in a reasonable time schedule." CML's Crandell, on the other hand, stresses the company's sound technological approach while alluding to the "drum-beating" by some other companies. Almost all say that the terrestrial interconnection system (mainly Bell's) won't be able to handle the growing volume so that domestic communications satellites will become a necessity.

American Satellite plans to issue requests for proposals in early 1974 for its third-phase system, expected to be based heavily on the 24-transponder, three-axis-stabilized technology favored by Fairchild. It must have FCC approval soon to begin using up to four channels on Telesat's Anik 2 as the first phase. For its second phase, it will receive in the fall 1974 the first of three Hughes-built 12-transponder Anik-like spacecraft at a cost of \$25 million. Business from the cable industry and minority owner Western Union International should help it.

**Money team.** AT&T-Comsat, the most obvious moneymaker among the systems, entails Comsat use of four Hughes-built Intelsat-type spacecraft over seven years at a cost of \$150 million and a return of \$272 million [*Electronics*, April 12, p. 48]. It could be operating as early as 30

**Caesar's wife**

Corporate bigness, combined with FCC policy that domsat companies must be separate entities, is forcing some satellite builders to negotiate with their own parent companies. RCA's Astro-Electronics Division in Montreal is bidding on RCA Globecom's system, for example. Fairchild's Space and Electronics Co. will surely be interested in American Satellite's third-phase system, as will Lockheed Missiles and Space Co. in CML's system.

RCA Globecom, saying that it wants to make sure that all bidders are treated fairly in open competition, is hiring Computer Sciences Corp., McLean, Va., to evaluate the proposals.

Resolutions of 1 microvolt DC and 1 milliohm, along with 100% overranging on all functions, make the Hickok 3410 a value leader at \$695. This is a full capability instrument, measuring DC and AC voltage and current, and resistance. High level recorder output is provided. Options include an internal rechargeable battery and 300%

overranging. Send for complete specifications in 3400 Series Data Sheet.

## HICKOK

the value innovator

Instrumentation & Controls Division  
The Hickok Electrical Instrument Co.  
10514 Dupont Ave. • Cleveland, Ohio 44108  
(216) 541-8060 • TWX: 810-421-8286

# 4-digit microvolt multimeter for \$695



Circle 75 on reader service card

The new Hickok 3420 is different: it's a full 5-digit counter to 20 MHz and it also measures DC/AC voltage from 10  $\mu$ V to 1 kV, and resistance from 10 m $\Omega$  to 10 M $\Omega$  with 4-digit resolution. Frequencies are measured to 0.01-Hz resolution, accurate to  $1 \times 10^{-6}$  for 1 year. Sensitivity of 100 mV and the 20-MHz bandwidth make the 3420 useful in logic circuitry

and communications systems testing. Internal rechargeable battery is optional. Price, only \$750.

## HICKOK

the value innovator

Instrumentation & Controls Division  
The Hickok Electrical Instrument Co.  
10514 Dupont Ave. • Cleveland, Ohio 44108  
(216) 541-8060 • TWX: 810-421-8286

# 5-digit counter & 4-digit multimeter in one package



76 Circle 76 on reader service card

## Probing the news

months after the FCC gives its okay.

Satellite-builder Hughes is the biggest domsat supplier so far. Using its spin-stabilized technology from Intelsat and Telesat programs, the company has sold spacecraft to Western Union, for American Satellite's second-phase system, and probably will build the AT&T Comsat spacecraft as well as those for its own system with GTE.

**Stabilizers.** But bids due July 3 for RCA's \$85 million domsat system will bring out contenders championing body-stabilized technology. The new team of Fairchild Industries, Germantown, Md., and TRW Systems Group, Redondo Beach, Calif. [*Electronics*, July 7, p. 41], Lockheed Missiles and Space Co., and RCA's own Astro-Electronics division, Montreal, is bidding on the RCA system, which calls for three 24-transponder, three-axis-stabilized spacecraft and parts for a fourth craft, plus ground telemetry and control equipment to serve both Alaska and private wire services for continental U.S. corporations. Hughes will not bid, company officials say.

Hughes and the Fairchild-TRW team also are eying upcoming domsats for Australia, Brazil, and India. Of course, the Fairchild team is expected to bid on American Satellite's third-phase system, and Lockheed is interested in CML's.

One thing becomes ever more clear as the dust settles: while the various domsat systems will bring good contracts to satellite builders, they will mean even better money to earth-terminal-equipment suppliers.

**Coming in.** And it will be lively, as some new names are getting set to move in. Fairchild Industries' Space and Electronics Co., for example, will definitely get into that side of the domsat business, according to company president Wilbur L. Pritchard. A look at the companies that responded to RCA's ground station bids turns up the names of Comtech, GE, and ITT. Also reportedly interested are Philco-Ford, Harris-Intertype's Radiation division, RCA Ltd. of Canada, and Scientific Atlanta. A Comsat official hints that his company is thinking about it, too. □

Electronics/June 21, 1973

# Logic faults confess

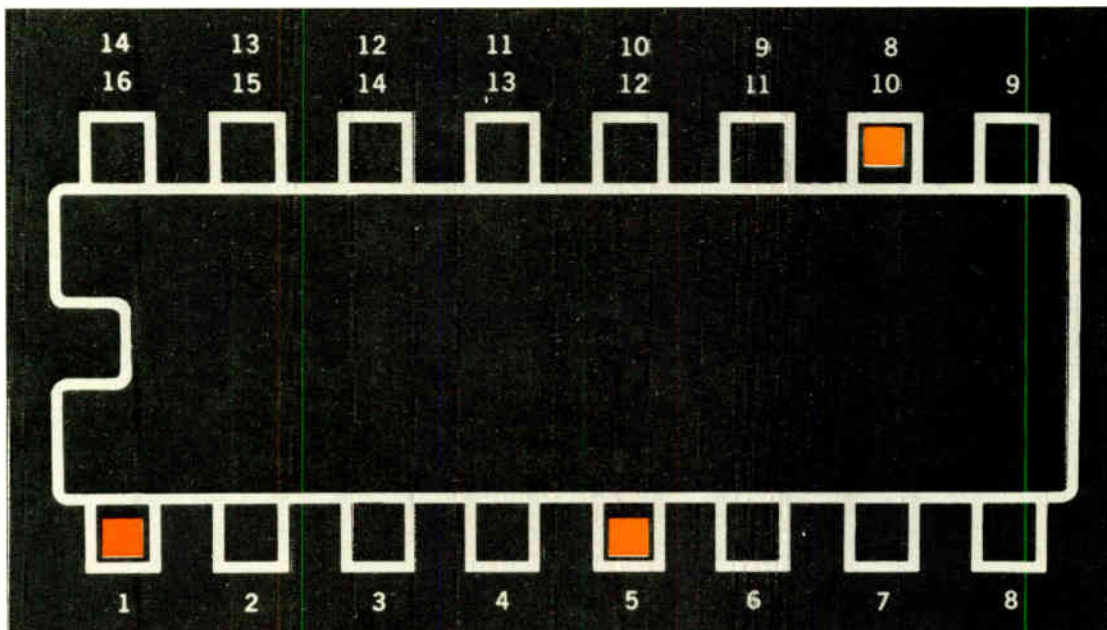

Logic failures within the circuit are identified by pin number on the TRENDAR 2000 IC display. Abnormal logic states are back-tracked to the cause.

## FAULTRACK™ takes you directly to the culprit

**FAULTRACK finds faults: single . . . multiple . . . and loop faults that defy software systems.** It is a universal procedure applicable to all digital logic troubleshooting. Faults leave a track: abnormal logic states are sensed and displayed automatically by the TRENDAR 2000 Test Station. Eight FAULTRACK aids include comparative I/O test, comparative IC test, logic states monitor, in-circuit IC test, race catching probes, variable clock rate, and differential propagation delay test.

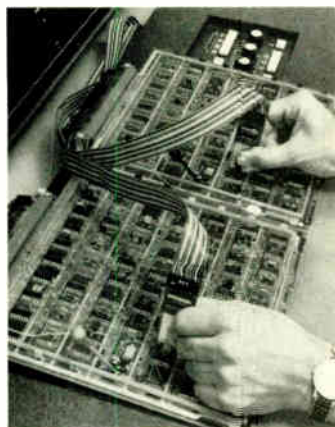

The TRENDAR 2000 Test Station is on the air within hours of delivery. It applies up to 4,000,000 tests per second . . . **512,000,000 pin tests per second.** It finds catastrophic component faults and board defects. It tests for normal dynamic behavior by sensing out-of-spec propagation delays.

**RESULT NO. 1 . . .** more boards per hour than with any other commercial tester. Users report a 10X increase in productivity per man-hour.

**RESULT NO. 2 . . .** higher confidence level in the tested board. Users report 90% reduction in final-product test board rejects, and corresponding major reduction in field service problems caused by board marginalities.

Get the TRENDAR story today. Contact your local Fluke TRENDAR representative or call Lee Egherman at 415/965-0350. Demonstrations are available in your region.



**LOGICTEST™ Centers Operating**  
LOGICTEST board testing centers are operating in the West, Midwest, and East. They perform commercial test and repair services at low cost . . . and provide contract support for TRENDAR users. Ask about them.

Circle No. 201 for TRENDAR 2000, No. 202 for LOGICTEST™

**FLUKE** TRENDAR

subsidiary of John Fluke Mfg. Co. Inc.

500 Clyde Avenue, Mountain View, California 94040 • 415/965-0350 TWX 910-379-6573

Europe, Address Fluke Nederland (BV), P.O. Box 5053, Tilburg, Holland. Phone (04250) 70130.

Communications

# German pay phone adds electronics

New instrument that detects slugs, figures credit, makes change may go to work by end of year; Bell is testing its own version in the U.S.

by John Gosch, Frankfurt bureau

**Except in appearance,** pay telephones have changed little since their birth over 80 years ago. Even through some recent models contain semiconductors, they are still essentially electromechanical systems, as they were when first demonstrated at the International Electrical Exhibition in Frankfurt, Germany, in 1891.

But now the staid pay-phone-equipment field is finally beginning to change by going all out for electronic components. Two West German companies, Standard Elektrik Lorenz AG (SEL) and Siemens AG, appear to be out front with a jointly designed coin-operated telephone featuring:

- Light-emitting diodes for credit indication. (Coins are deposited before the call, the time used is calculated after the call, and any unused money is returned.)
- Electromagnetic circuits to detect counterfeit coins or slugs.
- Digital techniques for rate pulse evaluations.
- Photodiodes for coin counting.
- An array of MOS integrated circuits for keeping tabs on all phases of equipment operation.

**Bell testing.** In the U.S., Bell Laboratories this year started trials of 90 electronic pay phones in Chicago and Philadelphia. The tests, says a spokesman, will run indefinitely. The Bell sets contain an electronic totalizer, coin tone oscillator, and an electronic speech network that replaces the old transformer-type network. The phone company won't say when such phones might be put into service, but it's believed that what's needed is compatibility with Bell's TSPS—traffic service position system. With that system, the long-

distance operator takes a call, dials it, pushes a release button, and a computer does the rest—times the call, makes certain enough money is deposited, and so on.

Why so much electronics for gear that has performed well with electromechanical devices? For one thing, the SEL/Siemens equipment is designed for direct dialing to any place around the world, and for communications between, say, Europe and Japan the rate pulses come so fast that electronics is needed.

Gerhard Zeidler, a department director at Stuttgart-based SEL and the chief designer of the equipment, cites several other reasons for developing it. "One is to replace existing design practices with new techniques that can do certain jobs better," Zeidler says, and he points to

detection of counterfeit coins as one example. Another reason is better service. This is done by push-button dial and the so-called indirect coin-collection method: call time is provided according to the value of coins deposited before coin collection. Unused coins are either returned or remain deposited for subsequent calls. And the new equipment, built in modular form, is easy to service, maintain, and repair.

Development was started about three years ago, being sponsored by the German Post Office. Three domestic communications firms participated, and SEL wound up heading the so-called NT 2000 development project. In addition to Siemens, the semiconductor maker Intermetall GmbH is in on the project as the

**Getting the word.** Block diagram of the SEL/Siemens NT 2000 electronic pay phone. The instrument, the result of three years of development work, may be in service by the year-end.

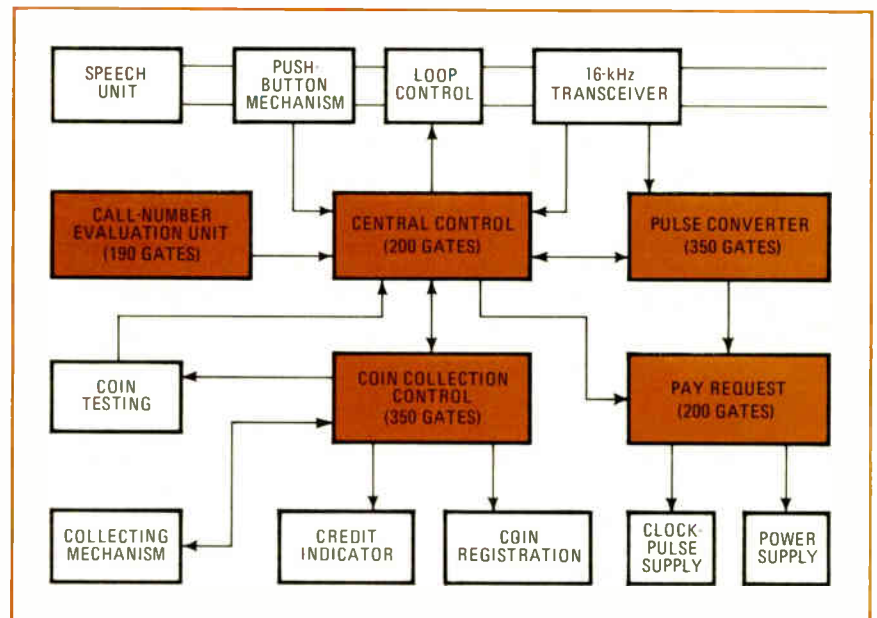

It's everything you've ever wanted in a peripheral for your mini. With a price/performance ratio superior to every other electrostatic printer/plotter on the market.

In fact, the Gould 5000 gives you 1200 lines per minute—or 600 more than Brand V. And at a lower price.

That means you get high speed for improved mini throughput efficiency. Low cost for economic justification. And, of course, high reliability backed by Gould's reputation for quality.

But you also get a lot more. Resolution of 100 dots per inch. Full alphanumeric and graphic capabilities. 132 characters per line. A 64 ASCII character set. Fan fold and roll paper. 8 bit wide data path.

Optional features? The Gould 5000 is loaded. 96 ASCII character set, upper and lower case. 128 ASCII character set custom designed to your requirements. On-line mini-computer and off-line magnetic tape interfaces.

What's more, Gould software is the most efficient and flexible available anywhere. It lets your mini print and plot considerably faster than competitive units.

We say that the new Gould 5000 is the best buy on the market, with the best features of any mini-computer printer/plotter. And our Pete Highberg or Bill Koepf can prove it to you. Get in touch with them now at Dept. E6, Gould Inc., Data Systems Division, 20 Ossipee Road, Newton Upper Falls, Mass. 02164.

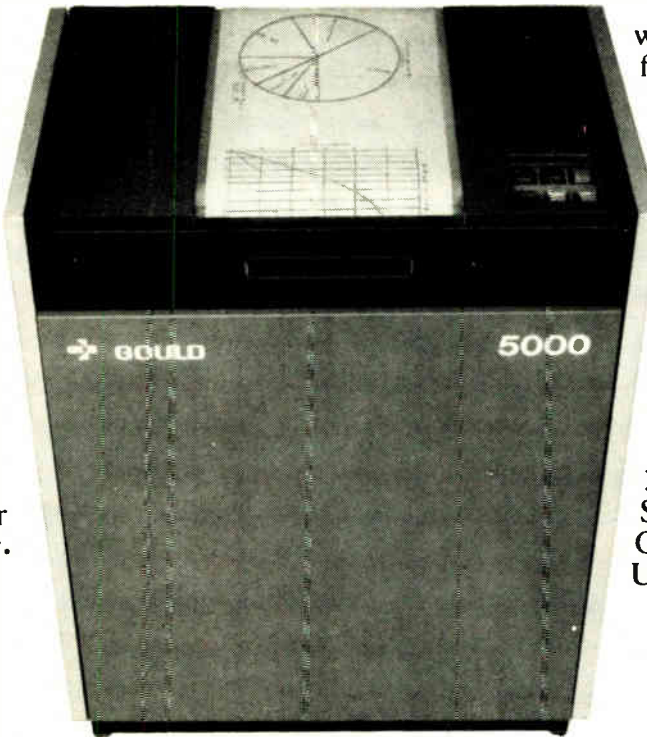

# The new Gould 5000. Twice as fast as any printer/plotter ever designed for mini-computers.

DATA SYSTEMS DIVISION

 **GOULD**

Circle 79 on reader service card

**Finally!**  
**A filter so precise,**  
**filter characteristics**  
**for every setting**  
**are printed**  
**on top.**



We've built a variable electronic filter that's so precise, it has enabled us to print the cutoff frequencies, center frequency, bandwidth, noise bandwidth and filter gain, for every setting, *on top of the instrument.* Besides being the easiest-to-use filters on the market, our 4200 series filters are twice as accurate, have less than half the self-noise, and provide 10 dB greater outband rejection than any other filters. Frequency coverage is .01 Hz to 1 MHz. Built-in selectable post-filter gain and remote preamplifiers are optional. A Butterworth response is used in the NORMAL mode and a Bessel response in the PULSE mode (transient response is superior to conventional "RC" or "Low Q" modes of other filters).

The price? \$695.

For complete specifications and your free copies of our variable electronic filter application notes, write to: Ithaco, Inc., Box 818-7R, Ithaca, New York 14850. For immediate response, call Don Chandler at 607-272-7640 or TWX 510-255-9307.

**ITHACO**

**Probing the news**

chief MOS-circuit supplier. A fully operational NT 2000 laboratory model using a combination of TTL and MOS integrated circuits has recently been demonstrated, and the much smaller all-MOS version is now in the prototype development phase. Zeidler hints that the Post Office may put the first system into service before the end of this year.

**Foreign markets.** With many of the world's 26 standardized coin telephone models soon to become outdated, the SEL and Siemens people are sure to cast an eye on foreign markets. As Zeidler points out, the NT 2000, although designed for Germany, can hook up with almost any switching center—conventional or electronic—anywhere.

The equipment converts the period of the rate pulses coming from the switching center into intervals corresponding to call units valued, in West Germany, at 10 pfennigs. Since the normal call unit is currently worth 21 pfennings, the conversion process first divides the pulse period by 21. Every 10th 1-pfennig pulse then constitutes a basic rate pulse, which is used to calculate phone charges on a 10-pfennig basis.

Any number of repeat calls can be initiated by pushing the NT 2000's "Repeat Dial" button. This

**Pretty pfennig.** The new pay phone utilizes eight MOS chips in its modular design.



# No-hitch Schottky Comparators



**Compatible multi-function plug-ins:  
more speed—more output—more profits in the end.**

Really bugs you, doesn't it? Make your move into ultra high speed comparators—and the penalty whistle goes off. Currently available parts just can't get along with TTL levels, and input characteristics are much too stringent.

Start counting your blessings: 521, 522. Signetics' exclusive linear breakthrough in extremely fast trouble-free dual comparators. There's nothing else on the market today that can touch 521/522 for cost-conscious ease of use, over a unique range of applications. You work *with* the remarkably high speed that Schottky technology delivers, instead of against it.

The 521 typically operates at 6ns, with 10ns guaranteed; 522, from 10-15ns. But you can't take advantage of these major increments in comparator speed if penalties keep cutting you down to size.

Use the 521/522 any place you'd snap your old 710/711/760 and you clear the board for maximized action. Pin-for-pin replacements for 75107/108: but Signetics' no-forfeit performance can't be matched, while requiring fewer auxiliary parts.

Absolutely TTL compatible in both strobes and output structure. Rock-bottom input characteristics for industrial applications. 20  $\mu$ A max input bias current guaranteed—so low you won't load down your input transducers. And you no longer add a preamplifier to detect more minute variations of input voltage.

We built in function flexibility too. You not only reduce parts count, you save on stock variety needs as well. These versatile Schottky-fast dual



comparators are smooth design-in's as zero crossing detectors, Schottky line receivers, and for A/D and D/A conversions. Plus the most popular alternate application to date—as MOS RAM sense amplifiers.

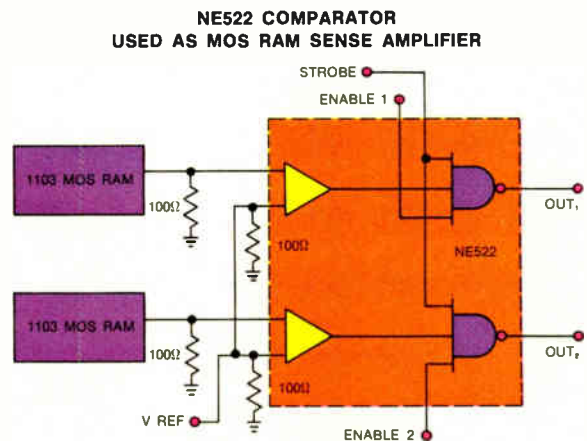

Optimized system performance, with lower costs coming in and going out. That's our commitment to you, the user. From one end of our linear line to the other: from phase locked loops and the IC timer, to these innovative 521/522 high speed Schottky-clamped comparators.

And they're all on the shelf at your distributor. Now.

## CLIP THIS COUPON TO YOUR LETTERHEAD FOR IMMEDIATE ATTENTION

- Please send us a free sample of 521/522.
- Include complete specs, data sheets and application literature for ultra high speed 521/522 comparators.

Name \_\_\_\_\_

Title \_\_\_\_\_

Attach this box to company letterhead, and mail to:  
Signetics-Linear  
811 East Arques Avenue  
Sunnyvale, California 94086  
(408) 739-7700

Signetics Corporation. A subsidiary of Corning Glass Works.

**signetics**

# How can you resist a 400% improvement in feedback stability?

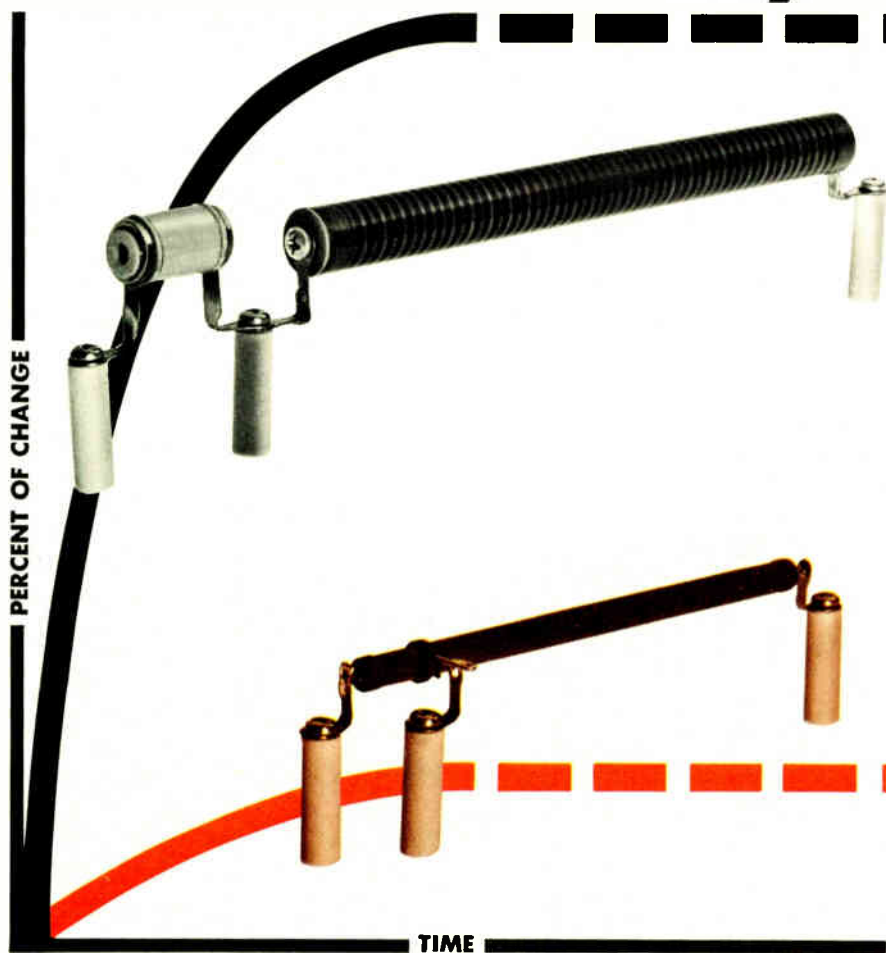

## So beautifully done!

With DIVIDER-MOX resistors, the effects of T-C matching, V-C, self-generated heat, and other control variables are minimized by a unique manufacturing process.

Precision is % allowable change over operating temperature range; DIVIDER-MOX resistors give 0.5% stability at 10% power dissipation over a temperature range of  $-55^{\circ}$  to  $125^{\circ}\text{C}$ .

And, along with precision and stability you also get size advantages as well . . . DIVIDER-MOX resistors are about  $\frac{1}{2}$  as large as the equivalent resistance carbon film.

Resistance ranges available from 25K to 2000 Megs with maximum power ratings up to 10W at 30kV. Customers may specify divider ratios in the range of 300:1 to 10,000:1.

Victoreen...where else can you get so many accurate ohms for your money:

VICTOREEN INSTRUMENT DIVISION  
VLN Corporation  
10101 Woodland Avenue  
Cleveland, Ohio 44104



### Probing the news

button can also be used for repetitive dialing of a number in case of a busy signal. The deposited money remains in the equipment until the line is free: the user need not hang up to get his money back, to make a repeat call, or for a repeat-dial operation.

**No glass.** In contrast to some other European coin telephones, the NT 2000 has no glass-covered coin store for the user to gauge the length of time he can phone. Instead, with the NT 2000 he watches the "Credit" indicator, a four-digit LED display at the top of the set. Another feature of the equipment is the "Pay Request" sign which comes on 10 seconds before the money is used up. This gives the user time to insert more coins.

The NT 2000's electromagnetic coin-detection principle is also new in telephony. It is based on the fact that a coin of a specific material combination detunes an electromagnetic circuit in a certain way when the coin passes it. The circuit used is Wheatstone bridge with inductances and resistances arranged alternately in the four legs of the bridge. A counterfeit coin, one with a material combination other than that used for a genuine one, is detected by an improper amount of detuning. Coins are counted by photodetection.

**Space saver.** For the NT 2000 to handle all coin-counting, calculating, collecting, and coin-return functions, extensive logic circuitry is required. If that circuitry were implemented with relays, Zeidler says, it would occupy space the equivalent of a normal telephone booth. Even TTL techniques would require several cubic feet of space—too much to suit the SEL/Siemens designers. For that reason they opted for MOS technology.

The NT 2000 uses only eight MOS chips, each with the complexity of those employed in a pocket calculator. Five of the chips are supplied by Intermetall, and the remainder by Siemens. The ICs are mounted on a 9.1-by-7.4-inch circuit board which, like the NT 2000's other component-carrying boards, simply snaps into the equipment case. □



# Centralab perspectives

FOR USERS OF ELECTRONIC COMPONENTS



## Covering Detroit's needs for thick film hybrids is a big order.

Whether you're in autos, computers, music, data processing, business machines, telecommunications or industrial electronics . . . Centralab can now provide the thick film hybrid circuits you need.

Tight schedules. Exacting specs. Volume orders for millions of pieces. Anyone who has supplied the nation's auto manufacturers with component parts knows this is the kind of mission he faces.

Centralab has run this fast track for some years, providing assembly plants throughout the U.S. with thick-film hybrid circuits for Detroit end use. These have included circuits for car radios, stereo tape players, fuel controls, headlight dimmers and dashboard instrumentation such as tachometers and sequential turn controls.

Why Centralab hybrids? Obviously, the auto makers are getting the high performance specs they ordered, and in the enormous quantities they demand.

Take the specs, for example. Package power up to 4 watts per square inch. Rugged ceramic substrates with special form factors. Compare resistor tolerances as low as  $\pm 0.5\%$  and TC of  $0 \pm 100$  PPM/ $^{\circ}$ C and you get an idea of the customized circuitry Centralab thrives on. Capacitor dielectrics range through NPO & N5250 to Hi K. Designs include plastic and glass encapsulated transistors and diodes, as well as chip devices.

Happily, this type of spec is also

required in other industries. Manufacturers of musical instruments, sound equipment, radio and TV come regularly to Centralab for custom hybrids. Typical circuits produced are tuner, IF, color and audio-circuitry. Electronic organ manufacturers are using Centralab thick-film circuits for staircasing networks, passive filters, keyers, frequency dividers, amplifiers, MOS protection and tone control circuitry.

Among the fastest growing fields is data processing. Here Centralab has produced such circuits as pull-up networks, voltage regulators, dis-

play drivers, one shot, multi-vibrators, hammer drivers and interface devices.

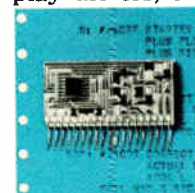

Centralab's programmed for thick-film usage in computers.

Also worth singling out are business machine and point-of-sale equipment manufacturers who specify circuits such as clock drivers, video amplifiers, high voltage bleeders, and motor speed regulators.

The list goes on and on. Telecommunications and the requirements for attenuator pads, passive filters and mixing networks. Industrial electronics and circuits such as motor speed control, solid state switches and frequency control networks.

But you get the idea by now. You set the spec. Centralab will set the precedent. It's virtually that easy when you deal with a leader. If you've a special application for hybrids, or you'd like to consider their adoption in your line, get in touch. Write A. R. Wartchow, Marketing Manager, Electroceramic Products. Ask for Centralab Bulletin No. 1429H.



Hybrids sound good to music makers, too.

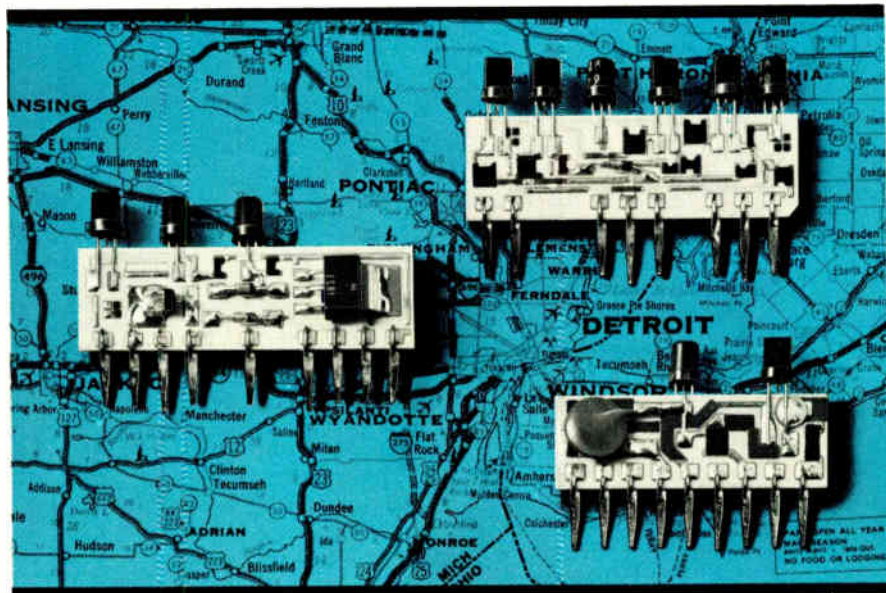

## Announcing Monometalic Silicon Nitride Passivated Glassivated Wireless Bonded Semiconductors in conventional packages.

Technically speaking that describes the new Raytheon Semiconductor line of *super-ultra-reliable* transistors and diodes available for the first time ever in standard packages. But we simply refer to them as our SURE products. They're specifically designed for critical applications calling for extremely reliable performance, or for operation under the most severe environmental conditions.

The SURE packaging innovation combines the latest advancements in beam lead technology with assembly techniques that are truly state-of-the-art (and that's not just the usual cliché). In this unique process there are no "flying" wire interconnections between the terminal post and the silicon chip. Instead, external leads for the base and emitter are formed to permit bonding *directly* to the beam leads of the device. Both collector beams are common to and bonded directly to the header.

This means there are two less interconnections than a standard transistor to worry about. Another plus factor: The bonds are the gold-

to-gold compression type, well known for their excellent reliability. So you end up with a device that's capable of much higher operating temperatures, higher shock, g's and vibration than comparable die-mounted semiconductors. (And we've yet to reach the ultimate



Actual scanning electron microscope picture of a SURE transistor mounted on the newly developed TO-18 header.

limits in these areas. Not an idle brag, but a fact.)

The beam lead chip is, of course,

silicon nitride surface passivated. It does not require additional sealing to protect the surface of active silicon from contamination. And if you are a real purist, you can specify beam leads that are glassivated over the metalization.

As you can see in the actual scanning electron microscope picture, the unique, perfectly shaped edges of the chip form a precise 54-degree angle with the vertical. This is a result of Raytheon Semiconductor's exclusive V-ATE process which ensures more accurate, repeatable separation of chips without the inherent stress producing scribe-and-break or irregular etch methods commonly practiced. In this way we can also maintain a thicker, more rugged device with superior thermal characteristics.

At present Raytheon Semiconductor SURE products include bipolar PNP and NPN transistors and switching diodes. They are available in a TO-18 3-lead metal can and a TO-86 14-lead quad-transistor flat pak.

SURE products are without a doubt the highest quality semi-

conductors of their kind ever built. In fact they're so good that maybe *Monometallic - Silicon - Nitride - Passivated-Glassivated-Wireless - Bonded-Semiconductors* is a more deserving name. But for our salesmen's sake if you want more information on Raytheon Semiconductor's new *super-ultra-reliable* transistors and diodes, just ask us for SURE.

Reader Service No. 231



The cover for the new Raytheon Semiconductor linear catalog really says it all: TOTAL LINEARS. That simply means we can fill 9 out of 10 of your needs for linear integrated circuits.

For example, Raytheon Semiconductor offers more than 50 op amps, a half-dozen wideband amps, 16 voltage regulators, two-dozen comparators and sense amps, 19 line drivers and receivers, as well as assorted memory drivers and low power audio amps.

Many of these linear devices are proprietary with Raytheon Semiconductor. Like the 1556A Beyond Super Beta Op Amp. Or the new 4194 adjustable and 4195 fixed voltage regulators you've probably read about. And the only true Quad 741 High-gain Op Amp; we call it the 4136.

Also we have a score of linear chips and beam lead circuits you

won't easily find elsewhere.

So that you can easily choose the right linear IC for a particular application, we've included special Selection Guides that give you a quick way of comparing key parameters of similar devices within each product group.

To get your personal copy of this new comprehensive 192-page catalog, send us your request on your company's letterhead. And for one-stop-shopping for your total linear IC needs, contact your nearest Raytheon Semiconductor salesman, representative, or franchised distributor.

### New Low-level Audio Amp Doubles Battery Life

Raytheon Semiconductor is now producing a new low-level audio amplifier that outperforms anything in its class. Designated the 8341, it's ideal in battery powered circuits such as hearing aids, remote microphones, tape pre-amps, and other milliwatt amplifier applications.

The quiescent current of the 8341 is only 0.5mA. So you'll get twice as many hours from your battery supply than you would with a similar device. The voltage gain is a healthy 70dB — even over a supply voltage range of 1.1V to 1.7V. And the total harmonic distortion is only 1%. What's more, it has AGC with a dynamic range of 30dB.

From a design standpoint, the first and second differential gain stages are biased with current sources that are independent of supply voltage changes. So you can expect less than a 2dB change in gain over the entire battery life cycle. The output stage is a single-ended class AB type to minimize battery current drain. It's also biased to provide a maximum AC output swing of plus or minus one-half of the supply voltage.

With an external resistor you can set the maximum gain below the nominal 70dB level. Or if desired, you can vary the gain by means of an external volume control.

The AGC threshold is adjustable by means of an external resistor, and its transient response is determined by a small external capacitor.

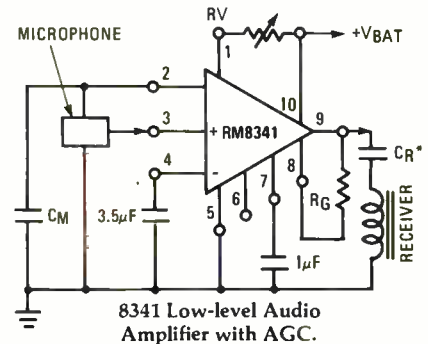

Don't put a drain on your next low-level audio design requirements. Ask a Raytheon Semiconductor salesman, representative, or distributor about the new 8341.

Reader Service No. 232

### 54R/74R: The Hot Ones

As you know, Raytheon Semiconductor is a reliable second source for the 54/74 MSI line. However, we also offer our own version with an "R" designation.

The "R" version gives you higher performance but with no change in price or operating requirements. Take for example the comparison of some important parameters between these popular counters and shift registers.

|                 | f Max. | t <sub>pd</sub> Average |
|-----------------|--------|-------------------------|
| 54/74192, 193   | 35MHz  | 44ns                    |
| 54R/74R192, 193 | 45MHz  | 31ns                    |
| 54/74194, 195   | 25MHz  | 24ns                    |
| 54R/74R194, 195 | 55MHz  | 19ns                    |

We have a new catalog describing more than 30 other 54R/74R devices. It's yours for the asking. Just contact a Raytheon Semiconductor salesman, representative, or franchised distributor. And if you want a hotter 54/74, put an "R" on your next order.

Reader Service No. 233

Raytheon Semiconductor, 350 Ellis Street, Mountain View, California 94042. Phone (415) 968-9211.



# “Let’s kill all the lawyers!”

*“The first thing we do, let’s kill all  
the lawyers!”*

*—Henry VI, Part II, Act IV*

Jack Cade, in Shakespeare’s play, was leading a rebellion and looking for a scapegoat.

He hit upon a somewhat bloodthirsty, but extremely popular, idea.

There is a new and different kind of rebellion in America today. An angry revolt against the pollution and despoilment of our environment.

And some people, again seeking a scapegoat, have also hit upon a popular idea.

**P**ut the blame, and the burden, on business.

Indict U.S. industry as “The perpetrator of an irresponsible assault on the environment.”

Demand that industry immediately stop all pollution, end all depletion, and forthwith “restore our natural heritage.”

And enforce these demands with new, harsh and punitive, laws and regulations. Impose criminal penalties on the owners and officers of offending companies. Launch an onslaught of “Citizens’ and workers’ suits for environmental damages.” Attack, harass, threaten, punish and compel.

The idea has its appeal. It focuses on a convenient, conspicuous and vulnerable target. It offers immediate action and immediate release for accumulated frustration and anger. Most temptingly, it promises a quick, easy and painless solution to the whole environmental problem.

Against this attack, and in the face of this appeal, industry is at a crippling disadvantage. It has, to put it bluntly, been hit with charges that cannot be denied—demands that cannot be satisfied. And, backed into its corner, it is in an awkward position.

A position in which anything it says is likely to be taken as defensive or evasive, anything it does is questioned in advance as inadequate.

**N**evertheless, some things *need* to be said.

First, that industry *is* guilty of an assault upon the environment, and *is* responsible for the consequences.

But, second, that the guilt has long since been acknowledged, the responsibility long since accepted. Today, however belatedly, U.S. industry stands firmly and fully committed to the environmental cause.

The commitment is sincere. It is also specific and binding. The U.S. Commission on Environmental Quality has designed a massive pro-

gram to cleanse and restore the American environment in the 1970's, at a total cost of \$287-billion. Industry's share of this cost is set at \$195-billion.

Clearly, this assigned task and this imposed burden will strain the financial, and test the technical and managerial, capacities of U.S. industry to the utmost. It adds an enormous responsibility and a formidable challenge to all of the other responsibilities and challenges that industry must continue to confront in a competitive and demanding world.

The responsibility has been accepted, the job will be done. But beyond this assigned task, beyond this designated goal, beyond these outer limits of the possible, industry probably cannot go. It is not a question of will, but of capacity. The issue is not what industry *ought* to do, but what industry *can* do.

To the extremists' premise that industry can be threatened, harassed and driven to exceed its utmost capacities—that it can somehow be *made* to do what it manifestly cannot do—a frank and unequivocal response must be made.

Industry cannot immediately stop all pollution, end all depletion, and overnight restore our natural heritage. It is impossible. It is financially impossible, technically impossible, economically impossible, morally impossible, and physically impossible.

It is financially impossible for industry to immediately allocate and spend \$195-billion. There is not that much money to be had, from any source, by any means, using any device.

It is technically impossible, at any price, to totally eliminate all forms of pollution.

It is economically impossible to bring all of U.S. industry to a complete halt while pollution control is given absolute priority over production.

It is morally impossible to close every offending plant, shut down every faulty operation, and throw thousands of people out of jobs, whole communities into bankruptcy.

And it is physically impossible, even if everything else could be done, to compress the work of a decade into a day, a month, or a year.

To these obvious impossibilities, one more must be added. It is impossible to separate industry from the society to which it belongs—and which it serves and reflects.

The environmental crisis is not an isolated, but a total, national crisis. The result of universal neglect and unanimous irresponsibility. And of a prolonged, overwhelming, devastating *mass* assault on the environment, made by millions of American citizens and consumers, in ignorance or blithe disregard of the consequences.

**W**e are no longer ignorant. We are no longer quite so blithe. But the assault continues. Because the insistent, unrelenting pressure of consumer needs, wants, desires and demands continues.

And this, ultimately, is the problem. Not for industry alone, but for the whole of a truly interdependent society. Any major solution to the environmental crisis requires a profound change in the personal expectations, habits, attitudes and actions of millions of individual Americans.

But the point, with regard to industry's responsibility, is simple. Industry cannot dictate change. It can control its own actions and reform its own habits. But it cannot refuse to meet needs, ignore wants, desires and demands, and reform the habits, attitudes and actions of 200-million Americans.

Killing lawyers does not further the cause of justice. Persecuting and punishing industry will not advance the cause of a better environment. The sacrifice of a scapegoat solves nothing and gets us nowhere.

Except off the track. A common, national problem demands a common, united, national effort. The job belongs to us all.

It is time to forget the diversion and get on, *together*, with the job.

---

*We at McGraw-Hill believe in the interdependence of American society. We believe that, particularly among the major groups—business, professions, labor and government—there is too little recognition of our mutual dependence, and of our respective contributions. And we believe that it is the responsibility of the media to improve this recognition.*

*This is the sixth of a series of editorial messages on a variety of significant subjects that we hope will contribute to a broader understanding.*

*Permission is freely granted to individuals and organizations to reprint or republish these messages.*

*John R. Emery*  
John R. Emery, President  
McGraw-Hill Publications Co.



# NOW, 400V & 600V DARLINGTONS FROM



**Delco Electronics**

DIVISION OF GENERAL MOTORS CORPORATION, KOKOMO, INDIANA

Delco's new DTS-4000 series Darlings with  $V_{CE0}$ 's of 400V and 600V are triple diffused mesa units built for rugged duty. They come to you with a practical 15 Ampere rating that you can depend on all the way up to the high voltage requirements of ac motor speed controls, for instance—or the 1.5 kW switching regulator in the illustration.

And they offer new possibilities

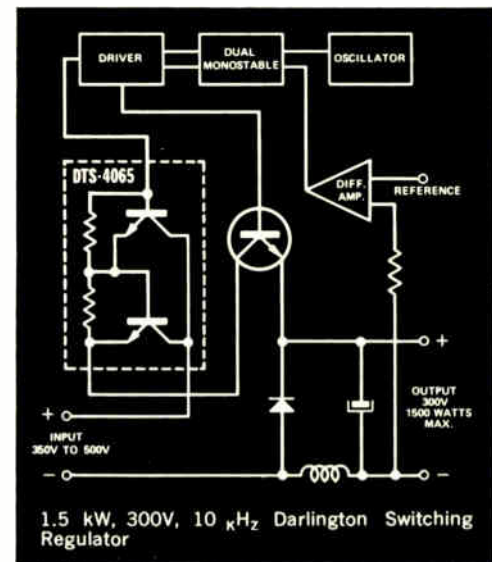

in circuit design where dc drive conditions may have created awkward problems when using SCR's.

Our new Darlings can save you space and give you more design flexibility. The high energy capability of the DTS-4000 series is

## SAFE OPERATING CURVES

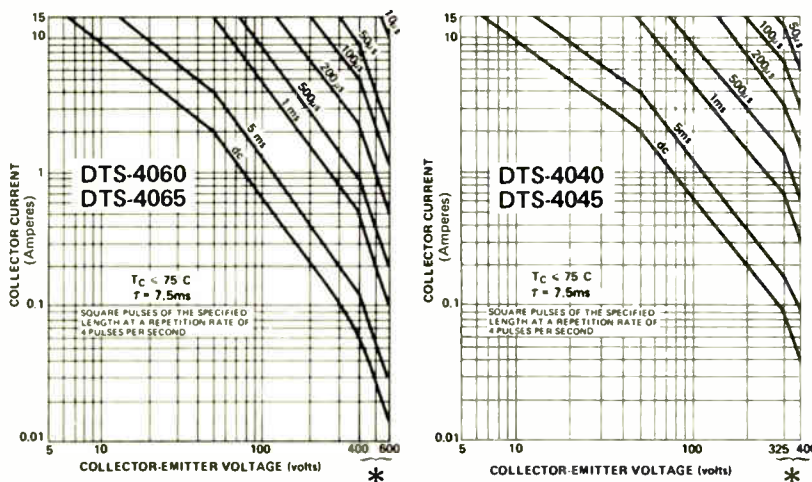

\*Reverse Bias Required

| TYPE     | $V_{CE0}$ | $I_C$ (Cont.) | $V_{EBO}$ (Max.) | $V_{CE0(sus)}$ | $h_{FE}$ @ $I_C$ | $t_f$ (com. base) | $P_D(max.)$ |
|----------|-----------|---------------|------------------|----------------|------------------|-------------------|-------------|
| DTS-4040 | 400V      | 15A           | 20V              | 325V           | 250/3A           | 0.25 $\mu$ s      | 100W        |
| DTS-4045 | 400V      | 15A           | 20V              | 325V           | 500/3A           | 0.25 $\mu$ s      | 100W        |
| DTS-4060 | 600V      | 15A           | 20V              | 400V           | 250/3A           | 0.25 $\mu$ s      | 100W        |
| DTS-4065 | 600V      | 15A           | 20V              | 400V           | 500/3A           | 0.25 $\mu$ s      | 100W        |

NPN—Triple diffused Darlington transistors packaged in solid copper TO-204MA (TO-3) cases.

# HIGH ENERGY THE KOKOMOANS.

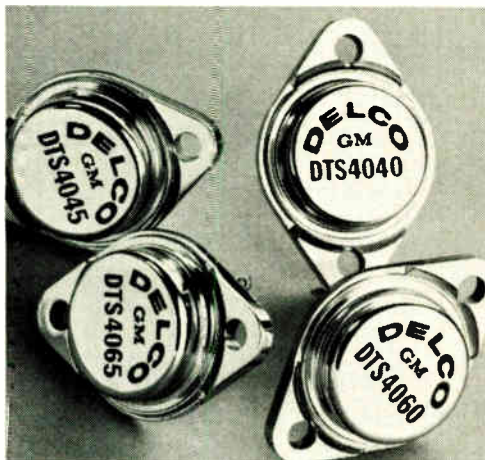

ILL., ROSEMONT (Chicago) • Kierulff Electronics (312)-678-8560  
 ILL., SKOKIE (Chicago) • Bell Industries (312)-282-5400  
 IND., INDIANAPOLIS • Graham Electronics Supply, Inc. (317)-634-8202  
 MD., BALTIMORE • Radio Electric Service Co. (301)-823-0070  
 MASS., NEEDHAM HEIGHTS • Kierulff Electronics, Inc., (617)-449-3600  
 MASS., NEWTON • The Greene-Shaw Co., Inc. (617)-969-8900  
 MICH., FARMINGTON • Harvey-Michigan (313)-477-1650  
 MINN., MINNEAPOLIS • Stark Electronics Supply Co. (612)-332-1325  
 MO., NO. KANSAS CITY • LCOMP-Kansas City, Inc. (816)-221-2400  
 MO., ST. LOUIS • LCOMP-St. Louis, Inc. (314)-647-5505  
 N.J., CLIFTON • Eastern Radio Corporation (201)-365-2600, (212)-244-8930  
 N.Y., BINGHAMTON • Harvey/Federal (607)-748-8211  
 N.Y., EAST SYRACUSE • Cramer/Syracuse (315)-437-6671  
 N.Y., ROCHESTER • Cramer/Rochester (716)-275-0300  
 N.Y., WOODBURY • Harvey/New York (516)-921-8700, (212)-895-9260  
 OHIO, CINCINNATI • United Radio, Inc. (513)-761-4030  
 OHIO, CLEVELAND • Pattison Supply (216)-441-3000  
 OHIO, DAYTON • Kierulff Electronics (513)-278-9411  
 PENN., PHILADELPHIA • Almo Electronics (215)-676-6000  
 PENN., PITTSBURGH • RPC Electronics (412)-782-3770  
 S.C., COLUMBIA • Dixie Radio Supply Co., Inc. (803)-253-5333  
 TEXAS, DALLAS • Adleta Electronics Co. (214)-741-3151  
 TEXAS, FORT WORTH • Adleta Electronics Co. (817)-336-7446  
 TEXAS, GARLAND • Kierulff Electronics, Inc. (214)-271-2471  
 TEXAS, HOUSTON • Harrison Equipment Co., Inc. (713)-224-9131  
 UTAH, SALT LAKE CITY • Cramer/Utah (801)-487-3681  
 VA., RICHMOND • Meridian Electronics, Inc., a Sterling Electronics Company (703)-353-6648  
 WASH., SEATTLE • Kierulff Electronics, Inc. (206)-763-1550  
 CANADA, ONT., SCARBOROUGH • Lake Engineering Co., Ltd. (416)-751-5980  
**ALL OVERSEAS INQUIRIES:**  
 General Motors Overseas Operations  
 Power and Industrial Products Dept.  
 767 Fifth Avenue, New York, N.Y.  
 10022. Phone: (212)-486-3723  
**Kokomoans' Regional Headquarters.**  
 Union, New Jersey 07083, Box 1018, Chestnut Station, (201) 687-3770.  
 El Segundo, Calif. 90245, 354 Coral Circle, (213)-640-0443.  
 Kokomo, Ind. 46901, 700 E. Firmin, (317) 459-2175 (Home Office)

backed by safe operating curves up to 600 volts, as shown at left. And to further aid your circuit design  $h_{FE}$  is plotted continuously from 15mA to the maximum collector current rating of 15A.

As you expected, the new DTS-4000's are in stock and ready for delivery. Contact us or your nearest Delco distributor for complete details. Ask for Application Note 52 on the switching regulator.

## Now available from these distributors in production quantities:

ALA., BIRMINGHAM • Forbes Distributing Co., Inc. (205)-251-4104  
 ALA., HUNTSVILLE • Powell Electronics (205)-539-2731  
 ARIZ., PHOENIX • Sterling Electronics (602)-258-4531  
 CAL., GOLETA • Radio Products Sales, Inc. (805)-964-4764  
 CAL., LOS ANGELES • Kierulff Electronics, Inc. (213)-685-5511 • Radio Products Sales, Inc. (213)-748-1271  
 CAL., PALO ALTO • Kierulff Electronics, Inc. (415)-968-6292  
 CAL., SAN DIEGO • Radio Products Sales, Inc. (714)-292-5611  
 CAL., SAN DIEGO • Kierulff Electronics, Inc. (714)-278-2112  
 CAL., SUNNYVALE • Cramer/San Francisco (408)-739-3011  
 COLO., DENVER • Cramer/Denver (303)-758-2100  
 CONN., NORWALK • Harvey/Connecticut (203)-853-1515  
 FLA., MIAMI SPRINGS • Powell/Gulf Electronics (305)-885-8761  
 FLA., ORLANDO • Powell/Gulf Electronics (305)-859-1450



# We've got designs on the analog CMOS market.

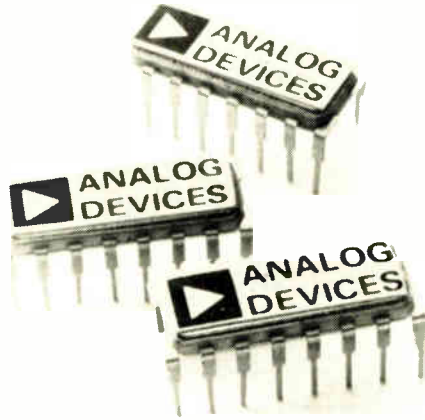

## They begin here.

With CMOS switches and multiplexers that have an ultra-low standby power dissipation of only  $30\mu\text{W}$  (max) at  $\pm 15\text{V}$ . And they're TTL, DTL, and CMOS compatible. So you get maximum flexibility in your logic design without sacrificing the benefits of low-power CMOS. Each comes in a 16-pin DIP and will operate in the military and commercial temperature ranges.

First there's the AD7510 quad switch. It's got four independent analog switches with ON resistance of 70 ohms, and leakage currents of 200pA. So it's ideal for sample and hold circuits, D/A converters and numerous other switching functions. AD7510. Priced from \$13.00/1-49 units.

Then there's the AD7501. And the AD7502. Simple eight channel and differential four channel multiplexers respectively. And they deserve that respect — with an ON resistance guaranteed

**Analog quad switches.  
Analog multiplexers.  
 $30\mu\text{W}$ .**

below 300 ohms, and leakage currents of only 100pA (typical). They'll do anything from analog data multiplexing to digital CMOS multiplexing. AD7501 and AD7502. Priced from \$28.00/1-49 units.

We can send you samples and data sheets. Or, if you have a special linear circuit design that could use a CMOS solution, just give us a call.

## And there's more to come.

We design, make and sell more analog circuits than anyone else: modular and IC. Analog CMOS is just a logical extension of this experience. And in the future we'll show you imaginative uses for analog CMOS, as well as FET and bipolar technology, to give you the special and often unique performance you're looking for. At the price you're looking for.

Analog Devices, Inc., Norwood, Mass. 02062



## Call 617-329-4700

for everything you need to know about analog CMOS.





## Special report

### **BUCKLING UP FOR THE BUMPY ROAD TO DETROIT**

---

The huge—but hard to crack—market finally is opening a bit to electronic products as auto makers respond to Government pollution and safety moves, early design efforts, and price declines

---

by Gerald M. Walker, *Consumer Electronics Editor*

# Special report

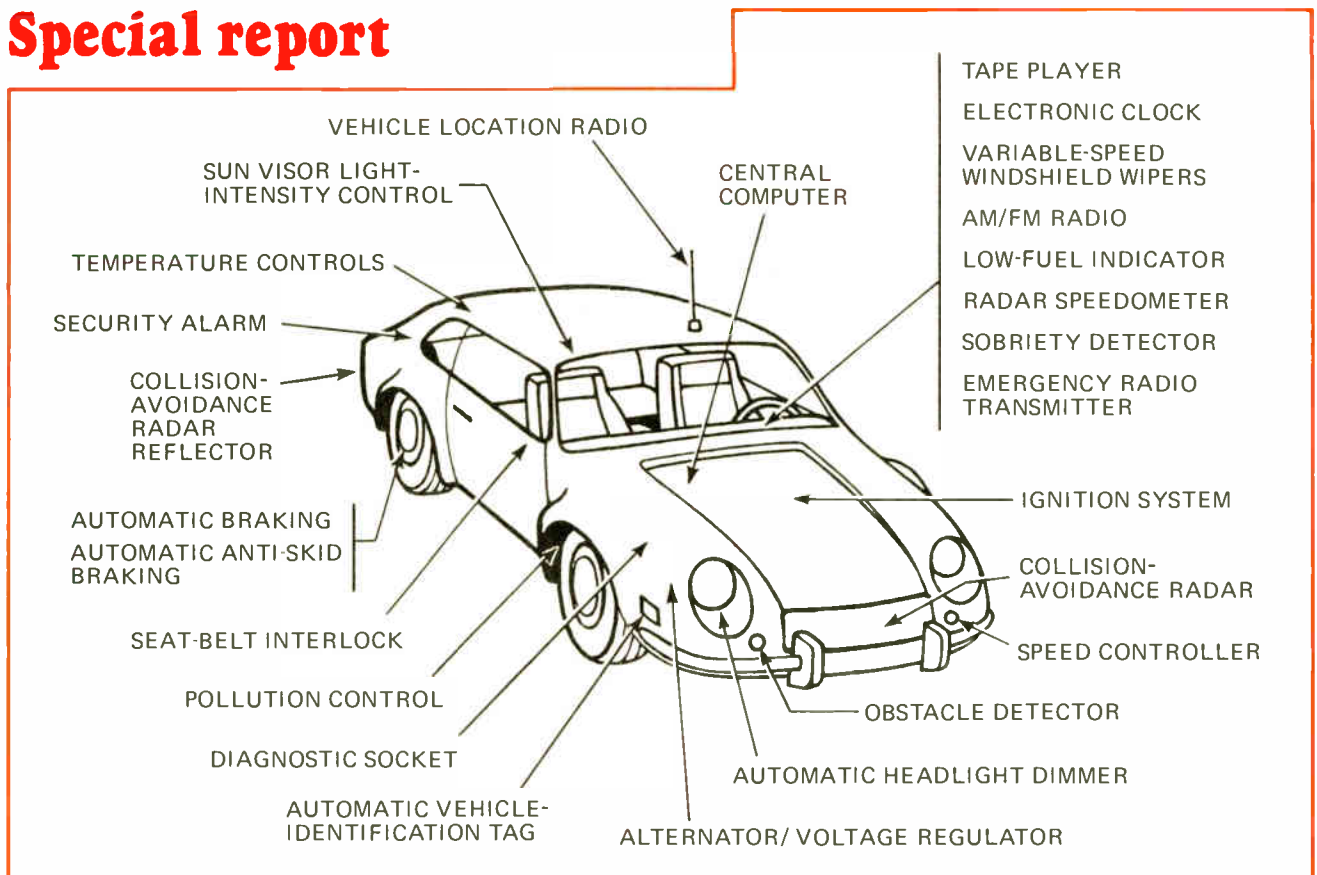

**1. Electronic dream machine.** The 1980's car as envisioned by electronics companies will have around \$100 in electronics on board, if Detroit buys all of these features. Some of the applications above are already available, others may not make it for several years—or ever.

□ After a long time of holding only potential promise, automotive electronics this year has hit the road and with the arrival of the 1974 model cars will be shifting into high gear. The second half of this decade represents the meshing of several factors favorable to increased application of electronic components and systems in passenger cars.

For one, the Department of Transportation and the Environmental Protection Agency have forced Detroit to come up with new safety and pollution-control systems, which will be heavy users of electronics. For another, years of design effort by the auto companies and their electronics suppliers are culminating in the late-1970s models. Finally, the inevitable price declines of electronic components, particularly digital integrated circuits, linear discretes, and power transistors have now made electronics more attractive to the penny-conscious car makers.

Functions in which electronics will play an important role (Fig. 1) generally fall into three categories:

- Safety, including seat belts, air bags, anti-skid/adaptive braking, speed control, and radar
- Performance, which includes electronic voltage regulators, alternators, ignition, and fuel injection, and
- Convenience, for such items as windshield wipers, sequential flashers, anti-theft alarms, clocks, tachometers, automatic temperature control, and other consumer-selling features.

This list does not include the entertainment package, which is also becoming more elaborate with a-m/f-m

radio, tape decks, and even quadraphonic sound becoming commonplace.

As for the next generation—the 1980 model years—plans are underway for on-board computers both for closed-loop engine control and for diagnostic systems coupled with digital displays and warning indicators. Further down the pike will be the use of radar headway control and collision-avoidance systems also tied to on-board computers. And with computers on the family car there is also an inevitable demand for computers inside the dealer's repair facility to test all these new systems.

Before these comparatively sophisticated applications can take off, the auto industry will need to find reliable and inexpensive sensors to feed information to the computers. In fact, concern over developing the right sensors—"For want of a nail, the shoe was lost . . ."—is common because of the fear that an ineffective sensor could incapacitate an entire on-board computer system.

## Foreign cars take alternate routes

Overseas, the move toward automotive electronics has not been as broad as in the United States. However, there are some significant developments that could influence American designers. In addition, features mandated by the U.S. Government are definitely influencing foreign producers that export to the American market. While electronic fuel injection has been a rarity on U.S. cars, it is a common standard in Europe. Electronic control of automatic transmission and electronic tachometers are also in use on some foreign makes.

But neither in the U.S. nor overseas have these electronic applications been overnight hits. The deliberate, conservative pace of Detroit just does not mesh well with the fast-changing tempo of electronics technology. What's more, the complexity of automotive organization is enough to intimidate newcomers.

General Motors Corp., to take the biggest as an example, has Delco Electronics, Delco-Remy, AC Spark Plug, GM Assembly and Fisher Body divisions providing electronic inputs to the various GM lines. The engineering staff of the GM Technical Center may also be working on advanced developments. But at the same time each car line from Cadillac to Chevrolet has its own influence on the electronic content of individual models. Surrounding this monolithic structure is another layer of original-equipment manufacturers with its own special influence.

Yet it is unfair to claim, as some observers have, that the Big Three auto makers have only accepted electronics because the Government required safety and emission-control systems. The Government's requirements certainly have moved the timetable ahead, yet it hasn't been a shotgun wedding. All of the Big Three have extensive electronics R&D efforts underway. And all have captive electronics manufacturing arms in Delco, Philco-Ford, and Chrysler's Huntsville facility.

### What it's like in the auto market

One reason electronics companies have had a difficult time meeting auto company requirements was their slow understanding of the nature of the beast. First, the physical environment of the automobile is fierce. Temperature ranges of  $-40^{\circ}\text{C}$  to  $+70^{\circ}\text{C}$  are typical in the passenger compartment. Under the hood, it's worse— $-40^{\circ}\text{C}$  to  $+125^{\circ}\text{C}$ . Vibration, humidity, dirt, caustic exhaust gas, and owner neglect add to the hostile environment. Electrically, the typical auto is an electronics designer's horror show. Transients, battery reversals, and "load dumps" abound. For instance, turning on a rear-window defroster could dump a  $-300$ -volt transient into a circuit, which might have to dissipate close to 1 watt in a severe temperature environment.

Once electronics gets on the road, warranty repairs

become important. When those electronic parts come to the attention of a garage mechanic, will he know how to test them? Will he decide that if they are new, they're trouble makers, and yank out perfectly good modules while stumbling toward the ultimate cause of the trouble? Thus ruggedness and reliability are prime considerations in developing auto electronics.

But the No. 1 consideration is cost. The huge volumes that auto makers deal in not only make them powerful customers, but make them addicted penny-watchers. A 1% difference in price for a \$1 electronic component quickly adds up to \$50,000. A \$1 increase in a part means \$2–3-million depending on the company.

The other side of the coin, of course, is that these big volumes represent big potential profits. Estimates of the size of the electronics market for any given year depend on who is doing the estimating. In a study made over a year ago, Arthur D. Little Inc., Cambridge, Mass., consultant firm, estimated that the per-car penetration of electronics would reach \$70 by 1976 and \$100 by 1980, bringing the total market from about \$350 million last year to \$700 million in 1976, and somewhere around \$1 billion by 1980. These figures included entertainment products, but not automotive test equipment, a market put at \$57.5 million last year. The figure of \$100 per car in 1980 has become fairly well accepted, but the Little report did not anticipate the immediate arrival of the seat-belt interlock system, required in the 1974 model year, which may put \$60 million worth of business in electronics companies' coffers. Los Angeles consulting firm Darling and Alsobrook puts auto electronics at \$652 million in 1971 and \$1.016 billion in 1976 including entertainment and diagnostic gear.

Semiconductor companies have made recent estimates of sales for their products, too. For instance, Texas Instruments, Dallas, Tex., figures that the 1971 model cars have \$5.69 each in semiconductors (does not include complete modules), the 1973s have \$6.48 each, and the 1976s will amount to \$14.55 for each of the 10.1 million cars expected to be sold that year.

Fairchild Semiconductor, Mountain View, Calif., estimates the components sales (not including assemblies) to the Big Three alone will be \$150–160 million in 1973.

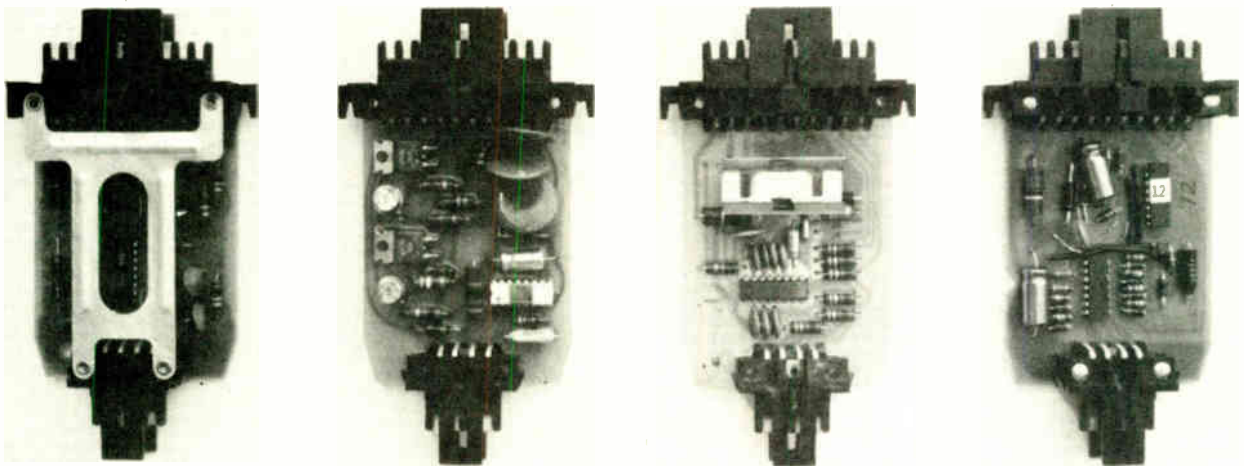

2. **Be seated.** Fisher Body is buying both bipolar and complementary-MOS IC logic modules for GM's seat-belt ignition interlock system. This system will be the first electronic product to be introduced across the board in one model year, because of DOT regulations.

## Special report

The market, including circuit-module assemblies, for the 1974 model year should be \$250-300 million, and, if assemblies of circuits and electromechanical devices are counted, the total amounts to about \$600 million, according to Fairchild.

Signetics Corp., Sunnyvale, Calif., figures that monolithic ICs alone—including those in entertainment products—will total 25 million circuits worth \$37 million for 1973 and 30 million circuits valued at \$40 million for 1974. Motorola Semiconductor Products Inc., Phoenix, Ariz., reports that the auto industry will lay out about \$130-140 million for new applications, adding that in a decade it will be impossible to make cars without semiconductors.

Though there are differences in estimating the actual dollars, there is no disagreement over the solid growth ahead, particularly by the 1976 model year. The Government's insistence on a seat-belt interlock system for the 1974 model cars dismayed the auto makers but provided a boost to electronics companies not even anticipated a couple of years ago. The control module, for example, may cost \$7.50 to \$8 each, including approximately \$1.50 for the IC logic circuit inside.

### Fasten your seatbelts

This month, seat-belt rigs designed to interlock with the ignition system will begin to be delivered to auto company assembly points. It is the first electronically controlled system to go across the board into every car in one year, and it breaks the traditional Detroit mode

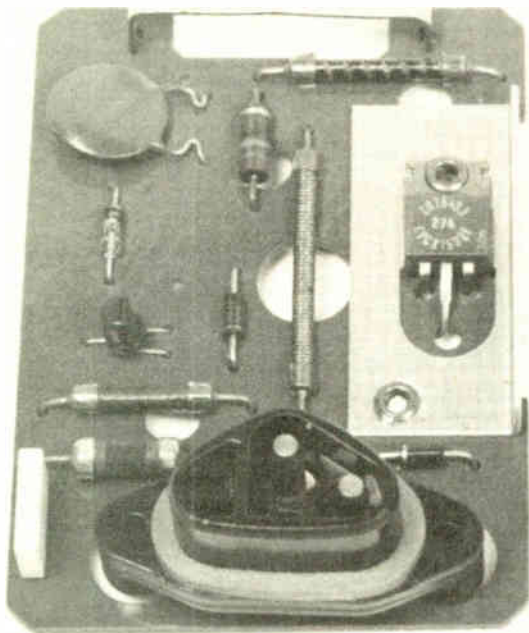

**3. A battery's friend.** Using discrete components, Chrysler developed this voltage regulator, now standard in all lines, to provide higher voltages to help charge the battery in cold weather and lower voltage to protect the battery from overcharge in hot weather.

of operation when introducing anything new. What's more, the consumer destined to buy a 1974 model is still largely unaware of what's in store. In order to start the engine, he will have to sit on a seat-mounted sensor, buckle up the combination lap/shoulder harness, and only then turn the ignition key. His front-seat passenger will also have to be buckled up before the car will start. The now-familiar seat-belt buzzer and warning indicator will be retained and will be activated if the occupant unbuckles the belt after starting. The DOT requirement does not dictate the interlock design—only that the car shall be unuseable unless the seat belts are buckled before starting the ignition. Interpretation as how to do this has led to considerable negotiation between auto makers and Federal bureaucrats.

Ordinarily, Detroit might take three or four model years to introduce anything like this as a standard item. The first year, it might go out into the field on 1,000 test cars and the second into the top of the line as an option. The third year has a push into a wider range of cars—maybe as standard on the top-of-the-line cars—and then in the fourth year it becomes a standard in all but the low-end models. During this time the manufacturers are busy making careful analyses of field experience, modifying designs, sharpening human engineering, working down the cost, and spreading the word to dealers on how to maintain the system.

None of these steps has preceded the seat-belt interlocks. Detroit is going into it cold turkey—and a lot of people are very nervous. Two unspeakable sins in Motown is to cause a production line to stop or to cause a re-call. "With the seat-belt interlock," says one IC marketing man with a brave little smile, "electronics may have a chance at causing both. I only know that we do not want to find out what happens after that."

For their part, the auto companies know that motorists will blame them, not the electronics companies nor the Government, for failures, even inconveniences, caused by the seat belts. They also know that many, many Americans do not like seat belts—even if they do save lives—and many, many more do not like shoulder harnesses. One of the design goals is to make the belt easier to use than to defeat, which is not the case with today's buzzer reminder systems. Even if this goal is met, the belts could well spawn a new back-alley industry of technicians capable of disengaging the ignition interlock so drivers can ignore their belts again.

Compounding what is already a skittish situation, precious weeks have been lost in getting the systems into final design form by constant changes in the interpretation of DOT's requirement. Thus, there was a flap recently over whether the middle front seat should be included in the controls. This doubt meant that IC designs were not firm until mid-May, prompting one semiconductor company engineering manager to comment, "It's like hitting a moving target."

### Now for the good news

The seat-belt system has put an uncomfortable burden on all concerned. But the design of a hybrid logic module—the critical part of the product, involving an IC surrounded by discrete components that provide noise protection, plus drive the buzzer and light (Fig. 2)—was

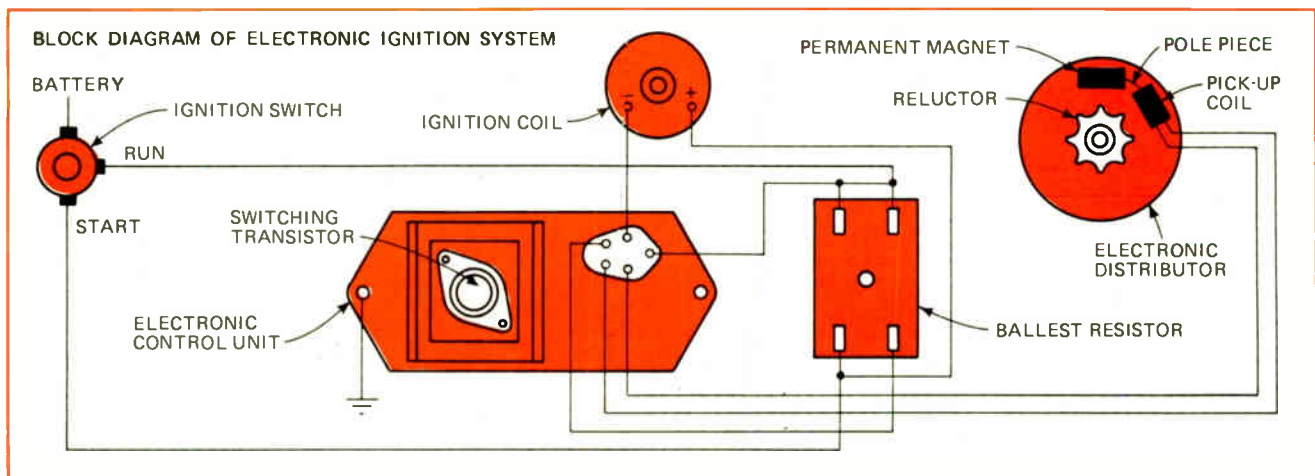

**4. Start your engines.** Block diagram of Chrysler's electronic ignition system shows how the electronic control unit with switching transistor fits into ignition layout. Because an electronic failure would immobilize the car, reliability of components and extensive testing were stressed.

no great strain on the capability of the semiconductor suppliers. Because of Detroit's penchant for multiple sources and the large volumes involved, several semiconductor companies are supplying either bipolar or complementary-MOS ICs for seat-belt interlocks. The electronics arms of the Big Three are in turn supplying the logic modules to the production divisions responsible for interior design. So, for example, Delco is making for itself, and buying outside as a custom chip, a bipolar circuit that goes into the logic module supplied to Fisher Body division of GM.

Fisher has designed and is manufacturing the complete interlock system for all GM cars, using modules supplied by Delco and also modules employing custom COS/MOS ICs from RCA and modules made by Packard Electric with custom bipolar ICs from Sprague Electric Co. In addition, TI is supplying a bipolar module for GM and a C/MOS version for Philco-Ford—the seat-belt-system designer for the Ford Motor Co. lines. RCA is also supplying its COS/MOS circuits to Ford and Chrysler.

While the ICs are all custom designs, the volumes are so large that they are virtually off-the-shelf products in terms of production level and cost. A controversy over the comparative merits of bipolar and C/MOS has arisen among the various participants, although Detroit is not yet playing a favorite.

Says Frank E. Jaumot Jr., director of research and engineering for Delco Electronics, Kokomo, Ind., "We like bipolar—it's compact, can be easily handled in production lines, and it gives us everything we want."

"With the bipolar chip we can combine the logic needed with enough power to drive the warning bulb, ignition solenoid relay, and buzzer drawing only 1 ampere," comments S. B. Marshall, manager of consumer IC engineering for Sprague's Semiconductor division, Worcester, Mass. "To get this with C/MOS requires off-chip power discretes or a Darlington. So if the seat-belt interlock does not become any more complex than it is now, we don't see a need for the packing density inherent with C/MOS."

Disagreeing, Herbert B. Shannan, manager of market planning for MOS ICs at RCA's Solid State division, Somerville, N. J., says: "COS/MOS is more comfortable in the auto environment than bipolar, because of its

noise immunity, low dissipation, and packing density. It's easy to design with and tends to work the first time."

Philco-Ford has been trying bipolar and MOS, working with Solid State Scientific Inc., Montgomeryville, Pa., RCA, Fairchild, and TI. "The momentum is toward C/MOS," observes Peter M. Ansbros, automotive electronics engineering representative in Philco-Ford's Dearborn engineering office. "The major technical problem with the system is the need for noise and transient protection, because the power supply on a car is not clean and may never be clean enough for ICs. Designing protection for ICs is taking more time than the semiconductor suppliers like."

Ford has some background in the interlock concept having offered it as a free option on 1972 model Pintos. Although this move provided some marketing data, the electronic controls were different from the present system, so there is no real technical field experience.

The rush to ready seat-belt systems on time may all be forgotten by the 1976 models when, if DOT holds to the schedule, the air-bag passive-restraint systems will be required. With these units seat belts will be replaced by a system that senses deceleration—indicating the possibility of a crash—and at impact deploys air cushions designed to restrain the passengers. Because of the need for sensors that will not fire the inflation mechanism on a false signal, nor fail on a real crash, the design effort is already going full blast. As a consequence, semiconductor suppliers do not expect design changes in the seat belts for the interim 1975 model year, since Detroit will be preoccupied with designing and testing the crash sensors, fail-safe devices, and storage and inflation equipment for the air cushions.

While the belt-system electronics concentrate on sensing a driver and controlling a light, buzzer, and starter solenoid, the air-bag electronics shifts the emphasis to sensing a crash, while suppressing false signals. Delco's Frank Jaumot explains: "One of the problems in designing the seat belt was to account for bounces that raise the driver off the seat sensor. We had recorded 3-second bounces. Bounce protection required adding a counter to provide 5-s leeway so the system does not activate when the car goes over a big pothole.

"With the air cushion we have two bumper detectors

# Special report

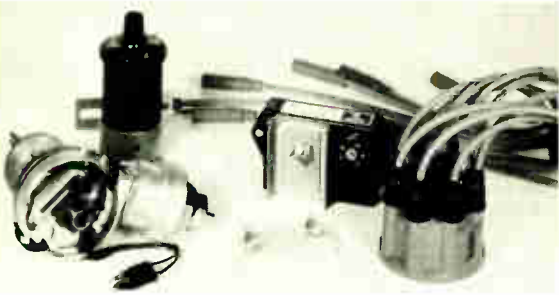

**An electronic start.** Chrysler's electronic ignition system, above, designed around RCA discrete components, is installed across the board in the company's 1973 model line.

**Digital dash.** General Motor's experimental car, Alpha I., contains some features that may find their way into 1980s autos, such as a digital display from on-board computers.

**Checked by radar.** Bendix Corp. has been experimenting with use of radar, below, for vehicle-headway control, but problems with target identification must be solved.

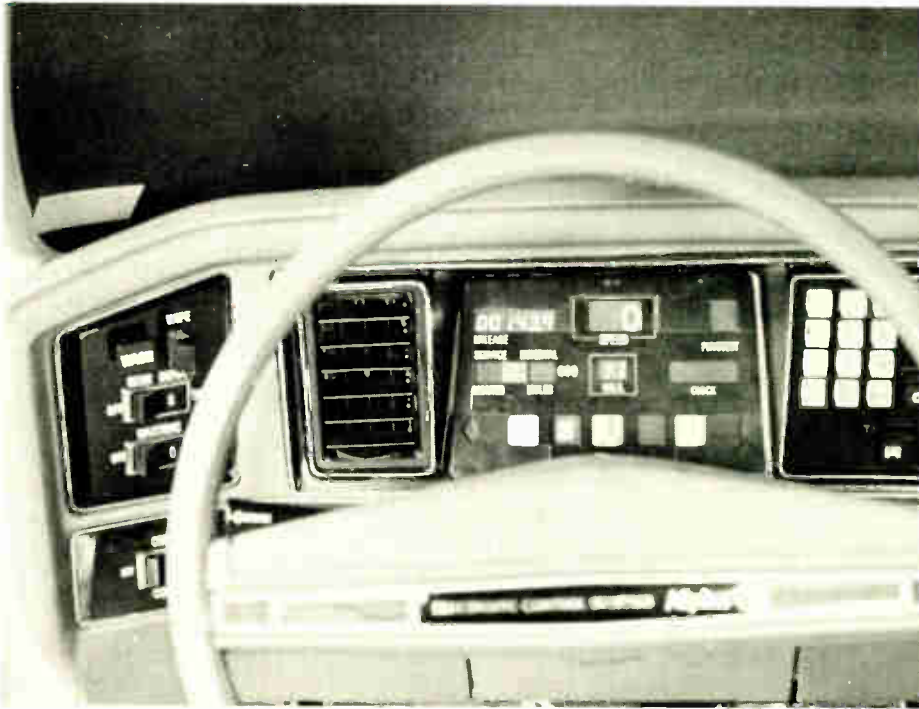

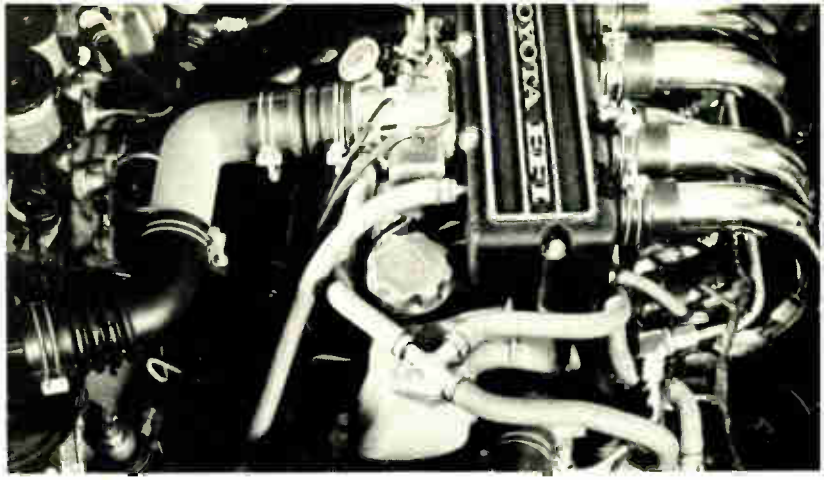

**Fuel injection, Japanese style.** The Toyota electronic fuel-injection system has been offered as an option this year as a gas-saving attraction. While sales have not been heavy, it is expected to become important as part of emission-control system for exports to U.S.

**Safety first.** The electronic control module of seat-belt interlock (left) will insure motorists are in their seats with belts buckled before ignition can function. IC module, like RCA COS/MOS version here, will also activate alarms if belt is removed after starting.

**Cold inside.** Testing for the severe environmental conditions to which the auto engine is subjected, an engineer for Robert Bosch of Germany wheels out ignitions from cold room. Typical cold temperature in an engine compartment is  $-40^{\circ}\text{C}$ , heat level is  $125^{\circ}\text{-}150^{\circ}\text{C}$ .

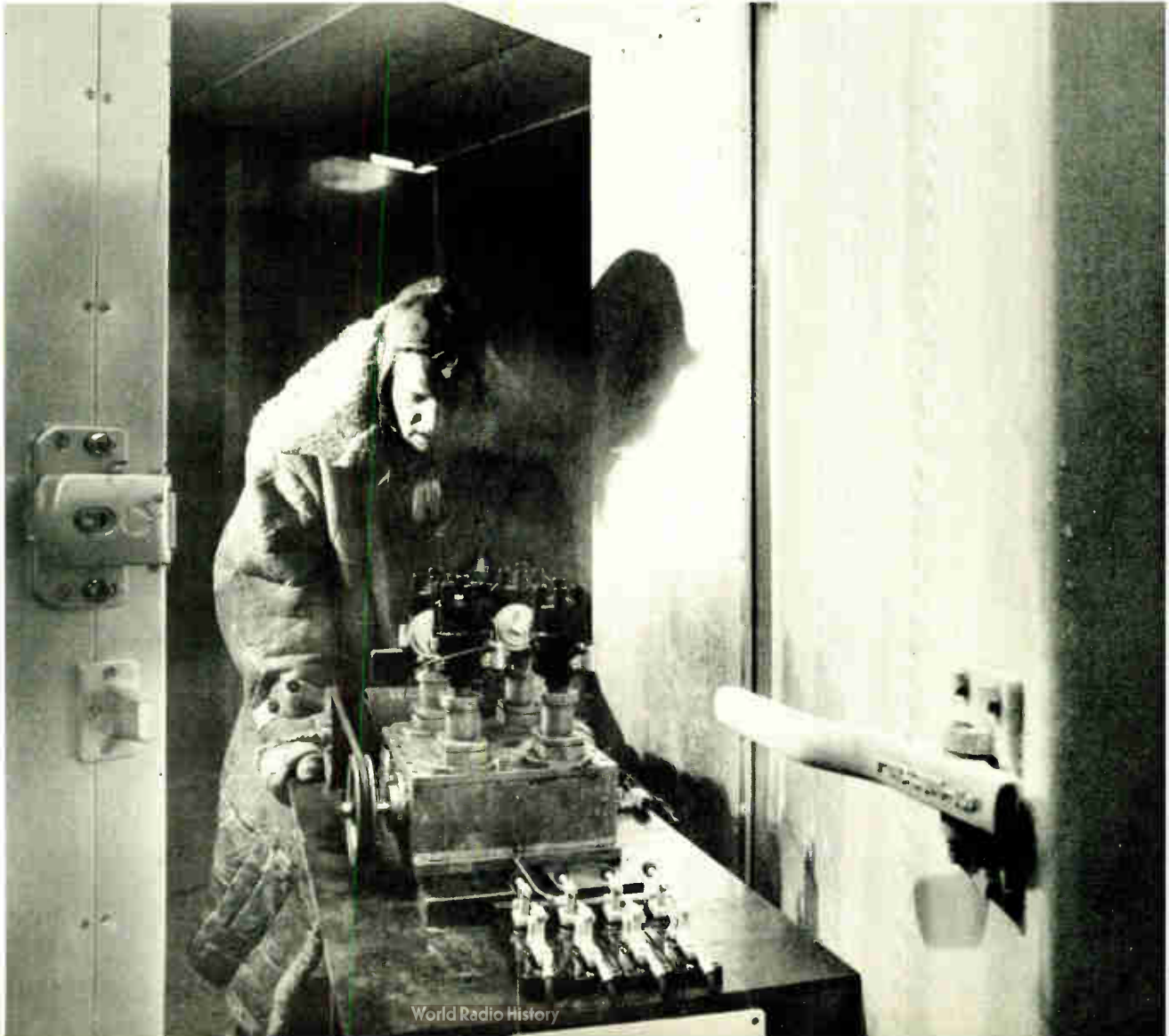

# Special report

that respond to change in velocity, not g forces. Problems with vertical force were encountered that required a change in the sensors. The GM air bag has a built-in diagnostics system that constantly monitors the key parts. If the system detects any condition that might prevent the bag from firing, it turns on a driver-warning light, which puts the car owner into the loop."

Jaumot points out that an on-board crash recorder may also be necessary in the bag system to record the time that the failure warning light went on as well as the speed at the time of impact. Such a recorder would establish after a crash if the motorist had failed to repair the bag, if the bag fired properly, or if the auto was travelling either under or over the speed range required by the Government. GM currently has about 1,000 air-cushion-equipped Chevrolets on the road for public and private fleet testing in everyday driving conditions.

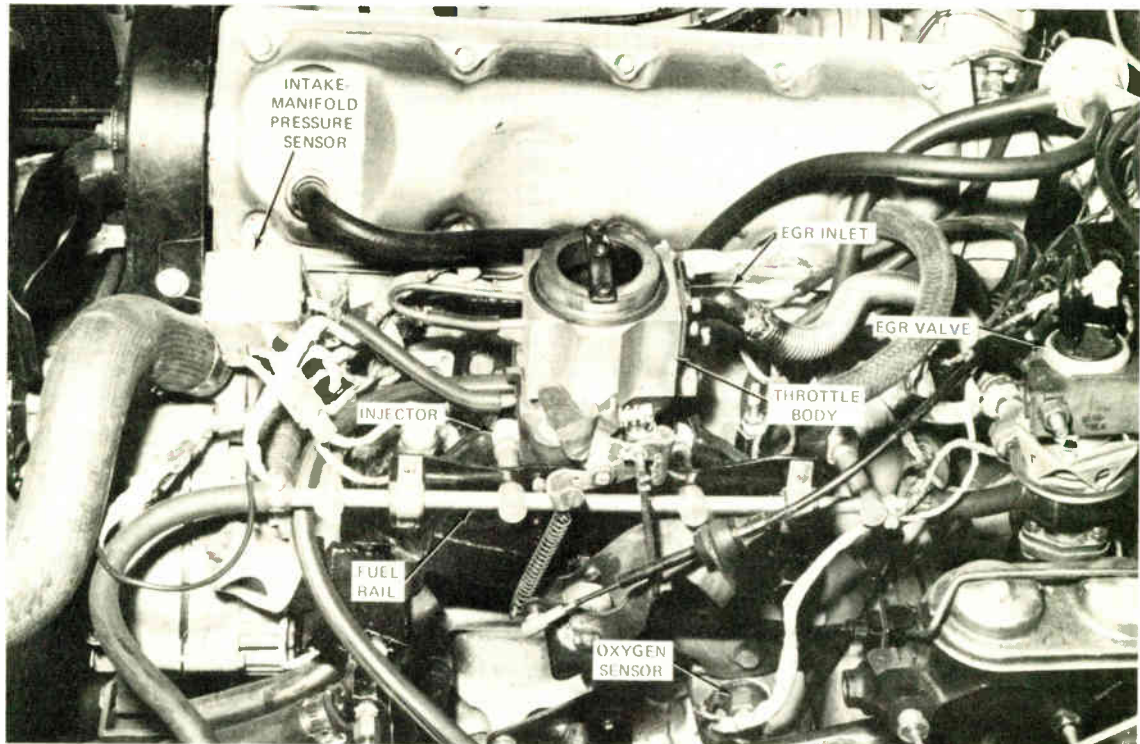

(a)

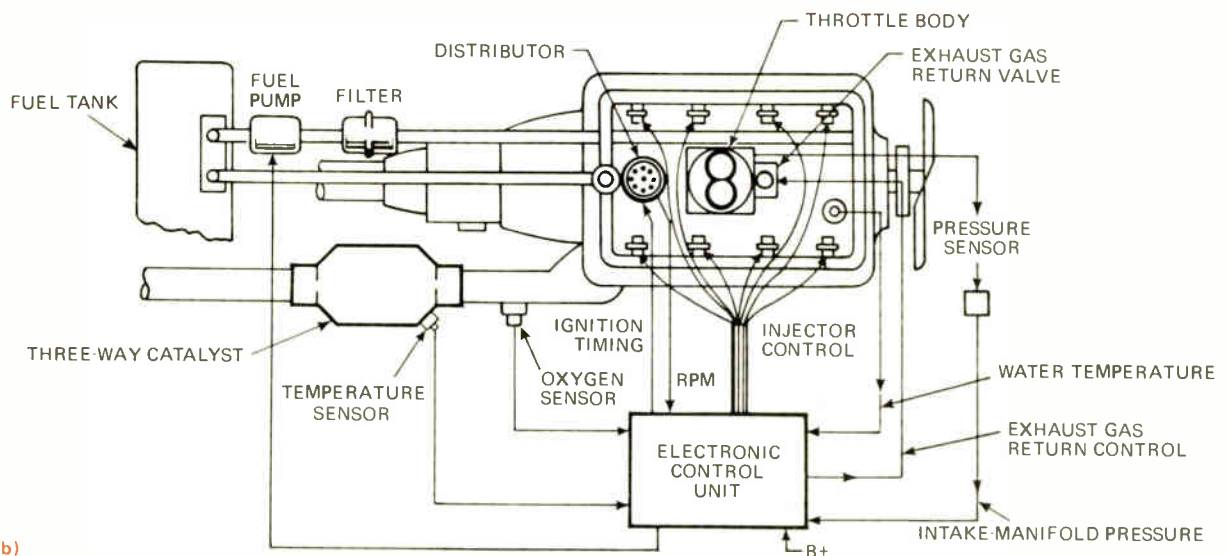

(b)

**5. Fuel management.** The Bendix closed-loop electronic fuel-injection system mounted on an engine (top) provides precise fuel management based on engine operating requirements signaled to a control unit (bottom) that computes maximum fuel-burning efficiency.





Based on that experience, GM has planned to offer the air cushion as an extra-cost option to gain more field experience.

### Green light for voltage regulators, ignition

While motorists may be unprepared for what to expect in the seat-belt interlocks, Chrysler Corp. has seen to it that its pioneering effort in this country with electronic ignition has been amply promoted. Even competitors grudgingly admit that Chrysler has whipped the field on this product. GM is now introducing electronic ignition, but Ford has other ideas for now.

Chrysler was in a unique position to take the lead because of a decision made some 14 years ago when the company decided to make its own alternators rather than the conventional dc generator common at the time. The company used a selenium-plate rectifier and later converted to the then-new silicon rectifier, at the time a military-type component. This was Chrysler's first use of electronics outside of the car radio and set the firm on a path toward converting the next electrical section, the voltage regulator, to electronics.

In the mid-1960s, Chrysler designers perfected a voltage regulator using germanium transistors, but it was too expensive—heat sinks and related hardware added costs—for the assembly division to swallow. RCA then cracked the cost problem for Chrysler with a plastic-packaged silicon power transistor.

The electronic voltage regulator is designed to protect the battery from overcharge and the accessories from excessive voltage when the vehicle voltage rises. When the desirable upper limit is reached, the regulator "throttles" back. To do this, a diode conducts when the voltage rises to 9 v, turning on a driver transistor that in turn cuts off field current to the alternator. The result is that the increased voltage results in the alternator output being diminished.

In addition, a capacitor is used to reduce the sensitivity of the system response and to eliminate oscillations. A thermistor controls the regulating voltage—higher in cold weather, lower in hot weather. And a suppression diode protects the system from transients.

Prior to putting this unit in all 1970 Chrysler cars, a better voltage-trimming method had to be found. A cermet trimmer resistor commonly found in TV receivers was designed in, and the previous, manual voltage set-

**Test driver.** GM has done research on testing a driver's fitness prior to his being able to start the engine. While results have shown that punching out a series of codes as in this keyboard may stall some drunk drivers, systems are not perfect yet.

ting was replaced by an automatic method that not only set the voltage, but also tested the setting.

But just before full-scale production started, another problem cropped up. The steering-column lock and ignition switch just introduced subjected the voltage regulator to an unanticipated voltage transient when the engine was turned off. The solution was to add another suppression diode inside the regulator on the back side of the printed-circuit board. This unit is now Chrysler's production model (Fig. 3).

Having learned how to handle the electronic voltage regulator the way is clear for an IC version to replace the discrete approach; however, Chrysler is not convinced that's the way to go. Says Robert M. Weier, manager of engine electrical development, "The discrete-component construction allowed the addition of the suppression diode in 24 hours. There's more flexibility with discretely, but with ICs you turn your fate over to the electronics companies. Nevertheless, we have left the door open to ICs, if the cost is right."

As for its electronic ignition unit, Chrysler's original goal was to improve engine performance and sell consumers on the savings possible by eliminating engine tune ups. Because it has no conventional distributor contacts, there is nothing to wear out. Now the company has another advantage to sell: since the ignition setting remains as accurate after 50,000/miles as when new, electronic ignition can be an important component in the emission controls due to be rigidly imposed beginning in the 1976 model year. This type of ignition also provides more voltage to fire spark plugs during cold start up, when misfires cause heavy emissions of unburned fuel.

The ignition was introduced into 340-cubic-inch engines in the 1971 model year, advanced to an option on 1972 V-8s, and finally became an across-the-board standard in 1973. What this meant to RCA, the output and driver-transistor supplier, was a jump in requirements from a few thousand to 2 million units in three years. "The biggest problem," says Chrysler's Weier, "under these conditions is that supply is tight. There is still only one supplier qualified for certain key semiconductors. Suppliers have to make big jumps in capacity at a reasonable price with military reliability, and that's a tall order."

Essentially, the Chrysler electronic ignition consists of a voltage generator in the distributor, the output of which is related to engine rotation, and several stages of electronics which amplify and switch off the primary current of the ignition coil when the proper signal is received from the distributor, then switch on that current after a fixed time (Fig. 4). The electronic components that form the control circuit are mounted on a pc board and put in a steel box encapsulated with epoxy, a technique learned first with the voltage regulator.

Weier attributes part of the success of the electronic ignition to the arrival within Chrysler's auto family of the Huntsville Space division, which created a whole

# Special report

new concept in distributor test equipment for production and is now producing the ignitions. Another important consideration was testing the voltage regulator and ignition in the field. During development of the voltage regulator, diagnostic equipment had been designed for use in engineering test programs. This easy-to-use gear has now been manufactured commercially and listed as a tool requirement for all dealerships. The same procedure was followed for the electronic ignition test unit.

## Delco on another avenue

GM first introduced a voltage regulator with an integrated-circuit module in 1968 and installed it across the board in the 1973 lines. A few GM models had electronic ignition in 1972, but it was not until this year that a significant number reached the streets. The electronics portion of the voltage regulator, designed and produced by Delco Electronics, is a thick-film power hybrid.

The output section is connected to the battery by a sense regulator, which tells the system that the battery is in place, thus preventing an all-out charge without a battery present. Between the alternator output and the output section is a Darlington switch which will modulate "on" time and "off" time. A "diode-trio" circuit energizes the unit only when the car is running. In addition, this configuration turns on a driver warning light if the generator is not producing voltage to charge the battery. This unit provides overvoltage protection and will take a load dump from the alternator.

Like the voltage regulator, Delco's electronic ignition is also a thick-film power hybrid module and is also designed for mechanized production as well as ease of installation by the assembly division. It's a replaceable module that fits under the distributor cap in the upcoming 1974 model cars.

## Electronic fuel injection cranking up

Many auto industry observers feel that electronic fuel injection systems will be the next big market in Detroit. The main reason for this belief is that fuel-injection can contribute to—though not accomplish completely—a significant reduction in exhaust emission. To date the Big Three have used the concept sparingly, but despite some initial skepticism all are working on systems.

The other approach to more accurate fuel metering—the goal in cutting emissions—is to alter today's carburetor systems to make them more efficient. But this approach may in the long run favor fuel-injection, because the cost of altered carburetors would increase, thus reducing the cost advantage. On the other hand, Detroit has little experience with electronic fuel-injection and has lots of money tied up in tooling for carburetors.

The main argument for fuel-injection, according to Robert R. Hoge, director of automotive electronics for Bendix Corp., Southfield, Mich., is that it precisely controls the fuel-to-air ratio as a function of driving conditions and thus makes the converter and the engine more efficient than electronic control of a conventional carburetor system, which tends to decrease gas mileage.

Bendix has been in the vanguard of electronic fuel-in-

jection for some time, has licensed injector systems for production in Europe and, more recently, in Japan. For a time, injection fuel distribution was based on several inputs of engine condition. Now Bendix has refined the concept to provide a closed-loop system (Fig. 5). A sensor has been developed that measures oxygen concentration in the exhaust gases and produces a signal that reflects the point at which the air/fuel ratio approaches the most efficient combustion point. By sensing this optimum operating point and feeding back signals to the electronic control module shown in Fig. 5, the air/fuel ratio can be realistically held within a range of  $\pm 0.1\%$ .

This is an important characteristic, because at this point an exhaust-gas catalyst used with the closed-loop control will most efficiently remove hydrocarbons, carbon monoxide, and oxides of nitrogen.

Four custom-developed ICs form the basic module in the electronic control unit and other integrated circuits make the unit adaptable to particular cars. These are small-scale ICs, but with high-volume production the control unit could economically go to large-scale integration and take on additional operating tasks—including electronic control of automatic transmissions. Again the problem is the cost of reliable sensors to provide input to the control center.

The oxygen sensor is the key component in the current closed-loop injection system, and it has not yet met the Federal requirement that emission-control systems operate for 50,000 miles. However, Bendix has announced that it is confident that by the time the 1976 emission standards go into effect, the oxygen sensor will have been improved to meet the requirement.

## Other electronics, now and later

The list of other electronic parts on automobiles can get lengthy, depending on how far ahead one projects. As of now, two-wheel anti-skid controls and speed controls have made it, as have intermittent windshield wipers (Ford only) and anti-theft systems, as options. Electronic clocks are upcoming along with digital displays, eventually leading to a shared display for the radio, the clock, and the tachometer on demand. RCA has already begun to deliver COS/MOS circuits for Chrysler's clocks.

The anti-skid or adaptive-braking system could become a safety requirement depending on the experience gained with this requirement on trucks. If there is significant statistical improvement in reducing truck accidents, DOT might write a braking standard for passenger cars. But by the time anything like this requirement goes into effect, the auto companies will have gained some field experience. This system has encouraged the development of a family of quad amplifiers, quad comparators, and quad op amps tailored for the auto market's need for devices that operate from a single 12-v dc power source.

National Semiconductor, Santa Clara, Calif., for example, has brought out the LM2900 series op amp which is part of what the company calls building-block circuits, the auto industry counterpart of the standard-function circuit. AC Spark Plug was the first to try the building block approach, using a derivative of the LM2900 for an anti-skid braking system. It's used in a speed-regulation system with tachometer feedback as

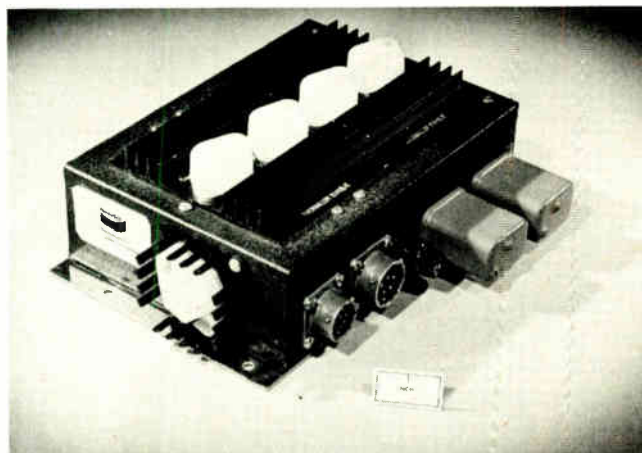
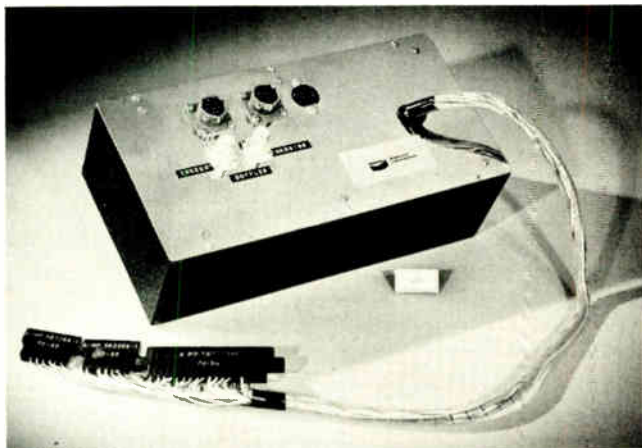

**Blips.** Headway-control radar designed by Bendix includes radar electronics unit (top) to generate range and range-rate voltage from return radar signal, signal processing unit to compute throttle and brake commands, and a dc-to-dc power supply (bottom).

well. Motorola has also announced a quad op amp, and Sprague will bring out a catalog-type this summer to be in position to meet the growing anti-skid demand.

The building-block approach, according to Thomas Frederiksen, section head in National's linear IC design department, allows quick turnaround for the auto companies, yet protects the semiconductor company by eliminating a heavy investment in a custom design that constantly is being changed. However, critics of this approach claim that it is too expensive compared to the custom approach. On the other hand, those favoring the idea point out that Detroit likes to have multiple sources, which these devices provide. Essentially the building block idea is to use standard circuit design to build a system, rather than develop a custom system.

Fairchild Semiconductor, meanwhile, has been look-

ing at the demand for sensors. Robert B. Hood, manager of automotive products, explains that this market includes pressure sensors (both rigid and compliant), resistance (temperature) types, and rotating-member sensors. As examples, Fairchild has developed an extremely rugged temperature-compensated hybrid IC containing a silicon strain-gage pressure transducer. It has also developed an ignition-control circuit, as well as a hybrid IC, that contains an inductive pickup for sensing rotation of the distributor shaft and is obviously intended for GM's uses.

The company has been working on bump-chip hybrid ICs on thick-film circuits since 1965. They now appear to have a future in the harsh environment around the auto engine. In addition, Fairchild's Hood points out, the bump-chip approach facilitates automated assembly of hybrids, thus reducing the costs when manufactured in automotive volumes.

### Electronics translated abroad

Overseas, there are not the stringent safety and emission-control regulations that are in effect in the U.S., and as a consequence this stimulation to automotive electronics has not been felt. On the other hand, design of seat-belt interlocks and emission controls are in proportion to the amount of American exporting that the foreign auto makers hope to do. Thus, most of the action is in Germany, Great Britain, and Japan.

Like the U.S., electronics in motor vehicles produced in Germany fall into the performance, safety, and user-convenience categories. There is a fourth area—service improvements—but in this case the electronic equipment is outside the car at diagnostic centers.

Safety electronics plays a minimal role in Europe's domestic-market autos. "That does not mean we are not safety-conscious," says an official at Bonn's Ministry of Transportation. "We have in fact proposed a number of safety standards for Common-Market-wide adoption, but agreement is hard to reach." He points out that if regulations are to produce maximum effects they should be uniform throughout most of Europe.

But because the German auto industry sold some 718,000 passenger cars and station wagons in the U.S. last year—more than 20% of total German non-commercial vehicle production—safety requirements involving electronic controls are being produced without much stimulus from the transportation ministry.

As for recent developments effecting performance and driving convenience, Intermetall GmbH, German member of the ITT Semiconductor Group, is offering an integrated circuit for driving-speed/mileage indicators. This so-called speedometer IC, model SAY115, which replaces the flexible shaft between the car's transmission and the dashboard, was designed in cooperation with several big automobile-instrument firms in West Germany, Italy, and France.

Using inputs from suitable pick-off devices at the transmission system, the SAY115 gives an output both for speed and mileage indication. It also has circuitry to generate a signal for triggering an external alarm if the speed exceeds or falls below a preset limit. Such alarms are not yet mandatory on European autos, but Intermetall included the alarm-triggering circuit in anticipa-

# Special report

tion of this requirement on American cars some day.

Another device from Intermetall is an IC for engine revolution counters, or tachometers. Designated the SAK115, it can be adapted to engines with from two to eight cylinders. The circuit, already being sold to car-instrument firms, converts the input coming directly from the breaker points into constant-voltage square-wave pulses for the tachometer.

Electronic fuel injection is probably the best known German automotive development, although it is the result of a licensing agreement between Stuttgart-based Robert Bosch GmbH and Bendix. Pioneered six years ago, Bosch's system has been very successful in Europe. It's become standard equipment on no fewer than 18 European cars, according to Bosch. To date, the firm has delivered about 2 million systems, with fuel economy rather than emission control, being the appeal. The system still uses discrete components, but an IC version which has already been tested, will hit the market either this year or early next.

Siemens AG has designed an electronic voltage regulator along the order of Delco's. It's a semiconductor device using hybrid technology with conducting paths and thick-film resistors on a ceramic substrate. All other discrete components are soldered onto it in a reflow-solder process. The device is built into a heat-sink unit and is then sealed. A diode protects the regulator against damage caused by faulty wiring and also guards the electrical system against voltage peaks. In addition, Siemens has developed transistorized and thyristorized ignition equipment and a system for electronically controlling spark-ignition timing. Siemens is not only an equipment maker, but a major supplier of components to accessory producers. The company claims a 30% share of the European market for diodes and rectifiers for automobiles.

Volkswagenwerk AG, maker of VWs, has developed a sophisticated seat-belt interlock system prompted by its large export business to the U.S. [*Electronics*, May 24, p. 35] It is built around a bipolar IC, the SAJ280 from Intermetall, and performs the same ignition-control functions as American versions. Other German car makers have opted for discrete solutions for their systems, al-

though an interlock IC is also being developed by Valvo GmbH, a Philips subsidiary.

Equipment under development and soon to hit the market includes a four-wheel skid-control system and an electronic transmission control from Bosch. Daimler-Benz AG will install the first anti-skid systems on its Mercedes cars later this year. Bosch is cooperating with Zahnradfabrik Friedrichshafen, a big transmission-gear maker, on the electronically controlled transmission. The work is aimed at a solid-state system that functions without loss of traction during the gear-shift operation. First models will go into trucks, where fast shifting is important, and into autos some years from now.

Further ahead, a group of German electronics houses—Bosch, AEG-Telefunken, and Standard Elektrik Lorenz AG—are participating in a project sponsored by the government's research ministry to develop collision-avoidance systems. The project is aimed at developing for passenger cars inexpensive microwave-based systems that would not only determine the vehicle-to-vehicle distance, but also give approach speed.

## Japan ready for U.S. requirements

Auto manufacturers in Japan are tooling up to produce seat-belt interlocks to be required in the U.S. and a variety of other electronic options using their own sources of supply, rather than importing U.S.-designed systems. The same made-in-Japan approach will also be followed to meet American emissions requirements.

Initially seat-belt systems will use discrete components, because of greater experience with using them and shorter lead time compared with ICs. But the initial discrete systems will be followed by a second generation with ICs, according to industry sources.

In Japan much of the automotive electronics development is centered around the two largest manufacturers, Toyota Motor Co. and Nissan Motor Co. and their suppliers. For auto electronics, Toyota has a very close working relationship with Nippon Denso Co., which at one time was part of Toyota and is still in the same industrial group. The companies have also gone into a joint venture with Fujitsu Ltd.

Nissan, on the other hand, has a large development group at its Central Research Laboratory and buys almost two thirds of its electrical and electronic equip-

**That's the brakes.** With the Anti-Block System, developed by Daimler-Benz of Germany, the test Mercedes, left, keeps its track as brakes are applied while cornering on wet pavement. Car without anti-skid system is unable to maintain traction.

**Learning about brakes.** Engineers at the Institute for Automotive Engineering of Hanover Technical University in Germany evaluate passenger-car braking behavior records. Results will be used in designing electronic anti-skid systems for future cars.

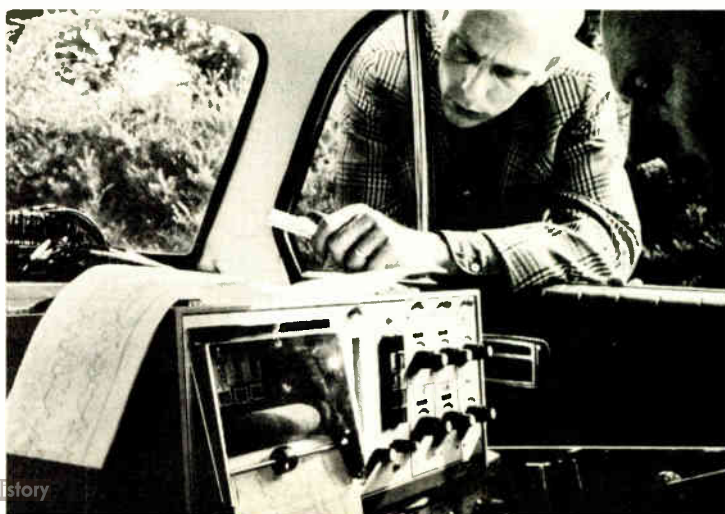

ment from Hitachi Ltd. and most of the remaining third from Mitsubishi Electric Corp. Mitsubishi also supplies some 80% of the requirements of Toyo Kogyo. of Mazda rotary-engine fame, which has designed an electronically controlled afterburner for this engine.

While auto electronics is keeping a fair number of engineers busy, it has not yet become a big business for either semiconductor-device or electronic-equipment manufacturers. Hitachi, for instance, reports that it still has not produced any special discrete devices or monolithic IC chips for auto makers, although it has several designs ready and waiting. Tokyo Shibaura Electric Co., Mitsubishi, and Nippon Electric Co. have had similar experiences.

While electronic transmission and electronic fuel-injection have not yet taken off, research on automotive electronics continues at an increasing rate. Nissan and Mitsubishi Electric have recently reported on the performance of two prototype radar systems, using microwave ICs, that they have developed for air-bag systems. One type is a dual-frequency doppler radar in which the frequency difference gives distance information. The other is a pulsed doppler-radar system in which pulse returns give distance information. The pulsed system had better performance than the bistatic, dual-frequency approach. However, the cost of both types makes application doubtful for the near future, the companies concluded.

As for present-day products, both Toyota and Nissan offer anti-skid controls in the \$300 price range as op-

tions, and both report sales are low and will probably continue to be low unless anti-skid is required by law. Nissan offers hybrid voltage regulators made by Hitachi and Mitsubishi on several car models. They are now more expensive than the mechanical units they replace, but since the electronic regulator is small it can be installed inside or on the alternator, eliminating the wiring used with traditional regulators mounted on the firewall between the engine and passenger compartments. This wiring savings evens off the cost difference.

Nissan also offers a transistor ignition system, eliminating distributor contacts, on two models. Other Nissan electronic parts, either standard or options, include fuel-injection, window-wiper controls, tachometers, and air conditioner control. Toyota's current models have as standard or as options fuel-injection, electronic transmission, (Fig. 6), constant-speed control, air conditioner control, and a meter that shows all systems are operating.

### Electronics under British bonnets

With a couple of exceptions, electronics has hardly penetrated British automobiles. These exceptions are a module for alternator voltage control made by the Lucas Electrical Co., for use in its own production alternators, and a thick-film module, incorporating a bipolar monolithic chip, designed by Smiths Industries Ltd., to drive the revolution counters it makes. The monolithic chips are supplied to Smiths by Texas Instruments Ltd.

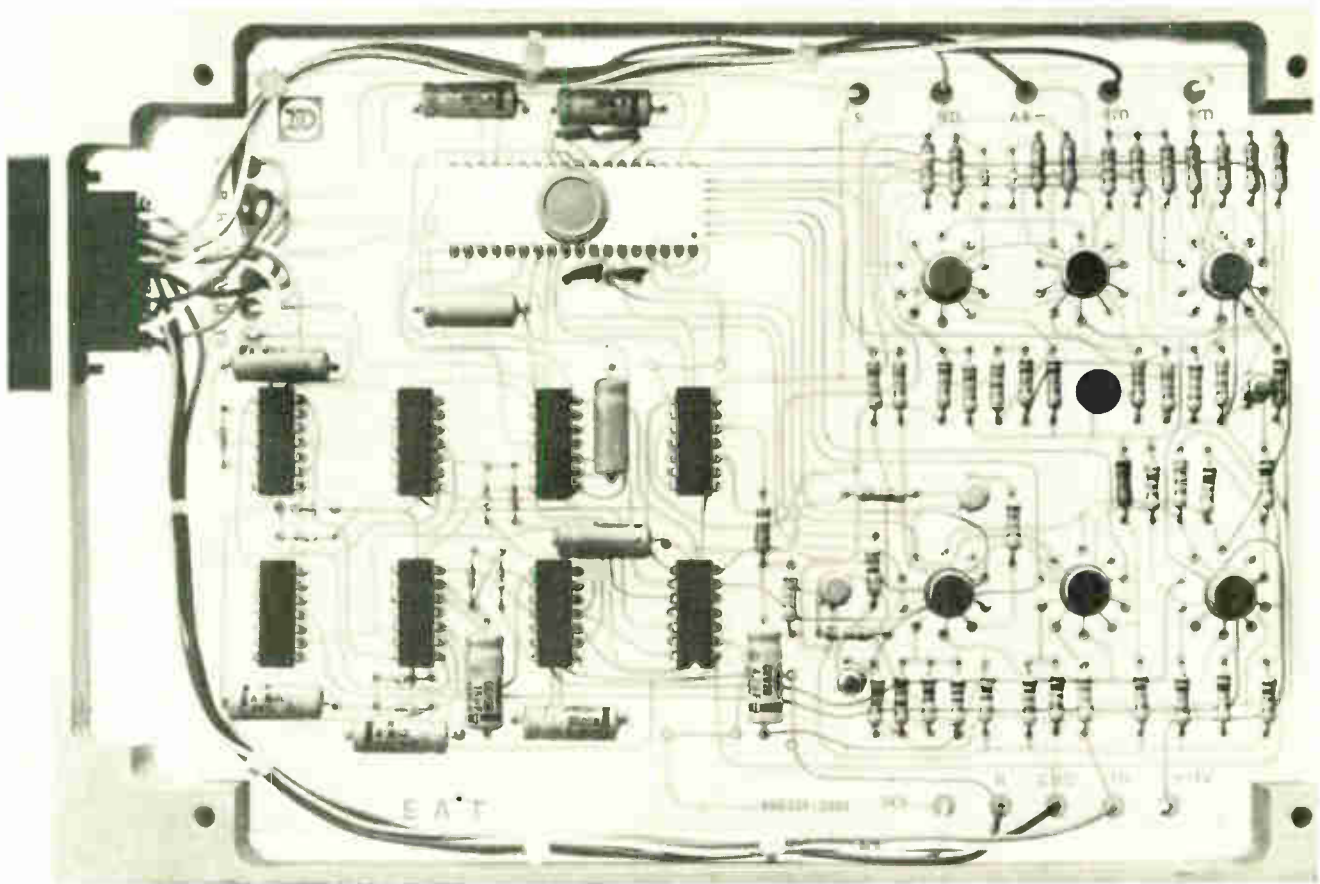

**6. Japanese in gear.** Toyota's Electronic Automatic Transmission is entirely Japanese-made as are all other electronic systems designed for Japanese automobiles. This transmission is intended to improve gas mileage by shifting gears more precisely than do hydraulic versions.

## Special report

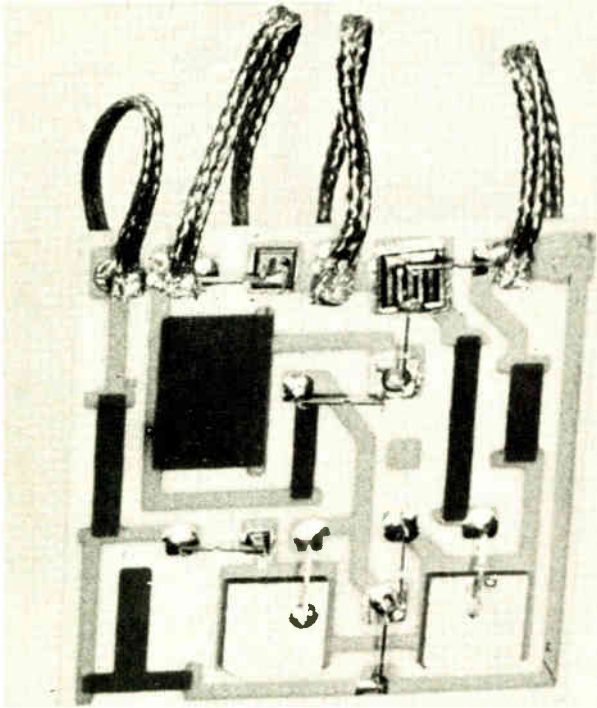

7. **Alternator control.** The Lucas electronic voltage controllers for alternators come in two formats. One is on a thick-film module packed in silicone rubber (shown). The other is a discrete circuit on a pc board potted in epoxy resin.

A third item will become progressively more prominent this summer—a seat-belt interlock system incorporating another Smiths-designed bipolar IC made by TI. It will be supplied in quantity to British Leyland Motor Corp. for use in its exports to the U.S. Later, non-BLMC cars for export will get it.

Smiths' IC-driven revolution counter is already in large-scale production. The bipolar monolithic IC is, essentially, an ignition-driven monostable passing closely-defined current pulses to a moving-coil meter that integrates them and displays a mean value. The entire electronic system, the IC and five capacitors, is on a substrate about 1 square inch. A speedometer has been developed out of this unit and will be in production in about two years. It uses gearbox revolutions as the input, and the monolithic chip includes a divider driving a motor to turn the total mileage indicator.

Brian Shepherd, chief electronics engineer of Smiths Instrument division, prefers to design his own chips and use semiconductor companies as custom suppliers. He believes he has a more accurate idea what is wanted on an automobile and what car makers will accept. So far he appears to be right, for the only companies that have got fair quantities of electronics into British autos—Lucas and Smiths—are car-equipment makers, and they've done as much as possible to control the electronics designs.

By contrast, Mullard Ltd., a big components supplier, has spent much money developing automobile electronics systems, which it hopes to license to equipment

makers, then supply them with the parts. But so far, there have been no takers—because, first, Mullard wants a commitment to buy large quantities before it tools for production and, second, it is seeking joint-venture operations to spread the financial risk. Neither proposal has appealed to the industry.

Meanwhile, Lucas has been fitting electronic voltage controllers in alternators for over 10 years, turning out about 25,000 of two modules a week. These units are more or less the same in performance. But one is a thick-film module about 1.25 in. on a side by 3/16 in. thick, packed in silicone rubber, and the other is an identical discrete circuit on a pc board, potted in epoxy resin, and is about 1.5 in. on a side by 3/8 in. thick. The circuit uses three transistors and two diodes, one of which is a zener providing the charge-voltage reference (Fig. 7). When the charge exceeds the reference, one of the transistors switches off the output, which is a Darlington amplifier arrangement.

Lucas also supplies 400 to 500 electronic ignition systems each week to the Jaguar division of BLMC for its V-12 engines. Most of these cars go to the U.S., and the electronic ignition is used to help meet U.S. emission regulations.

The unit is a somewhat massive, two-piece structure that includes a 12-cylinder distributor and a finned amplifier box, both mounted in the engine V. A continuously running oscillator in the box energizes the outer limbs of an E-core differential transformer in the distributor. But no waveform is generated in the central output limb of the transformer until a ferrite element passes between the central limb and one outer limb, upsetting the balance of the transformer. Twelve of these ferrite elements, one for each cylinder, are mounted on a rotor in the distributor. Output from the central limb is rectified, amplified, and used to switch off a power transistor, which passes current to the ignition-coil primary wiring, thus building a high-voltage pulse in the secondary in the usual way.

The oscillator, rectifier, amplifier, and output transistor are discrete elements mounted on a single board in the amplifier box. Lucas claims that the system provides permanently accurate static ignition timing and requires no maintenance.

This is the only large-scale use of electronic ignition in British cars. However, industry observers feel that more autos will convert within two years. It appears that the U.K. subsidiaries of American car makers will opt for U.S.-made ignitions, leaving BLMC as the major customer for British versions. While the Lucas system may be too expensive for high-volume requirements, another type is being developed by Autocar Electrical Equipment Co., of London, called Lumenition (Fig. 8). It's possible Lucas will take this system for volume orders.

For the future, Lucas is working on a front-mounted vehicle radar intended to control speed and headway relative to cars ahead. Lucas has a contract with the government's Transport and Road Research Laboratory to build two radar units and test them along with an RCA passive-reflector radar system. Results of these tests are expected to be released soon.

The two Lucas radars will be very similar, employing a varactor-tuned, 25-milliwatt Gunn-diode source

working in Q-band (36,000–46,000 megahertz), modulating over 400 MHz. The fm action provides range information and doppler action, the velocity information.

### French autos sans electronics

Counting less heavily on American exports, French auto makers have not made a major effort toward electronic applications. Yet the government-owned company that makes Renault cars offered an automatic gearbox—that worked with an “electronic” clutch as an option—for a brief period back in 1962. And today four top-of-the-line Renault models can be had with an automatic transmission that includes an electronic “nervous system.” This transmission option boosts the price of the car by about \$420.

Renault also uses on some lines electronic fuel-injection systems, produced by Germany’s Bosch, and tachometers, also purchased outside. Citroen’s top-of-the-line DS23 and SM models have Bosch-made fuel-injection as well. And aside from the possibility of Peugeot coming out with an electronic ignition system, that’s about the size of automotive electronics in France.

Renault plans to put electronic fuel-injection into U.S.-bound cars and will buy U.S.-made seat-belt interlocks for these vehicles. As for the transmission, Renault’s head of long-range planning, Pierre Bouthors, reports, “We used electronics instead of hydraulics for the brains of the system for two main reasons—electronics was easier to mount in the transmission and it adapts to different car models.”

The transmission itself is not unusual. A hydraulic torque-converter paired with a planetary gear train gives three speeds forward and one in reverse. Speeds are selected by clutching and braking gear-train elements, but this is done automatically through a pair of solenoid valves driven by the transmission electronics.

A preset program starts in first gear, then progresses to second and third gear as the speed picks up. However, shift points can’t be set at fixed speeds because of varying road conditions. To handle the variations, the electronic comparison unit gets signals that represent the position of the range-select lever, the car’s speed, and the engine loading. There’s also a kickdown signal, fed in through a switch when the driver stomps all the way down on the accelerator.

The lever-select signal is actually a fixed voltage picked off a switch in the comparison unit and actuated by a link to the select level. It sets the basic level of the reference voltage. An instantaneous-speed signal is picked off a small generator driven by the speedometer shaft. The generator output also reflects the engine loading since its poles are rotated by a link to the accelerator pedal. The generator output is compared with the reference signal to develop drive signals for the solenoid valves.

The comparison unit (Fig. 9) is built from discrete components and the completed pc card, about 8 centimeters square, is encapsulated and carried in a metal hat can fixed to the transmission housing through mouldings that insulate it from heat and vibration.

### The 1980s: Computers hitch a ride

The piecemeal manner in which auto makers have in-



**8. Low-cost ignition.** Complete electronic breakerless-ignition conversion unit made by Autocar Electrical Co. Ltd. of England uses chopper inserted on distributor shaft and infrared emitter and photodiode. Breaking of beam by chopper is sensed by photodiode.

produced electronics into their lines will probably not linger into the 1980s models. All of the Big Three have already begun to look at systems approaches that could integrate various functions under the control of central processors and eventually break down the traditional policy of separating design of the engine space and passenger compartments.

As in most changes initiated by Detroit, the arrival of on-board computers will come in stages. The most likely starting point will be the emission-control system, for the closed-loop system sets a possible direction. A cost-effective computer could then emerge by adding adaptive braking and electronic transmission control to the fuel-management and converter-sensing tasks they would already perform.

Another possible function for an on-board computer is diagnostics. Here the cpu would be attached to a network of sensors keeping tabs on wheel conditions, electrical systems, brake-fluid level, lights, and environmental conditions. These signals measured by the processor against stored norms would trigger warning displays to the driver and perhaps head off accidents, breakdowns, and expensive repair bills.

A third mission for an auto computer will likely be in processing target-acquisition data from collision-avoidance radar. A first step in this direction may be in expressway traffic control requiring dedicated lanes, the freeway becoming part of the total system. Although planning and experimentation on all of these potential concepts are proceeding, the problems are numerous. GM has built a test car, Alpha I, to explore several ver-

# Special report

sions of a car computer. The categories studied included drive-train control, chassis and suspension control, exterior-lighting control, driver convenience, and safety and reliability functions.

One of the conclusions reported at the 1973 Society of Automotive Engineers meeting suggested that "if a successful car computer . . . can be used in multiple applications through reprogramming, the semiconductor industry will have a stable production base . . . far more resistant to technological changes than is the case at present where the industry historically has gone through a technological upheaval every four or five years."

The Alpha I test car's areas of processing were split roughly along product lines. These were stability and control processor, electronic fuel-injection processor, electronic transmission control, physiological tester processor for driver proficiency, instrument panel, and central processor.

GM engineers concluded that a generalized, on-board computer system is quite feasible and within the present state of the art for LSI circuits. The problems are in the developing of reliable sensors, the cost of introduction, and the difficulty of choosing a profitable first application. The SAE report concluded: "It seems likely that a system with the sophisticated capabilities of a digital computer will ultimately prove to be the most cost-effective solution to many of the problems facing the automobile industry."

## Radar, multiplexing are still ahead

Future application of radar is also receiving much attention, but routine installation on cars is still some years off. Radar faces both a technical problem and a human-engineering dilemma. The technical problem is in devising a means of signature identification—that is, processing target signals in such a way that it has meaning to the driver. This ability also means sorting out false signals. Ford, GM, and Bendix are all working on this problem, as are Bosch in Germany, Lucas of Great Britain, and Nissan in Japan. The human-engineering

issue is whether a radar-equipped auto will prevent accidents by timely warnings or create accidents by lulling drivers into carelessness. Effective solution to the technical problem will help work out this question.

A look at what impact more electronic systems will have on the electrical wiring harness of the automobile would suggest the need for multiplexing in order to reduce the jungle of cables. There is little if any penchant on the part of Detroit to bite off this task at present. A Ford study indicated that on present-day cars, multiplexing would not save money in most applications. Semiconductor suppliers are hopeful that the economics will change, however, by the 1980s, as this approach would open new applications for electronics. More likely, trucks will find reason to apply multiplexing before cars because the number of wires that can be run to sense conditions on multi-wheel axles is limited.

What the electronics firms have learned in entering the auto industry, even those with corporate family entrée into the special world connoted by the term "Detroit," is the awesome economic power of the Big Three. Auto giants are unimpressed by the marvels of electronic technology. They impose their will on the industries that supply them, never the reverse. In addition, electronics companies have learned that auto companies deal sharply, but fairly.

Over and over, electronics marketing men sound a common theme, succinctly put by Paul R. Thomas, manager of marketing planning for commercial power transistors for RCA. "You go to Detroit when you're asked." As Robert O. Silco, automotive marketing manager for TI, states it, "There's only one way it's going to be done, it's their way."

Gene Hnatek, linear product manager at Signetics perhaps speaks for most when he says, "The degree of penetration that a given manufacturer makes in the automotive market place depends on how well he adapts to doing business on the auto manufacturers' terms, on cost and reliability, on delivery, and on service to the auto manufacturers' needs. The IC manufacturer must truly be customer oriented." □

Reprints are available at \$3 each. Write to Electronics Reprint Dept., P.O. Box 669, Hightstown, N.J. Copyright 1973 Electronics, a McGraw-Hill publication.

**9. La difference.** Renault's automatic transmission has electronic comparison circuit (left) that, with signals on speed, engine load, and gear-lever setting, controls shifting of gears to fit driving conditions. Comparison unit (b) is built from discrete components.

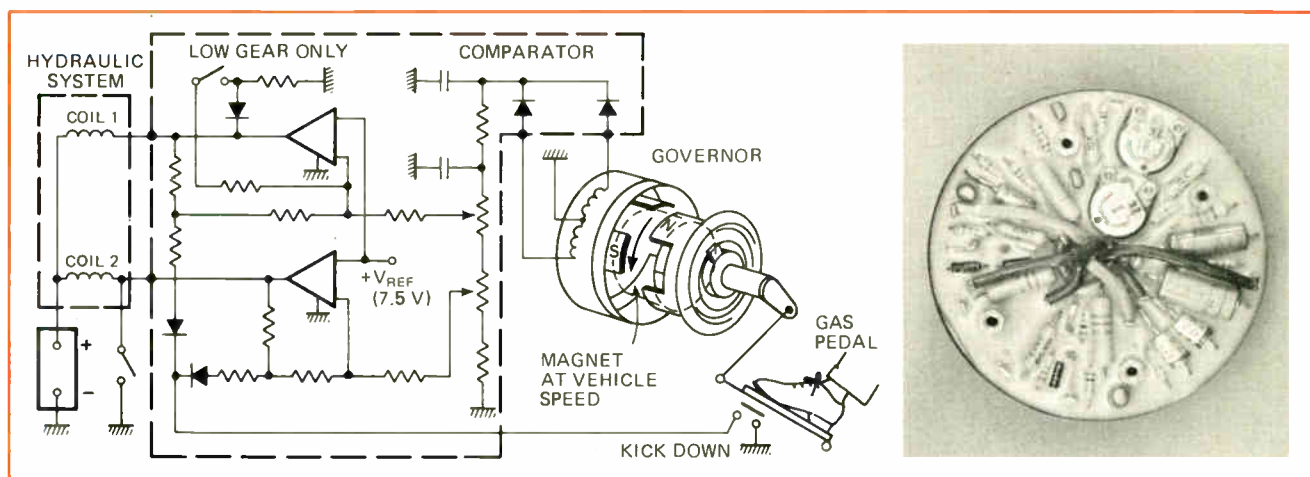



**MADE IN**

**FAIRCHILD**

**A CIRCUIT  
FOR EVERY  
RADIO/AUDIO  
FUNCTION**

**A circuit for every socket: All the building blocks for any Radio/Audio System. Ask for a desk top demonstration.**

**AM**



μA720 AM RADIO SUBSYSTEM



μA706 AUDIO AMPLIFIER

**FM**



3075 FM DETECTOR AMPLIFIER



μA706 AUDIO AMPLIFIER

**HIGH GAIN FM**



μA753 FM GAIN BLOCK



3075 FM DETECTOR AMPLIFIER



μA706 AUDIO AMPLIFIER

**FM STEREO**

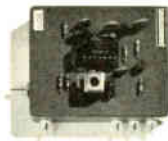

3075 FM DETECTOR AMPLIFIER



μA758 PLL STEREO



μA706 AUDIO AMPLIFIER



μA706 AUDIO AMPLIFIER

**HIGH GAIN FM STEREO**

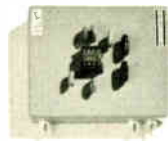

μA753 FM GAIN BLOCK



3075 FM DETECTOR AMPLIFIER



μA758 PLL STEREO



μA706 AUDIO AMPLIFIER

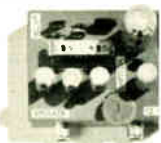

μA706 AUDIO AMPLIFIER

Each working module (above) contains a Fairchild radio/audio circuit in combination with several passive components. Using these Fairchild LIC Demonstration Blocks, you can have an actual working demonstration of how to build similar systems. We'll plug them together instantly at your desk. Just call any of these Fairchild sales offices (at the right) and one of our applications engineers will arrive, pronto, demonstration kit in hand.



Boston 617-237-3400 Cleveland 216-461-8288

Chicago 312-671-4660 Dallas 214-234-3391

**AM/FM STEREO  
WITH PHONO/TAPE**



μA753 FM  
GAIN BLOCK



3075 FM DETECTOR  
AMPLIFIER



μA758  
PLL STEREO



μA720 AM RADIO  
AMPLIFIER



μA739 DUAL  
PRE-AMPLIFIER



μA706 AUDIO  
AMPLIFIER



μA706 AUDIO  
AMPLIFIER

Indianapolis 7-542-0641 New York 516-293-2900 Philadelphia 215-886-6623

Los Angeles 4-558-1881 Orlando 305-834-7000 San Francisco 415-941-3150

Ours is the most complete line of consumer analog circuits available anywhere.

|       |                       |          |
|-------|-----------------------|----------|
| μA720 | AM Radio Subsystem    | DIP      |
| μA703 | Gain Block            | CAN      |
| μA757 | Gain Block            | DIP      |
| μA753 | FM Gain Block         | MINI-DIP |
| 3076  | FM Gain Block         | CAN      |
| 3075  | FM Detector Amplifier | DIP      |
| 2136  | FM Detector Amplifier | DIP      |
| μA758 | PLL Stereo Decoder    | DIP      |
| μA767 | Stereo Decoder        | DIP      |
| μA732 | Stereo Decoder        | DIP      |
| μA768 | Stereo Decoder        | DIP      |
| μA769 | Stereo Decoder        | DIP      |
| μA739 | Dual Pre-Amplifier    | DIP      |
| μA749 | Dual Pre-Amplifier    | CAN      |
| μA706 | 5W Audio Amplifier    | DIPP     |

We have a comprehensive family of the most used, and the most useful, radio/audio IC's for AM and FM radio, tape and phono-graph applications. High in performance and low in cost, they answer all the LIC needs of any radio/audio system designer. A circuit for every socket. In many cases, even, a choice of circuits for a given socket.

We invented the first consumer industry LIC standard, the μA703, today one of the largest selling IC's in the world. We added 7 more. Then, in the last year, an additional 7, including these new industry standards:

**μA758 Phase Locked Loop Stereo Decoder.** A complex subsystem that consists of pilot subcarrier regenerator, multiplex decoder circuit, audio output stage, and stereo function switch, all on one chip. Designed to satisfy performance and reliability

requirements of premium high fidelity stereo components. Plus the tough economic requirements of low-cost FM receivers. Features minimization of parts count (no coils required), 40dB power supply rejection, 45dB channel separation, and alignments eliminated.

**μA720 AM Radio Subsystem.** Combines RF amplifier, IF amplifier, RF oscillator-converter, voltage regulator and AGC detector. Features overvoltage protection, regulated power supply, separately accessible amplifiers.

**μA706 5 Watt Audio Amplifier.** Up to 5.5 watts continuous output into a 4 Ohm speaker, using single 14V power supply. Operates over a 6-18V range. Features high peak output current, self-centering bias, direct coupling input, low quiescent current, low distortion. Few external components and high ability to withstand AC shorts make it ideal for automotive applications.

**μA753 Gain Block.** Input and output designed for use with ceramic filters, minimizing external parts count (filter equalization components are on the chip). Full temperature compensation provides excellent gain/temperature stability. Built-in short circuit protection. Low-level output pin for AGC. Excellent noise performance and power supply ripple rejection.

FOR MORE INFORMATION write for our new IC Radio/Audio Design Kit (including application notes and product data).

**MADE IN  
FAIRCHILD**

## Stable crystal oscillator works over wide supply range

by Terence King  
*Oroco Communications Inc., Middletown, N. Y.*

If single-gate MOSFETs are wired as a modified Pierce oscillator and an isolating source-follower, they form a crystal oscillator that has unusual supply-voltage stability. This crystal-controlled clock is not expensive to build, interfaces easily with transistor-transistor-logic circuits, and can operate directly from a 5-volt supply.

Changes in output frequency due to supply-voltage variations are very small because of the high-value source resistors in both stages and the large fixed capacitances in the gate and drain loops of the oscillator stage. Even if the supply voltage increases from 3 to 9 v, output frequency changes by less than 1 hertz from its nominal 1-megahertz value.

Since the circuit itself is very stable, the over-all performance of the oscillator depends principally on the

quality of the crystal. A good oven-stabilized crystal should maintain a stability of one part in  $10^{-8}$  per day after warmup. And if ambient temperature is fairly stable, the whole circuit will approach this performance.

An excellent interface to TTL circuits can be provided by a type-7413 Schmitt trigger. The pulldown resistor of 2.2 kilohms biases the Schmitt trigger within its hysteresis characteristic without excessively loading the oscillator's source-follower. A type-7413 trigger will provide reliable TTL driving with as little as a 3-v supply applied to the oscillator.

The Schmitt's output is rich in rf harmonics and can be beat against a WWV broadcast of the National Bureau of Standards at 10 MHz, allowing adjustment of the oscillator to within 0.1 Hz of its nominal operating frequency without much difficulty. This sort of monitoring also permits relatively sensitive day-to-day checks of the circuit's short-term and long-term stability. Oscillator performance can then be established as a secondary frequency standard that is traceable directly to the National Bureau of Standards.

Capacitor  $C_R$  sets the range of the calibration of the trimmer capacitor. The value of  $C_R$  may vary with different makes and types of crystals. □

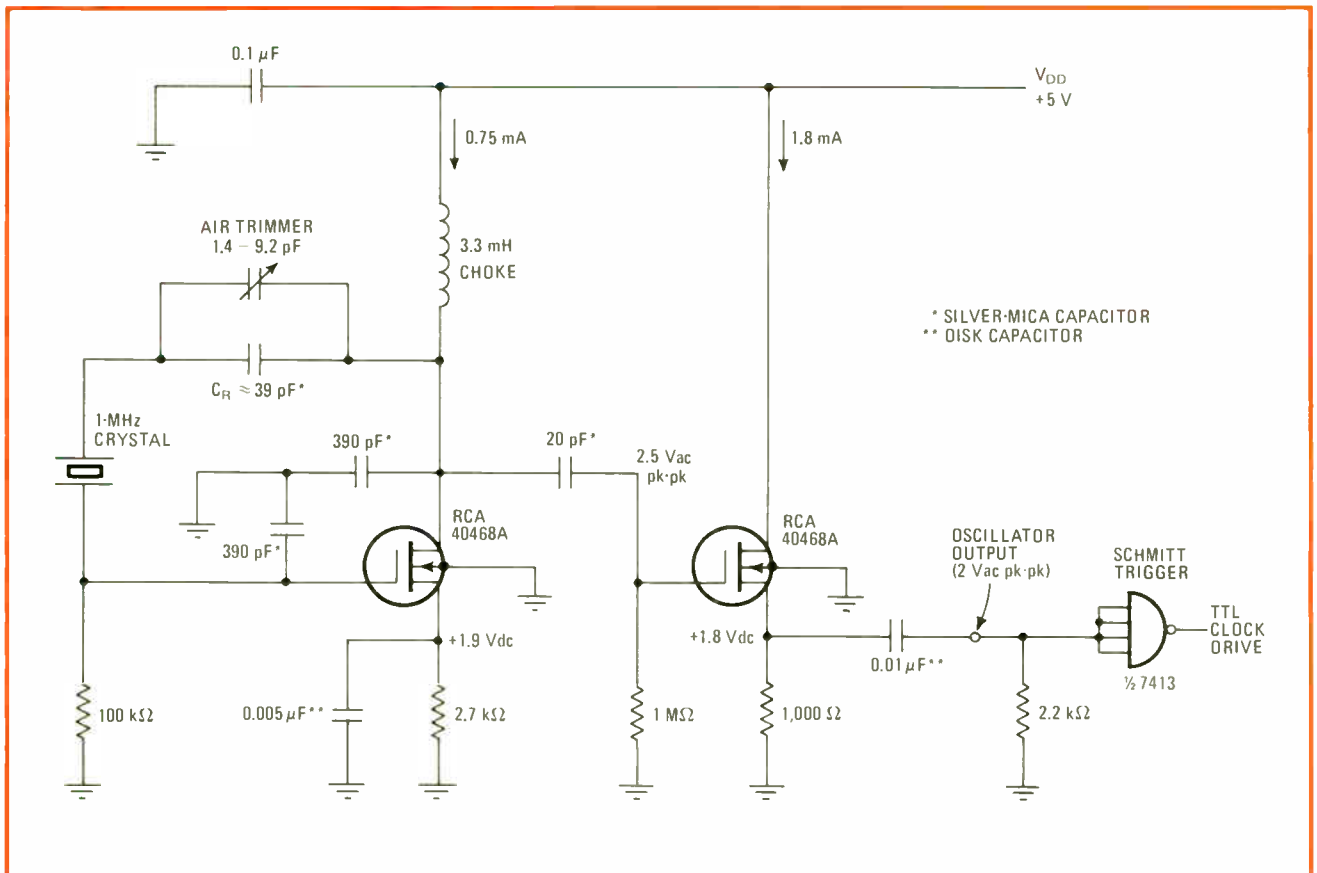

**Supply immunity.** Output frequency of crystal-controlled oscillator changes less than 1 hertz even when supply voltage varies from 3 to 9 volts. The circuitry—a modified-Pierce-oscillator MOSFET and a source-follower MOSFET—is so stable that over-all oscillator performance depends mostly on the crystal. A Schmitt trigger makes an excellent interface for using the oscillator to drive TTL devices.

## Varistor voltage divider improves receiver agc

by M.J. Salvati

Sony Corp. of America, Long Island City, N.Y.

Adding a varistor to the automatic gain-control circuitry in a communications receiver is a simple way to improve output-signal leveling. The varistor and a fixed resistor make up a variable voltage divider that is placed between the rf amplifier and the agc rectifier.

This arrangement improves the effectiveness of the agc circuitry because the percentage of the agc voltage applied to the controlled rf-amplifier stage varies in the same direction as the input-signal level. Furthermore, at low signal levels, this percentage is very small, allowing the amplifier to operate at maximum gain for the best noise-figure performance. The varistor agc, therefore, provides the benefits of delayed agc (or manually switching off the agc) without the abrupt discontinuity in control characteristic of the latter technique.

When the agc voltage is at its highest level (for a strong signal), the varistor's resistance is low, causing most of the agc voltage to appear across resistor  $R_1$ . This provides maximum gain reduction. When the agc voltage is at its lowest level (for a weak signal), the varistor's resistance is high and only a small agc voltage appears across the resistor, producing very little gain reduction.

The resistance values of the varistor and the resistor are selected so that the varistor is about half the value of the resistor when the agc voltage is at its maximum level (for the largest expected input signal). This selection will provide the best receiver output-signal leveling for inputs ranging from 1 to 1,000 millivolts and the best receiver noise figure (because of nearly complete agc turnoff) for inputs below 10 microvolts.

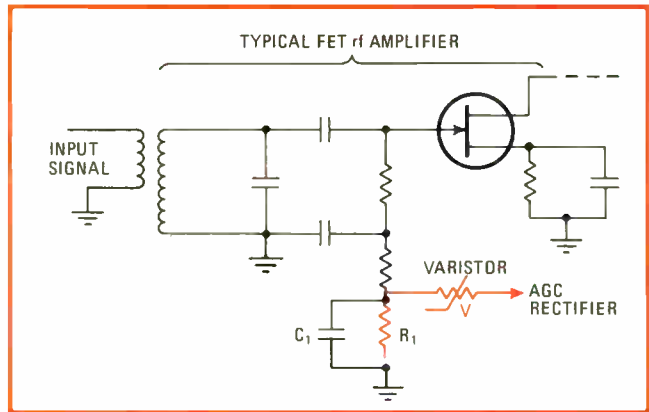

**Varistor agc.** Variable voltage divider formed by a varistor and a fixed resistor gives the advantages of delayed automatic gain control without any abrupt discontinuities. The varistor resistance becomes low for strong signals and high for weak signals, thereby varying the agc voltage applied to the controlled rf-amplifier stage. The scheme enhances receiver sensitivity and improves output-signal leveling.

The resistance values actually chosen for the varistor and resistor will depend on the signal levels available at the agc rectifier. In general, resistor  $R_1$  will be about 2 megohms for vacuum-tube receivers and about 100 kilohms for semiconductor receivers. Since the time constant of the agc filter formed by the varistor, the resistor, and capacitor  $C_1$  changes with signal level, the value of the capacitor should be chosen for adequate filtering of modulation variations when the varistor resistance is half the value of the resistor.

When included in all the controlled stages (along with the rf amplifier stage) of a semiconductor receiver, varistor agc can improve receiver sensitivity by 3 decibels, halve the decibel change in receiver output for a given change in input level, and increase the receiver's absolute output level by 8 to 12 dB. □

Designer's casebook is a regular feature in Electronics. We invite readers to submit original and unpublished circuit ideas and solutions to design problems. Explain briefly but thoroughly the circuit's operating principle and purpose. We'll pay \$50 for each item published.

## Regulating high voltages with low-voltage zeners

by Glen Coers

Texas Instruments, Components Group, Dallas, Texas

A regulator for a high-voltage power supply can be built with a low-voltage zener acting as the reference-voltage source. The output of this regulator circuit can be adjusted between 50 and 250 volts, and regulation is typically 0.5%. The circuit is particularly useful when operational amplifiers cannot be employed because the low-voltage positive and negative supplies needed to power them are not readily available.

Zener diode  $D_1$  supplies the reference voltage. It should be chosen according to the temperature coefficient desired and the maximum current required. The

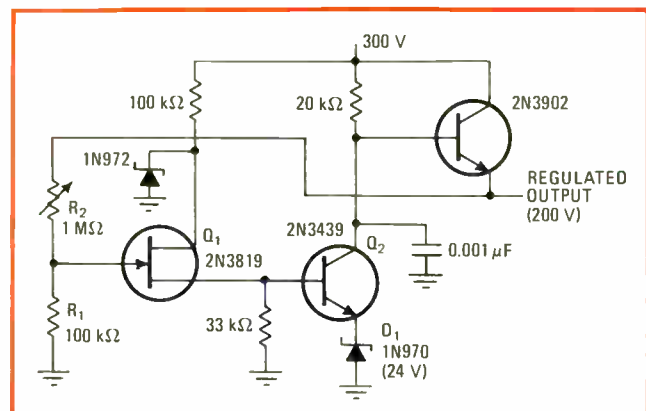

**Discrete-component regulator.** High-voltage power-supply regulator produces output of 50 to 250 volts at a typical regulation of 0.5%. A low-voltage zener,  $D_1$ , provides the reference voltage, establishing the circuit's current output and its temperature coefficient. The field-effect transistor,  $Q_1$ , allows large-value low-wattage resistors to be used for  $R_1$  and  $R_2$ , thereby minimizing loading.

REGULATOR PERFORMANCE

| INPUT VOLTAGE           | OUTPUT VOLTAGE             | LOAD CURRENT             | OUTPUT VOLTAGE             |
|-------------------------|----------------------------|--------------------------|----------------------------|
| 270 V } $\Delta = 30$ V | 199.2 V } $\Delta = 1.2$ V | 0 mA } $\Delta = 50$ mA  | 200.3 V } $\Delta = 0.3$ V |
| 300 V } $\Delta = 30$ V | 200.4 V } $\Delta = 0.8$ V | 50 mA } $\Delta = 50$ mA | 200.0 V } $\Delta = 0.5$ V |
| 330 V }                 | 201.2 V }                  | 100 mA }                 | 199.5 V }                  |

field-effect transistor,  $Q_1$ , allows resistors  $R_1$  and  $R_2$  to have high values so that output loading can be kept to a minimum and low-wattage resistors can be used. If these resistors were connected directly to the base of transistor  $Q_2$ , the circuit would provide poor regulation and have a high dynamic output impedance because of  $Q_2$ 's low input impedance.

The regulator's output voltage can be written as:  
 $V_o = (V_{D1} + V_{BE} + V_{GS})(R_1 + R_2)/R_1$   
 The open-loop gain of transistor  $Q_2$ , which is equal to

67 decibels, is a function of the FET's transconductance and the circuit's load resistance. The feedback factor,  $\beta$ , for the regulator is:

$$\beta = R_1 / (R_1 + R_2)$$

where  $R_2 = 9R_1$

The closed-loop voltage gain, which equals 20 dB, can be expressed as:

$$A_{VC} = A_{V_o} / (1 - A_{V_o}\beta)$$

And the gain with feedback becomes:

$$A_{Vf} = 67 - 20 = 47 \text{ dB}$$

□

## More applications for the 741-type op amp

by Edward Beach  
 McGraw-Hill Continuing Education Center, Washington, D.C.

The large common-mode rejection ratio of the popular 741-type op amp makes it possible to realize a variable-gain amplifier and even an analog switch quite inexpensively. The gain of an op amp can easily be changed by varying the proportion of the signal applied to both its inputs. If equal signals exist at each input, there is no output because of the op amp's common-mode rejection, but applying more signal to one input than the other will result in useful gain.

For the variable-gain amplifier of (a), resistors  $R_1$  and  $R_2$  are selected in the usual manner—with regard to the required input impedance ( $R_1/2$  in this case) and overall gain ( $-R_2/R_1$ ). Feedback resistor  $R_2$  may have to be trimmed to provide maximum attenuation when the gain-control resistor,  $R_3$ , is set to its maximum value ( $R_3 = R_2$ ). In practice, the voltage gain can be varied from zero to  $-R_2/R_1$  as the gain control goes from maximum to zero, and there will be no shift in the dc output.

The circuit can also be used as an analog switch, as shown in (b). For this application, however, there are a few restrictions. The output must be capacitively coupled, the input signal must be less than 1.2 volts peak to peak, and the amplifier must be set up for unity gain ( $R_1 = R_2 = R_3$ ). But within these limitations, the circuit makes an excellent analog switch.

When a logic 1 (2.4 to 4 v) is applied to the digital control input, the transistor saturates, effectively grounding resistor  $R_3$  to give an attenuation of 70 to 90 dB. As the transistor turns on, the op amp's noninverting input goes to approximately 0.6 v dc, causing the dc

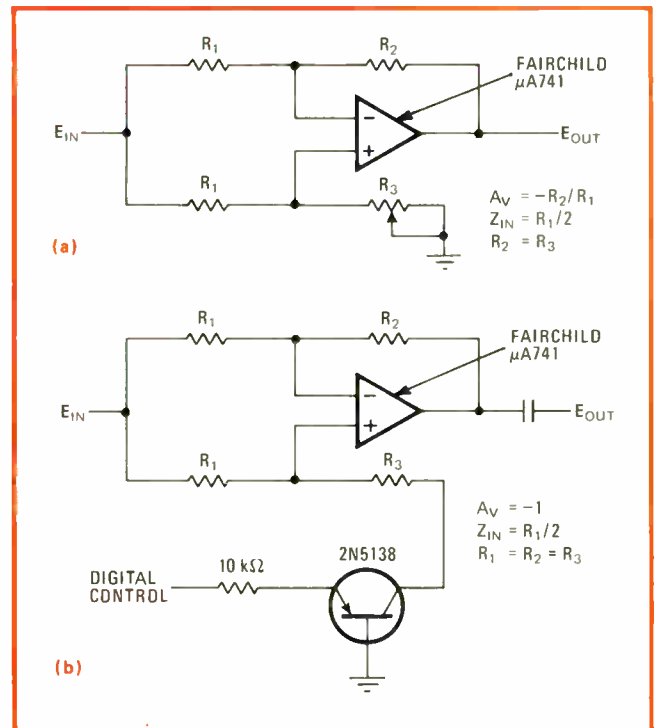

**Handy circuits.** Everyday 741-type op amp can be used as a variable-gain amplifier (a) or an analog switch (b). Only four external resistors are needed for the amplifier circuit, which maintains the same dc output as the gain is varied. For the analog switch, the op amp passes the input signal when the digital control line is grounded. The 741's large common-mode rejection permits it to perform well.

output voltage to also be 0.6 v and making an output coupling capacitor necessary.

A logic 0 (ground) input turns the transistor off, allowing the op amp's noninverting input to float so that the signal passes through the amplifier. If the signal becomes positive enough to forward-bias the transistor's base-collector junction, the output signal will be distorted on positive peaks. □



P-channel  
J FET



N-channel  
J FET

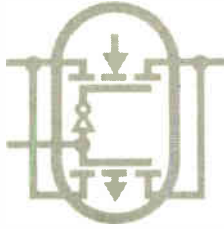

CMOS  
FETs



P-channel  
MOS FET

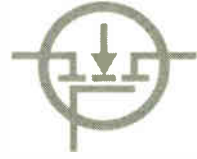

N-channel  
MOS FET

Since 1962, Siliconix has evolved FET technology and applied it to a complete line of singles, duals, arrays, and ICs. So what's new?

# Switch 10 MHz Signals with better than 60 dB OFF Isolation

The Siliconix DG181-DG191 family of FET switch/IC drivers is well-suited for processing high-frequency signals, and is directly compatible with most computer logic. FET switch/monolithic driver combinations are available in SPST, SPDT, or DPST functions.

Features include:

- Constant ON resistance with signals to  $\pm 10$  V and 100 MHz
- 60 dB OFF isolation at 10 MHz with 75  $\Omega$  load
- $t_{on}$  and  $t_{off}$  = 150 ns typical
- 1 nA max (100 pA typical) leakage from signal channel in either ON or OFF state.

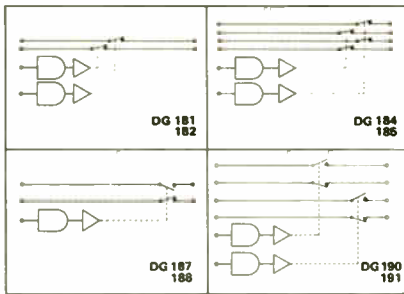

DG181-DG191 Functional Diagrams

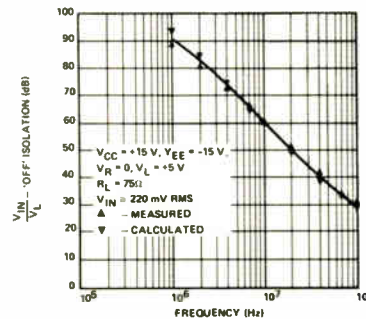

Switch OFF Isolation vs Frequency—DG181

The key to this exceptional performance is the Siliconix concept of monolithic driver design, with careful attention to critical details such as low driver output impedance. DG181-DG191 driver (switch OFF) resistance

to ground is only 200 $\Omega$ , providing good a-c by-pass on the FET switch gate. Contrast this with other driver circuits with impedances as high as 26 M $\Omega$ , which adversely affect isolation characteristics.

The DG181-DG191 series of FET analog switches is an ideal solution to most switching problems. If your case is unique—and whose isn't—our applications people are eager to help. For complete information

## write for data

Applications Engineering (408) 246-8000, Ext. 501



### Siliconix incorporated

2201 Laurelwood Road, Santa Clara, California 95054

# Digital storage improves and simplifies analysis of low-frequency signals

A spectrum analyzer in which a digital memory takes over the storage function needs only an inexpensive cathode-ray tube yet achieves high resolution; an adaptive sweep also speeds up presentation of a signal

by Jerry Weibel and Larry Whatley, *Hewlett-Packard Co., Loveland, Colo.*

□ Spectrum analysis of low-frequency signals is a well-established technique in such diverse areas as communications, geophysical and oceanographic studies, and vibration analysis. Conventional methods of studying spectra in this range use either expensive storage tubes or slow X-Y recorders to display the signals.

But now a combination of digital storage and adaptive sweep techniques, in the 3580 analyzer, makes it possible to display and store such signals with high resolution and at relatively high speed. What's more, the digital storage provides more flexibility for signal analysis than was previously available. And digital storage makes it possible to use an ordinary, inexpensive cathode-ray tube for the display, instead of a special storage tube.

## The digital display

Using digital storage for the display has many advantages over storage-tube approaches. Display adjustments need not be made when the sweep speed of the analyzer is changed. The display automatically updates the trace at the correct rate. And the instrument's intensity and focus controls, once set, do not have to be readjusted.

Digital storage is also free from the loss-of-contrast problems that come up when a variable-persistence tube is used at slow sweep rates. As a new sweep is gen-

erated by the analyzer, the old trace is automatically cleared, and the new trace is put in its place (Fig. 1a). If a single sweep is made, the trace that was generated will continue to be displayed until it is either cleared or replaced by another sweep.

If a trace is needed for future reference, it can be stored in the digital memory, allowing both this stored trace and the input trace to be displayed simultaneously (Fig. 1b). To add to the usefulness of the store made, the stored trace may be blanked from the display, and recalled when desired.

## Design considerations

Since the spectrum analyzer was meant to be a portable, battery-operated instrument, as well as a laboratory tool, power consumption was minimized. Complementary metal-oxide-semiconductor logic was used wherever possible, and a standard CRT with a low-power filament allows the instrument to operate for five to six hours from its internal rechargeable battery.

Perhaps the most unusual design requirement for the digital display was an ability to deal with the extremely slow sweep speeds of the analyzer. These slow sweeps must be transformed in time to sweeps on the CRT that are faster than 20 milliseconds to avoid flicker when a standard P31 phosphor is used.

Resolution is also an important consideration. Since

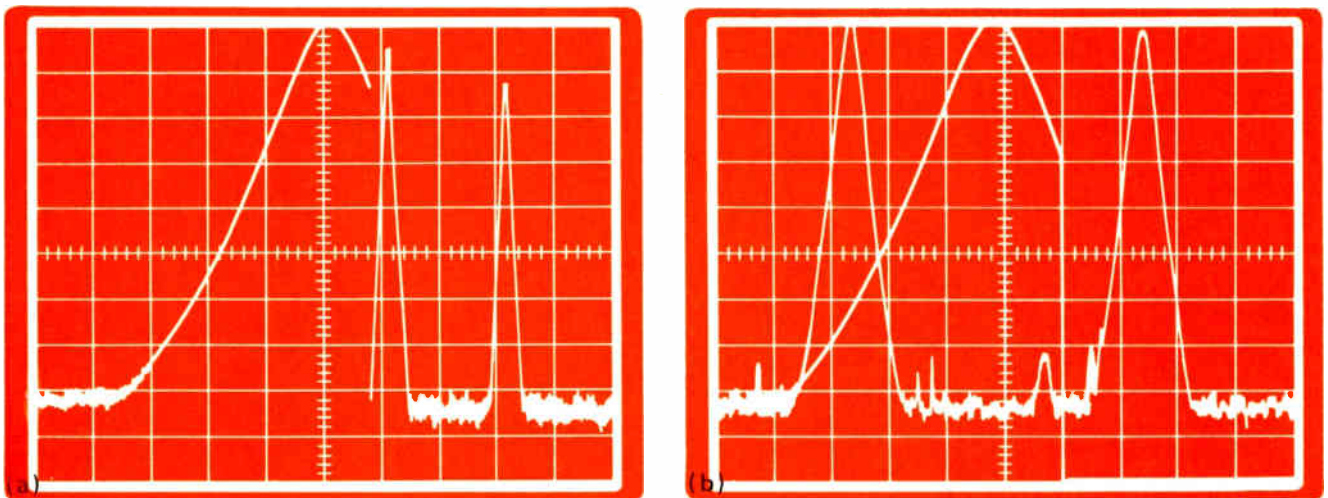

1. **Digital advantages.** As each new sweep is made, it takes the place of the old one, which is retained until the very last moment (a). Simultaneous display of a stored trace along with the one being updated is accomplished at the touch of a button (b).



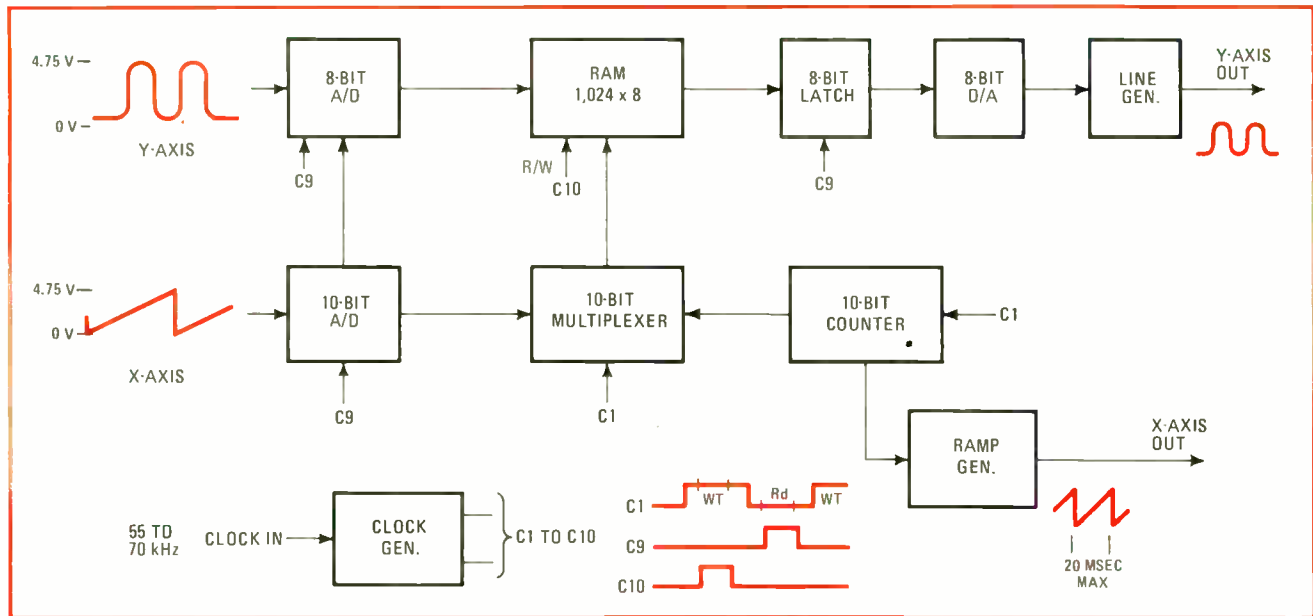

2. Digital system. Partial block diagram shows 10-bit analog-to-digital converter for the X axis and the 8-bit converters for the Y axis. The multiplexer's function is to switch the RAM address inputs between the X-axis converter and the 10-bit address counter.

the display is digital, both the X and Y axes must be broken up into discrete segments. It was found that 1,000 X-axis segments provide as much resolution as can be discerned on a CRT.

Even when 1,000 X-axis segments are used, the Y-axis magnitude can vary greatly over a given segment. In the digitally stored display, only one number may be picked to represent the value of the Y axis in each segment. Since the magnitude of the response is the important measurement, the peak value of the signal in each segment must be chosen. The accuracy of this number is determined by the Y-axis resolution, and it must be chosen so that it does not contribute appreciable errors to the measurement. Also, the display must be able to show small changes in the Y-axis analog signal. The resolution of 256 segments provides 0.4% of full-scale resolution and satisfies both of these requirements.

### Display implementation

A partial block diagram of the system that meets these requirements is shown in Fig. 2. The clock generator provides the timing for the whole system. The input to the generator is the high-voltage supply oscillator, which generates the operating voltage for the CRT. This can be any fixed frequency from 55 kilohertz to 70 kHz. For ease of discussion, this clock frequency will be considered to be 50 kHz, which corresponds to a period of 20 microseconds.

The X-axis analog input to the display system is converted to a 10-bit digital word by the input analog-to-digital converter. The conversion gives 1,024 segments of X-axis resolution. This 10-bit word becomes the input address to the random-access memory. The system RAM consists of eight 1,024-by-1-bit static n-channel MOS RAMs.

The Y-axis analog input is made into an 8-bit word by the Y-axis a-d converter. This gives 256 segments of resolution. This 8-bit digital word is stored in memory at the address generated by the X-axis converter.

The 10-bit multiplexer switches the RAM address between the X-axis converter and the 10-bit address counter. The switching input to the multiplexer is the C1 output from the clock generator. This is a 50-kHz square wave; the first half is the write phase and the second the read phase.

During the write phase of C1, the multiplexer switches the 10-bit address lines for the RAM to the X-axis converter. The write command (C10) is then given to the RAM, and the 8-bit Y-axis word is written into the address corresponding to the X-axis analog input.

During the read phase of C1, the address to the RAM is supplied by the 10-bit address counter. The 8-bit word at this address is latched out to the output d-a converter. Every C1 period, or every 20  $\mu$ s, the counter is advanced one count. Therefore, a new word is supplied to the output converter every 20  $\mu$ s, and all 1,024 8-bit output words are generated approximately every 20 ms. Each set of words constitutes one CRT sweep. This process is continuously repeated to provide a stable CRT presentation.

The d-a converter output consists of a series of discrete levels that cannot be applied directly to the CRT. The samples would generate a display of dots that would be satisfactory in some low-resolution displays but not in this application. Therefore, the signal first goes to the line generator, which draws lines between the dots. One means of doing this would be to calculate the vectors between points and slew X and Y axes accordingly. However, it is simpler to sweep the X axis linearly and slew the Y axis at a rate that connects each point.

A Y-axis line generator that can do this job is shown in Fig. 3. It accepts the input data consisting of discrete voltage levels, and a sample pulse indicating that the data are valid, and gives an output signal composed of connected line segments for driving the Y-axis deflection amplifier.

The operation of this circuit, sometimes called a

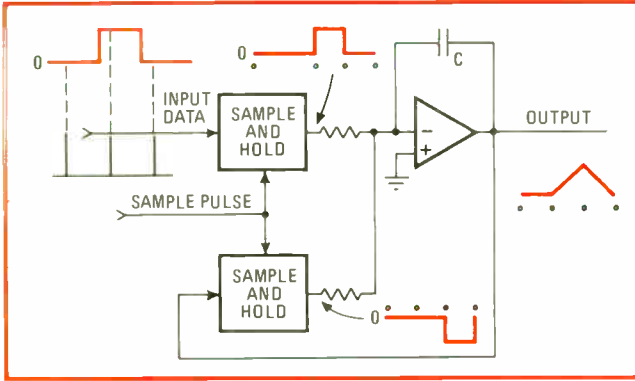

**3. Connect the dots.** Linear point connector takes discrete input-voltage levels and uses them to generate connected line segments that will drive the Y-axis deflection amplifier.

linear point connector, can most easily be understood by using a single nonzero input point and observing the time functions at various points. The output always slews at a rate proportional to the difference between the current data sample and the previous sample, considering the inversion of the integrator. For zero input, zero output is observed. When the input datum occurs, the output slews at a proportional rate. During the next period, however, the integrator input consists of the zero input data and the value of the output at the end of the previous sample period. The output accordingly slews back to zero.

### The working system

As was noted, it is essential to sample and digitize the peak value of the Y-axis signal in each X-axis segment. Therefore, a peak-detecting a-d converter is needed for the Y-axis signal. Such a converter, shown in Fig. 4, has three input signals: the Y-axis input, a clock input, and an input from the X-axis a-d converter that indicates when a new X-axis segment begins.

The 8-bit up/down counter supplies eight lines to the d-a converter and the input to the RAM. The output of the converter is compared with the Y-axis analog input by the comparator. The comparator output indicates whether the count to the converter is too high or too low and supplies the appropriate count-up or count-down signal.

The up/down control logic controls the clocking of the counter and the direction in which it counts. The lines into the up/down control logic, other than those of the comparator, are from the X-axis a-d converter, the clock generator, and the counter's carry-out. The carry-out holds off the clock to the counter whenever it contains all logic 1s and a count-up is given, or when the counter contains all logic 0s and a count-down is given. Stopping the clock holds the counter at all 1s or all 0s when the input voltage is higher or lower than the maximum or minimum output voltage of the d-a converter.

The input from the X-axis a-d converter is a pulse—actually the clock to the X-axis a-d converter counter—that occurs at the beginning of a new X-axis segment. This signal resets the four-state machine to state A (Fig. 5). The counter is allowed to count in the direction indicated by the comparator in each state with the exception of state D, in which the four-state machine allows

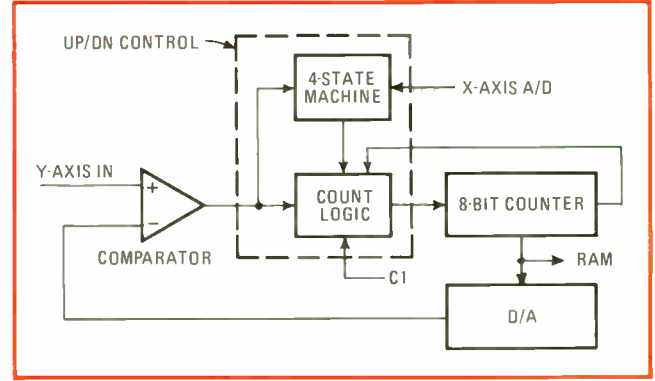

**4. Peak-detecting converter.** Y-axis analog-to-digital converter operates under the control of the four-state machine. The unit acts as a peak-detector, except in the case of rapidly decreasing inputs.

the counter to count only in the up direction.

The operation of the four-state machine is controlled by the condition of the Y-axis analog input. There are three input conditions of concern: input moving up, input holding steady at some dc level, and input moving down.

In the first case, when the Y-axis input signal is climbing as the X axis is swept, the output of the comparator can do one of two things, depending on whether the input is climbing rapidly or slowly. If the input is climbing rapidly, the comparator output will remain high after each clock pulse, because the d-a converter output is too low and the counter is trying to catch up to the Y-axis input. Under these conditions, after two clock pulses the four-state machine will go to state D and remain there until it is reset. Since the counter can only count up when the machine is in this state, the converter acts as a peak detector of the Y-axis input over the given X-axis segment.

If the input is climbing slowly, the comparator switches between count-up and count-down with each clock pulse, with an occasional extra count up. When this happens, the machine again arrives at state D and causes the counter to peak-detect, but this time it may take as many as three or four clock pulses to arrive at state D.

In the second case, when the Y-axis input is a dc level, the alternating high and low comparator output will again cause the four-state machine to reach state D and peak-detect the inputs.

The third input condition occurs when the value of the input signal moves down with the X-axis sweep. If the Y-axis signal moves down more than one least significant bit of the d-a converter every three clock pulses, the four-state machine will not reach state D. If this occurs, the signal is not peak-detected and the value at the end of the segment is the chosen Y-axis value.

If the down movement of the input is slower than one least significant bit of the d-a converter, the Y axis will be peak-detected at a value equal to the Y-axis input near the start of the X-axis segment. If the movement continues down throughout the segment, the Y-axis counter must catch up at the beginning of the next segment. The counter will always be able to catch up within the first third of the X-axis segment. This type of peak-detecting control is one that provides a more accu-

rate representation of the negative input slope.

The system also has a mode of operation in which the presentation being displayed may be stored as a permanent record. The trace is stored by depressing the STORE button, which causes two traces to appear on the screen. One is the trace that has been stored, and the other is the trace that represents the analyzer's present output. These traces are displayed alternately, each taking 10 milliseconds. A four-state machine is incorporated in the system to control the store operation. In the store mode, half of the memory, or 512 words, is used for the stored trace and the other 512 words are available for the input.

However, this storage technique has a drawback. The splitting of the memory cuts the resolution of the display in half. Still, this reduced resolution is adequate for almost all the measurements made by the analyzer. Moreover, the reduced resolution is justified because doing without an extra memory just for the store oper-

ation reduced cost and power drain. The cost of the auxiliary control circuits is about the same for splitting the memory or having two memories.

Several design goals determined the configuration of the input section of the analyzer. The 1-hertz bandwidth was considered necessary to meet high-resolution applications, and low cost was a second important objective. A single-conversion configuration was chosen to satisfy these two requirements.

### The analog analyzer at work

Input signals from 5 Hz to 50 kHz are mixed with the local oscillator signal operating from about 100 kHz to 150 kHz. Signals falling at the difference frequency of 100 kHz are passed by the intermediate-frequency filter, having a center frequency of 100 kHz and a bandwidth selectable from 1 Hz to 300 Hz. The signal is then passed through either a linear or logarithmic amplifier, detected, and then fed to the digital display circuitry or an X-Y recorder. This is a very basic configuration. The i-f is determined by a practical matter: how high a frequency can crystals or other resonators achieve while maintaining a high enough Q for the 1-Hz bandwidth? To eliminate the analyzer's sensitivity to signals outside its frequency range, the local oscillator's tuning range is limited to about half the i-f.

In this respect, the design of a spectrum analyzer can be considered as a serial chain of objective-conclusion decisions. Low cost leads to a single-conversion scheme, and a 1-Hz bandwidth implies a 100-kHz i-f, which in turn, determines the maximum tuning range.

Applications of spectrum analysis to the audio-frequency range demand a high dynamic range (low distortion and spurious responses) and a wide range of selectable input sensitivity. The analyzer's input-sensitivity control changes the signal level at five locations (Fig. 6). The requirements leading to this configuration are 1-megohm input impedance, 90-decibel dynamic range for this segment of the signal path, 10-dB attenuation steps, a continuously variable 10-dB vernier,

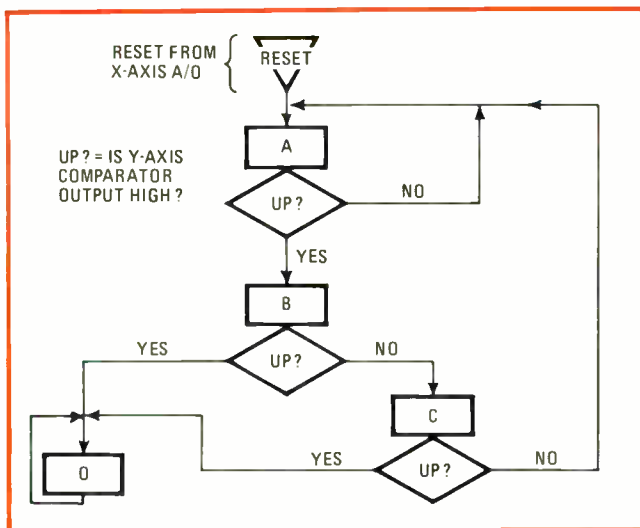

5. **Controller.** Flow chart for four-state machine in Y-axis a-d converter is controlled by value of Y-axis analog input.

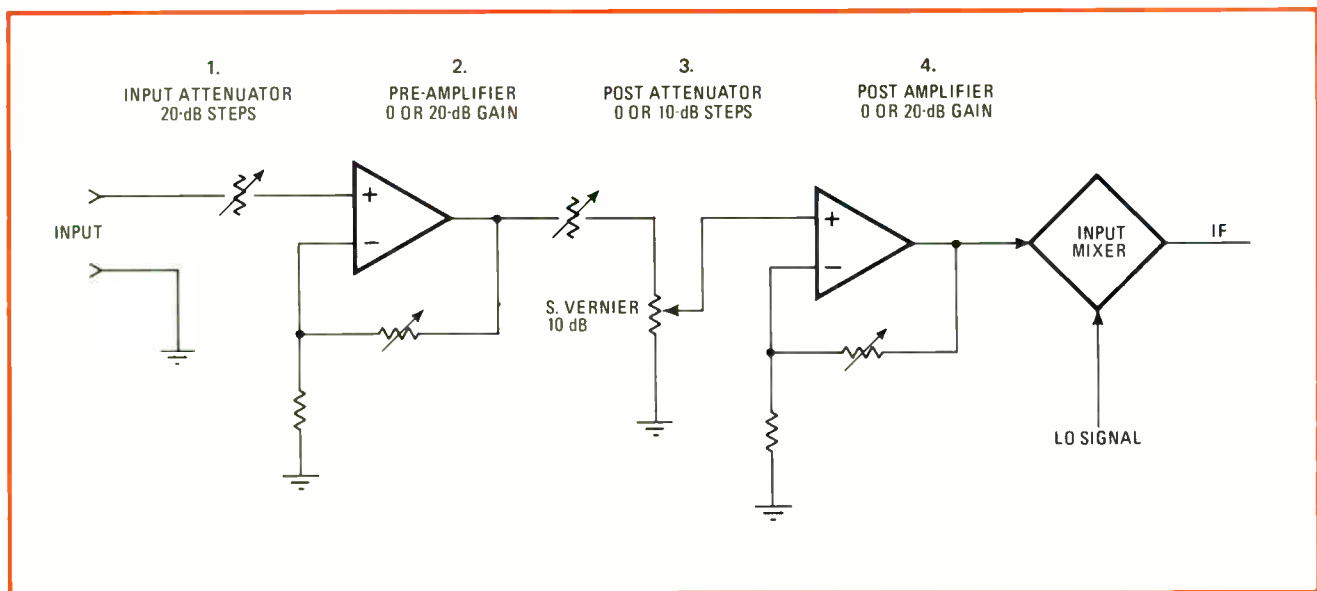

6. **Sensitivity control.** Configuration of input circuitry is dictated by requirements listed in text. Signal attenuation (or gain) must be adjusted at five points along signal path when input sensitivity is changed with this front-end design.

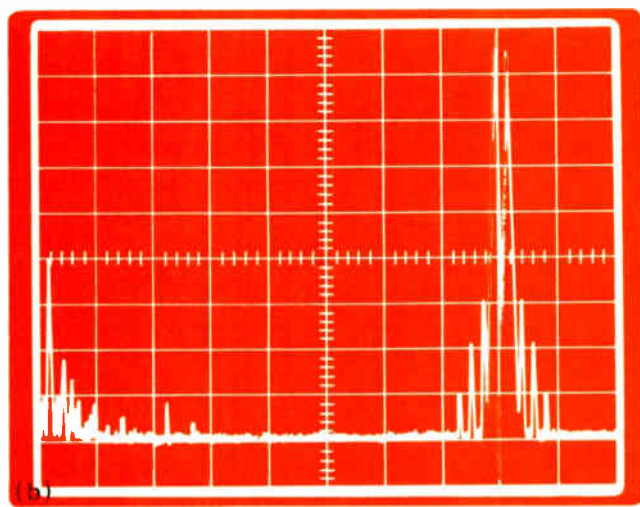
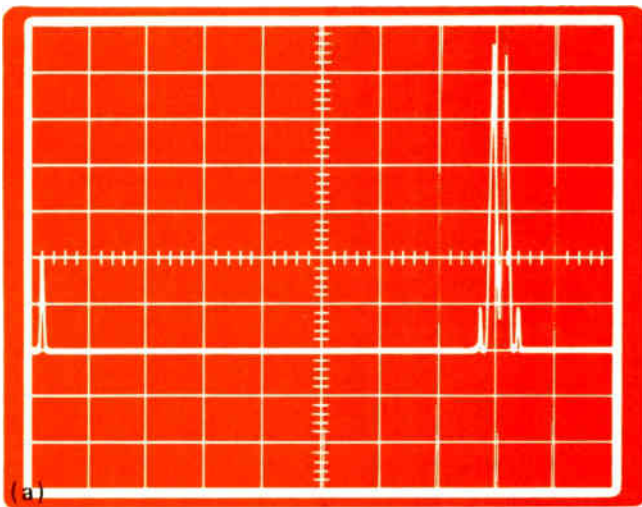

7. **Sweep speeder.** Trace made with a conventional sweep at optimum speed takes 100 seconds (a). Adaptive sweep, however, reduces dynamic range, eliminates noisy signal floor, and cuts sweep time to 10 seconds (b). The adaptive-sweep cutoff threshold is adjustable.

and sensitivity limited predominantly by noise riding on the input to the pre-amplifier.

Altering any one of these requirements leads to a different configuration. For a single example, lowering the input impedance requirement would allow use of a 10-dB-step input attenuator and a simpler configuration. Thermal noise of a 10-dB pad with 1-megohm input impedance is too great for the dynamic range objective, however. A 20-dB pad has lower output impedance and consequently less thermal noise. The two amplifiers must be made with discrete components rather than off-the-shelf ICs because of the requirement for low noise, low distortion, and high input impedance. An IC was chosen for the input mixer, however, because of favorable specifications of noise, distortion, gain, and cost.

The i-f filter is truly the heart of a spectrum analyzer. It determines the selectivity of a spectrum analysis and how fast the spectrum can be swept. Since sweep time is such an important consideration for a high-resolution analyzer, synchronously tuned stages of filtering were used. This type of filter is a close approximation of a Gaussian filter, considered optimum for sweeping, and it is easy to align it and to switch bandwidth.

### Adaptive sweep

For the first time, a spectrum analyzer incorporates a sweep feature that can substantially reduce measurement time in certain applications. Figures 7a and 7b show two spectrum displays, the first using a conventional optimum sweep, the second an adaptive sweep. The first display took 100 seconds to generate; the second only 10 seconds.

The idea behind the adaptive sweep is to speed up the sweep when the signal is below some adjustable threshold level, and to slow it down to the optimum speed when the input exceeds the threshold. A speed factor of 20 is used in the analyzer described. This approach, of course, reduces the dynamic range of the measurement, but in many applications the lower part of the spectrum consists of noise, anyway, so no information is sacrificed.

This more complicated sweep can be implemented with combinational logic. But though this was done in a

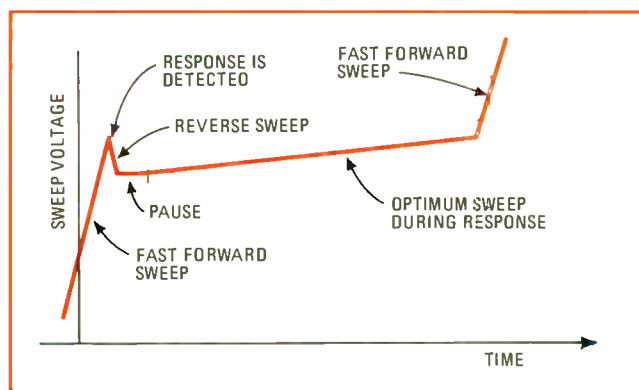

8. **Adaptive-sweep control.** The operation of the adaptive-sweep circuitry is controlled by a dedicated eight-state machine. The four states through which the sweep voltage must pass whenever an above-threshold signal has been detected are illustrated here.

prototype, synchronous logic controlling an eight-state machine proved to be superior. In this hardware, the eight states correspond to various sweep conditions such as "fast forward sweep," "reverse sweep" (a necessary condition for sweeping an entire response after it has been detected), and "pause" for allowing transients to decay. For each response in Fig. 7b, the sweep voltage as a function of time goes through the sequence shown in Fig. 8.

In addition to these design ideas, the special capabilities of the analyzer include selection of the frequency control to indicate start-of-sweep or center-of-sweep frequency, an indicator lamp to warn of input overloading that may be causing spurious responses, and a tracking oscillator signal, available from the back panel, that can be used to measure the swept-frequency response of a device. This last feature allows the analyzer to be used effectively as a network analyzer—but without the network analyzer's ability to measure phase.

The 3580 has been optimized for frequencies between 5 Hz and 50 kHz. The combination of digital storage, adaptive sweep, 1-Hz bandwidth, 30-nanovolt sensitivity, and battery operation makes this instrument suitable for communications, geophysical, and other applications, in the lab and the field. □

# Laser trimming is an art that must be learned

Lasers can trim thin- and thick-film resistors with a precision unattainable by other processes—provided the user takes care to select the right materials, the right geometries, and appropriate laser-beam parameters

by R.C. Headley, E. I. DuPont de Nemours & Co., Electronic Materials division, Niagara Falls, N.Y.

□ Over the last decade, laser trimming has grown into one of the most powerful hybrid-circuit fabrication techniques, enabling designers to achieve previously unheard-of combinations of precision, speed, and cleanliness. With its ability to trim resistors in completed circuits without the overspray of dust that characterized abrasive trimming, laser trimming is becoming an essential tool in the fabrication of a whole range of thick- and thin-film products—from resistor ladder networks to 12- and 13-bit analog-to-digital converters.

But experience gathered over the last seven years has proven that the trimming technique is one filled with pitfalls. Careful attention must be paid to the details of the trimming process, or the trimmed resistor will probably turn out to be unstable over temperature and time. Indeed, hybrid fabricating specialists have learned the hard way that although trimming techniques are simple in theory, any small deviation from the established rules can spell disaster in practice.

## Taking care

To maximize the stability of the trimmed resistor, three areas must be watched closely: laser-beam parameters, resistor trim geometry, and resistor composition. Ideally the laser-beam energy consists of a train of very narrow pulses of very high peak power (Fig. 1a). For the Q-switched YAG laser used in the described experimental work, the pulse duration is in the range of 50 to 200 nanoseconds. Since the time between pulses is typically in the range of 100 microseconds to 1 or 2 milliseconds, the short pulses allow very high peak powers to be obtained at rather low average powers.

High peak power in pulses of short duration is desirable because it provides rapid vaporization of material with minimum heat flow into regions bordering the path of vaporization. Excessive heat flow can raise the temperature of the region surrounding the laser cut (or kerr, as it is called) several hundred degrees above the temperature of the rest of the resistor. The ensuing rapid cooling can create localized mechanical stress strong enough to cause crack formation and propagation over extended periods of time, giving rise to instability of resistance values.

Strictly speaking, the plot of peak power versus pulse-repetition rate shown in Fig. 1 applies only to Du Pont's particular laser assembly—a laser-trimming system from Electro Scientific Industries Inc. However, other systems

built around Q-switched YAG lasers may be expected to exhibit similar behavior. Newer systems differ in only one important respect: the sharp drop in peak power at low repetition rates is replaced by a flattening of the curve in this region. The improvement is attributable to the use of better Q switches. The really important characteristics—the decrease of peak power and increase of average power with increasing repetition rate—remain unchanged.

Thus, as the repetition rate is increased from the opti-

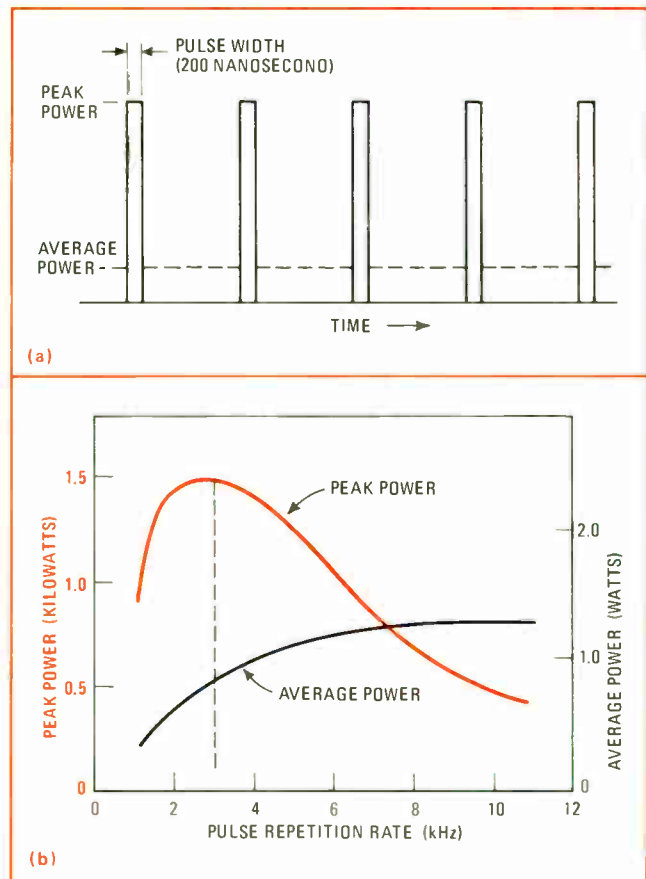

**1. Beam parameters.** Idealized Q-switched laser output consists of train of narrow powerful pulses (a). As pulse repetition rate increases from optimum value, peak power decreases and average power increases (b). These curves apply to a particular ESI laser trimming system, but their over-all shape is valid for Q-switched lasers in general. Most trimming systems use Q-switched YAG lasers.

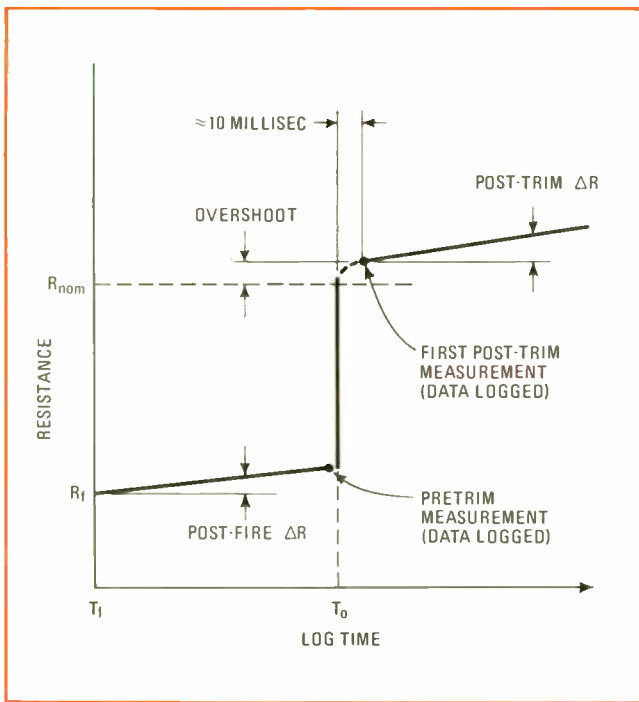

**2. Resistor behavior.** Final resistor stability depends upon both the intrinsic stability of the fired material and the effects of trimming. If the thick-film firing procedure isn't carried out properly, laser trimming may become the least of the engineer's worries.

imum range of 2.5 to 3.5 kilohertz, the peak pulse power diminishes substantially. At a high enough repetition rate, the peak power is insufficient to properly vaporize the material being trimmed. The consequence is incomplete trimming or the presence of trimming debris in the kerf. A further consequence is appreciable heat flow into the region surrounding the kerf, giving rise to noticeable microcracks and a general disturbance of the material in that region.

Our experience has been that the cleanest kerfs and minimum amounts of peripheral damage are obtained under conditions of high peak power and low average power. These are obtained by using pulse frequencies no higher than necessary for sufficient pulse overlap to get a continuous kerf at a given trim speed.

As an example, conditions for best performance at a trim speed of 0.5 inch per second are a pulse-repetition rate of 3 kHz, average beam power of 1 watt, pulse width (estimated) of 100 ns, and peak power (estimated on basis of 100-ns pulse width) of 3 kilowatts.

### How resistors behave

The stability of thick-film resistors is influenced by many factors besides trimming. In fact, with certain materials and particularly when improper firing procedures are used, these other factors may greatly exceed laser trimming as a source of resistance drift. Thus, to be meaningful, stability after trimming must be related to the intrinsic or untrimmed stability of the resistor.

In Fig. 2, a hypothetical history of a resistor's stability from the end of the firing step to a point in time after trimming is shown schematically. For both laser and abrasive trimming techniques, stability data is based upon post-trim  $\Delta R$  measurements, which use as a refer-

ence point the first post-trim measurement. This point does not generally coincide with the nominal, or trim target, value,  $R_{nom}$ , because of an overshoot effect. The overshoot is strongly influenced by machine parameters such as pulse frequency, spot size, beam power, and trim speed, as well as resistor geometry and size. Bridge measurement response and beam cut-off delays may also be a factor. Reproducibility of overshoot is very important for precision trimming, and is best achieved by careful adjustment of machine parameters and maximizing resistor size.

### Factors causing drift

The quality of the kerf and the integrity of the resistor material in the peripheral region are of prime concern in considering the causes of post-trim  $\Delta R$  that can result from laser trimming (Fig. 3). Detritus in the kerf can form highly unstable shunting paths for current flow. The peripheral region may experience thermal shock strong enough to cause microcracks that penetrate the trimmed current path. Current, crowded into this damaged region by the region's geometry, may produce hot spots which lead to further instability. Q-switch trail, a not uncommon occurrence, can degrade resistor stability and is a consequence of faulty machine operation. Laser manufacturers are aware of the problem and have instituted corrective measures.

Detritus can result for several reasons, as indicated in Fig. 4. Insufficient peak power (b) at a high pulse frequency (about 8 kHz) left substantial material on the floor of the kerf. In another case of insufficient peak power (c), pulse frequency was optimized for high peak and low average power. A moderate increase in lamp input power (about 20%) led from (c) to the clean kerf shown in (a). In (d), the detritus consists of a bridge resulting from beam shutoff prior to a delayed turn for an L cut. Similar bridging has been seen in the case of table vibrations at high trimming speed. Backlighting at relatively low magnification is an excellent means of detecting kerf detritus.

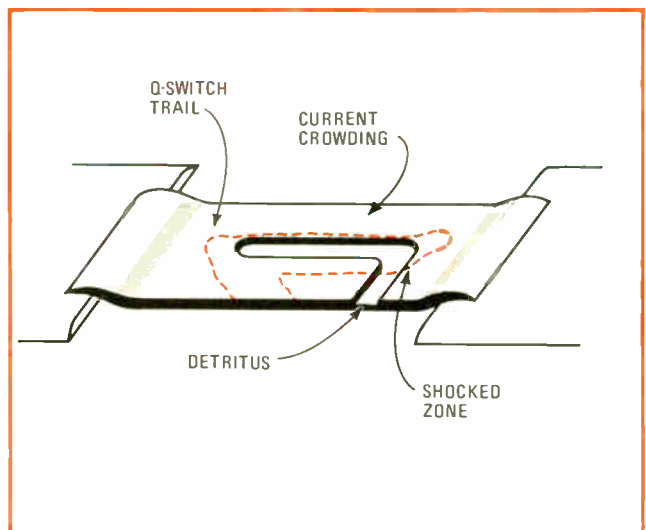

**3. Possible problems.** Detritus in the kerf, microcracks in the region surrounding the kerf, current crowding in the shocked zone (due to poor geometrical design), and Q-switch trail are the major potential sources of trouble in a laser trimming operation.

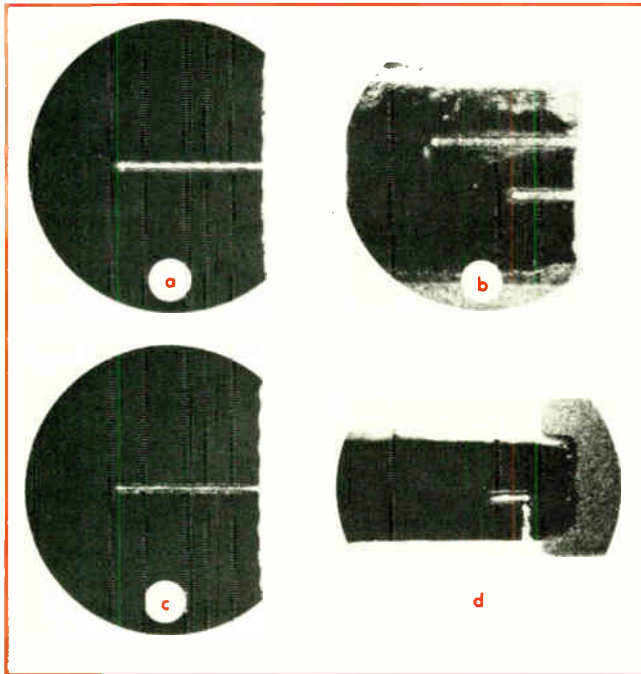

**4. Keep It clean.** Photo A shows what a clean kerf looks like. In B insufficient peak power at a high repetition rate has left a lot of material on the floor of the kerf. In C the peak power was also too low, but the repetition rate has been optimized. In D the kerf is clean except for a bridge of material caused by a beam shut-off that occurred just before a delayed turn in making the L-shaped cut.

Ideally, the kerf should show a leakage resistance approaching that of the substrate surface, a property that exists when kerfs are clean and of sufficient width. Laser-trimming parameters leading to clean kerfs can be determined using the pattern shown in Fig. 5. Resistors are trimmed across their entire span for a variety of lamp input power levels and beam pulse frequencies. Leakage currents across the kerf are measured at a test voltage of 200 volts, and a set of curves showing the calculated leakage resistance is obtained. The plateau on these curves is comparable to the surface insulation resistance of the substrate for the test configuration shown. The deterioration of kerf leakage resistance with increasing pulse frequency is attributed to the drop-off of beam peak power, as shown in Fig. 1. The efficiency of cutting decreases at higher pulse frequencies, kerf width decreases, and increasing amounts of detritus occur.

Demonstrating the effects of different beam parameters on a trimmed resistor, Fig. 6 shows four photomicrographs of the terminal end of a kerf cut into a resistor made of Bixox 1051 material. In (a), the region from the kerf lip out to the surrounding large microcrack (about 1.5 mils) consists of a zone of disturbed material containing many, barely visible, smaller microcracks. The dark blobs and tails are the spatter of melted material expelled during trimming. The damaged zone has been raised above the surrounding resistor surface, and there is evidence of considerable reflow. As expected, this resistor showed poor stability, drifting several percent in the course of a hundred hours. The trimming conditions were a pulse-repetition rate of 10 kHz, a trim speed of 0.1 in./second, average

beam power of 2.5 w, and linear energy density of 10 joules/centimeter. (Linear energy density is the average beam power divided by the trim speed. It is perhaps more useful than a bald statement of average power because it gives a measure of the amount of energy spread over a unit length of kerf.)

The trimming conditions cited above, and the results shown in (a), should never be encountered in an actual production situation. Nevertheless, they serve to illustrate what can happen if the wrong trimming parameters are used.

The same material trimmed on a different YAG laser system using more benevolent parameters suffers less severe damage (b). However, serious microcracks are still to be seen. Trimmed stability is poor, although not as bad as in the previous example. Conditions used were a pulse-repetition rate of 500 hertz, a trim speed of 0.2 in./s, an average beam power of 1 w, and a linear energy density of 2 joules/cm.

For the example shown in (c), a high pulse frequency (10 kHz) at substantial beam power (8 w average) was used in an attempt to get sufficient reflow action to effect sealing of the kerf wall. Microcracks still persist, and the resulting stability is poor.

Under optimized conditions, the same material displays no visible microcracks and a minimal damage zone (d). Resulting drift is less than 1%  $\Delta R$  after 1,000 hours. Trim conditions used were a pulse-repetition rate of 3 kHz, a trim speed of 0.4 in./s, an average beam power of 0.9 w, and a linear energy density of 0.9 joule/cm.

The implication is clear. Although new materials

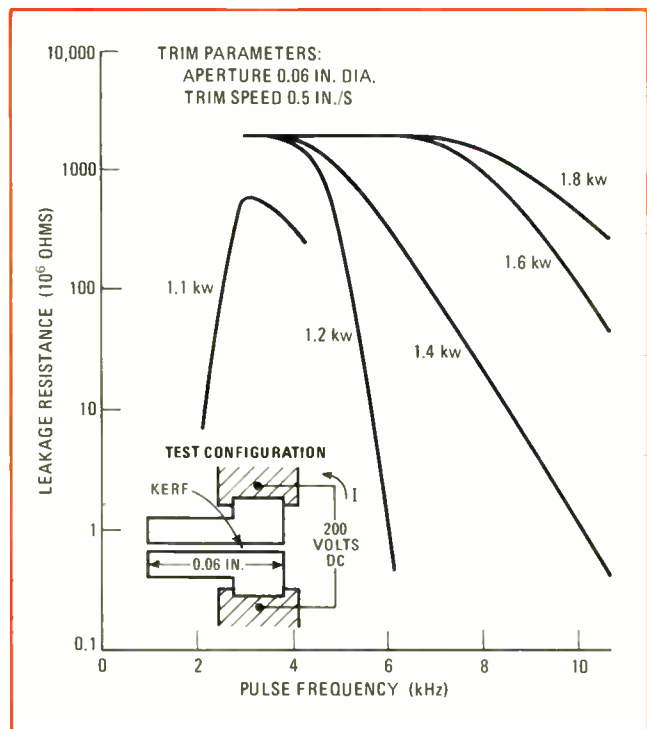

**5. Test pattern.** By means of simple geometry, kerf leakage resistance has been measured for various combinations of lamp input power and pulse repetition rate. Operation along the sloping portion of these curves should be avoided because leakage resistance is unstable there and can cause instability in trimmed-resistor value.

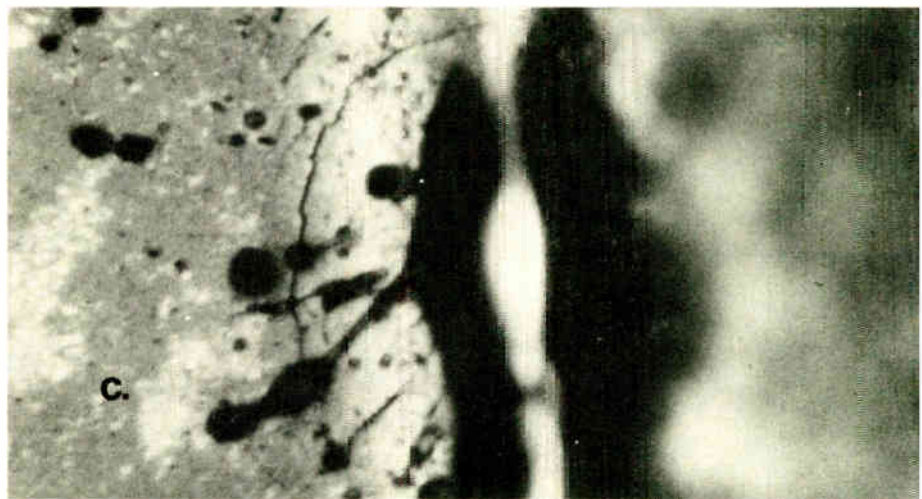
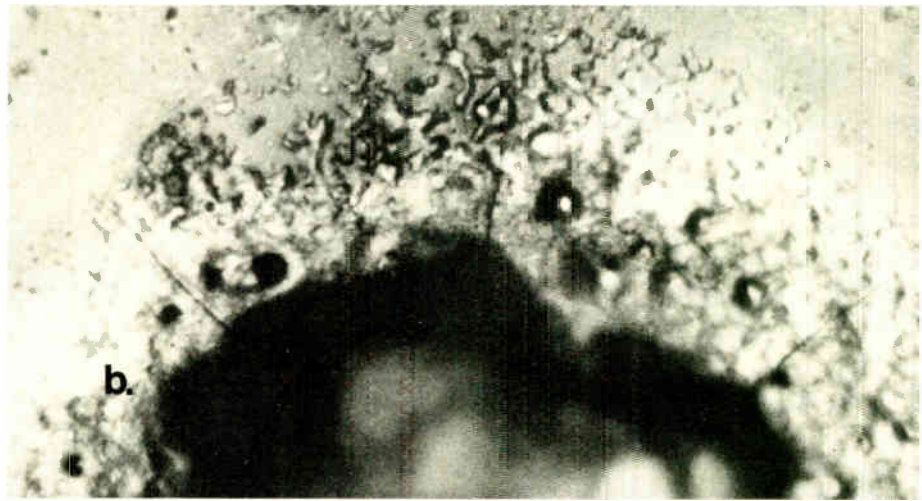

**6. Through the microscope.** Photo A shows that making average power and pulse repetition rate too high can mess things up. Cutting the rep rate and the linear energy density improves things somewhat, but large microcracks are still evident in B. Using extremely high power and rep rate to cause reflow to seal the kerf wall sounds like a good idea, but C shows it doesn't work. Finally, optimizing the rep rate to maximize peak power and minimize average power yields the kerf in D, with no visible microcracks and with a very narrow shock zone.



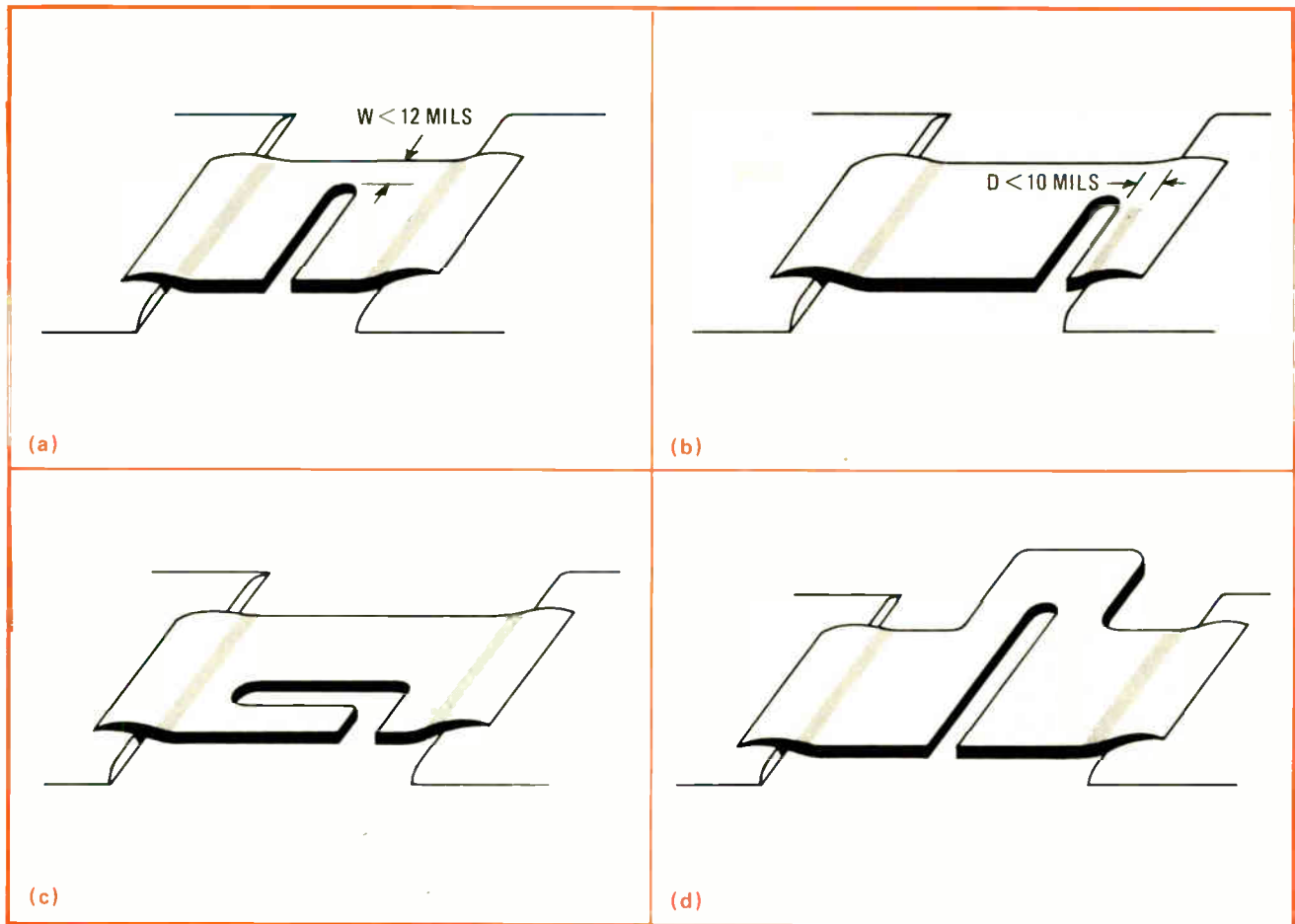

7. **Four deadly sins.** Making current paths too narrow (a), trimming too close to a termination (b), making the kerf too long in the direction of current flow (c), and crowding the current into the shock zone (d) are all to be avoided if stable resistors are desired.

being developed are more resistant to the rigors of laser trimming, judicious control of machine parameters will go a long way toward realizing the best performance of available materials.

### Resistor geometry

The photomicrographs have shown how microcracks and peripheral damage can occur as a result of improperly chosen machine parameters. It is reasonable to expect that even with an optimally adjusted machine a certain amount of damage to the resistor will occur on occasion. The influence of this damage on resistor stability is a function of geometry (Fig. 7) as well as of the parameters of the laser trimming system.

Where the kerf and the peripheral damaged zone occupy a significant part of the over-all resistor area, instability can become pronounced. Where kerfs are used to constrict current paths to widths of 12 mils or less, stability will usually be impaired (a). Trimming close to a termination, as in (b), also produces problems. Thick-film resistors sometimes are unusually thick near terminations, and the beam energy may be insufficient to clear out all the material for a proper kerf. Inadequate control of print registration can also lead to beam impingement upon the overlap area.

The effects upon stability often do not show up until the part is subjected to a subsequent process involving heat-up of the circuit, such as heat-column exposure.

Then, catastrophic changes in resistance, usually in a negative direction, occur. Apparently metals from the termination, lightly fused into the kerf walls during trimming, become active at the elevated temperature. These problems usually occur where the spacing between the terminating electrodes of a resistor is less than 10 mils.

Long kerfs parallel to the axis of current flow (c) expose the trimmed resistor to the full effect of the damage zone bordering that part of the kerf. If the width of the damage zone approaches 10% of the trimmed resistor width, noticeable instability may occur.

The popular top-hat configuration can result in a combined effect of current crowding and long current traverse along the laser-shocked zone. The final current path is not only concentrated around the terminus of the kerf (d) but also encounters a maximum extent of damage zone around its periphery. This leads to a large increase in voltage gradient and current density at the corner that encompasses a portion of the kerf damage zone. Power dissipation increases as the square of the current, and at this corner a severe hot spot may occur. In addition, the local voltage gradient greatly exceeds that prevailing over most of the resistor. For these reasons, use of the top-hat configuration in cases where appreciable current flow or high voltage gradients of several hundred volts per inch are anticipated should only be undertaken after careful design consideration. □

Along with some of the newest and most sophisticated modules in the business.

Because we're big and bright enough to stockpile and document every advance we make so that when we obsolete a module, we don't obsolete what you're doing with it.

We promised to back up the first module we made back in 1957.

You buy the same module today, we'll make the same promise.

And we'll let you buy as little

as one or two at a time, anytime you need them.

Which is one reason why a lot of people like you, like doing business with us.

And one reason why it really isn't worth your time, trouble and talent to try to make them yourself.

## **Fifteen years ago, we sold our first module.**



One more thing.

Every module we design, we design more conservatively than any other module maker.

Which is why we can back them up longer, unless you try to make them do something they weren't designed to do in

the first place.

In which case, we could design you a special one, to do whatever you want it to do.

Like interfacing one of ours or anybody's computers.

Which is one more thing we've been doing better longer than most people have been in the business.

We're the Logic Products Group, Digital Equipment Corporation, Maynard, Massachusetts 01754, (617) 897-5111 (Ext: 2785) in the U.S.

81 route de l'Aire, 1211 Geneva 26/(022) 42 79 50 in Europe.

**digital**

# We still do.



Circle 127 on reader service card

# Engineer's notebook

## Integrated-circuit timers

Monolithic timing circuits may well replace the general-purpose operational amplifier as the most versatile linear integrated circuit. The IC timer offers a number of admirable features, not the least of which is its price tag of under \$1. The circuit was first introduced about a year ago by Signetics Corp., but is now available from a number of sources (see p. 142).

Besides providing time delays ranging from microseconds to hours, the 555-type IC timer can function as

either an astable or monostable multivibrator whose output duty cycle can be adjusted. What's more, the timer can source or sink 100 milliamperes or so and operate over a supply-voltage range of approximately 5 to 15 volts. This makes the device directly compatible with TTL circuits.

IC timers are now said to have more applications than the everyday op amp. The next few pages contain a sampling of the timer's applications flexibility.

## IC timer plus thermistor can control temperature

by Donald DeKold  
Santa Fe Community College, Gainesville, Fla.

Although it is really intended for timing applications, the 555-type timer IC makes an economical and versatile solid-state thermostat when used with a negative-temperature-coefficient thermistor.

The timer's internal resistive divider establishes reference voltages at  $(1/3)V_{CC}$  and  $(2/3)V_{CC}$  for each of the timer's comparators. When an external voltage applied to the threshold input (pin 6) exceeds  $(2/3)V_{CC}$ , an output is generated by the threshold comparator that toggles the flip-flop. This turns on the discharge transistor and results in a low output signal from the timer's driver-amplifier output stage.

In most applications, as in this one, the turn-on of the timer's discharge transistor lowers the voltage at the

threshold input to less than  $(2/3)V_{CC}$ . If the trigger input then drops below  $(1/3)V_{CC}$ , the trigger comparator generates a pulse that retoggles the flip-flop, drives the discharge transistor off, and causes the output stage to return to its high output level.

This circuit action lends itself nicely to temperature-control applications, particularly those normally reserved for thermostats that must maintain an environment within a bounded temperature range. A voltage that is directly proportional to temperature will rise (along with temperature) until threshold voltage  $(2/3)V_{CC}$  is reached. The timer's output stage will then change state, so that a refrigeration unit can be turned on or an oven can be turned off. Temperature will then drop until  $(1/3)V_{CC}$  exists at the trigger input, causing the output stage to return to its first state—with the refrigerator off or the oven on.

For the thermostat in the diagram, thermistor/resistor divider networks produce the voltage that is directly proportional to temperature. When temperature is rising (high output state, discharge transistor off), the threshold input voltage is determined by the division between the combination of  $(R_T + R_1)$  and  $R_2$ , and in-

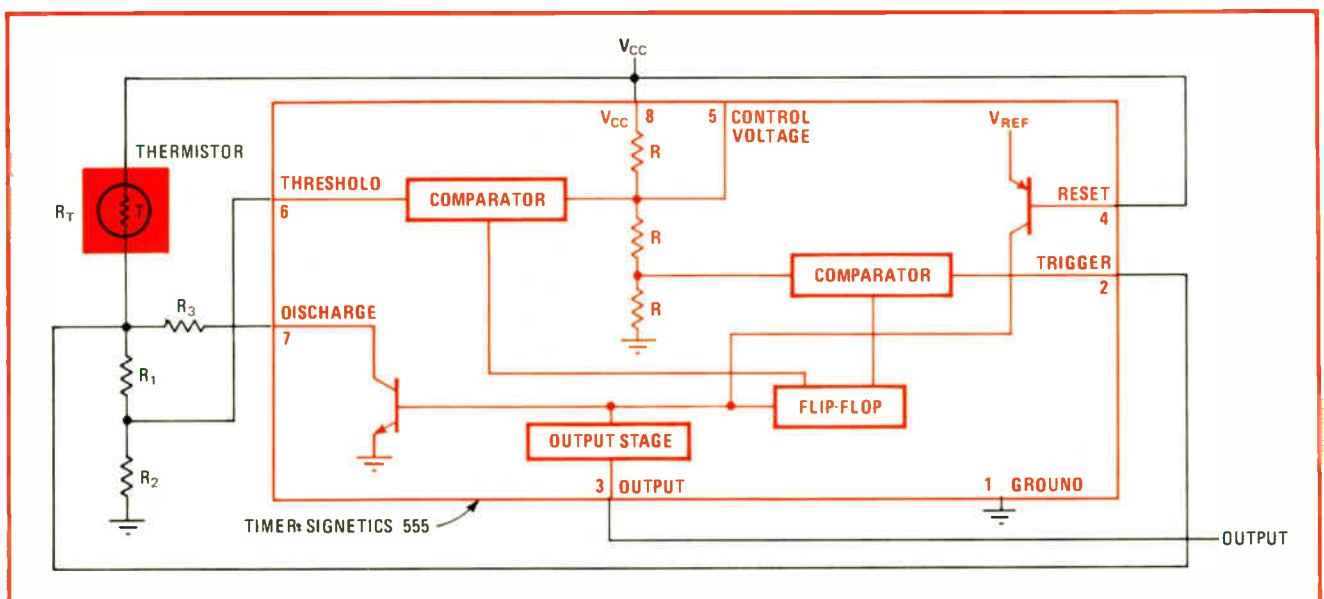

**Temperature controller.** Voltage divider formed by thermistor and fixed resistors converts IC timer to solid-state thermostat. Upper and lower temperature limits are set by the switching voltages of the threshold comparator and the trigger comparator, respectively.

creases as the value of  $R_T$  decreases.

When  $R_T$  is equal to the thermistor resistance at the hot setpoint temperature,  $R_{TH}$ , the divider relationship needed to establish  $(\frac{2}{3})V_{CC}$  at the threshold input is:

$$(R_{TH} + R_1)/(R_{TH} + R_1 + R_2) = \frac{1}{2}$$

After an input to the threshold comparator reaches this level, the discharge transistor is switched on, effectively placing  $R_3$  in parallel with  $(R_1 + R_2)$ .

As the temperature drops,  $R_T$  increases in value, and the division is between  $R_T$  and  $[R_3 \parallel (R_1 + R_2)]$ . When  $R_T$  is equal to the resistance at the cold setpoint temperature,  $R_{TC}$ , the divider must produce  $(\frac{1}{3})V_{CC}$  at the trigger input. The divider relationship becomes:

$$[R_3 \parallel (R_1 + R_2)]/[R_{TC} + (R_3 \parallel (R_1 + R_2))] = \frac{1}{2}$$

Therefore, the impedance level of the thermistor/resistor dividers is effectively changed in different ways, depending on whether the thermostat is in the rising temperature portion of its operating cycle or the cooling portion. This is necessary since a thermistor's resistance varies quasi-exponentially with temperature and may exhibit a two- or three-fold change over a narrow temperature range. That is, the thermistor's cold setpoint resistance,  $R_{TC}$ , may be several times larger than its hot setpoint resistance,  $R_{TH}$ .

If a standard thermistor is used and its resistance as a function of temperature is known, a straightforward design approach applies. When  $R_{TC}$  exceeds  $R_{TH}$  by a fac-

tor of 2 or more, let  $R_2 = R_{TC}$  and let  $K = R_{TC}/R_{TH}$  where  $K$  is a constant. For proper divider ratios:

$$R_1 = (K/2 - 1)R_{TH}$$

$$R_2 = KR_{TH}$$

$$R_3 = [(3K^2 - 1)/(4K - 2)]R_{TH}$$

However, if the setpoint resistance ratio,  $R_{TC}/R_{TH}$ , is less than 2, then let  $R_1 = 0$  and  $R_2 = 2R_{TH}$ , so that:

$$R_3 = 2R_{TH}R_{TC}/(2R_{TH} - R_{TC})$$

(For this analysis, it is assumed that the timer's trigger and threshold inputs do not load the dividers.)

Thermistor power dissipation must be kept as low as possible to maintain the accuracy of the thermostat's setpoints. By operating the timer from the lowest possible supply voltage—5 volts—thermistor self-heating can be minimized. But at high temperature setpoints, where thermistor resistance may be quite low (only a few hundred ohms), this approach may not be practical. On the other hand, at very cold temperatures, the thermistor/resistor divider impedance levels must be evaluated in terms of the timer's threshold and trigger input impedance levels.

To prevent noise signals from causing premature state changes, the timer's trigger and threshold inputs should be bypassed with capacitors. This is particularly important when divider impedance levels are high, the environment is noisy, or long leads are used to connect the thermistor to the circuit. □

## Integrated-circuit timers

### IC timer's duty cycle can stretch over 99%

by Michael S. Robbins  
Los Angeles, Calif.

The duty-cycle range of the 555-type timer IC can be extended by providing independent charging and discharging paths for the timing capacitor.

With the circuit (a) suggested by the manufacturer for an astable rectangular-pulse generator, the duty cycle can be adjusted from about 0.01% to almost 50%. The charging path for the capacitor is the series network of resistors  $R_A$  and  $R_B$  to the supply,  $V_{CC}$ ; the discharge path is through resistor  $R_B$  to ground.

The addition of two diodes, as done in (b), makes the capacitor's charging and discharging paths independent of each other so that the timer's duty cycle can be extended to more than 99%. The charging path is now through resistor  $R_A$  and diode  $D_1$  to the supply, while the discharging path is through  $R_B$  and  $D_2$  to ground.

For the component values shown, the timer's duty cycle can be adjusted from less than 10% to greater than 90% with only a 1% variation in the output period, which, in this case, is 1 millisecond. The output pulse frequency is 1 kilohertz. □

**More duty cycle.** Usual configuration for astable multivibrator (a) limits output duty cycle to about 50%. Adding two diodes, as shown in (b), separates the capacitor's charging and discharging paths, allowing duty cycles of greater than 99% to be achieved.

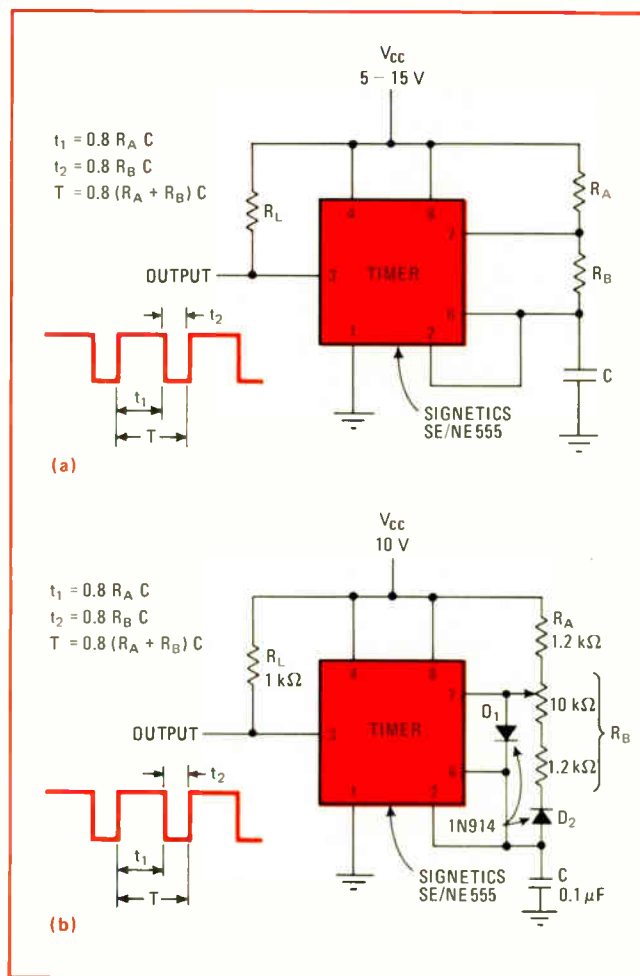

# IC timer plus resistor can produce square waves

by S.A. Orrel  
Ellicott City, Md.

An inexpensive square-wave generator can be put together quickly by using the 555-type timer. With only one external resistor, this circuit can be made to generate fairly accurate square waves.

The generator of (a) produces square waves because the output voltage is essentially 180° out of phase with capacitor voltage, making capacitor voltage change in a direction that forces the output to change state. The circuit of (b) works identically and may be used where it is necessary to eliminate the slight ringing that occurs with circuit (a) just prior to positive output transitions.

The output symmetry of the generator depends on the accuracy of the timer's internal resistor string which produces the device's comparator reference voltages. These errors can be eliminated by adding the trimming resistor,  $R_T$ , as shown in (c). (The trimmer goes to the positive supply line or to ground, depending on the correction needed.) The value of the trimmer is determined by the timing resistance used, how much asymmetry can be tolerated, and the specifications of the particular timer being used.

If a variable pulse width is desired, the circuits drawn in (d) and (e) may be used. In circuit (d), the output varies from a symmetrical square wave to a negative pulse train as resistor  $R_W$  ranges from infinity to zero. In circuit (e), the output varies from a symmetrical square wave to a positive pulse train. The minimum pulse width is, of course, a function of the timer's propagation delay and capacitor size. □

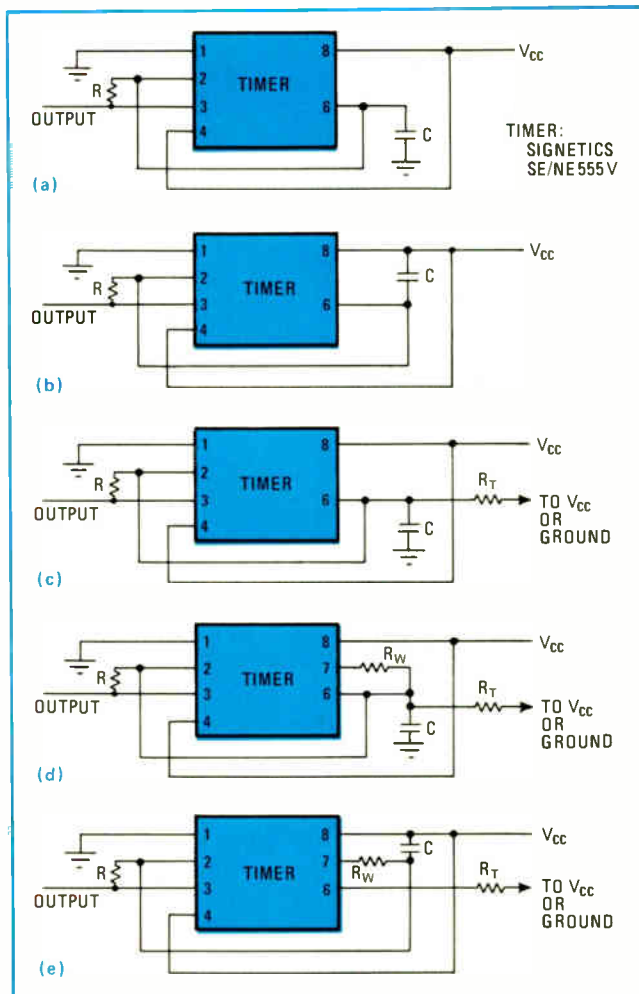

**Choice of generators.** Timer IC (a) generates symmetrical square-wave output. Slight output ringing can be eliminated with circuit (b). Output symmetry can be adjusted with external trimmer (c), or output pulse width made variable, as in circuits (d) and (e).

## Integrated-circuit timers

# IC timer automatically monitors battery voltage

by Edward J. McGowan, Jr.  
Stoelting Co., Chicago, Ill.

The 555-type timer IC can conveniently function as the heart of an automatic battery charger. The circuit is intended to maintain a full charge on a standby battery supply for an instrument that is always connected to the ac power line, whether in use or not. This charger uses the timer's two on-chip comparators, its set-reset flip-flop, and its high-current driver amplifier.

The zener diode,  $D_1$ , provides a reference voltage for

**Battery charger.** Integrated timer functions as the command post for automatic battery-charging circuit. The zener diode sets the reference voltages for the timer's on-chip comparators. Desired turn-on and turn-off battery voltages are determined by the potentiometers.

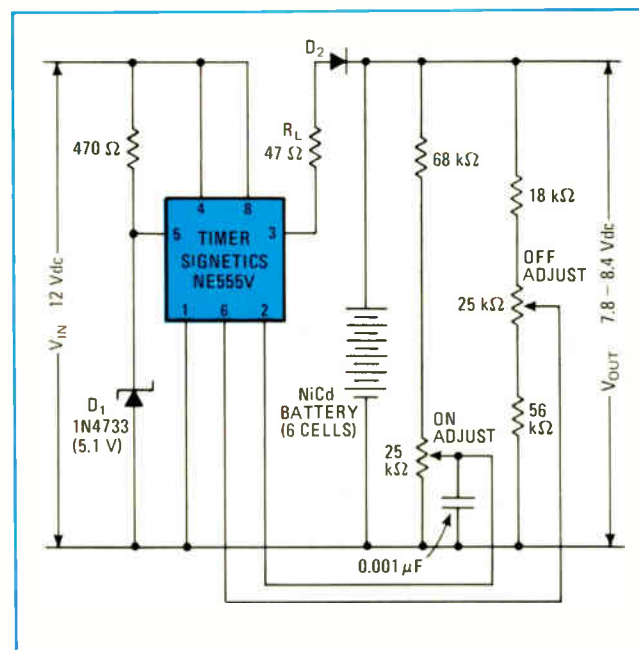

both comparators through the timer's internal resistive divider network. The output of the timer (pin 3) switches between 0 and 10 volts.

The circuit is calibrated by substituting a variable dc power supply for the nickel-cadmium batteries. The OFF adjustment potentiometer is then set for the desired battery cutoff voltage, which is typically 1.4 v per cell; and the ON adjustment potentiometer is set for the de-

sired turn-on voltage, around 1.3 v per cell.

Resistor  $R_L$  limits the circuit's operating current to less than 200 milliamperes under all conditions. Diode  $D_2$  prevents the battery from discharging through the timer when the timer is in its off state. The capacitor stops oscillation during the circuit's off transition. The feedback divider can be decoupled for better load transient immunity, if desired. □

## Integrated-circuit timers

### Pair of IC timers sounds auto burglar alarm

by Michael L. Harvey  
Ropal Corp., El Segundo, Calif.

An inexpensive car burglar alarm system can be built with only two low-cost 555-type timer circuits. The timers are connected as indicated in the diagram.

Timer A serves two purposes: it provides a time delay (roughly  $1.1R_A C_A$ ) for arming the system and allowing the driver to exit the car, and it also permits the driver to enter the car and disarm the alarm. This time delay eliminates the need for an inconvenient and vulnerable arming switch on the outside of the car. The on/off switch for the alarm can be hidden somewhere under the car's dashboard.

When the alarm goes "off," timer B is triggered on by the falling edge of the output from timer A. After the initial turn-on, however, the SCR prevents timer B from triggering until one of the grounding-type sensor switches fires this timer. □

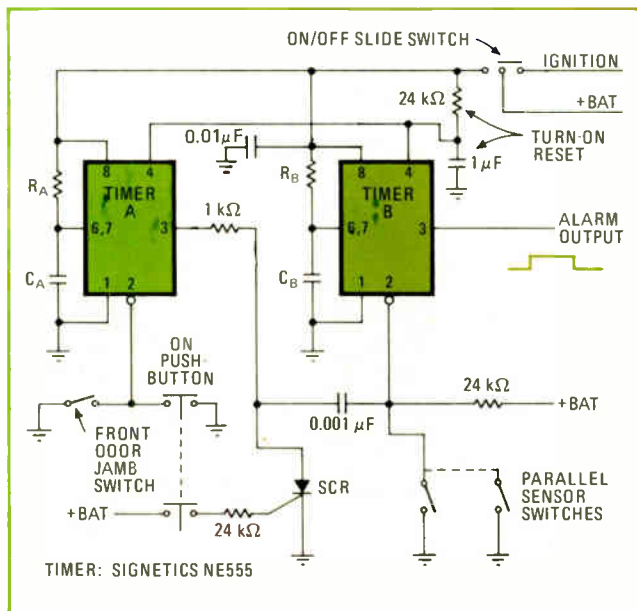

**Auto watchdog.** Timer A produces a safeguard delay, allowing driver to disarm alarm and eliminating vulnerable outside control switch. The SCR prevents timer A from triggering timer B, unless timer B is triggered by strategically located sensor switches.

## Integrated-circuit timers

### IC timer converts temperature to frequency

by Donald DeKold  
Santa Fe Community College, Gainesville, Fla.

When wired as an astable multivibrator, the 555-type IC timer may be used to generate a square-wave output voltage whose frequency has a one-to-one correspondence with temperature. A negative-temperature-coefficient thermistor is used in the IC's charging network.

The circuit's output frequency varies in a nearly linear manner from 38 to 114 hertz as temperature changes from 37°F to 115°F. At no point in this temperature range does the frequency count differ by more than  $\pm 1$  Hz from the corresponding temperature. Due to the small parts count, low cost (about \$3), and low power requirements (9.3 milliamperes at 10 volts dc), this temperature-to-frequency converter makes an inexpensive temperature transducer that can be used for telemetry applications.

The conventional astable configuration for the 555-type timer employs two fixed resistors. In place of one of these, the converter circuit uses a thermistor/resistor series combination. The other fixed resistor is replaced by transistor  $Q_1$ , which is turned on during the charging interval and off during the discharging interval. This transistor's near-zero on-resistance and very large off-resistance result in equal charge and discharge intervals that depend on only  $R_T$  and  $R_R$ . Operating frequency can then be given by:

$$f = 1/[2(R_T + R_R)C \ln(2)]$$

or:

$$f = k/(R_T + R_R)$$

Frequency variation with temperature, therefore, is similar to the voltage variation of a thermistor/resistor divider network. (This type of divider is often used in a bridge arrangement to produce a linearized voltage output with temperature.) The divider's output voltage can be expressed as:

$$V_{OUT} = [R_R/(R_R + R_T)]V_S$$

Since the denominators of this equation and the frequency equation are the same, the frequency/temperature relationship of the converter circuit will have the same shape and degree of linearity as that of the voltage

output of a conventional thermistor/resistor divider.

When a thermistor having an  $R_0$  value of 5,000 ohms at 25°C and a resistance ratio of 9.06:1 over the temperature range of 0°C to 50°C is used, the converter circuit produces a linearity error of less than  $\pm 1^\circ$  over a 78°F range. The figure contains a plot of this temperature/frequency performance.

It is purely coincidental that the frequency count of the circuit is the same as the useful fahrenheit temperature range (37°F to 115°F) for which the circuit is nominally designed. In general, the frequency will be linear with respect to temperature in any interval of interest,

but the frequency count will probably be different from the absolute value of the temperature being sensed.

To minimize circuit error, it may be necessary to use temperature-stable polycarbonate capacitors. For this circuit, off-the-shelf capacitors having nominal  $\pm 5\%$  tolerances were employed, with the final capacitance being a number of parallel capacitors hand-selected to give the correct frequency count at a given temperature.

The IC timer itself contributes negligible error to the frequency output over temperature. Without adequate power-supply bypassing, the circuit is somewhat sensitive to supply-voltage variations. □

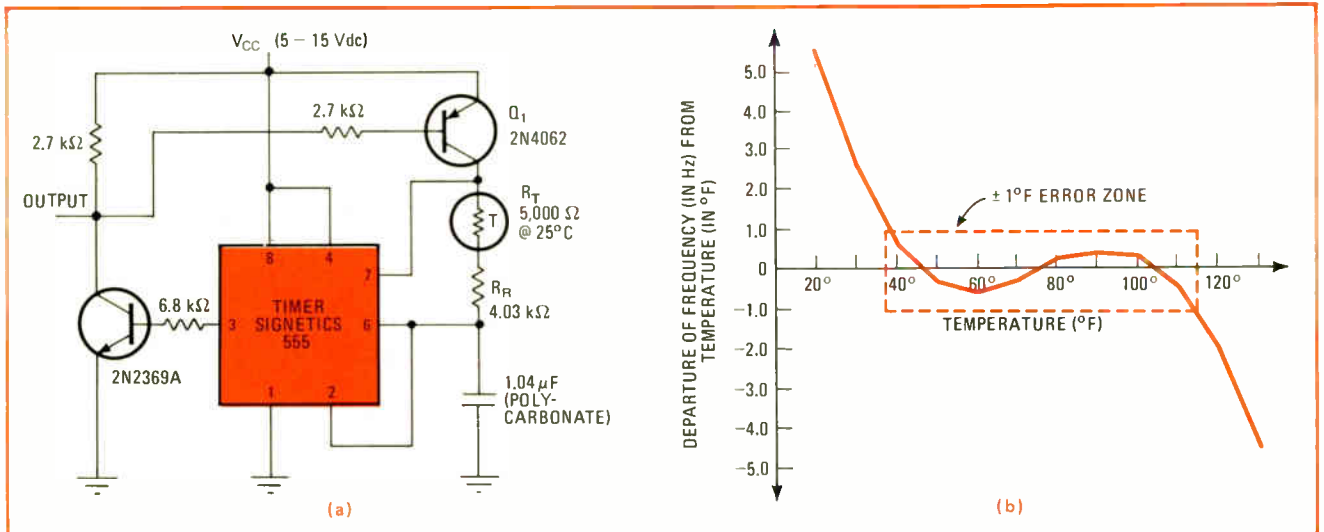

**Temperature transducer.** A couple of transistors and a thermistor in the charging network of the 555-type timer enable this device to sense temperature and produce a corresponding frequency output. The circuit is accurate to within  $\pm 1$  hertz over a 78°F temperature range.

## Integrated-circuit timers

### IC timer can function as low-cost line receiver

by John G. Pate  
Orbitec Corp., Carmel Valley, Calif.

Sometimes the operating speed of TTL or DTL circuits can be a handicap, rather than an advantage. This is especially true in many control circuits where system speed is limited by electromechanical devices. Furthermore, these electromechanical devices can generate current and voltage transients that may get into the logic paths.

Problems can become severe when the logic circuits to be coupled are not close to each other. While the standard line drivers and receivers offer a good solution to this problem, they are often not the most cost-effective approach in applications where speed is not important. Additionally, these drivers and receivers require an interface device at each end of the line; and the line must be a twisted pair.

However, the 555-type timer IC can be employed as a level-sensing device. When preceded by an RC integrator, the timer makes a noise-immune line receiver that

has a high input impedance and requires no special driver at the sending end. Moreover, besides providing an output that is directly TTL-compatible, the timer can operate from a 5-volt supply. Only one signal conductor is required, and it can be unshielded.

The timing capacitance used should be as large as possible, consistent with the system's operating speed. A low signal on the strobe line holds the output low. □

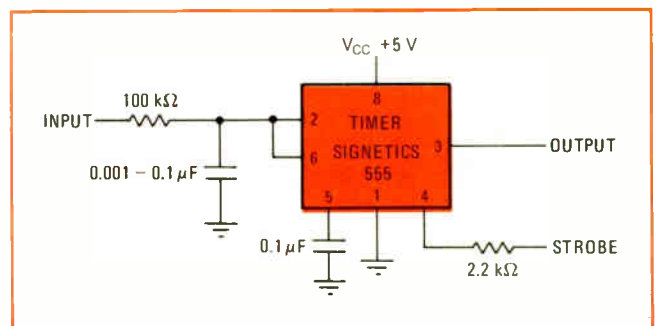

**Interface circuit.** Timer makes excellent line receiver for control applications involving relatively slow electromechanical devices. It can work without special drivers over single unshielded lines.

Engineer's notebook is a regular feature in Electronics. We invite readers to submit original design shortcuts, calculation aids, measurement and test techniques, and other ideas for saving engineering time or cost. We'll pay \$50 for each item published.



# Sorensen has a bargain for you: DCR power supplies selling for \$360-\$4200.



Sorensen's DCR power supplies offer you the lowest cost per watt in the industry. More power output for each dollar you invest.

And DCR's comprise the broadest lab/systems line available anywhere: 37 models in 10 voltage ranges, 7 power levels.

Features? All silicon solid-state electronics. Precision regulation. Remote voltage, current or resistance programming — and remote sensing at distances to 200 feet. Operation in either voltage or current modes.

For complete data and prices, write Sorensen, a unit of Raytheon Company, 676 Island Pond Road, Manchester, N.H. 03103. Telephone (603) 668-1600. Or TWX 710-220-1339.

## **Sorensen** POWER SUPPLIES

### Key Data

- 37 models available.
- 10 voltage ranges from 20 to 30,000 Vdc.
- 7 power levels from 400 to 20,000 W.
- Low output ripple.
- Voltage and current regulation with automatic crossover.
- Typical efficiencies to over 80%.
- Fits standard 19" rack (except 20 kW models).
- Optional overvoltage protection for all models (except 20 kW).
- Series or parallel operation.
- MTBF greater than 25,000 hours.

## Screening for popcorn noise

For fighting popcorn noise, here's a tip from John MacDougall, a semiconductor specialist from Fairchild. Popcorn noise is a term coined by the hearing-aid industry for the molecular noise in semiconductors—users of early devices complained that it sounded like corn popping in their ears. **Popcorn noise in semiconductor devices usually exceeds the background noise by a factor of two but occurs randomly at very long intervals**, making it difficult to call out the offending devices with simple tests.

MacDougall, using statistical techniques, has found that **devices high in 10-hertz noise also suffer popcorn noise**, so that it's possible to get a popcorn noise reading on a simple meter manned by ordinary production personnel. The confidence factor of this kind of test is 88%, says MacDougall.

## Integrated optics are almost here

Designers of the next generation of data-handling systems would be wise to keep abreast of the developing technology of integrated optics, now that **workable systems are rapidly becoming available at practical prices**. For instance, Perkin-Elmer Corp. of Norwalk, Conn., has developed a waveguide light-scanner data terminal. Moreover, new gallium-arsenide-diode lasers can operate continuously at room temperature for thousands of hours and provide source energy for waveguides. And it won't be long before electronics and optics are together in the same package, or even on the same substrate, with the optics handling the data and the electronics providing control.

## Tunable lasers detect air pollutants

The tunable dye laser, billed as **the dream of spectroscopists working in gas analysis and pollution control**, finally has arrived as a standard product. At least two suppliers by now have commercially available devices.

The system 580 from Spectra-Physics, Mountain View, Calif., has a 30-milliwatt output with a 1-watt pump, tunable from 560 to 620 nanometers, and the model 490 from Coherent Radiation is tunable from 530 to 700 nm at a 1- to 2-w maximum output with an 8-w pump. In a pollution-detection system, a swept laser beam passing through an air sample is absorbed at the characteristic absorption frequency of any gas pollutant or pollutants present.

## A silver lining for every contact

**Reducing overheating and maintenance of metal contacts in high-power systems is made easy** with a wipe-on silver-plating powder that comes in a jar—you just clean the contacts and wipe the Cool-Amp on. A 1-pound bottle, costing \$23.25, coats 6,000 square inches of surface, and that's a lot of contacts. It's made by Cool-Amp Co., 8603 S.W. 17th Ave., Portland, Ore. 97219.

## Tail twist

And for those untidy bundles of wire, Thomas & Betts, Elizabeth, N.J. 07207, has a handy nylon tie **that bundles wire flat in no time**. No tools are needed. It's called Tyger Tail, and you just wrap and twist a tail.

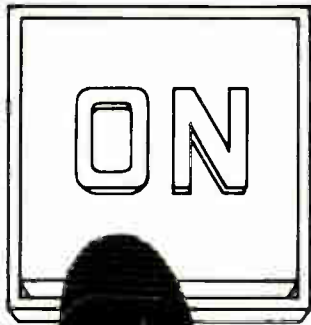

# Norplex...your reliable hand for multilayer circuits from prepreg preparation to push button performance

Thin-clad laminates or prepreg materials. Whatever your application calls for, it's the Norplex team reliability that can mean the difference at start-up time.

In thin-clad laminates, it's the reliability of optimum dimensional stability. Plus Norplex's ability to adhere to the many precise tolerances demanded by today's sophisticated multilayer circuits.

And in prepreg materials, it's the Norplex team effort to maintain quantity production under the strictest hygienic conditions . . . conditions that assure you prepreg which is clean, free of foreign particles and available in many varieties.

Finally, it's the pride of every plant worker, office employee and field representative . . . a team that serves every customer with 100% effort through Norplex's Quality Assurance program.

All together, this Norplex reliability spells out satisfaction for all your thin-clad laminates and prepreg needs . . . from plants in both La Crosse and Franklin, Indiana. Start the Norplex team working for you by writing or phoning for catalogs. Norplex Division, UOP (Universal Oil Products Company), Norplex Drive, La Crosse, Wisconsin 54601. Telephone: 608/784-6070.

**Norplex® laminates  
by UOP**

©1973 UOP

Circle 135 on reader service card

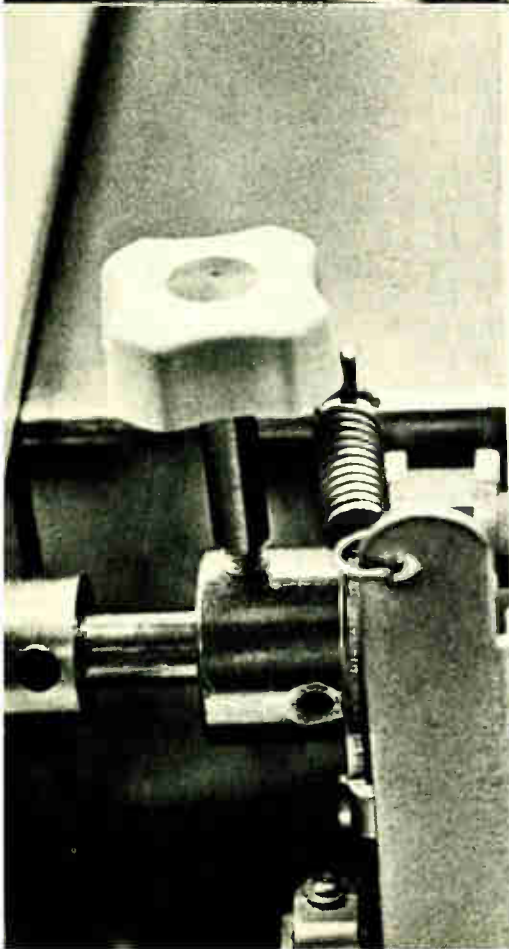
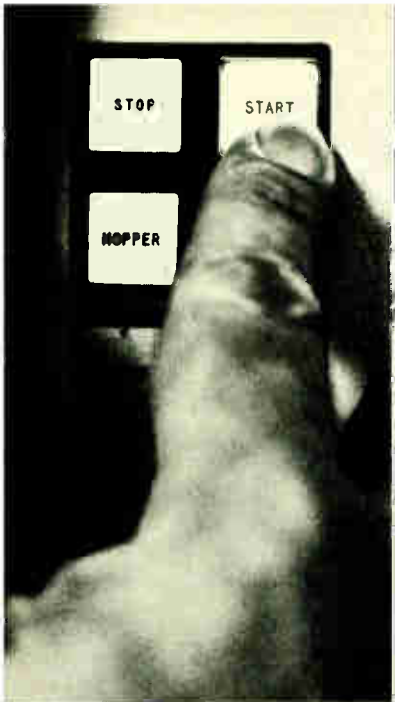

|          |   |        |        |
|----------|---|--------|--------|
| ● *TVECT | S | 000384 | 000343 |
| ● *DIFBU | S | 000096 | 000049 |
| ● *DOFBU | S | 000096 | 000049 |
| ● *FCOM1 | S | 001248 | 001214 |
| ● *DBUP  | S | 001392 | 001390 |
| ● *CRDTA | S | 001008 | 000997 |
| ● *TAPLP | S | 001152 | 001150 |
| ● *LISTC | S | 000336 | 000292 |
| ● *FRIT  | S | 003408 | 003362 |
| VT       | S | 000288 | 000271 |
| 1        | S | 013680 | 013658 |
| DE       | S | 015552 | 015512 |
| VE       | S | 012624 | 012596 |
| DC       | S | 015216 | 015208 |
| AK       | S | 000000 | 000000 |
| EC       | S | 000240 | 000205 |
|          | S | 011088 | 011056 |
|          | S | 006000 | 005985 |
|          | S | 001008 | 000971 |
|          | S | 001536 | 001490 |
|          | S | 002112 | 002069 |
|          | S | 001296 | 001268 |

# Too many testers are installed and left to their own devices.

## We can help.

You turn the key, the current flashes on. And everyone disappears. But just try to conjure up field service when the tester's feeling low, and you discover the cord's been cut.

What we have here, gentlemen, is a failure to communicate. By the system's manufacturer. And that leaves you with a large-scale circuit tester on your hands, and no one to give you a lift.

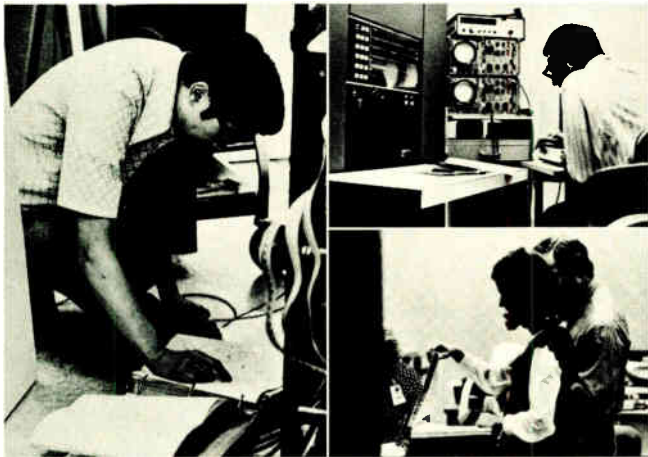

When Fairchild Systems sets up one of our Sentry semiconductor testers in your plant, you never get us out of your system. If we couldn't back up every piece of equipment we produce, we'd back right out of the business. We consider our job is still only half-done even when you're up and running.

With the largest service task force ever fielded by a test system producer, Fairchild's primed to keep in close touch. You don't always have to call us...we'll call on you. Small problems can grow into big ones, and if our experts can catch them while they're still nothing much, we can often save a lot of grief later on.

Of course there may be times when you just can't prevent a real crisis in the system. Count on Fairchild for a fast turnaround. Because our service network extends around the world, we can turn on a dime, providing next-door repairs, maintenance, and systems support.

Field service reps are not the only Fairchild forces you can tap. Just as our engineering/applications/software groups play a major role in targeting your Sentry equipment levels and software packs, you can go to them anytime to solve unusual testing problems, and to help you get the most out of existing software.

The Sentry concept—one family of six interrelated circuit testing systems with total compatibility between each function-optimized component—may require these teams to pitch in with appropriate programs to meet your upgrade or downgrade into a sister system. You can also dip into their expertise when specialized programs are needed. They can devise custom programs for virtually any test requirement.

When we tie you into a Sentry, we tie you onto the lowest cost, highest throughput, most advanced test/measurement technologies available anywhere in the field—for every device type, configuration, and sophisticated component you could use today. From MOS to bipolar, from ICs to discretes, MSI/LSI, from transistors to ECL (with software/hardware compatible to all), Sentry offers you total semiconductor testing capability for both production and engineering, with enormous expansion and adaptability options. And with all that going for you, you'll never get us out of your system.

**FAIRCHILD** Fairchild Systems Technology  
3500 Deer Creek Road  
Palo Alto, California 94302

Send me information on the Sentry Test Systems.  
Our monthly test requirement is approximately \_\_\_\_\_  
of  transistors,  I.C.s  MSI.

Name \_\_\_\_\_  
Title \_\_\_\_\_  
Company \_\_\_\_\_  
Street \_\_\_\_\_ City \_\_\_\_\_  
State \_\_\_\_\_ Zip \_\_\_\_\_  
Phone (     ) \_\_\_\_\_ Ext. \_\_\_\_\_

# Fairchild Systems

Fairchild Systems Technology, a division of Fairchild Camera & Instrument Corporation.

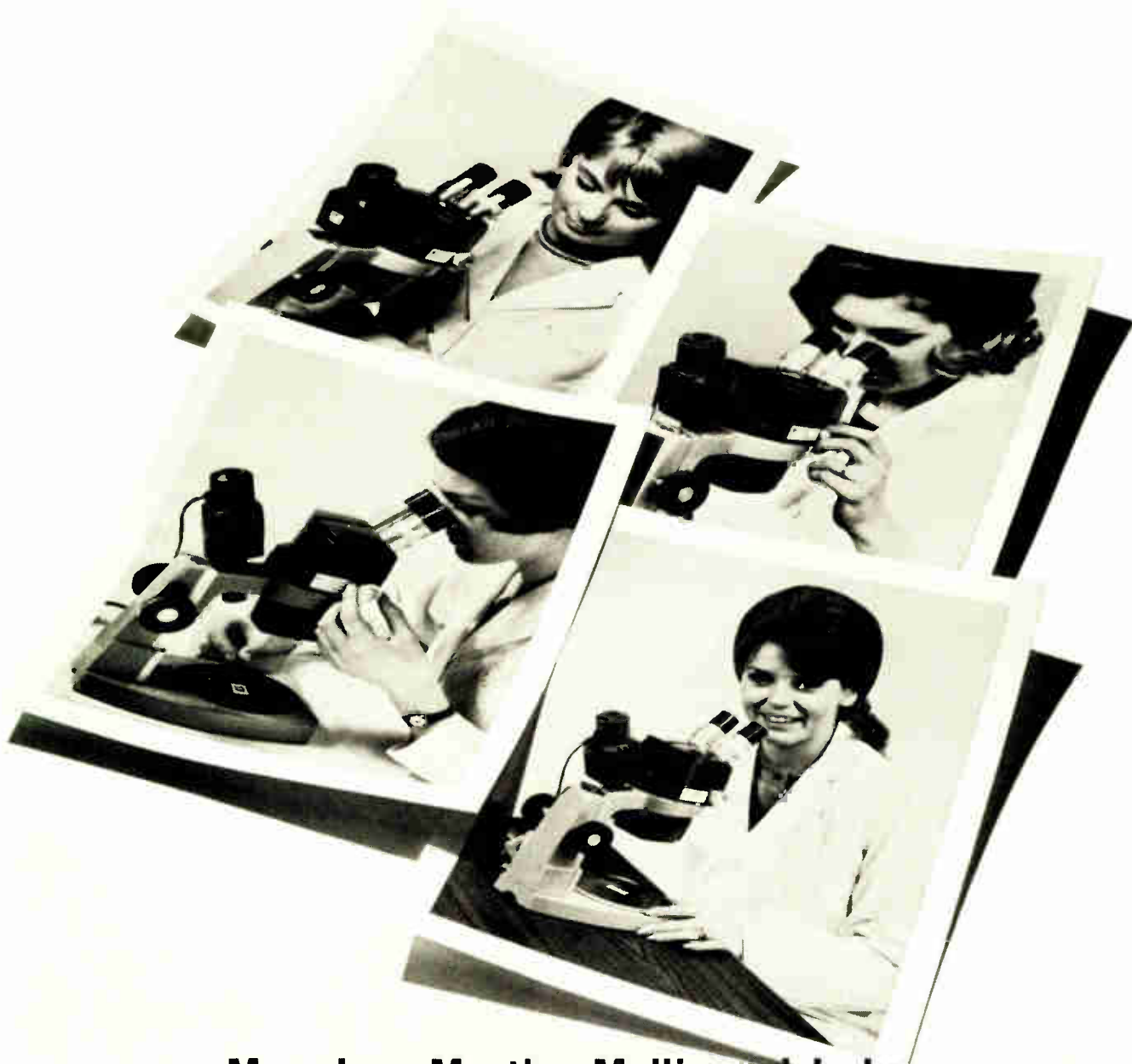

**Mary Lou, Martha, Mollie and Judy  
are sold on the AO STEREOSTAR<sup>®</sup> Zoom Microscope.**

## Here's why.

The AO STEREOSTAR Zoom stereoscopic microscope was specifically designed for convenience, working ease and optical performance. Zoom controls are located on both sides for convenience. It eliminates awkward reaching when changing magnification. The high resolution optical power pack may be rotated 360° to accommodate most any assembly or inspection situation. Full optical equipment offers a magnification range of 3.5x through 210x. Working distance of 4.0 inches is maintained at all magnifications in basic models, and if that's not enough, add a 0.5x

auxiliary lens to make it 5.7 inches. STEREOSTAR Zoom microscope assures a wide field of view, up to 2.25 inches with the 10x high eyepoint eyepieces. It also features an extremely efficient illuminator that stays cool even after long hours of continuous use. See for yourself. Contact your AO dealer or sales representative for a convincing demonstration.



**AMERICAN OPTICAL  
CORPORATION**

SCIENTIFIC INSTRUMENT DIVISION • BUFFALO, N.Y. 14215

# They have software you can't see and hardware that isn't there?



First they told me they developed all the system software before putting together the hardware to run it. Then they expected me to believe that I can't see the software and the hardware isn't there. And I thought I had problems.

I felt the least I could do was give them a chance to explain what it all meant. They told me that by dealing with the system software first, they were able to make it as transparent as possible to user programs. In other words, you can develop your software and build your data bases without ever being aware of the presence of the disk operating system that makes it happen so smoothly and efficiently. You can write FORTRAN programs knowing there are no object program inefficiencies or tediously long compilations. And you can manage the system's resources with a real time operating system that takes very few of those resources to manage itself.

As for the hardware that isn't there, they introduced me to their brand new PRIME 300 with virtual memory. Imagine being able to write programs without worrying about how to fit them into memory. PRIME's virtual memory disk operating system guarantees they will fit. All you do is pick the amount of real memory that gives you the level of performance you want.

Of course if you like hardware you can see, the PRIME 300's got plenty of that too: floating point hardware with FORTRAN-optimized instructions, up to 256K words of high-speed MOS memory, stack procedure instructions, memory protection, and microverification and byte parity.

If PRIME can offer that much performance with software you can't see running on hardware that isn't there, I can't wait to see what they do for an encore. Prime Computer, Inc., 17 Strathmore Road, Natick, Mass. 01760. (617) 655-6999.

## Prime

*Prime sales offices:* Boston (617) 237-4565, New York (212) 896-6262, Washington D.C. (703) 533-9343, Philadelphia (215) 688-0396, Jacksonville (904) 396-5253, Chicago (312) 887-1845, Dayton (513) 435-1343, Detroit (313) 356-4840, Palo Alto (415) 968-6003, Los Angeles (213) 881-8433.

*Authorized representatives:* Phoenix (602) 957-9110, Albuquerque (505) 255-2330, Denver (303) 771-0140, Seattle (206) 454-9332.

PRIME International, Natick, Mass. (617) 655-6988, C.N. Rood b.v., Rijswijk Z.H., Holland 070-99 63 60, C.N. Rood, Brussels, Belgium 02/35.21.35, PRIME Computer Ltd., Ealing, London W5, England 01-5795631, Bacher Elektronische Gerate GmbH, Vienna, Austria 0222/83 63 96, Erik Ferner AB, Snormakarvagen, Sweden 08/80 25 40, Erik Ferner AB, Copenhagen, Denmark 01/31 16 07, Erik Ferner AB, Ruomela, Finland 90/88 06 34, Erik Ferner AB, Oslo, Norway 02/60 62 45.

Circle 139 on reader service card

# The floppy disk that works

There are several floppy disks on the market today — and, no doubt, more to come. But there's only one that works reliably — today. Only one that's available for quantity delivery — today.

And, only one that costs as little as \$500 in OEM quantities — today. That one is the Diskette™ from Innovex.

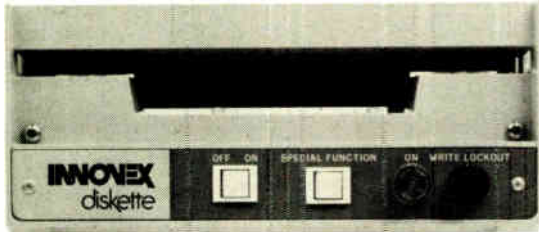

## Floppy, not sloppy.

In concept, the floppy disk is beautiful. The performance of a disk, the convenience of a cassette and a price range that says everybody can afford one. But only the Diskette can deliver these attributes plus proven, day-in, day-out reliability.

In short, the Diskette works better because it works differently from any other floppy disk.

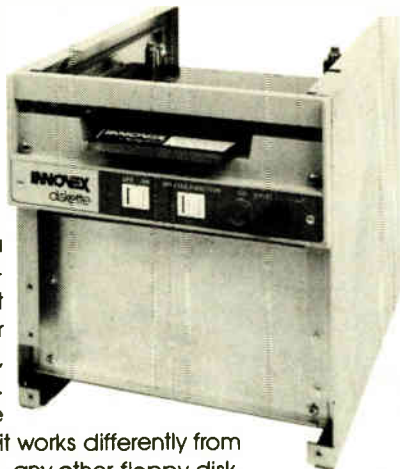

## A square disk that doesn't spin,

Rather than trying to read and write data on a flexible spinning disk, the Diskette leaves the disk stationary and spins the head instead. In fact, the Diskette cartridge isn't really a disk at all but rather a sheet of evenly tensioned computer tape in a rigid plastic frame. (Life tests so far show single track media life is in excess of 3 million passes; cartridge life in excess of 25 million passes.)



## and a head that doesn't wear out.

By flying the head instead of running in contact with the media, the problems of head "wear-out", head static charge and early media failure simply don't exist. (Life tests show a head life in excess of 3000 hours.) An inexpensive motor and belt drive are

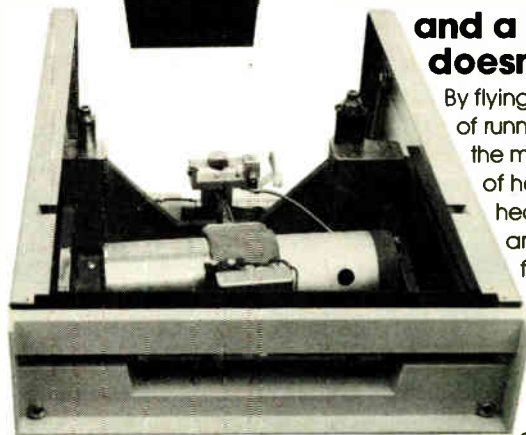

all it takes to spin the head. A foolproof stepping motor moves the head from track to track.

## Look at the performance

|                                |                                  |
|--------------------------------|----------------------------------|
| Capacity                       |                                  |
| per track                      | 26,900 (single record)           |
| per diskette cartridge         | 1,291,200 bits                   |
| Density (Phase Encoding)       |                                  |
| bit density                    | 2,000 bpi (inner track)          |
| number of tracks               | 48 data tracks plus parking ramp |
| sectors per track              | 8 nominal, user selectable       |
| Transfer Rate (Phase Encoding) |                                  |
| bit rate                       | 172,000 bits/sec.                |
| Access Time                    |                                  |
| track to track                 | 5ms                              |
| settling time                  | 25ms                             |
| latency                        | 75ms avge. (400 RPM)             |
| Dimensions                     |                                  |
|                                | 9 3/8" wide                      |
|                                | 10" high                         |
|                                | 14 1/2" deep plus 5/8" bezel     |
| Weight                         | 19 1/2 Lbs                       |

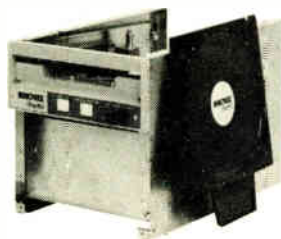

CONTACT:  
INNOVEX CORPORATION  
FOUR ALFRED CIRCLE  
BEDFORD, MASS. 01730  
(617) 275-2110

# INNOVEX

## How a Diskette can work for you.

If you're designing intelligent terminals, word processors, programmable calculators or systems based on minicomputers, look into Innovex's Diskette. If you need optimum price/performance from your random access storage medium — you need the Diskette. (and you can get it today.)



# More ways to go with DVM's & DMM's from DigiTec



All DigiTec instruments are available for rental or lease through Rental Electronics, Inc.

The DigiTec line of digital voltmeters offers a selection that will enable you to choose the perfect instrument for your needs. Each unit provides its own special features. You select the instrument that has the functions you require, and you'll pay for only the useful features you want.

For digital voltmeters with guarded inputs, isolated BCD outputs, LED displays and basic accuracy of .02%, you can

select from:

**the model 266**, 4 range DVM at \$525.

**the model 267**, 4 range auto-ranging DVM at \$625.

**the model 268**, 6 range DVM with  $1\mu\text{V}$  resolution at \$795.

**the model 269**, 23 range DMM at \$695.

Portability is available with either:

**the model 261C**, a 10 range VOM at \$289.

**the model 262C**, a 25 range DMM at \$345.

Both offer .05% basic accuracy, LED displays and integral batteries as standard equipment.

All DigiTec instrumentation is backed by a one year warranty and a network of Field Service Centers in the U.S. and Canada. Contact your nearest DigiTec representative or call, United Systems Corp.

**United Systems Corporation**  
918 Woodley Road, Dayton, Ohio 45403  
Ph. (513) 254-6251 Twx: (810) 459-1728  
a subsidiary of

**Monsanto**

**DigiTec**

Circle 141 on reader service card

## IC timers make the most of delay

Applications base for low-cost integrated timing circuits continues to broaden as new devices offer the user additional versatility

by Lucinda Mattera, Circuit Design Editor

In about only a year, integrated-circuit timers have begun to pervade many industrial and commercial applications. They already rival the low-priced general-purpose operational amplifier for applications flexibility, and they are inexpensive, costing under \$1 in high volumes.

IC timers can provide precision timing intervals, from microseconds to hours, or can be used as oscillators or monostable or astable multivibrators. Other applications include sequential timing, pulse-width modulation, and pulse detection (see p. 128 for more ideas).

Another feature is their ability to operate from a wide range of supply voltages—from less than 5 volts to more than 15 v. Moreover, they are directly compatible with TTL circuits and can drive loads requiring 100 (or more) milliamperes. Temperature stability is also excellent.

The commercial versions are intended to compete with mechanical and electromechanical timers and, with demand exceeding the supply, business is now quite brisk. But a number of IC manufacturers will shortly be introducing several new timer products. Presently, manufacturers of IC timers are selling upward of 7 million to 8 million units a year, so that current estimates place industry-wide sales at about \$8 million in 1975.

The 555. Signetics Corp., Sunnyvale, Calif., started the ball rolling. Gene Hnatek, linear marketing manager, credits the success of the first IC timer, the 555, to aggressive pricing and economical packaging. Signetics sells its military metal-can model, the SE555T, for \$10.50 in 100-up quantities, and its commercial molded-DIP model, the NE555V, for 79¢ for 100 or more.

As its functional block diagram proves, the 555-type timer is a simple circuit, so that even people who never use other ICs can wire it up. When the 555 is operated as a monostable multi, its output period is determined by a single resistor and a single capacitor. Connecting the device as an astable multi, is just as simple, requiring only

two resistors and one capacitor.

Currently the 555-type timer is also available from Intersil Inc., Cupertino, Calif., at a cost of 95¢ in 100-up quantities for the commercial version and \$8 for the military version. By the end of the summer, National Semiconductor Corp., Santa Clara, Calif., will introduce its type LM555 timer, selling for \$1.25 (commercial DIP version) in 100-unit quantities. Both Fairchild Semiconductor of Palo Alto, Calif., and Motorola Semiconductor of Phoenix, Ariz., also hope to be second-sourcing the 555-type timer by the end of the year.

Newcomers. Signetics will soon be introducing two follow-up designs to the 555. In late August, the company will release its model 556, a dual version of the 555 packaged in a 14-pin DIP. In mid-September, the 557 will be released. This model, which will contain a constant-current source, is intended to provide long timing intervals, of 2 to 3 hours, without the need for large expensive capacitors.

Exar Integrated Systems Inc. of Sunnyvale, Calif., also has two timers that perform similarly to the 555. They are the XR-220 and the XR-320 models, which are available in both commercial and military versions. For 100-unit quantities, cost ranges from \$1 to \$10.

This month, Exar is announcing the first dual 555-type timer—its model XR-2556. In addition to lower cost per function (prices will be \$1.50 to \$9.50 for 100 or more), the circuit provides improved tracking when two timers are connected in tandem. The delays of the timers can be set independently, so that the desired interval can be selected dig-

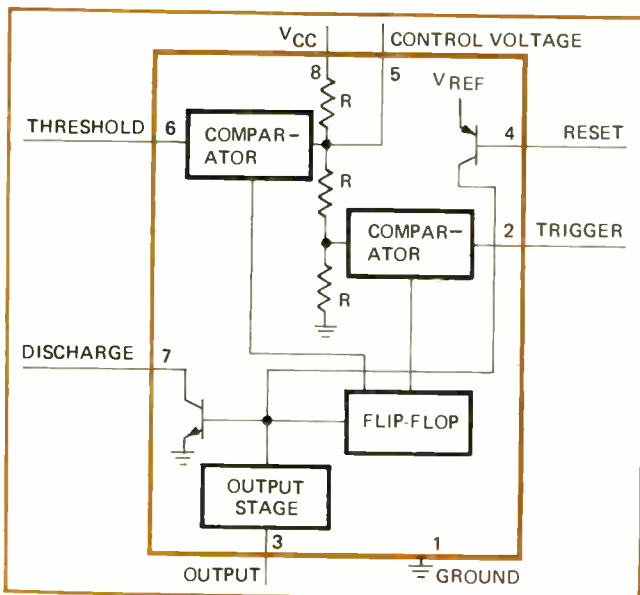

555-type timer. Internal resistive divider sets switching voltages for both of the circuit's comparators, which then toggle the flip-flop.

itally. Some possible dual-timer circuits are keyed oscillators, frequency dividers with pulse shaping, and pulse-width modulators with an internal clock.

Another new product, to be introduced by Exar sometime in the fall, is the XR-2240 programmable timer. Alan Grebene, vice president of engineering, says that the XR-2240 is intended to satisfy the need for truly long timing intervals—for example, running 1,000-hour tests for semiconductor devices; and controlling irrigation gate cycles on farms, time-lapse photographic systems, and the monthly readings of remote meters.

The XR-2240 contains a time-base generator, a control flip-flop, and a binary counter that can "slow up" the time base by as much as  $2^8$ , multiplying the timing interval by a factor of up to 255. The counter section is programmable. For a given RC time constant, up to 255 timing intervals can be selected by shorting together selected pins on the counter side of the package. The XR-2240 can also be operated from a battery, and it has a unique power extension output that allows a series of timers to work from the same supply.

**Longer delays.** National Semiconductor is also announcing some new timers. Now available in sample quantities are the LM122 series, which has a timing range of microseconds to several hours, and the LM2905 series, which are extended-temperature-range units. Pricing for these timers varies from \$1.65 to \$5 for 100 or more.

Both the LM122 and the LM2905 series offer several features that the 555-type timer does not have, says Stephen Wm. Fields, product marketing manager for interface circuits. For instance, they contain an internal voltage regulator that makes timing accuracy independent of supply variations. This regulator produces a reference voltage that can be used for other circuits, too. And their input current is kept low so that long timing intervals can be obtained with small capacitors and large resistors.

In addition to its second-source 555, Intersil makes another timer

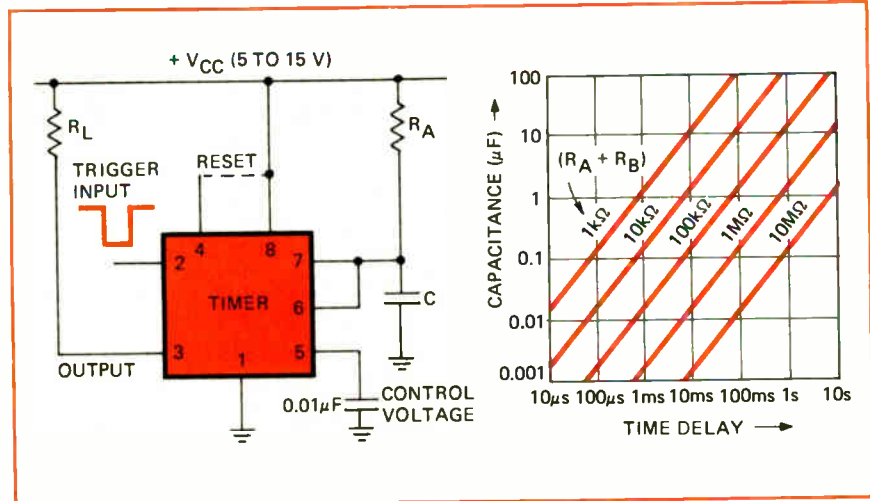

**Monostable hookup for the 555.** Output pulse width for one-shot operation is determined by one resistor and one capacitor. The timing curves show the delay range.

product—the 8038—a precision voltage-controlled oscillator that is intended as a replacement for crystal oscillators, notes Jack F. Gifford, director of analog products. This device's timing range can be extended by making it drive a binary counter. Timing accuracy is maintained to within 1% because the 8038 employs thin-film resistors in its reference voltage section. Applications include modems, a-d converters, computer clocks, and process controllers.

A low-cost complementary-MOS timing circuit is expected to be introduced this fall by Texas Instruments of Dallas. "I think MOS, and especially C-MOS, is going to have more and more importance in timing circuits," says Daniel Baudouin,

MOS strategy manager at TI in Houston. "It's ideally adapted to industrial environments because of wide power supply variations."

Mostek Corp., another Dallas-based company, introduced a timer product last summer—its MK5009 counter-time-base circuit, which is primarily aimed at the instrumentation market. The timer is designed to replace time-base circuitry in frequency meters, explains Robert R. Cook, applications engineer, but it can also be used for such jobs as photographic timers and industrial controllers. The device has 14 programmable divider stages. An external crystal will drive its on-chip oscillator at up to 2 megahertz. Cost is \$9 for 100 to 499. □

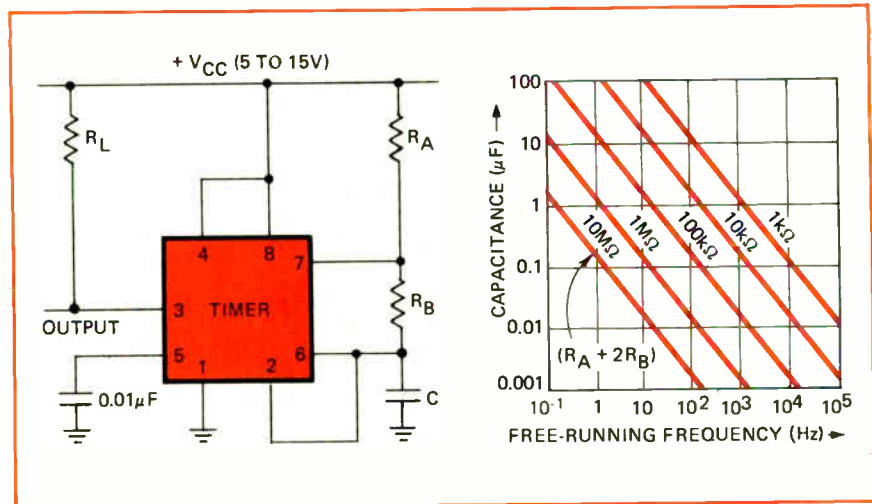

**Astable hookup for the 555.** With this simple connection, the timer operates in its free-run mode. The capacitor charges through resistor  $R_A$  and discharges through resistor  $R_B$ .

Semiconductors

## Hybrid buffer supplies 50 mA

Unit slews at more than 6,000 volts/microsecond, can drive 50-ohm cable

Many wideband communications systems require components with a level of performance that is out of reach of ordinary monolithic ICs. So IC manufacturers are using hybrid techniques to meet the power demands.

National Semiconductor Corp. has developed a hybrid IC buffer amplifier that can supply 500 milliamperes and  $\pm 10$ -volt drive capability at frequencies from dc to more than 100 megahertz. Moreover, the LH0063, a FET-input voltage follower/buffer, will slew at a rate of more than 6,000 volts per microsecond. It can be used as a 50-ohm cable driver (see below), an isolation buffer for driving reactive loads, a video impedance transformer, and in other medium-power, wideband applications.

To drive a 50-ohm cable through a  $\pm 10$ -volt swing ordinarily takes what buffer designers call a "moose" output transistor. But mooses can't move at rates fast enough for some video systems, analog-to-digital converter drivers, and emitter-coupled-logic testers. A voltage follower that would drive such loads at slew rates of 4,000

volts per microsecond and higher needed a different approach, and National chose the hybrid.

When lightly loaded, the new LH0063 hybrid integrated-circuit buffer will slew at 8 kilovolts per microsecond, says National. The company had previously claimed the IC speed record with the LH0033, which slews at rates to 1,200 volts/microsecond. According to Dean L. Coleman, hybrid marketing manager, the LH0063 even outruns modules and discrete assemblies, which are considered ultrafast if they slew at 4 or 5 kilovolts/microsecond.

Speed is not the only feature of the circuit. It has field-effect transistor inputs and laser-trimmed offset, bias and crossover networks. The latter, located in front of the output stages, are trimmed to minimize crossover distortion at high slew rates.

Typically, output offset voltage is 10 millivolts and input bias current 100 picoamperes. With trimming, the maximum values of these characteristics can be held to as little as 25 mV and 200 pA, respectively. The offset voltage's average temperature coefficient is typically 100 microvolts. Voltage gain is near unity. Input and output impedances of the units are  $10^{11}$  ohms and 1 ohm, respectively.

Some maximum specs include  $\pm 20$ -volt supply and input range,  $\pm 250$ -milliampere continuous output current and  $\pm 500$ -mA peak output current. Two versions will be available: the LH0063, operating at  $-55^\circ$  to  $125^\circ\text{C}$ ; and the LH0063c,  $-25^\circ$  to  $85^\circ\text{C}$ .

The FET-input device is built using special junction FETs and active laser trimming to achieve performance specifications.

National Semiconductor Corp., 2900 Semiconductor Drive, Santa Clara, Calif. 95051

## 16-channel multiplexer IC has overvoltage protection

Systems designers using monolithic multiplexers usually have to provide external protection circuitry, and sometimes additional power supplies, to guard against overvoltage.

A 16-channel multiplexer IC developed by Harris Semiconductor offers internal analog/digital overvoltage protection circuits, in addition to fast access times and low power requirements. Key to the fault-protection feature, Harris says, is the company's dielectric-isolation type of C-MOS processing, plus several circuit innovations.

Called the HI-506A, the multiplexer is designed for DTL/TTL as well as C-MOS logic compatibility. It is pin-for-pin interchangeable with the Siliconix DG-506.

The Harris internal-protection circuits prevent an analog input overvoltage to one channel from causing an output error when other channels are being addressed. The same circuits eliminate latch-up and unpredictable characteristics, regardless whether transient voltages originate in the signal or supply. A similar circuit protects the digital input of the C-MOS device against static charges.

The HI-506A uses break-before-make switching to eliminate channel interference. The DI/C-MOS process, Harris says, makes possible an access time of 500 nanoseconds, and standby power requirement is only 7.5 milliwatts. More importantly, the company points out, the HI-506A continues to consume only 7.5 mW in the enabled mode.

The device requires a low supply current at high frequencies—only 4 milliamperes at a toggle rate of 1 megahertz. It is also easy to use because the analog signal range is

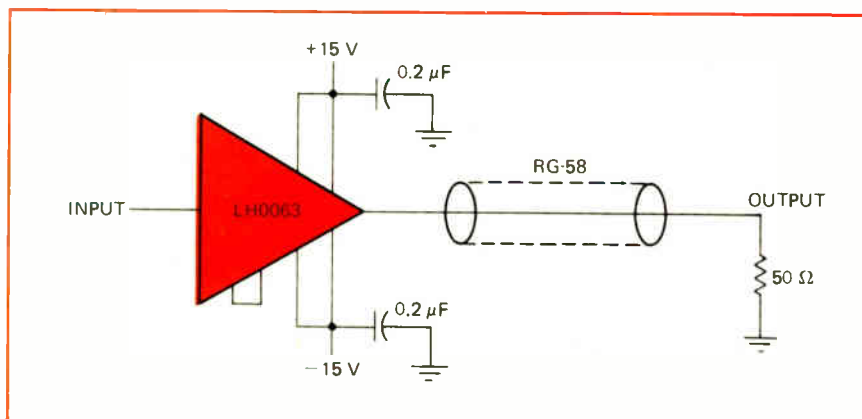

# Microprogramming made simple

The microprogramming Design Automation System you've always wished you had is here. Now.

You know that complex hardware is much simpler to design and much less costly to implement with microprogramming. Before now, though, there just haven't been any design aids available to you. Every step you took was time-consuming, laborious and frustrating. Thanks to a new and unique Design Automation System from SMS, the past problems of microprogramming are no more.

## Now, you can generate your own microprogramming software support system in less than a day!

Up to now, one of the biggest hang-ups in microprogramming was design support. Software development costs were extremely high. But today, the SMS Design Automation System offers you thousands of dollars in software — plus the hardware simulation aids and application notes you need — for considerably less than you would spend to develop your own. The SMS system allows microprogrammers to write their programs in assembly language (rather than binary) and reduces what was once a laborious months-long process to days. No matter what the design of your microprogrammed device, you can use the RAPID computer program to generate a cross assembler for your machine in just a few hours. You can write your microcode in a language and symbology meaningful to you. You select your own mnemonics and get symbolic addressing as well. The RAPID general purpose cross assembler will reduce the time required to generate and debug a microprogram by a factor of five!

## Now, you can generate a real-time hardware simulation system in just a few hours!

RAPID generates input for your own hardware simulation system, built around the SMS-1000A ROM Simulator. Once you've written your microprogram, you debug it on your existing system hardware. The SMS Simulator connects to your hardware, and you enter your microprograms into it. The 140 nanosecond access time lets you run your hardware at full system speed. Using the Simulator, you can conduct the hundreds of experiments necessary to locate errors quickly and easily. Your programs can then be simply updated using the assembler produced by RAPID. That's why the largest computer, calculator and peripherals manufacturers using the SMS system say they can't get along without it. Fill out and return the coupon below, and you'll be well on your way to making your microprogramming a breeze, too.

## Find out why 80% of all the SMS Design Automation Systems sold go to customers who already own one! Fill out the coupon or write or call

# sms

a subsidiary of Corning Glass Works

520 Clyde Ave., Mountain View, Ca. 94040. Phone (415) 964-5700

**Microprogramming can be much easier. Five application notes tell you how. 25,000 copies have already been requested. You can ask for yours. Here. Now.**

### PLEASE SEND APPLICATION NOTES ON

- Design of Microprogrammable Systems
- Debugging Microprogrammed Systems
- Economics of Microprogrammable Systems
- Design of a General Purpose Microcontroller
- Microprogramming Software Aids

### INTEREST IN INFORMATION IS FOR

- Developing microprogram for microcomputer chip sets
- Developing microprogram for new microcontrolled system design. Type of system: \_\_\_\_\_

\_\_\_\_\_  
\_\_\_\_\_  
\_\_\_\_\_

- File copy for future reference

### HARDWARE REQUIREMENTS FOR MICROPROGRAMMED EQUIPMENT START

- Within next 3 months
- Within 4 to 6 months
- More than 6 months

### I CAN'T WAIT FOR THE MAIL! PLEASE

- Phone me at \_\_\_\_\_
- Contact me to arrange a demonstration of the microprogrammed Design Automation System.

Name \_\_\_\_\_

Title \_\_\_\_\_

Company \_\_\_\_\_

Department \_\_\_\_\_ Mail Stop \_\_\_\_\_

Area Code \_\_\_\_\_ Phone Number \_\_\_\_\_

Street \_\_\_\_\_

City \_\_\_\_\_

State \_\_\_\_\_ Zip \_\_\_\_\_

**sms** scientific  
micro  
systems

520 Clyde Ave., Mountain View, Ca. 94040. (415) 964-5700

# Multi-Octave Double Balanced Mixers\*

## Now with Built-In IC Preamplifiers

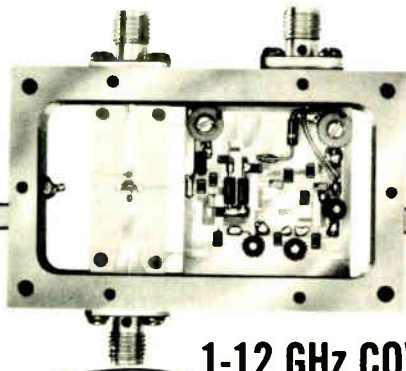

Now Available  
Series DM 1-18/10  
1-18 GHz Coverage

### 1-12 GHz COVERAGE IN A SINGLE MIXER

**LOW INTERMODULATION DISTORTION**  
**HIGH ISOLATION**  
**IF CENTER FREQUENCIES TO 200 MHz**  
**IF BANDWIDTHS TO 200 MHz**

| RF BAND         | MODEL NUMBER | IF FREQ/BW | PRICE |
|-----------------|--------------|------------|-------|
| 1.0 to 12.0 GHz | DM1-12/10A   | 60/10      | \$775 |
|                 | DM1-12/10B   | 60/20      | \$775 |
|                 | DM1-12/10C   | 30/10      | \$775 |
|                 | DM1-12/10D   | 70/10      | \$775 |
|                 | DM1-12/10HH  | 10 to 200  | \$850 |

**NOTES:**

1. LO-RF Isolation 20 db nominal
2. Noise Figure < 9 db to 8 GHz  
< 11 db to 12 GHz

**Also Available:**

- A wide variety of double balanced mixers providing octave and multi-octave coverage with and without preamps
- IC preamps with output capability to +20 dbm
- Gain and phase matched IC preamps with gain control

Write for technical performance curves and detailed data sheets.

\*U.S. Pat. #3,652,941

# RHG

## RHG ELECTRONICS LABORATORY · INC

161 EAST INDUSTRY COURT ■ DEER PARK  
NEW YORK 11729 ■ (516) 242-1100 ■ TWX 510-227-6083

for Reliability, Innovation and Service

## New products

specified as equal to the two power supplies, each value being  $\pm 15$  volts.

The HI-506A is designed for data acquisition, telemetry, process control, and general analog-switching applications. It comes in 28-pin dual in-line packages. In quantities of 100, the commercial version—the HI-506A-5—is priced at \$28.60 each; and the military type—HI-506A-2—at \$57.20.

Harris Semiconductor, Division of Harris-Intertype Corp., P.O. Box 883, Melbourne, Fla. 32901 [412]

C-MOS circuits include  
multiplexers, quad switches

A line of analog C-MOS circuits includes a single eight-channel analog multiplexer, the AD7501; a differential four-channel multiplexer, the AD7502; and an uncommitted quad analog switch, the AD7510. All devices are TTL-, DTL-, and C-MOS-compatible—the K and S versions featuring true TTL- and DTL-compatibility by requiring no pull-up resistors—and all are available for operation over the 0 to +75°C and the -55 to +125°C ranges. The units are designed for use in a-d and d-a converters, digital gain-controlled amplifiers, chopper amplifiers, in

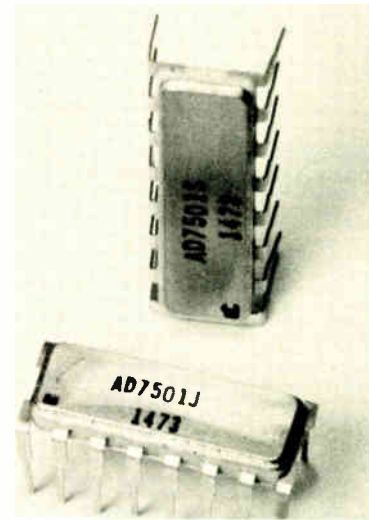

analog channel multiplexers for data acquisition systems, frequency multipliers and dividers, and digital filters. Price ranges from \$13 to \$44 for 1 to 49 pieces.

Analog Devices Inc., Route 1 Industrial Park, P.O. Box 280, Norwood, Mass. 02062 [413]

Digital prescalers simplify  
phase-locked-loop design

A two-modulus prescaler circuit called MC12012 contains three function blocks: a controllable divide-by-5/divide-by-6 prescaler, a divide-by-2 prescaler and a MECL-to-TTL translator. Together with the model MC12014 logic control block and suitable programmable counters, the MC12012 is said to make phase-locked-loop design easier by providing a direct programming technique to 200 MHz. The subsystem is an alternative to the construction of counter-divider chains frequently

# PROBLEM: Find thin-wall wire and cable with solder-, abrasion-, and cut-through-resistant insulation.

## SOLUTION: Specify Brand-Rex Vylink™ irradiated PVC products.

Vylink is the trade name for the Brand-Rex line of irradiated PVC wires and cables, supplied in a wide range of constructions, meeting applicable UL and military specifications.

**What is irradiation?** As applied to Vylink, irradiation is the exposure of wires insulated with specially formulated PVC compounds to high speed electron bombardment. The source of the electron beam is a high voltage accelerator.

**What is the effect of irradiation?** Conventional polyvinyl chloride is made up of long chain-like molecules. Where PVC insulation is to be irradiated, special additives are included in the formulation. Under high-speed electron bombardment, the additives are activated to form bridges between adjacent PVC chains. The result is a thermosetting material, which unlike conventional PVC (a thermoplastic) will not soften or melt on application of heat.

**What are the advantages of Vylink?** Vylink is a relatively low-cost, inherently tough insulation. It retains the flame resistance and good electrical properties of PVC, while offering substantial improvement in physical characteristics, even with reduced wall thickness. Vylink exhibits superior resistance to solder iron heat, cut-through, abrasion, and solvents. And it offers space and weight-saving advantages as well.

To engineering, it offers a wider choice of circuit design alternatives and higher wiring densities.

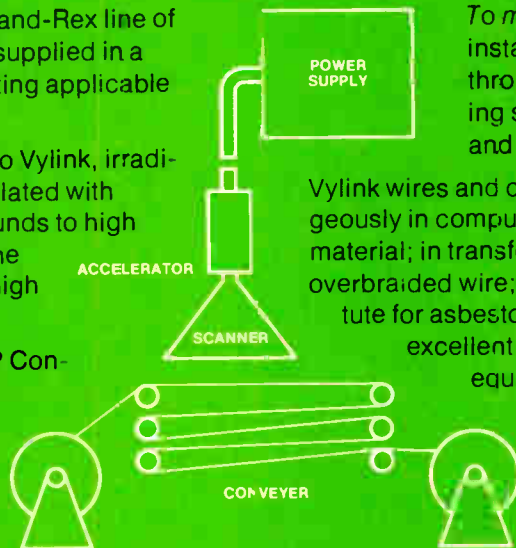

To manufacturing, it makes possible installed-cost savings in material and through a lower reject rate by minimizing shorts due to shrinkback, abrasion and poor solder resistance.

Vylink wires and cables may be used advantageously in computers, as an excellent internal wiring material; in transformers, as a replacement for textile overbraided wire; in electric ranges, as a substitute for asbestos covered wire; in TV sets, as an excellent high voltage lead; in military equipment, as a substitute for Types BN, E and EE, MIL-W-16878; and in telephone equipment, to save space and reduce incidence of circuit failure.



AS EXTRUDED

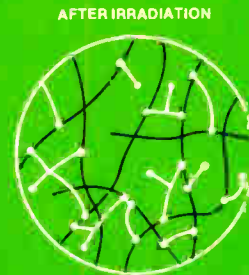

AFTER IRRADIATION

### A Comparison of Vylink with equivalent Military types and UL styles.

| TEST                               | REQUIREMENTS                             |                                       |                                  |
|------------------------------------|--|---------------------------------------|----------------------------------|
|                                    | MIL-W-16878 Type B                       | UL 1429, 1430, 1431, 1472, 1534, 1536 | Vylink                           |
| <b>Electrical Properties</b>       |  |                                       |                                  |
| Insulation Resistance min          | 500 megohms-M*                           | 2.5 megohms-M*                        | 1500 megohms-M*                  |
| Dielectric Constant @ 1 MHz        | Not given                                | Not given                             | 2.7                              |
| <b>Physical Properties</b>         |  |                                       |                                  |
| Unaged Insulation Tensile Strength | 1500 psi                                 | 1500 psi                              | 4000 psi                         |
| Elongation                         | 100%                                     | 100%                                  | 150%                             |
| <b>Solder Iron Resistance</b>      | Not given                                | Not given                             | 600° F. 5 minutes max.           |
| <b>Flammability</b>                | 45° angle 30 seconds max. 3" travel max. | Horizontal 1" per minute max. travel  | Vertical 1 minute max. No travel |
| <b>Cold Bend</b>                   | 4 hrs./-54° C 1" or 2" mandrel*          | 1 hr./-10° C 1/16" to .563"           | 4 hrs./-54° C 1" or 2" mandrel*  |

\*Varies with size

To learn more about Vylink, and how it can help in the design, production and trouble-free operation of your products, write Brand-Rex Co., Dept. VY, Willimantic, Conn. 06226.

## BRAND-REX

4,000 solutions in search of a problem.

Circle 147 on reader service card

# Forecast: Warmer tonight with Northern Electric and Plenco.

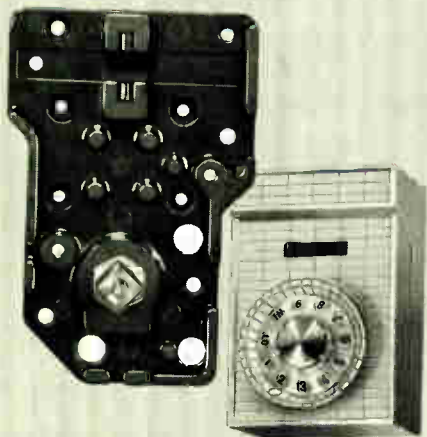

Everything's coming up cozy when the control is turned on for the luxurious blankets produced by Northern Electric Company, Chicago, world's largest manufacturer of electric blankets.

The terminal board used for mounting the controls of this attractive control housing is molded of our Plenco 512 Black phenolic compound. A general-purpose compound made with fast-cure, two-stage resins for efficient production

with all molding techniques, Plenco 512 offers a balance of physical and electrical properties approved for use in a wide variety of applications. Name yours.

**PLENCO**  
THERMOSET PLASTICS

PLASTICS ENGINEERING COMPANY  
Sheboygan, Wisconsin 53081

Through Plenco research . . . a wide range of ready-made or custom-formulated phenolic, melamine, epoxy and alkyd thermoset molding compounds, and industrial resins.

## New products

used in the feedback loop of digital phase-locked loops. Price of the MC12012 two-modulus prescaler is from \$13 to \$19.50, depending on quantity; and the price of the control-logic circuit ranges from \$4.25 to \$6.40.

Motorola Inc., Semiconductor Products Division, Box 20924, Phoenix, Ariz. 85036 [414]

Darlington amplifier switches  
5 amperes at 450 V in 500 ns

A line of monolithic Darlington amplifiers is capable of switching 5 amperes at 450 volts in 500 nanoseconds. Applications include motor drives, off-line switching power sup-

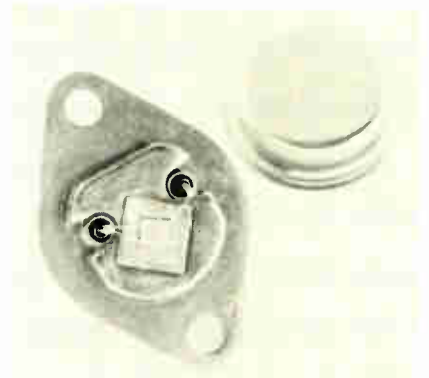

plies, and consumer equipment such as TV sweep circuits. The units are designated SVT6251, and are priced at \$6.75 in 100-lots.

TRW Semiconductors, 14520 Aviation Blvd., Lawndale, Calif. 90260 [415]

Bus line driver-receiver is  
for party-line operation

With drive capabilities said to be higher than in similar devices, a combination bus line driver and receiver is designed for party-line operations. The Am26S12 and the Am26S12A transceivers, built with Schottky-clamped transistors, offer driver current-sinking capability of 100 milliamperes at a maximum of 0.8 volt. This feature, coupled with the high input impedance of the receivers, enables as many as 200 devices to be connected onto a 100-ohm double terminated bus line. Price of the Am26S12 and the



# Excellon

## Mark III. It's more sophisticated than the Monomatic/7.

When it comes to p.c. drilling systems, nobody can compete with Excellon.

So we've decided to compete with ourselves. Our Mark III against our Monomatic/7.

Which is best for you? Judge for yourself.

The Mark III is the most advanced p.c. drilling system in the industry today, designed to give you the *highest* production rates possible for the *lowest* hole costs possible.

It's directed by a General Automation SPC-12/15 Stored Program Control. The SPC-12/15, with 16K memory, handles a variety of code formats, and is plug compatible with central computers. It offers step and repeat, repeat pattern, stored



pattern (16 and 14 pin dual in-line, 8 pin L package), automatic table offsets, mirror image and automatic rewind.

Table travel speed of the Mark III is 400 ipm on each axis. A computer-driven,

high torque, low-inertia servo motor provides *instant* acceleration for unmatched production.

The Mark III can produce drill hit rates of 200 per minute. And we're talking about *quality* holes at .25-inch movement and .002 chip load.

AC, variable-frequency, air-bearing spindle motors reach 80,000 rpm. And spindle feed rates range from 20 to 250 ipm.

If your application calls for high quality, high production rates and high utilization, the Mark III is best for you.

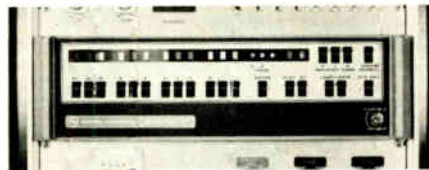

The General Automation SPC-12/15

# vs. Excellon

## Monomatic/7. It's more versatile than the Mark III.

If your application calls for medium to high production, the Monomatic/7 is best for you.

It's designed to be economical for short runs and highly profitable for long runs.

And it's designed to grow with your growing production needs.

The NC-controlled Monomatic/7 accommodates from one to seven spindles. You can start out with one or two, using the standard work table. Then you can add more spindles and an extension table that increases the work dimensions to 3 stacks of 12 3/4" x 25 1/2" panels.

Like the Mark III, the Monomatic/7 can be equipped with optional 80,000 rpm

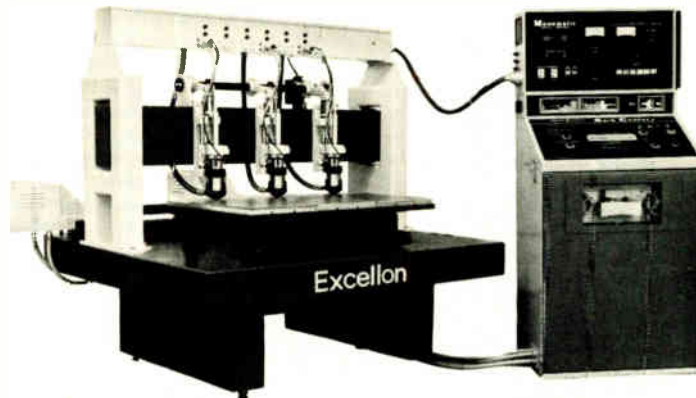

air-bearing spindle motors.

Of course, it's a little less sophisticated than the Mark III. But then it's a little less expensive, too.

For a competitive costs analysis of the Monomatic/7 and Mark III, and complete specifications, call Dick Hogan, Sales Manager, at (213) 325-8000.

Or write him at the address below.

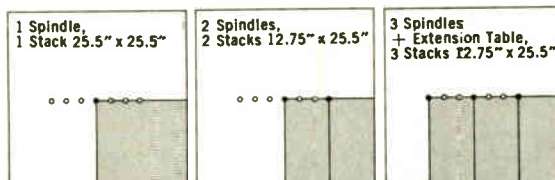

• Active Spindle = Inactive or Vacant



**Excellon**

EXCELLON INDUSTRIES  
21915 GANNIER / TORRANCE,  
CALIFORNIA 90505

Phone: (213) 325-8000

Telex: 674562 - Cable: EXCELLON TORRANCE

Excellon Sales and Service in ENGLAND • FRANCE • SCANDINAVIA  
• W. GERMANY • SPAIN • HOLLAND • ITALY • ARGENTINA • ISRAEL  
• AUSTRALIA • HONG KONG • TAIWAN • JAPAN

# OUR CLAIM TO FAME... TRIMLINE ENCLOSURES

- RUGGED—FUNCTIONAL CONSTRUCTION
- ESTHETICS KEYED TO MODERN SYSTEMS
  - ECONOMICAL PRICING
- PROMPT SERVICE & AVAILABILITY

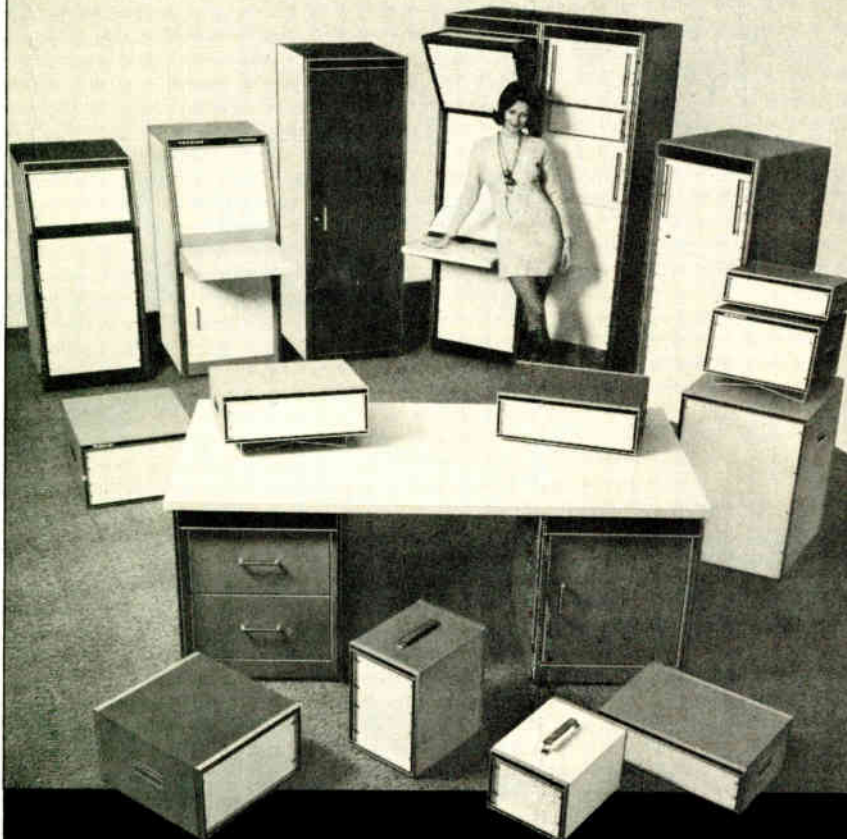

INSTRUMENT CASES—TIC SERIES

TVA Series Vertical Assembly—  
Construction Details  
(1 Frame, 2 End Panels, Rear Door)

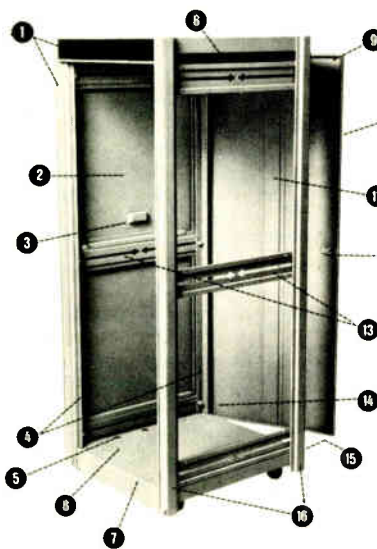

1. Trim: extruded anodized aluminum with textured vinyl inlays
2. Outside removable flush end panels (16 ga.)
3. Recessed hand grip for panel removal
4. 2 pr. panel mounting angles, fully adjustable front to rear with tapped 10-32 holes on EIA & WE Standards spacing (12 ga.)
5. 1" dia. holes for cable entry beneath base
6. Recessed caster mounting holes
7. 1 piece formed steel base provides for heavy equipment mounting area and concealed caster mounting (14 ga.)
8. 1 piece solid top for extra rigidity and squareness (14 ga.)
9. Foam gasketing (3 sides)
10. Magnetic closure gasket
11. Door stiffener channel
12. Keyed latch and brushed aluminum pull handle
13. Horizontal cross-brace and panel mounting angle supports
14. Quick release, spring loaded door hinges (top and bottom)
15. 1/8" dia. knock-outs for rear cable entry underneath rear door
16. Formed steel uprights (14 ga.) provide 1/2" recess to panel mounting angles

All features shown are standard in the Trimline TVA Series  
Welded, formed steel construction

Complete catalog and prices on request



**PREMIER METAL PRODUCTS COMPANY**  
337 Manida St., Bronx, N.Y. 10474/(212) 991-6600

## New products

Am26S12A range from \$1.95 to \$6.40, depending on temperature range and packaging.

Advanced Micro Devices Inc., 901 Thompson Pl., Sunnyvale, Calif. 94086 [416]

Quad comparator works with MOS, bipolar ICs

The LM339 quad comparator is compatible with MOS, C-MOS and bipolar circuits. It can operate over a wide range of power-supply voltages—from 2 to 36 volts—on a single supply or from  $\pm 1$  to  $\pm 18$  volts on dual supplies. The input common-mode voltage range includes ground, even on a single supply, enabling it to compare voltages at or below ground potential. Input offset voltage on all four comparators is typically 2 millivolts and is guaranteed to be a maximum of 5 mV at room temperature. Price is \$3.80 in quantities of 100.

National Semiconductor Corp., 2900 Semiconductor Dr., Santa Clara, Calif. 95051

Power transistors are rated at 250 watts

The 2N6257, 2N6258, and 2N6259 are single-diffused power transistors packaged in TO-3 cases. The units can dissipate 150 to 250 watts at from 50 to 170 volts and currents up to 30 amperes. The transistors also



feature high forward- and reverse-biased second-breakdown ratings. Prices in 100-lots are \$1.80 for the 57, \$2.70 for the 58, and \$4.02 for the 59.

Silicon Transistor Corp., Katrina Rd., Chelmsford, Mass. 01824 [418]

# 5000 production-line types make us dominant in discretetes

Our standard line of discrete semiconductor devices includes more than 5000 separate types. More than 2000 of them have been introduced within the last two years. Newer entries include 3 A rectifiers with PRVs to 1200 V; tuning diodes; 400 mW, 500 mW and 1 W zeners in glass hermetic packages and monolithic 16-diode arrays in ceramic DIPs made with the latest ion implantation techniques. Among the old standbys are silicon transistors, 4-layer diodes and just about every type of silicon and germanium switching diode ever offered by anybody anywhere. Get with the people who still think discretetes are important — write for details today!

## We're doers, not talkers!

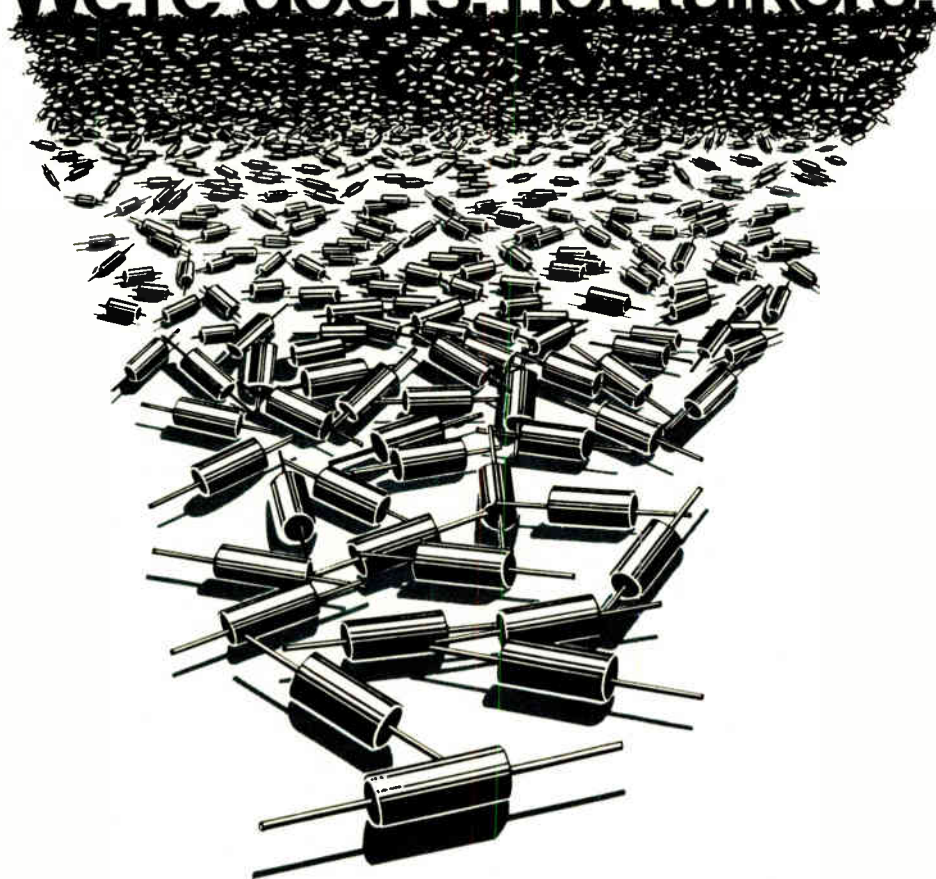

# semiconductors

# ITT

ITT Semiconductors is a division of International Telephone and Telegraph Corporation, 500 Broadway, Lawrence, Mass. 08142. Phone 617-688-1881.  
Factories in West Palm Beach, Florida • Lawrence, Massachusetts • Footscray, England • Colmar, France • Freiburg, Germany • Cascais, Portugal • Sydney, Australia.

# SURPRISE!

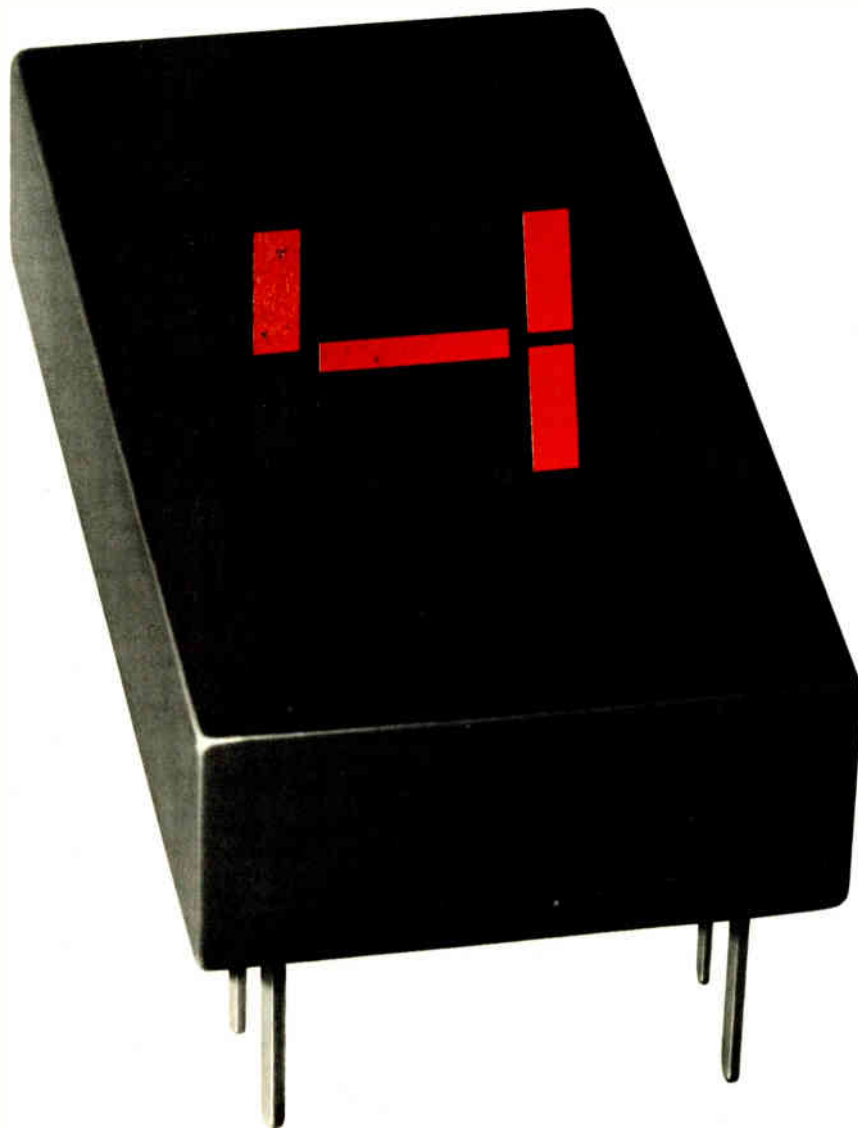

## HP's new \$2.95\* displays!

Now a great looking solid-state display for only \$2.95.\* HP's new low-cost digit is really something to see. Wide viewing angle and bright, evenly-lighted segments offer excellent readability.

Designed for commercial applications, the 5082-7730 Series is a pin-for-pin replacement for other displays such as the MAN 1, MAN 7, DL 10 and DL 707 and offers a large 7-segment 0.3 inch character with right or left hand decimal points. Quality? Still the best around. Contact your nearby HP distributor for immediate delivery. Or write us for more details.

This display is worth a closer look.

01326

\*1K quantity; Domestic USA Price Only.

HEWLETT  PACKARD

Sales, service and support in 172 centers in 65 countries.  
Pat. Alt. Cal form 94304. Off. reg. in pr. no. pat. c. l. es throughout the U.S.

152 Circle 152 on reader service card

Electronics/June 21, 1973

# SURPRISE! SURPRISE! SURPRISE!

Our new \$2.95 displays  
are in stock now!

Distributor Stocking Locations:

## SCHWEBER ELECTRONICS

Hollywood, Florida  
(305) 927-0511  
Elk Grove Village, Illinois  
(312) 593-2740  
Troy, Michigan  
(313) 583-9242  
Rockville, Maryland  
(301) 881-2970  
Waltham, Massachusetts  
(617) 890-8484  
Rochester, New York  
(716) 328-4180  
Westbury, New York  
(516) 334-7474  
Somerset, New Jersey  
(201) 469-6008  
Beachwood, Ohio  
(216) 464-2970

## WYLE DISTRIBUTION GROUP

Liberty Electronics/Arizona  
Phoenix, Arizona (602) 264-4438  
Liberty Electronics  
El Segundo, California (213) 322-8100  
Elmar Electronics  
Mt. View, California (415) 961-3611  
Western Radio  
San Diego, California (714) 235-6571  
Elmar Electronics  
Commerce City, Colorado (303) 287-9611  
Liberty Electronics/Northwest  
Seattle, Washington (206) 763-8200

## HALL-MARK ELECTRONICS

Huntsville, Alabama  
(205) 539-0691  
Lenexa, Kansas  
(913) 888-4747  
St. Louis, Missouri  
(314) 521-3800  
Raleigh, North Carolina  
(919) 832-4465  
Oklahoma City, Oklahoma  
ENterprise 50094  
Tulsa, Oklahoma  
(918) 835-8458  
Austin, Texas  
(512) 454-4839  
Dallas, Texas  
(214) 231-6111  
Houston, Texas  
(713) 781-6100

## EUROPE

**Celdis Ltd.**  
37-39 Loverock Road, READING, Berks, England  
Tel.: READING 58 22 11  
**I.S.C. France**  
20, rue Gambetta, 92-Boulogne, France  
Tel.: 604.52.75  
**Ingenieurbüro Dreyer**  
238 Schleswig, Flensburger Strasse 3, Germany  
Tel.: (04621) 2 31 21  
**EBV Elektronik**  
8 Munich 2, Gabriel-Max-Strasse 90  
Tel.: (0811) 644055-8  
6 Frankfurt/Main 1, Myliusstrasse 54  
Tel.: (0611) 720416-18

HEWLETT  PACKARD

## New products

Packaging & production

## Memory tester is flexible

Computer-operated system  
is designed specifically  
for semiconductor units

Users of semiconductor memories have had two main alternatives when buying test equipment. One route is a dedicated, desk-top tester, programmed by a read-only memory. But it lacks the ability to perform more sophisticated functions, such as data logging and multiplexing. The other avenue is using a general-purpose, computer-operated test system that can perform such functions. But it is much more expensive and performs many more operations than are necessary for memory testing. Now Teradyne Inc. has introduced a computer-operated system, the J384, which is designed exclusively for semiconductor memories. It performs function and parameter tests on static and dynamic MOS and fast bipolar memories of all types.

At the heart of the system is a Teradyne computer, and because the J384 is computer-controlled, the user can obtain all the standard test patterns and wide flexibility in designing patterns, the company says. The computer can support several satellites, which in turn can support up to four multiplex test stations, and each station can handle memories with up to 4,096 four-bit words.

Drive levels are programable in two ranges for testing bipolar and MOS memories, and there is a dc measuring system for full parameter testing. The cable drive has the ability to test at 20 megahertz at the probes. In addition, closed- or open-loop timing can be used at each station.

But Teradyne says the most important technical feature of the J384 is what the company calls vector-list autocalibration that automatically compensates for time delays

inherent in the system and insures accurate timing, either closed- or open-loop, at each test station. Testing semiconductor memories accurately depends on having very precise time intervals between signals at the probe. But since each test station has cables of different lengths running to it from the computer, and different tests run on different stations, it can be difficult to get accurate time intervals because of system delays. Teradyne claims to have solved this problem by letting the user define the interval at the test station through use of an oscilloscope or counter. When the operator has determined, say, a 2-nanosecond interval, he pushes a button that sets an automatic calibration list at the station. Thereafter the computer knows what it must generate in order to deliver the time wanted—for instance it may take 2.7 ns at the computer to deliver 2 ns at the probe.

Four clock pulses are each directly programable both in delay and duration over a 3-to-1 range established by an interchangeable range calibrator. All time intervals are defined only by passive components for added stability.

Teradyne says the architecture of the J384 has been designed for the lowest cost per test station. A single-station system costs \$80,000, while a four-station system costs \$125.

Teradyne Inc., 183 Essex Street, Boston, Mass. 02111 [391]

Packages come with  
pre-bent leads

Pre-bent leads are offered on a group of standard package configurations consisting of 24-, 28- and 40-

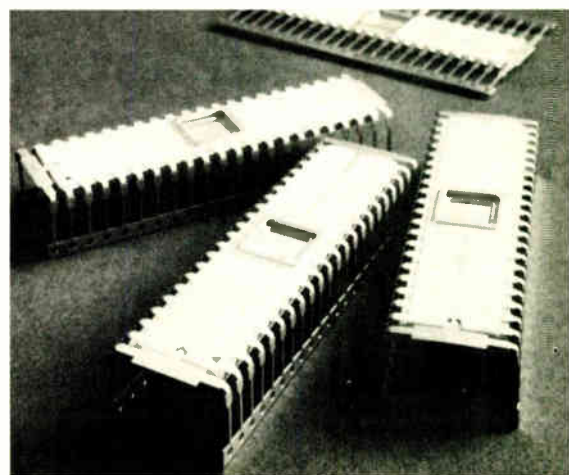

## Self-Sealing Fasteners that fight clean.

Environmental contamination can play havoc with equipment. So play it smart: protect equipment performance with leak-proof hardware that seals tight against air, gas, and fluid pressures over 10,000 psi.

APM makes protection a family affair with Seelskrews®, Seelbolts®, Seelrivits® and Adjust-A-Seels® —the fasteners with the patented

built-in bodyguard under the head.

Contained in a precision-tooled groove under the head, a silicone rubber O-ring compresses with installation to form a positive metal-to-metal seal—vibration can't budge. Usable in any standard dimension hole; reusable again and again.

Write or phone for free literature, price information and samples: APM-Hexseal 44 Honeck St. Englewood, N.J. 07631

(201) 569-5700



**APM-HEXSEAL**  
DIVISION OF APM CORPORATION

**THE CLEAN FIGHTERS.**



Circle 154 on reader service card

## New products

lead top-brazed packages on volume orders, and at a slight additional cost on smaller orders. In addition to assuring an end to yield losses during final forming operations, this service enables customers to process both top- and side-brazed packages on one line.

Metalized Ceramics Corp., Huntington Industrial Park, 100 Niantic Ave., Providence, R.I. 02907 [393]

## Jumpers provide connections between pc boards

A family of flexible jumpers provides electrical connections between printed-circuit boards. The jumper construction consists of two rows of round or flat copper conductors between two thin sheets of insulation. The sheets are bonded together to create the multiconductor jumper. A

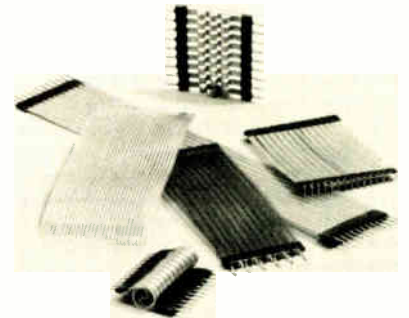

choice of termination leads is available, including round pins and flat leads. Price is 80 cents for a 10-conductor jumper 3 inches long.

Masterite Industries, 2841 Lomita Blvd., Torrance, Calif. 90505 [394]

## Sockets 0.150 inch high offer 28 or 40 pins

A 28- and 40-pin low-profile DIP solder socket for high-density packaging of large-scale devices features a 0.150-inch over-all height. Other features are plastic barriers to eliminate solder-wicking and a closed entry insulator for easy device-insertion. Contacts are heat-treated beryllium copper, gold-plated and housed in a glass-filled nylon base. The 28-pin sockets are priced at

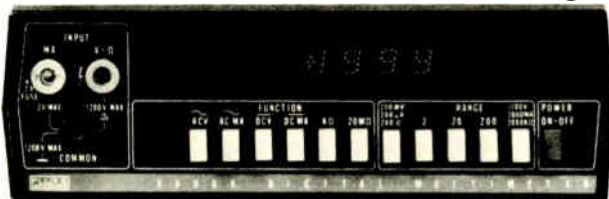

## Think of it as the best tester in your bag. Only \$299

Now you can get a high performance Model 8000A Digital V.O.M. from Fluke, America's foremost maker of quality digital multimeters, especially designed for TV, radio, stereo and audio service. No other digital V.O.M. gives you the resistance range to check breakers and switches, the high resolution voltage to look at emitter base and other transistor voltages, excellent ac accuracy and full accuracy with a 30 second warm-up.

Measures in 26 ranges 100  $\mu$ V to 1200 V, 0.1  $\mu$ A to 2A, and 100 milli $\Omega$  to 20 meg $\Omega$  with a basic dc accuracy of 0.1%. Full year guarantee. Low cost options include rechargeable battery pack, printer output, deluxe test leads, HV, RF & 600-amp ac current probes, carrying case, and rack mount. Unique self zero eliminates offset uncertainty. Electronics securely mounted in high-impact case. Service centers throughout U.S., Canada, Europe and Far East for 48-hour turnaround repair.



P.O. Box 7428,  
Seattle, Washington 98133.

Get all the details from your nearest Fluke sales office. Dial toll-free 800-426-0361 for address of office nearest you.

# This is a social problem.

# This is what we're doing about it.

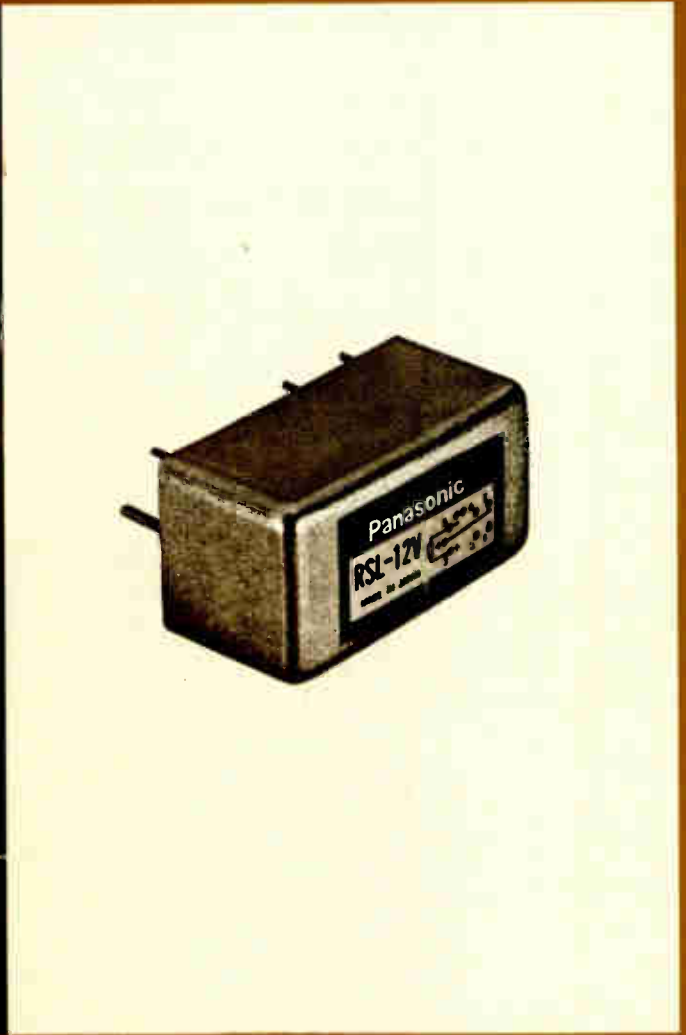

A lot of today's drug addicts are pretty clever. Clever enough to foil the burglar alarm that might have protected this drug store.

A better burglar alarm can't do anything to cure society's ills. But it could reduce some of the annoying symptoms while the search for cures goes on. Symptoms like the \$958 million American businesses lose each year to break-in artists who may wreck a pharmacy in search of drugs.

Panasonic makes a unique relay, available with a latching function (memory), that's small and inexpensive enough to be incorporated into improved bur-

glar alarms. The R relay. A reed relay of revolutionary design and construction that has features no other relay has. Because it utilizes an easily manufactured plastic bobbin instead of the expensive glass capsule used in every other reed relay. And it has a mechanical life of a billion operations performed at the amazing rate of 500 per second. It can operate with an extraordinarily wide range of current. Panasonic's R relay (type RH-12V) is now being used by the 3M Company of St. Paul, Minnesota in their commercial burglar alarm system.

The R relay. One of the many compo-

nents we manufacture. Including one you may be in the market for.

Or perhaps you need something we aren't presently manufacturing. No problem. More than likely we have the capability to conceive, design, and manufacture it. With the speed, efficiency, and quality you expect from a world leading electronics manufacturer. In fact, we may even be working on a new idea or introducing a re-designed component that fits your particular specs right now.

Panasonic prides itself on its ability to supply virtually any component you happen to be in the market for. We'd like to help you. Call us. (212) 973-8210.

Matsushita Electric Corp. of America  
Industrial Division  
200 Park Avenue  
New York, New York 10017

**Panasonic**  
our technology is all around you

Circle 155 on reader service card

# LAY YOUR CARDS on the table ...



Don't "throw-in" a potentially winning circuit design just because you need a special timing or current switching component. Adlake offers mercury wetted contact relays, dry reed relays, and load relays . . . custom motor start-winding timers, fault grounding switches, pulse start dual time delays, and bistable AC/DC switches as standard catalog items . . . or how about a full line of hybrid timers, transfer timers, pulse latches, and power pulse latches for special applications.

You need **RELIABLE, PRACTICAL, and ECONOMICAL** special components. And Adlake's design engineers, with decades of experience, can tell you if a special current or timer device can be built reliably, practically, and at reasonable cost — 24 to 48 hour turn-around time is not unusual.

*Before you decide to  
"reshuffle" your circuit design  
... CONTACT ADLAKE ...*

*our innovative engineers can design  
and build the special  
component  
you need.*

### PULSE START DUAL TIME DELAY

Provides two preset time delay functions to a common load. A momentary "switch-closure (or pulse)" to the selected timing terminal starts the output circuit (120 VAC, 5A). At the pre-selected time, the circuit switches off.



### POWER PULSE LATCHES, SERIES HR-1000

Power Pulse Latches are designed for main power switching control of machine tools, assembly line systems, display sign flasher/control systems, and other power switching applications requiring long life, highly reliable, heavy current switching. With rated positive "gate" voltage applied to the all solid state input circuit, successive control pulses will alternately switch the load contacts "on" and "off". Output is DPST (N.O. or N.C.) high current mercury displacement switch contacts which will switch up to 100 amps per pole at 120 VAC.

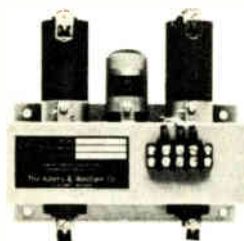

### MOTOR START WINDING TIMER

Dependable silent delay timing of start winding contactor. Same unit operates on voltage input from 120 to 460 V.A.C. Output capable of controlling up to 220 V.A.C. contactor coil. All solid state output insensitive to shock, dirt and most other environmental influences.



**ADLAKE CAN GIVE YOU AN UNBEATABLE HAND!**

**THE ADAMS & WESTLAKE COMPANY**



ELKHART INDIANA 46514  
219 . 264 1141  
TELEX 25 8458  
CABLE ADLAKE

## New products

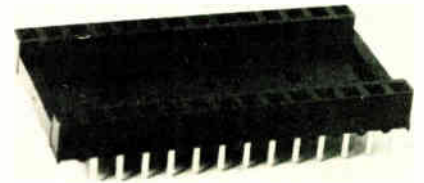

\$1.07 each in 100-lots, the 40-pin devices at \$1.51.

Stanford Applied Engineering, 340 Martin Ave, Santa Clara, Calif. [395]

Mounting pads replace  
prepunched circuit boards

Mini-Mounts are mounting pads that permit rapid assembly of almost any electronic component on a solid ground plane. The Mini-Mounts require no holes to be drilled in the ground plane, or

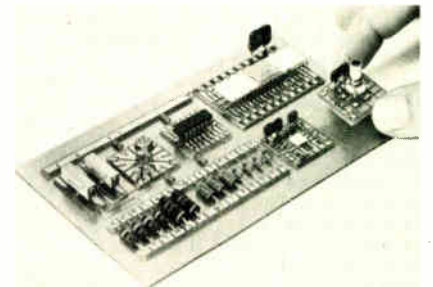

mounting pads, to produce a working circuit ready for environmental testing. A triple layer of adhesive and polyester film on the mounting side of the G-10 epoxy pad produces a rigid, low-leakage structure. Christiansen Radio Inc., 3034 Nestall, Laguna Beach, Calif. 92651 [396]

Wrapping head interconnects  
wiring on back panels

A semiautomatic sideload wire-wrapping head for the interconnection of wiring on back panels incorporates a teardrop-shaped opening in the side of the bit to provide faster operation. The bit retains the advantages of an endloading bit such as a stationary outer sleeve and bottoming-out of the wire as it is loaded. This eliminates visual judgment of insulation inserted into the bit by the operator, as is required on



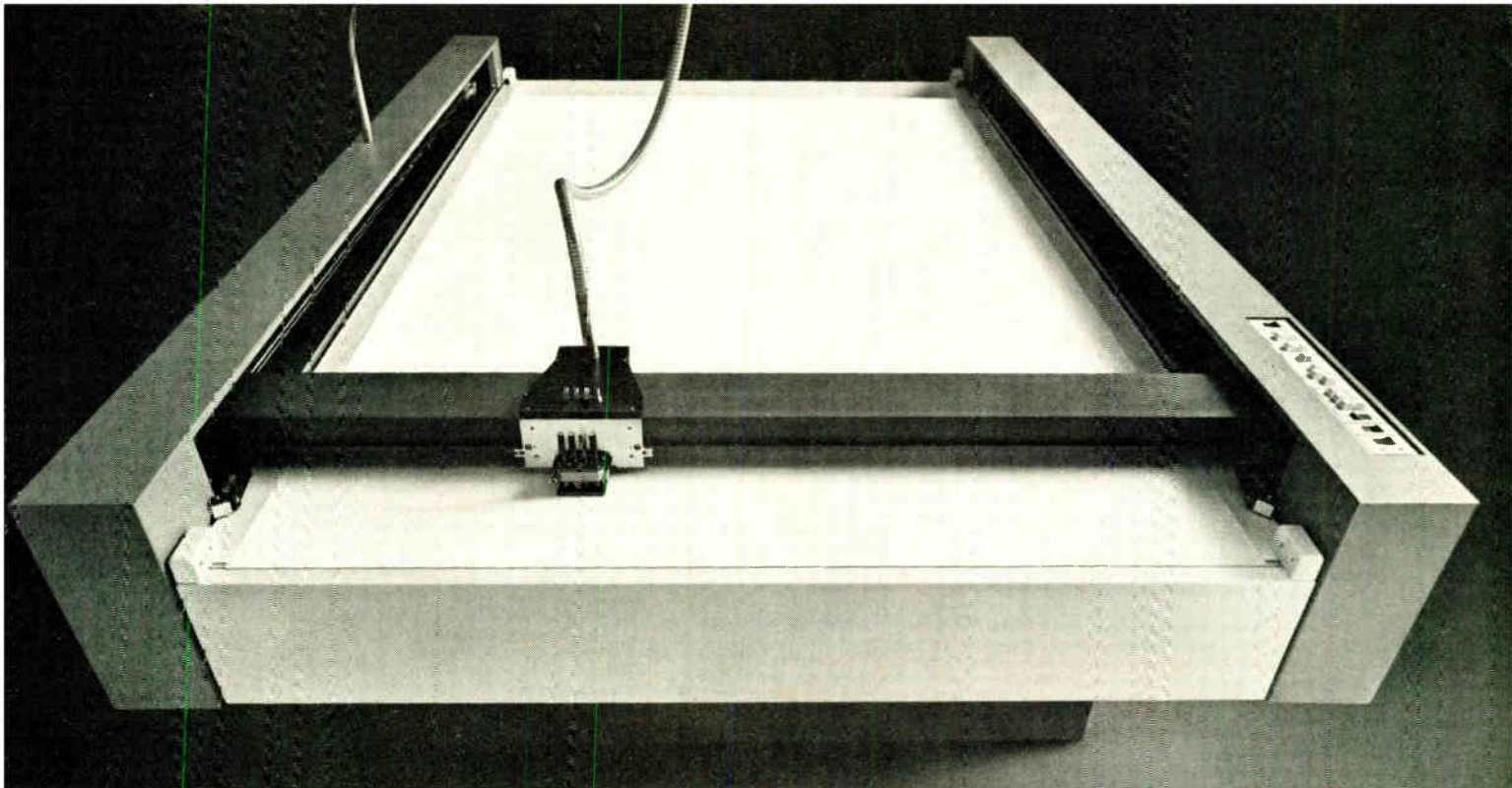

## The four-fingered fast-drawing kid is coming to town.

We call it the 748. It's big. And it's fast.

Its 4 inking pens move at speeds over 40 inches a second. That's faster than ink flows, so we had to figure out a pressure inking system that lets the ink catch up to the pens.

If you make integrated circuits or maps. Or if you have precision drafting needs, this is the new tool.

The 748's plotting area is 48"x82". It can scribe

coated materials and cut strippable film. At peak speeds!

The quality of its line is not impaired by its incredible speed. And like all CalComp flatbed plotters, the new 748 offers easy-to-use software for most computers.

We service it in 29 countries. But the way we've made it, you won't be calling us very often.

Do call us to see it. Our number is (714) 821-2011. Or

write California Computer Products, Inc., EM-M6-73, 2411 West La Palma Avenue, Anaheim, California 92801.



**CALCOMP**

your best value is a

# TRYGON

## SYSTRON-DONNER POWER SUPPLY

QUALITY/RELIABILITY/SERVICE



DPH from  
**\$875**

**DIGITAL POWER SUPPLY PROGRAMMER**  
A true digital-to-analog interface  
between a computer output and programmable  
DC power supply

- Use for computer controlled test sets
- Use for complex process control operations
- Use for automated production routines

**FEATURES** • Addressable memory stores up to 16 functions from only one computer I/O circuit • fully isolated to eliminate ground loops • self-verification option signals parity check and overcurrent • single or dual channel programmer in 5¼" half rack package • binary coded decimal input • 3-digit resolution • provides both digital and analog output.

*Write directly or call your local Scientific-Devices sales office for complete specifications and applications.*

**TRYGON ELECTRONICS**  
SUBSIDIARY

**SYSTRON**  **DONNER**

CORPORATION

1200 Shames Drive, Westbury, N.Y. 11590 (516) 997-6200

The Systron-Donner Instruments Group:

Concord Instruments  Computer Systems  Datapulse  Kruse Electronics  Microwave  Trygon Electronics

### New products



other types of sideloaded bits.  
Synergistic Products Inc., 1902 McGaw  
Ave., Irvine, Calif. 92705 [397]

Disconnect terminals are  
fully insulated

Straight and 90° flag-configuration female disconnect terminals, designated Sta-Kon, have full insulation covering the terminal portion as well as the wire and barrel. The insulated terminals provide increased reliability by insulating the full connection against accidental contacts.



In addition, the transparent polyvinyl insulation makes periodic wire inspection easier; this also provides a method of splicing where voltage and application permit, and it simplifies stocking of parts.

The Thomas & Betts Co., 36 Butler St., Elizabeth, N.J. [398]

Wave-solder system offers  
inclinable conveyor

The model 616 wave-solder system offers an inclinable conveyor whose angle of incline is adjustable from

# Celanex. It even sounds electrical.

For electrical-electronic applications, Celanex thermoplastic polyester performs small wonders. One reason is that glass-filled Celanex combines all the advantages of DAP, alkyds and phenolics. With none of their disadvantages.

The parts illustrated feature some other good reasons for choosing Celanex. In the Airpax slide switch (a), for example, Celanex SE-O grade combines excellent electrical properties with wear resistance, low coefficient of friction. And it received sole support approval from UL.

In the Permonite TV cathode ray tube socket (b), Celanex 3310 replaced polysulfone. Celanex withstands high voltage and high temperatures. Remains dimensionally stable. Replacing alkyds and nylons, Celanex combines fine electrical properties with fast

cycling and ease of molding in this high voltage contactor coil (c) by Essex International Controls Division, Inc. And the small grey TV tuner shaft (d) takes good advantage of another Celanex property—the lowest moisture absorption of any high-strength engineering plastic.

Celanex is also the high-strength insulating material for Magnum Electric Corporation's new, slimmer terminal strips (e). And Celanex's high dielectric strength assures an RMS breakdown voltage of more than 3,000 volts for the thin barriers between terminals. Celanex also contributes high arc track resistance and chemical inertness.

Plus all that, Celanex is one of the most processable plastics available. Molding is easier. Cycles faster. Which adds up to a very remarkable, performance-



boosting, cost-saving engineering resin. Get the facts on Celanex. And on Celcon and Celanese Nylons. Write Celanese Plastics Co., Dept. X-607, 550 Broad Street, Newark, N. J. 07102.

Celanese Plastics Company is a division of Celanese Corporation. Canadian Affiliate: Celanese Canada Ltd. Export: Amcel Co., Inc., and Pan Amcel Co., Inc., 522 Fifth Ave., New York 10031.

## Celanex: the original thermoplastic polyester

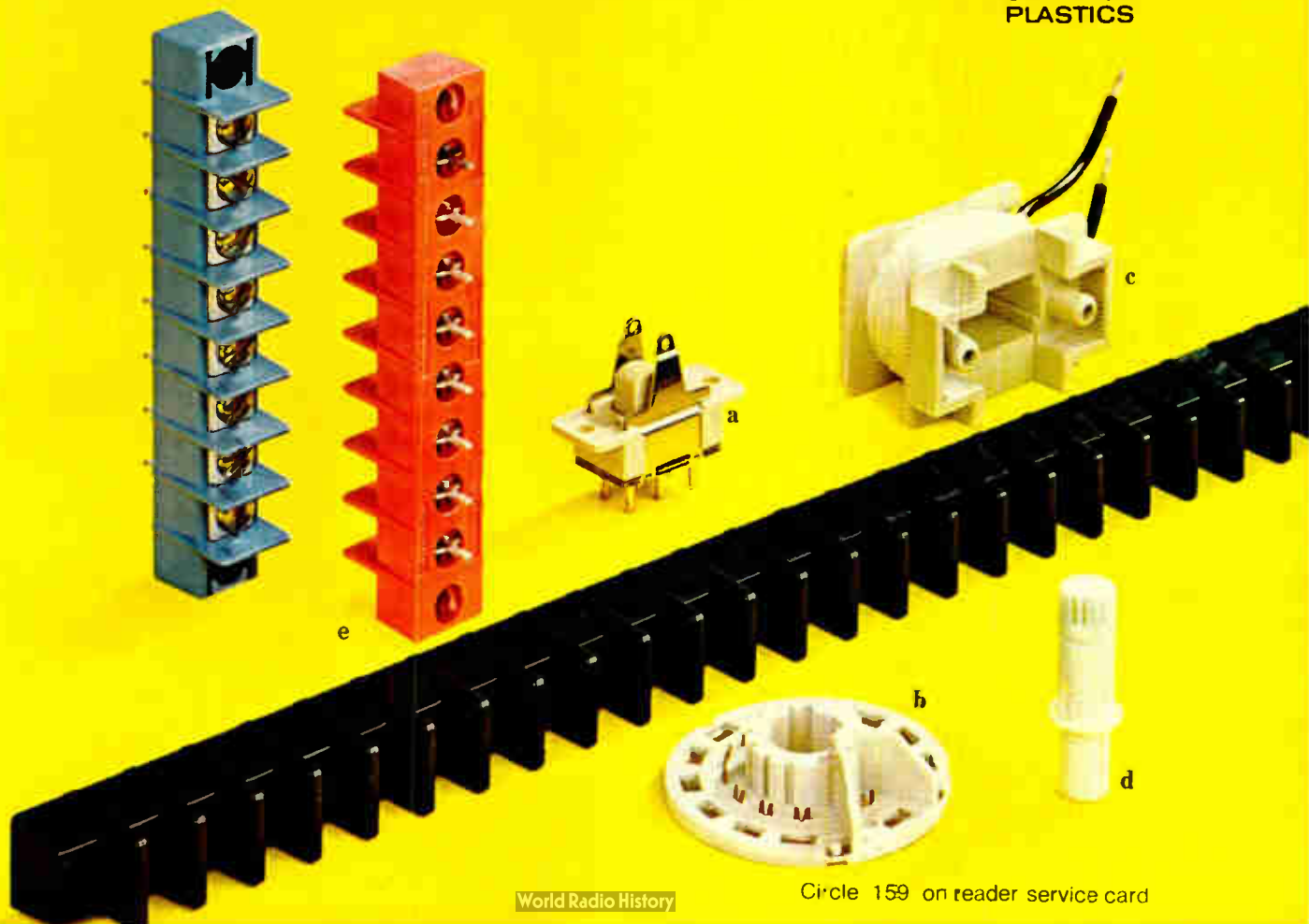

# Tarn-X<sup>®</sup>

## CLEANS INSTANTLY!

**If you work with silver, gold, copper or platinum contacts, terminals, tuning controls or machine parts... Tarn-X is the fastest, most efficient and economical way to clean them for better contact and better solder preparation.**

Perhaps you have seen the Tarn-X commercials on television. When Tarn-X is touched to silver, gold, copper or platinum, the tarnish is instantly removed and the metal is cleaned. Hundreds of manufacturers of electronic equipment have already found Tarn-X to be the fastest, most effective way of cleaning contacts and terminals.

Here is what **ELECTRONIC MANUFACTURERS, TV and RADIO STATIONS** are saying:

*"We use Tarn-X on the production assembly lines to clean up the silver contacts and terminals so that they take solder better..."* TV Manufacturer

*"Product was used for silver-plated R.F. plumbing, high-powered radars and silver-plated tube sockets in high-powered, high frequency transmitters. It is very effective. We intend to use more..."*  
Don Wilburn, Ogilvie Electronics, Inc.

*"Tarn-X has been used to clean silver-plated tuning cavities and controls on our TV transmitter and on our A.M. and F.M. radio transmitter. Your product is the most economical, efficient and best we have found to date. Thank you for a fine product..."*  
James H. Mellor, WINK-TV

*"Product is used for cleaning silver-plated machine parts that are tarnished. It is very satisfactory. We will be using more..."*  
J. Rogers, Tanko Screw Products Corporation, Chicago

**FREE  
SAMPLE**

**Don't take our word for the effectiveness of Tarn-X. Send for a free 8 oz. sample and book price lists.**

**E**

TARN-X Jelmar Company  
One Illinois Center, Chicago, Illinois 60611  
Please send me, postpaid, a free sample of Tarn-X.

Name \_\_\_\_\_  
Company \_\_\_\_\_  
Address \_\_\_\_\_  
City \_\_\_\_\_  
State \_\_\_\_\_ Zip \_\_\_\_\_

## New products

the horizontal to a maximum of 10°. This permits either soldering at an incline, when a Lambda wave configuration is used, or on a horizontal plane when other standard wave configurations are used. The conveyor width is adjustable and the standard stations include a foam fluxer, preheater and model WSU

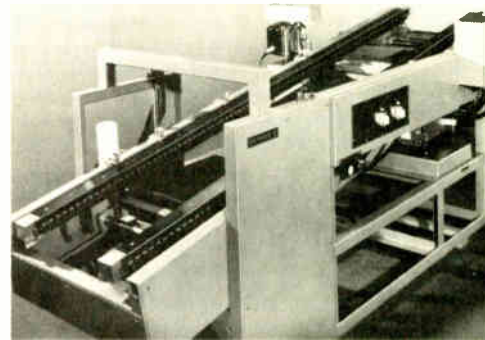

soldering unit. Each station has a variety of options available. Price is \$9,000 to \$25,000.

Electrovert Inc., 86 Hartford Ave., Mount Vernon, N.Y. 10553 [399]

Logic socket accepts any 14- or 16-pin DIP

The series 200 DIP-ER circuit logic pluggable socket and jumper accepts any standard 14- or 16-pin DIP. This allows, in one unit, jumper circuit versatility with plug-in capability. Up to 14 or 16 jumper wires can extend from either side, saving a board socket position. Various types of cable are available, and the wiring sequence is optional. Price of a 1-foot-long jumper ranges from \$5 to \$7 each for 1 to 10 pieces. Delivery is from stock.

Aries Electronics Inc., Box 231, Frenchtown, N.J. 08825 [400]

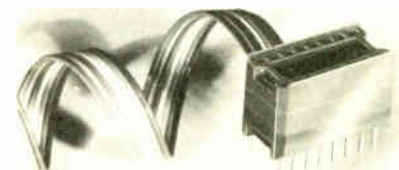



**Color enhances the legibility of your CRT displays and substantially speeds comprehension of the information being viewed.**

Four clearly distinguishable colors are obtained on the viewing screen of a CRT display by controlling the voltage of a single beam through a multiphosphor screen. These multiphosphor screen CRT's are particularly well suited for sophisticated displays (airborne, tactical, spaceborne, shipboard, etc.) where severe environmental conditions as well as high performance requirements are imposed.

| HV (KV) TYPE     | 7   | 9      | 11     | 13    | 15     | 17    |
|------------------|-----|--------|--------|-------|--------|-------|
| E 20             | Red | Orange | Yellow | Green |        |       |
| E 21             | Red | Orange |        |       | Yellow | Green |
| E 11             | Red |        |        |       |        | White |
| Multi-persistent |     | short  |        |       |        | long  |

Penetration CRT's manufactured by THOMSON-CSF provide very high brightness and outstanding picture contrast together with the good resolution of high quality monochrome displays. Multiphosphor techniques developed by THOMSON-CSF have been adapted to multipersistence screens to add variable persistence capability to radar presentation.



**THOMSON-CSF**

THOMSON-CSF ELECTRON TUBES, INC. / 50 ROCKEFELLER PLAZA / NEW YORK, N.Y. 10020 / TEL. (212) 489.0400

France - THOMSON-CSF Groupement Tubes Electroniques / 8, rue Chasseloup-Laubat / 75737 PARIS CEDEX 15 / Tél. 566 70.04

Germany - THOMSON-CSF Elektronenröhren GmbH / Am Leonhardsbrunn 10 / 6 FRANKFURT/MAN / Tél. 70 20.99

Italy - THOMSON-CSF Tubi Elettronici SRL / Viale degli Ammiragli 71 / ROMA / Tel. 638 14.58

Japan - THOMSON-CSF Japan K.K. / Kyosho Building / 1-9-3 Hirakawa-cho / Chiyoda-ku / TOKYO / 〒102 / Tel. (03) 264.6341

Sweden - THOMSON-CSF Elektronrör AB / Bux 27080 / S 10251 STOCKHOLM 27 / Tel. (08) 22 58.15

United Kingdom - THOMSON-CSF Electronic Tubes Ltd / Bilton House, Uxbridge Road, Ealing / LONDON W 5 2TT / Tel. (01) 579.1857 / Telex : 25 659

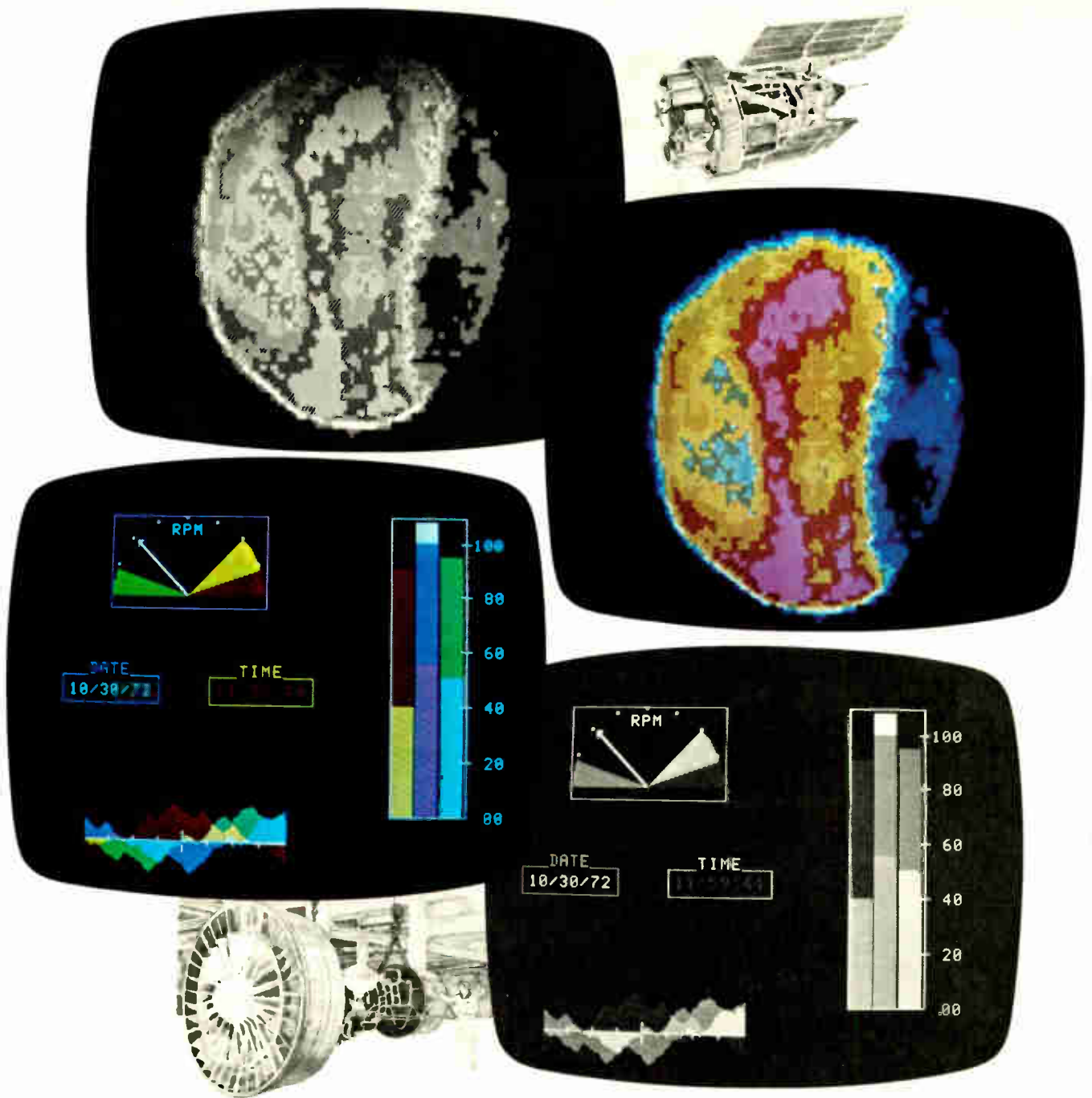

## RAMTEK... Fresh ideas for better pictures

Solid state speed and economy . . . outputs on standard TV monitors . . . single or multiple terminals . . . modular flexibility . . . all environment operation. Ramtek puts them all together in state-of-the-art raster graphic display systems.

### Gray Scale, Black and White or Color

Ramtek gives you any combination, using only one controller. You can have any number of colors, or shades of gray, in the Z axis of the display.

### Instruction Oriented

Ramtek graphic displays are

instruction oriented. So, there's less demand on your CPU, faster operation and less software overhead than with other kinds of systems.

### Matched To Your Application

Off-the-shelf components (all dual-sourced) and modular designs allow tailoring Ramtek displays to *your* application, whether you're controlling a power distribution network or analyzing data in a lab.

### Prices You Can Afford

Economy is another result of the Ramtek approach: you can have

complete graphics and full color at prices you'd expect to pay for black and white, alphanumeric-only displays. And selectable resolutions are available in all systems.

For a fresh look at *your* graphic display requirements, and for better pictures, call or write:  
 Ramtek Corporation, 292 Commercial Street, Sunnyvale, CA 94086, Phone: (408) 735-8400.

RAMTEK CORPORATION

THE DISPLAY COMPANY

### Subassemblies

# Supplies offer high efficiency

Hermetic power units reach 64 to 77%, put out 25 to 100 watts

Power shortages and compact equipment are making designers pay more attention to efficiency of equipment, and low-voltage dc power supplies are a prime target for improvement. Conventional supplies using 60-hertz transformers and series regulators are only about 25% efficient, wasting power and creating much heat that must be dissipated with large heat sinks. A solution to this is the switching power supply, such as the new Abbott Transistor Laboratories' series VN, which offers efficiencies of 64% to 77%. The units, with outputs of 5 to 50 volts, are hermetically sealed, military-grade units with 25- to 100-watt outputs. They cost only slightly more than Abbott's earlier lower-efficiency military versions—for example, \$265 versus \$249 for the 100-w, 5-v units.

Roy Baldarrama, Abbott marketing manager, says that a big emphasis in design was in getting high reliability in the units. "There have been a lot of problems with switching regulators," he explains. "The theory isn't hard, but getting a good reliable unit into production is another story." He says that even higher efficiency could be obtained by using Schottky rectifiers, but this would limit the temperature that could be handled. The new Abbott supplies are rated from 0° to 71°C.

Because of the high efficiency, the supplies can simply be bolted to thin card cages of the type widely used in modern systems. Earlier hermetic supplies depended on heat dissipation in heavy metal cabinets and enclosures. The units are also much smaller, 5-3/4 by 6 1/4 by 2 3/4 in. (under 100 in.<sup>3</sup>) compared to 6 1/2 by 12 by 9 3/4 in. (760 in.<sup>3</sup>).

The power supplies directly rectify the 110-v input, then generate a high-frequency (9-kilohertz) signal that is transformed to the low voltage and rectified. The high frequency permits very small power transformers. Regulation is by pulse-width modulation of the switching network operating at 9 kHz. Three low-power C-MOS integrated circuits control the switching.

One area in which switching regulators are inferior to conventional designs is noise output, but Baldarrama says the unit meets the requirements of MIL STD 461A for electromagnetic interference. The actual level is 30 mV rms. Though this is higher than for less efficient series regulators, he notes that many users are going to IC point-of-load regulators on cards for the last little bit of regulation.

The power supplies also meet applicable environmental specifications. The input voltage is 115 v ac, ±10%, 47 to 440 hertz. Line regulation is 0.4% or 50 mv, and load regulation is the same value from no load to full load. The output voltage can be adjusted over a small range by means of a screwdriver, and remote voltage-sensing is provided.

Baldarrama says that Abbott is also working on supplies with higher output powers.

The most popular units are available from stock (5, 6, 6.3, 15 and 28 v), with others 4 to 5 weeks after receipt of order.

Abbott Transistor Laboratories Inc., 5200 W. Jefferson Blvd., Los Angeles, Calif. 90016 [381]

## Synchro converters have resolution to 18 bits

A line of synchro conversion modules can be combined for dual speed applications and can convert 1:8, 1:16, 1:32, 1:36 and 1:64 speed inputs to a single combined digital

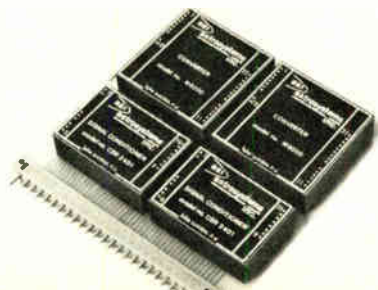

World Radio History

output. Outputs are in either natural binary or binary-coded decimal with binary resolutions from 11 to 18 bits and BCD resolution to 0.01°. Accuracy in all cases is to within ±1 least significant bit. All digital signals are DTL/TTL-compatible.

Astrosystems Inc., 6 Nevada Dr., Lake Success, N.Y. 11040 [388]

## Double balanced mixer has 6-dB conversion loss

A microminiature double balanced mixer, hermetically sealed in a metal case, is rated at from 0.1 to 500 MHz. The unit has a low 6-dB conversion loss, and isolation is 40 dB. The mixer requires the mounting area of a TO-5 transistor package. Called the SAM-3, the unit has a noise figure of 1/2 to 1 dB greater than its conversion loss, and its pins are structured on a 0.1-inch grid for mounting on pc boards. Price is \$17.95 in quantities of 5 to 24.

Mini-Circuits Laboratory, 2913 Quentin Rd., Brooklyn, N.Y. 11229 [383]

## Active bandpass filter takes up 0.25 cubic inch

A miniature active bandpass filter with a volume of 0.25 cubic inch is designated the model 1050. The unit is available pretuned at center frequencies from 200 hertz to 3,500 Hz. Gains may be specified from 0 to 40 dB, Q factors from 2 to 50. The filter was designed to compete with hybrid thin-film devices.

Ferritronics Ltd., 222 Newkirk Rd., Richmond Hill, Ontario, Canada [390]

## Synchro converters are small, consume little power

Hybrid synchro-to-digital and digital-to-synchro converters, in the H-series developed by ILC Data Device Corp. measure a tenth the size of the discrete-component modules on the market (see top of page 164). In addition, the use of hybrid tech-

## New products

nology reduces power consumption by two thirds—to less than 1 watt for a complete s-d converter channel.

A complete converter is made up of several basic 24-pin double dual in-line packages, each measuring only 0.8 by 1.4 by 0.23 inches. Thus, a single-speed s-d converter consists

of two function generators, an error processor, an up-down counter, and octant selector (all 24-pin double DIPs) and a 16-pin DIP solid-state Scott-T.

Multiplexed hybrid synchro converters are also available.

Current pricing for a single-chan-

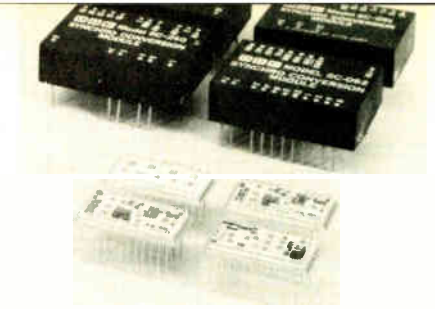

nel unit is about \$1,800 to \$2,000, depending on accuracy and quantity. As volume builds, the company says, the price will probably drop to \$200 to \$300 per package, or \$1,000 to \$1,200 for a single-speed s-d in small quantities.

ILC Data Device Corp., 100 Tec St., Hicksville, N.Y. 11801 [339]

Sample-and-hold amplifier is easily tailored to task

A guaranteed dynamic nonlinearity of less than  $\pm 0.01\%$  is offered by the model SHC23 sample-and-hold amplifier. Addition of an external storage capacitor allows the user to tailor the specifications of the unit to fit specific needs. For example, the selection of a 0.005- $\mu\text{F}$  capacitor will provide an acquisition time (to 0.01%) of about 25 microseconds. Price is \$45 each for 1 to 9 pieces and \$31 in lots of 100.

Burr-Brown Research Corp., International Airport Industrial Park, Tucson, Ariz. 85706 [384]

Broadband mixer covers from 0.5 to 1,350 MHz

The model FP-CDB-145 double balanced mixer provides a frequency range of 0.5 to 1,350 megahertz. The unit exhibits a low conversion loss across its frequency

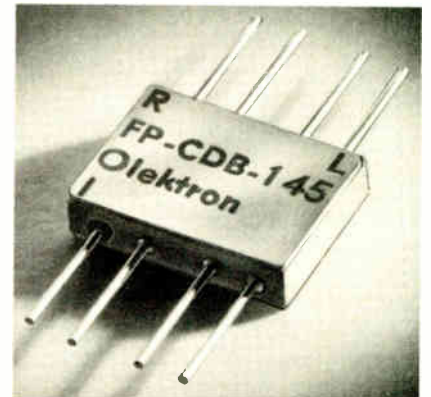

# THE INSIDE STORY...

## ON A CONSTANT VOLTAGE TRANSFORMER THAT LOOKS AS GOOD AS IT PERFORMS.

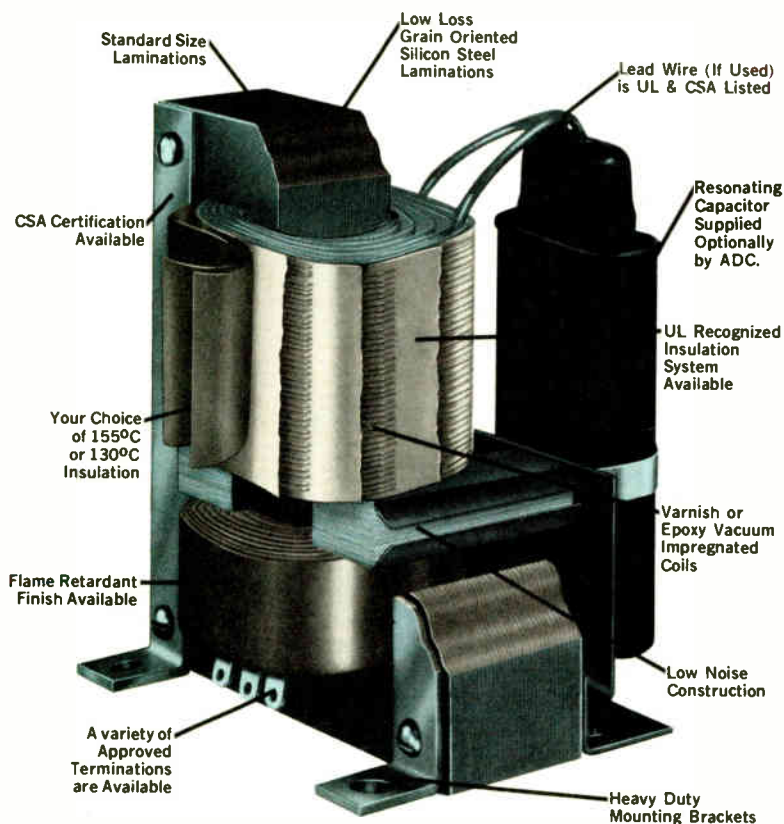

Computer-assisted design plus quality construction. Designed to meet the requirements of UL-478 for Data Processing Equipment.

For additional information contact Magnetics Division, ADC Products, or send for Bulletin 9-3.

**ADC PRODUCTS**

4900 West 78th Street, Minneapolis, Minnesota 55435  
Tel (612) 835-6800 — TWX 910-576-2832 — TELEX 29-0321

**ADC**





# OPTO

## The right coupler at the right (very low) price.

### You'll find it in TI's big new opto isolator line.

TI's newly expanded optically coupled isolator line now gives you two ways to lower system costs.

First, TI's broad selection (including six new units) allows you to more closely match device performance and circuit requirements. You won't have to pay for more coupler than you need.

Second, they're all available in economical six-pin plastic dual-in-line packages — at prices up to 50% lower than you'd expect to pay. For example, TI's TIL118 is \$ .88 in 1000-piece quantities.

Also available: Metal can couplers. If you need hermetically sealed units, TI also has these metal can JEDEC-registered optically coupled isolators:

| Device type | Current transfer ratio |         | Electrical isolation rating |
|-------------|------------------------|---------|-----------------------------|
|             | Minimum                | @ $I_F$ |                             |
| 4N22        | 25%                    | 10mA    | ± 1 kV                      |
| 4N23        | 60%                    | 10mA    | ± 1 kV                      |
| 4N24        | 100%                   | 10mA    | ± 1 kV                      |



A call to your local TI distributor (he's already well stocked) can get you quick quotes on the devices you need. Or call your local TI sales office.

But broad choice at low cost isn't the whole story.

TI introduced the industry's first optically coupled isolator back in 1965 — and since then has amassed more design and volume production experience than any other supplier. The result: Excellent availability, unsurpassed quality, proven reliability.



**TEXAS INSTRUMENTS**  
INCORPORATED

## Our new model 38 series.

**Even the most expensive ASR is a very inexpensive \$1480.**



Just because you need big machine features, you don't have to pay big machine prices.

Not when you've got some new alternatives: the Teletype® model 38 series terminals. They offer a lot of features. For only a little money.

Prices for an RO model 38 start as low as \$937. KSR model 38 terminals begin at \$1209. Even ASR terminals go for as low as \$1452. And for about \$200, you can equip any of them with a built-in, factory-tested modem.

Standard equipment on all model 38 terminals is a 132-character printing format on a 15-inch wide platen. Upper and lower case is also standard. So is two-color printing.

Speed? 100 words per minute. If you need more—up to 2400 wpm—the model 38 interfaces with the Teletype 4210 magnetic tape data terminal.

There's more, too. Like plug-to-plug compatibility with the model 33. So you can update your system without changing it.

The new Teletype model 38 series terminals. Where else can you get so much for so little?

It takes more than manufacturing facilities to build the machines Teletype Corporation offers. It also takes commitment. From people who think service is as important as sales. In terminals for computers and point-to-point communications.

That's why we invented a new name for who we are and what we make. The computer-communications people.



For more information about any Teletype product, write or call: TERMINAL CENTRAL; Teletype Corporation, Dept. 53N, 5555 Touhy Avenue, Skokie, Illinois 60076. Phone 312/982-2500

\*Prices subject to change without prior notice.

## New products

spectrum, and typical conversion is 7.0 dB at 1,000 MHz and 6.5 dB at 500 MHz. Size of the mixer is  $\frac{3}{8}$  by  $\frac{1}{2}$  by  $\frac{1}{8}$  inch. Small-quantity price is \$29 each.

Olektron Corp., 6 Chase Ave., Dudley, Mass. 01570 [385]

A-d converter operates at 4 microseconds

Packaged in a 2-by-3-by-0.375-inch module, the model ADC-EH10B analog-to-digital converter contains a single-chip LSI programer. Its word rate is greater than 100 ki-



lohertz, and total conversion speed is 4 microseconds. Voltage input can be unipolar (0 to +10 V) or bipolar ( $\pm 5$ V) by external pin strapping, and output digital coding can be straight binary, offset binary or two's complement with a wordlength of 10 bits. Unit price is \$159, and \$99 each for quantities over 100. Delivery is from stock.

Datel Systems Inc., 1020 Turnpike St., Canton, Mass. 02021 [386]

Op amp offers minimum slew rate of 1,000 V/ $\mu$ s

The model 9826 operational amplifier features a maximum closed-loop bandwidth capability of 300 megahertz and a minimum slew rate of 1,000 volts per microsecond. Output drive can power 50-ohm coaxial cables, and the unit is internally compensated to provide a 1-GHz gain bandwidth product and fully differ-

# DESIGN ENGINEERS

# TAKE FIVE

... save countless hours of valuable design time by using the ANNT Desktop Index to Electronic Engineering Periodicals. Nearly 400 category headings efficiently guide you to over 5000 design related articles. Indexed by engineers for engineers. Send \$7.00 for the annual Master Index covering 1970 through June 1973, or save by sending \$9.00 for the Master Index now and a six-month Supplement in January.

- ★ ELECTRONICS
- ★ ELECTRONIC DESIGN
- ★ DIGITAL DESIGN
- ★ EE/SYSTEMS ENGINEERING TODAY
- ★ EDN
- ★ IEEE SPECTRUM
- ★ COMPUTER DESIGN
- ★ ELECTRONIC PRODUCTS

the  
**ANNT**  
DESKTOP  
INDEX

P.O. BOX 11275  
KANSAS CITY, KS  
66111

PLEASE SEND ME:

\_\_\_\_\_ ANNT Desktop  
Index(s) @ \$7.00 ea

\_\_\_\_\_ Index(s) and six-month  
Supplement(s) @ \$9.00 ea

I ENCLOSE \_\_\_\_\_

NAME \_\_\_\_\_

COMPANY \_\_\_\_\_

ADDRESS \_\_\_\_\_

CITY/STATE \_\_\_\_\_ ZIP \_\_\_\_\_

# VIDEO FRAME FREEZE



**Now you can give your electronic displays stop-action and storage capabilities at low cost.**

Introducing the Hughes Model MSC-1 video storage unit. It's a completely self-contained electronic image memory system. Specially designed for high-volume (525 line) applications. With a price tag to suit the discriminating buyer.

It stores alphanumeric, graphic and pictorial data.

It integrates signals (automatically enhancing low level images).

It converts slow-scan and x-y information to TV format.

The MSC-1 can make your displays more versatile, more competitive. Write for new brochure: 2020 Oceanside Blvd., Oceanside, CA 92054.

Or call (714) 757-1200.



Circle 168 on reader service card

## Megohmmeter and Hipot?

**YES!** For true integrity in HV bench-testing of electrical or electronic equipment —you need both! Megohmmeter to test insulation resistance (IR) . . . Hipot to test dielectric strength.

### HIPOTRONICS OFFERS

a full line of high resistance megohmmeters — sixteen models with ranges to 20,000,000 megohms and high current capability for testing insulation resistance to ASTM specification D-257, MIL, and UL standards.

### HIPOTRONICS ALSO OFFERS

a full line of AC/DC hipots — twenty-seven models with ranges to 10KV AC and 25 KV DC for non-destructive measurement of leakage current, corona discharge, AC and DC insulation strength.

### HIPOTRONICS GUARANTEES

complete high voltage — high resistance capability for thorough testing of switches . . . motors . . . coils . . . chokes . . . insulation . . . transformers . . . cables . . . electrical/electronic assemblies . . . harnesses . . . and more.

For more information write or call our marketing department for brochures HP7101 and HP7107.

**HIPOTRONICS**® BREWSTER, N. Y. 10509  
Phone: (914) 279-8091



168 Circle 213 on reader service card

## New products

ential inputs with common-mode rejection ratios of 50 dB at 100 MHz. Output capability is  $\pm 5$  v at  $\pm 50$  mA.

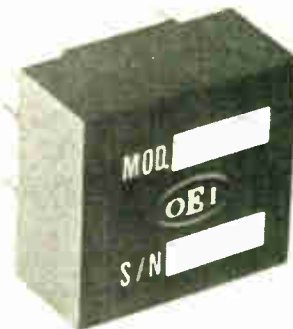

Price is \$52 each for 1 to 2 units. \$47 for 3 to 9 units and \$42 for 10 to 29 pieces.

Optical Electronics Inc., Box 11140, Tucson, Ariz. 85734 [387]

Op amp operates over  $\pm 5$ - to  $\pm 20$ -volt range

An internally compensated operational amplifier that is pin-compatible with National Semiconductor's LM112 series is designated the AMD 112/212/312 family. The units employ super-beta transistors to achieve improved performance

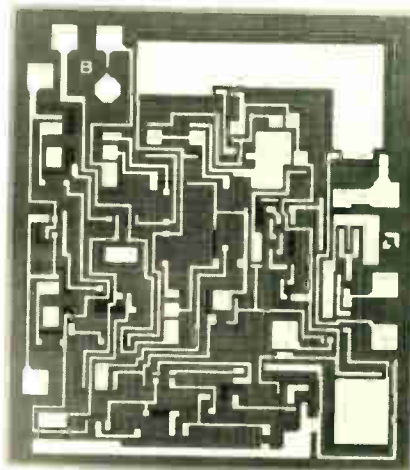

over the operating temperature range in offset current and voltage. The circuits operate of a  $\pm 5$ - to  $\pm 20$ -volt range with typical power consumption of 12 mw. Price in lots of 100 ranges from \$1.75 to \$19.45, depending on package and temperature range.

Advanced Micro Devices Inc., 901 Thompson Pl., Sunnyvale, Calif. 94086 [389]

Electronics/June 21, 1973



## Before you get boxed in to a design that's not giving you the best trade-offs, call G.I. power hybrids.

At GI, we've combined chip technology and advanced circuit design with the latest thick film packaging techniques to help you get out of the trade off trap.

With a power hybrid circuit, in one easy-to-install package, that can do what it used to take a lot of discrete components to do.

And do it in less space.  
More reliably and effectively.  
And in the long run, more economically too.

In everything from autos to X-rays.

### What's your application?

Today, GI power hybrids

are performing as speed and temperature controls.

They're power relays. Point of use regulators.

Timing controls. And audio amplifiers.

Let us know where you need help, and we'll put our know how to work for you.

Call us toll free at 800-645-1247  
Or write us at 600 West John Street,  
Hicksville, New York, 11802.

We'll get you out of your box.

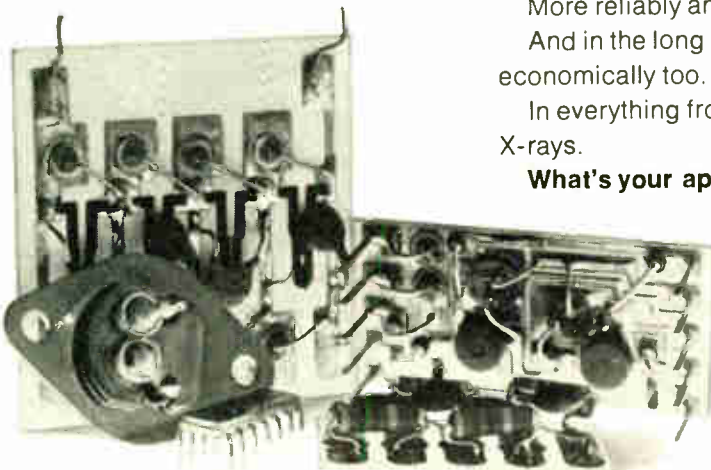

## General Instrument

Circle 169 on reader service card

## New products

Microwave

### Rf connectors are low-priced

Matched-impedance coaxial units designed to perform at frequencies to 6 GHz



Aimed at market applications somewhere between those traditionally filled by the familiar "phono" plug and by matched-impedance connectors such as the SMB or BNC, the ALC-5 family of coaxial connectors has been introduced by Amphenol's RF Division, Danbury, Conn. The company expects the new connectors to find wide use particularly in communications gear and test equipment.

A key feature of the ALC-5 series is low-cost—as little as 45¢ for a mated pair—combined with high electrical performance. Typical voltage-to-standing-wave ratio is about 1.2 at 2 GHz and less than 1.4 to frequencies above 6 GHz. The price of 45¢ per mated pair is for quantities of 1,000 and compares to about 20¢ for phono plugs and more than \$1 per pair for conventional SMB con-

nectors on the market.

The ALC-5 units are fully crimpable—both outer ferrule and center contact (as an option, the center contact can also be soldered). Compared with the phono plug, according to Amphenol engineers, the resulting savings in assembly costs more than offsets the initial price differential between the two.

The new series is now available off the shelf in push-on versions for interface with either RG 188- or RG 58-size coax. Snap-on versions, as well as additional configurations such as right-angle connectors, printed-circuit units, and adapters to conventional BNC coaxial connectors will be available later this year.

According to Ralph E. Perusse, area marketing manager at Amphenol, the new line was developed over the past two years in response to inquiries from land-mobile radio manufacturers seeking low-cost connectors to satisfy all coax wiring requirements from audio frequencies through 900 MHz. Says Perusse, "Our initial orders are for these applications, but we see a strong need in other areas, such as test equipment, where the ALC-5 unit will best fill needs for subassembly-to-subassembly interfaces."

Amphenol RF Division, 33 East Franklin St., Danbury, Conn. 06810 [401]

### Multioctave mixers cover 1 to 10 GHz

A line of reduced-size multioctave MIC microwave mixers covers the rf range of from 1 to 10 GHz and offers



# AMP District Offices.

**NEW ENGLAND DISTRICT**  
Suite 107, Riverside Park  
Weston, MA 02193. (617) 891-7500

**NEW YORK DISTRICT**  
25 Commerce Drive  
Cranford, N.J. 07016  
(212) 285-9575 (N.Y.)  
(201) 276-4382 (Cranford)

**MID-ATLANTIC DISTRICT**  
400 W. Swedesford Rd.  
Berwyn, Pa. 19312  
(215) 647-6060

**SOUTH ATLANTIC DISTRICT**  
955 L'Enfant Plaza North, S.W.  
Suite 4010  
Washington, D.C. 20024. (202) 484-9596

**GULF DISTRICT**  
2220 Parklane Drive, N.E.  
Suite 485  
Atlanta, GA 30345. (404) 934-6363

**OHIO DISTRICT**  
Landings Office Bldg.—Suite 207  
3040 Riverside Dr.  
Columbus, OH 43221. (614) 486-0276

**LAKE DISTRICT**  
30555 Southfield Rd.—Suite 440  
Southfield, MI 48075. (313) 645-5590

**ILLINOIS DISTRICT**  
1050 Morse Ave.  
Centex Industrial Park  
Elk Grove Village, IL 60007  
(312) 439-5800

**NORTH CENTRAL DISTRICT**  
4600 W. 77th St.—Rm. 319  
Minneapolis, MN 55435. (612) 920-8210  
TWX (910) 576-2849

**SOUTHWESTERN DISTRICT**  
Frito Lay Tower—Suite 1440  
Exchange Park, Dallas, TX 75235  
(214) 352-4852-4853  
TWX (910) 861-4227

**SOUTHERN PACIFIC DISTRICT**  
1840 S. Wilmington Ave.  
Compton, CA 90220. (213) 537-4490  
TWX (910) 346-7044

**NORTHERN PACIFIC DISTRICT**  
Vallico Park  
10300 N. Tantau Ave.  
Cupertino, CA 95014. (408) 255-3830

# AMP INCORPORATED

Circle 170 on reader service card

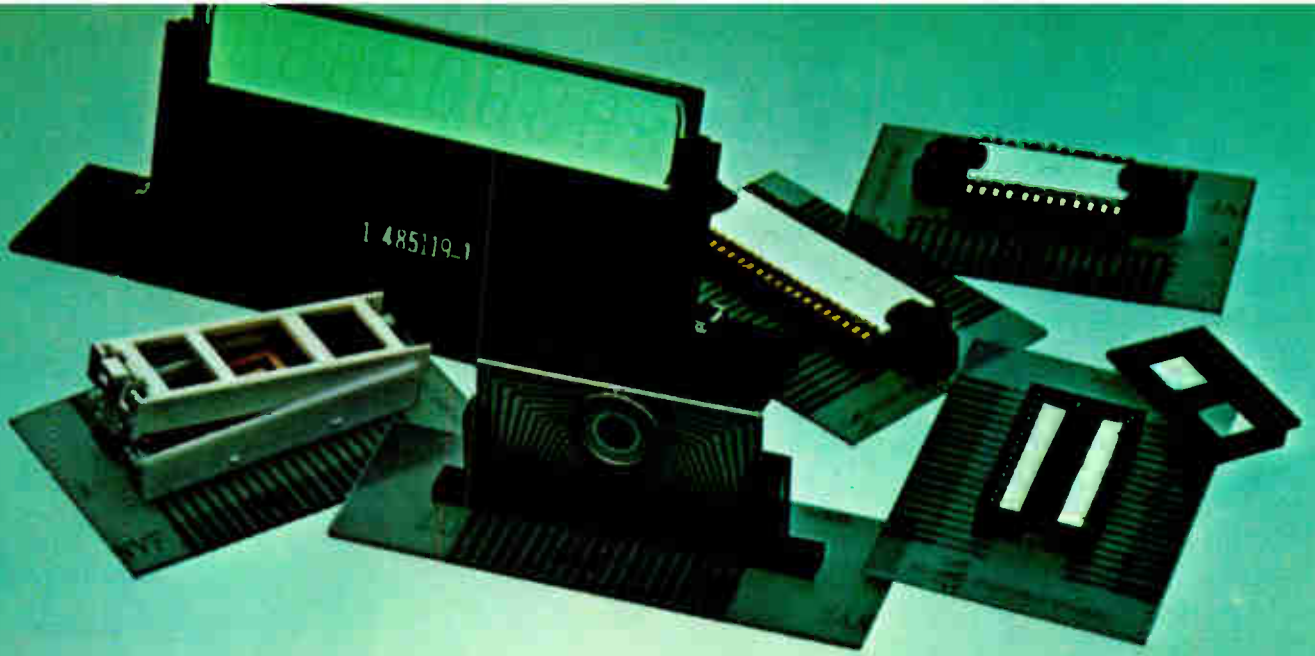

**AMP is making things smaller,**



**easier and denser  
for interconnecting MOS.**

Take the 42-position connector in the foreground, for example. It's less than .250-inch high, with lid installed. And only .050-inch lead centers! Simple, easy to use. With zero entry force.

Then, there's our 40-position connector (far right, foreground). It's only .235-inch high, .100-inch lead centers and—with its snap-on

adapter—converts in seconds to accept leaded as well as leadless packages. Also available for 24 and 28 package configurations.

We have others, too. Bottom metallized arrays, liquid crystal connectors, etc. But that's another story. To get the AMP microelectronics story, write AMP Industrial Division, Harrisburg, Pa. 17105.

AMP microelectronics: doing small things in a big way.

**AMP**  
INCORPORATED

AMP is a trademark of AMP Incorporated.

Circle 171 on reader service card

# Get it all together!

- TRUE RMS
- VOLTS, AMPS and WATTS
- 0.1% ACCURACY
- TIME-DIVISION TECHNIQUES (PATENTED)



Now, True RMS and power measurements with 0.1% accuracy are possible for general instrumentation applications. YEW's new Model 2503 provides the means. This revolutionary instrument utilizes a unique time division multiplier technique long proven in YEW's Lab Standard 0.02% Model 2885 Digital Wattmeter. Exceptional accuracy is retained over wide frequency ranges, with extreme wave form distortion AND over wide power factor variations because of this measuring technique. Wide measuring ranges from 3 volts to 600 volts, 0.1 amps to 30 amps and 300 milliwatts to 18 kilowatts combined with complete front panel control assures maximum versatility.

*Send for complete technical information today!*



Yokogawa Electric

For Sales and Service in the U.S.A. contact:  
Yewtec Corporation  
1995 Palmer Ave., Larchmont, N. Y. 10538  
Telephone: 914 834-3550

55 Years of Measuring  
and Recording Instrumentation.

## New products

cost savings achieved primarily by quantity production of stamped rather than machined housings. These savings are available to users whose requirements can be satisfied by slightly reduced specifications and tolerances, the company says. The double balanced units are designated the DML series and have a noise figure of 9 to 11.5 dB across the band. VSWR is 3.0 to 1. Price starts at \$145 and extends up to \$240 each.

RHG Electronics Laboratory Inc., 161 E. Industry Court, Deer Park, N.Y. 11729 [403]

### Transistor amplifier offers 4.5-dB maximum noise figure

The latest model in a series of low-noise transistor amplifiers is the model AM-4080, covering the 2-to-

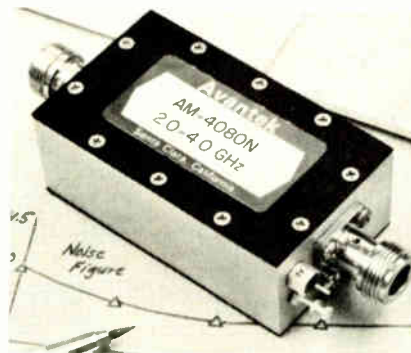

4-GHz band. Noise figure is between 3.5 and 3.8 dB and is guaranteed less than 4.5 dB. Other specifications include a minimum gain of 32 dB, a maximum VSWR (at 50 ohms) of 2.0 in and out, and a minimum power output for 1-dB gain compression of +9 dBm. Price is \$2,000.

Avantek Inc., 2981 Copper Rd., Santa Clara, Calif. 95051 [404]

### Gunn-effect oscillator tunes from 5.4 to 5.9 GHz

A Gunn-effect oscillator spanning the range of 5.4 to 5.9 GHz is designated the model ETO-217. The unit exhibits a typical frequency drift of 10 MHz (20 MHz worst case) over the range of -10° to +60°C while varactor-tuned anywhere in its band-

## Time coding can be simpler than you think

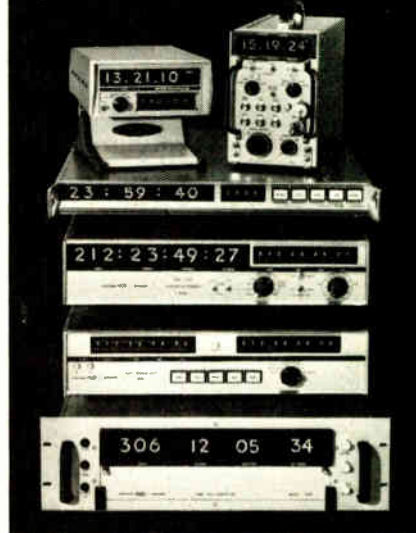

Systron-Donner can help you cut through the profusion of time code formats and equipment—to the selection of the right format and the right equipment for the job.

Our new 90-page handbook will guide you to the best technique for your application, and enable you to select appropriate equipment from the comprehensive line offered by Systron-Donner.

Systron-Donner equipment ranges from compact time code generator/readers costing as little as \$1495, through portable battery-powered generators for field use, to high-precision generator/readers with automatic tape search.

## Send for handbook sample.



Send for free copy of "Selecting time code format," Chapter 3 of our new 90-page, illustrated handbook on time coding techniques. Complete handbook: \$3.00.

SYSTRON  DONNER

Data Products Division,  
Systron-Donner Corporation,  
10 Systron Dr.,  
Concord, Calif. 94518.  
Phone (415) 682-6161.



**We have a half  
million ways to  
solve your card  
packaging problems...**

**We  
do it  
better**

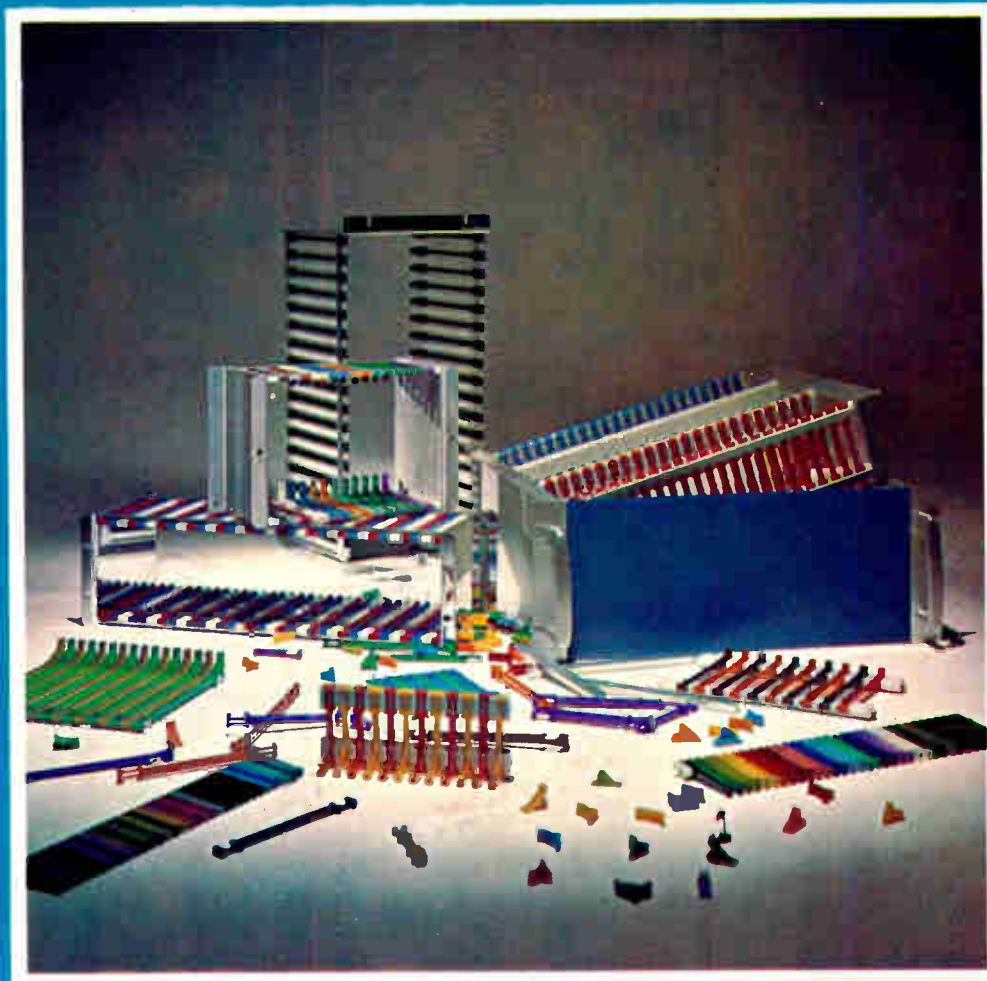

Configurations are virtually unlimited . . . bulk components, subassemblies, files, kits, drawers—horizontal or vertical.

We do it by offering nylon guides with integral connector mounting feet. This insures precise card/connector alignment while permitting complete card length and spacing flexibility.

We do it with guides that snap-on to strong extruded aluminum bars between end plates or drawer frames. This provides an exceptionally rugged, lightweight package perfectly suited to your particular card file needs . . . when it's put together, it stays together.

We do it by mounting mother boards and back planes in single or multiple row files. We do it by

mounting large or small cards with any connector arrangement.

We do it by really solving packaging problems . . . yours, his and theirs. So give Scanbe a call or send us your requirements. Either way, we can help you do it better.



**"The Packaging People"**

Scanbe Manufacturing Corporation  
3445 Fletcher Avenue  
El Monte, California 91731  
(213) 579-2300/686-1202 TWX: 910-587-3437

Circle 173 on reader service card

# syntronic

## OPTIMUM CORNER FOCUS

Is a function of ...

- deflection angle
- light output
- yoke impedance
- display speed
- CRT neck diameter
- CRT length
- yoke production capability

To produce one or one hundred yokes having optimum corner focus requires a thorough knowledge of system design trade-offs.

To see the difference our 25 years of experience can make, let us focus on your yoke problem.



**SYNTRONIC INSTRUMENTS, INC.**  
100 Industrial Road, Addison, IL 60101  
Phone: (312) 543-6444

### New products



width. No heater power is needed to maintain stability. Minimum output is 40 mW. Price is \$615.

Texscan Corp., 2446 N. Shadeland Ave., Indianapolis, Ind. 46219 [405]

Coaxial adapters are for type N, SMA connectors

Designed for use with type N and SMA connectors, a line of coaxial adapters provides a typical VSWR on the order of 1.065 maximum (30 dB return loss minimum). This applies to all bands in the range from 2.60

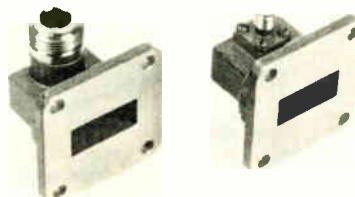

to 18 GHz. Swept-frequency sliding-load techniques are used for testing all models.

Microwave Development Laboratories Inc., 87 Crescent Rd., Needham Heights, Mass. 02194 [406]

Line source array has 300 inclined edge slots

Fractional degree beamwidths are possible at millimeter wavelengths with a linear array antenna, which is composed of 300 inclined edge slots. The unit is 48 in. long and has a half power beamwidth of 0.33° in the



## Need Sub-Masters and Production Masks?

## Help yourself with GAF® Microline High Resolution See-Through Photoplates.

Meet all your mask requirements—as you need them—via simple dry ammonia vapor process. No wet processing or use of etchants. Obtain high quality, low defect masks. Sub-micron lines and spaces—very sharp edge and corner definition.

The advanced diazo pattern generation technology requires only a UV light source to expose and ammonia vapor to develop. Obtain increased yield of usable devices—especially those involving dense, packed circuits.

**gaf**® **GAF Corporation** 459-0200  
Photoimaging Products  
Dept. 606A-063  
140 West 51st Street  
New York, New York 10020

Gentlemen:  
 I'd like a demonstration.  
 Rush me more information on Microline Photoplates.

NAME \_\_\_\_\_

TITLE \_\_\_\_\_

COMPANY \_\_\_\_\_

ADDRESS \_\_\_\_\_

CITY \_\_\_\_\_

STATE \_\_\_\_\_ ZIP \_\_\_\_\_

PHONE \_\_\_\_\_

# OPEN WIDE AND SAY "Ahhh... Now that's what I call a THUMBWHEEL CATALOG!"



## Send for this new Cherry Handbook and Guide

For everything you could possibly want to know about Cherry Thumbwheel and Leverwheel Switches, this new catalog is just what the doctor ordered. You'll find details and specs on nine series of Thumbwheels and Leverwheels—available in hundreds of variations. You'll find truth tables . . . cross-indexed product listings . . . application data . . . specials . . . and more. You'll also find never-before-published "inside" information on Cherry's Thumbwheel Switch total in-house manufacturing capabilities: Including printed circuit, precious metal plating, silk screening, metal stamping and plastic molding operations. All in a handsome, new, easy-to-use 72-page format. **And it's yours for the asking: Just TWX 910-235-1572 . . . or PHONE 312-689-7703 . . . and ask for Frank.**

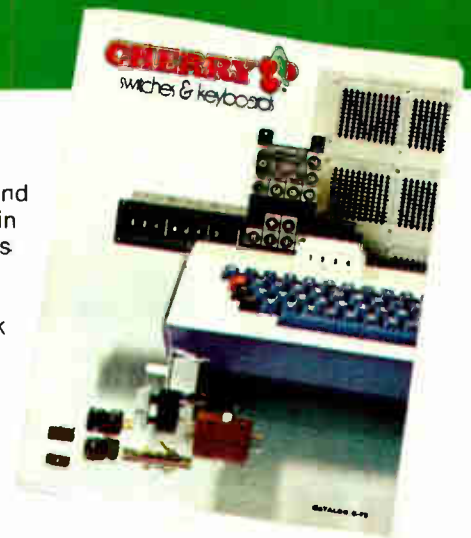

# CHERRY



CHERRY ELECTRICAL PRODUCTS CORP.  
3608 Sunset Ave., Waukegan, Ill. 60085



Cherry affiliates worldwide • Hirose Cherry Precision Co., Ltd., Tokyo • G. W. Engineering Pty. Ltd., Sydney  
Cherry Electrical Products (U.K.) Ltd., St. Albans, Herts • Cherry Mikroschalter GmbH, Bayreuth, Germany

World Radio History

Circle 175 on reader service card

# It looks like a recorder but it works like a lab.

What you're looking at is the first 4-channel portable with all the quality and features usually found only in your expensive lab recorders.

The 3M Series 120 Recorder/Reproducer.

The 120 provides 5 switch-selectable speeds from 15/16 to 15 ips, with automatic equalization. It has an analog response of 70 Hz-64 kHz and an FM S/N ratio of 35 db at 15 ips. It includes a phase-locked capstan servo, level monitoring, interlocked push-button controls and records up to 12 hours of data on 10½" reels.

Optionally, you can add a Repeat Scan, for repeating up to 10 seconds of tape continuously. A -30% to +50% speed vernier. A 4 to 60 ips variable speed search. Monitor electronics. FM squelch. Voice logging. And remote control.



**We've been there.  
And brought the answers back.**

All yours in a rugged, low-cost portable that's ideal for your industrial, medical, educational or military applications.

For details, contact Instrumentation Products, Mincom Division, 3M Company, 300 So. Lewis Road, Camarillo, Calif. 93010. Telephone: (805) 482-1911. TWX: 910-336-1676.

Circle 176 on reader service card

Why mess around when you can have the ELECTRONICS BOXER clean up your copies—keep them in top condition.

And, it's easy and

inexpensive to keep the ELECTRONICS BOXER in your corner. Just complete the coupon and mail. Your order will be processed immediately, postpaid.

## ELECTRONICS BOXER

Jesse Jones Box Corporation

2250 E. Butler St., Philadelphia, Pa. 19137

Please send me:  boxes @ \$4.25 each;  
 3 boxes @ \$12.00;  6 boxes @ \$22.00

My check or money order is enclosed.

Name \_\_\_\_\_

Address \_\_\_\_\_

City \_\_\_\_\_ State \_\_\_\_\_ Zip \_\_\_\_\_

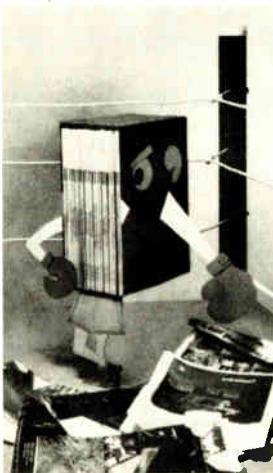

## New products

plane of the array. The pattern of the orthogonal plane is essentially that of the slot element. Frequency range is 50 to 55 GHz, and VSWR is 1.2 maximum.

Control Data Corp., Boston Microwave Products Division, 400 Border St., East Boston, Mass. 02128 [407]

## Tube amplifiers

need no field-tuning

A series of high-power broadband vacuum tube amplifiers includes the model A-2045, which, without any field tuning, covers a 2-dB bandwidth of 100 MHz in the L band while delivering a minimum of 500 W peak. With a 3-dB bandwidth of 70 MHz, peak-power output of 1,000



W has been measured. Gain is 10 dB minimum, and duty cycle is up to 0.4%. Input VSWR is 1.5 or less, across 50 ohms, over the entire band. Applications include radar, communications equipment, and intermediate or final amplifiers.

Acrodyne Industries Inc., 21 Commerce Dr., Montgomeryville, Pa. [408]

## Thin-film amplifiers

cover 5.0 to 6.4 GHz

Designated the WJ-6500 series, a family of thin-film amplifiers is designed to cover the 5.0-to-6.4-GHz band. Applications are in radar and communications. Guaranteed specifications include a noise figure of 7.5 dB, +3-dBm power output at 1-dB gain compression, and a choice of 14-, 22-, or 30-dB gain.

Watkins-Johnson Co., 3333 Hillview Ave., Stanford Industrial Park, Palo Alto, Calif. [409]

# THE SUPER 70



**The new 1-1/4-inch cermet trimmer  
that replaces all these...**

|     |     |      |       |       |
|-----|-----|------|-------|-------|
| 55  | 215 | 949  | 3051  | AB-MH |
| 56  | 235 | 993  | 3052  | AB-NP |
| 58  | 272 | 995  | 3059  | AB-NX |
| 78  | 276 | 2855 | 6011  | AB-RP |
| 140 | 450 | 3011 | 6022  | AB-RH |
| 185 | 650 | 3012 | AB-MP | ET-12 |

**...with the most advanced features, too!**

- Improved wiper and unique slider block design
- Excellent setability and stability
- TEMPCO of 100 PPM/°C
- 1 W @ 85°C
- Five configurations
- Conforms to MIL-R-22097.

Send for data sheet and quantity price information, or contact your local Spectrol representative or distributor.



**SPECTROL ELECTRONICS GROUP**

**UNITED STATES Spectrol Electronics Corporation** 17070 E. Gale Avenue, City of Industry, Calif. 91745, U.S.A. • (213) 964-6565 • TWX (910) 584-1314

**UNITED KINGDOM Spectrol Reliance Ltd.** Drakes Way, Swindon, Wiltshire, England • Swindon 21351 • TELEX: 44692

**ITALY SP Elettronica spa** Via Carlo Pisacane 7, 20016 Pero (Milan) Italy • 35 30 241 • TELEX: 32242

# Beware the un-opportunity

Opportunity. You've read enough employment opportunity ads and listened to enough employment personnel by now to know that they all like to discuss opportunity. But, unfortunately, they would usually rather talk about opportunity than offer it. We at Fairchild believe that if you're going to talk about something, you'd better be able to back it up.

And back it up we can. First, there's the Fairchild opportunity. A chance to build a career with a company that's headed in the right direction at the right speed. Second, there's the individual opportunity. A chance to use both your brains and your

initiative in an environment that doesn't let protocol stand in the way of a good idea. We at Fairchild believe that opportunity exists within the individual, not the system. If you feel that way too, we should get together. Call or send us your resume. Employment Opportunities, Fairchild Semiconductor Components Group, Dept. 35, 465 National Avenue, Mountain View, California 94040. (415) 962-3401.

An Equal Opportunity Employer M/F

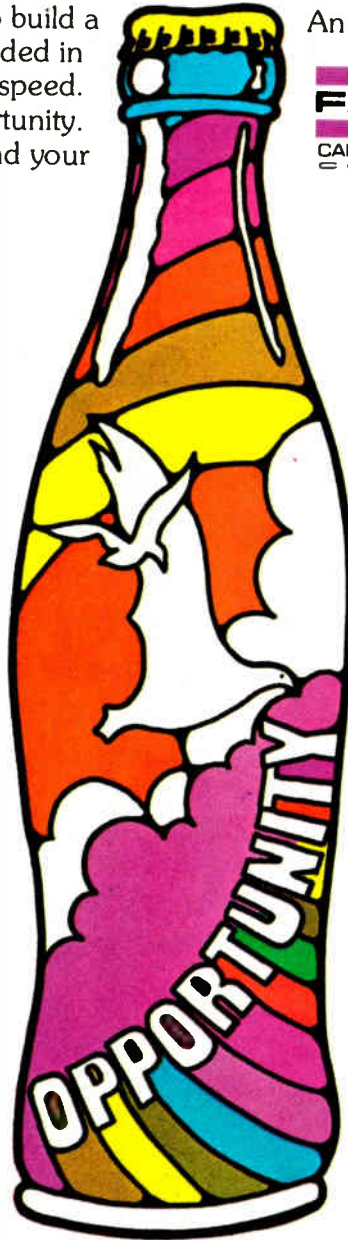

**FAIRCHILD**

CAMERA AND INSTRUMENT  
CORPORATION

**A Fairchild career... more than a pretty package**

## New products/materials

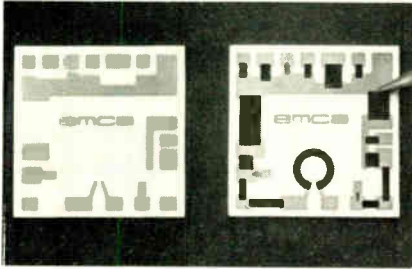

A commercial resistor ink for thick films is designated the EMCA 5000 series and offers stable laser trimming, power, and heat-storage properties. Test results simulating extreme use have shown that inks trimmed on a Q-switched YAG laser had no drift after 10 minutes at 400°C and that after 60 minutes there was no resistivity change in the 10-ohm ink and only 0.25% change in the 1-megohm ink. Price of the ink is \$35 to \$40 per ounce in quantity.

Electro Materials Corp of America, 605 Center Ave., Mamaroneck, N.Y. [476]

Epoxy dipping and sealing compound 161 provides rheologically controlled coating thickness. The thixotropic formulation will not sag under adverse conditions, and the material is for use at room temperature. Moreover, it has the electrical insulation properties found in cured plastic. Applications include capacitors, resistors, chokes, coils, and rectifiers.

Mereco Products, 530 Wellington Ave., Cranston, R.I. 02910 [477]

A resilient adhesive and sealant, Tra-Bond 2143D liquid polymer epoxy polyamide system, is particularly suitable for aerospace and electronics bonding applications for a wide variety of materials, including glass, metals, and rigid plastics. The medium-viscosity material has a low exotherm and is for use at room temperature. When fully cured, it has good electrical insulation qualities.

Tra-Con Inc., Resin Systems Division, 55 North St., Medford, Mass. 02155 [478]

Material 517 is a two-part adhesive used in joining materials where a high thermal conductivity is required. Thermal expansion rate is

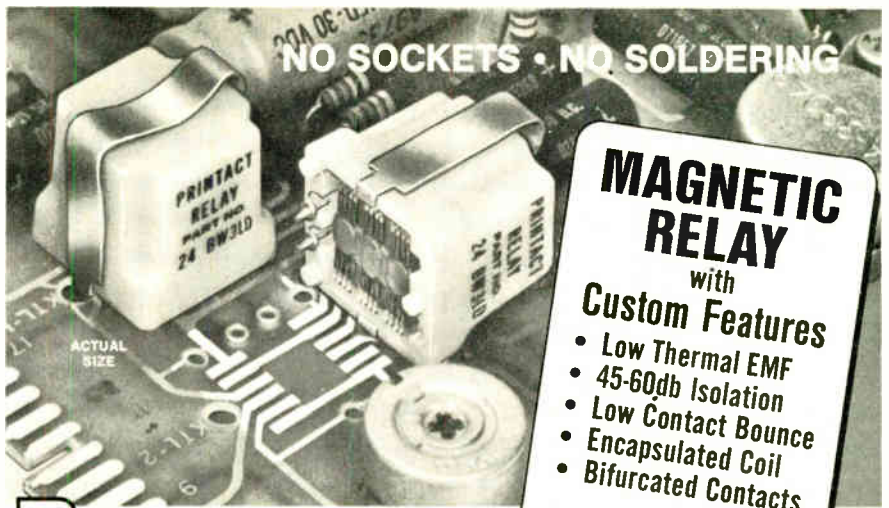

# Printact®

Plugs into your PC board... mates with plated conductors

The unique design concept of the Printact magnetic latching and non-latching relays provides <math>< 5.0\mu\text{V}</math> thermal EMF, 45-65 db cross talk isolation, <math>< 0.5\text{ms}</math> contact bounce and other custom features as standard at no extra cost. The single moving part is the pivoting armature with series break contacts held by a permanent magnet eliminating return springs, mechanical linkage and pigtail connections thus assuring reliable performance for many millions of cycles.

For a sample and/or data, write or call 212-EX 2-4800

Printact Relay Division, Executone, Inc., Box 1430E Long Island City, N.Y. 11101

Circle 179 on reader service card

**MAGNETIC RELAY**  
with  
**Custom Features**

- Low Thermal EMF
- 45-60db Isolation
- Low Contact Bounce
- Encapsulated Coil
- Bifurcated Contacts

**At No Extra Cost!**

## Here's an optical tachometer for tape drive control



(that won't blow your manufacturing costs!)

- Mounts directly to drive motor
- Frequency output <math>< 0.7\%</math> FM deviation
- Uses LED light sources, extremely reliable
- Square wave, TTL compatible output
- Temp. range of  $-20^{\circ}\text{C}$  to  $+80^{\circ}\text{C}$
- Priced under \$35.00 in quantity

Write or call for spec sheet on Disc's new 990 Series Tachometers.



DISC Instruments, Inc. 102 E. Baker St., Costa Mesa, Calif. 92626, Phone (714) 979-5300

Disc Instruments Division  
Finnigan GmbH  
Dachauer Strasse 511, 8 Munchen 50, Germany  
Phone: (0811) 142291 (2)

Disc Instruments Division  
Finnigan Instruments Ltd.  
Paradise, Hemel Hempstead, Herts, England  
Phone: (0442) 57261

# SOLID RELIABILITY

## Micropackaged pulse transformers with outstanding performance.

Toko pulse transformers are proven performers in the electronics world, and are known for compactness, reliability and product quality which are hard to beat. Make your selection from our list of standard types or let us design a unit specifically for your application.



### Standard Types

| Type        | Turns ratio | Primary inductance | ET Constant (min.) | Leakage inductance (max.) | Interwinding capacitance (max.) | DC resistance (max.) | Connections |
|-------------|-------------|--------------------|--------------------|---------------------------|---------------------------------|----------------------|-------------|
| PGWB 4-1AA  | 1:1         | 1.8                | 1.2                | 0.10                      | 8.0                             | 0.20                 | A (LCED)    |
| PGWB 10-1AA | 1:1         | 11.0               | 2.5                | 0.15                      | 12.0                            | 0.20                 | A (LCED)    |
| PGBB 8-1AA  | 1:1         | 38.0               | 3.5                | 0.15                      | 8.0                             | 0.20                 | A (LCED)    |
| PGRB 10-1AA | 1:1         | 134.0              | 5.0                | 0.15                      | 12.0                            | 0.20                 | A (LCED)    |
| PGRB 16-1AA | 1:1         | 340.0              | 10.0               | 0.15                      | 18.0                            | 0.30                 | A (LCED)    |
| PGXB 22-1AA | 1:1         | 1,400.0            | 20.0               | 0.20                      | 25.0                            | 0.35                 | A (LCED)    |

### Technical Data

- Operating temperature range: 0~70°C ● Storage temperature range: -40~+100°C ● Insulation resistance: (At 250 VDC) More than 10<sup>10</sup> M
- Package: Transfer molding (epoxy) ● Environmental test: Units satisfy MIL-STD-202D



## TOKO, INC.

Head Office: 1-17, 2-chome, Higashi-Yukigaya, Ohta-ku, Tokyo, Japan  
 New York: Toko New York Inc., 350 Fifth Avenue, New York, N.Y. 10001 U.S.A. Tel: 565-3767  
 Los Angeles: Toko, Inc. Los Angeles Liaison Office 3440 Wilshire Blvd., Trishman Building, Suite 1106 Los Angeles, Calif. 90010, U.S.A. Tel: 380-0417  
 Düsseldorf: Toko Elektronik G.m.b.H. 4 Düsseldorf, Lakronstrasse 77, W. Germany Tel: 0211-284211

Circle 180 on reader service card

# WISH TO IMPORT

## EXCLUSIVELY TO JAPAN

ELECTRICAL MATERIALS, EQUIPMENTS, PARTS, CHEMICALS FOR ELECTRICAL USE, ETC. WHICH ARE NEWLY DEVELOPED OR PATENTED IN USA. WE ARE WHOLESALERS AND IMPORTERS OF ALL KINDS OF ELECTRICAL MATERIALS, ETC. IN JAPAN. HAVING BRANCHES ALL OVER JAPAN, TOKYO, NAGOYA, FUKUOKA, SHIKOKU, KASHIMA, HIROSHIMA, ETC. OUR MONTHLY TURNOVER IS ABOUT US\$2,400,000.00. OUR BANKERS: SUMITOMO, FUJI, KYOWA, DAI-ICHI KANGIN, KOBE. PLEASE CONTACT US DIRECTLY.

## Z. KURODA & CO., LTD.

56-2, 5-CHOME KIGAWA HIGASHINOCHO  
 HIGASHI YODOGAWAKU OSAKA, JAPAN  
 TELEX: 523-8426 CABLE: KURODEN OSAKA

## New products/materials

similar to that of aluminum or copper, and the material adheres to metals, ceramics, glass, and most plastics. Applications include bonding devices such as silicon controlled rectifiers, power transistors, or integrated-circuit packages to heat-sink chassis. Price is \$21 per pint kit or \$32 per quart kit.

Aremco Products Inc., Box 145, Briarcliff Manor, N.Y. [479]

Unclad laminates are suitable for use with any copper additive method now in use. The materials are available in paper or glass base, catalytic or noncatalytic, with or without adhesive, and in panels or sheets in the size and thickness specified by the customer. Applications of the laminates are in color-television receivers, automotive parts, computers, and minicalculators.

NVF Co., Yorklyn, Del. [480]

Ablefilm 542 is a pliable, unsupported film adhesive designed to produce resilient bonds between material with different coefficients of expansion. The material can be cured as low as 165°C for 1½ hours or quick-cured at 225°C for 2 minutes. Lap shear strength is 5,000 psi, and the standard thickness is 0.003±0.0005.

Ablestik Laboratories, 833 W. 182nd St., Gardena, Calif. 90248 [374]

Screen printing of thick-film microcircuit multilayer capacitor electrode and conductive silver compositions can be enhanced with a pretreatment of screens and substrates with a system called Prinar. Prinar, when applied to the surface of a screen or mask, reduces the tendency of thick-film compositions to wet the treated surfaces. This leads to cleaner breakaway of the composition from the screen, improved definition and uniformity of pattern formation on the substrate, easier screen-cleaning, and improved screen life. An evaluation kit is available for testing the process at \$50. The kit contains 1 quart each of 9125 pretreatment solution and 9126 surfactant solution. One-gallon lots are priced at \$98 each.

Du Pont Co., Wilmington, Del. [375]

180 Circle 216 on reader service card

Electronics/June 21, 1973



# How to multiply your draftsmen's time.

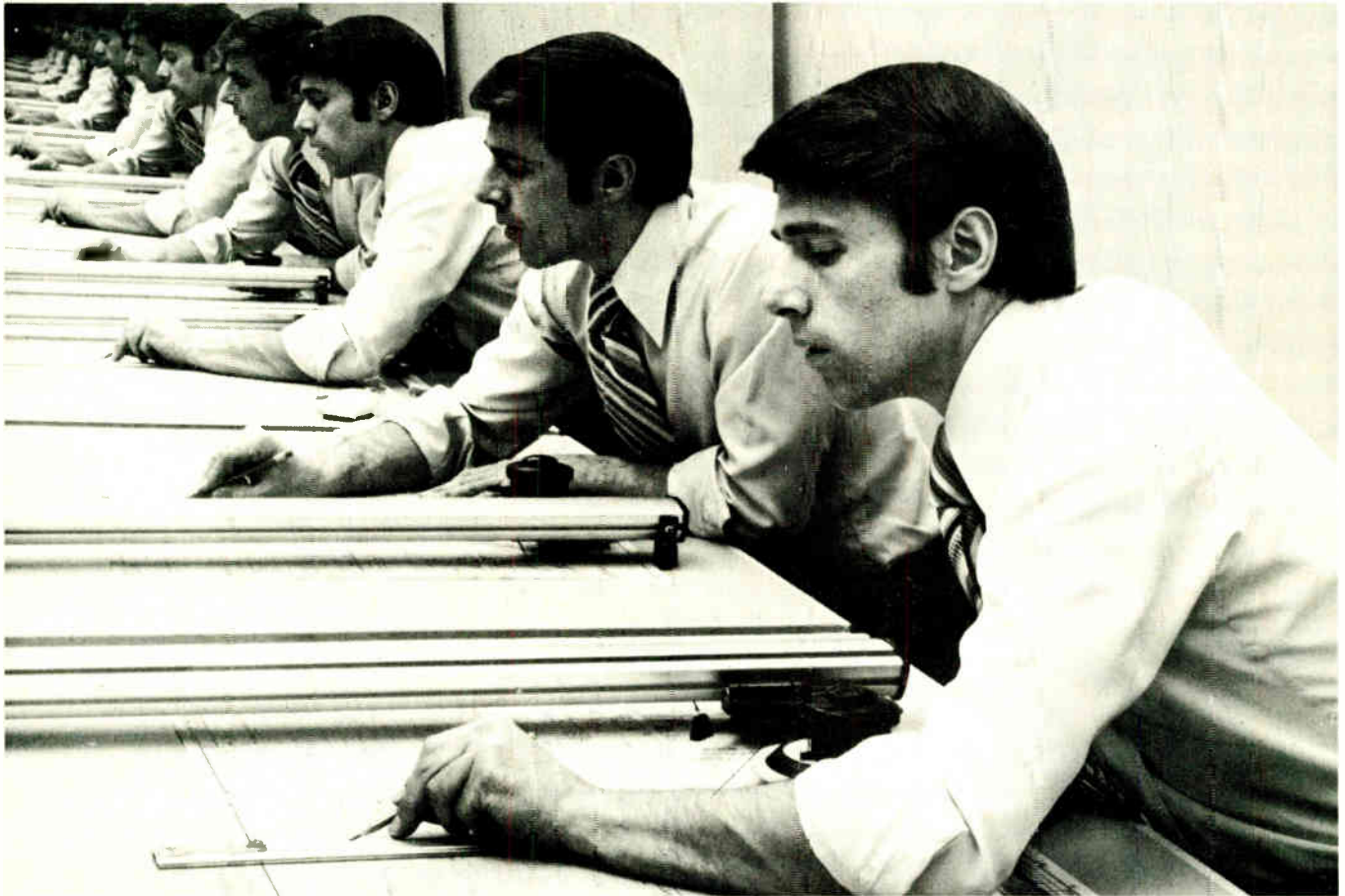

---

Shortcuts from Kodak turn drafting hours into minutes—on job after job.

---

Routine redrawing chores take a lot of valuable board time. Kodak can show your draftsmen how to restore drawings, make revisions, and handle repetitive elements—without redrawing. You'll save hours of drafting time and save money, too.

It's easy, because it's done photographically! We'll explain how to do it and help you select the proper Kodagraph films and papers for your particular work. And we can show you how, with an automated Kodak

processor, you can get reproductions back to your draftsmen faster, to save even more time.

There are other ways that Kodak can help multiply your draftsmen's efficiency. Microfilming your drawings will make them more accessible, save filing space, provide security, and give you other benefits, too.

---

Get the details.

---

For additional information write: Eastman Kodak Company, Business Systems Markets Division, Dept. DP867, Rochester, N.Y. 14650.

**Kodak products for drawing reproduction.**



keep electrical contact

# facts

at your fingertips

ONLY  
**\$8.50**  
(8.00 each,  
5 or more)

## a thousand and one design answers

for low energy uses

This new 175 page text, by Kenneth E. Pitney, features the basics of contact technology . . . comprehensive treatment without complex derivations . . . emphasis on theory, practical design and application, especially for low energy uses. Topics range from General Contact Theory to Properties of Materials to Design and Application. Order direct from J. M. Ney Company, Bloomfield, Conn. 06002.

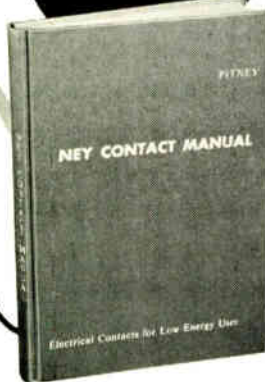

Circle 182 on reader service card

## Contacts...

... establish connections. In the radio- and phono-industry as well as in the electronics industry. Contacts don't necessarily have to be people. For example, take our Type 4138 Miniature-Push-Button-Switch. With it you can make contacts in undreamed-of combinations, for 2- to 10-fold switching, with a maximum of ten change overs per key and with 3 key functions: Interlock, Push-push and Momentary. And all that in the smallest size and with high reliability. It is suited for use in printed-or in conventional circuits. So if you have contact problems, contact us first, then we can inform you about contacts.

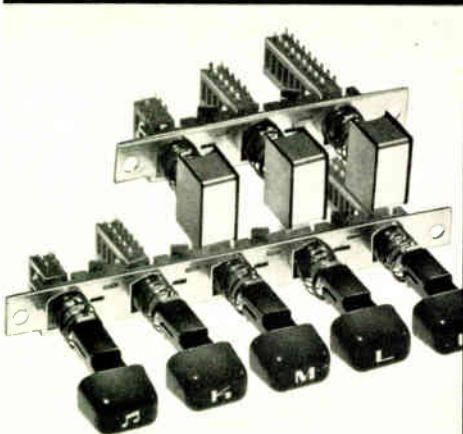

Schoeller & Co.,  
Elektrotechnische Fabrik,  
6 Frankfurt a. M. 70  
Mörfelder Landstr. 115-119

## New literature

**Relays.** A range of 61 solid-state relays is described in a catalog available from Grayhill Inc., 561 Hillgrove Ave., LaGrange, Ill. A guide to parts numbering is provided, as well as specifications and rating curves. Circle 421 on reader service card.

**Main memories.** Advanced Memory Systems Inc., 1276 Hammerwood Ave., Sunnyvale, Calif. 94086. A two-page brochure describes the company's line of solid-state, plug-compatible main memories for the Honeywell DDP-516. [422]

**Terminals.** Burndy Corp., Norwalk, Conn., is offering a 54-page terminal and splice catalog for OEM applications. Catalog CG-107 features open-barrel strip terminals and closed-barrel vinyl-insulated, nylon-insulated and uninsulated terminals and splices for copper wire, sizes 26 to 4/0 AWG. [423]

**Packaging materials.** Corning Glass Works, Corning, N.Y. has published a four-page folder describing its semiconductor packaging materials. [424]

**Rectifiers.** Subminiature, silicon, single-phase bridge rectifiers are discussed in a bulletin available from Edal Industries Inc., 4 Short Beach Rd., E. Haven, Conn. [425]

**Transmission system.** A comprehensive 36-page bulletin is being offered by GTE Lenkurt Inc., 1105 County Rd., San Carlos, Calif. 94070, covering the type 25D telegraph transmission system. [426]

**Hybrid circuits.** Hughes Micro-electronic Products, 500 Superior Ave., Newport Beach, Calif. 92663. A 16-page brochure describes the company's capability in the manufacture and assembly of thin-film and thick-film hybrid integrated circuits. [427]

**Power supplies.** Abbot Transistor Laboratories Inc., 5200 W. Jefferson Blvd., Los Angeles 90016. A 56-page catalog describes and illustrates the company's line of power

# New generation of high-performance, low-cost, ultra-precision resistors

Tolerances: .01% to 1%  
Temp. Coeff.: 5 to 25 PPM/°C  
T.C. Matching: to 1 PPM/°C

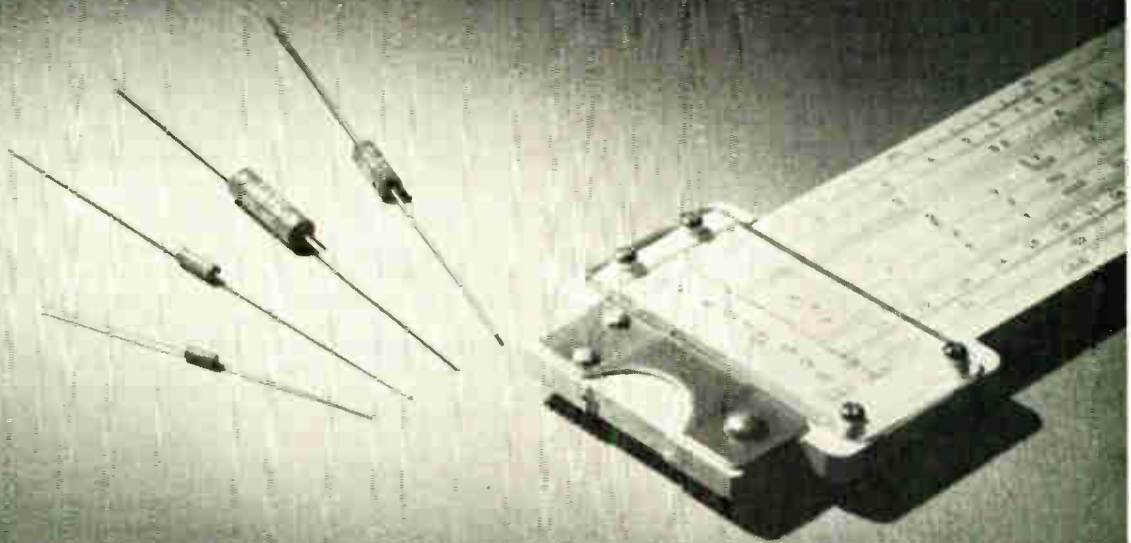

Caught in a cost/performance bind on precision resistors? Solve the problem with TRW/IRC's new MAR Series of ultra-precision metal film resistors. Where speed and precision count, they offer the ultimate in cost/performance ratio. And by "performance," we mean better than premium wirewounds.

With the MAR Series, you get an ultra-stable, ultra-precision resistor with an extremely low temperature coefficient. You also get the non-measurable noise, low voltage coefficient and stress stability previously available only in pre-

cision wirewounds. Yet you still have the high-frequency response, reliability, pulse stability and resistance/size ratio of metal film.

Also available as part of the MAR technology are resistor matched sets and modules providing additional performance and cost advantages. For comprehensive technical data and MAR samples, contact your TRW representative. Or write TRW/IRC Fixed Resistors, 2850 Mt. Pleasant St., Burlington, Iowa 52601. Phone: (319) 754-8491.

| IRC TYPE | RESISTANCE RANGE (Ohms) | TEMPERATURE COEFFICIENTS <sup>1</sup> (-20 °C to +85 °C) (± ppm/°C) | TOLERANCES (± %) | POWER RATINGS @ 85 °C (Watts) | VOLTAGE RATINGS (Volts) | DIMENSIONS IN INCHES |                       |                        |
|----------|-------------------------|---|------------------|-------------------------------|-------------------------|----------------------|-----------------------|------------------------|
|          |                         |   |                  |                               |                         | Body Length (L Max)  | Body Diameter (D Max) | Lead Gage (A)          |
| MAR3     | 20-100K                 | T10 = 15  | 1.00, 0.50, 0.25 | 1/20                          | 200                     | .191                 | .082                  | ≈ 26 .016 <sup>2</sup> |
| MAR5     | 20-250K                 | T13 = 10  | 0.10, 0.05, 0.02 | 1/10                          | 250                     | .281                 | .102                  | ≈ 22 .025              |
| MAR6     | 20-500K                 | T16 = 5   | 0.01             | 1/8                           | 300                     | .425                 | .155                  | ≈ 22 .025              |
| MAR7     | 20-1 Meg                |   |                  | 1/4                           | 500                     | .650                 | .195                  | ≈ 22 .025              |

<sup>1</sup>Wider ranges available. Contact factory. <sup>2</sup>Lead length 1.00 ± 0.2

## TRW<sup>®</sup> IRC RESISTORS

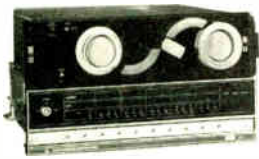

NOVA  
\$3950.00 (quan. 1)  
PLUG COMPATIBLE



PDP-11  
\$4500.00 (quan. 1)  
PLUG COMPATIBLE



H/P-2100  
\$4350.00 (quan. 1)  
PLUG COMPATIBLE

## PLUG A LINC TAPE INTO YOUR MINI.

- Most Reliable Tape System in the Industry
- 100,000 Tape Passes Guaranteed
- 8,400 Bytes/Second Transfer Rate
- Block Addressable Disc Format for True Random Access
- 204,800 or 335,872 Bytes/Reel in Blocks of 512
- Slave expansion units \$1700.00 per drive
- Available for all more popular Minis

NCC Booth 212A

A complete operating system to expedite program preparation through a text editor, assembler, two loaders, and various file handling routines is available. Paper tape is completely eliminated. LINC Tape is used for source, object, and image files. Full BASIC and FORTRAN support.

**Computer Operations, Inc.**

10774 Tucker St. • Beltsville, Md. 20705 • 301-937-5377

Circle 184 on reader service card

### Our single-chip concept:

Copper grid distributes current most efficiently for lowest  $V_{CE(sat)}$ .

Integral solid copper leads and heat sink make pre-bond chip test and inventory possible.

Meet stringent MIL requirements best with the NPN silicon transistor that's single-minded about performance. The concept: a unique single-chip design that packs the highest current rating in its class... keeps saturation voltage low and eliminates second breakdown problems.  $V_{CE(sat)}$  is .60V max. @ 50 Amps, and guaranteed at 90 Amps.  $E_{S/b}$  is 6 joules. And because its very simplicity allows pre-rating

One bigger, beefier chip.

Void-free bonding techniques eliminates hot spots.

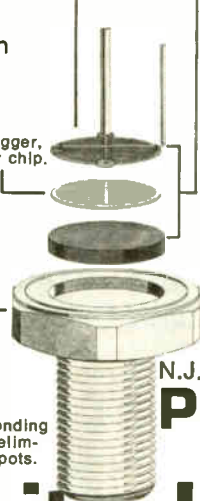

and pre-testing, you can order our PT 7511 device off-the-shelf for switching regulators, motor controls and other hi-rel power circuits. For tech. data and application assistance, write or call, PowerTech, Inc., 9 Baker Ct., Clifton, N.J. 07011; (201) 478-6205

**PowerTech**  
BIG IDEAS IN  
BIG POWER

**Top of its class.**  
**200v, 90A**  
**silicon transistor**

184 Circle 219 on reader service card

## New literature

modules. Over 2,533 models are detailed with electrical specifications and dimension charts. [428]

**Digital IC tester.** A brochure outlining the operation of the model 3200 digital IC tester is available from Sitek Inc., 1078 W. Evelyn Ave., Sunnyvale, Calif. 94086 [429]

**Memory systems.** Alpha Data Inc., 8759 Remmet Ave., Canoga Park, Calif. 91304. A bulletin provides details on a plug-compatible Nova computer head-per-track disk memory and highlights a family of fast-access, head-per-track disks covering the storage range of 64,000 to 2,500,000 words per drive. [430]

**Capacitors.** A 20-page catalog published by The Potter Co., 10441 Roselle St., San Diego, Calif., gives information on the series 3000/4000 film capacitors for instrumentation, data processing, telecommunications, industrial controls, and special applications. [431]

**Amplifiers.** Dynamic Measurements Corp., 6 Lowell Ave., Winchester, Mass. A short-form catalog provides information on digital-to-analog converters and operational amplifiers. [432]

**Back package.** National Beryllia Corp., Greenwood Ave., Haskell, N.J. 07420, has issued a technical data sheet on the Sealox hybrid 3/8-by 3/8-inch metal back package, the SP-2272. [433]

**Circular headers.** TO-8 and other circular headers for microelectronics circuit applications are described in a four-page bulletin from Tekform Products Co., 2770 Coronado Ave., Anaheim, Calif. 92806 [434]

**Cabling.** Whitmor Wire and Cable Co., 13161 Sherman Way., N. Hollywood, Calif. 91605, has published a booklet describing the company's production and service capability as a custom electronics cabling supplier. [435]

**Connectors.** A 40-page catalog describing over 800 connection prod-

Electronics/June 21, 1973

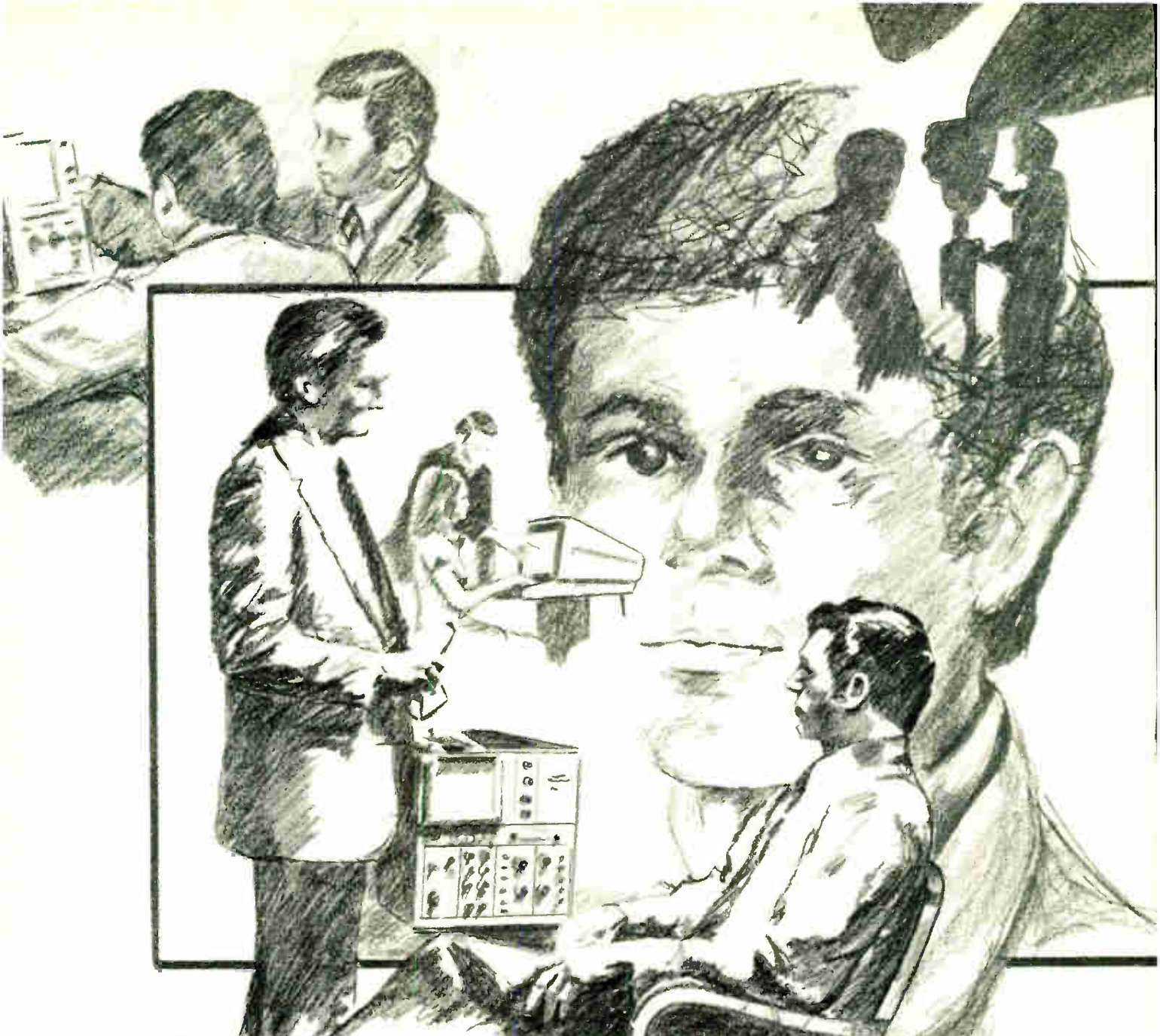

# Tektronix field engineer

a man of business & science

The TEKTRONIX Field Engineer is a man of business and science, able to relate across many technical and business disciplines.

He is an innovator, a self starter and a professional salesman. He provides products, measurement solutions and support to our customers. Interested? We'd like to hear from you. We'll keep your response confidential.

Write: Dan Thompson  
Marketing/Engineering  
Personnel Manager  
Tektronix, Inc.  
P.O. Box 500  
Beaverton, Oregon 97005



**TEKTRONIX®**  
committed to  
technical excellence

An Equal Opportunity Employer



## When it comes to TRANSIENT VOLTAGE PROTECTION

*Signalite* wrote  
the book!

**And, It's Yours FREE!**

### It's all part of the SIGNALITE TRANSIENT VOLTAGE PROTECTION KIT!

Including a 28-page book entitled, "Gas Discharge Devices For Use In Transient Voltage Protection and Electrical Energy Transfer." Part I, Transient Voltage Protection, details sources of voltage transients, operation and construction of protectors, comparison of various transient protection devices, pulse breakdowns, V & I characteristics of protectors in AC & DC circuits, follow-on current, etc. Part II, Electrical Energy Transfer, details various devices, applications and glow-to-arc transitions. Included in the Signalite Transient Protection Kit are specification bulletins on Signalite's UNI-IMP, the fastest surge arrester in existence... COMM-GAP, a high quality, low cost protector with a wide range of applications... TWO ELECTRODE & TRIGGERED SPARK GAPS... AC/DC LINE PROTECTORS... plus an Applications Engineering Worksheet so that the Signalite Application Department can help in the design of your protection circuitry.

*Signalite*  
DIVISION OF GENERAL  
INSTRUMENT CORPORATION

1933 Heck Ave., Neptune, New Jersey 07753  
Area Code 201-775-2490 ■ TWX 201-775-2255

329

## Three Simple, Safe



## Temperature Indicators for Electronics

Let you know when rated temperature  
is reached... with an accuracy of  $\pm 1\%$

**1. TEMPILABELS<sup>®</sup>:** self-adhesive temperature monitors consisting of one or more heat-sensitive indicators sealed under transparent, heat resistant windows. The centers of the indicator circles turn from white to black irreversibly at the temperature ratings shown on the label. Tempilabels<sup>®</sup> are available in several sizes, and in single or multiple temperature ratings from 100° to 500°F. Accuracy is within  $\pm 1\%$  of the stated rating. They are particularly useful for monitoring operating temperatures of equipment or processes; obtaining temperature data of components as a guide to design and material selection; safeguarding temperature-sensitive materials in storage or transit. To serve as a permanent record, Tempilabels<sup>®</sup> can be removed from the surface and attached to a report.



**2. TEMPILAQ<sup>®</sup>:** materials of calibrated melting points suspended in an inert, volatile non-flammable vehicle. Available in over 100 systematically spaced temperature ratings from 100° to 2500°F. Tempilaq<sup>®</sup> indicates its temperature rating by liquefying within  $\pm 1\%$  of its rating. Available in bottles or spray cans.

**3. TEMPILSTIKS<sup>®</sup>:** temperature-indicating crayons of calibrated melting points. Available in over 100 systematically spaced temperature ratings, Tempilstiks<sup>®</sup> cover the range from 100° to 2500°F. Tempilstiks<sup>®</sup> indicate the specified temperature, by liquefying with a tolerance of  $\pm 1\%$  of its rating.

Detailed data and price sheets as well as samples are available upon request.



**Tempil<sup>®</sup>** DIVISION, BIG THREE INDUSTRIES, INC.

Hamilton Blvd., South Plainfield, N.J. 07080  
Phone: 201 • 757-8300 • Telex: 138662

10014

# How to ship small packages in a big hurry.

**DELTA'S DASH**  
DELTA AIRLINES SPECIAL HANDLING

Delta guarantees delivery on the flight or routing you specify between most Delta cities.

Packages accepted up to 50 lbs. with length plus width plus height not to exceed 90" total, with only one dimension exceeding 30".

Delivery to Delta's passenger counter or air freight terminal at the airport at least 30 minutes prior to scheduled departure time.

Pick-up at DASH Claim Area next to airport baggage claim area 30 minutes after flight arrival at destination.

Charges for DASH shipments are nominal. Delta reservations will be pleased to quote actual charges between specific points.

Payments accepted in cash, by company check, most general-purpose credit cards, special credit arrangements or on government shipments by GBL. **DELTA**  
The airline run by professionals.

**Rate examples (Tax included)**

|                         |         |
|-------------------------|---------|
| Atlanta-Washington      | \$21.00 |
| Boston-Miami            | \$26.25 |
| Cincinnati-Louisville   | \$21.00 |
| Cleveland-Phoenix       | \$26.25 |
| Los Angeles-New Orleans | \$31.50 |
| Dallas-Los Angeles      | \$26.25 |
| San Francisco-Atlanta   | \$31.50 |
| Philadelphia-Houston    | \$26.25 |
| New York-Tampa          | \$26.25 |

For full details, call Delta reservations.



## Delta is ready when you are!

Circle 221 on reader service card

## New literature

ucts is available from Robinson-Nugent Inc., 800 E. 8th St., Box 470, New Albany, Ind. 47150 [436]

**LEDs.** A 12-page catalog of light-emitting-diode products is being offered by Litronix, 19000 Homestead Rd., Cupertino, Calif. 95014. The catalog contains information on selecting indicator and panel discrete LEDs, opto-isolators, infrared LEDs, single- and multiple-digit numeric and several types of alphanumeric displays. [437]

**Connectors.** Rectangular connectors are described in a 66-page catalog published by Bendix Electrical Components Division, Sidney, N.Y. 13838. Printed-circuit and rack and panel versions are also discussed. [438]

**Signal sources.** Seventeen signal sources for applications from dc to 2 GHz are described in a 20-page booklet from General Radio, 300 Baker Ave., Concord, Mass. 01742. Nine models of synthesizers are featured as well as six oscillators and two standard signal generators. [439]

**Power converters.** A 14-page catalog describes the line of power-conversion equipment manufactured by Arnold Magnetics Corp., 11520 W. Jefferson Blvd., Culver City, Calif. 90230. The catalog includes charts, general information, graphs, diagrams, specifications, applications, and prices. [440]

**Communications.** Syntech Corp., 11810 Parklawn Dr., Rockville, Md., has published a short-form catalog of data communications products, including data sets, modems, time-division multiplexers, and error-rate test sets. [371]

**Readout system.** Sequential Information Systems Inc., 249 N. Saw Mill River Rd., Elmsford, N.Y. 10523. A four-page bulletin describes the model DIR digital incremental readout system. The bulletin contains information on applications and specifications, and general information. [372]

# \$125



## it's so easy to take . . .

You can replace your thermopile with a SBN PYROELECTRIC DETECTOR.

- **BROADBAND RESPONSE**—UV to microwaves
- **HIGH SENSITIVITY**—> to 125 V/W
- **FAST RESPONSE**—better than 5ns
- **NO CRYOGENICS**—operates from -40°C to 90°C
- **RUGGED AND NONHYGROSCOPIC**

This package includes a sensing element plus a integral FET and fits a standard 9 pin miniature tube socket. Available from stock for only \$125.00.

Call us at 216/248-7400 with your IR detection and measurement problems.



## HARSHAW

THE HARSHAW CHEMICAL COMPANY  
DIVISION OF KEWANEE OIL COMPANY

Crystal & Electronic Products Department  
6801 Cochran Road • Solon, Ohio 44139  
(216) 248-7400

Circle 187 on reader service card



**EMPLOYMENT OPPORTUNITIES**

**CERAMIC CAPACITOR ENGINEER**

We have a senior opening for an experienced ceramic capacitor engineer with full knowledge of design and production of MIL CK Types as well as commercial and industrial monolithic capacitor engineering. Excellent opportunity with a well-financed organization for the right person. Send complete details of past experience and education to:

**P-2734**

Electronics, Class. Adv. Dept., P.O. Box 900, NY, NY 10020

*An Equal Opportunity Employer*

**RESUME KIT**

Free Engineer's Resume Kit for Electrical Mechanical and Industrial Engineers. Scientific Placement, Inc., Employment Service 5051 Westheimer, Houston, TX 77027.

**HELP!**

**Q. How do I reply to a box number ad?**

**A.** Address an envelope with the box number indicated in the ad, c/o Electronics, Class. Adv. Dept., P.O. Box 900, NY, NY 10020

**Q. Whom do I contact or call to renew my classified ad or make corrections?**

**A.** Write Electronics, Class. Adv. Dept., P.O. Box 900, NY, NY 10020 or call: (212) 997-6585 or 6586. Give full company name, size of ad, & date or dates it is scheduled to appear.

**AUTOTRACK MOUNT**

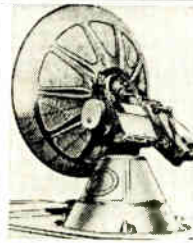

**AUTOTRACK SCR-584 RADARS**

360 degree azimuth, 210 degree elevation sweep with better than 1 mil. accuracy. Missile velocity acceleration and slewing rates. Amplidyne and servo control. Will handle up to 20 ft. dish. Supplied complete with control chassis. **ALSO** in stock - 10 cm. van mounted radar system. Conical scan. PPI. 6 ft. dish. Ideal for S band telemetry, weather, balloon trk, missile trk, rocket trk, ECM range. Write for complete data. 600 pg. instr. bk. avail. at \$25 ea.

**1 MEV LINEAR ACCELERATOR**

Dual Mode, Ion or Electron, RF Drive, 300 KHZ at 45 KW. Includes control console, RF unit, accelerator, etc.

**MOD IV HIGH RESOLUTION TRACKER**

Instrumentation radar, freq. 8.5-9.6 GHz, Pwr: 250 KW, .1 mil tracking accuracy, 6' Fresnel lens antenna with 4 horn monopulse feed. Tracking range 50 or 200 miles. Formerly used as range safety radar at Cape Kennedy.

**MIT MODEL 9 PULSER 1 MW—HARD TUBE**

Output 25kv 40 amp., 30kv 40 amp. max. Duty cy. .002-.25 to 2 microsec. Also 5 to 5 microsec. and 1 to .5 microsec. Uses 6C21. Input 115v 60 cycle AC. Mfg. GE. Complete with driver and high voltage power supply. Ref. MIT Rad. Lab. Series, Vol 5, p. 152.

**2 MEGAWATT PULSER**

Output 30 kv at 70 amp. Duty cycle .001. Rep. rates. 1 microsec. 600 pps. 1 or 2 msec. 300 pps. Uses 5948 hydrogen thyatron. Input 120 / 208 VAC 60 cycle. Mfr. GE. Complete with high voltage power supply.

**17 MEGAWATT LINE PULSER**

Output 17KV at 1000 Amps. Rep. rate 150-2000 PPS 2.5 Microsec. Keyer tube 5948 thyatron. Pwr: 208V, 3Ph, 60HZ, 38KVA.

**HV POWER SUPPLIES**

6.3 KV @ 5. Amp; 20KV @ 1.3 Amps; 35KV @ 1.5 Amps; 28KV, 70MA; 12KV @ 800MA 18KV @ 2.25 Amps; 17.5KV @ 1.8 Amps.

**RECON DRONE CONTROL RADARS**

X Band systems autotrack and search complete with plotting boards. Fully mobile van mounted. Gives PPI, slant range, altitude data. Ground to air control links and beacons also in stock. AN / MPQ-29 & AN / UPW-1

**PARAMETRIC AMPLIFIER**

Collins type, 2.3 Ghz, 30 Mhz band width, 1.7 DB noise figure, 20 DB gain, 5-way power splitter output.

**SPARE PARTS IN STOCK**

Nike Ajax, Nike Hercules, M-33, MPS-19, TPS-ID, TPS-10D, FPS-6, SPS8, SCR-584, HIPAR

**RADAR & RF PKGS.**

34ghz 40kw Pulse RF pkg  
24ghz 40kw Pulse bomb toss system  
16ghz 130 kw Pulse B-58 search radar system  
**X BAND SEARCH 40 KW PULSE WEATHER RADAR**  
**X BAND AUTOTRACK 250KW PULSE M-33**  
compl w / plot boards  
**X BAND BEACON 400 W PULSE AN / DPN-62**  
**X BAND AUTOTRACK 50KW PULSE B-47**  
fire control complete  
**C BAND WEATHER RADAR 250 KW PULSE**  
**C BAND HEIGHT FINDER**  
AN / FPS-26 5 megawatt output.  
AN / TPS-37, 1 megawatt output.  
**C BAND 1 MEGAWATT AUTOTRACK**  
10ft dish mortar locator MPQ-21  
**C BAND 285KW PULSE Search AN / SPS-5**  
**S BAND AUTOTRACK 500 KW PULSE 10' DISH**  
**S BAND 1 MEGAWATT COHERENT AN / FPS-18**  
**S BAND 1 MEGAWATT PULSE NIKE ACQ.**  
**S BAND 5 MEGAWATT HEIGHT FINDER AN / FPS-6**  
**S BAND BEACON 1 KW PULSE**  
**L BAND 500KW PULSE AN / TPS-ID / E**  
**L BAND 5 to 20KW PULSE**  
400mhz 1KW CW AN / FPS-23  
225mhz 1 MEGAWATT PULSE AN / TPS 28  
2-30mhz 100K W PULSE  
CW .950-5ghz 150 WATTS  
CW 1.5mhz-10.5ghz 5 WATTS  
CW 7.4 GHZ 2 KW



**AN / GPG-1 SKYSWEEP TRACKER**  
3 cm. auto. tracking radar system. Comp. pkg. w / indicator sys. Full target acquisition & auto. tracking. Input 115v 60 cy. new. In stock for immed. del. Entire sys. 6' x 3' x 10'. Ideal for infrared tracker, drone tracker, missile tracker, R & D.

**Radio-Research Instrument Co. INC.**

3 Quincy St., Norwalk, Conn. 06850 • 203-853-2600

**Job-seekers... be the first to know with McGraw-Hill's Advance Job Listings**

By having our new weekly ADVANCE JOB LISTINGS sent First-Class (or by Air Mail, if you prefer) to your home every Monday you can be the first to know about nation-wide openings you qualify for both in and out of your field.

This preprint of scheduled employment ads will enable you to contact anxious domestic and overseas recruitment managers BEFORE their advertisements appear in upcoming issues of 22 McGraw-Hill publications.

To receive a free sample copy, plus information about our low subscription rates (from one month to 12), fill out and return the coupon below.

ADVANCE JOB LISTINGS / P.O. BOX 900 / NEW YORK NY 10020

PLEASE SEND A SAMPLE COPY OF ADVANCE JOB LISTINGS TO:



NAME \_\_\_\_\_ ADDRESS \_\_\_\_\_  
CITY \_\_\_\_\_ STATE \_\_\_\_\_ ZIP \_\_\_\_\_



# NEW SHORTER CASE! SCHAUER 1-WATT ZENERS

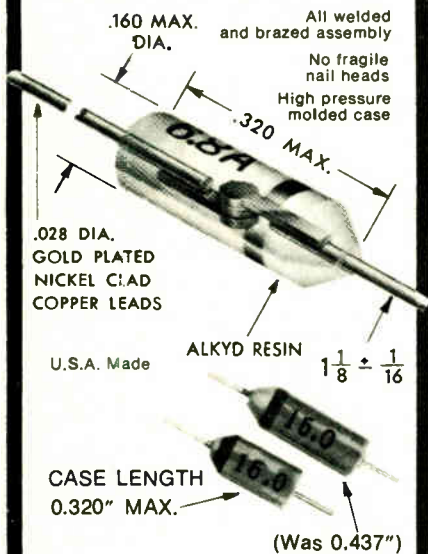

**SAME LOW PRICES FOR  
1% TOLERANCE ZENERS**

**ANY VOLTAGE  
FROM 2.0 TO 18.0**

| Quantity  | Price Each |
|-----------|------------|
| 1-99      | \$1.07     |
| 100-499   | .97        |
| 500-999   | .91        |
| 1000-4999 | .86        |
| 5000 up   | .82        |

## IMMEDIATE SHIPMENT

Send for rating data and 20%, 10%, 5% and 2% tolerance prices.

Semiconductor Division

# SCHAUER

MANUFACTURING CORP.

4514 Alpine Ave., Cincinnati, Ohio 45242  
Telephone 513/791-3030

## Advertising Sales Staff

**Pierre J. Braudé** [212] 997-3485  
Advertising Sales Manager

**Atlanta, Ga. 30309:** Joseph Lane  
100 Colony Square, 1175 Peachtree St., N.E.  
[404] 892-2868

**Boston, Mass. 02116:** James R. Pierce  
607 Boylston St. [617] 262-1160

**Chicago, Ill. 60611:**  
645 North Michigan Avenue  
Robert W. Bartlett (312) 751-3739  
Paul L. Reiss (312) 751-3738

**Cleveland, Ohio 44113:** William J. Boyle  
[716] 586-5040

**Dallas, Texas 75201:** Charles G. Hubbard  
2001 Bryant Tower, Suite 1070  
[214] 742-1747

**Denver, Colo. 80202:** Harry B. Doyle, Jr.  
Tower Bldg., 1700 Broadway  
[303] 266-3863

**Detroit, Michigan 48202:** Robert W. Bartlett  
1400 Fisher Bldg.  
[313] 873-7410

**Houston, Texas 77002:** Charles G. Hubbard  
2270 Humble Bldg. [713] CA 4-8381

**Los Angeles, Calif. 90010:** Robert J. Rielly  
Bradley K. Jones, 3200 Wilshire Blvd., South Tower  
[213] 487-1160

**New York, N.Y. 10020**  
1221 Avenue of the Americas  
Warren H. Gardner [212] 997-3617  
Michael J. Stoller [212] 997-3616

**Philadelphia, Pa. 19102:** Warren H. Gardner  
Three Parkway,  
[215] 997-3617

**Pittsburgh, Pa. 15222:** Warren H. Gardner  
4 Gateway Center, [212] 997-3617

**Rochester, N.Y. 14534:** William J. Boyle  
9 Greylock Ridge, Pittsford, N.Y.  
[716] 586-5040

**San Francisco, Calif. 94111:** Don Farris  
Robert J. Rielly, 425 Battery Street,  
[415] 362-4600

**Paris:** Alain Offergeld  
17 Rue-Georges Bizet, 75 Paris 16, France  
Tel: 720-73-01

**Geneva:** Alain Offergeld  
1 rue du Temple, Geneva, Switzerland  
Tel: 32-35-63

**United Kingdom:** Keith Mantle  
Tel: 01-493-1451, 34 Dover Street, London W1

**Milan:** Robert Saidel  
1 via Baracchini Phone 86-90-656

**Brussels:** Alain Offergeld  
23 Chaussee de Wavre  
Brussels 1040, Belgium  
Tel: 13-65-03

**Stockholm:** Brian Bowes  
Office 17, Kontor-Center AB, Hagagarten 29,  
113 47 Stockholm. Tel: 24 72 00

**Frankfurt/Main:** Fritz Krusebecker  
Liebigstrasse 27c  
Phone 72 01 81

**Tokyo:** Tatsumi Katagiri, McGraw-Hill  
Publications Overseas Corporation,  
Kasumigaseki Building 2-5, 3-chome,  
Kasumigaseki, Chiyoda-Ku, Tokyo, Japan  
[581] 9811

**Osaka:** Ryji Kobayashi, McGraw-Hill  
Publications Overseas Corporation, Kondo  
Bldg., 163, Umegae-cho Kita-ku [362] 8771

**Australia:** Warren E. Ball, IPO Box 5106,  
Tokyo, Japan

## Business Department

**Stephen R. Weiss, Manager**  
[212] 997-2044

**Thomas M. Egan,**  
Production Manager [212] 997-3140

**Carol Gallagher**  
Assistant Production Manager [212] 997-2045

**Dorothy Carter,** Contracts and Billings  
[212] 997-2908

**Frances Vallone,** Reader Service Manager  
[212] 997-6057

## Electronics Buyers' Guide

**George F. Werner,** Associate Publisher  
[212] 997-3139

**Regina Hera,** Directory Manager  
[212] 997-2544



**New Low Cost Time Code Translator.** Advances technology of Astrodata product line acquisition. Translates all serial time code inputs into parallel BCD or binary outputs. Plug-in TTL logic modules offer compatible interface to any related equipment. Most readable 7-segment displays of days/hrs/min/sec are gas discharge type. MOXON, SRC DIV. CIRCLE 188

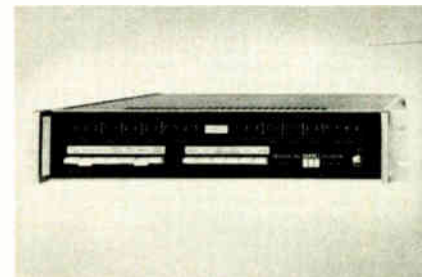

**New Search and Control Unit —** Fully automatic, self-contained unit controls magnetic tape transport. It features multiple search modes for wider system applications plus adjustments for best search operation characteristics. Auxiliary outputs included for control of data reduction processes. Plug-in circuit boards replace difficult to service "mother boards." MOXON/SRC CIRCLE 189

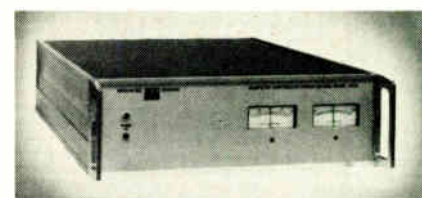

**New Computer Compatible, Programmable DC Power Source.** Automatic systems use. Output 100V @ 0.5A or 50V @ 1A. 16-bit binary or 8-4-2-1 BCD. Hi speed — over 10 kHz. Noise and ripple 800 uv p-p max. Load transient recovery 30 μsec. Data circuit interface selection, programmable current limiting. Hi AC/DC isolation w/guard shield. Data line isolation. MOXON, SRC DIV. CIRCLE 190



**Moxon Inc/SRC Division**  
2222 Michelson Drive  
Irvine, California 92664  
Phone: (714) 833-2000

# Electronics advertisers

June 21, 1973

|   |           |  |           |   |             |
|---|-----------|--|-----------|---|-------------|
| ‡ Acopian Corp.<br>Mort Barish Associates, Inc.   | 56        | ■ General Electric Company,<br>Utility & Process Auto. Prod. Dept.<br>Robert S. Cragin, Inc.               | 12-13     | ‡ Rohde & Schwarz, Inc.<br>R + S Sales Company  | 59          |
| Adams & Westlake Company Relay Division<br>Adwest Advertising   | 156       | ■ General Instrument Corp.,<br>Semiconductor Products Division<br>Graphics & All, Inc.                     | 169       | * Rohde & Schwarz<br>Scanbe Manufacturing Corp.<br>Warren C. Wilson, Associates         | 1E<br>173   |
| ADC Products (OEM)<br>Midland Associates, Inc.  | 165       | * Goetz Electro GmbH<br>Dr. Heinrich Fuchs   | 20        | Schauer Manufacturing Corp.<br>Nolan, Keeler & Stiles                                   | 188         |
| * Adret Electronique<br>P. Romain   | 7E        | Gould Data Systems<br>Marsteller, Inc.   | 79        | Schoeller & Co.<br>Sigma Studio 1   | 182         |
| * Advance Electronics Ltd.<br>Evan Steadman (Services) Ltd.   | 12E       | Harris Semiconductor<br>Tucker Wayne & Company   | 48-49     | Scientific Micro Systems, Inc.,<br>sub. of Corning Glass Works<br>The Warr Dept.        | 145         |
| Advanced Micro Devices<br>Keye/Donna/Pearlstein   | 10-11     | * Harshaw Chemical Company<br>Industry Advertising Company   | 187       | ‡ Siemens<br>Ries Cappiello Colwell, Inc.   | 20-21       |
| * Advanced Micro Devices<br>Keye/Donna/Pearlstein   | 18E       | ■ Heath/Schlumberger Scientific Instruments<br>Advance Advertising Services                                | 191       | * Siemens Aktiengesellschaft<br>Linder Presse Union GmbH                                | 54          |
| * AEROCOM<br>Jacster Enterprises, Inc.  | 20E       | ■ Hewlett-Packard<br>Richardson, Seigle, Rolfs & McCoy, Inc.   | 152-153   | Signetics Corp.,<br>Sub. of Corning Glass Works<br>Hall Butler Blatherwick, Inc.        | 81          |
| Allegheny Ludlum Steel Corporation<br>VanSant Dugdale and Company, Inc.   | 2         | ■ Hewlett-Packard<br>Tallant Yates Adv., Inc.  | 62-63     | Signalite, Inc.<br>MSD Advertising Agency, Inc.   | 186         |
| Allen-Bradley Company<br>Hoffman, York, Baker & Johnson, Inc.   | 26        | ■ Hewlett-Packard<br>Richardson Seigle Rolfs & McCoy, Inc.   | 1         | Silconix<br>Robertson West, Inc.  | 115         |
| American Optical Corporation,<br>Scientific Instrument Div.<br>Fuller & Smith & Ross, Inc.                          | 138       | ■ Hewlett-Packard<br>Tallant Yates Advertising, Inc.   | 24-25     | ‡ Sorensen Company, A Unit<br>of Raytheon Company<br>Provandie Eastwood & Lombardi Inc. | 133         |
| AMP Incorporated<br>Aitkin-Kynnett Co., Inc.  | 170-171   | Hickok Electrical Instrument Company<br>Key Marketing Associates   | 76        | ■ Spectrol Electronics Corp.<br>J M R, Inc.   | 177         |
| ■ Analog Devices, Inc.<br>Schneider Parker Guy, Inc.  | 92        | ■ Hipotronics, Inc.<br>Kenmarc Advertising, Inc.   | 168       | Sprague Electric Company<br>Harry P. Bridge Company                                     | 8           |
| Analogic Corporation<br>Grover and Erickson, Inc.   | 39        | ■ Hughes Aircraft Company<br>Foote, Cone & Belding   | 168       | SRC Division/Moxon, Inc.<br>Ron Jenner & Company  | 189         |
| * Anritsu Electric Co., Ltd.<br>Diamond Agency Co., Ltd.  | 16E       | * Industrie Bfossli S.A.S.<br>C. E. T. I.  | 17E       | Syntronic Instruments, Inc.<br>Moody & Harrison, Inc.                                   | 174         |
| ■ APM-Hexseal<br>The Sommer Agency, Inc.  | 154       | Innovex Corporation<br>Weber Donohue Cooper, Inc.  | 140       | ■ Systron Donner Concord Instruments<br>Bonfield Associates                             | 9, 172      |
| Applied Micro Technology, Inc.  | 167       | ■ Intronics<br>Impact Advertising Incorporated   | 6         | * TEAC Corp.<br>Dentsu Advertising Ltd.   | 74          |
| ■ Augat<br>Creamer, Trowbridge, Case & Basford, Inc.  | 60-61     | ■ Ithaco, Inc.<br>Stahlka/Faller, Inc.   | 80        | Tektronix, Inc.<br>Dawson, Inc.   | 35, 37, 185 |
| ‡ Baron Blakeslee<br>Kolb/Tookey & Associates, Inc.   | 74-75     | ITT Semiconductors<br>Hall & McKenzie Advertising  | 151       | Teledyne Semiconductor<br>Regis McKenna, Inc.   | 53          |
| Bausch & Lomb, Inc.<br>Wolff Assoc., Inc.   | 192       | Jelmar<br>A. Eicoff & Company  | 160       | Teletype<br>N. W. Ayer & Son, Inc.  | 166         |
| Bell & Howell-<br>Electronics & Instruments Group<br>Boylhart, Lovett & Dean  | 44-45     | ■ Johnson Company, E. F.<br>Martin Williams Advertising  | 16        | Tempil Ind. Div. of Big Three Ind.<br>Black-Russell-Morris                              | 186         |
| ‡ Bourns, Inc.<br>Marlborough Assoc., Inc.  | 73        | Krohn-Hite Corporation<br>Impact Advertising, Inc.   | 5         | Teradyne, Inc.<br>Quinn & Johnson, Inc.   | 69          |
| Brand-Rex<br>Creamer, Trowbridge, Case & Basford, Inc.  | 147       | ■ Lambda Electronics Corporation<br>Michel Cather, Inc.  | 3rd cover | ■ Texas Instruments Incorporated<br>Shaw Elliott, Inc.                                  | 83-84       |
| ■ Burndy<br>Intermarco Publicem   | 11E       | Litronix, Inc.<br>Regis McKenna, Inc.  | 46-47     | Texas Instruments Incorporated,<br>Semiconductor Group<br>Tracy-Locke Advertising Inc.  | 165         |
| California Computer Products<br>Dailey & Associates Advertising   | 157       | ‡ Littlefuse, Inc.<br>LF Advertising, Inc.   | 7         | ‡ Thomas & Betts Company<br>McCarthy, Scelba, DeBiasi<br>Advertising Agency, Inc.       | 19          |
| Celanese Corporation<br>D'Arcy-MacManus International, Inc.   | 159       | Lockheed Electronics Company<br>McCann-Erickson, Inc.  | 41        | ■ Thomson CSF<br>Bazaine Publicite  | 161         |
| Centralab, Electronics Div.<br>of Globe Union, Inc.<br>The Brady Co.  | 85        | * LTT<br>Pubibel   | 73        | Toko, Inc.<br>Hakuhodo, Inc.  | 180         |
| Cherry Electrical Products Corp.<br>Kolb/Tookey and Assoc., Inc.  | 175       | MEPCO/ELECTRA, INC.<br>Welborn Advertising, Inc.   | 64-65     | TRW/IRC Resistors<br>Gray & Rogers, Inc.  | 183         |
| ‡ Cinch Connectors, Operation of<br>TRW Electronic Components<br>Stral Advertising Company, Inc.                    | 66        | ■ Micro Switch Division of Honeywell<br>N. W. Ayer & Son, Inc.   | 18        | ■ Trygon Electronic Subsidiary<br>of Systron Donner Corporation<br>RAMA Advertising     | 158         |
| Computer Operations, Inc.<br>R & J Associates   | 184       | ■ 3M Company - Mincom Division<br>D'Arcy-MacManus & Masius, Inc.   | 176       | United Systems Corp., A Sub. of Monsanto Co.<br>Advertising & Merchandising, Inc.       | 141         |
| ■ Dale Electronics, Inc., A Sub. of<br>The Lionel Corporation<br>Swanson, Sinkey, Ellis, Inc., Advertising          | 4th cover | * Molex (International) Incorporated<br>Total Communications Service                                       | 7         | ■ Unilrode Corporation<br>Impact Advertising  | 29          |
| Delco Electronics Division,<br>General Motors Corp.<br>Campbell-Ewald Company                                       | 90-91     | Mostek Corporation<br>Kaufmann Advertising, Inc.   | 15        | Universal Oil Products, Norplex Div.<br>Campbell Mithun, Inc.                           | 135         |
| Delta Air Lines<br>Burke Dowling Adams, Inc.  | 187       | Motorola Semiconductor Products, Inc.<br>E B Lane & Associates, Inc.                                       | 17, 43    | Victoreen Instrument Division<br>Dix & Eaton, Inc.                                      | 82          |
| Digital Equipment Corporation<br>Schneider Parker Guy Inc.  | 126-127   | ■ Nelson Ross Electronics,<br>Div. Polarad Electronics<br>McCarthy-Scelba-DeBiasi Advertising Agency, Inc. | 192       | * Wandel und Goltermann<br>Werbeagentur   | 19          |
| Disc Instruments, Inc.<br>Jansen Associates, Inc.   | 179       | ■ The J. M. Ney Company<br>Cooper Advertising, Inc.  | 182       | Wavetek San Diego<br>Chapman Michetti Advertising                                       | 50          |
| ■ Eastman Chemical Products, Inc.,<br>Industrial Chemicals<br>J. Walter Thompson Company                            | 6         | * Nippon Kogaku K.K.<br>K & L Advertising  | 66        | YEWTEC Corporation<br>Kenmarc Advertising, Inc.   | 172         |
| Eastman Kodak Company,<br>Business Systems Markets Div.<br>J. Walter Thompson Co.                                   | 181       | * Oscilloquartz SA, Neuchatel<br>M. R. Hofer Werbeagentur BSR/EAAA Bern                                    | 14E       | Z. Kuroda & Co. Ltd.<br>JTS Co., Ltd.   | 180         |
| Electronic Measurements, Inc.<br>Hill Advertising Agency  | 2nd cover | * Oxy-Metal<br>Reinhardt Publicite   | 4E        |   |             |
| ■ Electronic Navigation Industries<br>Hart Conway Co., Inc.   | 14        | Panasonic Industrial Div.<br>Dentsu Corporation of America   | 155       |   |             |
| ■ Erie Technological Products Co., Inc.<br>Altman Hall Associates Advertising                                       | 23        | * Phillips N. V. Pit/T & M Division<br>Marsteller International S. A.                                      | 56, 9E    |   |             |
| ‡ Excellon Industries, Inc.<br>Elgin Davis, Inc.  | 149       | * Pignone Sud<br>Linea Spn   | 59        |   |             |
| Executone, Inc., Printac Relay Div.<br>J. A. Richards   | 179       | Plastics Engineering Company<br>Kuttner & Kuttner, Inc.  | 148       |   |             |
| Fairchild<br>StanbroDrummond Advertising, Inc.  | 178       | * Plessey, Inc., Materials Div.<br>TCI, Adv.   | 15E       |   |             |
| Fairchild Semiconductor, Inc.<br>Carson/Roberts, Inc. Adv., Division<br>of Ogilvy & Mather, Inc.                    | 109-111   | ■ PowerTech, Inc.<br>The Sommer Agency, Inc.   | 184       |   |             |
| Fairchild Systems Technology<br>Hall Butler Blatherwick, Inc.   | 136-137   | * Practical Automation, Inc.<br>Carol Marketing Associates   | 18E       |   |             |
| * Figaro Engineering, Inc.  | 21        | ■ Premier Metal Products Corp.<br>Commercial Press, Inc.   | 150       |   |             |
| Fluke Manufacturing Co., John<br>Bonfield Associates  | 154       | Prime Computer, Inc.<br>Grover and Erickson, Inc.  | 139       |   |             |
| Fluke TRENDAR<br>Lincoln Associates, Inc.   | 77        | Ramtek<br>Murphy Advertising, Inc.   | 162       |   |             |
| ■ GAF Corporation<br>Michel-Cather, Inc.  | 174       | Raytheon Semiconductor<br>Durel Advertising  | 90-91     |   |             |
| ■ General Electric Co.,<br>Semiconductor Products Department<br>Advertising & Sales Promotion<br>Syracuse Operation | 30        | * RCA Ltd.<br>Marsteller Ltd.  | 2E-3E     |   |             |
|   |           | ■ Rental Electronics, Inc.<br>Communications Unlimited, Inc.   | 22        |   |             |
|   |           | ■ RHG Electronics Laboratory, Inc.<br>Samuel H. Goldstein  | 146       |   |             |

## Classified & Employment Advertising

F. J. Eberle, Manager 212-971-2557

EQUIPMENT (Used or Surplus New) For Sale  
Radio Research Instrument Corp. 188

■ For more information on complete product line see advertisement in the latest Electronics Buyer's Guide  
\* Advertisers in Electronics International only  
‡ Advertisers in Electronics domestic edition only

# It's a question of maturity.



A lot of people don't buy U.S. Savings Bonds because they think it takes them 10 years to mature. Take another look. The old green Bond ain't what it used to be. Now Bonds mature in less than 6 years.

That's one reason Bonds are so popular nowadays. They're simple to buy, and one of the surest ways to build a nest egg for something (or someone) special.

U.S. Savings Bonds. Maturity at 5 years, 10 months. If you don't want to use that money right away, there's a 10-year extension privilege. Either way, you'll find that Bonds mature at just the right age for you.



## Take stock in America.

Bonds mature in less than six years. Now E Bonds pay 5 1/4% interest when held to maturity of 5 years, 10 months (4% the first year). Bonds are replaced if lost, stolen, or destroyed. When needed they can be cashed at your bank. Interest is not subject to state or local income taxes, and federal tax may be deferred until redemption.

The U.S. Government does not pay for this advertisement. It is presented as a public service in cooperation with the Department of the Treasury and The Advertising Council.

# FREE...

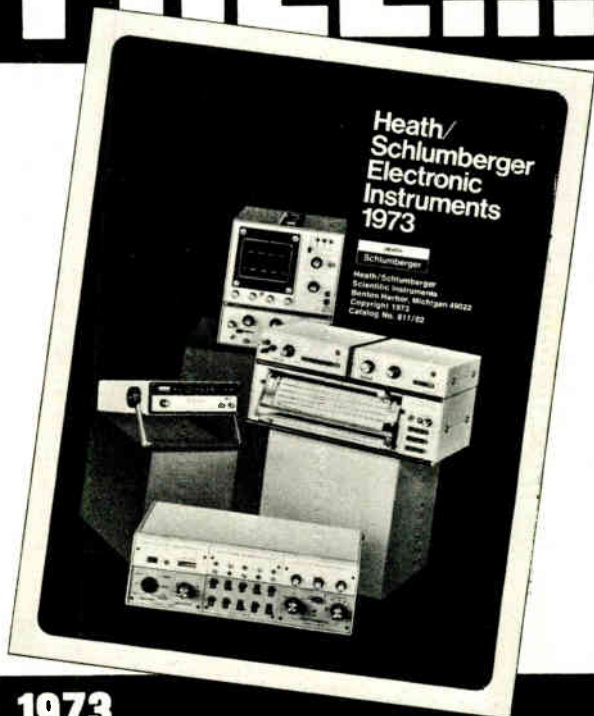

## 1973 Heath/Schlumberger electronic instrumentation catalog.

The new '73 Heath/Schlumberger instrumentation catalog is here...52 pages of high performance electronic equipment...all at budget-stretching prices. Whatever it is that you need in electronic equipment for test and design work, R&D applications or for teaching, Heath/Schlumberger has it...



at less than you planned to spend. 600 MHz frequency counter with 7-digit LED readout and complete programmability for only \$795\* (left)...dual trace 15 MHz scope only \$595\*...multi-range, multi-speed strip chart recorder system just \$675\*

...a patchable mini-computer interface system, just \$1250\*...the famous Malmstadt-Enke Lab Stations...dozens of plug-in circuit cards...power supplies...generators...digital multimeters...and hundreds of other instruments. To get your FREE copy of this catalog now, visit your local Heathkit Electronic Center or use the coupon below.

|   |                       |
|---|-----------------------|
| <b>HEATH</b>  |                       |
| <b>Schlumberger</b>   |                       |
| Heath/Schlumberger Scientific Instruments<br>Dept. 581-286                    |                       |
| Benton Harbor, Michigan 49022   |                       |
| <input type="checkbox"/> Please send 1973 Electronic Instrumentation catalog. |                       |
| Name _____  |                       |
| Title _____   |                       |
| Company/Institution _____   |                       |
| Address _____   |                       |
| City _____  | State _____ Zip _____ |
| *Mail order prices; F.O.B. factory.   |                       |
| EK-355  |                       |

# the Champ

problem solver

Bausch & Lomb StereoZoom 7 Microscope with Coaxial Illuminator is the answer to your need for full field, full aperture illumination; full color, high contrast imaging and better resolution.

This unique form of incident illumination eliminates surface glare from highly reflective surfaces and also effectively illuminates low contrast objects.

You zoom over a magnification range of 15X through 280X. Field diameter ranges from 0.55 in. through 0.03 in. Working distance is 3.0 in.—0.56 in.

**Send today for our catalog 31-15 and our FREE DEMONSTRATION offer.**

StereoZoom. Reg. T.M. Bausch & Lomb

**BAUSCH & LOMB** 

SCIENTIFIC OPTICAL  
PRODUCTS DIVISION

61418 Bausch Street, Rochester, New York 14602



For literature circle Reader Service Card No. 192

For demonstration circle Reader Service Card No. 193

# Value Packed SPECTRUM ANALYZERS

**0.5 Hz — 6.5 GHz**

**The Specs You NEED at the Price You Want**

... You choose from the largest selection of complete Spectrum Analyzers and plug-ins.\* Get the specifications you need at lowest cost. Our analyzers cover Sub-Audio, Audio, Ultrasonic, Video, Telemetry Subcarrier, RF/SSB, RF/UHF, CATV, and Microwave applications. And, Nelson-Ross' reliability has been proven by thousands of users for more than a decade.

**Get your Nelson-Ross Spectrum Analyzer Catalog;** phone, write or circle the reader service number.

\* For HP 140/141 series, Tektronix 530/540/550/580 "Letter" series and 560 series scopes.

**nelson • ross  
electronics**

A DIVISION OF POLARAD ELECTRONICS CORP.

5 Delaware Drive/Lake Success, N.Y. 11040  
516-328-1100 • TWX: 510-223-0414

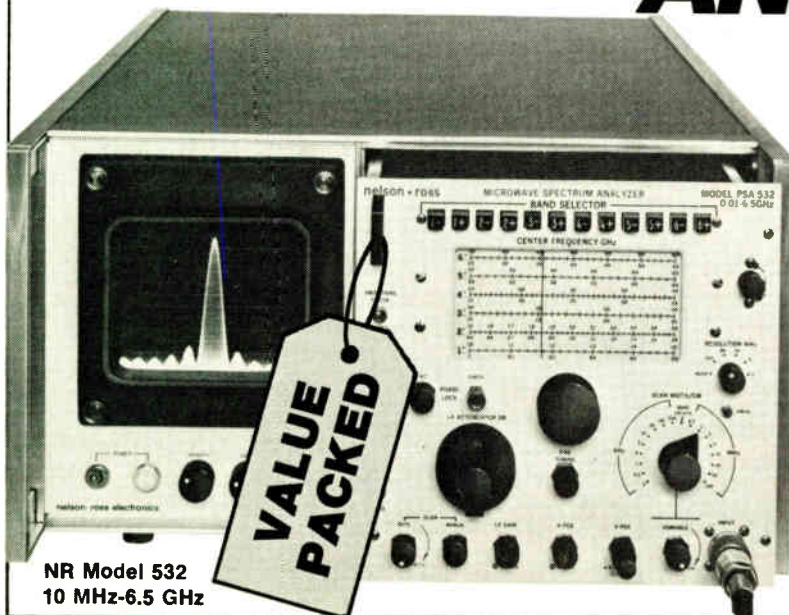

Circle 224 on reader service card

World Radio History

Do you face a make or buy decision on power supplies?

# BUY LAMBDA LX SERIES

Now LX series available in 54 models in 9 package sizes

... single, dual and triple outputs

Regulation: 0.1%      Ripple: 1.5 mV RMS

Temperature Coef.: 0.03% /°C

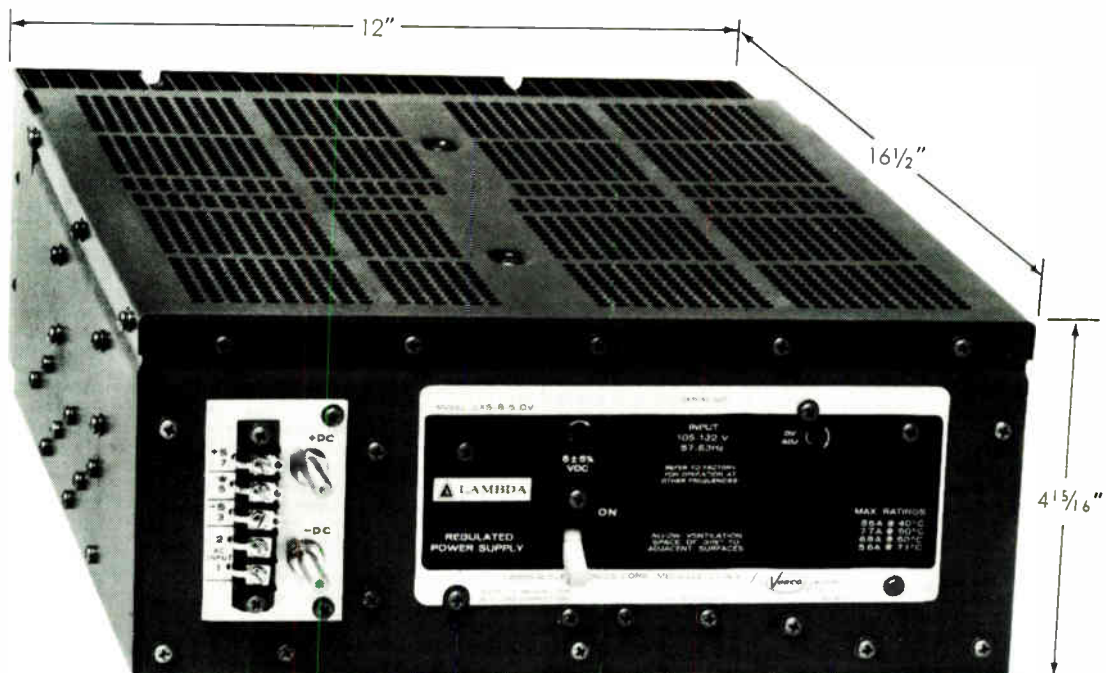

**NEW 2/3 RACK, SINGLE OUTPUT "8" PACKAGE  
LXS-8-5-OV 5 VOLTS 85 AMPS (WITH OV)**

**\$560**

**listed in Underwriters' Recognized  
Components Index\***

**designed to meet MIL environmental specifications**

**in stock for 1-day delivery**

**guaranteed 5 years**

AC input: 105-132 VAC; 47-440 Hz.

LX-8 available in 7 models up to 28 volts

Send for 1973 Power Supply Catalog and Application Handbook

\* LX-8 and LX-EE models presently undergoing qualifying tests.

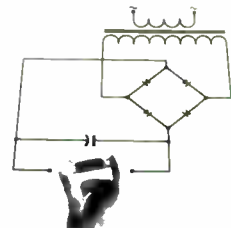

**WHETHER  
YOU MAKE  
OR BUY...**

**LAMBDA  
ELECTRONICS CORP.**  
A Veraco Company

MELVILLE, NEW YORK 11746 515 Broad Hollow Road Tel. 516-694-4200 ARLINGTON HEIGHTS, ILL. 60005 2420 East Oakton St., Unit Q Tel. 312-593-2550  
NORTH HOLLYWOOD, CALIF. 91605 7316 Varna Ave. Tel. 213-875-2744 MONTREAL, QUEBEC 100C Hymus Blvd., Pointe-Claire, Quebec-730 Tel. 514-697-6520  
PORTSMOUTH, HANTS, ENG. Marshlands Road, Farlington Tel. Cosham 73221 VERSAILLES, FRANCE 64a 70 rue des Chantiers 78004 Tel. 950-2224

Circle 901 on reader service card



# Shape up faster with Dale resistors

We offer more ways to  
keep your current in shape  
without bothering your budget.

Dale NS-2 is a vital non-inductive wirewound resistor used in the highly-regarded Micromemory 3000. *Electronic Memories & Magnetics Corporation* selected it for ability to control voltage while permitting the generation of fast rise time currents. But if resistors are your concern, the important thing is that the NS-2 is only one of 108 standard coated, molded and housed non-inductive styles readily available from Dale. Make sure you're taking advantage of all the time and dollar savings available from our broad wirewound line. Here's how:

## SEND FOR FREE WALL CHART

Big, new, comprehensive wirewound resistor chart details all Dale precision, industrial, commercial wirewound styles.

Write today or circle reply card.

electronic memories  
micromemory 3000

**EMM**

DALE ELECTRONICS, INC.  
1300 28th Avenue, Columbus, Nebr. 68601  
A Subsidiary of The Lionel Corporation  
In Canada: Dale Electronics Canada, Ltd.

Circle 902 on reader service card

