

NOVEMBER 11, 1976

ELECTRONICA PREVIEW: A CAUTIOUS MOOD PREVAILS/73

The case for distributed-processor systems/ 105

Designing high-quality filters economically/ 111

FOUR DOLLARS A McGRAW-HILL PUBLICATION

Electronics®

SPECIAL REPORT

THE OUTLOOK FOR PHOTOVOLTAIC ENERGY



97232

MATT NEILL
2014 INC CLACKAMAS
PORTLAND OR

The right DVM Decision means >1 ppm resolution, HP-IB, and math... all for \$3200*.

Introducing HP's 3455A DVM—a microprocessor controlled DVM with high resolution and computational capability for the lab plus high speed and good noise rejection for systems use... complete with true r.m.s. ac to 1MHz, dc and ohms for \$3,200*. HP's new high-speed microprocessor gives the lab user:

5½ or 6½ digit resolution. Choose from the normal 5½ digit mode or the High Resolution 6½ digit mode for >1 part per million resolution... ideal for trimming, matching and balancing in the Standards lab. Wide bandwidth ac readings are always displayed with 5½ digit resolution.

Math capability. Enter constants into memory and you can offset readings, take ratios or scale a measurement to give direct readout in engineering units. Or, display percent error from a standard value in memory to speed calibration and inspection tasks.

But the microprocessor is also control oriented to give the systems user:

Fast reading. Read at rates up to 24/sec on dc ranges, up to 12/sec in the fast ac mode and up to 12/sec on ohms ranges. You get this high dc speed with >60 db normal mode noise rejection at line related frequencies.

Easy programming. Program by pushing front-panel buttons. That's right, program-code knowledge is not required. In the Binary Program Mode, the HP-IB (HP's implementation of IEEE's 488-75) compatible 3455A

automatically monitors front-panel control settings and reports their status to the controller, speeding and simplifying instrument programming. Front-panel indicators give complete instrument status at all times.

Removable reference and automatic calibration. Calibrate your 3455A on the spot. Now your DVM needn't go to the lab for dc and ohms calibration. Simply keep an extra reference on hand. Then, to calibrate, just pull one out... slip another in... and with HP's Auto Cal you're ready to go again in seconds.

And for both lab and systems:

Microvolt sensitivity and high accuracy. Read directly from thermocouples and other low-level sources... with >140 dB CMR. On dc you have 1 µV sensitivity, 10 µV on ac, and HP's Auto Cal provides dc accuracy of ±0.005% of reading + 1 digit) for 90 days by automatically measuring reference constants and digitally correcting readings. A test function signals out of tolerance constants and identifies the constant for rapid repair.

Plus convenient features and options. Choose either 2-wire k Ω or 4-wire k Ω measurements. Switch select 50 or 60Hz operation... front or rear panel inputs. And for \$200 less (\$3,000) you can substitute an average ac converter for the r.m.s. converter.

Once you see the 3455A, you'll know it's the right system or lab DVM decision. Ask your local HP field engineer for all the details.

* Domestic U.S.A. price only.

**HP DVM's—
the right decision**

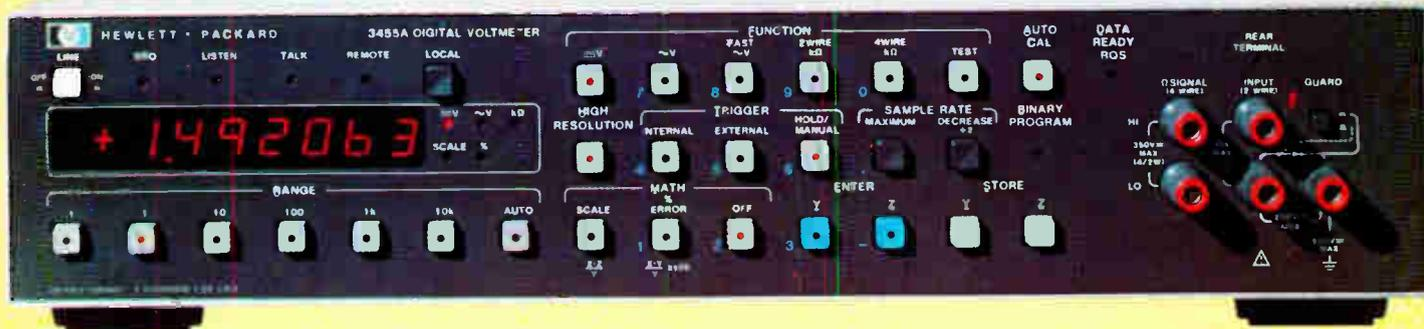
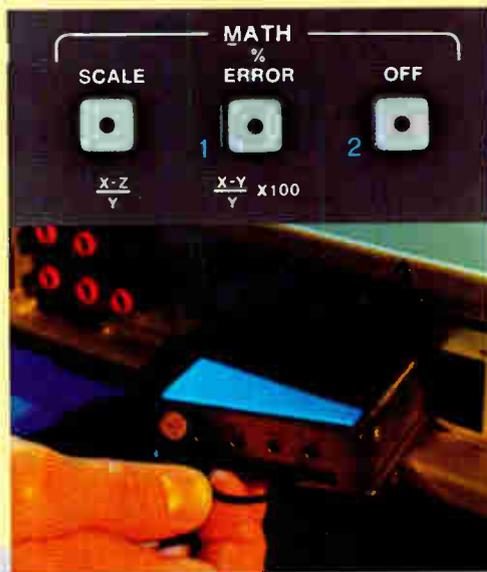

HEWLETT **hp** PACKARD

Sales and service from 172 offices in 65 countries.
1507 Page Mill Road, Palo Alto, California 94304

For assistance call: Washington (301) 948-6370, Chicago (312) 677-0400,
Atlanta (404) 434-4000, Los Angeles (213) 677-1282.

Circle 900 on reader service card

Introducing push-button microprocessor system debugging.

HP's 1611A Logic State Analyzer ... Dedicated to all 8080 or 6800 based systems.*

View program flow in mnemonics. With CRT data and addresses selectable in either hexadecimal or octal format and external lines in 1's and 0's.

Maintain testing control. LED indicators show status at all times. You can monitor system operation at normal speed or stop the microprocessor and give control to the 1611A for single or multiple keyed steps.

Enter data quickly and easily. The hexadecimal keyboard makes trigger and qualifier data entry as easy as operating a calculator. And the CRT display gives you a quick visual check on your entries.



Choose your display. Either mnemonic or absolute (op codes). Roll the display to view any 16-line slice of the 64-byte memory.

Pinpoint virtually any specific event. Trigger on address, data, or external signals — or on any combination of the three. You can also qualify the trigger by bracketing the address and opting to trigger on the nth occurrence of the trigger word. TRIGGER ENABLE and DISABLE keys act as firm and disarm circuits providing unparalleled pinpointing flexibility.

Move the display window. Delay up to 65,472 qualified clocks or memory transactions from the trigger word. Or, pre-trigger to see up to 63 bytes leading up to the trigger word (negative time).

Obtain program and timing data. Qualify the display with TRACE TRIGGER and see only those bytes that match your trigger inputs — or write instructions, for example: Press COUNT TRIGGERS and the 1611A displays the number of trigger occurrences between the TRIGGER ENABLE and TRIGGER DISABLE events. Push TIME INTERVAL and you get a display of actual elapsed time between selected points in your program on your hardware.

The 1611A should be on hand when you start up your microprocessor-based system. Imagine the time you'll save with push-button operation and an unparalleled view of your system's operation, viewing things dynamically that you never could see before. And there's more: self test, trigger outputs to drive external equipment, error messages to warn of improper operation or setup, and the choice of two initial μ P personality modules that let you tailor the 1611A to either 8080 or 6800 based systems.



Let HP's 1611A, priced at \$5,000** help you speed development, production-line testing or service. Ask your local HP field engineer for all the details. Ask him about HP's digital seminars too. He can tell you when one will be held in your area and how you can attend.

*and more modules for other microprocessors to come. **Domestic U.S.A. price only.

HEWLETT **hp** PACKARD

Circle 1 on reader service card

Managing the data domain.

Sharpen your competitive edge.

Use an HP computing calculator for design, analysis, control, and test.

In the highly competitive, high-technology electronics business, everything counts: keeping costs in line, exploring promising design alternatives, shortening lead times, product and prototype testing, increasing productivity. That's where HP computing calculators, software, peripherals, and interfacing capabilities come in. They can help you get and maintain a competitive edge.

Three computing calculators and plenty of peripherals: it's your choice.

Three different models—the low-cost HP 9815, the powerful HP 9825 and the all-purpose HP 9830—offer a range of computing power.

HP peripherals include paper tape punch and readers, printers, storage devices, a digitizer, a CRT, and an X-Y plotter. You choose the model and I/O options to configure a system just right for you.

Software, specialized and generalized, helps you look at more alternatives.

HP engineers developed software to optimize designs and analyze engineering problems quickly. There's a State Variable package for control system analysis. There's CNAP for circuit design and analysis, BAMP for microwave design and analysis, and Digital Simulation for state and timing analysis.

You can add other programs, too—commonly needed math routines and statistical programs to name but two. Programs are also available for accounting applications, report generation, and financial analysis.

Automate your instruments. We make the connection friendly. From simple data logging to complex integration, our programming commands and interface cards make instrument interfacing easy. Whether your instruments require BCD, bit-parallel, RS-232-C, or HP-IB (HP's implementation of IEEE Standard 488-1975), you plug the correct interface into the calculator and connect the cable to your instrument. It's the friendly connection.

HP computing calculators: from initial design to final test. Whether you're in research, design, production, or test—or all four—we can provide the computing power and programs to help you increase productivity and sharpen your competitive edge. Our new brochure for electronic engineers will show you how. Get a copy from your HP representative, or circle our reader service number in this magazine.



HP desktop computing systems put the power where the problems are.

HEWLETT  PACKARD

Sales and service from 172 offices in 65 countries.

P.O. Box 301, Loveland, Colorado 80537
For assistance call: Washington (301) 948-6370, Chicago (312) 677-0400
Atlanta (404) 434-4000, Los Angeles (213) 877-1282, Toronto (416) 678-9430

For literature circle 3
For information on OEM applications circle 2

29 Electronics Review

DISPLAYS: Hand-held terminal gives troops access to data, 29
SOLID STATE: Motorola, Fairchild exchange helps Intel's rivals, 30
Industry moves toward Mostek's dynamic RAMs, 30
MILITARY: RCA developing real-time CCD reconnaissance camera, 31
FIBER OPTICS: Voltage-responsive crystal modulates light, 32
SOLID STATE: Electron Devices meeting again to show trends, 34
INDUSTRIAL: Capacitance yields yarn's denier, 34
NEWS BRIEFS: 36
COMPUTERS: Low-cost analog unit simulates digital ICs, 38

53 Electronics International (Domestic version)

JAPAN: μ L chip provides phase-locked loop for citizens' radio, 53
AROUND THE WORLD: 53

69 Probing the News

YOU AND YOUR CAREER: Manpower studies need surgery, 69
ABROAD: Apprehension pervades Munich show, 73
SEMICONDUCTORS: Keeping an eye out for counterfeits, 76
INSTRUMENTATION: DPMs head for new applications, 78
COMPANIES: Cybernet expects to stay on top, 80

86 Technical Articles

SPECIAL REPORT: Part 1, Can solar technology deliver? 86
Part 2, Companies look for ways to raise solar-cell output, 91
DESIGNER'S CASEBOOK: Digital lock is virtually crackproof, 100
PROM provides linear or logarithmic display, 101
COMPUTERS: Satellite processors lighten the burden in systems, 105
CIRCUIT DESIGN: How to build high-quality filters cheaply, 111
ENGINEER'S NOTEBOOK: Color-TV set calibrates oscillators, 114
Direct-reading ohmmeter needs no calibration, 115
HP-26 calculator serves as clock, 116

127 New Products

IN THE SPOTLIGHT: First-in first-out unit is fast, dense, 127
Miniature relay handles 15 amperes, 129
COMPONENTS: Solid-state relays are priced low, 133
SEMICONDUCTORS: IC converter resolves 10 bits, 142
PACKAGING & PRODUCTION: IC socket takes chip carriers, 152
MICROPROCESSORS: Prototype system offered, 163
SUBASSEMBLIES: Hybrid pair resolves 14 bits, 173
MATERIALS: 182

Departments

Publisher's letter, 4
Readers' comments, 6
News update, 8
Editorial, 12
People, 14
Meetings, 19
Electronics newsletter, 25
Washington newsletter, 49
International newsletter, 55
Engineer's newsletter, 118
New literature, 188

Services

Employment opportunities, 193
Reprints available, 199
Reader service card, 201

Highlights

Cover: Solar-energy technology grows, 86

Photovoltaic power systems already answer some specialized needs, and companies worldwide are trying to boost solar-cell capabilities to rival those of conventional power sources. Part 1 of this special report examines the work on lower-cost, more efficient solar cells, while Part 2 reports on efforts to develop volume production of the cells.

Cover construction by Ann Dalton uses a solar-cell array supplied by Exxon subsidiary Solar Power Corp.

European markets recover slowly, 73

As electronics firms on the Continent prepare for the end-of-the-month Electronica show, they look back on a year that hasn't shown the expected full recovery from the 1975 slump.

Sharing the work lightens the load, 105

Adding satellite processors turns a computer-controlled system into a distributed control system that runs faster than a computer-only setup. Another plus is simpler software.

Low-cost filters can perform well, 111

By designing active-filter circuits for minimum sensitivity to component values, it's possible to use loose-tolerance resistors and capacitors and still achieve high performance.

And in the next issue . . .

A family of one-chip microcomputers unveiled . . . tips on memory-system design . . . digital trouble-shooting through current tracing.

EDITOR-IN-CHIEF: Kemp Anderson

EXECUTIVE EDITOR: Samuel Weber

MANAGING EDITOR: Arthur Erikson,
International

SENIOR EDITORS: Laurence Altman,
Ray Connolly, Lawrence Curran,
John Johnsrud, H. Thomas Maguire,
Stephen E. Scrupski

ART DIRECTOR: Fred Sklenar

ASSOCIATE EDITORS: Howard Wolff,
Gerald M. Walker, Alfred Rosenblatt

DEPARTMENT EDITORS
Aerospace/Military: Ray Connolly
Circuit Design: Don Blattner
Communications & Microwave:
Richard Gundlach
Components: Lucinda Mattera
Computers: Stephen E. Scrupski
Consumer: Gerald M. Walker
Industrial: Raymond P. Capece
Instrumentation: Andy Santoni
New Products: H. Thomas Maguire,
Michael J. Riezenman

Packaging & Production: Jerry Lyman
Solid State: Laurence Altman

CHIEF COPY EDITOR: Margaret Eastman

COPY EDITORS: Everett C. Terry, Ben Mason

ART: Charles D. Ciatto, *Associate Director*
Paula Piazza, *Assistant Director*

EDITORIAL SECRETARIES: Janet Noto,
Penny Roberts, Marilyn B. Rosoff

FIELD EDITORS

Boston: Lawrence Curran (Mgr.), Pamela Leven
Los Angeles: Larry Waller (Mgr.)
Midwest: Larry Armstrong (Mgr.)
New York: Bruce LeBoss (Mgr.)
San Francisco: Bernard Cole (Mgr.)
Judith Curtis
Washington: Ray Connolly (Mgr.)
Frankfurt: John Gosch
London: William F. Arnold
Paris: Arthur Erikson
Tokyo: Charles Cohen

McGRAW-HILL WORLD NEWS

Editor: Michael Johnson
Brussels: James Smith
Milan: Andrew Heath
Moscow: Peter Gall
Paris: Joel Stratte-McClure
Stockholm: Robert Skole
Tokyo: Colin Gibson

PUBLISHER: Dan McMillan

MARKETING ADMINISTRATION MANAGER:
Wallis Clarke

CIRCULATION MANAGER: Karl Peterson

MARKETING SERVICES MANAGER:
Tomlinson Howland

RESEARCH MANAGER: Margery D. Sholes

"**D**istributed-system architecture goes all the way back to the Illiac 4 concept of about 10 years ago," according to David Fisher, co-author of the article on page 105. "However this concept didn't really take hold until minicomputer prices dropped in the early 1970s. Now, low-cost microprocessors have changed the whole dimension of the problem."

Fisher, an associate professor at Michigan State University's Department of Electrical Engineering and System Science, first became involved with distributed systems through work with environmental monitoring. Since then, he has consulted on many large-scale distributed systems including ones to monitor and control water pollution and to manage farming pests for his university and the state of Michigan. In his eighth year at MSU, Fisher has written a number of technical articles, including one in *Electronics* on calculator-based systems.

One of Fisher's most successful systems is a monitoring and control setup for agricultural pest management on a statewide basis. Weather information was "stripped" off 27 stations in an existing country-wide aviation weather network and stored in a minicomputer, which calculated temperature, dew point, and visibility, before passing on the data to a large central computer. Data loggers in the field collected other variables, such as soil temperatures, which were also fed into the computer. The central computer, working with a built-in management model, could then tell when to collect biological samples, spray

insecticides, or plant crops. This system is now being applied to farming-crop management in Michigan.

Gary Krause, Fisher's co-author, is an engineer specializing in designing microprocessors for Motorola's Communications division in Chicago. Earlier, though, he did his thesis on Fisher's water-pollution project. Discussions of this thesis triggered the idea for their article.

Solar energy is an up and coming discipline, although there seem to be a number of obstacles that cast shadows over the quick harnessing of the sun's outpouring of energy. In this issue, you'll find a detailed report on the status of research and development into one of the most potentially useful of solar-energy collectors, the photovoltaic cell.

On page 86, the first part of the report homes in on the efforts being made to raise the efficiency and lower the cost of these solar cells, which can convert the sun's rays directly into electricity. It was written by Joel duBow, assistant professor of electrical engineering at Colorado State University, Fort Collins, Colo., where he is in charge of the school's solar-cell projects. Before moving to Colorado, incidentally, he was components editor on the New York staff of *Electronics*. The second part, by our Boston bureau manager, Larry Curran, starts on page 91 and examines the problems of turning out solar cells in large volume.



October 28, 1976 Volume 49, Number 23
95,472 copies of this issue printed

Published every other Thursday by McGraw-Hill, Inc. Founder: James H. McGraw 1860-1948. Publication office 1221 Avenue of the Americas, N.Y., N.Y. 10020; second class postage paid at New York, N.Y. and additional mailing offices.

Executive, editorial, circulation and advertising addresses: *Electronics*, McGraw-Hill Building, 1221 Avenue of the Americas, New York, N.Y. 10020. Telephone (212) 997-1221. Teletype 12-7960 TWX 710-581-4879. Cable address: MCGRAW HILL NEW YORK.

Subscriptions limited to professional persons with active responsibility in electronics technology. Publisher reserves the right to reject non-qualified requests. No subscriptions accepted without complete identification of subscriber name, title, or job function, company or organization, and product manufactured or services performed. Subscription rates: in the United States and possessions \$12.00 one year, \$30.00 three years; Canada and Mexico \$14.00 one year, \$32.00 three years; Europe \$35.00 one year, \$87.50 three years; Japan, Israel and Brazil \$60 per year, Australia and New Zealand \$80.00 per year, including air freight; all other countries \$40.00 per year. Limited quota of subscriptions available at higher-than-basic rate for persons outside of field served, as follows: U.S. and possessions and Canada \$25.00 per year, Europe \$40.00; Japan, Israel and Brazil \$85.00; all other countries \$50.00. Single copies: \$4.00. Please allow four to eight weeks for shipment.

Officers of McGraw-Hill Publications Company: Gordon L. Jones, President; Paul F. McPherson, Executive Vice President; Gene W. Simpson, Group Vice President; Senior Vice Presidents: Ralph Blackburn, Circulation; John B. Hoglund, Controller; Ralph R. Schutz, Editorial; David G. Jensen, Manufacturing; Vice Presidents: James E. Boddorf, Planning & Development; Edward E. Schirmer, Marketing Administration.

Officers of the Corporation: Harold W. McGraw, Jr., President, Chief Executive Officer, and Chairman of the Board; Robert N. Landes, Senior Vice President and Secretary; Ralph J. Webb, Treasurer.

Title registered in U.S. Patent Office. Copyright © 1976 by McGraw-Hill, Inc. All rights reserved. The contents of this publication may not be reproduced in whole or in part without the consent of copyright owner.

Subscribers: The publisher, upon written request to our New York office from any subscriber, agrees to refund that part of the subscription price applying to copies not yet mailed. Please send change-of-address notices or complaints to Fulfillment Manager, subscription orders to Circulation Manager, *Electronics*, at address below. Change-of-address notices should provide old as well as new address, including postal zip code number. If possible, attach address label from recent issue. Allow one month for change to become effective.

Postmaster: Please send form 3579 to Fulfillment Manager, *Electronics*, P.O. Box 430, Hightstown, N.J. 08520.

From DC to 1 megahertz, the Model 7500 direct coupled amplifier puts up to 75 watts and 125 VRMS at your fingertips. This all solid state unit offers typical frequency response of $\pm .05\text{db}$ and harmonic distortion of .05%. Output circuit is both current and voltage protected. Voltage gain is 0 to X100, fixed or variable. Both AC and DC input coupling are provided. Ideal for precision meter calibration and transducer driving. Price \$1500.00. Stick with the WAVEMAKERS.™ Write for complete details, phone (617) 580-1660 or any listed office.

KH KROHN-HITE CORPORATION

Avon Industrial Park, Avon, Mass. 02322 • (617) 580-1660

SALES OFFICES ALA., Huntsville (205) 534 9771 ARIZ., Scottsdale (602) 957 9110 CAL., San Jose (408) 292 3220 Inglewood (213) 674 6850 COL., Denver (303) 773 1218 CONN., Glastonbury (203) 633 0777 FLA., Orlando (305) 894 4401 GA., Atlanta (404) 237 7272 HAWAII, Honolulu (808) 941 1574 ILL., Arlington Hts (312) 394 3380 MD., Baltimore (301) 321 1411 MASS., Lexington (617) 861 8620 MINN., St Paul (612) 645 5816 MO., St Louis (314) 423 1234 N.M., Albuquerque (505) 255 2330 N.J., Cherry Hill (609) 482 0059 N.Y., Elmont (516) 488 2100 Rochester (716) 328 2230 Syracuse (315) 437 6666 Vestal (607) 785 9947 N.C., Burlington (919) 227 3639 OHIO, Chesterland (216) 729 2222 Dayton (513) 434 8993 OKLA., Tulsa (918) 299 2636 ORE., Portland (503) 297 2248 TEX., Dallas (214) 661 0400 Houston (713) 688 1431 VA., Falls Church (703) 573 8787 WA., Bellevue (206) 434 3400 CANADA, Montreal Quebec (514) 341 7630 Ottawa Ontario (613) 235 5121 Toronto Ontario (416) 445 9900 Vancouver British Columbia (604) 253 5555 Halifax Nova Scotia (902) 454 8321 St John's Newfoundland (709) 726 2422

the 7500 amplifier... WIDEBAND-AID for system designers

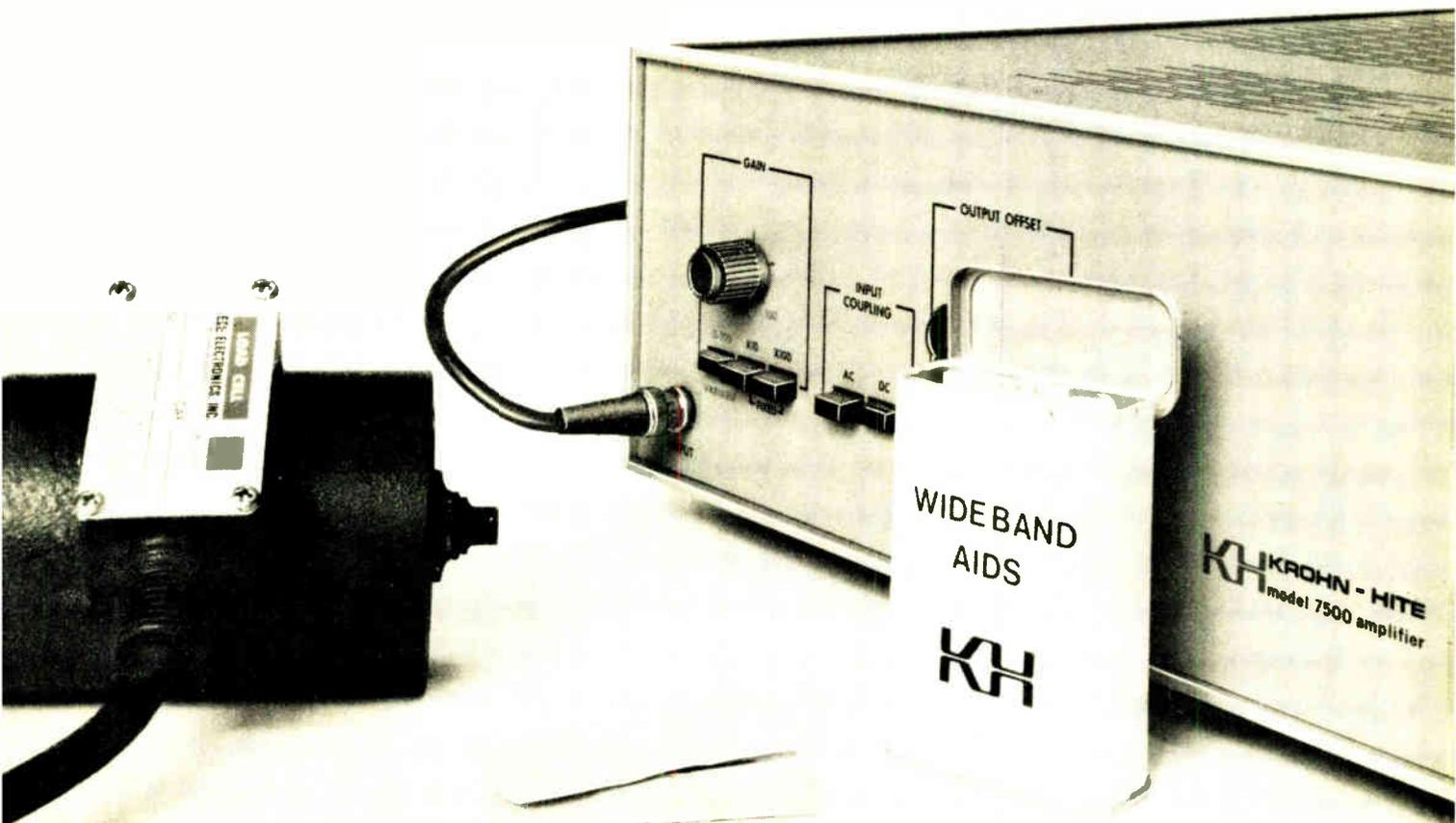

Circle 5 on reader service card

Ben would have liked you.

Ben thought that there had to be more to lightning than just fire in the sky. So he ignored what people told him and did a little rainy-day research on his own.

Determined curiosity—like Ben's—has guided your imaginative progress in the microelectronics field. At Kodak, we have combined extensive research with a deep understanding of your industry, so that our skilled representatives can help improve your product or production techniques.

We try to make your job

a little easier, a little more efficient.

For more information about our products for microelectronics, write Eastman Kodak Company, Dept. 412L (48-F), Rochester, N.Y. 14650.

RESULTS COUNT

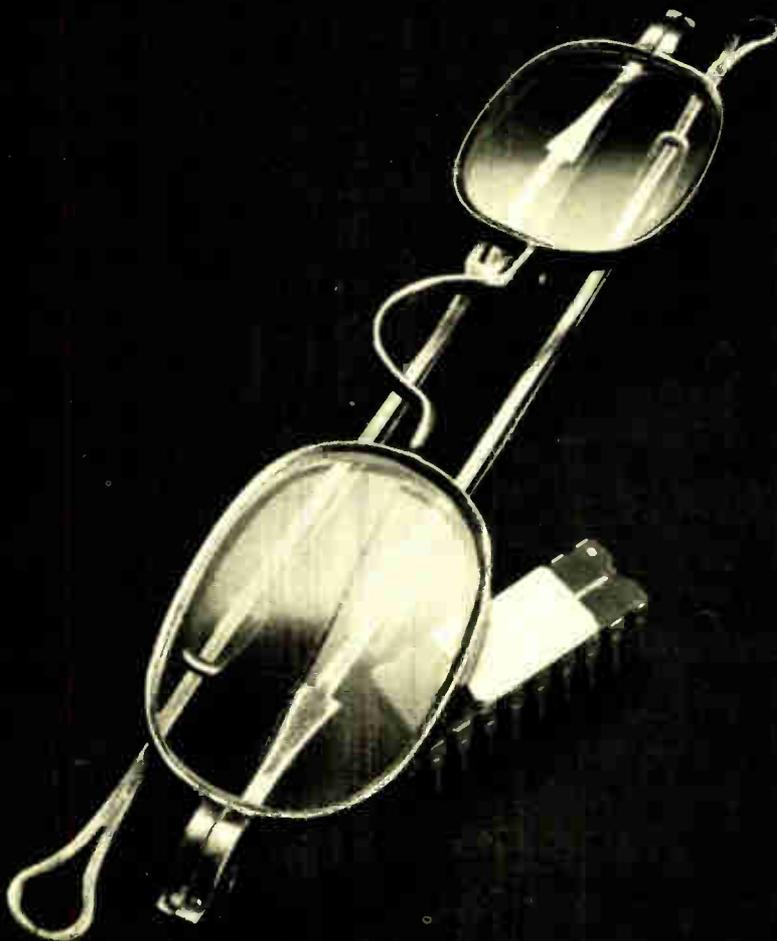

Readers' comments

Force funds aren't transferable

To the Editor: I am writing in hopes of correcting a misunderstanding that is implicit in your editorial, "Computer security: a case of priorities" [Sept. 30, p. 10].

I do see the obvious implication of the juxtaposed facts, but, as usual, the matter is more complex than is stated. Each year, Congress funds the Department of Defense within an overall ceiling, but DOD is not free to use these funds as it wishes.

The money is directed into various categories, called major force programs, and may not be transferred between the programs. One such category contains tactical jet fighters, such as the F-15. Security research falls into a separate program.

The Congress and the people they represent have an enormously difficult job in sorting out a balanced military program from increasingly scarce resources; therefore, it is easy to find any number of apparent incongruences within any given program.

Please consider that we, both the military and the Congress, are simply trying our best to cover the needs with available wherewithal. After all, the number of F-15s is also drastically reduced from the number required for the envisioned threat.

Robert J. Kunkle
Capt. USAF
Bedford, Mass.

Surveys no help to engineers

To the Editor: The Oct. 14 issue of *Electronics* reported that the Engineering Manpower Commission had overwhelmingly decided not to modify its policies of issuing its inaccurate supply and demand forecasts [p. 36].

These "forecasts," which are distributed to high school and college guidance personnel, are used to seduce gullible students into the engineering profession. Thus, EMC serves its academic and corporate masters, rather than the working engineer.

Irwin Feerst
Massapequa Park, N.Y.

SORENSEN IS THE SOURCE.

FOR MODULAR SWITCHING POWER SUPPLIES.



5V 30 Amps.

\$295.

Check our standard features:

- 10 models, 1.8V to 56V with power levels ranging up to 225 watts.
- 115/220 Vac input by external barrier strip change.
- 50/60-Hz operation with no derating.
- Logic shutdown for system applications.
- Extra long hold-up time.
- Low ripple and noise through use of double-stage filtering.
- Wide-range output voltage adjustment.
- Built-in adjustable overvoltage protection.
- Superior line and load regulation.
- Internal adjustable current limiting.
- UL component recognition.
- High power-to-weight ratio.
- 20-kHz switching.
- Rack adaptors available.
- Immediate delivery.
- Made in U.S.A. of quality components.
- Five-year warranty, backed by worldwide service organization.

Check our specifications:

AC Input Power: 98 Vac-132 Vac, 187 Vac-250 Vac.

Frequency: 47-63 Hz single phase. 360-440 Hz (double rms Ripple spec.) *No derating.* Voltage selectable by a single link on the front panel.

Voltage Regulations: Line: 0.03% over full AC input range. Load: 0.03% for zero to full load.

Voltage Ripple: Typical 2m V rms, 20mV pk-pk (20Hz to 20 MHz). Max. 5mV rms, 50mV pk-pk (20Hz to 20MHz).

Temperature Coefficient: 0.01% max. per °C.

Stability: 0.05% max. for 24 hours after warm-up.

Transient Response Time: Output voltage returns to within 1% in less than 1.2 ms following a step-load change from either 50% to 100% or 100% to 50% of full load.

Overshoot: No overshoot at turn-on, turn-off or power failure.

Hold-Up Time: Full regulated voltage holds up for 40ms after removal of power at full load, and nominal input and output voltages (80ms for half load).

Overvoltage Protection: Built-in adjustable overvoltage protection standard on all models.

Efficiency: Up to 78%.

Remote Sensing: Voltage drops can be compensated for up to the max. specified terminal voltage.

Paralleling: May be directly paralleled without derating.

Soft-Start: In-rush current is limited by soft start circuit.

Model No.	Nominal Voltage	Output Voltage Adjustment Range		Output Current				Price
		min.	max.	@40°C	@50°C	@60°C	@71°C	
SSD2-30	2	1.8	3.0	30.0	27.0	22.5	15.0	\$295
SSD5-30	5	4.7	6.5	30.0	27.0	22.5	15.0	295
SSD9-20	9	6.5	9.5	20.0	18.0	15.0	10.0	295
SSD12-15	12	9.5	13.0	15.0	13.5	11.2	7.5	295
SSD15-12	15	13.0	17.0	12.0	10.8	9.0	6.0	295
SSD18-10.5	18	16.0	21.0	10.5	9.4	7.8	5.2	295
SSD24-8.5	24	20.0	26.0	8.5	7.6	6.3	4.2	295
SSD28-7	28	25.0	33.0	7.0	6.3	5.2	3.5	295
SSD36-5	36	32.0	43.0	5.0	4.5	3.7	2.5	295
SSD48-4	48	42.0	56.0	4.0	3.6	3.0	2.0	295

For OEM discounts call:
Sorensen, (603) 668-4500.
676 Island Pond Road,
Manchester, NH 03103.

SORENSEN
POWER SUPPLIES

A Raytheon Company

Circle 7 on reader service card

Get the scope you need-Now!

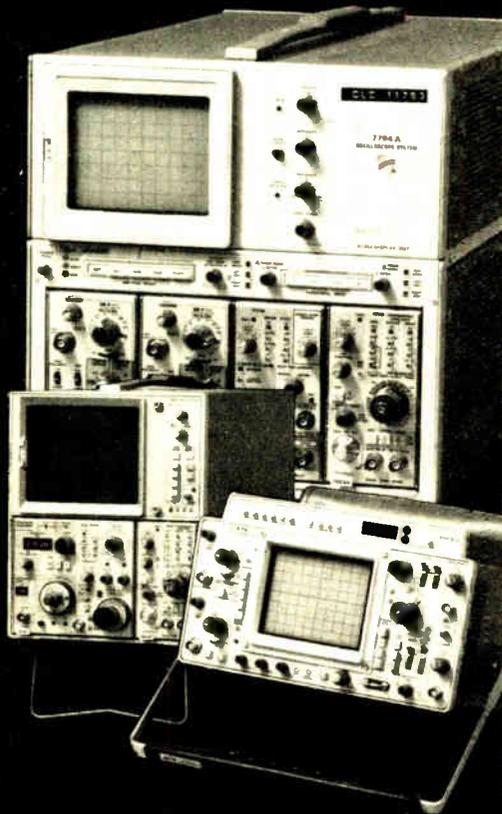

Our "Instrument Professionals" will tell you which scope will do the job best, at the lowest cost, make immediate delivery and guarantee performance.

Write or call for data on our other specialties: Instrument Leasing • Computer Peripherals • Equipment Sales • Instrument Service.

Circle 8 on reader service card

Call Get our FREE Catalog

Continental Rentals

Div. Continental Leasing Co., Inc.
175 Middlesex Turnpike, Bedford, MA, 01730 (617) 275-0850

Metuchen, NJ (201) 549-8500;
Gaithersburg, MD (301) 948-4310; TX (214) 357-1779; Elk Grove, IL (312) 439-4700; Costa Mesa, CA (714) 540-6566; Santa Clara, CA (408) 735-8300; Los Angeles, CA (213) 477-7521

News update

■ The first major telecommunications product from National Semiconductor Corp. is winning a good reception. The device is an active-filter receiver system for a push-button telephone [*Electronics*, Oct. 30, 1975, p. 26]. So far, says Mike Hamper, telecommunications marketing manager, National has received 5,000 orders. Encouraged by its success, National plans to offer several other telecommunications products. This month, the Santa Clara, Calif., firm will start selling sample quantities of a dial-pulse generator for less than \$20 each.

The unit will enable phone manufacturers to offer pushbutton dialing on a dial-pulse line. Then, by Dec. 1, National will introduce an under-\$10 tone-generator chip that puts out a signal when a phone is dialed.

The earliest product, the receiver system for the push-button phone, consists of two printed-circuit boards containing thick-film hybrid integrated circuits for eight-tone filters, a band-splitting filter, a dial-tone rejection filter, decode circuitry, and digital outputs.

■ When Tektronix Inc. told the world about its 4051 graphic computing system [*Electronics*, Oct. 30, 1975, p. 120], a 65-pound model that could be programed easily in Basic, industry sages said that Tek was headed for a market battle with IBM's 5100, a portable computer that was unveiled about six weeks before the 4051. But, says Tektronix, the opposite has been the case. IBM's endorsement of a personal computer easily programable in Basic has actually benefited Tek's 4051. In fact, say officials at the Beaverton, Ore., headquarters of Tektronix, they have had to revise sales forecasts for the 4051 three times in the past 10 months because sales increased so sharply.

The heart of the Tektronix terminal is an M-6800 n-channel micro-processor from Motorola's Semiconductor division, and up to 32-k bytes of random-access memory can be accessed by the central processing unit (though 8-k bytes is standard). □

When you want a small package delivered fast, it's in the bag.



Delta's DASH guarantees delivery on the flight or routing you specify between all Delta cities and most cities served by other airlines through interline agreements. Packages accepted up to 50 lbs. with length plus width plus height not to exceed 90".

Call Delta for an expedited pick-up, or bring your package to Delta's passenger counter at least 30 minutes before scheduled departure time (or to the air cargo terminal at the airport 60 minutes before scheduled departure time). The package can be picked up at the DASH Claim Area next to the airport baggage claim area 30 minutes after flight arrival at destination. Or we deliver it at an additional charge. **DELTA**
The World's Friendliest Airlines

Rate examples (Tax included)

Atlanta-Washington	\$21.00
Boston-Miami	26.25
Los Angeles-New Orleans	31.50
Dallas/Ft. Worth- Los Angeles	26.25
San Francisco-Atlanta	31.50
Philadelphia-Houston	26.25
New York-Tampa	26.25
Chicago-Orlando	26.25
Detroit-Memphis	21.00

For full details, call Delta reservations.

For expedited pick-up and delivery at extra charge, call 1-800-424-1092 toll free anywhere in the Delta system. In Washington, D.C. call 466-3131.

Delta is ready when you are.

Circle 203 on reader service card

Electronics/November 11, 1976

Want 4-week* turnaround on 16K ROMs?

Call Synertek.

- 1) Our SY2316B's are pinned to replace two hard-to-get 2708 EPROMs.
- 2) Our SY4600's and SY2316A's are pin-for-pin with existing standard parts, only better. Read on.

Where you've had to have patience, we come bearing parts.

The 2708 EPROMs you need can be easily and inexpensively replaced by our 16K SY2316B. Its extra address replaces the +12 Volt supply! And its 450ns access time makes it ideal for the fast new micros like our SY6500 family.

If you're looking for the 16K 2316A, spec'd at 850ns, you might consider our ion-implanted SY2316A, which will go at 550ns. It can help you improve your system's speed.

And Totally TTL Compatible!

For the past year we've been giving you MOS parts that can help cut system costs because they are **totally TTL compatible**: μ P's, static and dynamic



shift registers, RAMs. They don't require a negative power supply; a +5V supply is all you need.

And our new 16K ROMs are **totally TTL compatible**, too. **Bogging**.

Metal mask programming is our secret . . .

But don't worry about how we get such fast turnaround. Let us do it for you.

Give a call to your local Synertek rep. Or call Bob Cushman at the factory.

(408) 984-8900. TWX 910-338-0135.

Synertek.
Solutions.
Not problems.

*We can give 2 week turnaround on a limited number of codes each month. Give us a call.

Electronics/November 11, 1976

Circle 9 on reader service card 9

**Buy our
4K static
RAM's and
predict the
future.**

You knew we had a full, off-the-shelf family. (And nobody else did.) You knew it was fully static, low power, as fast as 200 nanoseconds and operated on just 5 volts of power. You even knew there were two organizations: 1K x 4 (Am9130 family) and 4K x 1 (Am9140 family).

Well now you know something new: the future!

\$11.40, now. Under \$8.00 in 1977. Under \$6.00 in '78. Under \$4.00 in '79. (100-piece price, commercial grade, 500 nanoseconds.)

So when your boss says "What price technology?" you say,

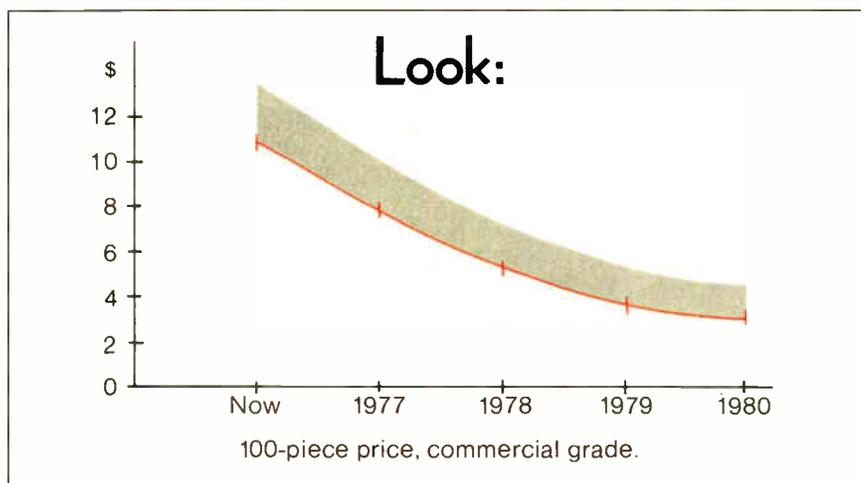

And if he says "What technology price?" you say,

Look again:

ORGANIZATION	1K x 4 (Am9130 Family) and 4K x 1 (Am9140 Family)
POWER SUPPLY	Single + 5 volt
ACCESS TIMES (MAX)	200/250/300/400/500 nsec.
POWER DISSIPATION (MAX)	578 mW
POWER DISSIPATION (MAX) Low Power Version	367 mW
INPUT & OUTPUT LEVELS	Fully TTL Compatible (400 mV —Noise immunity)
TEMPERATURE RANGE Commercial	0°C to 70°C
TEMPERATURE RANGE Military	— 55°C to + 125°C
100% MIL-STD-883 PROCESSING	YES

Advanced Micro Devices' 4K static RAM's: no memories ever had a future like this.

Advanced MOS/LSI



901 Thompson Place, Sunnyvale, California 94086 Telephone (408) 732-2400
Distributed nationally by Hamilton/Avnet, Cramer and Schweber Electronics
and regionally by Arrow, Bell and Century Electronics.

Circle 266 on reader service card

Solar energy: the pace quickens

It is heartening to see that the pace of solar-cell research is picking up. After all, photovoltaic cells offer the prospect of direct conversion of the sun's radiation into electricity.

The Energy Research and Development Administration has given a sizeable boost to the funds allocated to solar cells, although other energy programs still receive the lion's share of its R&D dollars. But even with a higher level of funding, which is necessary for the rapid development of solar-cell technology, ERDA must exercise caution in how it allocates its funds.

One of ERDA's goals, certainly, should be to stimulate competition in an infant industry so that the price of photovoltaic energy can be cut by a factor of as much as 50 to make it competitive with fossil fuels. However, it must find ways to utilize the experience, knowledge, and expertise of the small group of companies that early on invested their risk capital in solar energy. This is just as important now as it ever was, even though they are finally being joined by bigger firms.

The agency's chief tool is its procurement power—it can buy both finished cells and R&D studies. ERDA is purchasing photovoltaic cells for terrestrial applications from the pioneering solar-cell makers, the companies that years ago identified this small but profitable commercial market. They refined their materials-processing technology, built production lines, and were selling photovoltaic arrays in the open market even before ERDA was established. And they were logically the first suppliers that ERDA tapped, when it made two purchases of 176 kilowatts worth of solar cells for testing and eventual use at several Government installations, because they were among the handful of companies that could deliver them.

Now the agency is implementing an ambitious program that calls for technology advancements in tasks ranging from more automated manufacturing processes for silicon and other materials to more efficient ways to slice the ingots that are now produced. Some of the study contracts for assessments of manufacturing processes went to major semiconductor manufacturers, including Motorola, RCA, and Texas Instruments.

The entry of such companies is certainly welcome because of their long experience in processing silicon and other materials used for photovoltaic cells, such as gallium arsenide. They should be able to contribute to ERDA's long-term goals of making solar cells less expensive and expanding the industry.

Yet, ERDA should realize that there is the feeling among some of the pioneers that their own considerable technology is being overlooked. They feel they can do more than just produce cells; they can point the way to more efficient production themselves. One official at a solar-cell company puts it this way: "The solar-energy companies have a lot of technology that should be used more fully. We were disappointed that a solar-energy company didn't get some of that money to assess manufacturing processes." Another says flatly that "it's rankling to see people paid Government money to write reports about things we already know." No wonder some of them are worried that ERDA is funding the latecomers, who could nudge the early birds aside after getting up to speed with ERDA money and very little risk of their own.

It's clear, then, that ERDA should have yet another goal. It should do everything possible to take advantage of the technology that has already been developed and of the expertise that has already been gained.

DARLINGTON

POWER TRANSISTORS

The Designer's Choice from General Electric

NPN - HIGH GAIN - 1/2 AMPERE

GE TYPE	P_T $T_C = 25^\circ\text{C}$ Max. (W)	V_{CEO} Min. (V)	h_{FE} @ 5V, 200 mA		COMMENTS
			MIN.	MAX.	
D40C1	6.25	30	10,000	60,000	<ul style="list-style-type: none"> • Very High Gain - 60k typical; High input impedance - 50k ohm typ; 1.2 watts P_T @ 25°C ambient. • Applications: IC Interface audio output, touch switch, oscillator, buffer, high power transistor driver, relay replacement.
D40C2	6.25	30	40,000	-	
D40C3	6.25	30	90,000	-	
D40C4	6.25	40	10,000	60,000	
D40C5	6.25	40	40,000	-	
D40C7	6.25	50	10,000	60,000	
D40C8	6.25	50	40,000	-	

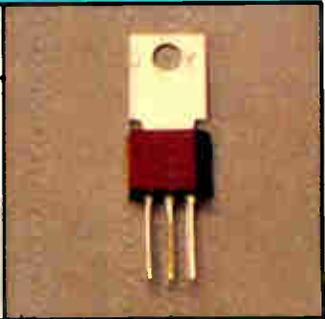

COMPLEMENTARY - 2 AMPERES

GE TYPE		P_T $T_C = 25^\circ\text{C}$ Max. (W)	V_{CEO} Min. (V)	h_{FE} @ 5V, 200 mA		COMMENTS
NPN	PNP			MIN.	MAX.	
D40K1	-	10	30	10,000	Typical Applications: <ul style="list-style-type: none"> • IC Interface • Driver • Regulator • Touch Switch • Lamp Driver • Audio Output • Relay Substitute • Servo-Amplifier • TO-202 Package 	
-	D41K1	10	-30	10,000		
D40K2	-	10	50	10,000		
-	D41K2	10	-50	10,000		
-	D41K3	10	-30	10,000		
-	D41K4	10	-50	10,000		

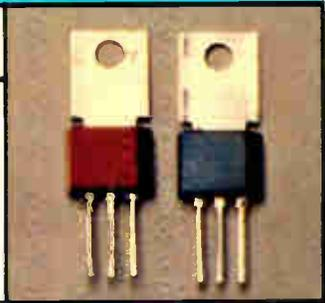

COMPLEMENTARY - 10 AMPERES

GE TYPE		P_T $T_C = 25^\circ\text{C}$ Max. (W)	V_{CEO} Min. (V)	h_{FE} @ 5V, 5 Amps		COMMENTS
NPN	PNP			MIN.	MAX.	
D44E1	-	50	40	1000	Typical Applications: <ul style="list-style-type: none"> • IC Interface • Relay and Solenoid Driver • Regulator • Inverter Power Supply Switch • Audio Output • Relay Substitute • Oscillator • Servo-Amplifier • TO-220AB Package 	
-	D45E1	50	-40	1000		
D44E2	-	50	60	1000		
-	D45E2	50	-60	1000		
D44E3	-	50	80	1000		
-	D45E3	50	-80	1000		

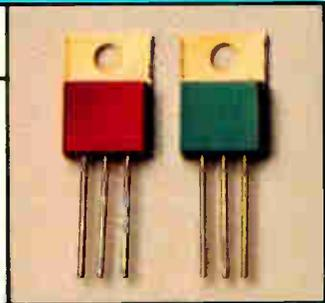

We'd like to show you our DARLINGTON POWER TRANSISTORS; for free sample, identify GE type and write on company letterhead to: General Electric Company, Semiconductor Products Dept., Electronics Park, 7-49, Syracuse, New York 13201.

GENERAL ELECTRIC

Circle 13 on reader service card



OPTRON OPTICALLY COUPLED ISOLATORS

NEW HIGH ISOLATION VOLTAGE
"DIP" SERIES OFFERS
HIGH TRANSFER RATIO

Now, OPTRON provides a 5 kV isolation voltage capability for its standard six pin plastic dual-in-line isolators. A new, unique internal design allows high voltage isolation while still maintaining a high current transfer ratio. The 5 kV DC or 3750 rms AC feature is available for all devices in OPTRON's popular OPI 2100 and OPI 3100 series.

OPTRON's extended "DIP" series includes JEDEC types 4N25 through 4N38A, features complete interchangeability with popular industry types and provides an inexpensive coupler for every application. Devices are available with isolation voltages of 1500, 2500 or 5000 volts with minimum current transfer ratios ranging from 2.0 to 500%.

OPTRON's "DIP" and a full line of other isolator packages with isolation voltages to 50 kV provide the versatility required for maximum electrical and mechanical design flexibility.

1.5 kV isolation with 60% current transfer ratio. Phototransistor base lead available. Hermetic TO-5 package.



OPI 102



OPI 110

10 kV isolation and 40% current transfer ratio. 4 μ sec switching time in low cost miniature plastic package.

Detailed technical information on "DIP" and other isolators as well as all OPTRON optoelectronic products... chips, discrete components, assemblies, and PC board arrays... is available from your nearest OPTRON sales representative or the factory direct.



OPTRON, INC.

1201 Tappan Circle
Carrollton, Texas 75006, USA
TWX-910-860-5958
214/242-6571

People

Norden's Ergott confers
military rank on PDP-11

"Do we need another company in the computer business?" asks Harold L. Ergott, the vice president for computer products at United Technologies Corp.'s Norden division in Norwalk, Conn. Not unexpectedly, his answer is yes, "because no one except us offers the military data-processing systems with software that's available in the commercial market. And we'll have a full set of militarized peripherals to go along with it too." Ergott is directing Norden's thrust into the military computer market.

The 45-year-old former manager of avionics and command control programs at IBM Corp.'s Federal Systems division, like an expectant father, is awaiting the birth later this month of his first product—a militarized, medium-performance version of Digital Equipment Corp.'s PDP-11 minicomputer.

This product is coming nine months after DEC licensed Norden to militarize, manufacture, and market its PDP-11 family. "By and large, computer companies have been serving the Federal Government's needs with boxes—that is, processor and memory systems," asserts Ergott.

Software costs. It's expensive for the military to develop and maintain the software, he points out, and he hopes to see Norden make its mark largely by eliminating that expense. "In time, we'll be offering all of the performance features and software that's available with the PDP-11 family," he says. That will be for the full PDP-11 range—even down to a militarized version of the LSI-11 single-board microcomputer.

The payoff for Norden could be handsome indeed. The Army and Navy have agreed to base their new family of software-compatible military computers for the 1980s with PDP-11 architecture [*Electronics*, Oct. 14, p. 77].

Three PDP-11 systems are under development now, and Norden, heretofore a builder of special-purpose computers for its traditional radar



Computer plus. The military will get more than just boxes from Harold Ergott.

and display-systems businesses, will start a fourth after the first model completes qualification tests around mid-1977. The company is relying on a one-for-one translation from commercial to military design. Components and interconnections are being changed to meet military specifications, says Ergott. But basic features won't be.

Identical. "We'll have more than compatibility with the commercial machines," says Ergott. "We'll have identity." The Norden machines will not just be able to run on the PDP-11 software. Rather, "we'll be bit-for-bit, and function-for-function identical," he says.

And he continues, "It's gratifying to see people in the military so high on the PDP-11 software. The fantastic software base of the PDP-11 will indeed be a tremendous asset."

Field service, says Presta,
needs decision-making

"The main difference between a laboratory and a field-service instrument is that the laboratory variety makes measurements, while field-service units must make decisions." The speaker is Eugene A. Presta, president of year-old Presta Digital Corp., North Bellmore, N.Y. He formed his company to develop instruments specifically suited to field service.

Several weeks ago, he introduced his first product—a logic probe that can also measure time intervals [*Electronics*, Sept. 30, p. 108]. Such

Dial Spectrol for Dials!



©1977 Spectrol
Electronics, Inc.
Model 16-1

Highest quality. better readability.

If you've got the pot, we've got the dial. Spectrol has a dial for any standard multi-turn pot. Choose from 7 standard models. Select chrome or black finish. Specify standard 1/4-inch or 1/8-inch shaft bores. Get maximum readability with even our smallest 7/8-inch concentric Model 16 — or swing with the tide to our unique 3- and 4-digit models. Try them, you'll like the action. (If you don't have the pot — we've got those, too.) Call or write.

Spectrol

SPECTROL ELECTRONICS GROUP

UNITED STATES Spectrol Electronics Corporation 11875 N. Oak Avenue, City of Industry, Calif. 91745, U.S.A. • (714) 964-8345 • TWX (310) 964-1214

UNITED KINGDOM Spectrol Reliance Ltd., Gales Way, Gillingham, Wiltshire, England • Gillingham ST20T • TELEX 4400Z

ITALY SP Elettronica spa Via Sarni Piacenza 7 20096 Piacenza (Italy) • Tel. +39 0521 4001

Circle 15 on reader service card

REST IN PEACE



The brittle bodied, grease shrouded warrior is forever gone — replaced by resilient, efficient Cho-Therm 1661.

This new grease-free, thin and flexible thermal interface material proved too easy to apply and carried BTU's too well.

Hail & Farewell BeO.

Copies of the eulogy (our 1661 specs) are available on request!

CHOMERICS <

77 Dragon Court
Woburn, Ma. 01801
(617) 935-4850

People

a probe is probably the simplest type of decision-making instrument—the one or zero is equivalent to a yes or no. But Presta has his eye on other decision makers as well.

Very few. According to Presta's definition, only a very few true field-service instruments exist today. Lacking them, most companies wind up swapping boards instead of replacing bad components. The cost of this practice, he points out, is enormous. He estimates that the typical float of digital logic boards between customers and the repair shop is about 20% of a manufacturer's production. And at an average price of \$500 per loaded, tested board, that float requires a lot of money to be tied up because of inefficient test instrumentation.

Having been a designer of electronic control systems for 15 years, the Brooklyn-born, 40-year-old Presta is well qualified to know the needs of field-service organizations. For about two years before founding his company, he worked for the Electronics division of Kurz-Kasch Inc., Dayton, whose main product was logic probes, one of the few instruments that meets his definition of a true field-service instrument.

In aiming exclusively at the field-service application, Presta believes he avoids head-on competition with the giants of electronic instrumentation. He hopes to sell mainly to training departments and service departments, rather than to engineering groups. His main business and selling strategy is to "attack the float." He points out, "No one wants to swap a \$1,500 board for the sake of a 20-cent chip."

Wait and see. As for the future, he is waiting for customer feedback on his first product before making his next move.

Meantime, he has not only built his probe with lots of optional plug-ins—for the timer function and for different time bases, as well as for the different logic families field-service technicians may have to deal with—but expects to develop new plug-ins as well. "Tektronix," he observes with a smile, "had a good idea there."



for consistent
quality,
count on

Videobrite
LCDs by LXD



reliability

For unequalled versatility, durability and readability you can rely on LXD. The most experienced engineering and manufacturing staff in the business, plus rigid quality control standards, insures bright responsive read-outs for the entire 50,000 hours of always-on life built into every LXD display.

LXD for your LCDs.



Liquid Xtal Displays

SUBSIDIARY OF DICKEY-john CORPORATION

2450 HIGHPOINT ROAD • CLEVELAND, OHIO 44122
TELEPHONE: 216/831-8100

Circle 17 on reader service card

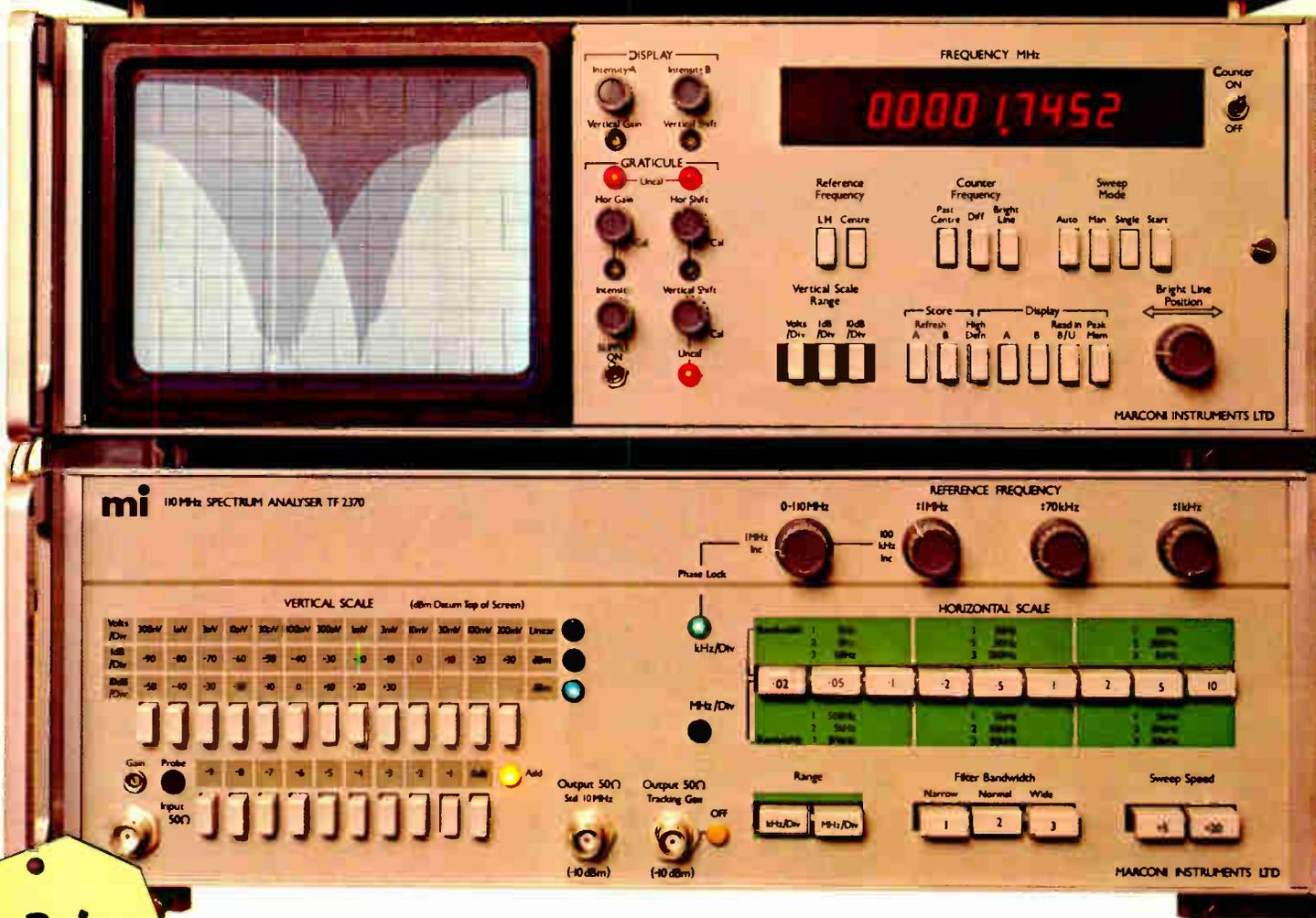

**Price
Reduced**
\$13,795

We've always had unique features and better specs than our competition... now, in addition, **OUR** price is **LOWER!**

Save your skilled engineers for more important work with **mi** Model 2370 Spectrum Analyzer. *Simplify* complicated measurements such as *response, level, gain, signal purity, modulation* and many more. Forget everything you have heard about spectrum analyzers. **mi** Model 2370 is unique. It employs advanced technology to make it as easy to operate as a multimeter. The facts speak for themselves.

- Flicker-free high brightness TV display (No more storage tubes to replace)
- Electronic graticule can pin point position of waveform display for rapid analysis and measurement.
- Choice of vertical scales: linear, 10dB/div for 100dB display, and 1dB/div for 0.1dB resolving power.
- Counter **automatically** displays center frequency, identifies the frequency corresponding to the manually

adjusted 'bright line cursor', or the difference frequency between the two. All to an accuracy of 2Hz.

- Integral synchronous signal source for measuring *networks, filters, amplifiers*, etc.
- For comparative measurements, memory storage can retain one display indefinitely, for simultaneous display with waveform from items under test.
- **Automatic** adjustment of amplifier gain to *optimize* noise performance.
- **Automatic** selection of *optimum* sweep speed.
- With the 5Hz filter, signals 100Hz from a response at 0dB can be measured to better than -70dB.

Such speed and accuracy must be seen to be believed, call us for an enlightening demonstration.

Circle 18 on reader service card

mi **MARCONI**
INSTRUMENTS
DIVISION OF MARCONI ELECTRONICS INC

100 STONEHURST COURT, NORTHVALE, NEW JERSEY 07647 • TELEPHONE: 201/767-7250 • TWX: 710-991-9752

Meetings

Electronica 76—7th International Trade Fair for Components and Production Facilities, Munich Fair Authority, Munich, West Germany, Nov. 25—Dec. 1.

Eighth Annual Precise Time and Time Interval Applications and Planning Meeting, Naval Electronic Systems Command, NASA Goddard Space Flight Center *et al.*, Naval Research Laboratory, Washington, D. C., Nov. 30—Dec. 2.

Forum on Computer Technology, American Society of Mechanical Engineers, Statler Hilton Hotel, New York, Dec. 5—10.

Chicago Fall Conference on Consumer Electronics, IEEE, Ramada Inn-O'Hare, Des Plaines, Ill., Dec. 6—7.

1976 International Electron Devices Meeting, IEEE, Washington Hilton Hotel, Washington, D. C., Dec. 6—8.

Bicentennial Winter Simulation Conference, IEEE, NBS., *et al.*, National Bureau of Standards, Gaithersburg, Md., Dec. 6—8.

1976 National Plastics Exposition and Conference, Society of the Plastics Industry, Inc. (New York), McCormick Place, Chicago, Dec. 6—10.

Distributed Data Processing Conference, American Institute of Industrial Engineers (Santa Monica, Calif.), Ramada Inn-O'Hare, Des Plaines, Ill., Dec. 7—10.

Solar Cooling and Heating: A National Forum, Energy Research and Development Administration, Fontainebleau Hotel, Miami Beach, Fla., Dec. 13—15.

1977 Winter Consumer Electronics Show, EIA, Conrad Hilton Hotel, Chicago, Jan. 13—16, 1977.

Reliability and Maintainability Conference, IEEE, Marriott Hotel, Philadelphia, Jan. 18—20, 1977.

Thin-Trim. capacitors

Tucked in the corner of this Pulsar Watch is a miniature capacitor which is used to trim the crystal. This Thin-Trim capacitor is one of our 9410 series, has an adjustable range of 7 to 45 pf, and is .200" x .200" x .050" thick.

The Thin-Trim concept provides a variable device to replace fixed tuning techniques and cut-and-try methods of adjustment. Thin-Trim capacitors are available in a variety of lead configurations making them easy to mount.

A smaller version of the 9410 is the 9402 series with a maximum capacitance value of 25 pf. These are perfect for applications in sub-miniature circuits such as ladies' electronic wrist watches and phased array MIC's.

Johanson

Johanson Manufacturing Corporation
Rockaway Valley Road
Boonton, New Jersey 07005
(201) 334-2676 TWX 710-987-8367

In-circuit emulation product can do while

The dream of design engineers is to develop, debug, and integrate hardware and software in their actual product environment—from day one. Thereby dramatically shortening the development time—and development cost—of their microcomputer-based products.

The Intellec® microcomputer development system makes the dream a reality. Because the Intellec system has everything you need to design microprocessor based products using Intel® 8080, Series 3000 and future Intel microprocessors.

You reverse the traditional product development flow which postpones hardware/software integration until late in the development cycle. Move from concept through design, system integration and debugging to production in a fraction of the time normally required.

With ICE-80 and ICE-30 Intellec's in-circuit emulation modules, you exercise your complete hardware/software prototype under control of high level diagnostic software. ICE-80 plugs into the 8080 socket in your prototype system and runs it in real time. Under Intellec system control, you single-step your system program, using Intellec's memory and I/O as though they were part of the prototype system. Powerful debug functions are extended into your system and you can examine or modify your system memory or Intellec memory using symbolic references instead of machine addresses.

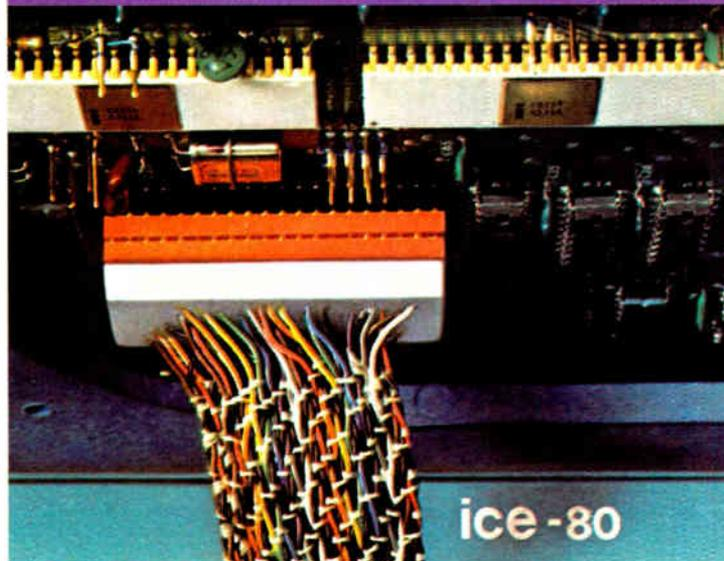
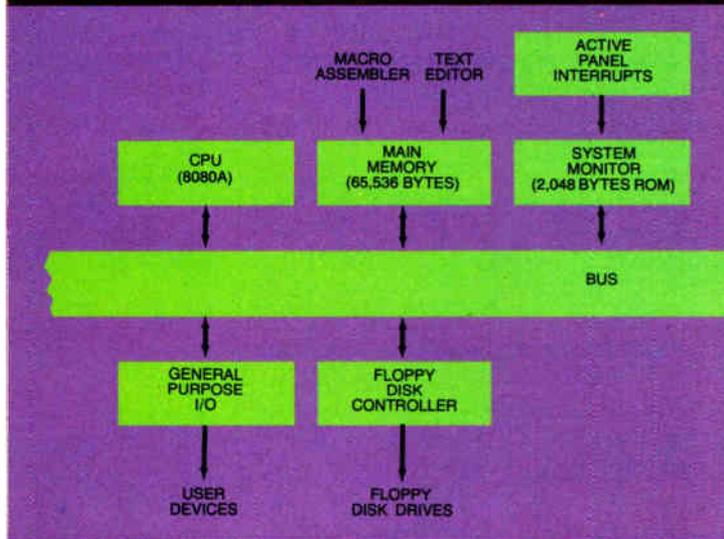

lets you see what your it's still on the bench.

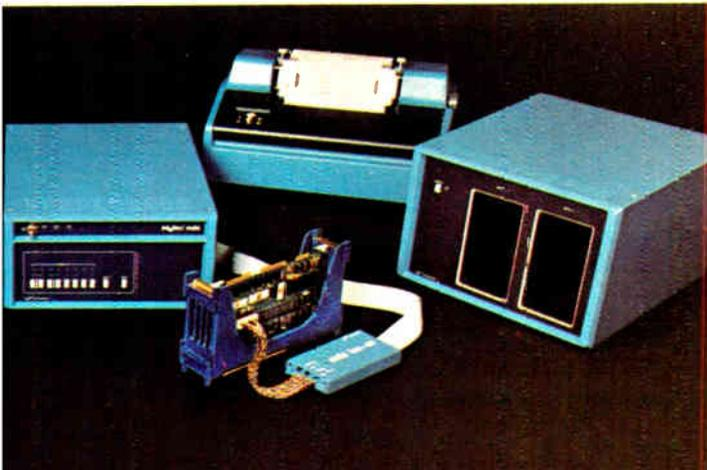

The Intellec system includes its own 8080 processor, memory, and a full range of peripherals designed to ease your development task. These include diskette operating system, CRT/keyboard, line printer, universal PROM programmer, high speed papertape reader, the in-circuit emulation modules, (ICE-80 and ICE-30) and interfaces for teletypewriter and high speed tape punch.

Under Intellec software you assemble, edit, execute and debug programs quickly. The diskette-based operating system, ISIS, performs all your program and file management tasks automatically. A wide range of system commands gives you complete control of your prototype, including the ability to set multiple hardware and software break point conditions.

The Intellec system provides the convenience of a complete in-house development system, backed with the quality support, service, training, and documentation you expect from the company that is the leader in microprocessor systems development. And the Intellec system is available for immediate delivery.

If you've always wanted to see how your product works while it's still on the bench, experience an Intellec system for yourself. For a demonstration or for technical information use the reader service card or write: Intel Corporation, 3065 Bowers Avenue, Santa Clara, California 95051.

intel[®]

Microcomputers. First from the beginning.

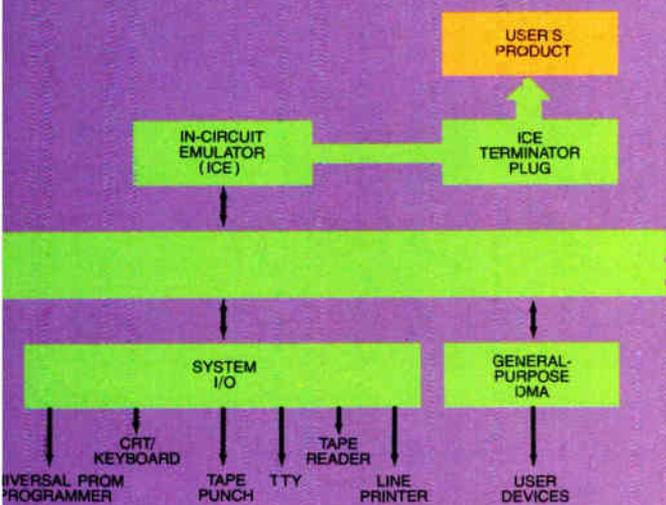

```
#GO FROM START UNTIL RSLT WRITTEN
EMULATION BEGUN

#DISPLAY CYCLES
STAT-ADR-DATA STAT-ADR-DATA STAT-ADR-DATA S
A2H-1326H-CDH 82H-1327H-E3H 82H-1328H-01H 0

#CHANGE DOUBLE REGISTER SP=13FFH
#BASE HEX
#EQUATE STOP=1333H
#GO FROM START UNTIL STOP EXECUTED THEN DUMP
EMULATION BEGUN
B=01H C=41H D=00H E=00H H=00H L=00H F=56H A=
```

More weapons for The Battle of the 80's

**Now a multiple attack against outmoded,
large and bulky microcomputers.**

This multiple attack features a stand alone Microcomputer Board, Zilog's mighty MCB, that has the capability to communicate with both serial and parallel I/O devices, has its own RAM and ROM capability and is backed up by a second board containing a disk controller and additional memory allowing the use of Zilog's complete disk operating system and applications' software.

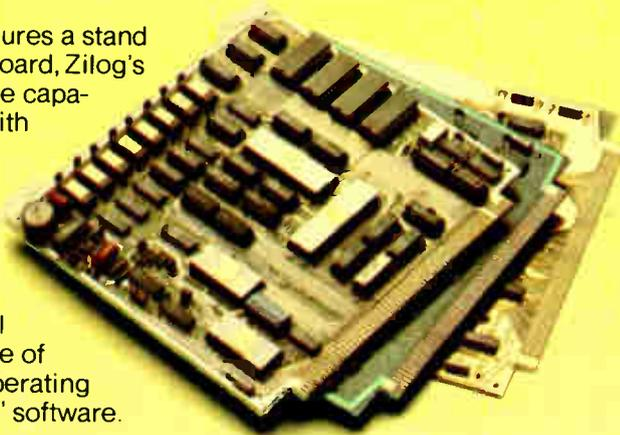

Announcing the Z80-MGB. An assault against big board computers.

A single 5-volt power supply does it. And it's small—only 7.7 x 7.5 inches with a standard 122 pin edge connector with 100 mil spacing that is designed for ease of use.

A squad of fighters against obsolete hardware.

Here's what Zilog's new weapon gives you:

- Z80-CPU single-chip n-channel processor with 158 instructions.
- 19.6608MHz crystal oscillator divided to 2.457MHz for Z80-CPU operation and dividable by Z80-CTC to provide any other desired system frequencies.
- 4K bytes dynamic RAM.
- Capacity for 4K bytes on non-volatile memory.
- Programmable serial I/O port with RS-232 or current loop interface.
- Universal parallel I/O with two independent 8 bit ports.
- Z80-CTC for programmable baud rate generation or other user functions such as real time clock.
- Bus drivers are provided for memory and I/O expansion to other boards.
- One-half K-byte monitor software has terminal handler, load and punch routines as well as set and display memory commands. A GoTo command begins execution of user programs. The 1K-byte version adds more debug aids such as set and display registers and breakpoints. The 2K and 4K-byte versions include a floppy disk controller and even more debug capability.

A second board gives you the advantage.

A second board gives you a 4-drive floppy disk controller and additional RAM backed up by a full disk operating system. Plus, you get the applications software you need: file, edit, assemble, debug, and high level languages such as BASIC, and more will be announced soon. This second board contains 12K of dynamic memory and additional 8 bit programmable parallel I/O ports.

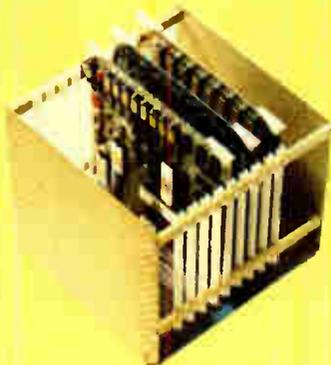

Both cards are easily interfaced in a simple, low-cost card cage.

The Mighty Weapon: Zilog's Z80-OEM System.

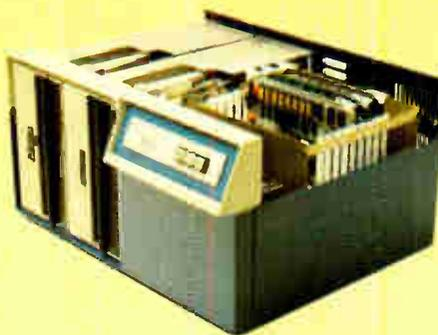

Start out with a strong front and get performance unmatched by any other microcomputer system in the field.

You get:

- Z80-MCB Microcomputer Board
- Z80-MDC Disk Controller/Memory Board with disk controller capability for up to 4 floppy disk drives.
- Z80-RMB 16K-byte RAM Board with memory expandable to 64K bytes in 16K-byte increments.
- Z80-SCC Standard Card Cage holds up to 9 P.C. cards.
- Z80-MCS Microcomputer System includes a standard card cage, up to 2 floppy disks, power supplies and a push button front panel.

A versatility of attack: you can buy only as much as you need.

We provide a modular approach to complete computing and processing systems. Zilog products are available as a basic CPU card, a card set or a complete self-contained computer with floppy disks and power supplies in one unit.

Behind all this is Zilog's pledge to stay a generation ahead. We're the specialists who are responsible for the development of the most successful first and second generation microprocessors. And we're hard at work on the next step—an advance that will keep us out in front in The Battle of the 80's.

Appropriate assistance will be dispatched upon your written request or telephone call.



10460 Bubb Road, Cupertino, California 95014
(408) 446-4666/TWX 910-338-7621

In Europe: Zilog, Inc., Nicholson House,
High Street, Maidenhead, Berkshire, U.K.
TEL 0628 36131/2/3/TLX 848-609

Circle 23 on reader service card

AN AFFILIATE OF EXXON ENTERPRISES INC.

Interested in network variety? Select from a spectrum of 347 standards.

Allen-Bradley has the popular configurations you need. Pull-ups, Pull-downs. Line Terminators. Networks to complement Core Memory Sense Amplifiers. TTL to ECL Translators. O-Pad Attenuators. All styles available from your Allen-Bradley *Electronic Distributor*. Call for specs or check your EEM Catalog. If you need specials, contact your local Allen-Bradley district office for fast turn-around. Ask for Publication 5840. A-B is an experienced twin-film manufacturer, i.e. precision thin film and thick film.

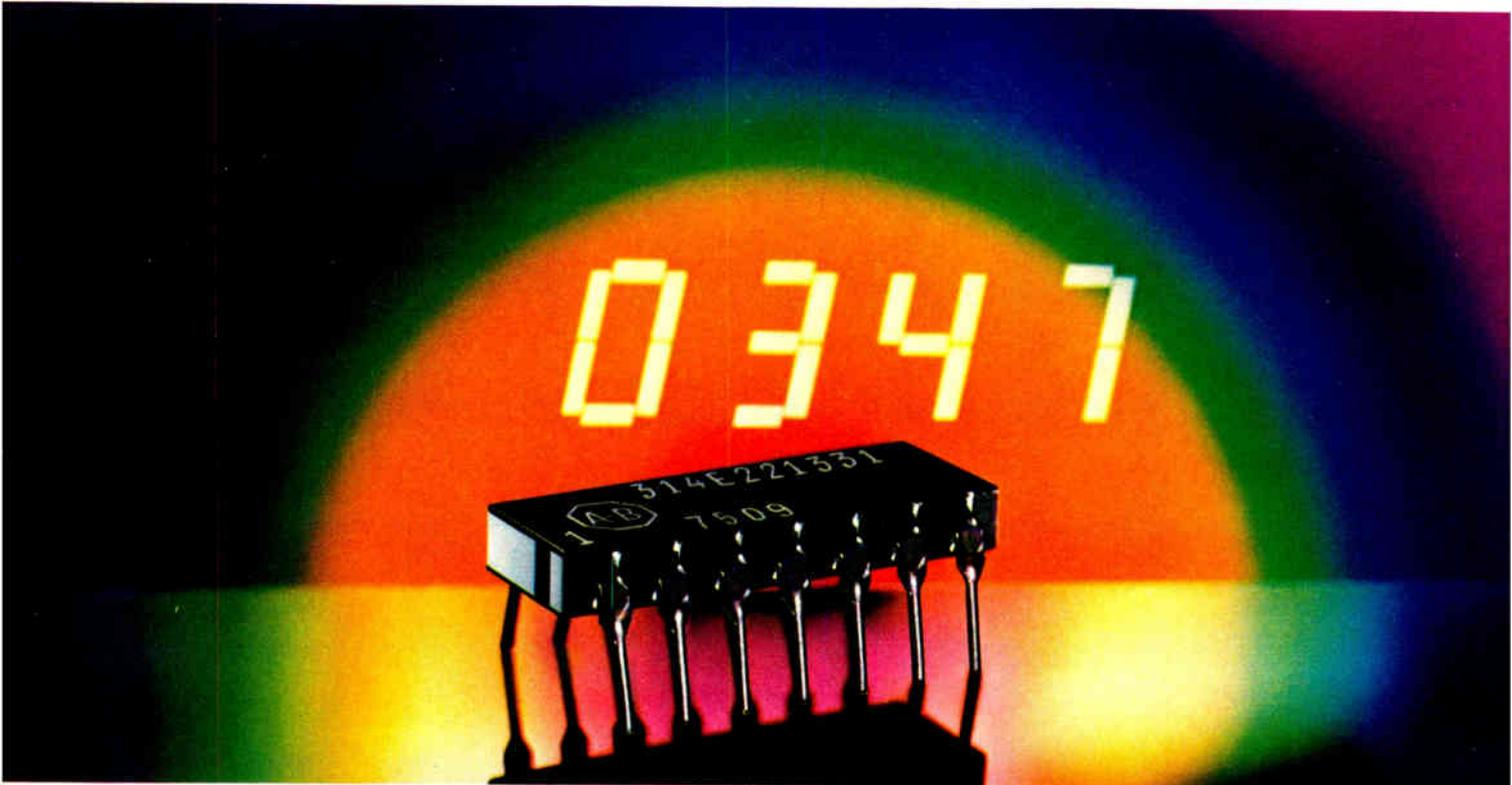
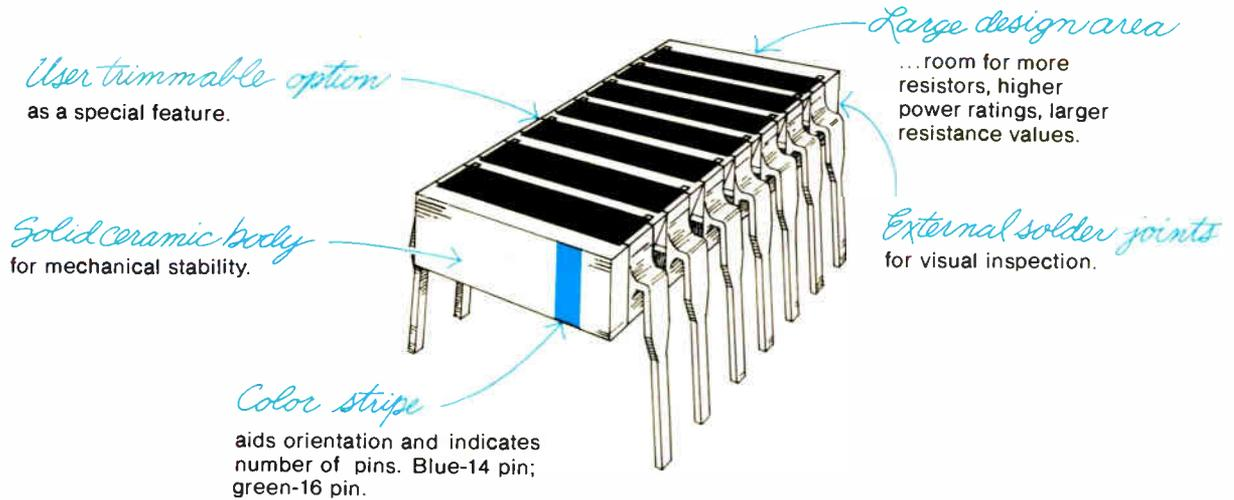

Quality in the best tradition.



ALLEN-BRADLEY
Electronics Division
Milwaukee, Wisconsin 53204

EC111

TI, Motorola join Intel in battle for 2708 market

Intel is about to face formidable competition in a \$30 million market that it practically owns: the 8,192-bit ultraviolet-erasable programable ROM. **The Intel device is one of the hottest items in the industry** because it is a key prototyping element in microcomputer systems, as well as a program ROM on a single-chip controller.

The competition will be coming from Texas Instruments, Motorola, and Advanced Micro Devices, which will introduce this part in the first quarter. Among others working on the difficult Famos process needed to build the device are National Semiconductor, Mostek, Electronic Arrays, Signetics, and American Microsystems Inc.

National prepares fast 18-pin 4-k memories

While the rest of the industry is adopting Mostek Corp.'s 16-pin 4027 for the market in high-speed (better than 200 nanoseconds) 4,096-bit dynamic memories (see p. 30), National Semiconductor Corp. is staying with fast versions of its 18- and 22-pin devices. Scheduled for the second quarter are parts that will have access times **in the 100-to-125-ns range**, with cycle times of only 220 ns, according to Jeff Kalb, National's director of memory development. Kalb sees the market growing for high-speed 4-k devices as the 16,384-bit memories begin to appear in volume for the slower applications. He says that this high-speed process is potentially capable of 80-ns operation as well as considerable reduction in die size.

Visually activated switch tested by Air Force

The Air Force Systems Command's Aerospace Medical division is testing a visually activated switch system as a way of simplifying control-system switching for fighter pilots in single-seat aircraft such as the F-16. Developed for Wright-Patterson Air Force Base by United Technologies Corp.'s Norden division in Norwalk, Conn., the system permits the pilot to activate cockpit panel switches **by directing a head-mounted infrared-light source onto cockpit-mounted switch sensors.**

Capacitor push mapped by TI

Watch for Texas Instruments to get into the capacitor business with a line of axial-lead devices, aimed at high-volume sales and rated at 10 to 1,000 picofarads with tolerances ranging from 1% to 20%. The Dallas firm has been quietly shipping the nitride-passivated MOS chip capacitors for four months, but it's now putting them in its standard diode package, a hermetically sealed glass cylinder with copper-clad iron leads **that lends itself to automatic insertion.** Nickel-iron plugs at the ends of the leads make a pressure contact with both sides of the capacitor chip.

TI is using three chip sizes, from 14 to 45 mils on a side, to cover the capacitance range. Prices will be from 5 cents to 15 cents each in production lots of devices with 5% tolerances.

Motorola to market add-on memory

Departing from a tradition of avoiding systems business competition with its customers, Motorola Semiconductor Products Group plans to compete in the memory-systems market. The first product, a 32-kilobyte RAM board made up of Motorola's 6605A-2 4-k RAMs, plus peripherals and connectors, **is a direct plug-in add-on to Digital Equipment Corp.'s PDP-11** intended to extend the system to 48 kilobytes. The board costs \$1,200 in quantities of five to 24. Although Motorola plans other memory systems for the microcomputer and minicomputer market, it has no

Electronics newsletter

immediate plans to compete head on with Intel, National, and Advanced Memory Systems in the main IBM add-on market.

M7 loses \$223,000 contracts for solar arrays

The Jet Propulsion Laboratory has terminated two solar-panel contracts worth \$223,000 awarded to M7 International Inc. in its program to develop low-cost silicon solar arrays (see p. 91). JPL sources in Pasadena, Calif., calling the move "obviously a touchy and sensitive issue," confirm that the contract was terminated, although yield problems appeared to be on the way to solution. **Enough uncertainty remained** that project officials judged it "risky and expensive to proceed."

M7 admits to early yield problems on its \$84,000 contract for 3-kilowatt arrays, awarded in January, "but I thought they had been solved," says Ronald W. Ignatius, president of the Arlington Heights, Ill., firm. "We were told that the cost-plus-fixed-fee R&D contract would be terminated because it would raise the per-watt cost above JPL's program goals." The firm's second award—\$139,000 for 5-kw arrays—was also terminated "for the convenience of the laboratory" and before we were allowed to perform on it," he says.

Thick-film hybrids used in Army's Stinger missile

The Army's Picatinny Arsenal in Dover, N.J., is making extensive use of thick-film hybrid technology in developing the warhead for the Stinger, a new portable, forward-area air-defense missile. Now in its final development stages, the missile features a new propulsion system, a new guidance system with infrared counter-countermeasures, a new fuze, and an identification-friend-or-foe interrogator.

TI readies new bipolar LSI logic

After two years of intense development, Texas Instruments Inc. is about to spring afresh into the digital market with a new bipolar large-scale integrated family—a market it now dominates with its small-scale and medium-scale integrated 54/74 series. This new family of microcomputer components has at its heart **two versions of a 4-bit microcomputer slice**. They are the SN54/74S481, which has a microinstruction cycle time of 100 nanoseconds for the maximum program throughput, including implementation of macroinstructions, and an upgraded SBP 0400 4-bit integrated-injection-logic slice that has a wide range of speed/power tradeoff and full military-temperature performance. Both 4-bit slices are in prototype production. Other Schottky members of the family, including program memory, control elements, and microcontrol memories, either are in production or soon will be.

Addenda

Superior Electric Co. of Bristol, Conn., is dropping its line of numerical-control equipment for the machine-tool industry. NC accounted for 21% of Superior's \$25 million in sales for 1975, **and 16% so far this year**. The company says it's dropping the line because of competitive price pressure and a changing market. . . . The Air Force Electronic Systems division has requested proposals for the design-verification portion of its Joint Surveillance System. Two parallel 15-month contracts will be awarded next summer. The system will link radars operated by the Air Force, the FAA, and Canada to assure air sovereignty of the two nations. **The entire program is expected to cost \$250 million.**

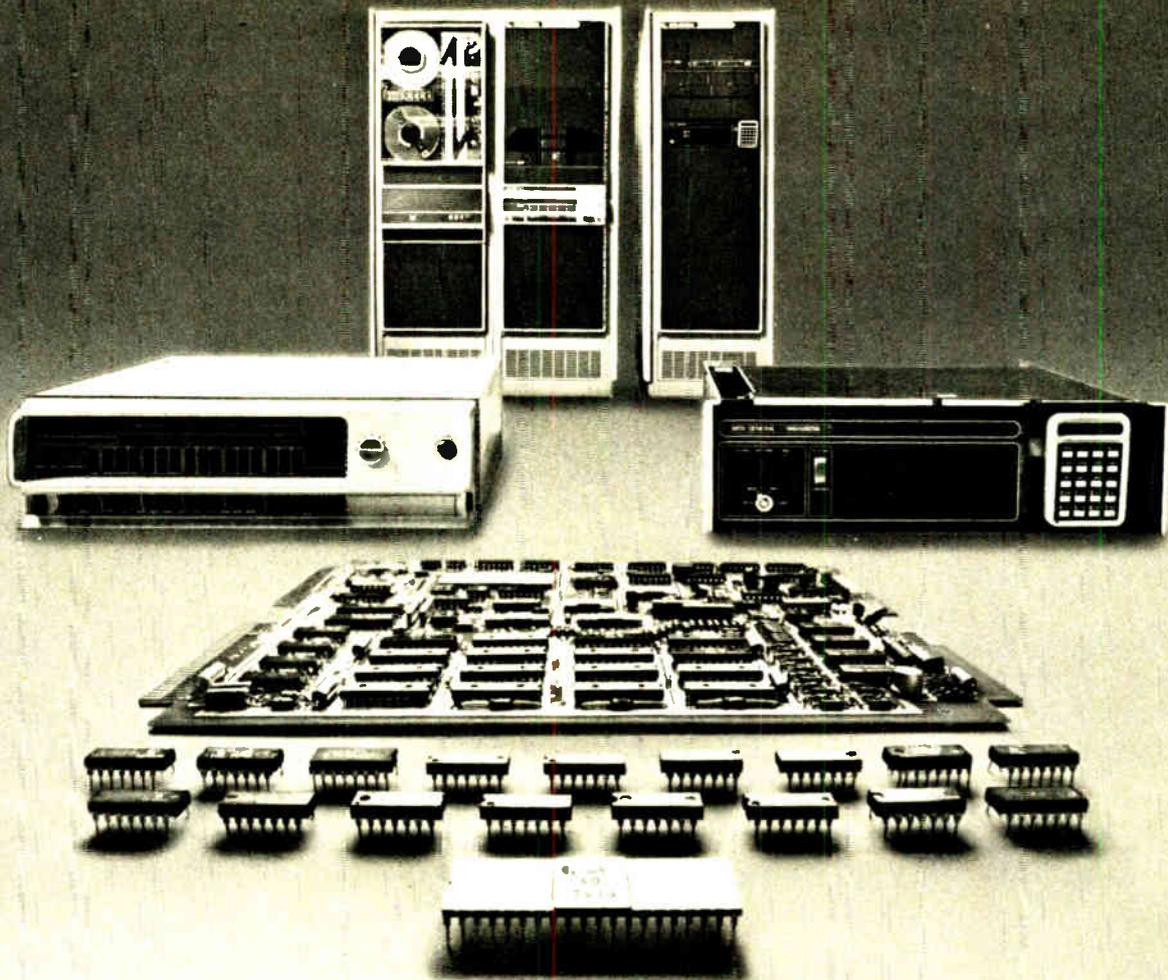

With a line of minis and micros like ours, we don't have to push any one of them.

With other companies, you might set out to buy a microprocessor chip and end up with the whole chassis. Or get a box when all you need is a board.

But Data General doesn't work that way. We don't have to push you into buying something you weren't really looking for. Because we can let you choose from microprocessor chip sets, microcomputer boards, completely packaged MOS minis and full-blown NOVA 3 systems. All four are compatible. And they give you a range of performance with a range of prices.

So, if you're a component user, there are both high-performance microNOVA chip sets and microcomputer boards that feature Data General's mN601 microprocessor. The mN601 is a full 16-bit NOVA-on-a-chip. And the microcomputer is a full 4K-word computer-on-a-board. You package them yourself, for greatest economy. (Speaking of economy, the board costs only \$589 in OEM quantities of 100.)

And if you're not ready for components yet, there's our fully-packaged microNOVA MOS minicomputer. It's available with up to 32K words of MOS memory and peripherals like

our diskette subsystem. And it's supported by our Real-Time Operating System and diskette-based Disc Operating System. You can get our mini with 4K words of MOS memory for only \$1995. Or as a complete development system with the diskette.

If you need bigger systems capabilities, take a look at our NOVA 3 computer. It's compatible with our microNOVA family. And it runs with high-performance peripherals, sophisticated software like Real-Time Disc Operating System, high-level languages like FORTRAN 5 and BASIC, and memory expansion to a full 128K words.

We've got it all. But we won't try to sell it all. Unless it's what you really need. If you don't believe that line, call us. Dial 800-225-9497 (in Massachusetts, 1-617-485-9100, extension 2509) and ask for information on microNOVA and on the free half-day microNOVA seminars that happen this fall all over the country.

Or write for our microNOVA and NOVA 3 brochures. And see for yourself.

DataGeneral

Data General, Route 9, Southboro, Mass. 01772 (617) 485-9100. Data General (Canada) Ltd., Ontario.
Data General Europe, 15 Rue Le Sueur, Paris 75116, France. Data General Australia, Melbourne (03) 82-1361
NOVA is a registered trademark of Data General Corp.

The Unitrode approach to power Darlington in plastic.

TO-202's up to 10A.

Introducing classic Unitrode quality and reliability in a brand-new line of inexpensive power Darlington in TO-202 plastic packages. These new fast switching Darlington are available in ranges from 3 to 10 amps and 60 to 300 volts.

And the 5 amp, 300 volt package is the only high voltage, high current, fast switching plastic Darlington now on the market.

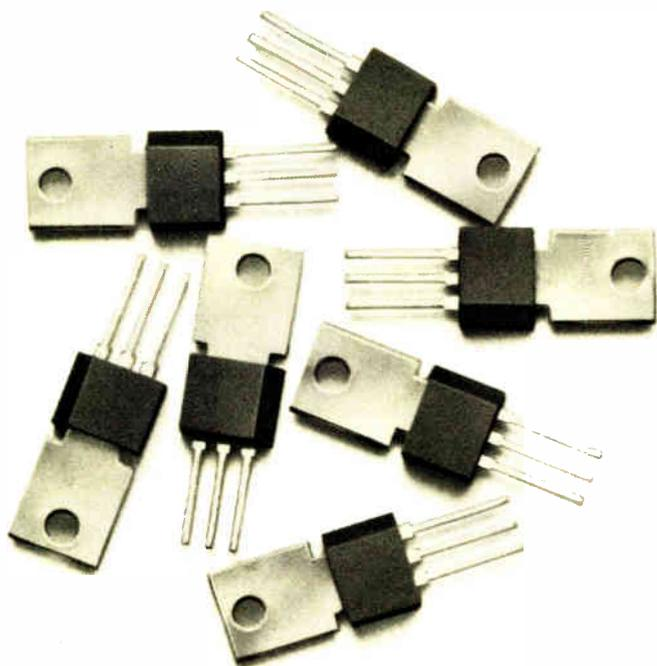

The first 3A in a TO-92.

We've also come out with the industry's first 3 amp, 100 volt power Darlington in a TO-92 plastic package. So for applications where you don't need a high power package, you no longer have to pay for it. The 3A TO-92 is less than 40¢ in volume and can be used with automatic insertion equipment.

Unitrode's new line of plastic power Darlington. Never before has so much performance been offered for so little money. The perfect answer for computer peripheral, POS, and industrial control applications.

For complete details, contact:
Unitrode Corporation,
580 Pleasant St.,
Watertown, MA 02172,
617-926-0404.

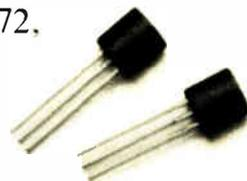

UNITRODE

Hand-held terminal to give field troops access to data nets

Litton unit transmits, over military voice links, data keyed in via see-through overlay on LED display

Headed for military evaluation is a hand-held data terminal that will give forward outposts "punch-up" access to command-network computers. While the 4-pound terminal from Litton Industries Inc. represents an innovation for the soldier in the field, it also uses innovative electronics.

It does its work, for example, without a conventional keyboard. Instead, it relies on a transparent switch plate that overlays a light-emitting-diode display. And the display, a good-sized area of 3 by 4½ inches, allows the operator to compose messages simply by touching displayed letters and numbers through the transparent plate. Programmed function "keys" can also be called up through the display, their titles touched in a "menu" list. And, the diodes will display graphics such as maps, as well as information transmitted to the terminal from command centers.

Basic module. "Seven years of homework and bits and pieces of lots of things" led to the interactive display terminal, says Tom O'Donnell, marketing manager at Litton's Data Systems division in Van Nuys, Calif. The display portion is built from a basic building block of a LED module with a display measuring 1½ by 3 inches. Three of the LED modules go to make up the terminal, which is 8.6 by 6.1 inches

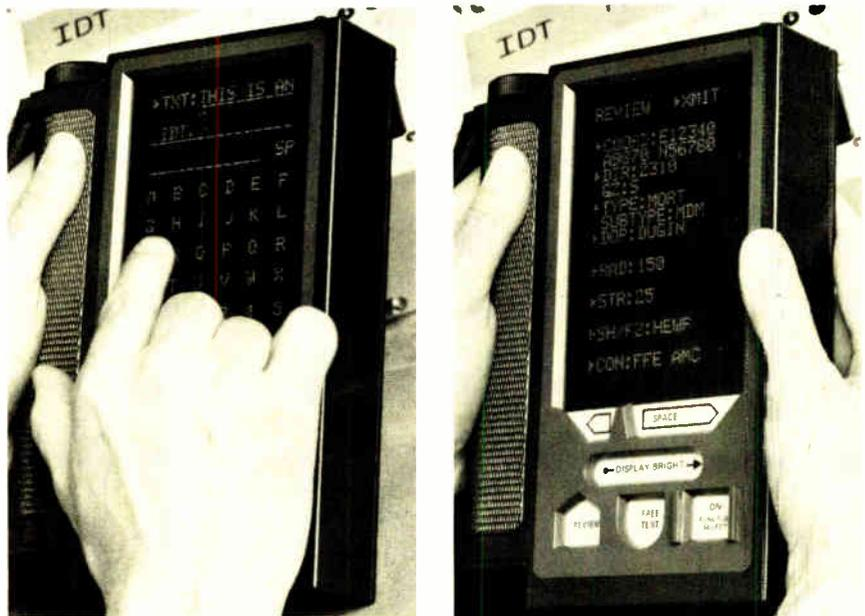

Clear view. Message keyed into interactive display terminal via transparent switch over light-emitting diodes (left) is reviewed for accuracy before being transmitted.

in area and 1.6 in. thick.

Under a \$350,000 contract, Litton is building three evaluation units to be delivered in March to the U.S. Marine Corps and, separately, two others for the West German Army. O'Donnell looks forward to a big market for the device. The Army, for instance, is interested in a portable terminal for its Tacfire battlefield tactical data system for which Litton is the prime contractor.

The display surface of the Litton device has a resolution of 33 lines per inch, according to Ron Harris, the engineering project manager. Each module has 4,698 diodes, on a basic 5-by-7 matrix, with the three together permitting a total of 288 characters.

While the transparent "membrane" switch is not new, it has not

been employed over a display before, say Litton developers of the terminal. The switch is a three-layer sandwich with almost invisible copper wires 3 to 5 mils thick attached to outer plastic layers. Contact, from slight pressure, causes the wires to touch through holes in a plastic insulating layer. With 54 separate switch positions controlled by a microprocessor in a time-shared mode, the terminal allows any number of functions to be keyed in, Litton explains.

C-MOS processor. Inside the terminal are the microprocessor, a random-access memory, a digital-data modem, a power supply, and three D-size military lithium batteries. There is also a backup "keep-alive" battery that keeps data in memory if the main batteries fail. Lit-

ton had to build a C-MOS processor because nothing with the low-power requirements was commercially available when design began. However, Harris says the RCA Corp. 1802 Cosmac microprocessor may be used in production.

The terminal has 20,000 bytes of RAM in five 4,096-by-8-bit hybrid packages of 1,024-bit chips. The model supplies a modulated signal that is frequency-shift-keyed onto the carrier of standard voice radio transmitters. Data rate is 600 to 1,200 bits per second.

So far, a single set of three batteries has run up to 44 hours, handling more than 1,000 messages, Harris notes.

While Litton put its own research and development funds into the LED modules, the big impetus came from an award to build a 4-foot-square interactive computer presentation panel for the Army. Litton has a \$2.5 million award for this three-color panel, which is made up of 392 edge-stackable, plug-in LED modules. It is in a run-off competition with Control Data Corp.'s plasma display approach [*Electronics*, June 10, p. 25].

Litton claims anyone can operate its terminal with only a few minutes training. "What the terminal does is allow the operator to think about communications, and not the device," says one developer. □

Solid state

Motorola, Fairchild technology exchange strengthens Intel's microprocessor rivals

As the dust settles from the double-barreled blast of second-sourcing and technology exchange between Motorola and Fairchild, it seems clear the cooperation of these industry giants will have great impact on the semiconductor industry.

The agreement, announced in two phases a week apart late last month, calls for Fairchild Camera and Instrument Corp., Mountain View, Calif., to build Motorola's 6800 microprocessor family, as well as the MC10800 emitter-coupled-logic 4-bit slice and the 8,192-bit erasable read-only memory. In exchange, Motorola Semiconductor Products Group, Phoenix, gets manufacturing rights to Fairchild's family of low-power Schottky TTL logic, the F-8 single-chip microprocessor, and the new 16,384-bit and 65,536-bit charge-coupled-device memories.

What appears to be happening is a double- and triple-teaming effort against Intel Corp., the microprocessor sales leader. Zilog Inc., and second-source Mostek Corp., are going after the high end of the 8-bit market with the Z-80, while American Microsystems Inc., Motorola, and Fairchild take on Intel in the

middle. At the low end, Mostek, Fairchild and Motorola have the F-8 in the \$7-to-\$12 one-chip range, while AMI, Fairchild and Motorola will offer the 6802 two-chip device at the \$15 level.

Intel's Microcomputer division general manager and vice president, William Davidow, declines to comment about how the Santa Clara, Calif., firm will react in the future.

Different. The top man at Motorola Semiconductor, group executive John R. Welty, calls the cooperation a "new kind of second-source agreement. We will provide masks and process information to Fairchild and assure compatibility. I am aware of no 8080 second-source [agreement] where Intel makes sure of compatibility."

He says the announcement will "help with customers sitting on the fence," looking at both the 6800 and 8080 but worried about dependable 6800 backup. He regards the exchange as even, since "there are three products involved on both sides."

Welty says that Fairchild's TTL is the "key element" in the technology Motorola will get. "It's no secret

that for the past five years, Motorola has not been a vigorous competitor in bipolar ICs. This means we'll step up our efforts in that marketplace," he says. And he notes his company will not keep working on anything that duplicates products already introduced by Fairchild.

Fairchild's choice. On the Fairchild side, Van Lewing, microprocessor-marketing manager, says the agreement also includes the two-chip 6802 microcomputer still under development at Motorola. Before choosing the 6800 for entry into the general-purpose microcomputer market, Fairchild considered alternatives that included Intel's 8080, Zilog's high-performance Z-80 and Signetics Corp.'s 2650.

"But if we had gone that [8080] route, we would have been just another company, another almost identical second source," Lewing explains. "If we are going to be in the same marketplace, we thought we'd better be there with something as good or better."

Industry insiders speculate the 6800 now has about 20% to 25% of the 8-bit market, up from 10% to 15% a year ago. If the new alignment goes according to plan, they say, within a year, the 8080 and 6800 will each have 45% of the market, the Z-80 will have 5%, and all other machines 5%.

The sole previous second source for the 6800, AMI, welcomes Fairchild's entry, says John Richardson, vice president of sales. "We'll have to hustle to remain competitive, but that is offset by the number of new markets that will be opened up for an 8-bit machine truly second-sourced by three companies." □

Industry moves to Mostek RAMs

To the surprise of the semiconductor industry, Mostek Corp. has suddenly become the technology leader in dynamic metal-oxide-semiconductor random-access memories. Although Intel Corp. and Texas Instruments Inc. entered the market first with

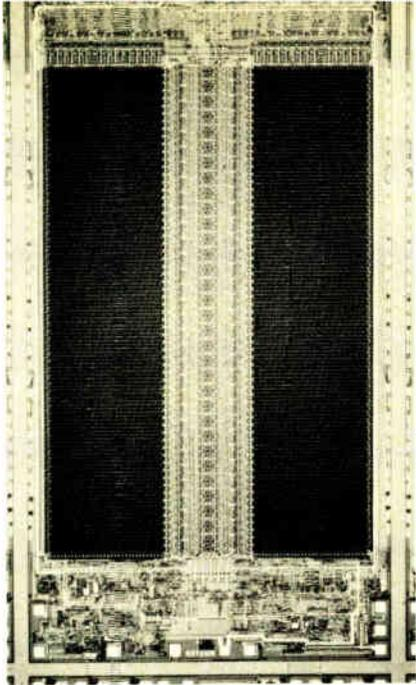

Speed leader. Mostek's 16-k MOS RAM, with access time of 150 ns, looks good to the users who've seen and tested it.

samples of their 16,384-bit RAM [*Electronics*, Jan. 8, p. 27], the recently introduced Mostek 16-k MK 4116-2 part, which has an access time of 150 nanoseconds, has impressed memory users and manufacturers alike. The RAM is much faster than Intel and TI production devices.

What's more, Mostek has caught the industry off guard in the 4,096-bit RAM market as well. The Carrollton, Texas, firm's 150-ns MK 4027, now in volume production, has found such strong acceptance that every major 4-k memory supplier but one is rushing into production with high-speed 16-pin 4-k parts of its own. The exception is National Semiconductor Corp., which will introduce 100-to-150-ns versions of its 18-pin devices [see p. 25].

Remarkable. Dick Foss, president of memory-consultant Mosaid Inc., Ottawa, Ont., points out: "The 4027 is a remarkable part—the first 4-k RAM ever to be exactly copied throughout the industry. With the 16-k device, it has squarely catapulted Mostek into a leadership position in the RAM business." Mosaid is helping several manufacturers copy the part.

Typical of user enthusiasm for Mostek's new RAMs is the comment by James Sheehan, manager of technology engineering at Prime Computer Inc., Framingham, Mass.:

"While Intel is the strongest 16-k supplier in terms of volume, the 150-ns speed of the Mostek part is just plain super." Robert Frankenberg, product manager of 21MX and 2100 minicomputer lines at Hewlett Packard Co.'s Data System's division, Palo Alto, Calif., says that preliminary lab tests show "the parts are all that Mostek says they are. But whether they'll stand up under rigorous testing is another matter."

At Digital Equipment Corp.'s facility in Maynard, Mass., Michael Gutman, product and engineering manager for MOS and core memories, says that, although the big minicomputer maker has not yet asked for the 150-ns Mostek part, the 200-ns MK 4116 is "clearly the fastest and lowest-powered part we've seen among 16-k units. I wouldn't be surprised to see the semiconductor industry model itself on the Mostek part."

Clearly, the 150-ns, 4-k and 16-k Mostek parts are already stimulating serious rethinking of speed specifications. TI, for example, is continuing to supply its single-level TMS 4070, which has a best-case access time of 250 ns, but is designing two-level parts, aimed at 200-ns speeds and faster. The parts will conform to the Mostek timing, which has no restrictions on the overlap timing for row- and column-address selection.

Moreover, in a surprise move, TI decided to enter the fast 4-k market with a copy of the 16-pin Mostek 4027. Ed Huber, MOS marketing manager, says TI's 4027, to be offered as samples in next year's second quarter, will match Mostek's speed. Huber predicts that the market for fast 4-k dynamic RAMs (200 ns and under) will quickly reach about 30% of the 4-k total, with a third of them 150-ns devices. TI will supply a range of 4027s rated from 150 to 250 ns, and it has no plans to redesign its 18-pin or 22-pin parts.

Iterations. At Intel, David House, memory-applications manager, stresses that, although design iterations are always underway, "We are not in a major redesign of our 16-k RAM." The company, which leads in 16-k shipments, is committed to latched parts with 64/128-cycle refresh. Intel, TI, and Mostek will ship about 50,000 16-k devices this year, and the total should reach 2 million next year.

Perhaps in response to Mostek's higher speeds in its unlatched 16-k part, Intel is specifying its latched part over a wider speed range—to a distribution of 200, 250, or 300-ns. "And, obviously we are looking at ways to tweak down to 150 ns," House says. In 4-k, Intel is in production with a 200-ns 16-pin part and is considering a 150-ns device. □

Military

RCA charge-coupled-device recon camera send to pictures to ground in real time

The Air Force is moving closer to reconnaissance cameras that beam their pictures back to the ground for instantaneous development. And it looks as if the cameras will be built around charge-coupled devices.

The need for real-time tactical photo-reconnaissance became apparent during combat in Southeast Asia, and the Avionics Laboratory at Wright-Patterson Air Force Base, Ohio, took steps to fulfill the need. The lab's latest move is a recent \$1.1 million contract to RCA Corp.'s

Automated Systems division, Burlington, Mass., for a solid-state wide-angle camera system that produces a photograph on the ground almost immediately after a scene has been captured by CCD arrays in the airborne sensor.

Flight test. James Rachal, project engineer for the program at the Avionics Laboratory, says RCA is to deliver hardware for flight testing in January 1978—about a year after the CAI division of Bourns Inc. is to deliver an electronic wide-angle

camera system it, too, is developing with CCD arrays. CAI received its contract in 1973. RCA's camera will use a stationary "push-broom" technique to gather image strips along the aircraft's flight path, while the CAI approach pans perpendicularly to the plane's track, delivering a "bow-tie" swath [*Electronics*, Aug. 22, 1974, p. 30].

Five lenses. According to Gardner T. Burton, manager of electro-optical system design engineering in the RCA division, a chief objective is to make the airborne package as simple as possible. It contains five lenses roughly equivalent to 35-millimeter gear, each focusing images onto its own 1,728-element linear CCD array, a CCD-121 from Fairchild Camera and Instrument Corp., Mountain View, Calif. The sensor-head electronics also includes a drive and synchronization mechanism for scanning the sensors about 1,000 times per second, plus minimal video-processing hardware.

The sensor head will measure 11 by 15 by 8 inches and weigh no more than 35 pounds. A magnetic-tape recorder will be added to it for non-real-time transmission, and the Air Force will furnish a data link to send the analog video signals to the ground. There, a laser-beam recorder and dry, thermal processing on a silver-halide film will put a film strip into a photo-interpreter's hands less

than 15 seconds after the CCDs capture the image.

The sensor head is designed to cover a 140° field of view. This corresponds to a 5,500-foot-wide path on the ground when the aircraft is flying at 1,000 ft. Because only one of the five lenses is aimed straight down, the geometrical distortion introduced by the oblique angles of the other four must be removed during ground processing.

Burton says this will be done in a digital time-base processor and digital buffer that follow the data-link receiver and analog-to-digital converter. The five sensor heads are scanned at a rate of 10.5 megasamples per second, which requires a minimum video bandwidth of 5.25 megahertz. "After the a-d conversion, the data goes into the first-in, first-out buffer," he says. "It goes in at a uniform rate, and we're taking it out at a variable rate controlled by the digital time-base processor."

That processor is built of transistor-transistor and emitter-coupled logic. The ECL speed is required to handle the readout rate of the buffer, which can be as fast as one sample per 50 nanoseconds and ranges from 4 to 22 megasamples per second. These samples are then converted back to an analog signal used to drive the optical modulator of the helium-neon laser-beam recorder. □

Fiber optics

Voltage-responsive crystal allows direct modulation of light beam

Loading information onto the light beam in a fiber-optic communications system is usually done indirectly, by modulating the injection current of the light source itself. But now Sperry Rand Corp.'s Sperry Research Center in Sudbury, Mass., has developed an electro-optic device that modulates the light beam after it is already in the fiber light pipe.

This approach not only eliminates an electronic-to-optical interface but could prove to be useful at very high

frequencies where the response of the light source might be inadequate. In addition, the basic modulator design can be used to switch data along different paths, a requirement of multiplexers and data buses.

Crystal. The Sperry modulator, as shown in the figure above, is based on a thin wafer of an electro-optical crystal, such as lithium niobate or lithium tantalate, having a refractive index that changes when a voltage is applied. But first, identical metal

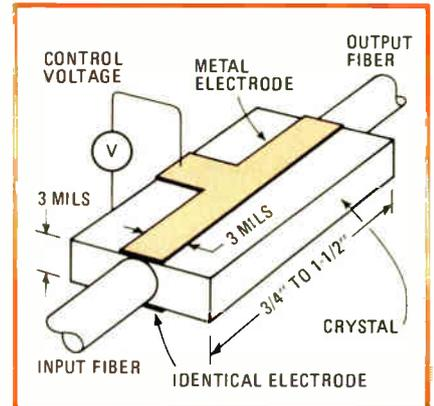

Mod crystal. Voltage applied across the surfaces of the electro-optic crystal modulates light in Sperry device. The longer the crystal, the deeper the modulation.

electrodes must be evaporated on both sides of the wafer, which is 3 mils thick, to match the diameter of a single multimode optical fiber. The fiber's end is polished and butted to the crystal.

Output nil. When no voltage is applied, only a small percentage of light entering the crystal will reach the output fiber. That is because the light coming from the multimode fiber is not collimated. Instead, it enters the crystal in a cone containing many different angles and is dispersed instead of impinging solely on the output fiber.

When a voltage is applied to the electrodes, the index of refraction in that part of the crystal varies, changing the angle at which the light enters. The incoming light tends to be guided along the metal-electrode path to the output. But the amount of light at the output depends on the applied voltage so that the output is intensity-modulated.

In its development, the Sperry researchers found that a 50% modulation depth could be obtained by applying 14 volts rms, and the throughput loss was 18 decibels. The bandwidth was larger than 600 megahertz. A 25% modulation was achieved with 5 v, but it took 900 volts to approach modulation depths of 100%.

At an angle. Throughput loss is considerably improved, Sperry found, by butting the fiber up against the crystal so that the axis of

We specialize in custom MOS designs. For far-out projects. Or down-to-earth savings.

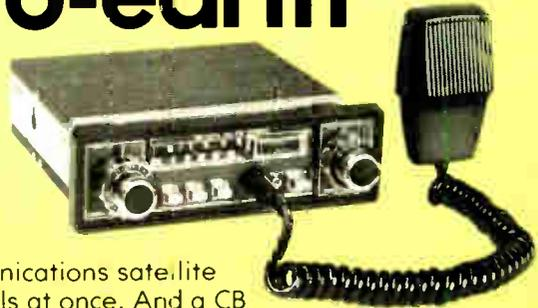

They're different. A communications satellite carrying some 14,000 phone calls at once. And a CB radio handling just one conversation. But both use Hughes custom MOS devices to perform exactly the job required.

Designing high performance and/or low cost CMOS and PMOS LSI circuits is our business. We work with your engineers to meet your unique requirements (no cell library or "half baked" slice could ever match one of our designs).

See us the next time you are considering custom circuitry, big job or small. You'll find us more hospitable than the "big boys."

We produce standard LSI circuits too, such as these CMOS units:

HCTR0320
1021-Channel Digital
Frequency Synthesizer



HCTR0200
1 Decade Counter/
Latch/Decader/Driver
Drives almost anything,
including LEDs and LCDs



HCTR6010
4 Decade Counter



And coming soon: a second source for RCA 1802 microprocessor and a programmable synthesizer dedicated to CB.

Read our brochure on Custom MOS Designs. For a copy, or more information on these standard CMOS circuits call (714) 548-0671, ext. 207; or send coupon:

Mail to:
HUGHES AIRCRAFT COMPANY
Solid State Products Division
500 Superior Avenue, Dept. E-11
Newport Beach, CA 92663



name _____ title _____
company _____
address _____
city _____ state _____ zip _____
telephone _____

PLEASE CHECK:

- Custom MOS Brochure
- HCTR0200
- HCTR0320
- HCTR6010
- Have a representative call.

HUGHES

HUGHES AIRCRAFT COMPANY
SOLID STATE PRODUCTS DIVISION

Circle 33 on reader service card

the fiber is not perpendicular to it. This angle helps to increase the amount of light that can be captured, with voltage on the electrodes, from the input's wide cone.

For example, for 50% modulation, throughput loss was reduced to 10 dB when the applied voltage was increased a small amount—to 23 v. The voltage required for capturing the entire cone of light—100% modulation—was 225 v with the fiber cut at a 67° angle. This is roughly a quarter the voltage required when a fiber is coupled with its axis perpendicular to the crystal. Sperry says it can reduce the voltage required for 100% modulation even more.

Working with the support of the U.S. Army Electronics Command, Fort Monmouth, N.J., Sperry has already built a time-division multiplexer/demultiplexer that interleaves the optical bit streams of four separate multimode fibers onto a single output fiber. Such a unit could be applied in a switchboard that the Army would like to have when fiber optics replaces the standard 26-pair copper cable it at present uses in tactical environments [*Electronics*, Jan. 9, 1975, p. 29].

Elsewhere in the laboratory, Sperry has developed some other electro-optic goodies, including a 12-port-to-three-port multiplexer as well as a low-crosstalk, four-port crosspoint switch. □

Solid state

Devices meeting shows trends again

The annual Electron Devices meeting held in Washington in December usually previews the new process and device technology being readied for new-product designs. This year is no exception. A wide range of new technologies will be aired at the meeting Dec. 6 to 8, including new bipolar and metal-oxide-semiconductor structures to boost the performance of both discrete and large-scale-integrated devices, as well as materials

and designs to make feasible optical and solar-cell devices for communications and energy applications. Microwave technology, both solid-state and vacuum, will be described that sets higher limits in frequencies and low noise.

CCD logic. Perhaps the most interesting developments to emerge will be TRW's ongoing work with logic structures built with charge-coupled devices [*Electronics*, June 10, p. 41]. Although CCD techniques are widely used in memory, imaging, and signal processing, the TRW Defense and Space Systems Group is alone in applying them to logic configurations, and with resounding success. The TRW CCD logic, for example, operates on only 10% as much power as complementary-MOS logic in 1% of the area. Moreover, the process is completely compatible with the CCD analog process. So far, a wide range of complex digital CCD functions have been implemented including half and full adders and multipliers.

A more conventional MOS-logic approach is a low-power LSI configuration using back-gated, or B-MOS structures, work that's underway at Hitachi Central Research Laboratory in Japan. Using a back-gated input terminal, which forms a p-type well in an n-type substrate, Hitachi researchers have built test inverters that operate with gain at voltage levels as low as 0.13 volt, or only a fraction of standard MOS voltages. Moreover, these test vehicles showed typical delay times of only 100 ns and power delay products of only 10 femtojoules, or 1,000th that of other logic systems.

A development of immediate application is the clocked C-MOS logic, or C²L, which RCA has built into its 1802 microprocessor chip. It provides triple the packing densities of standard silicon-gate C-MOS while increasing speed approximately 4 to 6 times. This makes its performance comparable to n-channel circuits, but power dissipation is much lower.

Linear too. Developments in mixed-process linear integrated circuits will also be described. With no additional processing steps, vertical-

junction field-effect transistors are being mixed on the same chip with bipolar transistors by Hewlett-Packard Laboratories, Palo Alto, Calif. The advantages are high operating frequency and impressive power-handling capability.

High-stability voltage references, which have been the province of bipolar technology, are now being implemented with MOS processing by General Electric Co., Schenectady, N.Y., for use in monolithic linears such as interface circuits and data converters. Also, process improvements in MOS technology are enabling the optimization of chip real estate.

IBM, Stanford. For example, both smaller polysilicon-gate MOSFETs are being made by IBM's T. J. Watson Research Center, Yorktown Heights, N.Y., and V-groove and double-diffused MOS transistors are being fabricated by Stanford University's Integrated Circuits Laboratory, Stanford, Calif.

Advances in microwave semiconductors will also be reported, among them low-noise bipolar transistors developed by Bell Laboratories with electron beams and Trapatt oscillators from Sandia Laboratories, Albuquerque, N.M., that utilize optically-generated carriers to lower frequency drift and speed up switching frequency. In opto-electronics, the news will include a position-sensitive photo-detector that exhibits high linearity and a whole rash of improved-performance photodiodes, as well as light-emitting diodes, for easing the characteristics of optical fibers for data transmission. □

Industrial

Capacitance yields yarn's denier

Capacitance measurements and the textile industry are not commonly associated. However, they are related in a piece of electronic gear when it comes to gauging the denier—or mass per unit length—of synthetic fibers coming off produc-

NEW IN SEMICONDUCTOR PROTECTION!

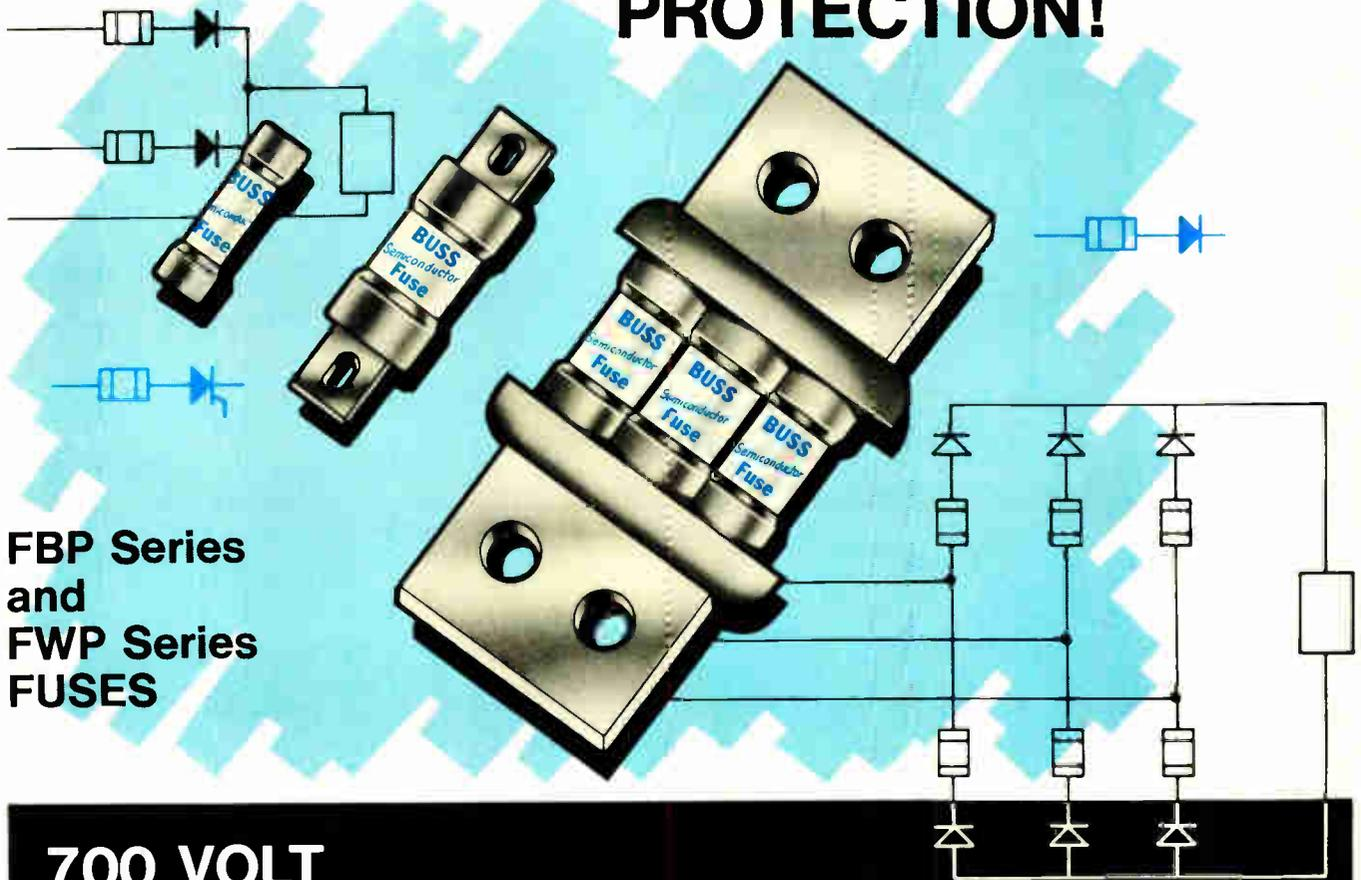

**FBP Series
and
FWP Series
FUSES**

700 VOLT BUSS[®] SEMICONDUCTOR FUSES EXTREMELY LOW I^2t and I_p LET-THRU VALUES

AMP RATINGS

15 to 1000

VOLTAGE RATINGS

700 V. a-c 700 V. d-c

BUSS Semiconductor Fuses provide a very high degree of current-limitation so necessary for the protection of Diodes, SCR's and other Semiconductors.

For detailed information and characteristic curves, write for **BUSS Bulletin SCFP**.

AVAILABLE IN TWO SIZES



FWP Series

dimensions made to fit mountings for 700 volt fuses that have been used in the past.



FBP Series

compact dimensions — shorter than FWP fuses — save equipment space.



BUSSMANN MANUFACTURING
a McGraw-Edison Company Division
St. Louis, Missouri 63107



tion-line textile machinery.

The right denier is a critical measure of fiber quality—so much so that a small analytical-instrument company thinks \$50,000 is not too much to pay for a system it has developed to measure denier right in the dirty environment of the mill rather than a laboratory. Micro Sensors Inc. of Holliston, Mass., says its M/8000 quality-control system will cut appreciably the lag between the time the fiber is spun, drawn, or texturized and the time it is sampled and measured.

Accuracy. Moreover, the system delivers much greater accuracy— $\pm 1\%$ —measuring denier than the $\pm 10\%$ of other measuring machines, says the company. Micro Sensors, 81% owned by Analog Devices Inc., displayed the system for the first time late last month at the American Textile Machinery Exhibition in Greenville, S.C.

Robert W. Smith, product marketing manager at Micro Systems, says the company's previous products have been either analytical instruments or in-process on-line monitoring systems. The analytical instruments, priced from \$10,000 to \$20,000, are intended for quality control in the laboratory and manufacturing-process development. The on-line equipment can cost as much as \$100,000 to gauge fibers for

Dialing denier. Technician sets desired denier for which fiber will be tested. Yarn-handling portion of system is at right.

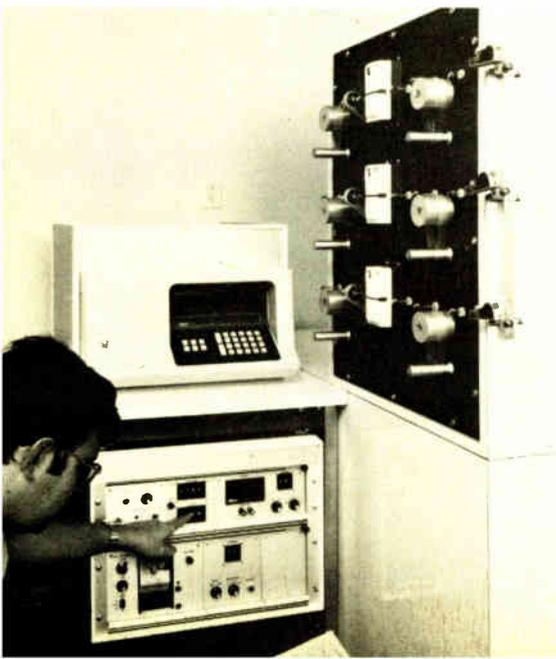

News briefs

Westinghouse to end TV-tube production

A sign of the competitive times in the U.S. television-set industry is Westinghouse Electric Corp.'s announcement that it will cease production of color-TV tubes in December. The last of the independent picture-tube makers in this country, Westinghouse cited rising costs, low selling prices, foreign imports of receivers, and lack of profits as the reasons for abandoning its Horseheads, N. Y., facility and idling 1,200 people. The company had previously ceased making its own TV receivers, but sold picture tubes to other U.S. setmakers and Europe. Still making the tubes in the U.S. are RCA, Zenith Radio, GTE-Sylvania, and General Electric.

IBM adds processor to its 370/158

Just two weeks after San Francisco-based Intel Corp.'s introduction of its AS/5, a computer system that duplicates the functions of IBM's 370/158 [*Electronics*, Oct. 14, p. 29], IBM announced an attached processor system for the 158, that improves performance by 1.5 to 1.8 times. The attached processor shares the main memory with the existing host processor and shares the load of processing instructions. This improves the system without adding main memory, disk storage, or input/output equipment. IBM introduced the concept of an attached processor earlier this year with a unit for the model 370/168.

Huge combat system awarded to RCA

RCA Corp.'s Missile and Surface Radar operation in Moorestown, N.J., has been awarded a \$159.2 million U.S. Navy contract to develop a shipboard combat system using the Aegis fleet air-defense system as its nucleus. It will incorporate a number of sensors and weapons in addition to the RCA-developed Aegis system, which uses the Standard missile (Type II) built by General Dynamics Corp.'s Pomona division. Components of the combat system include Mark 26 guided missile launchers, Harpoon surface-to-surface missiles, and 5-inch guns.

Control Data sales to China, USSR finally approved

It took a year longer than expected, but Control Data Corp. finally got Federal approval for its long-standing proposal to sell two Cyber 172 models to the People's Republic of China for approximately \$6 million [*Electronics*, Nov. 27, 1975, p. 59]. At the same time, cdc said it won approval to ship one Cyber 173 system worth \$5 million to the Soviet Union. The equipment for Machimpax—the China Machinery Import and Export Corp.—will be installed in a seismic institute outside Peking to monitor earthquakes and aid the search for new oil reserves. The Soviet Cyber 173 will be used in similar applications. The Chinese and Soviet 60-bit-word, medium-scale, general-purpose systems will each have 65,000 words of central core memory plus another 250,000 words of extended core storage. For peripherals, the Soviets will get three cdc 841 disk drives of 432 million bits each, while the Chinese system will have four 844 disk drives with capacities of 870 million bits each.

U.S. consumer-electronics trade deficit for first half tops \$1 billion

America's deficit in consumer-electronics trade during the first half of 1976 more than doubled the 1975 figure, soaring to a record \$1,333.5 million. Japan accounted for 80% of the total, more than \$1,075 million, according to new Commerce Department figures.

Imports of phonographs and tape recorders and players, the largest category, climbed 60% to \$471.8 million. The largest percentage of imports gain—313%—came in radio transceivers and receivers, which totaled \$413.3 million. Sales of citizens' band radios rose sevenfold to \$262.4 million. Imports of tv receivers jumped 80% in the half to \$333.5 million, with color sets accounting for \$183.8 million, more than double the 1975 level. Commerce reported "a major shift in product mix" as sets with 19-inch and larger screens now account for more than half the import total.

One button dialing.



The busy person is constantly dialing telephone numbers. Locally. Throughout the country. Even internationally.

But let's face it. Dialing is one of the biggest time wasters in a busy day.

Think of the number of digits you dial. And have to remember. If you forget a telephone number and your secretary is unavailable, you lose valuable time looking it up. If the line's busy, you have to re-dial.

But General Instrument Microelectronics is changing all that. Our MOS/LSI circuits are making the telephone easier to use and a whole lot more human. They're making possible today's third generation solid-state phone. And tomorrow's "super phone."

With one-button dialing, the sky is the limit. You program your phone's memory with the numbers you call most frequently. Then, instead of dialing, you simply push a button. The phone dials for you. Instantly. Automatically.

You can set up your own identification system, too. If you like surnames, list your telephone numbers by surnames. Or by locations. Or by digits in sequential order.

It's up to you.

That's not all. If you get a busy signal, the phone will re-dial until you hang up. You can see the number you're dialing with a digital read-out display. And you can even convert your phone into a data transmission center.

GI circuits are opening the way to advanced phone technology. You can select our AY-5-9200 that stores telephone numbers in multiples of ten. Or our AY-5-9100 that converts push button input to rotary dial pulses. Or our AY-3-9400 and AY-3-9410 that generate MF/tone telephone frequencies. Or our AY-5-9800 that decodes them.

Making engineering more human is our real job at GI Microelectronics. One-button dialing is a good example. Another is TV games. And hand-held calculators that print. And microwave ovens that practically nudge you when the food is cooked. And lots more.

True, GI makes standard and custom circuits. By the millions. Whole families of them. In depth. But we're really in business to help you make products that do things people want them to do. If you'd like to make your products more human, write or call General Instrument Microelectronics, 600 West John Street, Hicksville, New York 11802, Tel. (516) 733-3107.

We help you compete.

**GENERAL INSTRUMENT CORPORATION
MICROELECTRONICS**



Switch Access From Racked PC Boards

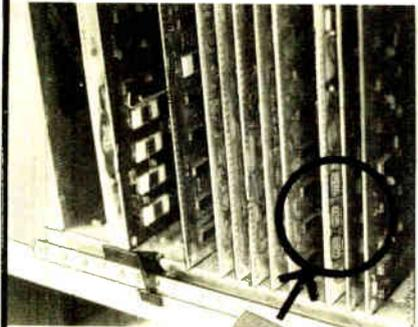

Grayhill Piano-DIP™ Side-Actuated Rocker DIP Switches

SPST circuitry under each rocker... Dimensionally compatible with SPST, SPDT, and DPDT Rocker DIP switches and standard sockets.

- Positive identification of rocker position from the side of the mounted switch.
- Low profile... can be readily edge mounted on racked PC boards.
- Grayhill's reliable spring loaded, sliding ball contact system... life rated at 50,000 operations with positive wiping action and immunity to normal shock and vibration.

Here's the latest entry to the comprehensive and innovative Grayhill DIP switch line... a new switch that can be actuated without removing the PC board from its rack. Because of its distinctive shape and side actuation, Grayhill calls this the PIANO-DIP™. It's ideal for mounting on the exposed edge of a racked PC board, allowing engineer or technician easy programming access. PIANO-DIP™ switches are now offered with 7 rockers; future versions will include 4 to 10 switch stations. Complete information is contained in Bulletin 260R321, available free on request from Grayhill, Inc.,

561 Hillgrove Avenue,
La Grange, Illinois
60525; phone:
(312) 354-1040.



Electronics review

denier and other specifications.

The M/8000 fits in between these two classes of equipment. It's an off-line station that quickly tests each package or bobbin of fiber just after it comes off the machines. Smith says this hasn't been possible before, especially with the accuracy the M/8000 offers. Heretofore, fiber makers usually had to gauge samples away from the production area. Because of the time lag between production and testing, large batches of fibers could wind up as expensive scrap before the out-of-tolerance machinery could be adjusted.

Six transducers. A standard M/8000 station consists of an automatic yarn-handling system, which controls the speed and tension of six parallel thread lines, six transducers, and a processor-based central measurement and control system. A digital panel meter and printed readouts present test results.

The transducers are the key to the station's performance. "We're measuring capacitance to 10^{-5} picofarads," notes Smith, pointing out that other fiber-measurement approaches are designed to measure deviation in capacitance. "They can measure changes, but we measure absolute and how far off the fiber is."

Fiber is fed through a slot in the transducer head, where its average absolute denier is measured. The system can also compute the fiber's coefficient of variation, which takes into account the amplitude and durations of deviations from average denier. The coefficient is the ratio of standard deviation to average denier for a given length of yarn.

No comment. All Smith will say of his system, which does not contact the yarn, is that MSI's transducers use the relationship between the dielectric constant of a fiber and fiber mass to measure the yarn's absolute denier as it moves through the sensing element at high speed. Circuitry translates a continuous dielectric measurement into a signal proportional to the absolute denier.

Four-year-old MSI was acquired by Analog Devices in 1973 to gain new markets for its own measurement and control capabilities. MSI

itself was formed originally in a diversification move by Northrop Corp., the aerospace concern. Sales of MSI could reach "several million dollars in several years," predicts John Corsi, vice president of the Analog Devices Instruments and Systems group. □

Computers

Low-cost analog unit simulates digital ICs

An analog computer for simulating the fastest kinds of monolithic digital circuit chips can be put together from hardware costing only about \$3,600, say two West Germans.

Built by Hans-Martin Rein, a professor of electrical engineering, and Roland Ranfft, a research assistant, both at Ruhr University's Institute of Electronics in Bochum, the computer is being used to analyze nonsaturated-logic families. These include emitter-coupled, diode-transistor, and Schottky transistor-transistor logic. The two researchers, applying their computer to developing experimental low-power subnanosecond devices, are checking out the limits of the bipolar silicon-planar techniques with respect to such characteristics as power dissipation and delay times.

Plug-ins. The computer consists of two (possibly three) "mainframes," plus their power supplies. Each "mainframe" consists of 12 plug-in modules, 10 of which model transistors and two of which model diodes.

The transistor models are based on the so-called transport model, which is similar to the well-known Ebers-Moll model. This model allows variation of the following parameters: base transit time, collector-and base-spreading resistances, four junction capacitances, and the collector-base capacitance, which is divided into extrinsic and intrinsic parts. Current gain and the emitter-base forward voltage can also be adjusted. If necessary, the equivalent circuit can easily be expanded to

Everything's coming up Cambion

Cambion is coming up with new ways that let you develop your IC systems to their fullest potential without component restriction. With Cambion's Double QQ approach and evergrowing line of digital/integrated packaging products, even your most advanced IC systems ideas become practical. Your Quality needs are met, no matter how great the Quantity – that's the Double QQ. And for quantity, everything at Cambion is coming up an endless variety of components. So extensive you'll never have to think "specials" again.

What's coming up next? Look in Cambion's new Catalog 119-A. Featured are: advanced new Cambi-Cards®, card files, drawers, universal panels with and

without pre-mounted socket strips and power planes, specific logic function cards, general purpose and discrete component cards, plus strip connectors, cable assemblies, integrated socket strips, component socket adaptors, cable cards and card extenders. You'll discover products that keep ahead of your design needs. Order a Cambion Catalog today from: Cambridge Thermionic Corporation, 445 E Concord Ave., Cambridge, MA 02138. Phone: (617) 491-5400. In Los Angeles, 8703 La Tijera Blvd. 90045. Phone: (213) 776-0472

Standardize on

CAMBION
The Guaranteed Electronic Components

Circle 39 on reader service card

Send
for
newest
catalog
119A

When Clear Displays Count

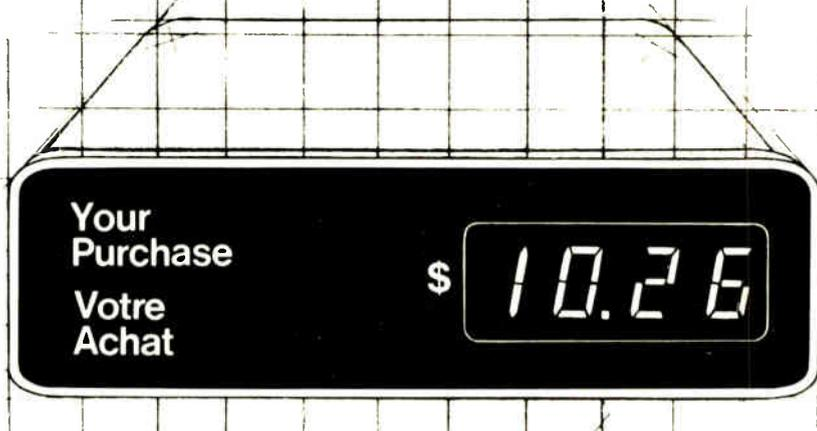
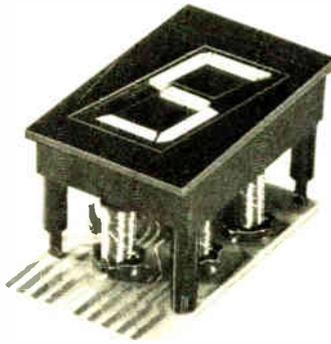

You can count on Ferranti-Packard's electromagnetic 7-Bar display module to give you the electronic compatibility you need plus the reliability and visibility your customers demand.

Only 7 moving parts to each display module — no complex mechanical linkages to wear out, or incandescent lamps and neon tubes to burn out.

Performance-proven for over 5 years, the simple design and construction, backed by Ferranti-Packard research and engineering, gives you the combination of reliability, visibility and flexibility that no other read-out component can match.

When you design an electronic read-out system, Ferranti-Packard display modules will help you do it better. It's clearly the display module you should consider. See the difference for yourself, write or call us and we'll prove it.

When clear displays count — Specify Ferranti-Packard.



Ferranti-Packard Limited

Electronics Division,
121 Industry Street,
Toronto, Ontario, M6M 4M3, Canada
Telephone: (416) 762-3661
Telex: 06-22007

take into account additional spreading resistances in series with the junction capacitance.

The diode models are analogs of 10 Schottky diodes, five in each of the two plug-in modules allotted to them.

The basic two-mainframe computer can simulate logic gates with as many as 20 transistors and 20 Schottky diodes. These numbers are usually the upper limit on what needs be simulated in the design of a circuit chip. However, if necessary, a third mainframe can be added.

Device parameters can be set by potentiometer knobs on the computer's front panel. As with other analog computers, no special programming knowledge is needed.

The \$3,600 cost of the computer is for a pair of 12-module mainframes and associated hardware, according to Ranfft. It does the same job as an expensive large-scale digital computer using elaborate and time-consuming network-analysis programs: a multitude of computer runs is required as parameters are changed to optimize the circuit.

Time scale. In typical analog fashion, the computer works with a time-scale factor that slows the speed at which the circuits operate. A factor of one million, for example, translates an actual transistor switching time of 1 nanosecond into 1 millisecond, slow enough for the gate elements to be interconnected by simple wiring.

Even at gate-delay times of 0.4 nanosecond, there has been good agreement between the transient response of the real circuit and the simulation, Rein says. This holds even though the transistor equivalents are less flexible, the two point out, than those available in modern network-analysis programs used on high-speed digital computers.

The low millisecond speeds of their computer allows switching behavior to be displayed as parameters are varied on an inexpensive low-frequency dual-trace oscilloscope. Dc characteristics can also be displayed. Any standard pulse generator with a variable pulse rise time can drive the computer system. □

57* La 138.90		64 Gd 157.25		70 Yb 173.04
	59 Pr 140.90		68 Er 167.26	
58 Ce 140.12		65 Tb 158.92		71 Lu 174.97
	60 Nd 144.24		69 Tm 168.93	
	62 Sm 150.4	66 Dy 162.50		90 Th 232.03
39 Y 88.90		67 Ho 164.93		
	63 Eu 151.96			

rare earths Rhône-Poulenc

all grades ranging
from 95% to 99,9999% purity

rhodia inc. Chemicals Division, P.O. Box 125 - Monmouth Junction - NEW JERSEY, 08852 (USA) - Telex 844.527 - Tel. 846.77.00
rhône-poulenc (CF/PSP), 21 rue J.-Goujon - F. 75360 PARIS - Cedex 08 - Tel. (1) 256.40.00

Name

Address

Tél.

Please send me information on rare earths.

CF G1 6/12 - Electronics



THE BiMOS OP AMP

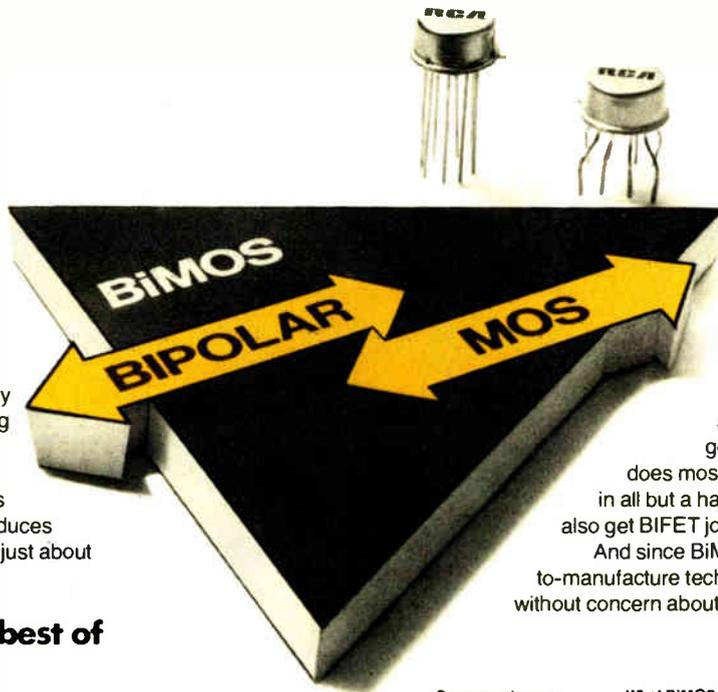

The BiMOS concept we announced just three years ago has already changed the thinking of many system designers. And has sweeping implications for both engineer and manager.

BiMOS is easy to use. Improves product performance values. And reduces costs over just about any op amp. In just about any socket that calls for one.

BiMOS combines the best of Bipolar and MOS.

The BiMOS technology was born with the CA3100. Without miracles of any kind. We simply put our experience in two technologies together on the same chip, using standard commodity manufacturing processes.

BiMOS proved that two technologies could be better than one. More stable. More rugged electrically than either unprotected Bipolar or BIFET. And lower priced by far than BIFET op amps.

By varying the mix of Bipolar and MOS we have made BiMOS op amps which match a wide variety of circuit requirements.

BiMOS fills today's need for a more universal approach.

The chart below represents a new guide to op amp performance and application for the design engineer.

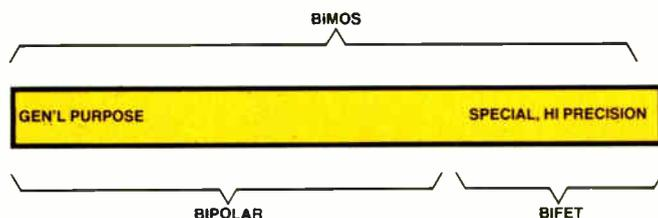

With just a few types, BiMOS affords the opportunity to establish new low-cost standards in all op amp categories. For example, the 3140 does most things better than the 741. Yet, in all but a handful of critical situations it will also get BIFET jobs done. At a fraction of the cost. And since BiMOS is a high-volume, simple-to-manufacture technology, you can use it freely without concern about availability.

Op amp category	What BiMOS contributes	RCA device
General Purpose	Wide applicability Low cost	CA3140 CA3130
FET Input	Lower device cost Reduced circuit cost	CA3140 CA3130
Wideband 4.5 to 70 MHz	High slew rate with low ringing	CA3140 CA3130 CA3100
Micropower down to 1.5 mW	Strobability	CA3130
High Current up to 22mA	Eliminates driver stage Low device cost Rail-to-rail output swing	CA3130

Simple manufacture means high yield with high uniformity.

From one manufacturing step to the next, the BiMOS op amp doesn't know whether it's a 3140 or a 741. It takes the same kind and number of processes to make both.

In sharp contrast to the simplicity of BiMOS, the BIFET process is longer and relies on ion implantation, used to define a channel in a doped epitaxial layer.

Since the electrical characteristics of this epi layer vary, the junction formed varies. That affects the FET pinch-off voltage, making device parameters harder to hold to BiMOS tolerances. This is illustrated by the gain vs. voltage and temperatures curves.

A management report on a technology whose time has come.

Since the BiMOS process is easy to control, high yields are the order of every manufacturing day. This has been our consistent experience in three plants producing BiMOS in three different parts of the world. So we are confident we can fill your high-volume needs without interruption.

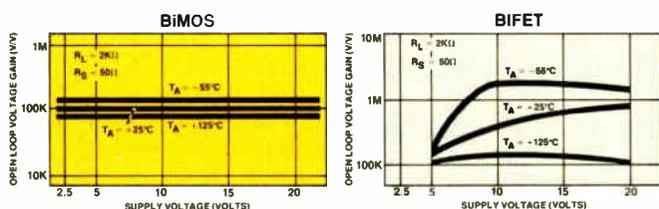

BiMOS puts a new slant on the learning curve.

The fast build-up of BiMOS production, already in the millions, brought a correspondingly sharp decline in the price-learning curve.

One year after our first announcement, the 3130 was introduced at the one-dollar level. And this year, we made the 3140 available at the same price as a 741.

Once again the BiMOS experience is in sharp contrast to that of BIFET op amps which, although announced in 1974, are still relatively high in price and low in volume.

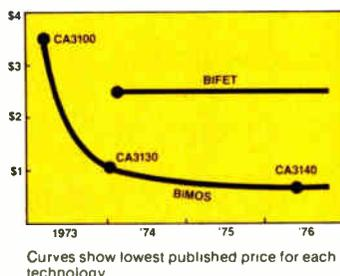

Curves show lowest published price for each technology

BiMOS encourages engineering and manufacturing economies.

Savings from BiMOS go beyond low purchase price. For one thing, the all-embracing performance of BiMOS simplifies and speeds up the design process for engineers.

Whether they're redesigning a circuit or tackling a new problem, they can confidently use BiMOS to do a wide spectrum of jobs — where previously, each of these jobs may have required careful, time-consuming selection from an array of specialized op amps. What's more, BiMOS op amps can often do jobs that used to require additional parts. This opens up further savings in design, manufacturing and parts costs.

TYPICAL PUBLISHED OP AMP PRICES

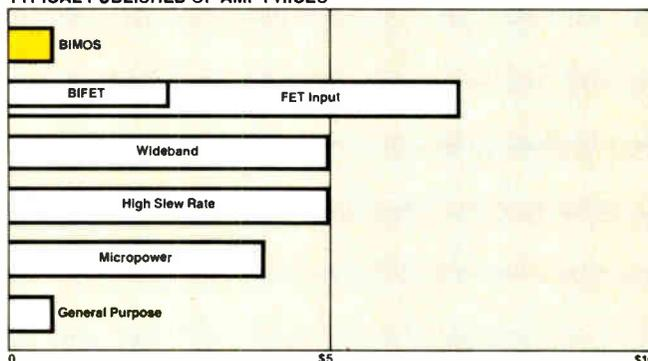

Standardizing on BiMOS offers other important cost benefits, too. Such as consolidated purchasing, simplified incoming inspection, and fewer types in inventory. You can treat BiMOS as a second source for all the op amps it replaces.

BiMOS answers consumer demands for improved values.

To sum up, BiMOS is an advance in step with the times. It provides many performance and reliability advantages over the old way of doing things — at no extra cost. It's in keeping with the trend toward standardizing on fewer components that can do more jobs. At a time of squeezed profits, it can help reduce costs all along the line — costs of design, manufacture, purchasing, inventory control, incoming inspection. The end result is that you can offer consumers more value at competitive prices.

A BiMOS offer from RCA management to yours.

If you want to know more about how to use BiMOS circuits in your new designs or redesigns, or if you'd like to discuss how you can fit BiMOS into your present inventory program, call us. Ask for the BiMOS Product Director at 201-685-6116. That's our specially dedicated BiMOS phone. Or write him at RCA Solid State, Box 3200, Somerville, New Jersey 08876.



DELCO'S NEW 25-AMPERE HIGH VOLTAGE DARLINGTONS WITH THE SPEED AND ENERGY CAPABILITY YOU ASKED FOR.

Good news for motor speed control designers who have expressed a need to upgrade horsepower ratings. The 25-ampere gain of these new Darlings permits increased horsepower ratings of existing AC motor speed control systems and a reduction in paralleling in new designs. However, grouping of t_{off} is available for current sharing in designs

with parallel Darlings. A speed-up diode is built into the DTS-4074 and DTS-4075 permitting data sheet t_r typicals of $1.0 \mu s$. Drive circuit techniques involving $I_{B2} \geq 2 A$ and a Baker clamp produce t_r typicals in the $0.4-0.6 \mu s$ range for the DTS-4066, DTS-4067, DTS-4074, and DTS-4075.

Our experience with tolerances, faults, transients, and start-stall conditions in most systems convinces us that these Darlings have the right trade-off between speed and peak power handling capability. Note the greater than 10 kVA region of the reverse bias safe operating graph. All this, and you still get Delco's traditional solid copper TO-3 hermetic package that has a conservative $0.75^\circ C/W$ thermal resistance.

These Darlings are already in high volume production and are available on distributor shelves. Prices, applications literature, and data sheets from your nearest Delco sales office or Delco distributor can complete the story on these new Darlings.

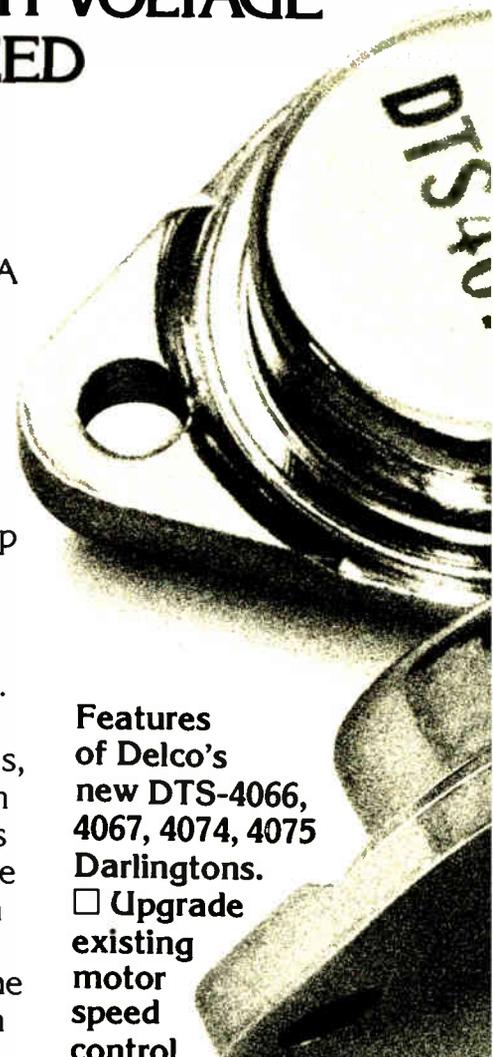

Features of Delco's new DTS-4066, 4067, 4074, 4075 Darlings.

- Upgrade existing motor speed control horsepower ratings.
- Reduce need for paralleling in new systems.
- Offer switching speed improvements over our earlier types.
- Achieve greater than 10 kVA peak power dissipation.
- Available with t_{off} grouping.
- Delco hermetic copper package with $0.75^\circ C/W$.
- Currently in high volume production.

MAJOR PARAMETER LIMITS

Type	h_{FE} @ 25A	h_{FE} @ 10A	V_{CEO} (sus)	V_{CE} (sat) @ 20A	I_{CEO} @ 600V
DTS-4066	5	75	350V	3.5V	0.25mA
DTS-4067	10	150	350V	2.0V	0.25mA
DTS-4074	5	75	350V	3.5V	0.25mA
DTS-4075	10	150	350V	2.0V	0.25mA

TYPICAL SWITCHING

	DTS-4066 DTS-4067	DTS-4074 DTS-4075
t_r	$0.5 \mu s$	$0.5 \mu s$
t_s	$5.0 \mu s$	$3.2 \mu s$
t_f	$4.5 \mu s$	$1.0 \mu s$

NPN triple diffused silicon Darlings are packaged in solid copper cases conforming to JEDEC TO-3 outline dimensions.

SAFE OPERATING CURVES

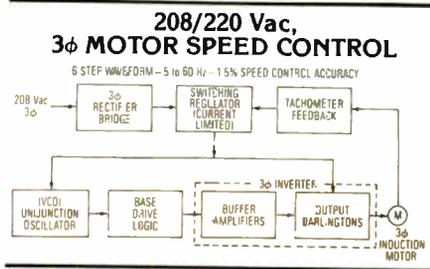
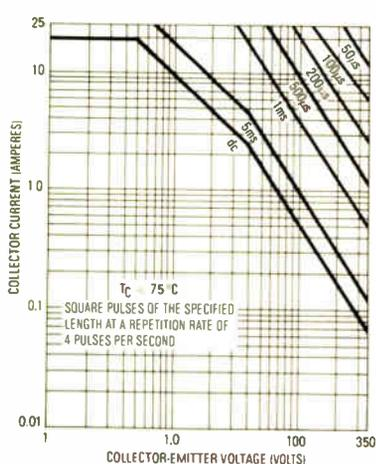



NOW AVAILABLE FROM THESE DISTRIBUTORS IN PRODUCTION QUANTITIES.

ALABAMA

BIRMINGHAM
Forbes Distributing Co., Inc.
(205) 251-4104

HUNTSVILLE
Powell Electronics
(205) 539-2731

ARIZONA

PHOENIX
Sterling
Electronics, Inc.
(602) 258-4531

CALIFORNIA

GARDENA
Electronics
Distributors Div.
Bell Industries
(213) 321-5802

GOLETA
R.P.S. Electronics, Inc.
(805) 964-6823

LOS ANGELES
Kierulff Electronics, Inc.
(213) 685-5511

R.P.S. Electronics, Inc.
(213) 748-1271

PALO ALTO
Kierulff Electronics, Inc.
(415) 968-6292

SAN DIEGO
Kierulff Electronics, Inc.
(714) 278-2112

R.P.S. Electronics, Inc.
(714) 292-5611

SUNNYVALE
Bell Industries
(408) 734-8570

COLORADO

DENVER
Kierulff Electronics, Inc.
(303) 371-6500

CONNECTICUT

NORWALK
Harvey Electronics
(203) 853-1515

FLORIDA

CLEARWATER
Diplomat/Southland
(813) 443-4514

MIAMI SPRINGS
Powell Electronics/Florida
(305) 592-3260

ILLINOIS

ELK GROVE VILLAGE
Kierulff Electronics, Inc.
(312) 640-0200

SKOKIE
Bell Industries
Electronics Distributors Div.
(312) 282-5400

INDIANA

INDIANAPOLIS
Graham Electronics
Supply, Inc.
(317) 634-8202

MARYLAND

BALTIMORE
RESCO/Baltimore
(301) 823-0070

MASSACHUSETTS

BILLERICA
Kierulff Electronics, Inc.
(617) 935-5134
(617) 667-8331

NEWTON
The Greene-Shaw Co., Inc.
(617) 969-8900

MICHIGAN

LIVONIA
Pioneer/Michigan
(313) 525-1800

MINNESOTA

MINNEAPOLIS
Stark Electronics Supply Co.
(612) 332-1325

MISSOURI

KANSAS CITY
Walters Radio Supply, Inc.
(816) 531-7015

ST. LOUIS
LCOMP-St. Louis
(314) 647-5505

NEW JERSEY

CINNAMINSON
Wilshire Electronics/
Philadelphia
(609) 786-8990
(215) 627-1920

CLIFTON
Wilshire Electronics/
New Jersey
(201) 340-1900
(212) 244-8930

NEW MEXICO

ALBUQUERQUE
Sterling Electronics
(505) 345-6601

NEW YORK

BINGHAMTON
Harvey Electronics
(607) 748-8211

BUFFALO
Summit Distributors, Inc.
(716) 884-3450

FARMINGDALE
Wilshire Electronics/
Long Island
(516) 293-5775

FREEPORT
Milgray/New York
(516) 546-6000

WOODBURY
Harvey Electronics
(516) 921-8700
(212) 895-9260

OHIO

CINCINNATI
United Radio, Inc.
(513) 761-4030

CLEVELAND
Pattison Supply Co.
Industrial Electronics Div.
(216) 441-3000

DAYTON
Pioneer/Dayton
(513) 236-9900

OREGON

PORTLAND
Almac/Stroom Electronics
(503) 292-3534

PENNSYLVANIA

PHILADELPHIA
Almo Electronics
(215) 698-4000

PITTSBURGH
CAM/RPC Electronics
(412) 782-3770

SOUTH CAROLINA

COLUMBIA
Dixie Radio Supply Co., Inc.
(803) 779-5333

TEXAS

DALLAS
Sterling Electronics
(214) 357-9131

HOUSTON
Harrison Equipment
Co., Inc.
(713) 652-4700
Sterling Electronics
(713) 627-9800

WASHINGTON

SEATTLE
Almac/Stroom Electronics
(206) 763-2300

Kierulff Electronics, Inc.
(206) 763-1550

SPOKANE
Almac/Stroom Electronics
(509) 928-0679

IN CANADA:

Zentronics Ltd.
Toronto (416) 787-1271
Ottawa (613) 238-6411
Montreal (514) 735-5361

OVERSEAS: EUROPEAN INQUIRIES:

European Parts &
Accessories Marketing
Group
General Motors Continental
Plant 2, Noorderlaan,
Postbus 9
B-2030, Antwerp, Belgium

ALL OTHER OVERSEAS INQUIRIES:

General Motors Overseas
Operations
Parts & Accessories Dept.
767 Fifth Avenue
New York, N.Y. 10022
(212) 486-4412

DELCO ELECTRONICS REGIONAL SALES OFFICES

Charlotte, North Carolina
28209
4600 Park Road
(704) 527-4444
Van Nuys, California 91404
Box 2968
(213) 988-7550

GENERAL SALES OFFICE

700 E. Firmin, Kokomo,
Ind. 46901
(317) 459-2175

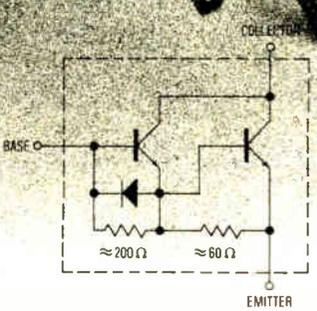

**SPEED-UP DIODE
USED ON DTS-4074/4075 ONLY**

3 ϕ DARLINGTON INVERTER DTS-4066-4067

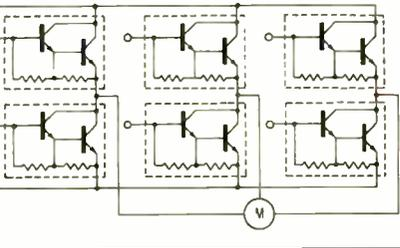

CLAMPED INDUCTIVE SWITCHING PERFORMANCE

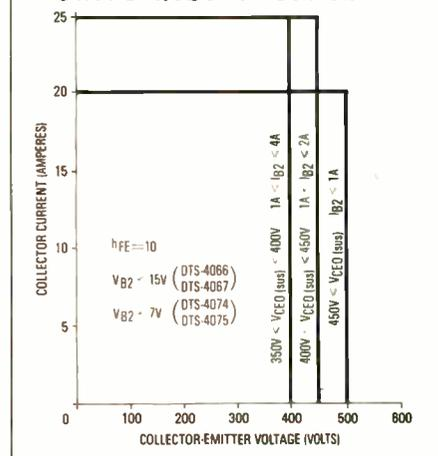

Under New

Management

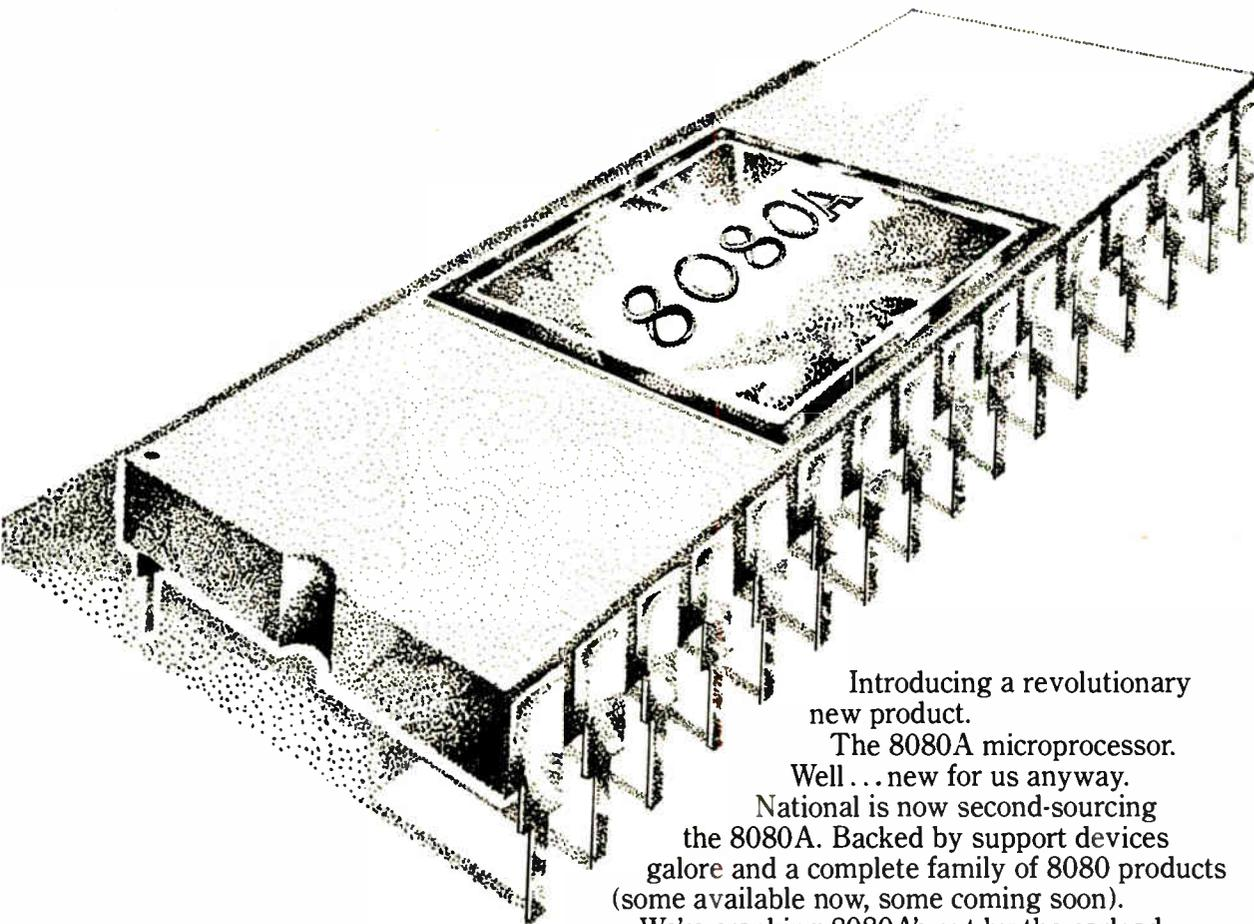

Introducing a revolutionary new product.

The 8080A microprocessor. Well... new for us anyway.

National is now second-sourcing the 8080A. Backed by support devices galore and a complete family of 8080 products (some available now, some coming soon).

We're cranking 8080A's out by the carload.

Delivery (as many as you want) is no problem.

So if the other guy's line is busy, you might give us a call.

National Semiconductor Corporation
2900 Semiconductor Drive,
Santa Clara, CA 95051

Gentlemen,

Please send your passel of prolific pontifications about your INS8080A, support devices, and related family products.

NAME _____ TITLE _____

COMPANY _____

ADDRESS _____

CITY _____ STATE _____ ZIP _____

 **National Semiconductor**

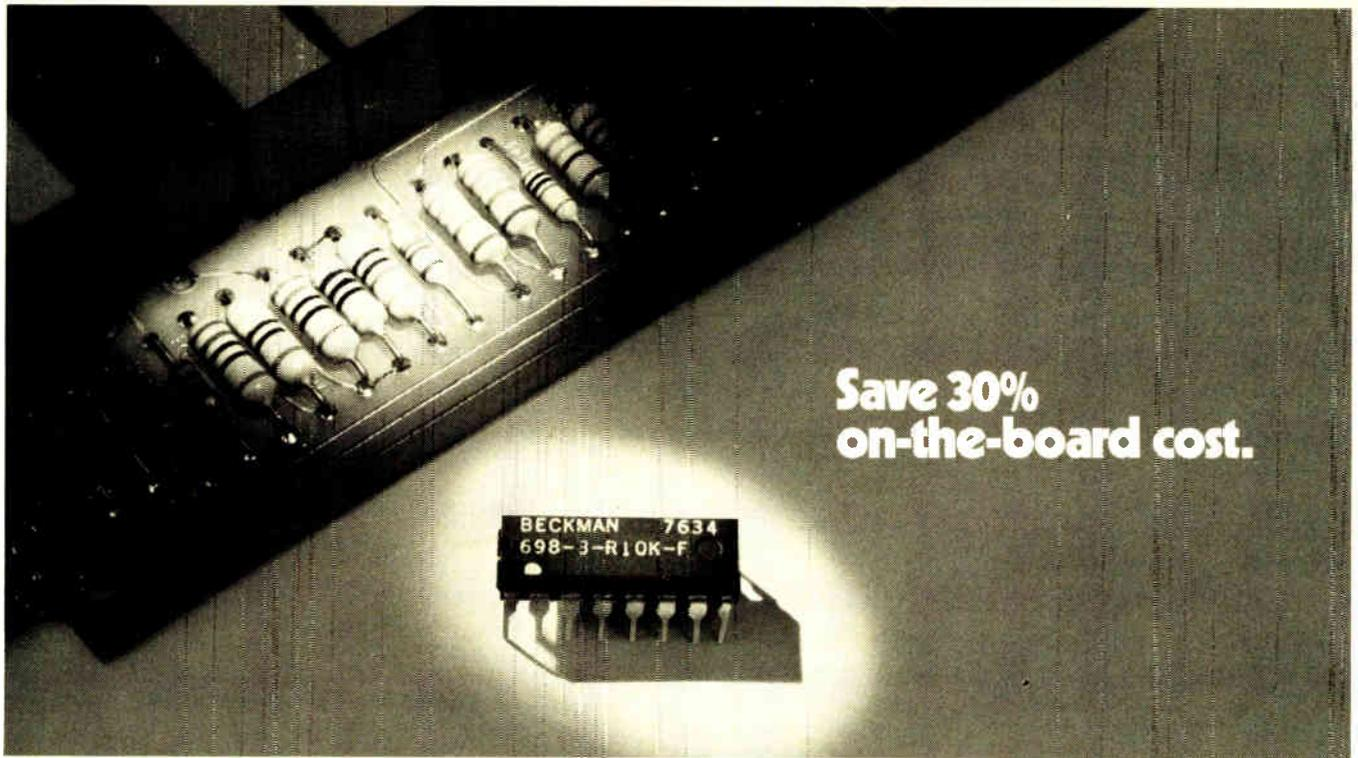

Save 30%
on-the-board cost.

Now, an alternative in the precision resistor world.

Beckman introduces precision film networks.

The board geography savings are obvious.

But our standard, 16-pin Series 698 Precision Film Resistor Networks mean much more.

First, they're competitive in purchase cost with thin film discrete resistors. And, when you consider inventory and handling costs, lead bending, QC and other factors, they mean about a 30% savings in "on-the-board" costs.

That isn't all. Beckman precision networks have better performance and stability than unmatched discretes. With ± 5 ppm/ $^{\circ}$ C tracking, the matched resistors in our dual in-line packages feature (1) absolute 1% resistance tolerance ratioed to 0.5%, and (2) ± 50 ppm/ $^{\circ}$ C tempo.

The two models (see schematics) are standard size and pin-spaced for automatic insertion. Series 698-1 comes in 17 stock resistance

values; Series 698-3 in 20 stock values. And these parts can be coupled, in series or parallel, to obtain other values in gain-setting, summing and feedback circuit applications.

The 1,000-piece price: just 65¢ for the 698-3 (8 resistors), 81¢ for the 698-1 (15 resistors). Compare with discretes!

And remember: they're standard...for quick delivery, off the shelf through our widespread distribution.

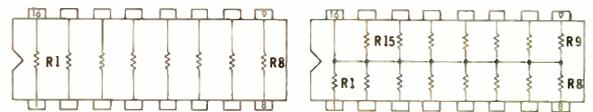

Get into the world of precision resistor networks. For more data, and applications information, contact your local distributor or Beckman Helipot today at (714) 871-4848, Extension 1776.

BECKMAN®

HELIPOT DIVISION

Independents dispute AT&T's \$1 million lobbying costs

American Telephone & Telegraph Co.'s disclosure that it spent \$1.04 million in three months lobbying for passage of the Consumer Communications Reform Act of 1976 is being questioned by an "outraged" North American Telephone Association, independent makers of telephone equipment. Citing AT&T's "massive" congressional lobbying effort, NATA asked "if this is the total quarterly expenditure incurred by Bell" in the April-June period covered by the company's report to the Federal Communications Commission.

The report is the first to the FCC since the Common Carrier Bureau ordered AT&T and its subsidiaries to separately report lobbying expenses on the company-sponsored bill to limit telecommunications competition. It will be reintroduced next year. AT&T expects to report lobbying outlays for 1975 and the first 1976 quarter soon. Apart from NATA's criticisms, the report received little notice in Washington because it came in the final week of the Presidential election campaign.

Trade balance drop seen steeper in second half . . .

The 40% decline in America's favorable electronics trade balance to \$818 million just posted for the first half of 1976 is expected to be even larger in the second. Commerce Department trade specialists privately estimate that consumer electronic imports, mostly from Japan, continue to rise sharply (see p. 36). "They are more than offsetting our exports gains in computers, components, and military hardware," says a Federal analyst. First-half imports rose 58% to \$3.12 billion from 1975, while exports of \$3.94 billion reflected an increase of only 18%.

. . . despite gains in exports of components, EDP

First-half component exports climbed 30% from last year to \$1.26 billion compared to a 45% rise in imports to \$746 million, according to new Commerce Department figures. Computer exports rose 11% to \$1.22 billion against \$83 million in imports, up 32%. The commercial/industrial/military category posted a 26% rise to \$609 million compared to a 53% imports gain to \$317 million. A 20% increase in medical electronics exports to \$115 million was partially offset by \$89 million in imports, up 11%. Telephone- and telegraph-equipment exports of \$112 million were up 12%, while imports dropped 2% to \$48 million. But test and measuring equipment shipments fell more than 7% to \$238 million, while imports rose 14% to \$82 million. Calculators again posted a negative trade balance of \$54 million, more than double last year's as imports rose 4% to \$169 million and exports dropped 16% to \$115 million.

Tougher scrutiny of military R&D sought in Congress

With an eye to earlier identification and termination of failing high-risk R&D programs, the new Congress will be asked to give tougher scrutiny to military and space R&D plans next year. That's one major proposal expected to come out of a new 115-page analysis for the Joint Economic Committee's subcommittee on priorities and economies in Government. Nearly \$15 billion will be spent in fiscal 1977 on military and space R&D, about 63% of all federal R&D outlays.

Sen. William Proxmire (D., Wis.), subcommittee chairman who won reelection handily last week, said the studies identify "serious and startling shortcomings" in the allocation and expenditure of Federal R&D funds. The study challenges congressional funding of large projects without a clear understanding that the potential or actual benefits are worth the

costs, the low termination rate of high-risk programs which have an acknowledged success rate of only about 10%, and the failure of the R&D community to "come up with scientific tools for measuring R&D results."

Tunney loss seen easing pressure on surveillance

Most Washington representatives of electronic intelligence and surveillance equipment makers are feeling less defensive about the release by November's end of a 1,000-page Senate subcommittee report. The document is expected to be **highly critical of surveillance technology and its possible threat to individual citizens' liberties**. The reason for their change in mood: Sen. John V. Tunney (D., Calif.), chairman of the Judiciary Committee's constitutional rights subcommittee and champion of the report calling for tighter industry regulation, was defeated in his reelection bid. Nevertheless, industry officials await the report in order to examine its section of the state of technology dealing with electronic eavesdropping, data processors, sensors, optics and imaging, including night vision.

Retailers urge shared, low-cost EFT terminals . . .

The nation's retailers say they expect bankers to share access to the hardware in their stores and pick up the operating costs if electronic fund-transfer systems are to succeed. The warning was delivered to the National Commission on Electronic Fund Transfers by the American Retail Federation during four days of hearings recently concluded in Washington. **The retailers "oppose the proliferation of hardware in our stores,"** and are convinced that "both the retail industry and consumers will reject EFT if its costs exceed those of existing cash, check, or credit sales."

Most bankers agreed EFT technical standards should be permitted to evolve after deployment of terminals in the marketplace, rather than be framed beforehand in anticipation of abuses. That was the view presented by the American Bankers Association to the commission and supported by former U.S. Comptroller of the Currency James E. Smith in a call for more marketplace experience. But it was sharply disputed by several citizens' rights organizations who urged greater protection for privacy of customer data in EFT systems. The commission is pushing to make a preliminary report to Congress by February in order to begin framing EFT legislation, even though it has until October 1977 to complete its final report.

. . . while bankers contest commission on new rules

The National Commission on EFT wants legislation freeing systems from restrictive Federal and state legislation regulating terminals as "branch banks" [*Electronics*, Oct. 14, p. 50]. **But that is opposed by mutual savings banks,** which see an unbeatable competitive threat from "multibillion institutions that might literally flood an area with electronic terminals and be able to shrug off resultant losses if they occur."

While banks dispute the nature and extent of regulation, savings and loan associations are gaining valuable EFT installations and experience. Since S&LS got initial approval two years ago for EFT systems, the U.S. League of Savings Associations say its 4,500 members have 23 projects under way. Of the 1,368 terminals involved, about half are installed and operating. Twelve projects with 336 terminals are proprietary, while the other 11 involve 1,032 terminals shared in varying degrees by 167 S&LS and 17 other institutions.

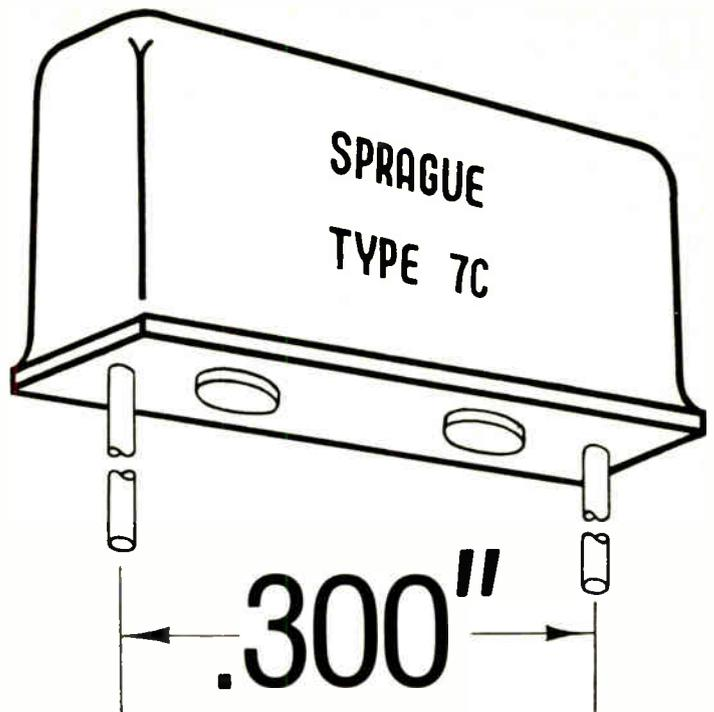

COMPATIBILITY

SPRAGUE GIVES YOU A CHOICE OF 2 MONOLYTHIC[®] CERAMIC CAPACITORS THAT GO HAND IN HAND WITH ALL TYPES OF STANDARD DIP COMPONENTS

Type 933C DIP-Style* Molded-Case

Moisture-proof case offers excellent mechanical protection during hand or automatic insertion. Made by alternately depositing thin layers of metallic electrodes and ceramic dielectric until desired capacitance is obtained, then firing into a homogenous block. Capacitance range: 18pF to .1 μ F @ 100WVDC; to .22 μ F @ 50V; to .47 μ F @ 25V.

Type 7C Saddle-Base Resin-Coated

Tough resin case, with outer epoxy varnish coating, protects against damage from handling as well as moisture. Phenolic base plate insures accurate lead spacing and eliminates resin run-down on leads. Capacitor sections made with proven layer-built construction. Capacitance range: 51 pF to 1 μ F. Voltage ratings: 50 and 100 WVDC.

For more information on these and other Monolythic[®] Ceramic Capacitors, write for Short-Form Catalog MC-108 to: Technical Literature Service, Sprague Electric Company, 35 Marshall Street, North Adams, Mass. 01247.

***Sprague puts more component families into dual in-line packages than any other manufacturer.**



QUICKER than a WINK

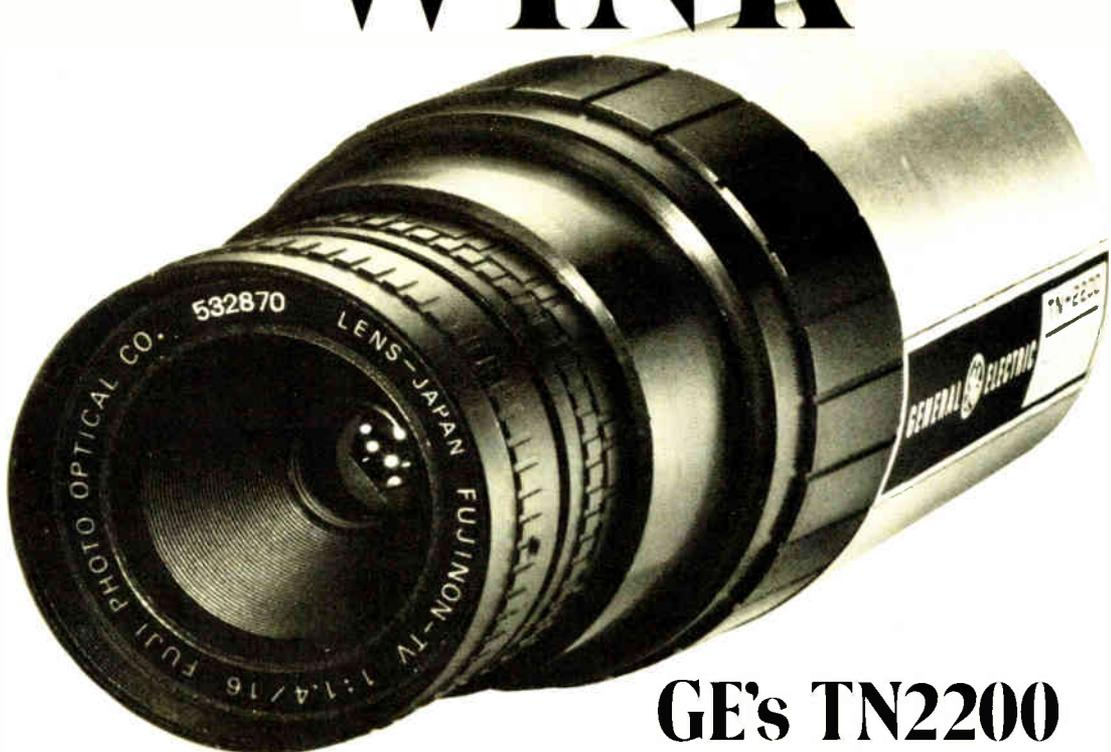

GE's TN2200 Electronic snapshots at 40 per second

Interface GE's latest automation camera to micro and mini computers for new sensor applications. Each exposure provides discrete data from 16,384 picture elements for inspecting parts, measuring hole diameters, handling materials, and controlling manufacturing processes. As the eyes of industrial robots or other automated equipment, TN2200's can exactly locate and identify an object on an assembly line.

For quality control the TN2200 can also view x-ray displays of packaged materials. Other applications include tracking airplanes, viewing callers on picture phones, and recording research observations as they occur.

GE's advanced design ensures long life and lack of drift. And being solid state it's small, rugged, and low on power consumption. For resolution and reliability at only \$840, call us about the TN2200.

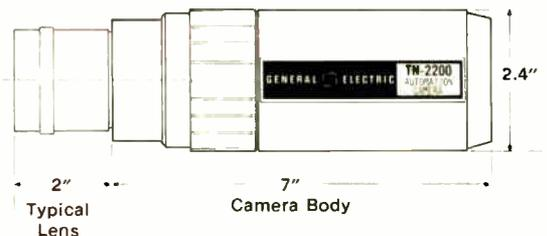

Optoelectronic Systems Operation
General Electric Company
Electronics Park 3-201
Syracuse, New York 13201
(315) 456-2832 or 2808

GENERAL  ELECTRIC

I²L chip, started in Japan, provides phase-locked loop for citizens' radio

Integrated injection logic is used in a phase-locked-loop frequency synthesizer that contains all frequency-determining circuits for single-crystal control of a class-D citizens' band radio, except for the voltage-controlled oscillator and the low-frequency-loop amplifier. Because of the versatility of the XC3390P I²L chip, initiated by Motorola Semiconductor Products Group applications engineers in Tokyo, many of the peripheral components needed with competitive complementary-MOS devices are eliminated.

Even though the device integrates high-speed and high-density logic on the same chip with linear functions, it is inexpensive because it is processed on the same line as the company's low-cost linear integrated circuits. Use of a 24-pin dual in-line package with same 0.3-inch spacing between lines of pins as packages with a smaller number of pins minimizes the space requirement and maximizes cost-effectiveness.

Operation. The basic design of the new device was developed by Motorola applications engineers in Tokyo, working with their customers. Development of the device, especially for the 40-channel transceivers to be used next year in the U.S., was completed by Motorola engineers in Phoenix, Ariz.

The phase-locked-loop frequency synthesizer operates in double-superheterodyne CB radios with intermediate frequencies of 10.695 megahertz and 455 kilohertz. In the transmit mode, the XC3390P generates the exact channel frequency. In the receive mode, it generates a frequency that is offset from the channel by the first intermediate frequency. A fixed 10.24-MHz frequency converts the first i-f to the second i-f in an off-chip mixer.

Like many other PLL chips, the Motorola device divides the frequency from the reference oscillator

down to 5 kHz in a fixed-ratio divider. Also, the frequency of an operating channel, derived from the voltage-controlled oscillator, is divided down to 5 kHz in a programable divider.

Comparing. The two frequencies are then compared in a phase comparator off the chip, which generates a correction voltage to maintain the VCO at the precise frequency of the channel. An internally generated out-of-lock signal is applied to the linear gate, and it effectively turns off the output at the exciter-output pin of the synthesizer

chip to prevent out-of-band radiation during the initial look-up time.

The Motorola I²L chip differs from most competitive devices in that it uses a crystal of 30.72 MHz rather than the usual 10.24 MHz. Two emitter-follower-logic prescalers on the chip separately divide the crystal-oscillator frequency by two to obtain 15.36 MHz and three to produce the 10.24 MHz. The frequencies are divided at a low level on the chip. The 10.24-MHz signal is divided in a binary counter by 2,048 to produce 5 kHz as one input to the phase comparator. □

Around the world

German coupler aligns optical-fiber ends

Researchers at West Germany's AEG-Telefunken have built several experimental connectors that align the ends of optical fibers accurately enough that the plug of one fits into the socket of any other. The connectors hold coupling losses to less than 0.4 decibel for multimode fibers with a core diameter of 45 micrometers and outer diameter of 130 μm . The fiber ends are cemented in V-grooves cut longitudinally to the centers of two steel cylinders that form the plug and socket.

The fibers, flush with the ends of the cylinders, are automatically aligned when the ends of the plug and socket are held in place by an overlapping cylindrical pin, which has one flat side to align the V-grooves of the two parts. The pin is fastened to the cylinder in the plug end, and a spring in the socket end opposite the V-groove forces the cylinder against the pin. The tolerance is controlled by the accuracy of the V-groove angles, rather than other physical dimensions.

Sony PCM adapter adds hi-fi to video recorder

An experimental pulse-code-modulation adapter can convert a home or industrial video-tape recorder into a stereo tape deck that performs better than the finest professional product. Japan's Sony recently demonstrated the adapter at the International Audio Fair in Tokyo and plans to produce it during the second half of 1977 at roughly the same price as a home VTR—about \$800. The attachment should provide outstanding reproduction when connected to the video terminals of any VTR, but Sony will guarantee performance only when it is used with the company's own recorder.

Best results are obtained with commercially recorded tapes, the firm says. However, standardization both of the VTR and the PCM recording technique may be required to build a commercially viable market for prerecorded tapes. The adapter/VTR combination plays back with a dynamic range of 85 decibels for program material it records and 95 dB for commercially recorded tapes. For operation at 0.1% harmonic-distortion level, these values are 40 dB and 50 dB, respectively—better than those that open-reel tapes can achieve. The system can provide harmonic distortion of 0.03%, better than the most expensive professional analog tape recorders.

**You can buy
this signal generator
for a 3-month job,
and then let it
gather dust.**

**You can rent
this signal generator
for a 3-month job,
and return it
when you're done.**

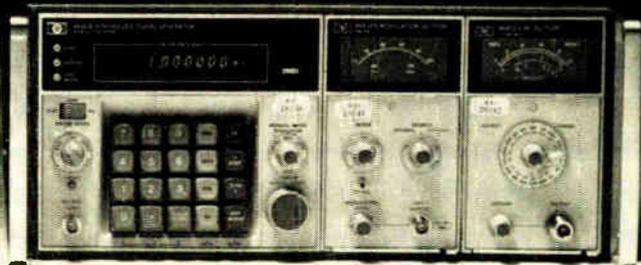
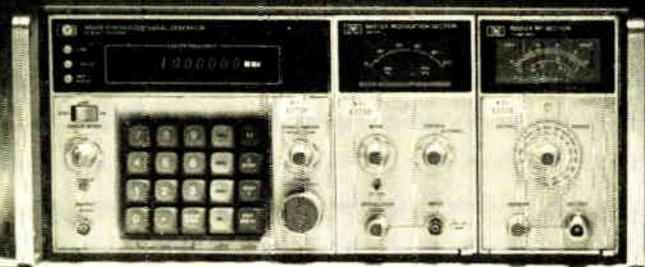

When you buy electronic test equipment for a short-term project, you're stuck with the equipment after the project is completed. Maybe it'll sit around gathering dust and costing you money. Or maybe you could sell it at a loss.

Or maybe, you should have rented it from REI.

When you rent equipment from us, you keep it only as long as you need it. When you're through with it, you send it back. Since you pay only for the time you have your instruments, you never have to spend your money on idle equipment. Short-term needs are just one reason for renting. Immediate delivery is another. Because we maintain over \$10 million in inventory in fully stocked instant inventory centers around the country, you can get delivery within hours.

REI stocks over 8,000 fully checked-out test instruments. And they're ready whenever you are. For the full story on renting as well as our low prices, send in the coupon for prompt delivery of our free illustrated catalog. Or call us now for your immediate requirements.

Rental Electronics, Inc.,
99 Hartwell Avenue, Lexington, Mass. 02173.
Please send me your free instrument rental catalog:

Name _____ Title _____

Company _____

Address _____

City _____ State _____ Zip _____

Tel. Number _____

Rental Electronics, Inc. 

A PEPSICO LEASING COMPANY

Burlington, MA (617) 273-2770 • Gaithersburg, MD (301) 948-0620 • Oakland, NJ (201) 337-3757 • Ft. Lauderdale, FL (305) 771-3500
Des Plaines, IL (312) 827-6670 • Dallas, TX (214) 661-8082 • Mountain View, CA (415) 968-8845 • Anaheim, CA (714) 879-0561
Rexdale, Ontario (PLC Leasing Ltd.) (416) 677-7513

Circle 54 on reader service card

Quality stressed in Japan's program to bolster defense . . .

Japan is stressing quality rather than quantity in its upcoming national defense program, which begins March 31 at the end of its fourth five-year plan. **One reason for the change is that the government no longer envisions a steady increase in numbers of weapons;** in fact, the number of operational aircraft is expected to decrease from about 490 to 430 because of the withdrawal of F-86 fighters, which are of Korean War vintage.

What's more, the program's provision for a new budget each year minimizes the chances for unreasonable reductions, which in the past have been forced by opposition parties because the entire budget had to be approved in the first year of the plan.

. . . and plan favors U. S. warplanes

U.S. aircraft are expected to be selected to fulfill Japan's latest five-year plan. The new mainstay fighter, probably the F-15 from the U.S., will be selected late this year or early next year. **The fighter is included in the authorizations for 10 squadrons of interceptor units, three squadrons of support fighter units, and one squadron of air-reconnaissance units.** Also authorized is a squadron of early-warning aircraft, which may come from the U.S.

Plessey speeds up ECL line at same power levels

The popular fast emitter-coupled-logic families are about to get even speedier siblings with the same power levels from Britain's Plessey Semiconductors. The first product in the Plessey ECL-3 family is the SP1660F dual four-input gate that is three times faster than standard devices. It has a gate delay of 500 picoseconds with a power dissipation of 200 milliwatts. Targeted applications are instrumentation, nucleonics, and pulse-code-modulation communications links. Still under development is the SP 10131, an ECL 10-kilobit dual-D flip-flop that quadruples the clock rate to 750 megahertz.

Plessey says the higher speed of the device comes from improving its own Process 3 to dope a fully implanted transistor with arsenic that way, it can get well-defined structure edges. Also made by the same process is the SP8619 1.5-gigahertz divide-by-four counter with guaranteed performance from 0°C to 70°C.

Nordmende markets TV games in color from West Germany

A new color television set featuring built-in games and a novel wired-in electronic-photocell rifle is being pushed by West Germany's Nordmende. The 26-inch Nordmende set, called Spectra-Color-Teleplay, provides six different ball games—squash, tennis, soccer, ping pong, hockey, and jai alai—and four shooting-type games—fox hunt, combat shooting, rabbit chase, and pigeon shooting. For the shooting games, the rifle is connected to the set.

The game module, designed around an integrated circuit from General Instrument Corp., is built into the receiver and connected to the video input. **Spectra-Color-Teleplay models cost only \$80 more than Nordmende's standard 26-inch color sets.**

Uncertainty clouds CDC computer sale to mainland China

Although President Ford has approved the sale of two Control Data Corp. Cyber 172 computers to the People's Republic of China, [p. 36], officials of Control Data France remain worried that the new Carter administration might delay or scrap the deal. And the Paris-based International Coordinating Committee for exportation to Eastern Countries still must approve the sale of the computers [*Electronics*, Oct. 14, p. 55].

Control Data France, which is furnishing the computer network in collaboration with France's Compagnie Générale de Géophysique, **hopes that Cocom approval will come by the end of this month and that the first computer will be delivered to Peking by the end of the year.**

Japan urges makers of VTRs to adopt standard products

The Japanese government has applied pressure to the country's manufacturers of consumer video-tape recorders to adopt an industry-wide standard so that a tape made by any of them will play on any recorder. Although the Ministry of Trade and Industry has unofficially urged the companies individually to standardize, this is the first "administrative guidance." **MITI officially called together executives of 13 manufacturers Oct. 28 and urged them to begin work as soon as possible on a new generation of compatible products and stop the proliferation of noncompatible ones.**

The three leaders in the sales race—Sony, Matsushita, and Japan Victor—are expected to intensify their sales effort to grab a dominant market share. If one of these systems is chosen for production and sale by a company not yet in the market, such as Hitachi, the standard could be virtually set. **Still, it may take several years to make agreements on a single design, work out a way to share patents, and formulate a policy with respect to present incompatible equipment and tapes.**

Philips color-TV concept extended to 20-inch tubes

Now that the Philips-developed 20AX self-converging beam system [*Electronics*, Aug. 8, 1974, p. 120] is being used on 18-, 22-, and 26-inch color-television tubes, the Dutch company and its subsidiaries are also gearing up for production of 20-inch versions. **The 20AX tube concept has become the dominant one in Europe since it was introduced about two and a half years ago, and it is gaining in Asia, Latin America, Australia, New Zealand, and South Africa.** The guarantee for color tubes using it has been increased to three years in Germany, says Philips subsidiary Valvo GmbH in Hamburg. Philips has nine factories producing color-TV tubes and three making tube-deflection units.

ICL system chosen by European Economic Community

The European Economic Community commission has decided to install a computer system from Britain's International Computers Ltd. at its data center in Luxembourg. The ICL 2980, chosen to meet needs of the center, which are growing about 25% annually, will replace existing equipment from Cie. Internationale pour l'Informatique of France and IBM of the U.S. **The complete system will rent for \$225,000 to \$245,000 a month.** For several weeks, the commission has leaned toward the ICL system, even though it is fairly new, and despite reports that a similar installation at the European Space Research Organization center at Darmstadt, West Germany, has been having software problems.

**At last.
A μ P
built for
engineers!**

**Programmers
have had it
all their way
too long.**

The Chip.

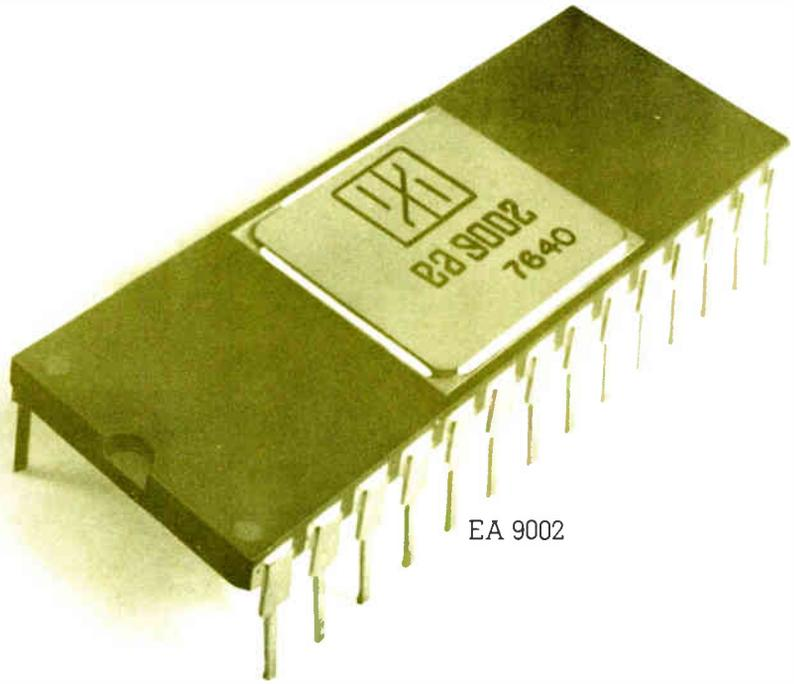

EA 9002



to do most of these jobs can be built with fewer components and at lower cost than is possible with other μ Ps.

This new engineer-oriented 8-bit microprocessor is both simpler and more economical. The EA 9002 is designed for hundreds of real-time, real-world jobs that engineers used to tackle with hard-wired logic. Systems

to do most of these jobs can be built with fewer components and at lower cost than is possible with other μ Ps.

It's easier to understand.

Easier to program.

Easier to interface because it connects directly to standard ROMs, PROMs, RAMs, I/Os and MSI circuits from most manufacturers. These include the EA 4600, EA 4700 and EA 4900 ROMs, the EA 2708 EPROM, the EA 2111 RAM, et cetera.

We designed the EA 9002 especially for small-to-medium data and process control applications. Like smart instruments. Data collection terminals. Peripheral controllers. POS terminals. Elevator controls. Video games. Machine tool controls. Electronic scales. Bottling machines. Any application that's essentially logic processing and control.

We gave it all these advanced features to make it simple to use:

A 512-bit RAM right on the μ P chip. (So you may not need an external RAM at all.)

Binary and BCD arithmetic instructions. (With built-in decimal correction.)

A 28-pin package in place of the usual 40-pin DIP. (That tells you it's got to be simpler — and cuts the cost too.)

A single +5v supply requirement. (Just like TTL.)

Standard TTL inputs and outputs. (So you can interconnect directly from the μ P to any standard TTL logic.)

A single-phase clock input (For more simplicity.)

A 2 μ sec fetch and execution time. (So the speed is there if you need it.)

Simple as it is you still need software and firmware support. So we've got that all together for you too. A comprehensive user's manual. A cross assembler available on National CSS and GE time-sharing networks. A micro-controller PC board for prototyping. An emulator for software development, program edit and resident assembly. And a full-blown software development terminal with complete ASCII keyboard, CRT display, and floppy disk memory.

Here's your chance to get out from under unnecessarily complicated μ P development — and end up with a less costly system as well.

EASE[®] μ P

Circle 57 on reader service card

The Micro controller.

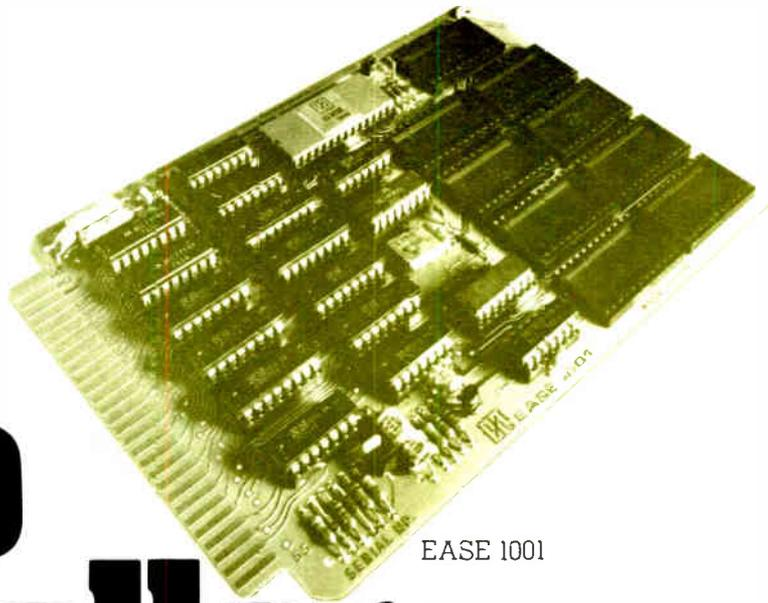

EASE 1001

Just plug programmed PROMs or one 16K ROM into the EASE 1001 board to make an operational microcontroller. Excellent for prototypes—and the final product in many cases.

Preconnected on the board are an EA 9002 microprocessor (with an on-chip 512-bit RAM), a clock, I/O circuits, and sockets for eight 1702A 2K PROMs plus one EA 4600 16K ROM.

The board interfaces directly to standard TTL circuits. Requires only +5v and -10v supplies.

Here's a breadboard for your system already complete except for programming. It can save you weeks of development time and expenses.

We built the EASE 1001 primarily for prototyping. The design is so generalized that it works well in a great variety of applications. And many low-volume users find it economical to incorporate this board into their final system.

If you load the board with eight 1702 erasable PROMs, you get 2048 8-bit bytes of program memory. Anytime you're ready, this memory can be replaced with a single economical EA 4600 mask-programmed ROM.

There are two 8-bit TTL input ports (16 terminals) and three 8-bit TTL output ports with latches (24 terminals).

The board has a crystal-controlled oscillator allowing an instruction execution time of either 3.2 or 6.4 μ secs for 1-byte instructions.

The EA 1001 board helps you realize the full potential of the EA 9002 microprocessor. Helps you build complete μ P systems, quickly, simply and economically.

and



The Emulator.

This \$995 emulator makes programming easy and inexpensive. Costs only a fraction as much as equipment with comparable capability. And it's the only hardware/software development system that's complete in one stand-alone desk-top machine.

The EASE 2000 is an in-circuit emulator that you can wire right into your system to see how it works. The emulator uses the same components as your final system — except it has RAM where ROM or PROM will be.

You can program with simple hexadecimal object code. Or plug in an optional \$250 assembler and program with instruction-set mnemonics through a TTY terminal.

The EASE 2000 has keyboards for both control and data entry. It can also be loaded and dumped via an ASR33 TTY terminal. A built-in hex LED display indicates keyboard entry, a 3-digit address, and 2 digits for data bus contents.

The emulator operates in two basic modes: either EXECUTE or EDIT. In the EXECUTE mode, the program may be run at normal clock speed, stopped automatically at preset breakpoints, or stepped through one instruction at a time while displaying the current address and data status.

In the EDIT mode you may read, modify or write into program memory and microprocessor memory locations as defined within the editor software. All EDIT operations appear in the LED display.

If you plug-in the optional resident assembler and program with mnemonics, the emulator will

flag errors in your program, assign symbol values, and convert instruction mnemonics to 9002-executable codes.

The emulator has 2K 8-bit bytes of RAM to store the program — the same program capacity that will go on the EASE 1001 micro-controller card in ROM or PROMs.

The EASE 2000 emulator really takes the place of the logic breadboard you used to build and debug. Like the breadboard, it can be wired right into your system for real-time operational tests. That's another reason we call the EA 9002 the engineer's microprocessor.

For a complete package of informative literature contact any of our worldwide offices. In the U.S. call on our toll-free WATS line below.

EASE μ P

Circle 57 on reader service card

Europe

ELECTRONIC ARRAYS, INC.
Hadleystraat 3
A-1315 Beerse, Netherlands
Tel. 02977-23722 23838
TLX: (844) 12674

Far East

RIKEI CORPORATION
1-18-14 Nishi-Shimbashi
Minato-Ku
Tokyo 105, Japan
Tel. 03-591-5241
TLX: (781) 24208

United States

ELECTRONIC ARRAYS, INC.
550 E. Middlefield Rd.
Mountain View, Calif. 94043
Tel. (415) 964-4321
TWX 910-379-6985

Outside California use toll-free WATS (800) 227-9962

EAST
Cherry Hill, NJ, (609) 795-5066

MID-AMERICA
St. Louis, MO, (314) 878-6446

WEST
Huntington Beach, CA
714) 968-3775



Switch to the LICON® LPB line...a spur to your imagination!

Your design ideas really *will* track better when you keep Licon LPB's in mind. With Licon's vast array of choices and options you're sure to find the switch you need quickly, save design time, and avoid frustration.

Take our Series 05 LPB's for example. These economical lighted or non-lighted low-level switching devices are available in seven lens cap colors, plus clear. Centrally-located red, yellow or green LED display, too. Excellent illumination with LED's or inexpensive T 1 $\frac{3}{4}$ wedge base lamps. Fits .625 panel cutout. Single or double pole versions. Unitized housing and mounting latches. Bifurcated contacts with long wipe. Good tactile feedback. U.L. listed. Wide application range. Ideal

for low energy digital electronics switching.

Our Series 06 LPB's feature Licon's ultra-reliable double-break Butterfly® switches. One or two-lamp illumination. Over 200 display options. One light full screen. Two-light vertical split, horizontal split, or full-screen illumination. Solid color, projected color, insertable legend or hidden display. Use standard T 1 $\frac{3}{4}$ flange base lamps. Fits .70 x .920 panel cutout. U.L. listed. C.S.A. certified, and meets 3 mm terminal spacing requirements. Wide

application range. Both Series 05 and 06 LPB's have standard PC or .110 quick-connect terminals.

Many other brilliant choices available in our amazing array of lighted and unlighted switches. Switch to us for best answers. Call or write for our Licon Switch Catalog: Licon, 6615 West Irving Park Road, Chicago, Illinois 60634. Phone (312) 282-4040. TWX 910-221-0275.



LICON

A DIVISION OF ILLINOIS TOOL WORKS INC.



Circle 61 on reader service card

Above Any Other
Bipolar Microprocessor
Family

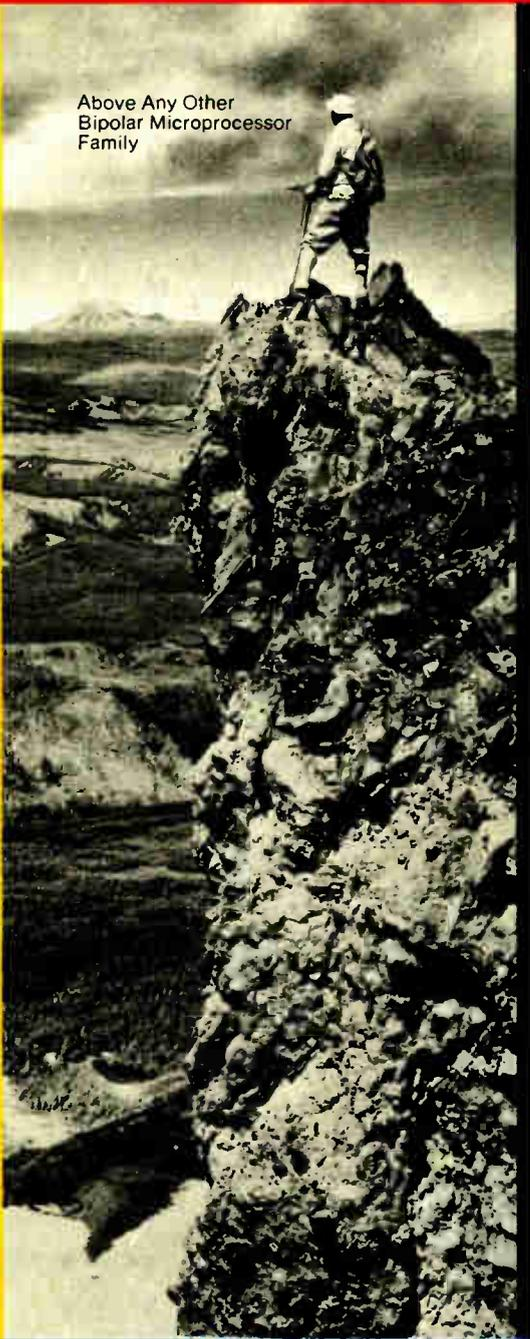

MACROLOGIC

FAIRCHILD'S BIPOLAR MICROPROCESSOR FAMILY.

FAIRCHILD 4-BIT SLICE vs 2901

	9405A FAIRCHILD	2901 AMD
COST (100-PIECE PLASTIC)	\$12.00	\$21.00
SPEED (MINIMUM CLOCK PERIOD)	75 ns	105 ns
PACKAGE SIZE	24-LEAD 0.4-INCH WIDE	40-LEAD 0.6 INCH WIDE
DIE SIZE	10,000 MIL ²	30,000 MIL ²
LSI DEVICES IN FAMILY (200 OR MORE GATES)	8	3

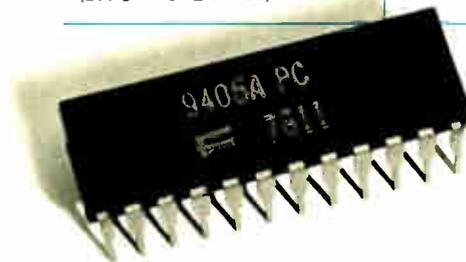

Macrologic Bipolar Microprocessors: by part, b

Faster. Cheaper.

Part for part, system for system, the Fairchild Macrologic family is faster and cheaper than any other Bipolar Microprocessor family around. There are currently eight 200-gate-plus LSI devices, with four more coming soon. Yet because we've kept design parameters simple (to meet 95% of potential applications), you pay less and get maximum speed.

Better matched.

The Macrologic family of Bipolar Microprocessors is the most advanced family available. There

is more flexibility, more combinations of functions to best meet your application needs. So you get a better matched system with better performance.

More memories.

Because there is more to a microprocessor than just the processing, Fairchild delivers more bipolar memories, in greater variety, than any other source. Thirty devices in total. Including our industry standard 93415 (1024 x 1) and 93422 (256 x 4), plus the fastest PROM around—our 93448.

Step into the future.

Our commitment to Bipolar Microprocessing is substantial. By combining our broad (and growing) Macrologic product base with our unique process background in Isoplanar, Injection Logic, Schottky and Subnanosecond ECL, we'll always be at the leading edge of this critical technology. We invite opportunities to put this engineering mix to work on your particular operation. Contact any Fairchild Distributor, Rep or Regional Office.

World's Fastest Microprocessor Family

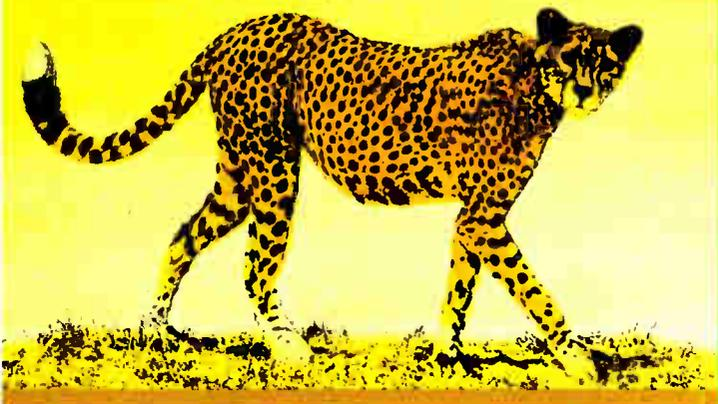

The Most Cost Efficient Family

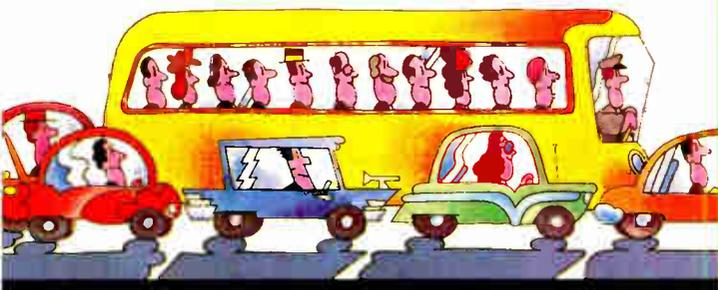

More Macrologic Family On The Way

MACROLOGIC vs SSI/MSI

ONE MACROLOGIC PART	REPLACES THIS MANY SSI/MSI PARTS
9401	12
9403	16
9404	22
9405A	17
9406	12
9407	12
9408	24
9410	4

FUNCTION vs FUNCTION (LSI ONLY)

DEVICE		FUNCTION
FAIRCHILD	AMD	
9405A	2901	4-BIT SLICE, ALU/REGISTERS
9408	2909/11	MICROPROGRAM SEQUENCER
9404		DATA PATCH SWITCH, BYTE MASKING, SIGN EXTENSION, SHIFTING
9406		PROGRAM COUNTER AND LIFO STACK
9407		ADDRESS ARITHMETIC
9401		CYCLIC REDUNDANCY CHECKER
9403		FIFO
	2914	VECTORED PRIORITY INTERRUPT ENCODER
9410		SCRATCH PAD EXPANDING MODULE
30 MEMORIES	14 MEMORIES	COMPATIBLE BIPOLAR MEMORIES

Family Heritage

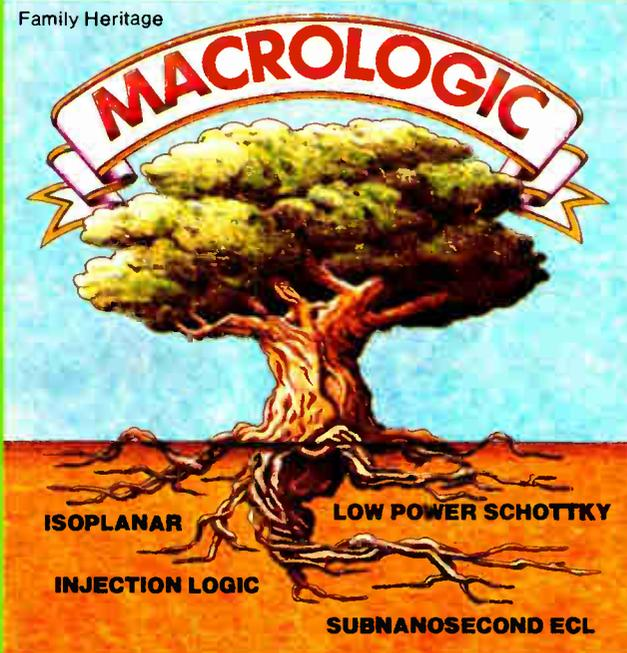

unction, by system, always a step ahead.

Added sources.

Our Macrologic line is being second sourced by another major bipolar manufacturer. So you are assured of always having sufficient supply at competitive pricing.

Fairchild Camera & Instrument Corp., Bipolar Memory & ECL Division, 164 Ellis St., Mountain View, CA 94042. Tel.: (415) 962-3541. FWX 910-379-6435.

Macrologic from Fairchild.

Special offer. For a limited time, we're offering complete data books on parts and applications for Bipolar Memories (@ \$3) and Macrologic (@ \$3) ... or both for a special price of \$5. Check the appropriate box and send it along with your check. Mail to: Fairchild Camera & Instrument Corp., Bipolar Memory & ECL Division, P.O. Box 880A, Mountain View, CA 94042

- Bipolar Memories @ \$3
- Macrologic @ \$3
- Both @ \$5
- Free Line Card

NAME/MAIL STOP _____
 COMPANY NAME _____
 ADDRESS _____
 CITY/STATE/ZIP _____
 PHONE _____

FAIRCHILD

WHO ELSE?

The only microcomputer with the power of a PDP-11. The PDP-11/03.

If you've been looking for a microcomputer with minicomputer power at a micro price, join the hundreds of OEMs who've already found it with the DIGITAL microcomputer. The PDP-11/03.

The 11/03 gives you everything you could ask for in a small computer. High performance. High reliability. And a low price — just \$1,357 in quantities of 50. And that micro price buys you mini features that quickly translate into benefits OEMs appreciate. Features like full PDP-11 instructions with eight general purpose

registers for fast program development. RAM (MOS or Core) and PROM memories that let you match the memory with the application. Hardware vectored interrupts with stack processing for real computer power. And multiple-sourced components for sure delivery.

Buying our 11/03 also buys you the chance to start small without staying small. Because you can add up to 32K words of memory, fast floating point instructions, and more. Whenever you and your customers are ready.

Besides growing bigger in size, the 11/03 lets you grow bigger in scope. It's software compatible with every other PDP-11 we offer. From our LSI-11 all the way up to our medium scale PDP-11/70. That means you can take full advantage of Digital PDP-11 software and services.

You can also take advantage of Digital's OEM Referral program — your chance to take on an international marketing and support team without hiring them. The OEM Referral program can help you locate new custom-

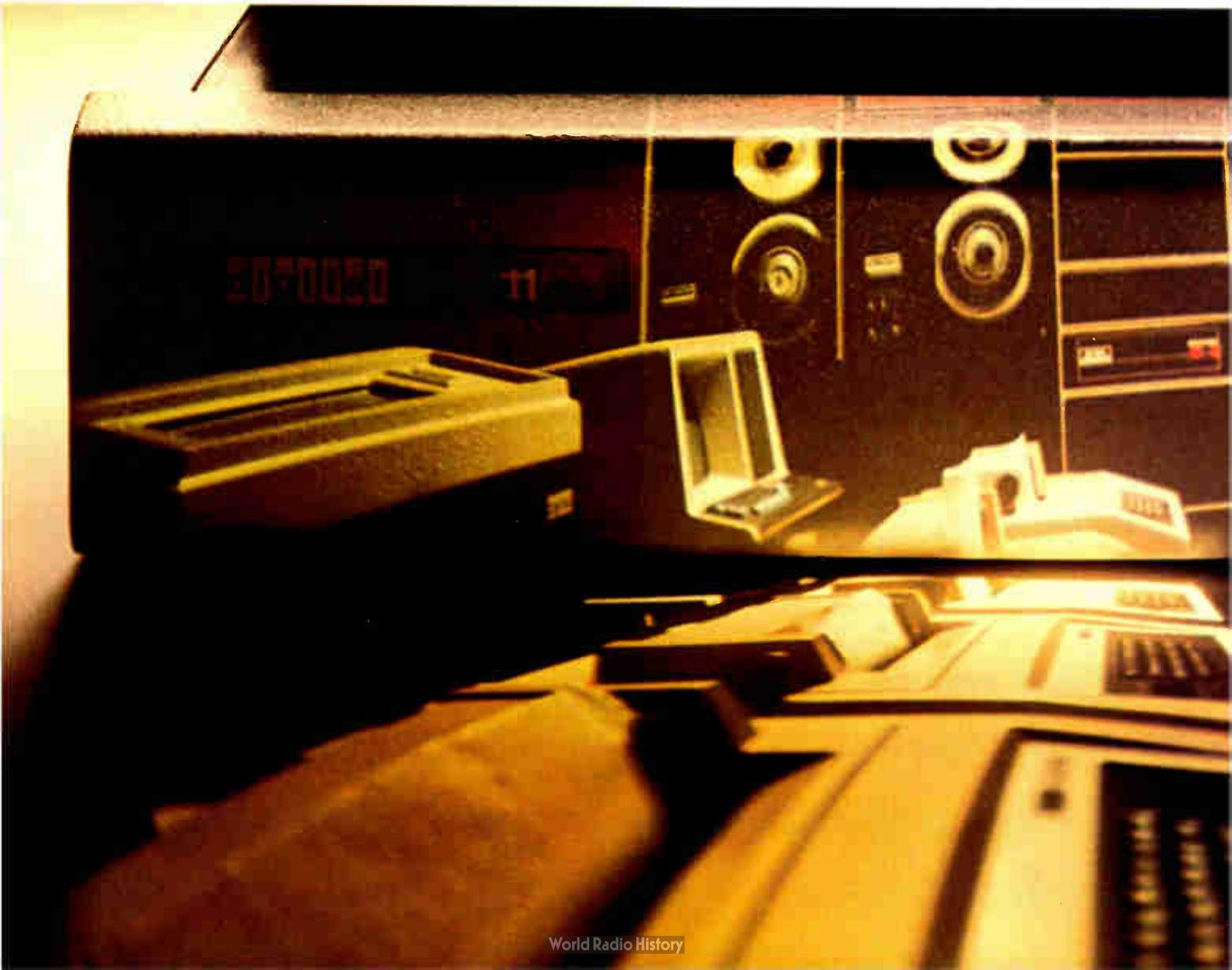

ers and new markets around town and around the world. And it can all start with the PDP-11/03.

So if you're looking for a

proven microcomputer with proven power and performance, get the micro with all the power and performance of a PDP-11.

Digital's PDP-11/03. Call your nearest Digital sales office. Or send the coupon to Digital Equipment Corporation, Maynard, Massachusetts 01754. (617) 897-5111. European headquarters: 81 Route de l'Aire, 1211 Geneva 26. In Canada: Digital Equipment of Canada, Ltd.

Digital Equipment Corporation, Maynard, Massachusetts

I'm interested. Please send information.

I'm more than interested. Please have your nearest Digital sales representative contact me.

Name _____ Title _____

Company _____

Address _____ Phone _____

City _____ State _____ Zip _____

E1114

digital

**50,000 computers saving
managers millions.**

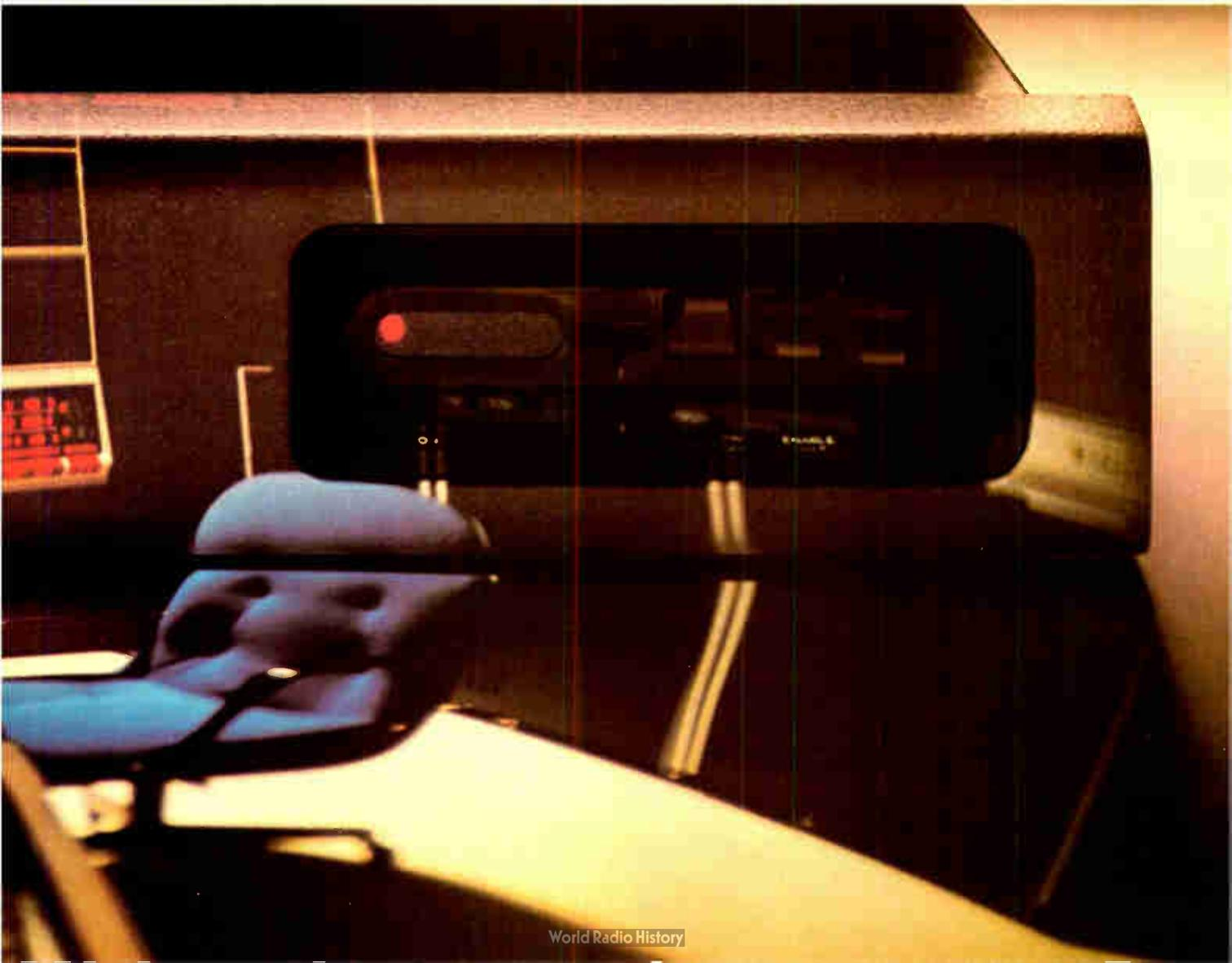

UNRETOUCHED

MICROPHOTOS

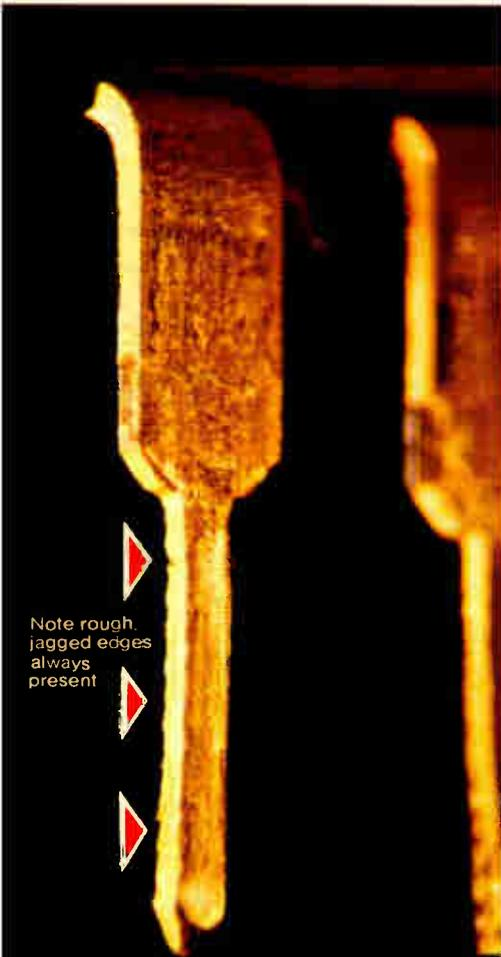

Note rough, jagged edges always present

Your IC lead frames look like this at 30X enlargement (unretouched). Because they are punched out of metal, the edges are rough, jagged and irregular. In contrast, the flat sides of the lead frame are smooth, even and perfectly plated.

Arrows indicate scars and abrasions made by rough edge of lead frame.



22X magnification, unretouched.

THEIRS

An ordinary edge-bearing socket contact after 5 insertions of DIP lead frame. Contact has been spread apart to show inside faces of contact. Notice how the contact has scars and abrasions from rough, irregular edge of IC lead frame. Electrical contact is degraded and resistance is increased. Reliability is obviously reduced.

Lead frame in place in an ordinary edge-bearing contact.



Arrows indicate contact surface still smooth, clean, free from abrasions.



22X magnification, unretouched.

OURS

ROBINSON-NUGENT "side-wipe" socket contact after 5 insertions of DIP lead frame. Contact has been spread apart to show inside faces of contact. See how the RN contact—because it mates with the smooth, flat side of the IC lead frame—retains its surface integrity. This 100% greater lead frame contact results in continued high reliability.

Lead frame in place in RN "side-wipe" contact.



High reliability IC sockets... we've got 'em all!

expose 'junk' socket problems

Secret of RN high reliability 'side-wipe' DIP sockets revealed by microphotos

Here's microscopic proof that high reliability Robinson-Nugent "side-wipe" DIP sockets make 100% greater contact than any edge-bearing socket on the market. This advance design provides constant low contact resistance, long term dependability—trouble-free IC interconnects. Yet RN high reliability DIP sockets cost no more than ordinary sockets!

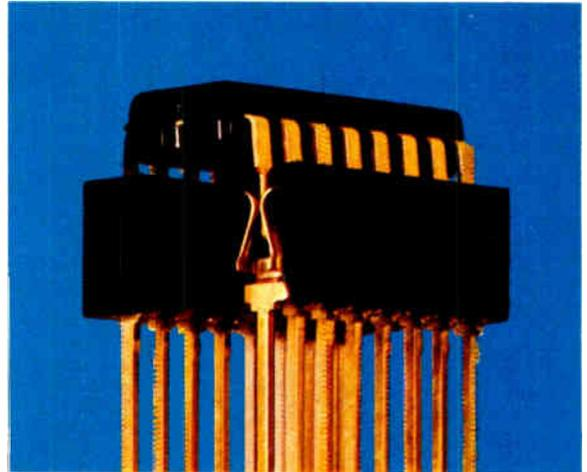

Get the high reliability that eliminates trouble. RN "side-wipe" DIP sockets make contact with the wide, flat sides of your IC leads. You get 100% greater surface contact for positive, trouble-free electrical connection.



WRITE TODAY

for catalog and informative book "What to Look for in IC Interconnects." Free from Robinson-Nugent—the people who make more kinds of high reliability IC sockets than anyone.

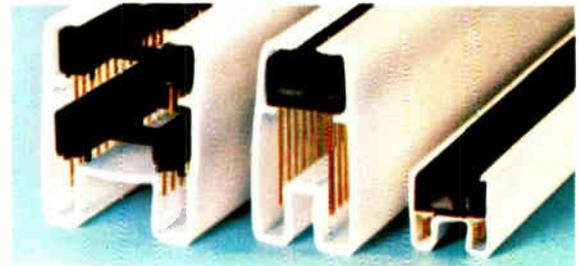

They're even packaged for high reliability. "Protecto-pak"[®] packaging delivers consistently perfect RN sockets to your production line—for automated or manual assembly.

RN ROBINSON NUGENT, INC.

800 East Eighth Street, New Albany, Indiana 47150 • Phone: (812) 945-0211

Call me, I'm interested circle 66

Send product information circle 205

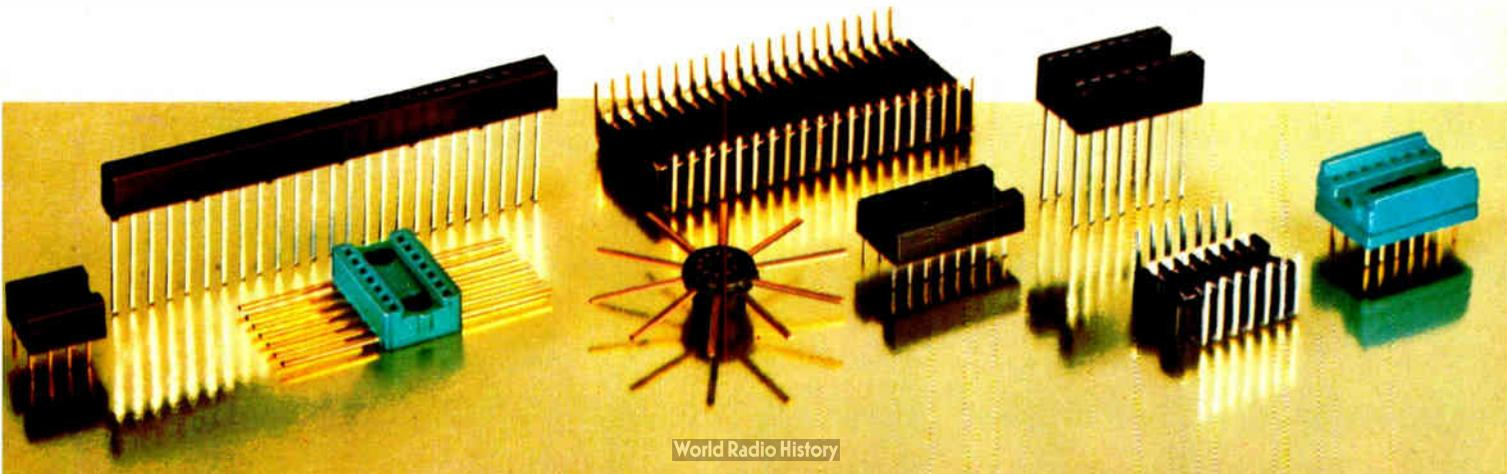

THE J387: WHEN PRODUCTIVITY COUNTS.

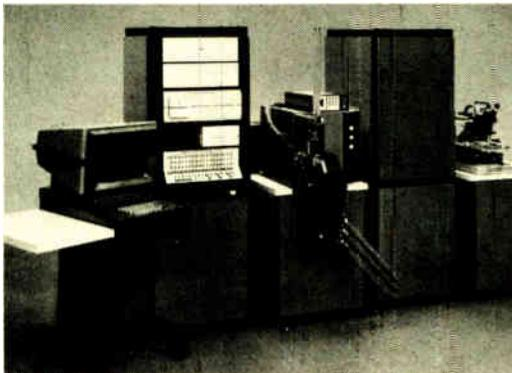

Here are seven ways in which the J387 Memory Test System helps increase productivity. Study them closely. When it's time to invest in memory testing equipment, you'll want to remember them all.

REPEATABLE RESULTS WITH HANDLERS or PROBERS.

Because the system was designed to drive devices at the end of cable, test results are consistently repeatable even when wafer probers or automatic handlers are connected to the system.

NO TEST STATION TWEAKING.

The system's software eliminates the need to modify the program every time you change test stations. Once set, the times stated in the test program are always valid.

PROGRAM YOUR OWN PATTERNS.

Teradyne's new programmable pattern generator allows you to produce whatever patterns will exercise your memories best in the least amount of time.

TWO STATIONS MEAN HIGH THROUGHPUT.

The basic J387 arrives with two test stations because experience has shown that two usually offer the lowest cost per device tested. Should you require more, they can be added.

TESTS RAMs, ROMs, EVEN 16Ks.

The J387 will test many different RAMs and ROMs, including 4k devices in 16-, 18-, and 22-pin packages. Even memories with up to 16 address inputs can be handled.

ALL THE DATA YOU NEED.

You're provided with cumulative Schmoop plots, lot summaries, distribution analyses, datalogged parametric values, and all the other data you need to increase yield and improve productivity.

TERADYNE PRODUCTIVITY TURNS UP EVERYWHERE.

You'll find it in hardware optimized for memory testing. And in Teradyne's unique 10-year circuit module warranty. It's why we maintain a seven-day, 24-hour trouble-shooting service. And a global service program backed up by local parts stocking centers.

Whether you're a memory user or manufacturer, the J387 delivers what you need. Optimized memory testing that will boost your throughput and increase your productivity. For the full story on the J387 Memory Test System, write: Teradyne, 183 Essex Street, Boston, Massachusetts 02111. In Europe: Teradyne, Ltd., Clive House, Weybridge, Surrey, England.

WE SELL PRODUCTIVITY.

TERADYNE

CHICAGO (312) 298-8610/DALLAS (214) 231-5384/NEW ENGLAND (617) 458-1256/NEW YORK (201) 334-9770
SUNNYVALE (408) 732-8770/LONDON (0932) 51431/PARIS 073 16 98/ROME 59 47 62/MUNICH (089) 33 50 61/TOKYO (03) 406-4021

*For people with memory problems
cut this out and save.*



Manpower forecasts need surgery

Experts agree that engineer demand studies are useless, but that fresher and better data could improve them

by Bruce LeBoss, New York bureau manager

Are existing forecasts of engineering manpower needs accurate and scientific? The answer from experts is no—but, they add, while such studies will never be perfect, improved data and methodology could make them better and more useful.

Authorities in the field agree that the forecasts share major faults. Among them:

- They're based on information that is outdated.
- They fail to consider market forces.
- They don't allow for short-term economic changes.
- They ignore regional and international factors.
- They are inaccurate when based on hiring plans, because employers tend to be secretive.

The result is that persons, particularly in engineering schools, using demand studies may be misleading students about career opportunities. That has been a major complaint about data furnished by the Engineering Manpower Commission in New York [*Electronics*, Sept. 16, p. 75], a research arm of the Engineers Joint Council that is supported by 36 professional societies. But other professional groups, industry associations, and government agencies share the guilt, and several of them are beginning to move toward remedies. The IEEE, for one, has a task force that will begin writing a report this month on what data it must have (see "The IEEE steps in," p. 70).

Until reforms are made, statisticians and economists will remain dissatisfied with demand surveys. Perhaps summing up the views of his colleagues is Eli Ginsberg, professor

of economics at Columbia University's Graduate School of Business and chairman of the National Commission on Manpower Policies.

"My general view of all demand studies is that they're not worthwhile. I'm unenamored by all of the high-powered model analyses. They're a lot of garbage," he asserts. Nonetheless, "this doesn't mean that they shouldn't be done, but that they should be both done and used with caution and restraint."

A good system of forecasting, according to Herbert Bienstock, New York regional commissioner of the Bureau of Labor Statistics, has to be revised frequently. "These kinds of regression forecasts have a Maginot Line aspect to them, as we are projecting on a number of givens and assumptions that are subject to change," he says. While certain assumptions tend to remain static, others are subject to change given a

different set of energy, ecology, and occupational safety and health policies, or a change in technology, administration, or regional movements, he notes.

In the engineering field, Bienstock adds, "we have been through a number of forecasting disasters. Today's job openings are not tomorrow's job opportunities, and tomorrow's job opportunities don't relate to growth alone but substantially to replacement needs." Generally, short-term forecasts (one to three years) tend to miss the mark more than long-term forecasts for obvious reasons, he says. "The economic level for the short term is unpredictable and subject to change. The level of economic activity is not well projected, and it's the most significant factor in any short-term forecast."

Bienstock feels short-term forecasts are just a springboard off the

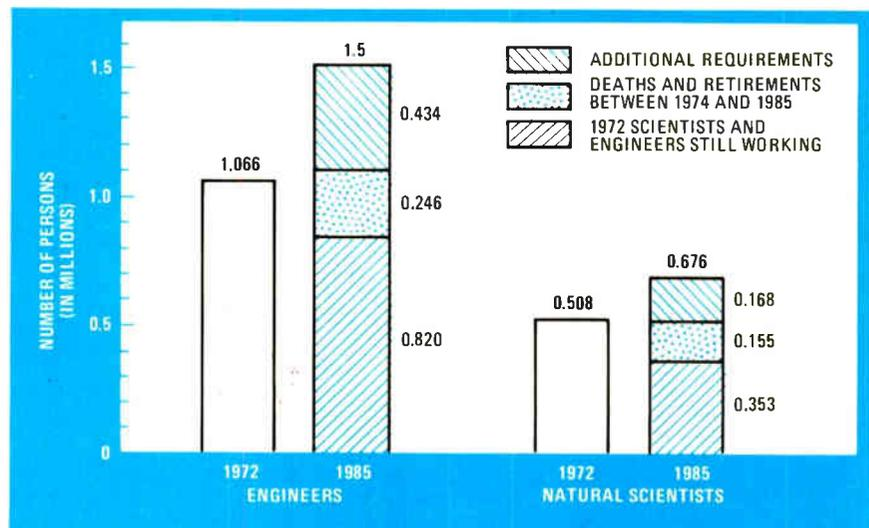

Slowdown. Typical demand chart, based on Bureau of Labor Statistics data, indicates slower growth in demand after 1980 than in the period leading up to that year.

Probing the news

basic data one has. "Projections will be no better than the basic data they jump off from. Therefore, there is a need for an improvement in the basic data." Included in such data, he says, should be better information on employment, productivity, production demand in relation to sales, as well as better updating of information of the supply side.

One of the needs for improving the basic data "is geographic disaggregation—in other words, not only data on the labor market, but data on where people live and work; a regional breakout by disciplines," adds Jesse Benjamin, chief of BLS program research. What also might help the demand picture, he notes, "is to do studies of the proportion of engineering graduates taking jobs in their major. We could then determine the number of those generally underemployed and use this as an indicator to be applied to the number of engineers coming out on the supply side."

Bad base. The National Science Foundation, whose *ad hoc* committee on manpower concluded "the data base upon which calculations are made is considered to be inadequate" and that for a number of reasons "manpower projections are tentative at best," is seeking a quantitative understanding of demand on supply and vice versa, "so that the effect of feedback can be better estimated in future projections," says Joel Barries, director of the manpower-utilization-studies group.

His organization also wants information on occupational-specific attrition rates. "We don't have good data on death and retirement rates for scientists and engineers," he says, noting that NSF's data is based on that supplied by the Bureau of Labor Statistics. "BLS has been applying the death and retirement rates for all people to its demand projections, but we believe it to be different for scientists and engineers. If so, this would have a significant impact on the supply and demand picture."

Barries sees a need for a better understanding of the market forces, as does Columbia University's Gins-

The IEEE steps in

For the IEEE, what's needed in projecting demand is breadth. John Kinn, the institute's program manager, says that the only way to do a good job of forecasting would be to first get a census, rather than just a sampling of industry and government inputs.

Not many of the companies sampled in the manpower-demand studies by the Engineering Manpower Commission were employers of electrical and electronic engineers, he notes. "We would get a much clearer picture of what's happening in our industry if there was a broader sample by disciplines. It's also important that someone look back to see how the forecasts compared with the actual demand. Otherwise, the demand study might just be an exercise in futility."

Meanwhile, the IEEE has formed a task force that is studying the manpower situation and will begin writing a report this month on what manpower data it thinks the institute should have. Ross Stander, project manager of the task force and manager of microprocessor product planning at RCA Corp.'s Solid State division in Somerville, N.J., says, "We should start giving more realistic projections to the schools so we could control the supply." He believes the IEEE should first establish a strong data base. "Present IEEE data is very limited. It's restricted only to members and not all of them at that."

Stander's task force will recommend that the IEEE make good use of its annual dues mailings. The first mailing, he says, could be broader and include a list of questions to be filled out that would provide data on the specific fields in which engineers are working. "This would establish a more extensive ground zero for future forecasting studies."

berg. This could include an improvement in estimates of both demand and supply on a regional basis and how they have changed through time. "There is a tremendous elasticity in the American economy," Ginsberg says. "If we're short on engineers, we have all kinds of technicians and other people that can fill engineering jobs. And if we're long on engineers, we have ways of keeping them around in technician-type jobs. If we could get a better handle on how companies tackle their utilization problems, then we might be able to do a better job of projecting demand."

Another important consideration is national versus international engineering demands. "A multinational company surveyed may have a demand for engineers, but it may be at some facility in South America where the company has to produce its equipment to be competitive in the world market," notes Martin Hamburger, professor of education at New York University's Graduate School of Education.

"We also need to understand regional needs, such as what would occur in the New York and Los Angeles areas if there is a change in policies affecting the aerospace in-

dustry. And there needs to be a breakdown by disciplines. It can't be done by groups because that would be meaningless in a real-world situation." Of prime importance too, is that "we need a method of forecasting demand that doesn't take up the lead time to produce the people."

Change coming. Moves are coming on several fronts to change things. The Bureau of Labor Statistics has begun a Federal/state program, in which 32 states are participating, to determine how many people are employed in the various occupations. The bureau provides the states with definitions of job categories, based on the Standard Industrial Classification Code. The states then develop samples that include members of the various industry groups, mail the surveys, and expand the returns to estimate the various occupational levels.

The bureau has a request before the National Science Foundation for funds to survey those states not in the program. Its proposal is being evaluated, and observers expect it to be funded, as it would maintain NSF's data on a yearly basis.

"BLS's long-range goal is to collect data annually," Barries notes. □

The Ansley "D" Connector...

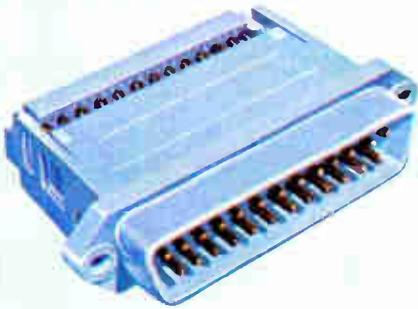

Our new series of male and female "D" connectors offer you a cost effective external mass termination cable and connector system second to none. Its uniqueness begins with a one-piece "D" connector package that meets industry standards for size, pin spacing, and contact reliability. With no loose parts to match up, positive cable-to-contact alignment is assured. Conductors are mass terminated in seconds with our standard BLUE MACS™ hand or bench tools. The results? Faster installation, higher reliability.

Contact pins are spaced on .0545" centers — a perfect fit for any standard inter-cabinet "D" type connector application. Our new "D" connectors are designed to mate with standard .050" pitch flat cable as well as our new, improved jacketed cable — the only flexible flat cable engineered specifically for out-of-cabinet use.



a new meaning to cost effectiveness.

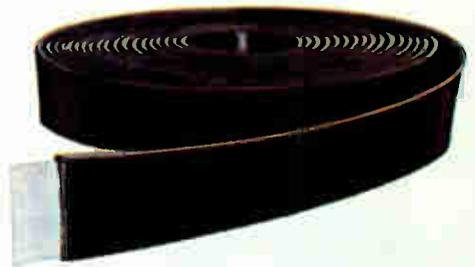

The Ansley BLUE MACS™ jacketed cable is U.L. listed for external interconnection of electronic equipment. Electrically, it outperforms standard jacketed twisted pairs in typical I/O applications. And there's no special zipper lock tubing required — reducing the need for an extra cable accessory. Installation is faster, easier. And like all Ansley connectors, you can daisy chain our "D" types anywhere in the cable — along with our DIP socket, card edge, or pc board connectors.

Cable alignment and high contact reliability is assured — because both cable and connector are grooved for absolute alignment. Our patented TULIP™ 4-point insulation-displacing contacts are permanently fixed and sealed-in to provide a reliable, gas-tight, corrosion-free mass termination.

For the full reliability/cost effectiveness story and technical data, call or write:

T&B / Ansley

The mass termination company.

T&B/Ansley Corporation • Subsidiary
of Thomas & Betts Corporation
3208 Humboldt St. • Los Angeles, CA
90031 • Tel. (213) 223-2331 •
TWX 910-321-3938

Available through authorized
Ansley distributors

In Canada: T&B/Ansley, Ltd.
700 Thomas Ave.,
Industrial Park
Iberville, P.Q.

Circle 71 on reader service card

TURNKEY 620 SYSTEMS FROM NEFF USING THE HP 9825 CALCULATOR.. the logical next step in data acquisition.

You're involved in a scientific, engineering, or industrial project that could use a high performance, low cost data acquisition system. But you know that system integration and software costs of most systems actually exceed the hardware. And your need is now, so you want a system that will take data immediately with minimum user training.

Our turnkey 620S was designed for you.

620S is a sophisticated data acquisition system with amplifier-per-channel or differential multiplexer analog signal processing and using the H.P. 9825 computing calculator for system control, data analysis and recording.

Neff systems are known for high performance and the 620S is no exception. Consider 0.1% accuracy with 50kHz channel scanning rate, fullscale input sensitivities from 5 millivolts to 10 volts, up to 256 channels or 2048 channels fully expanded, and 120dB rejection of common mode voltages up to 300 volts. Selectable data filters, simultaneous sample and hold and input signal conditioning are but a few of the many available features.

The Hewlett-Packard 9825 calculator provides the 620S computer performance with the operating convenience of a calculator. Programming is simple with HPL, an easy to learn, high level language designed for scientists and engineers. Standard features include a live-keyboard, alpha numeric printer and cassette recorder. Up to 24K memory is available. Plug-in peripherals include floppy disk, line printer, x-y plotter, and tape punch. It also attaches to H.P. Interface Buss.

A complete, integrated data acquisition system thats easy to use — thats our turnkey 620S.

Like to know more? Call us today at 213-357-2281 or write for our free brochure.

NEFF

INSTRUMENT CORPORATION

1088 E. Hamilton Rd., Duarte, Calif. 91010
Tel. (213) 357-2281 TWX 910-585-1833



Electronics abroad

Apprehension pervades Munich show

Manufacturers gathering at biennial Electronica agree that recovery falls short of expectations

by Arthur Erikson, Managing Editor, *International*, and John Gosch, Frankfurt bureau manager

In the vast beer halls of downtown Munich, the mood of heavy heartiness whipped up by the annual Oktoberfest lingers on. But at the fairgrounds, the late-November atmosphere will be charged with apprehension as Western Europe's electronics community converges there for the biennial Electronica show, Nov. 25 through Dec. 1.

To be sure, the components suppliers who dominate the show won't be as jittery this year as they were at the 1974 edition. Then, market watchers were predicting—rightly—a downturn for the year ahead.

There's been some recovery from the 1975 slump, of course. But 1976 hasn't brought the boom most components makers had hoped for. "This year's expansion won't even push the components business back up to the 1974 level," points out Alfred Prommer, vice president in charge of sales at Siemens' Components division.

Against that benchmark, this year's recovery for components sales turns out to be not as solid as the figures make it look at first sight. Price rises, too, bloat the totals. Industry officials, for example, peg 1976 components consumption in West Germany at \$1.63 billion, up 13% over 1975. (All dollar amounts are figured at exchange rates in effect at the end of October.) In France, the industry trade association GIEL (for Groupement des Industries Electroniques) sees a \$1.17 billion market this year, up 18%. In Great Britain, the Department of Trade and Industry figures

that this year's components business will run \$853 million, a gain of 10%. Partial returns from *Electronics'* annual market survey indicate a rise to a \$350 million market in Italy this year.

By and large, components-markets watchers figure the sales curves will continue heading upward next year as the recovery—albeit slowed—struggles on. However, Britain and Italy are beset by very shaky economies that could turn erratic. But color-TV set production this year in both countries turned out to be surprisingly high—1.45 million sets in Britain and better than 500,000 in Italy.

Despite less business than ex-

pected, then, in sectors like telecommunications, computers, and industrial equipment, components suppliers in both countries did reasonably well this year. So far, components marketing men are looking toward further rises next year—to something like \$1.01 billion in Britain and \$400 million in Italy. But either of these markets could turn sour fast.

Better gains. One thing seems sure: semiconductor makers should score above-average gains. "We see overall increases of about 22% with almost no price rise," says Piero Martinotti, marketing director for Motorola Semiconductor in Europe. In West Germany, the market

Munich in November. Scene at fairgrounds will be repeated at end of month as 1976 edition of Electronica opens.

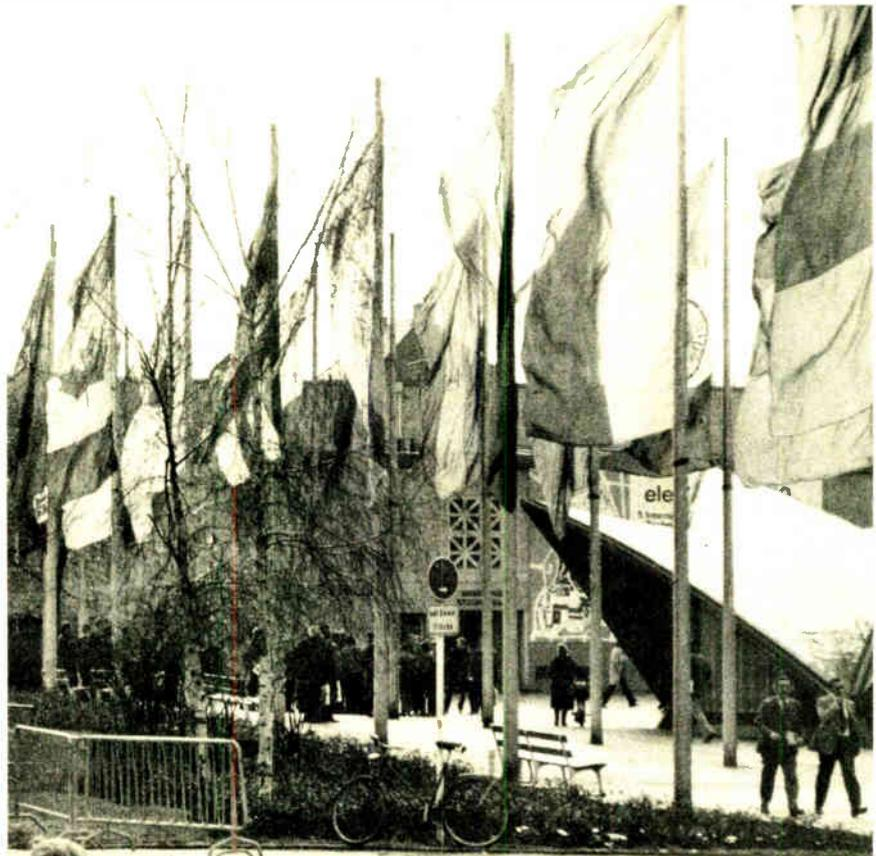

Why Do More Top Designers Insist On Working With Harris Generic PROMs?

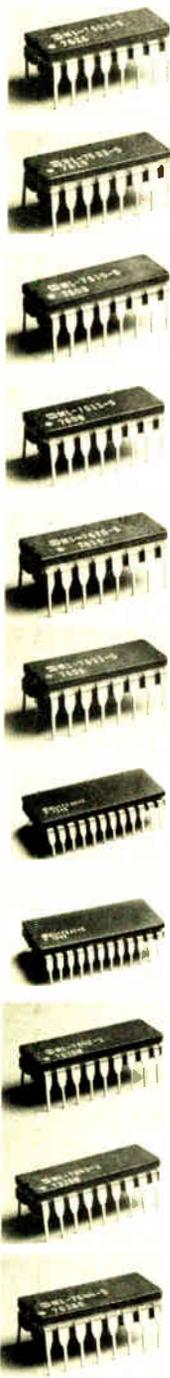

The compatibility and depth of our Generic PROM family simplifies selection, application, and production. But that's only the beginning. Here are a few specific reasons for choosing Harris.

- ✓ Identical programming specifications means that one programmer programs the entire family.
- ✓ Single pulse one millisecond per bit programming achieves fast programming and superior reliability.
- ✓ Industry's highest programming yield increases production efficiency, regardless of PROM size.
- ✓ Access times are guaranteed over full temperature and voltage ranges and any random addressing sequence.
- ✓ Harris is the only JAN-38510 QPL-1 approved PROM supplier.
- ✓ Proven Nicrome fuse design and Schottky technology.
- ✓ Complete family availability from prototype quantities to production volumes.

Now See How The 1Kx4 PROM Can Improve Your System.

- ✓ High-density 16 or 18 pin packages greatly reduce board area.
- ✓ HM-7644 (16 pin, no enables) provides direct upgrade for systems using 1K or 2K PROMs and having less than 1024 words.
- ✓ HM-7642/43 (18 pin, 2 enables) extends high density packaging to large memory configurations.
- ✓ Low power per bit: ($I_{CC} < 140$ ma or $< 180 \mu\text{W/bit}$).

For a quick look at our PROM family check the chart. And for complete details call your nearby sales location or write to Harris Semiconductor, P.O. Box 883, Melbourne, Florida 32901.

Device #	No. of Bits	Organization	No. of Pins	Max. Access Time*	
				Com.	Mil.
HM-7602 (open coll)	256	32x8	16	40ns	50ns
HM-7603 (three state)	256	32x8	16	40ns	50ns
HM-7610 (open coll)	1024	256x4	16	60ns	75ns
HM-7611 (three state)	1024	256x4	16	60ns	75ns
HM-7620 (open coll)	2048	512x4	16	70ns	85ns
HM-7621 (three state)	2048	512x4	16	70ns	85ns
HM-7640 (open coll)	4096	512x8	24	70ns	85ns
HM-7641 (three state)	4096	512x8	24	70ns	85ns
HM-7642 (open coll)	4096	1024x4	18	70ns	85ns
HM-7643 (three state)	4096	1024x4	18	70ns	85ns
HM-7644 (active pullup)	4096	1024x4	16	70ns	85ns

*Access time guaranteed over full temperature and voltage range.

Industrial ($T_A = 0^\circ\text{C}$ to 70°C , $V_{CC} \pm 5\%$)

Military ($T_A = -55^\circ\text{C}$ to 125°C , $V_{CC} \pm 10\%$)

Proven PROM Capability



HARRIS
SEMICONDUCTOR
A DIVISION OF HARRIS CORPORATION

Visit with us at Electronica 76 Booth 16232, U.S. Pavilion

**HARRIS SEMICONDUCTOR
GENERIC PROM
INFORMATION CENTERS
OEM SALES OFFICES**

CALIFORNIA: Long Beach (213) 426-7687; Palo Alto (415) 964-6443

FLORIDA: Fort Lauderdale (305) 971-3200; Melbourne (305) 724-7430

ILLINOIS: Hinsdale (312) 325-4242

MASSACHUSETTS: Wellesley Hills (617) 237-5430

MINNESOTA: Minneapolis (612) 835-2505

NEW YORK: Endwell (607) 754-5464; Melville, L.I., (615) 249-4500

OHIO: Dayton (513) 226-0636

PENNSYLVANIA: Wayne (215) 687-6680

TEXAS: Richardson (214) 231-9031

SALES REPRESENTATIVES

ALABAMA: Huntsville (205) 533-6640

ARIZONA: Scottsdale (602) 948-5590

CALIFORNIA: Los Angeles (213) 870-9191; Mountain View (415) 961-8121; San Diego (714) 565-9444

COLORADO: Denver (303) 773-0666

CONNECTICUT: East Norwalk (203) 838-1493

FLORIDA: Boca Raton (305) 395-6108; Oviedo (305) 365-3283; Tampa (813) 933-1759

ILLINOIS: Elk Grove Village (312) 640-1850

INDIANA: Indianapolis (317) 849-6454

IOWA: Cedar Rapids (319) 377-8275

KANSAS: Wichita (316) 943-6221

MARYLAND: Lanham (301) 459-1556

MASSACHUSETTS: Burlington (617) 273-1313

MICHIGAN: Farmington (313) 476-2446

MISSOURI: Hazelwood (314) 731-5799; Independence (816) 737-1100

NEW JERSEY: Keasbey (516) 567-5900; West Caldwell (516) 567-5900

NEW MEXICO: Albuquerque (505) 265-5655

NEW YORK: Albany (518) 489-7408 or 4777; Huntington Station (516) 567-5900

NORTH CAROLINA: Winston-Salem (919) 722-5151

OHIO: Cleveland (216) 831-8292; Dayton (513) 890-2150

OREGON: Beaverton (503) 643-1644

PENNSYLVANIA: Allison Park (412) 487-4300; King of Prussia (215) 265-0634

SOUTH CAROLINA: Greenville (803) 268-1125

TEXAS: Dallas (214) 691-4592; Houston (713) 661-3007

VIRGINIA: Charlottesville (804) 973-6672

WASHINGTON: Bellevue (206) 454-0300

CANADA: Mississauga (Toronto) (416) 676-1042, (416) 678-0401; Montreal (514) 626-6723, (514) 389-8051; Ottawa (613) 749-0740, (613) 226-3491

Probing the news

should do even better. Gerhard Lieb-
scher, director of marketing services
at Intermetall GmbH, part of the IRT
Semiconductor Group, puts next
year's rise at 25%, which would
carry the market to a level well
above \$550 million.

This assessment fazes almost no
one. At a preshow curtain raiser,
Electronica's organizers predicted
that by 1980, semiconductor and
electromechanical sales would match
sales of passive components. Last
year passives outsold semis almost
two to one in West Germany.

The push, of course, will come
from the consumer sector, which will
gobble up more than half the semi-
conductors in West Germany next
year. Although automobile, wash-
ing-machine, and camera makers are
becoming increasingly good cus-
tomers, it's the TV-set producers who
buy most. And they're putting more
and more semiconductor content
into their hardware.

A remote-control system, Lieb-
scher figures, accounts for roughly
18% of the semiconductors in a

color-TV set. Fully 65% of the 2.8
million sets have them. Electronic
content is continuing to rise as set
makers add to their receivers fea-
tures such as on-screen channel and
time displays, digital tuning, and the
like.

MOS out front. Although they still
rank well below the mainstays like
signal transistors and transistor-
transistor logic, metal-oxide-semi-
conductor devices will lead the
growth list next year, predicts Hel-
muth Schuett, a Siemens market
researcher. He predicts the West
German market for MOS and com-
plementary-MOS circuits next year
will be triple the 1975 level, which
reached \$22 million.

An even steeper rise—a quadru-
pling from 1975 to 1977—is in store
for microprocessors. That would put
the level in Germany at more than
\$14 million. For all of Western
Europe, the figure totals some \$50
million.

So it's little wonder that all the
U.S. and West European heavy-
weights in semiconductors will be
scrambling hard at Electronica to
woo customers and win shares of the
fast-growing market. □

The American way. Teradyne booth at 1974 show is typical of the stands of U.S.
manufacturers. American firms are placed in a single area.



Semiconductors

Keeping an eye out for counterfeiters

Makers, distributors, and buyers agree that major safeguards are to know your vendor and tighten test procedures

by Larry Waller, Los Angeles bureau manager

For semiconductor manufacturers, the sale of counterfeit semiconductors ranks as the industry's most nefarious practice. Almost everyone involved gets hurt when cheap or reject parts are mislabeled or repackaged: the manufacturer whose reputation suffers; the distributor who gets blamed for handling them (often unknowingly); the buyer and the end user whose equipment might fail; and, sometimes, the counterfeiter who now and then gets caught.

With the most recent storm over counterfeiting still boiling—bogus parts were uncovered in assemblies for the Space Shuttle, and paraphernalia allegedly used to alter package markings were turned up in Los Angeles—a major question is: what can potential victims do to protect themselves? A survey of manufacturers, distributors, and users elicits some basic procedures that, when rigorously applied, are effective. In fact, several sources say that letting down their guard caused some users to get burned.

The bedrock recommendation, proclaimed by big semiconductor users to be more important even than testing and inspection, is "know from whom you're buying." While such advice might sound simplistic, ignoring it is perilous, officials agree. Roger Borovoy, vice president and general counsel at Intel Corp. of Santa Clara, Calif., observes that some customers try to bypass the traditional distributor "to save money or for faster delivery. That is where they get into trouble."

Even the big military-systems firms, where large inspection and testing staffs labor to insure quality,

stress this principle. John J. Tamsen, who manages reliability and maintainability assurance for the aerospace groups of Hughes Aircraft Co., Culver City, Calif., calls distributor relationships the real key to a company getting what it pays for. Hughes goes as far as running quality audits on distributors, which include actually watching how parts are broken out of large batches and handled internally.

Another military-space contractor, TRW Systems Group of Redondo Beach, Calif., performs quality surveys of distributors that lean heavily on how well the distributors' traceability codes document a part's path from manufacturer to user. "The best protection is to buy from a major vendor and keep up your surveillance," a TRW procurement official advises.

It works. One major distributor, Cramer Electronics Inc. of Newton, Mass. confirms that this technique works, and that large-volume customers keep a vigilant eye on its internal operations. Inspectors come in periodically, "concerned about semiconductors more than anything," a spokesman says.

Also, Cramer buys only from manufacturers and will not sell any product that doesn't originate from the manufacturer. The result is a record unblemished by phony components, the spokesman claims. Another distributor, Hamilton-Avnet of Avnet Inc., New York, N.Y., says it has protective procedures but won't describe them.

Right behind knowing your vendor is testing, the thoroughness of which is largely governed by expense. At the upper end of the semi-



conductor cost spectrum—microprocessors and custom integrated circuits—buyers are willing to pay for reliability. Beckman Instruments Inc., Fullerton, Calif., for one, screens and tests each ic, and has since 1971. The firm even has an independent testing laboratory do 96-hour burn-ins of all parts. "It adds to the cost," notes Robert Appel, reliability specialist, "but it's worth it." Part failure rate in assembly is down to one-tenth of the 4% prevailing before outside testing was started.

For cheaper, commodity-type devices, such as transistors, resistors, and capacitors, even the large systems houses mostly stick to a sampling approach. Rockwell International Corp.'s Autonetics Group in Anaheim, Calif., which found some faked transistors aboard the Space Shuttle [*Electronics*, Oct. 28, p. 59] has tightened its procedures considerably. For the most part, it sticks to buying from franchised distributors, but, when going to an alternate source, the firm demands certification of source and testing. Then random destructive testing is done

on "an appropriate sampling plan based on normal statistical practices," according to a spokesman.

While large-volume consumer product manufacturers would seem to be prime counterfeiting targets, this does not seem to be happening. "We have seen no examples of counterfeit parts," says James R. Smith, director of quality and reliability for RCA Corp.'s Consumer Electronics division in Indianapolis. "On occasion, when we try to buy something through a jobber, he'll send one manufacturer's part when we've ordered another's. But nothing has been misrepresented."

This record is largely due to rigorous incoming inspection procedures instituted by RCA and other television manufacturers. "We 'fingerprint' a part before we qualify it," Smith says, "and our incoming inspection, based on samples, is almost an ongoing qualification. In addition, we dissect almost 100% of failed devices and also track parts through production by, not only the date codes, but also the batch numbers." This routine analysis is good enough to uncover changes in die placements or in process techniques.

Dumping hurts. An industry practice that contributes to counterfeiting is dumping by the manufacturer of surplus or rejected parts, which become stock for the fly-by-night dealer. This is most widespread during business recessions. Some semiconductor firms are recognizing the short-sightedness of that custom, and many will not sell surplus parts because "the counterfeiters would take them and brand them," as Intel's Borovoy says.

Among the majors, both Intel and Fairchild Semiconductor, Mountain View, Calif., say they are developing internal techniques to prevent counterfeiting, but decline to describe them. But they and other Bay-Area semiconductor firms are said to be looking at some exotic countermeasures. One is introduction of tracer elements inside the package, to quickly identify a suspicious batch of parts. Others are marking them with a multitude of codes top and bottom or stamping on the lead frame to make remarking by anyone much more difficult. □

Now, a single integrated circuit, our TAD-32 (Tapped Analog Delay), can provide filtering with passband-to-stopband ratios of 40 DB or more per device. Simple variation of the clock sampling rates over 5 decades will accordingly shift a given filter characteristic. Transversal or recursive filters can be constructed with over 60DB dynamic range and linear phase. Tapped delays up to several hundred milliseconds are possible.

Discrete time analog signal processing using charge transfer devices is a reality at RETICON.

The TAD-32 is just one device in this growing family.

We don't just talk about them, we make them.

THIS DIP DOES IT ALL.

TAPPED DELAYS
MATCHED FILTERS
CORRELATION
CONVOLUTION



RETICON®

910 Benicia Avenue, Sunnyvale, California 94086
PHONE: (408) 738-4266 TWX: 910-339-9343

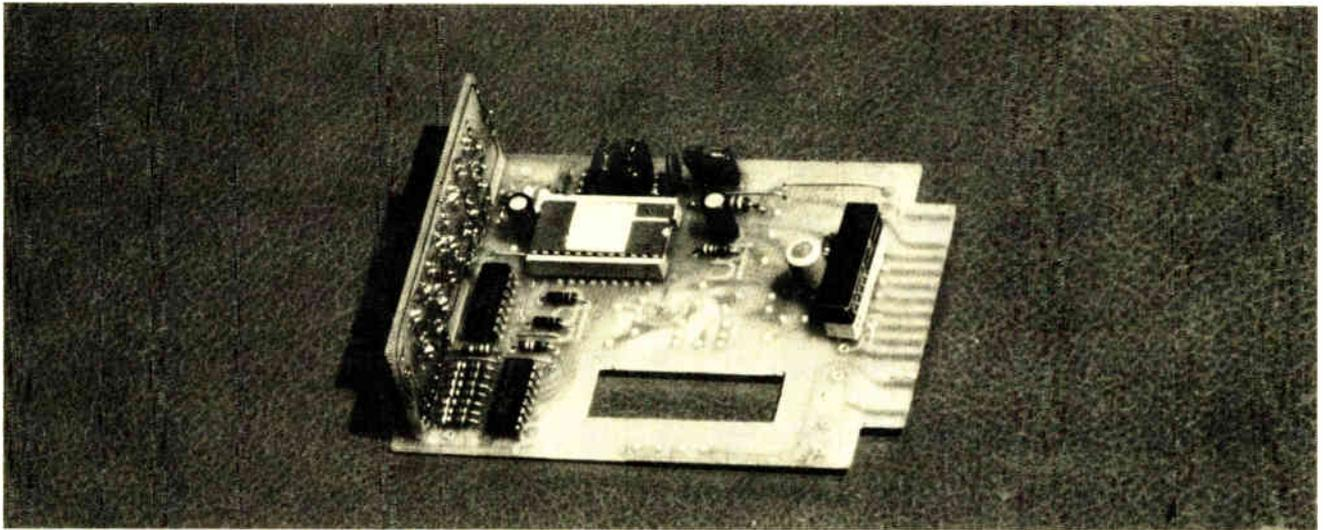

Low-priced DPMs to take two roads

Digital meters are expected to replace some analog units as prices drop and to find way into new applications

by Andy Santoni, Instrumentation Editor

The digital panel meter, heralded as the long-awaited digital replacement for analog instruments or as the wedge into new markets for the meter makers, may turn out to be both. The latest DPMs are still too expensive to replace analog devices—but price-competitive instruments may not be far off as semiconductor makers bring out new, lower-cost DPM chips.

Meanwhile, the DPM field is becoming segmented as the analog market did several years ago, says William Weir, marketing vice president at Weston Instruments Inc. in Newark, N.J. "Right now, we have two strong DPM segments: the classical high-priced, high-performance unit [selling for about \$70], and the new, much lower-priced [about \$40] and lower-performing DPM. I don't believe the lower segment is going to have any measurable effect on the higher-priced area, nor do I see the \$40 DPM having a measurable effect either on the \$10 or the \$40 analog-panel-meter segments."

Agreeing that the new low-priced DPMs won't replace analog instruments, Fred Katzmann goes a step further. Katzmann, president of Ballantine Laboratories Inc. in Boonton, N.J., says, "it appears there might be a new market developing for them." Although he, like his opposite numbers in the highly competitive instrument business, is reluctant to specify these new analog applications, they probably include microprocessor-based instrumentation. That's because the digital output of the more expensive DPMs analog-to-digital converter is not needed in such uses.

At Simpson Electric Co., Elgin, Ill., the thinking is perhaps typical of meter manufacturers. While marketing director Irving Linker says, "We haven't seen any real impact on our analog business from DPMs"—which Simpson also makes—he agrees that, as prices continue to drop, digital units will replace analogs in some places. "But there are some large markets that will never go digi-

tal," Linker maintains, naming trend measurement as one. "It will be a long while before they're used in battery-powered portable testers," he adds.

More coming. But Simpson will expand its digital family. By the end of this month, the firm will begin shipping a \$46, 3½-digit panel meter (shown above). It is accurate to within $\pm 1\%$, has automatic polarity indication, and has 0.43-inch light-emitting-diode readouts. The unit is built around a one-chip a-d converter from Motorola Semiconductor Products Inc. Next year, Simpson will add 3- and 4½-digit units.

Another DPM supplier with a low-priced instrument is Analog Devices Inc. of Norwood, Mass. Its 3-digit AD2026, selling for \$39 in hundred-piece quantities, uses a custom integrated-injection-logic chip from RCA [*Electronics*, Oct. 14, p. 34].

Charles Hasley, national sales manager at Newport Laboratories Inc. in Santa Ana, Calif., sees DPMs heading two ways: toward \$20 mod-

els for the analog replacement market and toward higher-priced instruments incorporating such functions as scaling, digital outputs, and systems interfacing. But price isn't the only consideration, he notes. DPMS aren't the same size as analog meters, so panels have to be replaced; they have printed-circuit connector contacts instead of threaded terminals, and they need a source of power.

One major question still unanswered is just how far the semiconductor firms now making DPM chips and modules will go toward building and selling complete meters. At RCA Solid State, Somerville, N.J. Robert Rauth, manager of industrial linear IC market planning, says his firm won't make either modules, which include conversion circuitry and display, or complete packaged instruments.

Texas Instruments plans to start delivering samples of two chips providing most of the circuitry needed to build a 4½-digit DPM. The set, to sell for \$15, consists of the TL 500, a bi-MOS analog chip, and the TL 502, an μ L logic control device.

All the way. But Fairchild Camera and Instrument Corp., Mountain View, Calif., takes a different approach. Its Semiconductor division makes light-emitting diodes, transistors, and ICs for DPMS, and its Instrumentation and Systems group assembles these and other parts into complete meters. The company has a 3½-digit panel meter that uses discrete transistors and sells for \$60 to \$70. It plans to introduce a \$30-\$40 unit next year. Later, a completely complementary-MOS, one-chip meter will be phased in.

National Semiconductor Corp.'s Jerry Zis, product marketing manager, says, "We plan to supply 3½- and 4½-digit modules by the middle of next year." The module would have to cost \$10 to \$15 so that a finished meter could sell for \$30 to \$40. Zis says the Santa Clara, Calif., company doesn't plan to get into the finished meter business. And Siliconix Inc., which makes two DPM components, plans to remain a component supplier. "The display is a major part of the cost of a DPM," says Art Fury, marketing vice president, "and we don't make them." □

The cool one from Tecnetics



55% efficiency in a 25 watt DC to DC Converter

Why pay for useless heat when you want power? That's the philosophy behind the new high efficiency 1200 Series 25 watt regulated converter from Tecnetics.

With efficiency as high as 55% at full load under normal conditions, an integral heat sink, improved circuitry and a black anodized aluminum case, this converter operates within a range of -20°C ambient to +100°C case temperature.

Available with a single output, this series features full input-output isolation to 500VDC allowing the user to change polarity and prevent ground loops. Compact size and sturdy barrier strip terminals make this the perfect converter for a wide

variety of military, industrial, aerospace and telecommunication applications.

For more information on the 1200, and hundreds of other power supplies, write for our 26 page catalog.

SPECIFICATIONS: 1200 Series 25 watt DC to DC converter

Inputs: 12 ± 2VDC to 48 ± 6VDC

Outputs: 12, 24, 28 and 48VDC

Dimensions: 5" x 4.1" x 1.25" (typ)

Weight: 16 oz.

Price: Single Output - \$198.00

tecnetics® The Power Conversion Specialists P.O. Box 910,
1625 Range Street, Boulder, Colorado 80302 (303) 442-3837 TWX 910-940-3246

Circle 79 on reader service card

CAREER OPPORTUNITIES

Usually the best opportunity to grow in your field lies within your present company. You have made an investment in them. They have an investment in you.

But occasionally the best opportunity lies somewhere else. No one can decide but you.

Companies looking for good people run their recruitment ads in our Classified Section in the back of this magazine. Perhaps you'll find an opportunity there that's worth following up.

Companies

Cybernet expects to stay on top

Haruki Tomonoh, president of the leading supplier of CB radios, pins hopes on automated production and wide distribution

Well before the post-oil-crisis boom in citizens' band transceivers in the United States, Cybernet Electronics Corp. of Kawasaki, Japan, set out to establish itself as a leading supplier. In a year's time, a combination of good luck and good timing have made the company number one with 40% of the CB market (according to Japan's Electronic Industries Association), despite the previous position of well-known firms, the overnight entry of some 200 newcomers and the fact that not a single set that it manufactures bears the Cybernet name.

But since the Federal Communications Commission has announced the expansion of CB frequencies from 23 to 40 channels in January and the simultaneous imposition of stricter compliance regulations, the transceiver market has been in a turmoil.

An interview in Japan with company president Haruki Tomonoh provides some insights into how Cybernet gained its position and how the firm hopes to stay on top.

Q. How would you describe the state of the citizens' band transceiver market?

A. There has been much confusion because we have to wait until January to sell the new models. I don't think the FCC fully understood the impact its decision would have on the market. Sales to dealers of 23-channel models have almost stopped.

Nevertheless, we estimate there will be a total of 20 million units sold in 1976. After that, demand should reach a level of about 10 million units a year. The change to 40 channels will change the makeup of the competition. By mid-1977 the number of companies making trans-



ceivers will probably drop to half the present number.

Q. Is the United States the only CB market; can't you look elsewhere around the world to expand your sales?

A. There are three factors that make a CB market: a large land space, a large population with buying power, and freedom of communications. Only the U.S. has all three.

Q. What effect will auto companies installing transceivers as original equipment have on Cybernet's business?

A. We see in-dash CB as two possible products: First as a unified CB and a-m/fm combination produced for the auto companies and second as a separate CB kit or part supplied to the regular auto-radio makers to put into their combination radios. Both products need high volume—perhaps 500,000 units a month—to bring down the cost of the ICs used to make in-dash units as small as possible.

Q. How do you account for the rapid growth of Cybernet?

A. Most people believe that the oil crisis brought about the boom in CB

radios, but it was only the trigger. Before the boom, we made a survey to find out why CB was not growing faster in America. We found that people wanted to use this personal form of communication but believed that the transceivers were too complicated. On the technical side, we found that failure rates were high and prices were also high.

Why did these conditions exist? We found that, even though production quantities were limited, there were many different models offered by each manufacturer.

Starting with this survey, Cybernet made important changes. First, we decided to design a transceiver that would be easy to use. Then we designed all our models around the same circuit to simplify production and provide room to cut costs through volume. Finally, we set up automated production lines to provide flexibility to expand capacity at short notice.

Our first automated factory has a capacity of 300,000 units a month and employs 800 workers. Our second automated facility has a capacity of 250,000 units a month, but has only 450 employees. We have two other semi-automated facilities making the combined capacity 900,000 units a month.

Cybernet's sales channels in the United States consist of automobile companies, consumer-product companies, CB specialists, importers, and after-market auto-supply companies. You have to have all five; otherwise you miss a share of the market. However, Cybernet will remain an OEM supplier. With this marketing arrangement, we couldn't have our own brand-name products. □

Industry asked us for hundreds of variations of these switches. Evidently we're pushing the right buttons.



And we intend to keep pushing them.

So that every time one of your new ideas creates a design problem, MICRO SWITCH will be ready with the miniature manual switch that solves it.

At last count, we offered hundreds.

The Series 8 lineup of miniature manuals includes toggles, pushbuttons, paddles and lighted or unlighted rockers. They're UL listed at 6 amp, 125 VAC. And every one is available in a low energy version as well.

Choose terminal variations ranging from solder to quick-connect to PC board or wire wrap. There's also a choice of panel and bushing-sealed pushbuttons and toggles. And non-threaded bushings on PC mounted toggles. Even colored sleeves and integral colored tips for the toggles.

And of course, you'll find one feature you won't find anywhere else—the quality you've come to expect from MICRO SWITCH. Series 8 switches are inspected to a 1% Acceptable Quality Level (AQL).

That's quality you can put your finger on.

For your immediate product needs, see your nearest MICRO SWITCH Authorized Distributor. If you have other requirements, contact a MICRO SWITCH Branch Office or call 815/235-6600.

MICRO SWITCH
FREEPORT, ILLINOIS 61032
A DIVISION OF HONEYWELL

MICRO SWITCH products are available worldwide through Honeywell International.

Circle 80 for Data.

Circle 111 for Salesman call.

If you think Mostek's only industry standard memory is the 4K RAM, forget it!

Our 4116 was setting standards even before it hit volume production. It's the smallest, fastest, most flexible and reliable 16K RAM in the industry. These are strong claims, but we've got the facts to back them up.

Speed/Power. We have the industry's two fastest 16K RAMs: The MK4116P-2 at 150 ns access time and 375 ns cycle time. And the MK4116P-3 at 200 ns access time and 375 ns cycle time. Max power ratings are 462 mW active and 20 mW standby.

Easy to Use. Mostek's 4116 features $\pm 10\%$ tolerance on all power supplies (+12V, $\pm 5V$.) This is a Mostek exclusive but you should expect it from all of your memory suppliers. Also, the 4116 features Schottky-TTL compatibility for truly high performance systems.

Unlatched Outputs. You asked for it, you

got it. And the reasons are self-evident: A common I/O data bus. Full control of data out, thereby controlling the length of valid output time. Extension of page mode boundaries beyond the 128 column locations in a single chip. And two methods of chip select.

Operation Flexibility. The 4116 offers greater versatility in operating modes — read, write, read-write, read-modify-write, and page mode. The unique page mode allows for successive memory operations at multiple column locations of the same row address. Access time during page mode is just 100 ns for the MK4116P-2 and 135 ns for the MK4116P-3.

Reliability. Mostek memories are recognized as the quality standard throughout the industry. And for good reason. Every memory circuit we make — and that includes the 16K

Introducing Mostek's industry

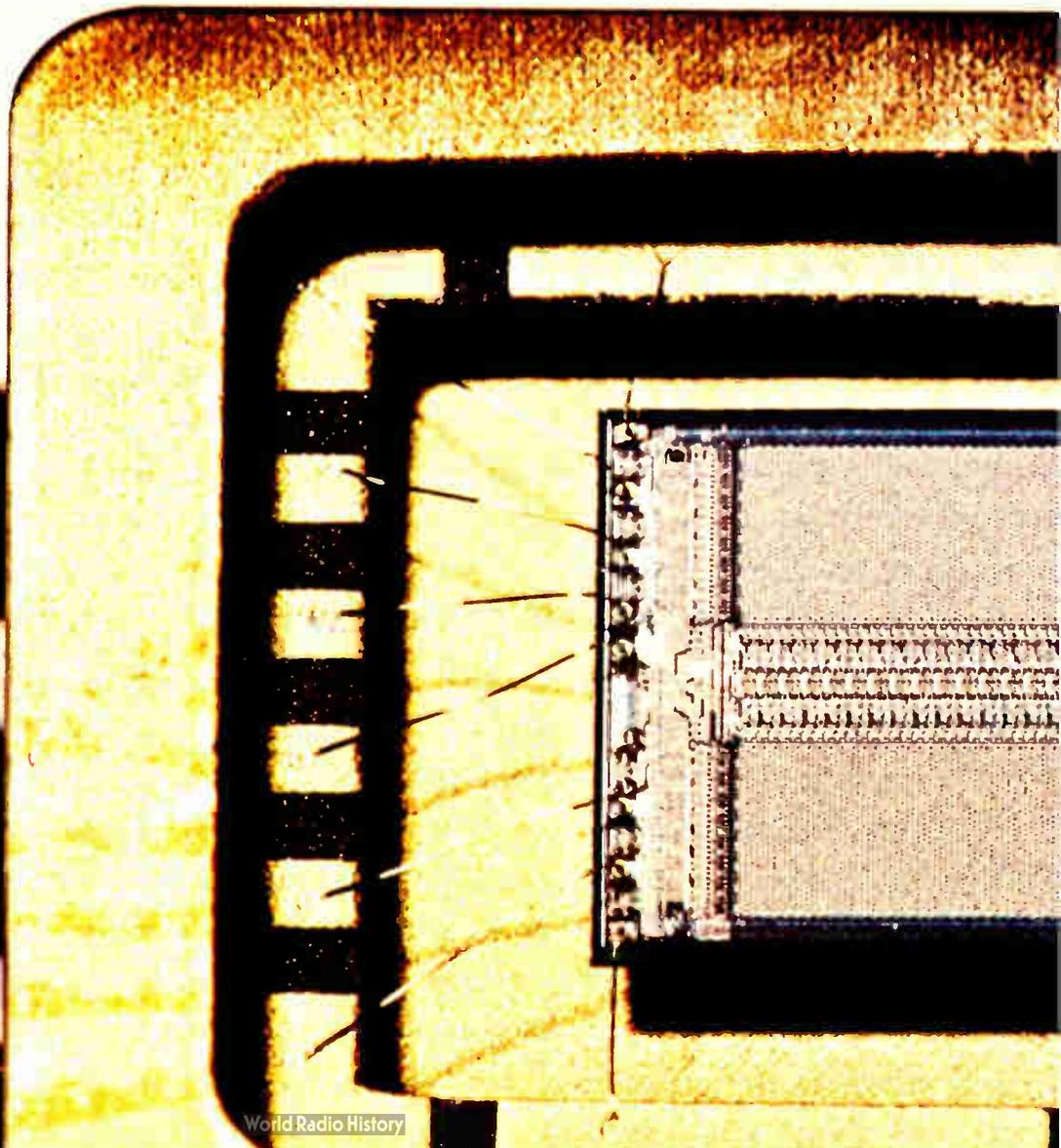

RAM — goes through an arduous series of screens and stresses: Full parametric pre-burn-in testing. Temperature cycling. Centrifuge. Dynamic burn-in at 125°C. And final test at high temperature with wide guardbands. Want proof? Ask our customers.

Processing. Mostek's state-of-the-art POLY-II™ process (double-level polysilicon) is an evolution of the N channel, silicon-gate process — the same process used with our high-performance 4027 4K RAM. And POLY-II™ is now a production-proven process.

Chip Size. At 122 mils x 227 mils, Mostek's 4116 is the smallest in the industry. 22% smaller than Intel's and 59% smaller than TI's. Remember, smaller chip sizes mean increased manufacturing productivity.

Mostek is the recognized leader in 16-pin

4K RAMs, shipping more 16-pin 4K's than all other manufacturers combined. This same production know-how will make Mostek the industry's largest producer of 16K RAMs in 1977.

How about alternate sources? Eleven other manufacturers planning to build 16K RAMs are designing for pin compatibility as well as functional compatibility with Mostek.

There are lots more facts on Mostek's industry standard 16K RAM. Just drop a note on your letterhead or call your Mostek sales representative.

MOSTEK

setting industry standards

1215 W. Crosby Rd., Carrollton, Texas 75006
214/242-0444

In Europe, contact:
MOSTEK GmbH, TALSTR. 172, 7024 Filderstadt-1,
West Germany
Telephone: (0711) 701096

standard 16K RAM. The 4116.

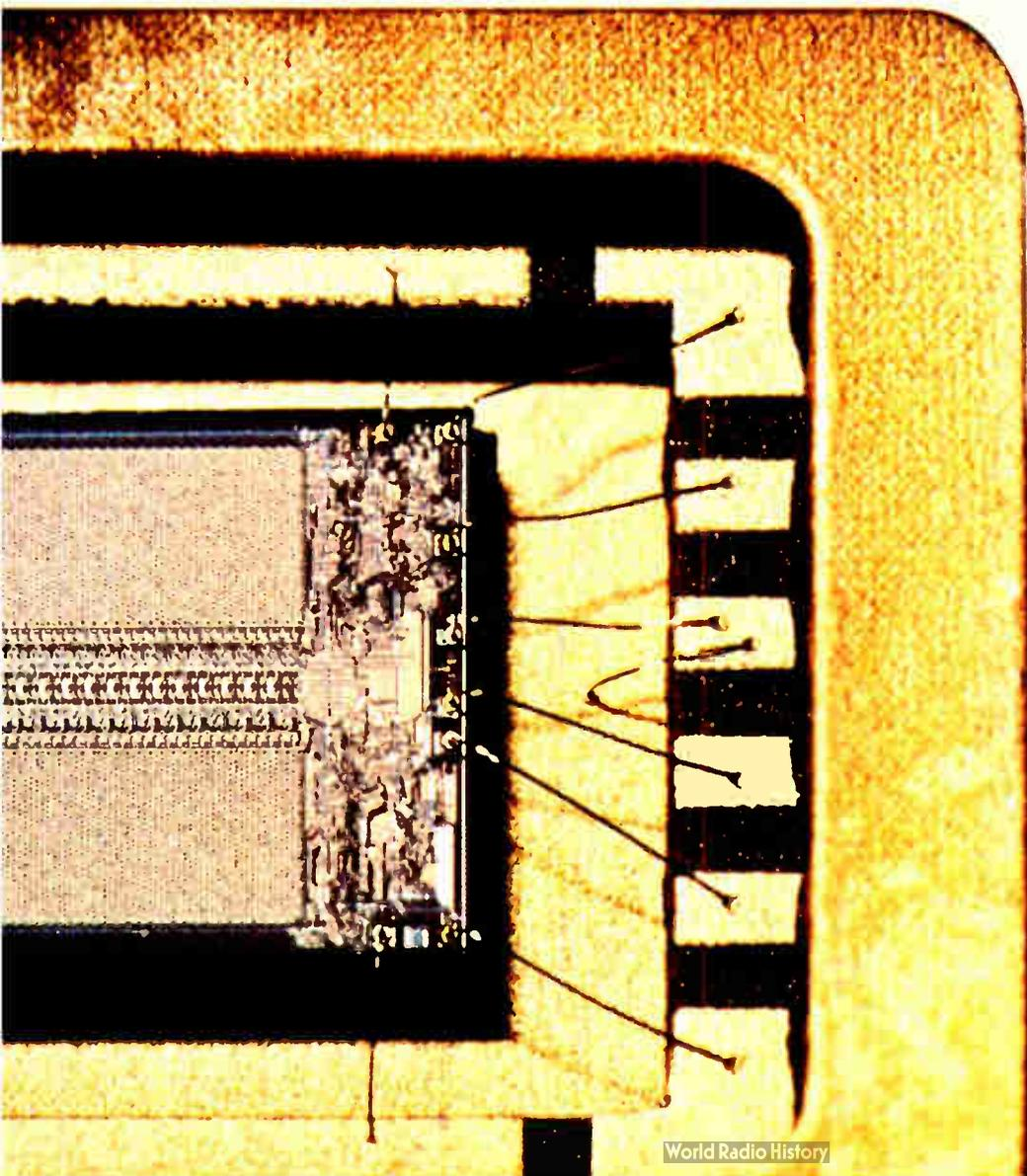

Circle 83 on reader service card

NEW FROM KEITHLEY: TWO "BEST BUY" DMMs.



Model 173



Model 172

**4½ DIGITS. 30000 COUNTS.
UNDER \$500.**

Advanced features are found in both these general-purpose DMMs:

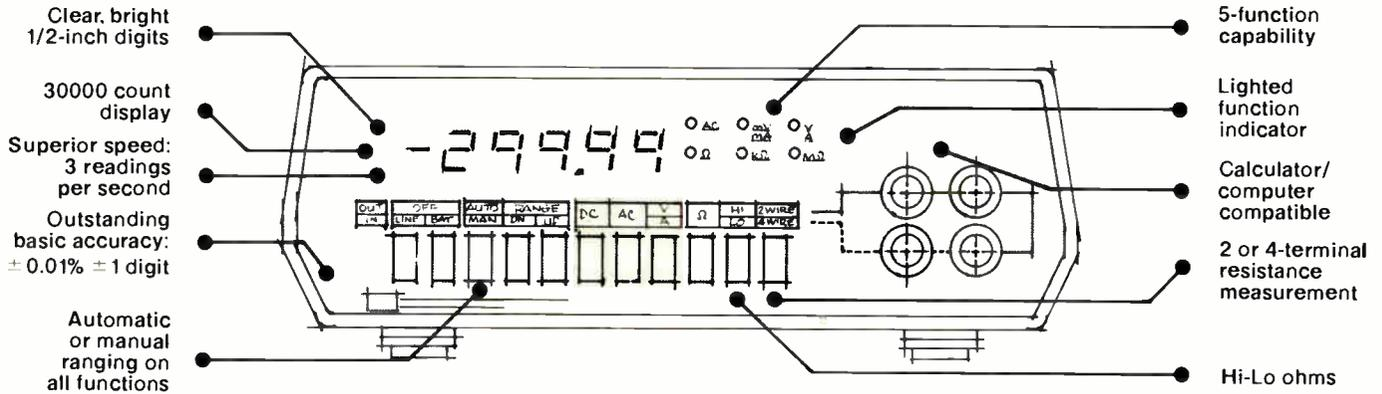

Take a look at the remarkable features of the new Keithley Digital Multimeters. They're unmatched in the industry.

Now consider price. At \$499 we think you'll agree the Keithley 172 is the best buy in a general purpose 4½-digit DMM.

There isn't another 4½ that matches the price-performance value of the 172. Except for its higher-rated companion, the Keithley 173.

For \$499: the exceptional 172.

To begin with, you get a dependable, durable, portable, easy-to-use, autoranging instrument with five functions. Designed for research, engineering or production applications.

Measure from 10 microvolts to 1200 volts dc, 10 microvolts to 1000 volts ac, 10 milliohms to 300 megohms, 10 microamps to 2 amps, ac or dc. DC accuracy is 0.01% ± 1 digit.

There's more: 3 month recal cycle. No-nonsense, full-year guarantee on parts, workmanship, and specs. 30000-count display yields maximum accuracy for 15, 18, 24 and 28-volt measurements.

For \$625: the even more exceptional 173.

The Keithley 173 is our top-rated 4½-digit DMM. It gives you all the performance and accuracy of the 172 plus superior autoranging current measurements from 10 nanoamps to 3 amps. This makes the 173 the most complete and versatile general purpose 4½-digit DMM in the world — at any price.

More versatility. Now or later.

Options and accessories expand the 172 or 173 to your specific needs: Rechargeable battery pack you can buy now or add later. Digital output/control. RF probe. 50-amp shunt. Clamp-

on ammeter. High-voltage probe. Rack mount kits. Test lead sets. Carrying case. IEEE 488 interface.

Make this easy decision.

For most 4½-digit DMM applications, the new Keithley 172 is your best buy. When you require more current measuring capability, the 173 is.

For convincing proof, send for detailed specs or request a demonstration. Or if you're already convinced, send your order to: Keithley Instruments, 28775 Aurora Road, Cleveland, Ohio 44139. (216) 248-0400. Europe: Heiglhofstrasse 5, D-8000 München 70, West Germany. (089) 7144065.

DMMs for all your needs.

We know you have a variety of measurement requirements. So we offer a growing family of DMMs to meet your application and price objectives. Send for details.



3½ digits

4½ digits

5½ & 6½ digits

Model 168
General purpose.
Low cost.

Model 160B
1 μV and 10 pA
sensitivity.

Model 616
Super-sensitive.
0.1 pA full-scale.

Models 172 and 173
Two "Best-Buys!"

Model 171
1 μV sensitivity.
5-functions.

Model 174
0.1 μV sensitivity.
(coming soon)

Model 180
30 nV sensitivity.

Model 190
Multi-function.
Low cost.

Model 5900
0.001% accuracy.
High stability.

Model 6900
Accuracy, stability
and sensitivity
measured in ppm.

KEITHLEY

The measurement engineers.

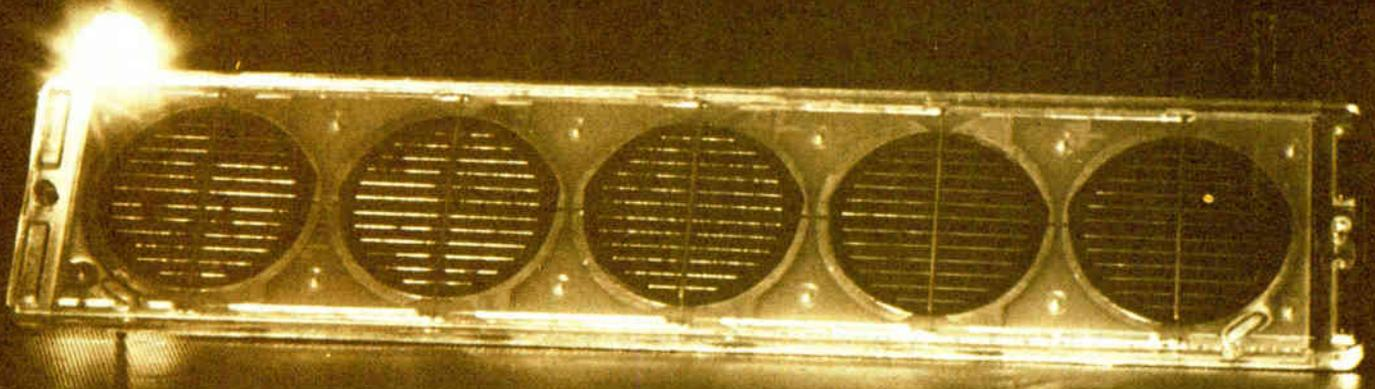

From photons to kilowatts: can solar technology deliver?

Lower-cost, more efficient solar cells are crucial, says Part 1
of this two-part report on photovoltaics today

by Joel duBow, *Colorado State University, Fort Collins, Colo.*

□ The direct conversion of sunlight into electrical power promises to provide energy that is both abundant and inexpensive. Although it's not a viable worldwide business yet, photovoltaics for terrestrial use is developing fast as a technology. And because of all the recent encouraging progress in the U.S., Japan, and Europe (see p. 92), it's quite possible that multimegawatt power plants based on solar light energy will be operational by the turn of the century.

Solar cells are the key

The success of photovoltaic power systems depends on the availability of solar cells that are sufficiently economical and efficient. Since solar cells represent the first stage in converting sunlight to usable electrical

power, overall systems costs are especially sensitive to the price and performance of the cells themselves and their associated hardware. In fact, even small changes in cell efficiency or cost can have important implications for system efficiency and cost.

Outlook is bright

Significant advances are being reported. The cost of conventional solar cells has been cut in half, and many new and promising types of cells are being developed. In the concerted effort to obtain economical power from them, even research bordering on technologies formerly considered esoteric is being brought to the forefront.

However, the present cost—approximately \$15 per peak watt—of photovoltaic arrays is still 30 to 50 times

too high to compete with fossil fuels. An order-of-magnitude reduction in individual-cell and array costs by 1986 is the present goal of the U.S. Energy Research and Development Administration, and some recent projections indicate that this goal could well be achieved.

Reviewing solar-cell basics

A solar cell is actually a semiconductor photodiode that is optimized to convert sunlight into electrical power efficiently. Although a diode is the oldest form of semiconductor device, much is still unknown concerning its performance limitations—particularly when it is used as a photoconverter.

Every solar cell has seven basic elements, as the structure of a typical device shown in Fig. 1a makes clear. It consists of a base material that forms one side of the junction, a diffused or deposited region that forms the other side of the junction, an anti-reflection coating to boost efficiency, front and back contact grids to reduce series resistance, and a transparent adhesive and cover glass to improve the environmental stability of the cell.

Figure 1b illustrates the electrical characteristics of a typical cell. In the absence of light, the device behaves as a conventional junction diode. But when illuminated, it exhibits a reverse current (I_{sc}) without the application of an external voltage and generates a voltage (V_{oc}) even with no current flowing. That fraction of the maximum output power ($V_{oc} \times I_{sc}$) available for delivery to a load is called the fill factor.

The traditional base materials for solar cells are silicon (Si) and cadmium sulfide (CdS). But a number of other possible semiconducting materials are being explored, including gallium arsenide (GaAs) and thin films of indium phosphide (InP), amorphous Si, or cadmium telluride (CdTe), as well as various combinations of these materials.

Silicon cells are the most promising

Since Si is the most highly developed semiconductor technology, it is the most promising material for solar cells. However, even for optimized versions of present-day technologies, Si solar cells cannot achieve the

required ERDA cost goals. At this time, the cost of single-crystal Si starting material is higher than the maximum permissible cost of completed cells under current ERDA targets. The main research efforts going into reducing the cost of current Si cell designs include lowering materials costs, automation of device processing, and development of low-cost materials like polycrystalline and metallurgical Si.

The most efficient Si cell is the nonreflecting structure (Fig. 2a), which can yield efficiencies as high as 18%. It has a textured upper surface that collects a large percentage of reflected light and minimizes the distance photogenerated carriers must diffuse before collection. However, this cell's voltage output is lower than desirable, and its response to short wavelengths is limited.

Two other Si solar-cell structures look very promising because of their potential for low cost and relatively high performance. One is the heterojunction structure (Fig. 2b), in which a thin layer of a semiconductor other than Si is deposited on a Si base, forming a diode between the two dissimilar materials. The other is the Schottky-barrier structure (Fig. 2c) that is made by depositing a thin metallic layer on the Si to create a diode.

Heterojunction Si solar cells are made from tin oxide (SnO_2), indium oxide (In_2O_3), CdS, or gallium phosphide (GaP) deposited on n- or p-type Si. Efficiencies of up to 10% may be achieved with SnO_2 on n-type Si, close to 6% with CdS on p-type silicon, and as high as 12% with indium-tin oxide on p-type Si.

Process simpler for heterojunction cells

Unlike the nonreflecting configuration, the heterojunction Si solar cell has no surface dead layer caused by low-lifetime, highly doped, diffused regions. So, its short-wavelength response is better, and its processing is simpler, as well as amenable to continuous-flow manufacturing. However, the junction interface itself must be carefully controlled because it critically affects device performance.

The Schottky-barrier Si cell also features good short-wavelength response. In addition, it does not require processing at elevated temperatures. Efficiencies of up to 8% have been obtained with aluminum (Al) as the

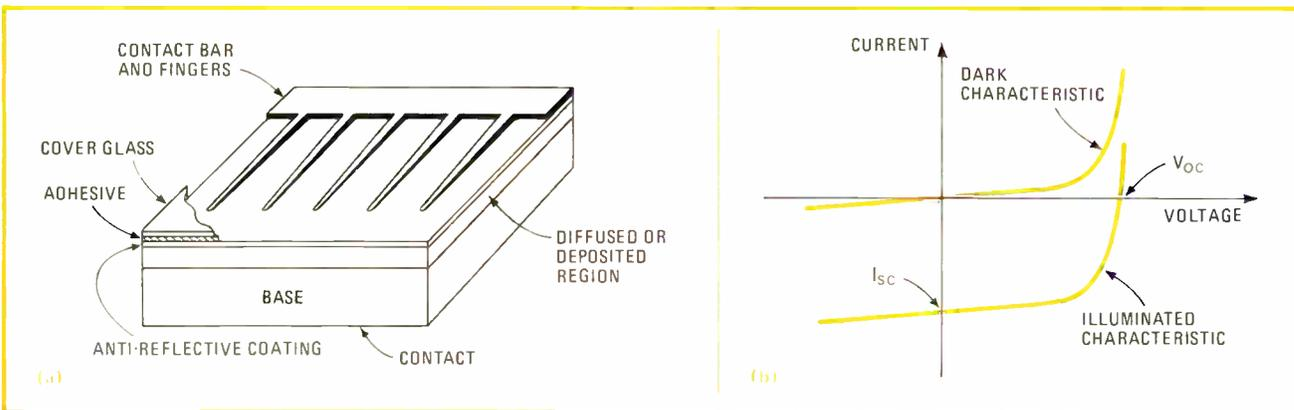

1. Typical solar cell. Essentially, a solar cell is a semiconductor photodiode. It is made up of seven structural elements (a), starting with a base contact and topped by a cover glass. Electrically (b), it behaves like a conventional junction diode when not illuminated. But when illuminated, it develops a small electrical signal, even though no external bias voltage or current is applied.

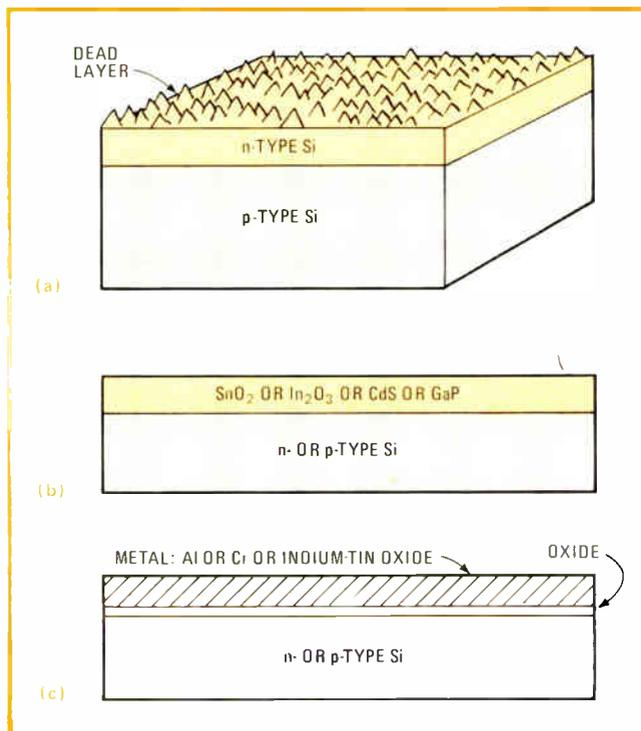

2. Good efficiency with silicon. Solar cells based on Si provide reasonable efficiencies—on the order of 15%—at reasonable cost. Several variations look quite promising—among them nonreflecting (a), heterojunction (b), and Schottky-barrier (c) structures.

barrier metal, increasing slightly to 8.6% when chromium (Cr) is the barrier metal.

Heterojunction Si cells are particularly attractive because they require only very small amounts of fairly scarce materials. Since the top layer of a heterojunction cell is typically about 1 micrometer thick, only a small volume of a rare metal, like indium, is needed for a comparatively large surface area.

Tandem cells boost efficiency

Additionally, heterojunction devices permit the construction of tandem cells, which consist of two pn junctions placed back to back. When a metal Schottky barrier or another type of semiconductor junction is deposited on the top layer of a heterojunction cell, creating a tandem cell, photovoltaic conversion occurs in both the top and bottom junctions.

If both junctions are suitably connected, the conversion efficiency of each junction adds, so that efficiencies as high as 40% are possible. Although no commercial tandem structures are currently available, development devices based on either Si or GaAs having conversion efficiencies in excess of 25% are being investigated.

Variations look worthwhile

Both heterojunction and Schottky-barrier Si cells look especially promising for implementation with low-cost Si materials because both are deposited, rather than diffused, structures. Diffusion is not possible with inexpensive ribbon or polycrystalline Si because the high concentration of grain boundaries and defects in these materials leads to uneven diffusion profiles, as well as

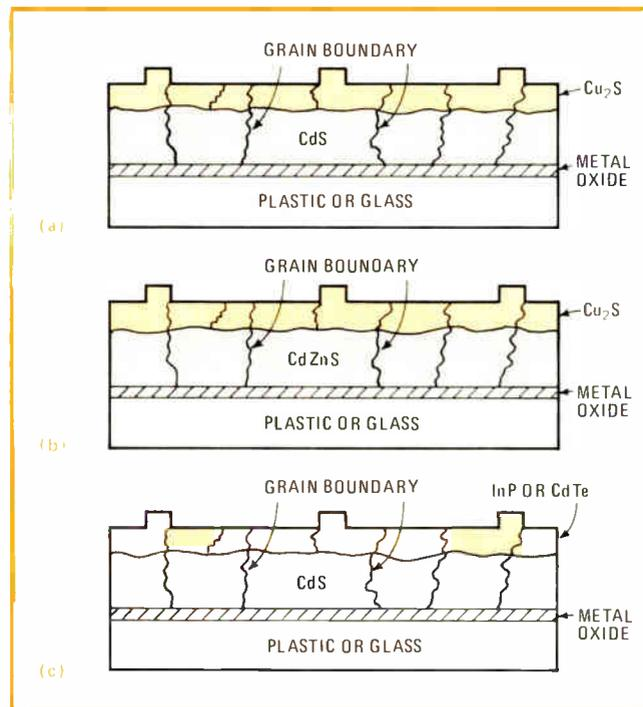

3. Cadmium sulfide for low cost. Although they deliver efficiencies of around only 6%, CdS solar cells are cheapest. They can be built on inexpensive substrates, like plastic or glass, with a cuprous-sulfide coating over either CdS (a) or cadmium zinc sulfide (b), or with either indium phosphide or cadmium telluride over CdS (c).

junction short-circuiting. In general, heterojunction and Schottky-barrier technologies require further development before commercial devices become available.

Another variation in Si cells—oxide semiconductors on Si—is starting to receive a lot of attention. These devices combine the advantages of heterojunction and Schottky-barrier structures. With indium-tin oxide, which is highly transparent and also highly conductive, efficiencies of up to 12% have been achieved with an oxide-semiconductor-on-Si structure.

And interest in metal-insulator-semiconductor solar cells is increasing. In these structures, a thin insulating layer, only 10 to 20 angstroms thick, separates a metallic layer and a semiconductor layer, which is usually Si. The insulator must be thin enough to reduce the short-circuit current only slightly, while yielding an increased open-circuit voltage. Efficiency is somewhat higher than that of Schottky-barrier cells. Both oxide-semiconductor and Schottky-barrier devices are being built as metal-insulator-semiconductor configurations.

Costs lowest for cadmium sulfide

Silicon solar cells combine reasonable efficiency—on the order of 15%—with reasonable cost. However, recent systems studies indicate that if solar cells were free, conversion efficiency need be merely about 6% to produce energy economically. If this hypothesis proves to be true, then CdS cells may well fit the bill—they are the least expensive of all solar cells, but have the lowest conversion efficiencies, only around 6% to 8%.

Figure 3a depicts a typical CdS cell, consisting of polycrystalline CdS deposited on an inexpensive glass or

plastic base. The CdS is then covered by a coating of cuprous sulfide (Cu₂S). Although they are the least-expensive solar cells on a per-unit-area basis, CdS devices are plagued by low efficiencies and by stability problems that reduce their effective lifetime.

At present, the efficiency of these cells is too low for them to be viable options for terrestrial applications. However, their low fabrication cost and the large body of expertise developed about them over many years are bringing about a number of other potentially viable structures based on CdS.

Principally, three other configurations of CdS cells are now being investigated—cadmium-zinc-sulfide (CdZnS) devices (Fig. 3b) and cells (Fig. 3c) fabricated on single-crystal CdS where the top layer is either InP or CdTe, replacing the Cu₂S coating of conventional CdS devices. Efficiencies of up to 15% have been obtained from CdZnS structures, close to 13% from cells coated with InP, and up to 7% from those coated with CdTe.

Concentrating sunlight on gallium arsenide

One technique for minimizing the effect of solar-cell fabrication costs on overall systems cost is to intensify the sunlight that shines on a cell. For example, GaAs

cells are at least 100 times more expensive than Si devices. However, if sunlight were concentrated by a factor, say, of 1,000, then the combined costs of their fabrication and the associated systems hardware could be less than the cost of making 1,000 cells that operate from unconcentrated sunlight. Moreover, concentrated sunlight causes the cell to operate at an elevated temperature, enabling it to convert both solar light energy and solar thermal energy into electrical power for higher overall systems efficiency.

Benefiting from solar thermal energy

On the whole, GaAs cells (Fig. 4a) are expensive small-area devices that are useful primarily at high concentration factors and elevated temperatures, which can be up in the range of 250°C to 300°C. As shown by the efficiency plot of Fig. 4b, for a concentration factor of 1,000 suns, combined photovoltaic and photothermal conversion efficiencies can be as high as 25%.

Although such overall efficiency numbers are impressive, a number of feasibility factors must be evaluated for these GaAs concentrator cells, including their susceptibility to environmental contamination, their performance in diffused sunlight, and the costs of maintenance

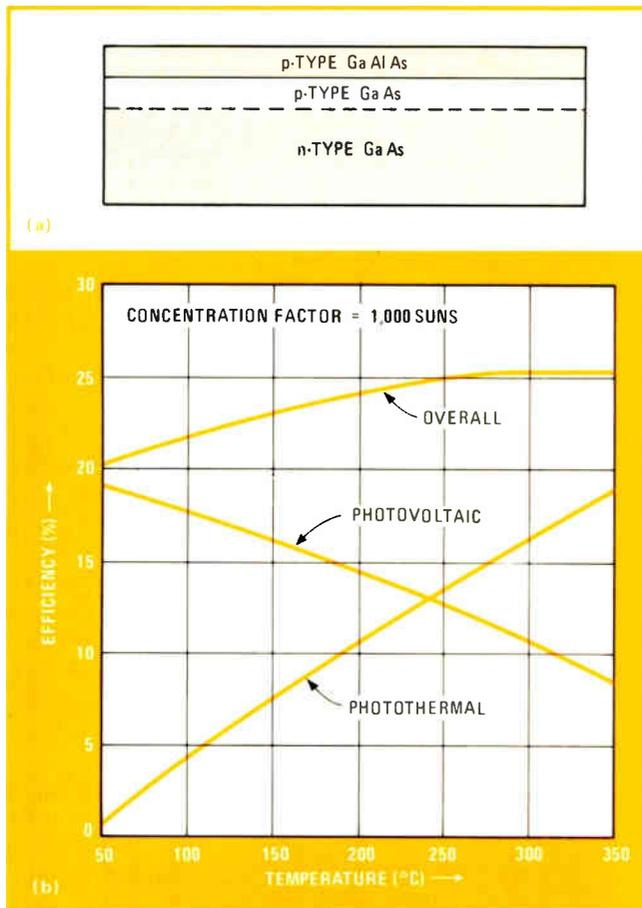

4. For concentrated sunlight. The high cost of fabricating gallium-arsenide cells (a) can be offset to a large extent by intensifying the sunlight that shines on them. What's more, concentrating sunlight raises cell operating temperature, so that both solar light energy and solar thermal energy can be converted into electrical power. The result, as shown in (b), is high overall efficiency.

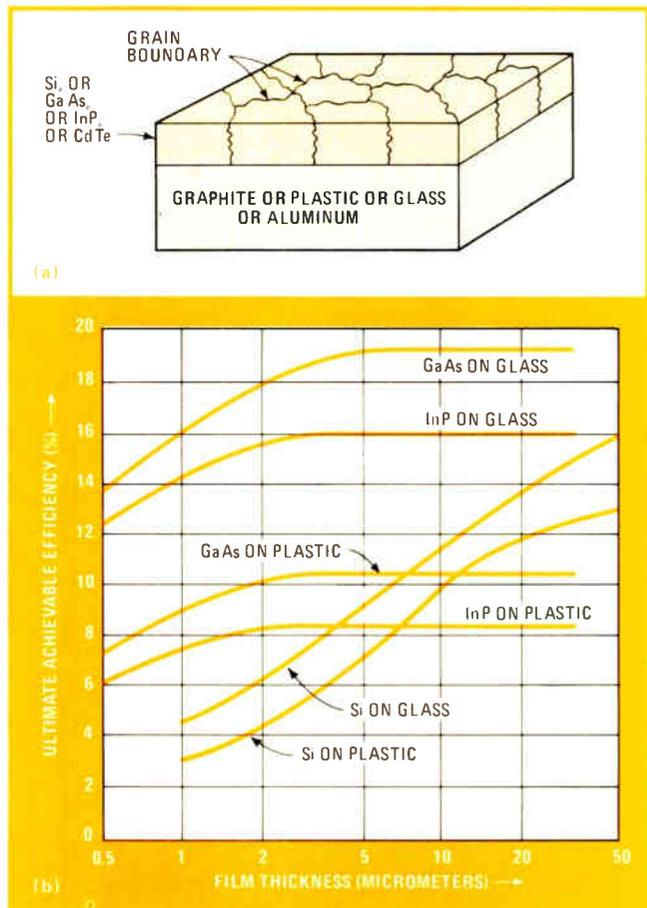

5. Low cost but not yet practical. Solar cells (a) made with thin films of polycrystalline semiconductors on inexpensive substrates hold the promise of reasonable efficiencies at low fabrication costs. The curves (b) show the theoretical efficiencies achievable for various combinations of substrates and semiconductor films, as a function of the thickness of the semiconductor film.

PERFORMANCE SUMMARY OF PRESENT SOLAR CELLS

Family	Structure	Efficiency (%)	Open-circuit voltage (V)	Short-circuit current density (mA/cm ²)	Fill factor (%)	Comments
Silicon	conventional	12 – 16	0.55	35	73 – 76	cost now \$15/W, commercially available
	nonreflecting	18	0.6	36	75	highest efficiency conventional cell
	heterojunction	6 – 10	0.5	15 – 25	0.5 – 0.7	still in research stage
	Schottky barrier	8 – 10	0.55	24	0.67	—
	indium tin oxide on Si	12	0.5	32	0.7	oxide semiconductor on Si structure
	tin oxide on Si	10	0.54	28	0.63	has stability problems
Cadmium sulfide	conventional	5 – 8	0.5	25	65 – 75	lowest cost
	Cd Zn S	15	0.68	28	67	single crystal structure
	InP on CdS	12.5	0.65	20	0.67	single crystal structure
	CdTe on CdS	7	0.5	17.2	0.6	single crystal structure
	cuprous indium selenide on CdS	5.7	0.4	27	0.5	—
Gallium arsenide	heterojunction	23	0.9	35	0.8	mainly for concentrator applications
	Schottky barrier	15	0.9	16	0.7	metal insulator semiconductor structure
Thin film	Si on graphite	5	0.5	17	0.6	polycrystalline Si structure
	amorphous Si on glass	5.5	0.8	10	0.58	—
	CdS on plastic	5.2	0.4	20	0.5	—
	indium tin oxide on CdTe	7.4	0.6	16	0.6	—

and hardware. In general, these cells are being considered principally for use in central power stations, as opposed to homes.

Conventional Si solar cells can also operate at concentrated sunlight levels, but the factors must be fairly low—on the order of 10 to 25—or else special cooling becomes necessary. However, it's quite possible that conventional Si cells, operating at low concentration ratios with inexpensive hardware, may be the most economical near-term photovoltaic technology for terrestrial use.

What's more, modifying the Si cell to a vertical multijunction structure enables it to operate at concentration factors as high as several hundred suns. Such a structure consists of a string of vertically oriented junctions formed by alternating adjacent regions of n- and p-type Si. But the fabrication cost of these devices is rather high, so—like GaAs concentrator cells—they are limited to power-station applications.

Cost projections promising for thin films

Solar cells can also be formed with thin films of polycrystalline semiconductors on inexpensive substrates. If reasonable efficiencies are achieved, thin-film cells could offer the low cost required for large-scale terrestrial photovoltaic applications.

For a typical thin-film structure (Fig. 5a), the key material parameters are grain size, grain orientation, and device thickness. Since material grain boundaries act as current sinks for photogenerated carriers, large

grain sizes are needed to ensure reasonable carrier collection efficiency. Moreover, a fibrous orientation, with grains extending vertically throughout the thickness of the film, is preferable to a more random orientation of the semiconductor grains.

Figure 5b shows the ultimate achievable efficiencies for various single-crystal thin-film structures as a function of film thickness. The minimum thickness of the thin polycrystalline film depends on the optical properties of the material itself.

Thin films not practical yet

Many of the thin-film cells represented in this graph are still theoretical devices. In practice, efficiencies of up to 4% have been achieved with a 10-μm film of CdTe on glass, nearly 5% with a 15-μm film of GaAs on Al, over 5% with an 8-μm film of CdS on plastic, and up to 5% with a 10-μm film of polycrystalline Si on a substrate made of graphite.

The table summarizes the performance of practically realizable solar cells. However, most of the structures listed here are still in the laboratory stage of development. Only conventional Si cells are commercially available at this time, although conventional CdS cells may soon also become available commercially. □

Bibliography

- A. Rothwarf and K. Böer, "Direct Conversion of Solar Energy Through Photovoltaic Cells," *Progress in Solid State Chemistry*, Vol. 10, pp. 71 – 102, 1975.
- H. Hovel, "Solar Cells: Semiconductors and Semimetals," Vol. 11, Academic Press, 1975.
- Proceedings of IEEE Photovoltaic Specialists Conference, Scottsdale, Ariz., 1975, and Baton Rouge, La., 1976.

Companies look for ways to raise solar-cell output

A specialized market exists, but only volume production will make energy from sunlight competitive with fossil fuels, says Part 2 of this special report on photovoltaics

by Lawrence Curran,
Senior Editor

□ Companies and governments the world over are busying themselves with photovoltaic cells. Already arrays of these cells are sitting on mountaintops, in deserts, or on oil-rigs out at sea, turning sunlight into electrical power at sites that cannot economically link up with the conventional ac grid. But the goal is more ambitious: photovoltaic energy that is cost-competitive for routine power-generation applications.

The main obstacle to commercial success seems to be not technology but the inability to produce efficient enough cells in enough volume. On that both cell makers and the U.S. Energy Research and Development Administration agree. But as to how soon that will change, opinions differ.

The problem is being attacked from many angles. Single-crystal silicon solar cells are still getting most of the attention in the U.S. and abroad. Cadmium sulfide and gallium arsenide are considered to be in the second generation of materials that will emerge between 1980 and 1985, as are polycrystalline and thin-film silicon. The conversion efficiency of silicon cells in production quantities with good yields has inched upward from 10% to 12% in the past two years. The use of sunlight concentrators to boost array power output is fast becoming attractive. And the price of a peak watt of electricity generated by photovoltaic cells has been cut in half—down to about \$15—in less than two years.

ERDA is justifiably proud of that \$15 figure (see

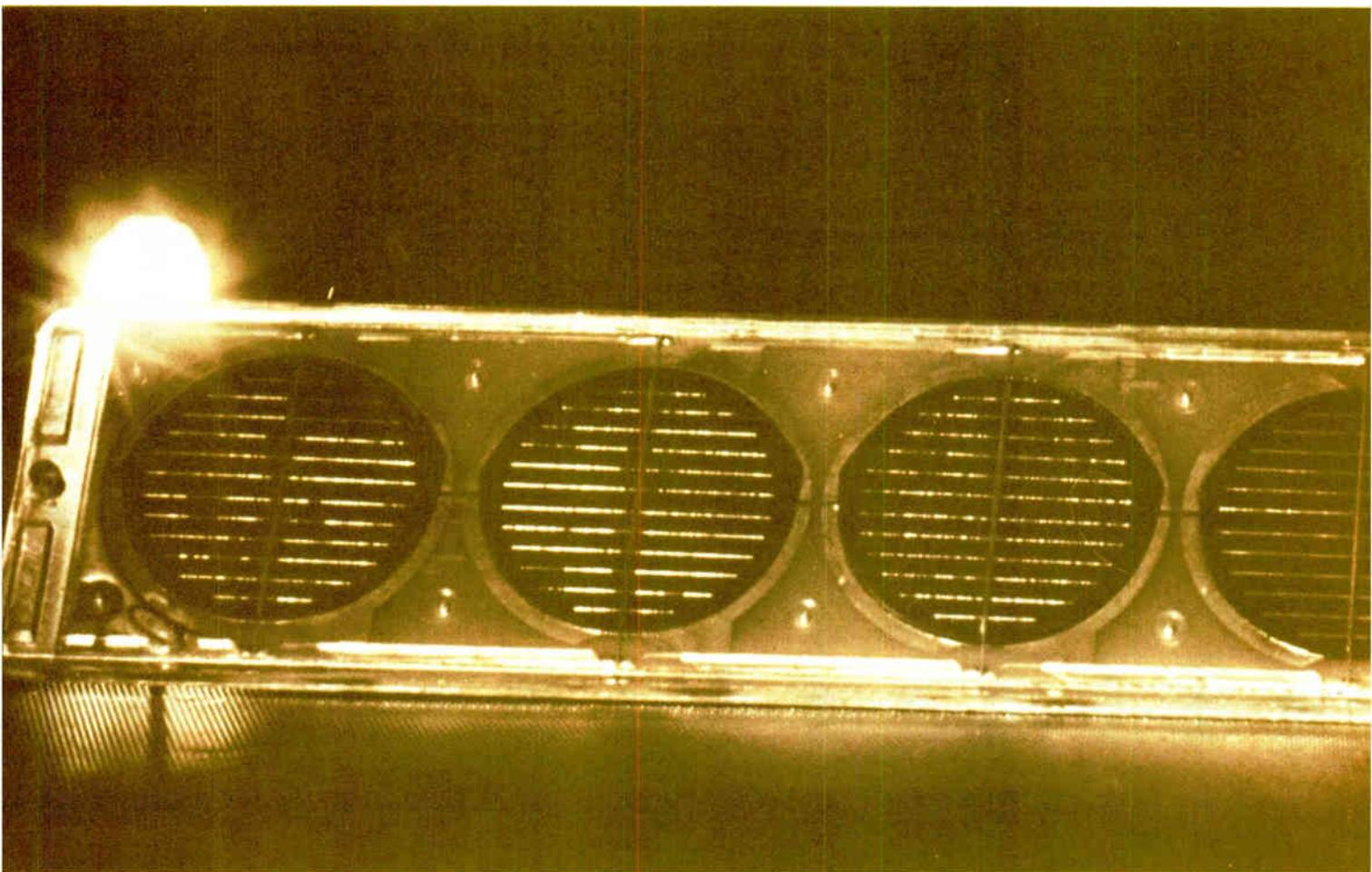

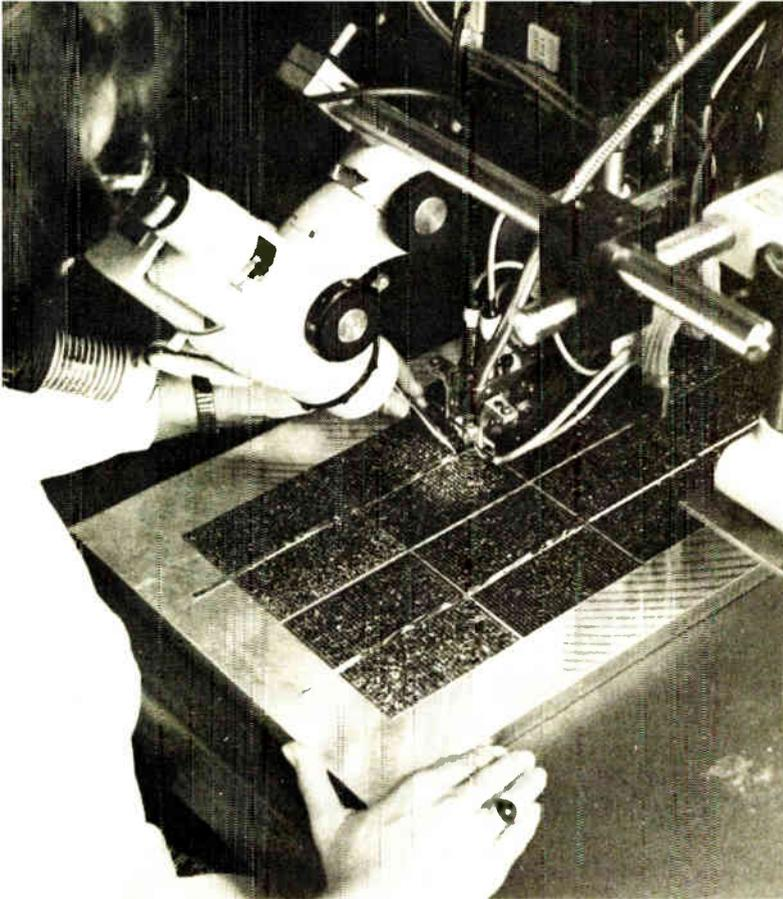

1. Quantity counts. A new polycrystalline material from Wacker-Chemitronic has enabled AEG-Telefunken to build experimental 10-by-10 centimeter cells with 10% efficiency. Here eight are being electrically welded into one module of a photovoltaic generator.

"ERDA's position on photovoltaics," p. 94). It beats the agency's original goal for this year of \$20 per peak watt and is the average ERDA is paying five companies for silicon cells that will generate 130 kilowatts of power. The price for a peak watt just two years ago was \$30 and had dropped to \$21 in an earlier ERDA buy of 46 kw worth of cells. Both procurements were part of the agency's low-cost silicon solar array project, which is administered by NASA's Jet Propulsion Laboratory, Pasadena, Calif. And both procurements were won by the same companies: Spectrolab Inc., Sylvar, Calif.; Sensor Technology Inc., Chatsworth, Calif.; Solar Power Corp., Billerica, Mass.; M7 International, Arlington Heights, Ill., and Solarex Corp., Rockville, Md.

Nevertheless, in announcing the 130-kw buy, Henry H. Marvin, director of ERDA's division of solar energy, candidly pointed out that "we have a long way to go to meet our 1986 goal of 50 cents a peak watt." That price, ERDA believes, will put photovoltaic energy in direct competition with other energy sources. But that timetable seems optimistic to some. To keep to it, says Joseph Lindmayer, Solarex president, volume would have to more than triple each year. "Volume is more than doubling," he notes, "but it still will not be a factor of three unless there is some change we haven't foreseen."

A growing industry

The 130-kw procurement attracted 17 bidders, and while Mobil Tyco Solar Energy Corp., Waltham, Mass., was not one of them, A. I. Mlavsky, its executive presi-

dent, says that the number of bidders is a notable achievement in itself, reflecting a considerable expansion of the photovoltaics "industry." Two years ago, such a request for proposals probably would have drawn just about five bids, says Mlavsky, whose company pioneered the silicon ribbon-growing process now being used worldwide by at least five other firms. And expansion of the industry is precisely ERDA's aim.

Another significant achievement, this one unaided by ERDA, will take place early next year if Solar Energy Systems Inc., which is 80% owned by Shell Oil Co., brings it off. The company plans to open a plant in Newark, Del., for the production of arrays of cadmium-sulfide cells capable of delivering more than 500 kw per year of electricity at full capacity. That's about two and a half times the total power today's terrestrial cells can generate—and from a material that has not topped a conversion efficiency of 8% even in the laboratory. It will also represent the first time cadmium-sulfide cells will reach the production stage, an accomplishment that's further in the future for gallium arsenide.

Is there a market for that much photovoltaic energy? SES officials apparently think so, mainly in remote, unattended applications. Like ERDA, president Steven DiZio sees his ultimate goal—a production volume great enough to support the generation of electricity at well below \$1 per watt—as 7 to 10 years away.

In Japan and Europe

Meanwhile, Japan Solar Energy Co., a joint venture, is fabricating silicon ribbons under license to Mobil Tyco. The goal is to produce ribbons suitable for evaluation by cell makers this year, says technical director Kenjiro Kimura. Capitalization of the firm is divided among Kyoto Ceramic Co. (51%), Sharp Electric Co. (24%), Matsushita Electric Industrial Co. (10%), and Mobil Oil Corp. and Tyco Laboratories (7.5% each).

The 2% improvement in solar-cell conversion efficiency in the U.S. and its 50% price reduction of the past two years has been paralleled in West Germany by AEG-Telefunken. Horst Fischer, who heads the company's solar-cell efforts, says his group is using low-grade polycrystalline silicon. With it, the efficiency of volume-produced cells at air mass zero has been boosted from 10.5% to 12.5%. That increase is the equivalent of approximately 7.5% to 9% efficiencies at air mass one—the standard atmosphere at sea level between the earth and the sun. Fischer says the improvements have been realized by obtaining higher yields from the production process and by enlarging the cell area from 2 by 2 centimeters to 2 by 6 cm. (Laboratory results at AEG-Telefunken are even more impressive: 15% efficiency measured at an atmosphere of air mass zero, while with an air-mass-one material the experimental cells shown in Fig. 1 are delivering 10% efficiency.)

The French leader in silicon photovoltaic technology is La Radiotechnique Compélec, the French components-producing subsidiary of Philips Gloeilampenfabrieken, which has an annual output of silicon cells for terrestrial applications of 30 kw. That makes RTC one of the largest producers in the free world.

To date, the preponderance of work in photovoltaics

for terrestrial use at both RTC and its confreres worldwide has drawn on experience gained in producing silicon cells for space applications. That means single-crystal semiconductor-grade material, which is becoming more expensive all the time. According to Paul Caruso, engineering vice president at Solar Power Corp., single-crystal cell efficiency in production devices will rise to 15% in the next two years, as a result of reducing the amount of light reflected off the cell, matching the spectral response of silicon with junction depth, and minimizing photon recombination on the cell's back and front. But in all probability, either cheaper material or the use of concentrators—lens-like devices that intensify the sunlight focused on arrays to boost the power output and cut the amount of material required—will be needed before photovoltaic energy costs can be brought down.

Toward lower-cost materials

Cadmium sulfide is by far the cheapest photovoltaic material on a per-unit-area basis, and Solar Energy Systems' commitment to it is echoed by physicist Karl Böer at the University of Delaware, also in Newark, Del. He cites some important recent advances in the knowledge of this material. Two years ago, not enough was known about it to predict its theoretical efficiency; Böer now says it is expected to be about 20%, although the highest repeatable conversion efficiency achieved in the lab has been 7.8% (Fig. 2). "We expect significant breakthroughs in efficiency in the next few years," Böer says. The work at the University of Delaware is sponsored by the National Science Foundation under the Research Applied to National Needs program.

Indeed, it is in the laboratory that most of the important recent steps have been taken with all photovoltaic materials. Silicon-ribbon pioneer Mobil-Tyco has an ERDA contract to refine what it now calls its edge-defined film-fed growth (EFG) technique. In the past year, reports executive vice president Mlavsky, the company has progressed from making vertically drawn 1-by-2-centimeter ribbon cells with a 10% efficiency to producing 1-by-4-inch ribbon cells that are 8% to 9% efficient. He is quick to point out, though, that the company is two to three years away from a commercial ribbon product—last year merely gave his firm a better understanding of the EFG process and the material.

Mlavsky probably sums it up best when he says that the company's EFG technique "doesn't produce pristine single-crystal silicon. It's not as good as Czochralski material, but we can make solar cells with efficiencies of 10% plus with it, and that's the bottom line."

The list of companies with a parallel aim includes major chemical firms like Dow and Union Carbide, as well as Westinghouse, Texas Instruments, Honeywell, and Crystal Systems Inc. in the U.S.; Ferranti in England; Laboratoires d'Electronique et de la Physique Appliquée (LEP); the Philips group research facility in Eindhoven, the Netherlands, plus Matsushita in Japan, among others (see "What other governments are doing for photovoltaics," p. 96). Also active in this field are Monsanto, the top U.S. silicon producer, and IBM, which is working on a ribbon process.

Westinghouse, for one, is bullish about being able to

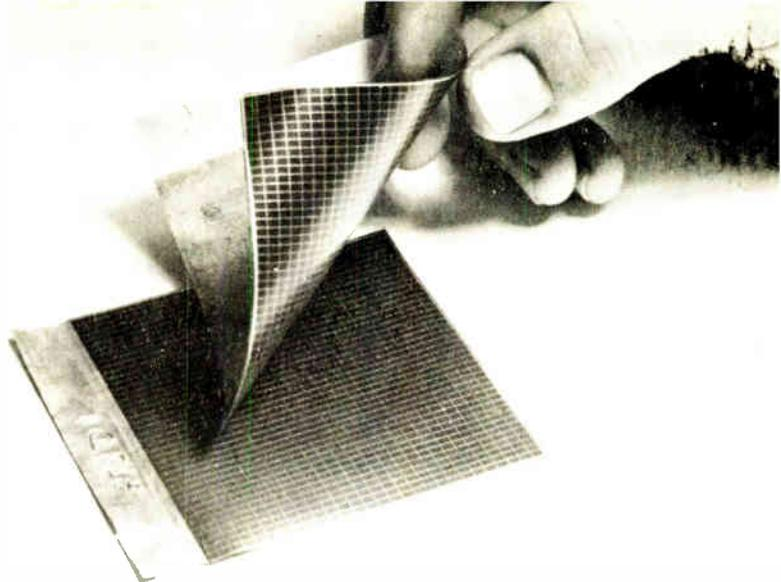

2. Next generation. Least expensive of photovoltaic materials, cadmium sulfide has a theoretical 20% conversion efficiency. These thin-film CdS cells, developed at the University of Delaware's Institute of Energy Conversion, have attained 7.8%, the highest yet.

cut the cost of high-grade silicon from \$60 per kilogram to \$10 using electric arc heaters to reduce a silicon intermediate to pure elemental silicon. The company has an ERDA contract via JPI with that cost reduction as its goal. But Westinghouse is still a long way from any kind of demonstration. The initial award is for a nine-month design and feasibility study, which would be followed by an experimental demonstration and, ultimately, construction of a full-scale demonstration plant that would produce large-area silicon sheets suitable for solar arrays. The study is a joint effort between the Westinghouse Research Laboratories, Pittsburgh, Pa., and the company's Power Circuit Breaker division.

Dow Corning Corp. has an ERDA contract with the same goal as Westinghouse—production of solar-grade silicon to sell for \$10/kg. It, too, homed in on the electric arc furnace after studying some 200 reactions for converting sand or quartz into single-crystal silicon. Texas Instruments Inc. is investigating a direct reduction of silicon, working with a plasma technology that is not as far advanced as the arc furnace. And Union Carbide Corp., along with Battelle Columbus Laboratories, is investigating still other processes for producing solar-grade silicon (Fig. 3, bottom right).

Larger ingots

Another approach is under development at Crystal Systems Inc., Salem, Mass., where the objective is to produce much larger silicon ingots than has been possible before. This effort, too, is funded by ERDA as part of the low-cost silicon solar array project [*Electronics*, June 24, p. 34], but is also in the early stages. President Frederick Schmid says his company will draw on extensive experience in growing large-area single-crystal sapphire ingots to do the same with silicon. Schmid believes his company's heat-exchanger technique will eventually yield single-crystal silicon ingots from which wafers 6 inches in diameter can be cut. He calls the process "directional solidification" and points out that it differs from Czochralski growth in that there is no

ERDA's position on photovoltaics

For fiscal 1977, the U.S. Energy Research and Development Administration has budgeted about \$65 million for work on photovoltaic energy. That's more than double fiscal 1976's appropriation but still less than half the almost \$160 million allotted to all fiscal 1977 solar-energy programs—the rest cover solar thermal energy, the solar heating and cooling of buildings, and similar efforts.

There are also much larger Federal technology programs devoted to research and development into fission power, fossil fuels, fusion power, and the nuclear-fuel cycle. Only energy conservation, environmental control, and geothermal energy rank behind solar energy in funding among the eight major energy technology programs in the Federal energy R&D budget.

With its \$65 million, however, ERDA is sustaining a broad program of research and development in photovoltaics, its aim being to reduce the cost of collector arrays from today's \$15 per peak watt of electricity produced. The chief elements of that program concern:

- Production of low-cost photovoltaic materials.
- Large-area crystal growth.
- Materials and techniques for array encapsulation.
- Improved cell and array designs.
- High-volume, cost-effective automated assembly techniques of production.

The initial emphasis is on single-crystal silicon because of its abundance and the widespread use of proven techniques for producing large single crystals. But gallium arsenide and cadmium sulfide are also being developed.

ERDA's timetable for achieving these objectives is, in outline:

- Establishment by 1983 of pilot plants capable of producing more than 5 million square meters of silicon sheets per year at a value-added cost of less than \$18 per square meter.

- Establishment by 1984 of plants capable of producing approximately 2,000 metric tons of silicon material at a market price of less than \$10 per kilogram.

- Establishment by 1985 of plants capable of producing more than 500 peak kilowatts of encapsulated solar-array modules at a market price of less than \$500/kW.

Along the way, ERDA will establish a Solar Energy Research Institute to support the national solar-energy program. The goal is to have the institute site selected by next January and to have whatever construction it requires completed by fiscal 1980.

To date, ERDA's investment in photovoltaic energy development, though not large as Government funding goes, far outweighs that of the private sector. Yet the agency's policy in its national plan for energy research, development, and demonstration clearly states that "the private sector has primary responsibility for the development and commercialization of new energy technologies." Federal programs are intended to assist industry "in accelerating the market penetration of energy technologies with near-term potential." However, until the cost of photovoltaic-derived electricity comes down drastically, the market for it will not take off in a big way, and for that reason there has been no big outpouring of private funds, except from some oil companies.

The problem, as ERDA says, is that today's materials and processing costs for photovoltaic arrays, are 30 to 50 times too high to be competitive with conventional systems for almost all but remote-site applications. The agency's timetable fixes 1986 as the year in which it hopes photovoltaic energy will become cost-competitive with fossil fuels. But even so, unless priorities change or there is a huge influx of private funding, it seems unlikely that solar-derived electricity will account for more than 1% to 2% of this nation's needs when the year 2000 dawns.

pulling of the crystal as it grows upward and outward from the bottom of a crucible.

At least one foreign producer of solar cells would like to see efforts such as those at Westinghouse and Dow Corning cut the price of U.S. silicon. Ferranti Ltd., Britain's only maker of photovoltaic cells, is working on a screening process to lower cell costs, but regards itself as at the mercy of U.S. silicon makers. Peter Lilley, product marketing executive at the Electronic Components division, Gem Mill, Chadderton, Oldham, Lancs., notes that cheaper silicon would do a lot to lower the price of cells. Nevertheless, the division is working on silk-screen printing to cut the cost of cell making by 30%, Lilley says. It's a way to get around such expensive processes in semiconductor fabrication as photolithography and evaporation, "replacing five processes with one," says Lilley, who won't divulge more details.

Screening is also getting some attention at Matsushita, along with chemical vapor deposition and vacuum (evaporation) deposition. Indications are that screening is the most economical.

Solar Technology International, Chatsworth, Calif., agrees and since January has actually been shipping products using thick-film conductors on silicon cells 3 inches in diameter (Fig. 3, top). President William

Yerkes says he chose screening on the grounds that it is the cheapest way to put conductors on solar cells—they embody a direct labor cost of only 15 cents per wafer.

One of the more novel processes for reducing cell costs is being studied at IEP in France. A research team there is trying to refine a method of dragging a ribbon of graphite across the surface of a molten silicon bath so that a layer of silicon carbide forms and the silicon layer is chemically bonded to the ribbon. Depending on the ribbon's withdrawal angle, temperature of the melt and pulling speed, the technique yields polycrystalline layers ranging from 70 to 150 micrometers thick, with the grains oriented almost parallel to the direction of pulling, explains Jean Jacques Brissot, a member of the team.

IEP is also at work on what it calls a "black cell" that would boost silicon cell conversion efficiencies to near 20% [*Electronics*, March 18, p. 48]. A textured front surface cuts light reflection to about 10% without any reflective coating, and a thin p⁺ layer on the back sets up an electric field that inhibits recombination of photocarriers on the back contact, cutting losses there. The black cell is promising enough for RTC-La Radiotechnique Compélec, to have undertaken a one-year program to evaluate its commercial producibility.

IEP is not alone in its dip-coating approach. Honey-

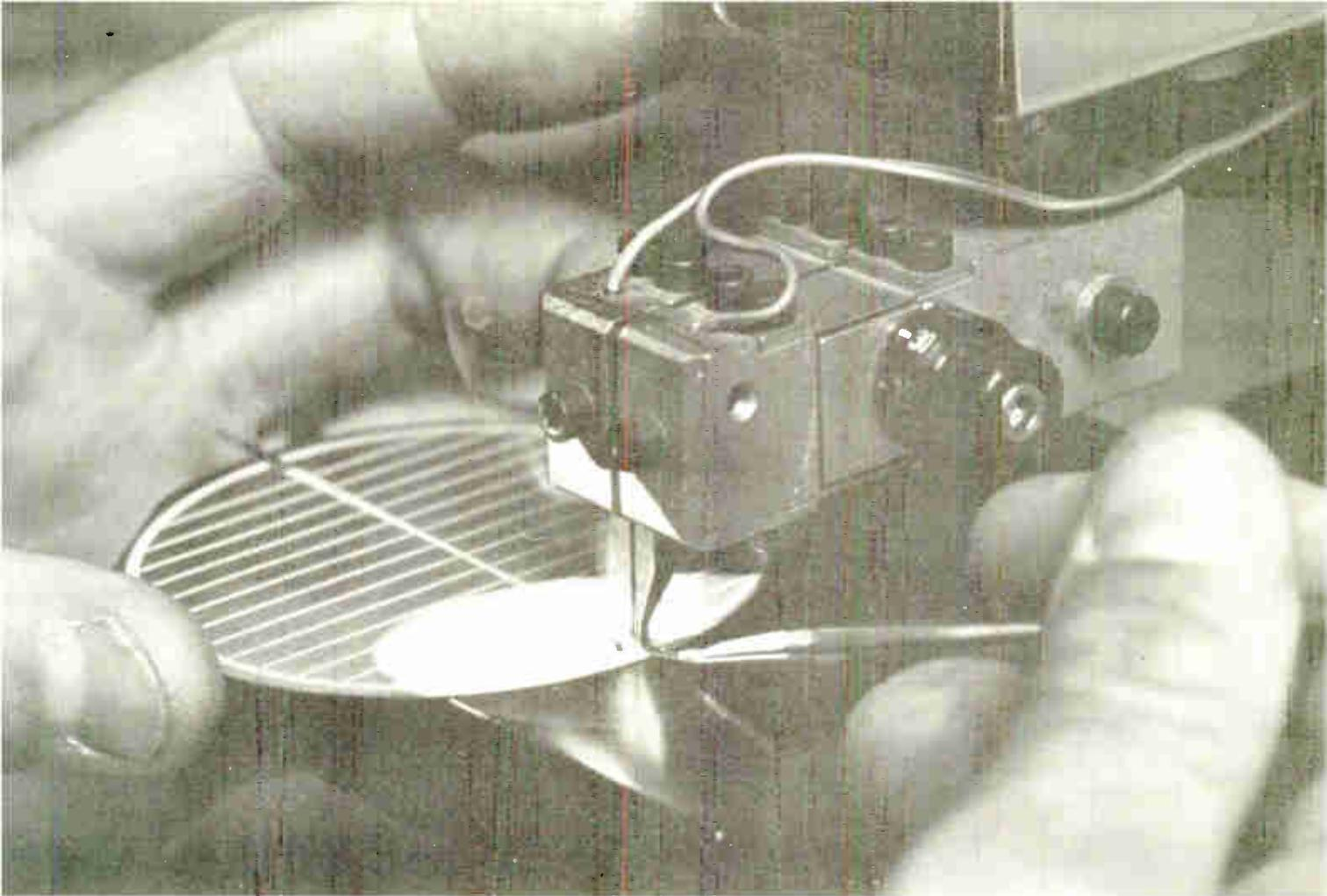

3. From the lab to the real world. Anticlockwise from right, researcher at Battelle Columbus Laboratories is checking silicon cells as part of a program aimed at reducing material and manufacturing costs of photovoltaic devices. In production at Solar Technology International is a 3-inch diameter silicon cell that uses thick-film conductors, shown here having lug welded to it. Prototype 1-kW photovoltaic generator under construction at Sandia Laboratories will have 135 Fresnel lenses to concentrate sunlight on 135 silicon cells. The unit also produces 5–6 kW of solar thermal energy.



What other governments are doing for photovoltaics

The governments of Japan, France, and West Germany have recognized the potential of photovoltaic-derived energy, and they are backing its development. In fact, Japan had established a high-priority "sunshine project" even before the U.S. Energy Research and Development Administration was set up [*Electronics*, April 4, 1974, p. 104].

By the turn of the century, the Japanese expect to have spent between \$3.6 billion and \$7 billion on the project, which they compare to the U.S. Apollo lunar landing program in national significance. Like ERDA's national program, it includes solar, geothermal, and hydrogen energy development, as well as the liquefaction and gasification of coal.

The Sunshine Project is under the aegis of the Agency of Industrial Science and Technology, which is attached to the Ministry of International Trade and Industry (MITI). This year's budget for solar-cell R&D is about \$1 million. There's also an effort in electrical-power generation from solar batteries. Its first phase covers basic research and will extend through fiscal 1980, and it will be followed by a

second phase that will be aimed at preparing companies for production.

Many leading companies are involved in the solar-cell portion of the project. Tokyo Shibaura Electric Co. is concerned with the fabrication of single-crystal silicon ribbons by vertical pulling, and Toyo Silicon Co. is doing the same but by horizontal pulling. Nippon Electric Co. and Hitachi Ltd. are working on a single-crystal equivalent to silicon ribbon, the former using ion plating on alumina substrates, and the latter using deposition on alumina substrates. Matsushita Electric Industrial Co. is studying compound cells using cadmium sulfide and similar substances, while Sharp Corp. is focusing on complete silicon solar cells.

The leading French agency in solar energy development is Direction Générale de la Recherche Scientifique et Technique, which has about \$1 million a year earmarked for photovoltaics. West Germany's Ministry for Research and Technology has allocated to photovoltaics some \$2.2 million out of a total of \$40 million to be spent on solar-energy work from 1976 to 1980.

well's Advanced Development Laboratories is working on a proprietary process for dip-coating a ceramic substrate with silicon. Paul Chapman, sensor section head, reports that if ceramic is carbonized and then dipped, a thin layer of silicon carbide forms to provide an interface on which the silicon will grow; it won't grow directly on ceramic. "Our layers look similar to ribbon," he says. "We have large grains—centimeters long and millimeters wide—rather than the micrometer-sized grains found in polycrystalline material."

The other approach to reducing the cost of photovoltaic material is to use less of it. This is possible if more of the sun's rays are concentrated onto a smaller area.

ERDA is pursuing concentrator R&D through Sandia Laboratories, Albuquerque, N. M. [*Electronics*, July 22, p. 41]. Sandia's work in photovoltaics is considered to be parallel to, and not competing with, the silicon efforts handled by JPL, but Sandia researchers feel their efforts should be funded by ERDA more in line with JPL's. Sandia has about a quarter of the \$12 million JPL got in fiscal 1976 out of ERDA's then total photovoltaic budget of some \$22 million.

Concentrators yield multi-sun intensity

The Sandia team, headed by Jerry G. Fossum and Edward L. Burgess, expects to use plastic Fresnel lenses in conjunction with silicon cells with conversion efficiencies of 15%. Using 135 lenses and 135 silicon cells to produce an intensity equal to that of 50 suns, they are putting together a prototype array that will generate 1 kw of electrical power from sunlight (Fig. 3, bottom left). Next year, Sandia will seek bids on a 10-kw concentrator system with a view to operating a 100-kw unit in 1978 at a price per watt of \$1 to \$1.50.

There are certain drawbacks to the concentrator systems, however. Most of them must track the sun, they must be cooled, and they depend on bright sunlight. Tracking and cooling add to their cost, although the

Sandia team foresees beating JPL to the ERDA goal of 50 cents per peak watt in 1986. They think this can be done with existing concentrator technology, while they believe the low-cost silicon solar array project will have to come up with breakthroughs in materials and in fabrication and automated assembly techniques to get there.

To progress toward that goal, Sandia has awarded a \$275,000 contract to RCA Laboratories, Princeton, N.J., to develop concentrator systems using silicon cells. The contract calls for RCA to: deliver six 100-w demonstration units for use by Sandia and the U.S. Army; try to improve the efficiency of silicon cells under high concentrations, and produce systems designs that can be manufactured in quantity at relatively low cost. The first two demonstration units, to be delivered this month, use vinyl plexiglass lenses rather than Fresnel lenses. For the lens size and focal point RCA is using, the only suitable Fresnel lenses have the grooved side facing the sun, and the dust they would collect would block out some light, explains Fred Sterzer, director of RCA's microwave technology center. He adds that later systems may use Fresnel lenses with the smooth side facing the sun.

In the 100-w concentrator systems for Sandia, RCA uses 4-by-4-inch lenses in a 6-by-6-array for each of a system's three modules. Up to seven modules, each providing upwards of 30 w, could be included in a system generating about 250 w. Eventually Sterzer hopes to get the cost of such a system down to about \$2 per watt. Further, he envisions producing the lenses in much the same way as phonograph records—by making a master and pressing copies from it. "We could get the cost per lens down to cents, but that's after we would first have to spend \$200,000 to \$300,000 to have a mold made," Sterzer points out.

Varian Associates, Palo Alto, Calif., is also developing concentrator arrays but is using gallium-arsenide cells with 20–22% efficiencies. John Heldack, marketing director in charge of the concentrator project, says the

company's two-axis tracking array of 120 cells will be completed next month. It will use a conical concentrator with a mirror surface and will generate 1 kw. Heldack says the concentrator will represent 80% of the system cost, and because of that, Varian is carefully evaluating slump glass and aluminum as concentrator materials. The glass looks more economical, but the final choice will be determined by the optical design limitations of each material "and by what kind of accuracy we can get," Heldack notes. Funding for the work came initially from the company but has since been supplemented by three ERDA contracts.

ERDA is also funding concentrator development at the Argonne National Laboratory, Argonne, Ill. A compound parabolic concentrator made of acrylic holds out hope for eliminating the need for daily sun tracking—depending on how much concentration of sunlight is desired, it might have to be moved only seasonally. Its basic element is a vertical bar of solid acrylic. The bar presents a flat rectangular surface to the sun, then curves downward in a parabolic taper to a much narrower and slightly shorter rectangle, which matches the shape of an underlying silicon photovoltaic strip. With the bar, six times as much sunlight is funneled onto the strip as would reach it without the bar.

A 36-by-60 array of these bars has been built into a panel having a 100-w output. Researchers at Argonne are currently studying various plastics to cut its cost and weight, and the laboratory hopes to have commercial panels available within two years.

In Japan, Sony Corp. researchers report development of a multiple-junction silicon cell with a multilayer structure that uses a 1,000× concentration. They say cooling it is not a major problem because thermal loading is less than in microwave power transistors. But they still lack an efficient way to track the sun.

Photovoltaic products on the market

Clearly, there's an abundance of R&D into reducing the cost of photovoltaic materials and finished cells, but even the efforts that succeed won't bear fruit for months or years. In the meantime, the market for photovoltaic-derived energy is still limited mainly to applications where a more conventional power source would be difficult or prohibitively expensive to provide. Even so, there are standard products on the market—mostly arrays of silicon cells—that are doing useful work in those applications. Solar Power Corp., a wholly owned subsidiary of Exxon Enterprises Inc., has been selling arrays for terrestrial applications since 1971. The Spectrolab division of Hughes Aircraft Co. has had arrays on the market for about three years, and its 1975 spinoff, Solar Technology International, has been shipping arrays since January—profitably since July, according to president Yerkes—while Sensor Technology, Solarex, Ferranti, RTC, and Nippon Electric also produce commercial arrays. These arrays turn up at railroad crossings, where they power the lights and warning bells, on offshore drilling platforms, at desert water-pumping stations, at remote television stations, and on microwave repeaters (Figs. 4–6).

Solar Power Corp. has two basic types of arrays. The

earlier has become a "commodity product," according to president Robert Willis. This module includes only five silicon cell wafers, but many of them can be connected to form a complete working array that sells for \$34 a watt now. A newer array with larger wafers develops 25 peak watts at \$14 per watt and was built under a JPL contract to provide 15 kw. (The company also holds a second ERDA contract for another 15 kw.)

Actual uses

Two Solar Power arrays are supplying photovoltaic energy to a microwave repeater. The repeater, built by GTE Lenkurt Inc., San Carlos, Calif., is undergoing field trials in a common carrier link between Kayenta, Ariz., and Mexican Hat, Utah. The arrays charge lead-calcium batteries that power the repeater. A GTE Lenkurt spokesman says the entire installation—arrays, batteries, the 2-gigahertz repeater—cost about \$15,000 vs an estimated \$100,000 for the traditional "billboard" type of passive repeater that would have been required.

A 6-v array from Sensor Technology Inc., Chatsworth, Calif., supplies power to nickel-cadmium batteries in a domestic water meter marketed by Zurn Industries Inc., Erie, Pa. The batteries power the indoor meter's outdoor display. Solar Technology, also in Chatsworth, makes an array of 33 to 39 cells. Designed to charge a 12-v battery, it puts out 16 v at 1.2 amperes and sells for about \$15 per peak watt.

Soon to be introduced is a solar-powered hydrogen-sulfide detector from Dictaphone Corp., Mountain View, Calif. The unit will protect oil field and petrochemical operating personnel from exposure to fatal concentrations of hydrogen sulfide. Four of the detectors will be monitored from a control box that will trigger a shutdown of the well if hydrogen sulfide is sensed. "Solar-powered alarms are cheaper than running a power line 50 to 75 miles," says Greg Horn, engineering manager of Dictaphone's Gas Detection Products division.

Ferranti arrays, besides being used in the more conventional applications, have also recharged batteries in a transatlantic boat race. The basic Ferranti module consists of 32 circular cells and sells for about \$170 in small quantities. Cables and Wireless Ltd. is testing three 24-w Ferranti arrays powering an operational repeater station in the Middle East "to see if they stand the test of time," says a Ferranti executive. The customer, however, is also trying out gas-, diesel- and wind-powered generators and may settle on a mix.

RTC's standard array puts out 11 w at 25°C at a cost of roughly \$40 per watt. Six panels powered the automatic pilot aboard Eric Taberly's one-man Pen Duick VI in his winning effort in this summer's solo transatlantic yacht race. But another RTC application is probably more indicative of the niche that photovoltaic-derived energy now fills. RTC has orders for "thousands" of panels from the builder of a water-pump system for desert regions, Société Briau. The system is powered by 400 w of silicon cells in parallel with a buffer battery, both controlled by an electronic circuit. The pump, with a capacity of 2,700 liters per hour at a draw of 20 meters, is driven by a 1/3-hp motor.

The system takes 4–6 hours a day for 10–15 cubic

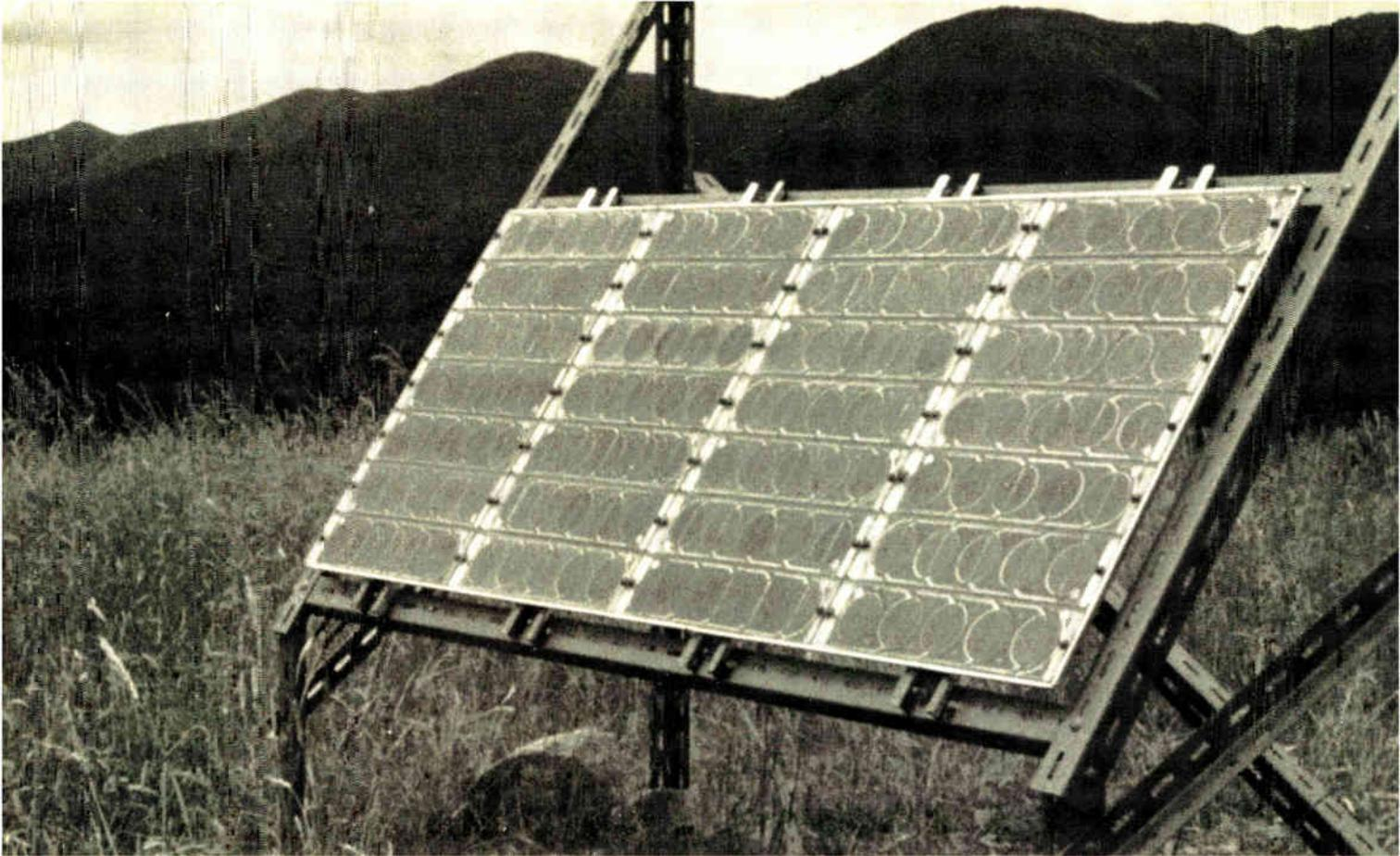

meters of water and is popular because it does not drain the water table too quickly. A high-power thermal pumping unit drains the well after a few minutes in the desert regions near Algeria and Tunisia, where the water table is 20–30 meters deep. The photovoltaic-powered pump provides a slower, steadier flow, has low maintenance, and costs about the same.

There have been some consumer products using photovoltaic-derived energy, too, but until recently they have chiefly been novelties, such as solar cells used to charge the batteries of electronic watches. Now M7 International, Arlington Heights, Ill., has introduced a silicon-cell array that can be used to directly power small appliances, requiring low current and up to 12 volts, such as calculators, two-way radios, and portable radios, or can be used as a battery charger [*Electronics*, Oct. 14, p. 30]. M7 is one of five winners in both the ERDA/JPL procurements and got its start as a producer of custom photovoltaic sensors for card and tape readers.

How is ERDA handling its tasks?

In the U.S., most of the incentive for developing photovoltaic energy clearly comes from ERDA. Most cell makers have contracts with ERDA and are understandably reluctant to bite one of the hands feeding them. There is some restiveness about policy, but no major quarrel with the agency's objectives and progress. Solar Power Corp.'s Willis, for example, says ERDA is doing a "reasonable job" of administering photovoltaic R&D, and that JPL was a good choice to handle the contracts. "They're willing to listen, and they're reasonable people," he adds, "and they have us convinced that

they're interested in stimulating this market."

Mobil Tyco's Mlavsky thinks ERDA "is not doing a bad job getting things started." He testified before Congress early this year on the Humphrey-Fannin bill, which helped to more than double ERDA's fiscal 1976 photovoltaics effort to 1977's \$65 million. Mlavsky says that scope for the program is appropriate, but believes more than that should be allocated next year, "and a hell of a lot more in fiscal 1979 because of the need to test and demonstrate systems."

ERDA's own Morton Prince, chief of the photovoltaics branch, acknowledges that the early low budgets have attracted some criticism but points out that more money is coming. The early studies, he says, "are intended primarily to give some guidance as to which materials and directions we should pursue. After a year or two, we'll reduce the number of directions and go after those we've selected with a larger program. If I had more money now," he adds, "I would just undertake more parallel approaches and get more performers in."

Getting more performers in is one of the sensitive points with the existing industry. The possibility that some of the non-cell-producing firms now doing R&D on JPL contracts could become competitors concerns Spectrolab, for one. "Let's just say I'm apprehensive about it," says Spectrolab president Gary Wrench. "I hope nothing happens to damage our demonstrated willingness to invest in the field now that we're getting our production capacity cranked up."

Mlavsky shares this concern, but ties it to "background rights" as covered by ERDA policy. These are rights to company-funded developments that are

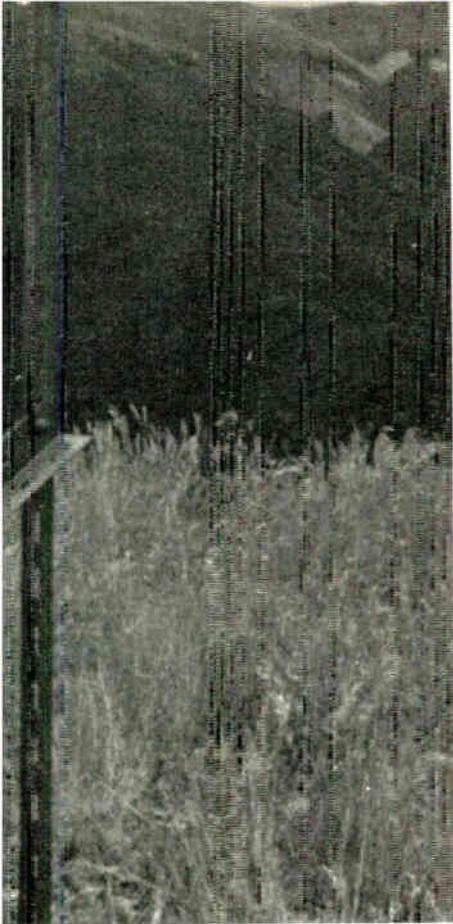

4. Far from the madding crowd. Array of photovoltaic cells in fields near Nelson, New Zealand, turns sunlight into electrical energy for battery-powered radio repeater.



5. The size of things to come? Powering a communications link on a mountaintop in southern California is a solar-energy conversion array from Spectrolab. Approximately 900 square feet in area, the array produces well over 3 kilowatts of peak power. A big advantage of this kind of power source is that it can be left unattended.

then applied to an ERDA contract effort, which could be compromised by the ERDA patent policy. In other words, ERDA could require its contractor to license a potential competitor before the licensor is in a strong enough position to compete.

ERDA's Morton is not convinced that this is a serious issue. He has worked in several small companies, and "the only way we kept alive was by working and staying ahead," he notes. "I wouldn't even try to patent our things to protect ourselves. It seemed to be a losing proposition because we couldn't afford to fight to maintain the patent. Even if we were successful, a company would be down the tubes with the legal fees."

Perhaps JPL's Robert Forney, manager of the low-cost silicon solar array project, best articulates the dilemma when he says that to bring material and solar cell costs down, "we have to enlarge the capacity of the industry. One of our biggest problems is how best to optimize the expansion of that industry." To achieve those goals, JPL believes it's mandatory to bring in those companies that offer vast technological resources and perhaps new approaches to the problems.

Contributions to this special report came from Margaret A. Maas, former Industrial Editor, and field editors Larry Waller, Larry Armstrong, Bruce LeBoss, Judith Curtis, Ray Connolly, John Gosh, William F. Arnold, Arthur Erikson, and Charles Cohen.

6. In operation today. This array of photovoltaic cells is in process of being installed on an offshore oil platform out in the Gulf of Mexico, where its job will be to supply energy to the batteries that power the rig's navigation lights and also its foghorn.

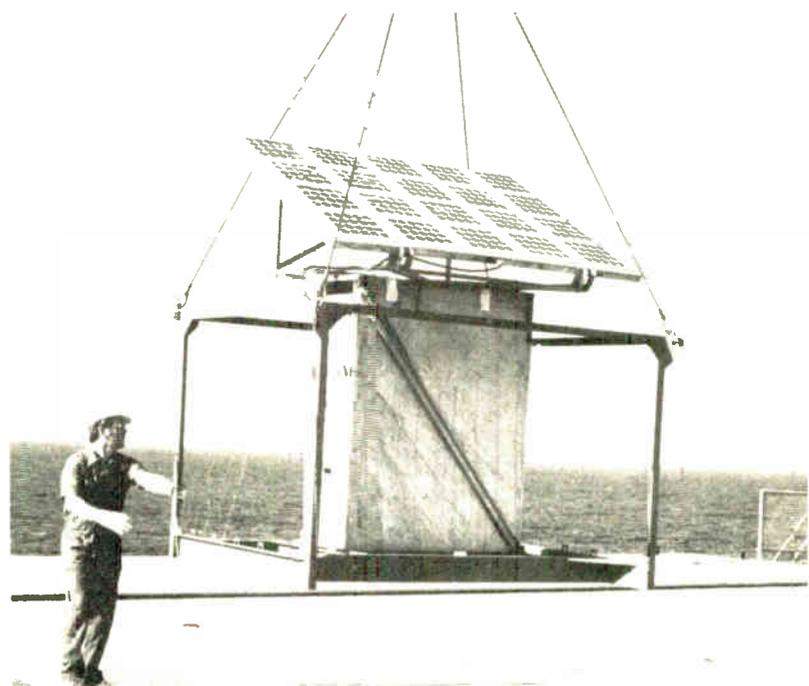

Digital combination lock is virtually crackproof

by Dale Platteter
Naval Weapons Support Center, Crane, Ind.

All the sandpaper in the world wouldn't help a safe-cracker open a 15-digit combination lock with the electronic "tumblers" described here. In fact, it could take more than a million and a half years to generate the correct code, if combinations were tried at the rate of one every 10 seconds.

Would-be thieves are further discouraged by the automatic reset of the circuit on entry of any incorrect number—which requires that the entire sequence be re-entered and thus disrupts any orderly trial-and-error approach. In addition, the 512-by-4 bit programmable read-only memory that stores the correct combination has room for as many as 32 easily selectable combinations, enabling the code to be changed periodically.

The circuit compares the combination entered with one stored in memory, a digit at a time, and latches a transistor-transistor-logic output high after the entire code is correctly entered. The reset button is pushed before the combination is entered to ensure that the lock

is ready for entry of the first digit. The operator also presses it to start over after he thinks he may have made a sequence error.

Only eight possible inputs—the reset and seven numbers—may be encoded, because the binary words representing each are 3 bits long. But it's a good idea to use a standard 0–9 push-button array and allow one, two, or all three of the spare buttons (0, 8, and 9 in this example) to serve as reset. This increases security of the lock, since no unauthorized person will know which button to push for reset.

Integrated circuits IC₁–IC₄ in the figure are quad NAND gates connected as R-S flip-flops to debounce the single-pole, double-throw push buttons. The entered numbers are encoded by IC₅, a Monolithic Memories Inc. type 5301 256-by-4-bit PROM programmed according to the truth table in Table 1. This chip was selected to simplify programing, because its background is initialized to logic 1 and the reset code of 111 means most of the addresses will be logic 1s. The unlocking codes are programmed into the combination memory, IC₆, an MMI type 5306 512-by-4 bit PROM.

Shown in the figure are code-selecting switches that determine the 5 most-significant bits of the address-data inputs (A₄ through A₈) and hence, which of the possible 32 combinations is selected. The five data lines may be programmed from a remote location for the temporary exclusion of particular "key holders," or just to change

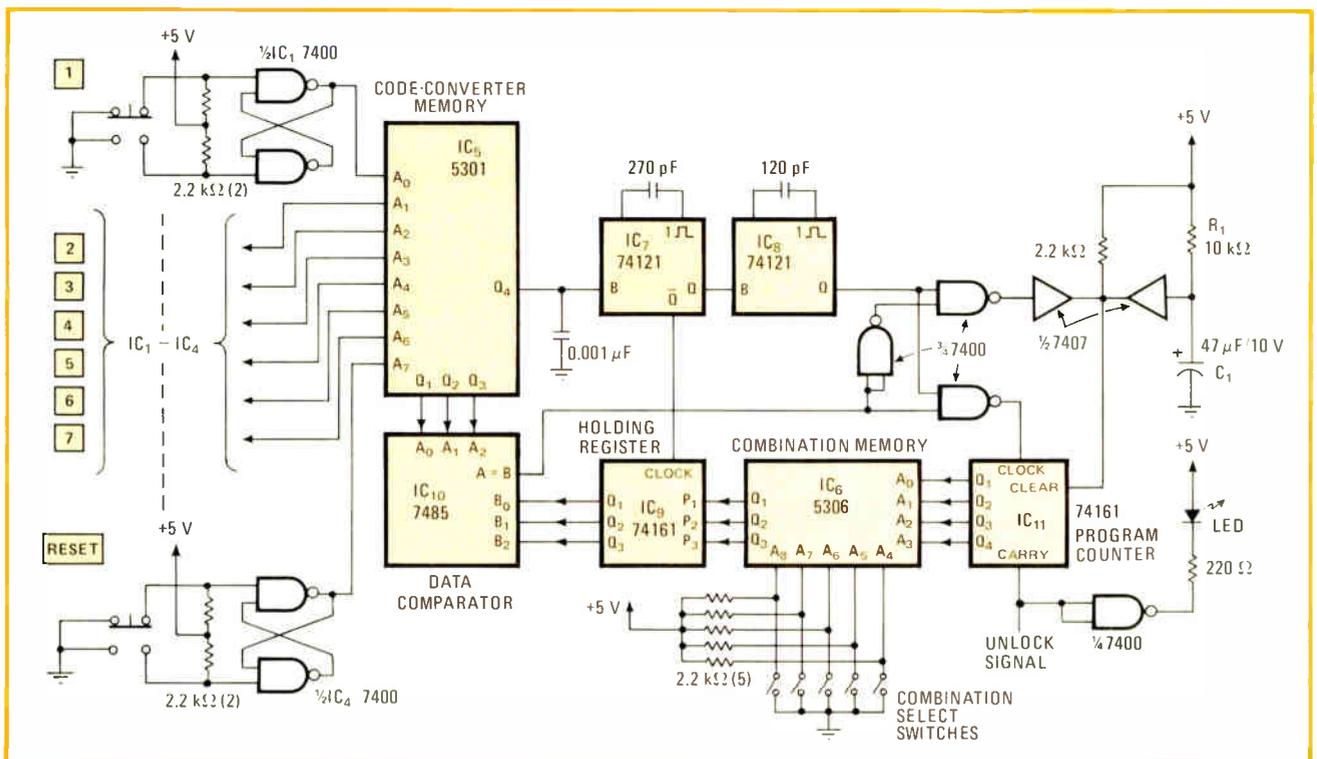

Maximum security. A total of 13 integrated circuits is used in this digital combination lock, which requires a sequence of 15 digits to open. The design permits easy changing of sequence length and number of possible digits, and the memory stores up to 32 combinations.

PROM PATTERN FOR CODE CONVERTER MEMORY (IC 5)													
Address								Decimal	Output				Comments
Binary									Q ₄	Q ₃	Q ₂	Q ₁	
A ₇	A ₆	A ₅	A ₄	A ₃	A ₂	A ₁	A ₀						
1	1	1	1	1	1	1	1	255	0	1	1	1	No inputs
1	1	1	1	1	1	1	0	254	1	0	0	1	Enter 1
1	1	1	1	1	1	0	1	253	1	0	1	0	Enter 2
1	1	1	1	1	0	1	1	251	1	0	1	1	Enter 3
1	1	1	1	0	1	1	1	247	1	1	0	0	Enter 4
1	1	1	0	1	1	1	1	239	1	1	0	1	Enter 5
1	1	0	1	1	1	1	1	223	1	1	1	0	Enter 6
1	0	1	1	1	1	1	1	191	1	0	0	0	Enter 7
0	1	1	1	1	1	1	1	127	1	1	1	1	Reset
-All remaining addresses--									1	1	1	1	Error input reset

the combination in the interest of security.

Timing of the circuit is controlled by two monostable multivibrators. When any button or combination of buttons is pressed, the MSB output (Q₄) of the code-converter memory, IC₅, goes high and triggers the first monostable, IC₇. The rising edge of its Q output latches the binary word at the output of the combination memory, IC₆, into the holding register, IC₉, a 4-bit programmable binary counter. After 375 nanoseconds, the rising edge of the Q output of IC₇ triggers the second monostable, IC₈.

While the Q output of IC₈ is high, which occurs for 165 ns, a 4-bit magnitude comparator IC₁₀, compares the entered and stored words. If the words of IC₅ and IC₆ are identical, the A=B output of the comparator will go high, incrementing the program counter, IC₁₁, another 4-bit binary counter, through the NAND-gates. If the words differ, the program counter is reset, and the entire combination must be entered again.

Upon entry of the correct combination, the program counter advances 15 counts, and the carry output goes high. This is the unlock signal, indicated by a light-emitting diode. It can drive external TTL circuits, or may be buffered to control a solenoid-operated lock.

The program counter could assume any initial state when power is applied. To prevent opening of the lock when power is periodically interrupted, a power-on reset circuit made up of the R₁-C₁ charging network and a buffer clears the program counter for the first few milliseconds.

If less security is permissible, the circuit may be simplified to keep down the component count and cost. A priority encoder such as the 74147 may be used in place

PROM PATTERN EXAMPLE FOR COMBINATION MEMORY (IC 6)														
Address								Decimal	Output				Digit	
Binary									Q ₄	Q ₃	Q ₂	Q ₁		
A ₈	A ₇	A ₆	A ₅	A ₄	A ₃	A ₂	A ₁	A ₀						
1	1	1	1	1	0	0	0	0	496	x	0	0	1	1
1	1	1	1	1	0	0	0	1	497	x	0	0	0	7
1	1	1	1	1	0	0	1	0	498	x	1	0	0	4
1	1	1	1	1	0	0	1	1	499	x	0	1	0	2
1	1	1	1	1	0	1	0	0	500	x	1	1	0	6
1	1	1	1	1	0	1	0	1	501	x	1	0	1	5
1	1	1	1	1	0	1	1	0	502	x	1	0	1	5
1	1	1	1	1	0	1	1	1	503	x	0	1	1	3
1	1	1	1	1	1	0	0	0	504	x	0	0	0	7
1	1	1	1	1	1	0	0	1	505	x	0	0	1	1
1	1	1	1	1	1	0	1	0	506	x	0	0	0	7
1	1	1	1	1	1	0	1	1	507	x	0	1	0	2
1	1	1	1	1	1	1	0	0	508	x	1	0	0	4
1	1	1	1	1	1	1	0	1	509	x	1	0	0	4
1	1	1	1	1	1	1	1	0	510	x	0	1	1	3
1	1	1	1	1	1	1	1	1	511	x	1	1	1	Reset
Remainder of memory is used to store 31 additional combinations x = not used														

of IC₅, sacrificing the automatic reset effected when two or more buttons are simultaneously pressed. A smaller memory may be used if 32 different combinations are not needed, and the power-on reset circuit may be eliminated.

A 2-bit word length might even be used, greatly reducing circuit complexity. It still could require as much as 4½ years to crack at the rate of one 15-digit combination every 10 seconds—and burying those three possible input numbers in a complete 0–9 push-button array would increase security many times over. The system is completely expandable—word length (hence number of inputs) and sequence length are easily adjusted to suit one's needs.

A PROM sample programing pattern for the combination 174265537172443 is shown in Table 2. Each of the 15-digit combinations is allocated 16 bits of memory, leaving the last bit unused. It is beneficial, as shown, to program 111 into these locations (since the first address is 0, the 16th bits are in every 2ⁿ-1 address, where n is greater than 3—for example, 15, 31, 63, etc.). Reset will then occur automatically when any digit is pressed after the lock has been opened. □

Designer's casebook is a regular feature in Electronics. We invite readers to submit original and unpublished circuit ideas and solutions to design problems. Explain briefly but thoroughly the circuit's operating principle and purpose. We'll pay \$50 for each item published.

PROM provides linear or logarithmic display

by John Brady

Applied Research Laboratories, University of Texas, Austin, Texas

A read-only memory, programed so that its output words are logarithmically related to the input address words, is useful for displaying a logarithmic response in digital-

signal processing. The display has none of the drift and gain error with time that are associated with the use of an analog log amplifier, and, in many cases, is more economical.

In digital-signal processing, the magnitude of a time-varying function or of a frequency-varying function is displayed on an oscilloscope by connecting the digital word to a digital-to-analog converter of the same bit length. The d-a output is the vertical input to the scope, and the sweep is triggered by a suitably repetitive synchronization pulse derived from the signal. If a logarithmic amplitude response is needed, the usual

Here are three electromagnetic X-Y display scopes that have a lot in common—each has a big 12-inch diagonal CRT, is economically priced, and is ideal for applications requiring continuous monitoring of response signals with bandwidths up to 15 kHz.

The one in front is specifically for use in OEM systems. With the Model 1951, you can have controls mounted on the rear panel, or they can be pre-set on an easily accessible PC board. And the unit's power supply can be removed and installed

elsewhere in your system. The 1951 is particularly well suited to medical electronic systems.

The scope on the left is our Model 1901C which can be used with our (or anybody's) RF or microwave sweepers. The unit has a sensitivity of 1 mV per division which is ideal for low-level detection requirements. Features such as Z axis intensity modulation, Y marker adders and a blanking protection circuit contribute to the unit's versatility.

Finally, the scope at right is our

Model 1910. It's basically the same as the 1901C except that it provides dual trace capability.

So just decide which of these low-priced scopes has the most in common with your operation. We'll be happy to ship as many as you want. WAVETEK INDIANA, P.O. Box 190, Beech Grove, Indiana 46107, Telephone (317) 783-3221, TWX 810-341-3226.

WAVETEK[®]

Scope City!

Model 1901C: \$545.00

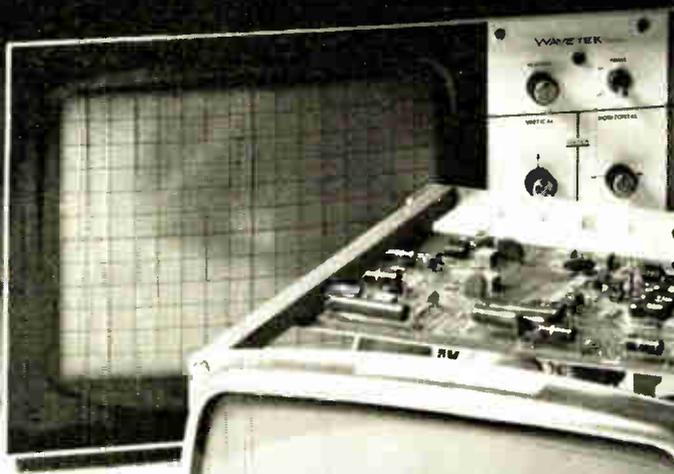

Model 1910: \$675



Model 1951: \$450 (in small quantities)

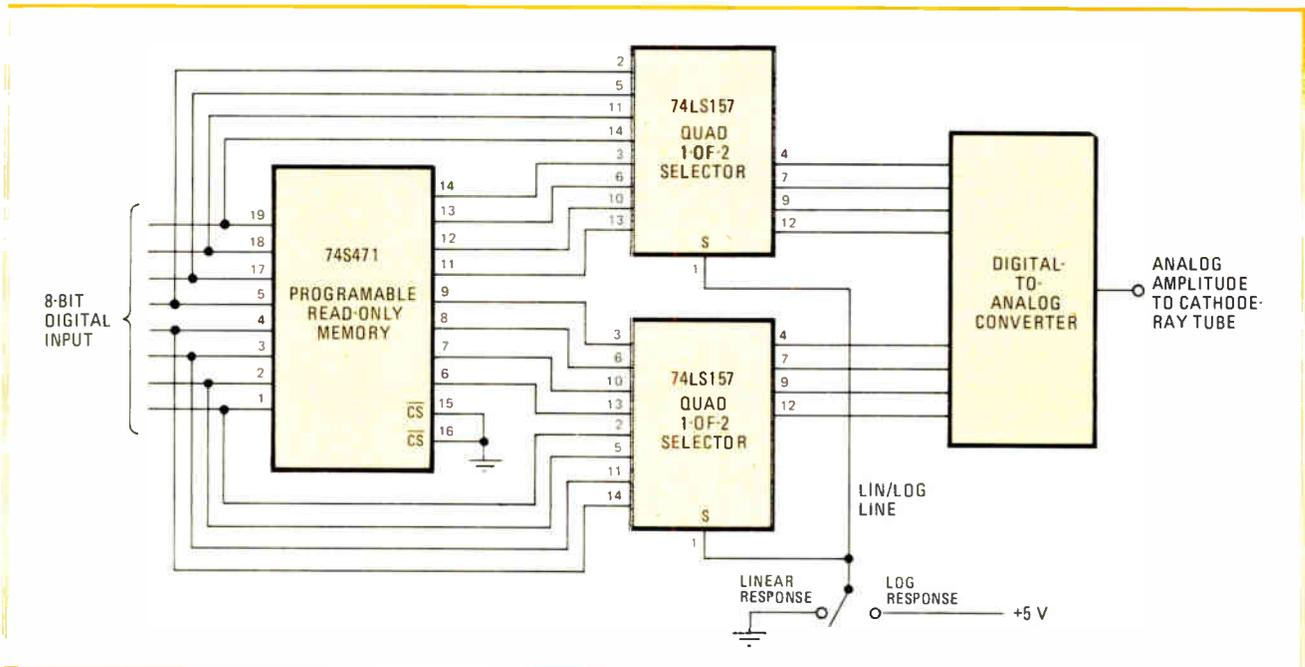

1. Three ICs select response. The 74LS157 quad two-line-to-one-line data selectors choose either the linear input code or the logarithmically scaled output from the 74S471 PROM and present it to the d-a converter for display on a scope.

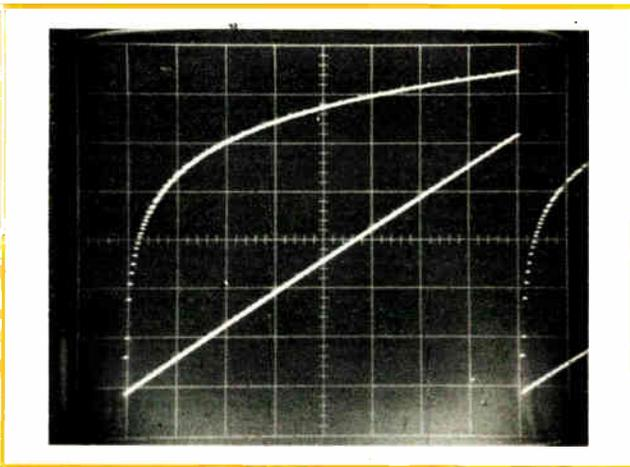

2. Log response. The logarithmic PROM output corresponding to a linear digital ramp input is shown in the top trace after conversion. The ramp input is shown in the lower trace. The scope is triggered by the overflow in the 8-bit counter that generates the ramp signal.

approach is to place an analog log amplifier between the d-a output and the cathode-ray-tube input. However, use of a programmable read-only memory makes possible the much simpler solution shown in Fig. 1.

In this circuit the 74S471 transistor-transistor-logic PROM converts the linear 8-bit amplitude into a logarithmically scaled output code. The two 74LS157's (quad two-line-to-one-line data selectors) allow selection of the linear input or the logarithmic response. When the LIN/LOG select line is low, input pins 2, 5, 11, and 14 of the 74LS157 are connected to output pins 4, 7, 9, and 12, respectively, so the response is linear. But if the

display-select line is high (+5 volts), pins 3, 6, 10, and 13 of the 74LS157 are connected to pins 4, 7, 9, and 12, so that the response is logarithmic. Both linear and log output responses to a digital input ramp are shown in Fig. 2.

The PROM is used in a basic look-up scheme. The linear input number serves as the address to the PROM. The stored code effectively performs the operation $20 \log$ (input address), with the output code linearly scaled in decibels. For an input signal with n bits, the smallest output step is k decibels, where k is given by:

$$k = (20 \log 2) n / (2^n - 1) \\ = 6.02 n / (2^n - 1)$$

The general form of the output is then:

$$y = (20 \log m) / k \\ = (2^n - 1) (20 \log m) / 6.02n$$

where y is the output code in dB, and m is the linear input code—i.e., the base-10 representation of the binary input number. If the input is a 8-bit binary signal, then:

$$y = 255 [20 \log (\text{input address})] / 48.1$$

In calculating the stored values of the PROM, fractional output codes are rounded to the nearest whole number. Any resulting error is less than 0.1 dB. An input amplitude of zero, which produces an unrepresentable value in decibels, is assigned an output value of zero.

Although the number of PROM output bits does not need to equal the number of input bits, maintaining the equality allows the linear and log displays to have the same base line and full-scale points. □

machinable glass? you've got to be kidding!

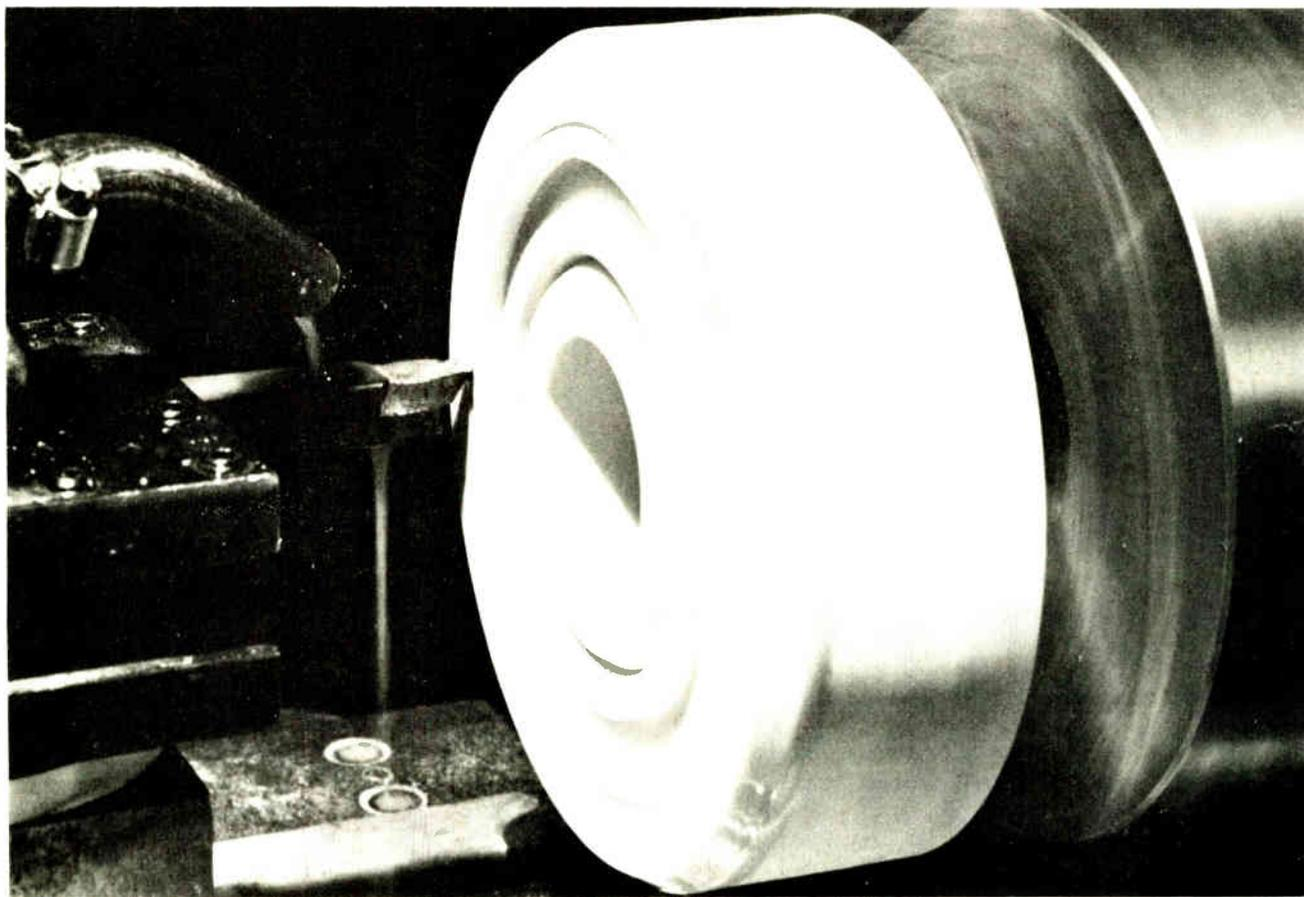

Corning Introduces MACOR™ Machinable Glass-Ceramic

Normally, glasses, ceramics, and glass-ceramics are not machinable without using diamond tooling. But MACOR™ glass-ceramic has a unique, partially crystalline structure which enables it to be machined to precision tolerances with ordinary metalworking tools and equipment.

MACOR™ glass-ceramic does not sacrifice strength, hardness or porosity to achieve this machinability, nor does it have to be fired after machining. Now, for the first time, there is a truly machinable, insulating material with physical properties that equal or exceed those of the best technical ceramics and glasses.

MACOR™ glass-ceramic can be hermetically sealed to metal, glass or ceramic utilizing a simple, glass-frit process that does not require brazing. It can also be metallized with thick-film inks and can be polished to excellent surface finishes. MACOR™ glass-ceramic has outstanding dielectric properties and is completely nonporous; in fact its electrical and vacuum properties are as good as the best alumina or glass materials. However, MACOR™ glass-ceramic is available in standard sizes from stock and can be conveniently fabricated in your own shop saving you time and money while increasing your control over results.

Features at a Glance

- machinable with ordinary metalworking tools
- no firing after machining
- excellent dimensional stability
- good thermal shock resistance
- ultra high dielectric strength
- compatible thermal expansion coefficient
- low thermal conductivity
- low loss tangent
- zero porosity and zero water absorption
- non-magnetic

For technical specifications and a stock/price list, write:
MACOR™ Glass-Ceramic Dept., E-1176
Corning Glass Works, Corning, N.Y. 14830

CORNING

Satellite processors lighten the burden in computer-run systems

Sharing monitoring and control tasks gives simpler software and faster operation than in centralized setups

by P. David Fisher and Gary S. Krause, *Michigan State University, East Lansing, Mich.*

□ Super-efficient, omniscient giant computers are the stuff of science fiction, but in real life computer architecture is evolving towards less monolithic systems with greater intelligence at the nerve ends. In fact, distributed monitoring and control using a group of satellite processors linked to a central computer looks like a good bet to displace conventional centralized control and measurement built around one large computer.

The new architectures offer simpler software and—if for no other reason than the reduction in system delays—higher operating speeds. Their success is due to the diminishing costs, greater availability, and improved computing capacities of minicomputers, microprocessors, programable calculators, and intelligent terminals—any of which may serve as the satellite processors in distributed networks.

Name that term

Distributed system, distributed monitoring, distributed control, distributed processing, and distributed control system each have their own distinct meaning, even though many of these terms are mistakenly used

interchangeably. So, before looking at the architecture of distributed control systems, it is best to define them.

In electronics, “distributed” refers to a characteristic that is spread out over an electrically significant length or area. For example, the capacitance of a coaxial cable is said to be “distributed” as opposed to the “lumped” capacitance of a discrete mica capacitor. The exact point at which a capacitance ceases to be lumped and becomes distributed often depends upon its usage in a circuit. Similarly, the exact point at which a system may be said to be centralized (lumped) is relative. Still, a distributed system may be defined as one spread out over a significant length or area.

Of course, a centralized system may contain distributed components, and vice versa. In a similar fashion, it is entirely possible and, in fact, often desirable for a distributed system to be centrally controlled or for a centralized system to be distributively controlled.

The terms distributed monitoring, distributed control, and distributed processing, on the other hand, do not

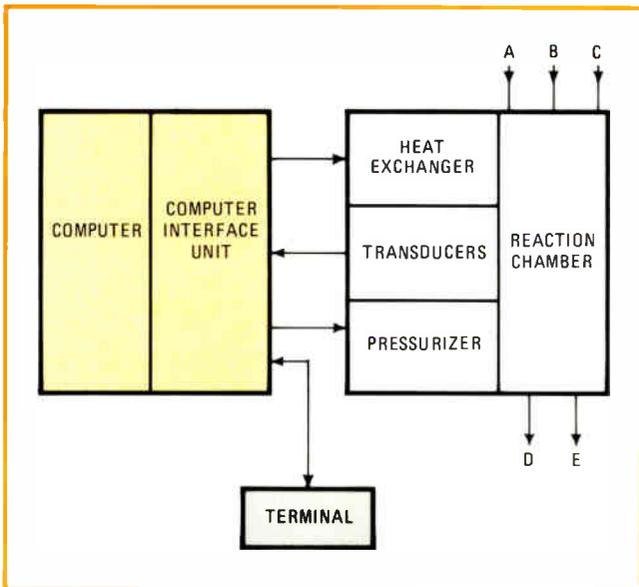

1. Centralized control. The data acquisition, processing, and control functions for this computer-controlled reaction chamber are not distributed since they are handled by a single processor.

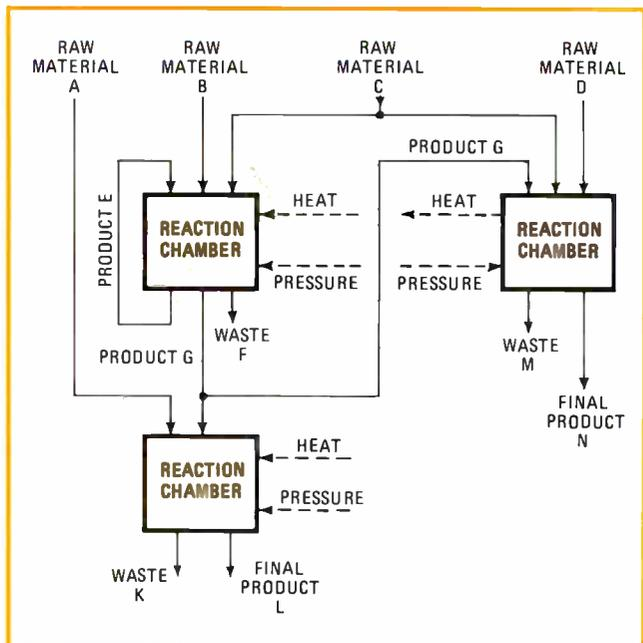

2. Distributed system. Because all the three chambers used in this process are interdependent and remote from each other, the system can be classified as distributed.

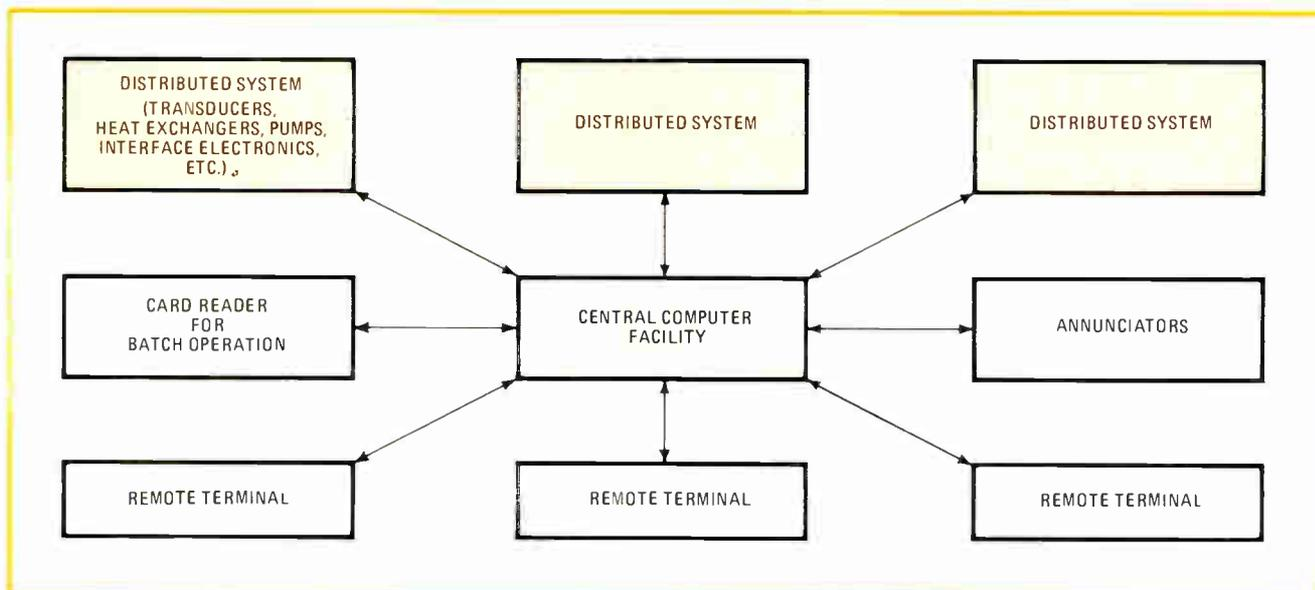

3. Centralized control. Multiple distributed systems can be controlled and monitored by one central computer. However, if a system of this type gets too large, real-time control may no longer be possible because of the resultant large time delays.

necessarily imply spatial distribution. Instead they indicate that particular functions—data acquisition, control, and data processing—are handled simultaneously by more than one piece of hardware. When any of these functions are so handled, then a distributed control system is said to exist, since there always is some control involved.

A simplified model of a completely centralized, computer-controlled reaction chamber is shown in Fig. 1. Materials A, B, and C flow into the chamber at a fixed rate and materials D and E flow out. Temperature and pressure are to be controlled. Since both are assumed to be uniform within the chamber, only one temperature transducer and one pressure transducer are required.

The computer controls

Temperature and pressure are sampled in response to commands issued by the computer to the computer interface unit. With the terminal interfaced to the computer via this unit, an operator may temporarily interrupt an instruction cycle (cycle-steal), ask the current status of the reaction chamber, command the computer to print out a record of a parameter versus time needed to document a reaction, change the control algorithm, or do unrelated computations.

Since all data acquisition is handled by a single data logger, monitoring is not distributed. The control algorithm for maintaining the desired reaction-chamber temperature and pressure is at a single location; therefore, the control function is not distributed. Since all data processing is done by a single processor, processing isn't distributed. Because of the uniform conditions within the reaction chamber, the system being controlled is not distributed.

The system of three simple reaction chambers in Fig. 2 is distributed because each of the chambers is separated from the others by significant distances. Individual chambers can't be viewed as independent systems because the flow of materials from one chamber to

another affects the temperature and pressure within the downstream chamber.

The wastes associated with each reaction may be pollutants that go up stacks or solid or liquid wastes that must be removed from the reaction chambers. For the end products to be safely and efficiently produced and have the desired properties, the following parameters must be continuously monitored and controlled:

- The rate of flow of each of the materials in each of the streams.
- The temperature, pressure, and analytic characteristics of each of the materials in the various streams.
- The temperature and pressure within each reaction chamber.
- The stockpile of raw materials, intermediate products, final products, and wastes.

Central computing

A rational decision for selecting the best scheme for monitoring, control, data processing, and operator interaction for such a distributed system is not simple. It depends upon the interrelationships of the process involved, the software, the wiring, the data format, and many other complex factors.

During the 1960s and early 1970s, a systems engineer would most likely have created a system like Fig. 3. The central-computer facility would include a large mainframe central processing unit, with several disk drives and magnetic-tape units, and many input/output ports. Data processing would be centralized, and the software would include a real-time operating system and application programs.

In general, the operating system would have a "foreground/background" architecture. In the foreground mode, it would perform all of the tasks necessary to control the distributed systems in Fig. 2. In the background mode, computer is used for non-real-time tasks such as inventory, billing, or simulation.

Depending upon the layout of the entire plant, analog

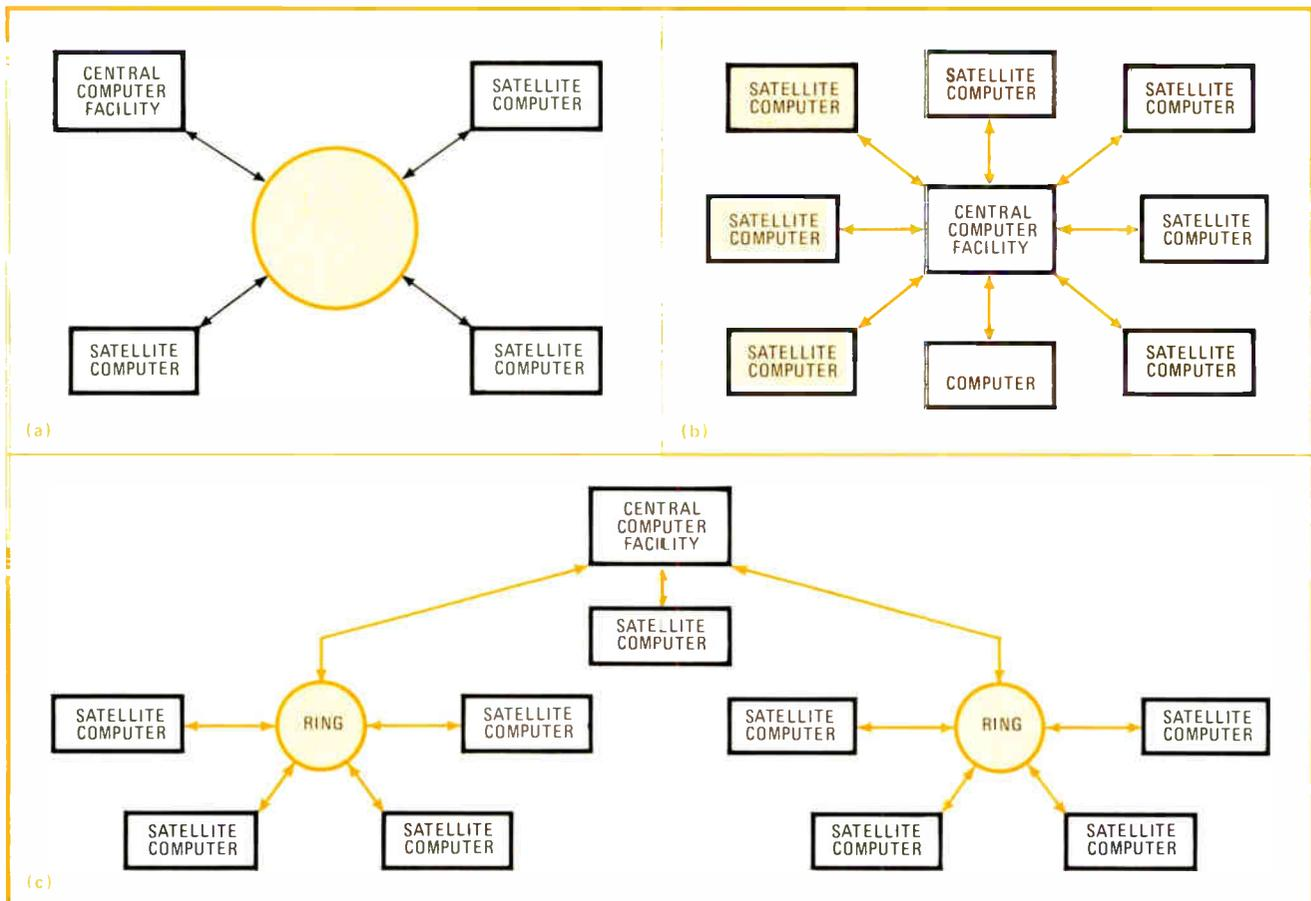

4. Distributed-control setup. A distributed-control system can take on three architectures: the ring (a), the star (b), and the hybrid (c). The star is most widely used since it is relatively simple to generate the hardware and software required.

signals or digital data words would be brought back to the control-computer facility. Layout of the plant would determine if bit-serial, byte-serial, or word-serial digital-data-communication interfaces would be employed between the central computer and a given distributed system being monitored or controlled. Annunciators (visual indicators) would be in a control room at the central-computer facility, or they would be strategically positioned at or near the systems being controlled. Remote terminals and card readers would be used for operator interaction or for background data processing. As demand on such a control system grew, main memory, disk drives, magnetic-tape drives, I/O ports, and remote terminals would be added to the existing computer mainframe.

Disadvantages of the centralized approach are manifold. The overall control system becomes very difficult to maintain, and computer downtime becomes intolerable to the point where a backup facility is required to ensure reliable operation. Software, data management, and data-communication formats and procedures (system protocols) become a nightmare. The number of distinct pairs of wires emanating from the computer's I/O ports becomes unwieldy.

However, the ultimate limitation on this architecture is that real-time control is no longer possible if the system gets too big. Significant time delays eventually will occur between the time a given distributed system or

portion of a system needs attention and gets it.

Many of these deficiencies can be overcome by distributing monitoring, control, and data processing. This requires intelligence at sites remote from the central computer facility.

Distributed-control system architecture

Three basic distributed architectures are possible: ring, star and hybrid. In the ring configuration of Fig. 4a, each remote-site (satellite) computer can directly communicate with every other computer in the system. This architecture has several important advantages and one key disadvantage.

On the plus side, routine data acquisition and control are distributed; therefore, the amount of information communicated to and from the central computer or any of the satellite computers is minimal. Furthermore, all routine data-processing tasks required for controlling the functions at any remote site are handled there.

In addition, the central computer or one of the satellite computers can make use of the data-processing capabilities of other computers in the system if they indicate that they are idle. Also, if the control strategies implemented at one remote site have an immediate consequence at another, then the satellite computers can communicate directly.

The big disadvantage of the ring approach is the software necessary. The required protocols, particularly

with ever-changing control-system requirements, can get quite involved. Each computer must know its monitoring, data processing, and control functions, but it must also be able to communicate intelligently with every other computer on the ring. So the software for every computer must be reconfigured if the ring is expanded. This means that, for many applications, the ring architecture is impractical.

The second distributed architecture is the star approach of Fig. 4b. This architecture has all of the advantages of the ring except that no satellite computer can communicate directly with another. All communications must go through the central computer, which views each satellite computer as just another remote terminal with each satellite oblivious to the others. This greatly simplifies the protocols and, consequently, the software requirements for all computers. As a bonus, expanding the system requires software changes only at the central computer. However, communication between any two or more satellite computers is slower than for the ring.

The third basic architecture combines the best features of star and ring networks to form the hybrid distributed system of Fig. 4c. For portions of the system that require rapid response, the ring setup is employed. For less critical data paths, the star approach is used.

For large, complex applications, this approach is the wave of the future. It eliminates the software headaches of the ring, so it is amenable to system expansion. However, it has more interconnections than the other two architectures, so it has greater protocol problems.

Implementing the star setup

The star architecture is the most widely used of the three distributed configurations, so it rates an in-depth look. The coordinator and supervisor of this type of distributed control system is the central computer. Typically located at some key managerial location, its duties include coordination of all remote-site activities, user interaction, and execution of various managerial programs such as summaries, reports, and projections. The hardware and software configurations are those that are used in any multiuser, multitask, real-time operating system. The only special feature is the central-site-to-remote-station communications interface. This will vary according to the turn-around time required between the central site and a remote site, as well as the volume of data to be communicated between them.

Each remote station functions primarily as a local data-acquisition system, data processor, and controller. It must have sufficient intelligence to control and manage the local processes. All of the attendant characteristics of a controller must be provided, such as changeability, expandability, ease of operation, and manual override capabilities. In these respects, a remote station doesn't differ from any standard autonomous controller.

In light of the importance of the network communication links, careful consideration must be paid to their implementation. Interfaces such as the bit-serial RS-232C or the byte-serial IEEE 488-1975 would always be preferred, because they are industry standards and would significantly increase overall system flexibility

while minimizing cost of the data-communication network.

Careful attention must also be paid to the data-communication media; e.g., 20-milliamper twisted-pair current loops, dedicated frequency-shift-keying circuits implemented with any one of a dozen different classes of modems, switched-telephone common-carrier networks, dedicated fiber-optic data paths, and so on. The medium used must be well suited to desired speed and data rates of the system.

Fast independent processing

Although a star network does not have as fast a response time as the ring approach, it is significantly faster than the centralized system of Fig. 3 because of its parallel-processing capability. Each computer in the star system can process data independently. Therefore many tasks that had to be done sequentially or on a cycle-steal basis with a single computer can be accomplished simultaneously.

The parallel processing capability means that operator interaction can be handled more easily than with centralized control. In particular, it is much easier for an operator at a satellite station to interact with the computer for seeking system status or for altering the control system.

Information interchange between a satellite station and the central-computer facility would be limited to record-keeping summaries indicating remote-site performance. The only other type of data transfer would be when a satellite computer can't keep its portion of the distributed system under proper control and needs central-site intervention. The central computer would only initiate information interchange when the control strategy must be changed or when it or its operator wants to check system status. In short, a well-designed distributed-control system with a star architecture has minimal data-communication requirements and simple data-management schemes.

The simpler software or hardware updates make for a flexible system. For example, a satellite computer could be used to evaluate the proposed changes. The upgraded portion of the system could then be "cut in" with minimum down time.

This upgrading is feasible because the hardware of each satellite could be identical, costing only a fraction of the central computer necessary to perform the functions distributed to the satellites. Maintenance of the satellite computers would be relatively easy because of the low cost of one or two standbys. These could be used in place of down units or in system development.

Distributed-control systems will replace centralized controllers in many instances. However, their principal impact will be in applications not particularly amenable to centralized control. Prototype systems exist for such applications in the fields of electric-power generation, distribution, and consumption; credit-authorization systems; health-care delivery in hospitals and medical centers; climate control, security, waste disposal, and fire protection in large buildings; urban and intercity mass transportation; manufacturing; agricultural production, processing, distribution, and marketing, and energy and

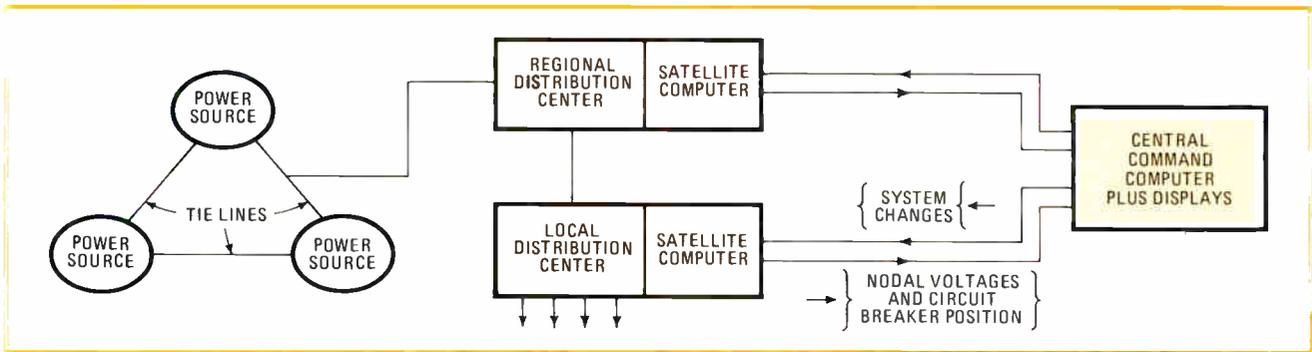

5. Power generation. Monitoring, managing, and control of a power grid is best done by a distributed network. A typical system will have a number of regional centers and associated local centers, all with processors tied into the central computer.

other natural-resource exploration and use. Distributed architecture is proving its ability in these fields, as the following examples of prototype systems illustrate.

The power utilities are one of the first to apply distributed architectures on a large scale in order to monitor and control the generation and distribution of electricity. A typical company has three components: power generation, transmission, and distribution.

Typical power sources, interconnected in a grid with each other and regional distribution centers (Fig. 5), are monitored for line overloads, faults, and interruptions. Since the lines are not of equal capacity, an added on-line load means power must be routed to avoid line overloads. So there are monitoring and management functions to perform here.

Power from the sources, having reached a regional distribution point, is transformed to a lower voltage and switched onto lines for distribution to local switching centers, where it again is transformed and switched to the customer. The status of the various circuit breakers, transformers, and lines must be known and controlled for the efficient management of the power.

By superimposing a star system on the power network, effective control is achieved. At each switching and distribution center, nodal voltages and circuit-breaker positions are noted and relayed to a central command facility, which houses a mainframe computer.

The mainframe, which is responsible for system management and security, provides the various displays for the decisions. When the need for changing the system occurs, the operator enters the appropriate command, which is forwarded to the local and regional distribution centers for action. The high-speed digital computer can act upon network data, decide what needs to be done, and execute it all within a matter of seconds so that a customer is hardly aware of the action.

Computerizing credit

With more than 275 million credit cards in the hands of American consumers engineering efforts have accelerated rapidly to develop technologies and systems that will make commercial transactions faster, safer, less susceptible to human error, and more economical. Distributed architectures fit right in.

An example is the replacement of an "off-line" credit-authorization system with an "on-line" system (Fig. 6). Even though the computer facility at the bank may itself

be a highly sophisticated on-line data-processing system, the credit-authorization system at the top of the figure is an off-line system with respect to the point of sale. It has several serious limitations.

First, credit authorization is slow, principally because of the shortcomings of the telephone communications system. Second, it is difficult to maintain a current hot list at every POS terminal. Third, there is an unnecessary time lag between the updating of the authorization file in the bank and the customer's current credit position. Finally, the credit authorization doesn't relieve the manual data-entry load.

These deficiencies can be overcome with the on-line credit-authorization system at the bottom of the figure. At the heart of this system is an intelligent POS terminal. The retail clerk can enter essential information related to the pending sale using a keyboard. The magnetic-stripe credit card read by the terminal contains the customer's name, address, and account number, and important credit-authorization information.

The POS terminal automatically communicates all pertinent information on a real-time basis to the bank's central computer. If the central computer approves the sale, then the satellite computer generates the appropriate copies of the sales draft and updates the customer's authorization file at the central computer, as well as the file on the credit card.

Controlling intensive care

Distributed-monitoring-and-control techniques may also be used advantageously in a hospital's intensive-care unit. Here critical metabolic parameters must be watched closely 24 hours a day. Typically, one nurse monitors four patients from a central display console. By letting each bed represent a remote station and the nurse's station a central station, the four-patient networks of an intensive-care unit fall naturally into a star configuration.

By adding intelligent bedside terminals and a central computer at the nurse's station, it's easy to develop a distributed architecture. With intelligence at each bedside monitor, all required metabolic parameters can be extracted from the analog signals and checked against norms. Summaries of required data would be displayed at the bedside and sent to a central computer at regular intervals or upon detection of an abnormality.

Because of this minimum data flow, one supervisory

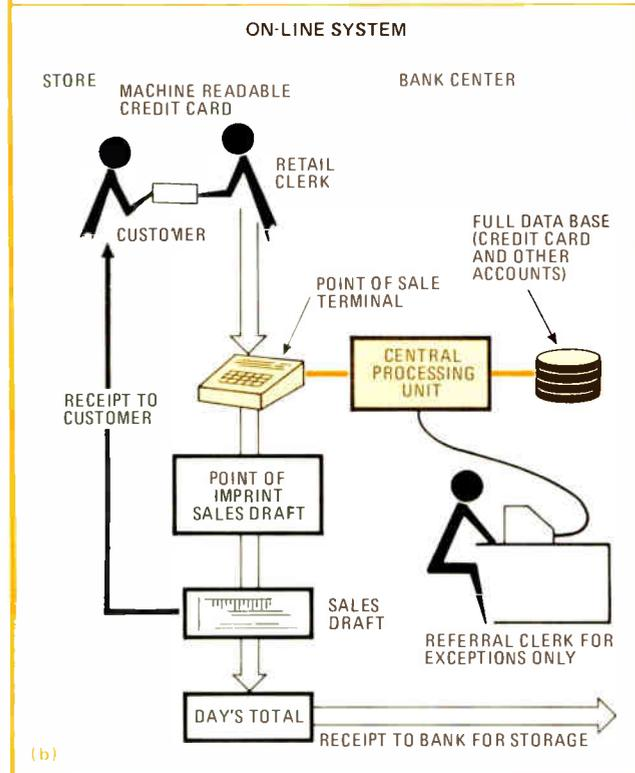
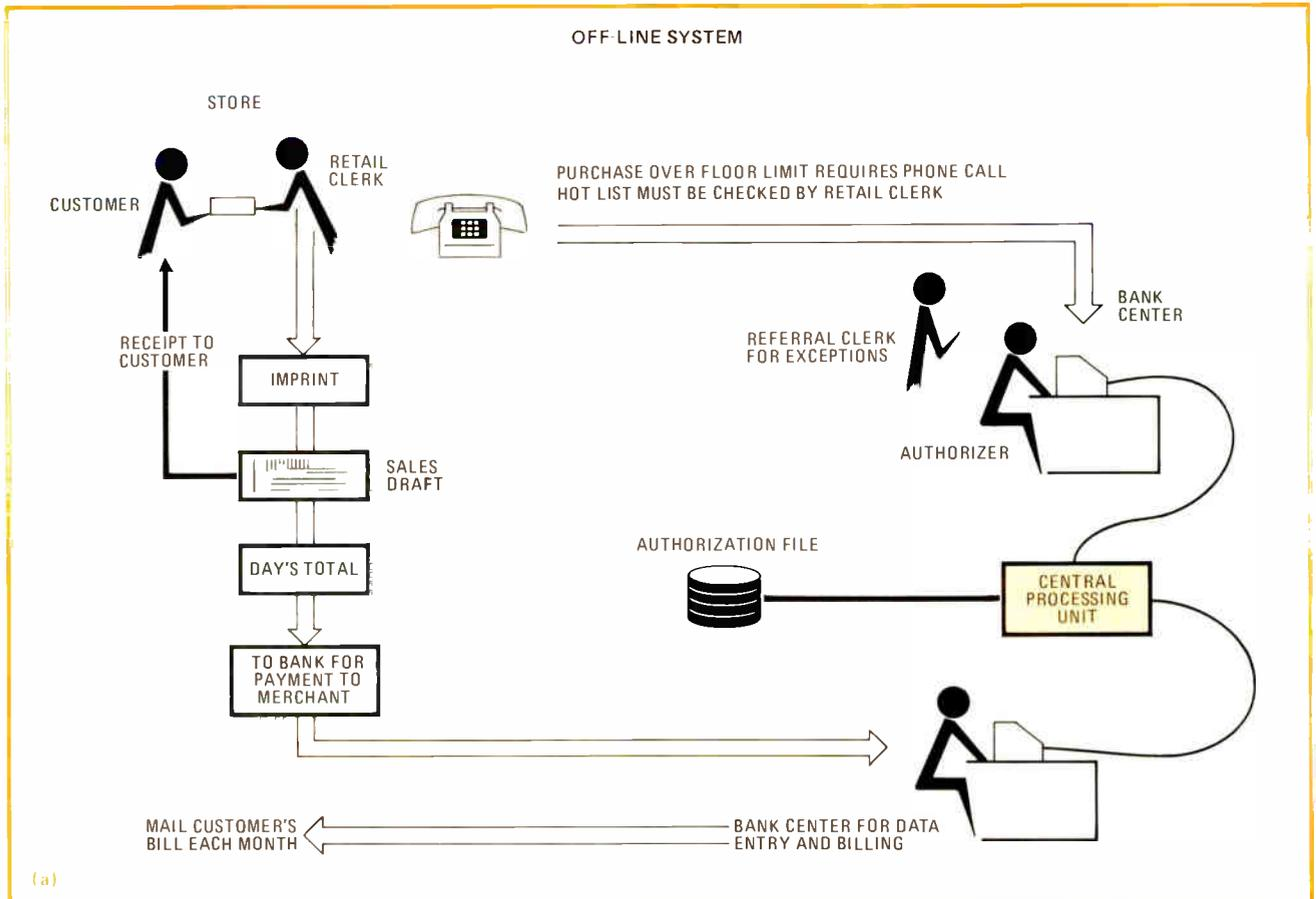

6. Electronic credit. Credit-card transactions can be made by the off-line method, top, or the on-line method. On-line authorization uses an intelligent point-of-sale terminal as the remote processor of an overall distributed-control system.

nurse at the central station could handle the entire intensive-care unit, not just four patients. Information on each patient's medical history, progress, treatment, and response to treatment may be maintained more completely and precisely, as well as in a more accessible format. Access to this data base may be from either the bedside terminal or the central station. Finally, the computer reduces the possibility of human error.

Future control

As the potential for the distributed-control field is better understood, a new wave of electronic subsystems will surely appear. One can envision the appearance of inexpensive, modular, microprocessor-based controllers that will be used for distributed data acquisition, data processing, on-line control, data communications, and operator interaction at satellite stations. It is conceivable that one or more of these controllers would be used for each of these functions.

A cost-efficient approach may well dictate the need for standard universal controllers based on microprocessors and reprogrammable read-only memories in order to quickly add, alter, interface, or repair remote-site functions. Finally, fiber-optic data links may find their first real test in a distributed-processing-control problem. Many tradeoffs are made today in data communications between remote sites and central sites because of data-channel capacity limitations and radio-frequency radiation problems. Fiber-optic links might solve these problems in many cases. □

How to build high-quality filters out of low-quality parts

If the operational amplifier is wired as a voltage follower, an active filter can use loose-tolerance resistors and capacitors—and still perform well

by Philip R. Geffe, *Lynch Communication Systems Inc., Reno, Nev.*

□ An active filter's sensitivity to component values is an important factor in determining its cost. If the circuit is designed for minimum sensitivity to these values, then inexpensive low-tolerance components can be used without harm to its performance.

In the three-pole filter of Fig. 1, the amplifier closed-loop gain, K , is the parameter that governs sensitivity. This results from the presence of the factor $(1 - K)$ in terms of the transfer-function denominator. If K is greater than unity, the denominator will contain negative terms that lead to high sensitivity. For this reason, the amplification is provided by an operational amplifier connected as a voltage follower. In addition to providing $K = 1$, use of a voltage follower also saves two gain-fixing resistors in the op-amp connection.

Low-pass design

If the amplifier in Fig. 1 is a voltage follower and the resistor values are all 1 ohm, a normalized Butterworth or Chebyshev filter response is obtained by choosing capacitance values from Table 1. The zero-ripple design is the normalized Butterworth filter. It has an attenuation of 3 decibels at a frequency of 1 radian per second, and its asymptotic slope in the stopband is 18 dB per octave. The exact attenuation at any frequency ω is given by the formula:

$$e_{out}/e_{in} = 1/(1 + \omega^6)^{1/2}$$

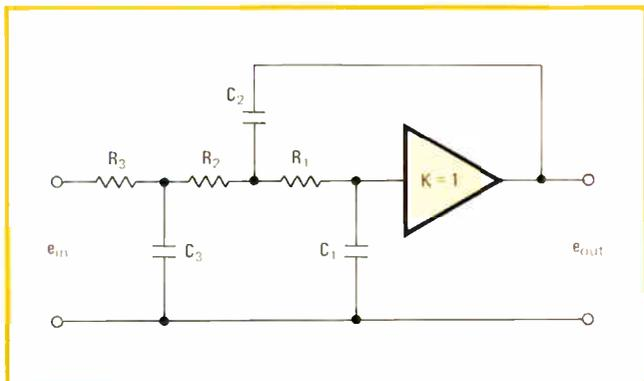

1. Uses loose-tolerance components. The performance of this three-pole low-pass active filter is insensitive to values of resistors and capacitors if the amplifier gain, K , is unity. Therefore inexpensive components with relatively loose tolerances can be used.

TABLE 1: ELEMENT VALUES FOR NORMALIZED THREE-POLE ACTIVE FILTERS

Ripple (dB)	C ₁	C ₂	C ₃
0	0.20245	3.5468	1.3926
0.01	0.091294	2.5031	0.84044
0.03	0.097357	3.3128	1.0325
0.10	0.096911	4.7921	1.3145
0.30	0.085819	7.4077	1.6827
1.00	0.05872	14.784	2.3444

TABLE 2: ATTENUATION CONSTANTS FOR CHEBYSHEV FILTERS

Ripple (dB)	Ripple factor (ϵ^2)
0.01	0.00230524
0.03	0.00693167
0.1	0.023293
0.3	0.0715193
1.0	0.258925

TABLE 3: BAND-EDGE FREQUENCY, ω_c , AS A FUNCTION OF RIPPLE AND BAND-EDGE ATTENUATION α

Ripple (dB)	Band-edge frequency ω_c (rad/s)		
	$\alpha = 1$ dB	$\alpha = 2$ dB	$\alpha = 3$ dB
0	0.798355	0.914491	1.00000
0.01	1.56352	1.74229	1.87718
0.03	1.36673	1.50770	1.61524
0.10	1.20154	1.30707	1.38899
0.30	1.08934	1.16726	1.22906
1.00	1.00000	1.05219	1.09487

The capacitance values corresponding to the nonzero values of ripple in Table 1 yield Chebyshev filters. These filters have equiripple passbands, with the edge of the ripple band at 1 rad/s. The attenuation for the Chebyshev filter designs can be calculated from the voltage-ratio formula:

$$e_{out}/e_{in} = 1/[1 + \epsilon^2(4\omega^3 - 3\omega)^2]^{1/2}$$

where ϵ^2 is the ripple factor obtained from Table 2. The user can be expected to define the attenuation at the edge of the passband, but the choice of ripple value is usually left to the designer. As an aid to meeting the passband edge requirement, Table 3 gives the frequencies for attenuations of 1, 2, and 3 dB for all ripple values.

As an example, consider the design of a low-pass Chebyshev filter with 0.3-dB ripple and the calculation of its attenuation at twice the 3-dB frequency.

Frequency scaling

The normalized circuit is shown in Fig. 2, with capacitance values taken from Table 1. Table 2 shows that a 0.3-dB ripple corresponds to ϵ^2 of 0.0715193. The 3-dB frequency of this filter is given by Table 3 as 1.22906

3. Practical 10-kHz low-pass filter. The example in the text shows how the component values in Fig. 2 are scaled to provide the edge of the ripple band (the highest frequency at which attenuation is equal to or less than 0.3 dB) at 10 kHz. Ductor compensation is added to voltage follower that uses a type 741 operational amplifier.

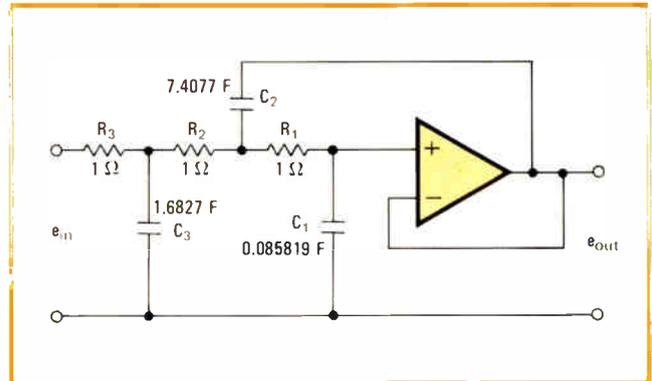

2. Normalized low-pass filter. Design of low-pass Chebyshev filter with 0.3-dB ripple starts with R values of 1 ohm and C values from Table 1, plus a voltage-follower op amp to make $K = 1$.

rad/s; at twice this frequency, i.e., $\omega = 2.45812$ rad/s, the attenuation is calculated to be 0.0716734. Expressed in decibels, this attenuation is $20 \log(0.0716734)$, or -22.89 dB.

To scale the design so that the edge of the ripple band (that is, the highest 0.3-dB frequency) occurs at 10 kilohertz, divide all capacitance values by $2\pi(10,000)$.

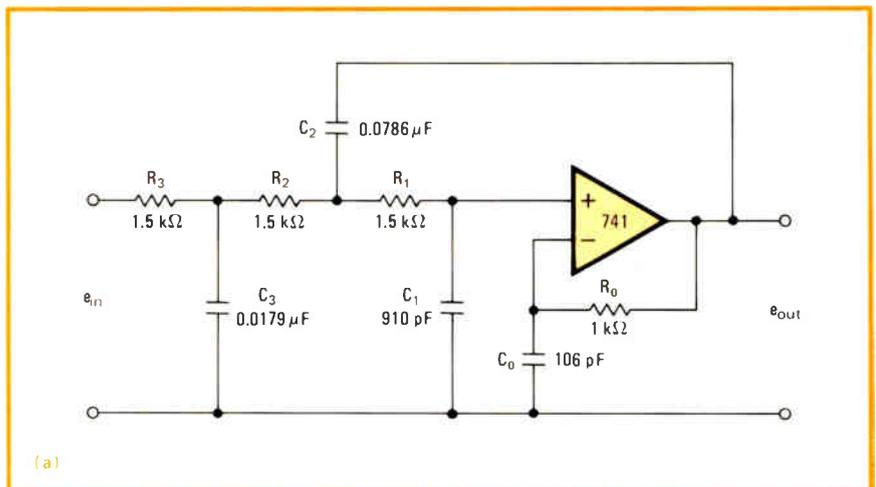

(a)

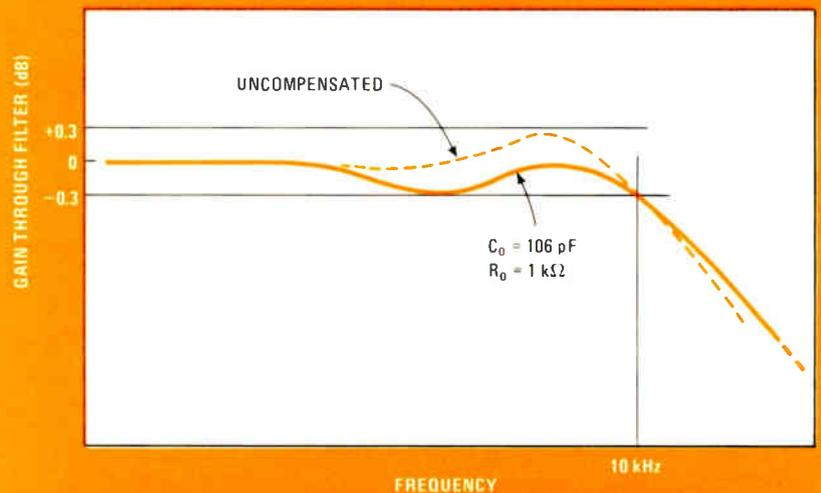

(b)

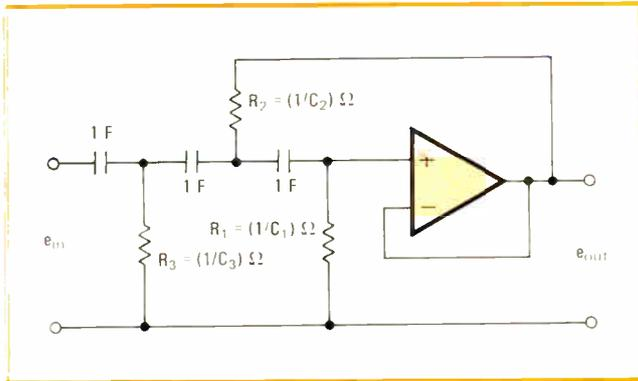

4. High-pass filter. In the normalized high-pass three-pole active filter, the series capacitors are all 1 F, and the resistor values (in ohms) are found by reciprocating the numbers in Table 1.

This gives:

$$\begin{aligned} C_1 &= 1.36585 \mu\text{F} \\ C_2 &= 117.897 \mu\text{F} \\ C_3 &= 26.7888 \mu\text{F} \end{aligned}$$

These values are correct but impractical. A practical design can be obtained by multiplying all impedances by a suitable scale factor, say 1,500. This gives:

$$\begin{aligned} R_1 &= R_2 = R_3 = 1,500 \Omega \\ C_1 &= 910.6 \text{ pF} \\ C_2 &= 0.0786 \mu\text{F} \\ C_3 &= 0.0179 \mu\text{F} \end{aligned}$$

The frequency response of this filter is the same as that of the normalized design, except that all attenuations are referred to the band-edge frequency, f_c , of 10 kHz, instead of to 1 rad/s. Consequently, the attenuation formulas serve for the denormalized filters if ω is replaced by f/f_c .

Gain compensation

These filters require rather precise values of closed-loop gain, which is why an operational amplifier is used instead of some simpler unity-gain amplifier. But even an op amp may require compensation if its open-loop gain drops to less than 60 dB at the band edge of the filter.

A voltage divider consisting of resistor R_o and capacitor C_o provides the Boctor compensation, as it is called, by shunting off part of the feedback at high frequencies. R_o and C_o are given by:

$$R_o C_o = 1/(2.6 \times 2\pi f_o)$$

where f_o is the 0-dB frequency of the amplifier open-loop gain curve.

For a 741 op amp, the open-loop gain is less than 40 dB at 10 kHz, and the measured value of f_o is 581 kHz. Therefore, R_o and C_o are 1 kilohm and 106 picofarads, respectively. The complete circuit for the 10-kHz filter in the example, including Boctor compensation, is shown in Fig. 3.

High-pass design

The element values given in Table 1 are the reciprocals of the resistances in a normalized high-pass filter, as

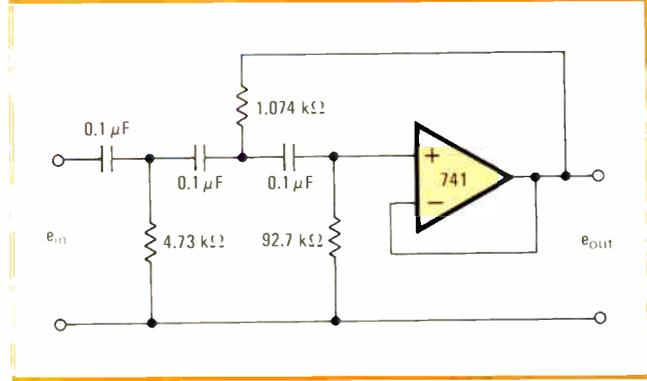

5. Practical 200-Hz high-pass filter. The example in the text gives details of the design of this filter, which has 0.3-decibel ripple above 200 hertz and 31.35-dB attenuation at 60 Hz.

How to design three-pole filters

The following equations will yield component values for three-pole active filters not covered by Table 1. Given:

$$e_{out}/e_{in} = 1/(a_3 s^3 + a_2 s^2 + a_1 s + 1)$$

with known numerical coefficients a_3 , a_2 , a_1 , component values for the circuit in Fig. 1 are obtained by finding a positive real root of:

$$18x^3 - 12a_1 x^2 + (2a_1^2 + 3a_2)x + (2a_3 - a_1 a_2) = 0$$

If x_0 is such a root, then:

$$y = -a_3/(3x_0^2 - a_1 x_0)$$

$$z = a_1 - 3x_0$$

Then the element values for Fig. 1 are $K = 1$, $R_1 = R_2 = R_3 = 1$, $C_1 = x_0$, $C_2 = y$, and $C_3 = z$, where resistances are in ohms and capacitances are in farads.

shown in Fig. 4. The normalized capacitance values for the high-pass filter are all 1 farad. In the attenuation formula used for frequency-response calculations, ω must be replaced by f_c/f , where f_c is the band-edge frequency; this applies to both normalized and denormalized highpass filters.

As an example, consider the design of a high-pass filter that must pass signals above 200 hertz and must suppress 60-Hz signals by at least 30 dB. Here f_c/f is 200/60; the voltage-ratio expression shows that a Chebyshev filter with 0.3-dB ripple will give an attenuation of 31.35 dB. Therefore, the resistors in the normalized circuit (Fig. 4) have values found from Table 1 as follows:

$$R_1 = 1/C_1 = 1/0.085819 = 11.6524 \Omega$$

$$R_2 = 1/C_2 = 1/7.4077 = 0.1350 \Omega$$

$$R_3 = 1/C_3 = 1/1.6827 = 0.59428 \Omega$$

Frequency-scaling this design to $\omega_c = 2\pi(200 \text{ Hz})$ gives 1256.6 for ω_c , and dividing the 1-F capacitances by this number gives the value $C_1 = C_2 = C_3 = 795.8 \mu\text{F}$ for the capacitors.

Finally, to get practical component values, all the impedances are multiplied by the factor 7,958 to make the capacitors 0.1 μF . The resistors then turn out to be as shown in Fig. 5. □

Color-TV set calibrates standard oscillators

by Carl F. Buhner
GTE Laboratories Inc., Waltham, Mass.

A 3,375-kilohertz crystal oscillator is a good laboratory frequency standard because it is easily calibrated with great precision against a commercial TV network color signal, and because its frequency can be divided to provide many useful substandards. Several other frequencies also possess these characteristics to greater or lesser extent, and therefore are also discussed here.

Use of the television color subcarrier for adjusting local frequency standards to high accuracy has been recommended by the National Bureau of Standards [*Electronics*, May 10, 1971, p. 96, and March 20, 1975, p. 107]. The frequencies suggested here don't need phase-locked-loop synthesis and display-generating circuitry in the frequency comparison. The calibration can be made with just a color-TV receiver.

The method is based on the formation of steady color-stripe patterns on the TV screen when certain frequencies are substituted for the set's chroma signal. A succession of these stripes, each having a red, green, and blue component, will intersect vertically m times and horizon-

tally n times per full video frame for an input frequency f_k given by:

$$f_k = f_c + nf_h + mf_v$$

Here n and m are positive or negative integers, and f_c , f_h , and f_v are the color-subcarrier, horizontal-scan, and vertical-scan frequencies, respectively. All three are nonintegral, but they are related as follows:

$$f_c = 5 \text{ MHz} \times 63/88 = 3.5795454 \dots \text{ MHz}$$

$$f_h = f_c \times 2/455 = 15.734265 \dots \text{ kHz}$$

$$f_v = f_h \times 2/525 = 59.940057 \dots \text{ Hz}$$

However, their combination, f_k , can be an integer. If n and m are chosen in relation to an integral index k such that:

$$n = -13 + 21k$$

and:

$$m = -7k$$

then f_k becomes an integral multiple of 15 kHz, given by:

$$f_k = (225 + 22k) \times 15 \text{ kHz}$$

The table shows suggested standard frequencies that correspond to k of -1 , 0 , 1 , and 2 . For the non-0 values of k , m is not 0, and the result is diagonal stripe patterns on the TV screen. Therefore 3,375 kHz is the most useful as a standard frequency; since $m = 0$, that frequency

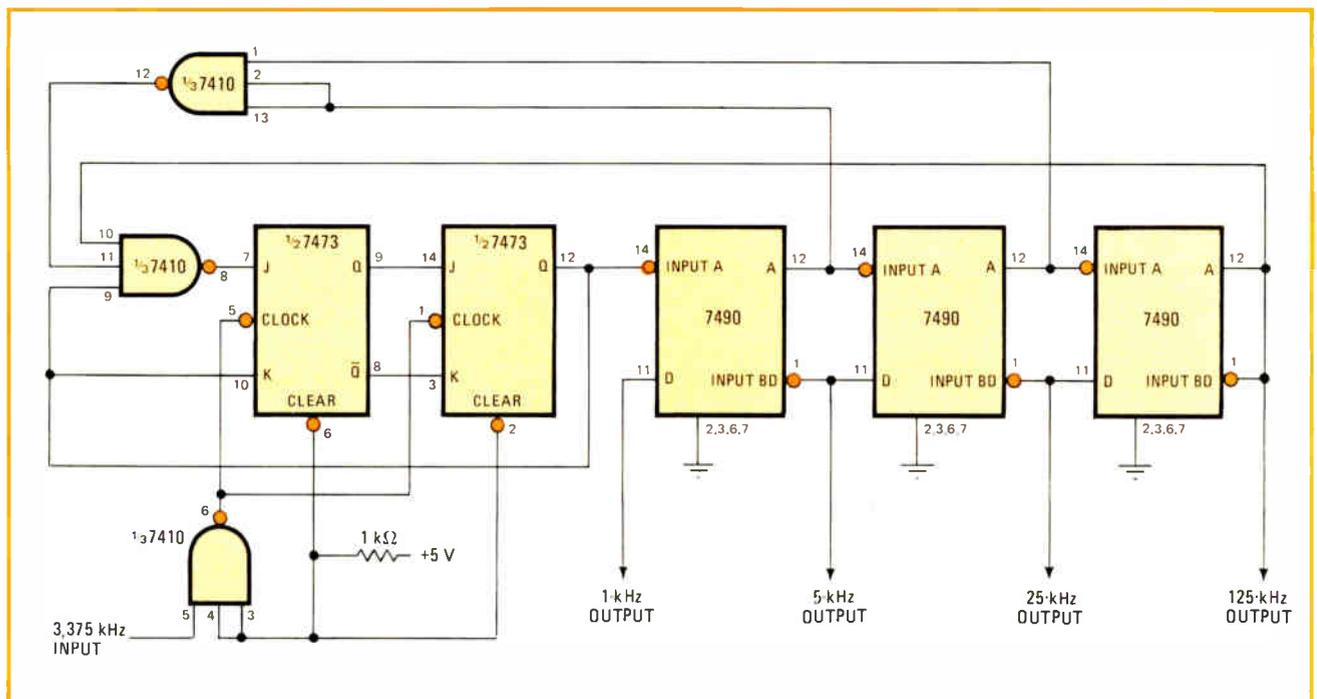

Frequency divider. This circuit uses a dual flip-flop and three divide-by-2 stages with feedback to divide the input frequency by 27. Three divide-by-5 stages then give further reductions. The input frequency of 3,375 kHz is convenient for use as a laboratory standard oscillator frequency because it has many useful submultiples and, besides, can be calibrated with great precision simply with a color-TV set.

gives a vertical stripe pattern easily distinguished from the associated $m = \pm 1$ frequencies, which are 59.94 hertz away. Moreover, all of its prime factors are small; $3,375 \text{ kHz} = 2^3 \times 3^3 \times 5^6 \text{ Hz}$, so a variety of lower frequencies such as 50, 60, 500 Hz, 1, 3, 5, 15, 25 . . . kHz can be obtained directly by division.

Calibration of the oscillator against the TV networks' rubidium standard for color video transmission requires selection of a broadcast originating live in New York or Los Angeles, where the standards are located. A sample of the 3,375-kHz frequency is injected into the chroma input of the demodulator circuit after the program color is turned off with the color-level control. About 1 to 2 volts fed into a 15-picofarad capacitor connected to the chroma input pin of the color-demodulator integrated circuit is sufficient to give vivid color stripes. (Since most TV chassis are not grounded, care is necessary to avoid electrical shock in this operation.)

When the crystal oscillator is tuned about 60 Hz higher than 3,375 kHz, the pattern with $n = -13$, $m = +1$ appears, with stripes tilting to the left. As the oscillator frequency is lowered, this tilted pattern drifts faster and faster to the left until the drift is too fast to be observed. As 3,375 kHz is approached, the desired vertical stripe pattern appears drifting to the right. As the frequency is further reduced through 3,375 kHz the vertical stripe pattern stops and then starts drifting to the left. At about 60 Hz below 3,375 kHz, the $m = -1$ stripe pattern, tilted to the right, appears to stop.

Because of an offset of approximately -300×10^{-10}

USEFUL STANDARD FREQUENCIES				
k	n	m	f_k	Factors
-1	-34	+7	3,045 kHz	$7 \times 29 \times 15 \text{ kHz}$
0	-13	0	3,375 kHz	$3^2 \times 5^2 \times 15 \text{ kHz}$
+1	+8	-7	3,705 kHz	$13 \times 19 \times 15 \text{ kHz}$
+2	+29	-14	4,035 kHz	$269 \times 15 \text{ kHz}$

in the network frequency relative to the National Bureau of Standards value, the crystal oscillator should be tuned to a frequency slightly higher than the network signal. This is done by adjusting the oscillator such that the vertical stripe pattern drifts to the right one stripe width in about 9.31 seconds. Exact offsets of the network standards are published regularly by NBS.

When 3,705 kHz is used as the standard frequency, the directions of tilt and drift are reversed, because n is positive. This frequency is a desirable standard if its prime factors 13 or 19 are needed.

As an example of use of the 3,375-kHz standard to produce precision submultiples, a simple divider chain useful as a counter time base or frequency synthesizer reference is shown in the figure. It consists of a 7473 dual flip-flop predivider followed by three binary stages with feedback to give a divide-by-27 output of 125 kHz and then three divide-by-5 stages with outputs at 25 kHz, 5 kHz, and 1 kHz. Harmonics of 125 kHz also permit comparison of this standard with all of the high-frequency transmissions of WWV. □

Direct-reading ohmmeter needs no calibration

by V. Ramprakash
Electronic Systems Research, Madurai, India

A direct-reading ohmmeter with a linear scale can be made by connecting an operational amplifier, a milliammeter, a zener diode, and some resistors as shown in the circuit diagram. This ohmmeter does not require calibration, is self-zeroing, and is insensitive to the supply voltage.

The value of an unknown resistor is measured by connecting it as R_x . The reading on the milliammeter, I_m , is then R_x/R_c , where R_c is the resistance of a known standard resistor in the circuit. The current through the meter equals $(V_o - V_z)/R_m$, where V_o is the voltage at the output of the op amp, V_z is the drop across the zener diode (3 V), and R_m is the resistance in the meter circuit; here R_m is (2.9 + 0.1) kilohms. Since the voltages at the

Milliamperes indicate resistance. The meter reading in mA is the value of the ratio R_x/R_c , so full-scale meter deflection indicates an R_x of 100 kilohms. An open circuit pins the meter, but does no damage because the germanium diode clamps the meter voltage. Since a short circuit produces no deflection, the circuit is self-zeroing.

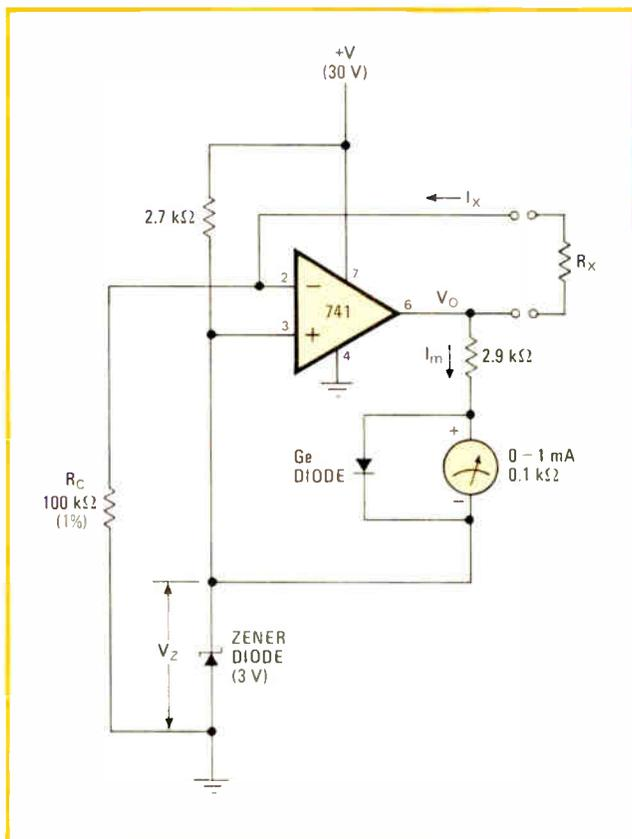

inverting and noninverting input terminals of the op amp must be equal, $V_o R_c / (R_c + R_x)$ must equal V_z . Therefore: $V_o = V_z(R_c + R_x) / R_c$, or $I_m = (V_z / R_m)(R_x / R_c)$. The values of V_z and R_m shown yield:

$$R_x = (R_c)(I_m)$$

if I_m is the meter reading in milliamperes.

For an R_c of 100 kilohms, the 1-mA meter deflects full scale when R_x is 100 kilohms. Similarly, full scale can be made to indicate 10 kilohms or 1 kilohm by selecting these values for R_c . A range switch can be included in the circuit to set these values.

The current through the unknown resistor, I_x , is independent of the value of R_x . The equality of the op-amp input voltages makes V_z equal to $I_x R_c$, so $I_x = V_z / R_c$.

The meter has automatic zeroing because, if the measuring leads are short-circuited, V_o rises to exactly 3 V, sending no current into the meter. No calibration is necessary because the meter deflection has direct correspondence to the value of resistance being measured.

The germanium diode limits the voltage across the meter, and thus protects it from over-current when the measuring leads are left open. □

Calculator notes

HP-25 calculator serves as clock

by Jack L. Aker
San Jose, Calif.

The HP-25 calculator can be programmed to serve as a clock, displaying the time of day as HH.MMSS. One or more digits show the hour, followed by a decimal point, and then two digits indicate minutes, and two digits the seconds.

As shown by the accompanying program steps, the last displayed value of time is kept in register 1 in decimal-hours format. The execution time of the program sequence (3.2975146×10^{-4} hours, or about 1.2 seconds) is then added to that value. If the incremented value is less than 13, it is converted to the hr/min/sec representation and displayed for about $\frac{3}{4}$ second (the pause period).

If the incremented decimal-hours time is greater than 13, only the decimal portion is retained, and a 1 is added to it (so that the hour after 12 is 1, not 13). The incremented value in register 1 is then converted to the HH.MMSS format and displayed for $\frac{3}{4}$ second.

In either case, the program then recycles after the pause.

To operate the HP-25 as a clock, first enter the program. Then, in the run mode, initialize registers 4 and 7 by the following entries:

3.2975146

EEX

CHS

4

STO 4

and:

13.00

STO 7

To run the clock program, enter the initial value of time in HH.MMSS format, and press:

f FIX 4

g → H

STO 1

f PRGM

R/S

HP-25 CLOCK PROGRAM		
LOCATION	CODE	KEY ENTRY
01	24 01	RCL 1
02	24 04	RCL 4
03	51	+
04	23 01	STO 1
05	24 07	RCL 7
06	21	x ≠ y
07	14 41	f x < y
08	13 13	GTO 13
09	15 01	g FRAC
10	01	1
11	51	+
12	23 01	STO 1
13	14 00	f →H.MS
14	14 74	f PAUSE
15	13 01	GTO 01

REGISTER	CONTENTS
1	decimal time
4	3.2975146×10^{-4}
7	13.00

If 24-hour timekeeping is preferred, 24.00 is stored in register 7 instead of 13.00, and a 0 is entered at location 10 in the program instead of a 1.

The accuracy of the HP-25 as a clock depends on its internal clock oscillator for the correctness of the value for program execution time that is stored in register 4. This number can be changed, if necessary, to give accuracy within a few seconds during several hours. To adjust the timing, compare the timing accuracy with an electric clock over several hours. Divide the difference in seconds by the number of seconds of running time, and multiply this quotient by the value in register 4 to find the fractional correction that must be added to or subtracted from the value in register 4. □

Engineer's notebook is a regular feature in Electronics. We invite readers to submit original design shortcuts, calculation aids, measurement and test techniques, and other ideas for saving engineering time or cost. We'll pay \$50 for each item published.

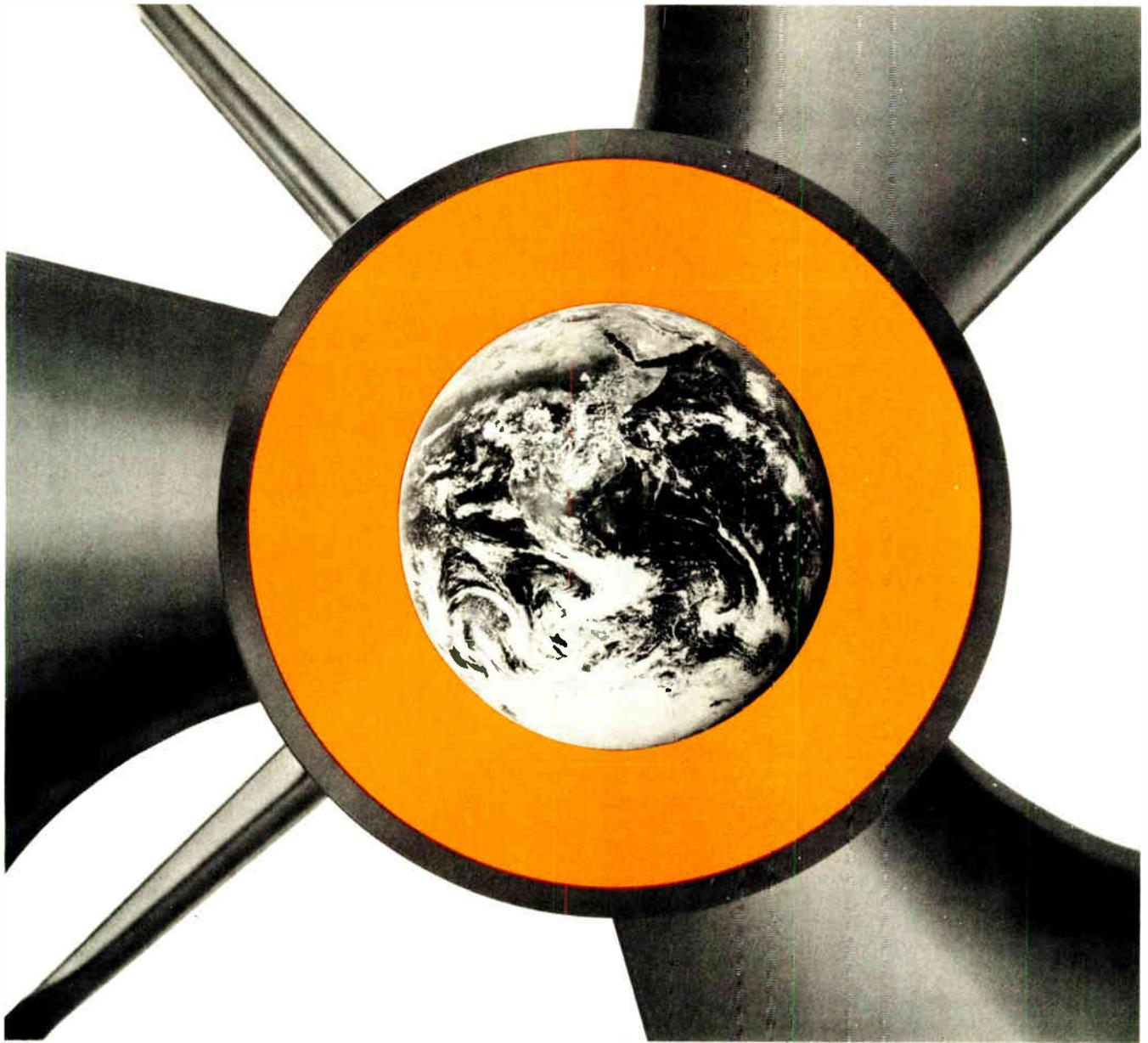

Behind every Rotron[®] fan and blower... Worldwide Facilities

The world is growing smaller. More and more companies are involved in international sales and international application of their products. Many in manufacturing abroad.

Rotron is such a company. If you are too, or hope to be, you'll be glad to know that Rotron is equipped to serve you throughout the world. With fan and blower manufacturing facilities not only in the U.S.A. but in The Netherlands and Japan as well. With an interna-

tional sales and distributor organization that reaches into all parts of Europe, the Middle East, the Orient, Africa, Australia, and South America.

When you deal with Rotron, you not only receive the best there is in air mover application engineering, in product quality and variety, in distributor service. You get it when and where you need it.

Why settle for less when the best costs no more?



ROTRON INC.
AN  **EG&G COMPANY**

Woodstock, N. Y. 12498 ☐ 914 • 679-2401 ☐ TWX 510-247-9033
Garden Grove, Cal 92641 • 714-898-5649 • Rotron B.V. Breda, Netherlands, Tel: 79311, Telex: 844-54074

What makes Josephson junctions interesting to IBM

Why is IBM so enthusiastic about the superconducting Josephson junction, which allows electrons to tunnel through an insulator in a controlled manner? Well, **Josephson-junction circuits dissipate about 0.1% the power of present silicon circuits, and this might mean they're the only way to get a large-scale computer with subnanosecond delays.** Propagation times like those won't permit any point in the circuitry to be more than 7 inches away from any other point, so the whole processor would have to fit inside a 7-inch sphere—about the size of a soccer ball. However, if the machine had the complexity and used the same circuitry as, say, an IBM 370/168, it would have to dissipate an impossible 10 kilowatts, say scientists at IBM's Thomas J. Watson Research Center, Yorktown Heights, N.Y.

The IBM group has built both logic and memory elements using Josephson technology—most recently a 4-bit multiplier on a substrate about 250 mils square. One of the major problems still remaining is the precise deposition of the insulating films between metal layers.

FETs and front ends

Those mixed-process operational amplifiers, which use a mixture of bipolar and field-effect transistors on the same monolithic chip, give you a choice between junction FETs or MOSFETs at the front end. Here's a gross distinction that can be made between the two types: **the JFET front end generally gives slightly better performance in some respects—like lower noise and lower offset-voltage drift.** But don't overlook the fact that the MOSFET front end should be the choice if you're really interested in broad common-mode-voltage operating range—in fact, it can go from rail to rail of the supply voltage. This means that you can even operate the op amp from a single-polarity supply without jacking up your input signal.

DMMs supply constant current

Need a constant-current source quickly for, say, low-voltage bias applications? Most digital multimeters use a precise current to measure resistance. **Just set the DMM to one of the ohms ranges and measure the current it puts out.** A 3½-digit (2,000-count) DMM, for example, typically puts out 1 milliampere on the 0-to-200 ohm range and goes down to 10 or 100 microamperes for the higher resistance ranges. Of course, unless the meter is well protected, be careful when working with active circuits.

Figure it out for yourself

You can't beat the price of this new infrared-radiation slide-rule calculator from Sensors Inc., P.O. Box 1383, Ann Arbor, Mich. 48106. A letter to marketing and sales director W. T. Baker gets you one for free. The calculator has 20 marked scales for such parameters as temperature, emissivity, power density, wavelength, and range. . . . And, for \$9.25, you can get a copy of a Government publication, "A User's Manual for Optical Waveguide Communications." Written by R. L. Gallawa of the Institute for Telecommunication Sciences in Boulder, Colo., **the 293-page report adopts an intuitive nonmathematical approach to subjects like optical sources and detectors, fiber waveguides, modulation, and multiplexing.** Order No. PB-252 901/WZ from the National Technical Information Service of the Department of Commerce, 5285 Port Royal Rd., Springfield, Va. 22151.

Stephen E. Scrupski

The most **FORGETTABLE** panel-mount switch you can buy...

is also the
fastest to install...

SNAP!

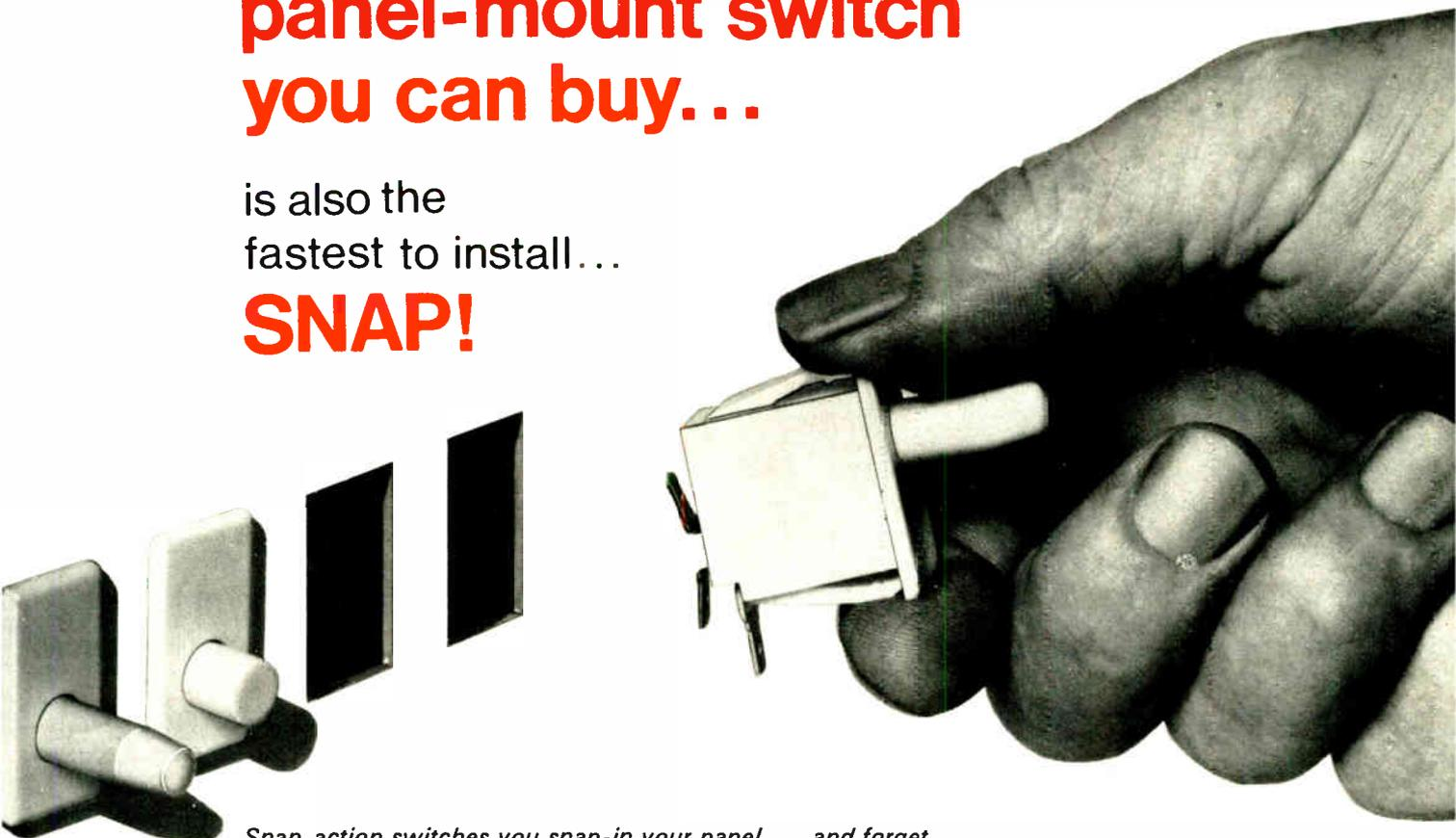

Snap-action switches you snap-in your panel . . . and forget. Switches that keep switching practically forever . . . because of Cherry's exclusive long-life, long-overtravel coil spring mechanism. Switches that stay put practically forever, too . . . because the semi-sealed nylon cases have molded-in serrated spring lock clips. These "forgettable" single pole (SPDT) switches are rated 10 amps, 125 VAC. Also available in double pole (DPDT) circuitry . . . and in Gold "Crosspoint" contacts for positive switching of low energy circuits.

See **CHERRY** at
Electronica-Munich
November 25-December 1
Hall #13, Booth #3110

SNAP UP A FREE SAMPLE FOR YOUR PANEL

Just TWX 910-235-1572 . . . or PHONE 312/689-7700 and ask Frank to give you facts on panel-mount switches . . . or circle appropriate reader service number.



E69-00A Momentary Action
Circle No. 206
for Free Sample



E69-20A Push-Pull (Reset)
Circle No. 207
for Free Sample



E69-30A Momentary & Pull-to-Override Interlock
Circle No. 208
for Free Sample



E69-60A Alternate Action
Circle No. 209
for Free Sample



E69-40A Momentary Action/Short Button
Circle No. 210
for Free Sample



CHERRY ELECTRICAL PRODUCTS CORP.
3608 Sunset Avenue, Waukegan, IL 60085

SWITCHES and KEYBOARDS — Available locally from authorized distributors.

Electronics/November 11, 1976

119

If you're looking for safety and reliability in electronics, see me.



I'm a distributor for Dow Corning silicones. And, like the other Dow Corning distributors throughout the United States, I have the silicone materials you need for today's demanding electronic applications.

Increased safety, reliability, reduced manufacturing costs, longer service life, protection against harsh environments, and reduced service and replacement costs are just some of the reasons why silicone insulating materials

are replacing organic materials.

Because silicones come in almost limitless variations of physical, electrical, and chemical properties, they can perform many functions.

They protect, insulate, support. They cool, lubricate, seal, and bond. They do many jobs and do them well because of the unusual properties of silicones as a class of materials. I'm sure you'll find several of them ideal for the manufacture or repair of

electronic devices.

If you'd like to know more about Dow Corning silicones, see me; I'm listed on the right-hand side of this advertisement. Write or call for more information and for your application/product needs. I'll recommend the safe, reliable Dow Corning silicones to match your requirements.

DOW CORNING

DOW CORNING

Circle 121 on reader service card

World Radio History

A-6401

Silicone Protectors

Silicone encapsulating, insulating, sealing, coating and dielectric materials are stocked by Dow Corning distributors at the following warehouse locations:

Electrical / electronic materials
from

DOW CORNING

DOW CORNING

A-6407

- ALABAMA**
Birmingham
Electrical Insulation Suppliers, Inc.
205 252-9046
Mobile
Brownell Electro, Inc.
205 479-5405
- ARIZONA**
Phoenix
Essex International, Inc.—
Magnet Wire & Insulation Div.
602 258-4589
- CALIFORNIA**
Berkeley
C. D. LaMoree Co.
415 841-0601
Culver City
E. V. Roberts & Associates,
Div. EVRA, Inc.
213 870-9561
Long Beach
K. R. Anderson Company, Inc.
213 367-1411
Los Angeles
Brownell Electro, Inc.
213 532-1150
C. D. LaMoree Co.
213 225-5666
Essex International, Inc.—
Magnet & Wire Insulation Div.
213 264-7000
Mountain View
K. R. Anderson Company, Inc.
415 961-6007
San Diego
A. E. Yale Enterprises
714 299-7710
San Francisco
Essex International, Inc.—
Magnet Wire & Insulation Div.
415 626-5351
- COLORADO**
Denver
Waco Electronics, Inc.
303 371-4370
- FLORIDA**
Orlando
Brownell Electro, Inc.
305 843-6770
Electrical Insulation Suppliers, Inc.
305 855-7100
Tampa
Essex International, Inc.—
Magnet Wire & Insulation Div.
813 621-5554
- GEORGIA**
Atlanta
Brownell Electro, Inc.
404 762-5181
Electric Insulation Suppliers, Inc.
404 355-1651
Essex International, Inc.—
Magnet Wire & Insulation Div.
404 691-8520
Chamblee
Prehler Electrical Insulation
404 451-4266
- ILLINOIS**
Chicago
Essex International, Inc.—
Magnet Wire & Insulation Div.
312 254-8787
Prehler Electrical Insulation
312 384-6100
Mt. Prospect
Magnuson Electronics, Inc.
312 956-0700
- INDIANA**
Fort Wayne
Essex International, Inc.—
Magnet Wire & Insulation Div.
219 461-4000
Hammond
Electric Supply Corp.
219 932-8840;
312 374-6000 (Chicago)
- IOWA**
Marion
Ensco Distributing Corporation
519 377-6313; 800 325-3232
- KANSAS**
Overland Park
Ensco Distributing Corporation
913 381-7557; 800 325-3232
- KENTUCKY**
Louisville
E & H Electric Supply
502 587-0991
- LOUISIANA**
Baton Rouge
Essex International, Inc.—
Magnet Wire & Insulation Div.
504 927-2686
New Orleans
Williamson Distributing Corp.
504 486-5584
Shreveport
Williamson Distributing Corp.
318 424-6638
- MARYLAND**
Baltimore
Essex International, Inc.—
Magnet Wire & Insulation Div.
301 644-0140
Baltimore/Washington
Pyttronic Industries, Inc.
301 792-7000; 301 953-3000
Columbia
Brownell Electro, Inc.
301 997-5660
- MASSACHUSETTS**
Cambridge
Brownell Electro, Inc.
617 864-7500
Peabody
Essex International, Inc.—
Magnet Wire & Insulation Div.
617 531-7100
- MICHIGAN**
Detroit
Essex International, Inc.—
Magnet Wire & Insulation Div.
313 925-6000
Farmington
Sheridan Sales Co.
313 477-3800
Madison Heights
McNaughton-McKay Electric
313 399-7500
- MINNESOTA**
St. Paul
Prehler Electrical Insulation
612 452-2470
- MISSOURI**
Kansas City
Glazer Chemical
816 842-2092
N. Kansas City
Essex International, Inc.—
Magnet Wire & Insulation Div.
816 842-1613
St. Louis
Ensco Distributing Corp.
314 567-3935;
TWX 910 764-0856
Essex International, Inc.—
Magnet Wire & Insulation Div.
314 371-2616
- NEW JERSEY**
Livingston
Robert McKeown Co.
201 992-0700;
212 267-9264 (NYC);
516 248-2525 (L.I.)
Moonachie
Essex International, Inc.—
Magnet Wire & Insulation Div.
201 641-4400;
212 695-7840 (NYC)
North Bergen
EISCO Plus, Inc.
201 589-2929; 800 631-8642
South Plainfield
Brownell Electro, Inc.
201 753-4600
- NEW MEXICO**
Albuquerque
Waco Electronics, Inc.
505 268-2409
- NEW YORK**
Buffalo
Summit Distributors, Inc.
716 884-3450
New York City
Brownell Electro, Inc.
212 691-7900
Rochester
Summit Electronics of
Rochester, Inc.
716 334-8110
- NORTH CAROLINA**
Charlotte
Brownell Electro, Inc.
704 399-9791
Electrical Insulation Suppliers, Inc.
704 394-4341
Essex International, Inc.—
Magnet Wire & Insulation Div.
704 394-1315
- OHIO**
Cincinnati
Electrical Insulation Suppliers, Inc.
513 771-4073
Essex International, Inc.—
Magnet Wire & Insulation Div.
513 771-6500
Sheridan Sales Co.
513 761-5432
Cleveland
Essex International, Inc.—
Magnet Wire & Insulation Div.
216 781-2310
Prehler Electrical Insulation
216 267-2650
- Columbus**
McGraw-Edison Co.
National Electric Coil Division
614 488-1151
- OKLAHOMA**
Oklahoma City
Essex International, Inc.—
Magnet Wire & Insulation Div.
405 236-5411
- OREGON**
Portland
Essex International, Inc.—
Magnet Wire & Insulation Div.
503 665-0138
C. E. Riggs, Inc.
503 226-3286
- PENNSYLVANIA**
Philadelphia
Brownell Electro, Inc.
215 632-3030
Essex International, Inc.—
Magnet Wire & Insulation Div.
215 236-7100
Prehler Electrical Insulation
215 725-5914; 215 725-5913
Pyttronic Industries, Inc.
215 643-2850; 215 242-6700
Pittsburgh
Essex International, Inc.—
Magnet Wire & Insulation Div.
412 242-5560
- TENNESSEE**
Memphis
Brownell Electro, Inc.
901 332-9254
Electrical Insulation Suppliers, Inc.
901 947-4176
Nashville
Brownell Electro, Inc.
615 835-1302
- TEXAS**
Dallas
Essex International, Inc.—
Magnet Wire & Insulation Div.
214 339-8346
Lubri-Kote
214 630-6007
Specialized Products Company
214 358-4663; 713 771-7227
Williamson Distributing Corp.
214 741-5831
Houston
Essex International, Inc.—
Magnet Wire & Insulation Div.
713 869-3667
Lubri-Kote
713 771-7227
Williamson Distributing Corp.
713 672-1715
- UTAH**
Salt Lake City
Standard Supply Co.
801 355-2971
- WASHINGTON**
Seattle
Atlas Packing & Rubber Co.
206 623-4697
Essex International, Inc.—
Magnet Wire & Insulation Div.
206 763-8650
C. E. Riggs, Inc.
206 623-5707
- WISCONSIN**
Milwaukee
Essex International, Inc.—
Magnet Wire & Insulation Div.
414 475-6188

AN INVITATION TO LEARN WHY THE FLUKE 8500A IS CALLED THE WORLD'S FINEST DVM.

We'd like to introduce you to a new concept in digital voltmeters.

The Fluke 8500A.

It's a measurement system—not a dedicated instrument, but a bus-oriented, microprocessor-controlled measurement device. Modules which convert parameters, such as ac voltage, resistance or current, are simply plugged into any available slot in the bus structure. The microprocessor then talks to the module and displays the new value in the desired parameter.

That's the heart of the 8500A—unlimited measurement architecture. At any time, different measurement, control or servicing modules can be plugged in the bus.

And the 8500A is a different measuring device.

All for a basic system price of \$2,695*.

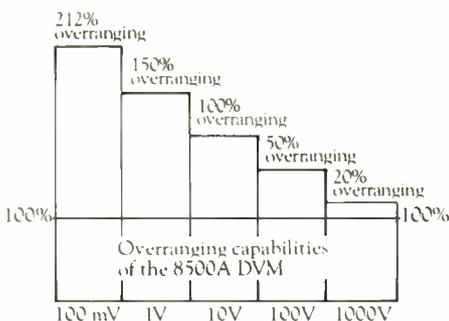

Most other DVM's offer only 20%-60% overranging.

The 8500A is a high-speed 5½-digit DVM capable of 500 readings per second at full resolution and accuracy. Fluke's patented Recirculating Remainder (R²) A/D Conversion technique is used for high, long-term accuracy and linearity. There's a calibration memory that allows for automatic correction of calibration error. And it's the only systems DVM that measures ac and dc current.

DC voltage measurement and dc ratio are standard features. DC voltages are measured over five ranges, with resolution between 1 μ V and 10 mV and a basic accuracy of $\pm 0.001\%$ (10 ppm) for 24 hours, 20°C $\pm 1^\circ$ C. Starting with the lowest range, a maximum display of

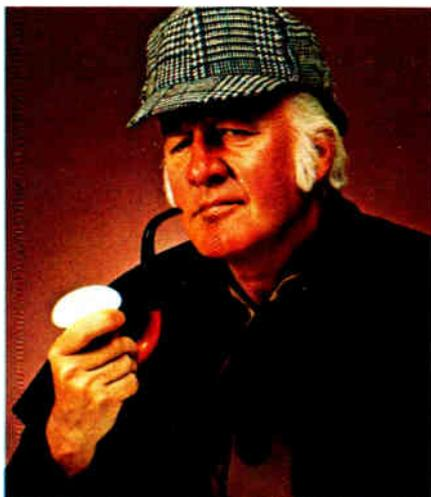

"It's not difficult to understand why it's called the finest. After all, it is a Fluke DVM, isn't it?"

312.5 mV is possible with a resolution of 1 μ V. Displays on the lower ranges are in volts, followed by an exponent display of -3.

Two types of ac measurement options are available for the 8500A. While only one can be installed in the instrument at a time, removing one option and installing the other requires a minimum of time and/or operator training. At power up or after reset, the front panel displays whether the averaging converter, true rms converter or neither is installed in the instrument.

The Averaging Converter (Option -01) measures up to 1000V ac on four ranges with a bandwidth from 30 Hz to 100 kHz and accuracies up to $\pm 0.05\%$ + 5 digits. The True RMS Converter (Option -09) measures up to 1000V ac on four ranges with a bandwidth from 10 Hz to 300 kHz and accuracies up to $\pm 0.1\%$ + 15 digits.

Resistance measurements can be made on eight ranges from 10 Ω full scale to 100 M Ω full scale with the Ohms Converter (Option -02). Basic ac accuracy from 100 Ω to 1 M Ω is $\pm 0.003\%$ + 1 digit, with resolutions up to 100 $\mu\Omega$ obtainable.

Both ac and dc current can be

measured with the Current Module (Option -03) provided one of the ac options is installed in addition to the basic dc. Current measurements to 1A can be made with sensitivity to 1 nA. Accuracies to $\pm 0.03\%$ + 10 digits, for dc readings and to $\pm 0.06\%$ + 8 digits for ac readings. Bandwidth of the 100 μ A through Amp ranges is 30 Hz to 10 kHz. For the 1A range only, the bandwidth is 30 Hz to 3 kHz.

Guaranteed accuracies for the 8500A measurement options are based on 90 days, 18°C to 23°C.

Three Remote Interface options are available with the system. Only one of the three may be installed at a time; however, one can be easily exchanged for another when the top cover is removed. This allows the instrument to be used with more than one interface system, requiring only that additional modules for the desired interfaces be obtained.

The IEEE Standard 488-1975 Bus Module (Option -05) provides an eight-bit (one byte) parallel interface. The Bit Serial Asynchronous Interface Module

8500A DVM at 7½ Samples/Second
--- Filtered — Unfiltered

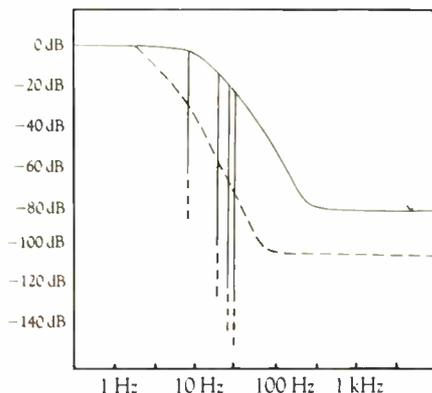

Fantastic noise rejection without sacrificing speed.

(Option -06) interfaces the 8500A to systems using either RS232B, RS232C, or Current Loop interface. Selection of type and Baud rate is made with bit switches accessible through an entry

Automatic correction for zero, offset, calibration and drift with microprocessor controlled memory storage.



Extra digit of resolution.

As an extra bonus, the range digit can be converted to a 6th measurement digit—*for 6½ digits of resolution.*

port on the rear panel. And the Parallel Interface Module (Option -07) provides a 16-bit duplex register interface compatible with mini-computer and microprocessor systems.

A non-volatile calibration memory module stores correction factors desired from a standard input during CAL mode operations. It can also be used to compensate for long-term drift, eliminating the need for manual adjustments or trips to the calibration laboratory. This al-

IEEE-488 interface bus	Fluke
ASCII interface	Fluke
Parallel interface (16 bit)	Fluke

Only one system DVM offers all the interfaces you need.

18 different sample rates	Fluke
5 different filter modes	Fluke
Programmable scaling factor	Fluke
Store and test for limits	Fluke
Local and remote lockout	Fluke
Front panel display on/off	Fluke
Line and non-line synchronized readings	Fluke
Store and display of highest and lowest values found	Fluke
Recall and display status	Fluke
6½ digits of resolution	Fluke

And with any interface there are expanded remote features.

lows the operator to remove power from the instrument or the system to suffer a power failure without loss of automatic calibration factors. The battery permanently installed on the module will keep power on the memory to retain the stored data in excess of 90 days after removal of power.

Service capability is one of the strong points in the 8500A program. Of course, extensive overload protection has been designed into the instrument. But should problems develop, most of them can be handled in the field by using the available service aids. An extender card, a bus monitor, a test module, and a static controller, together with diagnostic programs and the microprocessor control should handle 60%-80% of most troubleshooting problems.

If you've read this far, you know

why the 8500A is called the world's finest DVM. Microprocessor control, modular design, complete measurement and systems interface capability and ease of service are all combined in one instrument. And the best thing about it is that it's made by Fluke. So you know you can count on quality and service throughout the world.

The 8500A. One more reason why Fluke is the leader in digital voltmeters.

For data out today, dial our toll-free hotline, 800-426-0361.

John Fluke Mfg. Co., Inc., P.O. Box 43210, Mountlake Terrace, WA 98043

Fluke (Nederland) B. V., P.O. Box 5053, Tilburg, The Netherlands.

Phone: (013) 673-973 Telex: 52237

**U.S. price only.*



NOTHING COMPARES. 8500A DVM. **FLUKE**®

DAK

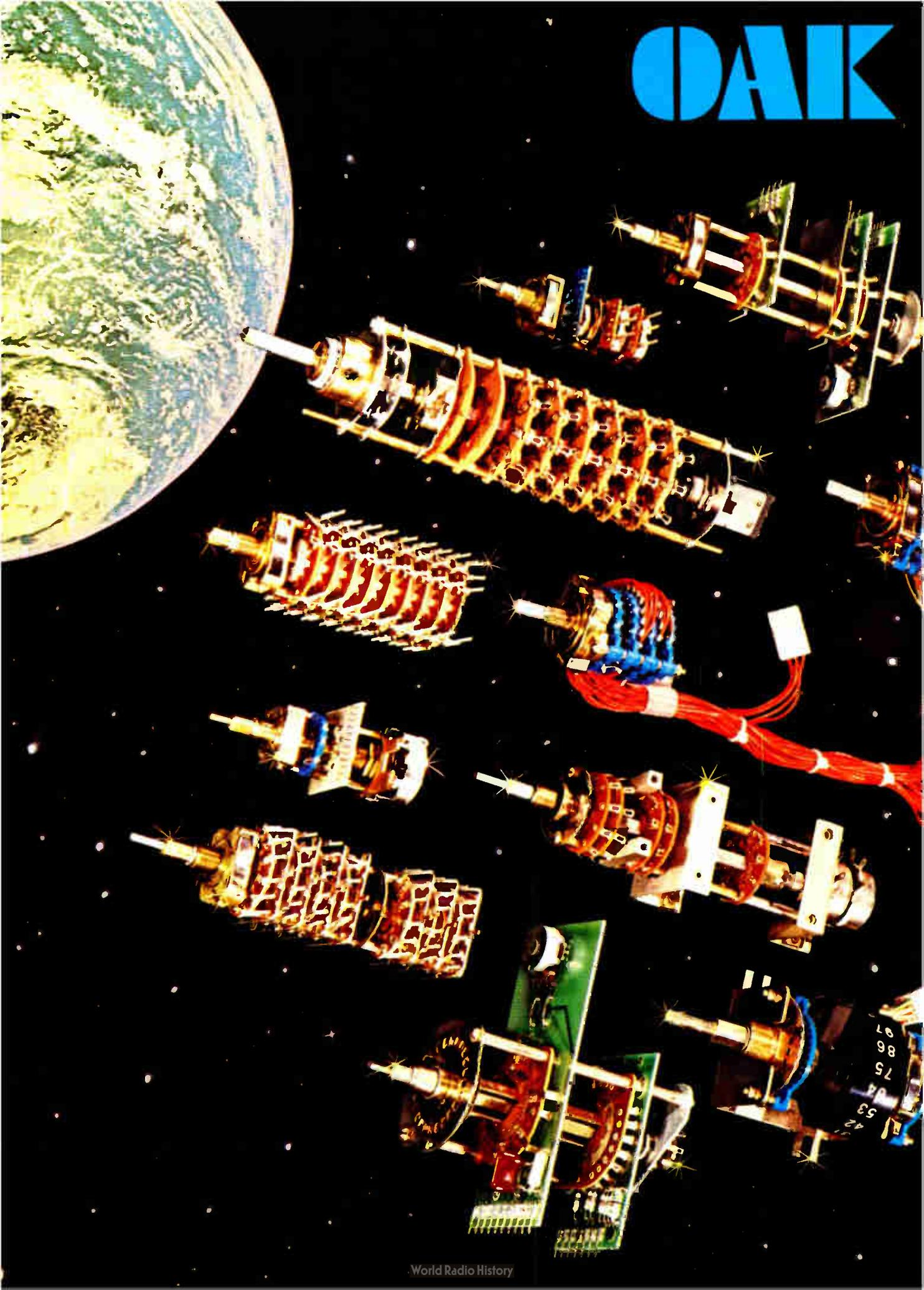

does more than provide the industry's most complete line of rotary switches

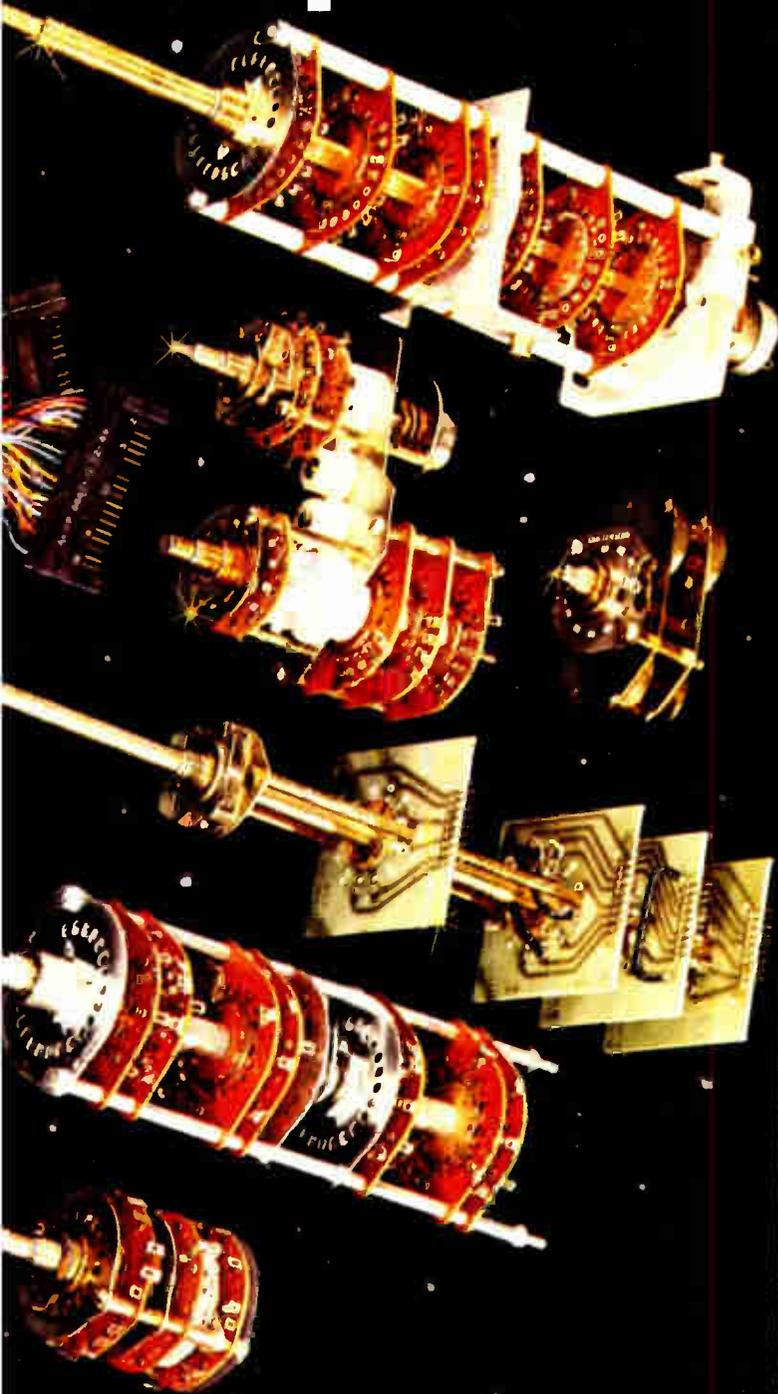

Supplying any rotary switch—from the simplest single wafer to complex multiple section types isn't enough.

We will build our switches into almost any mechanical or printed circuit sub-assembly that you specify—with parts fabrication and special testing performed in-house.

Oak has internal metal-working facilities for all metal-forming, machining and attachment operations. Of course, we'll incorporate and/or terminate any components that are required—either supplied by you or purchased by us.

Some typical examples are described below. If your requirements are not represented, call us—or provide prints—for a prompt quotation. (815) 459-5000

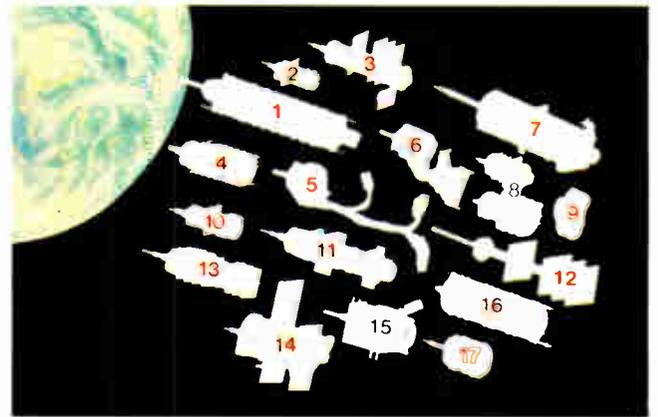

1. Combination push-button/rotary switch. Rotation can occur only after shaft is pushed in to activate push-button. Special hardware designed and built by Oak.

2. PC Board assembly with Unidex detent concentric shaft and PC switch section, with two variable resistors controlled from center shaft.

3. Test equipment assembly, combining phenolics switch sections, resistors and capacitors attached to PC boards, with concentric shafts, brackets and potentiometer.

4. Nine section Unidex switch with PC terminals at opposite sides for attachment to parallel PC boards.

5. Connector and harness assembly attached to four section, 24 position Multidex switch.

6. Five section Multidex switch wired and terminated with customer supplied connectors.

7. Triple concentric shaft with dual detent, with potentiometer on inner shaft, rear bank of 3 sections on center shaft and 4 front sections on outer shaft.

8. Switch assembly for electronic test equipment assembled by Oak. Includes six switch sections, gear system, potentiometer and special brackets.

9. Compact assembly controlling four 7.5A, 32V snap switches

10. For PC board insertion, this Unidex dual concentric switch combines a PC board switch section and shielded variable resistor.

11. Stamped and machined mounting brackets and shielding hardware on multi-section switch with variable resistors controlled by center shaft.

12. Glass epoxy PC board switch sections with added components, solder terminals, special brackets and shielding for hi-fi equipment.

13. Seven section dual concentric Unidex switch with PC board terminals and shielding between sections.

14. Printed circuit section switch with additional wiring and components; for attachment to PC mother board.

15. Dual concentric switch with bracket and special counting dials; wired sections and attached connector.

16. Dual-concentric, 7 section switch, with shielding and special locking mechanism for use in test equipment.

17. Three 18-position sections, dual concentric switch with counting gear mechanism used for airborne equipment. Special brackets and gears assembled at Oak to customer's specifications.

K-601

OAK Industries Inc.

SWITCH DIVISION/CRYSTAL LAKE, ILLINOIS 60014
TELEPHONE: 815-459-5000 TWX: 910-3353 TELEX: 72-244

We'll flip you over your ceramic capacitor specs... **heads you win** **tails you win**

Heads are our standard line of MONO-KAPS™. Radial-leaded, epoxy-coated monolithic ceramic capacitors with noble-metal electrodes whose proven formulation has not been modified or compromised. They meet MIL requirements, and are available off-the-shelf in a broad range of capacitances and voltage ratings to meet your specific needs.

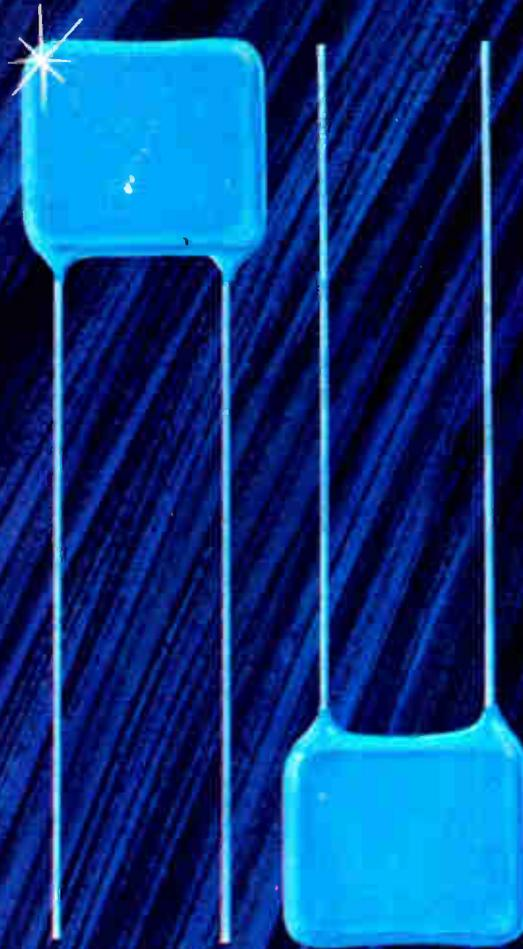

Tails are our BME-Radials™. They protect you from the noble metal cost spiral, and save you money right up front. They are the product of our unique BME capacitor technology which eliminates noble metal entirely from electrodes and terminations. But they'll meet most of the same circuit requirements with no sacrifice.

So you see, it's up to you — MONO-KAPS or BME-Radials. Both are immediately available in quantity from the only people who give you the choice. Either will do the job without compromise. Call or write for all the details today.



CENTRALAB/USCC 4551 Colorado Blvd. • Los Angeles, CA 90090 • (213) 240-4880
Electronics • GLEBE-UNION INC.

"See our complete catalog in EEM pages 317 to 335, and gold book pages 103 to 121, or contact us directly."

First-in first-out unit is fast, dense

Bipolar FIFO memory uses ion implantation to reduce resistor areas and allow 64 4-bit words of storage with 20-MHz input and output rates

by Stephen E. Scrupski, Computers Editor

By combining bipolar Schottky-TTL technology with ion implantation, Monolithic Memories Inc., Sunnyvale, Calif., has developed a first-in first-out (FIFO) memory that it says combines the speed of bipolar with the bit density of MOS shift-register circuits. The memory, type 67401, is in a 16-pin package that is pin-compatible with an earlier metal-oxide-semiconductor FIFO, the 3341.

However, the new memory runs at a typical speed of 20 megahertz and at a minimum of 12 MHz, both at the input and output, while the MOS device runs at 1 MHz minimum, according to Ed Barnett, marketing manager. An earlier bipolar part operates at about 12 MHz but holds only one fourth as much data, he adds.

The new memory is organized as 64 by 4—it takes in 4-bit-wide words and can hold 64 such words. It is essentially a pipeline—when a 4-bit word enters, it ripples down the register chain and queues up behind any other data that's in the pipeline. If no data is ahead of it, the word appears at the output at most 4 microseconds and typically 1.8 μ s later (the MOS device has about a 16- μ s maximum fall-through time). One of the key features of such devices is that they can be loaded and read out at the same time, and at different speed rates.

The higher density is required in this type of circuit because the shift-register circuits, comprising normal bistable flip-flops with load resistors, should have high-value load resistors in order to reduce the power dissipation. However, if diffused resistors were used, the achievable resistivities, typically about 200 ohms/

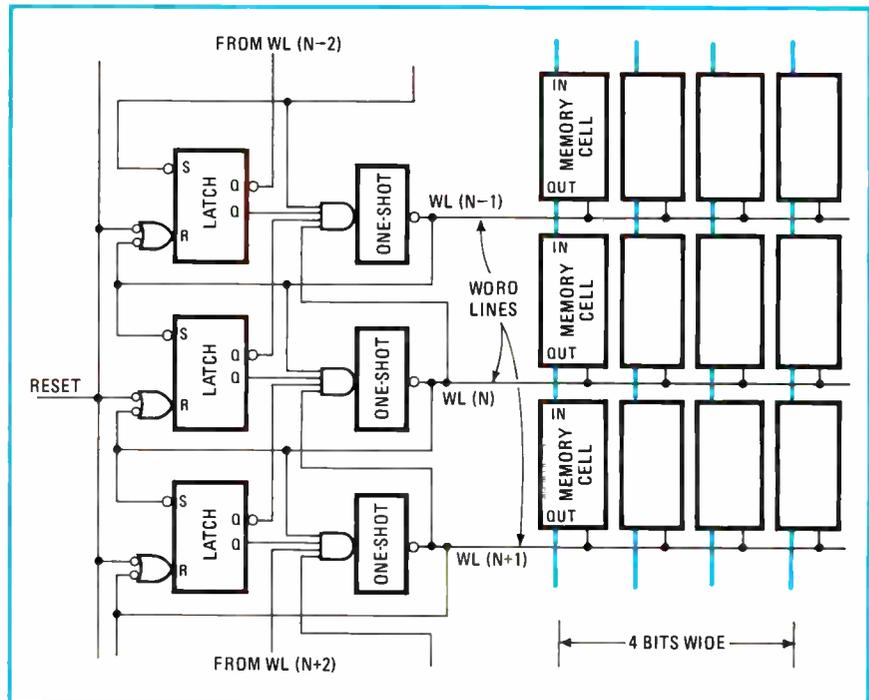

Shift down. Control circuitry for the 67401, comprising latch, AND gate, and one-shot, monitors cell contents and allows data to propagate from top to bottom. Data does not shift from word-line $N - 1$ into N unless the line is empty, having sent its contents to $N + 1$.

square, would mean that the resistors would take up a lot of chip area. With ion implantation, resistivities of about 1,200 ohms/square are achievable, so the resistors can be made much smaller. The result is that the gates typically dissipate about 0.7 milliwatt and delays range between 10 and 20 nanoseconds.

One application of the FIFO is as a buffer between a head-per-track disk and a memory. Data comes off the disk skewed, and then extra sense amplifiers, delay lines, and reshaping networks are used to adjust the data back to synchronization. The FIFO, however, can act as a variable-length memory that removes the

skew and as the place where the data can be taken out in parallel.

The 15 pins (one is unconnected) are used as follows: input, four; output, four; input ready—the device is ready to receive data; output ready—ready to be read out; write in; read out; master reset for control circuitry (to reset the cells themselves, a series of 0s must be sent in); power supply, and ground.

The 67401 is specified at 0° to 75°C. A military version will be announced by the end of the year. Price for the 67401 is \$25 each for quantities of 100 and up.

Monolithic Memories Inc., 1165 East Arques Ave., Sunnyvale, Calif. 94086 [338]

Want simpler backplane connections? Come to the source.

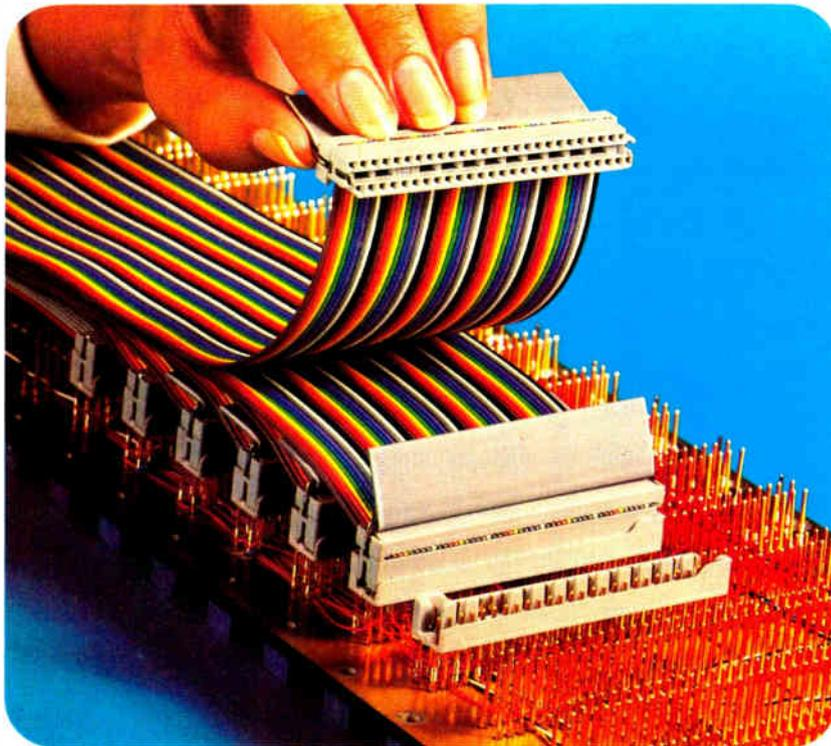

Now, a unique Scotchflex brand Socket Connector and Keying Header system lets you interface directly with backplane wire wrap pins and provides for easy, positive polarization and keying. The header design allows for thousands of unduplicated polarizing combinations without loss of backplane pins. The 50-position connector mates with .025" square pins on .100" x .200" grid spacing. Header allows space for and protects two layers of wrap below it. System also provides polarizing keys and strain relief handles.



Need some other ways to simplify wiring and increase circuit density? 3M's Scotchflex line offers you a broad choice of mass terminating socket connectors, plus wire wrap or solder tail headers to suit your specific design problem. Keying capability is also provided.

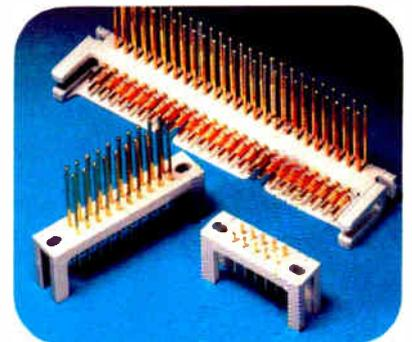

There are several more things you can get only from 3M. The broadest range of flat cables and complete system components. Best off-the-shelf availability. Proven performance. And the unmatched experience of the people who pioneered this reliable mass termination system.

**Scotchflex™ is a registered trademark of 3M Co.

Scotchflex[®] systems from 3M. The source.



See our
catalog in EEM,
page 1056

Miniature relay handles 15 A

Low-cost solid-state ac device occupies less than 0.5 cubic inch; family is aimed at appliances and other consumer applications

by Lawrence Curran, Boston bureau manager

The bulky type of solid-state ac relay package will become obsolete, if Edward T. Rodriguez has his way. He's chairman and technical director of Theta-J Relays Inc., which is introducing its J-Tab series of 5-, 10-, and 15-ampere ac units that aren't much larger than a TO-220 plastic triac package and cost \$7-\$8 less than their bigger fore-runners, he says.

The size has been cut substantially by using a highly simplified package that has the relay's output-switching triac acting as the mounting tab and heat-sink interface [*Electronics*, July 22, p. 35]. The units occupy less than half a cubic inch, which Rodriguez says is a sixth to an eighth of the volume of comparably rated larger relays. The package measures merely 0.875 by 0.6 by 0.7 in.

There are no printed-circuit boards or thick-film substrates inside the package. The circuit is assembled using semiautomatic techniques more common to mechanical assemblies. The J-Tab series includes the output triac, Theta-J's photocell optical coupler, and a light-emitting diode for optical isolation—a simple setup that reduces costs and improves reliability, according to Rodriguez. "All the user really wants is an isolated triac," he notes, "and he often has to pay \$10 for that isolation in the plate-mounted relays. With ours, he mounts it just like he would a TO-220 triac, and that's all there is to it. The other two components ride piggyback on the triac."

Rodriguez expects the 10-A entry to be the workhorse of the series, with applications including photocopiers, large appliances such as washers and dryers, as well as micro-

wave ovens which are being designed with triac controls. The relay will be offered in 120-volt (JT-12) and 240-v (JT-24) versions, with the JT-12 breaking the \$3 price barrier—it has a price tag of \$2.50 in quantities of 10,000. For 100-unit lots, the JT-12 sells for \$5 each, and for \$7.50 each singly.

The 5-A and 15-A members of the family will also be available in 120-v and 240-v ratings, with the prices of the former about 10% below the JT-12 levels, and the latter approximately 8% above.

"Our objective is to make the cheapest and best ac relay up to 15 amperes," Rodriguez says. "We took these to the raw bones so that the customer doesn't spend two cents more than necessary." Theta-J has made the relays programmable with an external input series resistor "so that we can tell the user which half-watt resistor to use to operate on 3 to 100 v ac or dc, whatever he wants," he points out.

Rodriguez is optimistic about the sales potential for the J-Tab, linking

it to the microprocessor boom in consumer electronics. "The low-cost solid-state relay is going hand in hand with consumer-oriented CPUs," he asserts. "We let the microprocessor do the thinking, and the interface device will do the work."

With an eye toward putting the J-Tab in intelligent home electronics devices, from self-defrosting refrigerators to remote-controlled equipment to entertainment sets, Rodriguez has already talked with major manufacturers of remotely operated televisions, garage-door openers, photocopiers, and pinball machines.

Load voltage for the 10-A JT-12 is 90-140 v ac; for the JT-24, it is 180-280 v ac. Off-state leakage current for the 10-A units is 1 milliamperes, and the contact voltage drop is 1.5 v maximum. Response time is typically 16 milliseconds, and input-output isolation is 1,500 v ac.

Delivery time of all three current ratings is 90 days.

Theta-J Relays Inc., 2 Linden St., Reading, Mass. 01867 Phone (617) 942-0390 [339]

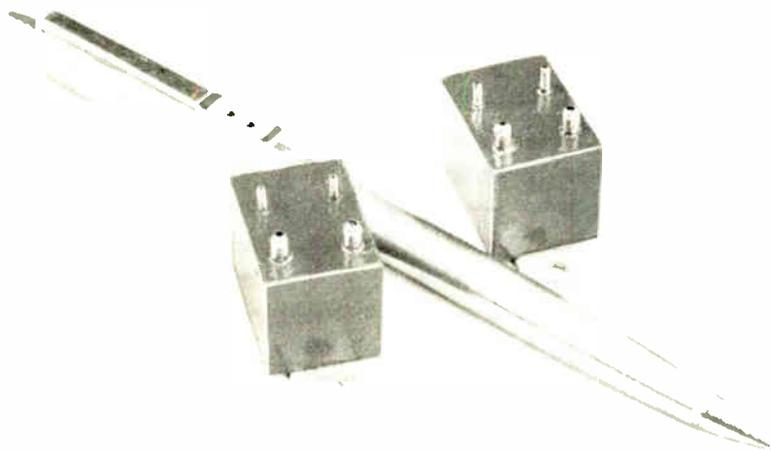

How does our broad line of discrete semiconductors fit your growing line of switching power supplies?

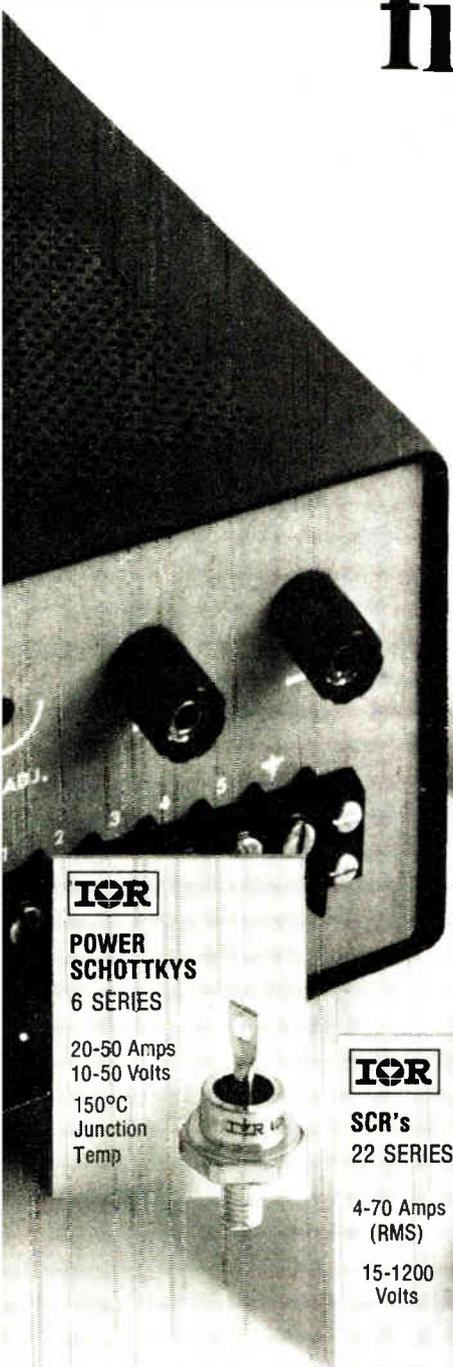

FAST RECOVERY RECTIFIERS 8 SERIES

6-12 Amps
50-1000 Volts



RECTIFIERS 28 SERIES

1-40 Amps
50-1000 Volts



ZENERS 26 SERIES 250mW-50W 2.4-280 Volts



TEMP. COMP. VOLTAGE REFERENCES 16 SERIES 250mW-1.6W 5.9-49.6 Volts



POWER SCHOTTKYS 6 SERIES

20-50 Amps
10-50 Volts
150°C Junction Temp



INVERTER SCR's. 4 SERIES

35 Amps (RMS)
20-400 Volts



SCR's 22 SERIES

4-70 Amps (RMS)
15-1200 Volts



POWER TRANSISTORS 34 High Gain Types 1-10 AMPS

15 Fast Switching Types
5-15 AMPS

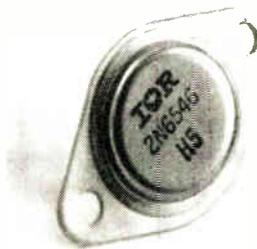

HIGH VOLTAGE POWER DARLINGTONS

25 High Gain Types
10-20 AMPS
9 Fast Switching Types
10-20 AMPS

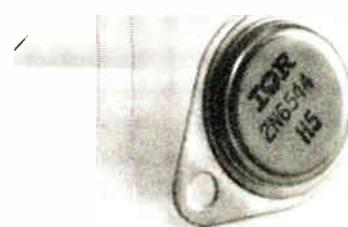

Beautifully.

When you're breaking new ground in switching power supplies you need a vendor who can solve most of your problems.

In discrete semiconductors, only a broad-line supplier like International Rectifier can help you in so many ways. Both in design and later in production.

Design Tradeoffs. Like your own circuits, each of our discrete semiconductors has its own limitations as well as advantages. If a part number you've previously specified doesn't seem to do the job, we can probably suggest one that will. We can also select standard devices with the special parameters you need, or start fresh with a new design.

If you need a capability trade-off between different types of discretes, no one has more knowledge to assist you with than IR.

Applications Assistance. We know it takes more than data sheets and application notes to keep your design and production running smoothly. No matter what your questions, if it has to do with discrete semiconductors we can help.

And we do help. Our application engineers will come when you call.

High, and consistent quality. For 28 years we have been specializing in discrete semiconductors. They have earned a reputation for consistently high quality, ruggedness, dependability, and good performance. Our manufacturing, test and QC procedures are sound, and painstakingly adhered to.

One source.

We save you design time.

We keep your production running smoothly.

We deliver the kind of performance that increases your sales.

For information, just give us a call. At the factory (213) 322-3331, at our 30 local sales offices, or at any of our nationwide distributors. Write to International Rectifier, 233 Kansas Street, El Segundo, CA 90245.



SEMICONDUCTOR HEAT EXCHANGERS

12 Types
readily available.



SEMICONDUCTOR FUSES

130 and 250 Volts
5-800 AMPS (RMS)



DIODE BRIDGES

1.8 to 25 Amps
50-1000 Volts

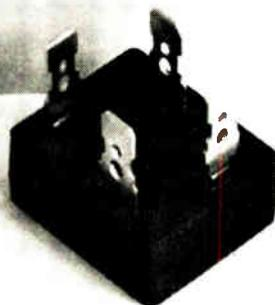

International Rectifier

... the innovative semiconductor people



Circle 131 on reader service card

Introducing a new idea in TR switches.

Solid state reliability.



Introducing the MA-8334 series solid state transmit-receive switch — the most reliable TR switch you can put into a piece of mobile communications equipment. The initial offering in our MA-8334 series has a CW input power rating of 50 watts

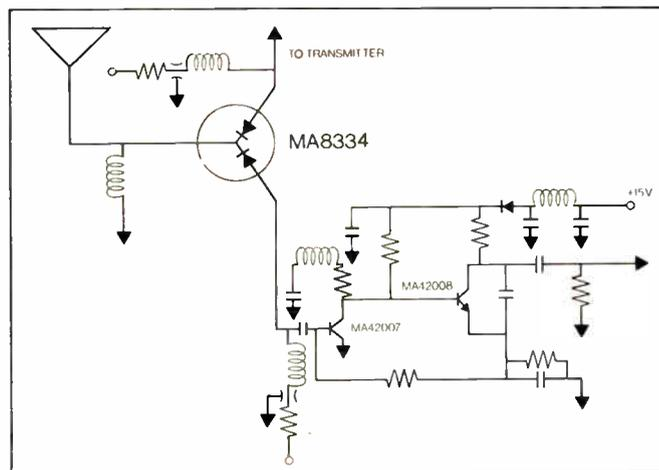

and a frequency range of 20 to 1000 MHz.

For a free sample and

complete specs, simply call or write: Microwave Associates, Semiconductor Sales, Northwest Industrial Park, Burlington, MA 01803, tel. 617-272-3000; Dunstable Woodside Estates, Dunstable, Beds., U.K., tel. Dunstable 601441.



MICROWAVE ASSOCIATES

Plan to visit us at the Electronica '76, Munich — Booth 16-341.

New products

Components

Solid-state relays are priced low

North American Philips breaks into market with three series

The new low prices for solid-state relays look like they're here to stay. Another established relay manufacturer, North American Philips Controls Corp., is entering the market with a miniature low-cost no-frills series without zero-crossover switching. The company is also introducing two series of larger zero-switching units.

Occupying less than 0.75 cubic inch, the series 501 non-zero-switching devices measure only 1.1 by 0.9 by 0.6 in. They are compatible with transistor-transistor, diode-transistor, and complementary-MOS logic circuits. Typically, control voltage is 5 volts dc at 7 milliamperes, and load voltage is 115 v ac at 60 hertz.

These printed-circuit-board units require no heat sink, yet they can switch load currents of 2 amperes maximum. Their turn-on time is

typically 8 milliseconds, while turn-off time is 32 ms typical. They are optically isolated, with a light-emitting diode and a photocell providing an isolation voltage of 1,500 v ac root-mean-square.

Applications for the new 501 series include business machines, computer peripherals, process controls, computers, and traffic controls. In quantities of 1,000, they are priced at \$5.85 each. Delivery time is six to eight weeks.

The zero-switching 512 and 513 series of relays are capable of handling load currents of 10 A maximum at 115 v ac and 60 Hz. They are designed to operate over a control voltage range of 3 to 30 v dc at a typical control current of 10 mA.

Between input and output, these units provide an isolation voltage of 1,500 v ac rms, which is obtained with a LED and a silicon photodetector. Because of the zero-switching feature, turn-on and turn-off times are each a half-cycle.

Series 512 units come with screw terminals, while series 513 devices have quick-connect terminals. Both sell for \$13.75 each in production quantities. Delivery takes six to eight weeks.

North American Philips Controls Corp., Frederick, Md. 21701. Circle [341] for series 501; [342] for series 512 and 513.

Sub-C nickel-cadmium cell has capacity of 1.4 Ah

Sub-C rechargeable nickel-cadmium cells, which previously were available only in capacities of 1 and 1.2 ampere-hours, are now being offered with a capacity of 1.4 Ah. Used in many OEM applications, including portable power and garden tools, scientific instruments, and photo equipment, sub-C cells measure 0.906 inch in diameter by 1.646 in. high. The published price of the 1.4 ampere-hour cell is \$1.47 in quantity, compared to \$1.25 for the 1.2-Ah unit and \$1.15 for the 1.0-Ah cell.

General Electric Co., Battery Business Dept., P.O. Box 861, Gainesville, Fla. 32602 [343]

Thermistor assembly includes heating element

The model K365 dual-circuited indirectly heated thermistor consists of a thermistor bead and a heating element enclosed in a common glass bulb. Since the input (heater) and output (thermistor) are separated, the K365 is easy to design into automatic-gain-control circuits such as those found in telephone repeaters, audio oscillators, signal generators, and harmonic distortion analyzers.

Sensitivity of the indirectly heated thermistor is quite high. With approximately 40 milliwatts of power applied to the heater, the thermistor temperature increases 1°C. For a typical thermistor, this changes the resistance from about 50,000 ohms to about 15,000 ohms.

Fenwal Electronics, 63 Fountain St., Framingham, Mass. 01701. Phone (617) 872-8841 [345]

Solid-state relay occupies only 1.27 square inches

Requiring only 1.27 square inches of space on a printed-circuit board, a miniature solid-state relay can

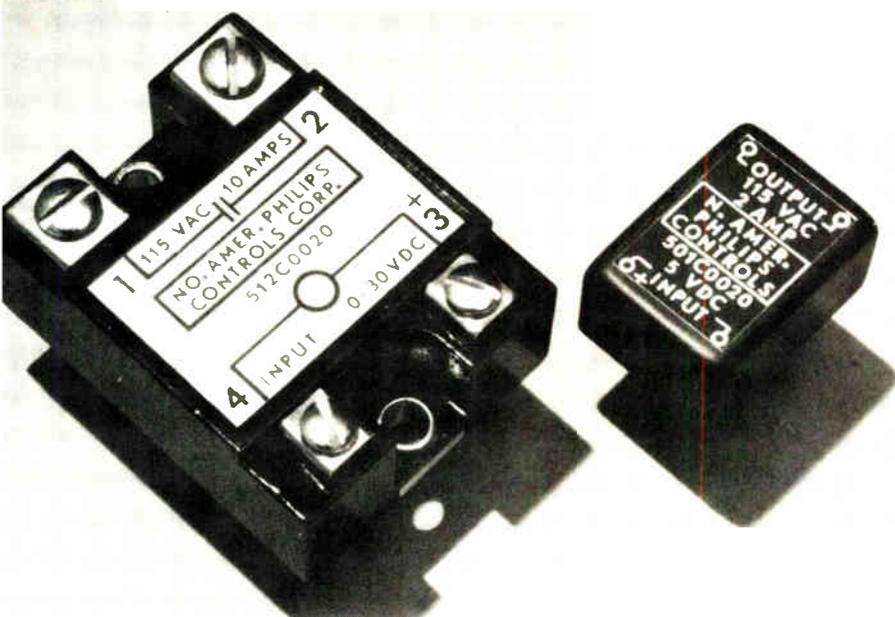

Dialight LEDs

The widest choice for your every application.

559-0101-001 MOUNTS IN 0.250" HOLE

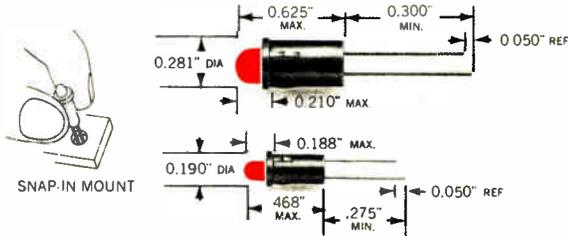

558-0101-001 MOUNTS IN 0.156" HOLE

558 and 559 SERIES Available in red, green or yellow LEDs, with and without integral current limiting resistors. Snap-in mounting requires no additional hardware. Straight terminals suited for wire-wrapping and/or soldering. Low power requirements—15 to 20mA. In 1000-lot quantities each
558-0101-001 . . \$.33. 559-0101-001 . . \$.33.

559-0101-003 MOUNTS IN 0.250" HOLE

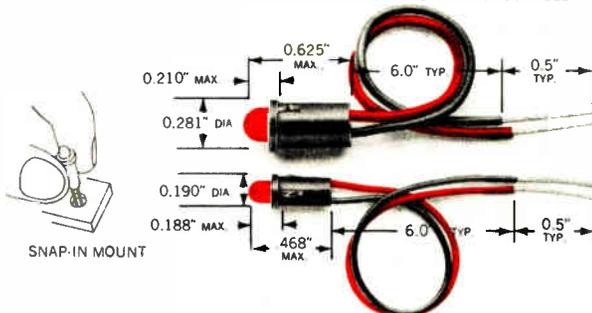

558-0101-003 MOUNTS IN 0.156" HOLE

558 and 559 SERIES Available with 6" wire leads, these red, green or yellow LEDs are designed for quick positive insertion in 0.031" to 0.062" panels. Compact design allows high density packaging. In 1000-lot quantities each
558-0101-003 . . \$.75. 559-0101-003 . . \$.71.



Dialight, the company with the widest choice in switches, LEDs, indicator lights and readouts, looks for needs . . . your needs . . . and then they develop solutions for your every application. No other company offers you one-stop shopping in all these product areas. And no other company has more experience in the visual display field. Dialight helps you do more

with these products than any other company in the business, because we are specialists that have done more with them. Talk to the specialists at Dialight first. You won't have to talk to anyone else. Send for your free new copy of Dialight's current catalog.

DIALIGHT

Dialight, A North American Philips Company
 203 Harrison Place, Brooklyn, N. Y. 11237
 (212) 497-7600

See Dialight.

New products



switch up to 3 amperes at 120 or 240 volts ac. Versions are available with input-voltage ranges of 3 to 8, 8 to 18, and 18 to 32 v dc. Capable of being driven directly by TTL levels, the relays offer zero-crossover switching and optical isolation between input and output. The price is \$5 each for 1,000 of the 1.5-ampere 120-volt version, and \$5.79 for the 3-A 120-v unit. Delivery time is six to eight weeks.

Elec-Trol Inc., 26477 N. Golden Valley Rd., Saugus, Calif. 91350. Phone (213) 788-7292 [346]

Relay packs three Form C contacts into a 14-pin DIP

A high-density, multipole reed relay that fits into a standard 14-pin dual in-line package is available with as many as six Form A, four Form B, or three Form C contacts. The Form A and B contacts are rated at 0.5 ampere, 100 volts dc, and 10 watts; the Form C contacts have ratings of 0.2A, 100 v, and 6 w. Available coil voltages are 5, 6, 12, and 24 v dc. Electrostatic shielding and clamping diodes can be supplied, if necessary. Delivery is from stock.

Computer Components Inc., 88-06 Van Wyck Expwy., Jamaica, N.Y. 11418. Phone (212) 291-3500 [348]

Zener transient suppressor can handle 1,500 watts

The TVP1500 series of zener transient suppressors can handle peak-power pulses as high as 1,500 watts to protect circuits, systems, and

New! Bi-polarity Silicon Transient Suppressors!

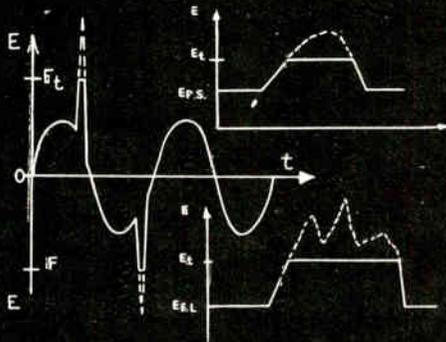

LOWEST DYNAMIC IMPEDANCE!

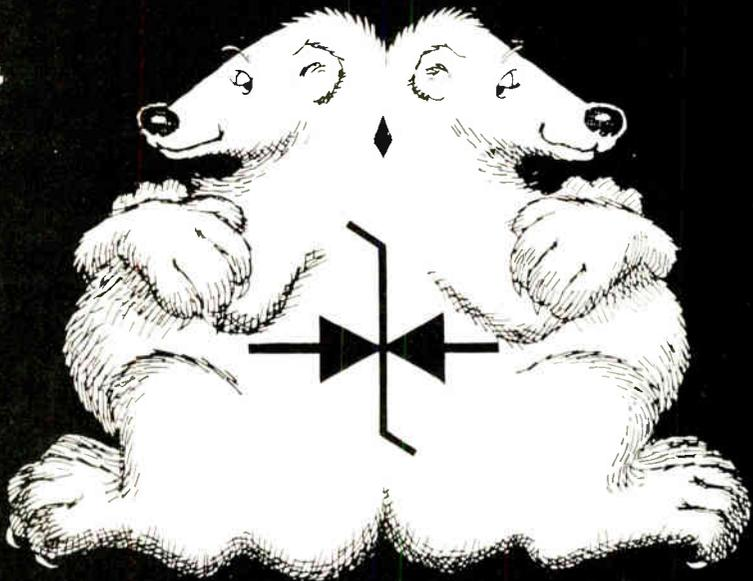

Can be supplied as **JAN, JANTX or JANTXV**
to **MIL-S-19500/516 (EL)**

This new series of silicon bi-polarity transient suppressors is unique in that a single device will provide voltage transient protection symmetrically (i.e., provide protection for A.C. signals in addition to D.C.). This new series of devices has peak pulse power ratings of 500 to 1500 watts for 1 millisecond and its response time is effectively instantaneous (less than 1×10^{-12} sec.). Therefore, these versatile devices have many protection applications where large voltage transients can permanently damage voltage-sensitive components. The devices are encased in Semtech's Metoxilite, fused directly to the high temperature metallurgically bonded assembly. For use in commercial, industrial, military and space programs.

500 Watt

Peak Pulse Power

Types: IN6102 through IN6137

Breakdown Voltage (V(BR)):

From 6.8 to 200Vdc $\pm 10^\circ$

Peak Surge Voltage (Vsm): 11.0 to 286.0V

Peak Surge Current (Ism): 45.4 to 1.7A

Temperature Coefficient of (V(BR)): 0.5 to 0.11%/°C

Case Size (Max.): .140" D x .165" L

1500 Watt

Peak Pulse Power

Types: 1N6138 through 1N6173

Breakdown Voltage (V(BR)):

From 6.8 to 200Vdc $\pm 10^\circ$

Peak Surge Voltage (Vsm): 11.0 to 286.0V

Peak Surge Current (Ism): 136.4 to 5.2A

Temperature Coefficient of (V(BR)): 0.5 to 0.11%/°C

Case Size (Max.): .180" D x .165" L

☆☆☆☆☆☆☆☆

4-LAYER DIODE IN METOXILITE!

Reduce circuit costs and increase reliability!

Semtech's 4 Layer Diode (PNPN) is a silicon switch that is controlled by the amount of voltage applied. The application of this diode to a circuit often reduces the number of associated components which in turn, leads to cost reduction and increased reliability. Now available in Semtech's proven Metoxilite construction as two terminal, fast-switching devices specifically designed for low voltage applications such as logic circuits, pulse generators, memory and relay drivers, relay replacements, alarm circuits, multivibrators, ring counters, and telephone switching circuits.

Types: 1N5779 thru 93, 1N5158 thru 6D

Switching Voltage: 10 to 15V

Switching Speeds: t(on) = 75ns, t(off) = 250ns

Junction Capacitance: 150pF

Case Size (Max.): .070" D x .165" L

1975 NATIONAL SBA SUBCONTRACTOR OF THE YEAR



SEMTECH CORPORATION

652 Mitchell Road, Newbury Park, California 91320

(805) 498-2111 • (213) 628-5392 • TWX: 910 336-1244

CHICAGO (312) 352-3221 • DALLAS (214) 3-1351

FLORIDA (305) 644-5404 • MARYLAND (301) 424-6663

NEW JERSEY (201) 654-4884 • SAN FRANCISCO (415) 494-0113

EUROPEAN SALES: British AG Zug Switzerland (042) 232-242

Better just got smaller.

The 501C AC power source.

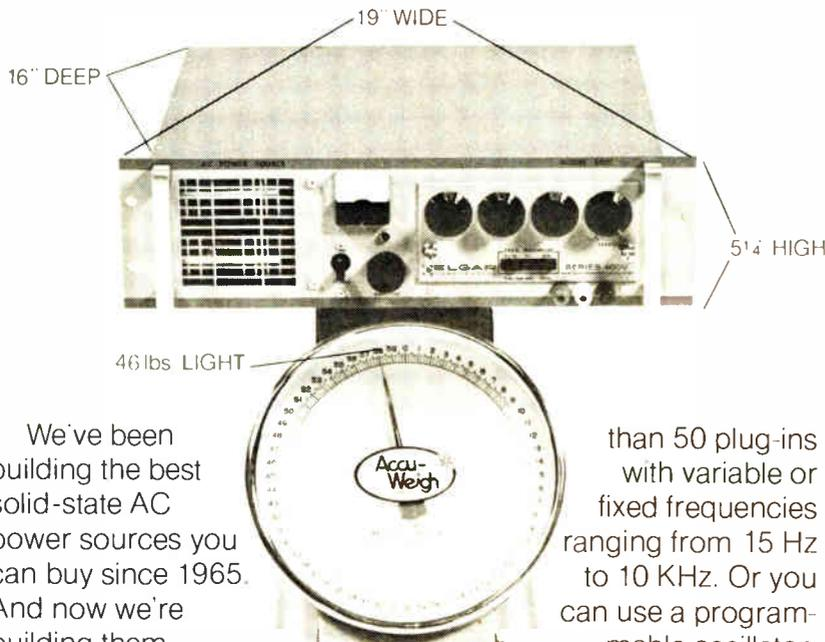

We've been building the best solid-state AC power sources you can buy since 1965. And now we're building them smaller and lighter as well. Our new Model 501C measures 5 1/4" high by 19" wide by 16" deep, and weighs in at a mere 46 pounds. Input voltage is 117 or 234 VAC; output power is 500 VA max. And like all Elgar AC power sources, the 501C accepts plug-in oscillator modules. You can choose from more

than 50 plug-ins with variable or fixed frequencies ranging from 15 Hz to 10 KHz. Or you can use a programmable oscillator.

By now, you've probably thought of at least half a dozen uses for this new instrument. So if you write us, we'll send you complete specs and application information.

ELGAR

8225 MERCURY CT., SAN DIEGO, CA 92111, (714) 565-1155, TWX 910-335-1246

New products



equipment from voltage surges. The devices, which are offered with breakdown voltages from 8.2 through 200 volts, have a clamping time of only 1 picosecond. All devices in the family can withstand temperatures to 400°C, and can be operated from -65°C to 175°C. In quantities of 100, they are priced at \$1.35 each and have a delivery time of six to eight weeks.

TRW Capacitors, 301 West O St., Ogallala, Neb. 69153. Phone John Gamet at (308) 284-3611 [347]

TOPICS

Components

The Micro Switch division of Honeywell, in Freeport, Ill., has added reflector-backed light-emitting diodes to its line of AML lighted push-button switches. The new design is said to improve both the brightness and viewing angle of the push buttons...

Cherry Electrical Products Corp., has added a seven-segment, 0.7-inch, four-digit clock display to its line of Plasma-Lux gas-discharge displays. The W04-0001 sells for \$12.45 each in small quantities, dropping to \$6.10 each for 2,000 pieces...

C & K Components Inc., Watertown, Mass., has introduced its model 1101CQ subminiature slide switch—a spst device with a contact rating of 6 amperes. A free engineering sample of the switch is available on request...

Sierra Electric, Gardena, Calif., introduced a line of 15- or 20-ampere toggle or key-lock switches that are totally enclosed and constructed with all exterior surfaces nonconducting and non-corroding. The dead-front, dead-sides, and dead-back switches meet all NEC, UL, NEMA, and Federal specification tests and design requirements.

Specifying custom pots for demanding applications was no bed of roses — until Duncan designers grew our New Breed of Hybrids. That's because they came up with a way to make hybrid versions of our entire line of precision pots — at very little extra cost! □ So if you need the precise linearity and low tempco of a wirewound pot *and* the infinite resolution and long life of conductive plastic, talk to Duncan now. With the industry's broadest line of hybrids, we're sure to have exactly what you're

looking for. □ We've got rotary, straight-line, *and* multi-turn types (including our famous 7/8" 10-turn Pixiepot®), with a huge variety of sizes—all available in either linear or non-linear functions. Standard specs like 0.1% output smoothness and ± 70 ppm/°C tempco — even better on special order. **All single and multi-turn Mil-R-39023 styles are QPL approved.** □ Duncan's New Breed is ready to solve

your toughest application problems now. We'd be happy to send you details.

Duncan's New Breed of Hybrids



*Plant one in your
toughest application.*

DUNCAN ELECTRONICS

SYSTRON  DONNER

2865 FAIRVIEW ROAD, COSTA MESA, CALIFORNIA 92626
(714) 545-8261 • TWX: 910-595-1128

Actual photo of Hybrid Red Rovers
grown especially for this ad

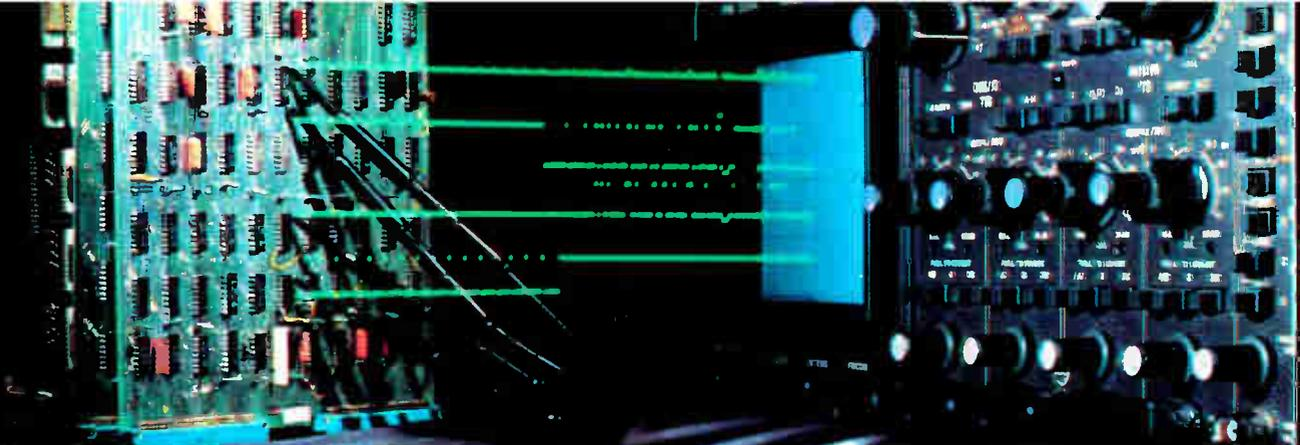

**Four 50 MHz channels. Unique triggering facilities.
Ideal for parallel data analysis.**

Zero in on

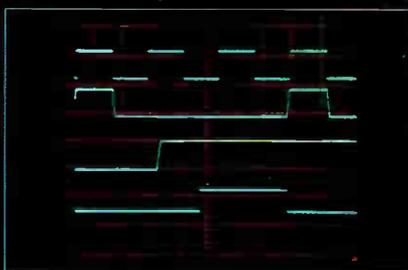

As illustrated on the front panel detail, triggering is fully independent and multi-sourced. This gives a number of unique triggering possibilities and is just as useful for more conventional dual-trace measurements.

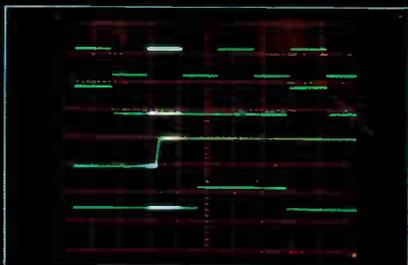

Here the main and delayed timebases are triggered from different channels, one example of the PM 3244's unique triggering facilities. Signals can therefore be shown even when they are not related to the main timebase.



Differential measurements can be made on the PM 3244 in the conventional manner or by using the composite triggering mode.

Four traces give you the logic story: show the relationships at a glance. But only the PM 3244 gives you four traces and fully independent triggering of main and delayed timebases. Thus the main timebase can be triggered on any of the four channels plus composite, external and line. The delayed timebase can be triggered on any of the four channels plus composite: independently! This gives a number of unique triggering possibilities, for example showing relationships that are not directly related to the main timebase, like the information in a data line when the main timebase is triggered on an address line.

Doubles for dual-trace with extra performance.

PM 3244 is the world's first four-channel compact and all channels have full display facilities i.e. sensitivity, attenuation, invert, etc. It can therefore be used to make isolated or differential measurements and when you need conventional dual-trace displays, this scope also gives them, with two traces in reserve plus unmatched triggering facilities.

All displays are on a large 8 x 10 cm screen and the compact construction weighs in at a mere 9.6 kg (21 lb). The price is rather compact too!

Write for more details. Read opposite about another data breakthrough.



**Test & Measuring
Instruments**

20 MHz with digitally delayed triggering to over 200 MHz.
Ideal for serial data.

ones and zeros

The PM 3261 is another world first. In addition to conventional triggering facilities, the instrument features a digitally delayed timebase that can be set to trigger on a particular pulse in a data stream, the position being displayed on the built-in, five-digit LED. This facility allows individual events to be located quickly and accurately in data streams of up to 100,000 bits and then be 'trapped' for detailed display.



The event is located using the illustrated delay counter, which can be set to count up or down at an adjustable speed as low as one step every two seconds. Specific sections can thus be examined and the counting stopped and stepped back to pick up and locate any irregularities.

The digitally delayed counter also overcomes problems of jitter, such as occur in mechanical systems like disk memories, tape drives, etc. In such cases, if the jitter is longer than one period, a conventional delayed timebase cannot be effectively employed. Once that display has been trapped, accurate time interval measurements can be made using the normal delayed timebase controls.

In addition, the main timebase has a TTL triggering facility to eliminate triggering problems on preshoot, overshoot, ringing, etc.



As illustrated on the front panel detail, one push button and one control knob are all that's needed to operate the digital delay. The required event in the data stream 'lights up', as shown, and can then be displayed using the normal delayed timebase in order to make accurate time interval measurements.

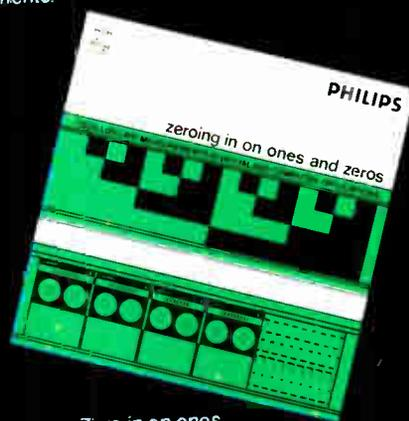

Zero in on ones and zeros with the aid of this useful 64-page booklet. For further information simply circle the reader service number.

In the United States:
400 Crossways Park Drive
Woodbury, New York 11797
(516) 921-8880

In Canada:
6 Leswyn Road
Toronto, Ontario Canada M6A1K2
(416) 789-7188

Philips Test & Measuring Instruments, Inc.
A NORTH AMERICAN PHILIPS COMPANY

World Radio History

PHILIPS

Circle 138 for information

**Now the line of AMP
Coaxial Ribbon Cable Assemblies
is wider than ever.**

And so is your design range.





The introduction of AMP Coaxial Ribbon Cable assemblies represented a major breakthrough in interconnection technology. Lower costs with no compromise in performance. Now, AMP has broadened the line to give you an extremely wide range of high speed, low noise interconnections.

AMP ribbon coax is available in 50-, 75- and 93-ohm ratings, 6 to 26 positions, on .100-inch centers. Or in a 95-ohm rating on .125-inch centers.

Multi-position connectors mate with .025²-inch posts, either 90° board-mount pin headers or I/O posts. Included are the new paddle-card and flanged types.

We can supply complete ribbon coaxial cable/connector assemblies of any length to fit your requirements. Or provide all the cable, connectors, and tooling you need to make your own.

Either way you get professional back-up by AMP field and home office engineers. They work with you from the prototype stage through production—and on to future design.

For more information on the design opportunities you get with AMP's extended range of Coaxial Ribbon Cable assemblies, call Customer Service at (717) 564-0100. Or write AMP Incorporated, Harrisburg, PA 17105.

SEE US AT
MUNICH ELECTRONICA

AMP
INCORPORATED

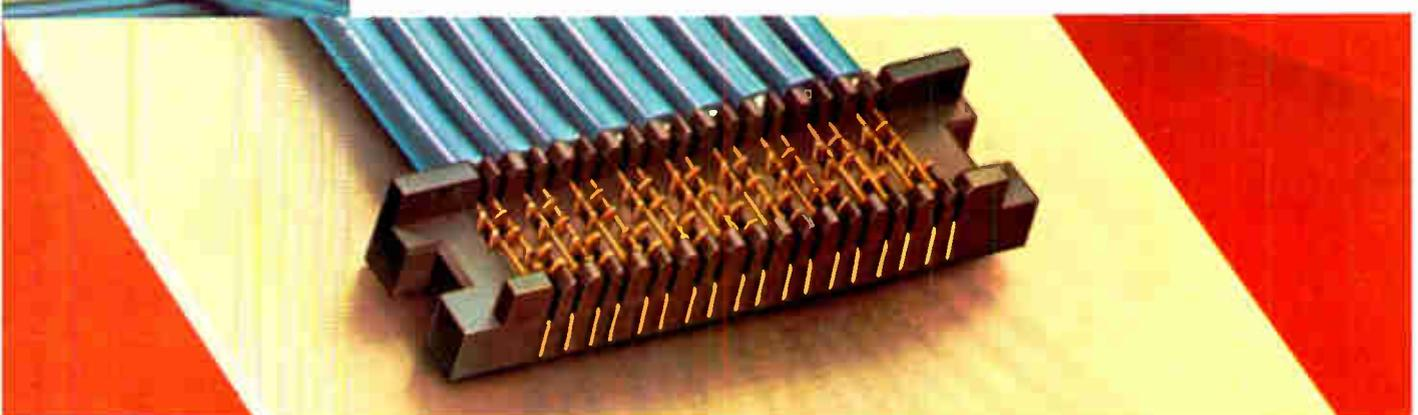

AMP is a trademark of AMP Incorporated.

World Radio History

Circle 141 on reader service card

FF101A FF101B FF101C

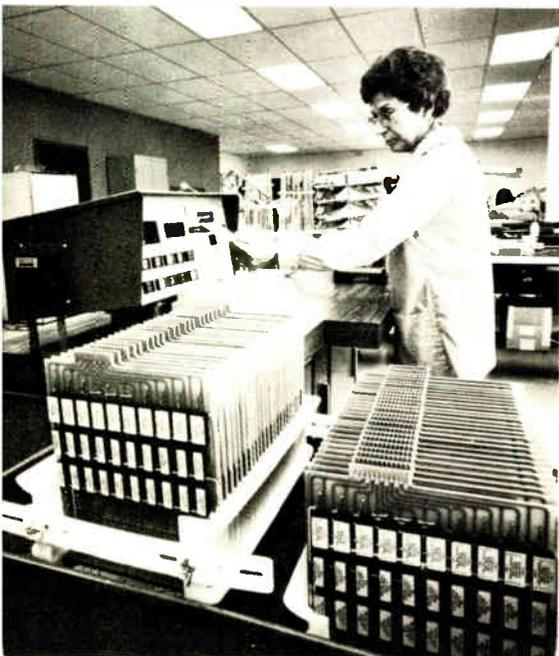

New products

Semiconductors

IC converter resolves 10 bits

Buried zener reference diode enhances stability; resistors are laser-trimmed

Semiconductor manufacturers usually peg integrated-circuit digital-to-analog converters at the highest resolution being sought, such as 10 bits. The best of the lot gets that rating, while the remainder are binned for sale at a less demanding 8 bits. That procedure is not followed with a new 10-bit d-a converter from Analog Devices Semiconductor division. The AD561 will be sold only as a 10-bit unit because its developers are confident that it will be an accurate and stable 10-bit monolithic converter.

Laser trimming of the thin-film resistors at the wafer level is the big contributor to accuracy, explains Rich Frantz, product-marketing specialist. And David Kress, also a

marketing specialist, points out that the device is trimmed to about 14 bits true resolution on the wafer. Two versions, the AD561K and AD561T, have a maximum relative accuracy to within $\frac{1}{4}$ least significant bit; and J and S versions deliver accuracy to within $\frac{1}{2}$ LSB.

Stability of 100 parts per million/ $^{\circ}$ C is achieved primarily through the integration of a buried zener reference diode, says Kress [*Electronics*, Sept. 16, p.111]. He says surface references can't deliver the kind of long-term stability that the buried zener does—it is diffused deeper into the device than are the surface zeners. The laser-trimmed thin-film resistors, buried zener and an R-2R ladder network with a low temperature coefficient all combine to produce the tight accuracy, stability, and monotonicity over the full operating temperature of each version of the converter.

The AD561J, which sells for \$9.95 in quantities of 100, is specified for operation from 0° C to 70° C, the same range as the K version, priced at \$15 in hundreds. The S and T versions, designed for the full military temperature range of -55° C to $+125^{\circ}$ C, are priced at \$18 and \$32,

Building blocks for the in-circuit/functional test system you need.

The system you use to test printed-circuit assemblies should be tailored to your specific needs and readily expandable to handle your future requirements. When you specify FAULTFINDER[®] FF101 test systems, you have the building blocks you need to do the job.

Think of Faultfinders first for test hardware, software and experience.

WRITE FOR COMPLETE COLOR BROCHURE

Circle 142 on reader service card

FF1 FAULTFINDERS Inc.
15 AVIS DRIVE, LATHAM, NY 12110 (518) 783-7766

Irvine, CA
Sunnyvale,
Park Ridge, IL
Faultfinders GmbH, Eschborn, Germany

Cicero, IN
Waltham, MA

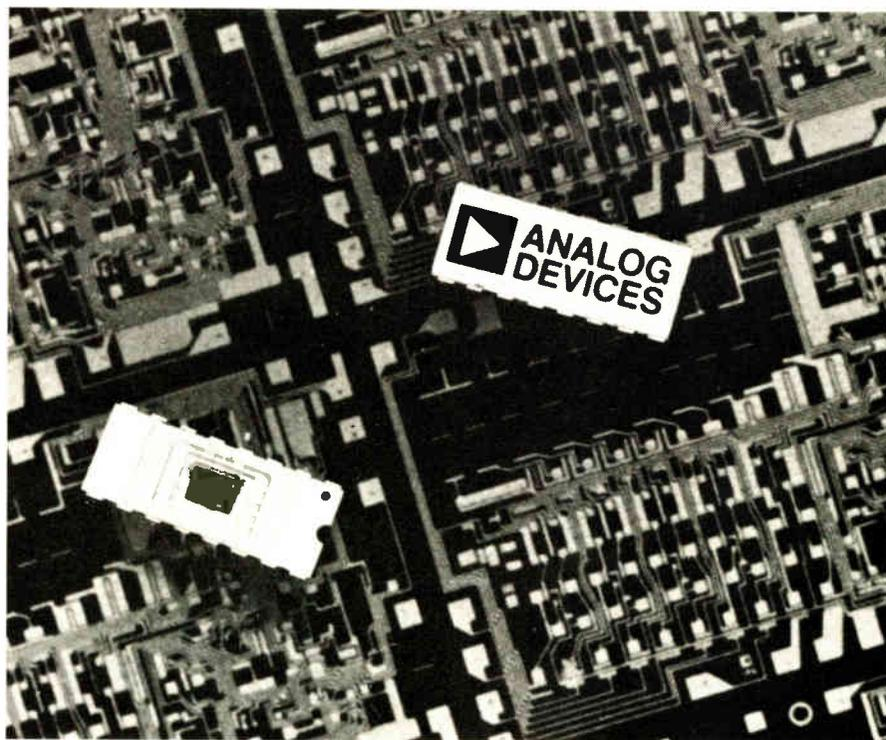

Look at the latest in plasma display.

alpha graphic terminals

- MILITARY ENVIRONMENTS
- 10 YEAR OPERATING LIFE
- LOW LIFE CYCLE COST
- HIGH BRIGHTNESS
- HIGH RESOLUTION
- HIGH CONTRAST
- REDUCED SIZE
- INTERACTIVE

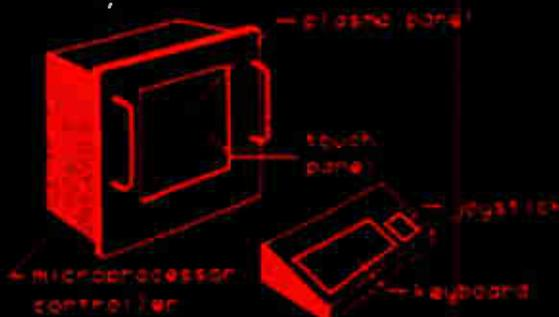

Now look at the source.

Interstate Electronics—veteran supplier of military computer-based electronic equipment.

For over 30 years, we've designed and delivered hardware for a range of environments, from laboratory to full Mil-Spec conditions. Today, we're among the leading 100 defense contractors in America.

Now we're producing plasma display terminals under multiple military contracts. Our products range from standard off-the-shelf models to special configurations, with display features like joystick interactive editing and microprocessor control. All have the inherent advantages of plasma

display—plus Mil-Spec capability.

Your new military display source—Interstate Electronics—a dynamic part of the Electronics Group of A-T-O, Inc.

Give us an opportunity to discuss your operational, environment and performance requirements. Write Sid Wing, Military Products Manager, Interstate Electronics Corp., Marketing Department, 707 E. Vermont Ave., Anaheim, CA 92802. Better yet, call him at (714) 772-2811.

**INTERSTATE
ELECTRONICS
CORPORATION**

SUBSIDIARY OF
ATO

Listen to the experts...



These Top 500 companies are now using our ultrasonic soldering system. They can tell you the benefits of using fluxless soldering for metals, exotics, glass and ceramics.

The G-35 generator shown here delivers 35 watts of ultrasonic heated power into the soldering iron, and features push button controlled power levels of heat and sound energy.

Solid state circuitry assures you of worry-free durable performance. And auto-feedback and power tracking leads to perfect production every time.

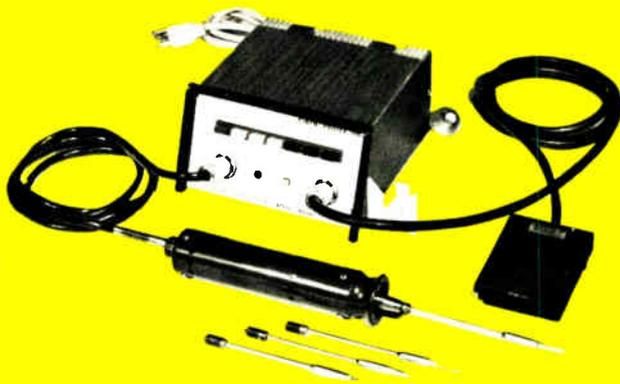

To find out how we can help you, send samples of your materials and a description of your requirements to Fibra-Sonics. We'll return them to you without cost or obligation.

FIBRA-SONICS, INC.

4626 N. Lamon Avenue • Chicago, Illinois 60630 / (312) 286-7377

Circle 144 on reader service card

New products

respectively. In addition, there are MIL-STD-883 versions of the AD561S and T.

All grades are housed in 16-pin hermetic ceramic DIPs, and all have the same fast typical settling time of 250 nanoseconds to 1/2 LSB. Kress points out that the current-steering switches are designed to settle in less than 250 ns for the worst-case digital-code transition, which allows a successive-approximation 10-bit conversion in 5 microseconds.

All versions of the AD561 are available from stock.

Analog Devices Inc., Route 1 Industrial Park, P.O. Box 280, Norwood Mass. 02062. Phone (617) 329-4700 [411]

Power MOSFET family takes aim on bipolar transistors

Six MOS field-effect transistors—three with a power rating of 4 watts and three that are rated at 25 w—are intended to replace assemblies built around bipolar power transistors. Because they have a negative temperature coefficient, the enhancement-mode MOSFETs do not suffer from current-hogging problems when two or more of them are connected in parallel for applications beyond the capability of either.

Noteworthy for their capability to be driven by lower-power C-MOS circuits such as those in microprocessors, the transistors have a typical



switching time of 4 nanoseconds at a drain current of 1 ampere. Other key specifications include a maximum continuous drain current of 2 amperes (for the 25-w VMP 1 series), and a typical input leakage current of less than 1 nanoampere.

The 25-w devices, housed in TO-3

The Answer Book. It makes your job easier. \$25.

Who makes what? Over 4000 products, 6000 manufacturers with their local contacts, directory of trade names and catalogs, inquiry "bingo" card for 5-second ordering of current catalogs.

Electronics Buyers' Guide
1221 Ave. of the Americas
New York, N.Y. 10020

Yes, send me a copy of The Answer Book. I've enclosed \$25 (USA and Canada only, elsewhere send \$35). Full money back guarantee if returned within 10 days.

Name _____

Company _____

Street _____

City _____

State _____

Zip _____



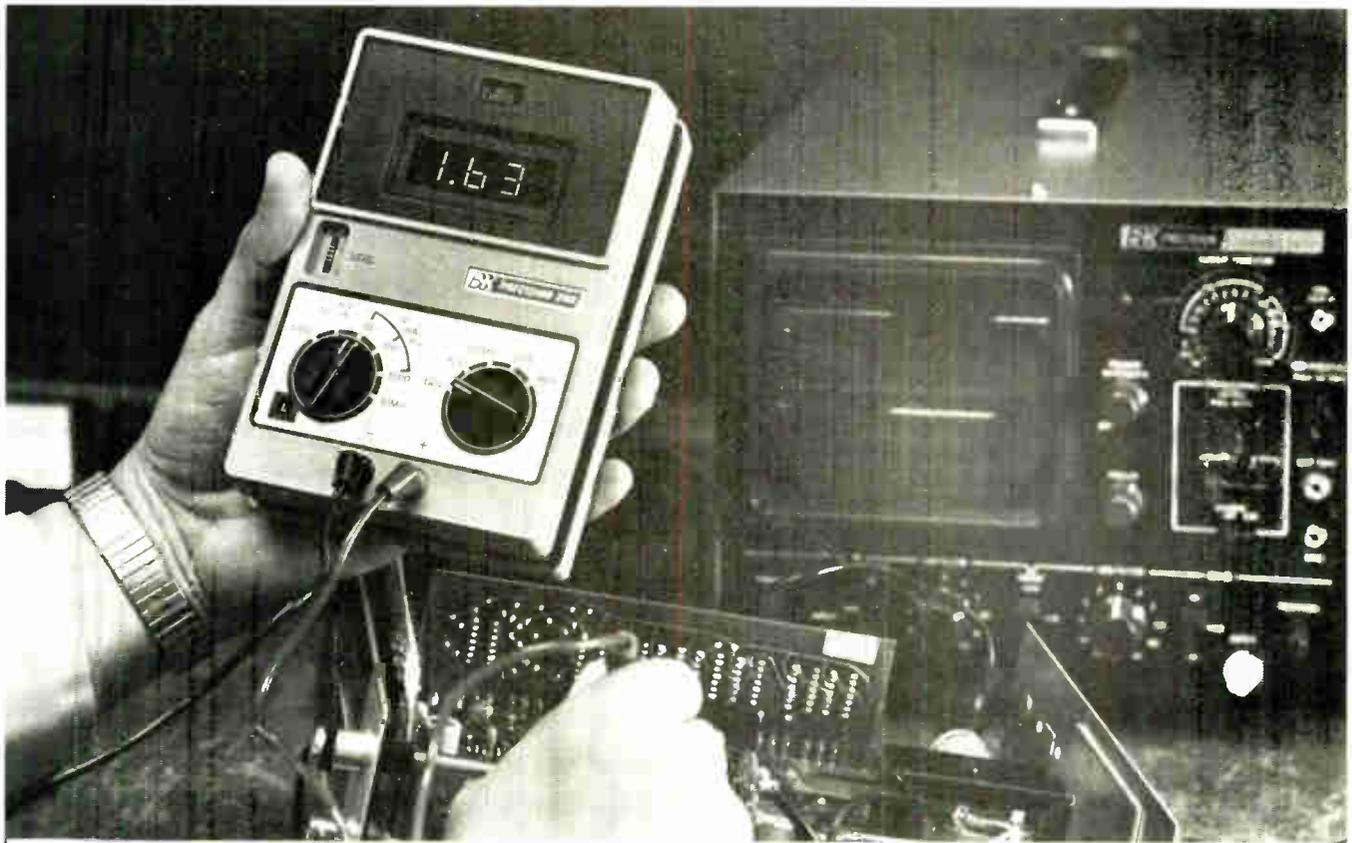

Why is the 280 at \$99⁹⁵ our fastest selling multimeter ever?

The reasons are easy to understand. The 280 is a battery-operated portable, full-feature digital multimeter at less than the price of a precision analog meter. The 280 features a large three-digit LED readout, automatic polarity indication, automatic decimal point placement and out-of-range indication. The 280 is fully overload protected for reliability and has an industry-standard input impedance of 10 megohms for all voltage ranges.

It has High, Low power ohms ranges for accurate in-circuit measurements. And digital accuracy $\pm 0.5\%$ DCV thru lowest ranges; $\pm 1\%$ 1000 V range. $\pm 1\%$ ACV thru lowest ranges; $\pm 2\%$ 1000V range. $\pm 1\%$ typical ohms and digital resolution (1mV, 1 μ A, 0.1 ohm).

No compromises on range either—DC and AC voltage ranges to 1000 V, DC and AC current ranges to 1000 mA and ohms ranges to 10 megs. There are actually 22 operating ranges controlled by the smooth rotary range and function switches.

B&K-PRECISION also has a full complement of optional accessories for the 280:

- LC-28 carrying case (\$6.00) protects your 280 and provides test lead storage.
- MS-28 wire tilt stand (\$3.00) allows positioning the 280 on two convenient viewing angles.
- BC-28 AC adapter/charger (\$8.00) offers AC operation and battery recharging.
- PR-28 high-voltage probe extends the 280's capability to 40,000 volts.
- PR-21 direct/isolation probe (\$10.00) prevents capacitive loading when measuring DC in an RF circuit.

Our fastest seller ever? We're not surprised.
IN STOCK AT YOUR DISTRIBUTOR.

B&K PRECISION

PRODUCTS OF DYNASCAN

6460 West Cortland Avenue • Chicago, Illinois 60635 • (312) 839-9087

In Canada: Atlas Electronics, Toronto

AIRPAX

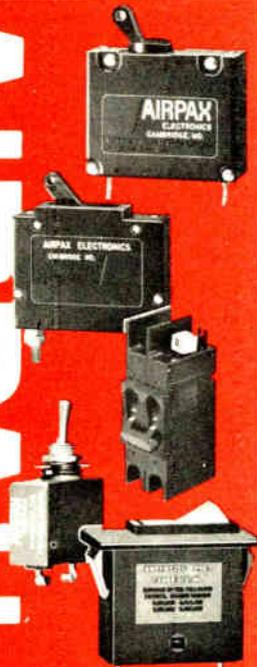

THE CIRCUIT BREAKERS THAT PUT THE PRO IN PROTECTION

It takes a real pro to produce circuit breakers with the built-in quality, service, and reliability of Airpax breakers. That's why they are the acknowledged standards in the protection of computer systems, military, industrial, and consumer electronic equipment.

Unaffected by temperature extremes (as is the case with fuses and thermal breakers), Airpax electromechanical circuit breakers are available in a wide variety of sizes, styles, voltage and current ratings to suit nearly any OEM application.



Get the full story of these pros of the protection field. Send today for the Airpax Short Form Catalog 2013.

AIRPAX

AIRPAX ELECTRONICS
CAMBRIDGE DIVISION

Cambridge, Maryland 21613
Circuit Breakers, Switches,
Glass/Ceramic-to-Metal Seals

Other Airpax Divisions:

CONTROLS DIVISION, Ft. Lauderdale, Fla.
Instruments for Industry

AMERICAN DATA, Huntsville, Alabama
TV Products

New products

packages, are priced from \$5.50 to \$8.10 each in hundreds, depending upon breakdown voltage. The 4-w transistors, which sell for \$3.60 to \$5.30 each in hundreds, are supplied in TO-39 packages. Available breakdown-voltage ratings are 35, 60, and 90 volts.

Delivery of the units is from stock.

Siliconix, 2201 Laurelwood Rd., Santa Clara, Calif. 95054 [413]

High-current diode chips have low recovery times

A line of diode chips for use in hybrid circuits includes units with forward-current ratings from 1 ampere to 100 A and reverse recovery times from 9 to 90 nanoseconds. The ion-implanted devices are offered with peak reverse voltage ratings from 20 volts to 660 v. Leakage currents range from 50 microamperes for the 1-A units to 500 μ A for the 100-A diodes. Maximum surge currents are 10 times rated current in the 100-A devices and 50 times rated current in the 1-A units. Chip prices range from 25 cents to \$5 each in lots of 100 pieces. Delivery is from stock.

Solid State Devices Inc., 14830 Valley View Ave., La Mirada, Calif. 90638. Phone (213) 921-9660 [415]

Analog multiplexers are protected against faults

A series of 4-, 8-, and 16-channel analog multiplexers, manufactured with a dielectrically isolated complementary-MOS process, has a high degree of immunity to input and power faults. No damage results even when an MX-series multiplexer



NOW!

42 NEW MODULAR A/D converters



One of two compact cases (2" x 4" x .39") that contain the 42 new Phoenix Data modules

All 42 units in Phoenix Data's six new series of modular A/D converters—ADC1300 through ADC-1800—employ the highly reliable and stable voltage switching successive approximation conversion technique. Note these features:

- 8 through 14 bit resolution.
- Overall T.C. to 2.5PPM/ $^{\circ}$ C.
- No adjustments over 10 $^{\circ}$ C to 40 $^{\circ}$ C range.
- Factory calibrated and pre-trimmed.
- RFI and EMI shielded.
- Pin selectable input ranges.
- Conversion time to 2 μ sec: 8 bits; 4 μ sec: 12 bits; 10 μ sec: 14 bits.
- Optional temperature ranges from -55 $^{\circ}$ C to +90 $^{\circ}$ C ambient.
- Guaranteed monotonicity.
- Accuracy to 0.01%.

If it's stability, accuracy, speed, or all-around quality you need in Data Conversion, contact Ron Brunnermer, director of marketing, or your area representative.



PHOENIX DATA, INC.

3384 W. OSBORN RD. PHOENIX, AZ 85017
Ph. (602) 278-8528, TWX 910-951-1364

Finally. A low-cost predictable filter.

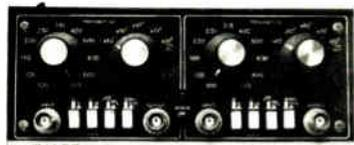
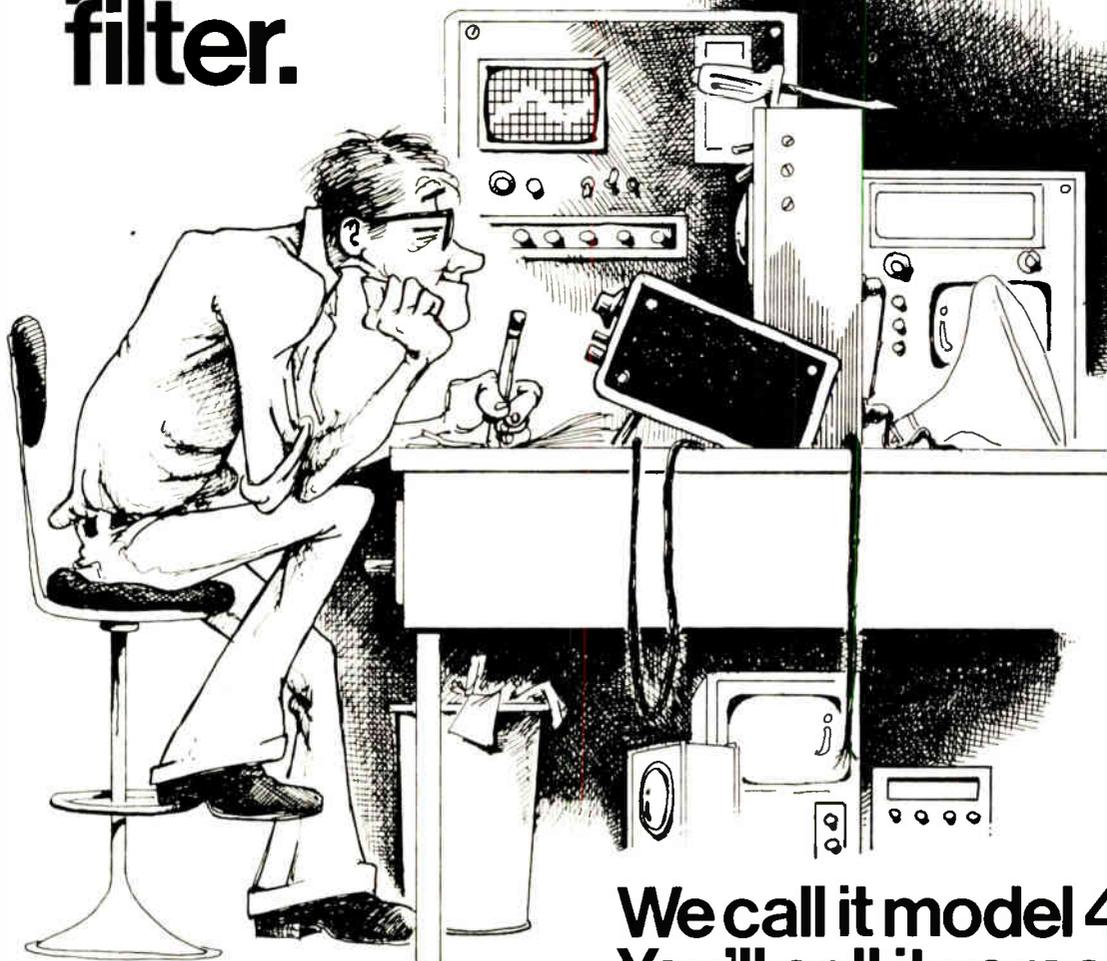

You probably have equipment in your lab or data acquisition system that you don't really trust, or that you have to calibrate whenever you use it. So we thought you'd appreciate a high performance, low-priced dual filter that's predictable.

It takes unusual performance to make a predictable filter.

Like .005% distortion at 20 volts peak to peak output. 25 μ volts self noise. 100dB outband rejection. And 100dB crosstalk attenuation. All better than any competitive filter, even higher priced ones. And switch selectable frequency

We call it model 4302. You'll call it versatile.

settings (10 Hz to 1MHz), let you repeat settings over and over again. With predictable results.

Versatility is written all over its face.

Each 24dB/octave filter can be used as high pass or low pass with selectable gain of 1 or 10. Or connect them in series for bandpass, 48dB/octave high pass, or 48dB/octave low pass, with selectable gain of 1, 10, or 100. Select normal (Butterworth) and pulse (Bessel) by the push of a button. All of this is standard.

Send for our data sheet.

It'll tell you all you need to know about our newest filter. And when you need a filter that does just what you expect, you'll know where to find it. The predictable filter.™ \$655. Ithaco.

Box 818, Ithaca, New York
14850. Call (607) 272-7640.



© Ithaco, Inc., 1975. The predictable filter™ is a trademark of Ithaco, Inc.

WHY YOU SHOULD USE VARO'S

SCHOTTKY BARRIER RECTIFIERS

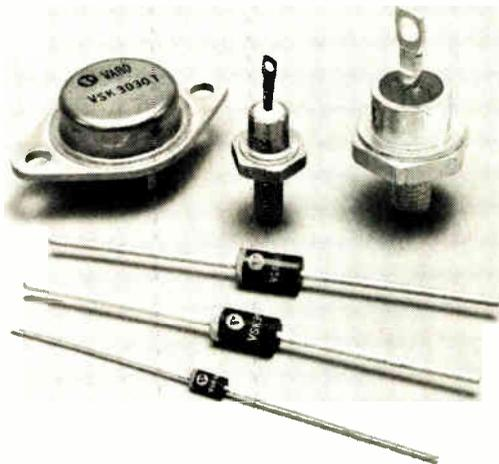

Varo Schottky Barrier Rectifiers offer you many significant advantages:

VERY LOW FORWARD VOLTAGE DROP (V_F)

Because of the large metal-barrier-to-silicon junction, V_F ranges are from 550 mV, $I_F = 1$ A, to 620 mV, $I_F = 40$ A. This results in less heat dissipation, low power loss, and greatly improved efficiency.

EXTREMELY FAST RECOVERY TIMES (t_{rr})

Typically ≤ 10 nsec. Schottkys are ideally suited for low-voltage power supplies, free-wheeling diode and flyback diode applications, and polarity protection in high-speed switching circuits.

MAJORITY CARRIER CONDUCTION

In addition to fast recovery, Schottky barrier construction results in high surge capacity and low stored charge. Schottkys are not subject to conventional P-N diode forward and reverse recovery transients caused by minority carriers.

OTHER VARO SCHOTTKY FEATURES ARE:

- -65 to +150°C junction operating temperatures
- 1 A, 3A, 5A, 15A, 30A and 40A (I_O) ratings
- 20V, 30V, and 40V (V_{RRM}) ratings
- Low reverse leakage
- Epoxy axial lead, DO-4, DO-5, and TO-3 package configurations
- Competitive pricing

Try one in your circuit; you will see for yourself these advantages and more.

For more information and data sheets on all Varo Schottky Barrier Rectifiers call Mike Hawkins, 214/272-4551



Design us in . . . we'll stay there

VARO SEMICONDUCTOR, INC.

P.O. BOX 676 1000 N. SHILOH GARLAND TEX 75040
(214) 272-4551 TWX 910 860-5178

EUROPEAN OFFICE: UK: VARO SEMICONDUCTOR INTERNATIONAL, INC.
Deedene House, Bellegrave Road, Welling, Kent, England DA163PY, 01-304-6519 0

New products

is subjected to an input overvoltage of up to ± 20 volts, a logic input overvoltage of up to ± 4 v, or a loss of power with control and signal inputs applied. Break-before-make switching ensures that no two channels are ever shorted together, and an inhibit input makes it easy to connect several of the devices together to expand their channel-handling capability.

Unit price is either \$14 or \$34, depending upon the number of channels and whether the inputs are single-ended or differential. The 16-channel multiplexer is offered only with single-ended inputs, while the 4-channel device is only available with differential inputs. All units are available from stock.

Datel Systems Inc., 1020 Turnpike St., Canton, Mass. 02021. Phone Eugene Zuch at (617) 828-8000 [414]

Unit multiplies two 8-bit words in 130 nanoseconds

The MPY-8 multiplier circuit is an 8-bit monolithic device that can perform a complete 8-by-8-bit parallel multiplication in 130 nanoseconds, typically. Inputs and outputs are TTL-compatible, and the outputs are of the three-state type.

The multiplier, organized as a four-port device, is housed in a 40-pin dual in-line package. It uses emitter-follower logic for high speed and lower power consumption. Only one 5-volt power supply is required.

The MPY-8 sells for \$100 each in small quantities. Delivery time for samples is 30 days.

TRW Defense and Space Systems, E2/9085, One Space Park, Redondo Beach, Calif. 90258. Phone Bill Groves at (213) 536-1977 [416]

3-digit voltmeter chip is accurate within 0.1%

Intended to provide competition for high-accuracy analog panel meters, the LD130 digital voltmeter is a monolithic device that includes most

of the circuitry needed for a three-digit voltmeter. The circuit, which is accurate within $0.1\% \pm 1$ count, needs only one external reference voltage, three capacitors, and a field-effect transistor to form a BCD-output voltmeter. To provide a display requires the addition of three LED seven-segment readouts, three digit-driving transistors, a BCD-to-seven-segment decoder/driver, and seven current-limiting resistors.

Automatic polarity and range-switching are included on the chip, so these features need add no cost to the meter. Priced at \$8.75 each in quantities from 100 to 999, the LD130 reduces the cost of building a meter into a new product to approximately \$15 to \$20, depending upon the number of measurement modes and the display elements.

Siliconix, 2201 Laurelwood Rd., Santa Clara, Calif. 95054 [417]

Semiconductors

Intersil Inc., Cupertino, Calif., is now second-sourcing the AM11424A five-function LCD watch circuit. The ICM11424A is a silicon-gate C-MOS circuit designed to drive a $3\frac{1}{2}$ -digit field-effect liquid-crystal display. . . .

Advanced Micro Devices Inc., Sunnyvale, Calif., has introduced three serial-in/parallel-out universal shift registers that have typical shift frequencies of 50 megahertz. The 8-bit registers are called the Am54/74LS299, the Am25LS23, and Am25LS299. . . .

The Linear Integrated Circuits division of Fairchild Camera and Instrument Corp., Mountain View, Calif., has extended its line of monolithic interface circuits with two dual memory drivers. The 55/75326 and 55/75327 are priced from \$2.62 to \$3.14, depending upon packaging. . . . **Signetics Corp., Sunnyvale, Calif.** has added two military versions of its field-programmable logic arrays to its product line. The Schottky-TTL devices operate over the temperature range from -55°C to 125°C .

TOUCH-TONE*



Actual Size

Telenetics' 7516-01 is a complete Touch-Tone Decoder in a $\frac{1}{2}$ cubic inch, 32 pin DIP. Telephone Standard 2-of-8 tones are received, processed and decoded into discrete 1-of-16 or BCD (plus strobe) outputs. Input signal ranges -22 to $+4$ dBm with a balanced, capacitively coupled, 50 K Ω impedance. Operating voltage range is 8 to 28V dc (single supply); temperature range -30 to 70°C .

Telenetics 7516-01 gives you one-tenth the size of one-third the cost of comparable Touch-Tone Receivers. Telenetics also offers these other devices:

- 7603 Touch-Tone Encoders
- 7511 Address Selector
- 7507 A complete line of Multiplexers and Analog Switches
- 7635 Touch-Tone Keyboards

Write or call today for a catalog—and pricing information:

Telenetics Telenetics, Inc., 4120 Birch Street,
Newport Beach, California 92660
Phone: (714) 752-6363

*R-Registered trademark of AT&T

Circle 149 on reader service card

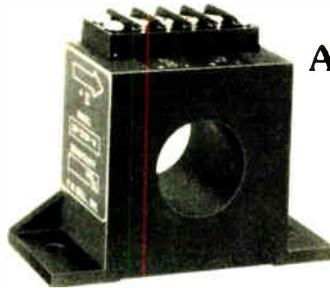

NON-CONTACT AC & DC CURRENT SENSORS

NEW

UNIQUE

This new Bell current sensor has unique capabilities to solve current measurement problems. The following four capabilities allow the use of ID-5(X)1M current sensors where other current sensing methods are difficult or impossible.

- 1) Non-contact operation provides complete isolation from the bus.
- 2) The ID-5(X)1M introduces a negligible power drain in the measured circuit.
- 3) The minimal insertion impedance has virtually no effect upon the measured circuit performance.
- 4) The dc current capability allows the measurement of dc, ac on dc, or dc on ac wave forms.

The standard current range is 350 amperes peak ac and dc. Response time is less than 50 microseconds and linearity is better than 2% of full scale. Other models are available to 2,000 amperes and to 100,000 amperes. For more detailed information, please use the inquiry card.

F. W. Bell, Inc.
4949 Freeway Drive East
Columbus, Ohio 43229
614/888-7501



A subsidiary of The Arnold Engineering Company

Circle 238 on reader service card

149

**“We’ll sell
you the best,
lowest priced
132-column
printer
available
anywhere.”**

Bob Howard, President, Centronics

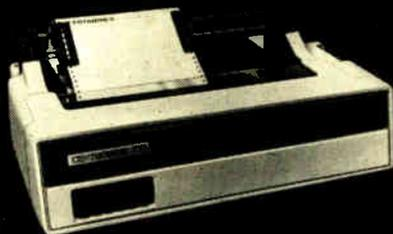

But the low initial price for the Centronics 700 Series 132-column printer isn't the whole story.

It's the lower cost of ownership based on the 700's inherent reliability and simplified construction.

The 700's unique modular construction using four different modules — printing, electronics, forms handling and keyboard — and less moving parts mean easier maintenance, lower cost and a smaller spares inventory.

Write for the full details of this tremendous offer . . . and information on the rest of the printers and teleprinters in the new Centronics 700 Series.

Centronics means more than low price.

And more than hardware. It's the widest range of models, features, options • Financially strong • Proven delivery response • Over 70,000 printers installed • 109 world-wide sales/service locations • Stringent quality control • Advanced R&D and manufacturing • Long-term spare parts availability • Customizing for specific needs.

CENTRONICS IS PRINTERS®

Centronics Data Computer Corp., Hudson, N.H. 03051, Tel. (603) 883-0111, Twx. 710-228-6505, Tlx. 94-3404; Eastern Region: (617) 272-8545 (MA); Central Region: (513) 294-0070, Twx. 810-459-1784 (OH); Western Region: (714) 979-6650, Twx. 910-595-1925 (CA) Centronics Data Computer (Canada) Ltd., Ontario, Tel. (603) 883-0111, Twx. 710-228-6505; Centronics Data Computer (UK) Ltd., Cheam, Surrey, England, Tel. 643 0821-4, Tlx. 851 945756; Centronics Data Computer, GmbH, 6 Frankfurt/Main., West Germany, Tel. 663321/22, Tlx. 841 413224; Centronics of Puerto Rico, Dorado, Puerto Rico, Tel. (809) 796-1881, Tlx. 3859349

NOW AVAILABLE!

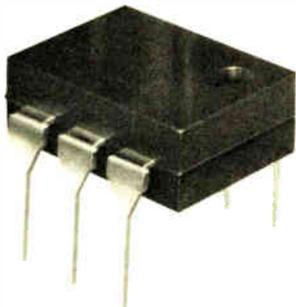

**5KV OPTICAL ISOLATORS
IN 6-PIN DIPs**

Industry's first 5KV isolators to be offered in the popular 6-pin dual in-line package are available now! They are directly interchangeable with standard industrial 6-pin isolators . . . **UL approved . . . No. E58979.** Circle R.S. NO. 239



**STANDARD
OPTICAL SWITCHES**

Six, low-cost off-the-shelf optical switches are available as direct replacements for such popular devices as the H13A1, A2; H13B1, B2; MCA 8, 81 and MCT 8, 81. Both phototransistor and photodarlington versions are available from factory stocks. Circle R.S. NO. 240



**LOW-COST
PHOTODETECTORS
& LEDs**

Spectronics provides industry's largest selection of standard off-the-shelf detectors and LEDs. Direct replacements for such popular industrial types as: LED55CF, BF, B, C; SSL315, 15, 35; TIL31, 81, 23, 24; and TIL601-616 Series. Call today for prices and deliveries. Circle R.S. NO. 152

Call Spectronics for everything you need in opto
We make optoelectronics work . . . for you!



Spectronics
INCORPORATED

830 E. Arapaho, Rd.
Richardson, Texas 75080
(214) 234-4271

New products

Packaging & production

**IC socket takes
chip carriers**

Zero-insertion-force
receptacle burns in
LSI devices up to 220°C

Both parametric testing and accelerated burn-in procedures are musts for expensive LSI chips like microprocessors or large-scale semiconductor memories. Today, a great many of these LSI-chip types are being packaged in small square ceramic chip carriers [*Electronics*, July 22, 1976, p. 98], which make neat space-saving, reflow-solderable, hermetically sealed packages for high-density hybrid applications. But until recently there was no commercially available solderless socket for testing chips mounted on a ceramic carrier. Most users soldered the ceramic substrates, which have gold bumps on their bottom faces, to a motherboard and functionally tested the entire board.

In response to queries from several

large companies for a test or burn-in socket for the square carriers, Robinson Nugent has developed a whole family of sockets that can do this dual job. The photo illustrates the general construction of the new devices. The square ceramic substrate of the carrier is placed in the square cavity of the socket. Then the top lid is snapped shut with the metal piece locking the assembly tight. The substrate is held down tightly on wiping contact springs that mate with the conductive pattern on the carrier. This arrangement makes a zero-insertion-force connection between carrier and socket. Contacts of the cavity are internally connected to solid pins coming out of the bottom of the unit. The pins interface with the outside world.

Body of the new socket is a brown polyphenylene-sulfide glass material. Normal temperature range of the new unit is -65 to +150°C. An optional socket configuration is available for use up to +220°C. According to Don Fleming, vice president of marketing for Robinson Nugent, "More and more users of LSI chips are going in for accelerated high-temperature burn-in of chips on ceramic carriers at up to 220°C. This

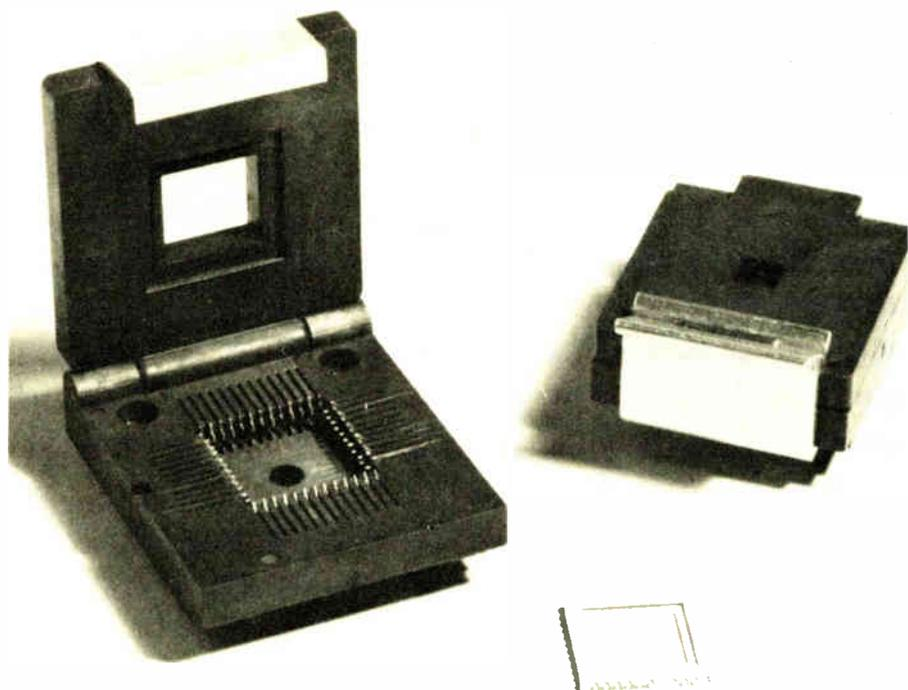

ELEC-TROL REED RELAYS

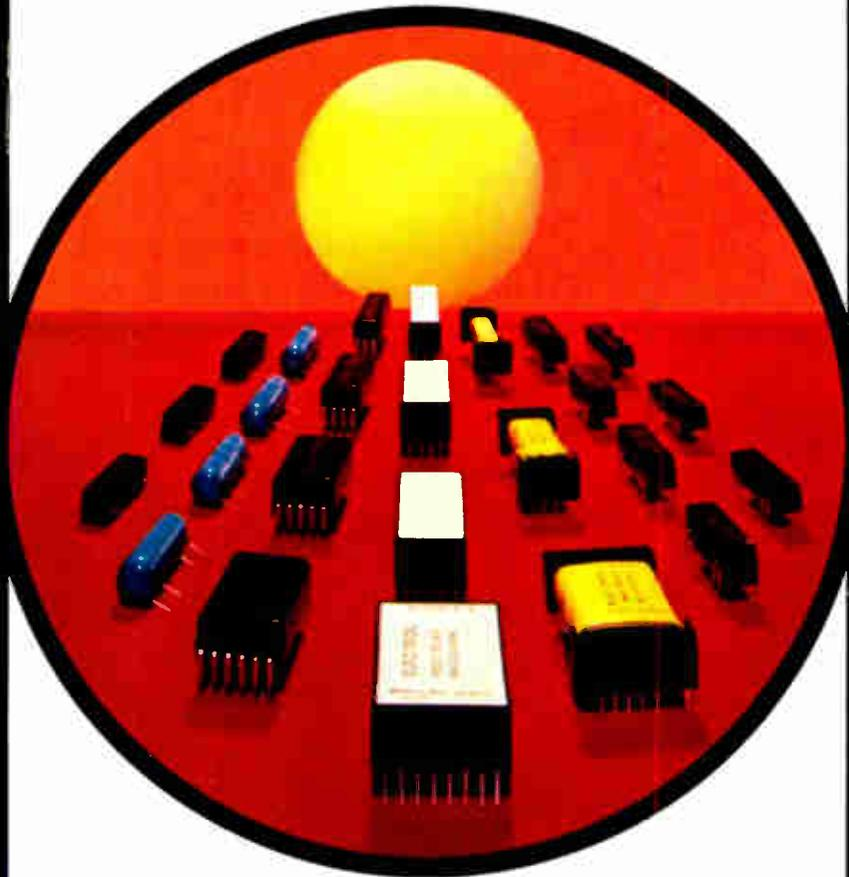

WE'RE NUMBER ONE!

Why does Elec-Trol sell more dry reed relays in the United States than any other manufacturer in the world? Maybe it's because we offer so many packaging styles—like DIP's, Open Lines, Encased-Lines, Molded-Lines, and Blue Boys. Maybe it's the optional features—like magnetic shielding, electrostatic shielding, contact run-ins, and miss-tests. It could be our complete range of contact forms, or perhaps it's our reputation for producing only high-reliability products.

Many of our customers say it's because we're the best single-source for most of their relay requirements—dry and mercury wetted reeds as well as solid state.

One thing for sure—when you specify Elec-Trol, you get better products at down-to-earth prices. For a quick overview of our products, ask for our Short Form Bulletin.

Elec-Trol, Inc., 26477 N. Golden Valley Road, Saugus, CA 91350, (213) 788-7292, (805) 252-8330, TWX 910-336-1556.

ELEC-TROL

ELEC-TROL SOLID STATE RELAYS



MEET SMALLFOOT!

Elec-Trol now offers miniature solid state relays for direct PCB mounting with the smallest "footprint" in the industry—only 1.27 square inches—with switching capability up to 3 amperes at 120 or 240 VAC. They are available with 3-8, 8-18, and 18-32 VDC inputs to minimize input current and operating temperature.

Some of the other features offered by these low-cost solid state units include: zero crossover switching, photo isolation between input and output, total epoxy encapsulation, long life, and immunity to shock and vibration.

With their convenient pin mounting and small footprint, these new solid-state units can be squeezed into tiny spaces on your printed circuit boards for such applications as business machines, air conditioning or traffic controllers, computer peripherals, medical electronics, process control units, automatic test equipment, and automated machine tools.

For more information, use the reader service card. For immediate action, contact your local distributor, representative or the factory direct:

Elec-Trol, Inc., 26477 N. Golden Valley Road, Saugus, CA 91350, (213) 788-7292, (805) 252-8330, TWX 910-336-1556.

ELEC-TROL

Let us show you the drawing power of HP's computer plotters.

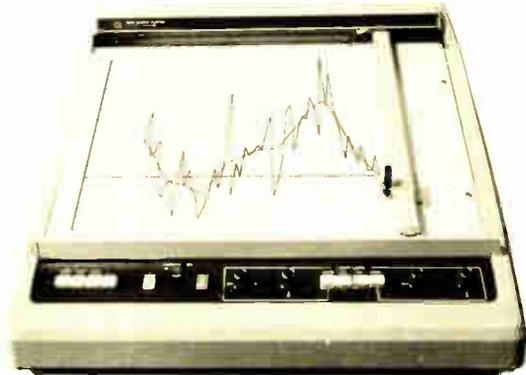

Our Graphic Plotters always draw a crowd when they start to work. Everyone around is quick to notice how the plotter reduces stacks of computer data into meaningful charts and graphs.

The plotters work wonders for electronic and mechanical designers. And sales managers, financial people, researchers, chemists or anyone else who uses data from a computer, time-share terminal or computer-operated measurement system.

With a minimum of software, they let you have graphics for engineering, research, marketing and financial problems. On any size paper up to 11 x 17 inches (28 x 43 cm). In red, blue, green or black.

And prices start at just \$3750 (domestic USA price).

For more information on why HP's Graphic Plotters are a top drawing item, write: Hewlett-Packard, 16399 West Bernardo Drive, San Diego, CA 92127. If you wish, you can have a live demonstration just for the asking. Then draw your own conclusions.

11607

**HP Graphic Plotters. Built for times
when a fine line separates success from failure.**

HEWLETT *hp* PACKARD

Sales and service from 172 offices in 65 countries.
1501 Page Mill Road Palo Alto, California 94304

Circle 154 on reader service card

HOPE in a word is what we are.

Project HOPE exists because there are people with hope—people who have given 3.5 million men, women, and children on four continents the chance for happier, more productive lives through improved health care.

Give to

**PROJECT
HOPE**

Department A
Washington, D. C. 20007

New products

testing weeds out the infant-mortality type of failure.”

Standard socket contacts are beryllium copper while beryllium-nickel contacts are used in the high-temperature version. Sockets with 18 to 64 contacts are available in this series. A typical socket, the 18-pin low-temperature version, costs \$6.12 each in 100-piece lots. The high-temperature versions of this socket cost \$8.40 in the same quantities. Delivery is from stock to 4 weeks depending on type.

Robinson Nugent Inc., 800 East Eighth St., New Albany, Ind. 47150. Phone (812) 945-0211 [391]

Nonmetallic grip fitting provides strain relief

A completely nonmetallic grip fitting, in which a nylon gripper and a neoprene seal are enclosed in a hex-head housing, provides positive-grip strain relief for cables and tubes. Made of high-impact Lexan, the fittings totally isolate the cable from contact with metal. They are oil- and water-tight, and meet the requirements of NEMA 4X. Eight sizes are available, to accommodate cable

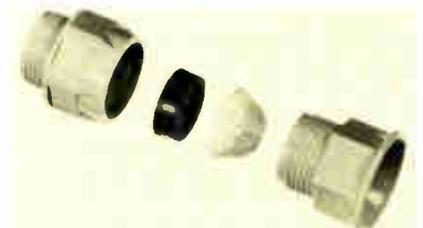

diameters from 0.23 inch to 0.70 in. Rose-Stahlin Enclosures Inc., Belding, Mich. 48809. Phone John Lawther at (616) 794-0700 [394]

Guided-clip/probe system tests logic circuit boards

The Magiclip system is an optional hardware and software package that provides users of the Mirco 6500 test/programming station with a tool that can be used by relatively

VACTEC Photodetectors

The Industry's Broadest Line Provides More Semiconductor Detectors for More Design Applications

Vactec serves manufacturers of a wide range of modern electronic products. Pictured are a few examples. All these devices are both made and sold by Vactec, including complete lines of LDR's (photoconductive cells, CdS and CdSe); silicon solar cells, as well as silicon high speed and blue enhanced cells; NPN phototransistors and darlington's; opto-couplers (LED/LDR, lamp/LDR and neon/LDR); selenium photovoltaic cells; silicon photodiodes, blue enhanced and PIN; and custom C-MOS and bi-polar IC's. Write for technical bulletins on the types that suit your requirements. Or send your application, and Vactec will recommend the right cell for the job.



Vactec, Inc.

2423 Northline Industrial Blvd.
Maryland Heights, Mo. 63043
(314) 872-8300



Electronic Organs

LED or lamp/LDR Vactrols for audio, and CdS cells for swell pedal controls.

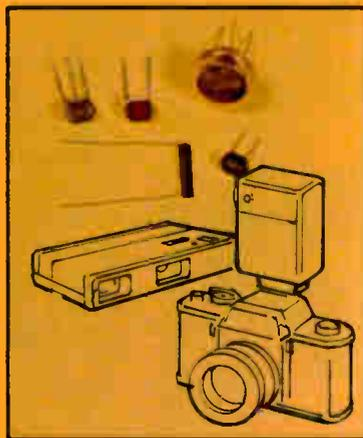

Cameras and Projectors

CdS or blue enhanced silicon photodiodes for automatic shutter timing; aperture servo systems for automatic projector focus, and slave flash controls.

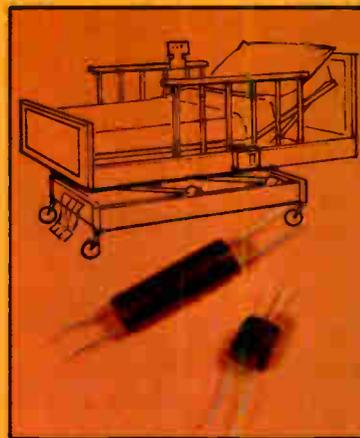

Triac Motor Controls

A special Vactrol gates a triac for forward and reverse motor operation as in hospital beds.



LED Watches

Photoconductive or phototransistor chip controls LED brightness

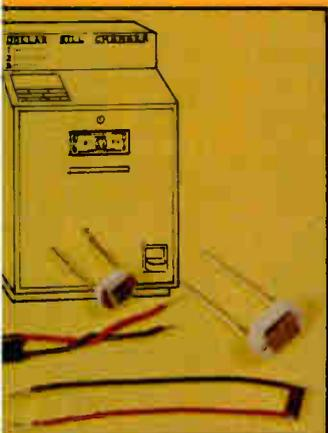

Dollar Bill Changers

Silicon photovoltaic cells analyze optical characteristics.

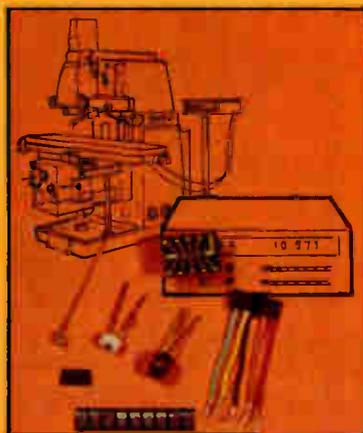

Machine Tool Controls

High-speed photovoltaic cells and transistor arrays help computer control repetitive operations, non-contact sensing, and counting and weighing.



Telephone Equipment

Neon/LDR Vactrols sense ringing. Direct a-c coupling, slow LDR response isolates electronics from noise.

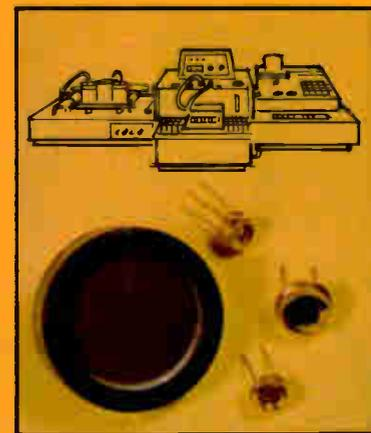

Scientific Instruments

Blue enhanced silicon or selenium photovoltaic cells detect solutions densitometrically for precise blood chemistry and other analyses.

Circle 155 on reader service card

from *Electronic Measurements* . . .

SCR 1 ϕ & 3 ϕ DC Power Supplies

We are pleased to report that we now produce the industry's largest selection of SCR phase-controlled power supplies.

How did we do it?

Slowly.

We didn't acquire the largest selection without selling a lot of power supplies along the way. Our way, for 35 years, has been giving the user what he wants; and in a watts/dollar ratio that gives him no choice but E/M.

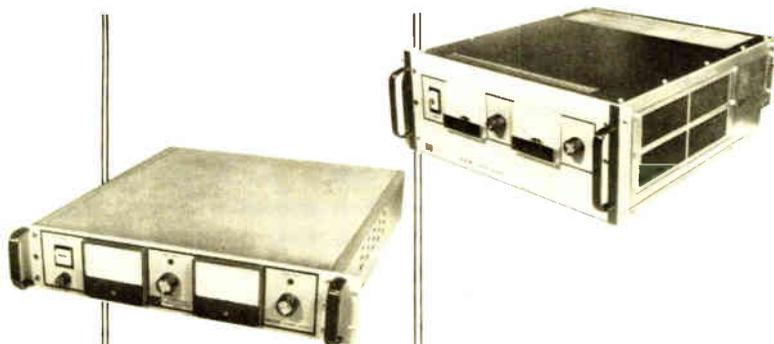

Type	SINGLE PHASE				THREE PHASE			
Watts	500	800	1600	2400	2500	5000	10 KW	To 60 KW
Volts	0 to 7.5 V up to 600 V DC							
Amperes	0 to 0.75 A up to 3000 A DC							
Height (in.)	3.50	3.50	5.25	7.00	7.00	8.75	12.25	To 4'
Price (\$)	450	575	800	1000	1200	1500	2300	To
	to	to	to	to	to	to	to	To
	500	650	895	1100	1600	2300	2900	9500

Over 100 standard models. Thousands of optional combinations.

To order, or for any technical information, call
TOLL FREE (800) 631-4298



ELECTRONIC MEASUREMENTS INC.

405 Essex Road, Neptune, N.J. 07753

Phone (New Jersey) 201-922-9300 (Toll free) 800-631-4298

Specialists in Power Conversion Equipment

New products



unskilled operators to isolate circuit-board faults. System hardware includes a 16-pin IC clip and a single-tip probe. Connected by cable to the 6500 test head, the clip and probe are positioned by the operator in accordance with instructions displayed on a CRT terminal. Both clip and probe are protected against overvoltages to ± 30 volts.

Depending upon other options, a 6500 system with Magiclip sells for from \$40,000 to \$60,000. Delivery time is two to four weeks.

Mirco Inc., Systems Division, 10888 North 19th Ave., Phoenix, Ariz. 85029. Phone (602) 997-5931 [393]

Card-edge connectors are for automated assembly

Designed for automated assembly, series CH card-edge connectors are high-reliability devices designed to be dimensionally and functionally interchangeable with those covered by MIL-C-21097. The connectors have contact tails for printed-circuit-board mounting or wire soldering and are available with 6, 10, 15, 18, 22, 36, or 43 dual positions. Series CH contacts are spaced on 0.156-

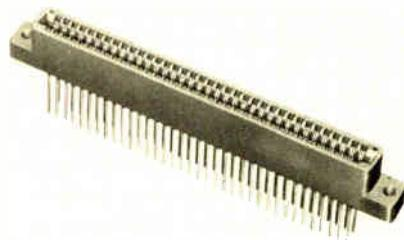

This is the most popular 4¹/₂ digit DMM ever made.

With over 30,000 units in the field, this is the most popular 4¹/₂ digit DMM ever made.

When we first introduced the Model 245 it was immediately recognized as "a revolutionary step in miniaturized instrumentation."

It still is.

Today, more than 30,000 Model 245s later, it is still the world's smallest, lightest and most accurate 4¹/₂ digit portable multi-meter.

It still sells for \$295.00* Complete.

Small enough to fit in the palm of your hand. Big enough to do whatever you want it to do, the Model 245 is a rugged, truly mini-

ature, lab-quality 4¹/₂ digit multi-meter. It measures AC volts, DC volts, AC current, DC current and resistance with .005% resolution and a basic accuracy of $\pm .05\%$ with 100% overranging. Line and battery operation.

For complete information or a demonstration, contact your local Data Precision representative or Data Precision Corporation, Audubon Road, Wakefield, MA. 01880, (617) 246-1600. TELEX (0650) 949341.

*price USA

 DATA PRECISION
...years ahead



For Demonstration circle 157
For Additional Information circle 214

New Clip-Coolers Obsolete Competitive Devices

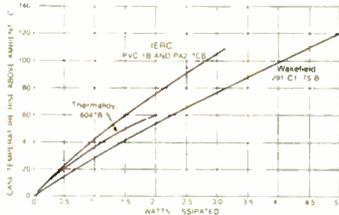
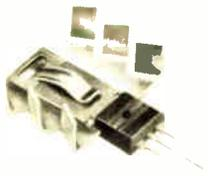

Compare Wakefield's Series 291 Clip-Coolers with similar heat sinks and you'll see why they are unquestionably the best buy.

Up to two times better heat transfer capability than competitive units. Just clip them on. Their one-piece construction needs no special springs or other mounting hardware. Only 4¢ in quantity.

Try one free:

See for yourself. Indicate your specs, then cut out and mail for a free sample.

Height: 36" 75"
Finish: Plain Black Gold
Configuration: TO-202 TO-220

Cut out and mail for a free sample.



WAKEFIELD ENGINEERING INC.

77 AUDUBON ROAD WAKEFIELD, MA 01880 (617) 245-5900
TWX 710 348-6713 AN EG&G COMPANY

Circle 158 on reader service card

New products

inch centers on the circuit card.

Series CM connectors are similar to series CH units except they are spaced on 0.100-inch centers and are supplied with bifurcated simple cantilever terminations. Series CM devices are offered with 15, 22, 36, 43, or 50 dual positions.

Eby Co., 4701 Germantown Ave., Philadelphia, Pa. 19144. Phone (215) 842-3000 [396]

PROM programmer

is low in price

A combination programmer and duplicator for programmable read-only memories, the series 92, consists of a master control unit and a plug-in PROM personality module. The M920 master control unit sells for only \$995, and personality modules range in price from \$350 to \$550.

By itself, the device is only a PROM duplicator. A 20-milliampere current-loop interface is provided for

This counter is different.



What makes Systron-Donner's new 6202B different from other low cost counters? The fact that it can *accurately* measure most of the signals encountered in low frequency applications. Here's why:

- Three-position attenuator: x1, x10, x100. (avoids false counting)
- Offset control allows measurement of *non-sinusoidal* waveforms
- Four selectable gate times from 0.1 Hz to 100 Hz
- 25 mV rms sensitivity
- Advanced input circuitry to assure error-free measurements
- 10 MHz frequency range
- Rugged and reliable
- Only \$295 (U.S. price).

In short, it's a super workhorse counter. It's the one low cost counter you can depend on. Find out more.

SYSTRON  DONNER

10 Systron Drive
Concord, CA 94518. Phone (415) 676-5000



connecting the programmer with a teletypewriter or similar terminal through which it can be commanded to program, list, duplicate, and verify PROMs.

The unit comes in an attaché case and weighs less than 15 pounds with the personality module. Options include an RS-232 interface.

Pro-Log Corp., 2411 Garden Rd., Monterey, Calif. 93940 [397]

Flat-cable system has
from 10 to 60 contacts

A line of insulation-displacement systems, including socket connectors, a variety of flat cable, plugs, and

Our climate is conducive to growth.

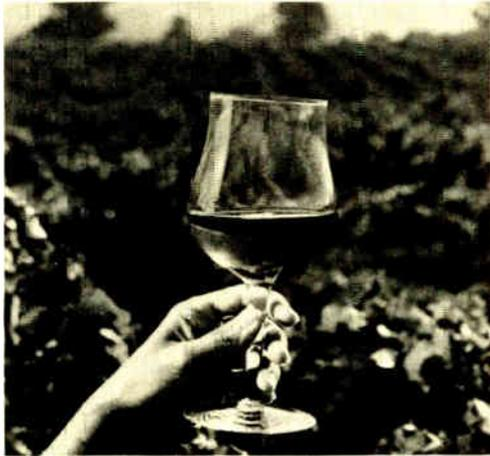

San Jose, California. Known world-wide for our wines, our prunes, and other agricultural products. Because our Mediterranean-like climate makes good things really grow.

And speaking of good growing things—San Jose is the hub of the 31st largest metropolitan area in the country—over 1.2 million people, with an effective buying income of \$16,804—7th highest in the nation. A climate people like for living—in fact, our area was recently rated the 4th best place in the United States to make your home.

But what if you're looking for a new home for your electronics firm?

That's where San Jose really shines.

Our area hosts the largest concentration of high-technology companies in the world, according to Fortune magazine.

And unlike a lot of places, you'll find this is a place that's quite receptive to new business, with policies designed to get you in operation quickly and smoothly.

There's more than just an "open for business" city attitude.

There's also a host of services in our city. Like a centrally-located airport, with connections to the world. Highways and interstates and railroads running everywhere. And only an hour to San Francisco's and Oakland's deep water ports.

There's a highly skilled pool of labor, with thousands more coming into the market every year from our area's superb educational facilities.

There's even the West Coast's newest international Foreign Trade Zone—with duty-free assembly of imported goods.

And most important, there's existing industrial space ready for you to move into, and 5,000 acres of industrial reserve ready for you to build on.

San Jose. A great place for growing things, like families, grapes, prunes, and electronics firms. Look into it today.

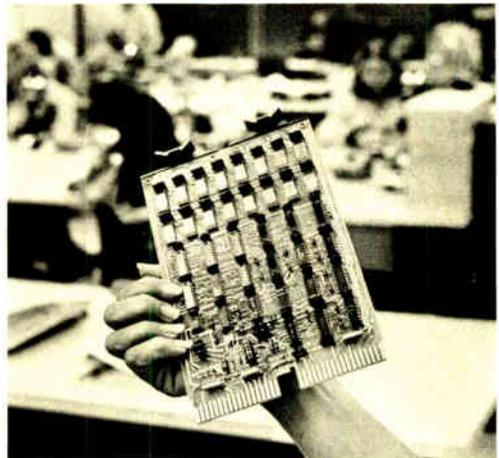

Good Growth/**San Jose**

Good Growth/San Jose. #1 Paseo De San Antonio, San Jose, CA 95113 (408) 998-7000. A joint venture of the San Jose Chamber of Commerce and the City of San Jose. For more information contact us or your Real Estate Broker.

asking about SUBMINIATURE LAMPS?

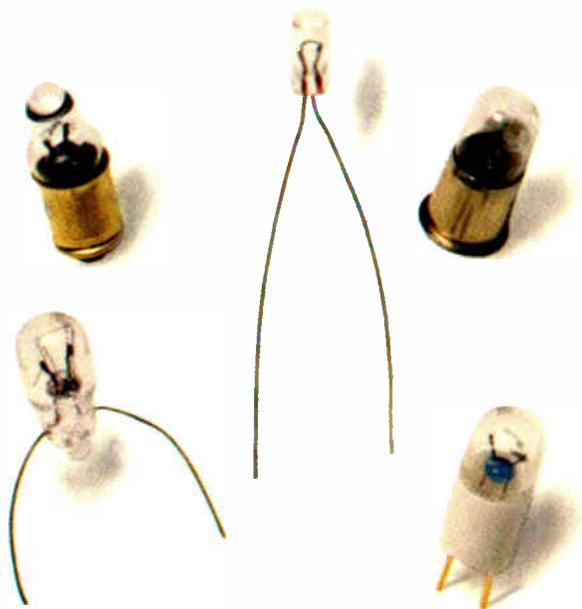

CHICAGO MINIATURE HAS THE ANSWER!

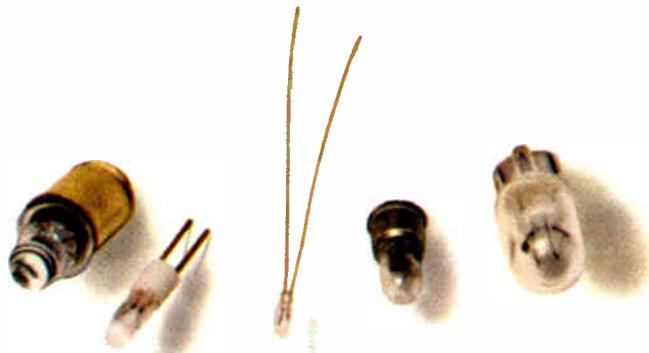

Chicago Miniature has the answer for every subminiature application. All base configurations or wire terminal . . . all colors . . . standard products and specials . . . whatever you need with high quality at competitive prices. There's off-the-shelf delivery on most items from your distributor. For more information, or expert design help, contact Chicago Miniature Lamp Works, 4433 N. Ravenswood Avenue, Chicago, Illinois 60640. Phone (312) 784-1020.

CHICAGO MINIATURE LAMP WORKS

GENERAL INSTRUMENT CORPORATION



New products

arbor presses, allows speedy fabrication of cable assemblies with no need for prestripping the cable insulation. Using the arbor press, the connectors are mass-connected to the cable by means of insulation-piercing tines that wrap around each conductor wire. Available connectors have 10, 14, 16, 20, 26, 34, 40, 50, and 60 contacts. The cables, all of which are spaced on 0.050-inch centers, are offered in twisted-pair, flat-ribbon, and combination types. The cable types are all listed by Underwriters' Laboratories under their component-recognition program.

Circuit Assembly Corp., 3169 Red Hill Ave., Costa Mesa, Calif. 92626. Phone (714) 540-5490 [398]

Universal fixture terminates most flat ribbon cables

A universal fixture for the mass termination of round-conductor ribbon cables can handle plugs with from 10 to 60 contacts. Unlike proprietary units, which handle only certain plugs, the Vector P187 fixture accommodates all female insulation-displacement connectors made by AMP, Alpha, Ansley, Berg, CW, JAE, 3M, SAE, and Vector.

The fixture consists of two aluminum blocks with milled slots to position the plug and a cable guide to align the cable. Spacing washers and stepped surfaces in both the pressure bar and the base accommodate the different vertical dimensions.

The fixture is used in conjunction with an arbor press, which supplies the force needed to seat the cover of the plug body and which Vector supplies in a low-cost version, the P186-1, for \$59.50. But, regardless of what arbor press is used, the fixture always exhibits positive bottoming to eliminate the need for delicate operator feel; one merely pushes on the press handle until it can't be moved any further. Available from stock, the P187 sells for \$29.50.

Vector Electronic Co. Inc., 12460 Gladstone Ave., Sylmar, Calif. 91342. Phone (213) 365-9661 [399]

If memories hold no future for you, come to where the action is.

RAMs and ROMs and P-ROMs are a huge market, and there's the rub. People get lost in the shuffle. Tied to too small an aspect of the job. Technology becomes technique, and soon it's boredom, boredom, boredom. We've all been there in the big semiconductor houses, watching the excitement of the early sixties become the mechanical men of a mature market. Yecch.

We can help. With a scientific based product line that requires a sure technological grasp at every phase of its design, manufacture and marketing. From device design through circuit design, from packaging through test and quality control, from wafer fabrication and applications engineering, in every aspect of our operations, you'll put your hard-won knowledge to work and watch it grow. As you grow. In a company which is big enough to support your ideas and small enough to encourage them. You won't be tied down to a single, repetitive responsibility, either. Our people track their responsibilities through manufacturing, applications, R&D and marketing. Customer contact extends to all members of our teams. We're the leader in a super market, substantial and growing. And one of the few remaining where technology reigns supreme.

You can help. If you've got the goods in any area of semiconductor technology—manufacture, process engineering, applications and circuit design, device design, packaging or marketing—we've got an excellent spot for you. With elbow room. Where your help will count. And be recognized. And rewarded.



For some people, it's too much work. For our kind of technological people, it's the opportunity to work. And see the results. For us, and for themselves. If you're that kind of person, call me or send me your resume. It's time we got together. Communications Transistor Corporation, a wholly owned subsidiary of Varian Associates, 301 Industrial Way, San Carlos, California 94070, (415) 592 9390.

Thomas E. Ciocchetti, President

CTC is hiring design development and applications engineers, process engineers, product engineers, assembly and packaging engineers, test engineers, Q.A., marketing and sales engineers. At all levels. We've grown it well; we're growing stronger.



THE ONLY DISK DRIVES THAT DON'T NEED CLEAN AIR TO BREATHE.

Each Trident disk drive has its own enclosed air filtration system. No other removable-pack disk drives do.

This means you can use a Trident just about anywhere. In a warehouse. Or a factory. Even in a smoke-filled room.

This kind of flexibility is just one reason Trident is the choice of growing businesses everywhere.

You find Tridents on the job in department stores—taking care of inventory control right at the point of sale.

Tridents are at the heart of the reservations systems for major hotel chains.

And Tridents are the continuing choice of the nation's leading OEMs.

NEW! LARGE CAPACITY TRIDENTS.

Now there are two new large capacity Trident disk drives—the T-200 and T-300.

They join the T-25, T-50 and T-80 to give you a wide range of capacities—all the way from 27 to 312 megabytes.

So now, as your needs grow, you have the capacity to meet those needs.

Each Trident model is functionally compatible with every other Trident model.

Each gives you track-following servo-technology. And each gives you one of the lowest cost-per-byte ratios in the industry.

A SOLUTION FOR YOUR PROBLEMS.

At CalComp we've been solving the data problems of growing businesses for years.

If your growing systems business needs

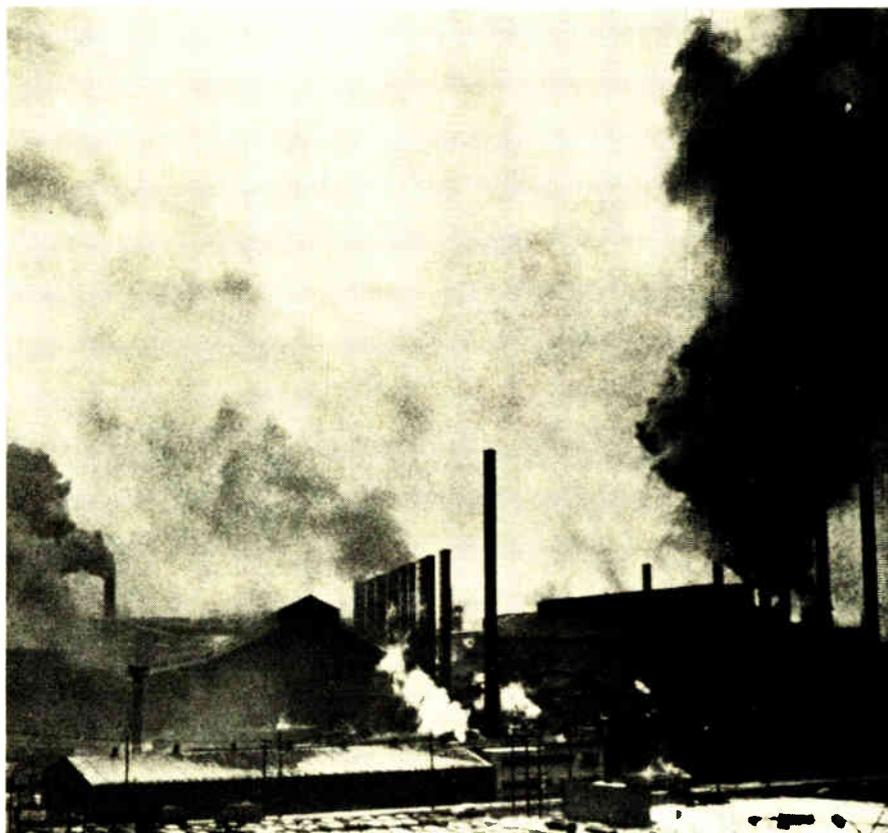

more flexibility, and if you want the experience and expertise that only CalComp can give you, call or write:

California Computer Products, Inc.,
EM-11-76, 2411 West La Palma Avenue,
Anaheim, California 92801. (714) 821-2011.

CALCOMP



New products

Microprocessors

Prototyping system offered

Prompt 80 from Intel is self-contained development service

Microcomputer-system designers can now enter, develop, and save machine-language programs with calculator-like ease on an intelligent programmer for erasable electrically programmable read-only memories (Eproms). The Intel Corp. Microcomputer Systems division says its Intellec Prompt 80 personal programming tool is the industry's first self-contained development service. John Doerr, product manager, says it is a complete self-programming microcomputer based on Intel's widely used SBC 80/10 single-board computer.

The programmer, which supports the design of any 8080 system, allows a user to enter, execute, debug, and save programs easily, much like a programmable desk calculator. Like a programmable calculator, Prompt 80 can be highly personalized by using self-program-

ing to develop new operating routines. These programs can be stored in Eproms provided by Intel and plugged into resident memory.

In addition, Prompt 80 can be used as a microcomputer-system prototyper, a satellite or peripheral of the larger Intellec microcomputer-development system, a production-line Eprom programmer, a programmer/communications terminal for field engineering, or a personal engineering computer, says Doerr.

The designer operates the Prompt 80 by keying in sentence-like command function and data sequences, similar to calculator keying sequences. However, the display panel is large and organized for easy interpretation and modification of instruction flows. As programs are entered or single-stepped, the designer can also check logic operations of the SBC 80/10's 8080A CPU, memory addresses and contents, and programmable input/output ports, Doerr points out.

This technique, which is easier and faster than using a display terminal or teletypewriter, says Doerr, eliminates the need to buy those peripherals or other auxiliary equipment. Programs are entered through a hexadecimal keyboard that also doubles as a hex calculator to speed data conversion. Hex entry allows typical 8080 operations to be

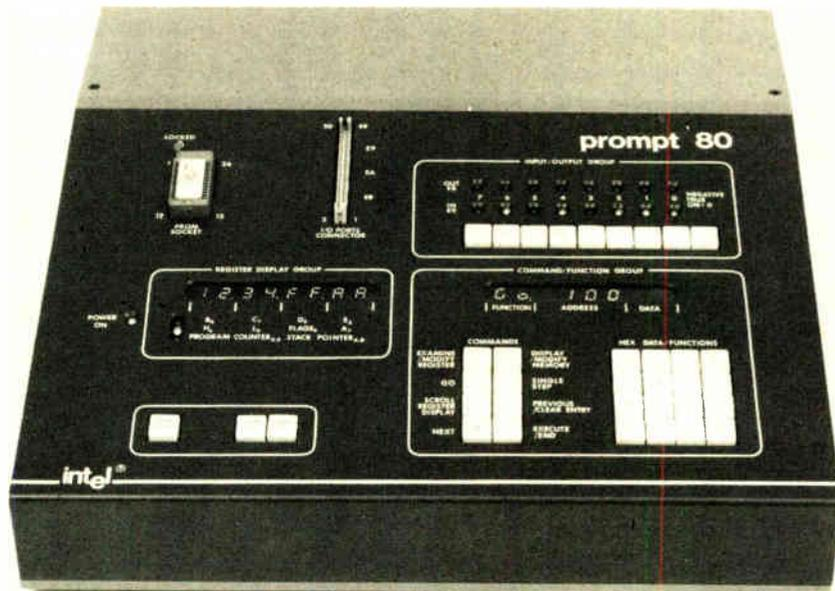

THERMISTORS

OBTAIN STATE-OF-THE-ART PERFORMANCE AT COSTS LOWER THAN YOUR PRESENT COMMERCIAL PRODUCT:

**BEADS
PROBES
FLAKES
RODS
ASSEMBLIES**

FAST RESPONSE ASSEMBLIES (TO 3ms)

HI-TEMP UNITS (TO 450°C)

SPECIAL CURVE MATCHES

0.05% TOLS. AND INTER-CHANGEABILITY

PRECISION CALIBRATIONS

DESIGNED TO MEET MIL-T-23648

QUICK REACTION TO SPECIAL APPLICATIONS AND ASSEMBLIES!

THERMOMETRICS INC.
15 JEAN PLACE
EDISON, N.J. 08817
(201) 548-2299

UNINTERRUPTIBLE POWER SYSTEMS

FROM 700 VA TO 37.5 KVA

- Single Phase & Three Phase
- On Line Systems
- Minimum MTRR
- Maximum MTBF
- Seismic IE Qualified

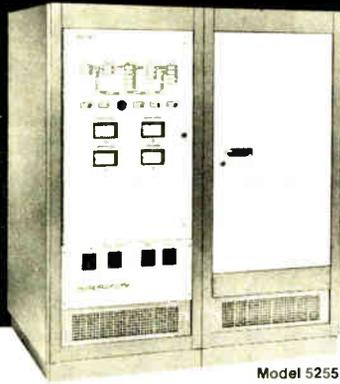

Model 5255
15 KVA

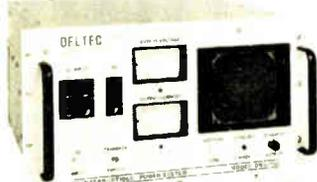

Model DSU-710
700 VA

WRITE FOR FREE POWER SELECTION GUIDE. Deltec has compiled detailed data to assist you in specifying a standard reliable system to meet your application. Installation requirements, including suggestions as to possible methods of maintaining maximum MTBF and MTRR at the most economical price, are also included.

Deltec's standard Uninterruptible Power Systems solve numerous types of power problems - blackouts, brownouts, transients - that cause expensive down time on critical electronic and computer systems. Our on line power equipment is available as standard single systems and as partially or totally redundant component systems. Options include an electronic transfer switch for ultimate reliability and load sharing between redundant systems for no break power, and complete monitoring and control systems for remote indication or other computer control.

Deltec enjoys a growing reputation for producing advanced-designed power conversion systems which meet specific customer requirements. Our equipment is engineered with the users' requirement in mind and that means ease of installation and maintainability by your own local electricians with complete factory support.

DELTEC
CORPORATION

980 Buenos Avenue • San Diego, CA 92110
(714) 275-1331 • TWX 910 335 1241

Circle 164 on reader service card

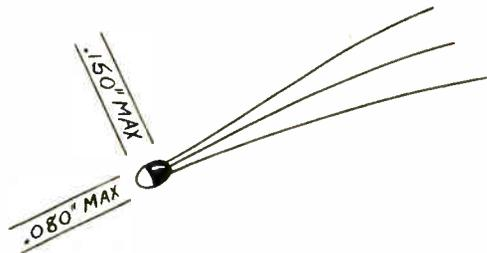

Linear temperature information and thermistor sensitivity, too

Small size, resistance linear to $\pm 0.2\%$, documented long-term stability, $\pm 0.15^\circ\text{C}$ interchangeability, **400 times greater sensitivity than thermocouples.**

These are the advantages you get with YSI Thermilinear® linear thermistors, the easiest to use and least expensive of all sensors for translating -30° to 100°C temperature data for digital readout. They're also great for precision temperature compensation.

Add a simple signal conditioner (YSI Thermivolt® or your own design) and the output is a near perfect linear signal with values as high as $30\text{ mV}/^\circ\text{C}$, or $10\text{ mV}/^\circ\text{C}$ or $^\circ\text{F}$ with **numeric correspondence for direct interface** with DVM's, meters, recorders, computers and similar equipment.

YSI linear thermistors are **the ideal building blocks for sensitive, stable, digital readout systems.** In quantities of 100, \$7.00 each.



Industrial Division
Yellow Springs Instrument Co., Inc.
Yellow Springs, Ohio 45387, U.S.A. • Phone 513-767-7241

New products

specified with only two keystrokes.

"To facilitate debugging, programs can be developed and executed in increments from 16 bytes to 2 kilobytes," he says. Large programs can be developed as modules up to 2 kilobytes, or continuously by expanding resident memory. Intel supplies two 8708 1-kilobyte Eproms that plug into the system, along with ROMs containing system-monitor programs. Also, the company supplies a comprehensive library of tutorial and 8080 system-design material for users who are just beginning to design software.

Doerr expects a high percentage of Prompt-80 users to be designers with little or no experience in micro-computing because surveys indicated that nearly half of all designers now planning to use the SBC 80, system 80, and other 8080 products lack that type of experience.

The Intellec Prompt 80 personal programming tool is available from stock at \$1,495. The price includes complete assembly and testing, two 8708 Eproms, three 8308 ROMs containing system monitor programs, and the design library.

Intel Corp., 3065 Bowers Ave., Santa Clara, Calif. 95051 [401]

Software development tools work on microcomputer

An inexpensive package of software-development tools is designed to ease the generation of programs for the Intel SBC 80/10 microcomputer. The package, called RDP2, includes an editor, an assembler, and a monitor. All are contained on four 2708 programmable read-only memories

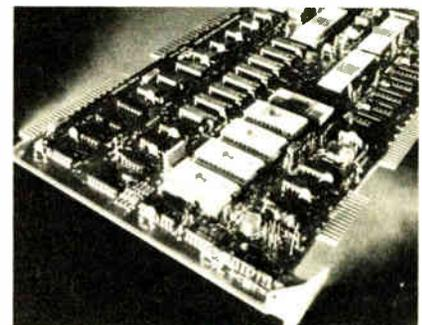

RIGHT ON TARGET AGAIN



Bearing it well!



NEW
FROM
SGS-ATES

Complementary power Darlingtons pairs

4 Amperes - TO 126 package

NPN	PNP
2N 6037	2N 6034
2N 6038	2N 6035
2N 6039	2N 6036
SJE 800	SJE 700
SJE 801	SJE 701
SJE 802	SJE 702
SJE 803	SJE 703

8 Amperes - TO 3 package

NPN	PNP
SJ 1000	SJ 900
SJ 1001	SJ 901
2N 6055	2N 6053
2N 6056	2N 6054

10 Amperes - TO 3 package

SJ 3000	SJ 2500
SJ 3001	SJ 2501

12 Amperes - TC 3 package

2N 6057	2N 6050
2N 6058	2N 6051
2N 6059	2N 6052

8 Amperes - TO 220 package

BDX 53/A/B/C	BDX 54/A/B/C
--------------	--------------

SGS-ATES Semiconductor Corporation - Newtonville, MA, 02160 - 435 Newtonville Avenue - Tel. 617-9691610 - Telex 922482
Stocking Distributors: Edmar Electronics Co., Des Plaines, IL, (312) 298-8580 - Energy Electronic Products, Los Angeles, CA,
(213) 670-7880 - Esce Inc., Dayton, OH, (513) 226-1133 - KA Electronics Sales, Dallas, TX, (214) 634-7870 - Radar Electric Co.,
Seattle, WA, (206) 282-2511 - Re-Coil Electronics Inc., Santa Clara, CA, (408) 984-0400 - Fical Electronic, Santa Ana, CA,
(714) 557-6543 - Sem-ex, Wakefield, MA, (617) 245-9050 - Wishire Electronics, Burlington, MA, (617) 272-8200 - Zeus Components
Inc., Elmford, NY, (914) 592-4120 - Burlington, MA, (617) 273-0750 - Pompano Beach, FL, (305) 942-4312 - Zeus/West Inc.,
San Dimas, CA, (714) 599-8374 - Mexel, Mexico 12, DF, (905) 575-7868 - Preico Electronics Ltd., Montreal 357, Quebec, (514) 389-8051

**SPRAGUE
GOODMAN**

TRIMMER CAPACITORS

Our only business!



PISTONCAP® Multi-Turn Tubular

- Low-Loss, Glass or Quartz
- High Stability/High Reliability
- Simple, Long-Life Adjust Mechanism
- Professional / Military Applications, MIL Approved

CERAMIC Single-Turn

- Compact, Conserves Board Space
- Variety of Mounting Configurations
- Low Cost for Commercial/Industrial Applications

FILMTRIM* Single-Turn Film

- PTFE, Polypropylene, Polycarbonate
- Most Stable Trimmer for Size
- Very Wide Capacitance Ranges
- Low Cost for Commercial/Industrial Applications

*Trade Mark

Tired of broken delivery promises and poor quality? Deal with the trimmer capacitor specialist, for quality products delivered on schedule! Call on us for custom designs too, we deliver!

TRIMMER CAPACITORS — OUR ONLY BUSINESS!

Sprague-Goodman Electronics, Inc.

(An Affiliate of the Sprague Electric Company)

134 FULTON AVE., GARDEN CITY PARK, N.Y. 11040 • 516-746-1385 • TLX:14-4533

Circle 166 on reader service card

33% more power to the people.

Power/Mate presents Econo/Mate II.

The open frame power supply.

Now Power/Mate brings you 33% more power in the same package size with the second generation of our Econo/Mate series.

The size is the same, the basic components are the same for easy interchangeability. But that's where the similarity ends.

Econo/Mate II adds features like dual AC primary and a plug-in IC regulator for improved regulation. And Econo/Mate II is tough.

Computer design, quality control, and Power/Mate's experience helps insure 100,000 hr. MTBF even at this higher power output.

But for all its features, Econo/Mate II is still, most of all, economical.

We wouldn't call it Econo/Mate if it wasn't.

Econo/Mate II is in stock, ready for delivery. Send for our free brochure.

Prices start at \$19.95.

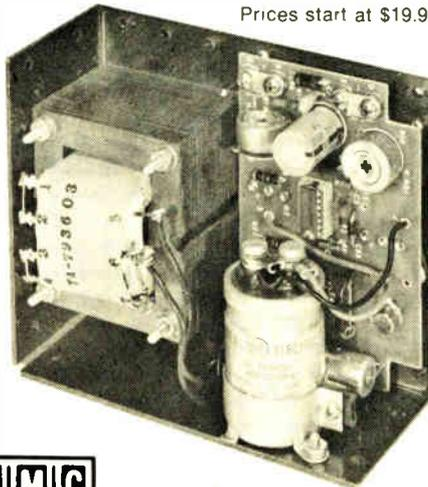

POWER/MATE CORP.

World's largest manufacturer of quality power supplies.

514 South River Street/Hackensack, N.J. 07601 / Phone (201) 343-6294 TWX 710-990-5023

166 Circle 219 on reader service card

New products

that plug directly into the SBC 80/10 board.

The editor aids in the preparation of input tapes. The one-pass assembler translates the assembly-language input tapes into machine code and stores them in the SBC 80/10 memory. The monitor contains functions for software debugging, including tape dumping and loading, storage and register modifications, and selective program execution.

The RDP2 price of \$995 includes the four PROMs, documentation, periodic software updates, and a warranty. Delivery is from stock.

Extensys Corp., 592 Weddell Dr., Suite 3, Sunnyvale, Calif. 94086. Phone (408) 734-1525 [363]

Floppy-disk system operates with SBC 80/10 computer

Designed to operate with Intel's SBC 80/10 single-board computer, the iCOM model FF36-1 floppy-disk system includes a disk drive with daisy-chain capability, an IBM-compatible controller, and all necessary cables and connectors. Also provided is the model 360-56 interface card, including a PROM with interfacing software that plugs into a slot in the Intel SBC card cage. The software includes a macroassembler and a string-oriented text editor. Priced at \$1,495, the disk system has a delivery time of three weeks.

iCOM Inc., 6741 Variel Ave., Canoga Park, Calif. 91303. Phone Terry Zimmerman at (213) 348-1391 [364]

Instrument analyzes any 6800-based microcomputer

The model MPA AO 6800 microprocessor analyzer is a development and debugging instrument that can be connected to any 6800-based microprocessor system without placing any constraints on hardware or software. Among its standard functions are the setting and examining of registers (A and B accumulators, index, stack pointer, condition codes,

Electronics / November 11, 1976

OK, you Power Schottkys, the heat's on. Talk!

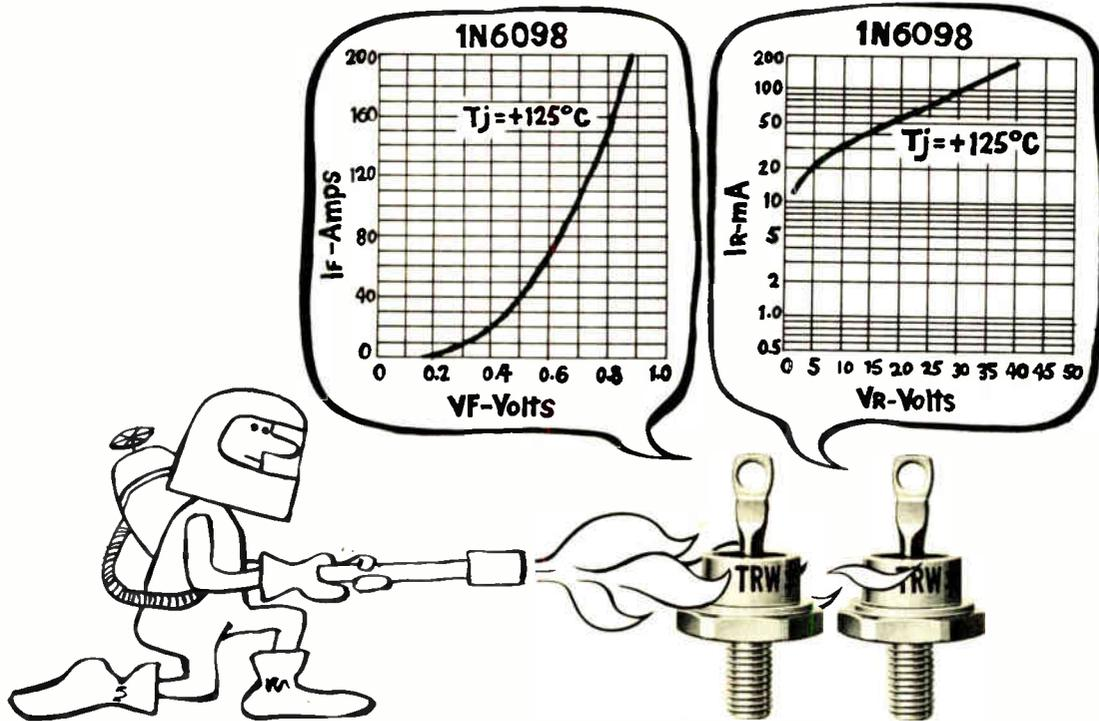

These new TRW Power Schottkys have quite a story to tell and it starts with the fact that they're JEDEC registered. Then they'll tell you that they let you maintain 50 Amps—typically 0.55 Volt forward drop at a Tj of 125° C. The highest operating junction temperatures, lowest reverse leakage typically less than 200mA @ 40V, 125° C, and highest voltages on the market today. (Yet, for all that, they're competitively priced.)

Yes, TRW's Schottky Diodes are now 1N registered. And they're about to be JAN and JANTX qualified.

Let these new Power Schottkys take your heat, try one in your present circuit or in the circuit you're working on, you'll find out they're not just talk.

1N6095	25 AMP	30V	DO-4
1N6096	25 AMP	40V	DO-4
1N6097	50 AMP	30V	DO-5
1N6098	50 AMP	40V	DO-5

If you'd like to hear more about how TRW's Power Schottkys can help you in the design of low-voltage, high-current power supplies, call John Power at (213) 679-4561. Or use the coupon. (These components are available from stock from our distributors.)

TRW Power Semiconductors

An Electronic Components Division of TRW, Inc.,
14520 Aviation Boulevard, Lawndale, California 90260

- Please send me data sheets on TRW's Power Schottky Diodes
- Have a salesman get in touch with me

Name _____

Company Name _____

Position _____

Address _____

City _____

State _____

Zip _____

E

TRW POWER SEMICONDUCTORS

MAGNETIC SHIELDING

MATERIAL

- CO-NETIC AA Alloy
High Permeability
.002" to .100" thick

EXCLUSIVE

Perfection Annealed — No further anneal required if severe forming is avoided.

- NETIC S3-6 Alloy — High Saturation Induction.
.004" to .095" thick
- Immediate Shipment from Stock

SEND FOR NEW MG-3

Material, Application & Fabrication Guide

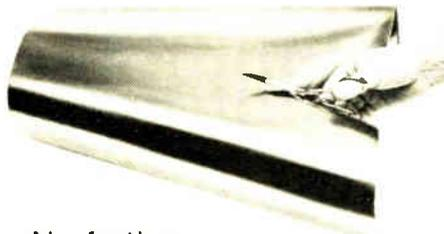

MAGNETIC SHIELD DIV.



PERFECTION MICA CO.

740 N. Thomas Dr.
Bensenville, Ill. 60106
Ph. (312) 766-7800
TWX (910) 256-4815

*The Preferred Source
for Magnetic Shielding*

Circle 168 on reader service card

THE SUNSHINE STATE OFFERS HIGHER PROFIT POTENTIALS TO ELECTRONIC PRODUCTS MANUFACTURERS THAN ELSEWHERE IN THE COUNTRY!

Florida's substantial labor and operating cost advantages, plus ready access to the markets of the United States, Latin America and the world, combine to offer a unique profit opportunity for a Florida-based manufacturer.

Before you make any decisions regarding your business, this new industry study documenting Florida's position should be reviewed carefully.

To get your copy of *Florida Profit Potentials in Electronic Products Manufacturing*, write or call:

FLORIDA
WE'RE MORE THAN SUNSHINE

Joe Hennessy, Director
Division of Economic Development
Florida Department of Commerce
107 W. Gaines Street, Room 103E
Tallahassee, Florida 32304
(904) 488-5507

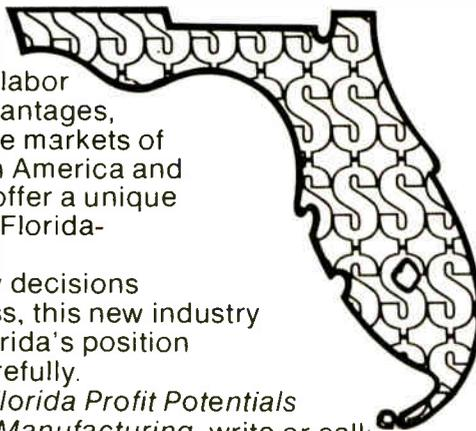

168 Circle 167 on reader service card

New products

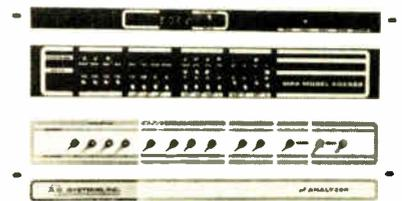

and program counter), examining and depositing data in memory, run/halt control, and single-step control. Readouts are provided to display system status, analyzer status, and the contents of the address bus and the data bus.

A special control function allows the analyzer to simulate the effect of a memory that is slower than the one in the system. An execute control allows the insertion of instructions independent of normal program flow.

The model MPA AO 6800 sells for \$695. It has a delivery time of four weeks.

A O Systems Inc., 1736 Front St., Yorktown Heights, New York 10598. Phone (914) 962-4264 [365]

Interface module generates three-dimensional displays

Designed to interface with standard 8-bit microprocessors, the model 6711 provides a means for storing 256 three-dimensional points in a high-speed recirculating memory. The display-interface module provides three analog output data streams representing each of the three mutually perpendicular deflection axes of a 3-d display.

To the microprocessor, the 6711 appears as a memory location. It connects to the 8-bit data bus or an 8-bit data output port. It requires two address lines plus a strobe or read/write command line. In addition, it sends back an execution bit when it is ready to receive another byte of data. Programs can be furnished for the F-8, 8080A, 6800, 2650, 1802, and SC/MP microprocessors.

The 6711 sells for \$322 in small quantities, dropping to \$261 for 10

STAR PERFORMERS

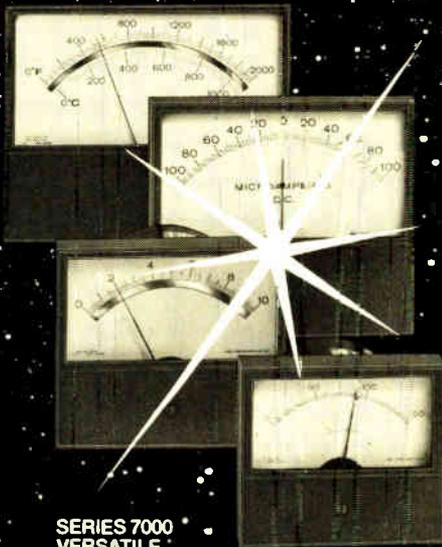

SERIES 7000
VERSATILE

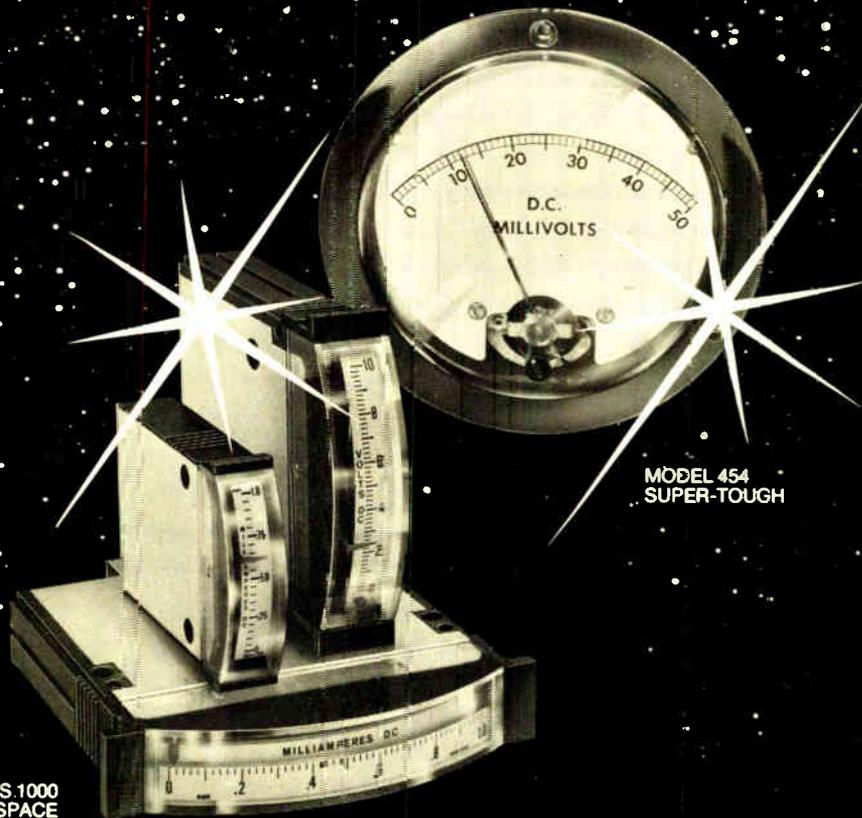

MODEL 454
SUPER-TOUGH

SERIES 1000
SAVES SPACE

api Panel Meters

Get the performance you need — with API panel instruments. Need economy? Small package? Tough case? ½% accuracy? LFE has them all.

VERSATILE: Series 7000 can be panel, lens, or bezel mounted. Slide-out scales facilitate modification.

SAVES SPACE: Series 1000 in 1½", 2½" and 3½" sizes feature rugged polycarbonate case, quick stackable mounting, and famous API quality and styling. Surprisingly economical too.

SUPER-TOUGH: Our new 4½" round Model 454 is an ideal replacement for glass-window instruments in portable, industrial, and plant uses. Its wrap-around polycarbonate case tosses off blows that would destroy lesser meters. Large clear dial for great visibility.

Circle 169 on reader service card

ACCURATE: Nobody makes more precise panel instruments. We start at a standard 2% rating, with 1% tracking for taut-band ranges. We stop at ½% accuracy. You can have anything in between.

There's a LFE distributor or authorized modification center near you to provide quick service on standard or special ranges. Call him. Or call us. We perform. LFE Corporation, Process Control Division, 1601 Trapelo Road, Waltham, Mass., 02154, (617) 890-2000

LFE
CORPORATION

Process Control Division

Reliable AC line filters

Advanced engineering of inductors combined with the unique ceramic capacitor technology acquired from Allen-Bradley offers the reliability your equipment demands. Spectrum power line filters are designed for:

- 125 240VAC @ 125°C 0-400 HERTZ
- Proven Reliability
- Controlled thermal characteristics
- Limited AC voltage rise
- Volumetric efficiency
- Available in C, Pi, L, T
- Mil-F-15733

TYPICAL PARTS	I Amps	Volts AC	Insertion Loss—Db		
			150KHz	10MHz	1GHz
54-367-006	15	125	12	53	65
51-353-112	3	125	13	70	70
51-320-023	1	240	24	70	70

For other ratings—see EFM 1-576 to 1-583

AVAILABLE from stocking distributors

HALL-Mark ELECTRONICS 215-355-7300 MOLTRONICS 213-773-6521
 METUCHEN CAPACITOR 201-442-0500 ROSE ELECTRONICS 415-697-0224

ELECTRO 76 Boston Booths 2624/2626
 IEEE EMC Symposium Wash. D.C. Booths 31/32



SPECTRUM CONTROL INC.
 152 EAST MAIN ST · FAIRVIEW, PENNSYLVANIA 16415



SPECIALISTS IN ELECTRO-MAGNETIC COMPATABILITY

For a complete EMC solution let us test and analyze your equipment.

Circle 170 on reader service card

The Answer Book. It makes your job easier. \$25.

Who makes what? Over 4000 products, 6000 manufacturers with their local contacts, directory of trade names and catalogs, inquiry "bingo" card for 5-second ordering of current catalogs.



Electronics Buyers' Guide
 1221 Ave. of the Americas
 New York, N.Y. 10020

Yes, send me a copy of The Answer Book. I've enclosed \$25 (USA and Canada only, elsewhere send \$35). Full money back guarantee if returned within 10 days.

Name _____
 Company _____
 Street _____
 City _____ State _____ Zip _____

New products

to 29. Delivery is from stock.
 Optical Electronics Inc., P.O. Box 11140,
 Tucson, Ariz. 85734. Phone (602) 624-1283
 [367]

External power supplies cut computer-design problems

By keeping high voltage, heat, and potential interface outside of the product enclosure, an external power supply can reduce some of the more annoying problems associated with designing a microcomputer. Two UL-listed supplies—a desktop unit and one that plugs flat against the wall—convert 120 v ac into regulated dc. Most useful for microprocessor applications is a triple-output version that provides 5 v at 500 milliamperes and ± 12 v at ± 150 mA. Line regulation is to within 3%, load regulation to within 2%. Ripple and noise are 3.5 millivolts rms.

Dynamic Instrument Corp., 933 L.I. Motor Parkway, Hauppauge, N.Y. 11787. Phone (516) 234-2900 [366]

TOPICS

Microprocessors

National Semiconductor Corp., Santa Clara, Calif., is selling its SC/MP kit microcomputer boards in assembled, fully tested form. Priced at \$125 for small quantities, this factory-assembled version of the kit will be known as the SC-8 board (pronounced skateboard)... **General Instrument Microelectronics, Hicksville, N.Y.**, has cut the price of its 16-bit CP1600 microprocessor from \$99 to \$49 for small quantities. Prices were dropped at higher-volume levels, too; for 100 to 499 pieces, for example, the price is down from \$65 to a selling price of \$38.50... **Mostek Corp., Carrollton, Texas**, has announced a three-week turn-around time on its MK 34000 16-kilobyte read-only memory. In thousands, the plastic-packaged version sells for \$13.85, and the ceramic version is priced at \$14.85.

All aerosols are not alike.

The constant progression of sophistication in electronics has demanded a parallel progression in standards of purity. Industrial cleaning is one very vital link in maintaining component and system purity and reliability.

Let's look at eight important criteria and compare Miller-Stephenson products to the general aerosol industrial cleaner industry.

SOLVENTS:

Miller-Stephenson — Most of our aerosols contain 80% Active Ingredient, 20% Propellant.

Other Aerosol Cleaners — Active Ingredient averages 70-75%.

Miller-Stephenson — Uses only Certified Virgin Solvent.

Other Aerosol Cleaners — Some utilize reclaimed solvents. Though lower in cost, reclaimed solvents usually contain foreign substances.

PROPELLANTS:

Miller-Stephenson — Uses only the highest purity, safest propellants. They are nonflammable - TWA 1000 ppm.

Other Aerosol Cleaners — Many use cheap, sometimes flammable, sometimes higher order of toxicity propellants.



FILTERING:

Miller-Stephenson — We double filter "Freon" solvent and propellant — first with a 0.5 micron filter, then with a Millipore 0.2 absolute filter.

Other Aerosol Cleaners — Some use no filters; others only a 0.5 micron filter.

LOADING LINES:

Miller-Stephenson — All loading lines are dedicated to the individual ingredients used.

Other Aerosol Cleaners — Loading lines are often used for multiple products and if not thoroughly flushed, contamination will occur.

LOADING ENVIRONMENT:

Miller-Stephenson — Class 100 Clean Room conditions.
Other Aerosol Cleaners — Normally uncontrolled — environmental contamination can occur.

VOLUME PRODUCTION:

Miller-Stephenson — Our principal raw materials come direct from Du Pont tankers into our 5500 gallon storage tanks through a closed system direct to container.

Other Aerosol Cleaners — Low volume suppliers often load from open 55-gallon drums thereby introducing possibility of contamination.

CONTAINER:

Miller-Stephenson — Our new seamless cans further reduce the possibility of contamination.

Other Aerosol Cleaners — Cans with soldered seams may introduce residual contaminants.

SAFETY IN SHIPPING:

Miller-Stephenson — Most of our "Freon" aerosol solvents are non-regulated items, exempt from all Federal Regulations "Restricted Articles". May be Shipped Air Transport.

Other Aerosol Cleaners — Do not meet Air Transport Regulations.

MS aerosol solvents have the lowest residual contamination in the industry — some approaching 5-7 ppm. The general range for the industry is 50-130 ppm.

"Freon" is Du Pont's registered trademark for its fluorocarbon compounds.

miller-stephenson

E-11U

Danbury, Connecticut 06810 (203) 743-4447

- Enclosed is \$2.00, please send my "Trial Unit" of MS-180.
 Enclosed is \$5.00, please send my "Trial Units" of MS-180 & Cobra Brush.
 Please send FREE literature and prices.

Intended Use _____

Name _____ Dept./Title _____

Company _____

Address _____

LOS ANGELES • CHICAGO • DANBURY, CT. • TORONTO

Circle 171 on reader service card

World Radio History



**Monolithic capacitors have been
our business for nearly three decades.**

We build them better.

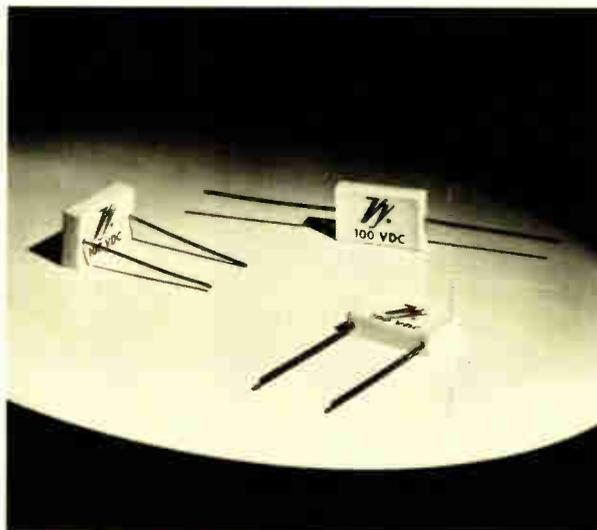
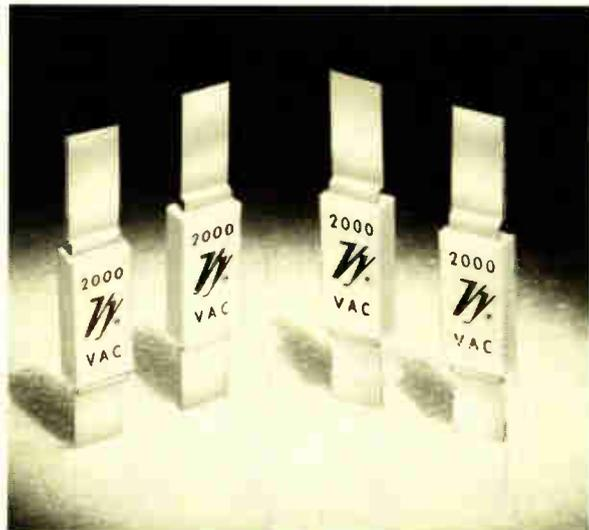

V[®] Porcelain Capacitors: first then and now.

Vitramon, Incorporated was the first company to offer monolithic capacitors when we introduced the porcelain dielectric back in 1948.

In those days, 'VY' Porcelain Capacitors were the most stable available. Today — 28 years later — our 29 styles of porcelain capacitors are still among the most stable components offered.

For nearly three decades, they've proven they can operate efficiently where the word critical is routine: in spacecraft, missiles and high-frequency microwave equipment.

'VY' Porcelain Capacitors are available for many special purposes. For example, our VY

87 High Current parts have ratings of 2000 Vac and 10 Amps RF. The High Voltage series operates at 2500 Vdc — and the 'THIN LINE' components feature axial, radial and edge-radial configurations.

If you're looking for established reliability, we offer CYR and CY parts approved to MIL-C-23269 and MIL-C-11272 — backed by millions of test hours.

In short, we're building porcelain capacitors better today than ever before — and we deliver what we offer.

Please call us for more details: (203) 268-6261.



Vitramon[®]

**Vitramon North America
Division of Vitramon, Incorporated
Box 544, Bridgeport, Conn. 06601**

Subsidiaries: Vitramon Limited (London) • Vitramon GmbH (Stuttgart) • Vitramon France S.A.R.L. (Paris) • Vitramon Pty. Limited (Sydney) • Vitramon Japan Limited (Tokyo)

New products

Subassemblies

Hybrid pair resolves 14 bits

Complete converter
for synchro inputs
fits in two 36-pin DIPs

Only about two years have gone by since synchro-to-digital converters were first reduced from large boards to compact modules. Yet already they have shrunk from modules to hybrid versions, supplied in dual in-line packages that are compatible with integrated circuits.

The latest entry to hit the marketplace is a pair of thick-film hybrids from ILC Data Device Corp. Together they form a complete 14-bit tracking synchro-to-digital converter that even includes its own solid-state input transformer. One package serves as the control transformer, while the other package is the data processor.

Because it is built with complementary-MOS logic, the model HSDC-14 converter set holds power consumption to a minimum—only 750 milliwatts for either package.

Accuracy, including quantizing error, is maintained within ± 4 minutes under all static and dynamic conditions, as well as over the full operating temperature range and for speeds of up to ± 10 revolutions per second at 400 hertz.

The HSDC-14 accepts broadband inputs of 360 to 1,000 Hz or 47 to 1,000 Hz. The output angle, which is coded as natural-binary parallel positive logic, is compatible with both C-MOS and transistor-transistor-logic circuitry. Also, the unit can be easily synchronized to a computer system via its output BUSY line and its input INHIBIT line.

Standard input options include all the normal three-wire synchro and four-wire resolver formats. What's more, says a company spokesman, separate input-isolation transformers are seldom required because the unit's solid-state signal and reference inputs are truly differential, with high common-mode rejection.

Supplied in two 36-pin DIPs, the converter set is processed to level C of MIL-STD-883, with level-B processing available on special order. All models are completely calibrated at the factory, so field adjustments are not necessary. Operating temperature range can be -55°C to $+125^{\circ}\text{C}$ or 0°C to 70°C .

The complete two-DIP set sells for

The greatest invention since the thumb and the wheel:

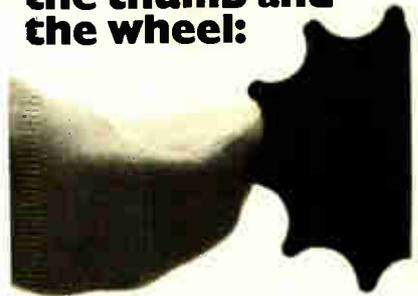

C&K's miniature Thumbwheel Switch!

Available in either front or rear-mounting models, C&K's miniature Thumbwheel is uniquely adaptable: each section is a switch by itself, or the sections can be easily stacked together—three, five, ten, or whatever—to handle the most complex switching requirement! Front-mounting model is only .315" (8.00 mm) wide and rear-mounting is .350" (8.9 mm) wide. Each section has a 10-position switch wheel with digits or optional symbols in your choice of 6 designer coordinated mix-and-match colors—black, gray, yellow, red, white or blue. The switch body is either matte black or gray. An 11-position switch including "off" is also available. For all the colorful details, make contact with C&K today!

Free Engineering
Samples on
Request

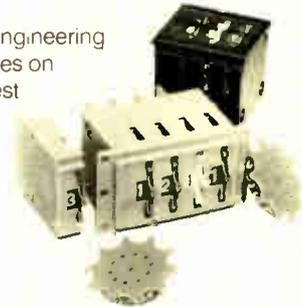

C&K Components, Inc.

103 Morse Street, Watertown, MA 02172,
U.S.A. Tel: (617) 926-0800
TWX: 710 327 0460 TELEX: 92 2546

IN EUROPE:

BELGIUM

C&K Benelux
Schuttersvest 44, Mechelen
Tel: 015-419868

FRANCE

C&K Composants S.A.
60 Rue Du Dessous Des Berges
75013 Paris
Tel: 5832454 Telex: 204317

GERMANY WEST

C&K Germany GMBH
8021 Neuried Munchen Gautinger Str. 2
Tel: 089 7557171 Telex: 5213068

ITALY

C&K Components S.F.A.
Via Frapolli 21, 20133 Milano
PH: (02) 719371-7386165

NETHERLANDS

C&K Benelux
Arnhemseboulevard 40, Driebergen
Tel: (03438) 2332 Telex: 40519

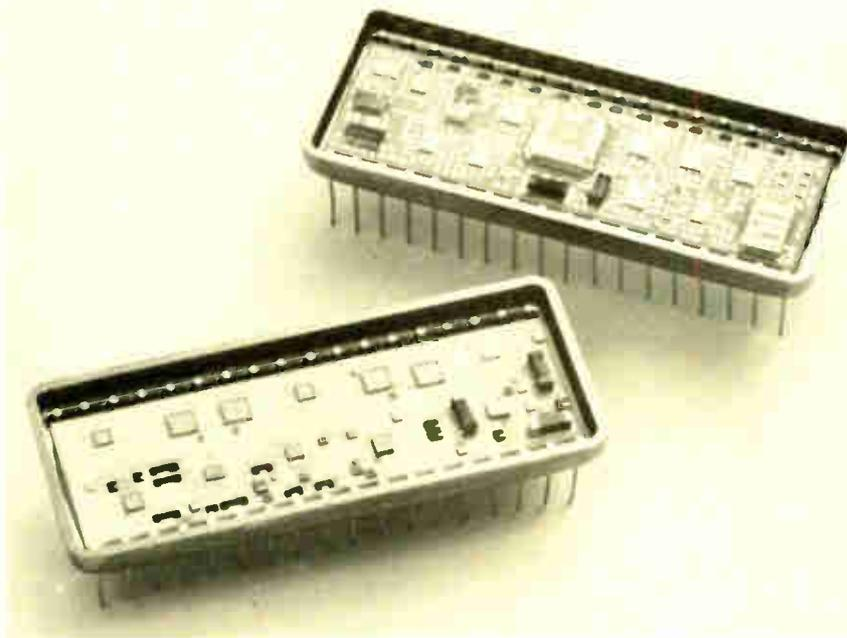

when you need it NOW

call National



and ten different terminal styles. Custom designs are no problem either. So whenever you need terminals or connectors of any kind, call National.

Take barrier blocks. We can deliver up to 400 standard variations right off the shelf.

High quality, double row blocks in $\frac{3}{8}$ " or $\frac{7}{16}$ " pitch

Write for our free barrier blocks brochure.

Circle 174 on readerservice card

nti
NATIONAL
TEL + TRONICS

Circle 174 on readerservice card

ERASE EPROMS IN MINUTES . . .

Why Wait?

Completely erase your EPROMs fast and efficiently . . . in minutes! Two high intensity systems provide powerful ultraviolet energy. Designed especially for EPROM erasing, they're the UV sources recommended by EPROM manufacturers and users.



The S-52T is the fastest, most powerful UV erasing system. The UVS-54T is a versatile, economical system. Both are equipped with a stand and timer, or can be hand held for on-the-spot erasing.

Call your authorized UVP EPROM lamp dealer today, or write the factory for additional information.

ULTRA-VIOLET PRODUCTS, INC. 
5100 Walnut Grove Ave. • San Gabriel, CA 91778

Circle 220 on reader service card

World Radio History

New products

\$495 to \$795, depending on the configuration, temperature range, and processing selected. Delivery time is within 60 days after receipt of order.

ILC Data Device Corp., Subsidiary of ILC Industries Inc., Airport International Plaza, Bohemia, N.Y. 11716. Phone (516) 228-7324 [381]

Dual-output dc-dc converters are housed in 24-pin DIPs

A series of dual-output dc-to-dc converters, designed to power operational amplifiers, microprocessors, and devices with similar requirements, comes housed in a 24-pin dual in-line package. The four devices in the series accept either a 5-volt input or a 12-v input and put out either ± 12 v or $+12$ v and -5 v. Output ripple is only 30 millivolts peak to peak over the band

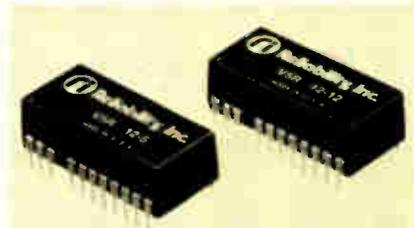

from 20 hertz to 20 megahertz. Line and load regulation are to within 0.3%, and efficiency is typically 65%.

The converters, which have a maximum power rating of 1 watt, sell for \$38.20 each in small quantities. Small lots are available from stock.

Reliability Inc., 5325 Glenmont, Houston, Texas 77036. Phone (713) 666-3261 [383]

Hybrid voltage regulator delivers 5 A at 5 V

Housed in a standard TO-3 package, a hybrid voltage regulator with built-in short-circuit protection delivers up to 5 amperes at 5 volts dc. The model 78H05KC regulator subsystem also has automatic thermal

Electronics / November 11, 1976

Logic Probe 1 is a compact, enormously versatile design, test and troubleshooting tool for all types of digital applications. By simply connecting the clip leads to the circuit's power supply, setting a switch to the proper logic family and touching the probe tip to the node under test, you get an instant picture of circuit conditions.

LP-1's unique circuitry—which combines the functions of level detector, pulse detector, pulse stretcher and memory—makes one-shot, low-rep-rate, narrow pulses—nearly impossible to see, even with a fast scope—easily detectable and visible. HI LED indicates logic "1", LO LED, logic "0", and all pulse transitions—positive and negative as narrow as 50 nanoseconds—are stretched to 1/3 second and displayed on the PULSE LED.

By setting the PULSE/MEMORY switch to MEMORY, single-shot events as well as low-rep-rate events can be stored indefinitely.

While high-frequency (5-10MHz) signals cause the "pulse" LED to blink at a 3Hz rate, there is an additional indication with unsymmetrical pulses: with duty cycles of less than 30%, the LO LED will light, while duty cycles over 70% will light the HI LED.

In all modes, high input impedance (100K) virtually eliminates loading problems, and impedance is constant for all states. LP-1 also features over-voltage and reverse-polarity protection. Housed in a rugged, high-impact plastic case with strain-relieved power cables, it's built to provide reliable day-in, day-out service for years to come.

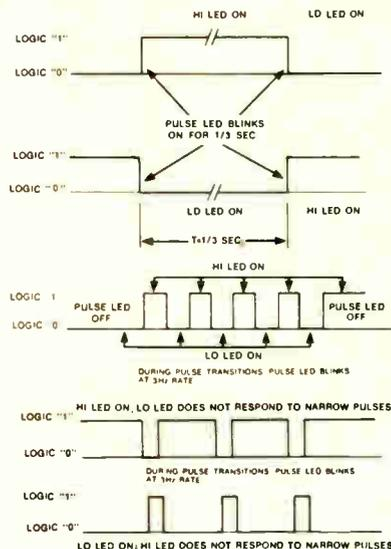

CSC'S MULTI-FAMILY LOGIC PROBE 1. AT \$44.95, IT DIGS UP A LOT OF INFORMATION WITHOUT BURYING YOUR BUDGET.

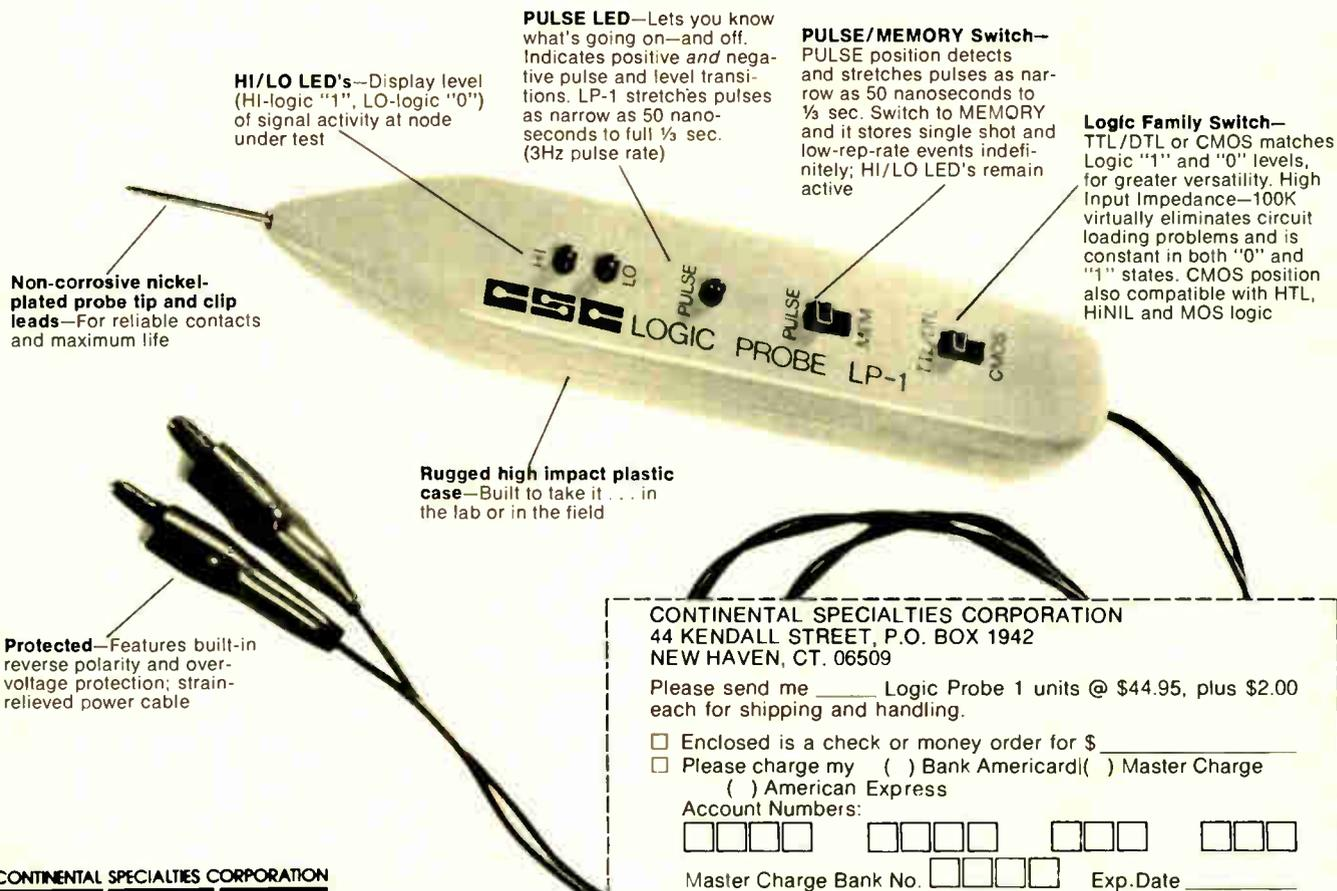

CONTINENTAL SPECIALTIES CORPORATION
44 KENDALL STREET, P.O. BOX 1942
NEW HAVEN, CT. 06509

Please send me _____ Logic Probe 1 units @ \$44.95, plus \$2.00 each for shipping and handling.

Enclosed is a check or money order for \$ _____
 Please charge my () Bank Americard/() Master Charge
 () American Express

Account Numbers:

Master Charge Bank No. Exp. Date _____

Signature _____
 Name (please print) _____
 Address _____
 City/State/Zip _____

CONTINENTAL SPECIALTIES CORPORATION

EASY DOES IT
 44 Kendall St., Box 1942 New Haven, CT 06509
 TWX: 710-465-1227
 West Coast office: Box 7809, San Francisco, CA 94119
 TWX: 910-372-7992

FOR FASTEST SERVICE, TELEPHONE 9-5 LOCAL TIME:
EAST COAST (New Haven) 203-624-3103 / WEST COAST (San Francisco) 415-421-8872

It's faster, easier and less expensive. That's why we call it Super-Strip.

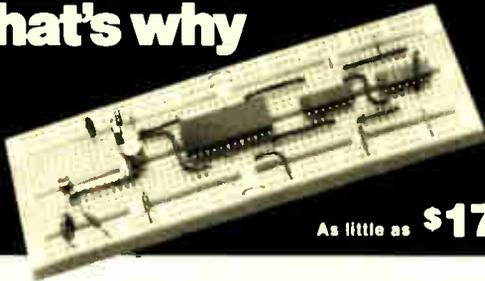

As little as \$17

This versatile mini breadboard features the same superior contacts, materials and construction we use in our full-scale ACE All Circuit Evaluators. Any solid hookup wire up to #20 plugs right in to connect DIPs, discretes and almost any components you have on hand. Super-Strip gives you 128 separate five-tie-point terminals in the circuit building matrix and 8 power and signal distribution lines — enough capacity to build circuits with as many as nine 14-pin DIPs. And when you're done with your hookup, just pull it apart — everything's as good as new. Super-Strips come with your choice of nickel-silver or gold-plated terminals. Plus an instant-mount backing and quick-removal screws for fast and easy stacking or racking. Heard enough? Then stop looking and start cooking with A P Products Super-Strips.

Part Number	Model Number	Terminal Type	Price Each
923252	SS-2	nickel-silver	\$17.00
923748	SS-1	gold-plated	\$18.90

Orders subject to acceptance at factory.
Company PD's FDB Painesville. No CDD Orders.



A P PRODUCTS INCORPORATED

Box 110-E Painesville, OH 44077 (216) 354-2101 TWX: 810-425-2250

For quick phone service, call the A P distributor nearest you:

(201) 224-8032	(513) 236-9900
(206) 682-5025	(516) 483-9200
(213) 768-3800	(516) 883-0999
(213) 875-2862	(914) 664-0088
(215) 698-4000	(602) 277-7661
(216) 441-3000	(612) 488-0201
(216) 587-3600	(617) 273-1860
(312) 298-8580	(617) 879-0860
(313) 525-1800	(713) 350-6771
(314) 863-7800	(713) 777-1666
(412) 782-2300	(714) 549-8611
(415) 326-5432	(714) 560-0515
(415) 969-9240	(803) 253-5333

Our Distributor List is growing daily. If none in your area call Toll Free 800-321-9668.

Circle 31 on reader service card

New products

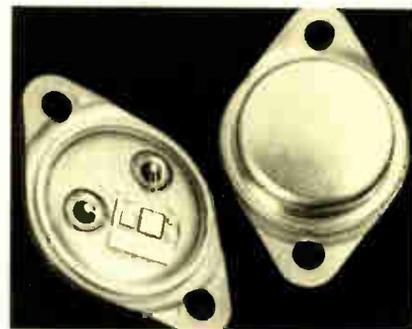

overload protection. If the junction of the power output transistor gets too hot, the regulator simply shuts down before it damages itself or any other system components. The 78H05KC is available from stock.

Automotive-Hybrid Products, Analog Products Division, Fairchild Camera and Instrument Corp., 464 Ellis St., Mountain View, Calif. 94042. Phone Bill Callahan at (415) 962-3816 [384]

Sine/cosine converter has 14-bit resolution

The SCMI677 sine/cosine converter is a completely digital module that accepts digital inputs representing angles from 0° to 360° and produces digital outputs representing either the sine or the cosine of the input angle. The input information is a 14-bit binary number while the output is a 12-bit binary number plus a polarity bit. The outputs may be switched from sine to cosine by changing the state of a programing pin.

Although designed for radar display systems, the converter is also useful in computer hardware for applications in which its speed

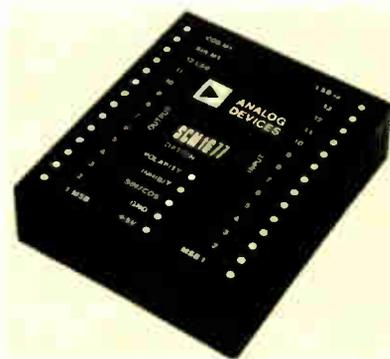

Electronics/November 11, 1976

RF PACKAGES — MICROWAVE SYSTEMS

AUTOTRACK ANTENNA SCR-584 RADAR SYSTEM

360 deg AZ 210 deg EL 1 mil accuracy Missile vel accel and slew rates. Amplifine control. Handle up to 20 ft dish. Compl control chassis. AI SO in stock 10 cm scan mounted rad. system. Conical scan PPI 6 ft dish. 300 pg. instr. bk. on radar \$25



RF SOURCES

CW: 300-535KHz 500W; 2-30MHz 3KW; 4-21MHz 40KW; 24-350MHz 100W; 385-585MHz 1KW; 750-985MHz 10KW; 95-8.8GHz 150W; 1-1.5GHz 110W; 1.7-2.4GHz 10KW; 4-4.5GHz 1KW; 8-11GHz 200W. Many more.

UHF: 1 Megawatt 210-225MHz 5μsec 180 PPS. 14KW 400-420MHz 0002DC. 1KW 400-700MHz 002DC
L BAND: 1KW 1-1.5GHz 1DC. 500KW 1.2-1.35GHz 2μsec 400PPS. Many more. Phone or write
S BAND: 1KW 2.4-2.6GHz 75μsec 1200PPS. 250KW 2.7-3.1GHz 8μsec 1600PPS. 500KW 2.7-3.1GHz 1200PPS. 5 Megawatt 2.7-2.9GHz 1μsec
C BAND: 225KW 6.275-6.575MHz 4μsec 680PPS. 250KW 5.4-5.8GHz 5μsec 680PPS. 1 Megawatt 6GHz 1μsec 1000PPS. 10 Megawatt 5.4-5.8GHz 5-10 μs 400 PPS.
X BAND: 100W 9.2-9.5GHz 5μsec 1000PPS. 1 KW 8.9-9.4GHz 001DC. 65KW 8.5-9.6GHz 001DC. 250KW 8.5-9.6GHz 001DC. 400KW 9.1 GHz 1.8μsec 450PPS. Many more. Phone or write
Ku-K BAND: 50KW 16.4-16.6GHz 001DC. 135KW 15.5-17.5GHz 0006DC. 40KW 24GHz 0007DC. 40KW 35GHz 0004DC. Many more. Phone or write

PULSE MODULATORS + H.V.P.S.

245 KW LINE Output 16 KV 16 A. 25 μs 4000 PPS.
405 KW FLOATING DECK Output 20 KV 20 A 1 μs to 10 millisecond pulse
500 KW LINE Output 22 KV 28 A. 4/1.75/2.25 μs 2500/550/300 PPS.
1 MW HARDTUBE MIT MODEL 9 Output 25 KV at 40 A. 25 μs 002 D.C.
2.0 MW LINE 30 KV 70 A. 1/2 μs 600/300 PPS.
3 MW LINE Output 39 KV 75 A. 25/1 μs 500 PPS.
10 MW LINE 76 KV 135 A. 2.5 μs 350 PPS.
17 MW LINE 17 KV 1000 A. 2.5 μs 150-2000 PPS.
66 MW LINE 160 KV 400 A. 5-10 μs 400 PPS.

SEND FOR FREE 20 PG. CATALOG

AN/MPS-19 S Band Tracker

Pwr: 500 KW. Range: 100 miles. Display: PPI and "A" scopes. 8' dish. Helibut mounted.

RADAR SYSTEMS

K BAND MONOPULSE 40KW E-34
KU BAND SEARCH 135KW B-58
X BAND MISSILE CONTROL NIKE AJAX/HERC
X BAND HI-RES. MONOPULSE TRACKER
X BAND FIRE CONTROL 250KW M-33
X BAND WEATHER/SEARCH 250KW AN/CPS-9
X BAND AIRBORNE TRACKER 50KW B-47
X BAND MOBILE TRACKER 40KW AN/MPQ-29
X BAND WEATHER/SEARCH 40KW AN/SPN-5
X BAND ANTI-INTRUSION 7 KW AN/TPS-21
X BAND ANTI-INTRUSION CW DOPPLER AN/PPS-9/12
X BAND TRANSPONDER 100W AN/DPN-62
C BAND HGT. FDR. 5MW FPS-26. 1MW TPS-37
C BAND SEARCH 285KW AN/SPS-5B/D
S BAND HEIGHT FINDER 5MW AN/FPS-6
S BAND SEARCH COHERENT 1MW AN/FPS-18
S BAND ACQUISITION 1MW NIKE AJAX/HERC
S BAND TRACKER 10' DISH 500KW AN/MPQ-18
S BAND MORTAR LOCATOR 250KW AN/MPQ-10A
S BAND TRACKER 250KW AN/MPS-9
L BAND SEARCH 40' ANTENNA 500KW AN/FPS-75
L BAND SEARCH 500KW AN/TPS-1D/GSS-1
UHF SEARCH 1MW TPS-28

DRONE CONTROL SYSTEMS

UHF COMMAND SYSTEM AN/URW-14
X BAND DATA LINK AN/UPW-1
X BAND TRACKER AN/MPQ-29
X BAND TRACKER AN/MSQ-51

60 FT. DISH

Complete with Az-El pedestal, ready for installation. Immed. delivery. Write or call.

SPARE PARTS IN STOCK

Nike Ajax, Nike Hercules, M-33, MPS-19, TPS-1D, TPS-10D, FPS-6, SPS8, SCR-584, HIPAR. Many more, write.



Radio Research Instrument Co., Inc.
2 LAKE AVE. EXTENSION, DANBURY, CT. 06810
203-792-6666

Circle 176 on reader service card

World Radio History

The world's smallest complete Isolation Amplifier has



the world's smallest price.

We knew what you needed in isolation amplifiers. Smaller size, lower cost, better performance. So, we did it. We designed the Model 284J Isolation Amplifier to give you the kind of performance and versatility you need for a broad range of applications.

The 284J costs only \$41 in 100s, yet delivers all the key parameters in a small (1.5" x 1.5" x 0.62"), self-contained module. It even includes isolated power supply outputs for input pre-amplifiers or calibration signals. And because it requires no external DC/DC converter, the 284J is the smallest and least expensive isolation amplifier available today.

The 284J's total noise referred to input is a mere $8\mu\text{V}$ p-p in a 100 Hz bandwidth. Add an adjustable gain of 1 to 10V/V, a CMV of 5000V pulse or 2500V continuous and a minimum CMR of 110dB. And you've got all you need for a myriad of applications where optimum measurement accuracy and safety are concerned.

We didn't stop there with the product line. Consider our higher performance, Model 277 Instrument Grade Isolation Amplifier. Its uncommitted op amp front end gives you extreme versatility. Its CMR of 160dB and its gain nonlinearity of less than 0.025% for a full 20V swing plus a drift of less than $1\mu\text{V}/^\circ\text{C}$ give you exceptional performance. The 277's versa-

tility and performance at a price of \$114 (1-9) make it an excellent alternative in your most demanding instrumentation applications.

Then there's our Model 275 Industrial Grade Isolation Amplifier, \$79 (1-9), that is gain programmable over a range of 1 to 100 by a single resistor with nonlinearity to less than 0.05%. And our Model 285 is like the 275 but features a low impedance op amp output. And our Models 279, 282 and 283 for multichannel applications.

We could go on and on about this line. But our free Analog Devices Isolation Amplifier Handbook says it all. Ask for a copy along with the data sheets on our new Isolation Amplifiers. Write Analog Devices, the real company in isolation amplifiers.



The real company in isolation amplifiers

Analog Devices, Inc., Norwood, Massachusetts 02062

East Coast: (617) 329-4700, Midwest: (312) 894-3300, West Coast: (213) 595-1783, Texas: (214) 231-5094, Belgium: 03 38 27 07, Denmark: 97 95 99, England: 01/94 10 46 6, France: 686-77 60, Germany: 089/53 03 19, Japan: 03/26 36 82 6, Netherlands: 076-122555 and representatives around the world.



MONOLITHIC CRYSTAL FILTERS



SPEAKING TO THE DEAF

Our monolithics find their way into some fascinating and unusual applications. For instance — a narrow-band FM system which allows children with severely impaired hearing to participate in normal classroom activities. One of the requirements of the system was that both the students' receivers and the teacher's transmitter allow unhindered movement by the wearer. Another was freedom from interference, including interference from other systems in nearby classrooms. Cost was also an important factor. One of our standard 10.7 MHz tandem monolithic crystal filters in each receiver takes care of the interference. Its size is consistent with the needs of the wearer. Its cost is consistent with educational budgets.

HAVE IT YOUR WAY

As regular readers of this column know by now, we offer the broadest line going of standard monolithic crystal filters. It may be worth mentioning that we're just as interested in helping you with a custom monolithic as we are in showing you new ways to use our regular models. We've done hundreds of production "specials" from 5 to 180 MHz. May we do one for you?

What's your production application? Talk with us about it. We may be able to help. And if your interests include teaching the deaf, we'd be happy to put you in touch with the manufacturer of this equipment.



Piezo Technology Inc.

2400 Diversified Way Orlando, Florida 32804
305 425-1574

The Standard in monolithic crystal filters.

New products

(2 microseconds) makes it a much better choice than a cordic or similar algorithm. Housed in a module that measures 3.125 by 2.625 by 0.8 inches, the converter requires only a single 5-volt supply that can deliver 600 milliamperes. A version that works from 0°C to 70°C sells for \$350 in small quantities. Also available is a unit that works from -55°C to 105°C.

Analog Devices Inc., P.O. Box 280, Norwood, Mass. 02062. Phone Lowell Wickesham at (617) 329-4700 [385]

Voltage-frequency converter is linear to within 0.025%

Able to operate from a single 15-volt supply, a line of general-purpose voltage-to-frequency converters features 13-bit resolution, a maximum offset temperature coefficient of 20 microvolts/°C, and a linearity to within 0.025% of full scale. Three full-scale ranges are offered: 10, 20, and 100 kilohertz. The full-scale frequencies of the 10- and 20-kilohertz models are trimmed to within 0.2%, while the 100-kHz models are trimmed to within 0.4%. Prices for the 8001 family start below \$30; evaluation quantities of all 12 models are available from stock.

Dynamic Measurements Corp., 6 Lowell Ave., Winchester, Mass. 01890. Phone toll-free at (800) 225-1151 [386]

Buffered multiplexer is completely self-contained

The model 4550 16-channel analog multiplexer is a buffered unit that contains digital input buffers, an output buffer amplifier, decoder logic, and analog switches in a single compact package. The multiplexer, which has a transfer accuracy of within 0.01% up to 20 kilohertz, accepts input voltages from -10 v to +10 v. It is overvoltage-protected up to ±35 v. And the protection is maintained even when the collector supply voltage is removed.

Typical small-signal bandwidth

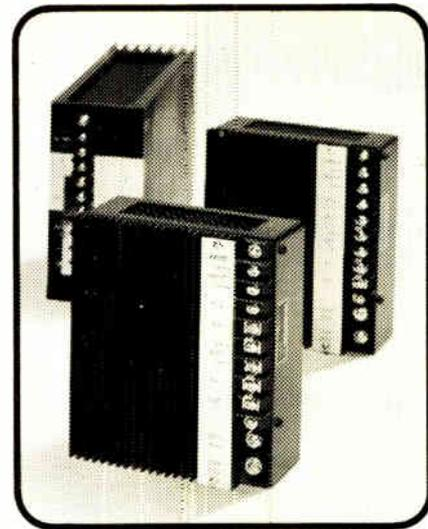

SWITCHING POWER SUPPLIES

- **COMPACT AND LIGHT-WEIGHT!**
- **LOWER PRICE WITH HIGHER RELIABILITY!**
- **SIMPLER CIRCUITS BUT HIGHER EFFICIENCY!**



MODEL NO.	OUTPUT VOLTAGE (V)	OUTPUT CURRENT (A)
YP-0510A	5	10
YP-0525A		25
YP-0650A		50
YP-1204A	12	4
YP-1210A		10
YP-1220A		20
YP-1504A	15	4
YP-1510A		10
YP-1520A		20
YP-2402A	24	2
YP-2405A		5
YP-2410A		10
YP-3002A	30	2
YP-3005A		5
YP-3010A		10

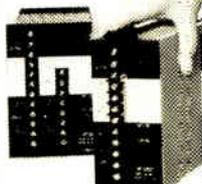

Sole Distributor:
WAMCO Technical Sales, Inc.
705 W. 16th St, Costa Mesa
Calif. 92627, U.S.A.
Tel. No. (714)-833-9361 or
(714)-642-5100
TELEX No. 678-459.

YUTAKA ELECTRIC MFG. CO., LTD.

No. 228 KARIYADO NAKAHARA-KU, KAWASAKI
CITY KANAGAWA PREF-211 JAPAN
TELEX: J22890 CABLE: TLX-J22890 YUTACO

Hutson's D-30 Diac ...A Quality Device! You Can Depend On It!



If experience counts, there's nothing finer than Hutson's D-30 Diac for reliability and low cost. Available in all voltage ranges from 30 through 60 with breakover voltage symmetry of 3.8 volts maximum.

Our only business is manufacture of solid state components. You'll like Hutson quality and off-the-shelf delivery. Call us, or one of Hutson's distributors today.

DISTRIBUTORS

CALIFORNIA Newport Beach Semicomp (714) 833-3070 San Diego Semicomp (714) 560-0373 San Leandro KEA Electronics (415) 352-0277
CONNECTICUT Norwalk Harvey Electronics (203) 853-1515 **FLORIDA** Clearwater Diplomat-Southland (813) 443-4514 Miami All American Transistor (305) 754-5531 **INDIANA** Indianapolis: Sheridan Sales (317) 547-7777
KANSAS Overland Park Sheridan Sales (913) 383-1635 **MICHIGAN** Farmington Sheridan Sales (313) 477-3800 **MINNESOTA** Minneapolis Cassidy (612) 835-7744 **MISSOURI** Florissant Sheridan Sales (314) 637-5200 **NEW JERSEY** Cinaminson Wishire electronics (215) 627-1920 Elizabeth Thor Electronics (201) 354-2420 **NEW YORK** Rochester Rochester Radio (716) 454-7800 **OHIO** Beachwood Sheridan Sales (216) 831-0130 Cincinnati Sheridan Sales (513) 761-5432 Dayton Sheridan Sales (513) 277-8911
PENNSYLVANIA Pittsburgh Sheridan Sales (412) 244-1640 **TEXAS** Dallas KA Electronics (214) 634-7870 Houston Altair Houston (713) 462-3029 Richardson Altair Dallas (214) 231-5166 **UTAH** Salt Lake City Diplomat Alta (801) 486-7227 **WISCONSIN** Milwaukee B & W Electronics (414) 545-8380



HUTSON INDUSTRIES

P.O. Box 34235 2019 West Valley View Lane Dallas, Texas 75234

(214) 241-3511 TWX 910-860-5537

Circle 180 on reader service card

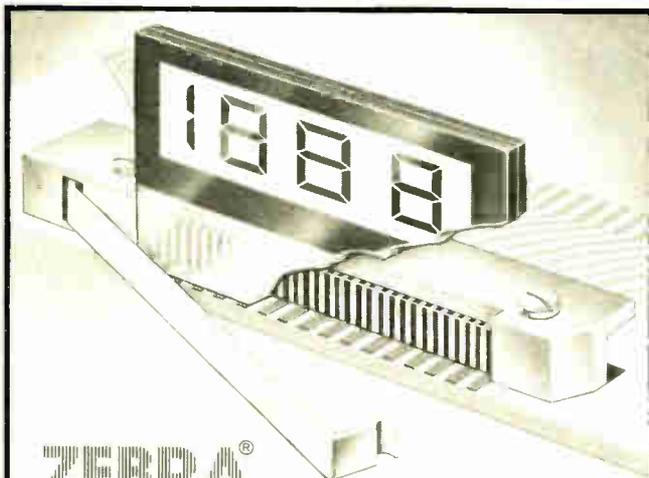

ZEBRA®

LCD CONNECTOR

90° EDGE MOUNT

CONDUCTIVE ELASTOMERIC CONNECTOR

- A unique design of a solderless connector and holder for 90° edge mount LCD's.
- Provides vibration and shock protection
- Gas-tight seal is created
- Zero insertion force
- Easily installed and replaced
- Standard configurations available from stock.

Send for Connector Catalog.



TECKNIT®

Eastern Division • 129 Dermody St. Cranford, N.J. 07010 • (201) 272-5500

Western Division • 427 Olive St. Santa Barbara, Ca. 93101 • (805) 903-1867

180 Circle 224 on reader service card

get your hands on...

Hands on micro-processor short course with **FREE** take home microcomputer included in the \$495 tuition.



Jan. 25, 26, 27 Dayton, OH
 Feb. 1, 2, 3 St. Petersburg Beach, FL
 Feb. 9, 10, 11 Los Angeles, CA
 Feb. 14, 15, 16 Palo Alto, CA
 Feb. 22, 23, 24 Philadelphia, PA
 Mar. 1, 2, 3 Washington, D.C.
 Mar. 8, 9, 10 Boston, MA
 Mar. 15, 16, 17 Chicago, IL
 Mar. 22, 23, 24 Huntsville, AL

Learn microprocessors first hand from the original hands on people.

For more information call Alice Anderson, (317) 742-6802 or write Wintek Corp., 902 North 9th Street, Lafayette, Indiana 47904.



- 6800 Hardware/Software
- Custom Hardware/Software
- In-house short courses

Circle 225 on reader service card

New products

of the unit is 2.5 megahertz. The 4550 sells for \$125 in small quantities; delivery of the multiplexer is from stock.

Teledyne Philbrick, Allied Dr. at Route 128, Dedham, Mass. 02026. Phone Robert W. Jacobs at (617) 329-1600 [387]

Quadrature hybrid
sells for \$35

Priced at only \$35 for small quantities, the Q-116 quadrature hybrid is an extremely compact device that operates over a bandwidth of 10% centered at 30 megahertz. Other center frequencies up to 300 MHz are also available by special order.

The device, which can be used to split a signal into two isolated, quadrature-phased outputs or to combine two quadrature-phased inputs into a single output, is housed in a four-pin TO-5 header that measures only 0.3 inch high and 0.375 in. in diameter. The hybrid weighs only 2.5 grams.

Key operating specifications for the model Q-116 include nominal coupling of 3 decibels, minimum isolation of 25 dB, maximum insertion loss of 0.25 dB, quadrature angle of $90^\circ \pm 3^\circ$, amplitude matching within 0.8 dB, impedance of 50 ohms, maximum VSWR of 1.3, and average power of 1 watt.

Merrimac Industries Inc., 41 Fairfield Pl., West Caldwell, N.J. 07006. Phone Alan Egger at (201) 228-3890 [388]

Hybrid amplifier spans
30 to 300 megahertz

The model CA2840 rf/i-f amplifier is a thin-film hybrid device that covers the frequency range from 30 to 300 megahertz. Intended for communications applications, the amplifier has a gain of 22 dB \pm 1.0 dB at 30 MHz and a noise figure of 6 dB, maximum. Its third-order intercept point is at 65 dBm. The amplifier sells for \$50.

TRW RF Semiconductors, 14520 Aviation Blvd., Lawndale, Calif. [389]

MULTIPOWER[®] for your MPU

Trio Labs Model 674/675 Multi-Output Switching Regulator Power Supplies will provide all your MPU power needs in only box for less cost than you could do it yourself!

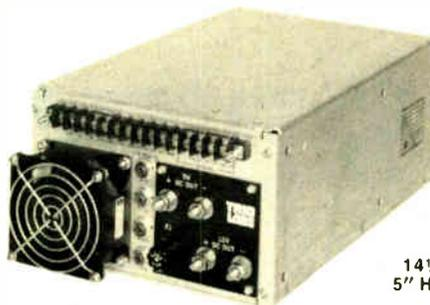

1 1/4" L x
5" H x 8" W

Up to 4 outputs—475 watts. A main 2 or 5 VDC @ 50 or 70 amps for your logic. A second rail @ up to 10 amps to power your memory. And two outputs @ up to 4 amps for your accessories.

Internal Cooling—Overvoltage, Overtemperature and Overload Protection—Remote Sense—Independent V adj.—U.L. rec.—are just some of the features of Trios Model 674-675.

And would you believe a single unit price as low as \$635?

Winners deserve each other. — Call or write:

**TRIO
LABS**

THE[®]
Switcher
Source

80 Dupont St
Plainview NY
(516) 681-0400

Circle 181 on reader service card

The Answer Book. It makes your job easier. \$25.

“What companies make the products I need? How do I contact them locally? How do I get their current catalogs fast?”

Ask The Answer Book. Over 4000 products, 6000 manufacturers with their local contacts, directory of trade names and catalogs, inquiry “bingo” card for 5-second ordering of current catalogs.

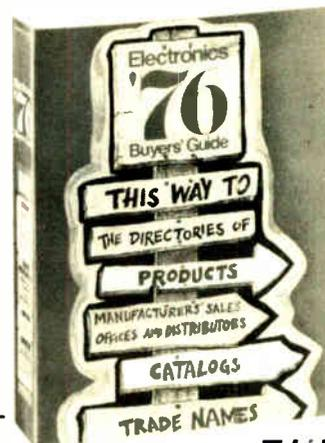

Electronics Buyers' Guide

1221 Avenue of the Americas, N.Y., N.Y. 10020

Yes, send me a copy of The Answer Book.

I've enclosed \$25 (USA and Canada only,

elsewhere send \$35). Full money back guarantee if returned within 10 days.

Name _____

Company _____

Street _____

City _____

State _____

Zip _____

5½ DIGIT ACCURACY. 4½ DIGIT PRICE.

The 4600 is our brand new 4½ digit multimeter. It gives you the accuracy and resolution of typical 5½ digit multimeters. At half the cost.

And the 4600 stays accurate longer than other DVM's. DC accuracy stays within 0.01% ± one digit for six months at a time. We guarantee it.

80dB normal mode noise rejection produces a 10,000:1 reduction of excess noise. A full decade better than the 1,000:1 reduction of comparable instruments.

Loading errors are virtually eliminated by the 4600's 10,000M Ω input impedance on the two lowest DC voltage ranges.

There's a lot more. Send for a free catalog on our new 4½ digit 4600 multimeter. And find out how to get 5½ digit accuracy without paying for it.

Dana Laboratories, Inc.,
2401 Campus Drive, Irvine,
California 92715. 714/833-1234.



DANA

Others measure by us.

"Now available through Electro Rents"

For product demonstration circle 182
For literature only circle 227

New products/materials

Single-crystal sapphire rod has tensile strength in excess of 25,000 kilograms per square centimeter, making it a superior material for wear guides, nonmagnetic supports, elec-

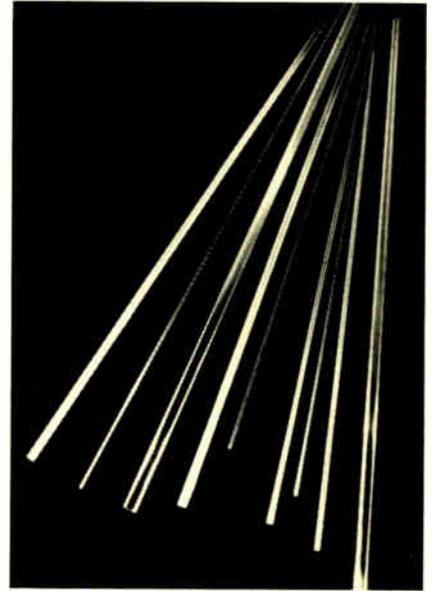

trical insulators, and similar applications that do not require optical transmission. It is offered in a variety of shapes—round, square, rectangular, elliptical, and triangular—in diameters from 0.01 to 0.2 inch. Available lengths vary from one inch to several hundred feet, depending upon diameter.

Tyco Saphikon Division, 16 Hickory Dr., Waltham, Mass. 02154 [476]

Metal ribbon for repairing or manufacturing circuit boards is available in a variety of sizes. Typically, widths are between 10 and 50 mils,

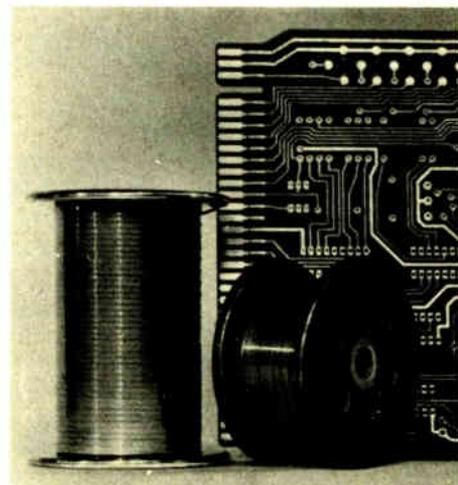

ok wire-wrapping
center

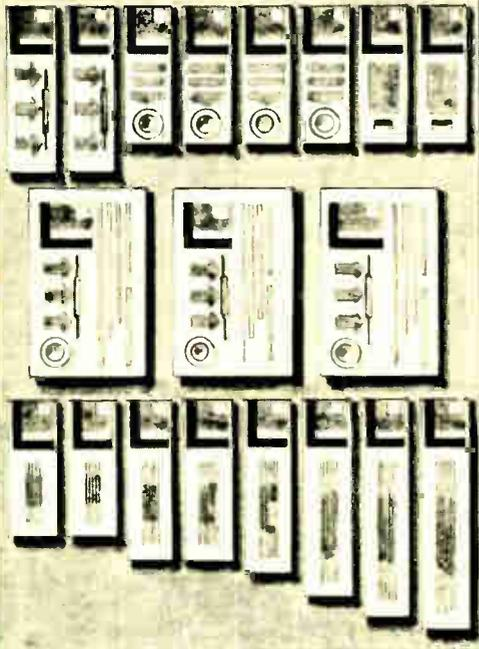

ok

wire wrapping center

your one stop shopping for quality
electronic parts and tools.

50ft. wire
roll



dip
socket

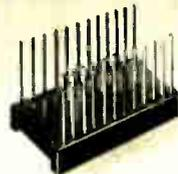

Hobby-wrap
tool

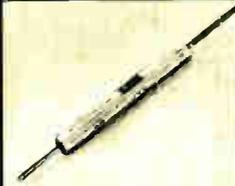

pre-stripped
wire

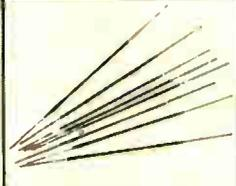

OK MACHINE & TOOL CORPORATION

3455 Conner St., Bronx, N.Y. 10475 / (212) 994-6600 / Telex 125091

Circle 183 on reader service card

FOR CUSTOM MOS WE'RE NUMBER ONE

NUMBER ONE for experience. Our MOS experience dates back to 1964 and our company has been producing Custom MOS since its' founding in 1969.

NUMBER ONE for making the economics of Custom MOS right for you, whether your production quantities are 1,000 or 1,000,000. (We have no production minimum or maximum.)

NUMBER ONE for quality. Reliability is built into every MOS/LSI circuit we manufacture, whether packaged in plastic or ceramic.

NUMBER ONE for protecting the proprietary nature of your product. Your competition will not know about your product design and we will not become your competition.

NUMBER ONE for flexibility. We offer you PMOS, CMOS, and NMOS (we help select the right process for your requirement) and the assurance that multisourcing is available when needed.

For immediate information call or write:

LSI computer systems, inc.

1235 Walt Whitman Rd., Melville, NY 11746 (516) 293-3850

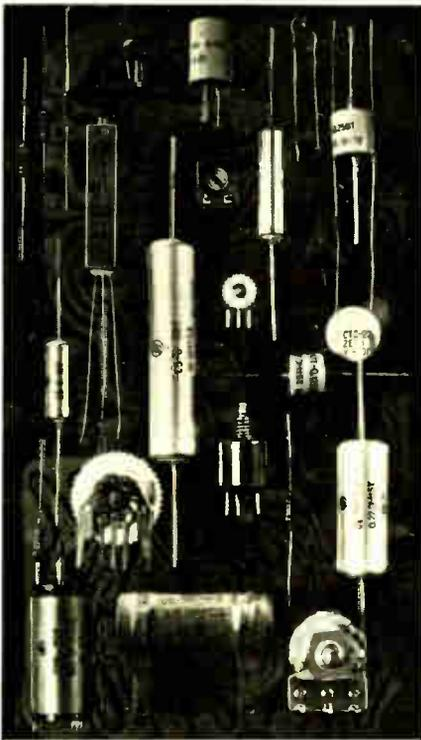

For Mini- and Micro-Circuits: The Infallible Soviet Resistors

- "MLT" fixed metal-film resistors
- "S2-331" non-wire fixed resistors
- "S1-4" fixed carbon resistors
- "SP3-22" fixed composition resistors, type "Malyutka"

Type	Resistance	Max. voltage [V]	Nom. dissipation power [W]	L ₁ [mm]	Dia. [mm]	Mass [g]
MLT-1	24ohm-10Mohm	500	1.0	13.0	6.0	2.0
MLT-2	24ohm-10Mohm	750	2.0	18.5	8.6	3.5
S2-331	10ohm-2Mohm	200	0.125	6.0	2.4	0.15
S2-331	10ohm-3Mohm	250	0.25	7.0	3.3	0.3
S2-331	10ohm-5Mohm	350	0.5	10.8	4.3	1.0
S1-4	10ohm-2Mohm	250	0.125	7.5	2.4	0.22
S1-4	10ohm-1Mohm	350	0.25	10.5	3.4	0.5
SP3-22	100ohm-1Mohm	150	0.1	7.0	3.1	0.4

Exporter:

ELORG

32/34 Smolenskaya-Sennaya
Moscow 121200, USSR
Telex 7586



New products/materials

and thicknesses are between 4 and 6 mils. Both gold-plated Kovar and gold-plated copper ribbons are recommended for repair work, while pure gold ribbon is available for the manufacture of microwave integrated circuits. In the latter, loops of ribbon are sometimes arched to produce lumped-circuit effects.

Consolidated Refining Co. Inc., 115 Hoyt Ave., Mamaroneck, N.Y. [477]

Three cleaning formulations, a polyurethane lacquer, and a mold-release material are offered for use in the manufacture and assembly of electronic equipment. Circuitklean re-



moves solder flux and other residue from printed-circuit boards. Polyklean is a fast-drying degreaser, and Electrical Contact Cleaner is just that. Polykote is a polyurethane lacquer for touching up and repairing printed-circuit boards and damaged insulation. And No-Sil-Kote is a silicone-free, paintable, mold-release agent, which is nonflammable, nonoxidizing, and greaseless. All five materials are packaged in aerosol cans and bulk containers.

Polycal Research Corp., P.O. Box 4624, Irvine, Calif. 92716 [478]

Solder-cleaning agent SnPb 2000 is a one-part solution for cleaning and activating solder prior to reflow fusing. It eliminates residual oxides and other contaminants and can also be used to clean, activate, and brighten tarnished and aged fused boards. SnPb 2000, which is available in 1-, 5-, 15-, and 55-gallon containers, has an unlimited shelf life.

Coppertech Inc., Ninth and Greenleaf streets, Allentown, Pa. 18102 [479]

PINPOINT HEAT

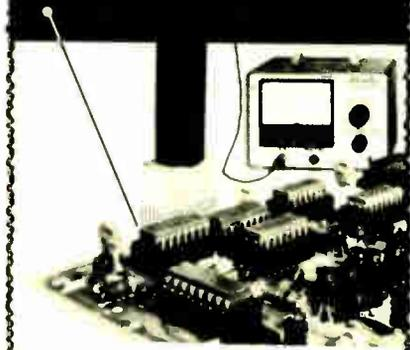

Heat any integrated circuit or electronic component to its rated temperature with a heat probe. Accuracy $\pm 3^\circ\text{C}$ or better. Or check the component's temperature with a thermo-couple probe. Model 810 Thermo-Probe does both. Reads out directly in $^\circ\text{C}$ and $^\circ\text{F}$ on a large 4 1/2-inch meter.

PRICE \$299.50 F.O.B. South Laguna

Models with other temperature ranges available. For details write to:

MTI MICRO-TECHNICAL INDUSTRIES

P.O. Box 287 South Laguna, CA 92677
(714) 545-3734 • TWX 910-587-3425 MICRO OHM ELM

Circle 240 on reader service card

PROFESSIONAL DISCOUNTS

Texas Instruments
electronic calculator

TI-30	\$22.95	TI-30C	\$62.95
TI-30A	21.95	TI-30C2	89.95
TI-30B	26.95	TI-30C3	229.95
TI-30C	29.95	TI-30C4	229.95
TI-30D	34.95	TI-30C5	99.95
TI-30E	43.95	TI-30C6	119.95
TI-30F	54.95	TI-30C7	26.00
TI-30G		TI-30C8	
TI-30H		TI-30C9	
TI-30I		TI-30C10	
TI-30J		TI-30C11	
TI-30K		TI-30C12	
TI-30L		TI-30C13	
TI-30M		TI-30C14	
TI-30N		TI-30C15	
TI-30O		TI-30C16	
TI-30P		TI-30C17	
TI-30Q		TI-30C18	
TI-30R		TI-30C19	
TI-30S		TI-30C20	
TI-30T		TI-30C21	
TI-30U		TI-30C22	
TI-30V		TI-30C23	
TI-30W		TI-30C24	
TI-30X		TI-30C25	
TI-30Y		TI-30C26	
TI-30Z		TI-30C27	
TI-30A1		TI-30C28	
TI-30A2		TI-30C29	
TI-30A3		TI-30C30	
TI-30A4		TI-30C31	
TI-30A5		TI-30C32	
TI-30A6		TI-30C33	
TI-30A7		TI-30C34	
TI-30A8		TI-30C35	
TI-30A9		TI-30C36	
TI-30A10		TI-30C37	
TI-30A11		TI-30C38	
TI-30A12		TI-30C39	
TI-30A13		TI-30C40	
TI-30A14		TI-30C41	
TI-30A15		TI-30C42	
TI-30A16		TI-30C43	
TI-30A17		TI-30C44	
TI-30A18		TI-30C45	
TI-30A19		TI-30C46	
TI-30A20		TI-30C47	
TI-30A21		TI-30C48	
TI-30A22		TI-30C49	
TI-30A23		TI-30C50	
TI-30A24		TI-30C51	
TI-30A25		TI-30C52	
TI-30A26		TI-30C53	
TI-30A27		TI-30C54	
TI-30A28		TI-30C55	
TI-30A29		TI-30C56	
TI-30A30		TI-30C57	
TI-30A31		TI-30C58	
TI-30A32		TI-30C59	
TI-30A33		TI-30C60	
TI-30A34		TI-30C61	
TI-30A35		TI-30C62	
TI-30A36		TI-30C63	
TI-30A37		TI-30C64	
TI-30A38		TI-30C65	
TI-30A39		TI-30C66	
TI-30A40		TI-30C67	
TI-30A41		TI-30C68	
TI-30A42		TI-30C69	
TI-30A43		TI-30C70	
TI-30A44		TI-30C71	
TI-30A45		TI-30C72	
TI-30A46		TI-30C73	
TI-30A47		TI-30C74	
TI-30A48		TI-30C75	
TI-30A49		TI-30C76	
TI-30A50		TI-30C77	
TI-30A51		TI-30C78	
TI-30A52		TI-30C79	
TI-30A53		TI-30C80	
TI-30A54		TI-30C81	
TI-30A55		TI-30C82	
TI-30A56		TI-30C83	
TI-30A57		TI-30C84	
TI-30A58		TI-30C85	
TI-30A59		TI-30C86	
TI-30A60		TI-30C87	
TI-30A61		TI-30C88	
TI-30A62		TI-30C89	
TI-30A63		TI-30C90	
TI-30A64		TI-30C91	
TI-30A65		TI-30C92	
TI-30A66		TI-30C93	
TI-30A67		TI-30C94	
TI-30A68		TI-30C95	
TI-30A69		TI-30C96	
TI-30A70		TI-30C97	
TI-30A71		TI-30C98	
TI-30A72		TI-30C99	
TI-30A73		TI-30C100	
TI-30A74		TI-30C101	
TI-30A75		TI-30C102	
TI-30A76		TI-30C103	
TI-30A77		TI-30C104	
TI-30A78		TI-30C105	
TI-30A79		TI-30C106	
TI-30A80		TI-30C107	
TI-30A81		TI-30C108	
TI-30A82		TI-30C109	
TI-30A83		TI-30C110	
TI-30A84		TI-30C111	
TI-30A85		TI-30C112	
TI-30A86		TI-30C113	
TI-30A87		TI-30C114	
TI-30A88		TI-30C115	
TI-30A89		TI-30C116	
TI-30A90		TI-30C117	
TI-30A91		TI-30C118	
TI-30A92		TI-30C119	
TI-30A93		TI-30C120	
TI-30A94		TI-30C121	
TI-30A95		TI-30C122	
TI-30A96		TI-30C123	
TI-30A97		TI-30C124	
TI-30A98		TI-30C125	
TI-30A99		TI-30C126	
TI-30A100		TI-30C127	
TI-30A101		TI-30C128	
TI-30A102		TI-30C129	
TI-30A103		TI-30C130	
TI-30A104		TI-30C131	
TI-30A105		TI-30C132	
TI-30A106		TI-30C133	
TI-30A107		TI-30C134	
TI-30A108		TI-30C135	
TI-30A109		TI-30C136	
TI-30A110		TI-30C137	
TI-30A111		TI-30C138	
TI-30A112		TI-30C139	
TI-30A113		TI-30C140	
TI-30A114		TI-30C141	
TI-30A115		TI-30C142	
TI-30A116		TI-30C143	
TI-30A117		TI-30C144	
TI-30A118		TI-30C145	
TI-30A119		TI-30C146	
TI-30A120		TI-30C147	
TI-30A121		TI-30C148	
TI-30A122		TI-30C149	
TI-30A123		TI-30C150	
TI-30A124		TI-30C151	
TI-30A125		TI-30C152	
TI-30A126		TI-30C153	
TI-30A127		TI-30C154	
TI-30A128		TI-30C155	
TI-30A129		TI-30C156	
TI-30A130		TI-30C157	
TI-30A131		TI-30C158	
TI-30A132		TI-30C159	
TI-30A133		TI-30C160	
TI-30A134		TI-30C161	
TI-30A135		TI-30C162	
TI-30A136		TI-30C163	
TI-30A137		TI-30C164	
TI-30A138		TI-30C165	
TI-30A139		TI-30C166	
TI-30A140		TI-30C167	
TI-30A141		TI-30C168	
TI-30A142		TI-30C169	
TI-30A143		TI-30C170	
TI-30A144		TI-30C171	
TI-30A145		TI-30C172	
TI-30A146		TI-30C173	
TI-30A147		TI-30C174	
TI-30A148		TI-30C175	
TI-30A149		TI-30C176	
TI-30A150		TI-30C177	
TI-30A151		TI-30C178	
TI-30A152		TI-30C179	
TI-30A153		TI-30C180	
TI-30A154		TI-30C181	
TI-30A155		TI-30C182	
TI-30A156		TI-30C183	
TI-30A157		TI-30C184	
TI-30A158		TI-30C185	
TI-30A159		TI-30C186	
TI-30A160		TI-30C187	
TI-30A161		TI-30C188	
TI-30A162		TI-30C189	
TI-30A163		TI-30C190	
TI-30A164		TI-30C191	
TI-30A165		TI-30C192	
TI-30A166		TI-30C193	
TI-30A167		TI-30C194	
TI-30A168		TI-30C195	
TI-30A169		TI-30C196	
TI-30A170		TI-30C197	
TI-30A171		TI-30C198	
TI-30A172		TI-30C199	
TI-30A173		TI-30C200	
TI-30A174		TI-30C201	
TI-30A175		TI-30C202	
TI-30A176		TI-30C203	
TI-30A177		TI-30C204	
TI-30A178		TI-30C205	
TI-30A179		TI-30C206	
TI-30A180		TI-30C207	
TI-30A181		TI-30C208	
TI-30A182		TI-30C209	
TI-30A183		TI-30C210	
TI-30A184		TI-30C211	
TI-30A185		TI-30C212	
TI-30A186		TI-30C213	
TI-30A187		TI-30C214	
TI-30A188		TI-30C215	
TI-30A189		TI-30C216	
TI-30A190		TI-30C217	
TI-30A191		TI-30C218	
TI-30A192		TI-30C219	
TI-30A193		TI-30C220	
TI-30A194		TI-30C221	
TI-30A195			

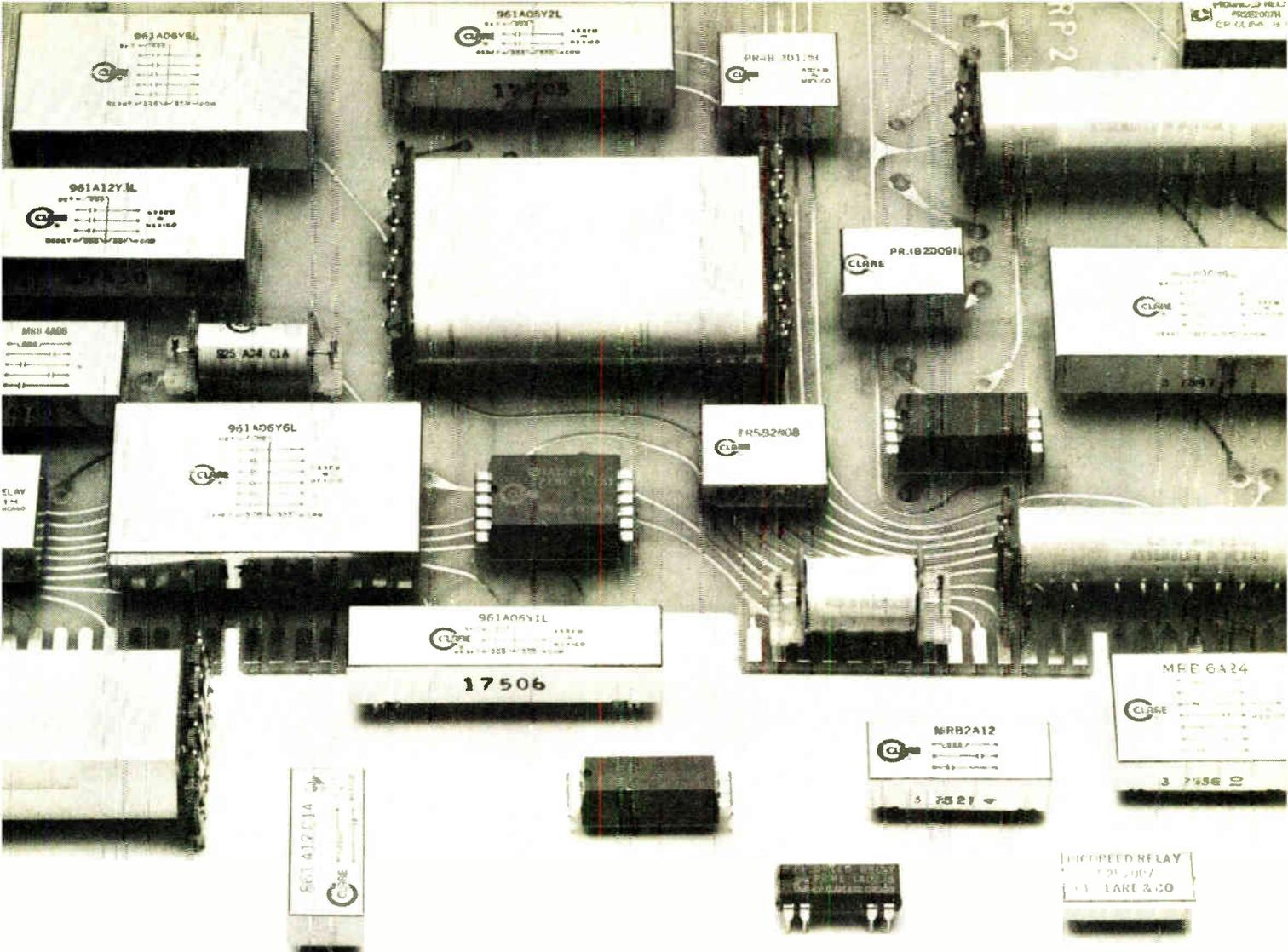

**There's a CLARE REED RELAY
for every PCB application.**

From standard dry reed operations to subminiature and high performance . . . pico, micro and self-latching reeds . . . all the way to a mercury reed relay . . . Clare can supply the reed relay you need.

All Clare reed relays provide economical, fast, reliable performance with total needed input/output characteristics. And all are immune to false operations and insensitive to voltage transients.

There's something for everyone in our reed relay selection. For the whole story, contact your Clare Representative, or C. P. Clare & Company, 3101 W. Pratt Avenue, Chicago, Illinois 60645. Phone (312) 262-7700.

QUALITY, SERVICE, RELIABILITY

**C. P. CLARE & COMPANY
GENERAL INSTRUMENT CORPORATION**



Use CLARE Reed relays across the board.

Circle 185 on reader service card

The Electronics Book Series offers you:

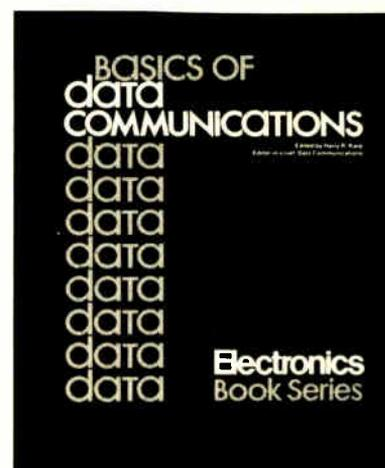
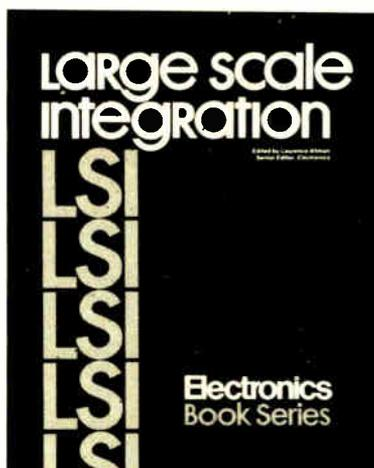
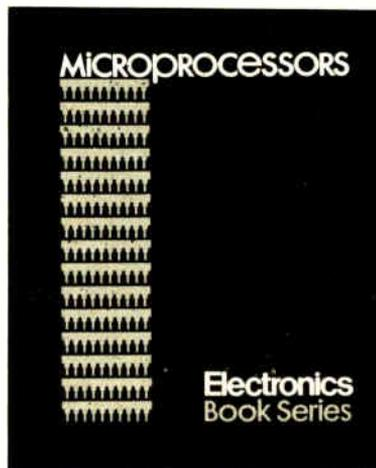

1 MICROPROCESSORS

The microprocessor has permanently changed the methods of designing and building electronic equipment—from process and industrial control to computer-based designs in instruments communication and consumer/commercial equipment.

This book cuts through the confusion, presenting the design and application potential of this exciting technology in a manner that will appeal to the design engineer who needs to know how to use microprocessors as well as the system analyst who must assess the tradeoffs between microprocessors and other techniques to accomplish his system goals.

Using articles from the pages of Electronics, this book contains practical and up-to-date information on available microprocessor devices, technology and applications.

2 LARGE SCALE INTEGRATION

The Electronics Book Series offers you a handbook on the current and revolutionary impact of LSI on digital design. This 220-page book presents a unique opportunity for circuit designers, systems designers, and engineering managers and supervisors to bring their expertise into line with today's LSI design requirements.

"Large Scale Integration" is a compendium of recent articles published in Electronics. Although in some ways it is a companion piece to "Microprocessors" because it explains the new circuits that play in mp systems, it is much more. "Large Scale Integration" deals with the entire range of design applications: main memory systems, peripheral memories, memory controllers, on-line industrial controllers, data acquisition boards, communication systems, calculators, watches, etc.

3 BASICS OF DATA COMMUNICATIONS

Data communications is one of the fastest-growing electronic equipment markets in the U.S.—during the decade of the '70's, better than 15-20% per year, compounded!

Chances are you are going to be a part of the data communications market. There's no better place to start than getting a copy of "Basics of Data Communications"—a 316-page compilation of essential articles which have appeared in Data Communications magazine. From the basic, tutorial, still state-of-the-art information published in the 1972 and 1973 Deskbook issues (now out of print), on through information on the practice of present-day data communications, this book includes forty-seven articles covering more than eleven key areas.

Electronics Book Series • PO Box 669, Hightstown, N.J. 08520



- 1 Send me _____ copies of "Microprocessors" at \$8.95 per copy.
- 2 Send me _____ copies of "LSI" at \$9.95 per copy.
- 3 Send me _____ copies of "Basics of Data Communications" at \$12.50 per copy.

Discounts of 40% on orders of ten or more copies of each book.

I must be fully satisfied or you will refund full payment if the books are returned after ten day trial examination.

Payment enclosed Bill firm Bill me

Name _____

Title _____

Company _____

Street _____

City _____

State _____ Zip _____

Signature _____

Credit Cards Charge My Book To _____

American Express Master Charge
 Diners Club BankAmericard

Acct. No. _____

Date Card Expires _____

Interbank No. _____

(1st No.'s. above name on Mastercharge only.)

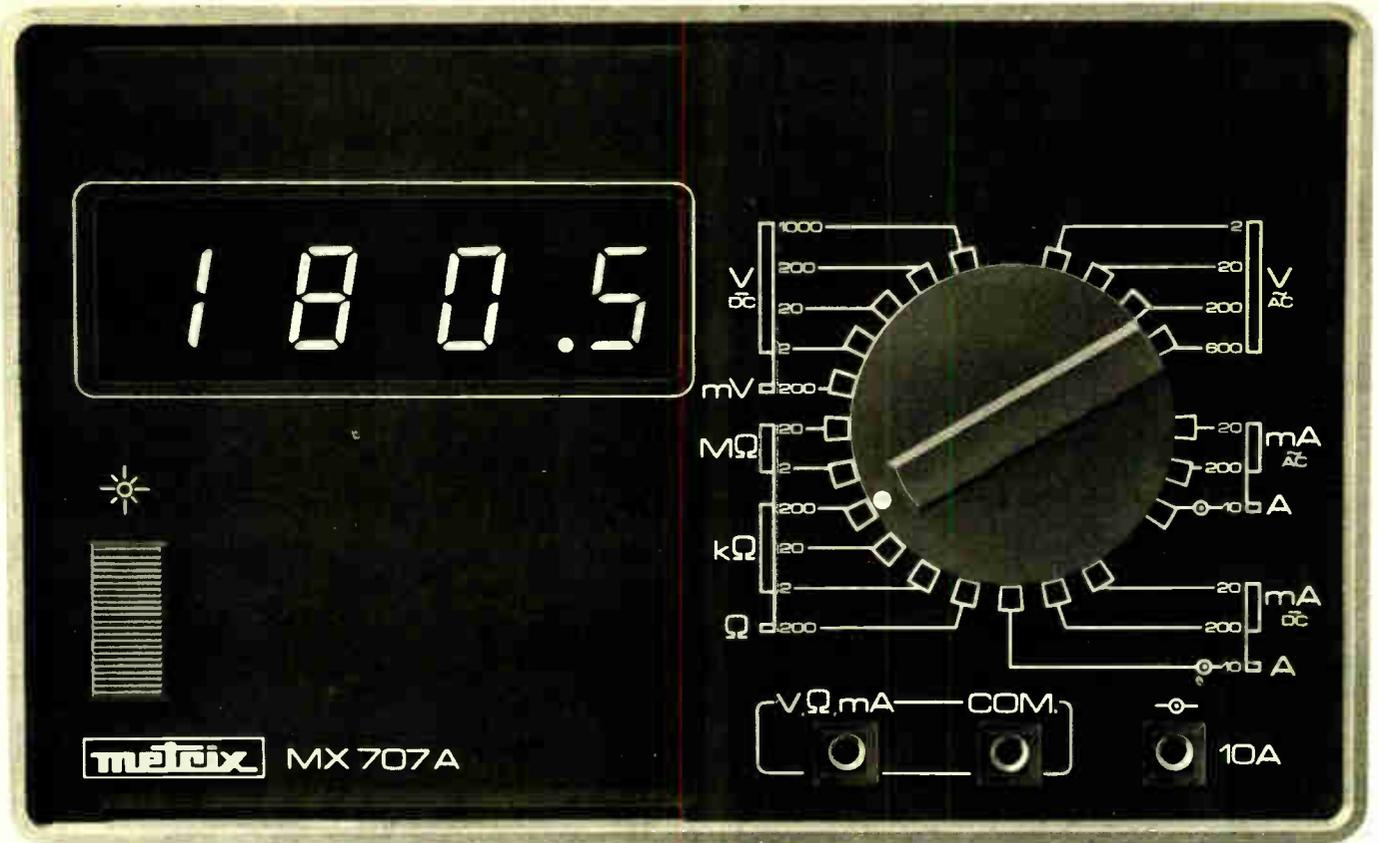

No strain on your eyes with the new MX 707A Multimeter ... even less strain on your budget

First look at that 3½ digit, daylight bright 16 mm read out. Then look at the simplicity of operation from one dial selector. Then realise that it's a complete, five-function, line-operated digital multimeter with a 2000 count and a 10A input that will measure on 20A for 30 seconds.

Now, add the fact that you can count on worst-case accuracies of 0.5% for dc voltage and 1.0% for dc current. And that you get full overload protection on all modes. Then, look at our mini-spec and calculate what you expect to pay (or have been paying) for the equivalent.

We can surprise you by coming in at around the \$200 mark. Circle the page number below on the reader service card at the rear of the journal. We'll come back to you with an illustrated data sheet and a firm price indication that will make your budget look bigger overnight.

Five functions

V_{DC} ± 100 μ V to ± 1,000 V
10 M Ω

V_{AC} 5 mV to 600 V
40 Hz - 25 kHz
1 M Ω // 100 pF

I_{DC} ± 10 μ A to ± 10 A

I_{AC} 10 μ A to 10 A
50 - 400 Hz

Ω 100 m Ω to 20 M Ω

Protection

1,000 V p. to p. on all V ranges
220 V rms on all Ω ranges
0.3 A on all mA ranges
20 A can be measured during 30 s on the 10 A input.

Dimensions

W 210 mm. H 130 mm. D 75 mm.

METRIX
Division Instrumentation de la SPI-ITT
Chemin de la Croix-Rouge - B.P. 30 -
74010 Annecy, France
Tel. (50) 52.81.02 - Telex: 300 722
Sales and service in 90 countries

metrix

Instruments and Components

ITT

**Convert your scope
for \$ 395.- into a powerful**

Logic Analyzer

The Scope Multiplexer SM 40 expands any single oscilloscope channel into a 4-channel parallel logic display.

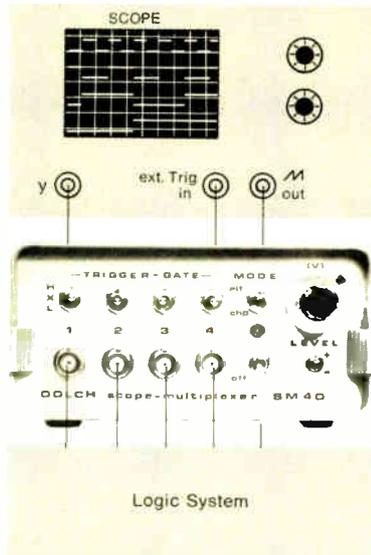

Features:

- Synchronous 4-channel display
- Signal bandwidth DC to 50 MHz
- 5-bit combinatorial triggering
- Alternate and chopped display
- Calibrated continuous logic-threshold from -10 to +10V
- Serves all logic families
- Cascadability to form n-channels

For more information contact



Industriestraße 48, 6056 Heusenstamm
Ph. 06104/3055, Tx 4-10153
West Germany

in the USA:

Glass Gorham CO.
7700 North Austin Ave.
Skokie, Illinois 60076
Ph. (312) 966-0300, Tx. 72-4421

New literature

Analyzing microprocessor systems. Eight application notes, each describing the use of logic-state troubleshooting instruments to analyze a commonly used microprocessor system, are offered by the Inquiries Manager, Hewlett-Packard Co., 1501 Page Mill Rd., Palo Alto, Calif. 94304. The format is identical for all eight notes. Operation of the particular microprocessor is described in detail with the aid of charts and schematics. Separate sections discuss pin assignments, probe and pin connections, analyzer control settings, interpretation of the display, mapping, and viewing address and data. Circle the indicated reader service number for the microprocessor of interest.

Fairchild F8	421
Intel 4004	422
Intel 4040	423
Intel 8008	424
Intel 8080	425
Motorola 6800	426
National IMP	427
National SC/MP	428

Specifying modules. The manufacturers and users of operational amplifiers, logarithmic amplifiers, and dc-to-dc converters often have different notions about the meaning of some of the specifications of these devices. To help reduce confusion in this area, Teledyne Philbrick has published three application notes that make clear exactly what that company means by the various terms that appear on its data sheets. AN-23 covers op amps, AN-26 deals with dc supplies, and AN-27 with log amps. Copies of all three notes are offered by Teledyne Philbrick, Allied Drive at Route 128, Dedham, Mass. 02026 [429]

Measuring microwave pulses. An eight-page application note, "The Automatic Microwave Pulse Counter—A New Approach to Frequency Measurement in the Time Domain," contrasts the operation of wavemeters, manual transfer oscillators, and the EIP model 451 microwave pulse frequency counter. The note, which includes a detailed description and block diagram of the 451, is avail-

VAC
VACUUMSCHMELZE

VACOZET®

a semi-hard
magnetic alloy
with rectangular
hysteresis loop
for impulse controlled
self latching relays.

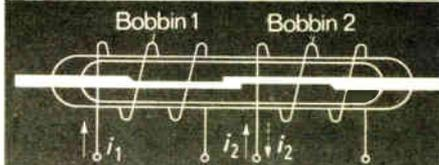

Properties:

- high remanence
- adjustable coercitive force

VACOZET		200	258	655	923
H _C	A/cm	15	30	50	75
B _r	T	1.5	1.45	1.45	1.25
B _r /B ₁₀₀	%	ca. 90			

For data sheet and further information apply to

**VACUUMSCHMELZE
GMBH
6450 HANAU
W.-Germany · POB 109**

WE'RE WARNING YOU...

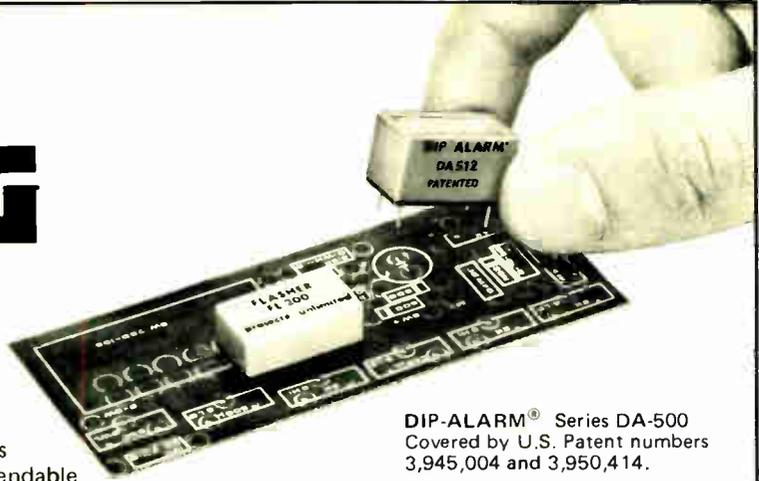

... this unique, miniature solid state sound device has unlimited applications. Plugs into 16 pin DIP sockets or PC boards. Rugged, reliable, loud. Models for 3, 5 and 12 vdc, 35 mA maximum current. Dependable solid state construction means no mechanical contacts, no arcing, no RF noise. 76 dbA at 400 Hz tone radiates in all directions for positive alarm, warning, fault detection.

DIP-ALARM® Series DA-500
Covered by U.S. Patent numbers
3,945,004 and 3,950,414.

Use in conjunction with
DIP-FLASH® Series FL-200
for pulsing operation.

Where to buy an audio indicator for every need:



3680 Wyse Road, Dayton, Ohio 45414
Tel. (513) 890-1918, TWX 810-450-2523

Distributors throughout the world.

CALIFORNIA, COSTA MESA
MarVac Electronics

COLORADO, DENVER
Waco Electronics Inc.

MASSACHUSETTS, SHARON
Adcour

MICHIGAN, FARMINGTON
CMP Distributor Co.

MISSOURI, ST. LOUIS
Olive Industrial Elec.

NEW YORK, ROCHESTER
Ossmann Component Sales

OHIO, CLEVELAND
CMP Distributor Co.

OHIO, CINCINNATI
COLUMBUS
Hughes Peters, Inc.

TEXAS, DALLAS
K. A. Electronic Sales

UTAH, SALT LAKE
Newark Electronics

WASHINGTON, SEATTLE
Frank Jackson & Associates

WISCONSIN, MILWAUKEE
Taylor Electric Co.

B. C., VANCOUVER
Deskin Sales Corp.

ONTARIO, TORONTO
Deskin Sales Corp.

ONTARIO, WILLOWDALE
Electro Sonic, Inc.

QUEBEC, MONTREAL
Deskin Sales Corp.

Circle 189 on reader service card

Paying More Than \$295 For Waterproof Load Cells?

Why?

Designing electronic weighing, force measuring or test systems for all weather use? You won't find a price this low for any other **waterproof** and **barometrically insensitive** strain gage load cell—especially one offering an error band of less than $\pm 0.04\%$!

Buy a definite competitive edge in price and performance with Sealed Super-Minis that operate in tension or compression—with capacities to 1,000 pounds.

For detailed specifications on 5 pound to 100 ton capacity load cells, call—write Interface, 7401 E. Butherus Dr., Scottsdale, AZ USA 85260. (602) 948-5555, Telex 668-394.



Low Profile



Minibeam



Super-Mini

interface
ADVANCED FORCE MEASUREMENT

PROM ERASER



Designed specifically to deliver a calibrated dose of ultraviolet at the correct wavelength and intensity to assure long-term data retention. Tested by leading manufacturers of EPROMS, it meets data-sheet requirements of Intel, National, AMD, AMI, Mostek and others.

- **SAFE** - Operator protected against uv and ozone
- **SMALL** - 7 in. wide, front loading
- **AUTOMATIC** lamp start and timer
- **CONVENIENT** - Metal-tray loading
- **FLEXIBLE** - One to 60 PROMS per cycle
- **AVAILABLE** from current stock

Write or call for further data, or to order

TURNER DESIGNS
2247A Old Middlefield Telephone
Mountain View, CA 94043
415/965-9800



Circle 233 on reader service card

Circle 234 on reader service card 189

available from EIP Inc., 3230 Scott Blvd., Santa Clara, Calif. [430]

Strain-gage specifications. The Instrument Society of America has published a standard on strain-gage specifications and tests. Designated S37.8-1975, the 16-page document outlines uniform general specifications, acceptance and qualification methods, and methods for data presentation. It also includes terminology. Copies may be obtained for \$5 each (\$3 to Instrument Society members) from the Publications Dept., Instrument Society of America, 400 Stanwix St., Pittsburgh, Pa. 15222

Computer privacy. The National Bureau of Standards has published a report entitled "A Methodology for Evaluating Alternative Technical and Information Management Approaches to Privacy Requirements."

The report deals with the costs of achieving the privacy requirements of the Privacy Act of 1974 (PL 93-579). Copies of the report may be ordered from the Superintendent of Documents, U.S. Government Printing Office, Washington, D.C. 20402. Orders must include payment (\$1.35 in the U.S.; \$1.70 elsewhere), and they must mention SD Cat. No. C13.46:906.

Image analysis. The Magicscan image-analysis system, a programmable, digital system for the analysis of TV images, is described in a 12-page brochure put out by Joyce-Lobel, Ltd., Princeway, Team Valley, Gateshead NE11 0UJ, England. Useful wherever quantitative assessment of visual objects is required—in particle-size analyses, in the making of measurements on aerial photographs, in the classification of biological cells, etc.—Magicscan has

sufficient built-in intelligence to extract the structural boundaries of features even when the boundaries are not well defined. [437]

Ultrasonic transducers. A line of ultrasonic transducers for use in nondestructive flaw-detecting equipment is described in an eight-page catalog put out by the Transducer

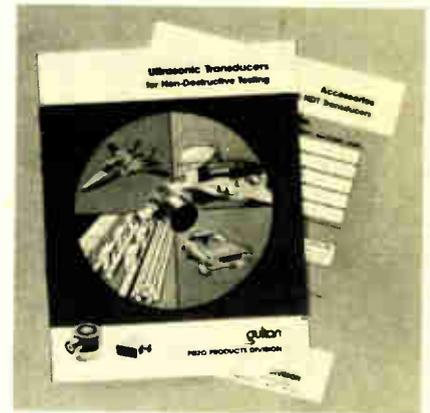

Phase Lock like you've

Separate modulation meter

100 Hz resolution with phase-lock

Wide deviation at all carrier frequencies

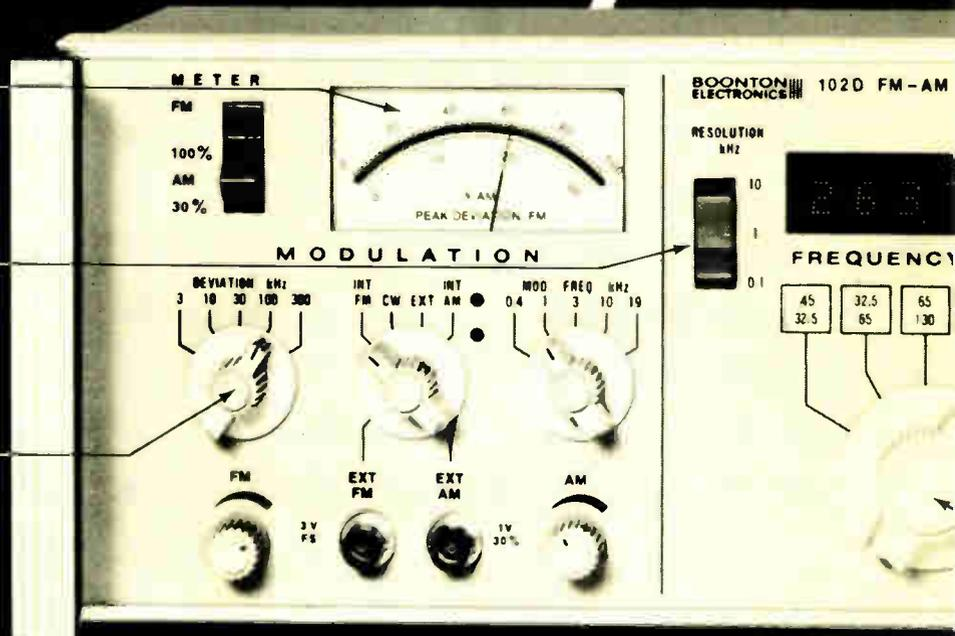

How do you make a great signal generator like our 102A better?

Simple—you not only extend the frequency range to cover 450 kHz to 520 MHz, but you make sure that the frequency you see is the frequency you get... exactly. (And virtually indefinitely.)

With the unprecedented phase-lock stability of this new model 102D, you can be as specific as you like. Simply lock-in the desired frequency with pushbutton ease to get a 6-digit display of the true locked output frequency with full 100 Hz resolution—even when the

vernier is used to tune between lock points. Phase-lock operates with either the stable internal TCXO or an external reference from your frequency standard or other generator.

No one else makes it that easy, even in generators selling for \$2100 more. But

Sales Dept., Piezo Products Division, Gulton Industries Inc., 300 S. State College Blvd., Fullerton, Calif. 92631 [434]

Power transistors. Lansdale Transistor and Electronics Inc., which recently purchased the germanium-manufacturing facilities of Motorola, has published a 16-page catalog that covers its line of germanium power transistors. Catalog No. 101 can be obtained from Lansdale Transistor and Electronics Inc., 600 W. 24th St., Tempe, Ariz. 85282 [433]

Iberian electronics. Names, addresses, and products of the significant electronics companies in the country are listed in the 1976 edition of "Electronics in Spain." The 118-page English-French-Spanish catalog covers both components and equipment. It is available free, upon

letterhead request, from Secartys, Avda. Jose Antonio 456, Barcelona 15, Spain

Components. A short-form catalog covering all of its components is offered by RCL Electronics division, AMF Inc., 700 South 21st St., Irvington, N.J. 07111. The 36-page guide supplies engineering information on precision and power wirewound resistors, miniature rotary switches, DIP switches, ladder networks, delay lines, knobs and accessories. [436]

Terminal boards. A 12-section catalog from Kulka Electric Corp., 520 South Fulton Ave., Mount Vernon, N.Y. 10551, gives data on the company's lines of terminal boards, blocks, and strips. The manual, which provides information on design, applications, and materials, covers standard boards, stud-and-turret units, wrapped-wire boards,

military devices, Quick Connect Kliptites, marker strips, surface and bottom termination hardware. Also included are details on the company's new series of thermoplastic components for printed-circuit boards. [438]

Filtering for signal processing. "The Application of Filters to Analog and Digital Signal Processing" is a 24-page book designed to provide all the information necessary for the effective employment of filters in signal-processing systems. The book uses Fourier-transform concepts to explain how proper filtering can improve signal-to-noise ratios and prevent aliasing in sampled-data systems. Available for \$3 from Rockland Systems Corp., 230 West Nyack Rd., West Nyack, N.Y. 10994, the book can be obtained free of charge, until Dec. 31, by circling reader service number [439]

never seen before.

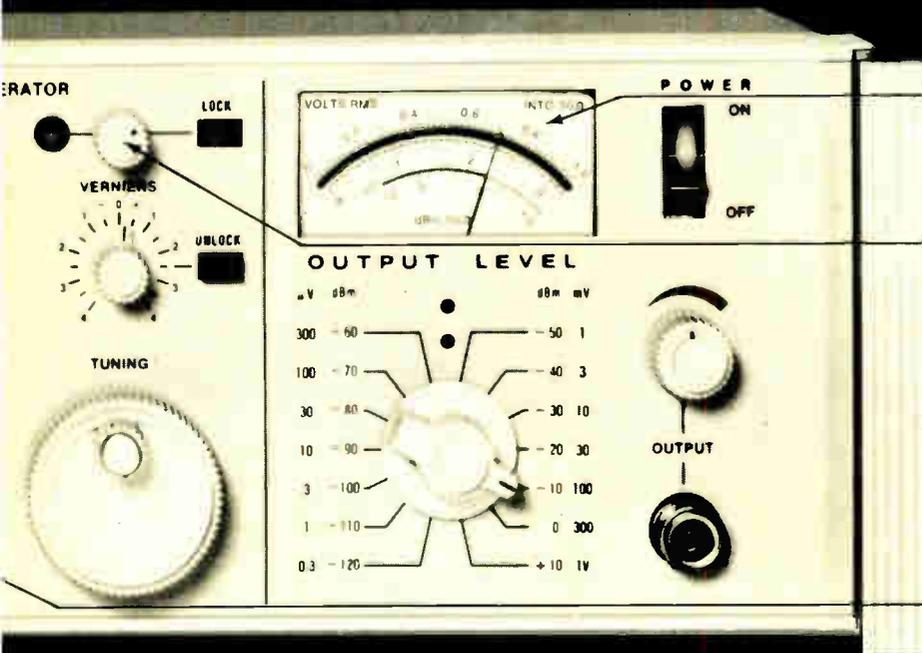

Separate output meter

Phase-lock with unique fine-tuning capabilities

Extended frequency range of 450 kHz to 520 MHz

if you think that's the only reason the 102D is right on the money, look again: At a panel control layout unmatched for easy-to-understand-and-use convenience; at the separate modulation and output meters; at the wide FM deviation unrestricted at low carrier fre-

quencies... and at all the other specs. Compare them against the competition's \$6400 unit, and see for yourself why our \$4295 domestic price-tag (\$3575 for the comparable 102C without phase-lock) is generating all the excitement today.

For complete data or a demonstration, write or call Boonton Electronics Corp., Rt. 287 at Smith Rd., Parsippany, N.J. 07054; tel. (201) 887-5110.

BOONTON

Circle 190 on reader service card

Talk to the 32,329 decision-makers in Japan's electronics industry.

翻訳

We'll furnish the language.

If you want to reach the most influential group of management and professional electronics engineers in Japan, we're certain you couldn't choose a more important medium than Nikkei Electronics. Or a more helpful one, either.

When you're thinking about selling to our 32,329 decision-makers, we offer you our full communications resources.

For instance, we'll translate your advertising message from English into the kind of Japanese that we know gets results from our readers. Then we'll set type for you. Also lay out the entire ad for you. And, wonder of wonders, there's no extra charge for these services.

Speaking the precise language of our very important readership is just one of the ways Nikkei Electronics gets more value for your yen in Japan.

As the bi-weekly product of Japan's largest business-economic newspaper and McGraw-Hill, Inc., we're by far the most-respected magazine in our field. (About

30% of our material is a translation of specialized contents from U.S. *Electronics*.)

As the only Japanese electronics magazine that's a member of the Japan Audit Bureau of Circulation, we can guarantee exclusivity as well as readability.

Our reader profiles are computer-controlled. The better to provide you with up-to-the-minute information on purchasing patterns, reader

analysis studies and proper market approaches.

And our Reader Information Service is a masterpiece of effectiveness. As many as 3,388 responses per issue, with 57.4% of the respondents acknowledging that they participate in or influence the purchasing decision of their companies.

Talk to the electronics decision-makers of Japan in our pages. We'll even furnish the language. Contact Mr H.T. Howland (in English), Marketing Services Manager, Electronics, McGraw-Hill Publications Company, 1221 Avenue of the Americas,

New York, N.Y. 10020. Telephone (212) 997-6642. Or talk to any member of McGraw-Hill's advertising sales staff in the U.S. or Europe, or contact us directly in Japan.



Nikkei Electronics: Ask anybody who can read us.

Classified section FOR ENGINEERING/TECHNICAL EMPLOYMENT OPPORTUNITIES

CLASSIFIED SALES REPRESENTATIVES
 Atlanta Jon Lane 404/892 2868
 Boston Holt Buchanan 617/262 1160
 Chicago Bill Higgins 312/751 3733

Cleveland Mac Huestis 216/781 7000
 Dallas Rick Olstie 214/742-1747
 Denver Shirley Kotz 303/837 1010
 Detroit Mac Huestis 313/873 7410

Houston Rick Olstie 713/659-8381
 Los Angeles Stan Kassir 213/487-1160
 New York Dave Hawksby 212/997 3594
 Philadelphia Dan Ferro 215/568-6161

Pittsburgh Dan Ferro 412/391-1314
 San Francisco Mary Kenny 415/362 4600
 Stamford Holt Buchanan 203/359 2860
 XEROX 100 TELECOPIER 212/997-6800

We have been placing graduate ENGINEERS
 in FEE-PAID positions THROUGHOUT THE U.S. since '59. Over 1,000 client companies. We are graduate engineers working full-time for you. Send resume & salary history today or request confidential application.
ATOMIC PERSONNEL, INC.
 Suite L 1518 Walnut St., Phila., Pa. 19102
 An Employment Agency For All Technical Fields

RF COMMUNICATIONS SYSTEMS ENGINEER

Must be experienced in all aspects of H/F voice and data system design. Need aggressive individual to assume project responsibility from proposal stage to installation and customer acceptance. Send resume and recent salary history to:

SUNAIR ELECTRONICS, INCORPORATED
 3101 S. W. 3rd Ave.
 Ft. Lauderdale, Florida 33315
 Attn: Personnel Dept.

Equal Opportunity Employer

POSITION VACANT

Faculty Position in Solid State Electronics—Applications are solicited for a senior faculty position in the Department of Electrical Engineering and Computer Science at M.I.T., rank and salary commensurate with qualifications. Duties include: teaching, thesis supervision and research in the area of integrated circuit technology or solid state devices, and expansion and improvement of an existing microelectronics laboratory. Applicants should preferably have had industrial experience in device development and should have an interest and ability to develop collaborative programs with groups at M.I.T. that seek to apply semiconductor technology to a variety of fields, e.g., computer technology, signal processing, biomedical engineering, and optical and microwave communications. Ability to work with industrial organizations is highly desirable. Previous teaching experience also desirable. Applications from women and minority professionals are encouraged. M.I.T. is an equal opportunity employer. Resumes should be sent to Professor Paul Penfield, Jr., Associate Department Head, Department of Electrical Engineering and Computer Science, Room 38-401, Massachusetts Institute of Technology, Cambridge, MA 02139. For further information, contact either Professor Penfield or Professor M.S. Dresselhaus, Chairman of Search Committee at above address.

POSITION WANTED

EE Graduate with 5 years reliability testing and analysis experience in a consumer's electronics industry. Write to PW-3563, Electronics.

LITTON
 Microwave Cooking

CONSUMER ELECTRONIC OPPORTUNITIES

Litton Microwave Cooking Products is the nation's leader in the manufacturing of microwave cooking products. Continuing growth within the field of microwave cooking systems has provided the following opportunities:

PROJECT MANAGER
 The successful applicant should have a BSEE or BSME with a minimum of 6 years of direct project management experience in electro-mechanical product design. Further, a strong background in electrical and electronic systems preferred, with the capability of functioning in a nonstandardized growth area. Promotional qualities are essential.

SENIOR ELECTRONIC ENGINEER
 The qualified individual should possess a BS or MS in electrical engineering with 4+ years of direct experience in solid state digital and analog circuit design with a minimum of 2 years design experience using microprocessors. In addition, the individual should have an in-depth familiarity with coding and programming of microprocessors with direct experience in industrial electronic applications.

PROJECT ENGINEER
 The successful candidate will have 4+ years of electrical-mechanical design in consumer products. Additional exposure in areas of program planning electronic and electrical systems design, functional documentation and preparation of programs and project exposure essential.

SENIOR DESIGN ENGINEER
 Successful candidate will have a BSEE in electronics with exposure to electronic digital display systems and logic memory systems with 3+ years of electronic design exposure, microwave design engineering helpful.

Litton Microwave Cooking is located in an attractive suburban setting, offering excellent living conditions, exceptional educational facilities and a variety of recreational and cultural attractions. If you are qualified for the above positions, please forward resume including salary history to:

T. L. Koenecke
LITTON MICROWAVE COOKING
 1405 Xenium Lane N.
 Minneapolis, Minn. 55440

We Are An Equal Opportunity Employer M/F

Litton... changing the way America Cooks.

ENGINEERING

Continuing expansion of our engineering activities has created 2 new opportunities.

MICROPROCESSOR ENGINEER with hardware experience in computer/peripheral interfaces, including microprocessors. Software background including assembly language programming is desirable.

SYSTEMS PROGRAMMER with knowledge of PDP 11 operating systems, especially RSK.

Contact Robert Masterson (216) 361-3315
GOULD INC.
 Instrument Systems Division
 3831 Perkins Ave., Cleveland, Ohio 44114
an equal opportunity employer

FREE Your dream job

We hope you're happy in your current position, but there's always that ideal job you'd prefer if you knew about it.

That's why it makes sense to have your resume on file in the Electronics Manpower Register, a computerized data bank containing the qualifications of career-conscious ELECTRONICS readers just like yourself.

You'll benefit from nation-wide exposure to industry firms privileged to search the system, and since the computer never forgets, if you match up with their job requirements you'll be brought together in confidence.

To take advantage of this free service, mail your resume to the address below. We'll do the rest.

ELECTRONICS MANPOWER REGISTER
 Post Office Box 900
 New York, N.Y. 10020

Engineering Professionals

San Francisco Peninsula

GTE Sylvania's Western Division of the Electronic Systems Group is on the move. Located in Mountain View, California, we are 1700 people deeply involved in a variety of technical projects and programs in Reconnaissance, EW and lasers. This division has a place for top professionals ready to take on the challenges and rewards in supervisory and non-supervisory positions. We have opportunities available now in the following disciplines:

- Signal Processing
- ELINT Systems
- Microprocessor Applications
- Security Systems—
Intrusion Detection Devices
- RF Systems
- Laser Products and Systems
- Real-Time Software Development
- Associative Data Base Management
- Computer aided Test
- Control Systems
- Power Supply Development

If you enjoy a professional attitude and a place to broaden and develop your knowledge, then we'd like to hear from you. You'll receive an excellent salary, great benefits package including tuition reimbursement, relocation assistance, and the opportunity for travel. U.S. Citizenship required. Please direct your inquiries in confidence to Dept. E-298, GTE Sylvania, P.O. Box 188, Mountain View, California 94040. An equal opportunity employer. M/F.

GTE SYLVANIA

Engineering

ELECTRICAL ENGINEERS R&D

Aggressive, growing manufacturer of data communication terminals has choice opportunities for experienced Electrical Engineers with a minimum of a BSEE degree to handle expanding Research and Development programs.

Strong background in computer software development or digital logic design required.

We offer attractive starting salaries plus participation in a liberal benefit program.

TELETYPE CORPORATION
 5555 Touhy Ave.
 Skokie, Ill. 60076

An Equal Opportunity Employer M/F

COMMUNICATIONS TECHNICIAN COOK INDUSTRIES

Cook Industries, a Memphis based Fortune 500 company, is seeking an individual interested in a career in communications. The candidate chosen will have a knowledge of fundamental electronics and experience as a computer field engineer or as a maintenance engineer with a communications company. Duties will include maintenance of an in-house corporate telecommunications network. The network consists of computer based voice switching, message switching and digital voice processing systems. Responsibilities will be primarily maintenance related with limited administrative duties. Occasional travel will be necessary. We offer a competitive salary, a complete fringe benefit package and excellent advancement opportunity. Please send resume detailing experience and salary requirements to:

Employment Manager
COOK INDUSTRIES
 P.O. Box 16902
 Memphis, TN 38116

EQUAL OPPORTUNITY
 EMPLOYER
 M/F

THIS SPACE AVAILABLE. ONLY \$230.

Your recruitment advertising in this five inch space will cost you only \$46 per inch, or \$230.

You'll reach over 68,000 domestic engineers and technical people, as they're reading to combat job obsolescence, while they're thinking about their future and bettering themselves.

There's no charge for typesetting and free layout service is provided. For more information, call or write:

Electronics

Post Office Box 900
 New York, N.Y. 10020
 Phone: 212/997-2556

Why your resume should be in the Electronics Manpower Register

Every engineer covets the job where he can contribute the most to his profession—and his family.

The Electronics Manpower Register, a computerized data bank containing the qualifications of career-conscious ELECTRONICS readers just like yourself, is our contribution to solving this problem of fitting the right engineer to the right job.

Here's how you'll benefit from having your resume on file:

- **It's absolutely free.** No charges or fees to you at any time.
- **The computer never forgets.** When your type of job comes up, it remembers you're qualified.
- **Service is nationwide.** You'll be considered for openings across the U.S.
- **Your identity is protected.** Your resume is carefully screened to be sure it will not be sent to your company or parent organization.

That's why it makes sense for you to take advantage of the Electronics Manpower Register. To do so, just mail your resume to:

ELECTRONICS MANPOWER REGISTER

P.O. Box 900
 New York, N.Y. 10020

ELECTRONIC ENGINEERS

Analog Circuit Design

Kearfott Division, the leader in aerospace navigation and guidance, has exciting ground-floor opportunities for experienced analog circuit designers. These assignments on the latest aerospace, aircraft and missile programs offer long-term stability, career growth and technical challenge.

BSEE required (MS preferred) together with in-depth experience in analog circuit design as well as a comprehensive knowledge of feedback theory. Additional experience in digital design and familiarity with design techniques and components applicable to micro-miniaturized system is necessary. A background in hybrid and/or nuclear hardened circuits an added plus.

Send resume including salary requirements in complete confidence to: **Mr. E. DeGennaro, Singer Company, KEARFOTT Division, 1150 McBride Avenue, Little Falls, N.J. 07424.**

SINGER
AEROSPACE & MARINE SYSTEMS

*An equal
opportunity
employer,
m/f
Who creates
opportunities*

Job-seekers... be the first to know with McGraw-Hill's Advance Job Listings

By having our weekly ADVANCE JOB LISTINGS sent to your home every Monday you can be the first to know about openings both in and out of your field. AJL will enable you to contact anxious recruitment managers BEFORE their ads appear in upcoming issues of 21 McGraw-Hill publications. To receive a free sample copy, plus information about our low subscription rates, fill out and return the coupon below.

ADVANCE JOB LISTINGS / P.O. BOX 900 / NY 10020

PLEASE SEND A SAMPLE COPY
OF ADVANCE JOB LISTINGS TO

NAME

ADDRESS

CITY

STATE/ZIP

Engineering Professionals

• SAN FRANCISCO PENINSULA •

If you're ready to take a positive step forward in your career, then investigate the exciting opportunities now available at GTE Sylvania on the San Francisco Peninsula. Find out why other top professionals continue to carve their careers with us. Current openings include:

RF Equipment Task Manager

You will have prime responsibility for customer interface regarding RF hardware equipment on a major program. You will monitor the design, development and test for a broad range of RF receiving and analysis equipment, requiring knowledge of receiver synthesizer and demodulator design and digital interface control equipment. Must have BS MSEE and 5-7 years' applicable experience. Respond to Dept. E-315.

RF Electronic Equipment Design

Qualified candidates will perform circuit design for receivers from HF through 1000 MHz. This includes audio and video amplifiers, oscillators, both voltage controlled and crystal, filters of all types, and overall receiver design. You should have a BSEE plus a minimum of 4 years' experience in a majority of the areas listed above. Respond to Dept. E-316.

Microwave Component Design Engineers

Design and develop microwave components such as filters, diplexers, multiplexers, and solid state amplifiers utilizing stripline microstrip and coaxial transmission mediums. Requires BS MSEE plus 3 or more years' directly applicable microwave design or development experience. Respond to Dept. E-317.

Control Systems Engineers

Excellent opportunity to design and develop subsystems and/or units and related equipment based on the application of closed loop control theory as well as general electro-mechanics and electronics. Requires BSEE/MS preferred. Respond to Dept. E-318.

Power Supply Specialist

Use your expertise in the design of all types of power supplies covering wide range of current and voltage and manner of control. Must be strong theoretician competent in closed loop analysis and CAD techniques. MSEE plus 8-12 years' in electronic design with last 5 years' directly related to power supplies. Respond to Dept. E-319.

Expand your career today, and expect an informal yet professional environment where meaningful challenges, excellent starting salaries and a wide range of benefits await you. For immediate consideration, please forward your resume with salary history/requirements and department number of interest to P.O. Box 188, Mountain View, California 94040. An equal opportunity employer M/F.

GTE SYLVANIA

Vector Wrap-N-Strap Wire Wrapping Tools Are More Versatile- Cost Less Than Most Others

Dual-purpose manual tools that fit power wrappers for faster action

Wrap-N-Strap right or left hand or unwrap right or left with same unwrap tool

Daisy-chain bare wire bussing or conventional wrapping from just a single tool



MANUAL WRAPPER P160-2A \$7.95

P160-4R POWER WRAPPER \$45.68 Rechargeable

SHOWN WITH P160-2A INSTALLED
NEW! 110V, power tool also available

Single combination tool P160-9 wraps AND unwraps 26 - 30 ga. wire

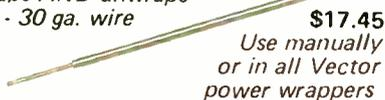

\$17.45

Use manually or in all Vector power wrappers

Unwrap right or left hand wraps with same tool. Dual-way P160-1A Unwrapper - \$9.50



Hooded spring-loaded tip coils and ejects unwrapped wire

Model P160-2A-1

Wraps right or left hand rotation.

\$12.45

Wraps standard insulated wire, or spooled bare wire with equal reliability and ease

Buy and stock only half the parts because Vector's exclusive tool design eliminates wrapping shells. Only two bits required to wrap 26 to 30 ga. wire on .025"/.028" posts, and 22 to 26 ga. wire on .045" sq. or .031" x .062" size posts.

New revolutionary P180 Slit-N-Wrap tool now available to wrap thin but tough insulated wire 3 times faster than conventional tools.

\$24.50



Vector

ELECTRONIC COMPANY, INC.
Dept. WS, 12460 Gladstone Avenue
Sylmar CA 91342
(213) 365-9661 - TWX (910) 496-1535

48876

Electronics advertisers

November 11, 1976

• Adrel Electronique	47E	‡ Eastman Kodak Company Graphics Division	6
‡ Advanced Micro Devices	10-11	• E.J.P. Inc.	2E, 3E
• Ailtech	20E	Electronic Arrays	57-60
■ Airpax Electronics	146	Electrol	153
Allen Bradley Company	24	Electronic Measurements Inc.	156
• Allen Bradley Electronics Ltd	10E, 11E	Electronic Navigation Industries	3rd Cover
■ AMP Incorporated	140, 141	Elgar Corporation	136
Analog Devices Inc.	177	Elong Electronorgtechnica	184
Anslay Electronics Corp.	71	• English Electric Valve Company Ltd.	16E, 17E
AP Products Incorporated	176	Fairchild Semiconductor Inc.	62, 63
• Bayer AG	39E	Faultfinders Inc.	142
‡ Beckman Instruments Inc. Helipot Division	48	■ Ferranti Packard	40
Bell, F.W.	149	Fibra Sonics Inc. Division of C.E. Niehoff	144
B & K Precision Division Dynascan Corporation	145	Figaro Engineering Inc.	197
Boonton Electronics	190-191	Florida Department of Commerce	168
■ Bourns Inc.	4th Cover	■ John Fluke Mfg. Co., Ltd.	122-123
• Burr Brown Research Inc.	19E	■ Frequency Devices Inc.	197
‡ Bussman Mfg. Division of McGraw Edison Co.	35	General Electric, Optoelectronics Div.	39
California Computer Products	162	General Electric Semiconductor Products Department	13
Cambridge Thermionic Corporation	52	General Instrument Corporation, Microelectronics Division	37
• Capital Calculator Co.	198, 18E	• General Instrument Corporation, Semi. Comp. Division	18
• Carlo Erba	35	• Gould Advance	26E, 27E, 29E
Centronics	150, 151	Grayhill Inc.	38
■ Cherry Electrical Products Inc.	119	Gulf Power Company	197
Chicago Miniature Lamp Works	160	Harris Semiconductor	74-75
Chomerics Inc.	16	■ Hewlett-Packard	2, 1, 2nd Cover, 154
C&K Components	173	• Hi G D'Italia	32E
• Communication Associates Inc.	61	■ Hughes Aircraft Company	33
Communications Transistor Corporation	161	Hutson Industries	180
Continental Rentals	8	Intel Corporation	20, 21
Continental Specialties Corporation	175	■ Interface Inc.	189
Corning Glass Works Fluidic Products Department	104	• International Devices, Inc.	24E
• C. P. Clare International N.V.	5E	■ International Rectifier Corp., Semi. Div.	130, 131
C. P. Clare & Company	185	Interstate Electronics Corp.	143
• Dale Electronics Inc. A Subsidiary of Lionel Corporation	14E, 15E	• Italtel/SIT	33E, 37E
Dana Laboratories	182	■ Ithaco, Inc.	147
Data General Corporation	27	■ Johanson Manufacturing Corporation	19
■ Data Precision	157, 32E	Keithley Instruments	84, 85
Delco Electronics Division General Motors Corporation	44-45	Krohn Hite Corporation	5
Delta Air Lines	8	Lemosa	42E
Deltec	164	LFE Corporation Process Control Division	169
■ Dialight Corporation	134	‡ Licon Division of Illinois Tool Works Inc.	61
Digital Equipment Corporation (OEM)	64-65	LSI Computer Systems	183
Dolch GmbH	188	‡ LXD Liquid Crystals	17
Dow Corning Corp., Industry Div.	120, 121	• LTT	21E
Duncan Electronics (Division of Systron Donner)	137	• Magneti Marelli	6E
		Magnetic Shield	168



ACTIVE FILTERS

Low Pass • High Pass
Band Pass • Band Reject
0.001 Hz to 50 kHz

FIXED FREQUENCY RESISTIVE TUNEABLE

F.D.I. also manufactures
Sinewave Oscillators, Tone Encoders,
Tone Detectors and other
Communications Products

Frequency Devices Inc.
25 Locust Street
Haverhill, Mass. 01830

(617) 374-0761/TWX 710-347-0314

Circle 197 on reader service card

Gas Sensing Semiconductor

FIGARO GAS SENSOR

TGS quickly senses even small amount of gas.

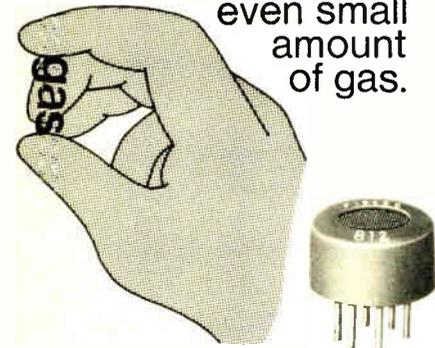

New Models,

some with highly sensitive CO sensor, now on the market.

Please contact the address below directly for catalogs and price/delivery information

FIGARO ENGINEERING INC.

3-7-3, Higashitoyonaka, Toyonaka City, Osaka 560.
Japan/Tel (06) 849-2156

Cable FIGARO TOYONAKA/Telex 05286155 FIGARO J

Circle 235 on reader service card

• Marconi Instruments	18
• Marconi Instruments Ltd.	43E
Micro Switch Division of Honeywell	81
Micro Technical Industries	184
Microwave Assocs. Inc.	132
Miller Stephenson Chemical Inc.	171
3M Electronics Division	128
• Molex (International) Incorporated	8E, 9E
• Monsanto Company	48
Mostek Corp.	82-83
• National Semiconductor Corporation	46-47
National Tel-Iconics	174
Neff Instruments Corp.	72
• Nikkei Electronics	192
• Nortron	13E
• Nuovo Pignone Division "Sistemi di Automazione"	46E
OAK Industries Inc. Switch Division	124, 125
OK Machine & Tool Company	183
Optron, Inc.	14
• Oscilloquartz	4E
• Philips Electrológica	54
Philips Test & Measuring Instruments Inc.	138, 139
• Phoenix Data Inc.	146
• Piezo Technology Inc.	178
• Powermate	166
• Procond S.p.A.	31E
Projects Unlimited Inc.	189
• Recal Thermionic Ltd.	23E
Radio Research Instrument Corporation	176
RCA Solid State Division	42, 43
• Rental Electronics Inc.	54
Reticon Corporation	77
• Rhone Poulenc	41
• Riifa	40E
Robinson Nugent Inc.	66, 67
• Rohde & Schwarz	1E
Rotron Incorporated	117
San Jose Chamber of Commerce	159
• Schlumberger	12E
• SDSA	41E
• SECI Divisione Componenti	34E, 35E
• Secme	44E
• S.E. Labs. (EMI) Ltd.	25E
• Sefram	44E
• Seimart	17
Semtech Corporation	135
• Seps S.p.A	22E
• Sternice	52
SGS Ates	165
• Shell Intern'l Chemical Co. Ltd.	38E

A great place to start expanding your company is right here.

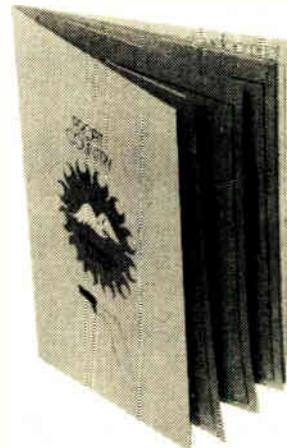

Our 16 page book talks about the labor force, about deep water ports, about utilities, temperatures, taxes. There's everything here from financing to flying times, from industries to schools—all the things that make Northwest Florida one of the most profitable, most livable business climates in the country. And it's free.

Gulf Power Company
Manager, Area Development
Department D-8
P. O. Box 1151
Pensacola, Florida 32520
Please send me your book.

Name

Title

Company

Address

City

State

Zip

Circle 236 on reader service card 197

**PROFESSIONAL
DISCOUNT
PRICES
AVAILABLE ON**



Texas Instruments Engineering Calculators

**PHONE TOLL-FREE
800-638-8906**

**FOR THE CURRENT LOW DISCOUNT PRICE
OF THE LATEST MODEL TEXAS
INSTRUMENTS CALCULATOR OF
YOUR CHOICE**

Texas Instruments SR-52



Programming power from Texas Instruments. Easy hand held programming for scientists, engineers, students — anyone who works with advanced mathematics. Check these features: 224 program locations, 20 addressable memory registers, 23 pre-programmed key functions, indirect addressing, permanent program storage on magnetic cards.

Texas Instruments SR-56



More power from Texas Instruments. Hand held key programmable calculator, 100 program steps, 5 program levels (up to 4 levels of subroutine may be defined). Easy single step editing. Main features include 26 preprogrammed key functions, 10 addressable memory registers, algebraic logic and 9 levels of parentheses.

PC-100

Lock down printer; for a hard copy of your results; step by step listing of programs, or "debugging" programs. The PC-100 printer may be used with the SR-56 or SR-52.

OTHER MODELS AVAILABLE

SR-50A, SR-51A, TI 255011, TI 250011, TI 5100

**ALL THE FAMOUS
TEXAS INSTRUMENTS
ELECTRONIC CALCULATORS
ARE AVAILABLE AT DISCOUNT PRICES**

Mail and phone orders accepted. Master Charge and BankAmericard accepted. Add \$2.50 per unit for shipping and handling. Maryland residents add 4% sales tax.

Use our toll free phone: 800-638-8906 (Maryland residents phone: (301) 340-7200) to order or for current discount quotations on the leading brands of electronic calculators: Texas Instruments, Hewlett-Packard, Rockwell, Ricoh, Kingspoint, Corvus, Novus, and many more.

THE GUARANTEE

10 day money back trial. If you are not completely satisfied you may return the Texas Instruments calculator you order within 10 days for a cash refund or charge cancellation. In addition Texas Instruments Inc. and Capital Calculator Co. Inc. warrant each calculator for a period of one year against defective parts and workmanship.

Capital Calculator Company

**701 East Gude Drive
Rockville, Maryland 20850**

• Skylab Srl	30E
• Sodeco	48E
Sorensen	7
Spectrol Electronics Corp.	15
Spectronics Inc	152
Spectrum	170
SPI-ITT	187
Sprague Electric Company	51
■ Sprague Goodman Electronics Inc.	166
• Stettner & Co.	40E
Synertek	9
Systron Donner Concord Instrument	158
• TEAC Corp.	185
Technit	180
Tecnetica	79
Teletype	179
Telenetia, Inc.	182
Teradyne Inc.	68
Thermometrics	163
T-K Enterprises	184
Trio Laboratories	181
Ultra-Violet Products, Inc.	174
TRW Semiconductor	167
Turner Designs	189
Unitrode Corporation	28
U.S. Capacitor Corporation	126
Vacuumschmelze	188
Vactec Inc.	155
Varo Semiconductor Inc.	148
Vector Electronics Company Inc.	196
Vitron Inc.	172
Wakefield Engineering Inc.	158
• Wandel und Goltermann	39
• Wavetek Indiana Inc.	102
• Wilmot Breeden Electronics Ltd	45E
Wintek Corp.	180
Yellow Springs Instrument Corp	164
Yutaka Electric Co.	178
• Yokogawa Electric Works Ltd.	161
Zilog	22, 23

Classified and employment advertising

F. J. Eberle, Manager 212-997-2557

Atomic Personnel Inc.	193
Cook Industries	194
GTE Sylvania	194, 195
Gould Inc.	193
Litton Microwave Cooking	193
Singer Kaertott	195
Sunair Electronics Inc.	193
Teletype Corp.	194

- For more information of complete product line see advertisement in the latest Electronics Buyers Guide
- Advertisers in Electronics International
- ‡ Advertisers in Electronics domestic edition

Advertising Sales Staff

Atlanta, Ga. 30309: Glen N. Dougherty
100 Colony Square, 1175 Peachtree St., N.E.
[404] 892-2868

Boston, Mass. 02116: Frank Mitchell
607 Boylston St. [617] 262-1160

Chicago, Ill. 60611
645 North Michigan Avenue
Robert W. Bartlett (312) 751-3739
Robert M. Denmead (312) 751-3738

Cleveland, Ohio 44113: William J. Boyle
[716] 586-5040

Dallas, Texas 75201
2001 Bryant Tower, Suite 1070
[214] 742-1747

Denver, Colo. 80203: Harry B. Doyle, Jr.
123 Speer Blvd. #400
[303] 837-1010

Detroit, Michigan 48202: Robert W. Bartlett
1400 Fisher Bldg.
[313] 873-7410

Houston, Texas 77002: Paul Reiss
601 Jefferson Street, Dresser Tower [713] CA 4-8381

Los Angeles, Calif. 90010: Robert J. Rielly
Bradley K. Jones, 3200 Wilshire Blvd., South Tower
[213] 487-1160

New York, N.Y. 10020
1221 Avenue of the Americas
Warren H. Gardner [212] 997-3617
Michael J. Stoller [212] 997-3616

Philadelphia, Pa. 19102: Warren H. Gardner
Three Parkway,
[212] 997-3617

Pittsburgh, Pa. 15222: Warren H. Gardner
4 Gateway Center, [212] 997-3617

Rochester, N.Y. 14534: William J. Boyle
9 Greylock Ridge, Pittsford, N.Y.
[716] 586-5040

San Francisco, Calif. 94111: Don Farris
Robert J. Rielly, 425 Battery Street,
[415] 362-4600

Paris: Alain Offergeld
17 Rue-Georges Bizet, 75116 Paris, France
Tel: 720-73-01

Geneva: Alain Offergeld
1 rue du Temple, Geneva, Switzerland
Tel: 32-35-63

United Kingdom & Scandinavia: Robert Ghey
Tel: 01-493-1451, 34 Dover Street, London W1

Scandinavia: Andrew Karnig and Assoc.
Kungsholmsgatan 10
112 27 Stockholm, Sweden
Tel: 08 51 68 70 Telex: 179 51

Milan: Luigi Rancati
1 via Baracchini, Italy Phone 86-90-656

Brussels: Alain Offergeld
23 Chaussee de Wavre
Brussels 1040, Belgium
Tel: 13-73-95

Frankfurt/Main: Fritz Krusebecker
Liebigstrasse 27c, Germany
Phone 72 01 81

Tokyo: Tsumi Katagiri, McGraw-Hill
Publications Overseas Corporation,
Kasumigaseki Building 2-5, 3-chome,
Kasumigaseki, Chiyoda-Ku, Tokyo, Japan
[581] 9811

Australia: Warren E. Ball
IPO Box 5106, Tokyo, Japan

Business Department

Thomas M. Egan,
Production Manager [212] 997-3140

Gayla Black
Production Manager [212] 997-2044

Carol Gallagher
Production Manager International
[212] 997-2045

Dorothy Carter
Production Manager Domestic
[212] 997-2908

Frances Vallone
Reader Service Manager
[212] 997-6057

Electronics Buyers' Guide

H.T. Howland, General Manager
[212] 997-6642

Regina Hera, Directory Manager
[212] 997-2544

Gayla Black, Production Manager
[212] 997-2044

Classified and Employment Advertising

Frank Eberle, Manager
[212] 997-2557

FEATURE ARTICLES FROM *ELECTRONICS* AVAILABLE IN REPRINT FORM

No. of
copies
wanted

New reprints

- ___ R-612 Fiber-optic communications special report 24 pp \$3.00
- ___ R-610 Special report on hybrid-circuit technology 19 pp \$3.00
- ___ R-606 Special issue—microprocessors \$4.00
- ___ R-600 World market report 1976 24 pp \$5.00
- ___ R-526 How reliable are today's components 16 pp \$3.00
- ___ R-524 Special report on bipolar large-scale integration 12 pp \$3.00
- ___ R-522 Special report on power semiconductors 12 pp \$3.00
- ___ R-512 Design of circuits for dangerous environments 4 pp \$3.00
- ___ R-510 Bipolar integration advances with μ L microprocessor 8 pp \$2.00

Charts

- ___ R-516 Electronic symbols \$2.00
- ___ R-211 Electromagnetic spectrum (16-page report and chart) \$4.00
- ___ R-326 Optical spectrum (6-page report and chart) \$3.00

Books

- ___ R-608 Basics of Data Communications—Electronics Book Series \$12.50
- ___ R-602 Large Scale Integration—Electronics Book Series \$9.95
- ___ R-520 Microprocessors—Electronics Book Series \$8.95
- ___ R-011 Computer-aided Design 135 pp \$4.00
- ___ R-032 Active Filters 88 pp \$4.00
- ___ R-031 Circuit Designer's Casebook 182 pp (U.S. only) \$5.50 (foreign) \$12.00

Other Reprints

- ___ R-518 Special issue—productivity \$4.00
- ___ R-514 Eight ways to better radio receiver design 6pp \$3.00
- ___ R-508 Designing microprocessors with standard logic devices 12pp \$3.00
- ___ R-506 The case for component burn-in 7 pp \$2.00
- ___ R-434 Designing automated systems with the new standard interface 12 pp \$3.00
- ___ R-432 An update on communications satellites 8 pp \$2.00
- ___ R-430 Choosing the right bipolar transistor model for computer-aided design 20 pp \$3.00
- ___ R-428 Designing with low-cost lasers 6 pp \$2.00
- ___ R-504 U.S. forecast 1975 20 pp \$3.00
- ___ R-502 European forecast 1975 20 pp \$3.00
- ___ R-500 Japanese forecast 1975 16 pp \$3.00
- ___ R-426 Special issue—technology update 1974 \$4.00
- ___ R-424 Microprocessor applications 28 pp \$3.00
- ___ R-422 A microprogrammable mini-computer 8 pp \$2.00
- ___ R-420 Computerized text-editing and typesetting 8 pp \$2.00
- ___ R-418 Computer analyses of rf circuits 8 pp \$2.00
- ___ R-416 Optical waveguides look brighter 8 pp \$2.00
- ___ R-414 The ion-implanted n-channel process 6 pp \$2.00
- ___ R-412 Liquid cooling of power semiconductors 6 pp \$2.00
- ___ R-410 Special report on passive components 16 pp \$3.00
- ___ R-408 Bringing sight to the blind 8 pp \$2.00
- ___ R-406 Designing with the new logic, C-MOS and bipolar 16 pp \$3.00
- ___ R-328 Special issue—pervasiveness of electronics \$2.00
- ___ R-324 Semiconductor memories are taking over data-storage applications 16 pp \$3.00
- ___ R-322 Special report: new displays complement old 10 pp \$2.00
- ___ R-320 Special report on designing with flat cable 14 pp \$3.00
- ___ R-318 Special report on auto electronics 16 pp \$3.00
- ___ R-316 Hybrid circuits solve tough design problems 16 pp \$3.00
- ___ R-312 Leadless, pluggable IC packages reduce costs 7 pp \$2.00
- ___ R-310 Penetration color tubes are enhancing information displays 6 pp \$2.00
- ___ R-308 Program for transition from nonlinear to linear transistor model 6 pp \$2.00
- ___ R-306 Charge-coupling improves its image, challenging video camera tubes 8 pp \$2.00
- ___ R-209 Semiconductor RAMs land computer mainframe jobs 15 pp \$2.00
- ___ R-207 Technology gap starts to close for computer peripherals 16 pp \$3.00
- ___ R-205 Bridging the analog and digital worlds with linear ICs 16 pp \$3.00
- ___ R-113 Optoelectronics makes it at last 34 pp \$4.00
- ___ R-104 The new concept for memory and imaging: charge-coupling 12 pp \$2.00
- ___ R-023 Special report on tomorrow's communications 32 pp \$3.50

Payment must accompany your order

Make check or money order payable to Electronics Reprints. All orders are shipped prepaid by parcel post. Allow two to three weeks for delivery.

Back issues now available:
1960 to 1969, \$5.00 each
1970 to 1973, \$3.00 each
1974 to 1975, \$4.00 each

USE THIS PAGE AS YOUR ORDER FORM

Cost of orders \$ _____
Plus 10% handling charge \$ _____
TOTAL AMOUNT ENCLOSED \$ _____

SEND REPRINTS TO

Name _____
Company _____ Dept. _____
Street _____
City _____ State _____ Zip _____

Mail your order to:
Janice Austin
ELECTRONICS REPRINTS
P.O. Box 669
Hightstown, N.J. 08520

Advertisers: Reserve space now for two special issues of Electronics

These two issues will generate unusual interest.
They will be kept for reference.
Your advertising will get extra attention initially,
then receive frequent exposure throughout the year.

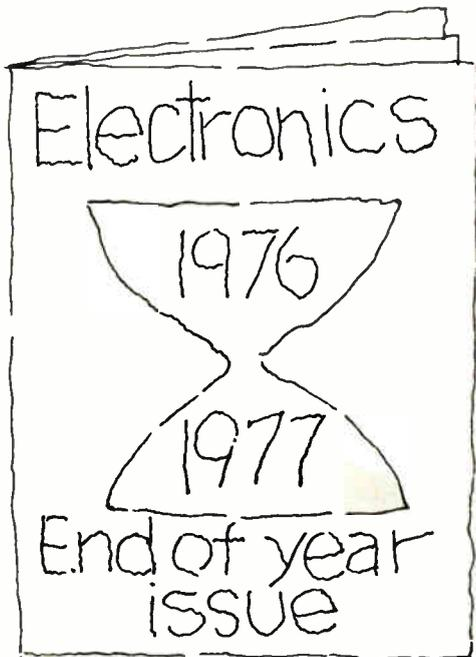

DECEMBER 23, 1976
Closes November 29, 1976

Features a special report on testing microprocessors, in response to pressing needs of engineers for better methods of evaluating and debugging microprocessors. A second special feature in the same issue is *Outlook For 1977*. This feature consists of exclusive interviews with key executives of the electronics industries on their economic and technological outlook for the new year, including problems their companies will face.



JANUARY 6, 1977
Closes December 13, 1976

Since 1968, Electronics' forecasts of world markets have been an indispensable planning tool for engineering management. Input is compiled from major electronics companies, key executives, trade associations, government businesses, and private market research firms. Result: the only public worldwide markets analysis in the electronics industries—saved and used by executives involved in planning.

Contact your Electronics salesman today for space reservations.

Electronics Magazine 1221 Avenue of the Americas, New York, New York 10020



Tomorrow ideas today.



Using solid-state technology to replace bulky tube-type equipment, ENI's broadband amplifiers are tomorrow ideas available today. ENI's Class A power amplifiers already cover the frequency spectrum of 10 kHz to 1 GHz, with power outputs ranging from 300 milliwatts to over 4000 watts. And we're still climbing. Driven by any signal generator, frequency synthesizer or sweeper, ENI's compact portable amplifiers are completely broadband and untuned. Amplifying inputs of AM, FM, SSB, TV and pulse modulations with minimum distortion, these rugged units are

versatile power sources for general laboratory work, RFI/EMI testing, signal distribution, RF transmission, laser modulation, data transmission, NMR, ultrasonics and more. Designed to be unconditionally stable and failsafe (impervious to severe load conditions including open or short circuit loads), ENI power amplifiers will deliver their rated power to any load, regardless of match. For information write: ENI, 3000 Winton Rd. So., Rochester, New York 14623. Call 716-473-6900. TELEX 97-8283 ENI ROC.

ENI

World's Leader in Solid State Power Amplifiers

Circle 901 on reader service card

World Radio History

the **DIP** **HIGH** **SIP**

Now in the only full line of super low profile SIP Resistor Networks.

If you haven't designed in Single In-line Package resistor networks because of their high profile, take another look. THE HEIGHT ON BOURNS SIPs IS ONLY .190 INCH! And that's standard for all 6, 8 and 10 pin configurations with:

- 5, 7 or 9 resistors and 1 common pin
- 3, 4 or 5 isolated resistors
- 12 resistors, dual terminator (8 pin)

Now you can fit the same number of resistors into less area and yet maintain close P.C. Board spacing. Something you can't do when using other SIP networks with .250 or .350 inch high profiles.

And only Bourns SIPs offer the same reliable Krimp-Joint™ lead termination design as our DIP packages, high-copper alloy leads and uniform molded package design. With added features like MACHINE INSERTABILITY, COMPETITIVE PRICING AND DISTRIBUTOR AVAILABILITY —

Why specify other than Bourns?

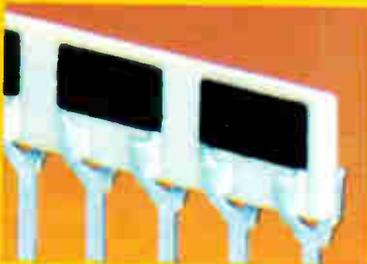

Bourns Krimp-Joint™ offers both a mechanical and electrical bond that lap or butt joint construction can't provide. The lead is crimped on the network element and a high-temp, reflow-resistant solder is used to prevent failure during wave soldering and in circuit thermal cycling and vibration.

FREE SIP and DIP SAMPLES!

Write on your company letterhead and let us know your requirements, we'll rush you a SIP or DIP resistor network sample and complete specifications.

TRIMPOT PRODUCTS DIVISION, BOURNS, INC., 1200 Columbia Avenue, Riverside, California 92507. Telephone 714 781-5415 — TWX 910 332-1252.

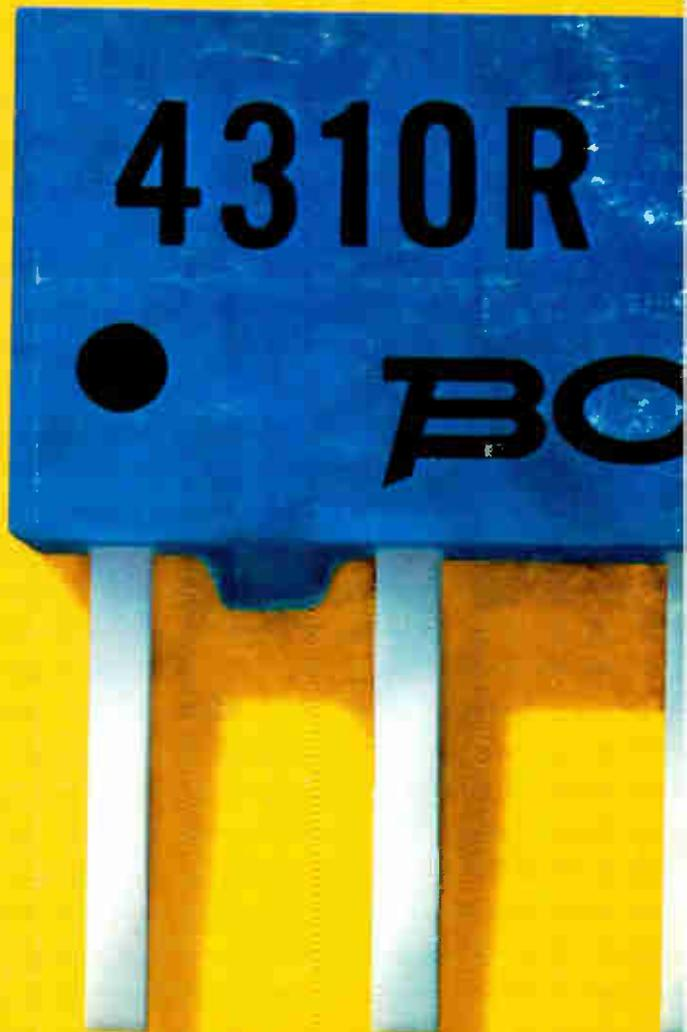

Int'l Sales Offices: European Hdqtrs. — Switzerland, 042/23 22 42 • Belgium 02/218 2005 • France 01/2039633 • Germany 0711/24 29 36
• Italy 02/32 56 88 • Netherlands 070/88 93 18 • United Kingdom 01/572 6531 • Japan 075 92 1121 • Australia 86 9410 • Brazil 257-3535

Circle 902 on reader service card