

APRIL 28, 1977

RIVAL TECHNOLOGIES VIE FOR PLACE ON CITIZENS' BAND CHIPS/77

How to design the new 16-k dynamic RAMs into memory systems/115

PRODUCT UPDATE: LSI enhances counter performance/130

FOUR DOLLARS A MCGRAW-HILL PUBLICATION

Electronics®

97232
MAY 1977
CLACKAMAS
PORTLAND OR

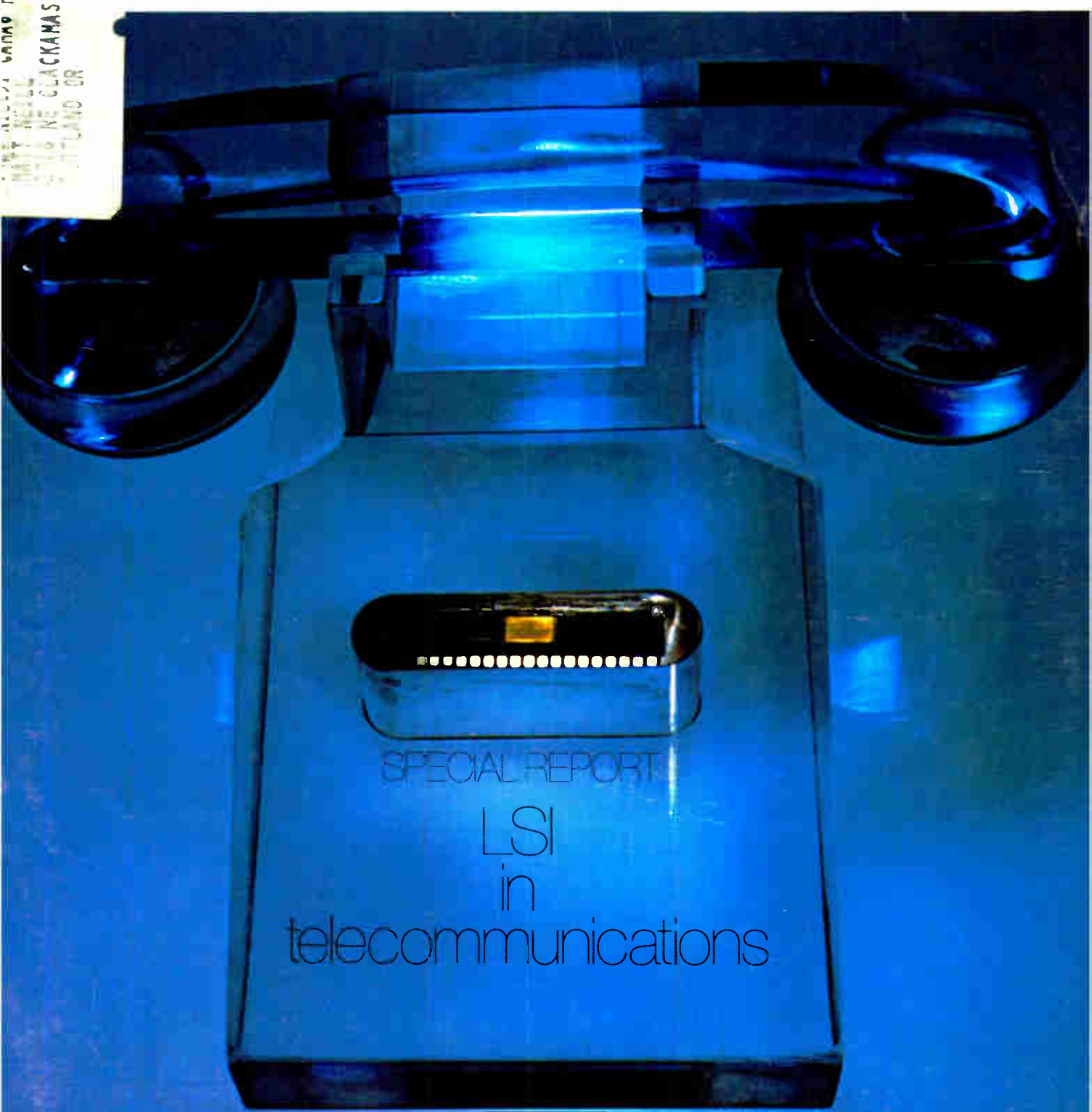

SPECIAL REPORT
LSI
in
telecommunications

HP quality, convenience and low prices mean big value in DMM's.

\$225*—The HP 3476A—3½ Digits—Autoranging, automatic polarity and automatic zero make the 3476 a big value. It's a convenient size to hold in your hand or carry in your briefcase. Just \$225* for the "A" version for AC line operation in your lab or \$275* for the portable "B" version (with built in batteries and recharging circuit).

\$375*—The HP 970A—3½ Digits—Handheld, autoranging, automatic polarity and zero, the 970 is totally self-contained and totally convenient. And the readout can be inverted with a flick of your thumb for easy reading. On the job measurement has never been easier.

\$400*—The HP 3435A—3½ Digits—Autoranging or manual operation and wide-range operation, plus built-in batteries and recharging circuits bring you laboratory

accuracies and portability in the same unit. If you don't need battery operation, option 001 gives you line operation only for just \$335*.

\$500*—The HP 3465B—4¼ Digits—1μV sensitivity gives you performance you'd normally expect from a 5½-digit multimeter. Fully portable too, with its own nickel-cadmium batteries and recharging circuit. Dry-cell operation and a rack-mount version are available in the 3465A for as low as \$425*.

Confidence in low-cost DMM's comes from knowing you've made the right decision. HP's quality and service give you assurance. Contact your local HP field sales engineer or write today for more information.

*Domestic U.S.A. price only.

**HP DMM's...
the right decision.**

097/42



Circle 900 on reader service card

HEWLETT **hp** PACKARD

1507 Page Mill Road, Palo Alto, California 94304

For assistance call Washington (301) 948-6370 Chicago (312) 255-9800 Atlanta (404) 955-1500 Los Angeles (213) 877-1282

World Radio History

SURPRISE!

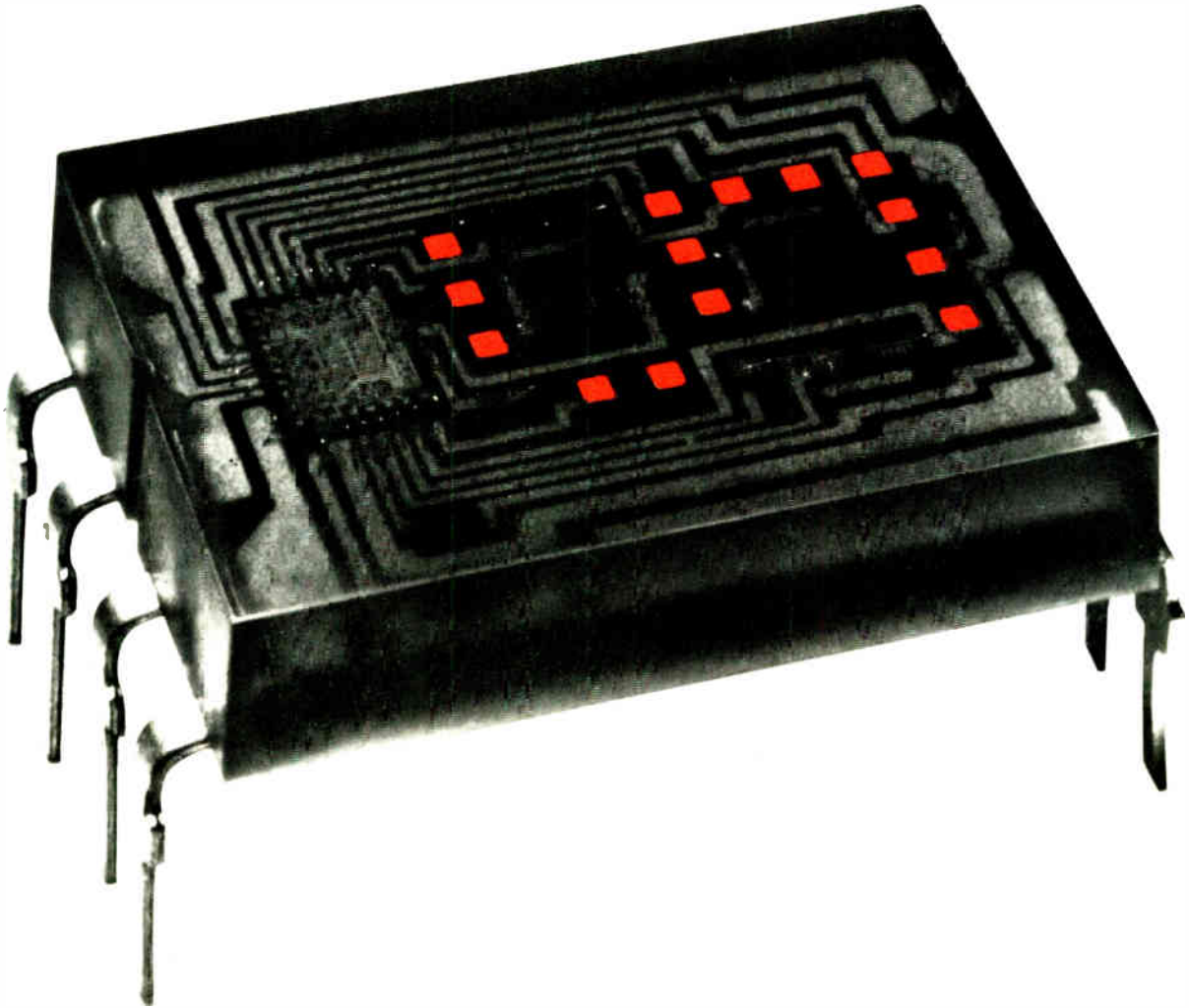

We built in the decoder/driver so you don't have to.

Not only the decoder/driver but memory too!

HP's family of integrated displays was designed with an on-board IC to save you time and up to 50% of the space required by conventional LED display systems. These bright 0.29 inch high, shaped character displays are completely TTL compatible. All you do is address them directly with four-line BCD input.

HP's 5082-7300 series displays include numeric displays with right- or left-hand decimal points, a hexadecimal display (0-9, A-F), and a " ± 1 " polarity overflow indicator.

For immediate delivery of any quantities you need, call Hall-Mark, Schweber, Wilshire, or the Wyle Distribution Group (Liberty Elnar) today.

01329A

HEWLETT  PACKARD

Sales, service, and support in 172 centers in 65 countries.



Instrument as shown has pulse-burst option and optional handles.

CMOS parametric testing makes special demands... Meet them with HP's 8015A Pulse Generator.

This pulse generator has standard features and options that make it ideal for MOS and CMOS parametric testing. For example:

You get dual-channel outputs, each variable to 16V. Or, they combine into a single 30V channel adjustable within a $\pm 16V$ window. That versatility makes the 8015A compatible with CMOS, and most MOS devices. You can delay channel B with respect to A for generating 2-phase nonoverlapping clocks. And combine the adjustable B delay with A + B to generate three-level signals.

Selectable source impedance on both channels lets you choose the best output termination configuration for your application. Of course you can vary the width (10ns to 1s), transition time (6ns to 0.5s), and rate (1Hz to 50 MHz). High-speed capability lets you work with advanced TTL and HTL logic as well as MOS. And low rep. rates or manual operation let you slowly step through logic states.

The 8015A options makes CMOS testing even easier. Pulse Burst (option 002) eliminates conventional gating problems. Just set the exact number of pulses you want (from 1 to 9,999) on thumb-wheel switches. That's exactly the number you get... independent of pulse-rate settings.

Upper Output Level Tracking (option 006) automatically keeps clock and data-pulse amplitudes at the proper level relative to the supply voltage. This prevents CMOS circuit damage due to overvoltage on the inputs, even if the power supply is turned off.

Direct Output Amplifier Access (option 004) lets you convert word generator outputs, or TTL signals, to MOS/CMOS levels, or amplify low-level analog control signals to MOS/CMOS levels.

With Remote Control (option 003), you can build the 8015A into a test system and control all pulse parameter ranges with digital signals. Verniers are controlled by

current or voltage inputs.

And TTL Output (option 005) gives you a separate TTL compatible, 50-ohm output that tracks channel A output with fixed TTL levels.

The 8015A, starting at \$2,250*, gives you parametric testing flexibility and saves valuable setup time.

Or, if your need is for functional CMOS testing, consider HP's 8011A. Priced at just \$525*, it gives you high amplitude (to 16V) pulses at rates from 0.1 Hz to 20 MHz, and offers the Pulse-Burst Option.

Contact your local HP field engineer for all the details. Or, write for the 8015A and 8011A data sheets and our Application Note 195— "Pulse Generator Techniques in CMOS Applications."

* Domestic U.S.A. prices only.

HEWLETT  PACKARD

Sales and service from 172 offices in 45 countries.
1507 Page M • Road Palo Alto, California 94304

Electronics / April 28, 1977

29 Electronics Review

MEDICAL: Silicon chip senses blood pressure continuously, 29
DISPLAYS: Liquid crystals for watches are in good supply, 30
Liquid-crystal cell to upstage cathode-ray tube?, 30
MILITARY: Hybrids, microprocessors head for battlefield, 31
CONSUMER: Infrared sensor in watch measures pulse rate, 32
MILITARY: Darpa seeks 19% boost in R&D, 34
COMMUNICATIONS: High-speed fax meets international specs, 34
NEWS BRIEFS: 36
PACKAGING & PRODUCTION: Making a case out of circuit boards, 39

67 Electronics International

GREAT BRITAIN: Firm seeks leg up with optical link, 67
WEST GERMANY: Shorter CCD chip packs more cells per mm, 68
AROUND THE WORLD: 68

77 Probing the News

COMPONENTS: CB chip market is technology battlefield, 77
CONSUMER ELECTRONICS: Swiss make up for lost time, 80
COMMERCIAL ELECTRONICS: Wiegand effect becoming practical, 84
GOVERNMENT: Storm rages over Japanese exports, 90

93 Technical Articles

SPECIAL REPORT: LSI answers call of telecommunications, 93
DESIGNER'S CASEBOOK: Sample-hold, op amp form differentiator, 110
FET pair and op amp linearize voltage-controlled resistor, 111
SCRs make serviceable relaxation oscillators, 112
SOLID STATE: 16-k RAM eases computer memory design, 115
ENGINEER'S NOTEBOOK: Digital multiplexers reduce chip count, 120
Coil-winding program saves rf design time, 121
PRODUCT UPDATE: Electronic counters, 130

135 New Products

IN THE SPOTLIGHT: CRT controller showcases microcomputer, 135
25-kilohertz signal analyzer boasts full calibration, 136
COMPONENTS: Cheap trimming potentiometers get better, 141
DATA HANDLING: Tough disk drive stores 2 megabytes, 145
PACKAGING & PRODUCTION: Wiring system is multifaceted, 152
SUBASSEMBLIES: High-voltage op amp slews at 150 V/ μ s, 161
SEMICONDUCTORS: Two-chip set converts 4 $\frac{1}{2}$ digits, 166

Departments

Publisher's letter, 4
Readers' comments, 6
News update, 8
Editorial, 10
People, 14
Meetings, 20
Electronics newsletter, 25
Washington newsletter, 57
Washington commentary, 58
International newsletter, 65
Engineer's newsletter, 124

Services

Reprints available, 170
Employment opportunities, 174
Reader service card, 181

Highlights

LSI moves into communications, 93

Telecommunications equipment may look much the same as always, but buried out of sight are the beginnings of a major switch to large-scale integration. This special report provides details on many of the LSI chips under development and examines applications of some of the chips and the uses of microprocessors.

Cover, constructed by Bob Strimban and photographed by John Ashworth, features a Collins Radio CRC 8030 LSI tone-detector package.

Time to go solid-state, say Swiss, 80

The Swiss watch industry has decided to wholeheartedly embrace electronic watches. The goal for many firms is digital timepieces completely made in Switzerland.

16-k dynamic RAM fits all systems, 115

A new 16,384-bit dynamic random-access memory has minimal control circuit delay and low-power dynamic sense amplifiers. It includes features that make it suitable for microprocessor, multiprocessor, and mini-computer applications.

Product update: electronic counters, 130

In the many-modeled electronic counter field, custom LSI chips are widely used. The first of a periodic feature on product areas, this report surveys the models available and the technology inside them.

And in the next issue . . .

A preview of the Electronic Components Conference . . . an overview of electron-beam technology . . . an analysis of a new 4,096-bit static RAM.

EDITOR-IN-CHIEF: Kemp Anderson

EXECUTIVE EDITOR: Samuel Weber

MANAGING EDITOR: Arthur Erikson,
International

SENIOR EDITORS: Laurence Altman,
Ray Connolly, Lawrence Curran,
John Johnsrud, H. Thomas Maguire,
Stephen E. Scrupski, Gerald M. Walker

ART DIRECTOR: Fred Sklenar

ASSOCIATE EDITORS: Howard Wolff,
Alfred Rosenblatt

DEPARTMENT EDITORS
Aerospace/Military: Ray Connolly
Circuit Design: Vincent Biancomano
Communications & Microwave:
Richard Gundlach
Components: Lucinda Mattera
Consumer: Gerald M. Walker
Industrial: Raymond P. Capece
Instrumentation: Stephen E. Scrupski
New Products: H. Thomas Maguire,
Michael J. Riezenman
Packaging & Production: Jerry Lyman
Solid State: Laurence Altman

CHIEF COPY EDITOR: Margaret Eastman

COPY EDITORS: Everett C. Terry, Ben Mason

ART: Charles D. Ciatto, *Associate Director*
Paula Piazza, *Assistant Director*

EDITORIAL SECRETARIES: Janet Noto,
Penny Rothman

EDITORIAL ASSISTANT: Marilyn B. Rosoff

FIELD EDITORS

Boston: Lawrence Curran (Mgr.), Pamela Leven
Los Angeles: Larry Waller (Mgr.)
Midwest: Larry Armstrong (Mgr.)
New York: Bruce LeBoss (Mgr.)
San Francisco: Bernard Cole (Mgr.)
Judith Curtis
Washington: Ray Connolly (Mgr.)
Frankfurt: John Gosch
London: William F. Arnold
Paris: Arthur Erikson
Tokyo: Charles Cohen

McGRAW-HILL WORLD NEWS

Editor: Michael Johnson
Brussels: James Smith
Milan: Andrew Heath
Moscow: Peter Hann
Paris: Andrew Lloyd
Stockholm: Robert Skole
Tokyo: Robert E. Lee

PUBLISHER: Dan McMillan

ADVERTISING SALES MANAGER:
Paul W. Reiss

MARKETING ADMINISTRATION MANAGER:
Wallis Clarke

CIRCULATION MANAGER: Karl Peterson

MARKETING SERVICES MANAGER:
Tomlinson Howland

RESEARCH MANAGER: Margery D. Sholes

In this issue we are launching a new feature series—Product update. The initial article in the series covers what has been happening lately with one of the basic tools of the engineer, the electronic counter.

Among the most significant developments in counters is the advent of large-scale integrated circuitry—not so much the microprocessor as widespread application of custom LSI chips. These chips are having a positive impact on the cost/performance ratio, and some of the newer counters are packing in features that either commanded a higher price tag or were not even available before LSI.

From microwave counters to low-cost portable models, there is a lot of activity going on now. For a good look at all the action, take a look at the Product Update that starts on page 130.

The penetration of advanced electronics technology into other industrial areas has certainly picked up speed of late, and starting on page 93 you'll find a special report on the inroads being made by large-scale integration in the once-all-mechanical telecommunications field.

The in-depth report was put together by Dick Gundlach, our communications and microwave editor, who came away from his rounds of interviewing impressed by both the amount of work going on in semiconductor houses and telecommunications companies and by the high level of secrecy they are maintaining about that work.

“Although most semiconductor firms are reluctant to talk about who they are working with to develop LSI chips specifically for telecommuni-

cations chores,” says Dick, “there’s obviously been quite a bit of talking going on. I think that Mike Hamper, telecommunications marketing manager for National Semiconductor best sums up the optimism shared by most semiconductor makers about the huge untapped market that exists in telecommunications: ‘If only 10% of the telecommunications people we talked with would buy just 10% of what they say they need, we couldn’t supply that kind of volume.’”

It seems that many of the independent operating telephone companies are making the rounds of semiconductor houses, showing them specifications that they feel must be met and asking them to come up with LSI chips to do the job. Other companies are doing the same thing but less openly. And as usual, the major telephone companies are looking and evaluating, but very reluctant to give away too much information to the semiconductor houses.

Says Dick: “From my travels, talking with telephone companies and semiconductor manufacturer alike, I think a major stumbling block is proving LSI reliability to the telephone companies’ satisfaction. A regulated industry like theirs cannot tolerate even slight outages of services. The consumer backlash is harsh and the regulatory agencies are getting tougher.”



April 28, 1977 Volume 50, Number 8 98,378 copies of this issue printed

Published every other Thursday by McGraw-Hill Inc. Founder James H. McGraw 1860-1948. Publication office 1221 Avenue of the Americas, N.Y. N.Y. 10020. Second class postage paid at New York, N.Y. and additional mailing offices.

Executive editorial circulation and advertising addresses: Electronics, McGraw-Hill Building, 1221 Avenue of the Americas, New York, N.Y. 10020. Telephone (212) 997-1221. Teletype 12-7960 TWX 710-581-4879. Cable address: MCGRAW HILL I N E W Y O R K.

Subscriptions limited to professional persons with active responsibility in electronics technology. No subscriptions accepted without complete identification of subscriber name, title or job function, company or organization, and product manufactured or services performed. Based on information supplied, the publisher reserves the right to reject non-qualified requests. Subscription rates in the United States and possessions:

\$14.00 one year, \$35.00 three years, company addressed and company libraries: \$20.00 one year, \$50.00 three years. APO/FPO addressed: \$35.00 one year only. Canada and Mexico: \$16.00 one year, \$40.00 three years. Europe: \$40.00 one year, \$100.00 three years. Japan, Israel and Brazil: \$65.00 one year, \$165.00 three years. Australia and New Zealand: \$90.00 one year, \$240.00 three years, including air freight, all other countries: \$45.00 one year, \$112.00 three years. Limited quota of subscriptions available at higher-than-basic rate for persons allied to field served. Check with publisher for these rates. Single copies: \$4.00. Please allow four to eight weeks for shipment.

Officers of McGraw-Hill Publications Company: Gordon L. Jones, President; Paul F. McPherson, Executive Vice President; Group Vice President, Gene W. Simpson; Senior Vice Presidents, John B. Hoglund, Controller; David G. Jensen, Manufacturing; Ralph R. Schulz, Editorial; Vice-Presidents, James F. Boddorf, Planning & Development, Robert L. Leyburn, Circulation; Edward F. Schremer, Sales.

Officers of the Corporation: Harold W. McGraw, Jr., President; Chief Executive Officer and Chairman of the Board, Robert N. Landes; Senior Vice President and Secretary, Ralph J. Webb; Treasurer.

Title registered in U.S. Patent Office. Copyright © 1977 by McGraw-Hill Inc. All rights reserved. The contents of this publication may not be reproduced in whole or in part without the consent of copyright owner.

Subscribers: The publisher, upon written request to our New York office from any subscriber, agrees to refund that part of the subscription price applying to copies not yet mailed. Please send change-of-address notices or complaints to Fulfillment Manager, subscription orders to Circulation Manager, Electronics, at address below. Change-of-address notices should provide old as well as new address, including postal zip code number. If possible, attach address label from recent issue. Allow one month for change to become effective.

Postmaster: Please send form 3579 to Fulfillment Manager, Electronics, P.O. Box 430, Hightstown, N.J. 08520.

30 MHz

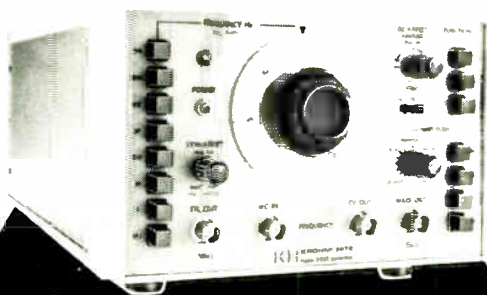

THE NEW
FUNCTION
GENERATOR
THAT OFFERS
MORE!

KH KROHN-HITE
CORPORATION

Avon Industrial Park, Avon, Mass 02322 • (617) 580-1660

Krohn-Hite's new Model 2000 function generator supplies sine, square and triangle waveforms from .003 Hz to 30 MHz. This powerful generator delivers 30 volts p-p, and over 1/2 watt of output power. It features a calibrated attenuator, external frequency control 1000:1, symmetry control, calibrated CV output and much more for only \$895.00.

For fast action call The Wavemakers at (617)-580-1660 or any local office listed below.

SALES OFFICES ALA., Huntsville (205) 534-4771 ARIZ., Scottsdale (602) 957-9110 CAL., San Jose (408) 292-4220 Inglewood (213) 674-6850 COL., Denver (303) 773-1218 CONN., W. Hartford (203) 525-7647 FLA., Orlando (305) 894-4401 GA., Atlanta (404) 237-7272 HAWAII, Honolulu (808) 941-1574 ILL., Arlington Hts. (312) 944-3300 KS., Overland Park (913) 432-5596 LA., Lafayette (315) 954-3416 MD., Baltimore (301) 321-1411 MASS., Burlington (617) 273-0198 MINN., St. Paul (612) 642-5816 MO., St. Louis (314) 413-9515 N.M., Albuquerque (505) 255-2330 N.J., Cherry Hill (609) 482-0059 N.Y., Elmhurst (516) 485-2100 Rochester (716) 338-2230 Syracuse (315) 437-5661 Vestal (607) 785-9947 N.C., Burlington (919) 227-3639 OHIO, Chesterland (516) 723-2222 Dayton (513) 424-8993 OKLA., Tulsa (918) 293-2636 ORE., Portland (503) 297-2248 TEX., Dallas (214) 661-0400 Houston (713) 688-1431 VA., Falls Church (703) 573-8787 WA., Bellevue (206) 444-3400 CANADA, Montreal Quebec (514) 341-7630 Ottawa Ontario (613) 235-5121 Toronto Ontario (416) 445-4900 Vancouver British Columbia (604) 253-5555 Halifax, Nova Scotia (902) 454-8321 St. John's Newfoundland (709) 726-2422

World Radio History

Circle 4 on reader service card

Narrowband
Spectrum
Analyzer

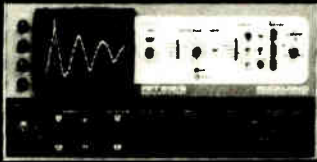

Tunable (selected-spectrum)
RMS Volt/Power Meter



1/3-Octave
Spectrum
Analyzer

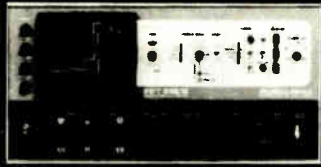

Octave
Spectrum
Analyzer

**We Sell All
Four of These
State-of-the-Art
Instruments in
One Box**

**For Less
than the Other
Guys Charge for One.**

Do you think of our Model FFT 512/S as merely the hottest real-time narrow-band spectrum analyzer in the 0-100 KHz range? It is, of course, but you may not realize that it is *also three other instruments* — a four-in-one design.

Who else can give you, in the same compact box, not only the most flexible, versatile, and accurate narrow-band analyzer, but also 1/3-octave and full-octave analysis (implemented as banks of precise digital filters), *plus* extremely versatile selected-spectrum RMS voltage/power measurement? Nobody else — at least at an affordable price, in a manageable physical format.

What's the catch? Do we ask you to trade off range, performance, or convenience for all this extra analytical power? *Au contraire* — we give you *more* range, *better* performance, *greater* convenience, and an astonishing total of *27 different operating modes* in the basic analyzer alone . . . many of them unique. And despite all this versatility, the 512/S is the simplest-to-operate, most convenient instrument in its class!

Small wonder that we had to increase production three times last year, to keep up with the demand!

There's no way to compress all of the features of the 512/S into this space — you've got to get your hands on the controls to appreciate it fully. Just to whet your appetite: triple-format transient-capture mode (signal-threshold, externally, or pushbutton triggered) with trigger offset (—1/2 to 4 time windows) for full capture; triple-format averaging (linear, exponential, or peak) over 1 to 1024 spectra; choice of normal-spectrum, f(t), dual-spectrum (comparison), or difference-spectrum (subtraction) display modes; choice of two digital I/O interfaces (general-purpose and IEEE Std 488); and the most versatile and informative cursor/readout system ever conceived.

DEMO, DATA, OR BOTH? Get this engineering data file on real-time spectrum analysis — applications, analysis theory, comprehensive specs. Use the inquiry number, or, for a demonstration appointment, call or write Joe Flink at



Rockland Systems Corporation
230 W. Nyack Road
W. Nyack, N.Y. 10994
(914) 623-6666

ADVANCED SIGNAL TECHNOLOGY
ROCKLAND
SYNTHESIS • PROCESSING • ANALYSIS

Our Second Decade of Leadership

Circle 6 on reader service card

World Radio History

Readers' comments

Don't forget Power Monolithics

To the Editor: You missed mentioning our Lambda Electronic IC Regulators in your special report on linear integrated circuits for power supplies [Feb. 3, p. 91]. For almost two years, we have manufactured series regulators that exceed every parameter in your article.

They are all hard-glass-passivated to protect the metallization runs from shorts and to protect their control circuits from long-term stability problems. Our expertise is semiconductors for power supplies, not semiconductors designed for large markets that can sometimes be used for power supplies.

Chris Field
Power Monolithics Inc.
Corpus Christi, Texas

Reaching for solar energy

To the Editor: Our Government has indeed delayed long enough in stimulating research and development efforts to harness the vast energy supply from the sun [March 17, p. 10]. However, many scientists suggest that solar energy collected from outer space might be the best long-term solution to our energy shortage.

With enough attention from Congress, there is no reason to believe that a program to construct orbiting solar power stations or perhaps space colonies could not begin in the future. Such orbiting colonies could conceivably be used to manufacture the solar cells needed on earth and to convert solar energy into microwave energy.

P. F. Justus
Kansas City, Mo.

Correction

In the preview of this year's International Solid State Circuits Conference [Feb. 17], a transposition took place in the last sentence of the last paragraph on p. 83 between "non-clocked" and "clocked." The sentence should read: "The price here is nonvolatility, since nonclocked devices dissipate more standby power than clocked ones and therefore are not suitable for battery-backup applications."

With higher speeds and density ...

Here are three new COS/MOS ideas, good buddy.

A new 40-channel CB synthesizer and two other circuits prove: RCA COS/MOS has really got the hammer down on the rip strip of hot new applications. In these circuits and more to come, you have improved speeds and density to work with. Plus the other COS/MOS advantages. All adding up to better performance and significant cost and space savings.

1 40-Channel CB: cut costs of ownership.

Our new synthesizer IC combines receiving and transmitting oscillator functions on a single chip. Result: lower CB manufacturing cost—and more. The low power requirements and environmental ruggedness of COS/MOS help reduce power-supply and operating costs, and make it a natural for use in vehicles. Operating between 15-20 MHz with no pre-scaler, TA10336 has a transmit-receive shift, 6-bit channel code, and a 10.24 MHz reference.

Circle 210

2 FIFO Register: simplify microprocessor interfacing.

On a single chip you get 4 independent FIFO registers that can be used in parallel. CD40105B is 4 bits by 16 bits long, is expand-

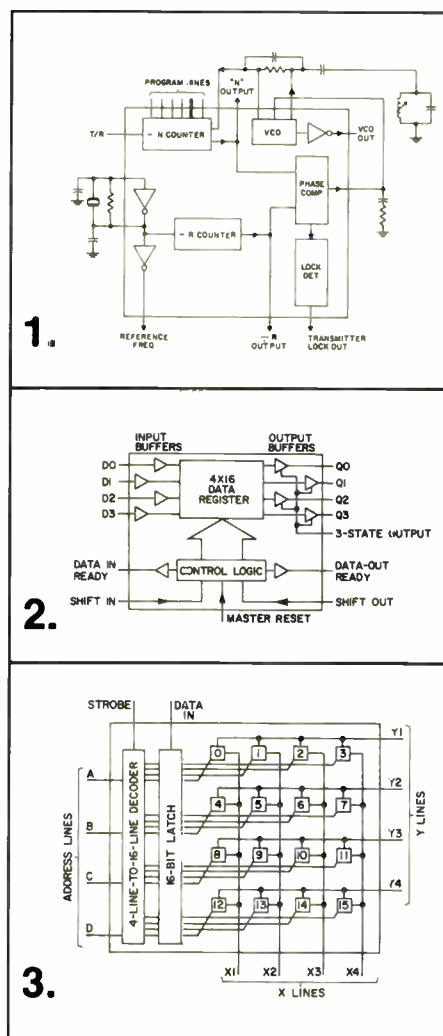

able, and features independent asynchronous inputs/outputs (outputs are 3-state). It really shines in microprocessor applications requiring input/output peripheral buffering.

Circle 211

3 4 x 4 Crosspoint Switch: lower the cost per crosspoint.

The CD22100 is 16 switches on a single chip, replacing 16 relays (at about 1/3 the cost) or 3 standard ICs. This can mean major space savings in in-house telephone and data communications systems, for example. And of course fewer connections means higher reliability. Coming soon: a 4x4x2 crosspoint switch.

Circle 212

For more information on these COS/MOS integrated circuits, contact your local RCA Solid State distributor.

Or write: RCA Solid State, Box 3200, Somerville, NJ 08876; Sunbury-on-Thames, Middlesex TW16 7HW, England; Ste.-Anne-de-Bellevue, Quebec, Canada; Fuji Bldg., Tokyo, Japan.

RCA COS/MOS experience is working for you.

WHO CARES?

...We do!

Our "instrument professionals" will make every effort to see that you rent the right test instrument for the job at hand. Too little won't do, and too much is too expensive.

Since 1962 we've cared about our customers. So we match tool to need, and guarantee performance . . . all at competitive prices.



Call  Get our
FREE
Catalog

Continental Rentals

Div. Continental Leasing Co., Inc.
175 Middlesex Turnpike, Bedford, MA 01730
(617) 275-0850

FOR IMMEDIATE RESPONSE CALL:
N.E. (617) 275-0850; L.I. (516) 752-1622;
NY, NJ (201) 654-6900; Gtr. Phila. (609) 234-5100;
Wash., D.C. area (301) 948-4310;
Mid West (312) 439-4700;
So. Central (214) 690-1706;
Costa Mesa, CA (714) 540-6566;
L.A., CA (213) 477-7521;
Santa Clara, CA (408) 735-8300.
Circle 8 on reader service card

News update

■ The Naval Air Systems Command has authorized Lockheed-California Co. to incorporate a color tactical display on the feasibility model of the Tactical Airborne Signal Exploitation System (Tases), a planned modification of the S-3A antisubmarine warfare aircraft. The display would be the first airborne color system for antisub use [*Electronics*, Oct. 14, 1976, p. 25].

Designed and produced by Loral Electronic Systems in Yonkers, N.Y., the display consists of a beam-penetration CRT that uses a multi-layer phosphor to produce three colors—red, green, and yellow—with two tones each, providing six codes for target identification and priorities. The Loral Corp. division hopes to get the color unit also on planned updates of the carrier-based S-3A and land-based P-3C patrol aircraft, both built by the Lockheed Aircraft Corp. division.

"We're looking also to add color displays for other command and control aircraft, such as the E-3A Airborne Warning and Control System [Awacs]," says Jules Frohmann, Loral division regional vice-president for marketing. The color CRT display, has its own 16-bit microprocessor to generate characters on the display and keep them there until new information comes from a central processor, thereby eliminating flicker.

The color display is interchangeable with the S-3A's monochromatic unit, now supplied by Loral, notes Ed Milkovich, Lockheed's Tases program manager. Use of the color unit, he continues, "is significant as it would increase the amount of data presented to the operator without generating any confusion."

The success of the program will largely determine whether the color unit goes on planned updates of the S-3A. "There are some very evident improvements we would get from a color display, such as highlighting a threat platform," says Capt. Toxic Caff, the Navy's S-3A program manager. But the decision as to what will go on S-3A updates, he adds, "won't be made for a couple of years."

Bruce LeBoss

Not just another A/P turn-on.

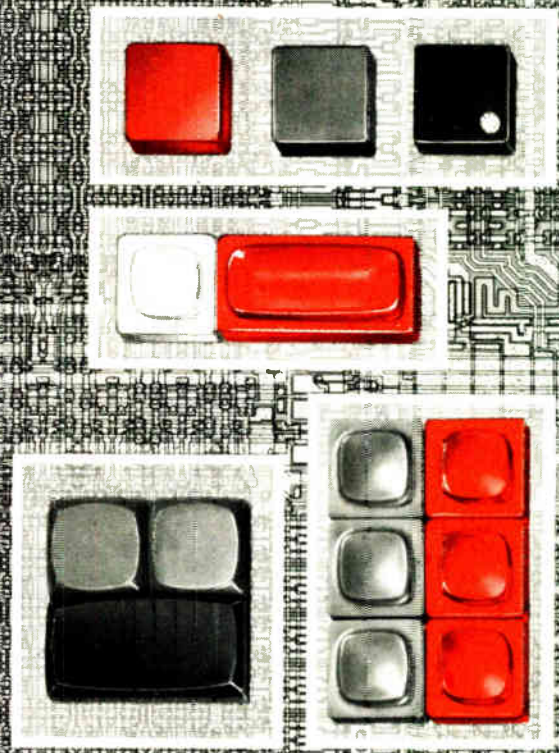

Oak's Series 415 Keyboard Switches.

A combination of low cost, dependability and adaptability that you won't find anywhere else.

Adaptable... You can use them as individual switches—or in any keyboard layout you want—in data entry devices, security systems, video games, educational and home entertainment equipment. There's a wide choice of cap styles and colors in both 5/8" and 3/4" sizes, including two-position.

Dependable... These switches use the same contact configurations and materials as Oak's high reliability switches. This results in an operating life that we're afraid you might not

believe is possible in a truly low-cost switch (But we'll tell you anyway: it's 10,000,000 operations at 100ma, 5VDC).

Low Cost... Here's the best part. The Series 415 is competitive with the least expensive individual switches you can find — yet the quality and reliability is equal to switches costing several times as much! We think they are the lowest priced keyboard switches on the market—regardless of quality.

When you need the finest: Series 475

Designed for data entry terminals, security systems, point-of-sale and financial systems and other equipment where absolute dependability is essential. These 20,000,000 operation switches are priced surprisingly low, and boast a wide choice of switching actions: SPST, DPST, N/O or N/C; SPDT nonshorting, alternate action and SPST with dummy lug. Crossbar-wiping, gold alloy contacts.

Contact any Oak distributor or sales office or call direct for detailed specifications, price and delivery information.

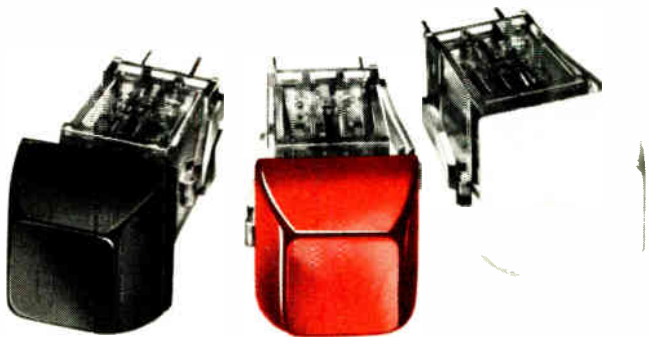

OAK Industries Inc.

SWITCH DIVISION / CRYSTAL LAKE, ILLINOIS 60014

TELEPHONE: 815 • 459 • 5000 ■ TWX: 910 • 634 • 3353 ■ TELEX: 72 • 2447

Circle 101 for further information

Circle 102 for salesman to call

World Radio History

Semiconductors: two steps forward. . . .

There is a lot of talk suddenly about 65,536-bit random-access memories. But, considering the fact that most semiconductor manufacturers are still struggling for volume production of 4- and 16-kilobit RAMs, why are these denser chips already as far along the development path as they seem to be? The answer is simple: fierce competition.

While some observers, overstating the case, see 65-k RAMs popping out soon in large quantities and swamping the smaller parts, 65-k dynamic RAM production appears to be closer to realization than most people thought only a few months ago. Disclosures of 65-k designs already are being prepared for next year's International Solid State Conference. Every major memory supplier has an active 65-k program—both in process development and fine-line fabrication. A leading supplier

. . . and one step back?

How much should a manufacturer looking to use the fruits of electronics technology in his own products reveal to the supplier of that technology? That is certainly one of the toughest decisions that management has to make. Put in simple terms, the problem comes down to deciding what balance to strike between two extremes.

On the one hand, the buyer could lay out all its development and marketing plans. But that course holds the risk of tempting the supplier to jump into that market itself. On the other hand, it could hold back so far as to straightjacket the supplier and risk coming up with a limited-use and costly design.

A major case in point is the tug of war now going on between the semiconductor houses and the telecommunications industry. Telephone companies and firms supplying hardware to them are giving more than just

even promises samples of manufacturable 65-k RAMs in two years.

If 1979 is indeed the year of the 65-k RAM, then the development time for memories has contracted sharply—to just over 2 years. And since advances in memory quickly filter into other digital designs, the same two-year cycle time would apply to microprocessors and peripheral circuits as well.

Such a frantic pace is, of course, nothing new in the semiconductor industry. But it does point up one immutable fact of semiconductor life: innovate or perish. Success appears to come more surely to the companies that continually recycle a large part of their revenue into next year's process and component design. Manufacturers who lack this focus learn the hard way how difficult it is to keep up with today's rapidly changing technology.

a casual look at what advanced solid-state technology can do for them. Indeed, the growth in demand for phone services is pushing the phone companies toward LSI because of its cost, reliability, and versatility benefits, and they need the know-how of the semiconductor makers.

The trouble is, the phone companies are reluctant to deal too closely with them because semiconductor houses have often used their supplier role as a springboard to competing in their customers' marketplace.

But this reluctance to work closely is really ill-founded. Semiconductor makers need all the information they can get if they are to produce the best designs. The enormous pressures in electronics have shown, time and again, the greatest benefits to all—supplier and buyer as well as consumer—come when open competition forces the strongest designs.

The \$5⁸⁸ circuit breaker. Lower cost protection than the \$1³⁷ fuse.

A fuse is destroyed with the first overload. It must be replaced. Not so with our Mini-Mag Circuit Breaker. It is there, protecting the circuit, again and again. Fast enough to protect solid state switches, too, because it is current, not temperature, sensitive.

When a fault in a circuit occurs, the Mini-Mag's toggle goes to "off," indicating a problem. Not so with a current-limiting fuse. A technician must make voltage and resistance checks to see if the fuse has indeed blown. That can mean a lot of expensive downtime.

Our Mini-Mag merely requires resetting. In the event a line surge caused the problem, your

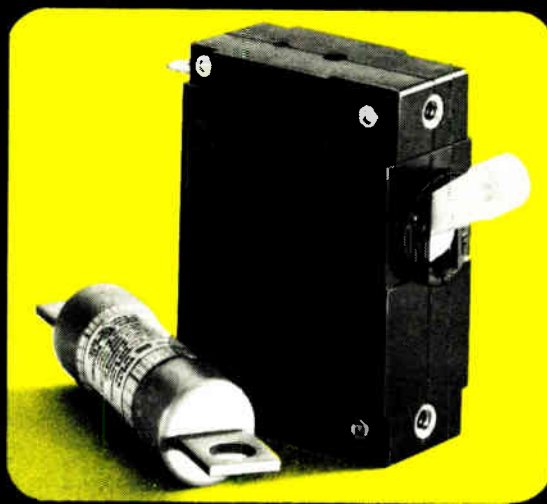

equipment is back on-line. If a short exists, the breaker will open, virtually instantaneously. What's more, it will stay open even though the toggle is held in the "on" position. That's protection!

Potter & Brumfield Mini-Mag circuit breakers, UL and CSA recognized, can add an important selling feature to your products. Get the full story from your

P&B representative or more than 100 authorized distributors. Or call Potter & Brumfield Division AMF Incorporated, 200 Richland Creek Drive, Princeton, Indiana 47671. 812/386-1000.

AMF
Potter & Brumfield

Potter & Brumfield

The 2900 Family: Two years later.

1975. Advanced Micro Devices introduces the world's best 4-bit microprocessor slice, the Am2901, along with a few support circuits.

1977. It's a whole new family. Now there's an Am2901A just like the Am2901, only better. Now there are 18 support circuits, two or three second sources and all the software you'd ever want. The 2900 family has become the family of the future. Here's why:

The first family.

The Am2900 family is the first group of products designed specifically for microprogrammed machines. Microprogramming is rapidly becoming the most popular way to design medium- and high-performance systems, to reduce development time, make changes easily, and conveniently add new features.

Less weight, less size.

With the Am2900 family, it's not uncommon for entire boards to be eliminated. You'll shrink system size and weight, increase

overall reliability and reduce manufacturing costs.

Time goes by, price goes down.

In July 1975, we told you we'd reduce the cost of the Am2901 by 30% per year. We've done it twice. Once in April 1976 and once in March 1977. The Am2900 family gets less and less expensive all the time.

We're so popular, we're the industry standard.

The Am2900 family is the most widely used Bipolar LSI family in:

- **Minicomputers:** For emulators, high-performance CPU's and add-ons by eight out of the top ten U.S. manufacturers.
- **High-performance controllers:** For discs, tapes, floppy discs and universal controllers.
- **Communications:** For PBX systems, central exchanges, multiplexers and modems.
- **Military:** For radar processors, display systems and the Navy's new standard avionic computer, the AN/AYK-14.

The Family:

CPU Slice (ALU and general registers)	Am2901A, 2902, 2903*, 2904*
Microprogram Control Units	Am2909, 2910*, 2911
Branch and Instruction Control for Microprogram Sequencers	Am29803, 29811
LSI Bus Interface Devices	Am2905, 2906, 2907, 2915A, 2916A, 2917A
Priority Interrupt Control	Am2913, 2914
Main Program Control	Am2930* 2931* 2932*
New More Powerful MSI functions	Am2918, 2919, 2920, 2921, 2922

*In Development

Plus:

Schottky and low-power Schottky MSI, MOS static and dynamic RAM's and all the devices you need to build your high-performance microcomputer.

We don't sell and run.

Advanced Micro Devices offers learning aids to help speed up designs and keep your engineers up-to-date on the very latest microprogramming techniques. Learning aids and application materials like these perennial favorites:

- A 16-Bit Microprogrammed Computer
- The Am2900K1 Learning and Evaluation Kit
- The Microprogramming Handbook

- A High Performance Microprogrammed Disc Controller

In development:

- Vertically Microprogrammed State Machines
- An emulation of the Am9080A/8224/8228 using the Am2900 family

And two terrific design aids:

AMDASM

Our powerful, easy-to-use microprogram assembler offering software support through the worldwide INFONET time-sharing division of Computer Science Corporation. (It supports user-defined mnemonics for producing microinstructions up to 128 bits wide, and includes formatting and default features as well as tape generation for PROM programmers. If you've got the other guy's MDS system, ask for AMDASM/80. It comes on a floppy disk and runs under their operating system.)

AMDS

Beginning this fall, we'll be offering hardware support with the Advanced Microprogram Development System. (It's the first prototyping system especially designed for microprogramming systems.) It'll help speed up construction of prototype systems and generation and de-bug of microcode. Resident AMDASM, of course!

The Am2900 family.

It's today's product family for tomorrow's high-performance machines. Am2900. Remember that number. You're going to be hearing it a lot.

Advanced Micro Devices

Bipolar LSI. N-channel, silicon gate MOS. Low-power Schottky. Multiple technologies. One product: excellence.



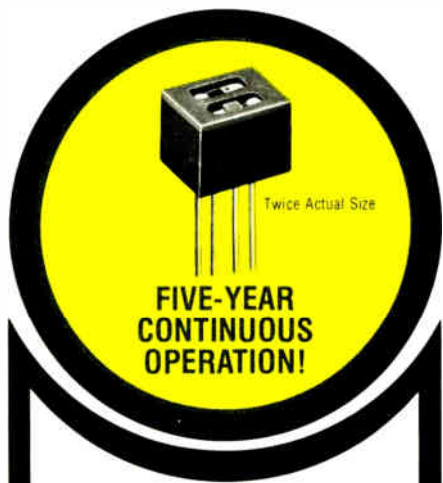

OPTRON REFLECTIVE TRANSDUCERS

NEW OPB 704 OFFERS
MAXIMUM RELIABILITY
IN A SINGLE
HERMETIC PACKAGE

OPTRON's new, low cost OPB 704 reflective transducer assures maximum reliability by combining a high efficiency solution grown LED with a silicon phototransistor in a single miniature hermetic package.

The hermetically sealed glass-metal-ceramic package offers extremely high reliability and stable performance at a cost competitive with that of plastic encapsulated devices. And, the OPB 704 has a usable continuous operating life of more than five years when operated at an average LED device current of 20 mA.

The OPB 704's phototransistor senses radiation from the LED only when a reflective object is within its field of view. With an LED input current of 50 mA, the output of the phototransistor is typically 0.5 mA when the unit is positioned 0.100 inch from a 90% reflective surface. With no reflective surface within the phototransistor's field of view, maximum output is 10 μ A with a LED input of 50 mA and V_{CE} of 5 volts.

Ideal applications for the OPB 704 reflective transducer include EOT/BOT sensing, mark sensing, detection of edge of paper or cards and proximity detection.

The OPB 704 and other low cost, high reliability OPTRON reflective transducers are immediately available. Custom designed versions for special applications are available on request.

Detailed information on the OPB 704 reflective transducer and other OPTRON optoelectronic products... chips, discrete components, limit switches, isolators and interrupter assemblies... is available from your nearest OPTRON sales representative or the factory direct.



OPTRON, INC.

1201 Tappan Circle
Carrollton, Texas 75006, U.S.A.
TWX-910-860-5958
214/242-6571

People

ITT's Thomas is out to be top MOS-memory source

"We're aiming to be the European source for MOS memories," declares Gerry Thomas, who was recently named general manager of ITT Semiconductors in England, the lead memory house for ITT worldwide. To get out in front, Thomas is counting on an ITT version of the second-generation 4,096-bit metal-oxide-semiconductor memory announced last year by Mostek Corp. of Carrollton, Texas. And to stay in front, ITT will be developing larger memories as well.

ITT will be one of the first manufacturers in Europe to supply the 4027. According to the 46-year-old Thomas, who has spent 16 years with the company, the device "puts ITT in the thick of the memory business." He looks for it to bring the firm a share in a worldwide market for MOS memory that the company expects will reach \$600 million by 1980, about half of it in 4,096-bit and 16,384-bit devices.

Million dollar update. Demand for the 4-k part will grow fast, Thomas believes. Having invested \$2.7 million in new design, production, and testing facilities at his plant in Footscray, near Sidcup in Kent, he is already making the 4027 in volume for such applications as computers, point-of-sale terminals, and television tuners.

As for a 16-k device, Thomas says ITT has one already well along in design. He expects to have samples available later this year of a device patterned on Mostek's 4116 RAM. By 1979, he will also have a 65,536-bit memory ready for market, he says. Key to the memory design for ITT Semiconductor will be the n-channel ion-implanted Coplamos process it licensed recently from Standard Microsystems Corp. and has successfully modified.

But Thomas, who was ITT Semiconductors' technical director and director of operations before becoming general manager, also has other targets in mind. One concerns a controller chip that has been used



Sharing. Gerry Thomas wants part of an MOS-memory market he expects will reach \$600 million in the year 1980.

successfully in washing machines but which he would like to see as successful in other home appliances. Another is to bring out special metal-oxide-semiconductor circuits for television, including a second-generation color-processing intermediate-frequency circuit.

Linear ICs, converters key to Zeltex growth, says Preletz

Three years ago, when Mike Preletz took over operation of Zeltex Inc., he set some high sales goals for the Concord, Calif., manufacturer of data-conversion products. This month the company, founded in 1962, revealed how successful Preletz has been—sales have nearly quadrupled to \$10 million, right on schedule.

Internal developments accounted for about half of this growth, while the remainder came from the acquisition last year of Silicon General Inc., a Westminster, Calif., producer of linear integrated circuits. Preletz has his sights set at the \$20 million level by 1980, and there isn't a doubting Thomas anywhere.

Aggressive? "Absolutely," says the 39-year-old president and chairman of the board [*Electronics*, May

Our REF-02's a TWOFER.



Free!

TEMP TRANSDUCER

with the purchase
of each
PMI REF-02
5V reference.



FREE

5 VOLT REFERENCE

with purchase of
each PMI REF-02
temperature transducer.

At \$1.95 (100's), our new 5 Volt reference circuit, REF-02, is a good buy. But when you consider that we've wired up an unused pin to give you—at no additional cost—a temperature transducer, it's a steal. And it is very accurate, from super low (-150°C) to super high ($+170^{\circ}\text{C}$)!

Let your imagination explore the idea for a minute. Let's say your system design requires a **voltage reference**. What could you do with a free temperature sensor? monitor cabinet temperature thermal drift correction prevent thermal runaway.

The feedback signal for a temperature control loop is right here, at the REF-02.

And if you've designed in a **temperature sensor** and could use a good voltage reference (ours is very reliable—referenced to the bandgap energy of silicon) the REF-02 offers a way to simplify your design. One part doing the work of several invariably translates into savings. **Two-fer-the-price-of-one.**

WANT CHIPS?

Send a P.O. We're glad to sell REF-02 Chips. And you'll find them easy to calibrate in your hybrid. How about knowing the ambient temperature **inside** your package!

For data sheet, App. Note, or name of your nearest PMI distributor, write, phone or TWX us. Ask about the Twofer.



Precision Monolithics, Incorporated
1500 Space Park Drive, Santa Clara, CA 95050
(408) 246-9222. TWX: 910-338-0528
● Cable MONO.

Circle 15 on reader service card

MOS/LSI comes to Dual-Tone detection.

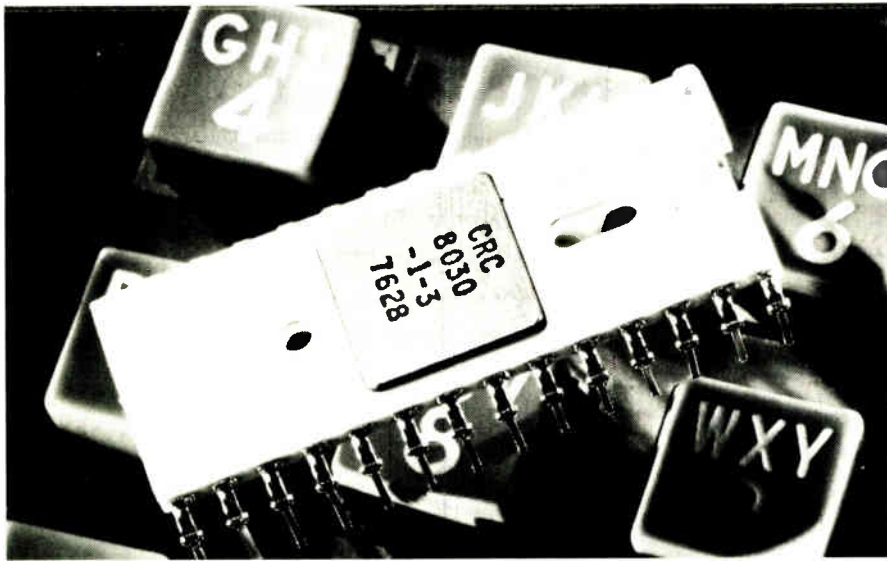

The Collins MOS/LSI digital Touch-Tone* detector is now in production. High quantity production.

It's the Collins CRC-8030.

For a low cost, high performance solution to dual-tone multi-frequency (DTMF) detection, you can't beat it. You get the economics of MOS/LSI — plus central office quality.

Here are the CRC-8030's features: Digital range filter detects all 16 Touch-Tone signal combinations. Detection in 22 to 39 MS. On-chip-oscillator operating at 3.579545-MHz color burst crystal frequency. Binary or 2-of-8 coded outputs. Operation with single or dual power supply. Many parameters can be mask programmed for custom applications.

A product of Collins high technology MOS/LSI experience, the CRC-8030 performs the key critical functions of a DTMF receiver. When used in conjunction with a front-end band-split filter/limiter, it implements a complete DTMF receiver.

Also, if you need DTMF-to-dial pulse conversion, use the CRC-8030 in conjunction with our CRC-8000 (a MOS/LSI Binary-to-Dial Pulse Dialer).

For more information on our telephony or custom MOS/LSI products and services, call your local Collins MOS/LSI Product Sales Representative. Or use the coupon below.

*Touch-Tone is a registered trademark of AT&T.

I want Collins to come to me.

MOS/LSI Marketing
Collins Hybrid Microelectronics
Rockwell International
Newport Beach, California 92663
(714) 833-4638

I want information on CRC-8030 CRC-8000 Custom MOS/LSI
 Send it by mail Call me

Name _____ Title _____
Company _____
Address _____ City _____
State _____ Zip Code _____ Telephone _____



Rockwell International

...where science gets down to business

People



Growth. Zeltex will double to \$20 million by 1980, says Mike Preletz, its president.

16, 1974, p. 14]. "We can do it [\$20 million] with just 20% growth per year without extending ourselves or diluting our interest."

Preletz, a 1960 graduate of West Point, who was general manager of TRW's Semiconductor division before joining Zeltex in 1972, expects to increase the emphasis on high-technology products for the computer and military markets. Faster conversion rates and higher accuracy, resolution, and reliability are all evident in the firm's latest analog-to-digital converters and the data-acquisition system modules—trends which will be boosted further by the relationship with Silicon General, which shares many Zeltex customers. "We have just begun to realize the benefits of that union, and the total is definitely greater than the sum of the parts," Preletz says with a good deal of satisfaction.

Independent growth. Silicon General has strengthened its position in the linear market with the development of proprietary voltage regulators, power control circuits, and new linear devices. This has set the stage for steady independent growth, Preletz points out.

In addition, Zeltex is already using some of Silicon General's chips for its products and expects to use even more of them in the future as the two firms coordinate their new-product developments. Nor is this the limit of Preletz' ambition—he does not rule out the possibility of further company or product-line acquisitions.

One Mallory THF capacitor can replace up to four CSR types in a switching power supply.

These small, solid-tantalum capacitors give you a per-unit substitution factor as high as one for four and can by-pass 4.5 amp rms at 100kHz. So by using these high ripple performance capacitors you save in space, weight and cost.

Specially designed for low equivalent series resistance, at frequencies from 10kHz through 100kHz. They're ideal for high frequency power supply switching, for regulator switching, or for bypassing or filtering unwanted ripple currents.

Because ESR is low, power losses are low. With the solid electrolyte and hermetic seal, long life is inherent. Electrical characteristics are very stable over a temperature range of -80°C through 125°C . Two case sizes: .29 x .69 and .35 x .79 inches.

Mallory THF capacitors are available in a wide range of ratings: 5.6 to $330\mu\text{F}$, 6 to 50VDC.

They're the result of Mallory's engineering program that's finding ways to produce high performance type capacitors at less cost to you.

Just ask your Mallory representative. Available direct, or through authorized Mallory Distributors in U.S. or overseas. Or call Help-Force Headquarters at (317) 856-3731. Mallory Capacitor Company, a division of P. R. Mallory & Co. Inc., Box 1284, Indianapolis, Ind. 46206.

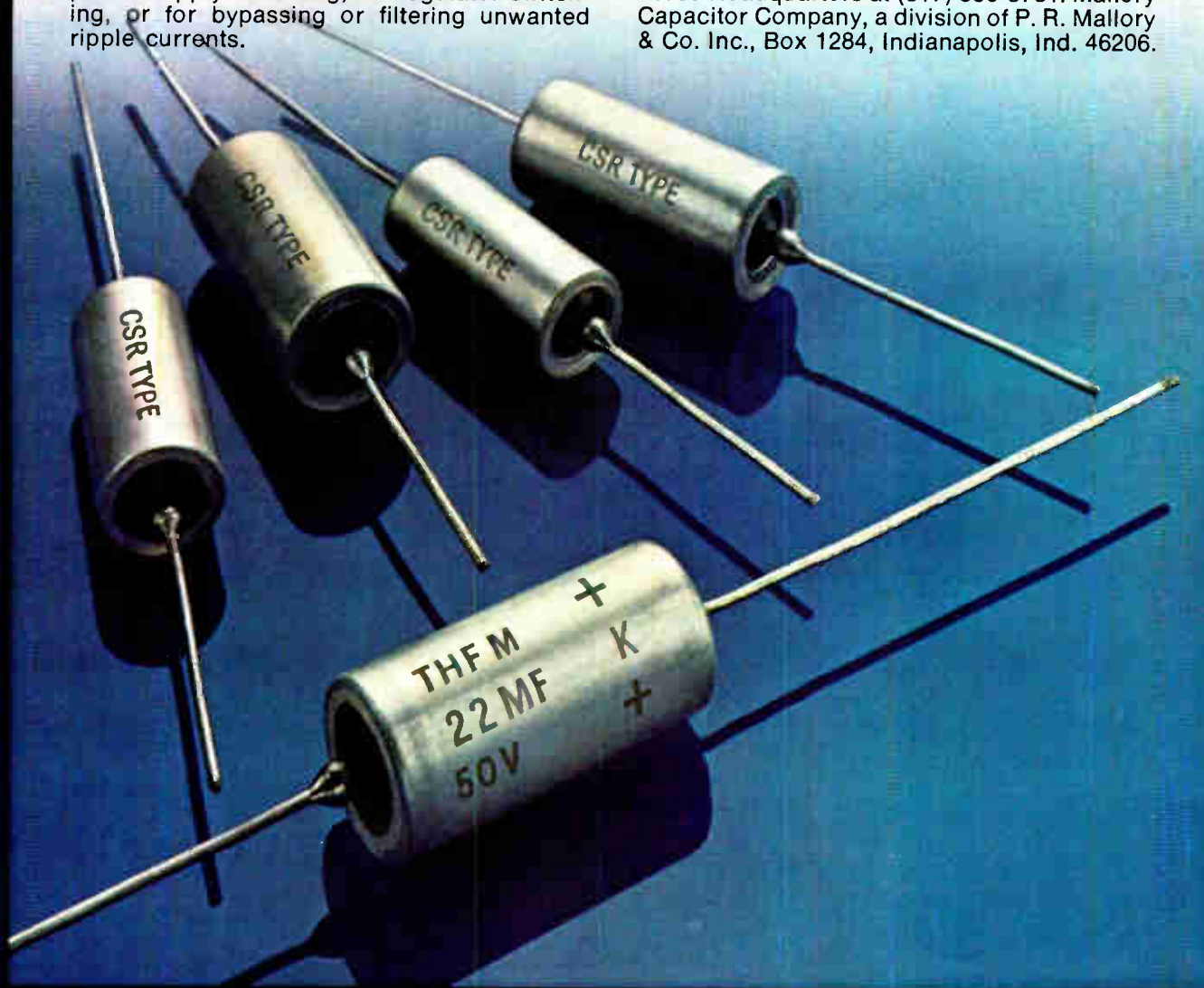

MALLORY

Intel delivers micro ahead of the fast

In 1971, Intel invented the microcomputer and quickly became the world's largest supplier of microcomputers and microcomputer support products. We still are.

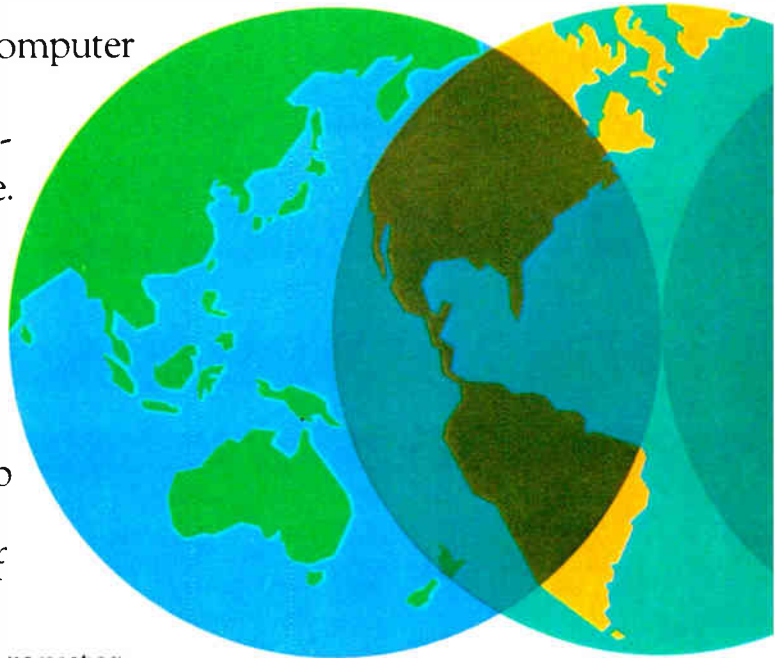

Over the past six years we've invested millions of dollars to make the microcomputer even more useful and more economical. Today there are over 195 Intel® microcomputer hardware and software products available to help people like you keep ahead of costs, ahead of the competition and ahead of the fast changing world.

We're now offering seven microcomputer families. Including the newest high performance 8085 and the single chip 8748 with resident PROM. And 81 LSI peripheral, memory and I/O support circuits to help you cut design time, do more and get to market first. To reduce design time even further, choose one of our SBC80 Single Board Computers or System 80

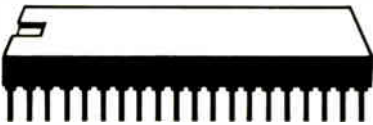

packaged microcomputer systems.

But a wide selection of microcomputer components and systems is only half the story. We also provide programming support, including the PL/M high level microcomputer language to help you cut months off those big software development jobs. And Intellec® microcomputer development systems with ICE™ in-circuit emulation

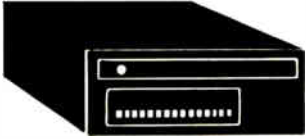
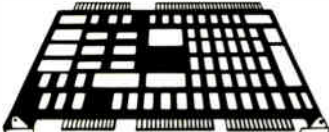
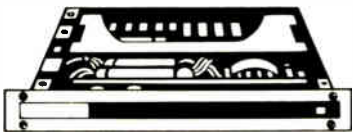
<p>7 microcomputer families</p> 	<p>81 LSI peripheral, memory and I/O support products</p> 
<p>33 software products, users' library with 235 programs</p> 	<p>Intellec Development System with 42 options and accessories</p> 
<p>30 SBC 80 Single Board Computer products</p> 	<p>2 System 80 packaged microcomputer systems</p> 

computers to keep you changing world.

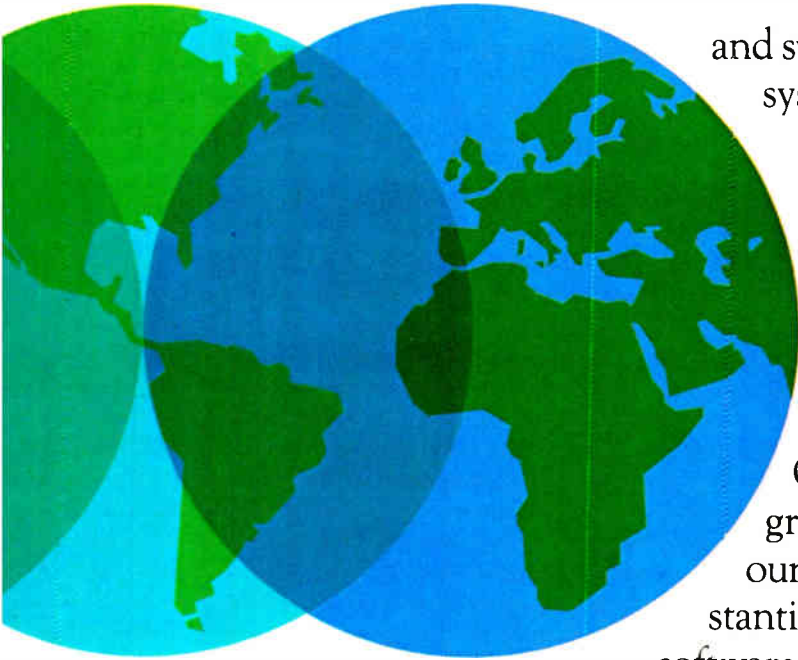

and symbolic debugging to help reduce system integration and debug time.

Then there's application assistance, training classes and regularly scheduled seminars available worldwide. A users' library with 235 programs and still growing.

Intel's investment protects your investment. Here are a few examples. Our new 8085 microprocessor offers greatly improved performance over our industry standard 8080, with substantial cost savings. Yet you use the same software, the same peripheral, memory and

I/O circuits as the 8080. You don't have to go through a new learning experience or re-invest in software to upgrade your system to 8085 performance. And that same kind of protection comes when you invest in an Intel development system. Last year's investment in an Intellec system is preserved even when we introduce a new microcomputer. Our newest 8085 and 8748 microcomputers are now fully supported with development software

for your present Intellec system. And you will soon be able to add low cost ICE-85 and ICE-48 in-circuit emulation modules.

Let Intel help you stay ahead.

Get started now by asking for our new microcomputer product line brochure describing the full line of Intel microcomputer products, systems and software. Use the reader service card or write: Intel Corporation, 3065 Bowers Avenue, Santa Clara, CA 95051.



intel® delivers.

Meetings

Appliance Technical Conference, IEEE, Pittsburgh Hilton Hotel, Pittsburgh, May 10-12.

Electronic Components Conference, IEEE, Stouffer's National Center Inn, Arlington, Va., May 16-18.

Naecon—National Aerospace and Electronics Conference, IEEE *et al.*, Dayton Convention Center, Dayton, Ohio, May 17-19.

National Quality Control Conference, American Society for Quality Control (Milwaukee, Wis.), Philadelphia Marriott Hotel, Philadelphia, May 16-18.

9th Annual Aviation Review Conference, FAA, Sheraton-National Hotel, Arlington, Va., May 16-18.

Nepcon '77 East, Industrial & Scientific Conference Management Inc. (Chicago), The Civic Center, Philadelphia, May 17-19.

National Micrographics Association Conference and Exposition, NMA, Dallas Convention Center, Dallas, May 17-19.

International London Electronic Component Show, Radio and Electronic Component Manufacturers Federation, Olympia, London, England, May 17-20.

Computer Security and Integrity Symposium, National Bureau of Standards and IEEE, NBS, Gaithersburg, Md., May 19.

Seventh International Symposium on Multiple-Valued Logic, IEEE, University of North Carolina at Charlotte, May 24-27.

Semicon/West 77, Semiconductor Equipment & Materials Institute (Mountain View, Calif.), San Mateo Fairgrounds, San Mateo, Calif., May 24-26.

1977 Incremental Motion Control Systems and Devices Symposium, University of Illinois, Ramada Inn, Champaign, Ill., May 24-27.



Thin-Trim capacitors

Tucked in the corner of this Pulsar Watch is a miniature capacitor which is used to trim the crystal. This Thin-Trim capacitor is one of our 9410 series, has an adjustable range of 7 to 45 pf, and is .200" x .200" x .050" thick.

The Thin-Trim concept provides a variable device to replace fixed tuning techniques and cut-and-try methods of adjustment. Thin-Trim capacitors are available in a variety of lead configurations making them easy to mount.

A smaller version of the 9410 is the 9402 series with a maximum capacitance value of 25 pf. These are perfect for applications in sub-miniature circuits such as ladies' electronic wrist watches and phased array MIC's.

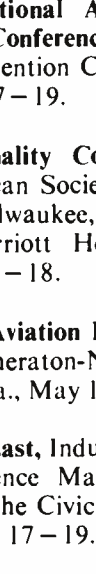

Johanson Manufacturing Corporation
Rockaway Valley Road
Boonton, New Jersey 07005
(201) 334-2676 TWX 710-987-8367

Choosing Systems or Components: Know your weapons.

Developed by Zilog. Manufactured by Zilog. Supported by Zilog. Here are the most powerful weapons on the microcomputer battlefield. Together or separately they herald victory over sluggish speeds and villainish inefficiencies.

Manufactured by Zilog.

Whether you need one or a million and one, Zilog's new facility can deliver. All of our production equipment is state-of-the-art (4" wafers)—the most modern microcomputer manufacturing in the world. You order. We'll deliver, plastic or ceramic. Your choice!



Masterminded by the Z80-CPU.

A single chip, N-channel processor arms you with a super-set of 158 instructions that include all 78 of the 8080A's and the 8085 instructions with *total* software compatibility. The new instructions include 1, 4, 8 and 16-bit operations, such as, memory-to-memory or memory-to-I/O block transfers and searches, 16-bit arithmetic, 9 types of rotates and shifts, bit manipulation and a legion of addressing modes. And that means less programming time, and less end user costs. With these features, the Z80-CPU generally requires approximately 50% less memory space for program storage yet provides up to 500% more throughput than the 8080A or the 8085. Powerful ammunition at a surprisingly low cost (less than \$10 each in large quantities) and ready for immediate shipment.



Deploy the Z80 peripheral devices:

Z80-PIO—Parallel I/O Interface Controller. Two (2) ports for fast I/O transfer under full interrupt control.

Z80-SIO—Serial I/O Interface Controller. Two (2) fully independent full duplex channels that can be programmed to operate in any asynchronous or synchronous modes including Bi-Sync and HDLC/SDLC.

Z80-CTC—Counter Timer Circuit. Four (4) independent channels that can be used to count external events or to generate interrupts at programmable intervals.

Z80-DMA—Direct Memory Access. Programmable circuit that transfers data between memory and peripheral devices at up to 1.2 megabytes per second. The DMA can operate in a transparent mode without slowing the CPU.

Deploy the Z80 software:

Resident Macro Assemblers. With cross-reference and conditional assembly, also relocatable assembler with linking loader.

PLZ Resident Compiler. Most powerful microcomputer compiler available today

Text Editor and File Maintenance.

Basic Interpreter. For writing programs in Basic.

Cross Software. Available from NCSS.



Made for the Military.

You can get Zilog components to meet MIL Spec 883B with extended temperature range of -55°C to $+125^{\circ}\text{C}$. The Z80 component family operates with less power in MIL Temp environments.

For victory over obsolescence:

Deploy these strong components from the leader in microprocessors. We are bound by our pledge to stay a generation ahead and determined to make your components and systems the most powerful in the field. We're ready to dispatch help immediately.



Zilog

10460 Bubb Road, Cupertino, California 95014
(408) 446-4666/TWX 910-338-7621

Boston (617) 890-0640

Chicago (312) 885-8080

Los Angeles (213) 540-7749

In Europe: Zilog, Inc., Nicholson House,
High Street, Maidenhead, Berkshire, U.K.
TEL 0628 36131/2/3/TLX 848-609

AN AFFILIATE OF **EXXON** ENTERPRISES INC

General Purpose Oscilloscope

New, Quick,
Accurate,
Convenient

EXPLORER II is a remarkable new general purpose oscilloscope, a digital oscilloscope. It is for use in exactly the same applications as low frequency analog oscilloscopes. What makes it remarkable is its combination of high precision, versatility, and convenient, hassle-free operation in both ordinary and demanding situations.

Imagine, for example, being able to touch a button to "freeze" the waveform on the screen. If you wish, the live waveforms continue, superimposed, so you can see changes while they are occurring. Then you can zoom-in on any detail of interest, with high magnification, to see changes as small as 0.025%. The stored waveform has almost unbelievable detail. It would take an analog storage 'scope with a screen area 400 times greater than usual to capture the same detail.

It has some long-needed conveniences such as automatic trace centering, with simultaneous numerical display of the voltage and time corresponding to screen center, so you know where you are. It has non-fading storage, which doesn't require adjustments, manual erasure, mode switching or sweep arming. It has automatic perfect persistence. Waveforms stay until replaced by the next to occur, when you wish. It has a numerical display of the true voltage and time corresponding to any selected point — with respect to zero or with respect to any other point.



EXPLORER II

There's a lot more to EXPLORER II. But a simple listing of features doesn't tell the story very well. You really have to see it in action, or better yet, use it. Then, we think you'll agree — It's some 'scope.

Plug-in units include model 204, which has 50 ns rise time; model 205, a single input, 500 ns rise time, high precision unit; model 206, a two channel unit similar to model 205; and model 201, a one millisecond rise-time, 10 μ v, ultra-stable unit for measuring slowly changing variables. Price \$4400 with model 205 plug-in unit. **EXPLORER III** is an EXPLORER II with an added module. This module provides two more features; an internal magnetic disk memory, and a digital input/output port to allow interfacing to computers and the fine HP 9825 calculator. The combination of an outstanding digital oscilloscope, the recorder, and the interface to processors or calculator make it possible to handle a wide range of signal acquisition and analysis problems conveniently, and less expensively. These EXPLORERS are new versions of EXPLORER I, now in use in hundreds of laboratories all over the world.

EXPLORERS II & III are identical, except for these two features. An EXPLORER II may be converted to an EXPLORER III by the addition of the third module shown.

The diskette can accept waveforms or recall them for viewing, in two seconds. Recordings may be on manual pushbutton command or in automatic sequence as the signals occur. Disks are removable for filing or for other EXPLORER III's to read.

There's more you should know about the EXPLORERS.

These are revolutionary new oscilloscopes. It's just not possible in this space to adequately discuss the significance of their extraordinary features and characteristics. We suggest that you write for a brochure, or call Bruce Hervey to arrange for a demonstration at your laboratory. (608) 271-3333.

NICOLET INSTRUMENT CORPORATION

5225 Verona Road
Madison, Wisconsin 53711
Telephone: 608, 271-3333

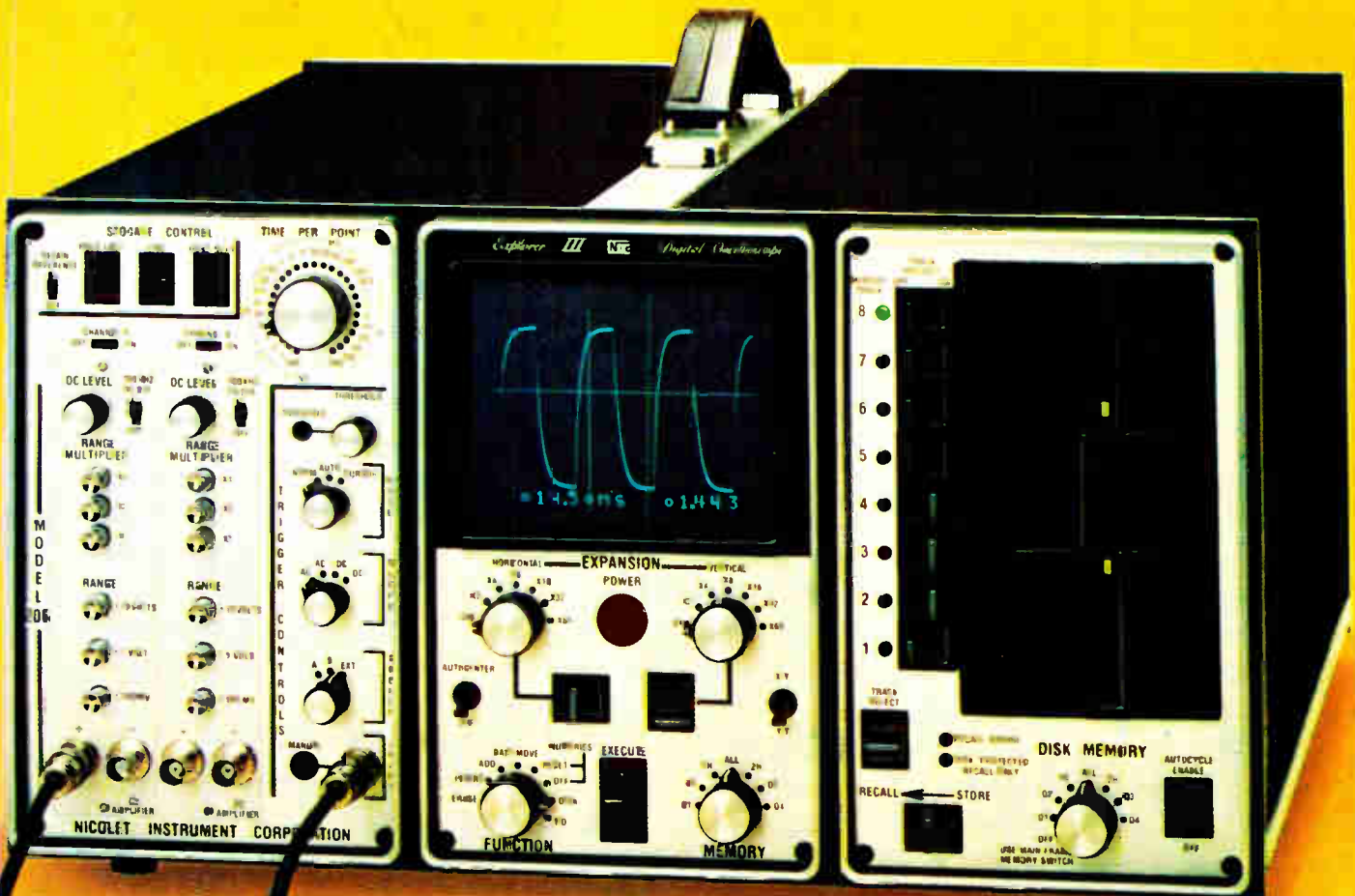

EXPLORER III

Circle 23 For Information Only
Circle 253 For Demonstration Only

It's lonely at the top.

Amphenol® SMA's
lead the way.
Because they're
better four ways.

You won't find a bigger, broader line than ours. So we can match just about any application. Including those that need Amphenol phase-adjustable SMA's or "Spark-Plug" SMA's (hermetically sealed launchers for MIC packages). Or plugs and jacks for semi-rigid and flexible cable (both crimp and field-serviceable). Choose bulkhead, panel, or printed circuit mounting. Straight or 90° right-angle configurations. Receptacles or adapters. Stainless steel or beryllium-copper.

Our quality is second-to-none. The Amphenol name is a proud one, famous for quality. So every Amphenol SMA undergoes rigorous multiple inspections—before, during, and after assembly. That's quality assurance for you.

Our technical know-how is tops. Depend on us for technical and engineering assistance. On-the-spot service. And a willingness to adapt and change to meet your needs.

Our SMA availability is practically next-door. That's how close your Amphenol distributor is. Call him for prompt delivery of Amphenol SMA's. One of our district sales offices is nearby, too, and ready to help. Or call: (203) 743-9272, Amphenol North America Division, Bunker Ramo Corporation, RF Operations, Dept. A47B, 33 East Franklin Street, Danbury, Connecticut 06810.

The right idea
at the
right time.

AMPHENOL



TI's Clough foresees 18% rise in 1977 for semiconductors

The worldwide semiconductor market shot up from \$4.2 billion in 1975 to \$5.6 billion last year, a 32% hike, but the best is yet to come, says Charles Clough, semiconductor marketing manager for Texas Instruments Inc. of Dallas. The 1977 market, he predicts, **"will be up strongly over 1976," increasing 18% to \$6.625 billion.** Integrated-circuit sales, which last year topped those of discrete components for the first time ever, will lead this year's growth with a 24% rise to \$3.580 billion, while sales of discretes will grow 12% to \$3.045 billion.

The U.S. semiconductor market, which jumped 33% from \$1.8 billion in 1975 to \$2.39 billion in 1976, **will tag on another 18% this year to reach \$2.83 billion.** Pacing that growth will be the computer (up 26% to \$540 million) and industrial (24% to \$620 million) segments. Also increasing strongly, says Clough, will be the distribution (15% to \$550 million), consumer (14% to \$620 million), and Government (14% to \$500 million) segments. The growth in computer end-equipment sales, Clough says, "will be paced by minis and peripherals, while the industrial segment will be led by the telecommunications industry." The major computer companies have their inventories in line and, he adds, 1977 procurement contracts indicate unit consumption increases of 20% to 30%. Second-tier computer companies have balanced inventories, and backlog is in line with lead times.

Harris readies 16-k PROM using new bipolar technique . . .

Look for Harris Semiconductor in Melbourne, Fla., to build a 16,384-bit bipolar programmable read-only memory with a new passive-isolation process. The so-called "sidewall-isolated" technology **resembles an old Harris process called poly-planar** and uses polysilicon as a backfill to isolate both elements within the bipolar devices and the devices themselves. It helps the 2,048-by-8-bit PROM achieve its 70-nanosecond access time and 500-milliwatt power dissipation. To be introduced later this year, the HM 7616 is designed as a pin-for-pin replacement for 4-k and 8-k PROMs, as well as 16-k erasable PROMs.

The Harris division is also developing a high-speed complementary-MOS 8-bit microprocessor and peripherals for a custom telecommunications application.

. . . and monolithic 12-bit bipolar d-a converter

Harris is also going into production with a monolithic 12-bit bipolar digital-to-analog converter, the second such chip to be announced in the last two months. Like the first device, which is being made by Precision Monolithics Inc., Santa Clara, Calif., the Harris d-a converter is functionally equivalent to Analog Devices' AD562, a 2½-year-old hybrid built with a pair of custom large-scale chips. **Providing both high speed and good stability,** the Harris device settles to within 0.01% of the final output value with 100 nanoseconds maximum and holds gain temperature coefficient to a tight 2 ppm/°C. Like the AD562, it is a current-output d-a converter and has no internal voltage reference. Price is approximately \$29 each in quantities of 1,000.

Fairchild to make 8-bit ECL chip set . . .

Fairchild Camera and Instrument Corp. plans to start production of an 8-bit microcomputer chip set with typical instruction execution times of 20 to 50 nanoseconds. Combining emitter-coupled logic with Fairchild's Isoplanar II, an oxide isolation process, the new family will make it possible to **build a high-speed "midi-computer" with a mere half-dozen chips**. The CPU and three other parts have already been defined.

. . . as systems unit prepares smart digital panel meter

Fairchild Camera & Instrument Corp.'s next big effort in digital panel meters will be "smart" DPMs, **which will incorporate an F8 microprocessor** to control high-low alarms, take average readings, do peak and valley recording, and so on. Oriented toward the upper end of the original-equipment-manufacturer market, the DPM will sell for under \$300 in quantities of 100, says James D. Bowen, vice president and general manager of the Instrumentation and Systems group. The San Jose, Calif., operation already has a large initial order from one customer and plans to introduce the meter officially this fall.

Avnet add to Shugart drives to micro line

Hamilton/Avnet Electronics, the largest independent electronic components distributor, is expanding its microcomputer activity with the addition of peripherals for OEMs building microcomputer systems. The Culver City, Calif., distributor, whose microcomputer activity to date consisted of distributing the learning kits of Intel and Motorola, **will handle the line of floppy-disk drives** from Shugart Associates of Sunnyvale, Calif. Soon to be added will be CRT terminals, line printers, and other peripherals.

Travel agents to try computer-run reservation system

Three companies will conduct on-site tests of their versions of a computerized reservation system for travel agents. Sponsored by 12 airlines, American Express, and the American Society of Travel Agents under special antitrust immunity from the Civil Aeronautics Board, this pilot project **will enable selected travel agents to tap many airline reservation systems from a single display terminal**. Approximately \$100,000 each has been awarded to Honeywell Information Systems, Incoterm Corp., and Time-share Inc. to test systems in Seattle, New York, and Chicago, respectively.

Addenda

Experienced old-guard members continue to lead President Carter's list for top technology appointments. **Latest example: Robert Frosch, 49, who will be named to head NASA**. He served in the mid-1960s as head of the Defense Department's Advanced Research Projects Agency before becoming assistant Navy secretary for R&D. He is now deputy director of Woods Hole Oceanographic Institution. . . . Navy Secretary W. Graham Clayton said in his first policy address, to the Navy League in Washington, that the Navy still puts **a high priority on the controversial Project Seafarer** shore-to-sub communications system despite the House Armed Services Committee's refusal to spend \$23.7 million to start the grid [*Electronics*, April 14, p. 49] . . . Texas Instruments will introduce a **new line of \$9.95 watches this summer**.

Here's how Data General's microNOVA system stacks up against the competition.

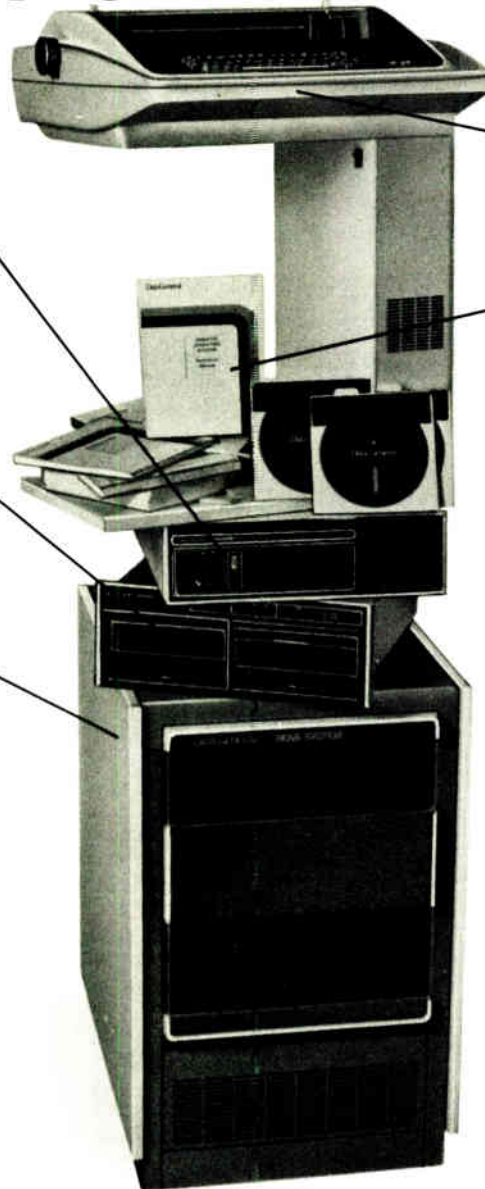

microNOVA Processor:
Fully packaged 9-slot micro-computer, 16K words MOS memory, 2.4-microsecond arithmetic operations, hardware stack facility, multiply/divide, DMA capability. Includes RTC, PF/AR and APL. Supports up to 32K words RAM/PROM memory.

Dual-diskette subsystem:
Integral DMA controller, compact 630KB capacity.

Cabinet:
37 inches high, holds all rack mounted components.

DASHER terminal printer:
30 cps, 132-columns, typewriter keyboard, upper/lower case.

Systems Software:
Multitasking Disc Operating System, Real-Time Operating System, FORTRAN IV, Extended BASIC, Macro Assembler, Utilities.

\$10,970

List*

The facts speak for themselves. For \$10,970, Data General's new microNOVA gives you more system, software availability and support than any other comparable computer. And we deliver in 60 days.

Any way you look at it, it all stacks up in your favor. For more information and our brochure, call our toll free number, 800-225-9497, or, fill out and return the coupon.

*Additional software fees apply to first system only. Quantity and OEM discounts available.

Data General, Westboro, MA 01581
Sounds like smart business. Send me more information.

NAME _____
TITLE _____
COMPANY _____
ADDRESS _____ TEL. _____
CITY _____ STATE _____ ZIP _____
NOVA is a registered trademark of Data General Corporation.
DASHER is a trademark of Data General Corporation.

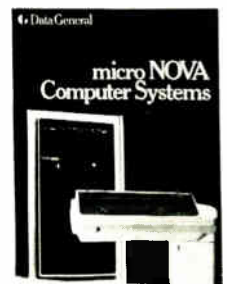

Data General

It's smart business.

Data General, Westboro, MA 01581, (617) 485-9100. Data General (Canada) Ltd., Ontario. Data General Europe, 15 Rue Le Sueur, Paris 75116 France. Data General Australia, Melbourne (03) 82-1361.

VARACTORS

5 10 20 30 40 50 60 70 80 90 100 110 115

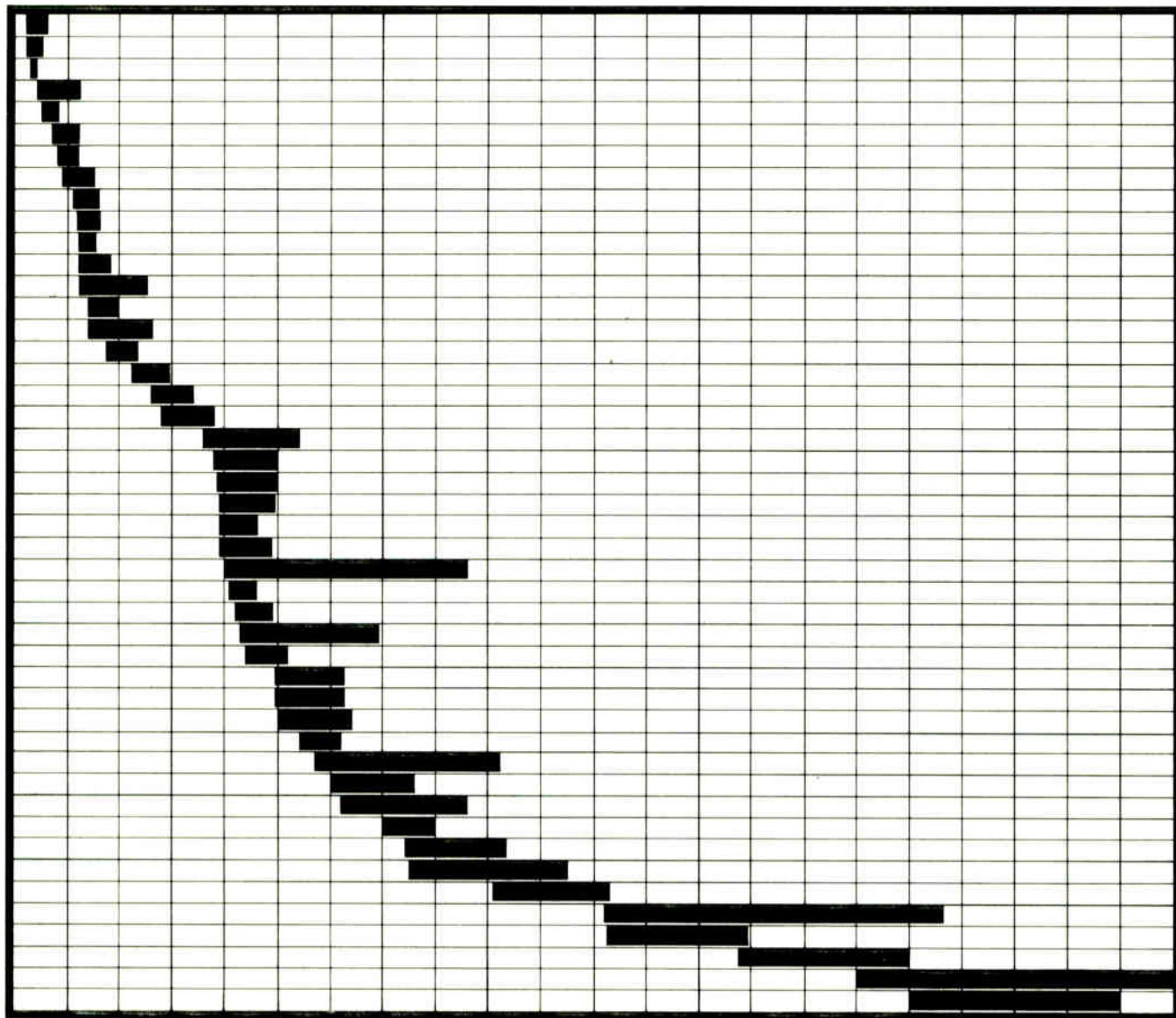

46 different ranges from 6.0 to 115 pF at 4V.

NPC offers from stock a line of Varactors that may be the broadest in the industry. Depending upon values, these devices are available in the most popular packages—DO-7, DO-35, DO-41, SOD-23 and TO-92. Matching can be guaranteed in sets of two, three and four.



THOMSON-CSF
NPC
 ELECTRONICS

NPC Varactors are manufactured by the epitaxial planar process and combine superior quality with excellent stabilization characteristics at high temperatures. They are available in varying capacitance ratios. Want more facts? Write NPC Electronics for Application Notes.

6660 Varel Avenue
 Canoga Park, California 91303 • (213) 887-1010
 Telex 69-8481 • TWX 910-494-1954
 A Division of DuMont Electronics Corporation

Where Pricing is as Important as Technology

ARIZONA G. S. Marshall (602) 968-6181 CALIFORNIA Brill Electronics (415) 834-5888; Intermark (714) 540-1322, (714) 279-5200, (408) 738-1111; G. S. Marshall (213) 686-0141, (714) 556-6400; Mouser Electronics (714) 449-2220; Rose Electronics (415) 692-5700; Semiconductor Concepts (213) 884-4560; Zeus Components (714) 990-1911 COLORADO Century Electronics (303) 424-1985 FLORIDA National Resistor Corp. (305) 792-2600; Zeus Components (305) 942-4312 ILLINOIS Advent Electronics (312) 297-6200; Bodelle/R-M Electronics (312) 323-9670; Edmar Electronics (312) 298-8580 INDIANA Advent Electronics (317) 297-4910; Ra-Dis-Co. (317) 637-5571 IOWA Advent Electronics (319) 363-0221 MARYLAND Technico, Inc. (301) 461-2200 MASSACHUSETTS G. S. Marshall (617) 965-5115; Zeus Components (617) 273-0750 MICHIGAN Advent Electronics (313) 477-1650; R-M Electronics (616) 531-9300 MINNESOTA Joel Company (612) 545-5669; G. S. Marshall (612) 559-2211 NEW JERSEY General Radio Supply (609) 964-8560 NEW MEXICO Century Electronics (505) 292-2700 NEW YORK Kahgan Components (516) 538-2300; Zeus Components (914) 592-4120 NORTH CAROLINA Resco (919) 832-2077 OKLAHOMA Component Specialties (918) 664-2820 PENNSYLVANIA General Radio Supply (609) 964-8560 SOUTH CAROLINA Resco (919) 832-2077 TEXAS Component Specialties (512) 459-3307, (214) 357-6511, (713) 771-7237; Quality Components (214) 387-4949, (713) 789-9320 UTAH Century Electronics (801) 487-8551 WASHINGTON Zepher Electronics (206) 575-0922 WISCONSIN Taylor Electric (414) 241-4321

Silicon transducer strapped to wrist reads blood pressure

Nicolet to produce first commercial unit to take pressure continuously with noninvasive device

Doctors have long relied on surgically-inserted catheters for continuous blood pressure readings of critically ill patients. There may soon be an alternative if a new instrument, an arterial tonometer developed by Nicolet Instrument Corp., a Madison, Wis., maker of medical research and clinical equipment, proves to be a success.

Instead of the surgical procedure, the \$7,000 tonometer relies on a noninvasive transducer, which is strapped over the artery in the wrist. Catheter-based equipment, selling for half this price, inserts into an artery a device that is tipped with or connected to a pressure transducer.

Physicians who have seen the Nicolet device are guardedly optimistic. "If I can get beat-by-beat pressure without sticking an artery, I'm very attracted to it," says one Veterans Administration physician, "but I'd want to test it against inter-arterial pressures [obtained with catheters] under various conditions."

As pressure in the artery builds up and subsides with each heart beat, the artery itself expands and contracts—and this is sensed by the transducer in the Nicolet machine. With the aid of a Z-80 microprocessor from Mostek Corp., the tonometer displays the blood-pressure waveforms on a Tektronix 5100 oscilloscope mainframe. These waveforms help medical personnel to

position the transducer for a maximum pulse signal. They also provide a visual track of changes in the patient's condition.

Scope readouts. The cathode-ray-tube scope also shows digital readouts of systolic/diastolic blood pressures, mean blood pressure, pulse pressure, and heart rate. These are calculated by the microprocessor, using algorithms that recognize and count the analog signal's peaks and measure areas under the curves.

The Z-80 also sounds an alarm when the signal changes more than 25%. The machine has a front-panel input to display electrocardiogram signals directly beneath the blood-pressure wave. Both signals can be "frozen" in the system memory and on its screen, a technique that brings up cursors for measuring time and pressure differences between points on the pressure curve and timing shifts between the pressure and cardiogram signals. Also there is a digital port for output to a hard-copy recorder.

"The advent of the microprocessor is what gives us a useful clinical product in a small package, instead of a laboratory curiosity," says Jeffrey C. Petzke, product manager for Nicolet. "It supervises the system, takes in the data, does the calculations, and puts the information into fixed memory areas."

But even the microprocessor cannot do everything, Petzke continues. Fast, hardwired logic is needed to take the analog and digital data

Reading. Nicolet Instrument's arterial tonometer is built into a Tektronix scope's mainframe. Cuff pumped up with air holds piezoresistive transducer securely on wrist.

from the tonometer's 12,288-by-8-bit random-access memory and display it. The program for the microprocessor is stored in a 5,120-by-8-bit programmable read-only memory.

The piezoresistive pressure sensor fits in a half-inch-diameter steel plug. "A cuff holds the sensor to the wrist, and an air bladder partially constricts the artery to maximize the waveform," Petzke explains. With the sensor in place and the waveform on the screen, a cuff like that on a common blood-pressure sphygmomanometer in a doctor's office is used to calibrate the instrument. The piezoresistive sensor then measures changes from this "norm." Electronics has been applied to sphygmomanometers but only to the point where they are pumped up and read out automatically; they don't read continuously (see International Newsletter).

The sensor is a silicon wafer 1 millimeter in diameter and doped



with four resistive areas. It is built by Kulite Semiconductor Products Inc., Ridgefield, N. J. "Two of the resistors are near the center of the wafer; the other two are near the wafer's edge," explains Dennis E. Bahr, engineering manager for the tonometer. "The edges of the device are held rigid, so as pressure increases, the center resistors lengthen, increasing their resistance, and the outer resistors compress and shorten." The resistor areas are wired in a four-arm bridge. "As the resistors change in value, the micro-

processor sees a voltage imbalance in the piezoelectric bridge that's directly proportional to the pressure."

The Nicolet project team has tested the instrument on dogs, comparing blood pressure waveforms obtained simultaneously with a conventional sensor-tipped catheter system. "If there are any differences in the waveforms, they were not visually apparent," Bahr says. Next month it will go on trial on catheterized patients in hospitals in Madison, and Iowa City, Iowa. Limited production starts next month also. □

Displays

Liquid crystals for watches are turning out to be in good supply

Punctured by the electronics industries' old bugaboo of double and triple ordering, the shortage of liquid-crystal displays for digital watches may be evaporating. Beckman Instruments Inc., the major LCD supplier began the year working around the clock seven days a week in an expanded facility, but now reports tapering down to 70% to 80% of its all-out effort. Motorola, too, thinks LCD production is now ample.

On the other hand, William K. Weakland, general manager of Hughes Aircraft Co.'s digital-watch operation, which only recently added LCD watches to its light-emitting-diodes designs, insists, "LCDs are still in short supply." He estimates that three or four months' lead time is needed at present "to buy LCDs from any quality house."

Several factors have helped dissolve December's near-unanimity that booming demand would snap up all LCDs produced well into this year [*Electronics*, Jan. 6, p. 67]. Bolstering that outlook, it seems, was a distortion of booking caused by double and triple ordering from suppliers.

Aggressive buyers. "From the start, I saw the [so-called] shortage caused by overly aggressive attempts to buy," observes Thomas Hyltin, president of Micro Display Systems

Inc., a Dallas-based module manufacturer. Agreeing, Beckman's Leslie W. Chapin, vice president and general manager of the Electroproducts group, Fullerton, Calif., says, "Module manufacturers panicked in January and February and said 'don't ship.'" The abrupt change was caused not only by the usual cyclic seasonal lull in the watch business, but by the negative effects on LCD module sales from "dumping of LED models by firms going out of the business."

Also, new capacity is starting to come onstream, from Motorola in particular, which claims that "shipments have been building fast since the fourth quarter." Timex also this month began pushing the display capability of the facility in Somerset, N.J., it recently acquired from RCA Corp. Several sources, though, claim added capacity is not yet making a difference.

As a supplier, Chapin is unworried about the slack period, noting that "the order pace is already picking up and should heat up again around June." Some standard LCDs are now available from stock, but specialized orders may take several months. He sticks with his earlier forecast of 12 million to 15 million LCD watches to be sold worldwide in 1977. But to lessen dependence on a few large

customers, Beckman is moving to diversify its order base. He says Beckman is now selling about 20% of its output to module makers in the Far East.

One thing spooking both component suppliers and module builders is Japanese competition. "The Japanese are already here," notes Weakland, "but so far it's been more talk than sales." Motorola concurs, "but it's only a matter of time," predicts Gene Simpson, assistant general manager of the Communications Systems division, located in Schaumburg, Ill. The plans are now very clear, he believes, "to inundate the American market with modules and components."

Finally, Micro Display's Hyltin sounds a cautionary note about the quality of LCDs built by new producers—"they could have the kind of reliability problems" that plagued early LEDs and hurt the reputation of digital watches. □

Liquid-crystal cell to upstage CRT?

A liquid-crystal projection display capable of showing 20 times as much information as a present-day cathode-ray tube is in the offing, or so John Dewey's group at IBM Research Laboratories in San Jose, Calif., believes.

"Today's CRTs must be pushed to display just 2,000 characters," noted Dewey last week at the Society for Information Display's conference in Boston. But 40,000 characters, each made up of 9 by 12 picture elements, will be possible with the laser-scanned 2,000-by-2,000-element display that "we feel we can see our way to." The group's initial system has only 500 elements on a side—a limitation imposed by the quality of the lenses and not by either the LC material or the laser, claims Dewey.

35-mm slide. The display basically comprises a liquid-crystal cell about the size of a 35-millimeter slide, an injection laser, a pair of galvanometer-driven mirrors that scan the

laser beam across the cell, and a light source and lenses for projecting the image at a 25X magnification. While being scanned across the cell, the laser beam turns on and off, forming the characters by heating up the liquid crystal and causing it to switch. It writes one character at a time, scanning the 10-micrometer-square area in a twentieth of a second.

An M6800 microprocessor controls both the modulation and the scanning of the laser beam. The modulation creates the characters, and here the M6800 works from a text stored in about 1 kilobyte of random-access memory. The scanning is directed by the M6800 through two digital-to-analog converters that control the galvanometer servo system.

To erase the display, an alternating voltage is applied to the cell. Alternatively, areas can be erased selectively, by heating them with an electrostatic field so that their threshold changes and then aiming the laser beam at them. "The main thing we proved is that we can produce a nice-looking display," Dewey says. "The characters are sharply defined and are black on white." □

Military

Army speeds application of hybrids and microprocessors to battlefield

Hybrids and microprocessors head a good-sized list of projects at the chief research and development arm of the U. S. Army's Electronics Command. "Over half the Army's [electronic] equipment to be built from here on out will use hybrid circuitry, both thin- and thick-film," predicts Clare Thornton, the new director of the Electronics Technology and Devices Laboratory at Fort Monmouth, N. J.

In microprocessors, his group is seeking both to qualify commercial units for military requirements and to develop a high-speed but low-power device built with complementary-MOS-on-sapphire technology [*Electronics*, March 31, p. 47].

Those are only two of the areas in which Thornton's 340-person lab can expect to spend a healthy \$25 million this year. Its other programs include the development of charge-coupled devices for radar signal processing, better fabrication methods for gallium-arsenide devices used for high-speed signal processing in electronic intelligence and radar processing systems, and lithographic resists more sensitive to electron beams than those available now.

The military would like to be able to buy standard hybrid parts from industry and then simply run go/no-go tests to see if they work as they do on other kinds of components, Thornton points out. But getting to this point "poses a problem because

there's no coherent industry base, but lots of small hybrid houses each doing their own thing."

Failure modes. His lab is researching failure modes and mechanisms associated with every known hybrid process and establishing a "Hybrid Microelectronics Process and Quality Control Guide" that will be "our bible for determining whether a vendor's process and parts will be suitable for a specific system's requirements." A draft of the guide is now out to several manufacturers, with their comments expected back shortly. Thornton says the first edition will be published "within a few months and updated as new knowledge is obtained."

As for microprocessors, he says, they are already having "a tremendous impact on the price and performance" of military hardware, often slashing its cost by 90%. Keeping costs low is why he hopes to qualify commercial devices instead of developing special military types. He also notes that "the C-MOS-on-sapphire microprocessor will be complemented by a range of special-purpose LSI parts, also on sapphire, to perform special functions such as high-speed frequency synthesis and signal processing." Incidentally, his lab has already developed a low-temperature C-MOS-on-sapphire fabrication process that Thornton hopes also to see adapted commercially.

Thornton has only good words as

far as his R&D budget level is concerned. Though this year's \$25 million is up only slightly from 1976, he points out that the Department of Defense wants "each of the services to increase funding for device research by at least 10% beyond inflation. We expect to get back into a real growth mode in 1978 with about \$30 million."

This upbeat in funding is in marked contrast to the situation when Thornton joined the lab in 1972 as director of its Semiconductor Devices and Integrated Electronics area. He came after a 17-year hitch with Philco-Ford's Microelectronics division, leaving as its director of research and engineering. Both industry and Government were



Director. Army's Clare Thornton is pleased at upturn he expects in funding for R&D.

then slashing research to nearly a quarter of what it had been, he recalls. Moreover, applied research was elbowing out basic research—a kind of atmosphere that is not healthy for the long pull, he says.

One area he feels should have had more development effort is an old

Here's the laboratory

Clare Thornton's Electronics Technology and Devices Laboratory at the Electronics Command at Fort Monmouth, N.J., is divided into five broad R&D areas: semiconductor devices and integrated electronics, frequency control and signal processing, electronic materials, power sources, and display and storage devices. In these areas, the laboratory is charged with taking the lead in developing the Army's technological base, both within its own organizations and outside in industry. The Electronics Command is now in the 3-year process of being restructured into three new commands [*Electronics*, April 14, p. 12]. However, the devices laboratory will remain at Fort Monmouth, although it is set to report to the new Electronics Research and Development Command (Eradcom) which will be in Adelphi, Md., the site of Harry Diamond Laboratories. Thornton expects his group will remain virtually unchanged, with perhaps only a 5% cutback, mostly through attrition.

one — microwave-tube technology. "When you're trying to protect our aircraft from the enemy's large radars, present solid-state technology falls far short of the power levels

required," he says. So he seeks to fund industry to develop new fabrication techniques for production of high-frequency microwave tubes for low-cost jammers. □

Consumer

Infrared sensor built into watch measures the wearer's pulse rate

Commuters running for a train can now worry about more than the time — with a new Pulse/Time Computer strapped to one wrist, they will also be able to check their racing pulses.

Two years in development, the \$500 combination of watch and pulse-rate monitor was placed on the

market this month by Time Computer Inc., the Pulsar watch people in Lancaster, Pa. It reads pulse rate with an infrared sensing unit that detects blood surges in the capillaries of a finger and serves up the data to a microcomputer.

The infrared transmitter and receiver are built into the top of the

device. A finger placed over this section triggers the transmitter, which aims an infrared signal at the finger. The capillaries beneath the skin then reflect the pulse back to the receiver — a phototransistor.

Expand, contract. During a blood surge in a capillary, the vessel expands, absorbing more of the infrared and reflecting less back to the receiver. As the vessel contracts between surges, however, it absorbs less light and reflects more. The system measures these differences in signals, counts the intervals between them, amplifies the data 10,000 times, and feeds it to the pulse-rate microcomputer.

The microcomputer, a dedicated two-chip complementary-MOS set, digitizes the data. It counts each pulse beat represented by the surge signal, continuously averages the result of every two beats, and displays the average pulse rate on a light-emitting-diode readout. With its four batteries, the pulse-rate monitor and watch should handle 25 time and pulse interrogations a day for one year before requiring the owner to change the battery.

Buyers of this watch, says Time Computer president John Bergey, will include the growing number of

Pulse watch. Infrared signals reflected from capillary are sensed, then counted by microcomputer to yield pulse rate that's shown on LED display of Pulsar timepiece.

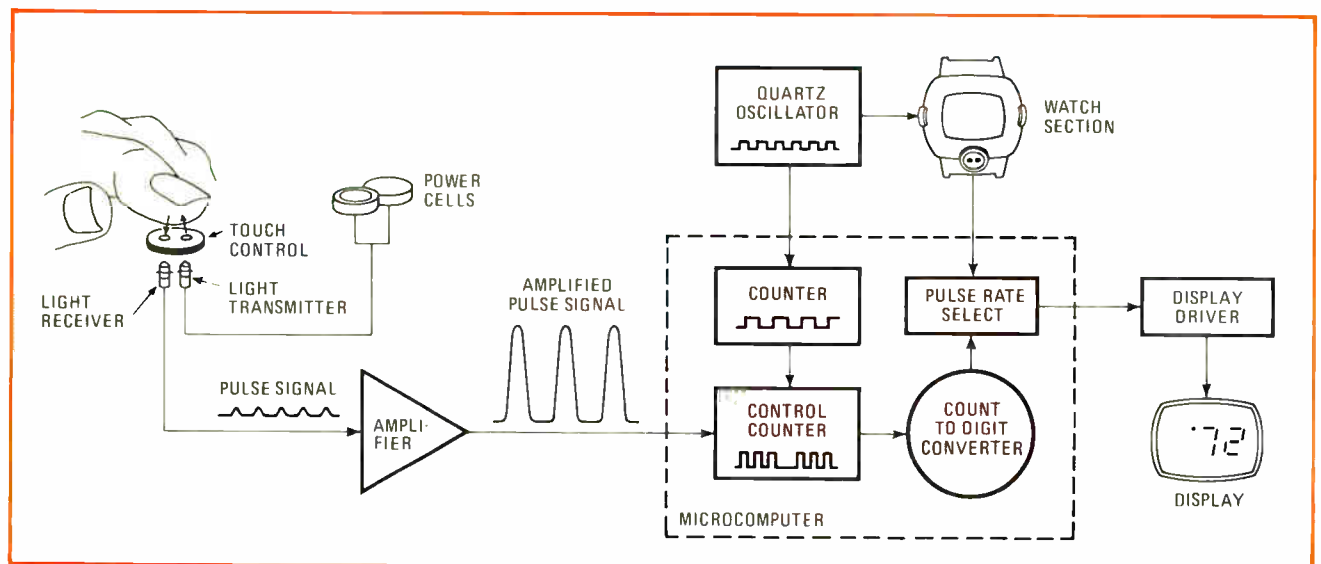

If you're only measuring voltage, you're only getting half the picture

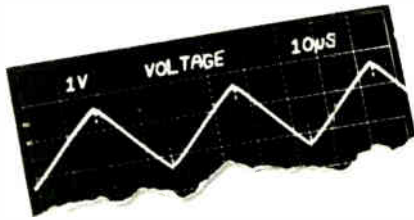

Current is the other half of the picture. And you can measure current accurately and efficiently with a TEKTRONIX Current Probe like the P6302/AM503. You'll find many uses for its 1 mA to 20 A current measurement range and its DC to 50 MHz bandwidth—such as plotting the current characteristics of a transformer, balancing an SCR circuit, or measuring the dc and ac peak current load on a power supply.

A current probe is also a helpful companion for your voltage probe when measuring signals at high impedance points in a circuit. The low circuit loading characteristic of a current probe means less signal attenuation and less rise time loss.

Tektronix offers a wide selection of general purpose and specialized probes to meet your current and voltage measurement needs. These include a number of active and passive voltage probes as well as logic probes.

The first step to an accurate, meaningful oscilloscope measurement is choosing the right probe. And your Tektronix Field Engineer can help you make the proper selection.

Once you get the whole picture, save it with a scope camera. It's still the most efficient and least expensive means of saving measurement results from your oscilloscope or waveform monitor.

With a camera you can record waveforms for publication in technical papers and journals. Prints can be kept as a permanent record in your engineering notebook, or used to support your position in a design meeting.

The low cost C-5A fits all TEKTRONIX Laboratory Oscilloscopes, 400-Series Portables and the new T900-Series. At \$250* you can afford a C-5A for your own test bench. You no longer need to share one camera with all the engineers in your group.

Other TEKTRONIX Cameras give you automatic single-shot control for transient recording, and photometer aided exposure setting for clear, no-fuss photography of even the dimmest displays.

For more information about the complete selection of TEKTRONIX Probes and Cameras, contact your local Tektronix Field Engineer or write Tektronix, Inc., P.O. Box 500, Beaverton, Oregon 97077. In Europe, write Tektronix Limited, P.O. Box 36, St. Peter Port, Guernsey, Channel Islands.

*U.S. sales prices are F.O.B. Beaverton, Oregon. For price and availability outside the United States, contact the nearest Tektronix Field Office, Distributor or Representative.

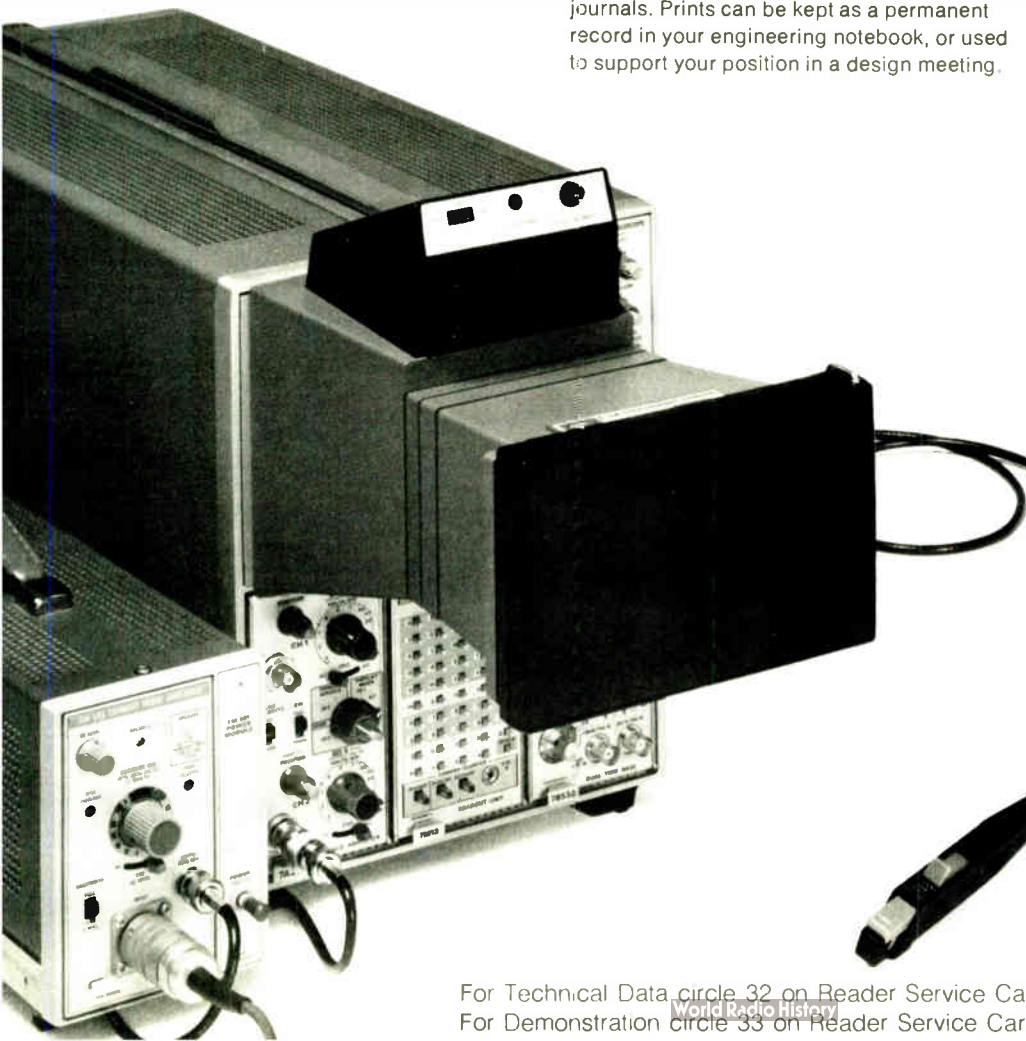

Tektronix
COMMITTED TO EXCELLENCE

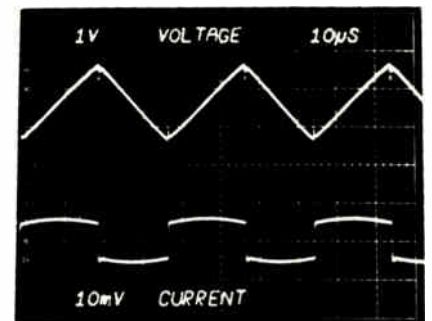

Once you get
the whole picture,
save it with
a scope camera

For Technical Data circle 32 on Reader Service Card
For Demonstration circle 33 on Reader Service Card

people interested in physical fitness. "We estimate the market for a stainless steel, \$500 model to be in the tens of thousands," he says.

Good interfacer. The IR sensor, according to Bergey, interfaces well with the user and the microcomputer. Its drawback is its extreme sensitivity to light, so that both the transmitter and receiver have to be covered completely in order to get an accurate reading. In addition, too hard a pressure on the sensor tends to cut down the flow of blood to the capillaries, inducing a false reading.

The two-chip complementary-MOS processor is supplied by RCA Solid State division and was developed by the RCA Advanced Technology Center. Both chips are basically logic arrays but also contain encoders, decoders, an analog-to-digital converter, and squaring circuitry. The display drivers and the pulse IR signal amplifier are separate discrete devices. Also, the watch does contain a separate C-MOS time chip for those who simply want to know the time. □

Military

Darpa seeks 19% boost in R&D

To fund some of the more avant-garde of the nation's electronic technologies, the Defense Advanced Research Projects Agency is asking Congress for a hefty 19% boost in R&D funds for fiscal 1978—to \$280.5 million. Taking high priorities are programs for high-energy space lasers, space surveillance, optics, and antisubmarine warfare.

To win over congressional military R&D subcommittees, agency director George H. Heilmeyer presented the programs in such extensive detail that some congressional and military staffers expressed concern about the disclosures. But a supporter of his on the Pentagon's R&D staff declared that "while there is a lot of fresh detail" in the presentations, there is nothing "Soviet intelligence could benefit from and probably doesn't already know."

Justifying his claim for a \$3.75 million boost in space-based high-energy laser programs to \$24.9 million, Heilmeyer says their potential could be "Sputnik-like" in influencing how foreign countries perceive the U.S. leadership in defense technology. Darpa has already demonstrated small-scale, hydrogen-fluoride chemical lasers operating in the 2.7-micrometer region "as the most promising candidate (for space) because of (their) high power per unit system weight," Heilmeyer says. Next year, he wants to scale them up to demonstrate high-precision, long-range tracking of space objects.

Further along. For the longer term, Darpa is developing electrically excited, high-energy, single-pulse lasers in the ultraviolet region instead of the chemical hydrogen-fluoride infrared type "because of optical-system design penalties imposed by longer wavelengths." In the UV/visible-light lasers, Darpa has gained courage from its success last year in pushing the output of rare-gas halide lasers from 1 joule per pulse to over 350 J/pulse with a 10% electrical efficiency. Heilmeyer called the development "a breakthrough" that provides "substantially increased confidence that such devices are feasible."

Problems with high-power UV/visible lasers, however, lie in the system optics, notably mirrors and windows to control the beam. "Pulses are so intense," Heilmeyer points out, "that antireflection and reflection-enhancement coatings are frequently blown off with a single laser pulse. If they are not, the components may optically distort and defocus the laser beam." To counter this, Darpa is accelerating a materials program for dielectric-enhanced mirrors, antireflection-coated windows, and other critical optics.

Surveillance. To maintain the U.S. lead over Soviet space-surveillance technology, Darpa wants \$52.9 million to push a variety of programs using new applications of charge-coupled devices, microprocessors, and lightweight optics. To sort out

weak target signals, Heilmeyer says Darpa wants "tens of thousands" of CCD signal processors on a single chip and integrated with CCD imagers. "We call this concept CCD²," he explains. The integration of signal-detection and processing functions on the same chip should enable targets to be extracted from clutter automatically, eliminating the cost and delay of using large ground-based computers for clutter suppression. At the same time, Darpa is developing new special filters to pass specific target radiation characteristics while blocking out natural background noise.

As for its proposed \$25 million investment in antisubmarine warfare technology, Darpa expects a significant return from its Project Seaguard, which attempts to define the limits of ocean acoustics and acoustic arrays. Seaguard is focusing on large acoustic arrays, for use as hydrophones and for telemetry, deployment, and mooring, and signal processing, including the automatic underwater search, detection, and recognition of sounds. Darpa's lead acoustic research center to accelerate ASW signal-processing research at Moffett Field, Calif., has real-time access via satellite to several operating ASW arrays. This is coupled to a massive, real-time computational capability in Illiac IV, the world's largest computer. □

Communications

High-speed fax meets proposed spec

The first high-speed digital facsimile machine to meet international standards proposed for sub-minute facsimile transmissions came forth this month from 3M Co. This represents the first important step toward a network of compatible fax machines that could communicate quickly throughout the world.

The 3M Co.'s machine, the Express 9600, was developed by the company's Information Management department in St. Paul,

The Only Full Performance



\$39⁰⁰* digital panel instrument

More than just a \$39.00 Digital Panel Meter, our new AN2570 Digital Panel Instrument combines full performance with low cost. It features a full 3½ digit (±1999 count) LED display. It offers accuracy of ±0.05% of reading ±1 count, a bipolar differential input, a built-in signal enhancement filter, and input protection of ±300 volts DC or AC RMS. Bias current is a very low 50 picoamps, input resistance > 1000 megohms, range tempco is ±35 ppm of reading/°C, and the auto zero holds zero drift to just ±1 μV/°C. Operating temperature range is from -10°C to +65°C. And, to add to its value, the AN2570 has a low parts count, is extremely cool running, has a calculated MBTF in excess of 100,000 hours, and a 24-month warranty. But that's just half the story.

You have the choice of either a ±1.999V or ±199.9mV full scale input range. Four power options are available, too. Depending on your application you may choose either +5Vdc ±5% @ 170mA, +8Vdc to +28Vdc @ 90mA, 110 Vac ±20% @ 1.6 Watts, or 220 Vac ±20% @ 1.6 Watts. Standard is a DIN/NEMA high impact plastic case, but if you have an EMI/RFI problem, you can order a metal case. To further simplify installation, a rear screw-terminal connector is available for solderless connections. Also available is a latched and buffered parallel BCD output option for driving long data lines.

And, when you get ready to hook it up to the real world, the AN2570 has provisions for that, too. Standard display and conversion control signals include HOLD, BLANK, DISPLAY TEST, EOC, and OVERLOAD. Also standard are such features as Automatic Zero, Automatic Overrange Indication, Automatic Polarity, 3 or 4 wire ratiometric operation, and externally programmable decimal points.

That's full performance! Can you afford anything less for your \$39.00? For complete technical information and off-the-shelf delivery, contact your nearest Customer Interface Center, or Analogic's Marketing Department. Analogic Corporation, Audubon Road, Wakefield, Massachusetts 01880. Telephone (617) 246-0300.

*\$39.00 each in 100's (+5V unit)
Even less in larger quantities:

ANALOGIC ■

...The Digitizers



CUSTOMER INTERFACE CENTERS

E.I.L. INSTRUMENTS

Baltimore Area (301) 252-1260
Los Angeles (213) 685-7020
Chicago Area (312) 430-2292

Burlington, MA (617) 272-9450
Norfolk, VA (804) 855-4241
Alexandria, VA (703) 354-4330
Pittsburgh (412) 731-5230
Dayton (513) 435-2134

Indianapolis (317) 545-1373
North Kingstown, RI (401) 885-1773

TROTT ELECTRONICS
Clarence, NY (716) 634-8500
Rochester, NY (716) 473-8010

AMPOWER ELECTRONIC INSTRUMENT
Paterson, NJ Area (201) 742-3215
Farmingdale, NY (516) 752-1078

METERMASTER
Los Angeles (213) 685-4340

Palo Alto (415) 968-0313
San Diego (714) 560-4841
Chicago Area (312) 593-8650
Garland, TX (214) 271-5671
Phoenix, AZ (602) 243-4111

CMP DISTRIBUTOR
Detroit Area (313) 477-7700
Cleveland (216) 333-5650

THERMO ELECTRIC (CANADA) LTD.
Brampton, Ontario (416) 451-0813

Minn. It sends a 300-word letter—about what fills up a standard type-written page—in about 20 seconds when transmitting at the unit's top 9,600-bit per second rate. It meets the transmission standards proposed by the CCITT (the multinational Consultative Committee International Telephone and Telegraph) based in Geneva. When approved, the standards will tie down key specifications for high-speed fax.

The major areas covered by the standards are: resolution (200 lines per inch horizontal by 96 lines/in. vertical with an option of 192 lines vertical); signalling protocol (high-level data-link control and redundancy code); data compression to speed transmission using Huffman coding (an encoding scheme that looks at a line being scanned, evaluates the amount of black and white information it contains, and decides on the best way to send it), and a standard modem that data-communications equipment makers proposed to CCITT.

Electronic mail. "By the year 1982, high-speed digital facsimile systems will have become a reality in many parts of the world, built around a new generation of microprocessor- and LSI-implemented facsimile- and word-processing terminals," says Howard Anderson, president of the Yankee Group, a consulting and market research firm in Cambridge, Mass. "And these terminals will be fast enough to usher in electronic mail systems which, by then, will be used by at least 35% of the Fortune 500 companies." Even more significant, Anderson continues, is that the electronic mail systems operated by the individual companies will also be connected to those provided by the U. S. Postal Service and other communications common carriers.

The CCITT proposed the facsimile standards late last year. They are circulating among the national groups making up the organization for their approval, a process that could take several years. In the meantime, other facsimile-machine makers like 3M Co. are understood to be developing units to meet specs

News briefs

IBM introduces System/34

A low-cost distributed data processing system has been introduced by International Business Machines Corp.'s General Systems division in Atlanta. Called the System/34, the small computer system consists basically of a central processing unit, disk storage of 8.6 megabytes, and a one-sided diskette drive. It includes 32,768 words of main storage (made up of metal-oxide-semiconductor integrated-circuit packages), with an access time of 600 nanoseconds, and a controller to allow attachment of up to eight display stations or tabletop printers. Compatible with IBM's earlier stand-alone System/32 small computer, the System/34 costs \$34,700, with first deliveries scheduled for January 1978. The computer's CPU contains multiple microprocessors to support a portion of the supervisor program and input/output control, and controllers for driving specific I/O devices.

Microfair: the show will go on

Microfair International, the trade show set for Chicago next October that is aimed at new and unsophisticated users of industrial microprocessors, will be taken over from Wema, the electronics trade association, by the original promoter and owner of the show name—Golden Gate Enterprises Inc., Sunnyvale, Calif. Wema decided to drop its sponsorship, after investing some \$15,000 in preparations, when five major members of its semiconductor device group formed the Semiconductor Industries Association and said they would not participate [*Electronics*, April 14, p. 50]. Bill Hickey, vice president at Golden Gate, says he has 20 companies already signed up and hopes to enlist some top Japanese microprocessor makers and users.

Sperry gets \$50 million for fire control

Sperry Rand Corp.'s Sperry division in Great Neck, N.Y., has received a U. S. Navy contract valued in excess of \$50 million for a new lightweight gun and missile radar fire-control system. The MK-92, as the system is called, permits a ship to respond swiftly to airborne or surface threats with either its gun battery or its defensive missiles.

McLucas, former FAA chief, named Comsat General president

John L. McLucas, former Federal Aviation Administration chief, has been named president and a board member of Comsat General Corp., Washington, succeeding John A. Johnson, who moves up to board chairman and chief executive. Johnson takes his new post from Joseph V. Charyk, president of Comsat General's parent, Communications Satellite Corp., who will now serve as chairman of the subsidiary's executive committee. McLucas headed the FAA under President Ford, holding the post from 1975 until this month. Earlier he was secretary of the Air Force (1973-75).

Two RCA European units fined for unlicensed exports

Two RCA Corp. subsidiaries in England and Belgium have been fined \$7,500 for illegal re-exports of U. S. avionics and semiconductors to Czechoslovakia and Yugoslavia, according to the Commerce Department. The shipments did not affect U. S. security, the Government says, noting that RCA itself voluntarily reported the failure to get the required U. S. authorization on learning that RCA Ltd., Sunbury-on-Thames, and RCA S. A., Liege, inadvertently made the shipments without the licenses required.

Motorola sources Mostek microprocessor

Motorola Semiconductor has agreed to second-source Mostek Corp.'s MK 3870 microprocessor (see p. 135), making the Mostek single-chip version of Fairchild's F8 microprocessor the first one-chip computer with an alternate source. The agreement allows Motorola access to Mostek masks and technology and brings Motorola's strengths in the industrial control and automotive markets to the Mostek part. Earlier, Motorola had negotiated a similar arrangement with Fairchild for the F8 family; now it will not bring the Fairchild multi-chip F8 versions to market.

COMPARE THE TOP-RATED 4½-DIGIT DMMs.

Put these three 4½-digit multimeters side-by-side and you'll want the Keithley 172.

The 172 gives you superior accuracy, resolution and convenience with no compromise—at a competitive price.

If you want more evidence, send for our detailed "Comparative Guide to 4½-digit DMMs."

The Keithley 172 rates best—not on every factor, but on most.

If you want hands-on proof, put our 172 side-by-side with the Fluke 8600A, HP 3465A, or any other 4½-digit DMM. The Keithley will stand alone.

Check the chart below or make your own comparison, you'll pick the Keithley 172.

Fluke 8600A



HP 3465A

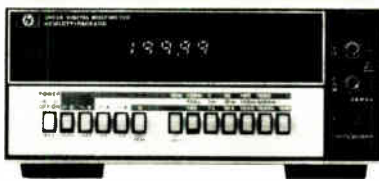

Keithley 172



	Fluke 8600A	HP 3465A	Keithley 172
Functions & Ranging: dcV acV dcI acI ohms	Auto/Manual Auto/Manual Manual Manual Auto/Manual	Manual Manual Manual Manual Manual	Auto/Manual Auto/Manual Auto/Manual Auto/Manual Auto/Manual
Basic Accuracy (dc volts @ 25°C ambient)	± 0.02% reading + 1 digit	± 0.02% reading + 1 digit	± 0.01% reading + 1 digit
Full Range Display (Counts)	19999	19999	29999
HI/LO Ohms	No	No	Yes
Ohms Configuration	2 terminals	2 terminals	2 or 4 terminals
Lighted Function Indicator	No	No	Yes
Price	\$549	\$510	\$525

Comparison based on manufacturers' published specifications. Prices are domestic U.S. for ac line-operated instruments.

It's easy to make your own comparison. Use coupon. Or call (216) 248-0400.

KEITHLEY INSTRUMENTS, 28775 Aurora Road, Cleveland, Ohio 44139.

In Europe: D-8000 München 70, Heighhofstrasse 5, West Germany (089) 7144065.

- Send specs on the Keithley 172. I'll make my own comparison.
- Send "Comparative Guide to 4½-digit DMMs." I need more proof.
- Bring in a Keithley 172 so I can make a side-by-side comparison.

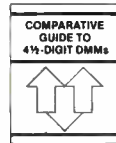

Name _____ Title _____
 Company _____
 Address _____
 City _____ State _____ Zip _____
 Phone _____

KEITHLEY
The measurement engineers.

People are beginning to see the light...

Corning is helping them do it!

Today, compact electronic panels are being used to display alphanumeric information on auto dashboards, airplane cockpits, POS

terminals, and in many other areas where CRT's were used.

Problem: The numbers and characters must be clearly visible from a wide viewing angle under a variety of lighting conditions.

Corning FOTOFORM® Opal, a glass-ceramic, helped solve the problem.

FOTOFORM materials can be chemically machined to produce holes and channels

of almost any size and shape, with precise tolerances of ± 0.001 inch. And they have excellent electrical properties.

Engineers at the Electronic Components Division of Burroughs Corporation took advantage of these characteristics to produce the new Self-Scan® panel displays.

Previously, a white material with limited machinability was

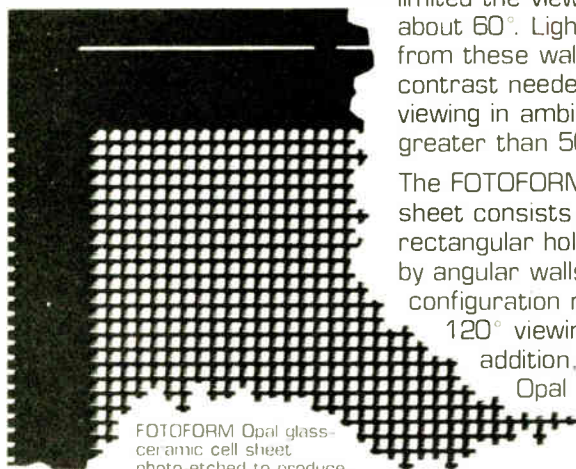
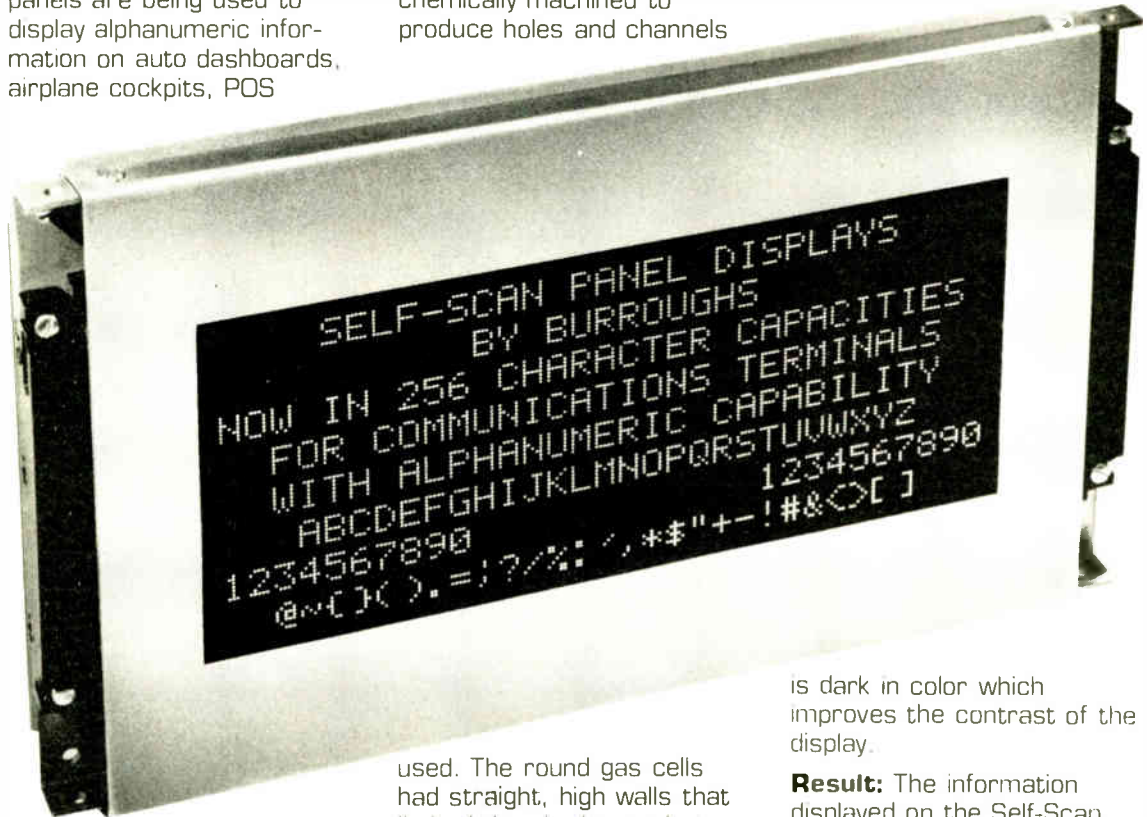

FOTOFORM Opal glass-ceramic cell sheet photo etched to produce precise rectangular holes

used. The round gas cells had straight, high walls that limited the viewing angle to about 60°. Light reflections from these walls limited the contrast needed for good viewing in ambient light greater than 50 footcandles.

The FOTOFORM Opal cell sheet consists of rectangular holes separated by angular walls. This configuration results in a 120° viewing angle. In addition, FOTOFORM Opal glass-ceramic

is dark in color which improves the contrast of the display.

Result: The information displayed on the Self-Scan panel is clear and sharp through a wide range of lighting conditions.

At Corning, we can shape your ideas

For details about this application, and more information about FOTOFORM and FOTOCERAM materials phone or write:

Fotoform Products Group

Corning Glass Works
Corning, New York 14830
(607) 974-8583

CORNING

Electronics review

they feel will be in the final version.

Others. Except for 3M, only Rapi-fax Corp., Fairfield, N. J., markets a sub-minute facsimile machine, which it introduced a few years ago. In addition, Kousai Denshin Denwa Co. of Tokyo recently demonstrated a unit called Quick-fax. However, neither machine, both developed in Japan, was designed to meet the proposed standards.

In these digital fax systems, material is scanned using solid-state light sensors composed of phototransistors or charge-coupled devices. Unlike the slower analog fax approach that can reproduce gray scale, the digital approach only senses black and white content in the interest of speed.

A data-compression scheme eliminates redundant information and the bit stream that results is sent to a modem. With amplitude- and phase-modulation techniques, the information goes out over voice-grade telephone lines.

In addition to the transmission rate of 20 s per page at 9,600 b/s, the Express 9600 needs an initial 15- or 20-s "electronic handshaking" period to set up the transmission. The unit's line-quality checking circuitry automatically adjusts trans-



Speedy. Digital fax from 3M Co. sends a page in 20 seconds, doubles as a copier when not transmitting or receiving.

mission speed (9,600 b/s, 7,200 b/s, 4,800 b/s, and 2,400 b/s) to assure acceptable quality under varying line conditions. The unit is a floor console measuring 38 in. high, 36 in. wide, and 22 in. deep and weighing

325 pounds. It will lease for \$295 a month with additional charges depending upon use. It can also function as a standard office copier. □

Packaging & production

How to make a case out of circuit boards

Why can't printed-circuit boards, the primary building blocks of electronic equipment, serve a structural purpose, as well as carry the components and printed wiring? They can—if they are made of the right material—says Chomerics Inc., a small manufacturer of conductive elastomers and keyboards for calculators and tone-signaling telephones.

That right material may be polysulfone, a durable general-purpose plastic used in the electronics industries for such things as connectors, integrated-circuit carriers, and coil bobbins, says Richard Seeger, operations vice president of the Woburn, Mass., firm.

Keyboard. Seeger's engineers have used polysulfone in the telephone keyboard shown in the photograph on page 40. Its holes, posts, and connector housing are molded when the board is shaped. Such molded-in features, Seeger points out, led to easier and cheaper board manufacture. For example, with holes already in place, expensive drilling and routing operations used on conventional laminated boards of glass epoxy or glass polyester are eliminated. So are the separate assembly steps that would otherwise be needed for adding hardware like connectors and mounting posts.

Off in the future, Chomerics' work might lead to cases and circuit boards molded in one piece for such things as calculators and instruments, Seeger says. Printed-circuit conductors could either be additively plated onto the polysulfone or, more simply, screened on with conductive inks. Adding circuitry should not be difficult. For example, instrument-maker Tektronix Inc. in Beaverton,

MATERIALS TO SHAPE YOUR IDEAS

FOTOFORM® Glass and FOTOCERAM® Glass-ceramic

These materials are rigid, strong, dimensionally stable and chemically inert. They have excellent electrical and physical properties. And we can precision-etch them with intricate and accurate outlines, holes, slots or cavities of almost any size and shape.



FOTOFORM Opal Glass-ceramic with variety of slots as small as .007"



FOTOFORM Glass with .005" square holes on .012" centers

FOTOCERAM Glass-ceramic .050" thick with American flag pattern etched .022" deep



FOTOCERAM Glass-ceramic with variety of holes and slots as small as .007"

FOTOFORM and FOTOCERAM materials are being used to solve design problems for such applications as: Cell sheets for gas discharge displays, substrates, magnetic recording head pads, fluidic devices, impact and non-impact print heads, and assembly jigs. Chances are they can solve a problem for you.

E-477

Fotoform Products Group
Corning Glass Works, Corning, N.Y. 14830.

CORNING

Circle 39 on reader service card 39

Electronics review

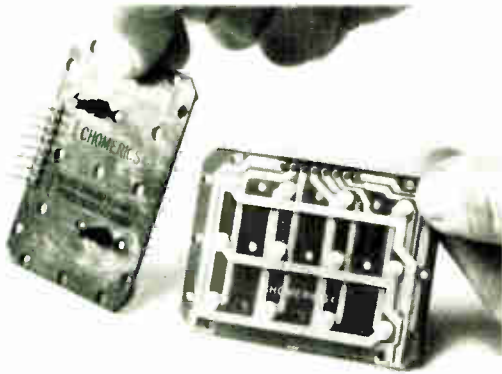

Molded keyboard. Chomerics molds holes, posts and connector housing in keyboard made of polysulfone. Flexible-circuit keys are attached to connector pins (right). The back of a similar board is at left.

Ore., is additively plating conductors onto polysulfone circuit boards it is using in high-frequency equipment because of the material's low dielectric constant.

In the Chomerics assembly, a folded flexible circuit with the pattern for a short-key-travel keyboard is fastened to one side of the board, shown at the right, by pins pushed through the molded connector and soldered in place. A five-second solder bath at 450 F fixes the pins to the flexible circuit's conductors. Seeger points out that polysulfone can take this extremely hot temperature for a short period, although that point is considerably above its 345 F heat-deflection temperature where the material begins to droop.

Better properties. Overall, polysulfone has excellent electrical properties, and its low dielectric constant is combined with a low dissipation factor. Unlike conventional board materials, polysulfone maintains these properties over a wide temperature/frequency range. It also has a high resistance to moisture, on a par with the moisture resistance of a "quality" epoxy-glass board.

Chomerics has also been experimenting with screening thick-film conductive inks onto a polysulfone board. Seeger says he has had good luck with it, adding that the screened patterns have a higher peel strength than on the glass-polyester boards he has also used. □

Tear out the new GI Microelectronics Product Guide

or contact any of
the offices below
for another copy or
for more information.



NORTH AMERICA

GENERAL INSTRUMENT CORP. MICROELECTRONICS

600 West John Street
Hicksville, New York, 11802
Tel: 516-733-3107, TWX: 510-221-1866

EUROPE

GENERAL INSTRUMENT MICROELECTRONICS LTD.

57/61 Mortimer Street
London W1N 7TD, England
Tel: 01-636-2023, Telex: 23272

ASIA

GENERAL INSTRUMENT HONG KONG LTD.

Room 704 Star House
3 Salisbury Road,
Kowloon, Hong Kong
Tel: 3-675528, Telex: 84606



GENERAL INSTRUMENT MICROELECTRONICS



1977 PRODUCT GUIDE

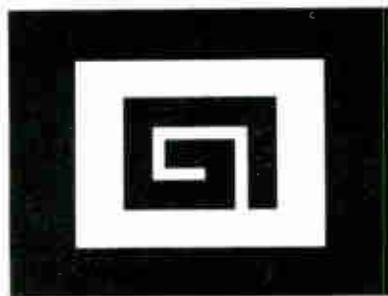

MICRO ELECTRONICS

GENERAL INSTRUMENT CORPORATION · MICROELECTRONICS

GENERAL INSTRUMENT

CALCULATORS

FUNCTION	DESCRIPTION	9V LED	9V FLUOR.	9V LED (IRECT)	15V FLUOR.	15V LED
8 DIGIT BASIC	4 functions and percent key.	C-683	CF-683	C-683D	CF-583	C-583
	4 functions, percent key, one-key or multi-key memory.	C-685	CF-685	C-685D	CF-585	C-585
8 DIGIT ALGEBRA	4 functions, percent key, x^2 , \sqrt{x} , $1/x$, $+/-$, one-key or multi-key memory, choice of 20 to 29 keys.		CF-687	C-687D	CF-589	C-589
	4 functions, percent key, x^2 , \sqrt{x} , $1/x$, $+/-$, one-key or multi-key memory, brackets, inch-centimeter conversion, choice of 24 to 30 keys.		CF-689	C-689D	CF-689HV	—
9 DIGIT BASIC	4 functions and percent key.				CF-593	C-593
	4 functions, percent key, one-key memory.				CF-594	C-594
	4 functions, percent key, multi-key memory.				CF-595	C-595
9 DIGIT SCIENTIFIC	Basic 4 functions, scientific notation, sin, cos, tan, arc sin, arc cos, arc tan, memory, square root, pi, natural logs, $1/x$, e^x , memory exchange, degrees and radians, exponent range ± 99 , choice of 19 to 35 keys.				CF-596	C-596
	All the above plus: 0 to 10^{99} degree trig range, \log_{10} , y^x , extended digit accuracy of transcendentals, choice of 21 to 38 keys.				CF-598	C-598
	All the above plus: two levels of parenthesis, x^2 , %, $+/-$, choice of 24 to 41 keys.				CF-599	C-599

FUNCTION	DESCRIPTION	PART NUMBER	PACKAGE	FEATURES
8 DIGIT PRINTING	Basic 4 functions and percent, automatic constant in multiply and divide, repeat add/subtract, decimal select mode, and other features. Interfaces with the Olivetti Pu1100 dot matrix printer. Option for use with thermal printing version of Pu1100.	*C-716	40 DIP	Accumulator and 4 key memory
12 DIGIT PRINTING	Basic 4 functions and percent, automatic constant in multiply and divide, repeat add/subtract, decimal select mode, memory-in-use indicator, rounding options, non-add (#)/date key, and other features. Interfaces with the Shinshu Seiki Model 310 impact printer.	C-717	40 DIP	Accumulator and Grand Total Memories.
		C-717X		Accumulator, item counter, and four-key independent memory.
		C-718		
PRINTER-DISPLAY INTERFACE	Adds display capability to the C-717X and C-718 printing calculator circuits.	C-719	28 DIP	For both LED and fluorescent displays.
	Adds display capability to the C-716 printing calculator circuit.	*C-720		

*For Future Release.

CLOCKS

FUNCTION	DESCRIPTION	PART NUMBER	DISPLAY TYPE	FLASHING SECONDS	ZERO BLANKING	50/60 Hz OPERATION	PACKAGE	FEATURES
4 DIGIT	12/24 hour clock	AY-5-1200A	7-SEGMENT FLUORESCENT		✓	✓	24 DIP	Direct fluorescent display drive.
		AY-5-1202A	7-SEGMENT FLOURESCENT	✓	✓	✓	24 DIP	Direct fluorescent display drive.
		AY-5-1203A	BCD OUTPUTS	✓		✓	24 DIP	See AY-5-8320 TV circuit.
		AY-5-1204A	7-SEGMENT FLUORESCENT	✓		✓	24 DIP	Direct fluorescent display drive.
		AY-5-1224A	BCD OR 7-SEGMENT LED		✓	✓	16 DIP	Zero blanking in 12 hour mode only.
4 DIGIT WITH ALARM	12 hour clock, 24 hour alarm	CK3000	7-SEGMENT PLASMA	✓	✓	✓	40 DIP	Snooze alarm, individual digit drive.
		CK3100	7-SEGMENT LED	✓	✓	✓	40 DIP	Snooze alarm, individual digit drive.
	12/24 hour clock, 24 hour alarm	CK3200	7-SEGMENT PLASMA	✓	✓	✓	28 DIP	Snooze alarm, duplexed digits.
		CK3400	7-SEGMENT LED	✓	✓	✓	28 DIP	Snooze alarm, duplexed digits.
4 DIGIT CLOCK RADIO	12/24 hour clock, 24 hour alarm	CK3300	7-SEGMENT LED	✓	✓	✓	28 DIP	Snooze alarm, duplexed digits, sleep-timer, timeswitch, battery standby capability
4 DIGIT AUTOMOBILE CLOCK	12 hour clock	CK3500	7-SEGMENT LED		✓	CRYSTAL INPUT	28 DIP	Operates directly from a 3.58MHz TV crystal. Direct drive of LED display.

CALCULATOR MODULES

FUNCTION	DESCRIPTION (SEE ABOVE)	PART NUMBER	FEATURES
8 DIGIT CALCULATOR	Same as C-683D	M-683	Self-contained module which requires only the addition of a keyboard and battery to produce a working calculator.
	Same as C-685D	M-685	
	Same as C-687D	M-687	
	Same as C-689D	M-689	

CLOCK MODULES

FUNCTION	DESCRIPTION (SEE ABOVE)	PART NUMBER	FEATURES
4 DIGIT CLOCK	Same as CK3400	M-3400	Self-contained module which requires only the addition of switches and a power source to produce a working clock.
4 DIGIT CLOCK RADIO	Same as CK3300	M-3300	
4 DIGIT AUTO CLOCK	Same as CK3500	M-3500	

RADIO

FUNCTION	DESCRIPTION	PART NUMBER	AM/MW/SW IF OFFSET	FM/VHF IF OFFSET	POWER SUPPLIES	PACKAGE	FEATURES
FREQUENCY COUNTER/DISPLAY	Counts & displays MW, SW, and VHF frequencies	AY-5-8100	460KHz	10.7MHz	GND, -17	28 DIP	4½ digit display: MW 2999KHz, SW 29.995MHz, VHF 299.95MHz, 0 to 99 FM channel indication (European standard).
		AY-5-8102	455KHz				
FREQUENCY COUNTER/DISPLAY WITH 4 DIGIT CLOCK	Counts & displays AM/FM frequencies with a 12 hour clock	AY-5-8110	262.5KHz	PROGRAMMABLE	+10 to +16, GND	28 DIP	Easy time set controls, low power consumption, on-chip intensity control. Clock functions down to +5V.
		AY-5-8112	455KHz				
STEREOMEGA® PHASE LOCK LOOP DIGITAL TUNING SYSTEM	Control circuit: accepts inputs to control and program system.	AY-3-8115	455KHz	10.7MHz	+10 to +16, GND	40 DIP	Tune up, tune down; search local, distant, stereo only; scanning mode; pre-program 10 favorite stations (5AM/5FM).
	Memory circuit: see ER 1400 EAROM description on page 9.	ER 1400	—	—	+12, -24	8 TO	
	Clock circuit: supplements the control circuit to provide time display.	*AY-3-8116	—	—	+5 to +16, GND	24 DIP	

*For Future Release

*STEREOMEGA is a trademark of General Instrument Corp.

TELEVISION

FUNCTION	DESCRIPTION	PART NUMBER	POWER SUPPLIES	PACKAGE	FEATURES
OMEGA® 82 CHANNEL DIGITAL TUNING SYSTEM	Control circuit: accepts keyboard/remote inputs to control and program system.	T-1001	+12, GND	40 DIP	Scan mode or search mode may also be selected.
	Display circuit: displays selected channel number.	T-1101	+12, GND	40 DIP	Decodes and drives BCD or LED displays.
	D/A converter circuit: converts output to coarse and fine tune outputs.	MEM 4956	VREF, +12, GND	14 DIP	14 bit accuracy for precise varactor tuning.
	Memory circuit: see ER 1400 EAROM description on Pg. 9	ER 1400	+12, -24	8 TO	100 × 14 bit memory
	Optional channel selector interface circuit: permits preset favorite channel selection.	T-1201	+12, GND	40 DIP	Up to 20 channels; pre-set and/or customer selection.
ECONOMEGA® I: 16 CHANNEL DIGITAL TUNING SYSTEM	Control circuit accepts direct/remote inputs to control/program system	AY-3-8203	+12, GND	40 DIP	16 programs, 14 bit accuracy with coarse and fine tune.
	D/A converter circuit: converts output to coarse and fine tune outputs	MEM 4956	VREF, +12, GND	14 DIP	14 bit accuracy for precise varactor tuning.
	Memory circuit: see ER 1400 EAROM description on Pg. 9	ER 1400	+12, -24	8 TO	100 × 14 bit memory.
ECONOMEGA® II: 20 CHANNEL DIGITAL TUNING SYSTEM	Control/memory circuit: accepts direct/remote inputs to control/program system.	*AY-5-8290	+17, GND, -20	40 DIP	Contains both control logic and EAROM memory in a single chip; 20 programs.
	D/A converter circuit: converts output to coarse and fine tune outputs	MEM 4956	VREF, +12, GND	14 DIP	14 bit accuracy for precise varactor tuning.
ON-SCREEN CHANNEL/TIME DISPLAY SERIES	Various circuits in series to display channel numbers on TV screen with some additionally featuring either separate or simultaneous time display. Selection of display position on screen, automatic display recall, BCD time inputs (see AY-5-1203A clock circuit).	AY-5-8300	+17, GND	14 DIP	Channels 0-15
		AY-5-8301			Channels 1-16
		AY-5-8310	24 DIP	-12, GND	Channels 0-15 or 00-99 or time.
		AY-5-8311		+17, GND	Channels 1-16 and/or time. Upper right screen display.
		AY-5-8320		+12, GND	Channels 1-16 and/or time. Lower center screen display.
		AY-5-8321		+13, GND	Channels 1-16 and/or time. Lower center screen display.
		AY-5-8322		+13, GND	Channels 1-16 and/or time. Lower center screen display.
AY-5-8324	+13, GND	Channels 1-16 and/or time. Lower center screen display.			
ON-SCREEN TUNING SCALE	Provides an electronic on-screen tuning scale for varactor tuned TV sets.	AY-3-8330	+12, GND	16 DIP	4 bands, mask programmable band or channel number display, mask programmable display positions.

*For Future Release

*OMEGA & ECONOMEGA are trademarks of General Instrument Corp.

REMOTE CONTROL

FUNCTION	DESCRIPTION	PART NUMBER	POWER SUPPLIES	PACKAGE	FEATURES
R/C SYSTEM I	30 Channel Transmitter	SAA 1024	9V BATTERY	16 DIP	30 ultrasonic control channels, 34-44KHz. Utilizes a 4.4MHz TV crystal for accuracy.
	30 Channel Receivers	SAA 1025-01 SAA 1025-02	+18, GND	16 DIP	Power on/off output, 16 TV channel selection (& 5 spares), 3 analog outputs (8 functions).
R/C SYSTEM II	23 Channel Transmitters	AY-5-8410	+15, GND	18 DIP	23 channels, either local control at receiver or remote control.
	31/63 Channel Receiver	AY-5-8411	9V BATTERY		
R/C SYSTEM III	30 Channel Transmitter	AY-5-8420	+15, GND	14 DIP	5 or 6 bit modes, error-detection.
	16 Channel Receivers	AY-5-8450	9V BATTERY	16 DIP	30 ultrasonic control frequencies, interfaces directly with a 5×6 matrix keyboard.
		AY-5-8460	+12, GND, -6		
		AY-5-8461		18 DIP	Interfaces directly with OMEGA 10 digit keyboard inputs plus on/off, recall, 2 analog controls (4 functions).

GENERAL INSTRUMENT

GIMINI TV GAMES

The General Instrument game repertoire offers game manufacturers a choice of approaches to the marketplace: GIMINI dedicated game chips and the GIMINI cassette programmable game set.

The dedicated game chips for 1977 include a choice of Ball and Paddle games with true game rules, realistic courts, and individual player identification. The Battle game offers all the thrills and excitement of its popular arcade big brother.

The programmable game set based on a variant of GI's CP1600, an advanced 16-bit single chip microprocessor, provides maximum

flexibility in implementing a programmable system. The game "program" ROM, which can be incorporated in a cassette, connects directly to the system address and data busses. With this ROM/cassette approach, a library of game ROMs can be developed encompassing a multitude of game families.

Additionally, since the heart of the programmable system is based on the powerful 16-bit CP1600 microprocessor, expanded capabilities beyond a "game" function are possible — including home interactive teaching systems, data storage and retrieval systems...in effect, a true "home computer."

DEDICATED TV GAMES

FUNCTION	DESCRIPTION	GAMES	PART NUMBER	LINE STANDARD	PACKAGE	FEATURES
BALL & PADDLE I	Six selectable games for one or two players, with vertical paddle motion.	Tennis Soccer Squash Practice	AY-3-8500	625	28 DIP	Automatic on-screen scoring. Sound generation (hit, boundary, score). Selectable paddle size, ball speed, rebound angles.
		Rifle Game I Rifle Game II	AY-3-8500-1	525		
BALL & PADDLE IA	Six selectable games for one or two players, with horizontal and vertical paddle motion.	Tennis Soccer Squash Practice	AY-3-8550	625	28 DIP	All features of the AY-3-8500/8500-1 with the addition of full two-axis player motion, color-coding of score and player, and "hit" and "miss" scoring in Practice game.
		Rifle Game I Rifle Game II	AY-3-8550-1	525		
COLOR CONVERTER I	Converts the black & white video outputs of either the AY-3-8500-1 or AY-3-8550-1 to a single color composite video signal.	—	AY-3-8515-1	525	16 DIP	Colors of the background and paddle outputs are selectively changed directly by the "game select" inputs. Also provides, as an output, a 2.045MHz clock for the game circuit.
BALL & PADDLE II	Eight selectable games for one or two players, with horizontal and vertical player motion	Tennis Hockey Soccer Squash Practice	AY-3-8600	625	28 DIP	Automatic on-screen scoring. Sound generation (hit, boundary, score). Selectable paddle size. (individually selectable for each player), ball speed, rebound angles. Full two-axis player motion. Color-coding of score and player. Realistic ball service and scoring. Flashing score as "end of game" indication.
		Gridball Basketball Basketball Practice	AY-3-8600-1	525		
COLOR CONVERTER II	Converts to the black & white video outputs of the AY-3-8600-1 to a single color composite video signal.	—	AY-3-8615-1	525	24 DIP	Colors of the background and paddle outputs are selectively changed directly by the "game select" inputs. Also provides, as an output, a buffered 3.579MHz clock for the game circuit.
BATTLE I	A two player "tank battle" game where each player has a completely steerable tank with forward and reverse speed control and a firing button.	Tank Battle	AY-3-8700	625	28 DIP	The on-screen "battlefield" includes anti-tank barricades and exploding mines to retard each tank's progress. Unlimited ammunition to a scoring limit of 31 "hits."
			AY-3-8700-1	525		

CASSETTE PROGRAMMABLE TV GAMES

FUNCTION	DESCRIPTION	GAMES	PART NUMBER	PACKAGE	FEATURES
GIMINI® PROGRAMMABLE GAME SET	The GIMINI chip set provides the basis for a user-programmed game series for up to eight players and featuring: up to eight user-controlled moving objects, 64 selectable moving objects, up to 240 programmable background locations, movable background field, and display in up to six colors plus black and white.	User game design for such as: Ball & Paddle, Aggression, Gambling, Racing, etc.	CP1601-G	40 DIP	A variant of the GI CP1600 microprocessor, the CP 1601-G is 16-bit unit utilizing 8 general purpose registers for fast and efficient processing of all game data.
			RO-3-20480	40 DIP	The "program" ROM organized as 2048 × 10, contains all game "rules", symbol locations, color, velocity and direction data.
			AY-3-8900	40 DIP	The "STIC", Standard Interface Chip, provides the video signals including sync and blanking and the manipulation and interaction of all graphics data in a non-interlaced pattern for the TV.
			AY-3-8900-1		
			RO-3-9316A	24 DIP	The "graphics" ROM organized as 2048 × 8, contains a series of 8 × 8 dot matrices for a large variety of game symbols, background/field data, and 64 alpha-numeric characters.
RAM	24 DIP	The "working" memory during game operation. A total of five 256 × 4 RAMs are required for a combined 256 × 12 and 256 × 8 memory complement.			



MOSFET TRANSISTORS - Contact any GI Sales Office for details on other available MOSFET Transistors

TYPE	PART NUMBER	V _{BR(DSS)} VOLTS MIN.	V _{BR(ISS)} VOLTS MIN.	I _{DSS} nA TYP.	I _{GSSF} nA TYP.	V _{GS(th)} VOLTS MIN/MAX.	r _{DS(on)} OHMS TYP.	Y _{fs} MHO TYP.	C _{iss} pF TYP.	C _{rss} pF TYP.	CASE			
P-CHANNEL ENHANCEMENT MODE	MEM806	-40	-40	-1.0	-0.1pA	-2/-5.5	150	2,800	4.5	1.0	TO-72			
	MEM807	-40	-40	-0.5	-0.1	-2/-5.5	150	2,800	4.5	1.0	TO-72			
	MEM817	-45	200	-0.1	-0.05pA	-2.5/-6.5	150	2,000	3.5	1.2	TO-72			
	3N183	-25	-25	-2.0	-0.3	-2/-6	50	9,000	15.0	10.0	TO-72			
TYPE	PART NUMBER	V _{BR(DSS)} VOLTS MIN.	I _{GSSF} nA TYP.	V _{GS(th)} VOLTS MIN/MAX.	r _{DS(on)} OHMS TYP.	Y _{fs} MHO TYP.	C _{gs} pF TYP.	C _{rss} pF TYP.	Y _{fs} RATIO TYP.	V _{GS} -V _{GS} mV TYP.	CASE			
DUAL P-CHANNEL ENHANCEMENT MODE	MEM550C	-25	-0.2	-3/-6	250	800	2.0	2.0	0.8	100	TO-77			
	MEM551C	-25	-1pA	-3/-6	250	750	1.5	1.5	0.85	70	TO-77			
	MEM954	-30	-0.03	-2/-5	100	1000	2.0	1.5	0.95	50	TO-77			
	MEM955	-35	-0.02pA	-2/-5	100	1000	2.0	1.5	0.95	50	TO-77			
TYPE	PART NUMBER	BV _{DSS} MIN. VOLTS	V _{BR(ISS)} VOLTS MIN.	I _{DSS} nA TYP.	I _{GSSF} nA TYP.	I _{D(on)} mA TYP.	V _{GS(th)} VOLTS MIN/MAX.	r _{DS(on)} OHMS TYP.	Y _{fs} MHO TYP.	C _{iss} pF TYP.	C _{rss} pF TYP.	CASE		
N-CHANNEL ENHANCEMENT MODE	MEM562	+20	30	1	1pA	15	0.5/4	150	2,500	3	0.3	TO-72		
	MEM711	+25	30	1	0.1	40	0.5/1.5	50	3,000	4.5	0.5	TO-72		
	3N177	+20	30	5	50pA	15	1/3.5	300	1,500	5	0.5	TO-72		
TYPE	PART NUMBER	V _{BR(DS)} VOLTS MIN.	V _{BR(I_{GS})} VOLTS MIN.	V _{BR(I_{GS})} VOLTS MIN.	I _{DSS} mA TYP.	I _{GSS} nA TYP.	V _{GS(off)} VOLTS MAX.	r _{DS(on)} OHMS TYP.	Y _{fs} MHO TYP.	C _{iss} pF TYP.	C _{rss} pF TYP.	G _{ps} dB TYP.	NF dB TYP.	CASE
N-CHANNEL DEPLETION MODE	MEM557	+20	10	—	5	.01	-4	200	10,000	3	0.32	18	2.5	TO-72
	MEM616	+25	6	6	10	20	-4	—	18,000	5.4	.02	18	3.0	TO-72
	MEM636	+20	6	6	15	50	-4	—	16,000	6	.02	22	3.5	Plastic
	MEM655	+20	6	—	4	10	-4	30	10,000	4	0.32	22	2.5	TO-72
	MEM670	+20	100	—	3	.05pA	-4	—	2,000	2	0.3	—	—	TO-72
	MEM680	+25	6	—	4/30	50	-4	—	18,000	5.4	0.2	21	2.5	TO-72

MUSIC

FUNCTION	DESCRIPTION	PART NUMBER	MAXIMUM FREQUENCY	POWER SUPPLIES	PACKAGE	FEATURES	
MASTER FREQUENCY GENERATOR/ TOP OCTAVE GENERATOR	Generates a complete octave of musical frequencies	AY-1-0212	1.5 MHz	+12, GND	16 DIP	250KHz minimum frequency	
		AY-1-0212A	2.5 MHz				
		AY-3-0214					12 outputs, 50% duty cycle
		AY-3-0215	4.5MHz	+10 to +16, GND	16 DIP	13 outputs, 50% duty cycle	
		AY-3-0216				13 outputs, 30% duty cycle	
LATCHING NETWORK	Establishes priority level of 13 latch inputs/outputs	AY-1-1313	20KHz	GND, -12, -27	40 DIP	Stackable for expanded latching/priority function	
RHYTHM GENERATOR	Generates 6 rhythms, drives 8 instruments	AY-5-1315	10KHz	GND, -15	18 DIP	Resets for coupling chords to rhythm, 32 beat pattern. Mask programmable.	
CHORD GENERATOR	Produces major, minor, 7th chords, walking bass	AY-5-1317A	50KHz	GND, -15	40 DIP	Mixed outputs, sustain, top key priority	
PIANO KEYBOARD	Electronically simulates piano operation and sound	AY-1-1320	—	GND, -10, -27	40 DIP	12 keys per unit, loudness proportional to key press velocity.	
FREQUENCY DIVIDERS	4 stage	AY-1-5051	1MHz	GND, -13, -27	10 TO	Arranged 2 + 1 + 1	
	5 stage	AY-1-6721/5	1MHz	GND, -13, -27	10 TO	Arranged 3 + 2	
	6 stage	AY-1-6721/6	1MHz	GND, -13, -27	12 TO	Arranged 3 + 2 + 1	
		AY-1-1006	50KHz	GND, -12, -27	14 DIP	Arranged 3 + 2 + 1	
		AY-1-2006	50KHz	GND, -12, -27	14 DIP	Arranged 2 + 2 + 1 + 1	
	7 stage	AY-1-5050	1MHz	GND, -13, -27	14 DIP	Arranged 3 + 2 + 1 + 1	
		AY-1-1007B	50KHz	GND, -12, -27	14 DIP	Arranged 3 + 2 + 1 + 1, power-on reset	
2 ¹⁶ J-L Counter/Divider	AY-9-1000		Operation is a function of current through a resistor from V _{CC} to Injection input	8 TO, 16 DIP	Crystal/RC oscillator input, divide by 2 ¹⁶ , 2 ¹⁵ , 2 ¹⁴ , 2 ¹³ , 2 ¹² , or 2 ¹¹ .		

APPLIANCES

FUNCTION	DESCRIPTION	PART NUMBER	POWER SUPPLIES	PACKAGE	FEATURES
CLOCK TIMER	24 hour programmable repeatable on/off time switch with 4 digit clock.	AY-5-1230	GND, -12 to -18	28 DIP	50Hz input (50 or 60Hz on AY-5-1231), BCD or 7-segment direct fluorescent display drive outputs, zero blanking, 24 hour display (12 or 24 hour on AY-5-1231).
		AY-5-1231		40 DIP	
		AY-5-1232		28 DIP	
		AY-5-1233		28 DIP	
COOKER TIMER	Appliance timer with clock. Full control of "start" time, "stop" time, or "duration".	*AY-5-1250 *AY-5-1251	-9, GND	28 DIP	Two timed outputs (3 on the AY-5-1251), "minute minder" feature, 12/24 hour system, temperature setting on AY-5-1251.
COINBOX CIRCUIT	A coin memory credit accumulator for use in coin-operated equipment.	AY-1-8622	GND, -12, -27	40 DIP	Seven different coin inputs, credit and "bonus" features.

TELECOMMUNICATIONS

FUNCTION	DESCRIPTION	PART NUMBER	POWER SUPPLIES	PACKAGE	FEATURES
PUSH BUTTON TELEPHONE DIALLER CIRCUIT	Converts push button input to rotary dial pulses	AY-5-9100	SEE DATA SHEET	18 DIP	Programmable timing, one-call memory. Optional redial and access pause capability (except on AY-5-9118).
		AY-5-9106			
		AY-5-9110		14 DIP	
		AY-5-9118		18 DIP	
		AY-5-9120			
REPERTORY DIALLER	Stores ten telephone numbers	AY-5-9200	SEE DATA SHEET	16 DIP	Complements AY-5-9100 to enable storage of up to ten 22-digit telephone numbers. Stackable.
COINBOX CIRCUIT	Controls the operation of a standard pay telephone.	AY-5-9300	SEE DATA SHEET	24 DIP	Up to 3 coin denominations recognized, 16 selectable coin ratios.
DUAL TONE MULTI-FREQUENCY GENERATOR	Generates DTMF/telephone frequencies.	AY-3-9400	+5, GND	14 DIP	With a low cost ceramic resonator, generates 12 tone pairs.
		AY-3-9401	+5, GND	16 DIP	Same as AY-3-9400 but generates 16 tone pairs for data transmission.
		AY-3-9410			
C-MOS GENERATOR	Generates 2-phase clocks from a single power supply.	AY-5-9500	SEE DATA SHEET	14 DIP	Generates 2-phase clocks for AY-5-9100 & AY-5-9200.
MULTI-FREQUENCY RECEIVER	Detects and converts DTMF/telephone frequencies.	AY-5-9800 SERIES	GND, -8.5, -17	28/40 DIP	Choice of output codes: 4 bit, 1 of 16, 2 of 8, binary, custom programmable.

HYBRID ACTIVE FILTERS

FUNCTION	PART NUMBER	DESCRIPTION
UNIVERSAL ACTIVE FILTER	ACF 7032C ACF 7092C	The ACF 7032C and the ACF 7092C filters are low cost devices which can be used to generate any filter response. Low pass, Band pass, Band Rejection, High pass, and All pass filter responses are available by means of external connections. The design provides for independent control of Frequency, Q, and Amplifier Gain, and is usable throughout the frequency range of 10KHz to 10KHz.
3825Hz LPF	ACF 7110C	The ACF 7110C filter provides for low pass filtering of speech frequencies while attenuating the 3825Hz signaling frequency to a minimum attenuation of 43dB. The reference 1.0KHz gain of this filter is 0dB with a maximum in-band ripple specification plus or minus 0.1dB.
PCM TRANSMIT LPF	ACF 7170C	The ACF 7170C filter has been designed for PCM transmit applications. This 0dB gain filter provides for a minimum 39dB attenuation at 4.6KHz and an in-band ripple specification of plus or minus 0.125dB.
PCM TRUNK TRANSMIT LPF	ACF 7173C	The ACF 7173C filter has been designed for PCM "Trunk" transmit applications. This variable gain, 0dB to 29dB, low noise filter is capable of exceeding the A.T. & T. D3 Channel Bank Compatibility specification. This filter provides a minimum attenuation of 32dB at 4.6KHz, a maximum in-band ripple of plus or minus 0.1dB, and 14.5dB minimum attenuation at 60Hz.
PCM TRUNK RECEIVE LPF & PAM GATE	ACF 7174C	The ACF 7174C filter has been designed for PCM "Trunk" receive applications. This variable gain, -16dB to +3.5dB, low noise filter is capable of exceeding the A.T. & T. D3 Channel Bank Compatibility specification. This filter has a self contained Pulse Amplitude Modulation (PAM) Gate and Sample and Hold Capacitor for demodulating and holding the input signal. The filter has been compensated for a Sin X over X correction and provides a minimum attenuation of 28dB at 4.6KHz and a maximum in band ripple of plus or minus 0.1dB.
PCM TRUNK TRANSMIT LPF	ACF 7175C	The ACF 7175C filter has been designed for PCM "Line" transmit applications. This fixed gain, 8.25dB, low noise filter is capable of exceeding the A.T. & T. D3 Channel Bank Compatibility specification. This filter provides a minimum attenuation of 30dB at 4.6KHz and a maximum in band ripple of plus or minus 0.3dB and also provides for DC blocking.
PCM LINE RECEIVE LPF & PAM GATE	ACF 7176C	The ACF 7176C filter has been designed for PCM "Line" receive applications. This fixed gain, 8.2dB, low noise filter is capable of exceeding the A.T. & T. D3 Channel Bank Compatibility specification. This filter has a self contained Pulse Amplitude Modulation (PAM) Gate and Sample and Hold Capacitor for demodulating and holding the input signal. The filter has been compensated for a Sin X over X correction and provides a minimum attenuation of 28dB at 4.6KHz, and a maximum in band ripple of plus or minus 0.3dB.
BAND PASS FILTER & FULL WAVE DETECTOR	*ACF 7300C *ACF 7301C *ACF 7302C	The ACF 7300C/7301C/7302C each consists of a full wave detector and a four (4) pole fixed band width band pass filter, factory tunable over a center frequency (Fo) range: ACF 7300C - 540Hz to 1980Hz; ACF 7301C - 700Hz to 1700Hz; ACF 7302C - 2280Hz to 3825Hz.
2600Hz BPF	ACF 7310C	The ACF 7310C is a sharply tuned filter designed to detect and pass the 2600Hz signaling frequency. This filter provides for a minimum attenuation of: 30dB plus and minus 200Hz, 50dB plus and minus 500Hz, and 70dB plus and minus 1000Hz from the center frequency of 2600Hz.
3825Hz BPF	ACF 7311C	The ACF 7311C is a sharply tuned filter designed to detect and pass the 3825Hz signaling frequency. This filter provides for a minimum attenuation of 40dB, plus and minus 200Hz from the center frequency of 3825Hz.
300-3400Hz BPF	ACF 7320C	The ACF 7320C is a 0dB, 300Hz to 3400Hz band pass filter with an in band ripple specification of plus or minus 0.15dB maximum. The filter provides for a minimum attenuation of 15dB at 170Hz and 3750Hz.
DTMF TONE DETECTION BPF	ACF 7323C ACF 7363C ACF 7383C	The ACF 7323C/ACF 7363C/ACF 7383C Band Pass Active Filters are factory pre-tuned filters designed specifically for tone receiver applications. These two pole constant Q filters are available in the standard AT&T tone frequencies and in the standard multifrequency steps.
DIAL TONE BAND SUPPRESSION FILTER	ACF 7401C	The ACF 7401C is a dual tuned band suppression filter which has been designed to reject frequencies of 350Hz and 440Hz, which are present on a telephone line. The unit is totally self contained and requires no external components for proper operation. The filter provides for 0dB insertion loss in the pass band of 697Hz through 1633Hz, the normal DTMF tone frequencies. The filter also provides for 60Hz attenuation for low noise operation.
2600Hz BAND SUPPRESSION FILTER	ACF 7410C	The ACF 7410C is a sharply tuned filter designed to reject the 2600Hz signaling frequency. This filter provides for a minimum attenuation of 60dB plus and minus 15Hz from the center frequency of 2600Hz.
60Hz NOISE SUPPRESSION FILTER	*ACF 7480C	The ACF 7480C is a sharply tuned filter for 60 Hertz suppression. It provides a minimum attenuation of 40dB plus or minus 0.25Hz from the center frequency. The filter is self contained and requires no external components for proper operation.
DTMF BAND SEPARATION FILTER	ACF 7711C	The ACF 7711C is a dual filter which has been designed to provide channel isolation between the low frequency group of the tone (DTMF) frequencies of 941Hz, and the high frequency group of 1209Hz through 1633Hz. This filter provides for a minimum attenuation of 30dB for the adjacent frequencies of 941Hz and 1209Hz, 0dB in the pass bands, and 25dB out-of-band attenuation.

*For Future Release

DATA COMMUNICATIONS

FUNCTION	DESCRIPTION	PART NUMBER	REPLACES (PIN-FOR-PIN)	BAUD RANGE	MAX. FREQ.	TEMP. RANGE	POWER SUPPLIES	PACKAGE	FEATURES
UAR/T®	Complete 5-8 bit serial/parallel, parallel/serial interface.	AY-3-1015	AMI S1757 SIG 2536	0 to 30KB	480KHz	0 to 70	+5, GND	40 DIP	1, 1.5, or 2 stop bits
		†AY-6-1013	SMC COM2505	0 to 22.5KB	360KHz	-55 to +125	+5, GND, -12	40 DIP	1 or 2 stop bits
		AY-5-1013A	TI TMS6011 WD TR1402A	0 to 40KB	640KHz	0 to 70	+5 to +14, GND	40 DIP	1, 1.5, or 2 stop bits
		AY-3-1014A	WD TR1602A	0 to 30KB	480KHz	0 to 70	+5, GND, -12	40 DIP	1, 1.5, or 2 stop bits
NEW P/SAR	A programmable receiver that interfaces variable length serial data to a parallel data channel.	*AY-8-1472B	WD1472B	0 to 100KB	100KHz	0 to 70	+5, GND, -12	40 DIP	Data conversion to formats compatible with all standard Synchronous, Asynchronous, & Isochronous data communications media.
NEW P/SAT	A programmable transmitter that interfaces variable length parallel data to a serial data channel.	*AY-8-1482B	WD1482B	0 to 100KB	100KHz	0 to 70	+5, GND, -12	40 DIP	

*For Future Release.

†Also available with MIL STD 883 screening (add suffix TX to part number).

*UAR/T is a trademark of General Instrument Corporation.

MULTIPLEXERS

FUNCTION	DESCRIPTION	PART NUMBER	PEAK-PEAK SIGNAL INPUT RANGE	ON RESISTANCE	TEMP. RANGE	SUFFIX/PACKAGE
RANDOM/SEQUENTIAL ACCESS MULTIPLEXER	Multiplexes 16 analog channels, with on-chip logic control.	AY-5-1016	20 Volts	500 ohms	0 to 70	40 DIP
		†AY-6-4016			-55 to +125	
MOSFET ANALOG GATES	4 CHANNEL	MEM 851	30 Volts	100 ohms	-65 to +85 (Plastic Dip) -65 to +125 (Ceramic DIP, Flat Pack)	P/14 Plastic DIP D/14 Ceramic DIP F/14 Flat Pack
	6 CHANNEL	MEM 855	25 Volts	350 ohms		
		MEM 856	40 Volts	1000 ohms		
	8 CHANNEL	MEM 857	25 Volts	150 ohms		
10 CHANNEL	MEM 853	25 Volts	150 ohms		P/24 Plastic DIP D/24 Ceramic DIP F/24 Flat Pack	

†Also available with MIL STD 883 screening (add suffix TX to part number).

INDUSTRIAL

FUNCTION	DESCRIPTION	PART NUMBER	MAX. COUNT FREQUENCY	OUTPUT CURRENT	POWER SUPPLIES	PACKAGE	FEATURES
4 DIGIT COUNTER	Counts, stores & decodes four decades to BCD outputs.	AY-5-4057	500KHz	—	+5, GND, -12	16 DIP	BCD outputs
4 DIGIT COUNTER/DISPLAY DRIVER	Counts (up or down), stores & decodes four decades to 7-segment outputs.	AY-5-4007	600KHz	25 mA/V	+5, GND, -12	24 DIP	BCD outputs, true/complement control
		AY-5-4007A				40 DIP	Includes features of AY-5-4007 & 4007D
		AY-5-4007D				24 DIP	Serial count output, three carry outputs
3½ DIGIT DVM	DVM logic incorporating dual ramp integration	AY-5-3507	40KHz	6 mA	GND, -15	18 DIP	Range to 1999, 7-seg. outputs
		AY-5-3510		—		16 DIP	Range to 1999, BCD outputs
3% DIGIT DVM	DVM logic incorporating dual ramp integration.	AY-5-3500	200KHz	6 mA	GND, -7.5, -15	28 DIP	3 ranges: 999, 1999, 2999. Dual polarity, BCD & 7-seg. outputs
4% DIGIT DVM	DVM logic incorporating dual ramp integration	AY-3-3550	400KHz	2.5 mA	+5, GND	40 DIP	Auto-range, auto-zero, auto-polarity, 7-segment/BCD outputs, counter mode.
10 BIT D/A CONVERTOR	Ladderless D/A converter.	AY-5-5053	SEE DATA SHEET	—	+5, GND, -12	24 DIP	Employs stochastic techniques
A/D CONVERTOR CONTROL	With AY-5-5053, performs A/D with transmitter facility.	AY-5-5054	SEE DATA SHEET	—	+5, GND, -12	24 DIP	For use in remote sensing applications.
NEW SEQUENTIAL BOOLEAN ANALYZER	A simple, single bit processor which can directly evaluate a set of Boolean equations.	*SBA	800KHz CLOCK	20 mA TOTAL	+12, +5, GND	40 DIP	A microprogrammable circuit which forms the basic controlling element for many systems requiring timing and control functions.

*For Future Release [World Radio History](#)

GENERAL INSTRUMENT

SERIES 1600 MICROPROCESSOR

FUNCTION	FEATURES	DESCRIPTION	APPLICATIONS	PART NUMBER	PACKAGE
16 BIT SINGLE CHIP MICRO-PROCESSOR	<ul style="list-style-type: none"> 8 program accessible 16-bit general purpose registers 87 basic instructions 4 addressing modes Unlimited interrupt nesting and priority resolution 16-bit 2's complement arithmetic & logic Direct memory access (DMA) for high speed data transfer 64K memory using single address 	The CP 1600 utilizes third generation mini-computer architecture with eight general purpose registers. The 16-bit word enables fast & efficient processing of alphanumeric or byte oriented data. The 16-bit address capability permits access to 65,536 words in any combination of program memory, data memory, or peripheral devices.	The CP 1600 Microprocessor is designed for high speed data processing & real time applications. Typical applications include programmable calculator systems, peripheral controllers, process controllers, intelligent terminals & instruments, data acquisition and digital communications processors, numerical control systems, programmable TV game systems.	CP 1600	40 DIP
INPUT/OUTPUT BUFFER	<ul style="list-style-type: none"> Single 16-Bit or Dual 8-Bit Ports for Bidirectional Input/Output Parity Check Logic on Both Ports Three Levels of Priority Automatic Handshake Logic and Signals Control Register 	The IOB 1680 is a byte oriented programmable input/output buffer which provides comprehensive interfacing facilities for the CP 1600 microprocessor. Data is transferred to and from the peripheral on 16 bidirectional lines, each of which can be considered to be an input or output.	The IOB 1680 enables efficient interfacing between a peripheral and the CP 1600 by the use of six 8-bit registers and a 16-bit programmable timer.	IOB 1680	40 DIP
DUAL DIGITAL TO ANALOG CONVERTER	<ul style="list-style-type: none"> 10 bit bidirectional data bus Synchronous/Asynchronous loading Manual input mode 	The DAC 1600 contains four registers which can be loaded or read through a 10-bit I/O data port.	The DAC 1600 Digital to Analog Converter has been designed to interface to a process control loop.	DAC 1600	40 DIP
18 CHANNEL ANALOG MULTIPLEXER	<ul style="list-style-type: none"> Connects 1 of 18 analog inputs Address latch on-chip 0 to 6 volt input range Analog output controlled by chip select signal 	The MUX 1600 is a binary addressed 18 channel analog multiplexer. The MUX 1600 includes on-chip address latches and separate address strobe and chip select signals.	The binary address selection of the 18 input channels provides for simplified direct control of analog signals by the CP1600 microprocessor chip.	MUX 1600	28 DIP
GIMINI MICRO-COMPUTER SYSTEM	<ul style="list-style-type: none"> Built around the CP 1600 Microprocessor Complete microcomputer system Separate Data, Address and Control Buses Up to 65K memory space. Unlimited DMA channels Nested interrupt system with full priority resolution. 	The GIMINI utilizes a totally modular design for maximum configurability. The system provides direct addressing to 65K words, unlimited DMA channels, and a multi-line multi-level nested interrupt system with full priority resolution and self-identifying addresses. All control & timing signals as well as data & address busses are fully buffered.	To simplify microprocessor hardware and software development, speed the product design cycle & support product prototyping, a microcomputer development system and its associated components are a must. The Series 1600 family fills these requirements with the GIMINI Microcomputer.	GIMINI	—
GIMINI SINGLE CARD MICRO-COMPUTER	<ul style="list-style-type: none"> 16K words of RAM 4K words of PROM Up to 32 input and 32 output lines Two UART/RS232 Serial I/O channels Real time clock 	The SC1600 GIMINI Single Card Micro-computer provides full 16-bit processing power on a single card. The SC1600 uses the CP1600 microprocessor with all circuitry for a complete operating system.	In industrial usage, the SC1600 can serve as the kernel of a modular expandable processing system with other cards added as required. In consumer applications, the SC1600 can serve as the basis for many user-programmable systems such as TV games, home TV terminals, etc.	*SC1600	—

*For Future Release

SERIES 8000 MICROPROCESSOR

FUNCTION	FEATURES	DESCRIPTION	APPLICATIONS	PART NUMBER	PACKAGE
8 BIT MICRO-PROCESSOR	<ul style="list-style-type: none"> 2 Chip Minimum System (plus clock) 48 Accessible 8 Bit Registers 48 Basic Instructions Binary and Decimal Arithmetic Direct and Indirect Input/Output Capability Automatic subroutine nesting on memory devices. 	The LP 8000 Logic Processor Unit is a complete 8-bit single chip MOS-LSI Microprocessor. It has a modern computer architecture with forty eight general purpose internal registers. The 8-bit Data highway is supplemented by a 6-bit Address bus to give a 14-bit address capability which permits access to 16,384 words.	The Series 8000 Logic Processor System is designed to perform any digital function using far fewer packages than a TTL or CMOS implementation. Typically a 100 package system can be reduced to a three chip solution of LP 8000 Processor, LP 6000 Program Memory and LP 1030 Clock Generator. Also available: LP 1010 I/O Buffer, LP 1000 Memory Interface.	LP 8000	40 DIP
				LP 6000	40 DIP
				LP 1030	8 DIP
				LP 1010	40 DIP
				LP 1000	40 DIP

PIC SERIES MICROCOMPUTER

FUNCTION	FEATURES	DESCRIPTION	APPLICATIONS	PART NUMBER	PACKAGE
8 BIT SINGLE CHIP MICRO-COMPUTER	<ul style="list-style-type: none"> User Programmable 32 8-Bit Registers 512x12-Bit ROM for Program Arithmetic Logic Unit 4 Sets of 8 User Defined TTL-compatible Input/Output Lines Real Time Clock Counter Self contained Oscillator Access to RAM Registers inherent in instruction. 	The PIC 1650 MOS LSI circuit array is a byte oriented programmable controller. The array is a complete chip controlled with an internal customer-defined ROM program specifying the overall functional characteristics and operational waveforms on each of the general purpose input/output lines.	The array can be programmed to scan keyboards drive multiplexed displays, control vending machines, traffic lights, printers and automatic gasoline pumps. Since it contains ROM, RAM, I/O as well as the central processing unit on one device, the PIC 1650 is truly a complete 8-bit microcomputer on one chip.	PIC 1650	40 DIP
8 BIT SINGLE CHIP DEVELOPMENT MICRO-COMPUTER	<ul style="list-style-type: none"> PIC 1650 microcomputer without ROM. ROM address and data lines brought out to pins. Can be stopped or single stepped via a HALT pin. 	The PIC 1664 circuit is exactly the same as the PIC 1650 except that the ROM portion of the PIC 1650 has been removed. Any external RAM or PROM can be used to aid in the development of a final PIC 1650 configuration.	The PIC 1664 has been designed as a useful tool for engineering development and prototyping and for initial field trial and demonstrations of systems which will utilize the PIC 1650	*PIC 1664	64 DIP



STATIC RANDOM ACCESS MEMORIES

BITS	MEMORY ORGANIZATION	PART NUMBER	REPLACES (PIN-FOR-PIN)	ACCESS TIME/CYCLE TIME	POWER SUPPLIES	PACKAGE	FEATURES
1024	256x4	RA-3-4256	—	500ns/500ns	+5, GND	24 DIP	Power down mode.
		RA-3-4256A	—	650ns/650ns	+5, GND	24 DIP	Power down mode.
		RA-3-4256B	—	650ns 650ns	+5, GND	22 DIP	
4096	4096x1	RA-3-4200	SEMI 4200	215ns 400ns	+12, +5, GND	22 DIP	TTL output
		RA-3-4402	SEMI 4402	200ns/350ns	+12, GND, -5	22 DIP	Differential output.

ELECTRICALLY ALTERABLE READ ONLY MEMORIES

BITS	ORGANIZATION	PART NUMBER	READ ACCESS	ERASE TIME/MODE	WRITE TIME/MODE	POWER SUPPLIES	PACKAGE	FEATURES
512	32 x 16	ER2050	10µs	100ms/16 bit word	10ms/16 bit word	+5, -28	28 DIP	10 year data storage @ +70°C.
		*ER2051	3µs	50ms/16 bit word	50ms/16 bit word			
1024	256 x 4	ER1105	2µs	100ms/32x4 block	5ms/4 bit word	+12, -12	24 DIP	
1400	100 x 14	ER1400	2.8 µs	16ms/14 bit word	16ms/14 bit word	-35	8 TO/DIP	
4096	1024 x 4	ER2401	2 µs	100ms/1024x4 block	10ms/4 bit word	+5, -14, -24	24 DIP	
		*ER3400	650ns	10ms/4 bit word or 1024x4 block	1ms/4 bit word	+5, -12, -30	22 DIP	
		ER3401	950 ns					
8192	2048 x 4	ER2800	2.6µs	100ms/2048x4 block	10ms/4 bit word	+5, -14, -24	24 DIP	
		*ER2805	2µs					

*For Future Release.

READ ONLY MEMORIES

BITS	MEMORY ORGANIZATION	PART NUMBER	REPLACES (PIN-FOR-PIN)	ACCESS TIME	CLOCKS/VOLTAGE	POWER SUPPLIES	PACKAGE	FEATURES
1024	256 x 4	RO-7-1024/4	—	1µs (typ.)	STATIC	+5, GND, -12	16 DIP	RO-6 versions available for -55°C to +125°C.
	128 x 8	RO-7-1024/8	—	1µs (typ.)	STATIC	+5, GND, -12	24 DIP	
2048	256 x 8	RO-5-1302	INTEL 1302	1.5 µs (typ.)	STATIC	+5, GND, -12	24 DIP	Masked version of 1702
		RO-7-2048/8	—	1.5 µs (typ.)	STATIC	+5, GND, -12	24 DIP	RO-6 versions available for -55°C to +125°C.
	512 x 4	RO-7-2048/4	—	1.5 µs (typ.)	STATIC	+5, GND, -12	24 DIP	
2560	512 x 5	RO-3-2560	—	450 ns	STATIC	+5, GND	18 DIP	
4096	512 x 8	RO-3-4096	—	500 ns	STATIC	+5, GND	22 DIP	
5120	512 x 10	RO-3-5120	EA 4000	500 ns	STATIC	+5, GND	24 DIP	
8192	2048 x 4	RO-5-8192	AMI S8865	1.2 µs (typ.)	2/TTL	+5, -12	24 DIP	
16384	2048 x 8	RO-3-8316A	INTEL 8316A AMI S6831A	850 ns	STATIC	+5, GND	24 DIP	Replaces two 2708 or 8708 UV PROMs.
		RO-3-8316B		450 ns				
		RO-3-8316C		400 ns				
		RO-3-9316A	INTEL 8316E AMI S6831B MOT 68317	850 ns	STATIC	+5, GND	24 DIP	
		RO-3-9316B		450 ns				
		RO-3-9316C		400 ns				
4096 x 4	RO-3-16384	AMI S8996	1 µs	STATIC	+5, GND	24 DIP	Address/Chip Select latch	
20480	2048 x 10	*RO-3-20480	—	850 ns	STATIC	+5, GND	24 DIP	
32768	4096 x 8	*RO-3-9332A	—	850 ns	STATIC	+5, GND	24 DIP	

*For Future Release.

Note: All Read Only Memories are mask-programmable.

KEYBOARD ENCODERS / CHARACTER GENERATORS

BITS	MEMORY ORGANIZATION	PART NUMBER	REPLACES (PIN-FOR-PIN)	ACCESS TIME	CLOCKS/VOLTAGE	POWER SUPPLIES	PACKAGE	FEATURES
2376	88 x 3 x 9 KEYBD. ENCOD.	AY-5-2376	SMC KR2376	10-100kHz Scan Rate	1/TTL or INT. OSC.	+5, GND, -12	40 DIP	2 key rollover, 88 keys, 3 modes.
3600	90 x 4 x 10 KEYBD. ENCOD.	AY-5-3600	SMC KR3600	10-100kHz Scan Rate	1/TTL or INT. OSC.	+5, GND, -12	40 DIP	2/N key rollover, 90 keys, 4 modes.
		AY-5-3600PRO	—					
2240	64 x 5 x 7 CHAR. GENER.	RO-5-2240S	MK 2302 FSC 3257	1 µs (typ.)	1/TTL for Scanning	+5, GND, -12	24 DIP	5x7 char. column output, on-chip scanning.
2560	64 x 8 x 5 CHAR. GENER.	RO-3-2513	SIG 2513	450 ns	STATIC	+5, GND	24 DIP	5x7 characters, row output.
5184	64 x 9 x 9 CHAR. GENER.	RO-5-5184	—	5 µs (typ.)	1/TTL for Scanning	+5, GND, -12	24 DIP	9x9 characters, on- chip left/right scanning.

Note: All Keyboard Encoders and Character Generators are mask-programmable. Standard patterns are available

STATIC SHIFT REGISTERS - Contact any GI Sales Office for details.

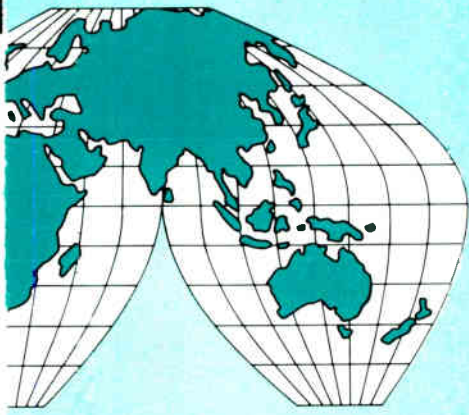

EUROPE

EUROPEAN SALES HEADQUARTERS:
GENERAL INSTRUMENT MICROELECTRONICS LTD.
57/61 Mortimer Street, London W1N 7TD
Tel: 01-636-2023/4/5, Telex: 23272

CENTRAL EUROPEAN SALES OFFICE:
GENERAL INSTRUMENT DEUTSCHLAND GmbH
(MOS Produktgruppe)
Nordendstrasse 1A, 8000 Munchen 40
Tel: (089)28.40.31, Telex: 528054

SOUTHERN EUROPEAN SALES OFFICE
Via Lorenzetti 6, 20100 Milano
Tel: 02/4084101, Telex: 39423

ASIA

HONG KONG
GENERAL INSTRUMENT HONG KONG LTD.
Room 704 Star House, 3 Salisbury Road, Kowloon
Tel: 3-675528, Telex: 84606

JAPAN:
GENERAL INSTRUMENT INTERNATIONAL CORP.
HEAD OFFICE - 17 Shiba-Fukide-cho,
Minato-ku, Tokyo 105
Tel: (03) 437-0281, Telex: 26579

OSAKA OFFICE - 299 Yamaguchi-cho,
Higashi Yodogawa-ku, Osaka
Tel: (06) 323-1877

TAIWAN
GENERAL INSTRUMENT
MICROELECTRONICS TAIWAN
B2-11 Kaohsiung Export Processing Zone, Kaohsiung
Tel: (07) 830402, Telex: 785-81901

MANUFACTURING FACILITIES

Hicksville, New York • Chandler, Arizona
Glenrothes, Scotland • Kaohsiung, Taiwan

CANADA

SALES REPRESENTATIVE

ONTARIO
Pipe-Thompson Ltd.
83 Cumberland Drive
Mississauga, Ontario
Tel: (416) 274-1269

DISTRIBUTORS

BRITISH COLUMBIA

RAE Industrial Electronics Ltd.
1629 Main Street
Vancouver, B.C.
Tel: (604) 687-2621
TWX: (610) 929-3065

MANITABA
Cam Guard Supply & Service Ltd.
1777 Ellice Avenue
Winnipeg, Manitoba
Tel: (204) 786-8481
Telex: 07-57622

ONTARIO
Downsview
Cesco Electronics Ltd.
24 Martin Ross Avenue
Downsview, Ontario
Tel: (416) 661-0220
Telex: 02-29697

Ottawa
Cesco Electronics Ltd.
1300 Carling Avenue
Ottawa, Ontario
Tel: (613) 729-5118
Telex: 053-3584

Rexdale
Future Electronics Corp.
44 Fasken Drive, Unit 24
Rexdale, Ontario
Tel: (416) 677-7820

Willowdale
Electro Sonic Inc.
1100 Gordon Baker Road
Willowdale, Ontario
Tel: (416) 494-1666
Telex: 06-22030

QUEBEC
Montreal
Cesco Electronics Ltd.
4050 Jean Talon Street West
Montreal, Quebec
Tel: (514) 735-5511
Telex: 05-25590
Future Electronics Corp.
5647 Ferrier Street
Montreal, Quebec
Tel: (610) 421-3251
Telex: 05-827789

EUROPE

AGENCIES & DISTRIBUTORS

AUSTRIA
Elbatex GmbH
Breitenfurter Str. 381
A-1235 Wien
Tel: 0222/869158
Telex: 013128

BELGIUM
C.P. Clare International N.V.
102 Gen. Grady
Bruxelles 4
Tel: 02-736.01.97
Telex: 24157

DENMARK
A/S Nordisk—Elektronik
Transformervej 17
DK-2730 Herlev
Tel: 84.30.00
Telex: 19219

FINLAND
Jorma Sarkkinen Ky.
Heikintori, P.O. Box 19,
SF-02100 Tapiola
Tel: 46.10.88
Telex: 122028

FRANCE
P.E.P.
4 Rue Barthelemy
92120 Montrouge,
Tel: 735.33.20
Telex: 204534

GERMANY
Frankfurt/Main
Berger Elektronik GmbH
Am Tiergarten 14
Tel: 0611/490311
Telex: 04-12649

Heilbronn
Elbatex GmbH
Caecilienstr. 24
Tel: 07131/89001,
Telex: 728362

Lehrte
Altron
A.E. Thronicke KG
3160 Lehrte
Postfach 1280
Tel: 05132/53024
Telex: 922383

Munchen
Electronic 2000
Vertriebs-GmbH
Neumarkter Str. 75
8000 Munchen 80,
Tel: 0 89/43 40 61
Telex: 02-2561

GREECE
Elfon Ltd.
Konstantinoupolous 18-20
Nea Smyrni, Athens
Tel: (021) 93 48 912,
Telex: 214150

HOLLAND
Curijn Hasselaar
V Utenhoveweg 100
P.O. Box 37, Geldermalsen
Tel: (0) 3455-3150
Telex: 40259

IRELAND
Neltroic Ltd.
John F. Kennedy Road
Naas Road, Dublin 12
Tel: (01) 501845,
Telex: 4837

ITALY
Milano
Adelsy S.p.A.
Via Domenichino, 12
20100 Milano
Tel: 4985051-2-3-4-5
Telex: 39423

Genova
Adelsy S.p.A.
P.zza della Vittoria, 15/25
16121 Genova
Tel: 010/589674

Roma
Adelsy S.p.A.
P.le Flaminio, 19
00196 Roma
Tel: 06/3606580/3605769

Torino
Adelsy S.p.A.
C.so Matteotti, 32/A
10121 Torino
Tel: 011/53914

Udine
Adelsy S.p.A.
Via Marangoni, 45/48
33100 Udine
Tel: 0432/26996

Calderara Di Reno
I.C.C. S.r.l.
Localita Lippo
Via Crocetta, 38
40012 Calderara Di Reno
Tel: 051/726186

NORWAY
J.M. Feiring A/S
Box 101, Bryn, Oslo 6
Tel: (02) 19.62.00,
Telex: 16435

SWEDEN
Algers Elektronik AB
Box 7052
S-172-07 Sundbyberg
Tel: 08-985475,
Telex: 10526

SWITZERLAND
Ellyptic AG
Postfach 174, 8036 Zurich
Tel: 33.05.89,
Telex: 56835

TURKEY
EFG Inc.
Buyukdere cad. Hayat
Ap. 28/1
Mecidiyekoy, Istanbul
Tel: 66 73 61,
Telex: 22562

UNITED KINGDOM
Keighley
Semicomps Northern Ltd.
Ingrow Lane
Keighley, W. Yorks
Tel: Keighley 65191,
Telex: 517343

Kelso
Semicomps Northern Ltd.
East Bowmont Street
Kelso, Roxburghshire
Tel: Kelso 2366,
Telex: 72692

Kenilworth
Semicomps Ltd.
3 Warwick House, Sta. Rd.
Kenilworth, Warwickshire
Tel: 0926-59411,
Telex: 31212

Manchester
GDS (Sales) Ltd.
24 Broughton St.
Cheeton Hill, Manchester
Tel: 061 831 7471
Telex: 668304

Portsmouth
SDS Components Ltd.
Hilsea Industrial Estate
Portsmouth,
Hants PO3 5JW
Tel: 0705 65311,
Telex: 86119

St. Albans
Semicomps Ltd.
Wellington Road
London Colney
St. Albans, Herts
Tel: Bowmans Green 24522
Telex: 21108

Slough
GDS (Sales) Ltd.
380 Bath Road
Slough SL1 6JE
Tel: 06286-63611, Telex: 847571

West Drayton
Semiconductor Specialists Ltd.
Premier House, Fairfield Road
Yiewsley, West Drayton,
Middlesex.
Tel: West Drayton 46415
Telex: 21958

YUGOSLAVIA
Ellyptic AG
Postfach 174, 8036 Zurich
Tel: 33.05.89, Telex: 56835

MIDDLE EAST

IRAN
A. Ardehali
138 Vozara Avenue, Tehran
Tel: 621583

ISRAEL
Alexander Schneider Ltd.
44 Petach Tikva Road
Tel-Aviv
Tel: 320.89-346.07
Telex: 033/613

ASIA

HONG KONG
Astec International Ltd.
Oriental Centre—14th Floor
67-71 Chatham Road, Kowloon
Tel: 3-694751, Telex: 780-74899

INDIA
SDM and Associates
A-3/9 Janakpuri
New Delhi—11058
Tel: 393349 or 391225

KOREA
Dongyoung Trading Company
CPO Box 7636, Seoul
Tel: 794-4812, Telex: 27305

PHILIPPINES
Astec Philippines
Makati Stock Exchange Bldg.
2nd Floor, Room 233
Ayala Ave., Makati Rizal 3117
Tel: 89-99-91, Telex: 07563553

SINGAPORE
Astec Singapore Pte Ltd.
1704, Golden Mile Towers
Beech Road, Singapore 7
Tel: 2-920-826,
Telex: 08723489

TAIWAN
Astec Taiwan
Room 803, 8th Floor
282 Lin Shinn Road, Taipei
Tel: 522-4800, Telex: 08523300

AUSTRALIA

New South Wales
G.E.S. (Pty) Ltd.
99 Alexander Street
Crows Nest, N.S.W.
Tel: 439-2488, Telex: 25486

Victoria
R and D Electronics (Pty) Ltd.
23 Burwood Road
Burwood, Victoria
Tel: 288-8232, Telex: 33288

SOUTH AFRICA

Bramley
Metlionics (Pty) Ltd.
P.O. Box 39690
Bramley 2018
Tel: 40-7746, Telex: 43-4852

Dunswart
Pace Electronic
Components (Pty) Ltd.
P.O. Box 6054
Dunswart 1508
Tel: 52-7545

**GENERAL INSTRUMENT CORPORATION
MICROELECTRONICS**



1977 Answer Book. It makes your job easier. \$25.

“WHO MAKES WHAT?”

**“WHAT COMPANIES
MAKE THE PRODUCTS
I NEED?”**

(See alphabetical directory
of 4000 products)

**“WHERE ARE THEIR
NEAREST
SALES OFFICES?”**

**“WHO ARE THEIR
DISTRIBUTORS?”**

**“WHAT ARE THEIR
LOCAL PHONE
NUMBERS?”**

(See alphabetical directory
of over 5000 manufacturers)

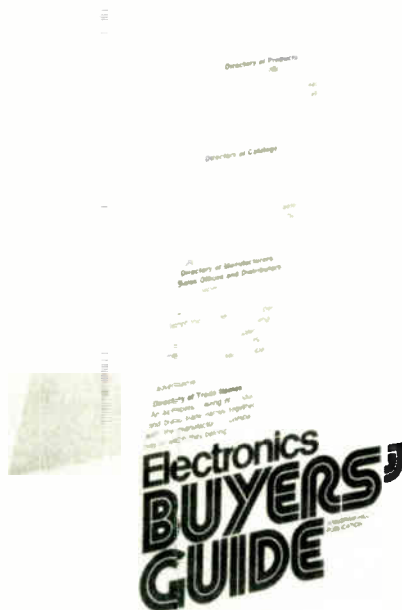

**“HOW CAN I GET THEIR
CURRENT CATALOGS
FAST?”**

(See directory of catalogs
by product and by company,
including catalog inquiry
cards for 5-second ordering)

**“WHO MANUFACTURES
THIS TRADE NAME?”**

(See Directory of
Trade Names)

**Special no-risk offer. If The Answer Book is not everything
we say it is and more, return the book to us within
ten days and we will refund your \$25.**

Electronics Buyers' Guide (EBG) is as easy to use as your telephone directory. The whole international world of electronics is at your fingertips. Great emphasis is put on *localizing* the information you need. You won't have to call half-way across the country to company headquarters because we list local sales offices and distributors.

To order from our Directory of Catalogs, simply circle the corresponding number on the post-paid Inquiry (“bingo”) Cards and mail. This way you get *current* catalogs. The Answer Book's objective: Make your job easier.

Electronics Buyers' Guide

1221 Avenue of the Americas
New York, N.Y. 10020



Yes, send me a copy of The Answer Book.

I've enclosed \$25 (USA and Canada only, elsewhere send \$35). Full money back guarantee if returned within 10 days.

Name _____

Company _____

Street _____

City _____

State _____

Zip _____

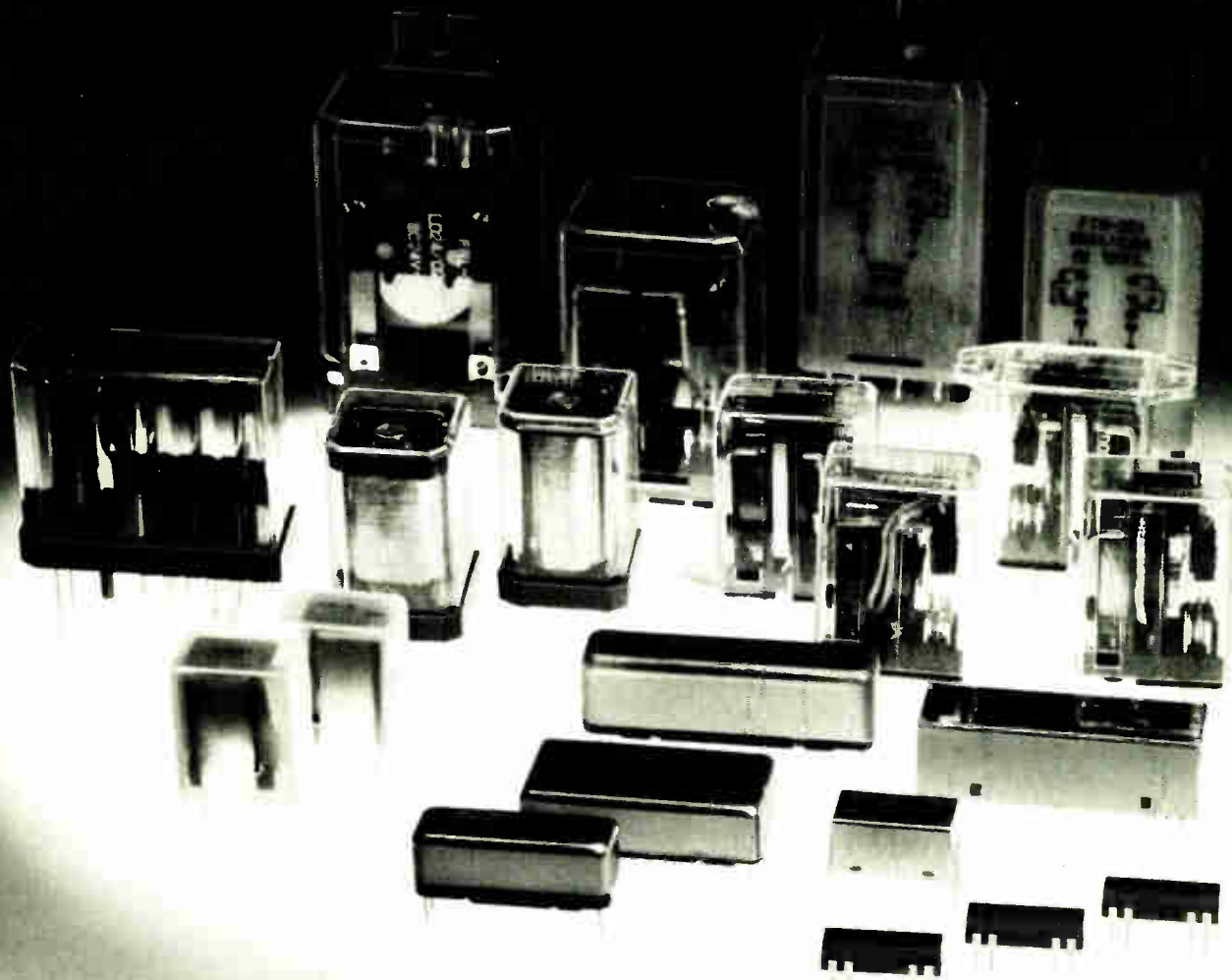

Make the switch to Fujitsu high

When it's time to put solid "switching power" into your equipment, it pays to select relays with proven performance and top quality. And that's just what you get when you specify Fujitsu relays. The wide-coverage Fujitsu relay lineup is here now ready to fill your total relay needs, from space-saving flat package units to powerful 10-amp general purpose models. Each and every Fujitsu relay is built to the quality standards that are synonymous with the name Fujitsu, and all feature proven performance that guarantees thousands of hours of failure-free operation. Here are just some of the features in store for you when you choose the name Fujitsu for your demanding relay needs.

Fujitsu flat package relays

The Fujitsu lineup of flat package relays offers exceptional coverage and the advantages of flux-contamination-immunity. Within the lineup are our FRL 410-series low-profile and our BR-series miniature GP models. The former are available in both DPDT and 4PDT contact arrangements and coil voltage ratings to 48V DC enabling the widest selection to meet demanding applications including those for communications. And our BR-series models offer you similar wide choice including 0.5A ultra-miniature models that enable exceptional component densities for solid savings in both equipment size and cost.

Circle 54 on reader service card

Fujitsu general-purpose relays

With a wide model choice, including units capable of handling loads to 10 amps, the Fujitsu general-purpose relay lineup is a winner. Most models are available in both DC- and AC-rated coils, and with a solid selection of mounting configurations. You also get solid load handling and a choice of contact material to meet your exact operation requirements. Contact arrangements available are from SPDT to 6PDT, depending on models, with 12PDT or 18PST available on special order with our 491-series miniature models. Yes, whether compact or high load, the Fujitsu GP relay lineup is solid to meet your total switching needs. And for special applications, Fujitsu relays with fixed, knob-adjustable, or driver adjustable time delay are also available.

Circle 41 on reader service card

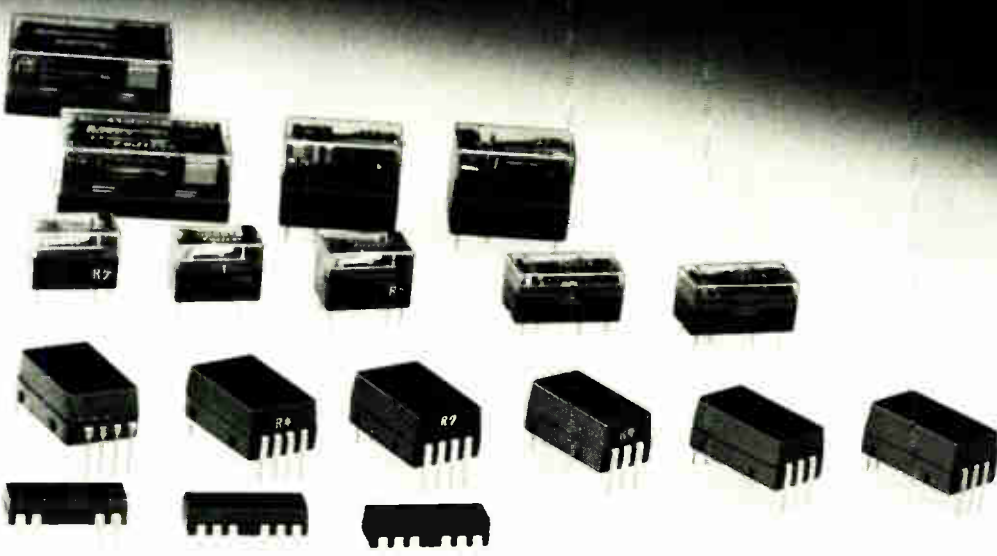

quality relays

Fujitsu reed relays
 Featuring Fujitsu-built reed switches of exceptional quality, the Fujitsu reed relay lineup is the unbeatable choice for today's high-speed, low current switching applications. As standard features, you get low contact resistance, compact size, a wide choice of contact arrangements and coil ratings, the availability of shielding and other features, and models including a built-in latching function via the Fujitsu MEMOREED® switch. You even have a choice of mounting grid patterns when you pick the FRL 640-series, low-profile reed switches. Full-featured and available in a wide range of models, Fujitsu reed relays are the solid choice for today's demanding data processing and control applications.

Circle 55 on reader service card

Fujitsu mercury wetted-contact relays
 Built to provide exceptional reliability for a variety of equipment applications, Fujitsu mercury wetted-contact relays are top performers. Among the advantages of our mercury wetted-contact models are freedom from contact bounce, low and stable contact resistance, wide load-handling capabilities (from micro-ampere levels to a full 2 amps), low unit profile, and the capability for being driven by ICs. In our five-model lineup, you can choose coil ratings to 24V DC, with all models guaranteeing at least 10×10^9 operations.

Circle 42 on reader service card



The Fujitsu relay lineup. It's full coverage and high quality for unbeatable performance, and at prices that will make you wonder why you didn't think Fujitsu before. So, join the growing number of makers who specify Fujitsu quality products. Call or write now for additional information. You'll be glad you did.

FUJITSU LIMITED
Communications and Electronics

FUJITSU AMERICA INC./Los Angeles Office: 1251 West Redondo Beach Blvd., Suite 304, Gardena, Calif. 90247, U.S.A. phone: 213-538-3397 twx: 910 346 6724 **Chicago Office:** P.O. Box 694, Lake Forest, IL. 60045, U.S.A. phone: 312-295-2610 twx: 910 651 2259 **FUJITSU LIMITED/Components Group (Head Office):** Syuwa Onarimon Bldg., 1-1, Shinbashi 6-chome, Minato-ku, Tokyo 105, Japan phone: 03-437-2111 cable: FUJITSULIMITED TOKYO telex: 2424511 FT SIN J **London Office:** Norman House, 105/109 Strand, London W.C. 2, England phone: 240-0461/0462 telex: 31 22305



We fit in just about anywhere.

For any application demanding high Q, high stability of inductance or low power losses at high flux density and minimum volume, all at the tightest specs, turn to the Cube.

Expanding your line? We're constantly expanding ours. Ferroxcube offers the most complete selection of linear ferrite materials. You get the electrical properties you want. In a broad variety of sizes and shapes. You get consistent quality. And you get delivery. Whatever the application we can supply the material. We'll even help you develop the application.

New from the Cube



U64 Core, with the largest cross-sectional area available in 3C8 material. Designed for high-flux density applications. It offers low losses under high-flux levels, high B saturation, and a high Curie temperature. It is ideal for high-power transformer and choke applications.



RM Square Cores, both RM6 and RM8 cores are now available in 3E2A material. This is a high-permeability material with a Curie temperature higher than 170°C. Specifically developed for broad band and pulse transformer applications, they are particularly suited for voice frequency transformers.



Toroids, from 0.5- to 1.5-inches are now available in 4C4 material. This is a low-permeability, high-frequency material designed for use in the 1 to 30 MHz range, making it ideal for hybrid combiners in citizen band radios.



A wide selection of bobbins and mounting brackets are available from the Cube. We've added hardware and bobbins for the EC-series of Power E-cores that are inexpensive and simple to use. The bobbins are designed for either chassis or PC board mounting. Termination for the most complex multiwinding transformer is facilitated by separate pins that can be inserted to your specifications.

Call on the Cube

The products shown here are just a sample of the materials, components and design information contained in the new Ferroxcube Linear Ferrite catalog. Write for your free copy today.

FERROXCUBE

Division of AmpereX Electronics Corporation/5083 Kings Highway/Saugerties, N.Y. 12477/(914) 246-2811
A North American Philips Company



E-477

Washington newsletter

First solar electric factory by ERDA set for Georgia

Even as President Carter battles to sell his new energy program, producers of solar electric systems and other manufacturers are watching the Energy Research and Development Administration's plan to fund **the nation's first production plant to derive all its power requirements from the sun.** The plant, which makes knitwear, will be in Georgia.

ERDA is beginning the selection process for one or more design contractors for the plant. Construction will start in the new town of Shenandoah in September 1979 for completion in March 1981. The factory, to be operated by Wilhelm Bleyle K.G. of West Germany, will initially occupy 25,000 square feet, employing about 70 people, and eventually grow to 42,000 ft², employing about 300. Electric power requirements will be about 200 kilowatts, plus up to 1,200 kw of heat energy.

GE, Garrett to build electric cars for ERDA

"Proof-of-concept" models of two electric cars, **one with new electronic controls and the other with a flywheel for better acceleration,** will be forthcoming from General Electric Co., Schenectady, N.Y., and Garrett Corp.'s AiResearch Manufacturing Co., Torrance, Calif. Next month, ERDA will award contracts for two models each: the flywheel cars from AiResearch, the electronic-controls models from GE.

Both of the four-passenger designs are for urban driving and will have a 75-mile range and top speed of 55 mph, using advanced lead-acid batteries. They will have microcomputer control, to prevent jackrabbit starts or other driver abuse that might waste energy or damage batteries, ERDA says. The two-year contracts will total \$3 million to \$5 million.

FAA begins 25-kHz channel spacing for air communications

Airliners and high-performance general-aviation aircraft that operate above 18,000 feet will have double the number of vhf air-traffic-control channels, the Federal Aviation Agency has decided. The move to **halve radio-frequency spacing at high altitudes to 25 kilohertz** is the result of a five-year study on ATC channel congestion. The planes must be equipped with 720-channel radios to get maximum benefit of the new channels.

Aerospace jobs to reverse slide, rise through 1978

Jobs in U. S. aerospace firms, including those for engineers and scientists, **will rise to 916,000 by December, up 2% from the year before,** and continue upward in 1978 to 935,000 — another 2.1% boost. The Aerospace Industries Association bases this projection on a survey of 45 companies. "The projected increase reflects a reverse of recent trends," AIA says, noting that aerospace jobs reached a low of 895,000 last September, from the peak of 1.5 million in 1968.

Commercial transport and helicopter production will account for much of the increase, according to the survey. The missile and space side is not as bright for 1977, although a 1978 gain is predicted as Space Shuttle activity accelerates.

Engineering and scientific employment, pegged at 165,000 last December, will move gradually upward, reaching 171,000 by year's end, a 3.6% rise for the year. The 1978 forecast of 175,000 would mark another 2.3% rise from this year. Engineering and scientific jobs in the aircraft and parts industry will rise 4% to 75,000 by this June from 72,000 at the close of 1976 and remain nearly stable through 1978, the association predicts. Missiles and space engineering scientific employment will continue at 47,000, then rise slightly to 48,000 in 1978.

Keeping NATO safe for America

What sounds and smells like the beginning of an electronics trade war between U. S. producers of consumer, semiconductor, and telecommunications products and their counterparts in Asia now appears to worry makers of military electronics selling to Europe, particularly to the North Atlantic Treaty Organization.

That is the message from the Electronic Industries Association's Government division, whose members say, "Safeguards are necessary to ensure that competition will be conducted under equitable conditions." Although the EIA division says Government spokesmen have assured it that foreign contractors will be subject to the same procurement regulations, audits, and inspections as U. S. contractors and would be judged on an equal basis, the EIA is proposing "safeguards" anyway. If adopted by the Department of Defense, the "safeguards" would indeed make the military electronics marketplace safe for American companies since they would in effect prohibit foreign entry.

Protecting the 10:1 share

The EIA, which formed an Export/Import Special Task Force on military imports, perceives manufacturers in NATO countries as its greatest threat. These manufacturers' earlier grumbling over the alliance's military outlays has escalated to shouting as NATO's 8:1 dollar ratio in favor of American suppliers has widened to 10:1. It may very well be that most EIA military manufacturers have large consumer operations, too, and corporate managements have now decided that they will not see their military markets go the way of television, radio, and stereo components. That threat seems very real since Defense Secretary Harold Brown told his NATO counterparts not long ago that there will be more buys of European military hardware, along with a more intensive DOD effort to standardize U. S. and NATO weapons.

Also distressing to EIA's members is the U. S./UK Memorandum Of Understanding, soon to be implemented, that eliminates, among other things, the "buy American" requirement for new weapons. EIA's task force wants a special industry briefing on just how that new treaty document will be put into effect.

But that is the least of EIA's demands. Topping the task force list of demands is the requirement "that DOD provide written assurance that if suppliers are recipients of subsidies from their government, or benefit from nontariff trade subsidies, they are not to be considered eligible to compete with U. S. industry." That, of course, would effectively eliminate just about

every West European producer from competition, since their governments have long identified such military development spending as "subsidies," rather than employ such American linguistic sugarcoatings as independent research and development or such R&D euphemisms as "advanced" or "exploratory." As one DOD observer familiar with the EIA's proposals puts it: "It looks like they're going for the whole hog."

Another EIA recommendation specifies that "if DOD authorizes release of technical data developed by U. S. industry and owned by the U. S. Government, it must establish monitoring and control procedures to preclude such data being transferred to third countries." That requirement seems no more than reasonable for protection of U. S. data, but it is likely to have a significant secondary effect: discouraging service project offices from working with Europeans if they can possibly avoid it, since their already strained staffs would then be obliged to take on a significant new workload with the "monitoring and control" job.

Prolonging the agony

The EIA task force also wants DOD to insure reciprocity in contracting affiliations so that "when a foreign country requires a U. S. firm to have a local affiliate or licensee in order to compete in that country's defense market, DOD should require that a reciprocal arrangement be applied to that country's industry when bidding for the U. S. market." That requirement is certainly reasonable, but may be tough for DOD to enforce. Europeans are perhaps more protective of their own defense industries' interests than America has had to be, simply because they rightly envision the U. S. as the dominant industrial force. Still DOD should push for it.

Next to last on EIA's list is its call on DOD to require its foreign allies to grant "expedited release of requests for proposals" to U. S. manufacturers if DOD does the same—as it sometimes does—for foreign producers who may compete for a NATO buy. Again, reasonable but perhaps not enforceable. If that proves to be the case, then it will prove one more barrier to Brown's pledge to buy more offshore.

But the kicker in EIA's proposals is the one that calls for EIA to help DOD draft the language "for the specific contractual requirements that foreign sources must meet for inclusion in the ASPR"—the Armed Services Procurement Regulation. "That would be laughable," says one DOD official, "if I didn't know that they are very serious about this."

Ray Connolly

This plant specializes in advanced IC technology.

It takes a lot of research, development, design, and production know-how to turn out a good line of semiconductor devices . . . it also takes a lot of sophisticated equipment . . . plus a lot of specially-educated and skillfully-trained people mutually striving for product excellence.

At Sprague Electric's Semiconductor Division, we have accumulated over fifteen years of intensive experience in the manufacture of *innovative* semiconductor devices . . . devices making special contributions to technology . . . devices manufactured under the most exacting QAR program . . . devices that assure total customer satisfaction.

We have built the kind of operation it takes to produce semiconductors compatible with today's as well as tomorrow's requirements.

We proudly invite customers and prospects to tour our plant, the nation's finest semiconductor facility of its type. Here you will see the magnitude of effort that goes into properly designed and manufactured devices. You'll be pleasantly surprised!

Write or call George Tully or Bob Milewski to arrange a visit. You can reach them at the Semiconductor Division, Sprague Electric Co., 115 Northeast Cutoff, Worcester, Mass. 01606. Tel. 617/853-5000.



FOR FAST INFORMATION, CALL YOUR NEAREST SPRAGUE SALES OFFICE:

ALABAMA, Sprague Electric Co. 205-883-0520 • ARIZONA, Sprague Electric Co. 602-279-5435 • CALIFORNIA, Sprague Electric Co. 213-649-2600 Wm J. Purdy Co. 415-347-7701 KCI Corp. 714-278-7640 • COLORADO, Wm J. Purdy Co. 303-777-1411 • CONNECTICUT, Sprague Electric Co. 203-261-2551 • DIST. OF COLUMBIA, Sprague Electric Co. (Govt. sales only) 202-244-6006 • FLORIDA, Sprague Electric Co. 305-831-3636 • ILLINOIS, Sprague Electric Co. 312-678-2262 • INDIANA, Sprague Electric Co. 317-253-4247 • MASSACHUSETTS, Sprague Electric Co. 617-899-9100 Sprague Electric Co. 413-664-4411 • MICHIGAN, Sprague Electric Co. 517-787-3934 • MINNESOTA, HMR Inc. 612-920-8200 • MISSOURI, Sprague Electric Co. 1-4781-2420 • NEW JERSEY, Sprague Electric Co. 201-696-8200 Sprague Electric Co. 609-795-2299 Trinkle Sales Inc. 609-795-4200 • NEW MEXICO, Wm J. Purdy Co. 505-266-7959 NEW YORK, Sprague Electric Co. 516-549-4141, Wm. Rutt Inc. 914-698-8600 Sprague Electric Co. 315-437-7311 Mar-Com Associates 315-437-2843 • NORTH CAROLINA, Electronic Marketing Associates 919-722-5151 • OHIO, Electronic Salesmasters Inc. 800-362-2616 Sprague Electric Co. 513-278-0781 • PENNSYLVANIA, Sprague Electric Co. 215-167-5252 Trinkle Sales Inc. 215-922-2080 • TEXAS, Sprague Electric Co. 214-235-1256 • VERMONT, Ray Perron & Co. Inc. 617-762-8114 • VIRGINIA, Sprague Electric Co. 703-463-9161 • WASHINGTON, Sprague Electric Co. 206-632-7761 • CANADA (Ontario), Sprague Electric of Canada Ltd. 416-766-6123 • CANADA (Quebec), Sprague Electric of Canada Ltd. 514-683-9220



. . . and you thought we only make great capacitors.

BIPOLAR MEMORIES

WE JUST SET THE LAND SPEED RECORD FOR RAMs.

If you thought our 45ns TTL RAM was hot stuff, you haven't seen anything yet.

The TAA for our newest TTL RAM clocks in at 30ns. Making it the fastest TTL RAM ever made. And it's just one of six new speed records turned in at our latest time trials for Bipolar RAMs.

And if that doesn't impress you, wait until you hear this: While we were increasing our speed, we also reduced our prices.

WATCH OUR DUST.

How fast is fast?

We took six of our most popular RAMs (four TTLs and two ECLs) and improved the specs across the board.

We also added a brand new TTL device that's no slouch in the speed department itself.

The line looks like this:

MAXIMUM ADDRESS ACCESS TIME (TAA) IN NS
Over a temperature range of 0-70° C

TTL	Organization	Old Spec	New Spec	100 Quantity Old Price	100 Quantity New Price
93L415*	1024 X 1	95	60	\$16.89	\$ 9.10
93L412*	256 X 4	70	60	\$30.67	\$17.03
93412*	256 X 4	NEW	45	—	\$17.75
93415*	1024 X 1	70	45	\$13.00	\$ 9.75
93415A*	1024 X 1	45	30	\$15.60	\$11.70
ECL					
10415	1024 X 1	60	35	\$29.82	\$15.60
10415A	1024 X 1	35	20	\$34.08	\$18.20

*All TTL parts are available in a 3-state version with the same specs as above.

GENTLEMEN, START YOUR RAMs.

Right from the start, our RAMs have outperformed the competition because of advanced Fairchild processing techniques. All our latest product improvements are the result of a process improvement called *Walled Emitter Isoplanar*™

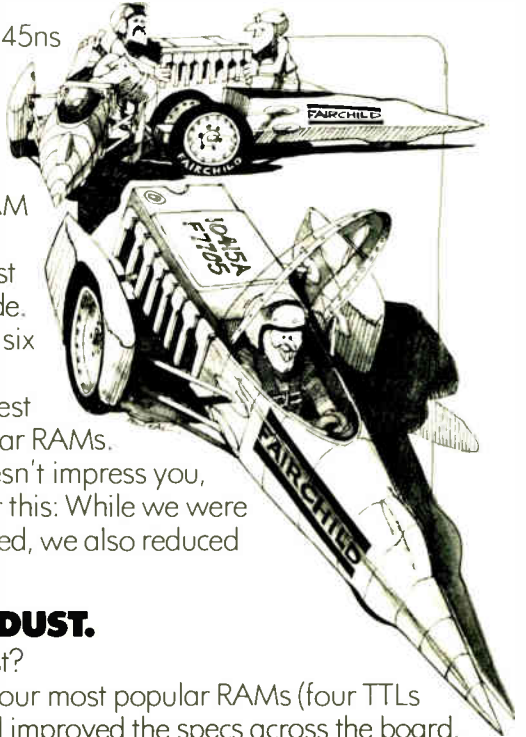

technology which, as you might suspect, is a patented Fairchild process.

The new process not only allows us to turn out faster parts for less cost, but also enables us to reduce die sizes from 20% to 50%.

And, if the initial results with the WEI process are any indication, you haven't seen anything yet.

SO WHAT ELSE IS NEW?

How about a 35ns 4096 X1 static TTL RAM? Or a 256 X 1 ECL RAM with a TAA of 6ns typical? Both of these products and more are way beyond drawing board status at Fairchild. In fact, we should be announcing quantity production and distributor availability any day now.

THE DYNAMIC DUO.

What about dynamic RAMs? Glad you asked.

Fairchild also makes the fastest dynamic 4K RAM in the industry. The 93481 boasts a TAA of 120ns and a cycle time of 280. The 93481A has an impressive TAA of 100ns and a cycle time of 240.

Both of these dynamic devices owe their performance specs to the I³L™ process. Which stands for Isoplanar™ Integrated Injection Logic.

WAIT TILL YOU SEE HOW FAST WE DELIVER.

Making the world's fastest RAMs is one thing. Delivering them is another. As luck would have it, we also excel in another.

Our whole line of speedy TTL and ECL RAMs are waiting for you on distributor shelves. In quantity.

If you're somewhat surprised that we not only have the best RAMs on the market, but can also deliver them in whatever quantity you need, don't be. Fairchild has delivered more large Bipolar RAMs than all our competitors combined.

For fast information and delivery, write or call your Fairchild sales office, distributor or representative today. For an even faster response, use the direct line at the bottom of this ad to call our Bipolar Memory Division. Fairchild Camera & Instrument Corp., 464 Ellis Street, Mountain View, CA 94042. Tel: (415) 962-3951. TWX: 910-373-1227.



FAIRCHILD
CALL US ON IT.
(415) 962-3951

Our IC Converter class.

Ten years of leadership in signal conversion design, manufacture and application support has put Analog Devices at the head of the class in IC Converters. We pace the field in every aspect: in innovation, quality, pricing and shipments. As a result we can deliver more than 20 different kinds of IC Converters today. As well as give you the strongest technical and application support. Our production capability is what really enables us to step out ahead of the rest.

Take our high density CMOS processing technique. It increased circuit packing density, made higher breakdown voltages feasible and produced unusual stability and reliability. And enabled us to give the world its first precision CMOS monolithic D/A converters.

And look what our bipolar expertise plus innovations in thin film processing and laser trimming technology ultimately led to. The first monolithic laser wafer trimmed bipolar converters with unmatched accuracy and stability.

AD572 — complete 12 bit successive approximation A/D converter can guarantee no missing codes over the full -55°C to $+125^{\circ}\text{C}$ temperature range.

AD7522 — first monolithic CMOS 10 bit multiplying D/A converter with input buffer and holding register, allowing direct interface to microprocessors.

AD7550 — 13 bit monolithic CMOS integrating A/D converter using our revolutionary "Quad Slope" conversion technique for extremely high precision and stability. Tri-state data output and byte control for direct interface to microprocessors.

AD7570 — monolithic CMOS 10 bit successive approximation A/D converter with tri-state data output and byte control for direct interface to microprocessors.

AD563 — 12 bit complete D/A converter with monotonic performance, over the full -55°C to $+125^{\circ}\text{C}$ temperature range.

AD7520 — first monolithic CMOS 10 bit multiplying D/A converter.

AD561 — 10 bit complete monolithic D/A converter, the new DAC Standard.

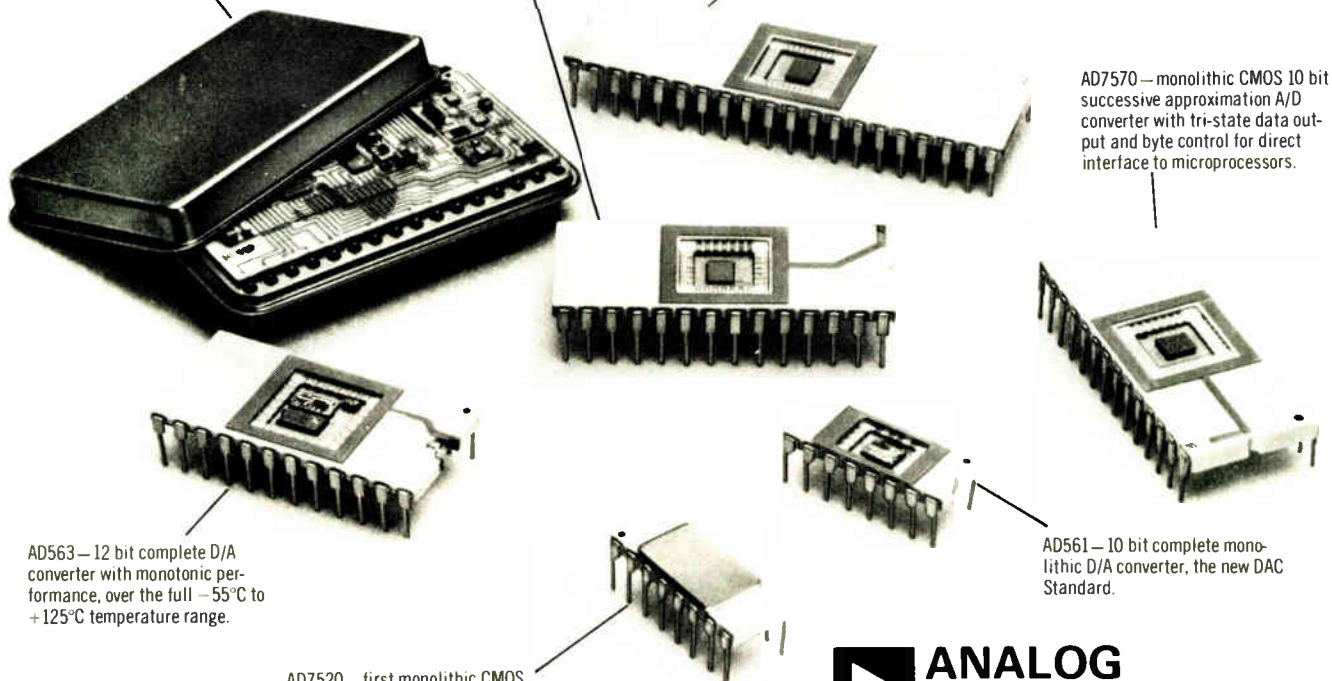

ANALOG DEVICES
The real IC converter company.

Your IC Converter class.

Program

I. A/D and D/A Converters:

D/A Converter Function and Selection Factors
Deciphering the Specification Page
A/D Conversion Techniques
Error Sources and Testing

II. Analog Signal Handling for High Speed and Accuracy

D/A Converter Output Signal Interface
Converter Dynamics and Compensation
Finding and Preserving the Signal Path in Operational Amplifiers
Analog and Digital Grounding and Decoupling

III. Application Versatility of Bipolar and CMOS Converters

IC Converter Components and Designs
The Complete Single-Chip Bipolar D/A
Application Strengths of the Multiplying CMOS Converter
Bipolar A/D's for Speed and Accuracy
Low Power Systems A/D's with CMOS
Peripheral Components

IV. Converter/Microprocessor Interface Techniques

Hardware Techniques for the Standard Converter
Simplifying the Interface with Peripheral Adapter Chips
Converter Components for Direct μ Processor Bus Connection
Configurations of Complete Data Acquisition Systems

One of our Application Seminars is a perfect opportunity to learn from the head of the class more about today's IC Converters and data acquisition systems and their potential. You will also get a glimpse of what the future holds in store for conversion components. You can expect an intensive, stimulating all-day program put on by some of the best engineering brains in our company.

Which means some of the best brains in the industry. A look at the program will give you an idea of the scope of each seminar. And how much richer in knowledge you'll be at the end of it. Check the schedule below for the one you would like to attend. Then send the coupon to the sales office listed or telephone them. We will contact you with specific details.



The real IC converter company.

United States

- Los Angeles^o
May 3
- Palo Alto^o
May 5
- Boston^{oo}
May 11
- Metropolitan N.Y.^{oo}
June 7
- Houston^o
June 9
- Detroit^{ooo}
June 14

International

- Tokyo
April 7 and 8
- Osaka
April 11
- Munich
May 24
- London
May 26
- Copenhagen
May 31
- Paris
June 2

Send coupon or telephone:

^oAnalog Devices, Inc., 2225 28th Street, Suite 500, Long Beach, CA 90806. Tel: (213) 595-1783

^{oo}Analog Devices, Inc., Route #1 Industrial Park, Norwood, MA 02062. Tel: (617) 329-5043

^{ooo}Analog Devices, Inc., 123 East Lake Street, Suite 200, Bloomingdale, IL 60108. Tel: (312) 894-3300

For international seminars, contact: Denmark: 02/84 58 06, England: 01/94 10 46 6, France: 686-77 60, Germany: 089/53 03 19, Japan: 03/26 36 82 6.

Yes, I want to attend your class.

I'm interested in the seminar in

_____ on _____
location date

Name _____

Title _____

Company _____ Department _____

Address _____ Phone _____

City _____ State _____ Zip _____

7 trimmers handle 95% of your applications.

Single-turn

With these industry standard cermet trimmers, you're assured design versatility, high quality, and fast delivery.

Just decide what you need regarding: (1) single- or multiturn; (2) sealed or not; (3) size; (4) resistance; (5) pin spacing; and (6) price.

Then call your local Beckman Helipot distributor for *free* evaluation samples. To get his number, or immediate technical literature, call (714) 871-4848, ext. 1776. See how fast and easily you can solve trimmer problems.



Model 91

- High quality—low price
- Unique brush contact
- Excellent setability
- Protective dust cover
- Top or side adjust
- Standoffs prevent rotor binding, permits board washing
- Small $\frac{3}{8}$ " dia. size



Model 72

- $\frac{3}{8}$ " square
- Sealed for board washing
- Available in flame-retardant SEO housing
- Top or side adjust
- Brush contact
- Excellent setability
- 2 ohms of end resistance



Model 82

- $\frac{1}{4}$ " dia. by 0.150" max. height
- Sealed for board washing
- Flame-retardant SEO materials
- 82P—top adjust; 82PA—side adjust
- Brush contact for excellent setability
- Resistance range: 10 Ω to 1 meg Ω

Multiturn

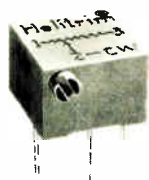

Model 64

- Miniature, sealed
- 22 turns of adjustment
- 0.25 watt at 85°C
- Resistance range: 10 Ω to 1 meg Ω
- $\frac{1}{4}$ " square for tight P.C. board packaging
- Unique brush contact
- Adjustability—voltage ratio within 0.01%

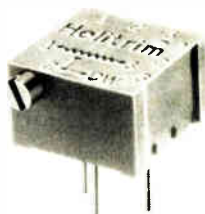

Model 68

- Low-cost
- Sealed for board washing
- 18 turns for adjustment accuracy
- $\frac{3}{8}$ " square housing
- Brush contact
- 3 pin styles for efficient packaging
- Broad resistance range: 10 Ω to 2 meg Ω
- Operates with $\frac{1}{2}$ watt at 25°C

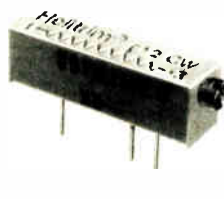

Model 89

- Our lowest cost multiturn
- Sealed for board washing
- $\frac{3}{4}$ " rectangular, 0.250" high
- 15 turns for accurate adjustment
- 7 pin styles for mounting versatility
- Panel mount available
- Resistance range: 10 Ω to 2 meg Ω

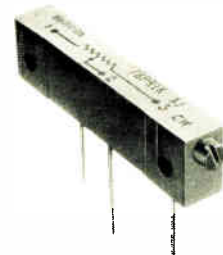

Model 78

- Military performance, industrial price
- $1\frac{1}{4}$ " rectangular, 0.195" wide
- Sealed
- 3 terminal styles: flex leads, P.C. pins, solder lugs
- Power rating: 0.75 watt at 70°C
- 22 turns of adjustment
- Resistance range: 10 Ω to 2 meg Ω

BECKMAN®

HELIPOT DIVISION

International newsletter

BPO to install fiber-optic test bed

Following the unveiling by Standard Telephones and Cables of a 140-megabit-per-second optical-fiber link [see Electronics International], the British Post Office expects to soon announce a versatile 12-kilometer testbed between telephone exchanges at its research labs in Martlesham Heath and Ipswich, Suffolk. Although BPO researchers primarily designed the link to test 8.48-Mb/s local exchange traffic, **they already have transmitted at the 140-Mb/s rates to one repeater installed 5.75 kilometers along and plan to test that high speed over the whole hop.**

Blood-pressure test unit goes to LSI

Add another item to the list of products boasting LSI circuitry—blood-pressure measuring gear. Matsushita Industrial Equipment Co. is starting shipments of an electronic sphygmomanometer in which **all logic circuits have been integrated on a single p-channel MOS LSI chip measuring about 3.5 millimeters square.** The unit, which is based on a cuff with a capacitor microphone inside, pumps up and releases cuff pressure automatically. It displays blood pressure and pulse rate digitally and uses the pulse rate data for gating of logic circuits to eliminate errors caused by noise. The new instrument, an updating of a non-LSI version the company has been selling since October 1975, sells for about \$1,450.

Sinclair launches \$29.95 programmable scientific calculator

Sinclair Radionics Ltd. of Great Britain takes a new turn in the calculator price war by introducing a \$29.95 programmable version of its small Cambridge scientific model. Targeted for the huge engineer and student market, the instrument has 19 multifunction keys plus such features as a 36-step program memory, conditional and unconditional branch instructions, program self-check, and an optional library of 294 programs. **Key to the 3-ounce unit is a National Semiconductor 5799 4-bit microprocessor chip operating from a Sinclair-developed program.**

Software aids equip Level 64 computer for competition

The Franco-American computer company, CII-Honeywell Bull, has given its French-developed Level 64 computer a more aggressive look with the announcement of software aids for conversion to it from competitive systems including IBM, NCR, ICL, and Philips. CII-HB expects Honeywell Information Systems to follow with similar announcements in the U. S. and other HIS territories, but these are likely to be tailored to local market requirements.

The new aids are aimed at helping users convert from systems such as the IBM 360/370 and ICL 1900 to the Level 64. The main application areas are file and program conversion. The Level 64 has also been beefed up with more memory, peripheral, and telecommunications capabilities, as well as other software, including text-editing programs.

Quartz clocks run on sunlight or room light

Telenorma GmbH, a subsidiary of Frankfurt-based Telefonbau und Normalzeit, has readied two quartz-driven clocks that can be kept charged by sunlight or room light greater than 700 lux. One is a table-top version with a liquid-crystal display, the other a wall clock with a conventional analog time indication. **Their power supply consists of high-efficiency, single-crystal-silicon solar cells capable of storing enough energy to keep the clockwork going through the night.** The time deviation for the two models is no more than ± 30 seconds per year.

OUR NEW SCHOTTKY RECTIFIERS WOULD STILL BE THE BEST BUY EVEN IF THEY WEREN'T THE BEST PRICED.



But they are. In fact, our new Axial Leaded Schottky Rectifiers are priced as low as 92¢ in hundreds (Model ITS 5818). And when you combine the price with ITT's superior technology, they clearly become the best buy on the market.

You get epitaxial construction for higher operating efficiency. Oxide passivation. Metal overlap contact system for improved reverse characteristics. A guard ring protected barrier for superior reverse power surge capability. Lower high temperature leakage. An inherently low forward voltage drop. Small size. And lots more. And they're all made right here.

Sure, other manufacturers can offer you some of these features. But it took ITT to put them all together in the Axial Leaded Schottky Rectifiers that are destined to become the new state of the art. And ITT to offer them at a price that makes them practical.

Get detailed technical information on our new Axial-Leaded Schottky Rectifiers. Write ITT Semiconductors, 74 Commerce Way, Woburn, MA 01801. Tel. (617) 935-7910.

ITT
SEMICONDUCTORS

Second to None

Call the ITT Semiconductors Representative nearest you • Encino, California: (213) 995-1571 • Palo Alto, California: (415) 961-5265 • Canada: (416) 625-9022 • Illinois: (312) 884-0990 • Ohio: (513) 435-3750 • Texas: (214) 243-7851 • New York: (315) 451-5980 • Pennsylvania: (215) 688-6990 1 2 3 • Georgia: (404) 939-6715 • Lexington, Massachusetts: (617) 861-0880

British firm to inaugurate 140-Mb/s transmission cable over 9-kilometer route

What is the commercial potential for optical-fiber telecommunications? A two-year field trial of a 9-kilometer, 140-megabit-per-second transmission link north of London is a starting point for the answer to that question. Standard Telephones and Cables, which is installing the trial link in British Post Office phone ducts, also hopes the project will give it a leg up on its worldwide competition [*Electronics*, April 14, p. 65].

The International Telephone & Telegraph subsidiary hopes that its field trial will stake a claim to commercial leadership in high-speed optical transmissions with the BPO and overseas telecommunications authorities. It also gives the company "a specific target to bring things out of the lab environment and into the real-life world outside," declares S.B. March, technical director.

Aside from the technical challenge, STC chose the stiff 140-Mb/s rate because economic studies showed that this international standard speed would be cost-competitive with coaxial cable. The trial hookup will initially carry simulated telephone traffic between two BPO exchanges when it begins operating this summer, but STC expects the Post Office to switch in some live traffic soon after. The link can carry as many as 1,920 simultaneous phone conversations or two color-television signals.

Mostly a private venture among STC and other ITT companies, the project is estimated to cost several hundred thousand dollars. The BPO supplied the ducting and space for the digital multiplexing equipment in the Stevenage and Hitchin exchanges. The pulse-code-modulation systems contain:

- Multimode graded-index fibers of germanium-doped silica, a commercial offering from STC using chemical vapor deposition [*Electronics*, Nov. 25, 1976, p. 6E].

Making ready. Top: optical fiber being spliced. Middle: terminal equipment in one of telephone exchanges. Bottom: engineer adjusts terminal equipment.

- Cable 7 millimeters in diameter from ITT's Standard Telecommunication Laboratory containing a central strain member that supports four copper wires to feed power to the repeaters, one dummy strand as a filler, and three 100-micrometer-diameter optical fibers, one a spare.

- Six gallium-aluminum-arsenide double-heterostructure lasers from STL operating at a wavelength of 850 nanometers for special purity. Marsh says STL has done more than 20,000 hours of life testing on the design.

- Two STL-made repeaters placed 3 km apart to rejuvenate the signal. Marsh says that it now looks as if one repeater would be enough.

- At each exchange, standard high-order multiplex equipment supplied by Bell Telephone Manufacturing Co. (an ITT company in Belgium not affiliated with AT&T in the U.S.), and the Italian Fabbrica Apparecchiature per Comunicazioni Elettriche Standard spa.

After the trial, STC hopes that the BPO will buy a system for its field trial, which could lead to orders for commercial systems. □

West Germany

Shorter CCD chip has more cells

More light-sensing cells per millimeter: that could mean shorter length and lower production costs or higher resolution for the linear charge-coupled service image sensors used in page-scanning and facsimile transmission systems.

At present, only laboratory versions exist of the so-called quadri-

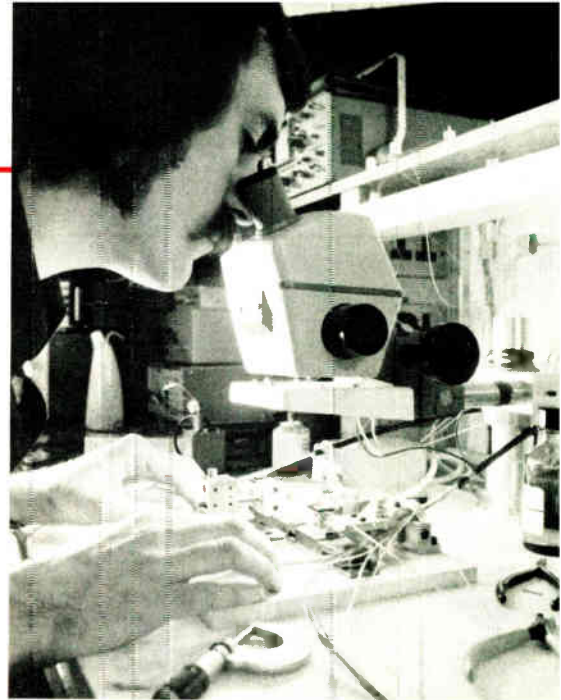

linear imager developed by H. J. Pfeleiderer and Heiner Herbst at West Germany's Siemens AG, and further development is necessary before Siemens will make a decision on volume production. But their work to date has convinced two researchers that the standard 1,728-cell imager can be shortened by 30%—to 17.5 mm from the normal 25 mm [*Electronics*, March 20, 1975, p. 25].

The other route would be to pack many more than 1,728 cells into a 25-mm-long imager—more than 2,500, investigation indicates. That, Pfeleiderer notes, translates into a big improvement in image resolution that would be useful in, say, remote picture sensing from satellites.

The quadrilinear imager uses four shift registers instead of the usual two. As a result, its information readout is more efficient, and it can use smaller sensing cells.

A conventional page-scanning imager has just two CCD shift registers, one on either side of the row of MOS-capacitor sensing cells. The charge that is produced when light impinges upon these cells is transferred into the registers and then shifted down the line of CCD elements to the output. All odd-numbered cells are connected to, say, the lower CCDs, while all even-numbered ones are hooked to the upper CCDs.

One drawback of such a bilinear imager, Pfeleiderer points out, is that most charges must undergo many shifts before reaching the output. This leads to some degrees of signal distortion, which impairs resolution. To be sure, this problem can be solved by replacing the normally used surface CCDs with bulk CCDs, which exhibit a better charge transfer behavior. But fabricating the bulk type is more complicated.

Further, Pfeleiderer contends, the device could be produced at less cost if it were smaller—that is, if the sensing-cell density were higher. But in the bilinear imager, that density is limited by the length of the CCD elements. With the 5-micrometer structures possible today, the total imager length cannot be made much

Around the world

TV set is system's input/output terminal

Despite company-sponsored microprocessor courses and seminars and a host of development systems, the number of engineers who know how to program microprocessors is still relatively small. The trouble is that many instruction methods either do not provide sufficient hands-on software experience or are beyond an individual user's financial means. Now, though, out of West Germany's Black Forest comes a simple, relatively inexpensive system that uses any black-and-white TV receiver as the input/output terminal. Developed by Franz Morat KG, a 250-man metal products company, the system enables the user to learn all about microprocessor programming right in his living room and at his own pace.

The heart of Morat's TV-Computersystem 6800/8080 is a microprocessor—either a 6800 version from Motorola or Intel's 8080—backed up with a 1-kilobyte random-access memory, electronic control unit, power supply, and light pen for controlling the display on the TV screen. The price tag: a mere \$540. For \$275 or so more, the user can add a cassette control and interface unit for reading or writing memory data on any commercially available tape at the rate of 1 kilobyte in less than 90 seconds.

4-company effort yields 65-k RAM

American semiconductor makers are not alone in closing in on the 65,356-bit random-access memory—a joint Japanese development effort has yielded a 65-k RAM that could be commercially available in two to three years. Small geometry and a thinner oxide between them cram the 65-k dynamic RAM on a chip a little larger than that used for many of today's 16,384-bit memories. The device was built at the Musashino Electrical Communication Laboratory of Nippon Telegraph and Telephone Public Corp. in a joint project with Nippon Electric Co., Hitachi Ltd., and Fujitsu Ltd. The commercial versions would be used in telephone exchanges, computers for on-line services offered by Nippon Telegraph, video communication, facsimile, and intelligent terminals, as well as in commercial applications.

Central data base cuts costs

Putting the data base in a central memory and relegating all processing tasks to peripheral microprocessors with direct access to the memory is an unusual way to set up a data-management system. But it is a system that takes advantage of the low cost of microprocessors while providing the power to combine real-time processing with off-line key-to-disk, remote-job-entry, or batch processing. Following through on the bright idea, Hyperion Data Systems Ltd. is launching two products. The Micro-Cell 101 is a general-purpose system to be unveiled in late May at the International Minicomputers, Microcomputers, Microprocessors 77 exhibition in Geneva.

The \$15,000 version comes with one visual-display-unit terminal, a 150-character-per-second printer, and 25 megabytes of disk memory. The \$77,000 version has eight visual-display units, two printers, and 100 megabytes of on-line memory. The Dentron D8000, a specialized form of the concept designed to store up to 35,000 dental records, already has attracted interest from dentists all over the world, the company reports.

less than 25 mm, however.

This is where the quadrilinear imager comes in. In this device, there are two CCD shift registers along each side of the cell row. In the charge-transfer process the contents of all cells are first shifted to the inner CCD elements. Then, every other charge packet in these elements is moved to the outer CCDs.

Finally, all charges are transported to the output.

The use of four instead of two shift registers virtually halves the number of transfers from one CCD element to the next, so that there is less signal distortion and hence higher resolution. That means that even long sensing-cell rows can be made with simple surface-CCDs. □



The electronics technology marketplace and the electronic distributor

Gathering in Las Vegas the first week in May for National Electronics Week will be the representatives of a \$4 billion segment of the electronics community—some 9,000 individuals, including: manufacturers of electronic components, equipment, and accessories; their field sales forces, among them a substantial number of independent manufacturers' representatives; and the distributors through whom these manufacturers bring their goods to market.

The Las Vegas visitors will be participating in the annual NEWCOM Show—often described as the "vital meeting place and marketplace for the world of electronic component distribution." This is a world which has played an indispensable role in helping bring a new era in electronic technology. Distribution has been responsive to and reflective of the changes, but also has been a critical force in facilitating the expansion and sophistication of the technology.

This is therefore an appropriate moment at which to review the evolution of electronic distribution and in particular to call attention to the emerging role of the industrial electronic distributor in selling electronic components and equipment,

and providing service to those that buy them. It has been estimated that today there are some 2,000 industrial electronic-distributor locations (main offices and branches) in the United States, serving approximately 40,000 industrial electronics-buying locations. Nobody quarrels with the estimate that this figure will reach 100,000 locations by 1983. It has further been estimated that some 350 industrial distributor firms now sell over \$2 billion worth of electronic components and parts annually to the OEM, MRO, and R&D markets.

Technology proliferation, accelerated by the potentials offered product designers by LSI and microprocessor technology, strengthens and accentuates the role of the industrial electronic distributor as the most efficient, if not the only, way to keep pace with electronics' burgeoning penetration into such areas as mechanical, hydraulic, electrical, as well as electronic product design.

For many component-manufacturing companies, products sold through the industrial distributor account for up to 60% of their total sales volume. As the LSI and microprocessor technology continues its penetration into new market

areas, distributors' share of the component sales dollar volume is likely to increase in answer to the demand.

It's not easy to draw a profile of industrial distribution as it operates today. There are probably as many different profiles and combinations of product mix, service orientation, and territorial coverage as there are industrial distributions—even more as many of the so-called "general-line distributors," whose traditional orientation was the radio and TV service parts business, begin to provide coverage of bits and pieces of the industrial market.

In zeroing in on the exclusively industrial electronic distributors, you can begin to classify them by the type of customers they serve, the type of products they carry, and by their range of geographical coverage. Within these differentiations and categorizations, there are further overlaps and hybrids.

Perhaps the most obvious differentiation among industrial distributors is geographic. These range from the large

For more information on buying from NEDA distributors, check 220 on the reader service card.



**Delivery may not be everything
BUT . . .
when it becomes the only thing,
COME OVER TO MAGNECRAFT.**

Magnecraft
ELECTRIC COMPANY

**With our distributors
as close as your phone
and 1200 stock relays,
we're the only name
you need to know.**

Magnecraft[®]
ELECTRIC COMPANY

5575 North Lynch Chicago, IL 60630 312/282-5500

ALABAMA

Hall-Mark Electronics
Montgomery 205/837-8700
G Electronics & Equip. Co.
Birmingham 205/328-4525
Wholesale Electronic Supply Co.
Tulalusa 205/222-5100

ARIZONA

Cramer/Arizona
Phoenix 602/267-7321
Alis Electronic Supply Co.
Phoenix 602/258-8151
Kierulff Electronics
Phoenix 602/243-1401
Kierulff Electronics of Arizona
Phoenix 602/258-6476

CALIFORNIA

Allied Electronics of California Inc.
Garden Grove 714/894-7581
A & B Distributors
Meriville 415/658-6713
All Industries
Merced 213/321-5802
All Industries
Pennyvale 408/734-8570
Kierulff Electronics
Los Angeles 213/685-5511
Kierulff Electronics
Alto 415/968-6292
Kierulff Electronics
San Diego 714/278-2112
Cramer Electronics
Glendale 213/678-0441
Classic Components
San Valley 213/768-6111
Smart Components
Woodland Hills 213/887-7260
Rose Electronics
Burlingame 415/692-5700
Sacramento Electric
Sacramento 916/441-4821
Kierulff Electronics Corp.
Vine 213/971-3721
Western Electronic Supply Corp.
Glendale 213/245-1226

FLORIDA

Stell's Electronic Supply Co.
Denver 303/244-4691
Integrated Electronics Co., Inc.
Denver 303/534-6121
Hutch & Son, Inc.
Evansville 812/425-7201
Iowa
Deeco Inc.
Cedar Rapids 319/365-7551
Hall-Mark Electronics
Cedar Rapids 319/393-3556
Iowa Radio Supply Co., Inc.
Cedar Rapids 319/364-6154
Newark Electronics
Cedar Rapids 319/362-1171
KANSAS
Hall-Mark Electronics
Shawnee Mission 913/888-4747
Radio Supply Company
Wichita 316/267-5216
LOUISIANA
American Electronics, Inc.
Shreveport 318/424-6591
Davis Wholesale Elec. Supply
Baton Rouge 504/357-6427
Lake Charles Elec. Supply
Lake Charles 318/433-4649
Menard Electronics, Inc.
Baton Rouge 504/355-4615
MG Electronics & Equip. Co.
Harahan 504/733-0070
Ralph's Electronics
Lafayette 318/234-4507
Wm. B. Allen Supply Co., Inc.
New Orleans 504/525-8222

GEORGIA

Ack Radio Supply Co
Atlanta 404/351-6340
Lance Engineering Inc
Tucker 404/938-8220
Newark Electronics
Atlanta 404/321-0413
HAWAII
Electrical Equipment Co
Honolulu 808/533-3884
Industrial Electronics
Honolulu 808/533-6095
ILLINOIS
Allied Electronics Corp.
Elgin 312/697-8200
Classic Components Supply
Northbrook 312/272-9650
Cramer Electronics
Mt. Prospect 312/593-8230
Ebinger Radio Inc.
Alton 618/462-9783
E.D.I.
Chicago 312/283-4800
Hall-Mark Electronics
Elk Grove Village 312/437-8800
Joseph Electronics, Inc.
Niles 312/297-4200
Kierulff Electronics
Elk Grove Village 312/640-0200
Klaus Radio & Elec. Co.
Peoria 309/691-4840
Newark Electronics
Chicago 312/638-4411
York Radio & TV Corp.
Decatur 217/423-3484
INDIANA
Fort Wayne Electronics
Ft. Wayne 219/423-3422
Graham Electronic Supply, Inc.
Indianapolis 317/634-8202
Hutch & Son, Inc.
Evansville 812/425-7201
IOWA
Deeco Inc.
Cedar Rapids 319/365-7551
Hall-Mark Electronics
Cedar Rapids 319/393-3556
Iowa Radio Supply Co., Inc.
Cedar Rapids 319/364-6154
Newark Electronics
Cedar Rapids 319/362-1171
KANSAS
Hall-Mark Electronics
Shawnee Mission 913/888-4747
Radio Supply Company
Wichita 316/267-5216
LOUISIANA
American Electronics, Inc.
Shreveport 318/424-6591
Davis Wholesale Elec. Supply
Baton Rouge 504/357-6427
Lake Charles Elec. Supply
Lake Charles 318/433-4649
Menard Electronics, Inc.
Baton Rouge 504/355-4615
MG Electronics & Equip. Co.
Harahan 504/733-0070
Ralph's Electronics
Lafayette 318/234-4507
Wm. B. Allen Supply Co., Inc.
New Orleans 504/525-8222

MISSOURI

Four State Radio Supply Co., Inc.
Joplin 417/624-0368
Hall-Mark Electronics
Earth City 314/291-5350
Olive Industrial Electronics, Inc.
St. Louis 314/863-7800
Van Sickle Radio Electronics, Inc.
St. Louis 314/621-5000
MONTANA
Electronic Supply
Billings 406/252-2197
NEBRASKA
Scott Electronic Supply Corp.
Lincoln 402/466-8221
NEW JERSEY
Kierulff Electronics
Rutherford 201/935-2120
Newark Electronics
Kenilworth 201/272-8410
Route Electronics, Inc.
Springfield 201/379-7710
NEW YORK
E E. Taylor Company, Inc.
Albany 518/438-4461
Electronic Equipment Co.
Hempstead 516/538-5510
Harrison Radio Corp.
Farmingdale, L.I. 516/293-7990
Harvey Electronics
Binghamton 607/748-8211
Lafayette Radio
Syosset, L.I. 516/921-7700

NEW YORK

Hall-Mark Electronics
Baltimore 301 796-9300
Kierulff Electronics
Gaithersburg 301/948-0250
Pioneer Washington Electronics
Gaithersburg 301/948-0710
RESCO/Baltimore
Baltimore 301 823-0070
Newark Electronics
Beltsville 301/937-5085
MASSACHUSETTS
Cramer Electronics, Inc.
Newton 617 969-7700
Dowiak Assoc., Inc.
Div. of Impact Sales Co., Inc.
Newton 617/964-7740
Gerber Electronics
Dedham 617/329-2400
Kierulff Electronics
Billerica 617/667-8331
Newark Electronics
Woburn 617/935-8350
MICHIGAN
Pioneer/Michigan
Livonia 313/525-1800
Newark Electronics
Oak Park 313/548-0250
Newark Electronics
Wyoming 616/241-6681
Wedemeyer Electric Supply Co.
Ann Arbor 313/665-8611
MINNESOTA
Hall-Mark Electronics
Minneapolis 612/884-9056
Newark Electronics
Minneapolis 612/331-6350
MISSOURI
Four State Radio Supply Co., Inc.
Joplin 417/624-0368
Hall-Mark Electronics
Earth City 314/291-5350
Olive Industrial Electronics, Inc.
St. Louis 314/863-7800
Van Sickle Radio Electronics, Inc.
St. Louis 314/621-5000
MONTANA
Electronic Supply
Billings 406/252-2197
NEBRASKA
Scott Electronic Supply Corp.
Lincoln 402/466-8221
NEW JERSEY
Kierulff Electronics
Rutherford 201/935-2120
Newark Electronics
Kenilworth 201/272-8410
Route Electronics, Inc.
Springfield 201/379-7710
NEW YORK
E E. Taylor Company, Inc.
Albany 518/438-4461
Electronic Equipment Co.
Hempstead 516/538-5510
Harrison Radio Corp.
Farmingdale, L.I. 516/293-7990
Harvey Electronics
Binghamton 607/748-8211
Lafayette Radio
Syosset, L.I. 516/921-7700

MARYLAND

Newark Electronics
Rochester 716/473/6600
Peerless Radio Corp.
Lynbrook, L.I. 516/593-2121
Rochester Radio Supply Co., Inc.
Rochester 716/454-7800
Simcona Electronics Corp
Rochester 716/328-3230
Masline Electronics
Rochester 716/546-5373
Standard Electronics, Inc.
Buffalo 716/685-4220
Summit Distributors
Buffalo 716/884-3450
NORTH CAROLINA
Hall-Mark Electronics
Raleigh 919/832-4465
Kirkman Electronics, Inc.
Winston-Salem 919/722-9131
MacVictor Electronic Supply
Concord 704/786-4175
United Electronic Supply
of Gastonia
Gastonia 704/867-4401
OHIO
ESCO Incorporated
Dayton 513/226-1133
Hughes-Peters, Inc.
Columbus 614/294-5351
Hughes-Peters, Inc.
Cincinnati 513/351-2000
Wm. Pattison Supply Co.
(Cuyahoga Hts.,) Cleveland
216/441-3000
Newark Electronics
Cleveland 216/361-4700
Newark Electronics
Cincinnati 513/874-5115
REPCO
Cleveland 216/248-8900
OKLAHOMA
Hall-Mark Electronics
Tulsa 918/835-8458
Radio Supply Inc.
Oklahoma City 405/232-6127
S & S Radio Supply
Tulsa 918/582-8242
OREGON
Aimac/Stroum Electronics
Div. of Laser Link
Portland 503/292-3534
North Coast Electric Co.
Portland 503/228-5111
PENNSYLVANIA
CAM/RPC Electronics
Pittsburgh 412/782-3770
Hall-Mark Electronics
Huntingdon Valley 215/355-7300
Simco Electronics, Inc.
Philadelphia 215/229-1880
RHODE ISLAND
Wm. Dandreta & Company
Providence 401/861-2800
W.H. Edwards, Inc.
Warwick 401/781-8000
SOUTH CAROLINA
Sawyer Electronics
Greenville 803/235-0438
Wholesale Radio Supply Co.
Industrial Div.
Charleston 803/722-2634

TENNESSEE

Curle Electronics
Chattanooga 615/266-4728
Electra Distributing
Nashville 615/329-3971
Radio Electric Supply Co.
Kingsport 615/247-8111
TEXAS
Allied Electronics
Fort Worth 817/336-5401
Altair Company
Houston 713/462-3029
Altair Company
Richardson 214/231-5166
ESI Supply
Midland 915/694-9657
Hall-Mark Electronics
Dallas 214/231-6111
Hall-Mark Electronics
Houston 713/781-6100
Hargis Company
Waco 817/754-5667
Ideal Industrial Electronics
Supply, Inc.
El Paso 915/665-4671
KA Electronic Sales
Dallas 214/634-7870
Newark Electronics
Garland 214/271-2511
R & R Electronics
Lubbock 806/765-7727
Southwest Electronics, Inc.
Stafford 713/494-6021
Sherman Electronic Supply
San Antonio 512/224-1001
Wholesale Electronic Supply
Austin 512/478-9568
UTAH
Stuart Electric Supply Co.
Salt Lake City 801/466-8605
Newark Electronics
Salt Lake City 801/486-1048
W.H. Bintz Co., Elec. Div.
Salt Lake City 801/363-5821
VIRGINIA
Arlington Electronics Wholesalers,
Incorporated
Arlington 703/524-6256
Meridian Electric
Richmond 703/355-6521
Roanoke Electronics, Inc.
Salem 703/389-7269
WASHINGTON
Aimac/Stroum Electronics
Seattle 206/763-2300
Consolidated Electrical Distributors
Tacoma 206/383-5961
H.D. Campbell Co.
Seattle 206/634-1200
WISCONSIN
Electronic Expeditors, Inc.
Milwaukee 414/228-8100
Hall-Mark Electronics
West Allis 414/476-1270
Newark Electronics
Brookfield 414/781-2450
Taylor Electric Company
Mequon 414/241-4321
Lakeview Electronics
Mequon 414/377-8250

TENNESSEE

Curle Electronics
Chattanooga 615/266-4728
Electra Distributing
Nashville 615/329-3971
Radio Electric Supply Co.
Kingsport 615/247-8111
TEXAS
Allied Electronics
Fort Worth 817/336-5401
Altair Company
Houston 713/462-3029
Altair Company
Richardson 214/231-5166
ESI Supply
Midland 915/694-9657
Hall-Mark Electronics
Dallas 214/231-6111
Hall-Mark Electronics
Houston 713/781-6100
Hargis Company
Waco 817/754-5667
Ideal Industrial Electronics
Supply, Inc.
El Paso 915/665-4671
KA Electronic Sales
Dallas 214/634-7870
Newark Electronics
Garland 214/271-2511
R & R Electronics
Lubbock 806/765-7727
Southwest Electronics, Inc.
Stafford 713/494-6021
Sherman Electronic Supply
San Antonio 512/224-1001
Wholesale Electronic Supply
Austin 512/478-9568
UTAH
Stuart Electric Supply Co.
Salt Lake City 801/466-8605
Newark Electronics
Salt Lake City 801/486-1048
W.H. Bintz Co., Elec. Div.
Salt Lake City 801/363-5821
VIRGINIA
Arlington Electronics Wholesalers,
Incorporated
Arlington 703/524-6256
Meridian Electric
Richmond 703/355-6521
Roanoke Electronics, Inc.
Salem 703/389-7269
WASHINGTON
Aimac/Stroum Electronics
Seattle 206/763-2300
Consolidated Electrical Distributors
Tacoma 206/383-5961
H.D. Campbell Co.
Seattle 206/634-1200
WISCONSIN
Electronic Expeditors, Inc.
Milwaukee 414/228-8100
Hall-Mark Electronics
West Allis 414/476-1270
Newark Electronics
Brookfield 414/781-2450
Taylor Electric Company
Mequon 414/241-4321
Lakeview Electronics
Mequon 414/377-8250

**Write for our NEW Stock Catalog, or
contact your local Magnecraft distributor. He's listed above.**

Circle 227 on reader service card

Allen-Bradley Trimmers:

**We have what
you need.**

**Our distributors have
them when your
need is now.**



CERMET TRIMMERS

 **Type A:** 1/4" diameter, single turn, 10 ohms to 2 megs ±10%. 0.5W at 85°C, immersion sealed, 3 terminal options. Publication 5238. **1000 piece price \$1.12 to 1.68.**

 **Type S:** 3/8" dia., single turn, 50 ohms to 1 meg ±10%. 0.5W at 85°C, immersion sealed, top or side adjust. Publication 5208. **1000 piece price \$1.15 or 1.40.**

 **Type E:** 3/8" square, single turn, 10 ohms to 2 megs ±10%. 0.5W at 70°C, immersion sealed, 13 terminal options. Publication 5219. **1000 piece price \$0.49.**

 **Type D:** 3/8" diameter, single turn, 10 ohms to 2 megs ±20%. 0.5W at 70°C, dust cover, 6 terminal options. Publication 5240. **1000 piece price \$0.42.**

 **Type 90:** Approx. 7/16" square, single turn, 100 ohms to 2 megs ±20%. 0.5W at 70°C, open frame, 2 terminal options. Publication 5242. **1000 piece price \$0.55.**

 **Type MT:** 3/8" square, 20 turn, 10 ohms to 2 megs ±10%. 0.5W at 70°C, immersion sealed, 3 terminal options. Publication 5241. **1000 piece price \$1.18.**

 **Type RT:** 3/4" long, 20 turn, 10 ohms to 2 megs ±10%. 0.75W at 70°C, immersion sealed, 3 terminal options. Publication 5237. **1000 piece price \$0.65 or 0.93.**

CARBON COMPOSITION TRIMMERS

 **Type Y:** 1/2" dia., single turn, 100 ohms to 5 megs ±10% or 20%. 0.25W at 50°C, dust/splash resistant, 5 styles, non-linear tapers, Pub. 5209. **1000 piece price \$0.90 to 1.59.**

 **Type F:** 1/2" dia., single turn, 100 ohms to 5 megs ±10% or 20%. 0.25W at 70°C, immersion sealed, 6 styles, non-linear tapers, Pub. 5234. **1000 piece price \$1.00 to 1.62.**

 **Type O:** 1/2" dia., single turn, 100 ohms to 5 megs ±10% or 20%. 0.40W at 70°C, immersion sealed, 4 styles, non-linear tapers, Pub. 5235. **1000 piece price \$1.20 to 1.58.**

 **Type FD:** 1/2" dia., 2 sec., 1 turn, 100 ohms to 5 megs ±10% or 20%. 0.25W at 70°C, immersion sealed, 4 styles, 5 tapers, 2 atten. Pub. 5231. **1000 piece price \$2.65 to 4.10.**

 **Type BT:** 1/2" dia., 2 section, 1 turn, for 75 ohm Bridged-T pad applications, dust/splash resistant, side and top adjust versions. Pub. 5236. **1000 piece price \$2.49.**

 **Type N:** 1 1/4" long, 25 turn, 100 ohms to 2.5 megs ±10% or 20%. 0.33W at 50°C, immersion sealed, Publication 5206. **1000 piece price \$2.50 or 2.65.**

 **Type R:** 1 1/4" long, 25 turn, 100 ohms to 2.5 megs ±10% or 20%. 0.25W at 70°C, immersion sealed, bushing mount option, Pub. 5205. **1000 piece price \$2.87 to 3.73.**

Quality in the best tradition.



ALLEN-BRADLEY
Milwaukee, Wisconsin 53204

EC120

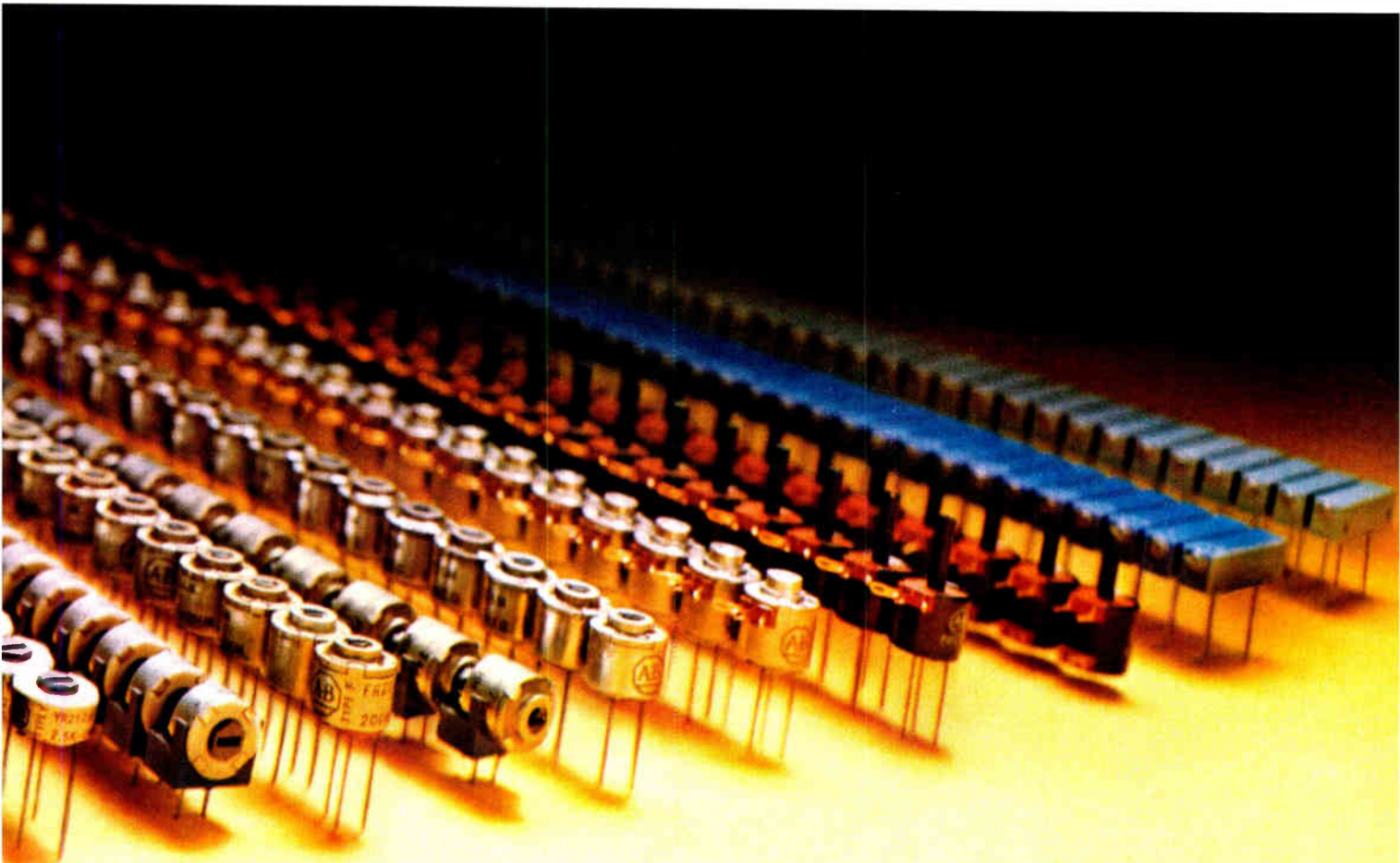

Circle 228 on reader service card

national chains (the biggest of which claims annual sales in excess of \$230 million) to strong regional networks, to highly effective local distributors.

Obviously, the local distributor will perform all sales and warehousing functions from a single location. The national is likely to maintain large and deep inventories in a few major markets, augmented by back-up stocks strategically located in between and sales offices which extend the reach even further. The regional distributor generally offers many of the sophisticated systems and services of his national-chain counterpart, combined with the shorter lines of communication and closer customer contact that are the forte of the local.

Product mixes differ as well. Many distributors, particularly those that trace their roots back as radio parts jobbers, tend to take a broad-line approach, carrying as many as 70,000 different items from as many as 250 vendors, many of them competitive with one another. Then there is the limited-line approach, offering a wide range of products within a limited number of brands, but only one brand in a product category. There also is the specialist, who carries very deep inventories of a comprehensive grouping of lines of a single product type.

A topic that has evoked considerable discussion in the industry—but that does not fall within the scope of this report—is that of franchises, whereby one or two distributors have exclusive rights to offer a given line in a given territory. However, many distributors have cooperative

working arrangements with one another. As a matter of fact, the last year or so has begun to see the emergence of super-distributors, whose sole business is fulfilling other distributors' special component needs.

The industrial electronic distributor, as a distinct entity, is a relatively new phenomenon. Industrial electronics distribution, like the rest of the electronics industry, is an outgrowth of the radio business, specifically the radio parts business. From the experimenters, hobbyists and hams of the 1920s and 1930s, and the explosion of radio as a primary entertainment device during the early Roosevelt era, emerged the radio parts jobber. World War II accelerated the growth of electronics technology for non-entertainment applications, but even in the late 1940s and early 1950s, the parts jobber was still primarily concerned with selling tubes and other replacement parts for radios and television sets.

In the middle 1950s, pioneer distributors like Sam Poncher of Newark Electronics were considered visionary when they said, "There is a customer for electronics every place there is a smokestack." But this gospel spread, and by the early 1960s, manufacturers were beginning to develop full-scale marketing programs offering off-the-shelf delivery from local distributors, in small-run production quantities with prices equivalent to the factory's.

This was the key to the revolution, the *sine qua non* for today's industrial electronic distribution to flourish as it does: the recognition that the distributor was

not a customer to whom the component manufacturer should sell, but a conduit to the end user, a vital part of the marketing team performing important value-added services for both the maker and user of components.

The distributor revolution was under way!

Today, in particular, a number of new market factors are in the picture, causing the role of distribution to flourish and expand. From the product designer's standpoint, one sees greater penetration of LSI into the existing component marketplace—consumer white goods, TV, consumer entertainment products, as well as a wide range of microprocessor-based industrial and commercial systems. Tied to this is increased awareness of the critical role components play in practical LSI system designs as well as a reduction in the number of engineers having critical influence on product design in both traditional and nontraditional sales situations.

While in any given buying location there may be fewer people making fewer of the so-called small decisions, there has been and will be a dramatic increase of unknown buying locations, created by high-technology-oriented engineers developing new products. This expanding customer base will surpass the capacity of current direct-sales coverage techniques.

Fortunately, the emergence over the last decade of the industrial electronic distributor as an OEM-quantity supplier, particularly in the nontraditional area, has already equipped him to fill the gap. When technology changes, the market changes; when the market changes, it's imperative to take new looks not only at who sells what to whom, but at how they do it. This report provides some insights into the role of distribution in today's marketplace and how the role of the industrial distributor is likely to function in the electronic-technology marketplace of the future.

Within the broad electronics community, those members of the population who are primarily concerned with distribution form a vital and significant subcommunity of their own. Thus, we will also provide a description of some of the ways in which the distribution community operates and of the machineries through which its members communicate with one another.



Super-modern offices and warehouses, frequently in industrial park settings, as well as advanced order-processing equipment such as shown at Hamilton-Avnet, are characteristic of distributor operations.

Your LICON distributor invites you to

We've made it easy for you to experience the unique design, production, pricing and customer service benefits other Licon switch users have enjoyed for years. Free of charge . . . without any strings of any kind!

Here's all you need to do. Ask your nearby Licon distributor (he's listed below) for a copy of the New Licon Switch Selection Guide. Pick out the model you'd like from the list of Licon lighted and non-lighted pushbutton switches and single and double break basic switches. Fill out the postage-paid card that's enclosed . . . and we'll take it from there!

We'll rush you the Licon switch you choose.

You can weigh it, measure it, plug it into your product or prototype, bite it, kick it, sniff it, life test it . . . do whatever you want. It's yours.

You've nothing to lose. So call or write for a test drive today. Offer good in the U.S.A. only. Licon, A Division of Illinois Tool Works Inc., 6615 West Irving Park Road, Chicago, Illinois 60634. Phone: (312) 282-4040. TWX 910-221-0275.

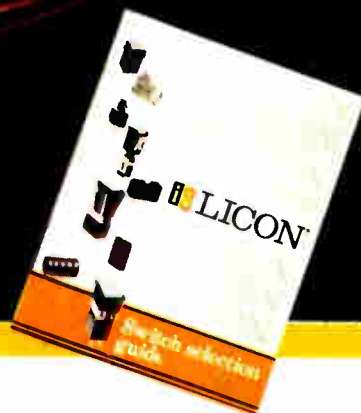

Call your LICON distributor for a TEST DRIVE

ARIZONA

Phoenix/Cramer Electronics
(602) 267-7321

CALIFORNIA

Burlingame/Rose Electronics Distributing
Co.

(415) 692-5700

Los Angeles/Electric Switches, Inc.
(213) 660-1310

Los Angeles/Kierulff Airline Supply

(213) 724-6600

Santa Clara/Fisher Brownell

(408) 244-6182

Sun Valley/Richey Electronics

(213) 768-3800

COLORADO

Denver/Cramer Electronics

(303) 758-2100

CONNECTICUT

Hartford/L. E. Whelan Company

(203) 246-5694

FLORIDA

Orlando/Cramer Electronics

(305) 894-1511

ILLINOIS

Chicago/Newark Electronics Corp.

(312) 638-4411

Chicago/Electronic Expeditors

(312) 236-1088

INDIANA

Indianapolis/RA DIS Co.

(317) 637-5571

KANSAS

Wichita/Radio Supply Company Inc.

(316) 267-5214

MARYLAND

Kensington/Marine Air Supply

(301) 949-1353

MASSACHUSETTS

Newton/Cramer Electronics

(617) 969-7700

West Springfield/Tectrol Assoc. Inc.

(413) 733-3695

Watertown/Sterling Electronics

(617) 925-9720

MICHIGAN

Detroit/Fife Electric Supply Company

(313) 963-1160

Wyoming/Newark Industrial Electronics

(616) 241-6681

MINNESOTA

Minneapolis/Stark Electronics Supply

(612) 332-1325

NEBRASKA

Lincoln/Scott Electronics Supply

(402) 466-8221

NEW JERSEY

Hackensack/Nassor Electrical Supply Co.

(201) 342-3737

NEW YORK

Binghamton/ASI Electronics Inc.

(607) 723-6326

Buffalo/Summit Distributors Inc.

(716) 884-3450

Farmingdale/Inis Electronics, Inc.

(516) 420-8400

NORTH CAROLINA

Winston-Salem/Kirkman Electronics

(919) 722-9131

OHIO

Akron/Akron Electronics Supply

(216) 762-8816

Dayton/Esco Electronics Inc.

(513) 226-1133

PENNSYLVANIA

McKeesport/Barno Radio

(412) 751-5966

Philadelphia/Pytronics Industries

(215) 643-2850

TEXAS

Houston/Lenert Company, Inc.

(713) 225-1465

Dallas/Wholesale Electronics Supply

(214) 824-3001

WASHINGTON

Bellevue/Bell Industries

(206) 747-1515

WISCONSIN

Milwaukee/Electronic Expeditors

(414) 228-6100



Hamilton-Avnet

The distributor — the engineers' friend

Much has been written about the role the modern electronic component distributor plays in the marketing of electronic components, particularly as it applies to his relationship with the engineer or component specifier.

Historically, the distributor's relationship with the customer has been through the customer's purchasing department—with generally sporadic contact with the engineering groups—while the major contact with engineers and specifiers has been more or less assigned to the manufacturers' independent representative or direct factory salesman. This is in keeping with the general consensus that the distributor's role is to service a demand created by the manufacturer or his representative by providing local product availability to the customer.

From the more practical standpoint, not every distributor salesman has the technical expertise to discuss component application, nor does he always have the time to spend in that function. Most distributor salesmen are paid commission on volume, and their time is money. However, the distributor today does, can, and wants to provide services to engineers that are meaningful, time-

saving, and important. And in many instances, he *is* technically equipped to do so. More and more distributor sales personnel today can boast EE degrees; and more and more distributors have product specialists on staff to furnish additional back-up.

Of the benefits that the OEM customer and its purchasing department receive when they buy through the industrial electronic distributor, the most obvious and most important is the quick local off-the-shelf availability of product. There are many implications of this key distributor service that should be explored further.

The distributor provides his OEM customer with the convenience of one-stop shopping. This shows up in the ease of ordering—a reduction in paperwork and a reduction in expediting—not to mention the incalculable benefit of helping the purchasing department eliminate product search time. Furthermore, if the distributor encounters an out-of-stock situation, he can frequently suggest and offer an equivalent alternative product.

Although typically the distributor sells at the same price as would the factory for a given number of components (the

so-called protected quantity—which may range from 9 to 9,999 or more pieces), he will usually absorb the delivery cost, reflecting an actual dollar savings to the OEM customer. This direct economic benefit is buttressed by the opportunity for additional discounts from the distributor when an order is placed for multiple products at the same time.

Knowing that the distributor has a product in inventory gives the purchasing department greater flexibility in ordering, reduces the cost of warehousing, and cuts both the cost and handling of inventory. Dealing with a distributor, the customer often has the option of buying components in smaller quantities. The back-up stock on the distributor's shelf improves not only improves inventory control but also cash flow.

Many OEMs today find benefits in using the distributor as their second source on a product where the factory is the first source. They order factory-direct on their production runs, but buy the equivalent product from the distributor for prototypes and short runs, as well as to fill in on low items as a production backstop. In a growing number of cases, in fact, even production-run quan-

Edge connector specialists in variety, price, delivery...

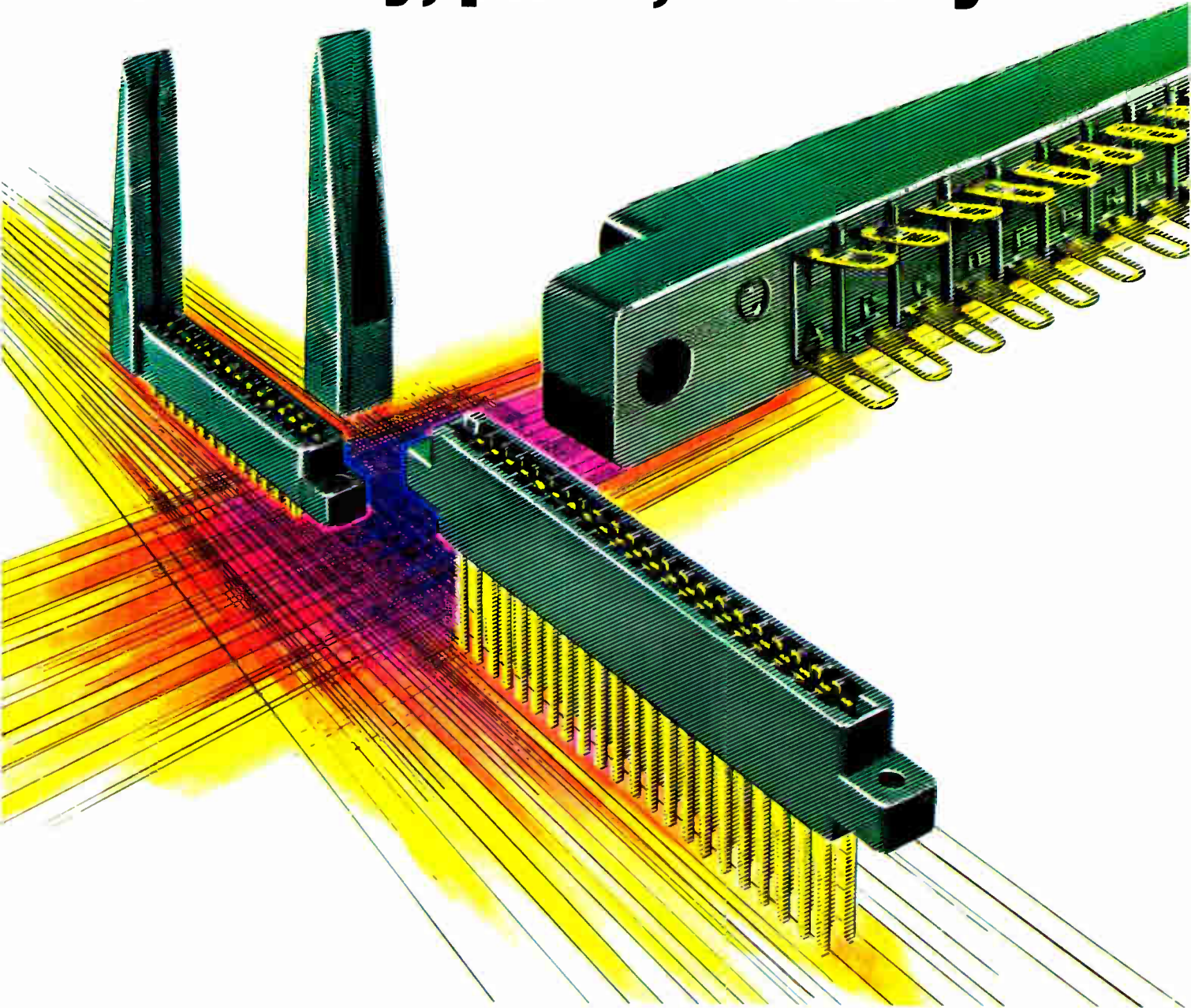

Your TRW Cinch Connectors distributor.

You're almost sure to find the edge connector you need at your local TRW Cinch distributor. He stocks a wide selection of printed circuit edge connectors, perhaps the widest in the industry. Precision military types, standard commercial units and the low cost Econoline offer a full range of price options.

TRW Cinch distributors will give you off-the-shelf delivery on most popular edge connectors. You can select contact spacing (.156, .100 and .050") and termination style—wrappost, solder tab or eyelet, and dip solder. Most series are available in numer-

ous sizes from 6 to 50 positions, single and double readout.

For price and delivery information, call your nearest TRW Cinch Connectors distributor—your edge connector specialist. Or call your local TRW/ECD field sales office, listed with our distributors in EEM. Or contact TRW Cinch Connectors, An Electronic Components Division of TRW Inc., 1501 Morse Avenue, Elk Grove Village, Illinois 60007; phone: (312) 439-8800

CD-7701

TRW CINCH CONNECTORS

Circle 237 on reader service card

ANOTHER PRODUCT OF A COMPANY CALLED TRW

World Radio History

Special advertising section

tities are being handled through distribution with economic benefits in production scheduling, warehousing costs, and inventory control accruing both to the component vendor and the OEM user.

One of the paramount advantages that the function derives from dealing with the distributor is in terms of information services. Most industrial distributors maintain active direct-mail programs. These keep the engineers on their mailing lists up to date on new products and technology, as well as on availability.

In addition, a good distributor maintains complete and extensive literature files. The engineer who wants to review a number of options can get information from one source, rather than having to call a number of sales representatives or manufacturers. Even if the distributor does not have the needed data on hand, he knows precisely whom to call to get the information. The engineer or purchasing agent who calls the factory is all too likely to find himself transferred from department to department before he finds someone who can send him the information he requires.

Many of these services are equally available from the sales representative, and the technically competent sales rep can probably give as fast or faster turn-around than can the distributor on the specific product he sells. The broad-line distributor, however, is much better able to provide an objective view of competi-

Secondary parts processing is one more way today's industrial electronic distributor customizes his service to the engineer's needs. Here, at Liberty Electronics, an operator installs contacts in coaxial connectors.



tive lines, and to advise on tradeoffs, options, and alternatives. In addition, distributor telephone and purchasing personnel are always available, not out making calls.

Fortunately for both buyers and sellers, the electronic-component industry is moving at an accelerated pace towards the team-marketing concept. When the same sales representative organization calls on both OEM and distributor accounts, they work together rather than vying for the identical order. In such situations, the distributor can call on the rep for technical backup when the customer

requires it. Everybody keeps in mind the separate functions each segment provides on the marketing team. The rep services the distributor and the major OEM accounts. The distributor adds "reach" to the smaller customers. The engineering department makes a serious and potentially expensive mistake in underestimating and underusing the product knowledge available through the distributor sales, purchasing, and product management personnel.

Another important benefit the distributor provides the engineering community is in sampling. While the distributor is not in the give-away business, he many times has arrangements with his vendors to replace material he furnishes as samples from his shelf stock. Particularly with low-ticket items, he is likely to provide what is needed, and provide it fast, without paperwork or charge.

All this shows that the distributor's ability to react and to shortcut many routines in serving all his customers and all their departments is an important plus. The distributor offers quick deliveries, quick reaction time, and quick follow-up. And yet, in today's electronic marketplace, many of these important features pale in importance compared with the key advantage of buying from the industrial electronic distributor. Obviously, when the OEM is buying from the distributor, he is buying standard parts, rather than proprietary components. The ability of the industrial electronic distributor to supply standard components in industrial quantities has gone hand in hand with

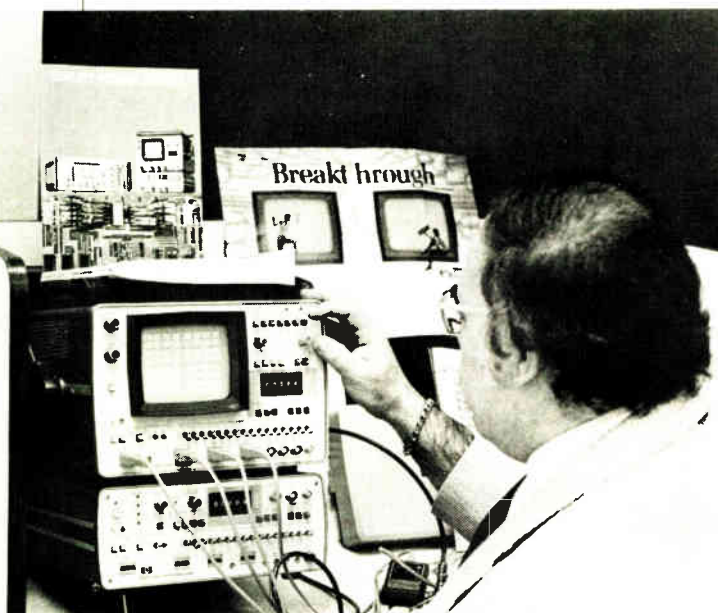

Distributor microprocessor design centers are equipped with highly sophisticated simulation, program analysis, editing and debugging equipment for design verification. This center is at Schweber Electronics.



Coming through...

with help getting your ideas off the ground

Whether you're thinking about new "black box" designs or better ways to work with wire, we can help get your ideas off the ground.

Involving Belden in the early stages of a project will almost always pay off in a cleaner, more economical package. It can also keep knotty—and costly—problems in compatibility, workability and availability from arising later.

We're coming through with extensive capabilities in problem solving and custom design. Plus thousands of high-quality wire, cable and cord products to draw from—high density, flat cable constructions.

Our know-how in the areas of insulation compound-

ing, shielding, innovative packaging, quality control and time motion have resulted in some extraordinary savings for our customers.

Talk to a Belden specialist about your new black box ideas, processing and application problems—all your wiring needs. For fast answers to special problems, call our engineering "hot-line" number, 317-966-6681. You'll like the results.

Whether your needs can best be met through our nationwide team of electronic distributors or through a totally new cable design, we won't let you down. Belden Corporation, Electronic Division, P.O. Box 1327, Richmond, IN 47374; 317-966-6661.

8-4-7

The Belden logo, consisting of the word "BELDEN" in a bold, sans-serif font followed by a stylized circular symbol.

Coming through...

with new ideas for moving electrical energy

the engineering community's recognition of the short- and long-term benefits of specifying standard components.

In prototyping and in research and development, the standard component is frequently selected because it is immediately available. If the standard item stays in the production design, the customer develops a cost advantage and a reduction in lead time. He also gains a confidence or experience factor in utilizing a component that has been on the market for a period of time and has worked successfully for other people. Moreover, he holds on to down-the-line benefits when a component goes out of repair; a product will not be subject to lengthy down time, because the replacement component is easily available. The end-use customer for a product will appreciate the ease of service and repair that readily available parts provide.

In addition, the distributor's capability to provide modification services, as discussed previously, gives the best of two worlds. Frequently the specialist distributor, with his depth of knowledge about a given component category, can develop and assemble "specials" out of standard components, at a realistic price,

even in relatively small quantities.

In the areas of passive components and the established semiconductor areas, the patterns for using standard components are well established. In microprocessor specification, we are still dealing with current events rather than history. The long-term prevalence of the standard versus the dedicated product is still emerging. At this juncture, it seems reasonable to assume that for larger-volume markets, product will be customized and will tend to go factory-direct. Lower-volume applications will clearly use standard chips, and the distributor will be involved.

The special sophistication and investment involved in microprocessor distribution indicates that many local distributors will continue to opt out of this market, as with the rest of the semiconductor market, and the lion's share of the distributor microprocessor business will be handled by the large chain operations, both national and regional.

The top 25 industrial electronic distributors, the major chains, are now estimated to handle over three quarters of the total semiconductor business, and to be doing more than half their volume in

solid-state products. The investments involved in handling the new technology seems likely to demand that the big semiconductor houses will concentrate more than ever on this segment.

Distributors have already responded to the microprocessor market by involving themselves in systems selling. Beyond developing programming capabilities, microprocessor centers and showrooms, and even microcomputer hobby shops, the systems-oriented distributor now offers a wide range of peripherals, including a-d converters, printers, CRTs, floppy disks, and input/output units—again contravening the myth of "that product is too technical to go through distribution."

The local distributor will thus concentrate on passive components, will exploit his capabilities for close, direct, personal service, and will continue to be a choice source for capacitors, resistive components, connectors, relays, switches, test instruments, etc.

One thing that is certain is that whether the components being purchased are active or passive, they will be supplied by active distributors, actively involved in helping the user.

Selling products through distribution

Electronic distribution in 1977 is big business. Today, about 3,000 manufacturers of electronic components, equipment, and accessories are offering their products for sale through distribution. The National Electronic Distributors Association estimates that distributors now sell in the vicinity of \$2 billion worth of active and passive components for OEM, MRO and R&D applications. Distributors, who just three years ago were selling only some 30% of all electronic components, are now estimated to be selling about 65%, and are expected to be selling 70% or more by 1980.

Yet some knowledgeable observers claim there may be as many as 6,000 manufacturers—possibly more—whose products could be offered through the distribution route but whose marketing has not yet gone in that direction!

Clearly, not all electronic products are appropriate for sale through distributors. Some products will always be too technical, too complex, or too specialized and limited in the number of customers who utilize them. But distributors have repeatedly confounded the world by getting involved—and being successful—with products originally deemed "too techni-

cal." The microprocessor is merely the latest example.

But even among skeptics, one thing is generally acknowledged. The distributor is not an extraneous middleman, but a functional link providing significant added-value functions in the process of bringing products from the manufacturer to the user.

First and foremost of these is physical coverage of the market. No manufacturer, whether he is selling components or end-use equipment, can field a large enough sales force to contact the conservatively estimated 40,000 buying

ANOTHER VINTAGE YEAR FOR CHERRYS

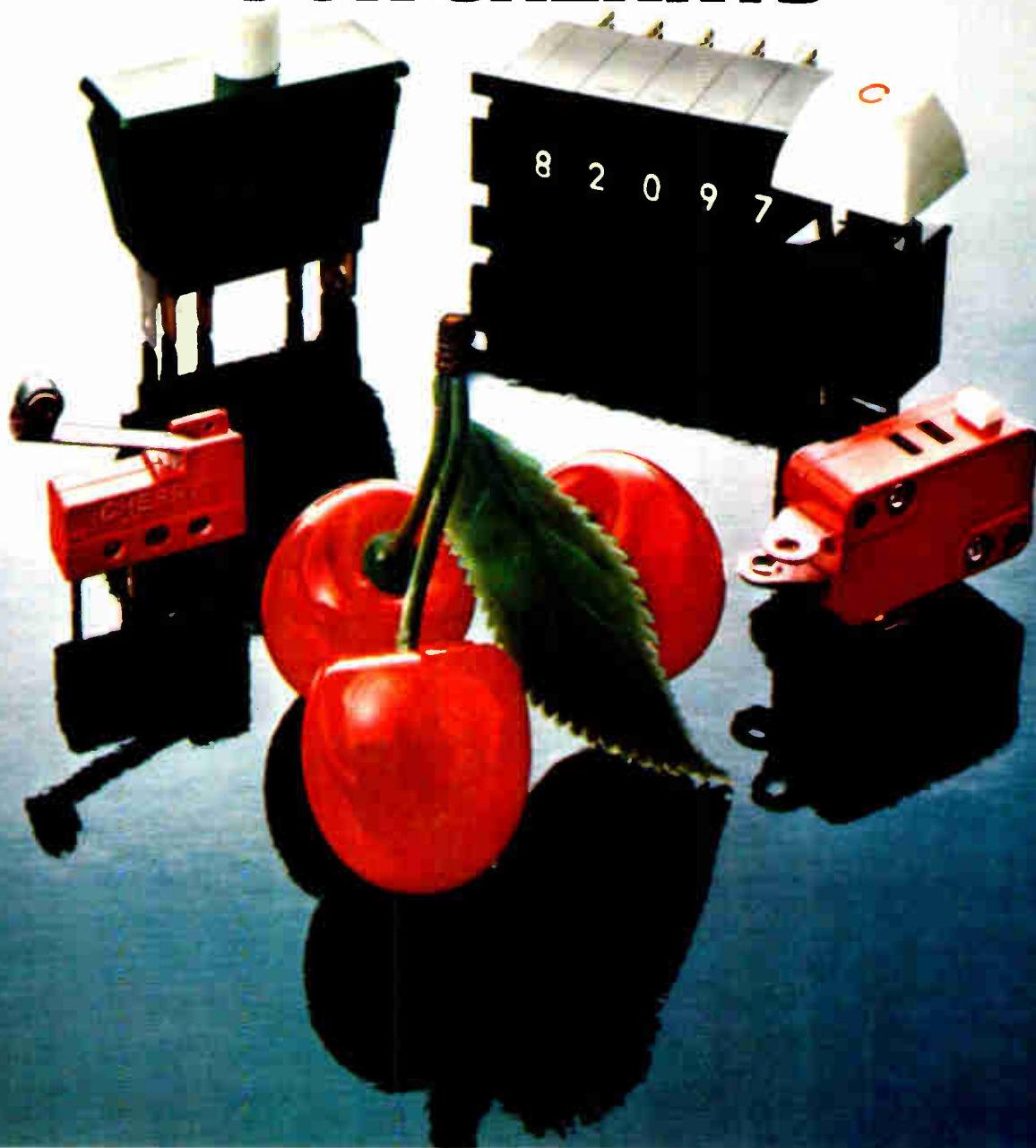

We planted the seeds for these Cherrys 25 years ago. Today they're the pick of the switching crop. Good, sturdy, hardworking switches with years of know-how, experience and refinement behind them . . . and a bright future ahead.

What kinds of switches? You name it, Cherry's got it. Snap-action switches with unique Cherry coil spring mechanism for long mechanical life. Gold crosspoint contact switches for low energy solid state circuits. Thumbwheel switches in a full range of alphanumeric readouts and output codes. Individual keyboard switches and complete keyboard assemblies with electronics. Rotocode® switches . . . a new rotary switch with coded electrical output.

If your products are made or sold overseas you'll be glad to know that Cherry's switches are available worldwide from our modern manufacturing plants in the USA, England, Germany and Japan and a licensee in Australia. All our switches have passed rigid performance requirements of independent testing laboratories. Many of our switches have been listed, certified or approved by various international testing and approval agencies.

Some selected distributorships available.

For details phone:
Don Galbo (312) 689-7680.

CHERRY



CHERRY ELECTRICAL PRODUCTS CORP.
3608 Sunset Avenue, Waukegan, Illinois 60085

SWITCHES and KEYBOARDS — Available locally from authorized distributors.

locations where there are users or potential users of electronic components. Virtually every industrial electronic distributor, even the smallest, has at least three salesmen, and the larger distributors have many times this number. A large component manufacturer may field a sales force of factory salesmen and/or independent reps of about 100 to 150 people, including clerical back-up. Such a sales force typically may sell directly to less than 1,000 accounts. However, adding in a network of 200 distributors expands the sales force to 3,000 sales people and the reach to over 50,000 accounts, most of which were far too small to be economically viable factory-direct customers! And, of course, the factory incurs no sales expense when the distributors' salesmen push its product in the marketplace.

Distributors also warehouse the product, with a distributor network providing national coverage, and thus obvious additional cost benefits to the manufacturer. In addition to the savings on warehousing costs, there is also a savings on the burden of carrying inventory and improved cash flow.

The component manufacturer is money ahead because the distributor extends credit to his customers. Since the distributor is local and has the benefit of local information and personal knowledge of his accounts, he will be more willing to extend credit to, and thus serve, custom-

ers that the factory would have to turn down.

A manufacturer who sells his product through distribution also eliminates costly manufacturing runs on small orders. He always produces his standard product at profitable quantity levels.

What does it cost you to handle an order? Whether the order covers 50 pieces or 5,000 pieces, you still have to (1) receive the order, (2) open the envelope, and (3) route it to the appropriate department. There it must be (4) entered, and (5) a shipping ticket made out. The order must (6) be sent to the shipping room which (7) must pull the merchandise, (8) wrap it, (9) make out the shipping label. Somebody has to (10) make out an invoice, (11) mail it to the customer, and (12) send an invoice to the bookkeeping department for entry on the books. (13) Statements must be mailed to the customer, (14) payments must be received and entered. What's the cost to you for each of these transactions? Then ask yourself at what quantity level it becomes profitable for you to sell. You don't want to not supply a good customer or, by turning down the prototype order, risk losing the production run. This is just one demonstration of the financial or economic benefits which a distributor program offers.

Nor are small-quantity orders unusual. Small quantities of components are needed for engineering designs, for

prototype runs, as replacements, as well as for small production orders. And in most instances, the customer wants the product right now, without waiting 12 or 14 weeks for delivery from the factory.

More and more engineers are thus learning to design around standard products. Thus, very frequently, if the item that first came to mind isn't available for immediate delivery, the customer specifies an off-the-shelf alternate. That's the product that goes on the print and which is ordered in quantity when the production order comes up.

While your product may have been the point of departure, you end up at best the second source. Thus, it is clear that the distributor already plays a significant role in the marketing process—a role that will expand. The distributor has been depicted in the past as being unwilling or unable to create demand. This will become less true as both products and distributors become more sophisticated. Nobody can question the distributor's impact on creating brand preference . . . if only because brand preference is so frequently related to what is available for delivery today.

Many of the value-added services that the distributor provides for this vendor can be measured in terms of direct economic benefit. But there are intangibles, too. Your distributor sales force is out in parts of the world where you might never get, gathering local information, interpreting it, and passing it on. Not only that, your distributor salesman also establishes a personal relationship with the key buyers in his territory. He knows what's what; he knows who's who. He's a valuable addition to your team.

Warehousing, expediting, extension of credit, and similar services have long been identified as the value-added functions that distribution offers. William Englehaupt, executive vice president of the National Electronic Distributors Association, likes to guard the phrase jealously to denote only those classic distribution functions. However, many of his constituents have extended the term to refer to their ever-growing activities in modification services, assembly services, testing services, programming, and the like.

Many of these distributor activities in secondary parts processing started out as an economic device whereby the distributor could hold down his inven-



Computerized information systems, such as this one at Sterling Electronics, link the sales desk with regional warehouses, so the salesman knows instantly what is in stock, how much it costs, where it is and when more will arrive, so he can get components en route on the same day the order is placed.



Who offers a comprehensive line of Electronic Wire & Cable? ESSEX/STANCOR

Stancor, a leading supplier of transformers and controls to the electronic industry, now offers you the comprehensive line of Essex Electronic Wire and Cable.

With nearly a half a century of wire and cable experience and a pioneer in the development of many insulated conductors, Essex is recognized as a leading designer and producer of coaxial cables (mil or commercial), hook-up wires, multi-conductor cable, power supply cordage, and cord sets. The company's wide



product range includes most types designed exclusively for use in the diversified electrical/electronic industry.

All Essex Electronic Wire and Cable is stocked by Stancor in its centrally located Chicago warehouse. For further information please request a complete set of catalogs from Essex Controls Division, Stancor Products, 3501 W. Addison Avenue, Chicago, IL. 60618.

See Us At NEWCOM Booths F45, F47, F49

ESSEX GROUP Subsidiary of **UNITED TECHNOLOGIES.**

a company called

TRW



believes the electronic distributor is the most effective and efficient way to supply the marketplace

That's why all of the TRW Electronic Components Divisions who manufacture standard products make them available through a nationwide network of electronic distributors.

Whatever quantities of products you need from these organizations, you can get them fast, from stock, from a TRW distributor.

For a complete list of these distributors and a product catalog, use the reader service number below.

TRW CAPACITORS

TRW CINCH CONNECTORS

TRW GLOBE MOTORS

TRW IRC RESISTORS

TRW SEMICONDUCTORS

TRW UTC TRANSFORMERS

T-701

TRW ELECTRONIC COMPONENTS DIVISIONS

10880 Wilshire Boulevard, Los Angeles, CA 90024

For additional information, circle reader service card number: 230 for capacitors, 231 for connectors, 232 for motors, 233 for resistors, 234 for semiconductors, 235 for transformers

tory. Rather than stocking a wide range of part numbers and variations, he stocked basic components and provided assembly service as needed, to fill customer orders. Today there's not an industrial distributor without a bench and a mini-production line for connector assembly, programming operations, customer labeling and product identification, testing, and the like.

As the industrial electronic distributor equipped himself for the assembly of standard components, he discovered a serendipitous by-product. He had the capability to *modify* components to the customer's specific needs. Technically knowledgeable distributors, working closely with customers' engineers, now routinely develop specials out of standard components, to create products that are basically not available anywhere as standards. Furthermore, the distributor provides these services at a realistic price, whereas the factory in most instances would not touch them at any price.

These services call attention to the technical capability of today's industrial electronic distributor. He is part of the factory's marketing conduit with a particular mission to cover the second-, third-, and fourth-tier accounts that the factory sales force does not reach. Thus the distributor must equip himself to provide or secure the same kind of technical support for his factory as would the rep or the factory man.

In reviewing the many things the distributor can do for the manufacturer in selling the product, it must be remembered the distributor's major job is to service the market, not to develop the market. The manufacturer still has to create the demand and still has to select distribution involved in serving the marketplace where the product is supposed to go.

Companies not now selling through distribution, who read into the maturation of the new technology that they can enhance their market share or sell more economically by participating in the distributor marketplace, will have to reflect this in total programming, not just in pricing strategy. Although distributors *can* co-exist with a manufacturer who competes with them by filling orders directly in "distributor quantities," they can't co-exist with a manufacturer who undersells them. Thus pricing must be

geared to compensate the distributor for maintaining inventory, extending credit, processing orders, servicing customers, expediting, absorbing shipping costs, and the like.

Marketing through distribution is not a panacea which will solve everybody's problems of availability and market shares. Nor can anyone set forth a quick and easy formula for establishing a distri-

bution program. But the proliferation of electronics technology into nontraditional markets and the increasing sophistication of industrial electronic distributors in selling high-technology components and systems provide clear indicators that no one should glibly underestimate or dismiss the possibility of today's industrial electronic distributor as part of the marketing team.

Today's representative: a vital link to supplier-distributor

To bolster his service image, the manufacturer's representative is stressing help for the buyer in his relationship with both the manufacturer and the distributor. Today's representative provides the purchaser with a "systems" approach to buying, technological updating, price and availability information, and one-stop shopping.

Under "systems selling," the representative brings product knowledge into play. A representative usually carries a number of compatible product lines, for example, relays, switches, panel meters, lamps, indicators, connectors, and capacitors. Instead of a time-consuming call from a factory man, who is concerned with selling just one product for which a buyer may or may not have an immediate need, the representative can offer knowledge on a number of products—"systems selling."

The value of multiple-line selling goes further. Often a representative is called on to hold in-plant seminars or presentations to make engineers and designers aware of the latest developments in new uses for a particular product or group of products.

A representative can in addition inform

a buyer of various economies that exist. Savings on blanket orders, special delivery, or credit terms can many times be negotiated by the independent representative.

The representative also knows which distributor is stocking a given component that might be needed for an emergency production requirement. He is in a better position to offer assistance in finding a component or part that is needed to fit some special or unusual engineering parameter.

Economies can also be provided in expediting or following through on an urgently needed shipment. The representative helps with rejects or early shipping, should they occur.

Because a representative is familiar with many products and product lines, a phone call from him can often uncover that elusive "widget" an engineering department has just specified into its latest design. Here again, multiple-line selling demonstrably benefits both purchasing and engineering alike.

Moreover, if the representative does not himself carry the particular brand or component you need, he will probably know someone who does. His competi-

tive-literature library comes in handy when a buyer needs to cross-reference part numbers for a bid as well.

In working with distributors for the components and materials, the representative again can be used to save time and money. His experience in dealing with numerous distributors for a variety of products provides him with a handle on local inventories and also on back-order situations.

The representative's rapport with local distributors can assure the buyer of quick no-cost samples, replacing the distributor's inventory when as the factory ships.

He can help with credit questions, perhaps recommending even a large OEM-quantity order be placed through a distributor with sufficient inventory to keep production rolling, while his manufacturer clears credit and goes into the production of your order.

The role of the representative with the distributor is really twofold. He not only helps the distributor move products, but he also makes the distributor aware of local usage for a variety of products. His suggestions keep inventories in line with actual as well as potential demands. This dual role keeps the correct products moving in a steady flow from the manufacturer through the distributor, directly to the buyer's production or MRO requirement.

Representatives help train the distributor salesmen, keeping them abreast of the latest technological advancements in components and materials. Representatives work with the distributors in cataloging and advertising. It is this counsel with the distributor that assures the buyer of literature that is both meaningful and helpful.

Manufacturers' representatives are more than salesmen. They can be used as experienced business consultants for products, providing buyers with technical assistance, product availability, cost information, and credit terms.

The representative is the important link between buyers and the product they need, whether from an industrial distributor or directly from a manufacturer. Acting like a quarterback, the representative is an integral part of the complex marketing system that brings the buyer the products he needs when he needs them.

In short, the representative furnishes a most important ingredient—service.

New horizons for electronic distribution

Advances in the state of the art stimulate change. In the area of technology such change may be and has been radical, even revolutionary. In distribution, however, changes tend to be evolutionary.

Clearly the enormous new range of markets and applications for electronics occasioned by the advent of microprocessor and LSI technology will broaden the base of applications and the base of customers for distribution. It seems certain that, in the not so long run, it will tend to more clearly define distributor types.

Thus we can anticipate being more readily able to classify distributors either as specialists in one or more types of active or passive components or as broad-line distributors, which will more and more come to indicate a wide range of passive components, either with a limited-line profile or with a multiple-brand profile.

In particular, as a result of the impact of the microprocessor, we shall see more distributors involved in systems selling and in enlarging the scope of their operations from the strictly industrial into microcomputer hobby-shop operations.

As indicated previously, the proliferation of electronic gear into usage situations in industry will augment the importance of the backup parts, accessories, and test equipment made available through the MRO distributor. As individual plants become larger and larger customers for electronic products for consumption, we shall see more widespread establishment of the in-plant parts depot as the rack jobbing phenomenon in industrial electronics.

Assembly services will continue to flourish, along with board stuffing, special component development, etc.

As product and application become

more sophisticated, the component manufacturer will require more technical support and expertise from his distributor, and it is likely there will be continued emphasis on the limited distribution network, through which the factory can maximize the effectiveness of its communications and sales training. As more and more buyers want the same products, and fewer and fewer distributors are franchised by the factory to sell them, and as more rigorous controls are exerted against the kind of counterfeiting and unauthorized transshipping which has been so much in the recent news, the super-distributor will emerge as an acknowledged entity in the industry.

Even in the traditional product areas, such as passive components that do not require field assembly, the distributor can be expected to play a larger role as a source of supply to the OEM. Where component manufacturers used to develop pricing structures so the distribution would be competitive in quantities up to 99, later to 999, and even 9,999, there will be a continuing trend to increase the protected quantity. OEM suppliers and OEM customers will work with the distributor on scheduled orders, even for 100,000 pieces and more.

Distributors will also be broadening their product lines, including developing involvements in instrumentation, mini-computers, peripherals, etc., which until now have tended to be the province of the direct salesman. This will represent not only the impact of cost reductions, moving such equipment from the capital expenditure category into the realm of operational budgets, but will also be a factor of the distributor's greater technical expertise in understanding and advising on the equipment that the customer is looking for.

Look For The ERA MARK



THE ERA LOGO HAS BECOME MORE THAN IDENTIFICATION FOR AN ASSOCIATION. IT'S THE SYMBOL OF AN INDUSTRY.

In an industry of superlatives. In an industry of change. Manufacturers' representatives have provided the stability necessary for true growth.

With each new surge of technology. With each new product innovation, the manufacturer's representative has translated the needs of his customers to the capabilities and the disciplines of his manufacturer.

MANUFACTURERS' REPRESENTATIVES HAVE COME OF AGE IN THE ELECTRONICS INDUSTRY.

Today the manufacturer's representative is an entity, a company with long range goals and objectives. He works his territory to develop every potential prospect into a profitable customer for his principals. He's

not in it for the "fast buck" or a promotion to the home office. His objective is to develop his territory into the best marketplace possible.

MARKET YOUR PRODUCTS THROUGH MANUFACTURERS' REPRESENTATIVES.

They are cost/effective. You not only can expect greater market coverage, but also better customer penetration. And that's a tough combination to beat!

THE MARK OF A PROFESSIONAL

Look for the ERA logo when talking with representatives. It indicates the mark of a professional. He belongs to ERA to learn, and for the opportunity to interface with other representatives like himself. It shows he cares.

It also shows that he is part of a marketing force responsible for selling over seven billion dollars worth of electronic products.

For a complete package of material about why you should be using manufacturers' representatives write or call their association.

More than an association — a philosophy



Electronic Representatives Association
233 E. Erie, Suite 1003
Chicago, Illinois 60611 312/649-1333

Views of future

Leonard Cravath Classic Component Supply Northbrook, Ill.

The evolving change in electronic distribution is the growing recognition that you can't be all things to all people. More and more, distributors will be positioning themselves in terms of a market niche, where they can buttress their product availability with information availability and people availability. Yesterday's caretaker distributor will give way to the distributor who takes care—who provides his customers with quick responses, who will work as hard over their "garbage" needs as on their big orders, and who has the technical savvy to know and understand the components he distributes and the applications his customers have for them.

Harvey Sampson Harvey Electronics Woodbury, N.Y.

The proliferation of technology will force us to change our marketing styles and strategies. In fact, microprocessor business today is definitely going in this direction. With component sales such as we have now, we go to the engineering people. In other markets, we have to sell to top management, especially in non-traditional markets for electronics such as hydraulics, and for this type of selling, you have to have both technical people and applications engineers. More business in the future will be systems business. The component business will still be there, but I think you will find more companies with dual marketing organizations. One will cover commodity sales, the day-to-day components. The other will be a high-technology group making the systems sales, in addition to selling those things related to the system. It's much like the broadcast business of

years ago. We would start by selling a tube, then we would sell recorders, consoles, and equalizers, until we ended up selling an entire broadcast system.

Albert Kass Kass Electronic Distributors Drexel Hill, Pa.

The basic distributor services are not going to change as much as will the people to whom and for whom the services are provided. Since the industrial use of electronics is no longer the province of relatively few plants, a greater premium exists in the distributor's ability to know his market area . . . to know where the rocks are and to happily dig under them. This ability is not only a boon to the component manufacturer, but to the OEM, MRO and R&D buyer, in anticipating and satisfying his proliferation of source and data requirements. And this will manifest itself also in the distributor is expansion of the breadth and depth of his inventories to cover new product spectrums and new customer horizons.

Don Yates Genesis Electronics South Bend, Ind.

There will be a continued proliferation of customers and product, and by the very nature of these numbers, the distributor is going to be increasingly important to all manufacturers. This is going to affect distributors mostly in that the service levels they provide will have to exceed those of the manufacturers. Distributors will have to use the tools of more sophisticated selling techniques, including such things as data processing and increased value-added, testing, and assembly services. In terms of the technical customer, more services will be needed by him also, but I don't know if the distributor will be that involved in the design area. He will most likely service it, but I don't think he will make the market.

James Silverman Electronic Expeditors Milwaukee, Wis.

Today's—and tomorrow's—industrial electronic distributor is born out of the marriage between economics and technology. He exists and survives because

For the name of
your nearest
B&K-PRECISION
test instrument
distributor...

Call:

- ALABAMA**
Mattland K. Smith, Inc. 3258 Cahaba Hts Rd
Birmingham, AL 35243 205/967-3080
- CALIFORNIA**
Johnson Associates 817 Douglas Street
Redwood City, CA 94063 415 365-6263
Mike Roth Sales 16117 Wyandotte Street
Van Nuys, CA 91406 213 989-3738
- COLORADO**
K-C Marketers, Inc. 1325 South Inca St
Denver, CO 80223 303 843-5561
- FLORIDA**
Sproch Sales, Inc. 3520 W Broward Blvd
Ft. Lauderdale, FL 33312 304 587-3972
4824 Bliss Road
Sarasota, FL 33581 813 924-7768
- GEORGIA**
Mattland K. Smith, Inc. 6 Indian Trail Drive
Tucker, GA 30084 404 938-7161
- ILLINOIS**
Brainard-Wilson Mktg. 2400 E. Oakton Avenue
Arlington Hgts., IL 60005 312 437-2700
Robert Dunn Sales Co. 512 S. Elm Street
Centralia, IL 62801 618 533-1775
- LOUISIANA**
The Texport Company 501 N. Jefferson Davis Pkwy
New Orleans, LA 70119 504 486-6073
- MICHIGAN**
Burcaw Company & Assoc. 18236 W. McNichols
Detroit, MI 48219 313 533 7700
1461 Hidden Valley Drive
Grand Rapids, MI 49508 616 531-1000
- MINNESOTA**
Kodo Associates 8100 Penn. Ave., South
Minneapolis, MN 55431 612 881 1255
- MISSOURI**
Nevco, Inc. 10132 Glenfield Terrace
Crestwood, MO 63126 314 843 7406
1715 Baltimore Avenue
Kansas City, MO 64108 816 421 1751
- NEW YORK**
L. J. McTaggart Assoc. 19 Windmill Court
Ballston Lake, NY 12019 518 877 8586
Louis W. Keller Assoc. 1680 New Bridge Road
North Bellmore, NY 11710 516 785 2826
1980 Whitehaven Road
Grand Island, NY 14072 716 773 9222
- NORTH CAROLINA**
Mattland K. Smith, Inc. 1605 Chatham Avenue
Charlotte, NC 28205 704 372 1026
- OHIO**
Craig P. Lucas 140 Green Briar Dr
Aurora, OH 44202 216 247-7980
- OKLAHOMA**
The Texport Company 1523 S. Harvard Suite 201
Tulsa, OK 74112 918 939-1727
- OREGON**
Fleehart & Sullivan, Inc. 8465 Beaverton Hillsdale Hwy
Portland, Oregon 97225 503 297-1033
- PENNSYLVANIA**
James Browne 4523 N. 10th Avenue
Temple, PA 19560 215 929-2886
- TENNESSEE**
The Texport Company 5118 Park Ave., Rm. 517
Memphis, TN 38117 901 683-0880
- TEXAS**
The Texport Company 10212 Georgiabelle Drive
Houston, TX 77403 713 464-2828
1401 K. South Floyd Rd.
Richardson, TX 75081 214 238-7117
- WASHINGTON**
Fleehart & Sullivan, Inc. 10109 Aurora Ave., North
Seattle, WA 98133 206 522-1533
- CANADA**
Alias Electronics Ltd. 50 Wingold Avenue
Toronto, Canada 416 781-6174
- INTERNATIONAL**
Empire Exporters, Inc. 270-278 Newtown Road
Plainview, L.I.N.Y. 11803 516 293-5582



B&K PRECISION DYNASCAN CORPORATION

A name you should know... for high performance instruments at practical prices.

Because B&K-PRECISION instruments are sold exclusively by electronic distributors who stock them for fast off-the-shelf delivery. Are generally priced well below similar devices because of increased efficiencies of sales through distributors—not by

sacrificing quality or performance. Are value-engineered to combine maximum use, accuracy and value. Within their defined functions, they perform better than any instrument you can buy—regardless of price.

To Get To Know Us Better

Write for our latest catalog or call your B&K-PRECISION distributor or sales representative for a copy.

B&K PRECISION DYNASCAN CORPORATION

6460 West Cortland Avenue, Chicago, Illinois 60635 • 312 889-9087
International Sales: Empire Exporters, Inc., 270 Newtown Road, Plainville, LI, NY 11803
In Canada: Atlas Electronics, Ontario

Grattan Hammond "wrote the book" on OEM distribution in the S.E. It's yours free.

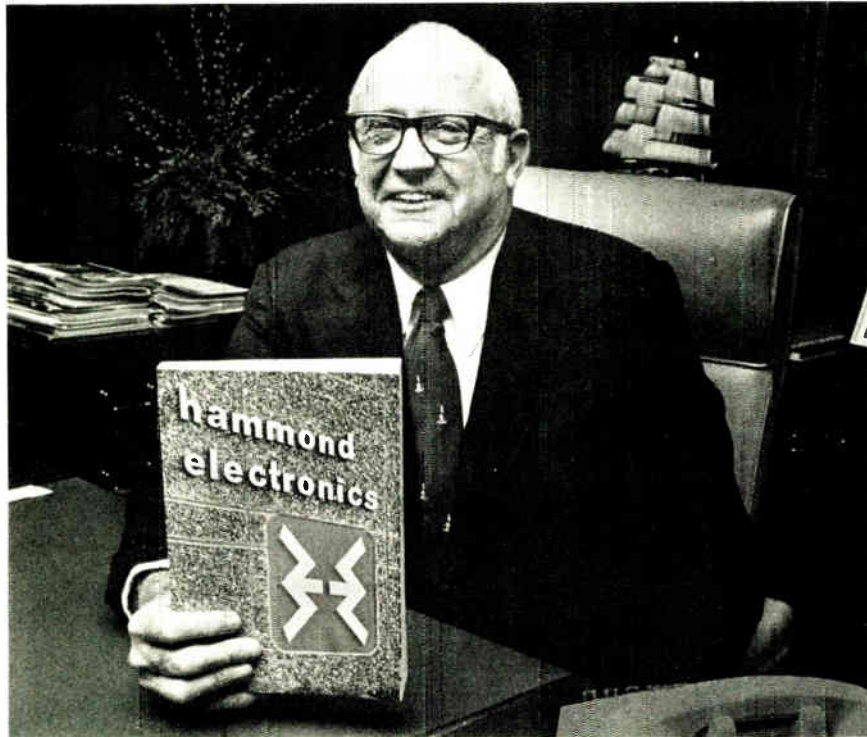

Grattan Hammond, Jr., President

He also built warehouses to stock complete lines—in depth.



hammond electronics

1230 West Central Blvd.
Orlando, Florida 32805
305-849-6060
TWX: 810-850-4121

2923 Pacific Ave.
Greensboro, N. C. 27406
919/275-6391
TWX: 510-925-1094

100 Augusta St.
Greenville, S. C. 29601
803/233-4121
TWX: 810-281-2233

Grattan Hammond, Jr., President
Hammond Electronics
P.O. Box 3671 • Orlando, Florida 32802
Please send your catalog to:

name _____ phone _____
company _____ position _____
address _____
city _____ state _____ zip _____

Special advertising section

he can do things for both buyer and seller more effectively and economically than can the factory. If extraneous factors—like the cost of public liability insurance, to take one example—prevent his continued economic viability, it can be a whole new ballgame. But if normal development is permitted to proceed, we can look for greater technical sophistication and product expertise on the part of the component distributor—the growth of the super-distributor as an institution in electronics marketing—thus reconciling the components manufacturer's desire for a strong franchise program with the buyer's need for ready availability of products from his regular source.

Gordon Graham Graham Electronics Indianapolis, Ind.

There's a strong trend toward regional distribution. The customer is demanding more service on a real-time basis, and he is not willing to depend upon the pure economies of the larger national distributor. The customer wants more personal service in the way of systems selling, the distributor knowing the customer's individual needs and professionalism. You can call this a value-added service in that the distributor's role here would be to take care of the order and ensure an on-time delivery, instead of taking the order with a promise of delivery.

Paul Carroll Semiconductor Specialists Chicago, Ill.

Technology is changing at a rapid pace now, and it will continue to change at an ever increasing pace in the future. The life cycle of a product used to be 5 to 10 years. Now it is six months or less, and while this will open new markets for the distributor, it will also require the distributor to sell complete systems, including software and training. To meet the needs of the new markets, the distributor is going to have to increase his productivity and will be using in his own business some of the same systems. Microcomputers will be found in branch offices tied into main computers for a total distributed processing system to control inventories. Eventually, these systems may even be tied directly to the factory.

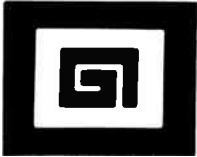

**CHICAGO MINIATURE LAMP WORKS
GENERAL INSTRUMENT CORPORATION**

4433 N. RAVENSWOOD AVENUE, CHICAGO, ILLINOIS 60645 TELEPHONE: (312) 784-1020

Dear Design Engineer,

We think it's our job to make your job easier. So, we've taken several steps to improve our product availability in an effort to serve you better in both your prototype design and on-line manufacturing activities.

First, we've developed new catalogs of standard products and initiated special stocking plans with our distributors. To make ordering easier and delivery immediate.

We've also added new off-the-shelf products through our distributor network which you're sure to be interested in: the unique Ultralite series of solid state indicators...a complete high-efficiency LED series...our new wide viewing angle status/fault indicators...and more.

We hope these changes help you get the products you need when you need them. And as always, our engineering staff is ready and waiting with application assistance at your request.

For more information, contact your local distributor, or Chicago Miniature Lamp Works, 4433 N. Ravenswood Avenue, Chicago, Illinois 60640. Phone (312) 784-1020.

Best regards,

Jim Flanagan
General Sales Manager
Chicago Miniature Lamp Works



TAKE YOUR PICK

Our distributors are so well stocked that they can give you your pick of hundreds of different Kulka terminal boards, blocks and strips. And if your specs call for the unusual, one of our Mod Centers can probably take care of that, too. Call one today.

AUTHORIZED KULKA INDUSTRIAL DISTRIBUTORS LOCATED THROUGHOUT THE UNITED STATES & CANADA

AL Birmingham, MG Electronics	205 328 4525	MA Needham, Gerber Electronics	617 329 2400	OH Dayton, John A. Becker	513 226 1341
AZ Phoenix, Mountain West Alarm	602 263 8831	* MA Newton, Greene-Shaw	617 969 8900	OK Oklahoma City, Electro Enterprises	405 478 1752
AZ Phoenix, Parts Electronics	602 258 6476	MD Baltimore, Radio Electric Service	301 823 0070	OR Portland, Eoff Electric	503 222 9411
CA Los Angeles, Fisher/Brownell	213 532 2170	MI Augusta, Great Lakes Electronics	616 731 4156	PA Altoona, Allegheny Electronics	814 946 0871
CA Los Angeles, Radio Product Sales	213 748 1271	MI Farmington Hill, CMP Distributors	313 477 7700	PA Erie, Advacom	814 455 8110
CA Santa Clara, Fisher/Brownell	408 244 6182	MI Grand Rapids, Stotts Friedman	616 459 0216	PA Erie, Mace Electronics	814 838 3517
CA Sunnyvale, Ratel Electronics	408 739 9220	MN St. Paul, R. G. Ragon Electronics	612 488 0201	PA Montgomeryville, Pyttronic Indust.	215 242 6700
CO Denver, Denver Wintronics	303 935 2401	MO St. Louis, L-Comp	314 647 5505	† PA Philadelphia, Almo Electronics	215 698 4000
CO Denver, Integrated Electronics	303 534 6121	MS Newton, May Electronics	601 683 6511	PA Philadelphia, Simco Electronics	215 229 1880
CO Denver, Industrial Electronics	303 771 2636	NB Lincoln, Scott Electronics Supply	402 464 8308	PA Pittsburgh, R. P. C.	412 782 3770
CT Fairfield, U-Tronics	203 255 4521	NC Raleigh, Southeastern Radio Supply	919 828 2311	PA Reading, George D. Barbey	215 376 7451
CT Waterbury, Bond Radio	203 757 0546	NC Winston Salem, Kirkman Electronics	919 722 9131	SC Columbia, Dixie Radio Supply	803 779 5332
FL Ft. Lauderdale, Peerless Radio	305 566 5966	* NJ E. Rutherford, Kappe Electrical	201 939 5751	TN Knoxville, Industrial Electronics	615 573 7135
† FL Miami, Electronic Equipment	305 871 3500	NM Albuquerque, Walker Radio	505 247 2288	TX Dallas, KA Electronics Sales	214 634 7870
FL Winter Park, Electronic Equipment	305 644 4833	NV Reno, Electronics Distributing	702 323 2766	TX Dallas, Solid State Electronics	214 352 2601
IA Cedar Rapids, Deeco	319 365 7551	NY Buffalo, Summit Distributors	716 884 3450	TX Fort Worth, Industry Electronics	817 531 2961
IA Des Moines, Mid State Distributing	515 244 7231	NY Elmsford, Ancar Electronics	914 592 7100	TX Stafford, Southwest Electronics	713 494 6021
IL Addison, Lectro Components	312 543 1680	NY Hempstead, Electronic Equipment	516 538 5510	UT Salt Lake City, Ra-Elco	801 487 0571
IL Broadview, L-Comp	312 865 7600	NY Lynbrook, Peerless Radio Corp.	516 593 2121	VA Charlottesville, Virginia Radio	804 296 4184
IL Chicago, Merrill Electronics	312 647 0755	* NY Mt. Vernon, QAR Industrial Electr.	914 699 2224	† WA Seattle, Almac/Stroum Electronics	206 763 2300
IL Rockford, Mid-West Associated	815 962 8036	* NY Rochester, Simcona Electronics	716 328 3230	WA Seattle, Radar Electric	206 282 2511
* IL Rosemont, Advent Electronics	312 298 4210	NY Rochester, Summit Distributors	716 334 8110	† WI Milwaukee, Electronic Expeditors	414 228 8100
IL Schaumburg, Control Design	312 882 7232	* NY Rockville Center, Midway Industrial	516 764 2400	WI Milwaukee, B. W. Electronics	414 545 8380
IN Indianapolis, Graham Electronics	317 634 8202	OH Cincinnati, Hughes Peters	513 351 2000	WV Beckley, Halley Electronics	304 253 2151
† IN Indianapolis, Ra-Dis-Co.	317 637 5571	OH Cincinnati, Newark Herrlinger	513 874 5115	CANADA	
IN South Bend, Radio Distributing	219 287 2911	OH Cleveland, Pattison Supply	216 441 3000	† OT Downsvew, Zentronics	416 635 2822
KS Wichita, Radio Supply	316 267 5213	OH Cleveland, R. P. C.	216 461 2280	PQ Montreal, Cesco Electronics	416 661 0220
KY Louisville, Peerless Electronics	502 637 7677	OH Columbus, Electronics Marketing	614 299 4161	* Authorized Kulka Modification Centers.	
LA New Orleans, Radio Parts	504 581 5959	OH Columbus, Hughes Peters	614 294 5351	† Authorized Mini Modification Centers.	

Kulka Electric Corp., A North American Philips Company

520 South Fulton Avenue, Mount Vernon, NY 10551 TEL: 914 664 4024 TWX: 710 562 0104 TELEX: 137413



So what?
So OEM's are dancing in the streets, that's so what. At least the pros are.

And what makes it such a big deal is the magnitude of the cost savings—possibly 20% or more per computer system.

One reason is that interfaces are generally long on duplication and short on common sense. Most interfaces, for example, faithfully repeat half or more of the circuitry on all the other interfaces. And with multiple interfaces, that gets to be a pretty expensive proposition.

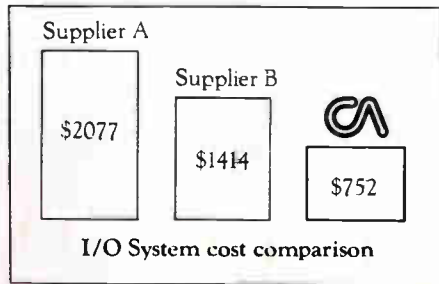

So we came up with the solution you see here: The Distributed I/O System. Designed to work specifically with our line of NAKED MINI® computers.

We figured a way to cut the cost of interface in half.

And once you get by its unorthodox appearance, the logic of it becomes pretty appealing. As do the cost savings.

All the basic circuitry is located on a single half-card I/O

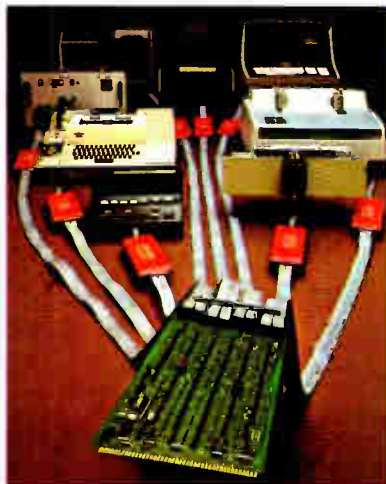

The Distributed I/O System
World Radio History

Distributor, which can be shared by as many as eight "Intelligent Cables." Packaged into every cable is an integral PicoProcessor, which handles the functional control for each interface.

This arrangement allows much smaller computer packages, since only one I/O

board is housed inside the computer cabinet.

And along with a smaller package, comes a smaller price.

The I/O cost comparison at left shows the savings on a typical four-interface system (2 CRT's, 1 line printer and 1 card reader). And since our System handles up to eight interfaces, imagine your savings using its full capability.

Consider ComputerAutomation's Distributed I/O System. It's an uncommonly sensible solution to a commonplace problem. From the price/performance people who brought you the NAKED MINI®



ComputerAutomation
NAKED MINI® Division
18651 Von Karman, Irvine,
California 92713, (714) 833-8830

Circle 69 on reader service card

LEDs, make

For most displays, they're up to 8 ways better.



You've seen their bright, large, eye-pleasing characters in inexpensive calculators. They're called, technically, "Vacuum Fluorescent Indicator Panels" or, for short, **FIPs**. Actually, **FIPs** are modern developments of very old technology, that of the vacuum tube. In fact, they're triodes, complete with plate (anode), cathode, and grid, but with the addition of a phosphor on the segmented plate so the characters will glow. Brightly.



THE CHART TELLS THE STORY. Even though NEC is among the world's largest producers of both LEDs and gas discharge (plasma) displays, we see **FIPs** rapidly taking over for most applications—such as calculators, data & POS terminals, clocks, radios, car dashboards, microwave oven controls, instruments, CB, TV, etc. For obvious reasons, that are summarized in the chart at far right.



Typical Red LED

AND THERE ARE OTHER GOOD REASONS, SUCH AS RELIABILITY & LONG LIFE. The tremendous variety of uses that **FIPs** can be put to calls for very high acceptance standards. NEC has developed what may be the most rigorous QA and QC in the world. In a recent, routine test cycle, a total of 1085 **FIPs** of various models were put through a total of 15 grueling tests...with a single failure. The tests, and their standards, are described in the new **FIP Selector Guide**, available by mailing the coupon in this ad.

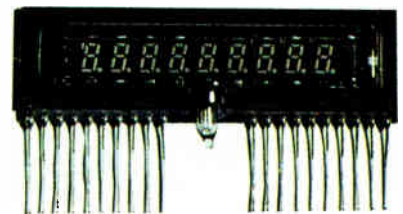

way for FIPs.*

ONE GLANCE TELLS THE COST/PERFORMANCE STORY. The larger the character size, the better the direct savings. That doesn't take into account the additional indirect savings from such things as simpler circuitry, fewer failures, and easier assembly. Check this graph, to get the idea.

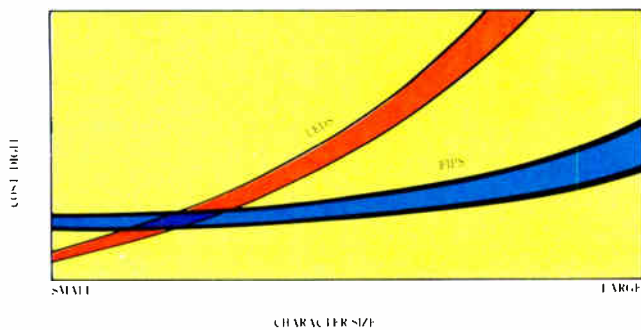

THE STORY ON BRIGHTNESS AND LIGHT BANDWIDTH. FIPs' phosphors are selected to be extremely efficient converters of electrical energy to light energy, minimizing power input. In addition, the light is spectrum-wide, from red to violet, and can thus be filtered to provide any single hue desired. The light predominates in the blue-green area, which overlaps the standard curve of human eye response (see graph), so the viewer perceives the maximum of brightness for the minimum of power input. And—the gentle, soothing blue-green glow is considered to be much less fatiguing to the eye than red and orange colors.

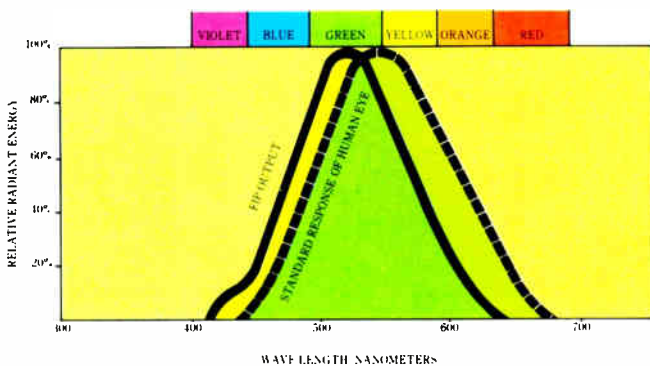

LED/GAS DISCHARGE/FIP COMPARISON CHART

	LED	GAS DISCHARGE	FIP
VOLTAGE	-1.7-5V	-150-200V	-10-40V
POWER/CHARACTER	high	low	low
CURRENT	high	low	low
MOS IC DIRECT DRIVE	no	no	yes
THIN & FLAT	yes	yes	yes
VIEWING ANGLE	wide	wide	wide
BRIGHTNESS	moderate	moderate	high
MOUNTING EASE	good	good	good
COST/PERFORMANCE	fair	good	excellent
READABILITY	fair	fair	outstanding
COLOR CHOICE	limited, fixed	red, limited	many—filterable

33 TYPES AVAILABLE IN HIGH VOLUME — HOW TO SELECT YOURS? Easy. Send for our just-off-the-press FIP SELECTOR GUIDE. It tells everything you need to know to select exactly the FIP for your application. Then, mail the postpaid return card bound into the guide, and we'll send you the data sheets you require, with the comprehensive specifications. Make sense? Then we hope to hear from you soon. Mail coupon, or telephone us at (408) 738-2180, Telex 34-7475.

NEC

NEC America, Inc.

SEND TO US TO GET THE FIP SELECTOR GUIDE

NEC America, Inc., Electron Devices Div.
3070 Lawrence Expressway
Santa Clara, CA 95051
Send me that 8-page FIP Selector guide.
My application is (or will be) _____.
 Call me for immediate requirement at
(____) _____, extension _____.

NAME		
TITLE		MAIL STOP
COMPANY		
STREET		
CITY	STATE	ZIP

*Registration Pending

IF YOU THINK FIBER OPTICS IS A THING OF THE FUTURE, IT'S TIME YOU SAW THE LIGHT.

Some people think fiber optics is still a few years away.

But then some people still haven't heard about us.

We're Galileo Electro-Optics Corporation.

And we've got the world's broadest line of optical communication cable.

It's called Galite.[®]

And it gives you the kind of choice in strength, propagation efficiency, thermal compatibility, chemical resistance, weight – and cost – to make all the incredible advantages of fiber optics practical for your application right now.

And just look at those advantages.

Optical fiber can handle over 10,000 times more information than copper wire, in the same amount of space.

Optical fiber can handle amounts of information copper wire can't even touch – a 30 volume Britannica, transmitted in a tenth of a second.

Optical fiber is virtually immune to electromagnetic interference, cross talk, short-circuit loading, and fire.

Optical fiber can resist temperatures up to 1000°C.

Within the Galite line, Galite 3000, for use up to 1100 feet, covers the broadest range of applications. With its wide light acceptance angle, it's the most efficient cable for LEDs, the most practical light source available.

We also offer, with varying light acceptance angles, Galite 1000, for use up to 150 feet. Galite 2000, for up to 250 feet. Galite 4000, for up to 3300 feet. Galite 5000, for beyond 3300 feet. Plus soon-to-be-introduced Galite 6000 and 7000, for even greater distances and wider bandwidths.

The reason we can offer so much is simply that we've had a head start. We've pioneered in glass fiber optic products since 1959 and are now the world's largest manufacturer, with over 2 trillion feet shipped.

We also have the country's most integrated production facility where we do everything from formulating the glass to making complete systems including light sources, detectors, and connectors. So we can keep reliability up. And costs down.

Why not call, write, or circle the reader service number for our new information package, "Fiber Optics Now."

It will bring a whole lot of solutions to light.

Galileo Electro-Optics Corp., Galileo Park, Sturbridge, MA 01518, 617-347-9191.

CURRENT APPLICATIONS FOR GALITE[®] CABLES

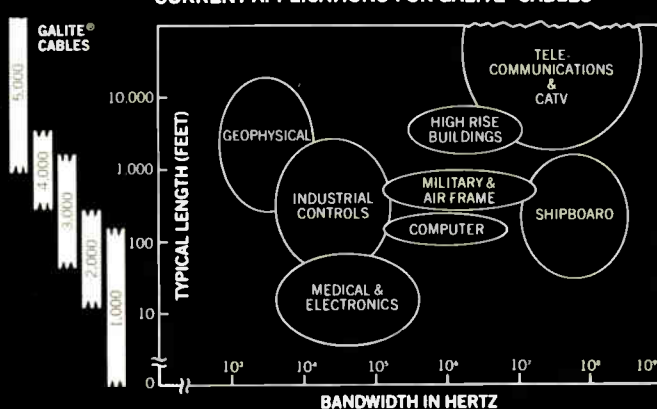

Galileo Electro-Optics Corp.

THE FIRST COMPANY TO BRING FIBER OPTICS OUT OF THE LAB AND INTO PRODUCTION.

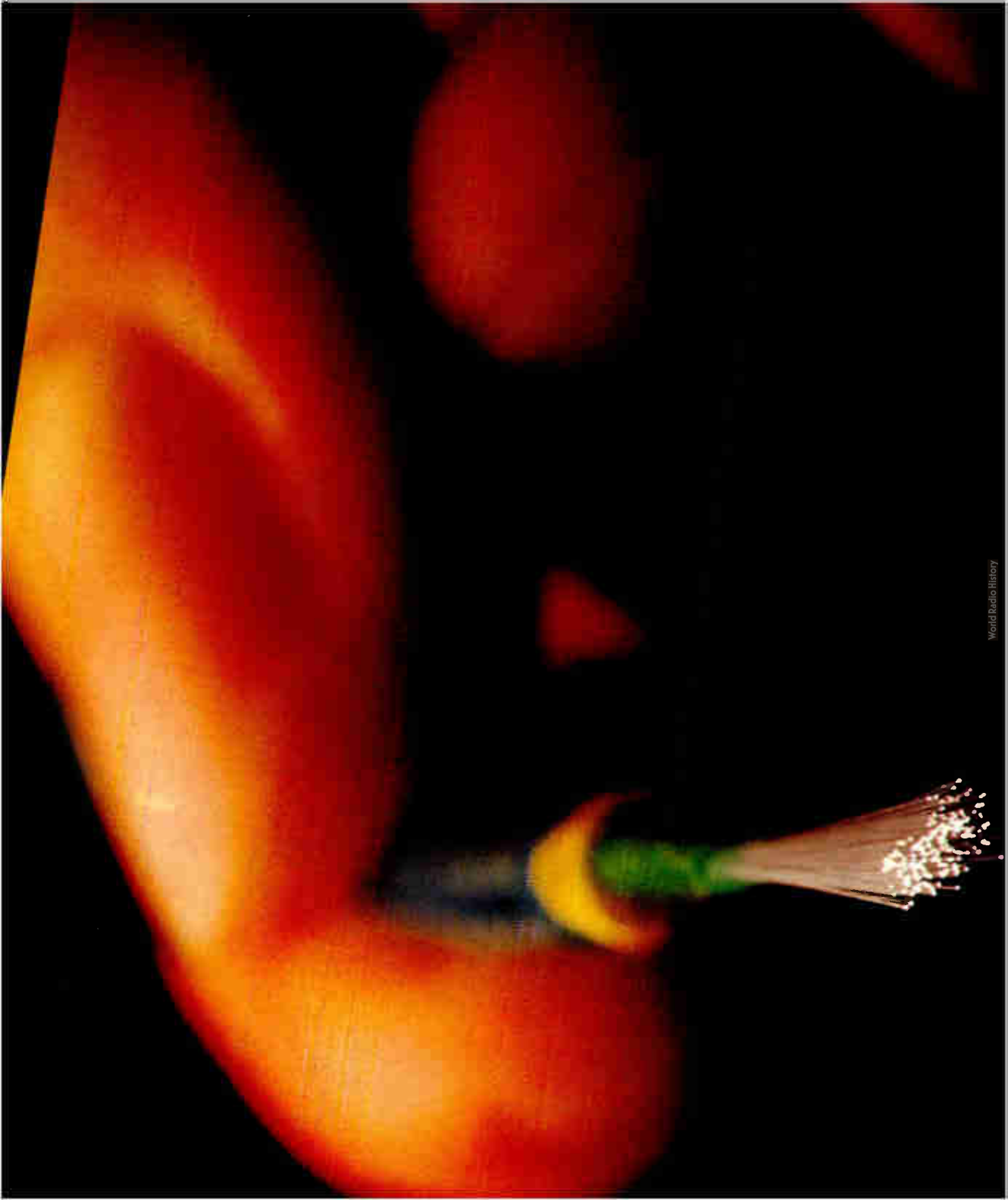

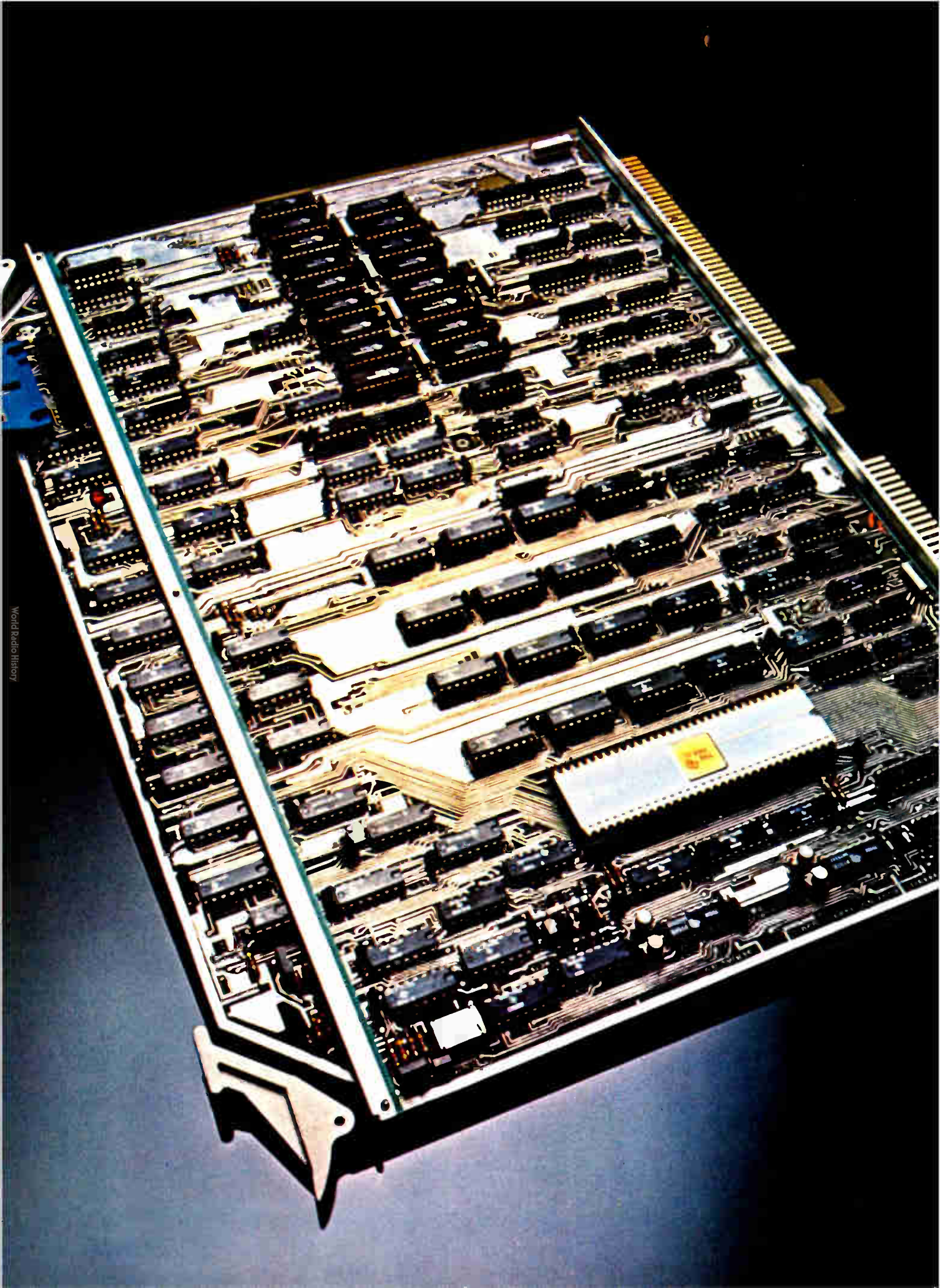

**When you're
designing microprocessors
into your products...
our 990 computer products
can give you a head start.**

TEXAS INSTRUMENTS.

Start with the TMS 9900 microprocessor.

It delivers surprising power, speed and flexibility in a low-cost, single-chip 16-bit package. Its repertoire of versatile instructions and high-speed interrupt capabilities provide computing power usually associated with a 16-bit TTL minicomputer.

Hardware multiply and divide is standard and the software you develop for the TMS 9900 is upward compatible with any other member of the 990 computer family.

When your application calls for a microcomputer—start with the 990/4 microcomputer on a board.

It offers all the advantages of the TMS 9900, plus flexible memory and CPU options ideally suited to manufacturers' applications: up to 8K bytes of dynamic RAM memory, up to 2K bytes of RAM and/or PROM, real-time clock input, eight vectored interrupts, expansion interface and optional ROM utilities. It's our off-the-shelf answer for many production needs.

The 990/4 microcomputer is also available in a low-cost three-slot OEM chassis... or housed in a 6- or 13-slot rack-mount chassis with programmer's panel... or in a 6-slot



tabletop chassis. And, the 990/4 is available as a complete computer system supported by your choice of performance options and peripherals.

For applications requiring greater speed, we offer the most powerful member of the 990 computer family... the 990/10 minicomputer. It uses a TTL implementation of the 990 architecture and features TILINE*, an asynchronous, high-speed 16-bit parallel I/O data bus which links the CPU, memory, and high-speed peripheral devices.



Rack-Mount 990 Computer

And to help you get on line faster and surer, there's a prototyping system using 990 computer hardware and software packages.

In addition, the 990 family is well supported by a substantial library of software development packages.

Whatever your needs... the TMS 9900 microprocessor, the 990/4 microcomputer, or the 990/10 minicomputer... you'll be working with some of the most attractive



990/9900 Prototyping System

computer component values on the OEM market. Price/performance leadership you expect from Texas Instruments.

You can start today by getting more information on the entire 990 computer family. Contact your nearest TI sales office, or phone (512) 258-5121, Computer Equipment Marketing, for your local distributor. Write Texas Instruments Incorporated, P.O. Box 1444, M/S 784, Houston, Texas 77001.



*Trademark of Texas Instruments Incorporated

See Texas Instruments products at Computer Caravan.

TEXAS INSTRUMENTS
INCORPORATED



A SCOPE FOR ALL REASONS

Finally a professional oscilloscope to fit your basic needs.
 High quality, easy to maintain, and easy to use.
 Ideal for production, design laboratories, field service and schools.

Ballantine Model 1010A Dual Channel and X-Y oscilloscope

- FREQUENCY:** DC to 15 MHz each channel
24 nanosecond rise time. 15 MHz full scan
- SENSITIVITY:** 2 mV/cm to 20 Volts/cm
Continuously variable gain.
- TIME BASE:** 100 ns/cm to 1.25 s/cm
X10 Magnifier, Trigger beyond 20 MHz
- PORTABILITY:** Only 7 Kg. (15 pounds)
- DISPLAY:** 8 x 10 cm CRT with 3600 volts
- ECONOMY:** \$ 595

Available on GSA Contract GS-00S-04619. Stock Number 6525-00-472-9910.

Circle 76 on reader service card

Ballantine

Ballantine Laboratories, Inc., Boonton, New Jersey 07005 USA

CB chip market is technology battlefield

Six IC houses making frequency synthesizers for 40-band models, with three using bipolar and three using C-MOS processes

Bernard Cole, San Francisco bureau manager, and Lucinda Mattera, Components Editor

The chance to make new inroads with technology has semiconductor manufacturers jumping into the citizens' band market with impressive frequency-synthesizer chips that meet the new 40-channel allotment. But, as so often happens in integrated circuits, a battle is shaping up between vying technologies—in this case, bipolar and complementary-MOS processes.

At least a half dozen semiconductor makers are now beginning to offer samples of new monolithic synthesizers, with a split down the middle between the two technologies. Three companies going with bipolar, and three with C-MOS.

Proponents of the bipolar chips point out that they can operate directly at the upper CB frequency of about 27 megahertz, so they do not require the prescalers or external mixer circuitry that C-MOS synthesizers do. On the other hand, C-MOS chips have lower power dissipation, sometimes a hundred times less than that of the bipolar chips.

Utilizing a combination of two bipolar processes—emitter-coupled logic and integrated-injection logic—Signetics Corp. of Sunnyvale, Calif., has come up with a one-chip synthesizer that could provide more than the 40-channel requirement, says consumer products marketing manager Neal Williams. The NE575 contains the equivalent of 800 to 1,000 gates (90% I^2L , 10% ECL) on a single 100-by-110-mil die. It can operate at input frequencies of up to 40 MHz, giving a 128-channel capability. In large quantities, the price is \$2.50 to \$3 each—scarcely more than present-generation chips.

Using bipolar technologies avoids a drawback of existing C-MOS chips,

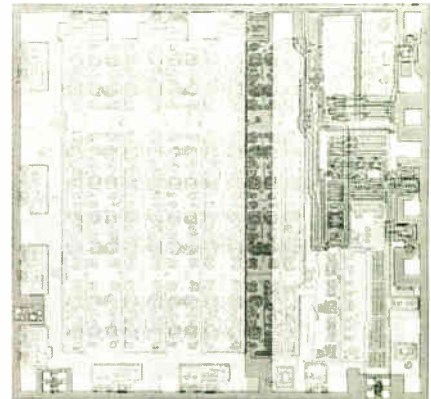
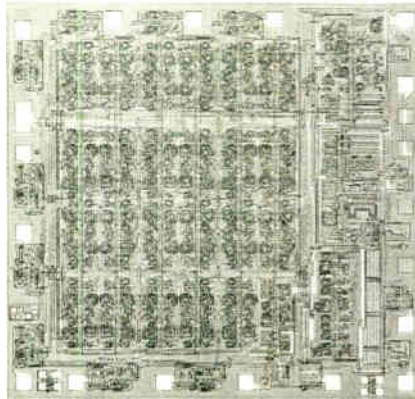

Big boy. This 102-by-206-mil chip from RCA houses a phase comparator, active filter, VCO, 11-stage counter, and a 13-stage counter. It uses C-MOS and closed C-MOS logic.

points out Russ Hansen, consumer applications manager, in that the latter were designed when the number of channels available for CB radios was only 20 or so. To meet the expanded range, most of them have programmable counters that must operate at the top-end CB frequency of 27 MHz, which is at the very limits of C-MOS technology, he says.

The ECL circuitry of the NE575 permits operating at input frequencies of up to 40 MHz, while its I^2L circuitry minimizes the external components needed and holds power drain to around 240 milliwatts. The NE575 requires only one external crystal and no tuned circuits other than those in the external voltage-controlled oscillator.

Like Signetics, National Semiconductor Corp., Santa Clara, Calif., has opted for a combination of ECL and I^2L in its DS8900 phase-locked-loop frequency synthesizer. The 29,000-mil² chip contains the equivalent of 500 to 1,000 devices, says Keith Mueller, senior designer.

The use of ECL input circuitry to

generate the transmit frequency directly from an off-chip VCO makes possible a 30% to 60% reduction in the number of components necessary to build a typical 40-channel CB system, he says. Previous C-MOS chips, he adds, required external mixer circuits, as well as external filters and other components to clean up the mixer-generated noise.

The 28-pin DS8900 is loaded, with an input amplifier, an ECL synchronous programmable divider, an ECL phase comparator, a high-speed charge pump, a lock detector, a subtracter, a 40-word-by-6-bit read-only memory, an up/down decade counter, channel-select logic, and segment decoder/drivers.

Despite its complexity, the device holds power consumption to 500 mw. In large volumes, price on the unit will be about \$5 each. National, which has been offering samples of the part for about two months, expects to be in volume production by the end of the second quarter.

A bipolar low-power-Schottky device in a 16-pin package, the IIC84,

Probing the news

is the CB-synthesizer contribution from Fairchild Semiconductor, Mountain View, Calif. It incorporates all the circuitry usually used in a digital PLL, including a programmable divide-by-N counter, a reference-frequency divider chain, and oscillator.

Low-power-Schottky technology permits Fairchild to achieve high-frequency dividers right on the chip, eliminating the need for a prescaler or down converter between the VCO output and the divide-by-N input. The only external circuitry required are the oscillator, an active integrator, and a crystal. Power dissipation is held to 550 mw.

To reduce frequency-modulation distortion in the VCO, the phase detector on the 11C84 incorporates an anti-backlash feature. "A common shortcoming of phase detectors is their inability to detect small phase-angle changes between the two frequencies under comparison," says Chuck Alford, applications manager for digital products. This causes fm distortion, which is avoided in the Fairchild chip by a technique that forces the detector to operate outside its dead zone. Like National and Signetics, Fairchild has samples available and expects to

be in production by the summer.

At least two semiconductor producers are responding to the bipolar challenge with new C-MOS chips designed for 40-channel operation. Several different processes are used.

Samples of a real beauty are available from the Solid State division of RCA Corp., Somerville, N. J.: a monolithic synthesizer that even includes an on-chip VCO. The device requires a minimum of external components—merely a reference crystal, an RC network for setting the frequency range, and a tuned LC tank circuit for improving the dispersion of the synthesized frequencies.

Built with a combination of C-MOS technologies—standard C-MOS and the newer C²L (closed C-MOS logic)—the chip is capable of generating all 40 channels at a typical power dissipation of 150 mw. Only about a year old, the firm's C²L technology provides faster speed and greater packing density than standard C-MOS, without sacrificing low power dissipation and high noise immunity.

On a 102-by-206-mil piece of silicon, RCA is squeezing a phase comparator, an active filter, a VCO, an 11-stage mask-programmed counter for dividing down the reference frequency, and a 13-stage

counter for dividing down the synthesized frequencies. This latter counter has nine electrically alterable stages and four mask-programmed ones. About half of the chip area is inactive, because the designers have isolated the VCO from the logic circuitry by a ground plane so as to decouple these two sections.

The high-speed programmable counting capability of C²L permits the phase-comparison frequency to be set equal to the 10-kilohertz channel spacing needed for CB, says the company, thereby minimizing the magnitude and number of possible spurious frequencies. Also, the low power dissipation of C²L tends to eliminate parasitic frequency modulation caused by coupling through transients, the firm says.

Yet another new C-MOS synthesizer chip is being made by the Solid State Products division of Hughes Aircraft Co., Newport Beach, Calif. Like the RCA device, it requires fewer external components than earlier C-MOS designs. Although the HCTRO347 still needs an off-chip VCO, it contains a mask-programmed logic array that converts the input format for channel selection, thus using fewer external parts.

The chip is capable of 45-channel operation, yet its typical power dissipation is an incredibly low 5 mw, he notes. Hughes has samples available and should be in production in six to eight weeks. Price for the 16-pin plastic dual-in-line part will be under \$2.50 each in volume.

Without offering new designs, Motorola Semiconductor Products Group, Phoenix, is on the C-MOS synthesizer bandwagon. Earlier this year, the firm said it planned to market a bipolar I²L chip, the MC3390, with capability up to 100 channels. But, says a company spokesman, the chip has been shelved indefinitely. Instead, Motorola is second-sourcing five existing C-MOS designs, part numbers MC145104, 06, 07, 09, and 12. "They are the industry standards for this year, with over 60% of the CB radios using them," notes Richard Ahrons, who is with Motorola's MOS facility in Austin, Texas. □

Combination. National's phase-locked-loop frequency synthesizer uses ECL and I²L technologies. The 29,000-mil² chip contains the equivalent of 500 to 1,000 devices.

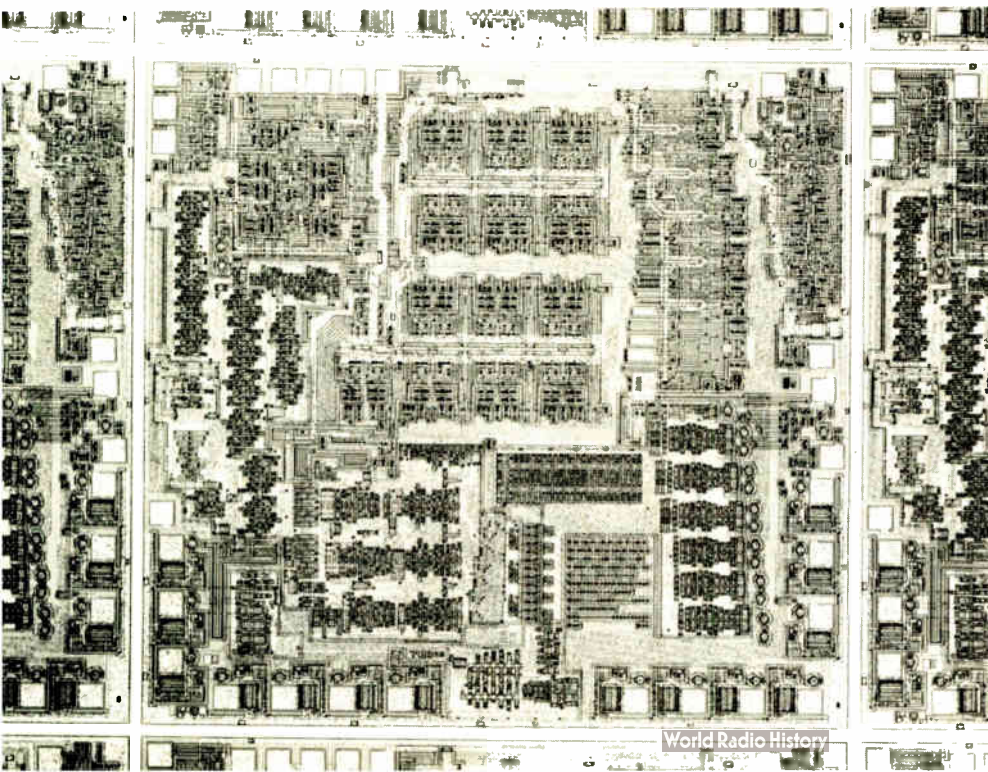

...new improved Ceramag 24B gives you more
of what you switched to a switcher for.

Bertie was an engineer
Designing switches, but this year
His boss said, "Bertie,
Cut your power loss by thirty
Percent, or, I fear,
I'll have to use some words
You'd rather just not hear."

Now Bertie saw he was in a hole,
So he picked up the phone,
and he called Stackpole,
And he said, "Hey, guys,
Have you got my size
In a 24B core
That'll use less power than before,
And save my face
When in comes the boss
To ask me questions
on power loss?"

And Stackpole said, "Alright,
We've got so many shapes and sizes,
It shouldn't come as big surprises
That we've got the one that's wisest
For your needs.
So when your boss reads
How your brain
Fixed the power drain,
All we ask is that you cite
24B as the right
Ferrite."

If you'd like to see our brochure,
The procedure's a real sinecure.
Just fill out the coupon below,
And we'll wrap one up to go.

Ceramag 24B.
The right ferrite.

Stackpole Carbon Co.
Electronic Components Div.
St. Marys, Pa. 15857



Take a looklet
at our booklet

name _____

game _____

company _____

address _____

city _____

state _____

Ceramag 24B. The right ferrite.

World Radio History

 **STACKPOLE**

Circle 79 on reader service

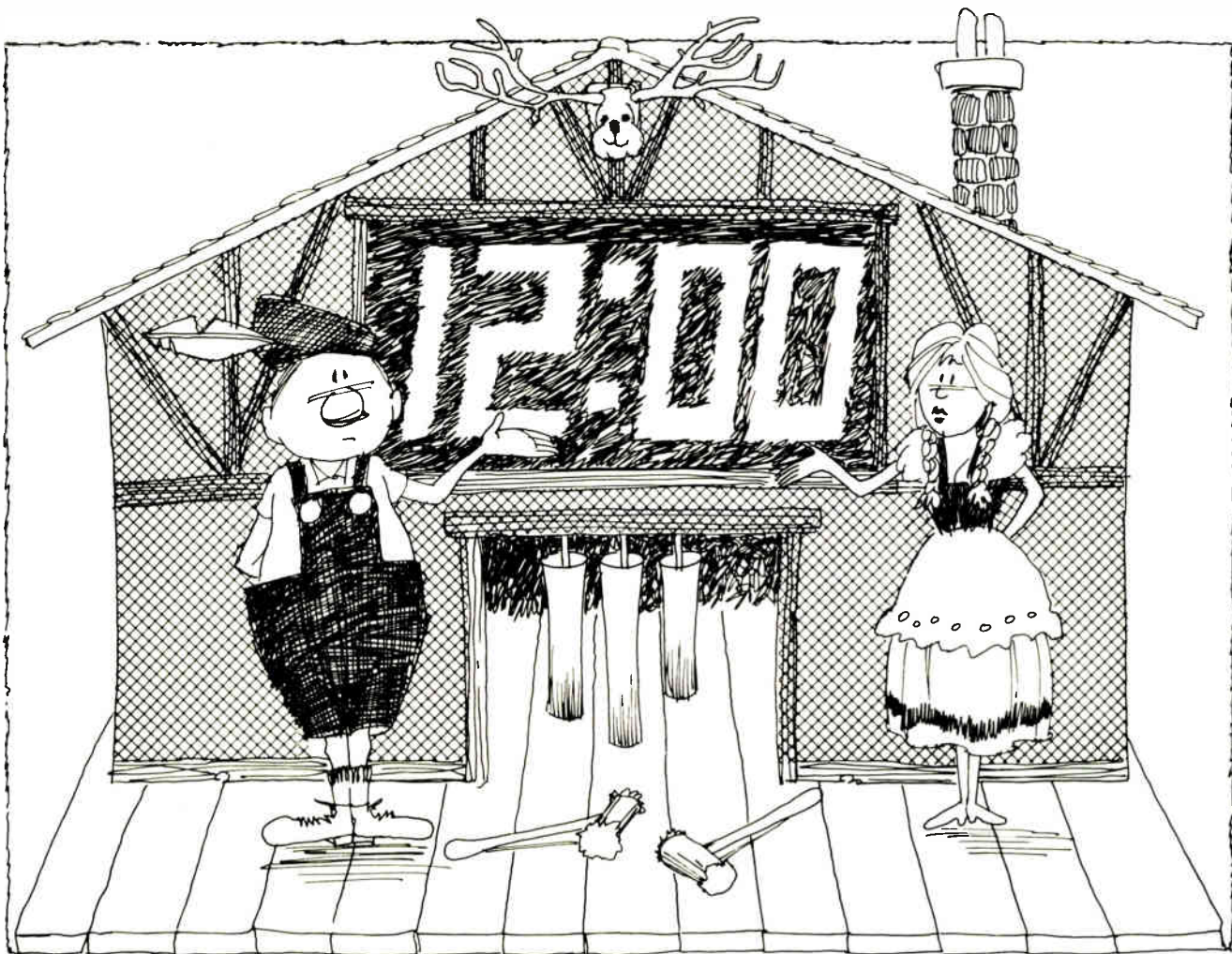

Probing the news

Swiss make up for lost time

by Laura Pilarski, McGraw-Hill World News

For Swiss watch makers, time and technology flew by as they spent years talking about getting into electronic watch production instead of doing it. But things are changing: the swing from traditional mechanical-electrical watch models to solid-state technology has accelerated to full speed this year. The Swiss are finally trying to catch up in the world race to manufacture and market crystal-clocked watches and movements.

This significant effort has been spurred in part by the American success in digitals and by the need of the Swiss to bolster overall watch sales, which have suffered from the world's economic ills, the ever-strong

exchange rate of the Swiss franc, and changing tastes.

Last year, electronic movements and watch exports were close to 2.7 million units worth more than \$100 million out of a total of 62.2 million watches and movements exported. The total this year is expected to more than double; next year, according to industry sources, could be another banner volume year. To prepare, the Swiss rather quietly have been putting themselves into position, both in technology and manufacturing facilities, to come up with a completely Swiss-made electronic watch, including circuitry.

Most Swiss watch companies—small and large—and all better-

known brands came to the Basel watch and jewelry fair this month with at least one representative digital watch—along with quartz-analog models, which have a strong appeal in Europe.

Paul Tschudin, vice-president of Ebauches S.A., Switzerland's biggest producer of watch movements, minces no words. "We are very definitely going after a share of the world market in digitals," he says, "and there should be no [mistake] about our [ability] to compete both in technology and price." However, he hastily adds, "not at the \$12.95 retail market price."

In the long-range, the Swiss see digitals growing in popularity. Mar-

We say they're the industry standards. And the 118,723 people who've bought them will back us up.

The Fluke 8000A, 8600A and 8800A digital multimeters. Far and away the industry leaders, both in sales and performance.

They're why Fluke is #1 in multimeters. Worldwide.

8000A 3½ digit DMM. More people use the 8000A than any other DMM ever built. And there are good reasons. Specifications are guaranteed for 1 year for 5 measurement functions in 26 ranges. Input overload protection on all ranges. Basic accuracy is 0.1%. MTBF is 21,000 hours. And the 8000A comes in many versions: high current, low-ohms, with analog meter, or milliamperesecond. Base price \$299.*

8600A 4½ digit DMM. The 8600A is the prestige DMM in the portable class, featuring high accuracy and full auto-ranging.

Five ranges each of ac and dc volts to 1200V with 0.02% dc and 0.2% ac accuracy. Five ranges each of ac and dc current to 2A with 0.1% dc and 0.3% ac accuracy. Six ranges of resistance to 20 MΩ with 0.1% accuracy. AC bandwidth to 100 kHz. And demonstrated 10,000-hr MTBF. \$549.*

8800A 5½ digit DMM. The 8800A is a unique portable, laboratory standard digital multimeter. It has, for example, a dc accuracy of 0.005%. Full autoranging. And it's fully guarded. Zero stability is better than 10 μV for 90 days. Isolated 4 terminal ohms. A demonstrated MTBF of 10,000 hours. \$985.*

So now you have a rough idea of why the 8000A, 8600A and 8800A DMMs are the industry standards.

But to really find out how good they are, ask almost anyone nearby. He's probably using one of our DMMs right now.

And he'll be able to tell you why Fluke is #1 in DMMs. Worldwide.

For data out today, dial our toll-free hotline, 800-426-0361. John Fluke Mfg. Co., Inc., P.O. Box 43210, Mountlake Terrace, WA 98043. Fluke (Nederland) B.V., P.O. Box 5053, Tilburg, The Netherlands. Phone: (013) 673-973. Telex: 52237.

*U.S. price only.

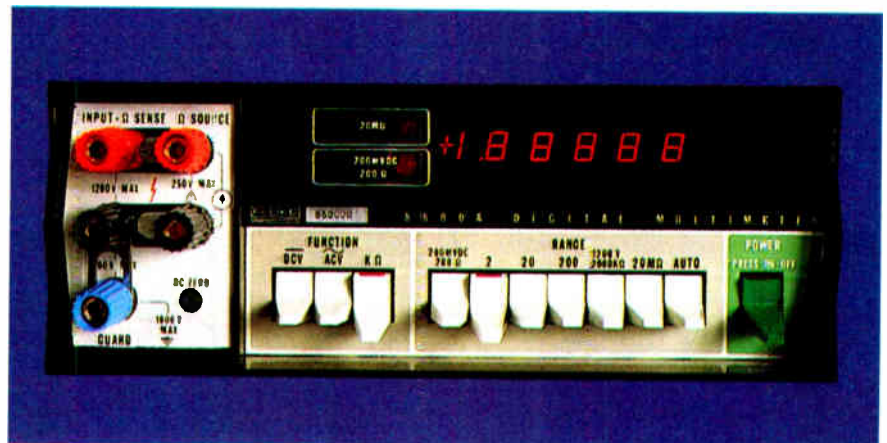
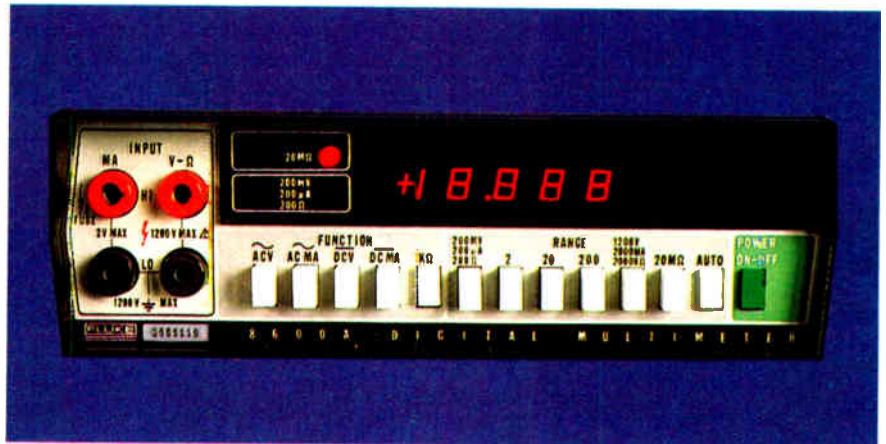
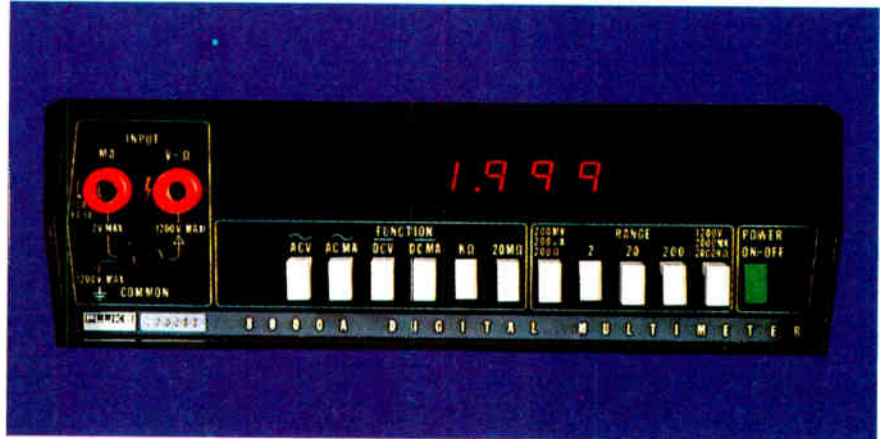

Fluke DMMs. Standards for the industry.



Circle 80 on Reader Service Card for literature

Circle 81 on Reader Service Card for demonstration

World Radio History

Now, more applicability for our most popular 1" switch

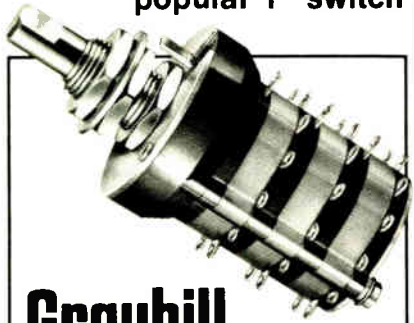

Grayhill U.L. listed 1 inch 1 amp rotary

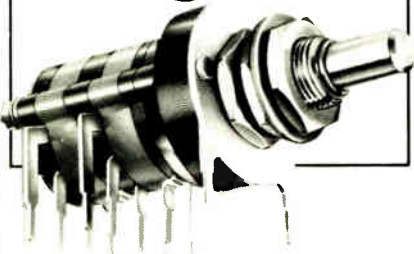

Use it for test equipment, medical electronics, instrumentation and other line voltage switching

- U.L. listed at 1 amp, 125 VAC, to accommodate most "power switching" requirements
- Switches measure approximately 1" diameter, 1" behind panel for a 1 deck switch, 5" behind panel for a 12 deck switch.
- Wide variety of circuit choices and features

The U.L. listed Grayhill series 42 and 44 Rotary Switches offer a wide variety of circuit choices including 30°, 36°, 45°, 60°, and 90° angle of throw, 1 thru 12 decks, 1 thru 6 poles per deck, and non-shorting or shorting contacts. Optional features include concentric shaft or "add-a-pot" types, shaft and panel seals, adjustable stops, and PC mount versions.

U.L. Card E35289 with complete listing data, and New Product Bulletin #251 containing Series 42 and 44 specifications, may be obtained free from Grayhill, Inc., 561 Hillgrove Avenue, La Grange, IL 60525 (312) 354-1040.



Probing the news

ket surveys show a current 8% European penetration in sales advancing to a possible 30%–40% in the 1980s.

The Swiss favor liquid-crystal displays as less power-hungry and more practical over light-emitting diodes. They also like complementary-MOS circuitry. Earlier this year, Ebauches signed on Brown-Boveri et Cie. as its main supplier of LCDs, with the goal of producing some 5 million electronic movements in 1977, probably half of them digital. At the same time, the two Swiss firms agreed to close cooperation in research and development of possible future electro-optic systems. Brown-Boveri went into mass production of twisted-nematic LCD cells at a special plant in Lenzburg in 1975, with opening year production going roughly one third to Switzerland, one third to the U. S., and one third to Japan. Now a sizeable proportion will be going to the home watch industry, with production of eight sizes of LCD cells and about a dozen front styles.

The closest competitor to Ebauches in supplying modules to the Swiss and others (including a large order to Bulova) is Modules Electroniques S.A., at LaChaux-de-Fonds—a subsidiary of Nepro Watch, an independent, enterprising company. Its head is Paolo Spadini, a maverick among Swiss watch makers in that he is a fervent disciple of the digital watch.

Last year, the firm went on line and turned out more than 250,000 LCD modules. "We could have sold 100,000 more if I could have produced them," Spadini says. This year the production will be more than doubled.

Three ways. Spadini says that consumers and the market, too, have become confused by price erosion. He sees three directions for the digital world market:

- A technically good, multifunction gadget-type watch, with the Japanese as the leading producer.
- A low-price, technically efficient model offering minimal information and no elaborate styling, with American companies like Timex and Texas Instruments as leaders.

■ A flat, more elegant dress-type watch for men and women, with the Swiss as leaders.

Together with Nepro and five other watch-involved firms, Mondaine, a Zurich firm, late last year founded the Electronic Precision Industries Cooperative in Zurich to facilitate purchases of electronic watch components at lower costs. "This gives us centralized buying power," explains company executive Ronald Berheim.

The growing importance of solid-state watches also is mirrored in stepped-up activity by the Societe Suisse pour L'Industrie Horlogere, a holding company for such prestigious brands as Omega and Tissot. SSIH Electronic S.A. was created the beginning of this year to continue and expand quartz crystal production—already among the biggest in Europe—and to make some LCD modules. At Basel, Omega introduced a quartz movement designed by SSIH that is just 0.533 cubic centimeters in volume. It measures 13 by 15.15 millimeters, and with battery is only 3.35 mm thick. And Heuer caused a stir when it said it will introduce this year an analog-digital stopwatch that is the same size as conventional ones.

Half enough. Faselec, owned by Philips of the Netherlands and watch-industry interests, says that about half of what is currently needed by Swiss watchmakers in the line of chips for digital watches comes from Switzerland. This firm makes silicon-gate C-MOS chips as well as custom devices.

For the future, Swiss technical experts see growth in functions and features of digital watches. "The flashy stage of digitals has passed and now we can get down to serious, down-to-earth considerations," says a top Swiss solid-state specialist. While the Swiss have looked at integrated injection logic, they do not see it as attractive until it can come up with the same yield at the same cost as C-MOS.

Solar cells already are being used in several watch models and micro-processing has been at least introduced, but is judged as too expensive and needing too big a chip. □

Six important questions to ask of any DMM that claims to be designed for field service.



We give you a choice of 3½ or 4½ digits, manual or autorange.

At Fluke, we've been building DMMs for a long time. We're the leader.

And if there's one thing we've learned over the years, it's that what works for the bench doesn't always work for the field.

But a lot of companies don't understand that. They'd like you to believe their DMM is perfect for field service. Just because they've put it in a different case.

Here's how to tell the difference:

1) Is the size and shape designed for the field?

How do you carry your tools? We designed the 8030A/8040A DMMs into an ideal shape after we researched the requirements of field service work. It's sized to fit in a case. And it's rugged, to take the beating field instruments must survive.



If it doesn't fit here, it's not for field service.

2) Does it have true rms ac?

Make sure you get usable accuracy. You'll need true rms ac to eliminate errors when measuring distorted waveforms. (And if you don't understand the importance of true rms, write for our bulletin on True RMS Measurement.)

3) Does it give full performance?

Just because it's a field instrument, you shouldn't sacrifice

performance. Demand five measurement functions in 26 ranges. Top specs, like our 8040A basic dc accuracy of $\pm 0.05\%$ or our 8030A basic dc accuracy of $\pm 0.1\%$. And the specifications are guaranteed for one year. Important extras, like diode test for measurement of semiconductor junctions in-circuit, high voltage protection, and self test feature. And a complete line of accessories: various battery options, and probes for measurement of rf voltages, high current ac, high voltage dc and temperature.

4) Do you have a choice of manual or autorange?

We offer two versions: the 8030A 3½ digit and the 8040A 4½ digit with autoranging. Because we know not all field service applications are alike.

5) What is the price?

A field service DMM is a tool, and should carry a practical price. Our 3½ digit 8030A is \$250.* Our 4½ digit 8040A is \$440.* Check around and you'll see how practical that is.

6) Do you trust the company that builds it?

We became the leader in DMMs for one reason only. We build digital multimeters that people trust and continue to use, year after year. We've sold hundreds of thousands of DMMs.

And every bit of that experience has gone into the 8030A and 8040A DMMs

For data out today, dial our toll-free hotline, 800-426-0361. John Fluke Mfg. Co., Inc., P.O. Box 43210, Mountlake Terrace, WA 98043. Fluke (Nederland) B.V., P.O. Box 5053, Tilburg, The Netherlands. Phone: (013) 673-973 Telex: 52237.

*U.S. price only.

The field service DMMs for field service people.



Circle 83 on Reader Service Card for literature

Circle 218 on Reader Service Card for demonstration

Commercial electronics

Wiegand effect getting practical

The 5-to-6-V pulse generated from a 3.5-cm wire can fire an SCR and switch electrical loads—no other trigger is necessary

by Gerald M. Walker, Senior Editor

The first products to exploit the Wiegand effect are already in sight [*Electronics*, April 14, p. 39]. In fact, the latest and perhaps the most dramatic application—a 3.5-centimeter wire that generates a 5-to-6-volt pulse upon encountering a magnetic field—will be demonstrated next month at the Chicago Product Engineering Show by the effect's chief patron, developer, and licensor, Echlin Manufacturing Co. of Branford, Conn.

To produce the 3.5-cm wire, John Wiegand, discoverer of the effect, worked closely with Echlin product designers. The pulse is large enough to fire a silicon controlled rectifier or switch electrical loads in industrial controls without any other trigger

input. It is generated whenever the specially treated ferromagnetic wire is subjected to magnetic energy, an event that causes a sudden change in the magnetic relationship between core and shell. This change is what produces the pulse.

"The Wiegand effect is not a substitute for semiconductor devices—it cannot match the speed and density of a semiconductor memory, for instance," acknowledges J. David Marks, Echlin's vice president of engineering. "But it is an adjunct to semiconductor devices in many applications." He recalls that Echlin originally became interested in the effect for use in an automotive part, "but when we saw possibilities for other, more extensive

products, Echlin proceeded a year ago to acquire the entire Wiegand technology."

Among the more immediate possibilities are an auto distributor, in which the wire will help time spark ignition, and plastic charge cards, where the wire would replace the standard magnetic stripe. Further off are other automotive applications, as well as industrial ones—for instance, a Wiegand-based limit switch could be designed into a machine-tool control.

Wiegand devices have other advantages, besides their ability to produce a pulse without an electrical input. They are stable in temperatures ranging from -196°C to $+300^{\circ}\text{C}$. The effect is not speed-dependent; that is, the amplitude and duration of the pulse stay constant, no matter how fast a magnetic field is applied to cause the "Wiegand jump." The special treatment of the wire—cold working ferromagnetic alloy wire by stretching and twisting it, followed by heat tempering—promises high yields and is fairly easy to automate when large quantities are required.

Going slowly. But Wiegand technology is still not completely understood, making manufacturers very cautious about jumping into product development. To remedy this problem, Echlin is both sponsoring basic research at Yale University's Department of Engineering and Applied Science and demonstrating the practical aspects of this technology by developing automotive products. (The firm is primarily an automotive parts manufacturer.) The company's original interest was in an auto distributor, which will probably be

Off and running. Wiegand effect is used in this automobile distributor, in which specially treated ferromagnetic wire will produce signals to time spark ignition.

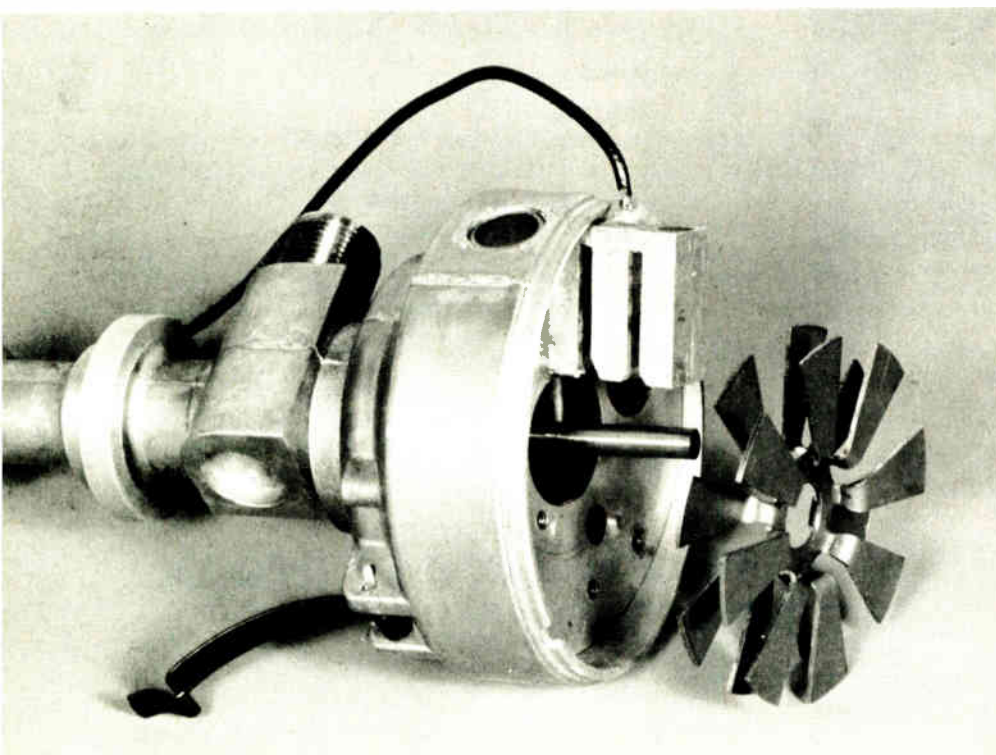

Did you know that you can save \$1,005 by buying a Fluke 1953A Counter instead?

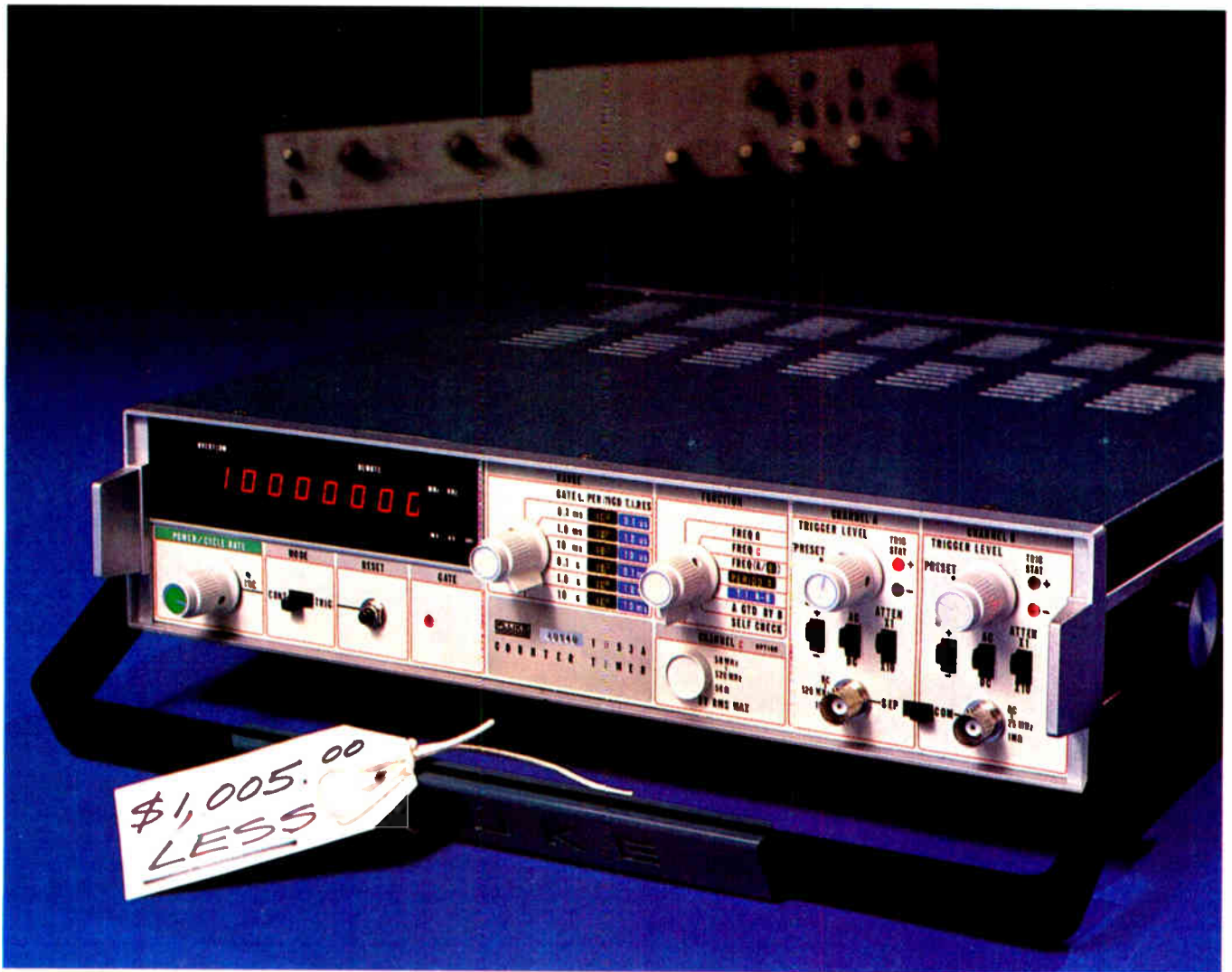

That's right.

Fluke's 1953A Universal Counter-Timer mainframe plus IEEE Programming option will cost you just \$1,595.* Instead of the \$2,600 or more you'd pay for comparable models.

And you won't get any less performance, either. In fact, you'll get extras.

Like "clean dropout." If the signal is too small, the 1953A will show zeros. Theirs can give you a wrong reading.

Our frequency range on Channel A is 125 MHz. Theirs is 100 MHz.

Our Z-axis time interval marker is standard. Theirs is optional.

Board access is better on the 1953A. We use one custom I.C. They use many.

Our input capacity on Channels A and B is 30 pF. Theirs is 40 pF. And our Channel B frequency response is 25 MHz. Theirs is 10 MHz.

The 1953A is half the weight, consumes one-fifth the power and makes no noise at all. On theirs you'll hear the fan and switching regulator.

Our switch and control "feel" is as good as theirs, and our front panel labeling is much less confusing.

Where the 1953A shows 9 digits all the time, theirs offers 9 digits only on

Channel C.

And, if you need the option of Parallel BCD, we have it. They don't.

So, if you're in the market for a programmable counter, consider the Fluke 1953A.

And consider how much you'll save.

For data out today, dial our toll-free hotline, 800-426-0361. John Fluke Mfg. Co., Inc., P.O. Box 43210, Mountlake Terrace, WA 98043. Fluke (Nederland) B.V., P.O. Box 5053, Tilburg, The Netherlands. Phone: (013) 673-973. Telex: 52237.

*U.S. price only

The 1953A. A programmable counter at a reasonable price.



Circle 84 on Reader Service Card for literature

Circle 85 on Reader Service Card for demonstration

μ P Power Supplies[®] Save Your Chips!

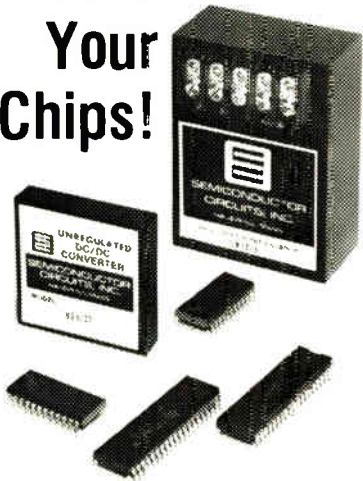

Choose ...

- ☐ **Output ratings** from a large selection of models
- ☐ **Input ratings** from among DC/DC converters and line operated supplies
- ☐ **Performance** you NEED at a sensible price
- ☐ **Low Unit Prices** from \$23.95 to \$99.95

Get The Facts Fast Call or write today for Free Catalog. We'll also include your copies of our new power supply journal,

WATTS UP at SCI



**SEMICONDUCTOR
CIRCUITS, INC.**

POWER SOURCES
DIVISION

306 RIVER ST., HAVERHILL, MA 01830
Tel. (617) 373-9104, TWX, 710-347-0269

Probing the news

placed on the market by the fall.

In the Wiegand-based distributor, the wire will produce signals to time spark ignition. A Wiegand module consisting of one wire wrapped in a coil is mounted between two permanent magnets of opposite poles. Eight-blade vanes (in the case of eight-cylinder cars) are mounted between the magnets and the module as interruptors so that when the vanes rotate, a Wiegand pulse passes through each air gap in time with the needs of sparkplug ignition. Precisely how the signal is handled to fire the plugs depends on the type of ignition system used.

"The Wiegand distributor signal replaces a light-emitting diode, or Hall-effect device, or variable inductor as a signal source to time the firing of the sparkplugs. It can be used with a capacitive discharge or an inductive ignition," explains Michael J. Sinko, project manager of advanced products for Echlin.

Auto work. The company is now working with the Big Three auto makers on various other applications. One is testing a product, and the other two will begin shortly. Besides the auto companies, Colt Industries and Robert Bosch GmbH of Germany have licensed Wiegand technology to develop automotive parts so that the prospects for fully established applications in this market seem more and more likely. One possibility, says Marks, would be as

sensors—either for crankshaft position and revolutions in microprocessor-based fuel-management systems or for wheel speed in adaptive braking systems.

Applications for the Wiegand effect in data handling also appear promising. Echlin licensed International Business Machines Corp. this year, and trials of access card readers have started in Boston's subways and Canada's airports.

A series of wires embedded in a plastic card produce a binary-coded-decimal signal when the card is passed through a reader. The wires are more secure than a magnetic stripe, because it is impossible to destroy or alter the information in the card without destroying the card itself. Also, a lot of information can be stored at a nominal cost.

But the main attraction is the ability to gain access to this information with a read head unit that requires no electrical power. This quality makes it easy to install readers in doors, turnstiles, vending machines, and the like—places where magnetic-stripe readers would be too costly and would get too much abuse to survive for long periods.

Echlin plans also to provide complete modules designed for specific applications such as card reading, sensing, or auto parts. These modules will consist of various configurations of the basic Wiegand parts, including treated wire, coil, and magnets, that can be handled as subassemblies for systems manufactured by the licensees. ☐

Card player. Wires embedded in a plastic card produce a BCD signal when it is passed through a reader. The system is undergoing tests in Boston's subways and Canadian airports.

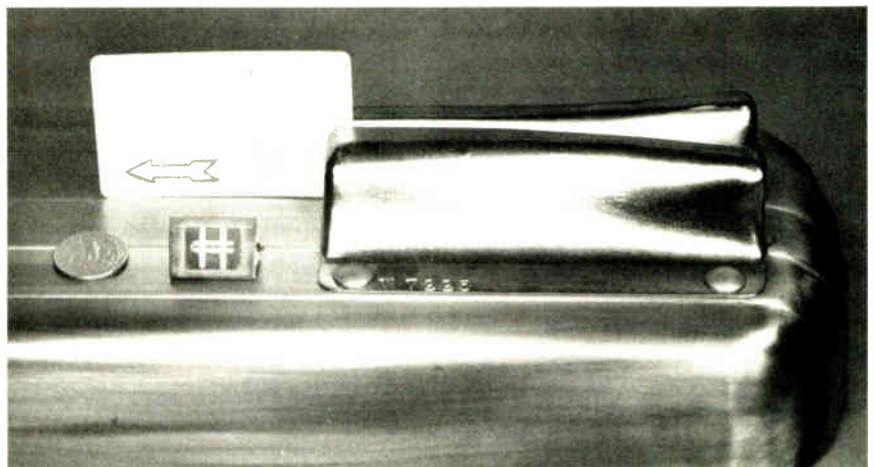

REACT

Rapidly Evaluate & Apply Custom Technology.

REACT means that custom LSI for many applications can be attained in 3 to 6 months, at costs ranging from \$18k to about \$38k. REACT does not gain its cost-efficiency from a library of gate arrays, cells or mask-programmable chips—but rather from our extensive background in using advanced processes to custom-integrate complete logic functions. Chances are we've already optimized the design for many of the logic functions your product requires.

Over the past six years, we've developed more than 300 microcircuits to help many manufacturers realize the benefits of custom LSI. Benefits like reduced assembly costs, lower power consumption and smaller size.

Along the way, we've even developed and refined our own brand of LSI—High-Density CMOS (HD/CMOS). This production-proven process has effectively reduced both size and power consumption in a wide range of products, including digital watches, CB radios, multimeters and pacemakers.

Thanks to innovations like HD/CMOS, and our long experience in integrating custom logic, the time and cost for custom LSI development is being dramatically reduced. This development is so significant that we decided to label it REACT—for Rapidly Evaluate & Apply Custom Technology.

REACT means compatibility with the standard CMOS devices in the 4000 Series. The transition from this standard logic family to our high performance HD/CMOS is a natural evolution. In fact, we encourage our customers to prototype their design with 4000/CMOS before custom HD/CMOS development.

REACT could also mean an effective way to streamline microprocessor-based designs. In many cases, HD/CMOS can be used to custom-integrate the peripheral logic required to make a microprocessor function.

We've prepared a special brochure which describes our REACT program more fully. This brochure also contains a discussion of custom LSI time/cost considerations in today's numbers. For your copy, circle the R.S. number, or contact REACT Marketing, at (408)247-5350.



3100 Alfred Street, Santa Clara CA 95050

Circle 87 on reader service card

NEC IS BULLISH ON

1. WE'RE THE COMPANY WITH ALL FOUR KINDS.

Now with the introduction of these four new families, we're the company with every kind of dynamic RAM you could need:

The μ PD414 Series — 4K, 16-pin, 200-350ns.

The μ PD418 Series — 4K, 18-pin, 150-300ns.

The μ PD411A Series — 4K, 22-pin, 200-350ns.

The μ PD416 Series — 16K, 16-pin, 150-300ns.

2. WE GIVE YOU A $\pm 10\%$ OPERATING MARGIN.

In all four families. Compare that with other people's margins of $\pm 5\%$. Imagine the manufacturing care that takes. And the added flexibility you get.

3. WE DESIGN THEM TO USE LESS POWER.

Our μ PD414's and 416's have as low a power dissipation as any comparable product in the industry.

And our μ PD418's and 411A's actually use less power than any other standard 18- or 22-pin 4K RAMs on the market. In fact, our 18-pin uses 60% less power.

And with this kind of power dissipation, we can offer all our RAMs in plastic, as well as cerdip, packages.

4. WE'LL EVEN PUT THEM ON A BOARD.

If you want any of our products on a board, we'll gladly design and build it for you. However you like. In whatever quantity you need.

So next time you're in the market for dynamic RAMs, why not contact one of our reps or distributors. They've got everything you need. And that's no bull.

NEC Microcomputers, Inc., Five Militia Dr.
Lexington, MA 02173, 617-862-6410.

NEC microcomputers, inc.

REPS: East — C&D Sales 301-296-4306, Contact Sales 617-273-1520, Harry Nash Assoc. 215-657-2213, Tech Mark 607-748-7173, 716-223-1252, 315-652-6229, Tronic Assoc. 516-466-2300; South — Perrott Assoc. 305-792-2211, 813-585-3327, 305-275-1132, Wolffs Sales Serv. Co. 919-781-0164; Midwest — Electronic Innovators 612-884-7471, W. Pat Fralin Co. 817-610-9101, 817-619-8981, 713-772-1572, K MAR Eng. & Sales 816-763-5385, R.C. Nordstrom & Co. 313-559-7373, 616-429-8560; Technology Sales 312-438-3300; West — Mike Duffy Assoc. 303-934-7392, Electronic Component Marketing 714-524-9899, 213-649-5374, Spedden Assoc. 714-295-6122, Summit Sales 602-994-4587, Trident Assoc. 408-734-5900, Tri Tronix 206-232-1993, 505-265-8400; Canada — R.F.Q. Ltd. 416-626-1445, 514-626-8321.

DISTRIBUTORS: Century Electronics (Albuquerque, Salt Lake City, Wheatridge CO), Diplomat (Chicopee Falls MA, Clearwater FL, Elk Grove Village IL, Farmington MI, Minneapolis, Mt. Laurel NJ, Salt Lake City, St. Louis, Sunnyvale, Totowa NJ, Woodbury NY), Future Electronics (Montreal, Ottawa, Rexdale, Canada), Harvey Electronics (Fairfield NJ, Lexington MA, Norwalk CT, Woodbury NY), Intermark Electronics (San Diego, Santa Ana, Sunnyvale), Lionex (Burlington MA), G.S. Marshall (Sunnyvale), Mirco Electronics (Phoenix), Resco (Raleigh), R M Electronic (Kentwood MI, Madison Hgts MI), Semiconp (Newport Beach CA), Semiconductor Specialists (Burlington MA, Chicago, Dallas, Dayton, Farmington MI, Hazelwood MO, Indianapolis, Kansas City, Milwaukee, Minneapolis, Pittsburgh, St. Louis, Malton Canada), Sterling Electronics (Albuquerque, Dallas, Houston, New Orleans, Phoenix, San Diego, Seattle, Sun Valley CA, Watertown MA), Technico (Columbia MD, Roanoke VA), Zeus Components (Elmsford NY).



DYNAMIC RAMS.



World Radio History

JOHN

Consumer electronics

Court intensifies import storm

Latest decision mandating countervailing duties, plus tariff body's call for increased TV duties, send shock waves across the Pacific

by Ray Connolly, Senior Editor

Bureaucratic blood pressures went up in Washington and Tokyo earlier this month when the U. S. Customs Court in New York upheld the Zenith Radio Corp. contention that Japan's exclusion of most consumer electronics exports from its 1962 Commodity Tax Law is a bounty or grant. The ruling orders that those U. S. imports from Japan would be subject to countervailing duties equal to the unpaid taxes in Japan—anywhere from 13% to 20% of the product's value.

The three-judge court's unanimous ruling went far beyond the March recommendation of the International Trade Commission of the U. S. calling for an increase in television imports tariffs (*Electronics*, March 31, p. 74). The court upheld Zenith's demand that tariff hikes be slapped on radio receivers; combinations of radios, phonographs, and television sets; tape recorders and players, and color TV picture tubes.

The Treasury Department, which lost to Zenith and must enforce the ruling through its Customs Bureau, immediately appealed to the U. S. Court of Customs and Patents Appeals—even before Japan's formal protest had reached the White House. The ruling, if upheld on appeal, could become a precedent affecting up to two-thirds of future imports of every kind.

Reactions. Akira Haranda, Matsushita Electric Industrial Co.'s executive managing director in Tokyo, seized on that issue, warning that European countries granting the same exemptions will be subject to the same measures. The economic and political impact on overall world trade would be strong, he asserted,

calling for U. S. Government appeals and other legal measures to "speedily rectify this irrational decision."

President Jimmy Carter appeared to oppose the ruling, telling the press three days after its issuance that a key feature of his anti-inflation program would be to take no protective Federal action to restrain cheaper imports. Yet he may not have that option if the court ruling holds up. As Judge Nils A. Boe points out in his concurring opinion, "If a decision of a court shall be predicated on political and economic expedience and, in so doing, shall ignore judicial precepts and the statutory mandates of the Congress, then assuredly an erosion of the basic constitutional doctrine of the separation of powers results. The judiciary should not nor cannot serve as the alter ego of the

Executive or the Congress." As to Treasury's argument that countervailing duties don't square with the General Agreement on Tariffs and Trade, Judge Bernard Newman pointed out that GATT must yield to previously existing law. "Moreover," he added, "GATT could not . . . modify or rescind an existing act of Congress."

Despite President Carter's strong free-trade stance, it is evident that he is in an increasingly tighter bind from pressure from the Customs Court and the ITC and from organized labor and TV manufacturers. Also caught are importers. They may be obliged to post a special entry bond as a contingency against higher tariffs. As one of them says, this could mean "a fortune in back tariffs, if this thing is upheld in a couple of years."

Import bond doubles

The Customs Court order to assess countervailing duties on imports of Japanese television sets was a blow to strained U.S.-Japan relations. But in an unrelated matter, the Treasury Department disclosed shortly afterward that it had ordered entry bonds to cover prospective penalties on Japanese TV dumping in the U. S. to be more than doubled from 9% of value to 20%.

In March 1971, the Treasury found that Japanese set makers, except Sony Corp., were dumping their products in the U.S.; that is, selling them for less than the prices in home market. At that time, the 9% bonds were ordered to cover possible penalties pending an assessment and, for political reasons, penalties were delayed. Now the Treasury data, complete only through 1974, shows that dumping has worsened.

Most U. S. industry officials were unaware of the move, but expressed delight when apprised of it. "This is an internal Treasury ruling not subject to court appeal like the Customs Court judgment, so it is already in effect," explains one industry official in Washington. "This means Japanese set prices will have to go up on any units taken from a bonded warehouse after the increase. I don't see any way importers can avoid boosting prices to cover themselves on dumping penalties. Remember, they could go back to 1971."

One short-term certainty is that the coming international economic summit conference in London next month will produce many new trade and tariff questions for Carter's representatives. Of U.S. options, one Treasury official moans, "Don't ask now. We don't have any answers yet, but we're trying like hell to come up with some," by the May meeting.

Price impact. The labor-industry coalition called Compact—Committee to Preserve American Color TV—which fought before the ITC for import quotas on receivers, sees the court ruling as a reaffirmation of its position. Compact cochairman Allen W. Dawson, executive vice president of Corning Glass Works, calls it "a myth that the consumer will take it in the chops if import restrictions are placed" on TV sets.

The coalition's argument for price stability is based on the large set inventories overhanging the present market—more than 2 million units at the end of 1976's third quarter, a figure swollen by the fourth quarter's unprecedented volume and the undiminished flow in the first 1977 quarter. "During the first two months of this year," Dawson asserts, "imports of color TV sets increased by 30% over the same 1976 period, a year that saw a record increase of 133% to 3.3 million imported sets from 1975."

Not only will inventory accumulation hold down prices, believes Compact, but so will RCA Corp.'s recent statement "that it would not raise prices in the event of restraints on imports," the group's statement concludes." Given this competitive environment, any significant increase in prices must be regarded as extremely unlikely."

Citing the latest court ruling, the ITC findings, and the "widespread hardship already suffered by industry workers," Dawson could not restrain a concluding needle for Carter policies: "We don't believe the President of the United States will want to sacrifice our (television) industry and its 70,000 remaining jobs to keep people working in Japan, which has 2% unemployment against the 7%-to-8% we have had here for the past several years." □

Digital filtering is old hat



You can now replace ten-bit A/D and D/A converters plus a digital filter module with a single integrated circuit.

Our standard product line already includes devices for audio and video delays, time-base correctors, transversal and real time adaptive filters, convolvers and correlators, and could well be the answer to many of your analog signal processing needs.

Our SAD-1024 is the industry standard in audio and musical effects; our TAD-32, tapped analog delay, is one of the hottest tools in sophisticated circuit design. We have built mask programmed chirp, linear phase, low pass and band pass filters which are the equivalent of a 14 pole filter in a single DIP.

If this doesn't do it, we can put your 19-inch rack into a DIP or two. Just remember, it is cheaper to quantize only in time than in time and amplitude... and we know how to do it. We have the tools from "old fashioned" silicon gate MOS to the latest n-channel BBD and CCD technologies.

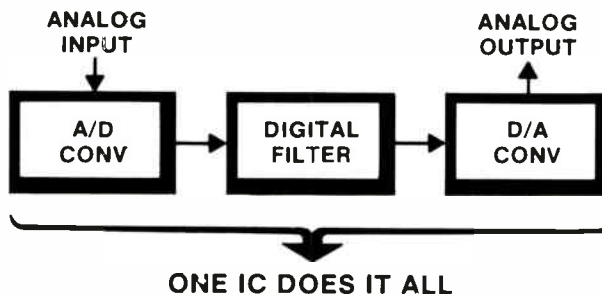

For further information, write or call:

RETICON®

AN EG&G COMPANY

910 Benic-a Ave. • Sunnyvale, Ca.94086 • (408) 738-4266

Wavetek's just put new life into the function/pulse generator business. Our Model 145 function generator not only doubles as a pulse generator, it does so without sacrificing any features.

The Model 145 is a 20 MHz function generator with sine, square, triangle, and DC output to 30V peak-to-peak.

Turn the function switch to pulse and you have a full-fledged pulse generator

with independent pulse width and delay control, plus single and dual pulse outputs. In addition to the 30V output, you get simultaneous ECL and TTL outputs.

Whether you use it as a pulse generator or a function generator, it offers triggering and gating manually or remotely, and external voltage control of frequency/period for frequency-shift keying and FM operation.

So if you've been coming down with a case of "should I buy a pulse or function generator-itis," the cure is obvious: Wavetek's Model 145. Just \$895. Circle our reader service number for details.

WAVETEK, P.O. Box 651,
San Diego, CA 92112.
Phone (714) 279-2200,
TWX 910-335-2007

WAVETEK[®]



**“Doctor, this
function
generator
has a
pulse!”**

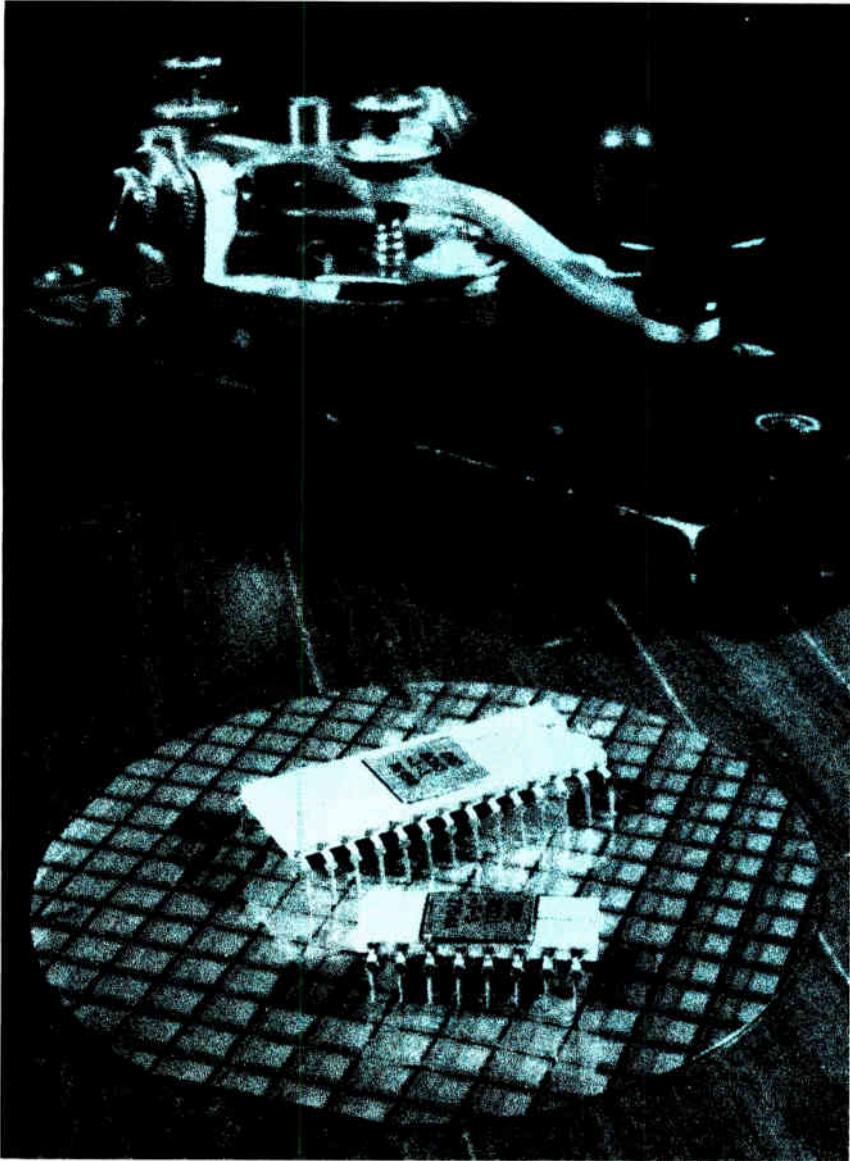

Large-scale integration is ready to answer the call of telecommunications

by Richard Gundlach, *Communications Editor*

□ Economy, reliability, and versatility—the three big bell-ringers of large-scale integration—are reaching the point where they meet the exacting standards of the telecommunications industry. After working changes in such segments of the field as data communications, LSI is on the verge of transforming the biggest of them all: the telephone industry.

The three levels of the telephone network—the telephones themselves and related equipment, the switching elements and other central-exchange

TABLE: COMPARING SILICON PROCESSES FOR TELECOMMUNICATION APPLICATIONS

Process	C-MOS	Single-channel MOS	Bipolar
Evolution: 1970 to 1980	metal gate silicon gate mixed C-MOS/bipolar oxide-isolation C-MOS/bipolar high-density (no guard bands)	p-channel MOS silicon-gate n-channel MOS silicon-gate depletion-load double-polysilicon-gate oxide-isolation fine geometry	linear & TTL I^2L Schottky ion-implant-resistor FET / linear oxide-isolation high-density
Key features	inexpensive LSI random logic low power wide operating-voltage range insensitive to power-supply fluctuations forgiving process for both system and process engineers easy for system designers to use without knowing process limitations	high-density digital circuits high-volume LSI manufacturing process more flexible than C-MOS in performance tradeoffs sample-and-hold capability inherent in process (active device-capacitor process) CCD fabrication process capability that allows n-channel MOS digital circuits and CCDs on the same chip	best current-drive capability for a given area low output impedance well-controlled voltage levels wide operating-voltage range low = voltage operation linear amplifier circuits (active device-resistor process) high = speed performance I^2L for high-density, low-power, low-voltage digital circuits I^2L for mixed digital and analog circuits on same chip withstands voltage and current overloads and reversals
Major applications	all standard logic requirements in PBXs, switches, terminal equipment, channel banks and other transmission equipment cost-reducing existing TTL designs codex and custom line circuits line-powered telephone circuits	memory and memory products microprocessor applications in switching systems and terminals, including interface and input/output devices CCD filters and analog-signal-processing circuits for voice in PCM and FDM channel banks and line circuits CCD imagers for readers, facsimile, and the like	all circuits connected to either end of the telephone line op amps for active filters and similar applications codex and tone generators voltage regulation and protection circuits high-speed performance devices for central processing units transmission equipment, such as PCM repeaters

Source: Bell Northern Research

equipment, and the transmission lines, terrestrial microwave radio relay and satellite links—are accelerating their use of distributed intelligence. Microprocessors, semiconductor memories, and specially tailored LSI chips are beginning to cut hardware and assembly costs, to shrink equipment sizes, and to provide a host of new features at all three levels of the network.

Telephone companies and semiconductor makers are providing LSI chips made with the metal-oxide-semiconductor, complementary-MOS, and bipolar silicon processes. Although none of these processes is best for everything, a low-power, low-voltage technology is needed. However, right now each of these processes suits some particular applications, says Neil Berglund, manager of silicon technology for Bell Northern Research, Ottawa, Canada.

Three processes

As outlined in the table, Berglund looks to C-MOS, which is an inexpensive approach to LSI random logic, to fill standard logic requirements in private branch exchanges, switches, terminal equipment, and channel

banks and other transmission equipment, as well as for line circuits and coder/decoders (codex). Custom-designed C-MOS circuits are cost-effective replacements for transistor-transistor-logic circuits in use today, he says.

MOS leads to CCDs

He looks to n- and p-channel MOS circuits for memories and memory products and for microprocessor applications in switching systems and terminals, including interface devices. Since the process lends itself to fabrication of charge-coupled devices, it can provide n-channel MOS digital circuits and CCDs on the same chip. So it will find use in CCD filters and analog signal-processing circuits in pulse-code-modulation and frequency-division-multiplexing equipment.

Bipolar technology is attractive because it combines high density, low power, and low voltage with the ability to mix digital and analog functions on the same chip. Berglund sees the process being used in all LSI chips that connect to either end of a telephone line, such as codex and tone generators, in transmission equipment such as

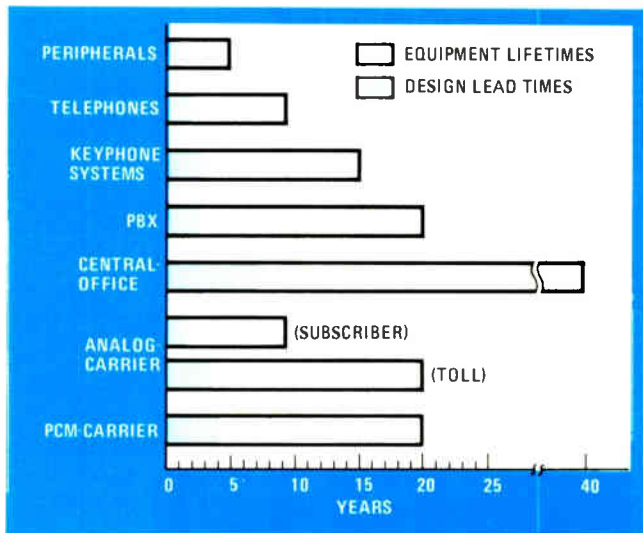

1. Time frame. It can take a long time to get LSI circuits designed into telecommunications equipment, but the reward could be worth the delay for semiconductor companies willing to chance it. Once designed, such equipment is likely to be produced for many years.

PCM repeaters, and in high-speed devices for central processing units.

As the telephone companies continue their slow conversion to digital networks, LSI chips will be used to transmit voice in digital form more cheaply and efficiently. A preview of the future can be found in some new subscriber switching systems (keyphones, which have a row of buttons for such functions as intercoms and choice of outside lines, and PBXs). They are using digital multiplexing exclusively to provide full features to each telephone in the system, but with only two or four thin wires (instead of the thick cable housing more than 50 wires) connecting the main console to the equipment cabinet that interfaces the system with the telephone network.

In these new PBX and keyphone systems, the LSI codecs for voice encoding and decoding are either in each individual phone or in a unit serving a dozen or so phones under microprocessor control. Each microprocessor shares control functions with a larger CPU and memory, all tied to a common data bus.

Telecommunications companies also are interested in built-in self-diagnosis, for which microprocessors are well suited. LSI circuits will help assure the reliable service demanded by data-communications users and will minimize the down time of just about every telecommunications system. The telephone company's new generation of large switching systems is starting to employ microprocessors for fault analysis on a routine basis.

Expanding marketplace

Just as important as microprocessors are the LSI chips tailored to perform existing functions in the telephone network. They also are providing new features in the telephones themselves, such as automatic repertory dialing and pushbutton dialing. Most of these specially designed chips are intended by the semiconductor makers as relatively standard devices, usable in all tele-

phone systems. The firms are also working on custom LSI circuits with some of the equipment manufacturers, and these chips may become available to all comers.

The telecommunications markets for LSI circuits are beginning to explode. The Stanford Research Institute, Palo Alto, Calif., puts worldwide LSI telecommunications sales at more than \$1 billion in 1985, up from \$25 million in 1975.

Three factors spur growth

Strong growth, widening use, and new customers are ahead, says Harry Newton, a New York City telecommunications consultant. He says American Telephone and Telegraph is expanding its purchases from outside suppliers from the present levels of \$900 million a year for equipment and several hundred million dollars for electronic parts.

Also, the Government's General Services administration is allocating more of its \$400 million annual telecommunications expenditures for cost-saving and innovative solutions to problems. Newton says the third factor is the rapid and extensive upgrading of telecommunications networks by the oil-rich Middle Eastern countries and Nigeria.

Equipment suppliers eyeing the emerging markets realize that their products must be upgraded. Their designers have realized that only LSI technology will provide them with the economic tradeoffs necessary to replace older equipment, while also allowing them to offer added features without extra cost.

Many equipment manufacturers, looking for a competitive edge, are designing with LSI circuits that the semi houses have yet to put into production, says Jim Solomon, manager of research and development for industrial linear integrated circuits at National Semiconductor Corp., Santa Clara, Calif. Cloaked in veils of secrecy, major equipment makers such as Bell's Western Electric, International Telephone and Telegraph, General Dynamics' Stromberg-Carlson Corp., GTE Automatic Electric, United Telecommunication's North Electric Co., and many smaller suppliers, are working with selected semiconductor companies to develop custom chips (see "Getting together," p. 96).

However, suppliers and semiconductor makers alike wonder how fast the pace-setting Bell System will design more LSI into its equipment. On the other hand, Bell and other major phone companies wonder if semiconductor makers are willing to pay the entrance fee: the time required to get their chips designed into telephone equipment. For those willing to wait several years or so, the payoff could be handsome. Telephone equipment lifetimes range anywhere from five to 40 years and so would represent a large continuing market for those LSI chips that are designed into the gear.(Fig. 1).

Telephone companies traditionally have been slow to replace installed equipment that represented large capital investments, so long as it essentially met existing demands. However, that policy is changing. With the press of competition and the need for cost-effective solutions for a more responsive network, coupled with customer demand for greater performance and economy, acceptance of LSI-implemented equipment should be

Getting together . . . sort of

Since telephone companies want the benefits of large-scale integration and since the semiconductor manufacturers have the LSI expertise, cooperation between the two industries would seem natural. But such cooperation is the exception rather than the rule—particularly in contrast to the joint development efforts of telephone-equipment makers and semi houses.

The capacity to produce custom chips exists in the major North American telephone companies—AT&T's Bell Telephone Laboratories Inc., Bell Canada's Bell Northern Research, General Telephone and Electronics Corp.'s GTE Labs, and International Telephone and Telegraph's various research labs—and overseas. In general, the labs want to work with semiconductor makers but will not help to put them in the telecommunications business. "As long as they are acting and looking like competitors, we must treat them as such," says one telephone-company spokesman.

Most major telephone companies claim they do not want to be chip producers, but each is developing in-house chips, along with the masks necessary to produce them. They also want the in-house expertise to be able to evaluate the various process technologies and to provide backup in some of the areas where the semiconductor houses are supplying chips.

There is some cooperation, exemplified by the joint effort of Texas Instruments Inc. and Le Centre National d'Etudes des Telecommunications, which spawns most of the equipment for the French nationally-owned telephone company. Texas Instruments is developing several LSI circuits for the time bases, codecs and transcoders in the second-generation pulse-code-modulation transmission equipment that CNET is developing.

However, the semiconductor manufacturers are finding it almost impossible to squeeze information about the intricacies of the telephone network from the operating companies. They have pretty much turned to the equipment suppliers in hopes of working together to develop

LSI chips that can become standard, volume-production devices.

The equipment makers see a competitive edge in working with the semiconductor houses. They expect the next generation of equipment to cost less, while including the host of extra features that large-scale integration makes possible.

Many of the equipment makers lean towards custom chips if cost can be kept down, and semicustom chips, especially where the initial quantities are low. Since the initial engineering of semicustom chips is usually handled by the customer, not the semiconductor firm, costs are held to a minimum. But for such relatively standard circuits as pulse-dialer and tone-dialer chips, suppliers expect to use the devices offered to all comers by the semiconductor industry.

The tailored chips will come from the cooperation between equipment makers and chip manufacturers like Exar, Signetics, Fairchild Semiconductor, and Hughes Microelectronics Products division. The equipment manufacturers find the approach appealing, because it results in economical custom chips without a commitment to large-volume purchases from the cooperating semiconductor manufacturer.

Typical of the approach is Exar's operation. The firm has several LSI device arrays without the final mask pattern. The engineer at the equipment maker designs the desired circuit and then prepares a layout simply by interconnecting appropriate device terminals on oversize drawings of the array supplied by the chip maker.

After reviewing the circuit layout and schematic, Exar generates a custom interconnection pattern—a metal mask—that is applied to prefabricated wafers. The customized wafers are scribed into individual IC chips, packaged, and delivered to the customer.

The Exar process usually takes one to two months and costs about \$2,000 for 50 IC prototypes. LSI prototypes will cost more—up to \$10,000.

much faster in coming than past experience suggests. "There's no new system in production at Western Electric or under development at the labs that doesn't use ICs," says Robert C. Fletcher, executive director of the IC Development division at Bell Telephone Laboratories Inc., Murray Hill, N.J.

Another indication of Bell's position came recently from the top, when company chairman John D. deButts told a group of investment analysts "The fact is that we are in the process of building a new nationwide network—an all-electronic network characterized by solid-state devices and stored program control." He pointed to Bell Laboratories' recently developed micro-processor [*Electronics*, Feb. 17, p. 83] as playing a leading role in the new network.

The enthusiasm of the telephone companies and equipment suppliers for LSI is genuine, but there are some reservations. For example, a low-cost LSI codec for individual telephones certainly will come, but right now the semiconductor firms are talking about a price tag around \$10. That is what the present codec shared between numerous lines costs on a per-line basis, says

John McDonald, vice president of research and engineering at TRW's Vidar division.

"We will evaluate the new LSI products thoroughly before designing them into our equipment," says McDonald, who has not been overly impressed with semiconductor reliability. "Failure of a 15¢ semiconductor part could end up costing us several hundreds of dollars," he says.

Toeing the mark

Telephone-company reliability requirements are in the neighborhood of one hour total system breakdown every 30 years. So some of the operating companies are hesitant about LSI because they do not know the cost of inspecting these circuits to make sure they meet the reliability standards. "Just to develop an efficient program to test all functions of LSI circuits would be costly," says Sture Edsman, assistant production director at L M Ericsson, Stockholm, Sweden. He feels that the phone companies would have to perform extensive dynamic testing at high temperatures—and that is a very costly proposition.

LSI aims at network functions

In spite of the reservations sometimes expressed by telephone-company officials, semiconductor firms are charging ahead with the development of LSI chips for telecommunications applications. Over a dozen semi houses are working on various types of chips, some of which are already designed into equipment. Most of the devices, however, are not yet in production, although equipment designers already are interested in them.

Microprocessors will have their place in telecommunications, filling all kinds of control functions. Semiconductor makers also see a number of opportunities for specially developed LSI chips:

- Pulse-dialer chips that convert push-button information into dialing pulses for phone lines not equipped to handle tone signaling.
- Repertory-dialer chips that store frequently called phone numbers, then automatically dial on push-button command.
- Tone-dialer chips to generate the dual-tone multifrequency signals that are replacing dialing pulses throughout the telephone network.
- Tone-detector chips that detect valid tone signals in

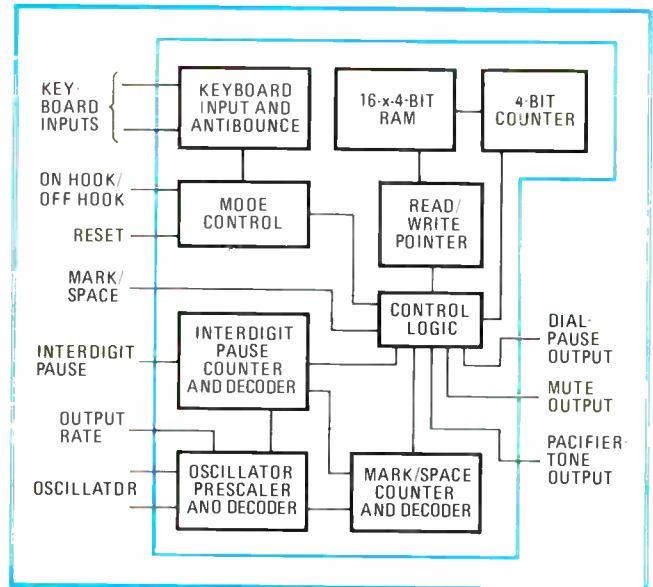

2. Push button in, pulse out. AMI's S2560 keypulsar converts pushbutton data into rotary dial pulses for use on phone lines not equipped to handle tone signaling. The chip requires no multiphase clocking, has 16-digit capability, and provides feedback.

central offices and in customers' equipment.

- Repeater chips that reshape, retime, and boost the pulse-code-modulated signals on digital telephone lines.
- Coder/decoder chips that convert voice to digital form

3. The hands have it. A single tone-dialer chip eliminates a handful of discrete components and wire, as well as the time to assemble and tune. The LSI circuit (AMI's S2559 is shown) functions properly even at the low telephone-line voltages.

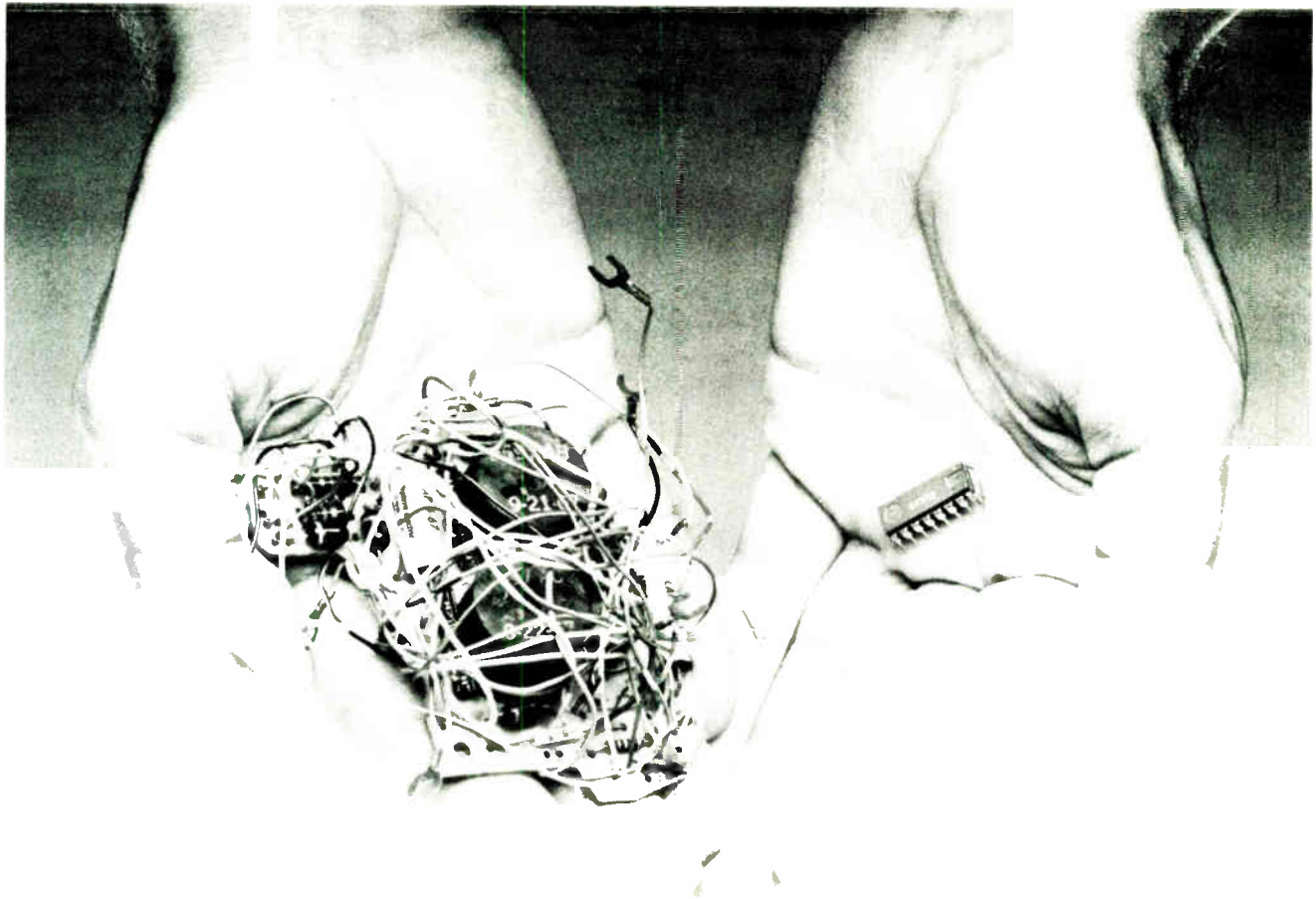

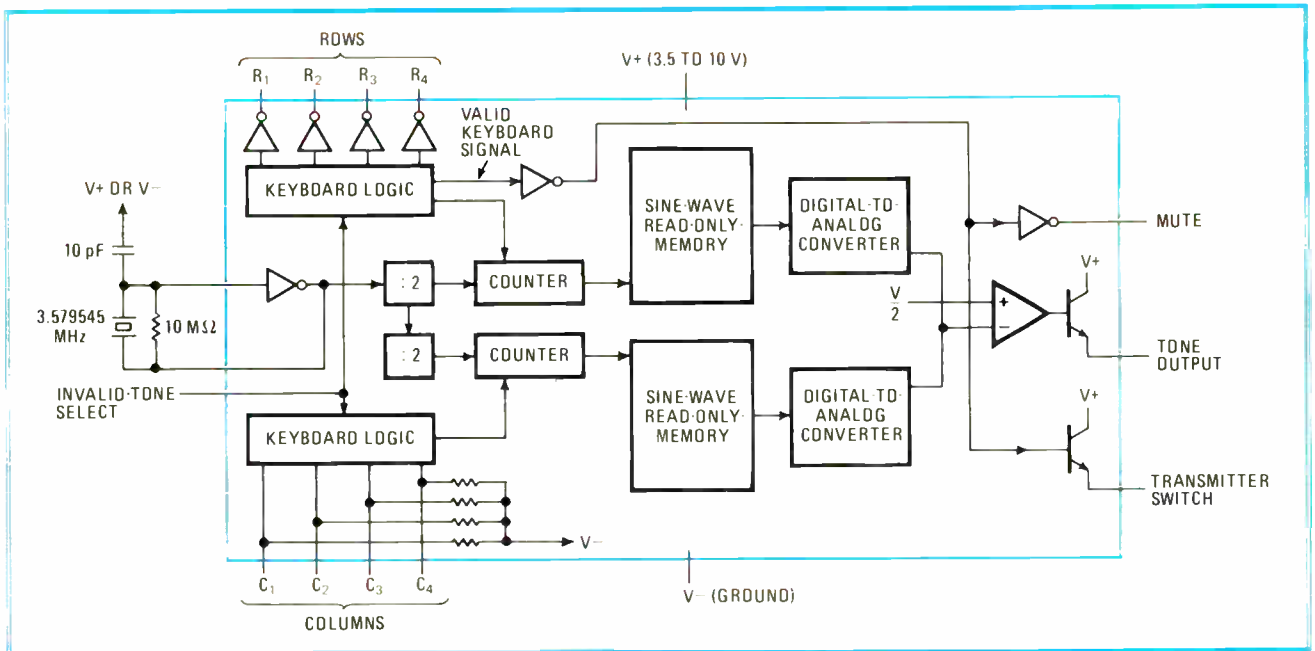

4. Generating tones. Mostek's tone-dialer, the MK5085, is typical of these chips that generate tone pairs for dual-tone multifrequency telephone dialing. The chip, powered directly from the telephone line, works with present telephone keyboard assemblies.

and back in PCM and delta-modulation systems.

- Frequency-synthesizer chips that generate carrier frequencies to transmit hundreds of telephone signals simultaneously in frequency-division-multiplexed trunks, microwave links, and the like.
- Analog compandor chips to improve the signal-to-noise ratio on telephone lines or trunks.
- Modulator/demodulator chips that frequency-multiplex several conversations onto a single telephone line.
- Programmable interface chips for data-communications applications.

There are chips in varying stages of development for each of these functions, from several companies.

From push button to dialing pulse

The first LSI chip to find its way inside the telephone is the pulse dialer, also known as the key pulser. Stored in memory are the dial pulses equivalent to the push-button inputs. These signals are pulsed out to the rotary-dial telephone exchange when the user punches in the number he is calling.

A typical pulse dialer chip from American Microsystems Inc., Santa Clara, Calif. is shown in Fig. 2. National, Motorola, and General Instrument Corp. have similar chips on the market, and Mostek will have one available soon. In Germany, IFT's Standard Elektrik-Lorenz AG has developed a custom LSI circuit for its Quickstep button-to-dial pulse telephone.

Adding extra memory to these chips can provide an automatic redial feature. The memory stores the last number dialed, and the caller need only punch a single button to redial. If he or she has a Touch-a-matic phone from AT&T or an Instafone from Great Britain's Pye TMC Ltd., it is possible to store many frequently called numbers. The Instafone will work anywhere in the world and is one of two automatic-signalling button-to-dial-pulse sets that Pye is building around its custom MOS LSI

circuit [*Electronics*, March 31, p. 55]. The other is the 47-number Multicall telephone for businesses. The British Post Office is planning customer trials of 1,500 Instafones, to be priced at under \$150 each, and 2,000 Multicall units, to be priced at under \$400.

Simplifying the pushbutton operation

In the long run, all telephone exchanges will handle the dual-tone multifrequency signals from push-button phones, so the extremely complex Touch-Tone assembly is another good candidate for LSI replacement. Extensive cost-reduction work has still left a discrete package that requires considerable assembly and tuning time. For example, the two large coils each have four windings that must be burned in and tuned by hand. All the components must be assembled on a board and interconnected with the keyboard assembly.

Replacing this circuit with an LSI chip (Fig. 3) is no easy task. To eliminate the LC oscillator, the sinusoidal frequencies must be synthesized digitally to an accuracy within 1.25%, and the resulting total harmonic distortion must be less than the telephone companies' worst-case specification of 10%. The signal level must remain constant over the 3.5-to-13.5-volt range that can exist at the telephone.

The chips developed assure proper functioning even on long subscriber loops when the voltage drops to 3 v or so. Moreover, they will work with an inexpensive calculator keyboard by performing many of the switching functions in logic rather than by metallic contacts.

One of the first tone-dialer chips came from Mostek Corp., Carrollton, Texas. The single chip (Fig. 4) provides tone generation and all the necessary keyboard logic. Bipolar and MOS transistors, all formed by the CMOS process, implement high-speed digital circuits, an operational amplifier, and two complete digital-to-analog converters. Ion-implanted resistor-ladder net-

works are used to avoid costly trimming procedures in production.

The chip has an inexpensive off-chip 3.58-megahertz crystal (the same as in color-television sets) for reference, which is divided down to obtain the audio frequencies. On the chip, the op amp performs current-to-voltage conversion and sums the two sine waves to produce the tone pairs representing each number on the keyboard. The low-distortion digitally synthesized sine waves need no external filtering.

A low-impedance bipolar buffer/amplifier is capable of driving telephone lines. An external silicon diode bridge avoids damage to the IC when the voltage polarity from the central office reverses—a common occurrence in the telephone network.

Mostek estimates its MK5085/6 costs half of its electromechanical equivalent. System economy stems from integration of all system functions on a single LSI chip, thus requiring few external components. Both tone dialers work with conventional telephone keyboards; the 5086 lends itself to machine-addressed inputs from automatic dialers and microprocessors.

Other tone dialers available include the AY-3-9400/10 from General Instrument, the S2559 from AMI, the ICM 7206 from Intersil, the MC14410 from Motorola Semiconductor, the MM5395 from National, and a chip from Texas Instruments.

A unit that replaces the entire Touch-Tone assembly comes from Telenetics, Newport Beach, Calif. (Fig. 5). Its keyboard assembly combines a p-channel MOS chip for digital timing and tone generation with hybrid thick-film circuitry for the analog interface in a 32-pin dual in-line package. The diode bridge for reverse-polarity protection is off chip. The unit, the model 7603, can handle inputs from keyboards, from hardwired program sequences that turn it into an automatic dialer, and from random-access memories, read-only memories, and programmable ROMs associated with repertory dialers and similar setups.

Other chips detect tones

As well as generating dual-tone multifrequencies, telephone networks must be able to detect them. And DTMF receivers in central offices, PBXs, and keyphones, as well as in mobile radio systems and computer signaling and control systems, are good candidates for LSI tone-detector chips. Receivers using discrete components cost from \$250 to \$500 and are constructed on pc boards that include several analog filters, automatic-gain-control circuitry, and tone detectors.

The detector must recognize the tone pairs representing each punched-in number within a certain bandwidth, while tolerating dial-tone noise and input-amplitude variation or amplitude differential between the two tones. Then it produces a 2-of-7-, 2-of-8-, or binary-coded data output indicating the presence of a valid tone. It also must comply with such telephone-company specifications as meeting the timing restrictions inherent in the process of generating DTMFs.

One of the first tone-detector chips on the market that eliminated many of the required components was the CRC 8030 from Collins Radio's Commercial Telecom-

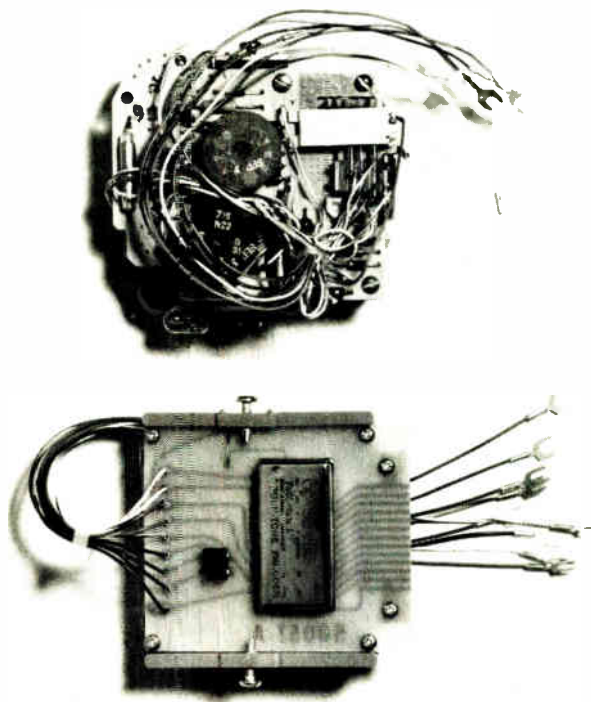

5. Tone signalling. Telenetic's tone dialer, (the 7603, mounted on the firm's keyboard assembly) generates DTMF signals from several input formats: a standard keyboard, a semiconductor memory, or hardwired 4- or 8-digit numbers sent on command.

munications division, Newport Beach, Calif. Implemented with a p-channel MOS ion-implanted process, the chip is hermetically sealed into a 28-pin ceramic DIP. It accepts filtered and shaped DTMF signals and converts them to binary- or 2-of-8-coded data. A complete DTMF receiver requires a filter/limiter along with the tone-detector chips.

As is typical of such circuits, the 8030 includes time-base generation, wave shaping, range counters with correlation circuitry, and output timing and decoding functions (Fig. 6). The characteristics of the necessary front-end filter must be geared to the performance of the system. For high-quality central-office detectors, a highly selective filter is needed; for the low-noise environment of subscriber equipment, less stringent filtering is acceptable.

Among the other semiconductor makers with tone-detector chips is Mostek, which is readying the C-MOS MK5102N that requires only a single supply ranging from 4.5 to 10 v. Some of General Instrument's AY-5-9800 series meet the filtering requirement with on-chip op amps coupled with external resistors and capacitors (Fig. 7). All versions have on-chip registers allowing designers to program the number of cycles of the incoming waveform that must be analyzed to determine if a valid signal tone has been received.

Significant savings in power consumption, as well as greatly improved reliability and performance, is the

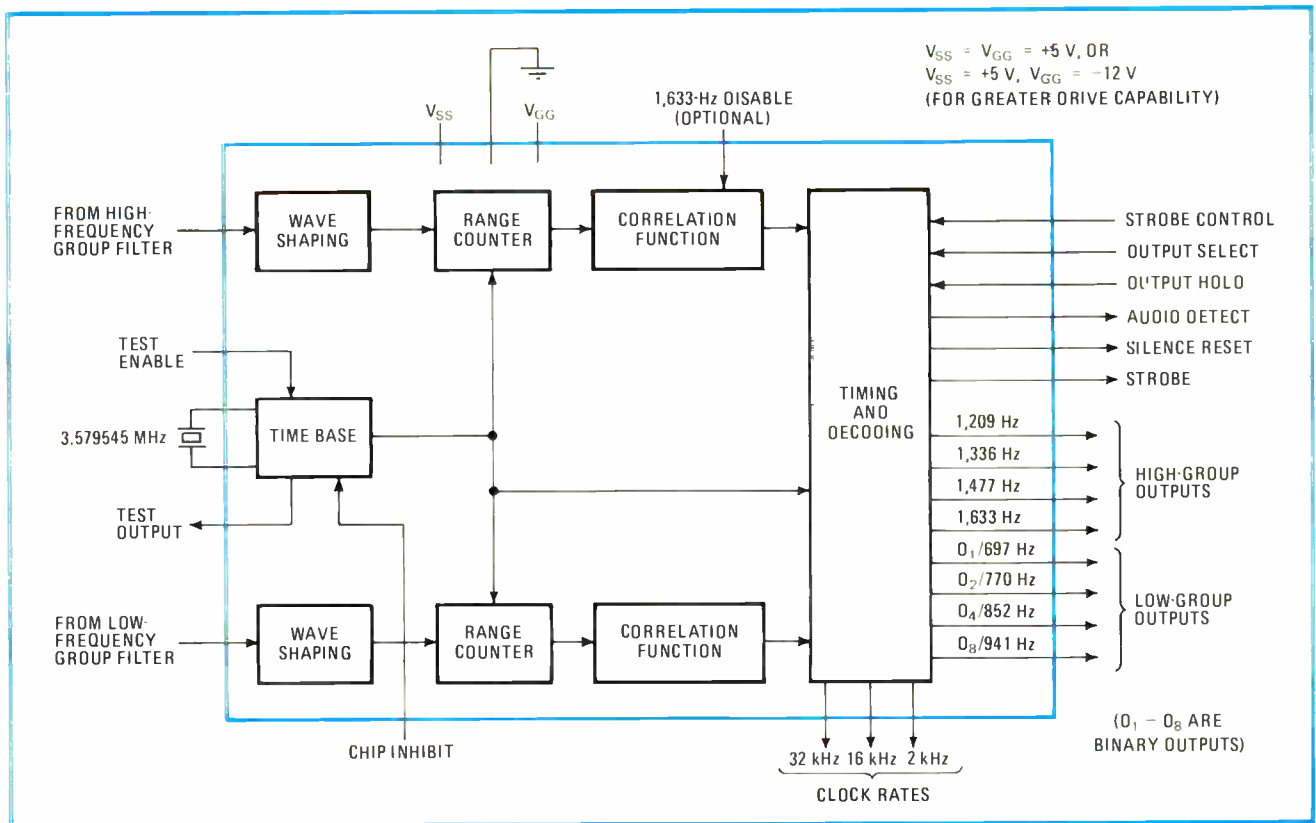

6. Detecting tones. Collins CRC 8030 DTMF detector includes time-base, wave shaping and correlation circuitry, as well as output timing and decoding functions to convert high and low group-filtered frequencies into binary data or 2-of-8 coded data.

boast of the PCM repeater chip. Pulse-code-modulation repeaters are used every few thousand feet in telephone lines to reshape and retune voice-frequency signals transmitted digitally. The regenerated pulse drives the next section of the line.

A monolithic repeater chip from Exar Integrated Systems Inc., Sunnyvale, Calif., replaces about 90% of the electronic components and circuitry in a discrete repeater and operates over a temperature range of -40°C to 85°C . Two chips are required for bidirectional operation.

The initial chip, the XR240, does the basic job very well, says Alan Grebene, vice president of engineering at Exar. But most of the equipment suppliers asked for modifications they felt were necessary to meet Bell specifications. So Exar developed the XR277, which incorporates the various modifications, as well as drawing less power—12 milliamperes at 6 v instead of 13.5 mA at 8 v. The reduced power is important to designers of repeater equipment because Bell has been pushing for low-power repeaters to cut demand on the central-office power supply. A new version on the drawing board will operate with lower s/n ratios at the repeater input, thus allowing greater space between the repeaters while assuring the same bit-error rate at the output.

Codecs are coming

The key to a fully digital phone network is the coder/decoder that converts analog voice to digital code and at the other end reconverts the coded bit stream back into voice signals. Using upwards of 200 discrete

components handwired onto a couple of relatively large pc boards, codecs are expensive.

To cut costs, phone companies have shared a single high-speed analog-to-digital and d-a converter among many telephone lines. But the cost is still high. Equipment designers would replace the single expensive codec if LSI codec chips were cheap enough to use on every telephone line with multiplexing of the resulting digital bit streams. The analog multiplexers could then be replaced with simpler, cheaper digital chips that are much less bothered by crosstalk.

Either a logarithmically companded PCM or a form of delta modulation can generate the digital codes used in telephone systems. The log-PCM circuits perform instantaneous companding in a time-invariant nonlinear process, while adaptive-delta-modulation circuits perform syllabic companding, a kind of automatic gain control that essentially is a time-varying linear signal processing.

The 32-kilobit-per-second sampling rate of ADM would seem to make it more attractive for voice digitizing than the 64-kb/s rate of PCM. But all over the world, PCM is firmly entrenched in telephone networks—and it is better for data signals.

However, ADM's efficiency, economical implementation, and lower idle-channel noise make it attractive in other applications such as military communications systems, mobile telephones, and some satellite channels.

A few companies, among them Motorola, Harris Semiconductor, Melbourne, Fla. and Consumer Microcircuits of America, Galesburg, Ill., have monolithic

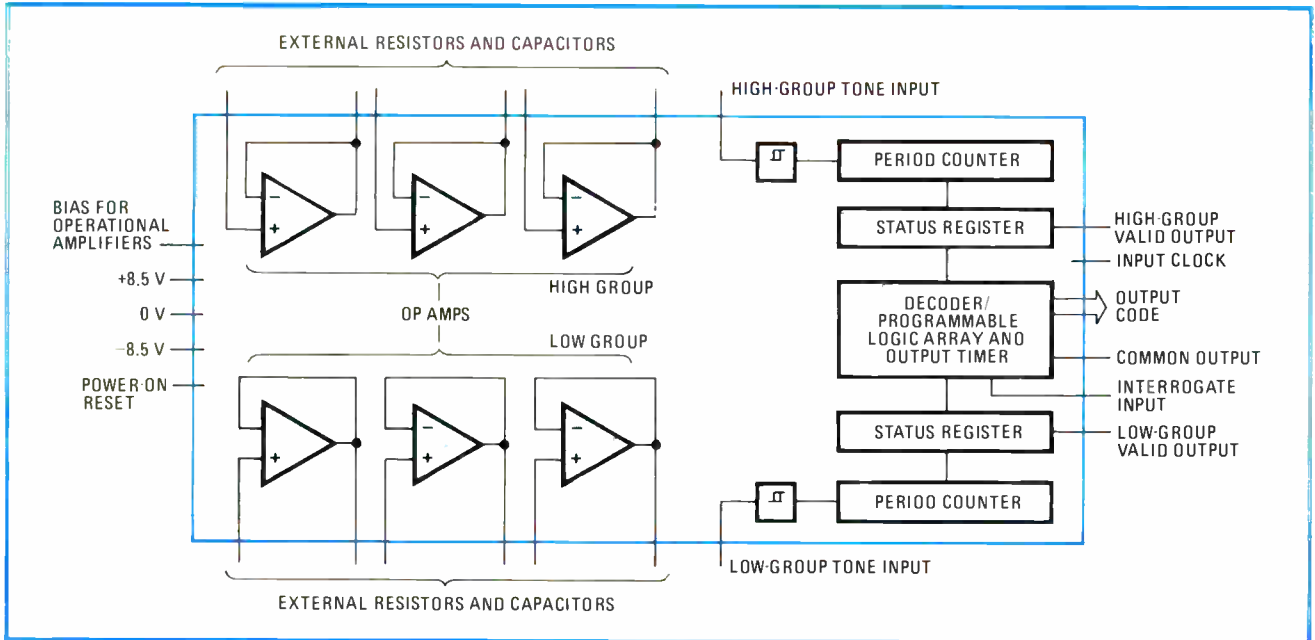

7. Tone receiver. Adding external resistors and capacitors to those models with on-chip op-amps in General Instrument's AY-5-9800 series of multifrequency tone receiver devices provides active filters to separate low-group and high-group tones.

versions of ADM codecs. But at least a dozen other semiconductor manufacturers have PCM codecs that are in varying stages of readiness.

Precision Monolithics Inc., Santa Clara, Calif., the first company with a monolithic companded d-a converter on the market, is adding the circuitry such as sample-and-hold and control circuits necessary to turn its Comdac into a full-blown codec. Other semiconductor firms, such as National, Siliconix, Signetics, Intel, AMI, Exar, Motorola, Fairchild, Raytheon, General Instrument, AMD, and Telenetics have LSI codecs in various stages of development. Of the several telephone companies working on codecs, Bell Northern Research has the most sophisticated device of all under test in its laboratories. It is a one-chip codec that includes charge-coupled filters.

Different designs

Instead of two on-chip converters, National's two-chip codec shares a single d-a converter between code and decode functions (Fig. 8). Since the a-d conversion always takes longer, it is continuous until d-a conversion is necessary. Then an interrupt takes place, and the a-d information is stored in memory until the d-a conversion is quickly accomplished.

The codec contains all the elements for converting one channel of voice input to standard 8-bit PCM and back to voice. It has a companded d-a converter and a successive-approximation register that makes it possible for the converter to perform the a-d encode function.

The National codec will directly generate a companding code that meets either the μ 255 standard used in the U. S., Canada, Japan, and some South American countries, or the A-law standard used in the rest of the world. The μ 255 standard calls for compressing the input signal according to a piecewise linear approximation of a logarithmic relationship where μ is the companding coefficient

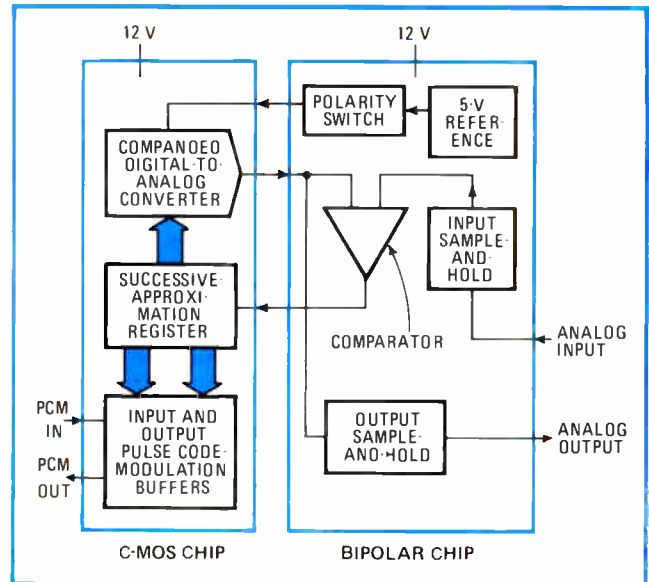

8. Shared. National's two-chip PCM companded codec—a 24-pin C-MOS DIP, and an 18-pin bipolar DIP—shares a d-a converter between encode and decode functions. A successive-approximation register is used with the d-a converter to perform the a-d encode.

in the log equation used. The similar A-law standard uses a slightly different companding coefficient.

Of the two National chips, the MM48100 is C-MOS, and the LM2700 is bipolar. The C-MOS chip has high-speed input and output buffers that allow the PCM words to be transmitted or received as a burst at any rate from 64 to 2,048 kb/s.

The bipolar analog chip has input and output sample-and-hold circuits, a precision 5-v reference, a polarity switch that converts the reference voltage to +5 v or -5 v depending on the most significant bit, a comparator, and an autozero function that eliminates drift. The zero

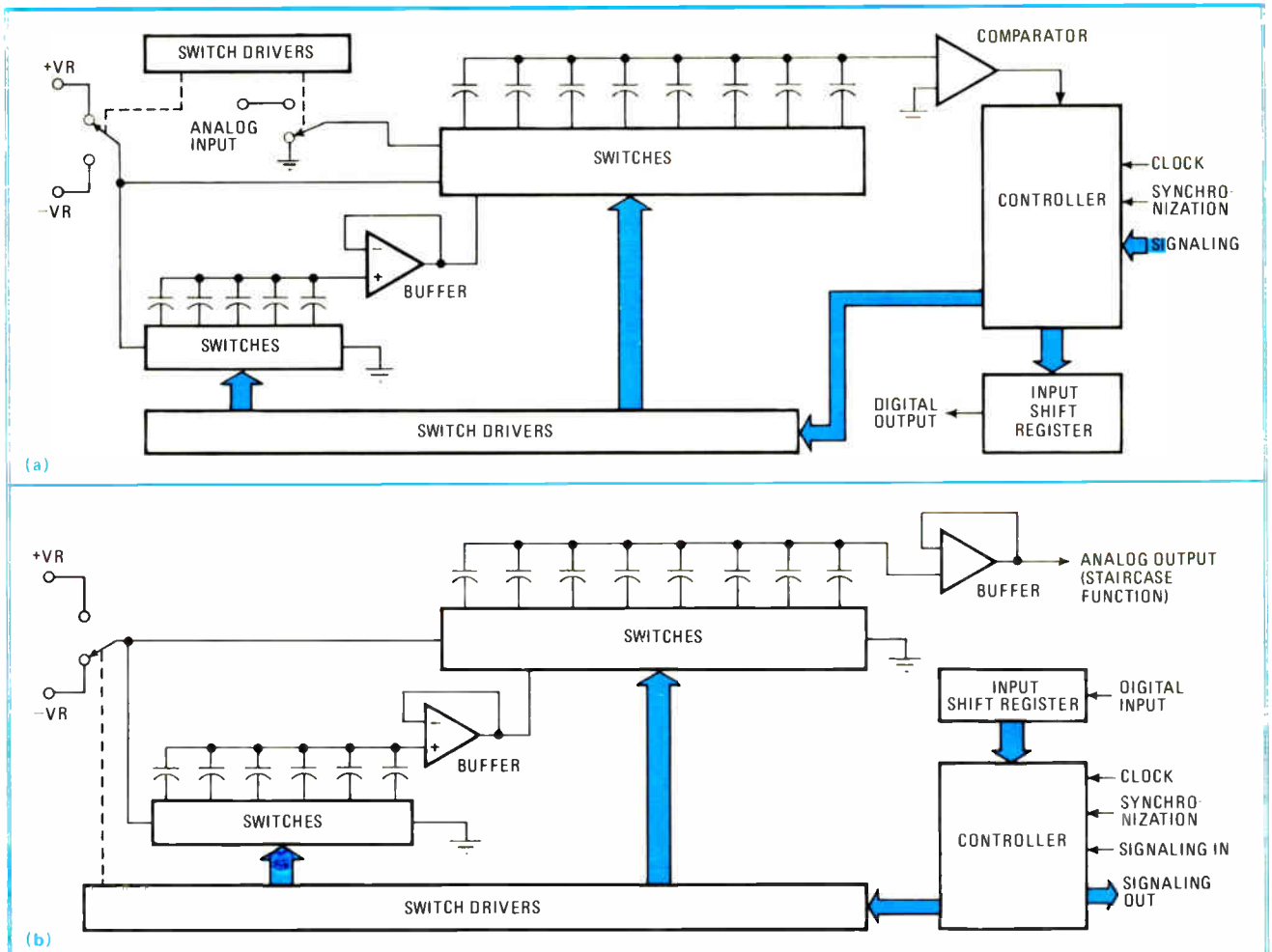

9. Separate functions. Siliconix also uses two chips for their companded codec. One chip (DF331) handles the encode chores (a); the other chip (DF332) does the decoding (b). Each works independently and can function at either North American or European sampling rates.

point of the d-a transfer can be shifted by temperature-induced drift, and eventually increased noise will result.

Other than power-supply-decoupling parts, the National codec requires only four external components. The sample-and-hold circuit has two 100-picofarad and a 0.1-microfarad capacitors and a 1-megohm resistor in the autozero filter. The codec can operate in a range of ± 8 v to ± 12 v with a typical dissipation of 150 milliwatts at 8 v.

Other codecs

A two-chip C-MOS codec that requires no external components except for input and output filters is available from Siliconix Inc., Santa Clara, Calif. The DF331 encoder (Fig. 9a) and the DF332 decoder (Fig. 9b) work independently of one another and can function at the North American 8-kilohertz sampling rate or the European 16-kHz rate.

A single-chip codec from Signetics Corp., Sunnyvale, Calif., is implemented with integrated injection logic. The breadboard version (Fig. 10) of the ST100 uses several ICs on a pc board and has already been checked out by major telecommunications-equipment makers. Samples of the 24-pin DIP version using 1^2T technology will be available later this year, with pricing of \$6 each

in 100,000-piece quantities expected.

A similar single-chip C-MOS codec for both $\mu 255$ and A-law companded 8-bit PCM systems is due from Motorola Inc.'s Semiconductor Products Group, Phoenix, Ariz. Scheduled for samples late this year, the chip will accommodate one full-duplex channel (Fig. 11). With a simple C-MOS transmission gate selector it will service two full-duplex channels, and it may be configured to decode four channels simultaneously.

The chip houses three op amps, a $\mu 255$ or A-law current-steered d-a converter, input and output sample-and-hold circuits that require two nonprecision external capacitors, and all the digital interfacing needed for the various standard PCM frame formats.

The 24-pin device uses the successive-approximation technique in the a-d conversion and will time-share the d-a converter for decoding serial digital words. It also has autozeroing.

A codec using charge-redistribution techniques with MOS capacitive voltage dividers to implement both d-a and a-d conversion and companding is coming from AMI. The firm's designers may even make the code pin programmable for either $\mu 255$ or A-law companding.

Industry sources expect Intel Corp., Santa Clara, Calif., soon to introduce an n-channel MOS single-chip

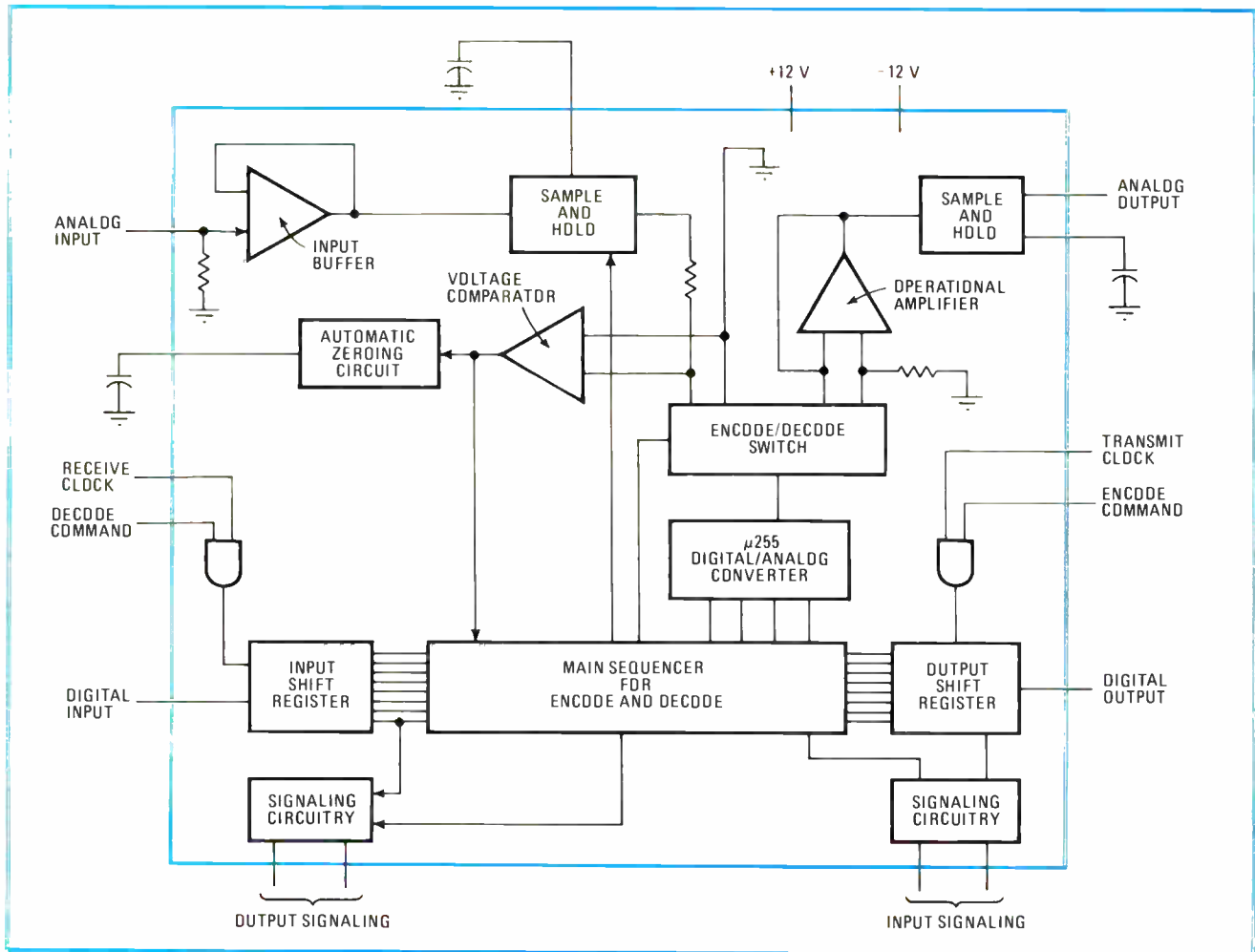

10. Single-chip sharing. Signetic's single-chip companded codec, the ST100, timeshares a digital-to-analog converter between code and decode functions. The L chip can operate at clock rates as high as 2 MHz and is capable of asynchronous operation on transmit and receive.

codec with some on-chip filtering. Also on the chip is circuitry allocating time slots or receiving control inputs from a microprocessor when the codec is shared among many telephone lines.

Low-cost filtering, such as an on-chip filter, is essential to the success of LSI codecs, because telephone companies say they need a \$2 codec plus filter to make it economically feasible to install a unit in each telephone. Right now semiconductor makers are considering pricing codec chips without filters at something under \$10 in large quantities, and some active filters cost about \$7 in large quantities.

Two filters

Codecs require two filters. A low-pass filter on the analog output gets rid of high-frequency noise and may smooth the reconstructed voice signals with minimal distortion. At the digital input, an aliasing filter removes any spurious high-frequency signals that might get translated down to the lower voice frequencies, thus causing intermodulation problems.

Active filters—op amps plus resistors and capacitors—are one solution, if large-volume production is possible. The many requirements for different center frequencies, bandwidths, and the like have worked

against standardization, but in the telephone industry these parameters are fixed. So the semiconductor firms are taking a new interest in active filters—National and GI, among others, have models on the market.

Signetics is developing an active filter using 1^2 technology and ion implantation to maintain the tight tolerances required to eliminate costly trimming of on-chip monolithic resistors. Small capacitors outboard of the chip will still be needed.

Another possibility is the hybrid approach that Bell Labs is investigating. The device under development uses monolithic op amps, chip capacitors, and thin-film laser-trimmed resistors.

However, some industry observers think a technology breakthrough is necessary to crack the filter price barrier. Perhaps closest to this goal is Bell Northern Research with its single-chip codec companding incorporating charge-coupled devices for the necessary filters. A BNR spokesman predicts that these one-chip devices will be commonplace in competitive digital-switching systems by the early 1980s.

The costly filters in the transmission part of the phone network are another target for semi houses. In frequency-division-multiplexing equipment, frequency-synthesizer chips are generating the transmission

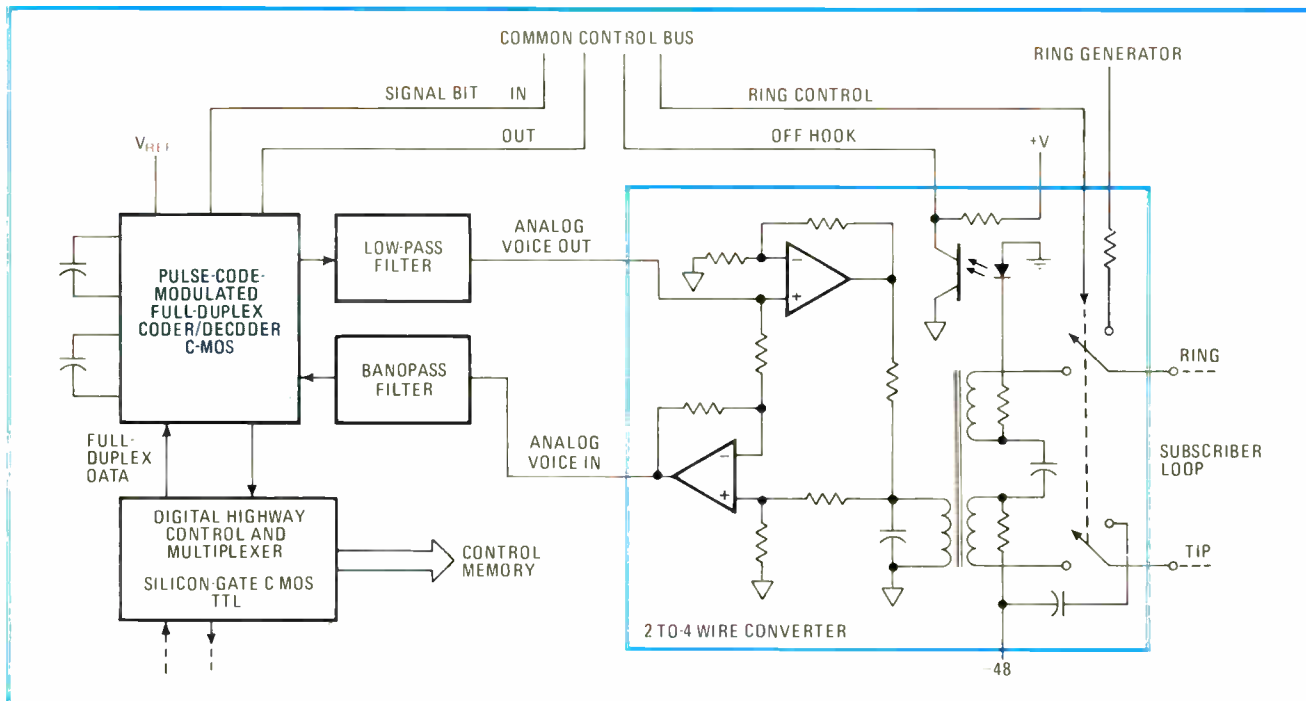

11. Per-channel codec loop. Motorola's C-MOS codec will accommodate one channel of full-duplex operation. With a simple C-MOS transmission gate selector, it will handle two full-duplex channels. It may also be configured to decode 4 channels simultaneously.

frequencies accurately enough so that filter banks are not necessary.

The Signetics 8X08 80-MHz chip is a typical example. It can generate as many as 1,999 frequency channels from a single crystal-controlled oscillator. It combines emitter-coupled logic and low-power Schottky TTL on the same substrate to implement counters, phase detector, reference oscillator, and programmable divider chain.

An LSI chip geared for analog telephone applications is the monolithic compandor. The analog equivalent of the codec, it expands and compresses voice signals to improve the s/n ratio. Exar's XR2216 and Signetics' 570 for trunks and 571 for single lines are typical compandor chips.

Also for analog systems is the modulator/demodulator chip that functions as a transmitter and receiver. A modem is essentially an a-m carrier system for frequency-multiplexing several conversations onto a single telephone line.

National has developed a two-chip FDM modem, the LM1823/6 that translates several voice frequencies simultaneously to some frequency between 20 kHz and several hundred kilohertz. Translation back to voice takes place at the other end of the transmission line.

In spite of the long-term trend toward digital phone systems, there probably is a good market for compandor and modem chips in existing analog equipment, which accounts for better than 80% of today's telephone network. Recent legislation encourages more one-party lines in rural communities, and these analog chips will help make them possible at least cost.

Just as in voice transmission, LSI is beginning to provide designers of data-communications equipment with powerful new chips. The chips will bring similar advantages, but the emphasis is on programmability.

The density of LSI shrinks the size, power, and cost of existing hardware, while programmable operation permits the same part to be used as a standard component throughout the system. Adaptability is another important benefit of programmability. Changes in baud rates, character lengths, error checking, and protocols can be accommodated through software configuration. Redesign time and cost are reduced significantly, and product life is improved.

Focus on data communications

Typical of the new LSI chips tailored for data-communications equipment are two programmable serial-communication circuits from Signetics. The 2651 PCI is a programmable communications interface; the 2652 MPCC is a multiprotocol communications controller.

The 2651 PCI combines the functions of a universal synchronous asynchronous receiver/transmitter with those of a baud-gate generator in a 28-pin DIP. The MOS chip is fully compatible with TTL, does not require a system clock, and operates from a single 5-v supply. A straightforward addressing scheme makes it compatible with most 8-bit microprocessors.

The chip greatly reduces hardware requirements and software overhead in modems, particularly for character- or byte-controlled protocols such as Digital Equipment Corp.'s DDCMP and IBM's Bisync. Its self-test capabilities can pinpoint failures in the processor-communications interface, in the modem, or in the communications channel—either locally or remotely.

The 2652 MPCC can receive, format, and transmit serial digital data in bit-oriented protocols such as IBM's SDLC (synchronous data-link control). Its ability to manage these protocols minimizes software-control requirements and program-development time. In a 40-

pin DIP, it can replace as many as two pc boards full of components.

The chip operates at speeds as high as 500 kb/s from a single 5-v power supply and is fully compatible with TTL circuits. Both receiver and transmitter sections are double-buffered and operate in half- or full-duplex modes. The 2652 can interface with an 8- or 16-bit data bus, which makes it compatible with minicomputer and microcomputer systems.

System designers put LSI to work

Equipment designers have already seized upon LSI circuits as the solution to many of their problems. As well as those chips already described that are in production, engineers are using semiconductor memory for storage needs in central-exchange offices and PBXs.

Microprocessors, custom logic, and timing chips are enhancing performance without adding much cost and are permitting updating and customizing of installed equipment through software changes. They are serving in sophisticated digital switching systems that route calls and data throughout the telephone network, and in PBXs and keyphone systems. In intelligent data terminals, they are being used for code conversion, transmission-error detection and correction, and data formatting. In telephone central offices, they are upgrading equipment to provide faster more versatile service.

An early example of LSI use was the CBX, an all-electronic computer-controlled PBX that Rolm Corp., Santa Clara, Calif., introduced in 1975. In addition to



13. User's choice. The custom LSI digital timing chip in the hand forms the heart of two Collins Radio single-frequency signaling units: the "piggy-back" version (lower left) that plugs directly into a Collins channel multiplex modem, and the stand-alone version directly behind. Above the stand-alone version is its Collins predecessor that updated the Western Electric signaling module (top).



12. Flexible dialer. The four printed-circuit cards of the speed-tone dialer can be programmed to provide other functions as well. The controller card in front houses a 6800 microprocessor, four PROMs, and two C-MOS RAMs with additional sockets on board for six more.

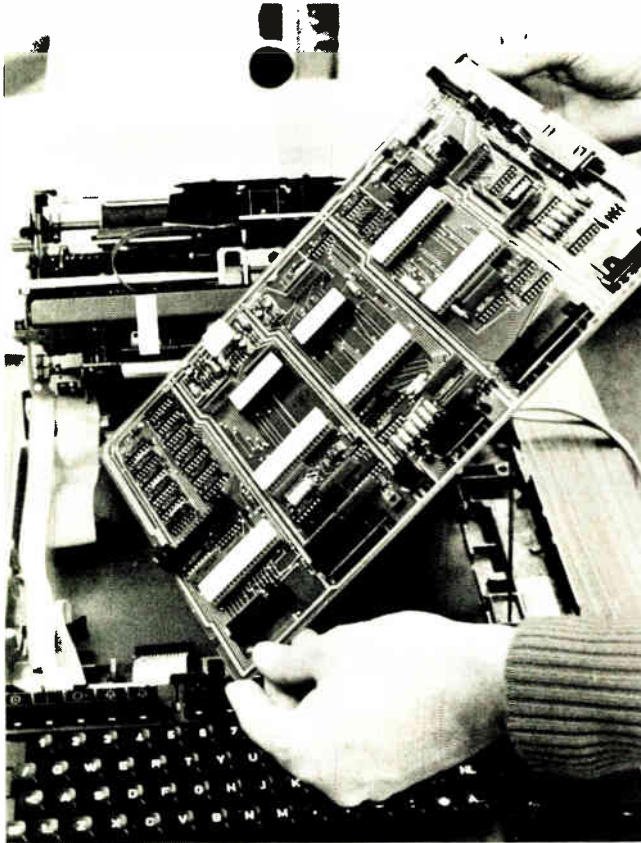

14. LSI shrinks size. Siemens' Teleprinter, model 1000, is built around seven MOS circuits. Custom-designed chips are used because standard, commercially available circuits would require considerably more peripheral components.

using much semiconductor memory for software implementation of formerly hard-wired functions, the system has an LSI-implemented module for self-testing, changing extension numbers and similar functions through remote software programming. CBX uses a shared-codec approach, but Rolm's designers envision per-channel LSI codecs with on-chip filtering in the long run.

One LSI chip in the module is the Collins CRC 8030 tone detector in the DTMF receiver board. Rolm's product plans feature microprocessor use in some desk telephones for special call routing and the like, in trunk interfaces for critical timing functions, and to lighten the load of the central processing units, thus permitting use of less powerful gear there.

The microprocessors on which Rolm has settled are Intel's 8080 and 8085. However, the designers are concerned because there is no licensed second source for these devices. "Others have copied the chip, but, like RAMs, microprocessor chips have pattern dependencies, and each manufacturer's chip is likely to be different," says James Kasson, engineering manager of Rolm's telecommunications division.

Microprocessors control the 580 digital switching system from Wescom Inc., Downers Grove, Ill., providing a single software package that meets the varied requirements of most telephone companies. Six 8080s in a distributed-processing configuration control the system. Each processor has its own memory unit,

which means the setup is inexpensive to interface, simple to program, and easy to maintain.

The Vidar division of TRW in Palo Alto, Calif., also takes advantage of low-cost LSI circuits in its new integrated digital switching system to distribute the processing load among various system elements instead of having a single large controller handle it all. The system, IMA2, was designed to meet telephone-company transmission and switching needs in rural exchanges. As well as integrating the standard functions, it provides automatic message accounting.

Let the software do it

The distributed processing permitted Vidar to use 8080 microprocessors and LSI memory. Digital words representing all the tones needed in a telephone office (dial, ring-back, and the like) are stored in a nonvolatile ROM and are converted to audio tones in a d-a converter upon command. The controlling unit is an 8080 with its programs and data stored in a 4,096-bit RAM and with a magnetic-tape cartridge for program backup. The switching function also uses LSI memory.

The high reliability demands of telephone systems means that faults must be detected quickly and redundant devices switched in without human intervention. The standard approach is to use two large computers with their outputs compared to determine a fault. Since 30% to 40% of the system software must be set aside just for self-test routines, each controller must have sufficient capacity for that as well as for the switching.

Vidar's new switching system uses a primary and secondary controller setup, with two microprocessors and comparator circuitry in both the primary and secondary systems. The two processors in each controller run in parallel. The outputs are compared, and any difference results in control being switched to the other system. Eliminated is the need to test for the faulty processor in the primary system. Since the processors need not perform self-diagnosis, they can be simpler devices than is necessary in the standard approach. Vidar's approach was made possible by low-cost microprocessors, LSI circuits, and some innovative software programming.

Other equipment manufacturers are taking advantage of the microprocessor's ability to handle program changes easily through software, even after the design is finalized. For example, Mitel Corp., Ottawa, Canada, uses Motorola 6800 microprocessors and LSI circuitry through several orders of system complexity.

The simplest kinds of these microprocessor-based products are used on a single line; for example, the CM8300 speed-tone dialer in Fig. 12 can be programmed not only to speed-dial numbers on a 2-digit command but to store as many as 90 16-digit telephone numbers for quick automatic dialing. With a slight modification, the 8300 will allow computers to automatically call one another when data transfer is required. Terry Matthews, the firm's executive vice president, says that simply adding more LSI chips to one of the four common pc cards can provide an updated or entirely new dialer without excessive redesign time or high cost.

Often the microprocessor's power is not necessary, and equipment designers are using other LSI circuits to take

over some of the functions of existing equipment they are updating. Typical of this approach is the recently developed in-band signalling board that snaps onto an existing section of a modem on a pc board (Fig. 13) from Rockwell International's Collins Radio Group, Dallas. It uses a custom LSI circuit manufactured by the firm's Newport Beach, Calif., facility. The circuit provides the timing control for transmitting and receiving and digitally reshapes incoming pulses.

With such a relatively low-cost retrofit, phone companies can pick up the advantages of in-band signalling, which eliminates two of the six wires required for each telephone line going to a central office. The reshaping of incoming pulses also means that marginal trunk performance may be improved.

A custom chip, developed with Exar, appears in a direction-detector subassembly from Lorain Products Corp., Lorain, Ohio. The firm puts the subassembly in its voice-frequency switched-gain PCM repeater module for two-wire telephone lines. From the existing hybrid subassembly, designers developed a discrete version, then a two-chip semicustom version, and finally the custom version. Frederick J. Kiko, the firm's manager of transmission research and development, says the full-custom subassembly needs no resistor array or field-effect-transistor switches, as did the semi-custom model. Moreover, it costs only an eighth of the hybrid version.

In Europe, LSI is helping teletypewriter designers shrink size by two thirds. It considerably reduces the number of moving parts, which improves reliability and cuts noise levels to less than one quarter the level of conventional electromechanical teletypewriters.

The new machines are coming from Siemens AG and Standard Elektrik-Lorenz, both in Germany, and from Philips Gloeilampenfabrieken in the Netherlands. The Siemens Teleprinter 1000 is built around seven custom MOS circuits (Fig. 14). Hans Helmrich, a director of Siemens' communications division, says that these LSI circuits have made possible functions that would be expensive and space-consuming if implemented by conventional techniques. A further advantage is a considerable reduction in assembly costs, he says.

The Philips teletypewriters can serve as programmed all-purpose communication terminals for telex and telegraph use and for data communications. Like the Siemens machine, the microprocessor-controlled terminal is smaller and quieter and has fewer moving parts.

Transforming the telephone

The most apparent revolution that LSI will bring to the telephone system will be the changes in what the telephone will look and what it can do. Several telephone companies, both in the U. S. and abroad, are working on LSI replacements for the electromechanical innards of the standard telephone. The aim is to include everything: the 2-to-4-wire hybrid transformer, the bell ringer, the carbon microphone, the receiver, and the dialpad

15. Electronic telephone. This set, undergoing trials in Canada, consists of (top to bottom) a conventional chassis, a calculator-type keyboard, a 3-chip solid-state circuit pack (to be replaced with a single LSI circuit), a tone ringer, a transmitter, and a receiver.

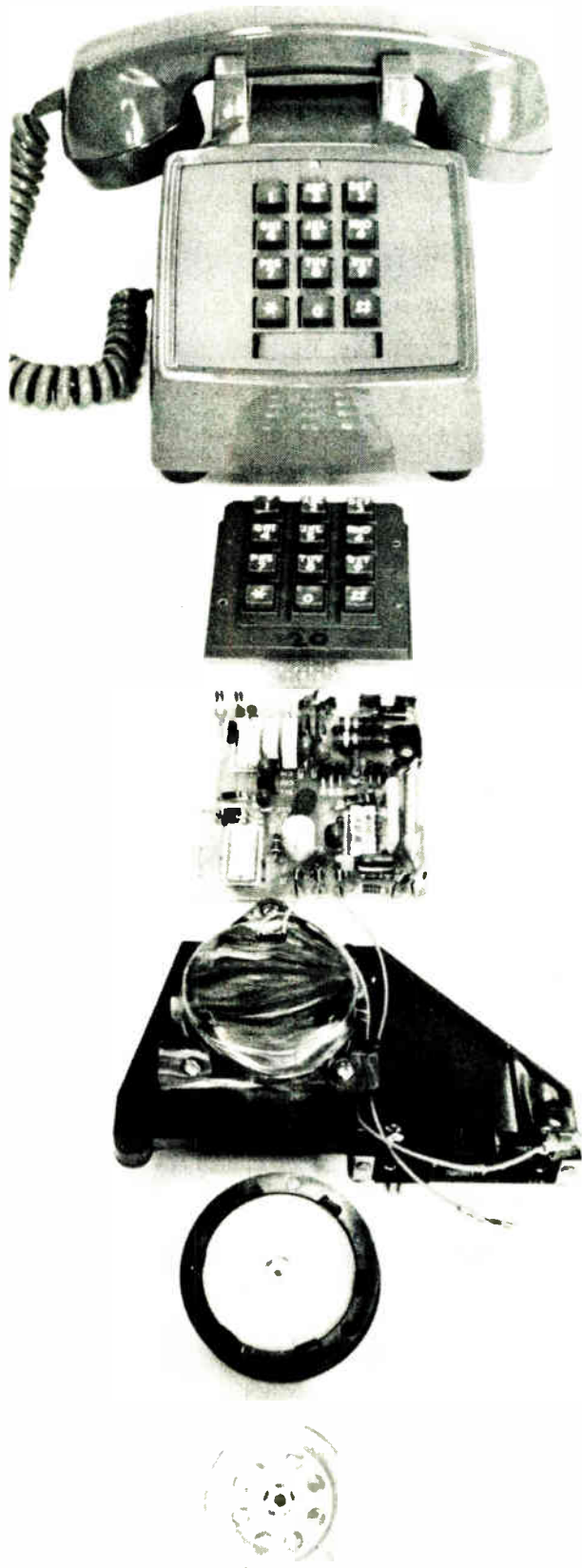

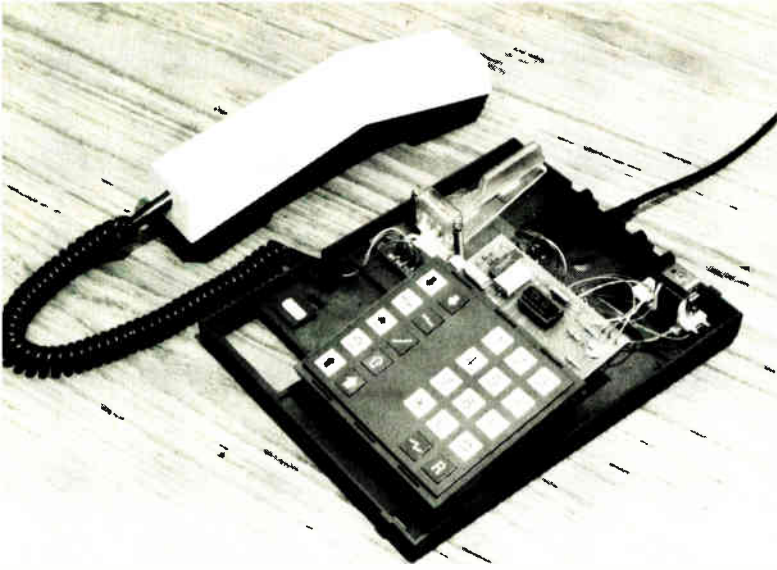

16. New generation. The key telephone, above, is part of GTE's new ATEA-8000 electronic business telephone system that incorporates several LSI chips designed in Belgium using computer-aided design tools worked out by GTE Labs, Waltham, Mass.

keyboard assembly. In Great Britain, ITT's Standard Telecommunications Laboratories is developing an LSI chip using standard buried-collector linear technology for a fully electronic operation in a standard chassis. But in Canada, BNR has 200 telephones already in field trial that have three-chip packages (Fig. 15). The phones combine a calculator-type keyboard with the three ICs. Under development is a single I-L chip that will replace all three chips.

The real advantage of LSI for phone innards is the extra features it will permit in new models and retrofitted standard units. Of course, the chips' small size signals an eventual wholesale redesign of the telephones.

Still, there is no general agreement on a time-table for the all-electronic telephone. Some observers predict it will appear in the telephone network within several years. At the other extreme, some think it will never go into widespread use. The telephone is the common denominator in any telecommunications system, and changing even a screw is a momentous event, says Mitel's Terry Matthews. This fact of life, coupled with the telephone's harsh operating environment, will hinder acceptance of electronic phones.

However, telephone manufacturers around the world are offering phones with calculator-type keyboards and tone-dialer and repertory-dialer chips. Besides Pye's Instaphone and Multicall and Bell's Touch-a-matic and new keyphones, there are ITT's Quickstep, the Digitone from Bell Canada's Northern Telecom Ltd., and GTE's new generation of electronic business-telephone systems, the ATEA-8000 (Fig. 16). An AT&T spokesman predicts that by the early 1980s, LSI circuits will appear widely in the company's PBX and keyphone systems—which currently are less than 1% electronic models.

Various equipment makers are marketing telephones with similar features directly to the consumer. Since LSI makes such features as repertory dialing an economic reality, more and more products are showing up. While the market is small, it could grow in light of recent rulings by the Federal Communications Commission

that make it easier to plug such equipment directly into the telephone network. The big question that remains is whether consumers will be willing to pay for the conveniences the new equipment offers.

What's ahead

The trend toward microprocessing techniques in all phases of telecommunications is already under way, and with the increasing availability of LSI chips aimed at communications chores, rapid acceleration is a certainty. The list of LSI applications will grow to cover everything from pocket phones to satellites. As more digital exchanges go into place, emphasis will be put on using low-cost codecs and filters for individual phones, thus completing the last link in a fully digital network.

Telephones seem destined for other changes, as well. "LSI is showing that you might bring the computer into a man's home with a TV-telephone-modem-computer combination," says John Shields, an ITT-Europe vice president. "LSI chips are making it possible for telecommunications to interact in new ways with the consumer."

It is not difficult to imagine the sophisticated telephone of the future with a DTMF receiver and control circuitry enabling the user to dial his or her home number and use more tone signals to get the phone to go off-hook electrically and to execute various commands. A phone call could turn lights on or off, regulate the thermostat, or start the oven.

With the telephone and a low-cost LSI-implemented intelligent terminal, a user could gain access to a computer in a library or other central location and receive information via the telephone line. In like manner, a salesman with a portable tone generator could quickly send information to a central computer. With a small visual receiving device, the salesman could acquire information instantaneously from the computer via tone signalling over telephone lines. Today, small portable cathode-ray-tube terminals with built-in modems serve this function, but for simple data transfer, the tone-receiver chip could cut costs drastically.

Utilities could automatically read gas and electric meters via the telephone network. Other service companies could obtain similar data. For example, American Subscription Television of Los Angeles will be sending scrambled TV programming over Channel 22 and then automatically bill subscribers for programs viewed by tying the leased home TV decoder to a central computer via the telephone network. Standard Microsystems Inc., Hauppauge, N.Y., is already building the LSI chips needed under a contract with Clarion Corp., a major Japanese manufacturer of electronic equipment.

A final area of telecommunications that will rely on LSI circuits and microprocessors is the rapidly developing field of teleprocessing—data communications, Picture-phones, and the like. The output of almost all data-processing equipment requires additional processing before transmission over the phone network. Moreover, the need to protect communicated data is creating a new family of LSI encryption/decryption chips. □

Reprints of this special report cost \$3.00 each. Write to Electronics Reprint Dept., P.O. Box 669, Hightstown, N.J. 08520. Copyright 1977, Electronics, a McGraw Hill Publication.

Want ~~4~~-week turnaround on 16K ROMs?

Send us your debugged EPROMs.
We'll talk back to you
in the same language.
It's getting easier!

Call Synertek.

If your ROM codes—on cards or paper tape—are in one of the usual formats, we handle them the usual way. And quick. BUT GOOD NEWS! If your program is in 2708 EPROMs, we can speed things up and simplify your life. Send us your debugged 2708's; we'll read your EPROMs directly into our mask-generating computer, and then send you a couple of new EPROMs back, programmed with your code, for verification, to make sure nothing got lost in translation. Fast. Simple. And you don't have to proof-read 16,384 1's and 0's. We think you'll drink to **that!**

2-week turnaround for prototype

The secret is metal-mask (last mask) programming! Other ROM suppliers use



contact-mask or diffusion-mask techniques which means that a lot of wafer processing must be done after they receive your codes.

All we have to do is strip metal from wafers that are **already in inventory**. This last step programs your ROM code and also selects pinouts—the SY2316B (Intel's 2316E), the SY2316A, or the SY4600. Metal-mask programming—a great approach if you're in a hurry for ROMs.

Give a call to your local Synertek rep or distributor. Or call Bob Cushman at the factory. (408) 984-8900. TWX 910-338-0135.

Synertek.
Solutions.
Not problems.

Sorry, we can only give 2 week turnaround on 4C codes per month (25 pieces per code). All others within the standard 4-week time frame. It's first come, first served!

Sample-and-hold and op amp form special differentiator

by John Nolte

University of Colorado Medical Center, Denver, Colo.

A sample-and-hold module and an operational amplifier can form a differentiator circuit that is especially useful at very low frequencies. In both accuracy and noise immunity it leaves conventional differentiators far behind, even when they are built with highest-quality components, i.e. low-drift, high-input-impedance amplifiers and high-value, low-leakage capacitors.

High-frequency noise, which can upset the operation of the common RC differentiator, is no problem with this "digital" circuit because its gain is independent of the noise frequency. In addition, its frequency of operation is set simply by adjustment of the sampling frequency. The circuit is therefore capable of a wide frequency response, quite unlike its analog counterpart, in which the components selected to reduce high-frequency noise also narrow the frequency response.

In essence, this circuit solves the equation for the slope of a line. The equation may be expressed as:

$$E_f = (d(e)/dt)dt$$

1. Sample waveforms. Input signal V_{in} (shown here as $\cos t$) is sampled at rate V_{T1} , and sample-and-hold output V_s is a sawtooth with an envelope that is the derivative of V_{in} , or $-\sin t$. Final sample-and-hold produces staircase of derivative, V_{out} .

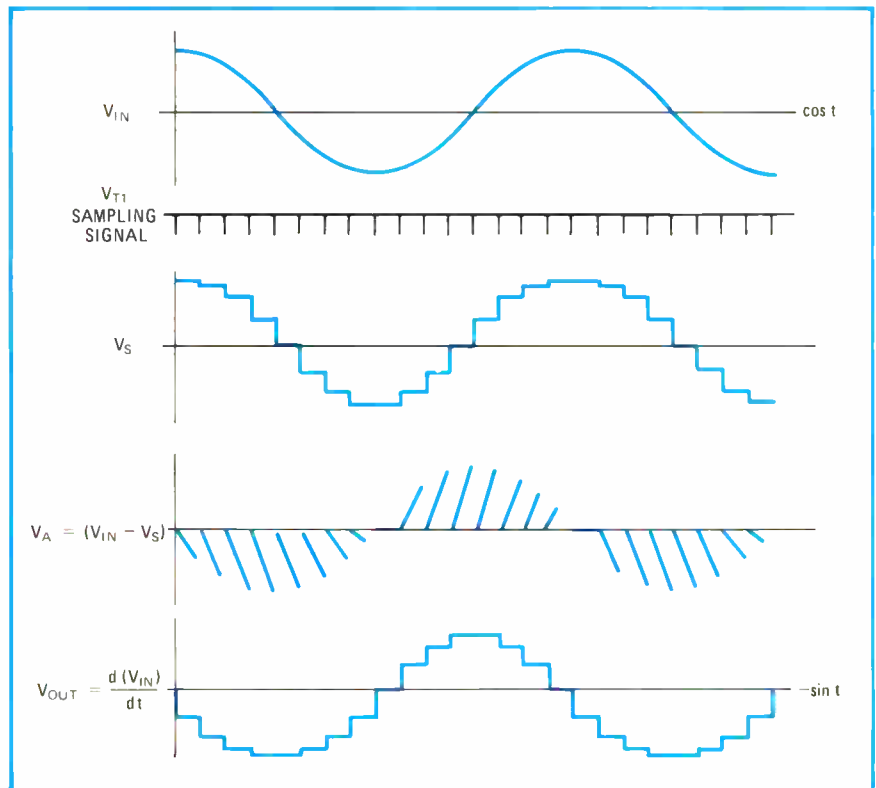

where E_f is the final output voltage at the time immediately before the next sample, and $d(e)/dt$ is the change in input voltage between sampling intervals, or the derivative of the input signal with respect to time. The output waveforms in Fig. 1 indeed confirm this equation. How is the output generated?

As shown in Fig. 2, the input signal V_{in} at pin 2 is sampled at a frequency introduced at pin 1 of the AD582 sample-and-hold device. The output of this device charges capacitor C_H with the instantaneous V_{in} potential at the sampling instant; therefore the output signal V_s is a staircase approximation to V_{in} , for a small sampling time with many samples taken per input frequency. (For clarity's sake the waveforms in Fig. 1 show a disproportionately low sampling frequency.) The difference between V_s and the original input frequency V_{in} is amplified by the 741 operational amplifier.

During each sampling period, the difference between these two signals is zero, making the output of the 741 (V_A) also zero. However, during each hold period, the output of the op amp rises to a value proportional to the change in input voltage with time. This proportionality is more or less linear, because of the small change in V_{in} versus V_s during a single sample period.

The output of the 741 is therefore a sawtooth waveform with an envelope (formed by the sawtooth peaks) approximating the derivative of V_{in} . To yield a true staircase approximation of the derivative, a second sample-and-hold device can be used to sample the peaks

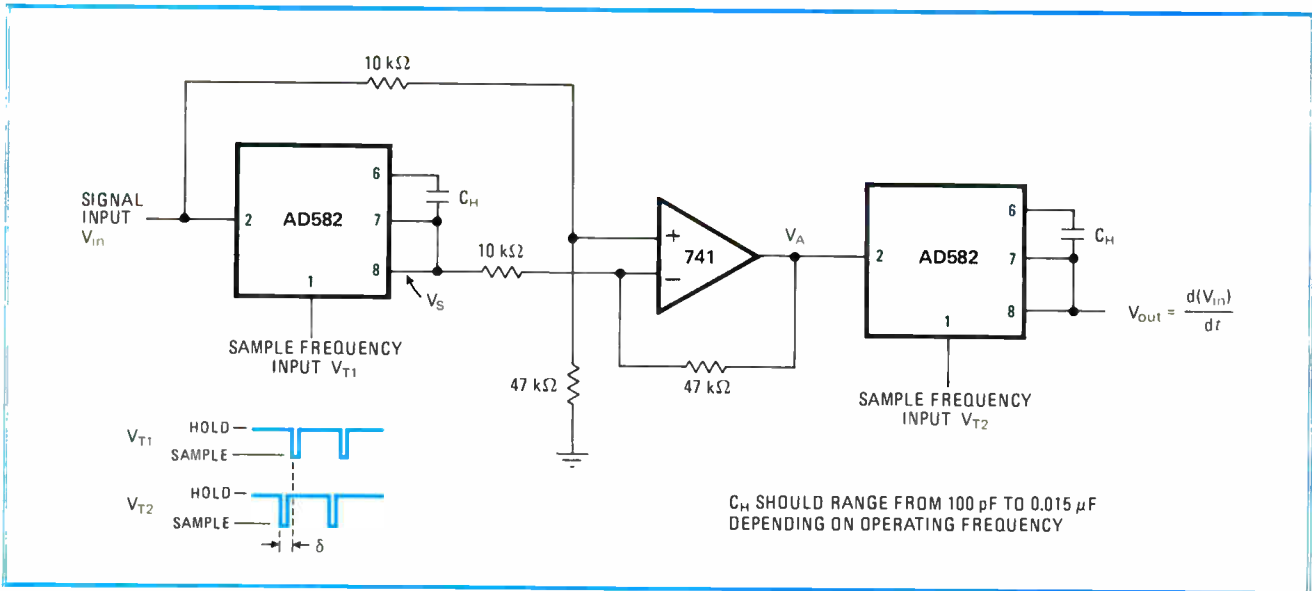

2. Different differentiator. Particularly useful at very-low-frequency signals, this differentiator uses a sample-and-hold and a difference amplifier to obtain the slope of the waveform. Second sample-and-hold recovers peaks of differentiated waveform. Negative pulse train (duty cycle approximately 1%) for sampling signals can be generated by a 555 timer circuit.

of the sawtooth, thus removing the unwanted components generated by the first sampling module.

For reasonable accuracy in differentiating a signal, the sampling frequency should be at least a few times,

but preferably on the order of 100 times, greater than the input frequency. Decreasing the sampling frequency will lower the input frequency that produces a full-scale or maximized-value output. □

FET pair and op amp linearize voltage-controlled resistor

by Thomas L. Clarke

Atlantic Oceanographic and Meteorological Laboratory, Miami, Fla.

A matched field-effect transistor pair can be combined with an operational amplifier and a few resistors to form a circuit in which one FET's drain-to-source resistance (R_{ds}) bears a precisely linear relationship to a control voltage (V_c). Though a single FET can serve as a voltage-controlled resistor, the relationship of R_{ds} to the gate-to-source voltage (V_{gs}) is nonlinear.

The basic idea in this circuit is to control V_{gs} through a feedback loop that senses if the amount of current flowing through the FET, and hence its R_{ds} , is of the proper value. As shown in Fig. 1, this is accomplished by deriving a signal from half of the FET and applying it to a "summing" node at the inverting port of an op amp.

The output of the op amp is connected to the gate of the FET, thus forming a closed loop. The resulting change in V_c causes a proportional change in R_{ds} because the op amp is a linear device, and because input voltages are compared to a fixed voltage (V_{ref}) at the noninverting terminal. Depending on the configuration, R_{ds} can be made proportional to V_c or its reciprocal.

In the circuit to be seen at the left of Fig. 1, R_{ds} varies in proportion to the reciprocal of the control voltage, as

is indicated by the following equation:

$$R_{ds} = |V_{ref}|R_c / (|V_d| - |V_{ref}|)$$

where V_{ref} is assumed to be between 0 and V_c . A voltage divider may be used to derive V_{ref} . Moving V_{ref} to the drain of the FET, as in the circuit to the right, the following equation holds:

$$R_{ds} = |V_{ref}|R_c / |V_d|$$

where V_{ref} should be a well-regulated source, since it may have to supply considerable current. These equations are based on the facts that V_c draws current from the negative input of the op amp through R_c and that this voltage drop results in current flow into the terminal by the FET. The application of Kirchhoff's law then yields the above relationships.

As shown in the circuit at the left of Fig. 2, R_{ds} may also vary in direct proportion to the control voltage. Therefore, the relationship becomes:

$$R_{ds} = R_d |V_d| / (V - |V_d|)$$

where V_c is greater than $-V_p$ but less than 0 v. This circuit, while not as linear as those of Fig. 1, can be improved significantly by replacing R_c with a current source, I , as shown at the right of Fig. 2. The relationship then simply becomes:

$$R_{ds} = |V_d| / I$$

The circuits are built with Siliconix 285 dual FET chips and LM324 op amps. Use of high-speed op amps such as the LM318 would permit more rapid variations of resis-



TYPICAL VARIAN RITTER PULSED POWER SOURCE

Varian resolves magnetron interface puzzles.

Radar system designers no longer need to be puzzled about matching magnetrons and modulator/power supplies, because Varian magnetrons are now available in completely interfaced Ritter transmitter packages.

Ritter, a recent acquisition of Varian, Beverly Division, has had extensive experience in airborne pulsed and CW transmitter systems, developing an expertise in high-density, high-efficiency and high-reliability packaged power sources. Ritter has shipped in excess of 2,000 subsystems annually, utilizing various types of prime power systems in the 3 kilowatt to 2 megawatt ranges.

The Ritter operation of Varian now offers the best combination of magnetron expertise plus excellence in modulator design and fabrication. All the system designer must supply are input conditions to the modulator and what he wants out of the transmitter. The Ritter operation of Varian does

the rest, including design, engineering and manufacturing—all with Varian's usual high standards of quality, reliability and performance.

To solve your magnetron interface puzzle, call Varian, Beverly Division, Salem Road, Beverly, Massachusetts 01915. Telephone (617) 922-6000. Or call any of the more than 30 Varian Electron Device Group Sales Offices throughout the world.



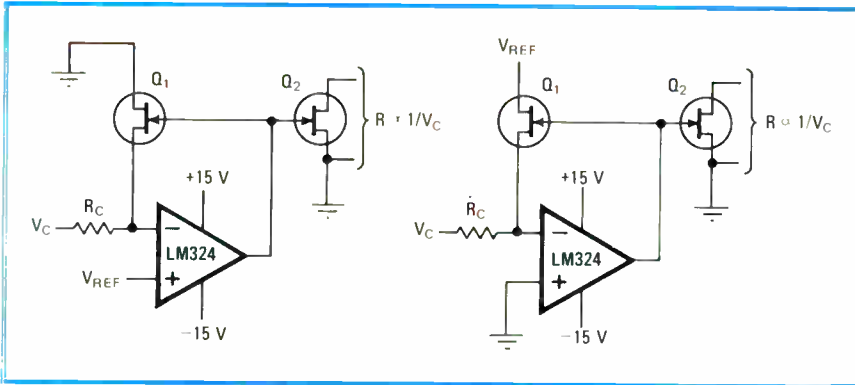

1. Voltage-controlled resistance. Unused half of FET Q_2 can function as voltage-controlled resistor in external circuits. R_{ds} is inversely proportional to control voltage in both circuits. V_c values are negative for n-channel FETs, positive for p-channel FETs.

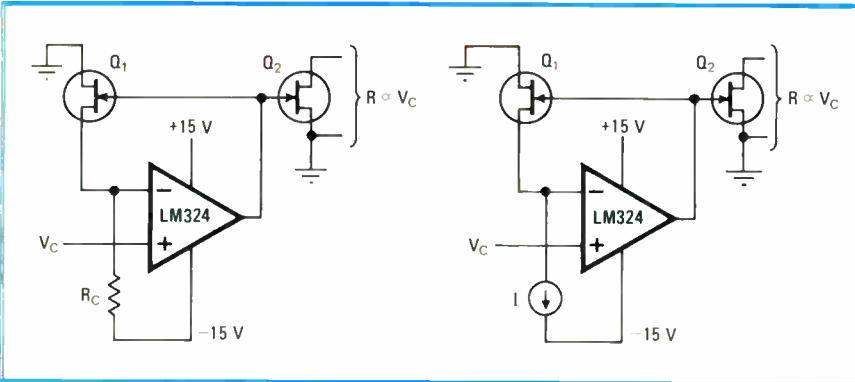

2. Direct proportional control. R_{ds} varies linearly with V_c in both circuits. If V_c exceeds V_{ref} or breakdown voltages of FET in either figure, a resistor should be inserted between output of operational amplifier and gate of FET to prevent burnout.

tance. No stability problems are encountered because the FET introduces negligible phase shift in bandpass frequencies of the op amp. Optimal results are obtained,

of course, with FETs formed on a common substrate, and if desired, p-channel devices may be used for positive control voltages. □

SCRs make serviceable relaxation oscillators

by Larry P. Kahhan
Princo Instruments Inc., Southampton, Pa.

Few designers realize that a silicon controlled rectifier can be used as a relaxation oscillator, just like its sister thyristor, the programmable unijunction transistor. The circuit arrangement is much akin to the PUT oscillator, as shown in the figure.

When power is applied, capacitor C_T charges, and the voltage across resistor R_T decreases exponentially. When the voltage across R_T , which is the cathode voltage of the SCR, drops to 0.6 volt less than the gate voltage, the SCR turns on. This turn-on produces current flow through C_T and a voltage spike across R_3 .

Since the large value of R_T prohibits there being sufficient current to maintain conduction, the SCR immediately turns off, and C_T begins its charge cycle again. The period of oscillation is approximately given by $t = -R_T C_T (\ln \eta)$, where η is the fraction of the supply voltage that is applied to the gate, or $R_2/(R_1 + R_2)$. The high-impedance (500-kilohm) sawtooth-waveform output is available at the SCR's cathode, and a pulse wave-

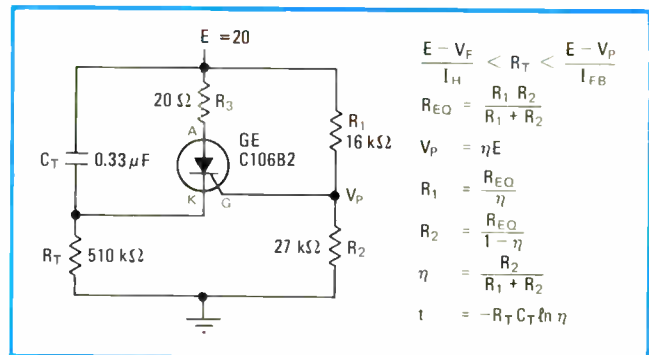

Programmability. An SCR oscillator retains the features of a unijunction-transistor circuit, including programmability of the firing point. Values shown yield an oscillation frequency of about 15 Hz. Gate-to-cathode voltage drop is neglected in the equations.

form appears at its anode. The output impedance at this point is less than 20 ohms. If a high-current pulse is desired, a pulse transformer might replace R_3 .

Design equations in the figure outline the criteria for oscillation. Values for SCR on-voltage, holding and forward blocking currents may be obtained from the data sheets. □

Designer's casebook is a regular feature in *Electronics*. We invite readers to submit original and unpublished circuit ideas and solutions to design problems. Explain briefly but thoroughly the circuit's operating principle and purpose. We'll pay \$50 for each item published.

How to pick the right frequency meter for your product.

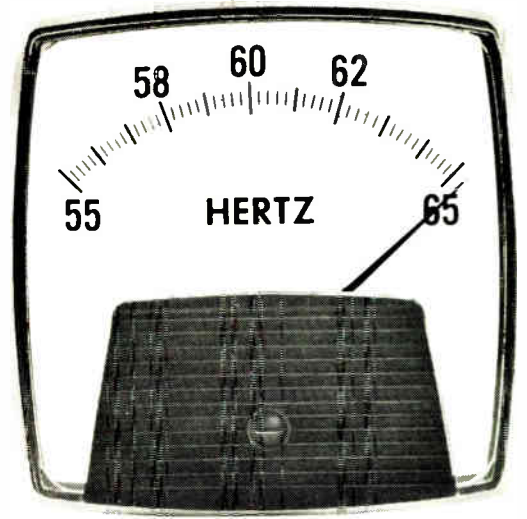

Two distinctly different kinds of panel meters exist for the purpose of measuring frequency — indicator type and vibrating-reed type. It's important to know these and other differences enumerated here if you want to pick the frequency meter that's right for *your* product every time.

1 Decide whether price, or accuracy plus appearance, is your prime consideration.

Pointer and large numerals in analog-type GE frequency meters are clear and easy-to-read... match BIG LOOK® and HORIZON LINE® styling of other GE panel meters.

Manufacturers who buy strictly on price prefer vibrating-reed type meters. They cost from 20 to 30 percent less than analog readout types. But analog readout meters permit faster, more accurate readings of frequency without guesswork.



with a solid-state circuit board and transducer. If the meter you pick needs a "black box" to go with it, that will of course add extra design and component cost considerations to your product.

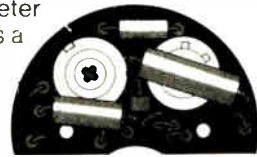

GE's Compact design includes both the circuit board and the transducer as integral parts.

2 Determine what frequency range you want to measure.

Nearly all frequency measurements can be made utilizing these standard five ranges: 45-55 Hertz, 45-65 Hertz, 55-65 Hertz, 50-70 Hertz and 380-420 Hertz.

3 Determine the right voltage rating, and the right panel meter case size, too.

GE frequency meters come in all standard ratings in 3½ and 4½ inch sizes.

By far, the most common ratings are 120-volt, 208-volt and 240-volt. Case sizes in nearly all instances are either 3½ inches or 4½ inches.



5 Make sure your meter will work in dirty environments.

There's no way you can control where your customer will use your product. As with all panel meters, frequency-type meters should be protectively enclosed in a good, tight case.

Gasketed cover on BIG LOOK® design helps keep dust and moisture out. Most distorted wave-forms no problem for newest GE models.

6 Will the meter you pick be easy to replace later?

Make sure both the frequency meter and the mounting requirement you have specified for your panel are flexible enough to permit easy replacement.

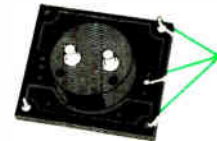

GE solves your mounting problems by ultrasonically placing studs to match your panel cutouts... for new or replacement meters.

7 And don't forget the manufacturer's reputation.

Make sure he stands behind his products... and that all his panel meters meet ANSI C39.1 specifications.

Specify General Electric just for good measure.

4 Find out whether the frequency meter needs accessory equipment.

Analog-type frequency meters, for example, must operate in conjunction

For a free guide entitled, "Pick the Right Panel Meter" (GEA-10340) and our complete Catalog (GEP-307), write to General Electric Co., Section 592-68, Schenectady, N. Y. 12345.

592-68

GENERAL  ELECTRIC

16-k RAM eases memory design for mainframes & microcomputers

by Derrell Coker, *Mostek Corp., Carrollton, Texas*

□ The 16,384-bit dynamic random-access memory is now in volume production. Already 100,000 devices have been designed into prototype memory systems, and an estimated 3 million to 5 million devices will be installed in mainframe memories this year.

Its attraction for mainframe designers is, of course, low cost—a quarter the cost per bit of 4,096-bit parts with the same level of performance. But a less obvious asset—ease of use—guarantees its popularity outside the mainframe area, particularly in the small peripheral and microprocessor-based systems that traditionally use static, not dynamic, RAMs.

Many aspects of this ease of use are common to all 16-k dynamic designs:

- They are packaged in the same 16-pin dual in-line package as many 4-k devices, so that upgrading a board of 4-k RAMs to a 16-k board requires only one address-line change.
- All inputs and outputs are at 5-volt levels required by transistor-transistor logic, so that there is no need for the high-level clocks required by some 4-k RAMs. Moreover, inputs are low-capacitance, and three-state outputs make for maximum flexibility in driving external TTL circuits.
- The existence of latches for all data inputs and address signals relaxes requirements for input timing.

- Timing of all column- and row-address signals is very simple, requiring no overlapping cycles.

- Power supplies are completely standard, at +12 v and ±5 v, plus or minus a freewheeling 10%.

But newer 16-k dynamic RAMs, such as the Mostek Corp. MK 4116, have even subtler properties—ones that simplify the job of designing them into small systems. Though organized internally as two 8,192-bit subarrays (Fig. 1), the MK 4116 looks to the user like a balanced 128-column-by-128-row memory because its 128 sense amplifiers are located between the two subarrays and multiplexed internally by on-chip clocks.

Moreover, the same amplifiers that do the sensing also do the refreshing. They are driven by the same internal address clocks and perform the refresh action automatically during the 2-millisecond refresh period.

No worst-case access time

The chip's layout also results in minimum access times, because it minimizes delays in the control circuitry. The control circuitry surrounding the array is run by a network of clock generators, which in turn are activated by the externally applied row- and column-address-select signals. Consequently, the delay in the control circuitry is due exclusively to the small (and constant) clock delays that are internal to the circuitry itself and not by clock-sequencing delays, which can be considerable and varied, depending as they do on the cycle's data-address requirements. This characteristic has another benefit. It makes testing the MK 4116 RAM chip easier, since now there is no reason to search for a test sequence or for a data pattern that is worst-case for access time.

Finally, note that the address input buffers are multiplexed between row and column addresses, while the row and column decoders are independent circuits. This layout keeps the input capacitance at these terminals very low compared to the high-capacitance inputs common in some multiplexed 4-k RAMs, where each

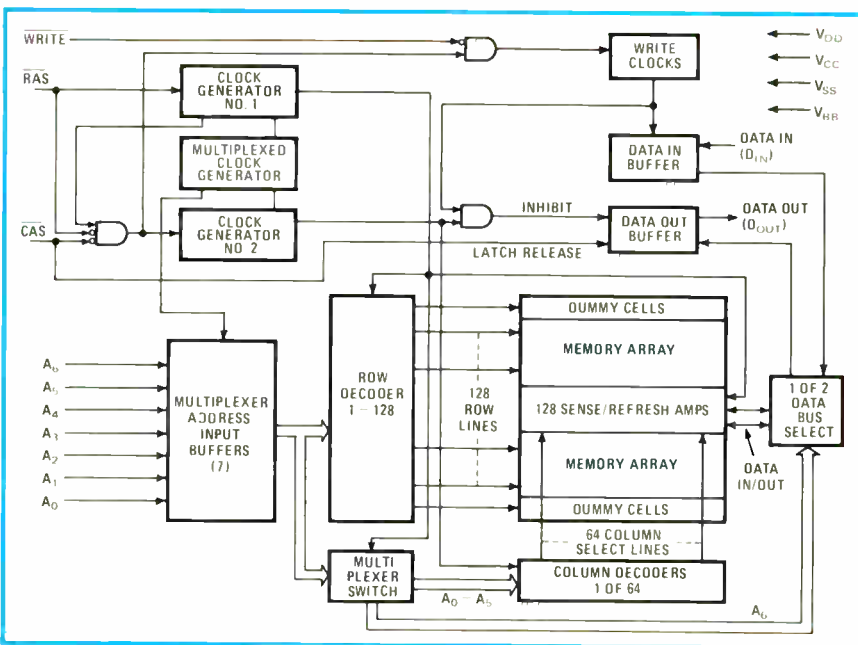

1. Organization. The MK 4116 is organized internally as two 8,192-bit subarrays separated by 128 sense amplifiers. To the user it seems to operate as a balanced 128-column-by-128-row memory.

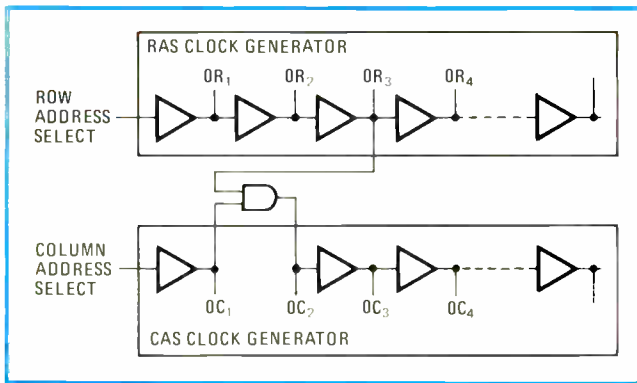

2. Gated CAS. Timing on the chip is made simple with a "gated-CAS" design. Row-address-select (RAS) and column-address-select (CAS) signals are controlled by different delayed internal clocks, but the two clock chains are linked logically so that the address multiplex operation is removed from the data access timing sequence.

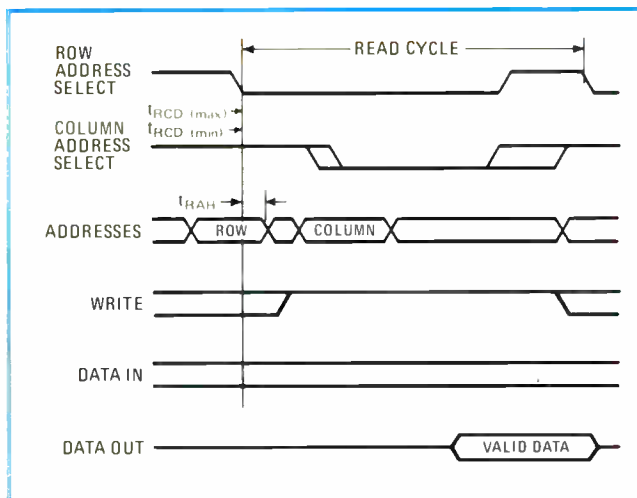

3. Mistake-free. To prevent errors in reading data, the start of the data chain is inhibited until the occurrence of a delayed signal triggered from the RAS chain. CAS is externally activated as soon as the row-address-hold time t_{RAH} is over.

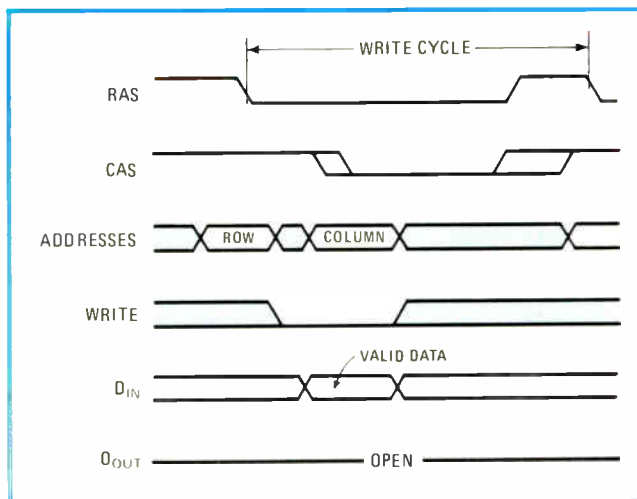

4. Data ready. In the MK 4116 memory, data is valid within the specified access period and remains valid until the CAS line becomes inactive. If CAS goes low early in the write cycle, the data-output line remains in the high-impedance state throughout the entire cycle.

address pin is connected to two input buffer circuits.

Although the multiplexed-address 16-k RAM requires two strobe signals (row- and column-address-select) for control purposes, the timing requirements of these clocks are much more flexible than in the original 4-k multiplexed RAM introduced in 1973. That design made no allowance for the time required to perform the address multiplexing, so that a worst-case multiplexing time delay (which is system-dependent) had to be added to the specified access time. Also, the fact that the internal RAS and CAS clock generators in the original 4-k part functioned totally independently of one another imposed several unwelcome restrictions on the precharge and refresh operations.

The 16-k design overcomes these timing inconveniences with a feature called "gated CAS." Here, each of the control signals, RAS or CAS, triggers a sequence of events that as before is controlled by different delayed internal clocks (Fig. 2). In this case, however, the two clock chains are linked logically so as to keep the address multiplexing operation outside of the critical timing path for data access. Indeed, the data sequence is inhibited until the occurrence of a delayed signal derived from the RAS clock chain. Thus, the gated-CAS feature allows the CAS clock to be externally activated as soon as the requirement for the row-address hold time (t_{RAH}) has been satisfied (Fig. 3) and the address inputs have been changed from row- to column-address information.

The gated-CAS scheme also avoids potential reading errors during the address cycle by establishing two timing endpoints called minimum and maximum row column delay ($t_{RCD(min)}$ and $t_{RCD(max)}$). No data storage or reading errors will result if CAS is applied to the device after $t_{RCD(max)}$. In this case, however, access time will be determined exclusively by the access time from CAS (called t_{CAC}) rather than from RAS and will be lengthened by the amount that t_{RCD} exceeds the $t_{RCD(max)}$ limit.

Timing is further simplified since now recharging of all internal circuitry is initiated by RAS going to the inactive state and not (as in 4-k dynamic designs) by the appearance of CAS. This removes several timing restrictions from the trailing edge of CAS, allowing for simpler, RAS-only refresh operations, as well as improved operation of the data output.

As for reading and writing in these 16-k RAMs, data out is valid in a read cycle within the RAM's specified access time and will remain valid until the column-address strobe becomes inactive. However, if CAS goes low early in the write cycle (Fig. 4), the data-output line will remain in the high-impedance (open-circuit) state throughout the entire cycle.

This type of output operation results in a unique system capability. If write operations are indeed handled early in the write mode, then the data-input pin, D_{IN} , can be connected directly to the data-output pin, D_{OUT} , for a common input/output data bus. Full control of the data-output is achieved during a read cycle because data out will remain valid from the time t_{CAC} until CAS goes back to its high-level (precharge) state, a time determined exclusively by the system designer. Thus, data can remain valid right up until a new memory cycle begins, with no penalty in cycle time. This makes the RAS/CAS

How structure affects performance

Most 16,382-bit dynamic random-access-memory chips are fabricated with a two-level n-channel polysilicon-gate process. Two levels of polysilicon greatly enhance circuit density over single-level designs without unduly increasing circuit complexity. They also (like the one-level process) allow independent adjustment of gate- and field-oxide thresholds by ion implantation, which maximizes performance, density, and reliability.

The storage cell is a conventional one-transistor dynamic design. Being metal, the row-select (word) lines do not suffer from the long propagation delays that occur with polysilicon word lines.

Data passes into and out of the cell through diffused column (digital) lines. The first level of polysilicon acts as the top plate of a storage capacitor, allowing charge to be stored in the depleted region beneath it. Metal word lines contact the second polysilicon level, which forms the gate of the transfer device, isolating the storage cell from the digit line. This makes the cell relatively insensitive to variations in the doping level of both first and second polysilicon levels.

In sum, the cell's performance is influenced primarily by junction depth, oxide thickness, and mask geometry—all parameters that can be carefully controlled.

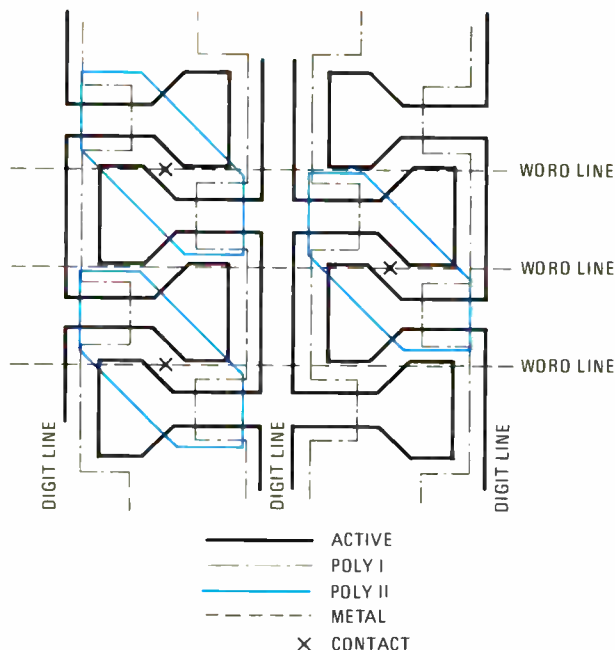

clock timing relationship very flexible. Moreover, since D_{OUT} is not latched, CAS and/or RAS can be decoded and used for chip selection. This property leads to still more flexibility of access, because now, when both RAS and CAS are decoded, a two-dimensional (X,Y) chip-select array is realized.

Two problems plagued the metal-oxide-semiconductor dynamic RAMs of an earlier generation: poor noise immunity and poor sensitivity to input signals. Both often precluded the unbuffered use of these memories with high-performance logic families, such as Schottky TTL and emitter-coupled logic.

Noise margins

A special input buffer stage in the MK 4116 solves both problems (Fig. 5). This stage allows the chip to accept directly, with wide operating margins, all bipolar level signals. A logic 1 can be detected down to 2.2 v and a 0 up to 0.8 v.

The circuit is actually a simple differential amplifier, which compares the incoming TTL level to an on-chip reference level of 1.5 v. In operation, a positive common-mode voltage is capacitively coupled (through C_2 and C_3) to the gates of transistors Q_3 and Q_4 in order to guarantee the operation of the latch command and the MOS-level flip-flop circuitry. This voltage boost assures that the buffer latches properly, even though both the input and reference voltages may be less than the device threshold voltage.

The insertion of Q_1 and C_1 in the V_{IN} input path increases the amount of negative undershoot on V_{IN} that can be tolerated between the time that the address-hold time goes low and the time that the latching action takes place. Consequently, the chip requires the shortest possible address-hold times and allows the inputs to

function independently of device thresholds and other process parameters.

Another design feature absent from other 16-k RAMs is the use of dynamic sense amplifiers. Compared with static sense amplifiers, they reduce the active power dissipation of the chip by 25% (Fig. 6), largely because they have no need for the power-hungry digit pull-up transistors needed for static sense amplifiers.

Moreover, dynamic sense amplifiers render the MK 4116 chip less susceptible to burnout than 16-k designs using static amplifiers. The dynamic devices are selected by the same address strobes used for column and row address; they are not powered by the main system clocks, as are static sense amps. With static designs, since maximum current is drawn during these clock operations, the chip can inadvertently be burned out in the event the clock input becomes shorted to ground during system malfunction. Blowout is prevented with dynamic designs, where the power drawn by the amplifier is a function of address strobe frequency rather than clock duty cycle.

Not only does the dynamic-current characteristic of the MK 4116 prevent inadvertent burnout, it also allows the device manufacturer to specify the operating power as a function of frequency, rather than as a fixed condition. This gives the system designer a worst-case power specification, guaranteed by the manufacturer, which applies to real-use conditions.

Use in microprocessor systems

The amount of read/write memory associated with microprocessor-based systems is ever-increasing, and with their accent on ease of use, the 16-k dynamic RAMs should be strong contenders for applications in these systems. The block diagram for a typical microproces-

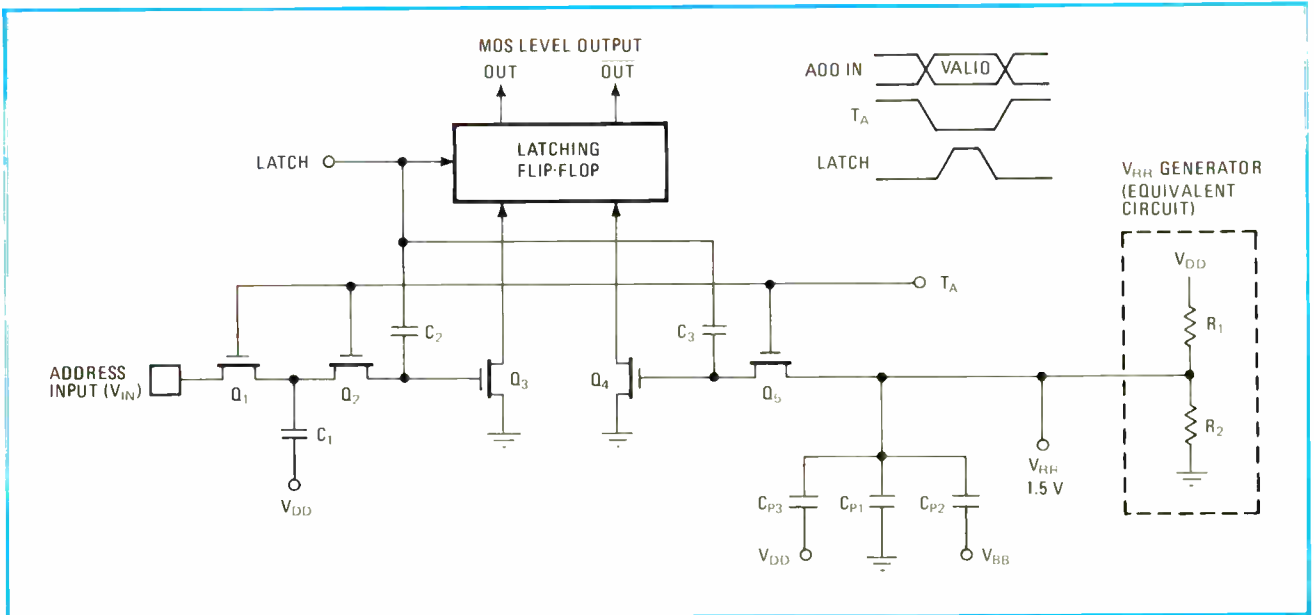

5. Input buffer. This input buffer stage is a simple differential amplifier. Its function is to compare the incoming TTL levels to an on-chip 1.5-volt reference level. It is capable of detecting a logic 1 above 2.2 V and a logic 0 down as low as 0.8 V.

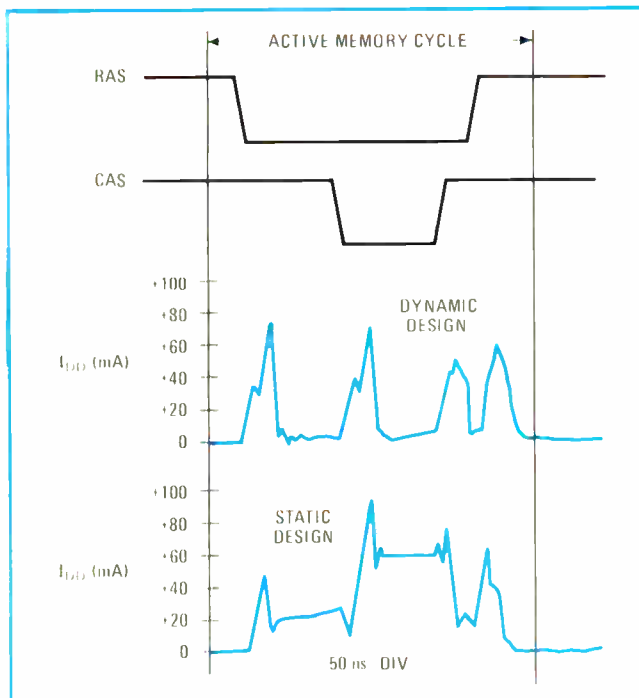

6. Dynamic is better. Dynamic sense amplifiers require much less power than static designs, which are powered by the main system clocks and depend on power-consuming pull-up transistors.

sor-controlled 16-k-RAM memory system (Fig. 7) shows the elements of such a system. Including interface logic, timing generator, decode logic, multiplex circuitry, refresh logic, and buffers, the entire system can be implemented with the addition of approximately 12 to 20 standard TTL devices. That means that a full 64-k-by-8-bit system (the most memory that microprocessors in general can address) will fit on one double-sided printed-circuit board less than 50 square inches in area.

The functions of most microprocessor-based memory

systems are reasonably simple and straightforward when compared to those of some minicomputers and large mainframes. Most microprocessors have independent memory-address signals and request read or write information on command. Thus, refresh of dynamic RAMs is easily handled during the portion of an instruction cycle that does not require a memory access.

Since most microprocessor systems do not require specialized memory operations, such as read-modify-write cycles, timing considerations for the RAM can also be kept very simple. In fact, interface convenience is more important than device operating modes. Here, because there is no output latch on the 16-k RAM, it is possible to interface the memory directly with the I/O bus of most microprocessors by using the device in its common-I/O-data-bus mode. For convenience, the data-input pin of the 16-k RAM can be directly connected to the data-output pin on the system's pc board.

Minicomputer/multiprocessor applications

A logical progression beyond the simple microprocessor systems is in multiprocessor and minicomputer applications. Usually in these larger, more diverse data-processing applications, memory-content integrity and reliability become critical. Often special error-detection and -correction schemes are employed to ensure maximum system reliability.

In these types of applications, the 16-k RAM will have much more of an impact than any previous semiconductor memory product. In systems like these, read-modify-write cycles and concepts like page-mode operation and read-while-write memory begin to affect system design (Fig. 8).

The read-while-write memory operation of the 16-k RAM (Fig. 8a) simply implies that both a read operation and a write operation can occur at the same memory address almost simultaneously. This is done by strobing both the row and column address into the device and

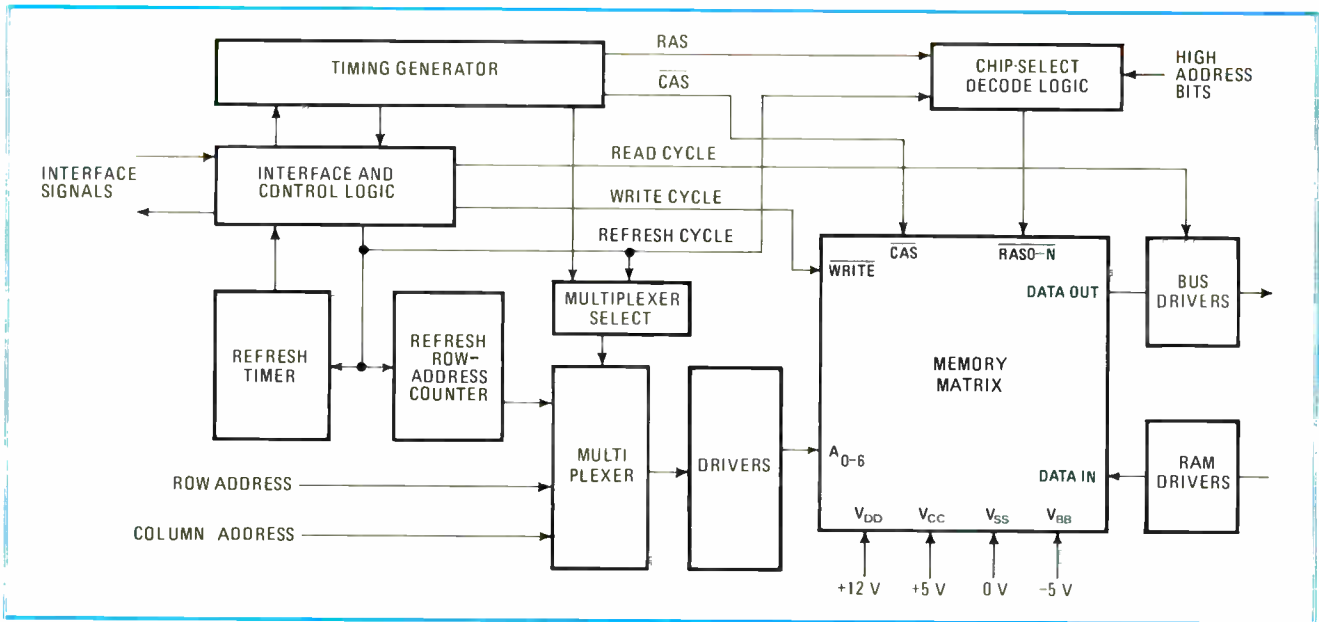

7. Microprocessor systems. The components of a 16-k RAM system for a microprocessor-based application RAM system can be implemented with no more than 20 TTL packages and can fit on one 50-in.² printed-circuit board.

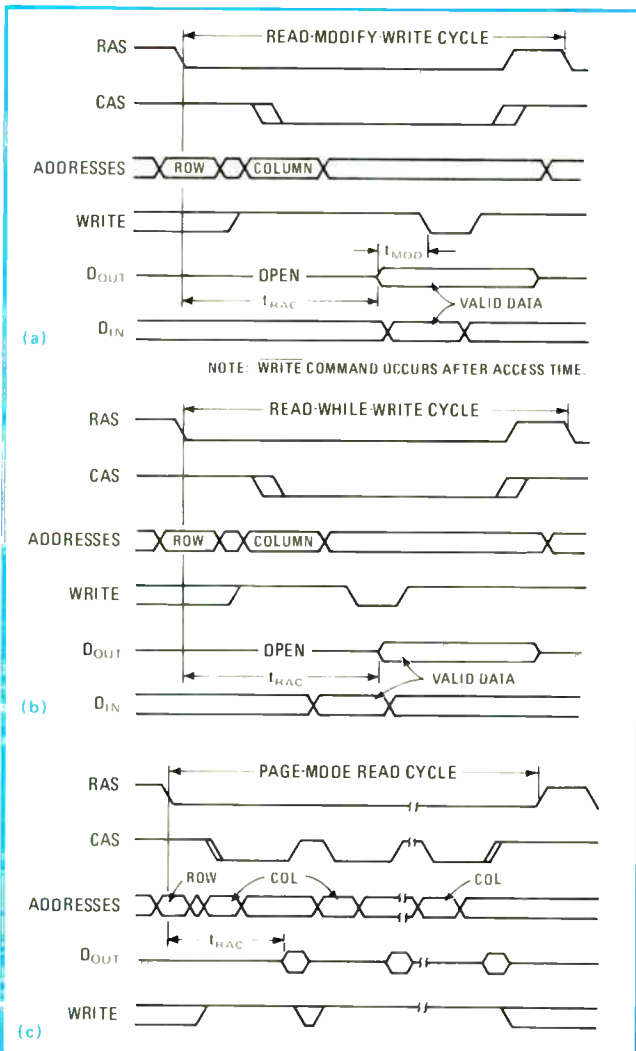

8. Mainframe performance. The MK 4116 features such system concepts as read-while-write, read-modify-write, and page mode.

then waiting a sufficient time after the column-address strobe is activated before the write command is given. The MK 4116 has been designed and characterized so that a read operation can begin at a particular address and, even before data is taken from the memory, a write operation can begin at the same address and within the same memory cycle. The result is that data stored at a particular cell location will appear at the output of the device within the specified access time and data at the input pin will have been written into the same selected cell location within the same period.

The read-modify-write cycle is different from a read-while-write operation (Fig. 8b) in that data is read from the selected cell, then modified, and finally written back in its modified form into the selected location. Such a read-modify-write cycle is usually used in conjunction with error-detection and/or error-correction schemes, whereas the read-while-write operation is used for high-speed shift-register or buffer applications. The same MK 4116 device can perform the read-while-write operations in significantly less time than the conventional read-modify-write.

Another type of operation that is a standard feature with the MK 4116 is page mode (Fig. 8c). Page mode allows successive memory operations to occur at multiple column locations of the same row address with increased speed and without an increase in operating power. For speed comparison, a 16-k RAM with an access time of 150 ns would have a page access of 100 ns. This represents a 30% increase in data throughput speed with page-mode operation.

To lend even more flexibility to the page mode of operation, the column-address strobe can be decoded and used as a page-cycle-select signal. This allows the page boundary to be extended beyond the 128-column locations within a single 16-k RAM. Moreover, there is no limitation to the types of operations that can be performed. □

Digital multiplexers reduce chip count in logic design

by James E. Siebert
Michigan State University, East Lansing, Mich.

When attempting circuit optimization, logic designers traditionally use algorithms directed at minimizing gate count, but not chip count. However, if digital multiplexers are used to implement the logic functions in a circuit containing less than six input variables, chip count may often be minimized. This can usually be done without tradeoffs in cost, speed, or propagation delay.

Multiplexers in the transistor-transistor-logic family are available in quad two-input, dual four-input, or single eight- and 16-input devices. A two-variable logic block of up to four functions can be generated by a quad two-input device, with the constraint that one variable is common to each function. A three-variable function can

normally be realized by using a single eight-input multiplexer, and a four-variable function can be implemented with a single 16-input multiplexer.

The primary design tool is the truth table of the particular function desired. For example, a function of three variables such as $F = AB + A\bar{C} + \bar{A}BC$ may be implemented with a 74151 eight-input multiplexer. Using its truth table, the desired function is implemented as shown in Fig. 1. The multiplexer-select lines serve as the inputs for variables A, B and C. Data inputs on the multiplexer corresponding to the select addresses are tied high or low to provide the proper output. Implementing the same function using gates requires two three-input NANDs, two two-input NANDs, and inverters to derive the complement of the input variables for a total of 1½ packages.

By providing one variable at the data input, a lower-order multiplexer may be used to realize the function. That is, a three-variable function can be implemented with only a four-input multiplexer, where an eight-input device was previously required. As shown in Fig. 2, partitioning the function table can aid in minimizing

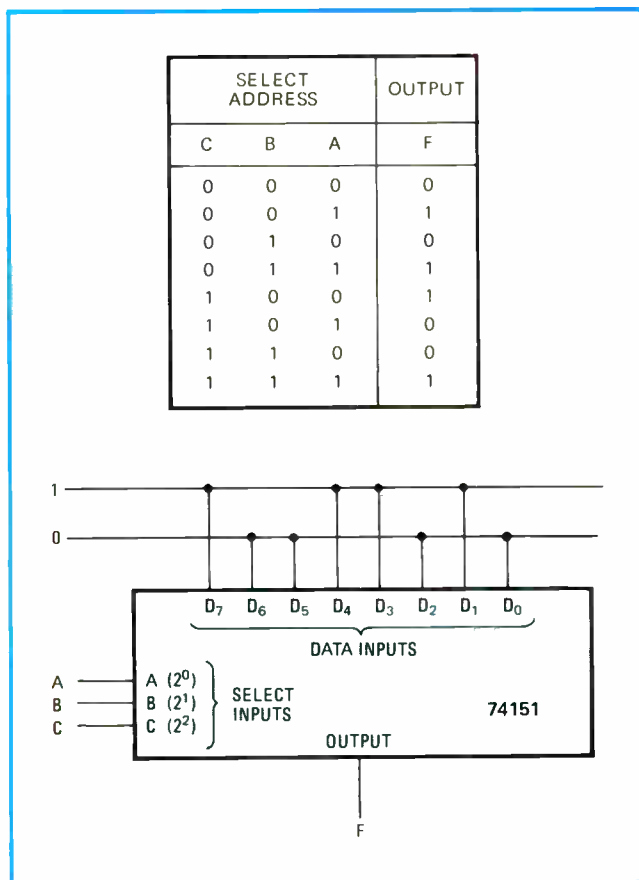

1. One-chip solution. This circuit implements the logic function $F = AB + A\bar{C} + \bar{A}BC$. Variables A, B, C steer select inputs, and data inputs are connected HIGH or LOW depending on the multiplexer function. Discrete-gate implementation requires 1½ packages.

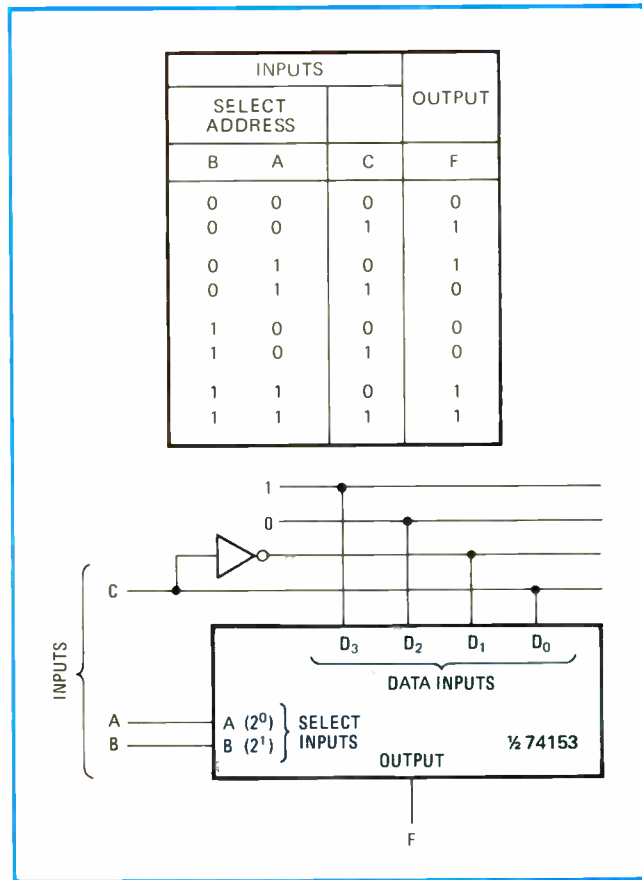

2. Increased-efficiency circuit. Reduction of an 8-input multiplexer to a 4-input multiplexer is possible if one variable is introduced at data inputs (other variables form the select addresses). Truth table is partitioned for variable C, and design proceeds as explained in text.

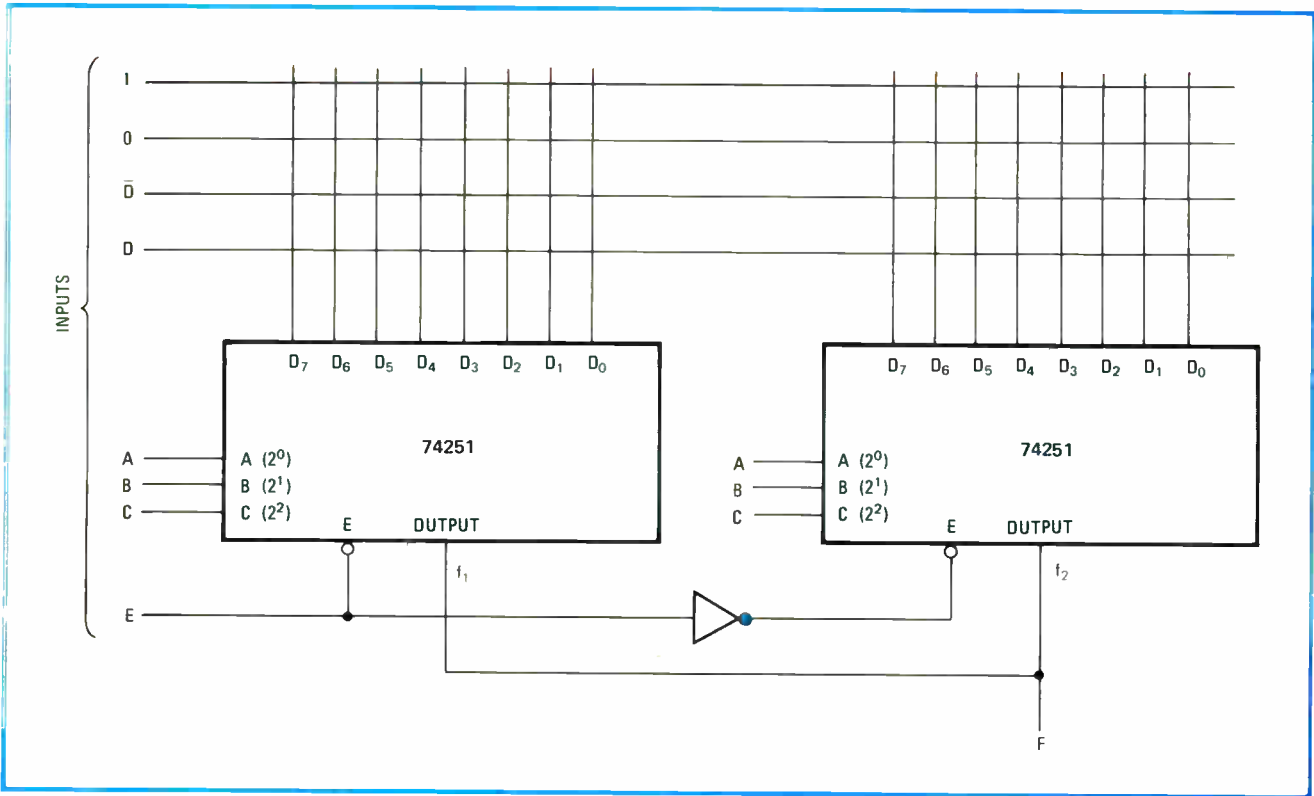

3. Five-variable realization. Two three-state eight-input multiplexers can generate any five-input function. Variable E is partitioned, and two four-input problems are solved when implementing function. This can also be accomplished by any 16-input multiplexer.

design time. The single partitioned variable is made available to the data inputs; the other variables form the select addresses. By comparing the function output and the partitioned variable for each select address, multiplexer data-input connections can be readily determined. This method is also useful when implementing a four-variable function with an eight-input multiplexer. However, an eight-input multiplexer usually cannot be used for five-variable functions.

With one 24-pin package, a five-input function may be realized either by the above method or by an alternative one. The first method is needed to generate a five-variable function with a 16-input multiplexer; four variables form the select address, and the partitioned variable serves the inputs. An alternative approach is to use the

three-state output available on some multiplexers. In this case, two 16-pin packages are needed, as shown in Fig. 3. The variable D is made available at the data inputs, but E is partitioned for ease in design in the truth table. There are two four-input problems to be solved, and each may be resolved by the method previously described. Variable E actually selects one of the two multiplexer functions.

Minimizing more than a five-variable combinational function is an unwieldy problem. This design approach does not result in a low package count or propagation delay. A six-variable function requires five packages. Generation of a seven-variable function requires nine multiplexers, and an eight-variable function requires 17 multiplexers. □

Calculator notes

Coil-winding program saves rf design time

by Andrew M. Hudor
Department of Physics, University of Arizona, Tucson, Ariz.

Designs for rf circuitry, especially in the low vhf region of the spectrum, often require air-core inductors that are most easily wound by hand. When given the diameters of the wire coil form to be used and the value of inductance desired, this HP-25 program calculates the number of

close-wound turns that the inductor will require.

The program uses an algorithm based on a derivation of the single-layer, air-core-inductor equation:

$$L = \frac{r^2 n^2}{9r + 10l}$$

where L is the inductance in microhenries, r is the radius of the coil in inches, l is the coil length in inches, and n is the number of turns. Since this program was designed for close-wound coils, l is effectively replaced by $d(n+1)$, where d is the wire diameter in inches.

The equation above and the replacement of l allows a new equation to be expressed as a function of n, which is found by the HP-25. The new equation is:

THE LOGICAL CHOICE: Third in a series

SYMMETRICAL AND UNSYMMETRICAL PULSES
0.5 Hz to 5 MHz

CONTINUOUS MANUAL ONE SHOT & EXTERNAL TRIGGER OPERATION
External triggering to 10 MHz

INDEPENDENTLY CONTROLLABLE PULSE WIDTH & SPACING
100 nanosec to 1 sec in 7 overlapping ranges
10⁷ 1 duty cycle range

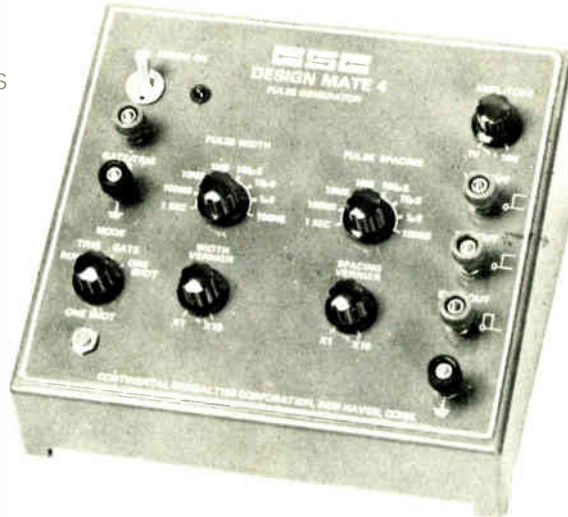

INDEPENDENT CMOS AND TTL OUTPUTS Fan-out to 40 TTL loads

SYNCHRONOUS OUTPUT GATING

100mV 10V POSITIVE OUTPUT Less than 30 nanosec rise/fall times

CSC'S DESIGN-MATE™ 4: \$124.95. NO OTHER DIGITAL PULSE GENERATOR GIVES YOU SO MUCH, FOR SO LITTLE.

Sounds hard to believe... but even a brief look at Design-Mate 4's specifications proves CSC's engineers have done it again. Whatever your application — whether you're looking for precision, flexibility or just plain economy — this compact source of fast, clean digital pulses offers the performance you need... at a price that discourages procrastination.

Use it as a clock source, delayed pulse generator, synchronous clock, manual system stepper, pulse stretcher, clock burst generator or in dozens of other applications. Use it alone or in

See Us At NEWCOM Booth C42-44

tandem with other DM-4's for gated control. The wide range of controls and multiple outputs give you enormous versatility... plus compatibility with all major logic families, for research, design, development, quality control, production testing, maintenance, troubleshooting... you name it.

Now, read the specs that follow... and check the price again. Or better yet, try DM-4 for yourself at your local CSC distributor. We think you'll find it's as hard to do without as it is easy to own.

For more information, pick up your phone and call your dealer — or order direct.

Circle 122 on reader service card

DM-4 SPECIFICATIONS

Frequency Range:	0.5 Hz to 5 MHz	ONE-SHOT	Pushbutton for single pulse Output pulse occurs each time push-button is pressed
Pulse Width and Spacing Controls:	100 nanosec to 1 sec in 7 overlapping decade ranges A single-turn vernier control provides continuous adjustment between ranges	OUTPUTS:	
Duty Cycle:	10 ⁻¹ to 1 Range adjustable over entire pulse width; spacing range, 100 nanosec ON, 1 sec OFF to 1 sec ON and 100 nanosec OFF	VAR OUT	0-10 V positive
Operating Modes:		TRISE	Less than 30 nanosec
RUN	0.5 Hz to 5 MHz as per width/spacing and amplitude control settings	IMPEDANCE	400Ω max
TRIG	DC to approx. 10 MHz	FAN-OUT	40 TTL Loads
Input requirements	Sine waves 2 V _{P-P} pulses 1 V peak - 40 nanosec wide maximum input 10 V input impedance approx 10KΩ DC coupled	SINK	160 milliamps - 0.8 V max
GATE	Synchronous gating. Leading edge of gate signal turns generator ON. Last pulse is completed even if gate ends during pulse	RISE/FALL TIME	Less than 20 nanosec
Input requirements	Same as TRIG Mode	SYNCH OUT	Approx 40 nanosec. Other sync pulse specs same as TTL out
		PULSE LEAD TIME	Sync pulse leads outputs by approx 20 nanosec
		POWER	117 VAC - 10% 50/60 Hz 5 watts; 220 VAC 50/60 Hz also available at slightly higher cost
		SIZE (WxLxH)	7.5 x 6.5 x 3.25
		WEIGHT	191 x 165 x 83 mm 2 lbs 10.91 Kg

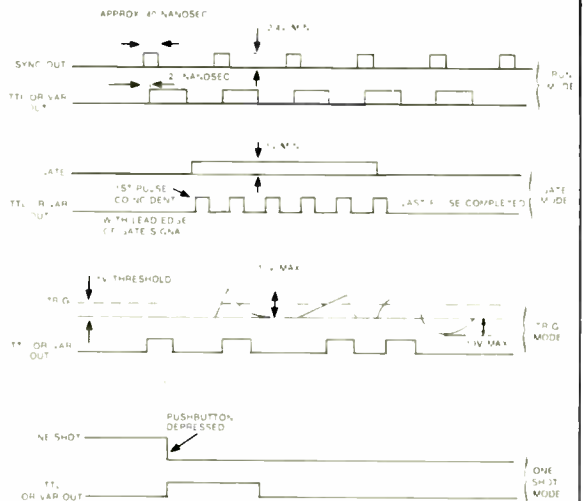

© 1976, Continental Specialties Corp

CONTINENTAL SPECIALTIES CORPORATION

 44 Kendall Street Box 1942
 New Haven CT 06509 • 203-624-3103
 TWX 710-465-1227
 West Coast office Box 7809
 San Francisco CA 94119 • 415-421-8872
 TWX 910-372-7992

EASY DOES IT

See your CSC dealer or call 203-624-3103 (East Coast) or 415-421-8872 (West Coast) 9 AM to 5 PM local time. Major credit cards accepted. Add \$2.50 for shipping and handling in the U.S. and Canada on direct orders of \$50.00 or less; \$3.00 for orders over \$50.00. On all foreign orders add 15% to cover shipping and handling.

$$n = \frac{10dL \pm [100d^2L^2 + 4r^2L(9r + 10d)]^{1/2}}{2r^2}$$

and it is solved by the HP-25 for given dimensions.

For instance, you might want to find the number of turns needed for a 0.32-microhenry inductor to be used

in a 50-megahertz pi-matching network. The result is that 11.08 turns of AWG 18 enameled wire ($d = 0.0403$ inch) will be needed round a 0.25-in.-diameter form. □

Engineer's notebook is a regular feature in *Electronics*. We invite readers to submit original design shortcuts, calculation aids, measurement and test techniques, and other ideas for saving engineering time or cost. We'll pay \$50 for each item published.

HP-25 COIL-WINDING PROGRAM

LOCATION	CODES	KEYS
01	24 03	RCL 3
02 - 03	01 41	1 -
04 - 05	24 02 61	RCL 2 X
06	24 03	RCL 3
07 - 08 09	24 00 61 51	RCL 0 X +
10 - 11	24 01 61	RCL 1 X
12 - 13 14	24 02 15 02 61	RCL 2 g x ² v
15 - 16	04 61	4 X
17 - 18	24 01 15 02	RCL 1 g x ²
19 - 21	24 00 15 02 61	RCL 0 g x ² X
22 - 23	24 03 15 02	RCL 3 g x ²
24 - 25	61 51	X +
26 - 27	14 02 23 06	f √ x STO 6
28 - 30	24 00 24 01 61	RCL 0 RCL 1 X
31 - 32	24 03 61	RCL 3 X
33 - 34	24 06 14 41	RCL 6 f x < y
35 - 36	13 44 51	GTO 44 +
37 - 38	24 02 15 02	RCL 2 g x ²
39 - 41	02 61 71	2 X ÷
42	23 07	STO 7
43	74	R S
44 - 45	41 13 37	- GTO 37

INSTRUCTIONS

- Key in program
- Store wire diameter:
[d], STO 0 (inches)
- Store inductance value:
[L], STO 1 (microhenries)
- Store coil radius:
[r], STO 2 (inches)
- Store constant:
10, STO 3
- Press R/S
- Value of n is displayed, stored in register R_7

REGISTERS

R_0	d
R_1	L
R_2	r
R_3	10
R_4	free
R_5	free
R_6	free
R_7	n

555 turns 60 Hz into 60 clean square waves

You can use a 555 timer to isolate a system like a digital clock from line noise and transients as well as produce a clean square wave at line frequency, says Wistar Macomson of Boston, Mass. To lock the 555 into synchronism with the 60-hertz line frequency, you **select the RC network for oscillation at or near 60 HZ**. Then all you have to do is connect the timer as an astable multivibrator in accordance with the manufacturer's literature, except that you don't ground the control-voltage input, pin 5 — you just leave it unconnected. A low-ripple power supply is unnecessary, adds Macomson, and a battery backup will also keep the 555 running, although then it may drift off 60 HZ.

Take care to write SR-52 cards right

If you've experienced difficulty getting your TI SR-52 programmable calculator to accept programs you've recorded on the magnetic cards, it's probably because you're inconsistent in the way you insert the cards. Stavro Prodromou, Texas Instruments' calculator applications manager, says that the cards must be read at the same speed as they are written. The data recorded depends on the speed of the card moving past the read/write head, and if the card started sluggishly during recording, it would have to be read the same way or an error condition would be indicated. **The proper technique, says Prodromou, is to allow the motor to rev up to full speed before recording.** Insert the card just enough to start the drive motor, but not far enough for it to grab. Then, inserting it a little further will cause it to be pulled in and recording will take place uniformly.

Incidentally, adds Prodromou, although a flashing display indicates an erroneous read, try checking the keycodes by putting the machine into the learn mode. Sometimes a read error may only be incurred in a few steps, and these can easily be written over.

Have you thought about the changes in the ASCII standard?

You still have a month if you want to comment on **a new ANSI standard that will add 25 control functions to the present ANSI ASCII standard computer character set.** The new control functions, for such applications as interactive cathode-ray-tube and printer terminals, line printers, and microfilm printers, lie in the area of editing functions, formatting, and status-setting and interrogation functions, and others. The public comment period ends May 28, and copies of the proposed standard can be obtained from R. M. Brown, Computer and Business Equipment Manufacturers' Association, 1828 L Street, N.W., Washington, D. C. 20036. Price of the 100-page BSR X3.64 is \$3.

Where to find out about analog switches and programmed logic

Manufacturers' handbooks usually are pretty good bargains for up-to-date design information. Among the most recent crop are at least two worthy of attention: Siliconix has "Analog Switches and Their Applications," a 352-page book selling for \$4, while Pro-Log Corp. has "The Designer's Guide to Programmed Logic," featuring the 8080 microprocessor, a 150-pager for \$5. Addresses are Siliconix Inc., Marketing Services Department, 2201 Laurelwood Rd., Santa Clara, Calif. 95054 (and the company will include a 20-page design catalog on its new DG-300 complementary-MOS analog switches), and Pro-Log Corp., 2411 Garden Rd., Monterey, Calif. 93940.

Stephen E. Scrupski

The early bird catches the worm.

Two years ago National Semiconductor invented BI-FET technology.

And we've been making these devices ever since.

Now, some other companies are getting into the act. But as usual in electronics—as in everything else—experience is the best teacher.

Experience has taught us how to make BI-FET products better than the other guys, and cheaper.

That's the way our business works.

And that's a fact.

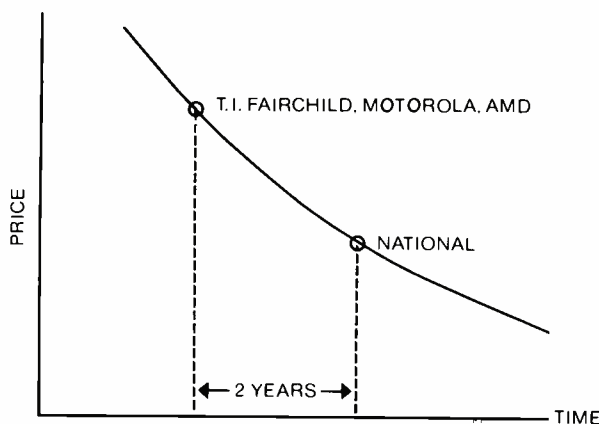

The BI-FET™ Learning Curve

The BI-FET Company, National Semiconductor.

Practice makes perfect.

With two extra years **L** of BI-FET experience under our belt we're coming up with some devices that are clearly superior in performance.

For example, our new LF 356B family.

They have a maximum offset voltage of only 5 mV.

And a maximum bias current of a mere 100 pA.

Those are pretty hot specs. And how about this for price?

LF 355/6/7BH	\$1.45	(100 & UP)
LF 355/6/7BN	1.10	(100 & UP)

And that's just for openers.

If you don't think practice makes perfect, check out this comparison of our new low cost LF 351 BI-FET op amp versus TI's version.

	<u>NATIONAL LF351N</u>	<u>T.I. TL081*</u>
$V_{os}(+25^{\circ}\text{C})$	10 mV max	15 mV max
I_{bias}	200 pA max	400 pA max
Bandwidth	5 MHz	3 MHz
Slew Rate	13 V/us	12 V/us
Noise (f=1 KHz)	22 nV/ $\sqrt{\text{Hz}}$	47 nV/ $\sqrt{\text{Hz}}$
$V_{os}(\text{drift})$	8 $\mu\text{V}/^{\circ}\text{C}$	10 $\mu\text{V}/^{\circ}\text{C}$
Price (100 & up)	\$.50	\$.52

*Per T.I. Publication #63133 CSS 177

**The BI-FET Company,
National Semiconductor.**

A penny saved is a penny earned.

We've shown you some examples of how our extra two years in the BI-FET business means better quality products. Now let's take a harder look at how our experience means lower price.

We're cutting our prices on our entire line of BI-FET op amps:

Product Family	Old Price*	New Price*
LF 155/6/7H	\$8.50	\$3.50
LF 255/6/7H	6.00	2.50
LF 355/6/7H	2.50	1.05
LF 355/6/7N	2.10	.75
LF 13741H	.95	.75
LF 13741N	.80	.50

*Quantity 100 & up.

The BI-FET Company, National Semiconductor

GENERATOR SYNTHESIZER AND FREQUENCY SYNTHESIZER

6000 SERIES

**300Hz
600MHz**



The modular design of the Adret Series 6000 instruments allows you to assemble programmable frequency signal generators suited to your particular application.

The series features two output plug-in units capable of frequency coverage from 300 Hz to 110 MHz and 400 kHz to 600 MHz respectively. These plug-in units are inserted in either a 6100 or 6101 mainframe for maximum versatility.

Inserted in the 6100 mainframe, the plug-in will provide a true stable and accurate frequency generator synthesizer with AM, FM and PM capability, 0.01 Hz resolution, frequency comparison and sweep mode with markers. For applications requiring an accurate frequency source with AM capabilities, the 6101 mainframe associated with either plug-in will satisfy your needs. Both mainframes and plug-ins are programmable for remote operation.



This 600 MHz plug-in unit features 9 digit frequency display, 400 kHz to 600 MHz frequency coverage in one range, 1 Hz resolution (0.01 Hz as an option), 5×10^{-9} /day frequency stability after one months operation, + 13 dBm/50 Ω (1 Vrms) nominal output level, an attenuator with 140 dB dynamic range : two verniers associated to a graduated meter ; amplitude, frequency and phase modulation ; sweep mode...

so let **ADRET** guide you to the

right frequency synthesizer : circle our number on the reader service card, return the coupon or write us on your letterhead. We'll rush you our new 1977 catalog. It gives you a lot of practical tips about frequency measurements as well as the details on our hardware.

Circle 128 on reader service card



1630 Manheim Pike,
Lancaster,
Pennsylvania 17601,
Telephone (717) 569-7059,
TWX 510-672-0516

Name : _____ Title : _____
Firm : _____ Phone : _____
Address : _____
City : _____ State : _____ Country : _____

PRODUCT UPDATE

All classes of electronic counters reap performance benefits from custom-designed LSI chips

by Stephen E. Scrupski, Instrumentation Editor

□ Stirring up most of the action in electronic counters today, as in electronic systems everywhere, is large-scale integration. In this area, however, microprocessors are winning far less favor than custom LSI chips. In low-end counters, custom LSI is enormously enhancing performance, and the high sales volumes more than offset its extra expense. But a microprocessor, for all the flexibility and easier instrument use it promises, has appeared in only one

counter to date—a high-end model, which is more than a year old.

Basically, electronic counters fall into four categories:

- Low-low-cost, no-frills, portable units, intended for the hobbyist and service markets, where as little as \$120 buys a single-function counter of frequencies up to 30 megahertz. LSI plus packaging accounts for the low cost.
- Low-cost, single-function counters covering frequencies up to around

80 MHz for less than \$400 and above 80 MHz for up to about \$1,000. Here again, LSI and packaging make the prices possible.

- Universal counter-timers, which measure frequencies every which way—time interval, period ratio, you name it—and therefore cost up to \$4,000 or so. Here, Hewlett-Packard Co.'s 5345A still seems to hold sway, even though it is now about three years old.

- Microwave counters, now extending up to about 24 gigahertz, and the preserve of just a few manufacturers.

Overall, Hewlett-Packard still dominates the counter business. Prime Data of San Jose, Calif., a market research firm specializing in instruments, estimates that HP accounts for about 50% of counter sales in terms of dollars. Then the lower in unit price one goes, the greater the competition.

HP steers serenely through the fray. "Our product line is right now pretty well-balanced and is poised to be replaced one at a time," says its Santa Clara division's Duncan MacVicar, marketing manager for counters. But while HP introduced its

Dana Laboratories. An Intel 4004 microprocessor equips the series 9000 timer-counters to help users set up operations like sensing inputs and setting trigger levels.

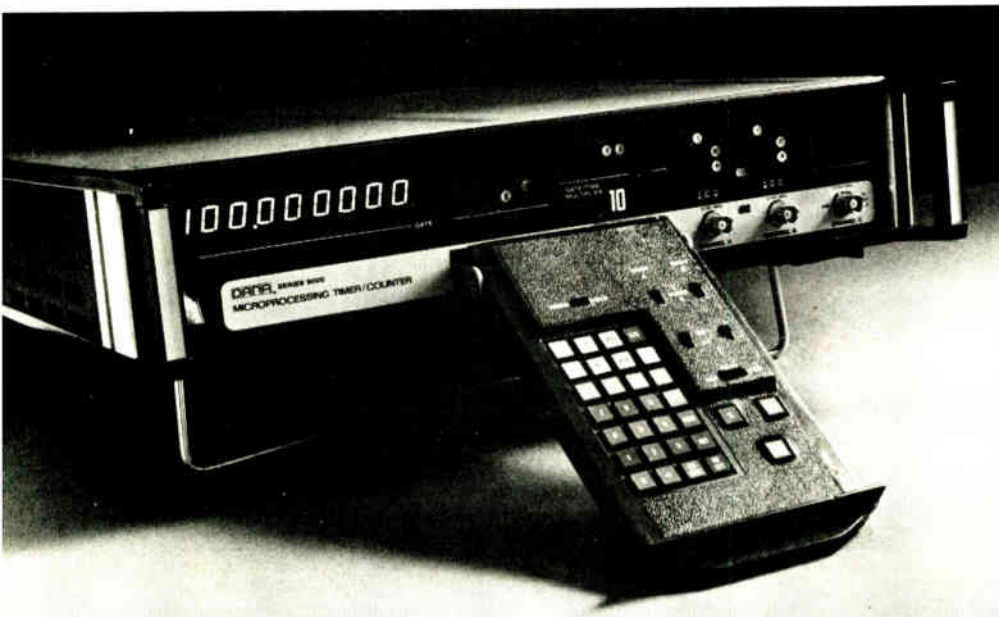

last new counter well over a year ago, other companies have unveiled a number of new models within the last half year.

Systron-Donner Corp., Concord, Calif., for example, has almost completely revamped its product line in that time. At Wescon '76, it introduced several new models, and more recently it also replaced its 80-MHz model 6203A, which sold for \$435, with a B version costing \$325—about a 25% price cut. The new counters use a custom p-channel metal-oxide-semiconductor chip made by Hughes Semiconductor.

Of its Wescon '76 introductions, the most unusual was the 6361A, a dual universal 100-MHz counter-timer. Both channels have the same capability and can be used simultaneously for measurements of two different frequencies or periods, with each set of figures displayed separately. According to Gail Dishong, Systron-Donner's counter marketing manager, one advantage here is in dealing with alternate periods. Conventional counters measure the period of every other event, whereas the 6361A will measure the periods

missed by the other counters. In addition, the counter can simultaneously measure pairs of pulse-train parameters such as repetition rate and pulse width.

Also introduced at Wescon was the company's lowest-cost counter: the 10-MHz model 6202B, a frequency counter selling for \$295. Although adequate for most jobs in that frequency range, Dishong does point out that the stability of the 6202B's crystal oscillator is not up to measuring frequencies at Federal Communications Commission standards. "Many users don't need the stability," he says, "but if anyone must meet FCC requirements, he must get the high-stability option"—

a temperature-controlled crystal oscillator having about 10 times better stability but adding \$100 to the 6202B's price.

At this low end of the market, a very recent entry is the 250-MHz model 585 portable counter from Data Precision Inc., Wakefield, Mass. The instrument, priced at \$345, is built around a custom emitter-coupled-logic chip and operates from rechargeable nickel cadmium batteries. Data Precision, which had previously developed a line of portable digital multimeters, moved into portable counters only about two years ago. Company president Harold Goldberg says his low pricing is predicated both on LSI and on

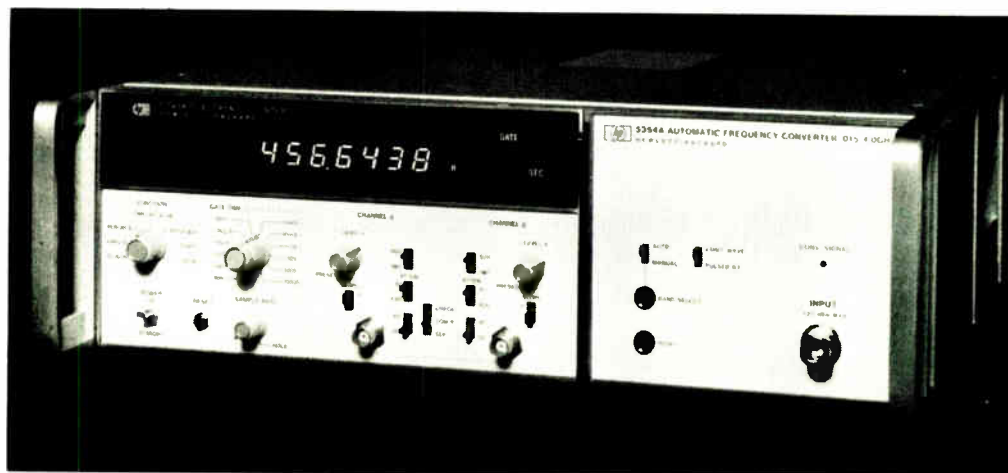

Hewlett-Packard. The 5345A, though three years old, is still the top of HP's line, covering input frequencies from dc to 500 MHz with 20-millivolt sensitivity.

PRODUCT UPDATE on counters

designing for production volumes. "This is no area for timidity," he says. "You've got to grit your teeth and say 'this product will sell so many' and then you can go out and get decent volume buys on the components."

John Fluke Manufacturing Co., Mountlake Terrace, Wash., is also competing heavily in the low-cost area with its model 1900A, a \$375, 80-MHz frequency and period counter. However, the company may be ready for an update of its line since its most recent counter, the 1920A frequency counter, was introduced two years ago at Electro75. Selling for \$895, the 1920A covers frequencies from 5 hertz to 520 MHz with 15-millivolt sensitivity.

Philips Test & Measuring Instruments Inc., Mahwah, N.J., introduced several units at last year's Wescon, including the \$295, 80-MHz model PM6661 and the PM6664, which goes to 520 MHz for \$675. Both frequency-only counters, they are portable instruments with 20-millivolt sensitivity.

Basic to their design is a chip made by Philips' proprietary Locmos (local-oxidation complementary-MOS) process, which, according to the company, offers the low power and other advantages of standard C-MOS, while also providing higher speeds, buffered outputs, and higher noise immunity. Worth noting also, says marketing manager Stu Rauch, is that these portable instruments are built with rugged metal, rather than plastic, cases.

Even Tektronix, the world leader in oscilloscopes, plays a part in low-cost counters through its line of TM500 modular instruments. The most recent of these is the lowest-priced of the counter series, the DC504, which was introduced about two years ago. Selling for \$425, the unit performs frequency measurements to 80 MHz and period measurement to from 1 microsecond to 999.99 seconds.



Systron-Donner. The 6361A is a dual universal counter-timer that can make two simultaneous measurements on signals at frequencies ranging up to 100 MHz.

Also worth including here are the industrial panel-mounted counters, an area characterized by their leading manufacturer as a "sleeping giant." These use variable time bases so that industrial users can obtain readouts directly in such engineering units as revolutions per minute, gallons per minute, and the like. United Systems Corp., located in Dayton, Ohio, recently introduced its Digitec 8150 series, designed around a Hughes p-channel MOS chip. Priced at \$450, the dc-to-1-MHz counter can be programmed, from the front panel or through a rear connector, to change the frequency of its time base so that the count displayed is directly in the engineering units.

At the very lowest end of the market is the new \$120 portable instrument from Dynascan Corp.'s B&K Precision in Chicago, Ill. A 100-hertz-to-30-MHz frequency counter, the model 1827 runs off six AA batteries and has a six-digit light-emitting-diode readout. Resolution is 1 part per million, and the crystal oscillator has 0.25-ppm stability. Sensitivity is 100 mv from 200 kilohertz to 30 MHz; 200 mv below 200 kilohertz. The 1827 uses a custom complementary-MOS chip made by Hughes.

While the B&K Precision counter shows how low the cost can go



B & K Precision. The model 1827 frequency counter covers 100 hertz to 30 MHz with 100-mV sensitivity. It operates from six AA batteries and sells for only \$120.

when a custom LSI chip is used, the use of microprocessors may turn out to be reserved for counters with more capability—and a higher price. For the past year, Dana Laboratories, Irvine, Calif., has been the only counter manufacturer to make a unit in which a microprocessor directly handles some of the operational functions. (Several other manufacturers have incorporated microprocessors to handle interfacing with the IEEE 488 bus.) Based on the Intel 4004 4-bit, p-channel MOS microprocessor, Dana's series 9000 timer-counters cover frequencies up to 512 MHz.

"We use the microprocessor in places where it takes over functions for the user," says Norbert Laengrich, Dana vice president for marketing. "The microprocessor doesn't improve the specs any," he amplifies, "but it does improve the ultimate performance for the user because it allows him to make accurate measurements without having to worry about operator error. One of the biggest problems, for example, is setting up trigger levels accurately. The microprocessor in the 9000 series lets the user do this merely by punching a button."

The basic model in the series, the 100-MHz 9015, sells for \$2,995, while the 512-MHz 9035 sells for \$3,945. Shipments of the original



Philips. The PM6661 is an 80-MHz portable frequency counter priced at \$295, while the PM6664 goes to 520 MHz and sells for \$675. Both units have 20-mV sensitivity.

units began in early 1976. Their most recent updating, at Wescon '76, added new user-oriented options. Among other things, these allow the user to control the measurement gate so that he can measure parameters of only a selected portion of a complex wavetrain—for example, he can select one pulse out of a train and make width and risetime measurements only on that.

With Dana the only manufacturer to have a microprocessor-based counter for more than a year, other manufacturers surely cannot now be far behind. In the next six months to a year, most of the major firms will probably introduce one. What they are saying now, however, is something like "We're not just going to add a microprocessor so that we can say we have a microprocessor-based counter. It has to justify itself by making the instrument better or easier to use." Or, more pointedly: "The microprocessor-based counter is more sizzle than steak. We're not going to put a microprocessor in simply to do some gymnastics."

Nevertheless, all agree there are functions that it would be worth using a microprocessor to perform. For example, HP's MacVicar points out that there are five areas in which a microprocessor would prove useful:

- Making the counter easier to use (for instance, by setting trigger

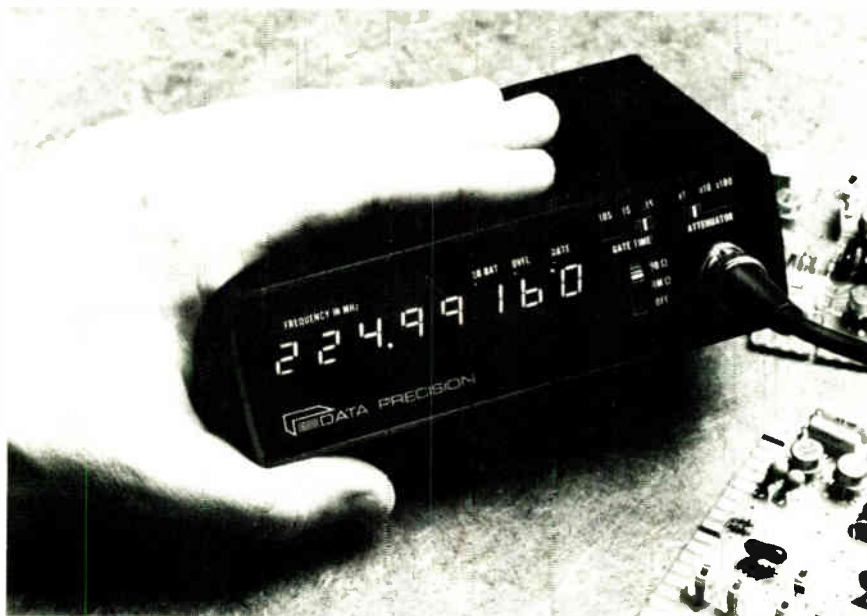

Data Precision. The 585 portable frequency counter covers a range up to 250 MHz with 10-mV sensitivity, and it uses rechargeable nickel-cadmium batteries. Price of the unit is

levels, as Dana's series 9000 does).

- Performing averaging and displaying only meaningful digits obtained during repetitive measurements.

- Performing conversion arithmetic on inputs, as for display of results in engineering units, or subtracting offset frequencies, as when an intermediate-frequency amplifier is used to measure an input's frequency.

- Adding extra capabilities, such as a digital-voltmeter function. MacVicar points out that "with a microprocessor in a counter, the block diagram looks a heck of a lot like a DVM. The only difference is one chip—it's either a counter or a DVM—and all the rest is the same." The point is amplified by Philips' Rauch: "We're getting toward a universality of instrumentation. We will find counters and DVMs in a common box, and with digital memories, users will be able to make simultaneous measurements, storing readings for display upon call-up."

- Lowering the cost of high-end instruments. Of the 5345A, MacVicar says, "If we had had a microprocessor when we introduced it, we

could have saved an awful lot of hardwired processor circuitry."

Even so, the HP 5345A, although three years old, still appears to be the top of the line in universal counter-timers. Priced at \$4,250, it performs direct counting to 500 MHz with dc input amplifiers, and it has 20-millivolt sensitivity across the band. An unusual feature is the high-frequency 500 MHz clock, which allows the 5345A to make all frequency measurements by first measuring period and then converting to frequency. As a result, the counter takes only 1 second to measure any frequency from 1 Hz to 500 MHz with nine-digit resolution.

The 5345A also serves as the mainframe for microwave counter plug-in units in HP's line. Generally, the top frequency for today's microwave counters is about 23 or 24 GHz, which is obtained with a transfer oscillator technique. These counters sell for about \$6,000 and, in fact, have been at that price level for several years, primarily because of the continuing high cost of microwave components. □

again



New 1400 page 3rd edition Semiconductor Data Handbook from General Electric...leading supplier of transistors, unijunctions, diodes, optoelectronics, rectifiers, varistors, SCR's and triacs.

To get your copy, contact any authorized GE distributor, GE Electronic Components Sales Office, or send \$6.95 plus tax to GE Semiconductor, Electronics Park, 7-49 Syracuse, N.Y. 13201.

In Europe send £ 6 to ETC, County Louth Dundalk, Republic of Ireland.

GENERAL  **ELECTRIC**

CRT controller showcases processor

Mostek's one-chip version of the F-8 handles communications, character generation, and formatting

by Larry Armstrong, Midwest bureau manager

Casting about for a way to demonstrate its new single-chip microcomputer, Mostek Corp. has put it into a controller that provides the intelligence for cathode-ray-tube terminals. While the mask-programmable device will eventually find its niche as a replacement for discrete logic in simple control applications, its debut will be in a new CRT terminal interface that Mostek will start selling next month.

"We figured the terminal application was a good example of a microcomputer displacing a lot of logic," says Robert F. Schweitzer, microprocessor marketing manager at the Carrollton, Texas, firm, "and CRT terminals make up a good part of the computer peripheral business." Built around Mostek's one-chip MK 3870, the single-board VAB II—for video adapter board—can be mated with an ASCII keyboard and video monitor—all that's needed for a complete CRT terminal. The board will sell for \$195, which means a full terminal can be built for less than \$450. That is substantially less money and a bit more capability than is presently offered by so-called dumb terminals, now being marketed for \$850 and up.

The 3870 is Mostek's single-chip version of the two-chip F-8 microcomputer originally developed by Fairchild Semiconductor [*Electronics*, Nov. 25, 1976, p. 46]. When programmed as a CRT controller, it replaces between 40 and 70 packages, Schweitzer says. The version being sampled provides full cursor control including character, line, and screen erase, and direct cursor addressing. Moreover, it handles full-duplex asynchronous communi-

cations with four baud-rate options. The device also formats the CRT screen into 16 lines of 64 5-by-8-dot-matrix characters. Other features that could be incorporated into custom mask programs include keyboard scanning, debouncing, and decoding; various code conversions; flashing and alternate-color fields; and screen readback control.

In addition to the microcomputer chip, the VAB II board has a character-generator ROM that supplies 96 symbols and alphanumerics, including lower case, and seven 1,024-by-1-bit static random-access memories for refreshing the display. Synchronization and timing of the video monitor, along with parallel-to-serial conversion of the character-generator output, are handled by standard TTL circuits.

The 3870, programmed as a CRT controller, complements the dedicated monitor scan controllers coming on the market from such firms as Standard Microsystems Corp. [*Elec-*

tronics, Feb. 17, p. 119], Intel Corp., Texas Instruments Inc., Fairchild Semiconductor, and Motorola Inc. "We're not trying to eliminate the dedicated CRT controller chips—they basically provide the high-speed counter chains that synchronize the refresh RAM with the CRT monitor," Schweitzer says. "The 3870 provides terminal intelligence, such as recognizing special control characters for editing. The two chips together will make a complete terminal interface," he points out, "but we're going to where the user options are, and that's where a mask-programmable device is going to be very attractive."

Mostek is not going into the terminal business, however, although it will probably eventually market a VAB II-based CRT terminal to support its own F-8 and Z-80 microprocessor development systems. Mostek Corp., 1215 West Crosby Road, Carrollton, Texas 75006. Phone Bob Schweitzer at (214) 242-0444 [338]

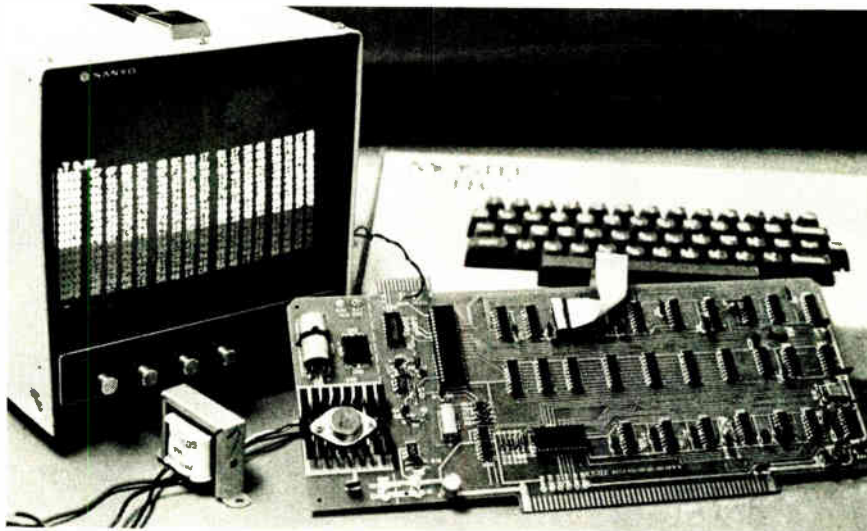

Signal analyzer is fully calibrated

Digitally controlled 25-kilohertz instrument performs frequency- and time-domain analyses on signals and systems

by Stephen E. Scrupski, Instrumentation Editor

Today's electronics engineers have spent many hours in class learning how to analyze signals and systems with Fourier transforms, correlation functions, transfer functions, and so on. It's just too bad they didn't have the new Hewlett-Packard model 5420A digital signal analyzer, which handles signals up to 25 kilohertz and can determine such time- and frequency-domain functions as time-record averages, cross-correlation, autocorrelation, impulse responses, Fourier spectra, coherence, and so on. Well suited for servo-loop analysis, the instrument can even make Nyquist and Nichols plots, and it is equally useful for analyzing shock, vibration, and noise signals.

"The big thing about it is that it is fully calibrated," says HP's product marketing manager for the 5420A, Dick Watts. "In the past, instruments of this type required a great deal of user effort—taking into account gain settings, attenuator positions, and the like. Now, with the 5420A, all the user has to do is connect a signal to the front panel, check for overload, and push the run button to get an automatically calibrated result."

The \$29,900 unit comes in three stacked cases. The bottom box holds the input-signal-conditioning circuitry and a digital filter, which has about 80-decibel rejection in the stop band and can translate a higher frequency (up to 25 kilohertz) down to near dc, where resolution is best. The middle box is actually an HP 2108-K computer on a board with a new front control panel. The upper box holds the cathode-ray-tube display and a minicartridge tape drive, which stores results.

The unit operates over a 25-kHz bandwidth with a dynamic range of 75 db. Resolution to at least 0.004 hertz can be achieved anywhere in the frequency range, while down between dc and 250 Hz, the resolution can be as fine as 20×10^{-6} Hz.

The unit has dual-trace capability so that signals stored on the minicartridge can be displayed and compared with incoming signals to reveal differences—for example, in signature analysis of vibrations, which would indicate impending mechanical failures.

In the time domain, the unit performs such measurements as time-record average, autocorrelation, cross correlation, histograms, and impulse response, while in the frequency domain, it performs such measurements as linear Fourier spectrum, power spectral density, cross power spectrum, transfer function, and coherence function.

One application, according to

Watts, is in servo-loop analysis. Here the 5420A can measure the closed-loop gain and calculate the open-loop gain, which can be difficult to measure directly because it is often quite high. The instrument then can display a Nyquist plot on the CRT so that the user can determine stability criteria for the system. Watts cites the servo in a disk drive as typical of such analyses.

The instrument also takes over many of the calculations that previously were left up to the user. In Fourier spectrum measurements, for example, it is necessary to select a "window" in time for which the spectrum will be calculated, because otherwise there could be discontinuities at the edges. The system will set up the window and automatically smooth the edges without the user having to understand the complex mathematics involved.

Hewlett-Packard Co., 1501 Page Mill Rd., Palo Alto, Calif. 94304 [339]

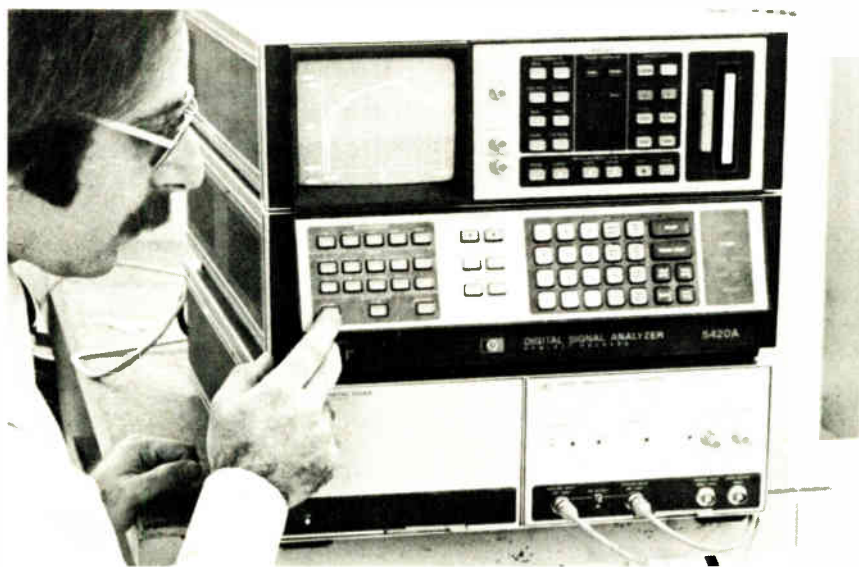

WAFERTRAC. STILL STEAMING AHEAD!

Since GCA introduced the revolutionary WAFERTRAC™ a few months ago—the completely automatic, microprocessor-controlled wafer processing system, 9 out of 10 of the world's largest manufacturers of semiconductors have purchased their WAFERTRAC systems. Why?

WAFERTRAC provides higher yields in less facility space.

WAFERTRAC improves up-time and reliability to higher levels than ever before possible.

WAFERTRAC eliminates traditional 25-wafer group processing limits.

WAFERTRAC lets you design your own specific configuration, according to your firm's unique requirements.

WAFERTRAC. The first practical application of the microprocessor to semiconductor processing, requiring only a single person in your processing loop ... and *then* only to load and unload carriers.

Don't be the last to get on board. WAFERTRAC's still steaming ahead ... destination: greater profits!

GCA/SUNNYVALE DIVISION ●●▲

PART OF THE GCA/IC SYSTEMS GROUP
1050 Kifer Road, Sunnyvale, Calif. 94068 TWX: 910-339-9211 (408) 732-5330

Electronics / April 28, 1977

Circle 137 on reader service card 137

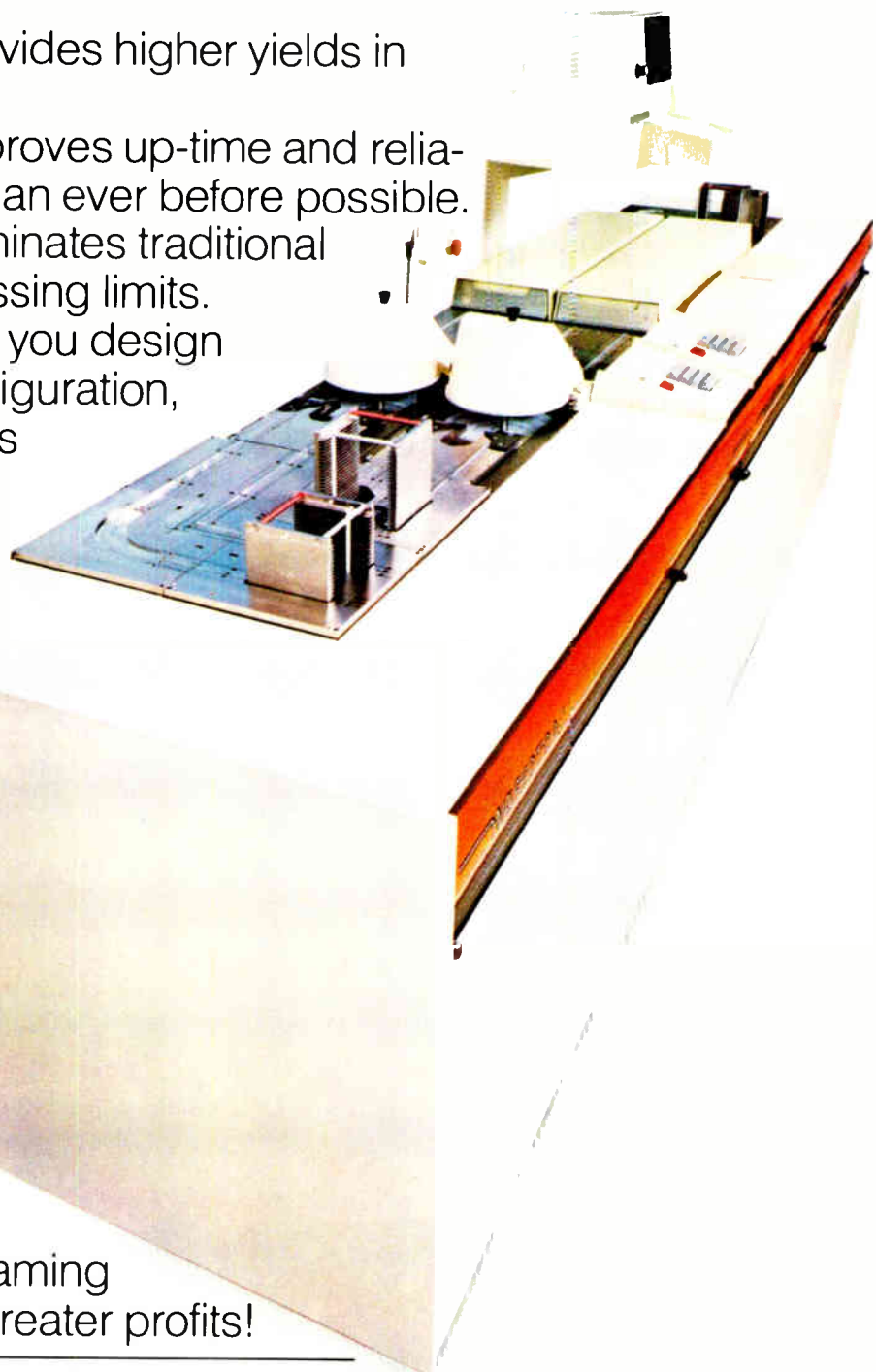

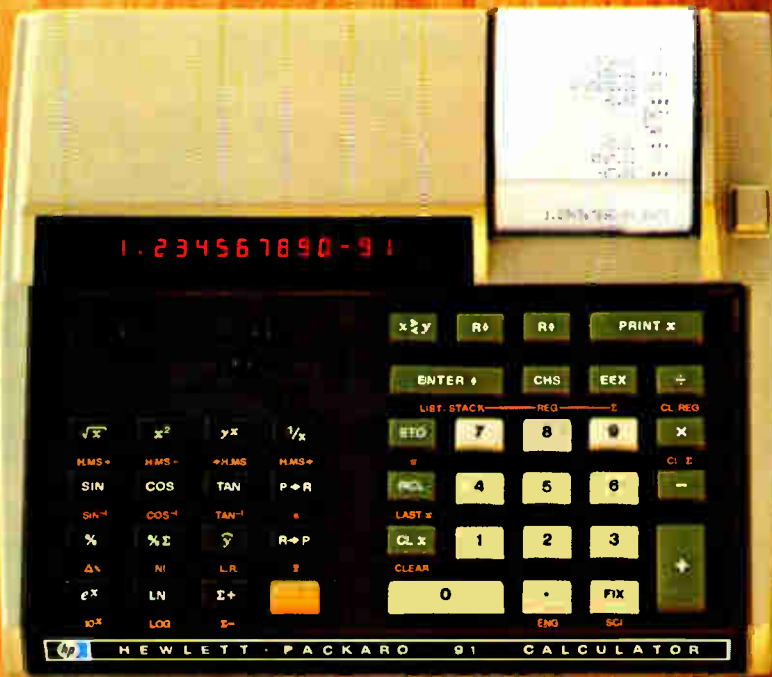
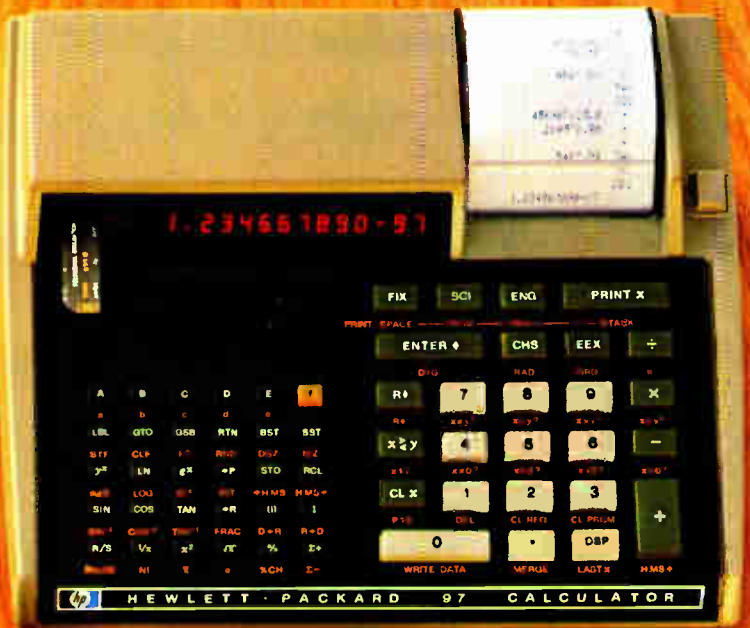

Displays are photographed separately to simulate typical appearance.

Capability, reliability and support.

They all come in the first family of advanced calculators from Hewlett-Packard.

There's never been a better time to get acquainted with the added value of a Hewlett-Packard calculator. Right now, you can choose from a broad spectrum of innovative time-and-error-saving features that you just can't get any place else.

Hewlett-Packard created the world's first advanced pocket calculator back in 1972. And has been leading the way ever since. With more features-per-dollar than ever before plus uncanny product reliability.

Hewlett-Packard calculators offer features like step-saving pre-

programmed scientific and business formulae available at the touch of a key, non-volatile memories that remember programs and data even when turned off, quiet thermal printers and unprecedented programmable power.

When you buy a Hewlett-Packard calculator you get one year's protection on parts and labor. And fast turn-around on repairs. Because when Hewlett-Packard builds it, Hewlett-Packard backs it.

Every Hewlett-Packard calculator comes with its own comprehensive

Owner's Handbook. Plus a complete selection of optional accessories that increase the versatility of your calculator: application books, battery packs, programming worksheets, rechargers, cases and desk-top security cradles.

Small wonder Hewlett-Packard calculators have become The First Family of advanced calculators and—more importantly—the first choice of millions of satisfied owners worldwide.

Added Value Days

Now, during "Added Value Days" is a perfect time to select a Hewlett-Packard calculator. If you purchase any one of the following calculators—HP-21, HP-22, HP-25, HP-25C, HP-27—between April 1, 1977 and May 31, 1977 we will give you a reserve power pack—free. It's our way of emphasizing the added value you get when you buy a Hewlett-Packard calculator. See your dealer for details.

Just call (800) 648-4711 toll-free (in Nevada 323-2704 collect) for the name of your nearest dealer. Or complete the coupon below.



Dept. 214J, 1000 N.E. Circle Blvd., Corvallis, Oregon 97330

HEWLETT-PACKARD
Dept. 214J
1000 N.E. Circle Blvd.
Corvallis, Oregon 97330

Please send me additional information on the Hewlett-Packard First Family of advanced calculators.

NAME _____
ADDRESS _____
CITY _____
STATE _____ ZIP _____

Suggested retail price, excluding applicable state and local taxes—
Continental U.S., Alaska and Hawaii #6169/38

HP-21 Scientific. \$80.00*

Performs all standard math and trig calculations, the latter in radians or degrees. Performs rectangular/polar conversions. Displays in fixed decimal or scientific notation. Our lowest priced scientific.

HP-22 Business Management. \$125.00*

A new kind of management tool. Combines financial, statistical and mathematical capabilities. Enables managers to forecast faster, more easily and with greater certainty.

HP-25 Scientific Programmable. \$145.00*

Solves repetitive problems automatically. Enter your formula *once*; thereafter only your variables. Requires no software, no "computer" language. Our lowest priced programmable.

HP-25C Continuous Memory. \$200.00*

Identical to our HP-25, plus it offers a Continuous Memory capability that lets you retain programs and data even when it's turned off.

HP-27 Financial/Statistical/Scientific. \$175.00*

Contains most every preprogrammed scientific function we've ever offered, *plus* comprehensive statistical and financial functions.

Lets you forecast, allocate resources, analyze costs—quickly.

HP-80 Financial. \$295.00*

Performs calculations involving the relationship between time and money: bond prices and yields, annuities, amortization schedules, trend line analysis, interest calculations and more.

HP-91 Portable Printing Scientific. \$325.00*

Battery-powered or AC, it tucks into a corner of your briefcase. Performs all standard math, log, trig and many statistical calculations. Thermal printer operates in three modes.

HP-67 Fully Programmable. \$450.00*

The most powerful pocket calculator we've ever offered. 224-step program memory—all merged codes. "Smart" card reader records programs steps and contents of the 26 data registers. Superior editing capability. Very easy to use.

HP-97 Fully Programmable Printing Portable. \$750.00*

Gives you the same powerful capability as the HP-67, plus a quiet three-mode thermal printer that makes programming and editing easier and also provides a permanent record of your calculations. Battery-powered and briefcase portable.

Molex Introduces...THE Insulation Displacement Ribbon Cable Connector.

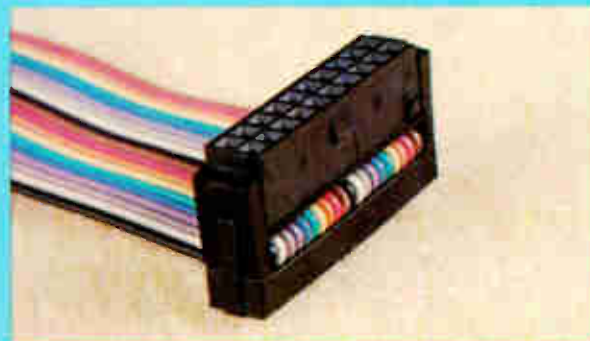

Strain Relief



Daisy Chain Applications

MOLEX 4700 FEATURES

- High Reliability
- No Insulation Stripping
- No Soldering
- Simultaneous Termination Technique
- Gas Tight Connections
- Reduced Labor Costs
- Error Free Wiring
- Industry Compatible
- Terminate Either Side of Flat Cable
- Contacts Accept Cable on .050" Centers
- Positive Flat Cable Alignment
- Avoid Bends in Cable
- Consistant Electrical Characteristics
- Mates With .025" Square or Round Pins
- Probe Holes in Cover
- Visual Inspection
- UL 94V-O Rated Plastic
- Solid or Stranded Wire
- Recessed Cover and Strain Relief
- Dual Wiping Box Contact
- Snap On Strain Relief
- Industry Compatible Assembly Tooling
- Broad Line of Sizes
- Closed End Cover Available

For more information about Molex's "affordable technology", write MOLEX Incorporated, 2222 Wellington Court, Lele, Illinois 60532 or call (312) 969-4550.

molex [®] ... Affordable Technology

Components

Cheap trimmers get better

Bourns enters market with low-cost cermet and conductive-plastic devices

The vast market for trimming potentiometers selling for a quarter or less has finally attracted the attention of the Trimpot Products division of Bourns Inc. One of the largest producers of trimmers, Bourns is introducing its first 25-cent and 15-cent devices: two open-frame units containing a cermet and a conductive-plastic element respectively.

The company wanted to produce low-cost units for the industrial-grade sector that maintained performance characteristics consistent with its higher-priced units, and the only way to do this, says Ronald P. Zimmerman, sales manager for trimmers, was to employ a different element material from competing open-frame devices. "It was ridiculous to take one more stab at carbon," he asserts.

Bourns wanted a contact-resistance variation of 1%, ease in setting, and board-washability. "None of these is possible with carbon elements," Zimmerman says.

Accordingly, Bourns chose cermet for its 25-cent 3354 model, and conductive plastic for its 3355 trimmer, to sell for about 15 cents in production quantities. "We knew both materials would work, but the trick was to build them at a low price," he says. In fact, development of the low-priced trimmers should be viewed primarily as improvements in production processes.

While using conductive-plastic elements on a plastic substrate is not unusual in other potentiometers, it is new to trimmers, Zimmerman explains. "It is faster and cheaper to work with and lends itself to continuous processing." So to get as "much hands-off production as possible," Bourns developed new types of ovens, handling equipment, and test equipment.

The 1% contact-resistance variation of the single-turn 3355 trimmer is considerably better than the 3% to 6% of comparable carbon models, Zimmerman says. The temperature coefficient of 500 parts per million per degree Celsius is also about half the competition. Settability on the smooth plastic surface is improved over the rough carbon material, and holes do not result from wear on the element at frequently set spots. Resistance range is 100 ohms to 5 megohms. The unit comes in three adjustment types: thumbwheel and smooth wheel with screwdriver slot, and thumbwheel with hexagonal adjustment.

With a cermet element on a ceramic substrate, the 3354 trimmer has a power rating of 1.25 watts at 40 C°, which Bourns says compares to 0.5 or 0.75 w for carbon elements. The temperature coefficient of 150 ppm/C also is an improvement over the 250 ppm/C of competing devices. Within the 100-ohm-to-5-megohm resistance range, special fixed values are available by request. Like the lower-cost 3355, the cermet trimmer is board washable.

Both trimmers are in stock.

Bourns Inc., Trimpot Products division, 1200 Columbia Ave., Riverside, Calif. 92507. Phone (714) 684-1700 [341]

Tapped capacitors save on size and weight

A new type of capacitor with metallized dielectric windings can be tapped at different points to provide two or more capacitance and voltage ratings. It weighs less and takes up less space than two or more separate capacitors. Called a Multipacitor, a typical unit might provide 4 microfarads at 200 volts, 2 μF at 200 v, 1 μF at 400 v, and 0.47 μF at 400 v.



This typical unit would occupy only 70% as much volume and weigh only 70% as much as four discrete capacitors with the same ratings. Another advantage claimed for the patented device is increased reliability over discrete film-and-foil capacitors.

Multipacitors are available with individual sets of leads for each capacitor they embody, or they can be supplied with a common lead at one end and multiple leads at the

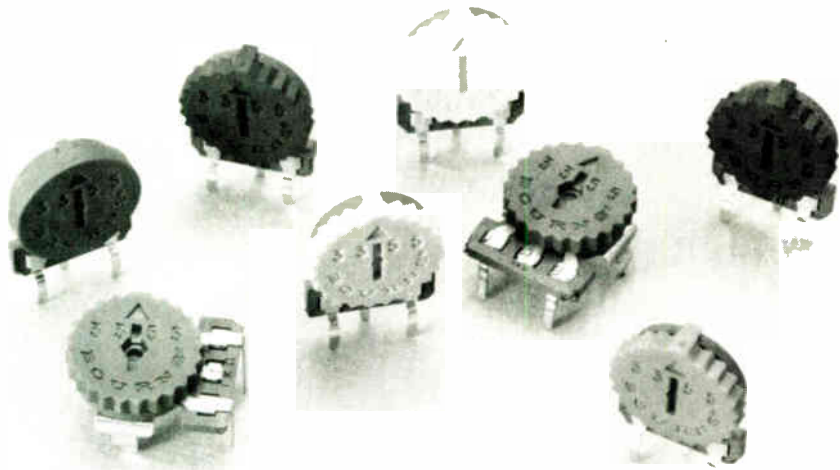

You eliminate short circuits and reduce costs with these AMP connectors.

Unique, low-cost, all-plastic AMP straight posted and right-angle headers.

Now circuit paths can be located directly under the connector without shorting. Because AMP 94V-O rated AMPLIMITE headers are of all-plastic construction. These low-cost high-density headers intermate with standard AMPLIMITE connectors, other similar designs and those meeting EIA specification RS-232-C. Housings have built-in stand-off relief and are available in 5 popular right-angle versions, and a new 25-position low profile straight posted version.

A better way to terminate flat-cable fast.

We put teeth in low-cost mass termination with 25-position HDF AMPLIMITE plugs and receptacles. A simple, miniature press is all that's needed. Fork-like teeth penetrate the cable, make electrical contact with each conductor and interlock with the housing.

Accommodate any 26-position solid or stranded round-conductor flexible cable on 0.050" centers—with no preparation other than

squaring the end. The HDF connector is the one to use for highest production rates and lowest applied cost.

And AMP's unique technical service is the one to use, too. It's in-depth help that's yours for the asking even if you are only in the product planning stage. In fact, we prefer to be involved early. Because it lets you take full advantage of the capabilities and willingness of AMP people to search out better ways for better products.

For further details on the unique AMPLIMITE all-plastic or HDF connectors, call Customer Service at (717) 564-0100. Or write AMP Incorporated, Harrisburg, PA 17105.

AMP has a better way.

AMP

INCORPORATED

AMP EUROPE

Austria — AMP Austria, Branch of AMP Deutschland GmbH, Markgraf-Ruediger Str., 6-B, 1150 Vienna, Phone: 924191/92

Belgium — AMP Belgium, Branch of AMP, Halland B.V., Rue de Brabant 62-66, Brussels, Phone: 322.17.55.17

Finland — AMP Finland OY
Pastilokero 3, 00401 Helsinki 10
Phone: 90/584122

France — AMP de France, 29 Chaussée Jules-César, Boite Postale No. 39, 95301 Pontoise
France, Phone: 030 82 20, 030 92 30

Germany — AMP Deutschland GmbH, Ampèrestrasse 7-11, 607 Langen, B. FFM., West Germany, Phone: (06103) 7091

Great Britain — AMP of Great Britain Limited, Terminal House, Stanmore, Middlesex, England, Phone: 01-954-2356

Holland — AMP Holland B.V., Papierstraat 2-4 's-Hertogenbosch, Holland, Phone: (04100) 25221

Italy — AMP Italia S.p.A., Via Fratelli Cervi 15, 10093 Collegna (Torina), Italy, Phone: 785-656

Spain — AMP Española, S.A., Apartada 5294, Pedra IV, 491, 495, Barcelona 5, Spain, Phone: 307-75-50

Sweden — AMP Scandinavia AB, Datavägen 5, 17500 Jakobsberg, Sweden, Mailing Address: Fack S-175 20 JARFALLA 1, Sweden, Phone: 0758/10400

Switzerland — AMP AG, Haldenstrasse 11, 6006 Luzern, Switzerland, Phone: (414) 235421, 235422, 235423

AMP NORTH AMERICA

Canada — AMP OF CANADA LTD., 20 Esna Park Drive, Markham, Ontario, Ph: 416-499-1251

Mexico — AMP de Mexico, S.A., Apartada Postal 179, Naucalpan de Juarez, Edo. de Mexico, Phone: Mexico City 576-41-55

Puerto Rico — AMP OF CANADA LTD., 677 Calle de Diego, Rio Piedras, Puerto Rico 00924, Phone: (809) 766-2346

United States — AMP Incorporated, Harrisburg, Pa. 17105, Phone: 717-564-0100

AMP SOUTH AMERICA

Argentina — AMP S.A. Argentina 4 de Febrero, 76 Villa Zagla — SAN MARTIN, Buenos Aires, Argentina, Phone: 752-4612

Brazil — AMP do Brasil Ltda., AV Camendador Martinelli 1B5, Lapa, Sao Paulo, Phone: 262-4353

AMP PACIFIC

Australia — Australian AMP Pty. Limited, 155 Briens Road, Northmead, N.S.W. 2152 Australia, Mailing Address: P.O. Box 194, Baulkham Hills, N.S.W. 2153 Aus. Ph: 630-7377

Japan — AMP (Japan), Ltd., No. 15-14, 7-Chame, Rappongi Minato-Ku, Tokyo, Japan, Ph: 404-7171

Products and services for many specialized industries are provided by the AMPLIVERSAL Division. In the United States, this division is known as AMP Special Industries.

For Amp products and services in other countries, write: AMP International Division, Harrisburg, PA 17105, USA.

New products

other—one for each capacitor

Precision Capacitor Division, American Radio-nic Co. Inc., 51 Austin St., Danbury, Conn. 06810. [343]

SIP resistor networks

stand only 0.175 inch high

The latest addition to Stackpole's line of thick-film resistor networks is a family of miniature single in-line packages with 4, 6, 8, 10, or 12 pins. The SIPs, which are rated to dissipate 0.125 watt, measure just 0.175 inch above standoff; standard is 0.350 in. Resistances from 33 ohms to 10 megohms are offered in 64 standard values. Standard tolerance is 2%. A typical network sells for less than 15 cents.

Stackpole Components Co., P.O. Box 14466, Raleigh, N.C. 27610. Phone Joseph Slater at (919) 828-6201 [344]

Latching relays resist mechanical shock

A new type of latching relay consists of two relays mounted on a common plate. Either relay, when momentarily energized, is mechanically held in by the other one. Intended for on/off switching, power reversal, and similar applications, the arrangement is highly shock-resistant and can be supplied with either iden-

tical or different voltages for each coil. The contacts are rated to handle 5 amperes at 120 v ac. Available coil voltages are 6, 12, 24, 120, and 240 v ac. Required coil power is nominally 2.5 watts dc, 7.0 volt-amperes ac. Maximum power-dissipation capability of the coil is 4.0 w. Artisan Electronics, 5 Eastmans Road, Parsippany, N.J. 07054 [346]

Subminiature indicator lamps offer mechanical dimming

Two types of operator-actuated mechanical dimming are offered on Dialight subminiature indicator lamps to allow lamp brightness to be adjusted to ambient illumination. In both cases, a knurled portion of the lens cap is rotated to dim the light. In one case, a mechanical diaphragm is operated; in the other, the dimming mechanism is a Polaroid filter. All the lamps that offer the dimming feature use T 1 $\frac{3}{4}$ lamps and meet the requirements of MIL-L-6723 and -3661B. Prices, in lots of 1,000 pieces, range from \$2.57 to \$2.91 each.

Dialight, a North American Philips Co., 203 Harrison Place, Brooklyn, N.Y. 11237 [345]

Miniature high-resistance units have 1% tolerance

A line of miniature film resistors with resistance values from 2 to 100 megohms boast tolerances of 1% and temperature coefficients of 80 ppm/ $^{\circ}$ C. Both the model MK 632 (0.3 inch square) and the MK 620 (0.25 in. square) measure only 0.1 in. thick. The resistors operate over the temperature range from -55° C to 175° C. The MK 620 units can dissipate up to 0.5 watt, while the MK 632 are rated at 0.75 w. A typical price is \$1.05 each for a 10-megohm model MK 632 in quantities of 500 or more.

Caddock Electronics Inc., 3127 Chicago Ave., Riverside, Calif. 92507. Phone Richard Caddock at (714) 683-5361 [347]

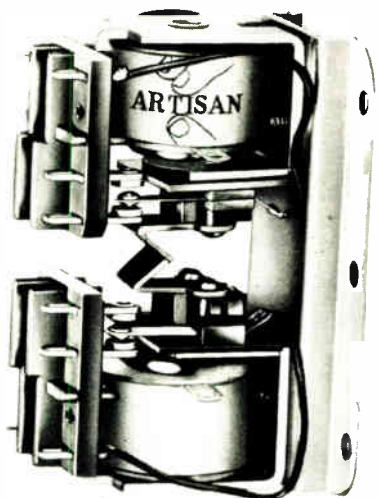

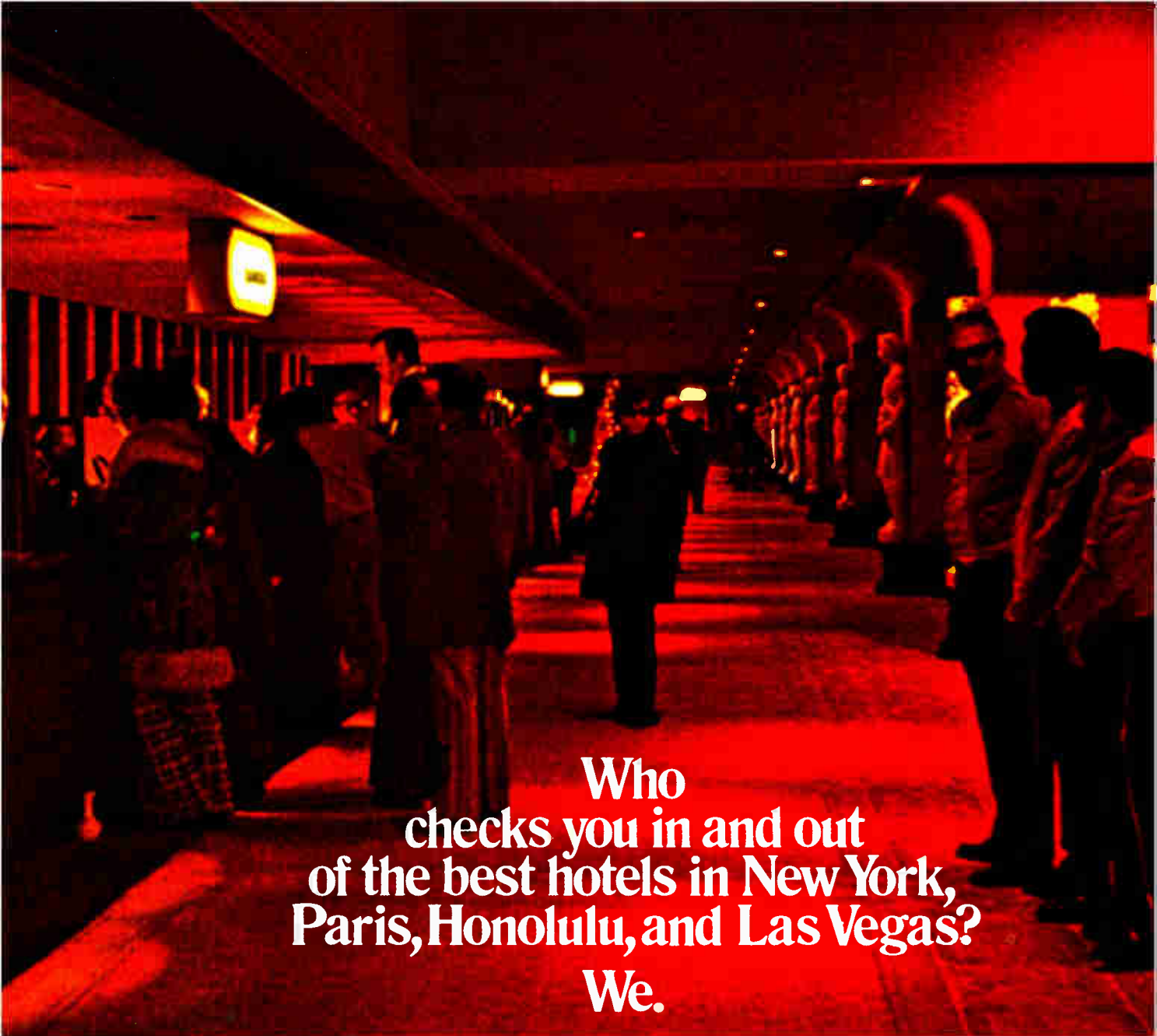

**Who
checks you in and out
of the best hotels in New York,
Paris, Honolulu, and Las Vegas?
We.**



SYSTEM INSTALLATIONS IN:

Aladdin Hotel & Casino • Cerritos
Beach Hotel • Dorado Beach Hotel •
Hotel Inter-Continental Maui • Hotel
Inter-Continental Paris • Hyatt House Orlando
• Hyatt Regency Waikiki • Innisbrook Resort & Golf
Club • MGM Grand Hotel • Sea Pines Plantation • Sheraton-
Boston Hotel • Sheraton-Four Seasons Hotel • Sheraton
New York Hotel • Sheraton Waikiki • Princess Kaiulani
Hotel • Royal Hawaiian Hotel • Tamaron

The computer system that takes your reservation, registers you, continuously updates your guest folio from hotel points of sale, and prints out your final bill is almost certainly our EECO Hotel System. Because we dominate the field you'll find it unobtrusively doing its job at a growing number of the world's best hotels and resorts.

We're telling you now because we thought it's time you knew we do more than make thumbwheel switches, tape readers, and packaging hardware.

EECO is part of your life.

EECO

1441 E. Chestnut Ave., Santa Ana, California 92701 • Phone 714 835-6000

New products

Data handling

Tough disk drive stores 2 Mbytes

Sealed moving-head unit operates at 131°F, resists shock and vibration

Because moving-head disk drives are physically delicate mechanisms, it has not been practical to use them in such otherwise promising applications areas as machine-tool control, oil exploration, and moving platforms (land vehicles, ships, aircraft, etc.) Now the D-100 disk drive from Digimetrix promises to change all this with its ability to operate at a temperature of 131°F, at a tilt of up to 45° from the horizontal, and while undergoing up to 10 g of shock and 1 to 2 g of vibration. (The drive can take 1 g of vibration from 5 to 30 hertz and 2 g from 30 to 500 Hz.)

Because it is completely sealed, the unit operates reliably in dusty, dirty, and humid environments. To further enhance its reliability, its dual flying heads are designed to land harmlessly at very low rpm, thus making it unnecessary to

employ troublesome head-retracting mechanisms. The two parallel flying heads share a common ceramic slider unit that is positioned by a stepper motor and lead-screw assembly. The wear-compensating head carriage, for which a patent is pending, rigidly controls the head-to-disk spacing and effectively dissipates the stepper motor torque while providing necessary damping.

The D-100 is offered with storage capacities of 0.5, 1, and 2 megabytes. Two bit-transfer rates are available: 1.1 and 2.2 megabits per second. With a disk speed of 1,800 rpm, the drive has an average latency time of 7 milliseconds, a random average access time of 130 ms, and an average access time of 240 ms.

The recording medium is a 9-inch solid aluminum disk with nickel-cobalt plating and a nickel conversion wear coating. Track density is either 64 or 128 tracks per inch depending upon system capacity, with an error rate of 1 in 10¹¹ in both cases. Both formatted and unformatted versions are available.

The D-100 measures 7 by 15 by 15 inches and weighs 20 pounds. In small quantities (1 to 9) the 524,000-byte D-100-2 sells for \$1,350, the 1,048,000-byte D-100-3 for \$1,650, and the 2,096,000-byte

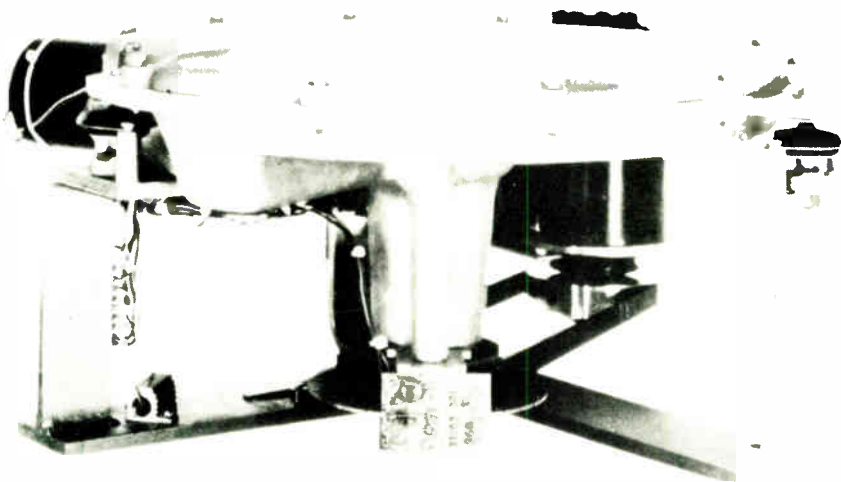

ULTRA FINE LINE PRINTING

50—70"
Lines & Spaces
by screen printing technique



custom production

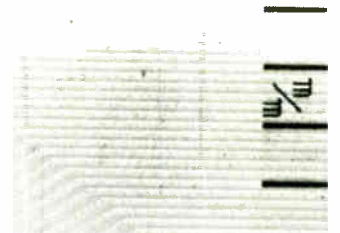

- Low cost
- Mass production

Applications

1. Plasma display panel
2. Thermal printer head
3. Multi layer HIC etc.



MFP
CORP.

25-1, Minami-cho 6-chome, Fuchu,
Tokyo, 183 Japan
Tel. 0423-68-3341

Now get a firm grip on your lead-mounted semi's and heat problems, too

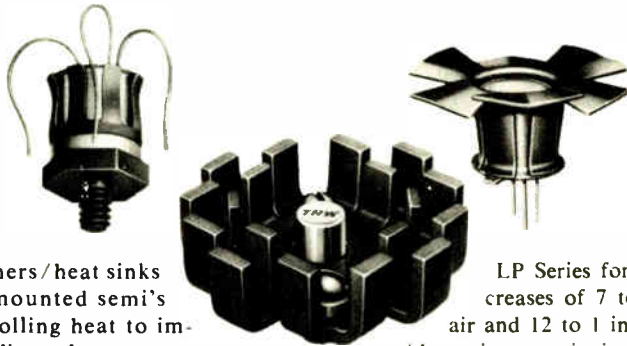

IERC retainers/heat sinks hold lead-mounted semi's while controlling heat to improve reliability or let you operate at higher power levels. Our TXB's for Mil-spec environments are excellent retainers on p-c boards or serve as efficient thermal links between case and heat sink. BeO washers are available for electrically-hot-case applications. Use our staggered-finger

LP Series for power increases of 7 to 1 in still air and 12 to 1 in forced air with no increase in junction temperature. And, if your semi's are already mounted, slip on a Fan Top and get higher wattages for just pennies. Send for catalog. IERC, 135 W. Magnolia Blvd., Burbank, Calif. 91502, a subsidiary of Dynamics Corporation of America.



Circle 146 on reader service card

New products

D-100-4 for \$1,950. In hundreds, these prices drop to \$995, \$1,195, and \$1,395, respectively. The drives are also offered with Diablo 31-compatible electronics, with a formatter that includes an 8- or 16-bit parallel interface, and as a complete turn-key system.

Digimetrix Inc., 20954 Corsair Blvd., Hayward, Calif. 94545. Phone Dennis Setera at (415) 783-5614 [361]

Magnetic-card reader minimizes bit drop-out

The model 40 Magstripe card reader uses a gimbal-mounted card head suspended in a yoke by parallelogram springs to provide precise spacing between the head gap and the card. This minimizes spacing losses and bit dropout when warped, old, and dirty cards must be read. The unit provides C-MOS or TTL outputs consisting of a data stream

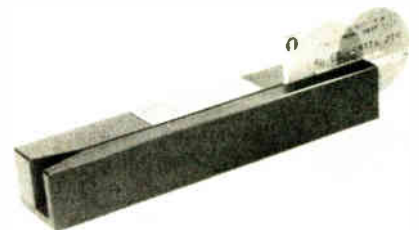

and a strobe. A companion unit, the model 50, has the same output, but offers a special security feature: the card must remain in the reader until the transaction or access is completed. Both units are manually operated; they thus require no electrical power for transport.

American Magnetics Corp., 2424 Carson St., Torrance, Calif. 90501. Phone (213) 775-8651 [365]

\$400 computer terminal has built-in display

Designed for two-way communication with any RS-232-equipped device, the KDM/1 terminal has a built-in display and a price of only

More Power (and Storage) to You!

New!



Electronic Product Associates announces the availability of the all new MICRO-68b Microcomputer. The MICRO-68b combines the economy and reliability of the MICRO-68 with additional performance and memory capabilities. The MICRO-68b comes completely assembled with hexadecimal keyboard, 6 digit LED display, 8K RAM, 1K PROM monitor system, and a CRT/TTY/Audio Cassette Interface. It is housed in a blue, ruggedized aluminum cabinet with a 13 slot excorisor compatible mother board and 20 amp power supply. The MICRO-68b utilizes the 6800 Microprocessor chip set and lists for an economical \$1878.

EPA Electronic Product Associates, Inc.
1157 Vega St., San Diego, CA 92110
(714) 276-8911
First in Microprocessor Systems

Circle 221 on reader service card

"SNAP-OUT" CONTACT PROBES

REPLACEABLE ELECTRICAL CONTACTS THAT IMPROVE TESTING RELIABILITY.

- Machined Probe Tips cut through PCB build-up and residue.
- Complete selection of sizes and tip configurations.
- Replace or change probes without wiring disturbance, eliminates flexing. Receptacle stays in place.
- High contact density to 441/sq. in. (.050" centers)
- Available from stock.

*Size "O" Spring Contact Probes

EVERETT CHARLES, INC.
2806 Metropolitan Place
Pomona, CA 91767
PHONE (714) 593-2541



Circle 222 on reader service card

the Fastest Biggest Bipolar Multipliers you can buy

130 ns



8 by 8 Bits – Ideal for on-line multiply in micro and mini computers – operates directly on most data bus lines – consumes only 1.8 watts (typical)
Price \$100 each in 1-9 quantities.

150 ns

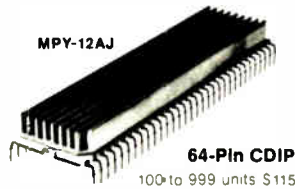

12 by 12 Bits – New size multiplier for data communications and Signal Processing – needs only 3-1/2 watts for room temperature operation – single TTL Clock – fully TTL compatible – Price \$165 each in 1-9 quantities.

160 ns

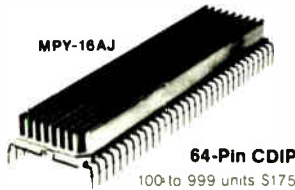

16 by 16 Bits – Smaller chip improves performance – 64-pin DIP easy to use – dissipates 5 watts with built-in heat sink – perfect for micro/mini applications – signal processing – price \$300 each in 1-9 quantities.

FULL MIL-TEMP RANGE NOW AVAILABLE

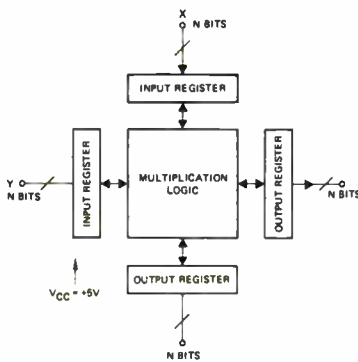

Features

- Two's Complement Multipliers
- Double Precision Products
- Single Chip Bipolar Design
- Asynchronous Multiply
- Single or Multi Bus Operation
- TTL Compatible Input/Output $\pm 5V$

**Operating Sequence
Mini/Micro Computer
Data Bus Operation**

- Load Input Registers
- Wait Multiply Time
- Load Output Registers
- Read-Out

For detailed data, applications information and prices, call (213) 535-1833 or order direct with coupon. **TRW LSI Products**, One Space Park, E2/9085, Redondo Beach, Calif. 90278.

Order Today

- Send Data Sheets
 Enclosed is check or purchase order

Name _____
Title _____
Company _____
Div/Dept. _____
Mailing Code _____
Street _____
City _____
State _____ Zip _____

More LSI Products from a Company Called **TRW**

+0.5 to
+2.0 Volts

AT LAST! WIEGAND EFFECT PULSE GENERATION TO BE DEMONSTRATED

How can a little, surface-hardened magnetic wire, plus a permanent magnet and a pick-up coil, produce up to 2V, 20 μ s pulses? Find out at the Design Engineering Show.

Pulses are not rate sensitive, and there's no need for external power. The Wiegand Effect is ideal for switching, counting, ignition, security devices, etc., and some of these applications will be demonstrated.

20 μ s

Echlin is granting licenses for this remarkable, basic technology. Learn how industry's most advanced pulse generation technology will help *your* application. If you can't make the show, write or phone for our new technical brochure. The Echlin Manufacturing Co., U.S. #1 & Echlin Road, Branford, Conn. 06405. (203) 481-5771.

ECHLIN

BOOTH
772
DESIGN
ENGINEERING
SHOW

New products

\$400. The terminal includes a full ASCII keyboard and a 32-character alphanumeric LED display. The companion model KDM/2 is a similar device displaying 16 rows of 64 characters on a standard TV set. It sells for \$500. The KDM/3, which uses a CRT monitor as a display, provides



24 lines of 80 characters at a price of \$700.

All KDM models operate at any of eight switch-selectable speeds up to 9,600 bauds. They are intended for use with computers, computer-controlled test equipment, bar-code readers, optical-character-reading scanners, and microprocessor development systems. Options include an acoustic coupler, cassette tape storage, and a badge reader. Delivery is from stock to 30 days.

Micon Industries, 252 Oak St., Oakland, Calif. 94607. Phone (415) 763-6033 [363]

Small-system disk drive stores up to 75 megabytes

Designed specifically for use with small computer systems, the model 601 disk storage drive is offered with storage capacities of 25, 50, or 75

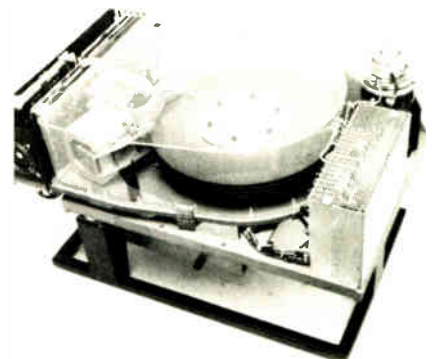

miproc gives the systems man 1980s micropower now

Miproc is right now being planned into a wide range of systems by designers who recognise the trend to programmed hardware. For many the 'single chip' MOS microprocessor provides adequate power. Miproc is for those who need an extra order or two of magnitude of computing power to handle their work. One Miproc can outrun most minis and leaves the MOS micros miles behind. Plessey Microsystems are now planning multi-Miproc configurations with their customers for compute-hungry applications.

We realise that a device like Miproc will often find its work as part of a larger system and in a wide range of environments. Consequently we build Miproc to our customers' equipment practices to meet both civil and military standards.

David Tarrant
Plessey Microsystems
Water Lane, Towcester
Northants, United Kingdom NN12 7JN
Tel: Towcester (0327) 50312

Alan Senior
Plessey GmbH,
Motorstrasse 56, 8 München 40
West Germany
Tel: (089) 351-60-21

Jay Jhu
Plessey Microsystems
1674 McGaw Avenue
Irvine, California 92714, USA
Tel: (714) 540 9945

David Garrison
Plessey Microsystems
Suite 414, 11141 Georgia Avenue
Wheaton, Maryland 20902, USA
Tel: (301) 949 1664

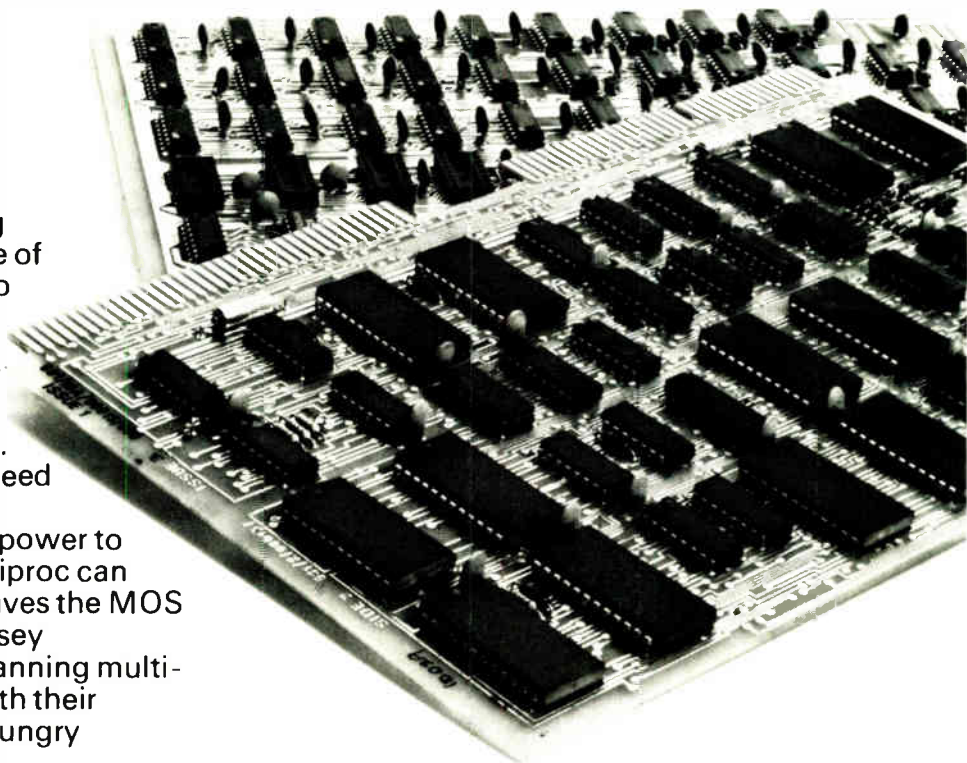

- 16 bit word
- 2,850,000 instructions per second
- Up to 65k data
- Up to 65k program
- Super-rapid interrupt
- Standard modules :
double Europa format
- Specials to your own civil or
military standards, including thin
film hybrids.



PLESSEY
MICROSYSTEMS

Move up..to our miniature.

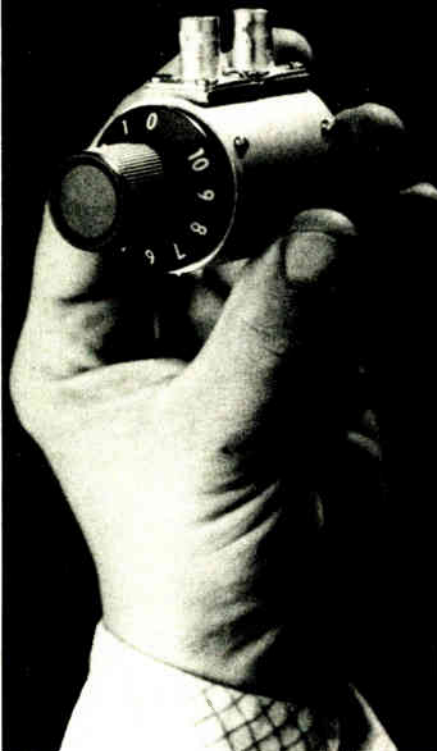

2 GHZ: Maximum VSWR: 1.3:1
Insertion Loss: .3 dB
Overall Accuracy: 2%

We're very excited about introducing to you our newly designed miniature rotary attenuator. We've worked very hard to bring to you a new miniature that exceeds our standard rotary in every way. At high frequencies the specs are really impressive, at lower frequencies they're even better. And the price is unbelievable. We still bring to you 25 years of innovative engineering experience and superior quality. Very precise resistors and goldplated contacts maintain our high level of accuracy. And our unique self-cleaning switch action insures positive repeatability over a prolonged period of time. We feel so sure you will be impressed with our new miniature rotary that we have a large supply in stock. Write for more information, or better yet, call in your order for immediate delivery.

AVAILABLE IN STOCK.

KAY Elemetrics Corp.
12 Maple Avenue, Pine Brook, N.J. 07058
(201) 227-2000

Circle 150 on reader service card

low cost data system

**Easiest to use: Monitoring Processes, Logging Data,
Tracking Tests & Studies**

Gather analog or digital data from up to 248 channels—thermocouples, transducers, etc.—print out results, tape them, feed your computer. It's all under your keyboard control with a microprocessor in the proven PD 2064 System. You easily set or change all functions: crystal clock timing, scan intervals, channel signal conditioning, alarms, auto-programming with new multi-program bank and program printout, plus timesaver subroutines like true integration and averaging if you want. We believe it's the most powerful, versatile, and lowest cost standardized way to reduce more data per dollar in industry, lab, or field applications. Some units stocked for quick shipment. Request Bulletin B110 from Esterline Angus Instrument Corporation, P.O. Box 24000, Indianapolis, IN 46224. Tel. 317-244-7611.



150 Circle 223 on reader service card

New products

megabytes. To maximize reliability, the system's read/write heads, rotary actuator, spindle, filter, and disks are housed in a factory-sealed airtight module. A special disk-coating technique and surface shield, which are proprietary to Memorex, are said to provide high output and resolution and to extend the useful life of the disk more than 100 times that of unshielded disks.

Memorex Corp., San Tomas at Central Expressway, Santa Clara, Calif. 95052. Phone (408) 987-2203 [366]

Tape cartridge carousel stores 32 megabytes

A compact mass-storage system that resembles a 35-millimeter circular slide projector holds 16 quarter-inch cartridges in a removable pack. The system, which has a capacity of 32 megabytes, includes a dual-microprocessor formatter to simplify interfacing, handle routine housekeeping functions, and reduce user programming requirements. Designed for unattended operation, the system is well suited for small and medium-size computer applications in which



short response time is not as important as low cost and large storage capacity.

A complete one-station carousel lists for \$3,215 in quantities of 50. Four-station carousels go for \$6,185 in similar quantities.

National Computer Systems, 4401 W. 76th St., Minneapolis, Minn. 55435. Phone (612) 831-4100 [367]

Electronics / April 28, 1977

DEVICES	INP/JT	DRIVERS PER PACKAGE	OUTPUT CURRENT	OUTPUT VOLTAGE	TYPICAL SPEED	CLAMPED DIODES	PACKAGE
SN75401-404	TTL	2	500mA	35V	33ns	No	14-pin NE DIP
SN75411-414	TTL	2	500mA	70V	33ns	No	14-pin NE DIP
SN75416-419	TTL/MOS	2	500mA	70V	100ns	Yes	14-pin NE DIP
SN75430-434	TTL	2	300mA	15V	15ns	No	8-pin DIP*
SN75450B-454B	TTL	2	300mA	30V	21ns	No	8-pin DIP*
SN75460-464	TTL	2	300mA	35V	33ns	No	8-pin DIP*
SN75470-474	TTL	2	300mA	70V	33ns	No	8-pin DIP*
SN75476-479	TTL/MOS	2	300mA	70V	100ns	Yes	8-pin DIP
ULN2001A-4A	**	7	500mA	50V	1 μ s	Yes	16-pin DIP
SN75466-469	**	7	500mA	100V	130ns	Yes	16-pin DIP
SN75441	ECL	2	100mA	30V	22ns	No	14-pin DIP

*SN75431-434/451B-454B/461-464/471-474 (AND, NAND, OR, NOR functions) are 8-pin devices. SN75430/450B/460/470 (AND function with externally connected output transistor bases) are 14-pin devices.

**Input capabilities include TTL; CMOS (5V and 6V-15V); and PMOS (5V, 6V-15V, and 14V-25V).

INTERFACE ICs

Peripheral drivers from TI. Broadest choice. Highest power.

TI's wide selection of peripheral drivers makes it easier to implement your most demanding designs. Easier to match optimum current/voltage/speed combinations to your specific requirements.

Check the chart above. In it you'll find specs on the industry's best selection of peripheral drivers: Series SN75401/SN75411/SN75416 — two-watt power dual drivers with 500mA output current. The special 14-pin NE package has copper-clad silver-plated lead frames, with eight active pins and the six center pins used for heat dissipation. Inserts easily into standard 14-pin pc board mounting holes.

The 401 series has a 35V off-state output voltage; the 411 and 416 series, 70V. The 416 series features output clamped diodes.

Series SN75430/75450B/75460/75470 — general-purpose duals with 300mA output current. These series offer a broad choice of voltage/speed combinations.

Series SN75476 — dual drivers with 70V off-state output voltage and output clamped diodes on the chip. No longer are external clamped diodes required to drive inductive loads.

These monolithic linear ICs deliver the specs you need. Within each series you have a complete choice of logic functions—AND, NAND, OR, NOR.

In addition to these dual drivers, TI also offers two series of seven-channel Darlington transistor array inverting buffers. The SN75466 series has an off-state output voltage of 100V; the

ULN2001A, 50V. Input compatibilities include TTL; CMOS (5V and 6V-15V); and PMOS (5V, 6V-15V, and 14V-25V).

And there's also the SN75441 dual driver with positive OR logic, compatible with Series 10K ECL inputs.

Take stock of your peripheral driver needs today and place your order with Texas Instruments or your local authorized TI distributor.

Free data book. For your personal copy of the new 120-page Peripheral Driver Data Book, circle the reader service number indicated below or write Texas Instruments Incorporated, P.O. Box 5012, M/S 308, Dallas, Texas 75222.



TEXAS INSTRUMENTS
INCORPORATED

The Ultimate in Manual Writing Transport.

- * 2 CH ABA READ ONLY MINTS READ/WRITE
- * SAMPLES S300, QUANTITY LOT \$150. F.O.B. JAPAN
- * SMALL COMPACT DESIGN

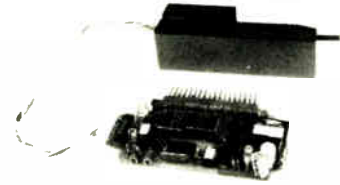

MODEL MCR-201-AR

- ABA, MINTS, STANDARDS SPECIFICATION
- SINGLE POWER SUPPLY
- WITH 1 024 BITS RAM IN "LSI"
- FULL CONTROL OF CARD TRANSPORT BY LSI
- APPLICATION BANKING, POS TERMINAL, GAS STATION TERMINAL
- OTHER MODELS QUANTITY LOT MCR-110-1R (ABA READ ONLY) LESS THAN \$39. MCR-111-2R (ABA, MINTS 2 CH READ ONLY) LESS THAN \$59

SR.D. CORPORATION



2 12 1, KAGA, ITABASHI KU, TOKYO, 173 JAPAN
CABLE ADDRESS
SRDCORPORATION TOKYO
TEL (03) 964 1151
TELEX 0272 3546 SRD CO J

Circle 152 on reader service card

Gas Sensing Semiconductor

FIGARO TGS GAS SENSOR

quickly senses
even small
amount
of gas.

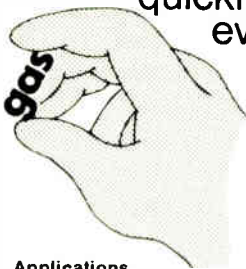

Applications

1. Natural Gas-Leak Alarm
2. Propane Gas-Leak Alarm
3. Carbon Monoxide Detector
4. Automatic Fan Control
5. Fire Alarm (Detecting
6. combustible gases contained in smoke)
7. Alcohol Detector (Detector for drunken driver)
7. Air Pollution Monitor

Please contact any of the addresses below directly for catalogs and price/delivery information

FIGARO ENGINEERING INC.

●Head Office: 3-7-3 Higashitoyonaka, Toyonaka City, Osaka, 560, JAPAN TELEX 05286155
FIGARO J. CABLE FIGARO TOYONAKA
TEL (06) 849-2156

●North America: 3303 Harbor Boulevard, Suite D-8, Costa Mesa, California 92626, U.S.A.
TELEX 678396 CABLE FIGARENGIN
COSTAMESA TEL (714) 751-4103

152 Circle 224 on reader service card

New products

Packaging & production

Wiring system is multifaceted

Machine solder wraps
twisted pairs, wraps wires,
and aids in part insertion

All automatic wiring systems are built around accurate X-Y positioning systems that move a special-purpose wiring tool only suited to its particular wiring method. In a departure from these single-purpose wiring machines, United Wiring and Manufacturing Co. has designed and produced a relatively low-cost automatic Solder-Wrap machine that, in a semiautomatic mode, can be adapted to laying down solder-wrapped twisted pairs, wire-wrapping, or inserting components. In addition, the machine can verify finished wiring panels or drill tapes.

The Model 100, which is priced at \$35,000, is basically a fully automatic solder-wrapping machine that tests its wiring continually during the wire routing and soldering process [*Electronics*, April 14, p. 111]. It can position, solder, and cut 250 to 300 wires per hour on printed circuit boards as large as 20 by 29 inches.

With a \$5,000 option, the new machine can be converted to a twisted-pair semi-automatic solder-wrapping machine. A light source, programmed with twisted-pair wiring data on paper tape, shines on the proper row/column address of a board. The operator then routes the twisted-pair wires with a motor-controlled tool by following the light's programmed positions. The result is a continuous net of twisted pairs that can be soldered and cut with the standard automatic mechanism of the machine. From 130 to 150 twisted pairs per hour can be put down with this special head.

The model 100's Solder-Wrap mechanism can be removed, and a \$2,000 Wire-Wrap head secured in its place in about ten minutes. While wrapping connections at a pace of 200 to 250 wires per hour, the machine displays the address location of the point being wrapped and also the wire length required for any particular wire on its console.

With the add-on light-pointing system, the machine can be programmed—for an additional \$2,000—for component insertion. Guided by light shining on the board, an operator inserts a programmed component. The unit's three 5-digit console displays can be programmed to display bin number, part type, and address location on a pc board. From 500 to 600 components per hour can be inserted by

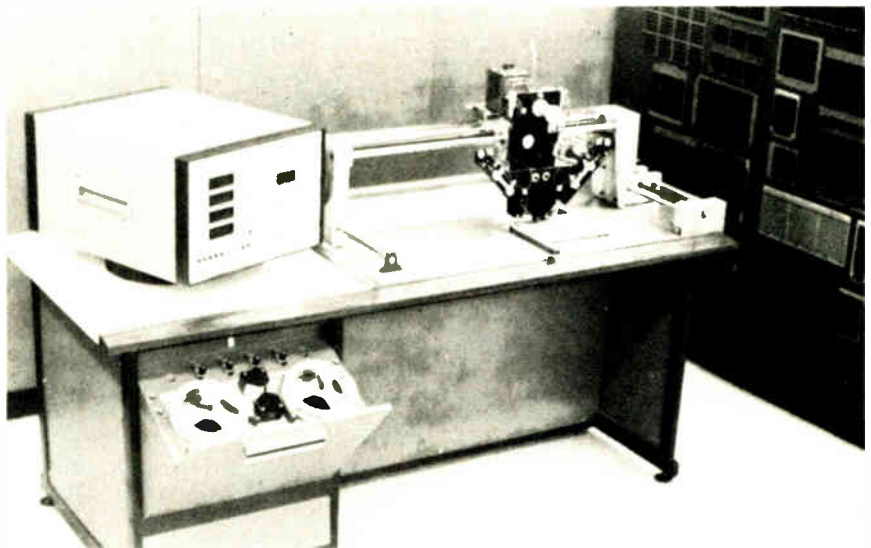

New from Centralab...

IMPS PUSHBUTTON SWITCHES

A new miniature modular building block system that offers microprocessor control designers more of what they need.

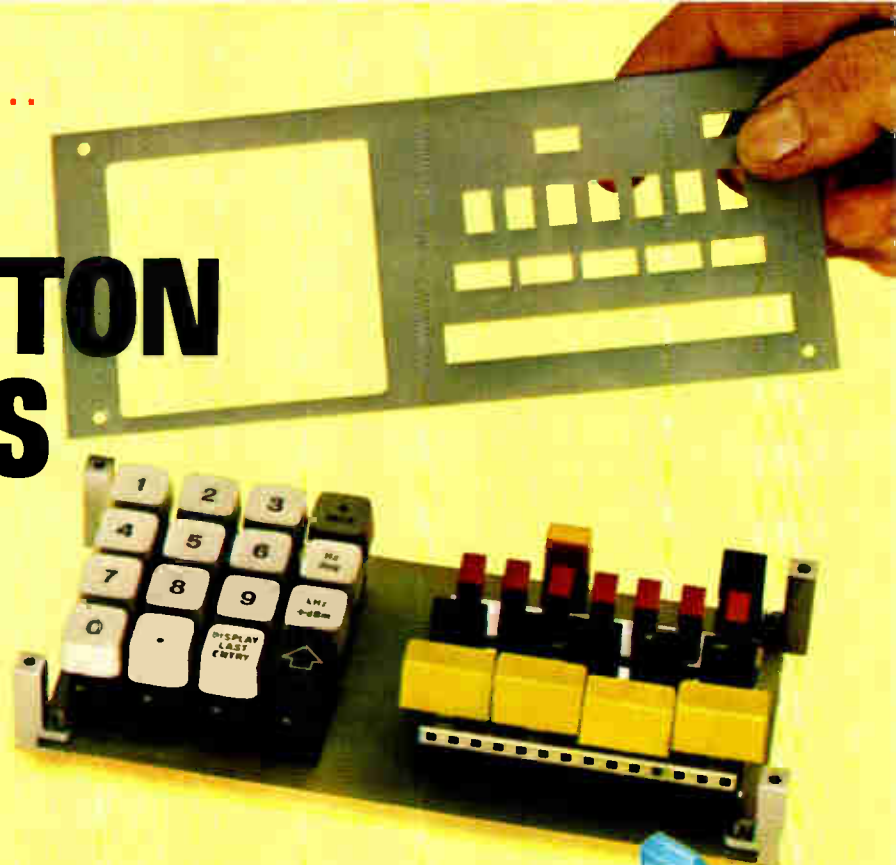

To meet the special digital and analog needs of today's μ P-based controls, Centralab offers design engineers a whole new system of modular pushbutton switch building blocks. We call it IMPS — Integrated Modular Panel System. IMPS saves PC board and panel area and simplifies front panel design, cuts assembly costs, reduces back-panel space requirements, and meets the digital-analog needs of μ P-based controls. Check these space saving, cost-cutting features.

Simplify front panel interface.

All IMPS switches regardless of function, are uniform in size, simplifying design and selection of front panel hardware. They have high volumetric efficiency, occupying .505" x .388" PC board area and require only .608" of space between PC board and front panel.



Cut assembly costs.

IMPS switches may be mounted on the front panel, and are designed for automatic wave soldering installation and PC board cleaning. Insert molded terminals prevent flux and solder wicking and contact contamination. Integral PC board stand-offs provide for efficient board cleaning.

Meet analog and digital needs.

IMPS switches are available with momentary, push-push and interlocking actions, with a long-life contact system that switches both digital and analog signals. To accommodate critical signal requirements, housings are high-insulation molded plastic with UL 94V-0 rating.

Available options.

Optional installations include ganged assemblies, front-panel mounting and wire-wrapping.



All IMPS pushbutton switches are built to Centralab's highest quality standards (see specifications at right). They're priced as low as 41 cents in 1,000 quantity. For full technical details, samples and quotation, call (515) 955-3770, or write to the address below.



CENTRALAB

Electronics Division

GLOBE-UNION INC.

P.O. BOX 858

FORT OGDON, IOWA 50501

Built To Centralab Quality Specs.

IMPS Pushbutton Switches combine compact size, low cost and highest quality throughout.

- Silver or gold inlay wiping contacts for long-life and low-contact resistance.
- Less than 2 milliseconds contact bounce.
- SPST, SPDT, DPST, and DPDT switch contacts.
- Printed circuit, DIL socket or wire-wrap terminations available.
- 2.5 to 3.5 oz. actuation force (momentary).
- Choice of button interface — square or blade shaft (shown) — permits use of a variety of Centralab and industry standard buttons and keycaps.
- 10, 15, 20 or 25mm center-to-center spacing.

Circle 153 on reader service card

Pinpoint The Problem

HP's Current Tracer locates low impedance logic faults.

By tracing current to sources or sinks, it can find the one bad component on a bus, pinpoint hairline solder bridges or backplane shorts. It quickly troubleshoots wired AND/OR and 3-state busses in all logic families. No cutting circuit traces or removing good circuit elements. Sensitive only to AC currents with fast transitions; adjustable sensitivity of 1 mA to 1 A; single lamp readout displays relative current levels. Model 547A, \$350*. Also available are HP's 546A Programmable Logic Pulser for single pulse or streams (\$150*) and HP's Logic Probes and Clip for voltage based problems. *Domestic U.S. prices only.

Northeast, contact Schweber: Westbury, NY; Somerset, NJ; Danbury, CT.
West, contact Wyle-Elmar: Denver, CO; Mt. View, CA.
Wyle-Liberty: Seattle, WA; Phoenix, AZ; San Diego, CA; El Segundo, CA.
Elsewhere, contact your nearby HP sales office, or write.

HEWLETT  **PACKARD**

1507 Page Mill Road, Palo Alto, California 94304



Circle 154 on reader service card

1977 Answer Book. It makes your job easier. \$25.

Who makes what? Over 4000 products, more than 5000 manufacturers with their local contracts and distributors, directory of trade names and catalogs, post-paid inquiry cards for 5-second ordering of current catalogs.

Electronics Buyers' Guide
1221 Ave. of the Americas
New York, N.Y. 10020

Yes, send me a copy of The Answer Book. I've enclosed \$25 (USA and Canada only, elsewhere send \$35). Full money back guarantee if returned within 10 days.

Name _____
Company _____
Street _____
City _____ State _____ Zip _____



**Electronics
BUYERS'
GUIDE**

World Radio History

New products

utilizing this assembly aid.

The light-pointing system can be also used to test for wire verification of both Wire-Wrap and Solder-Wrap panels. The wire-net number under verification is shown on one of the console's 5-digit displays.

The Model 100 also can be programmed to be a flat-bed plotter for checking drill tapes, and the Solder-Wrap stringer mechanism can be adapted to hold a plotter pin. This pin can be programmed up or down to verify tapes for Solder-Wrap, Wire-Wrap, and pc boards of all types.

United Wiring and Manufacturing, 2612 Electronic Lane, Number 404, Dallas, Texas 75220. Phone (214) 350-4978 [391]

Heat-dissipation system cools board-mounted DIPs

A heat-dissipation system for circuit boards loaded with dual in-line packages uses copper strips to carry heat from the DIPs to the board edges, and, subsequently, to the surrounding environment. The copper strips, called conduction planes, are the heart of the system. They are arranged in parallel rows across the circuit board so that the DIPs straddle them.

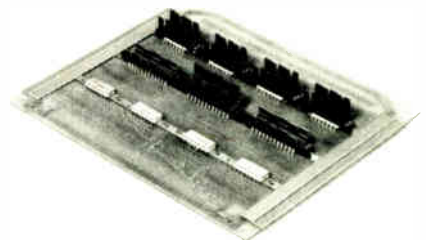

Each strip makes good thermal contact with the DIPs in its row and carries an estimated 25% to 35% of the heat generated by those devices to transfer bars that attach to the sides of the boards. From the transfer bars, the heat is carried to the outside world. The system can be augmented by the addition of ordinary staggered-finger radiators that clip onto the DIPs.

A major benefit of the system is

Electronics / April 28, 1977

AUGAT ANNOUNCES THE PC BREAKTHRU OF THE DECADE

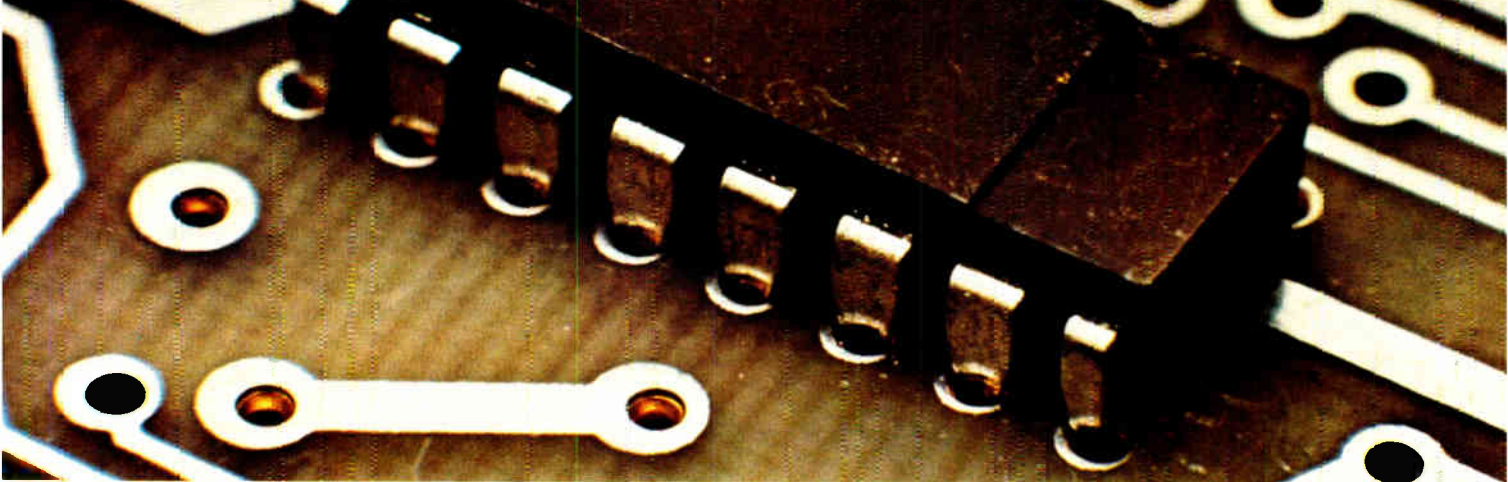

The card you're looking at is an ordinary printed wiring board with an extraordinary difference. There's not a solder joint anywhere. Every component is plugged into place.

It's this simple: Augat has invented a way to turn plated-through holes into plug-in sockets.

Think what that means: all the benefits of component



plugability with no need for sockets or the headaches of soldering. You get socketed components with card spacing as low as .400!"

And the cost? Less than the total soldered cost of typical inexpensive sockets.

Intriguing, yes? So is the way it works. At the heart of our new method, (which we call the Augat Holtite™ system), is a special adaptation of the long-proven, beryllium copper precision contact that we've turned out by the billions over the past decade for reliable component lead interconnections

You simply insert the contacts into your plated-through holes, press them into place...



and just like that you've got a component "socket" built right into your board. It's that simple.

Another thing you'll like: switching to our new Holtite system is totally painless. You continue to use the same artwork, drill tapes and process specs. Simply drill the holes to the recommended diameter.

As to mass loading the contacts into your boards, that's easy too. We lease you a machine that does it automatically at a rate of 30,000 con-



tacts an hour, which includes pressing them into place using a standard hydraulic press.

We're confident our Holtite system is going to revolutionize PC component socketing,

and we invite you to be a part of it.

To get started, order one of our Holtite prototyping kits (for \$94.50) from your Augat distributor, or from us. It has everything you need (1,200 contacts, tools, instructions and test report) to try out our idea firsthand on your own boards. Give it a whirl — this week!



Order Kit No.
398-HK-001

Augat Inc., 33 Ferry Avenue,
P.O. Box 779, Attleboro, Mass.
01703. Tel. (617) 222-2202.

AUGAT®

Augat interconnection products,
isotronic microcircuit packaging,
and Alca subminiature switches.

The CROWN M-600 will drive shake tables, speaker coils, sonar transducers or servo motors.

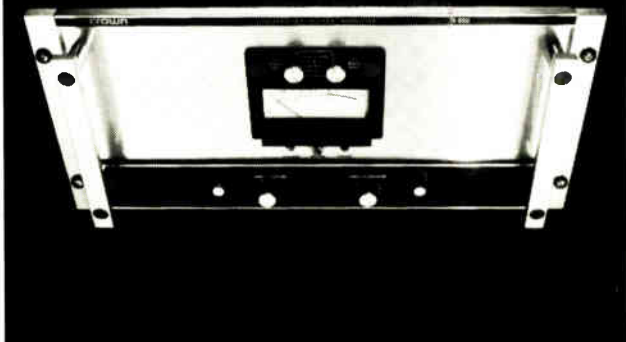

The Crown M-600 Amplifier is good at driving transducers, no matter what they're used for.

It's immune to damage from shorted, open or mismatched loads.

It operates continuously at full rated power.

It will give you up to 78 volts RMS. It will give you up to 1000 watts into 4 ohms, DC to 15 KHz. It works into any impedance. Compare the M-600 to any other amp in its frequency range, no matter what it's used for.

We're especially interested in helping you answer any application questions you might foresee for the M-600. Tell us your problem. We may already know a solution.



1718 W. Mishawaka Road, Elkhart, Indiana 46514

219/294-5571

New products

its flexibility, according to the manufacturer. Where competitive systems force the user to work within fixed dimensions, the company supplies conduction plane strips and transfer bars in any desired lengths or in bulk. The heat-dissipation system was unveiled in New York last week at Electro77.

International Electronic Research Corp., a subsidiary of Dynamics Corp. of America, 135 W. Magnolia Blvd., Burbank, Calif. 91502. Phone (213) 849-2481 [393]

Brush-contact connectors cut mating forces up to 90%

A line of connectors for printed-circuit boards are said to provide reductions in mating and unmating forces of 70% to 90%. Called the Bendix Bristle Brush (B³) Line, the connectors incorporate the brush-contact concept in which connector mating is accomplished by the meshing of bundles of brush-like wires, rather than the mating of conventional pins and sockets.

Each brush contact is a bundle of fine gold-plated beryllium-copper wires retained in a metal holder. The wire clusters provide redundant current paths and minimize constriction

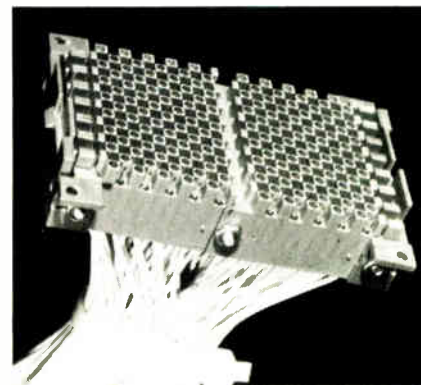

resistance. Designed for durability, they are reported to have a lifetime in excess of 20,000 mating/unmating cycles.

The new connector line includes mother and daughter board connectors, pc receptacles, and input/output connectors. Versions with two, three, and four rows are available

Dialight Switches

A switch for all reasons.

Reason 1: Dialight offers three switch configurations to meet all your needs—*snap-action switches with silver contacts* for moderate-level applications, *snap-action switches with gold contacts* for intermediate-level applications, and *wiping-action switches with gold contacts* for low-level applications.

Each of these ranges is served by two switching actions—momentary (life: 750,000 operations) and alternate (life: 250,000 operations).

Reason 2: Dialight's snap-action and wiping-action switches come in a new modular design concept... a common switch body for either high or low current operation. All 554 series switches and matching indicators have the same rear-panel projection dimensions.

The snap-action switching mechanism guarantees a fast closing and opening rate. This insures that contact force and contact resistance

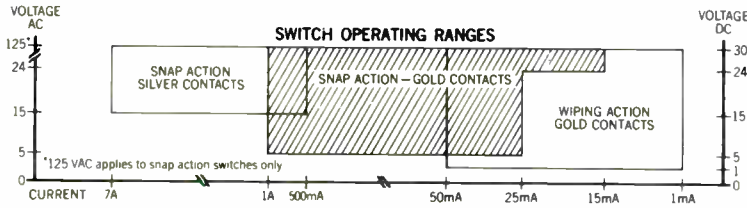

Reason 3: Dialight offers a wide variety of panel and snap-in bezel mounting switches with momentary and alternate action configurations in SPDT and DPDT

types. There are over 240 switch variations to choose from.

The 554 illuminated switch, designed for front of panel lamp replacement, gives you a choice of five different bezel sizes... $\frac{3}{4}$ " x 1", $\frac{5}{8}$ " x $\frac{3}{4}$ ", $\frac{3}{4}$ " square, $\frac{5}{8}$ " square, and $\frac{1}{2}$ " square. The first four sizes are also available with barriers. You also get a choice of six cap colors... white, blue, amber, red, green, and light yellow... four different underlying filter colors... red, green, amber, and blue and a variety of engraved or hot-stamped legends... over 300 cap styles... over 100,000 combinations.

There is also a variety of terminal connections... solder blade, quick connect, and for PC board insertions.

Reason 4: Dialight's 554 series is designed as a low cost switch with computer-grade quality.

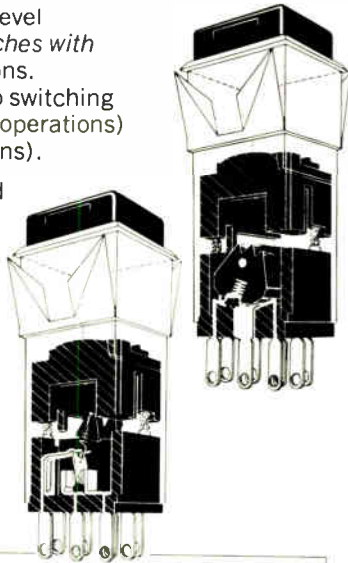

PRODUCT SELECTOR GUIDE						
SWITCHING ACTIONS	Snap-Silver contacts		Snap-Gold contacts		Wiping-Gold contacts	
	SPDT	DPDT	SPDT	DPDT	SPDT	DPDT
MOMENTARY	<input type="radio"/>	<input type="radio"/>	<input type="radio"/>	<input type="radio"/>	<input type="radio"/>	<input type="radio"/>
ALTERNATE	<input type="radio"/>	<input type="radio"/>	<input type="radio"/>	<input type="radio"/>	<input type="radio"/>	<input type="radio"/>
OPTIONS						
PUSH BUTTON CAP SIZES						
	$\frac{1}{2}$ " Sq.	$\frac{5}{8}$ " Sq.	$\frac{5}{8}$ " x $\frac{3}{4}$ "	$\frac{3}{4}$ " Sq.	$\frac{3}{4}$ " x 1"	
BEZEL MOUNTING TO ACCOMMODATE	<input type="radio"/>	<input type="radio"/>	<input type="radio"/>	<input type="radio"/>	<input type="radio"/>	
BEZEL MOUNTING WITH BARRIERS TO ACCOMMODATE		<input type="radio"/>	<input type="radio"/>	<input type="radio"/>	<input type="radio"/>	
PANEL MOUNTING TO ACCOMMODATE	<input type="radio"/>	<input type="radio"/>	<input type="radio"/>	<input type="radio"/>	<input type="radio"/>	
MATCHING INDICATORS	<input type="radio"/>	<input type="radio"/>	<input type="radio"/>	<input type="radio"/>	<input type="radio"/>	

are independent of the switch's actuation speed.

In the wiping-action switch, the contacts are under constant pressure (A unique Dialight design). This insures long life with a minimum build-up of contact resistance.

Both switch types are tease-proof.



DIALIGHT

A North American Philips Company
203 Harrison Place, Brooklyn, N.Y. 11237
(212) 497-7600

AS LOUD AS A FREIGHT TRAIN.

As soft as a whisper.

Mallory Sonalert® Signals.

Choose from over 30 sounds.

Sound levels range from 55 to 100db —
at two feet.

100% solid state.

124 space-saving models.

AC or DC.

Ideal for battery-powered equipment.

Entire package can weigh less than an ounce
and install in 1¼" diameter hole.

We also make special environmental models
for military applications.

Available direct, or through authorized
Mallory Distributors in U.S. and overseas.

Give us a hearing. Send for our newest catalog.

P. R. Mallory & Co. Inc., Box 1284,
Indianapolis, Indiana 46206. (317) 856-3731.

Sonalert® is a registered
trademark of
P. R. Mallory & Co. Inc.



Continuous

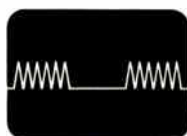

Slow pulse



Fast pulse

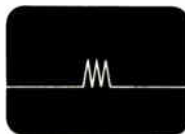

Short pulse



Warble



Chime

MALLORY

Sonalert signals... limited only by your imagination.

New products

with lengths of 10 to 100 contacts.
Marketing Dept., Bendix Electrical Compon-
ents Division, Sidney, N.Y. 13838. Phone
(607) 563-9511 [394]

Monitor checks wiring during and after assembly

The model AM-200 electronic as-
sembly aid is a portable instrument
designed to monitor the wiring of
cables with connectors at one or both
ends. It requires no special program-
ming and is used to alert assemblers
to wiring errors during and after
assembly. Audio and visual alarms
are energized each time a wrong
termination is attempted, and the
miswired conductors are identified
on a LED display.

The AM-200 can also be used as
an automatic continuity tester. It
sells for \$995.

T&B/Cablescan, 145 E. Emerson Ave.,
Orange, Calif. 92665. Phone (714) 998-1961
[395]

Tester checks microprocessor boards at full rated speed

Designed specifically to test micro-
processor boards, the 3040A Logic-
tester can apply user-defined test
sequences at rates up to 1.5 million
words per second. According to the
manufacturer, this will more than
match the instruction execution
speeds of today's microcomputer
boards and provides for the testing
of devices not yet announced.

In addition to the application of
user-defined sequences, the 3040A
can also run its own automatic
sequences at rates up to 5 mega-
hertz. It can intermix both types of
sequences to minimize programming
time while maintaining a high test
confidence.

As a diagnostic tool, the 3040A
uses cyclic redundancy checks. Of-
fered in 128- and 240-pin versions,
the tester sells for \$60,000 to
\$95,000 depending upon options.

Fluke Trendar Corp., 630 Clyde Ave., Moun-
tain View, Calif. 94043 [396]

VACTEC Photodetectors

The Industry's Broadest Line Provides More Semiconductor Detectors for More Design Applications

Vactec serves manufacturers of a wide range of modern electronic products. Pictured are a few examples. All these devices are both made and sold by Vactec, including complete lines of LDR's (photoconductive cells, CdS and CdSe); silicon solar cells, as well as silicon high speed and blue enhanced cells; NPN phototransistors and darlington's; opto-couplers (LED/LDR, lamp/LDR and neon/LDR); selenium photovoltaic cells; silicon photodiodes, blue enhanced and PIN; and custom C-MOS and bi-polar IC's. Write for technical bulletins on the types that suit your requirements. Or send your application, and Vactec will recommend the right cell for the job.



Vactec, Inc.

2423 Northline Industrial Blvd.
Maryland Heights, Mo. 63043
(314) 872-8300



Electronic Organs

LED or lamp/LDR Vactrols for audio, and CdS cells for swell pedal controls.

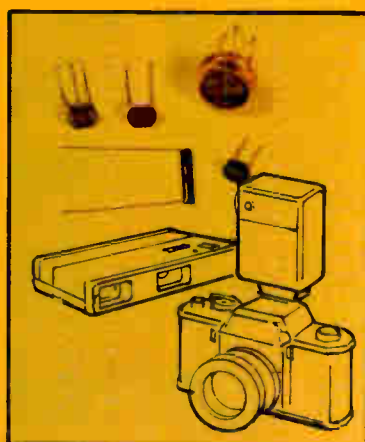

Cameras and Projectors

CdS or blue enhanced silicon photodiodes for automatic shutter timing, aperture servo systems for automatic projector focus; and slave flash controls.



Triac Motor Controls

A special Vactrol gates a triac for forward and reverse motor operation as in hospital beds.



LED Watches

Photoconductive or phototransistor chip controls LED brightness.

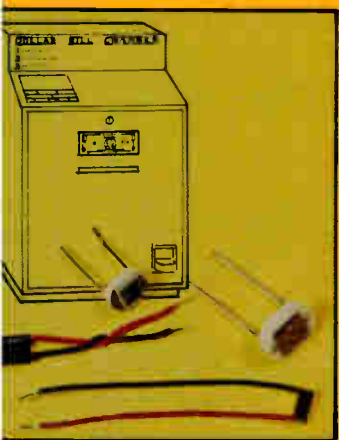

Dollar Bill Changers

Silicon photovoltaic cells analyze optical characteristics.



Machine Tool Controls

High-speed photovoltaic cells or transistor arrays help computer control repetitive operations, non-contact sensing, and counting and weighing.



Telephone Equipment

Neon/LDR Vactrols sense ringing. Direct a-c coupling, slow LDR response isolates electronics from noise.

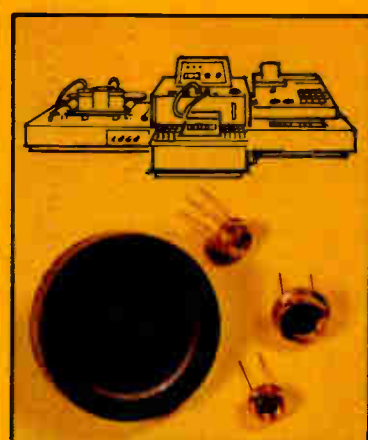

Scientific Instruments

Blue enhanced silicon or selenium photovoltaic cells detect solutions densitometrically for precise blood chemistry and other analyses.

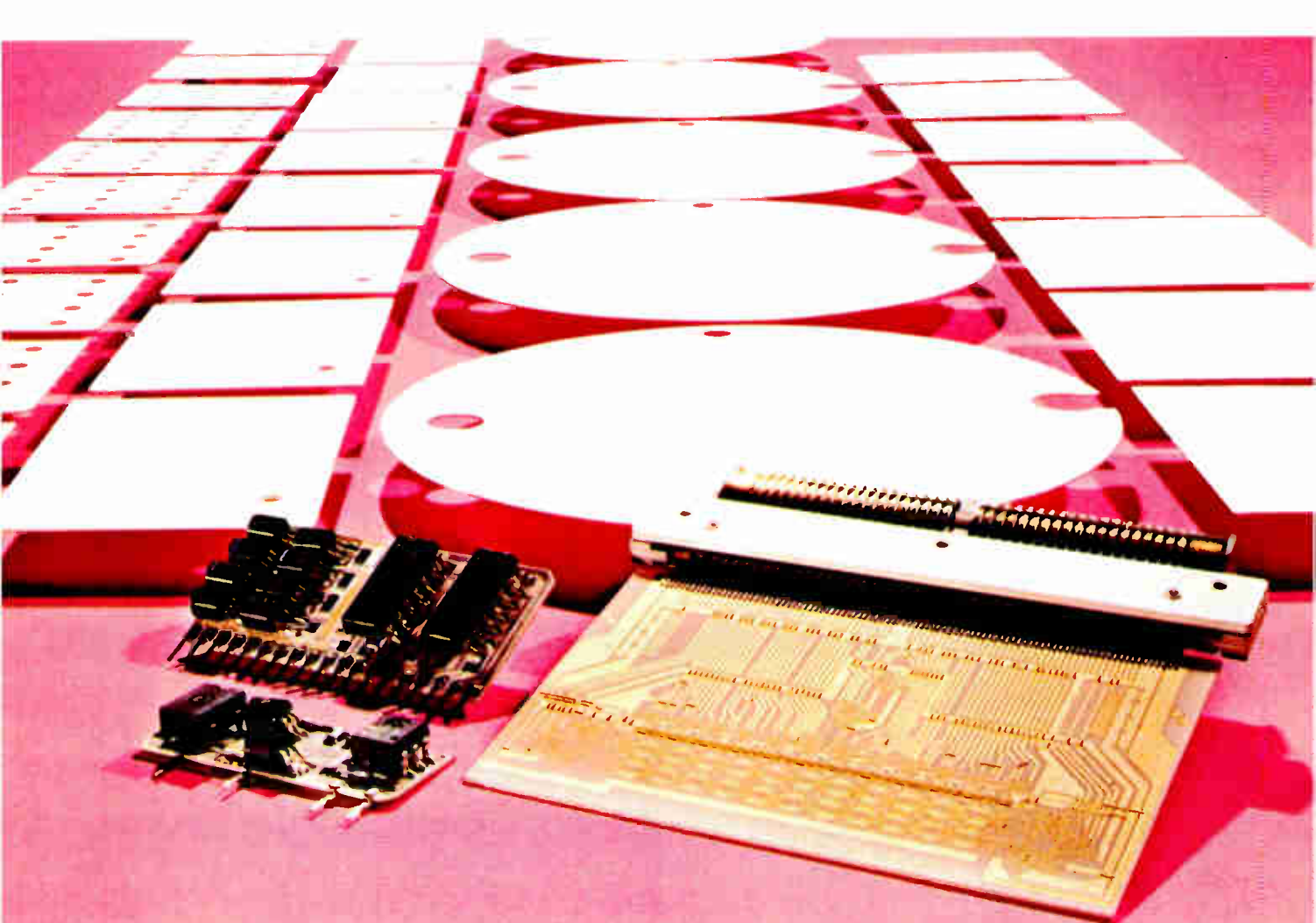

Coors Substrates Aren't Just Better. They're Faster.

You've told us fast response to customer orders is critical to your success in hybrid markets. Coors understands. We've made a commitment to give you the fastest delivery of thick- or thin-film substrates.

Through continuing investment in production facilities, we've cut lead times to give you better service on the largest or smallest orders. A new plant, under construction now, will significantly expand capacity for

even faster delivery in late summer, 1977.

But plant capacity is just one factor in Coors ability to cut your lead times. A special substrate service group—with a direct Substrate Hotline—gives you fast quotes and personal follow-through on all orders.

For complete details on Coors substrates and manufacturing capabilities, write for our free Electronic Ceramic Handbook, or call your local Coors sales engineer.

For quick delivery, call Coors Substrate Hotline: (303) 279-8320

Coors CERAMICS

Coors Porcelain Company

600 Ninth Street / Golden, Colorado 80401
(303) 279-8320/Telex 45-593

Circle 160 on reader service card

World Radio History

New products

Subassemblies

High-voltage op amp is fast

Thick-film hybrid device swings up to ± 145 V dc at slew rates to 150 V/ μ s

Although high-voltage operational amplifiers are fairly fast devices, their output slew rate has heretofore been limited to about 30 volts per microsecond. Now, however, Burr-Brown has produced a truly high-speed, high-voltage op amp—one capable of slewing at 150 V/ μ s, and swinging over an output range of ± 65 to ± 145 v dc.

Designated the 3584, the new amplifier is a thick-film hybrid circuit packaged in a hermetically sealed TO-3 metal can. Among the applications that design engineer Bill Olschewski ticks off are: analog computers, digitally controlled power supplies, electrostatic transducers, and deflection amplifiers for cathode-ray tubes.

Most of the resistors in the op amp are thick-film cermet components, but a few critical ones were fabricated in thin-film nichrome, Olschewski notes. "We attach the capacitor, semiconductor, and thin-film resistor dice with epoxy," he says, "while the output transistors are attached using the eutectic-gold reflow method." Interconnects between the chips and the package are made with 1-mil-diameter gold and aluminum wire.

At a voltage gain of 100, the 3584 provides a minimum gain-bandwidth product of 20 megahertz, with 50 MHz being typical. It operates over a wide range of supply voltages, from ± 70 to ± 150 v dc. Common-mode rejection is 110 decibels.

Input bias current is kept down to 20 picoamperes by means of a field-effect-transistor input stage. Input offset voltage is a maximum of 3 millivolts, and it drifts no more than 25 microvolts/ $^{\circ}$ C.

The secret behind the 3584's excellent common-mode performance is its true cascode input stage and its overvoltage protection circuitry. Voltage-limiting diodes prevent damage caused by reverse-bias breakdown of the input FET pair, and current-limiting resistors hold the steady-state input current to a maximum of 1 milliampere even with the maximum supply voltage applied to the input terminals.

Additionally, the 3584 contains thermal-sensing and shut-off circuitry that automatically turns the amplifier off when the internal substrate temperature reaches approximately 150° C. This feature, says the firm, means that the 3584 does not require a massive heat sink for protection in case the power dissipation should become abnormally high.

Because of the cascode input stage, the unit's input bias current is virtually independent of the applied common-mode voltage. Also, since its metal case is electrically isolated, the device need not be mounted with insulating spacers. In quantities of 1 to 24, the op amp is priced at \$86 each, dropping to \$68.80 each for 25 to 99. Delivery is from stock to within six weeks.

Burr-Brown Research Corp., International Airport Industrial Park, Tucson, Ariz. 85734. Phone (602) 294-1431 [381]

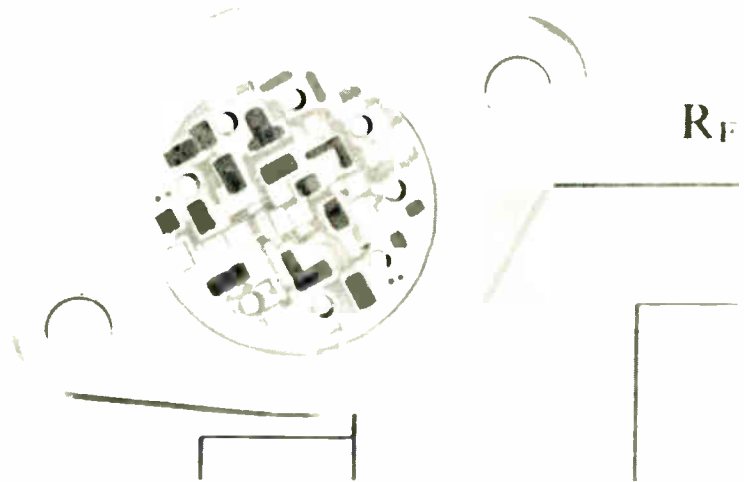

10-kHz v-f converter sells for only \$21

Priced at only \$21 apiece in hundreds, the model 4723 voltage-to-frequency converter is a 10-kilohertz unit that can be used to make a 10-bit a-d converter for about \$25. The converter has a maximum non-linearity of 0.01% of full scale, a maximum full-scale error of 0.5%, and a temperature coefficient of 50 ppm/ $^{\circ}$ C. Its initial zero-offset error is no more than 5 millivolts.

The 4723 is housed in a module that measures 1.14 inches square by 0.4 in. high. It requires a ± 15 -volt power supply from which it draws a maximum of ± 18 milliamperes. It is available from stock.

Teledyne Philbrick, Allied Drive at Route 128, Dedham, Mass. 02026. Phone (617) 329-1600 [386]

Adjustment-free a-d converter pulls only 230 mW

Housed in a hermetically sealed dual in-line package, the MN5260 is a 14-bit analog-to-digital converter that consumes only 230 milliwatts of power. The adjustment-free device operates over the temperature range

New products

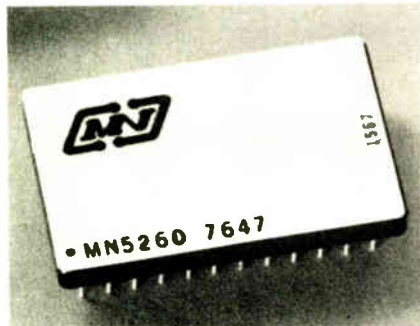

from 0°C to 70°C with a maximum nonlinearity of one least significant bit and a maximum total error of

0.4%. At 25°C its maximum nonlinearity is reduced to half an LSB and its maximum total error to 0.04%. The unit's 14-bit conversion time is typically 175 microseconds.

Typical applications for the MN5260 include remote-site seismological monitoring, precision portable instrumentation, and high-accuracy industrial equipment. In small quantities, the converter sells for \$275.

Micro Networks Corp., 324 Clark St., Worcester, Mass. 01606. Phone (617) 852-5400 [385]

Dot-matrix display can be programmed

The model SSD0132-0081 Self-Scan display is a dot-matrix, gas-discharge panel that can show up to 32 characters at once. Its repertoire of 64 characters is contained in a pair of programmable read-only memories so it can be changed at any time. The 0081 can be outfitted with a 128-character repertoire by providing 64 standard characters in

One way...

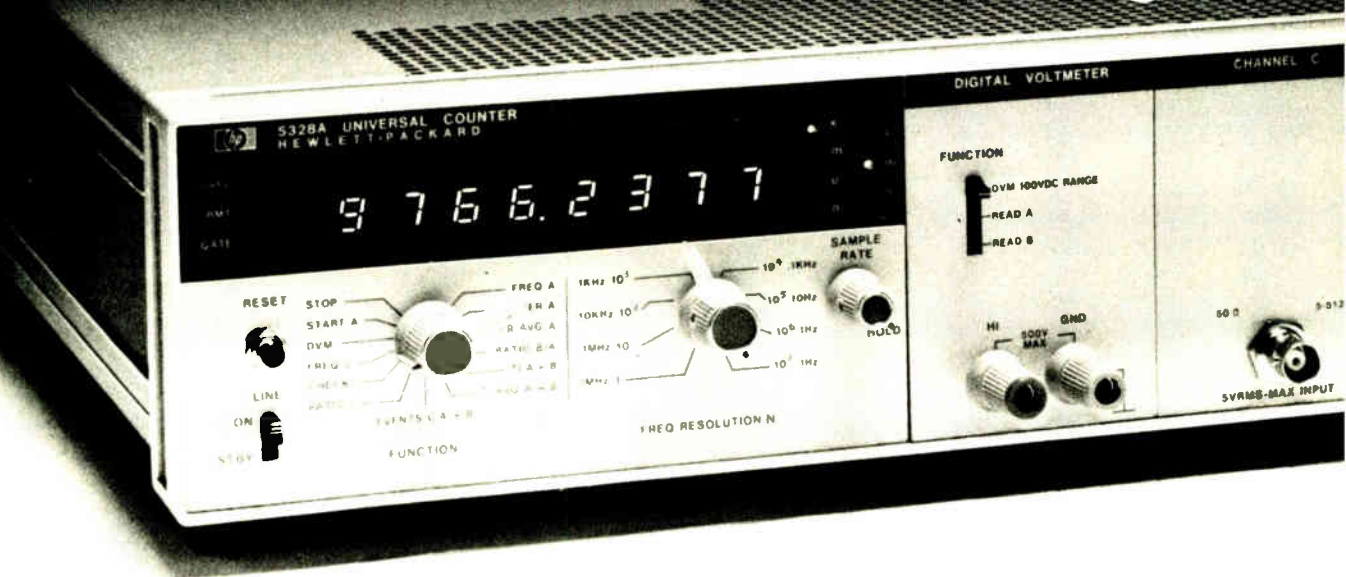

HP's Universal Counters

satisfy the needs for most electronic counter measurements up to 1300 MHz, and do it without breaking your budget. Two distinctly different models are loaded with features, and a wide variety of options are available.

One way is the 5328A for high performance frequency, period and time interval measurements in a modular 8 or 9-digit unit for systems or bench use. Start with the basic 100 MHz/100 ns unit for just \$1300*. Modules expand its capabilities to 512 or 1300 MHz for frequency, 10 ns for time interval and add 10 μ v to 1000v, digital voltage measurements. Other options include ultra-stable time base, and full HP Interface Bus operation. Standard at no extra cost are burst frequency measurement and time interval averaging to

10 ps resolution... matched input amplifiers make this resolution meaningful.

The other way is the 5300B/5308A System for lower cost yet highly versatile 8-digit frequency, period and time interval measurements in a modular portable package that also can be rack mounted. In just 30 seconds, snap on any of 10 other modules including: a full capability DMM, battery pack and 1300 MHz and HP Interface Bus modules. The 5300B/5308A's low \$910* price even includes time interval averaging for resolution to 1 ns!

Use the 10855A Preamplifier for higher sensitivity with any model: 22 dB gain, 2 to 1300 MHz for just \$225*

To do it your way contact your nearest HP field engineer for full data, or write.

*Domestic U.S. prices only.

a masked read-only memory with an additional 64 custom characters in the pair of PROMs. Maximum character entry rate is 166,000/s.

The panel's 5-by-7 dot-matrix characters measure 0.2 inch high by 0.14 in. wide; they are easily readable at distances up to 15 feet. In thousands, the display sells for \$172 each, without ROMs or PROMs. Delivery is from stock.

Burroughs Corp., Electronic Components Division, P.O. Box 1226, Plainfield, N.J. 07061. Phone John Pittman at (201) 757-5000 [384]

Modular digital-to-analog converter resolves 18 bits

The model DAC1138 digital-to-analog converter is a modular unit with a resolution of 18 bits. Capable of settling to within one least significant bit within 18 microseconds, the high-resolution converter is offered in two versions: the DAC1138J, which sells for \$750, is linear to within 1 LSB; while the DAC1138K, priced at \$950, is linear to within

half an LSB. Both devices will operate over the temperature range from 5°C to 50°C. The "K" version will maintain 18-bit accuracy over any 20°C span in that range.

Expected applications for the 18-bit d-a converters include high-resolution cathode-ray-tube displays, automatic semiconductor testing, type-setting, frequency synthesis, and reactor control. Delivery of the converter is from stock to 30 days.

Analog Devices Inc., P.O. Box 280, Norwood, Mass. 02062. Phone Alan Haur at (617) 329-4700 [383]

or the other,



the right performance at the right price.

HEWLETT  PACKARD

1507 Page Mill Road, Palo Alto, California 94304

For assistance call: Washington (301) 948-6370, Chicago (312) 255-9800, Atlanta (404) 955-1500, Los Angeles (213) 877-1282

Circle 163 on reader service card

If high start-up costs have delayed your expansion, contact Georgia.

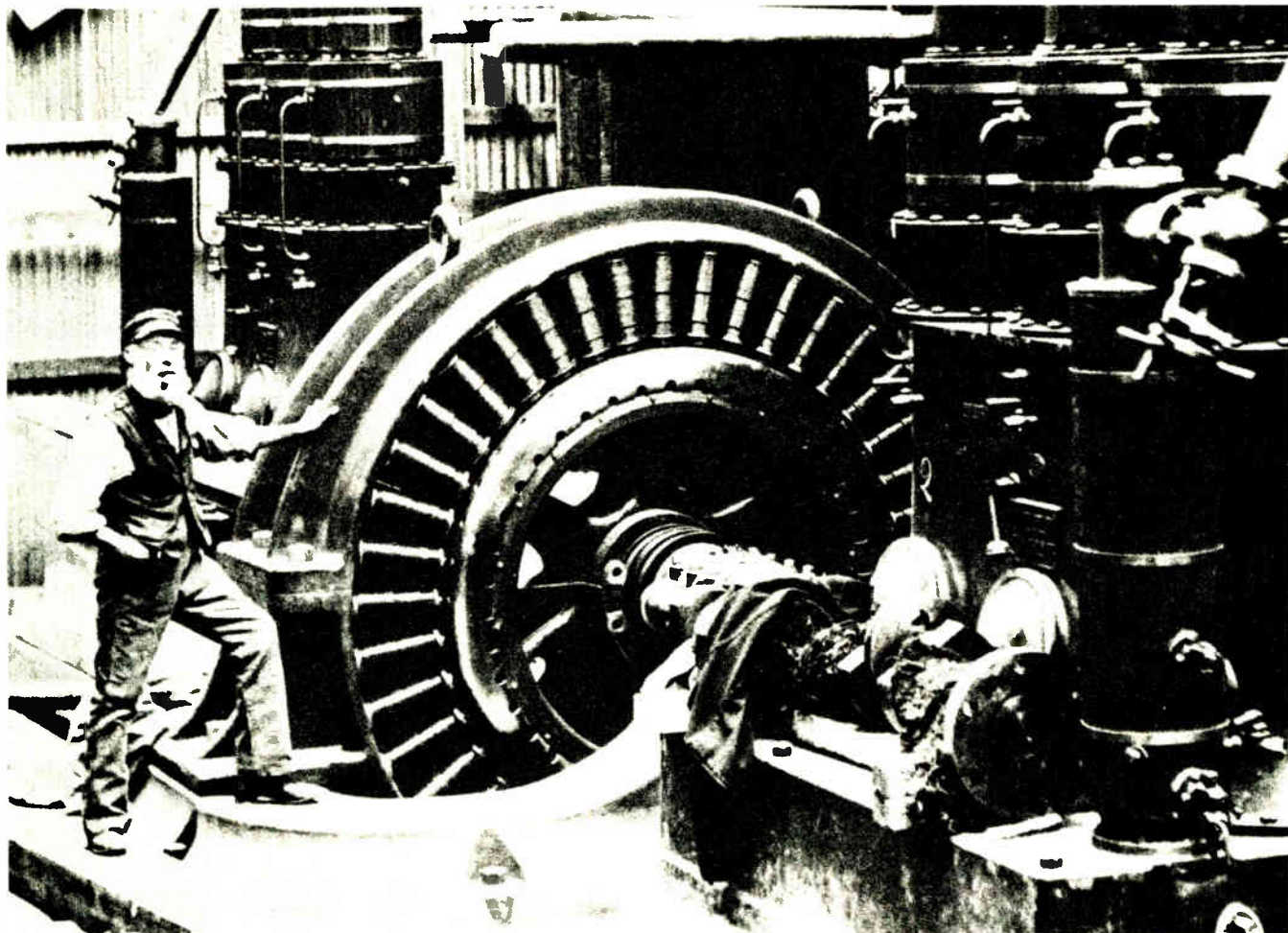

The Bettmann Archive, Inc.

We're wired into the needs of the electronics industry. And we'll come to you with profit incentives you can appreciate.

Like available buildings and low-cost construction. A skilled and stable work force that

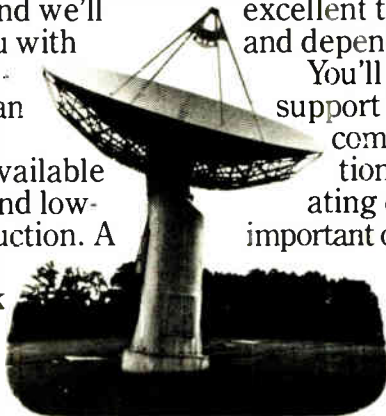

we'll train free. Fiscally-responsible government, excellent transportation and dependable utilities.

You'll also find good support from allied companies. In addition to lower operating costs, we offer important opportunities for higher education. Including the country's

second largest electrical engineering school at Georgia Tech. And the cultural amenities that help provide a pleasing lifestyle.

For more information contact Milt Folds, Commissioner, Georgia Bureau of Industry & Trade, P.O. Box 1776, Atlanta, Georgia 30301, Dept. EL-77.



Georgia

Now Norden gives DIGITAL's PDP-11/34 all the muscle it needs to work in any military environment.



New PDP-11/34M uses exactly the same software as commercial PDP-11/34.

First in a new family of militarized computers, the PDP-11/34M combines Norden's experience in military electronics with DIGITAL architecture and DIGITAL software.

The result is the PDP-11/34M, a fully militarized mini-computer designed and tested to meet all mil specs—airborne (MIL-E-5400), shipboard (MIL-E-16400) and land (MIL-E-4158).

This new system uses the identical software as the commercial PDP-11/34—same applications software, same support software, same operational software. You save time and money on development, training and operations. You start with a time-tested software system as well as a proven hardware system.

Familiar features plus militarized peripherals.

Packaged in half or full ATR chassis, the PDP-11/34M offers standard PDP-11 features as well as modular core memory from 16K to 128K words in increments of 16K and 32K. Also, a full range of militarized peripherals is available including tape drives, disk drives and display terminals.

First shipments go out in July 1977.

For more information, call or write Director of Marketing, Computer Products Center, Norden Division, United Technologies Corporation, Norwalk, CT 06856. Telephone (800) 243-5840 toll-free, or call (203) 838-4471.

PDP-11 data processing with Norden military muscle.

NORDEN



Division of

UNITED TECHNOLOGIES.

Circle 165 on reader service card

Semiconductors

Two-chip set converts 4½ digits

Quantized feedback reduces sensitivity to frequency drift and comparator error

By combining a "quantized feedback" conversion technique with an ion-implanted mixed MOS and bipolar process, Siliconix Inc. has developed a two-chip analog-to-digital converter for a 4½-digit (20,000-count) voltmeter.

Designated the LB120/121, the chip set consists of an analog processor (the LD 120) fabricated with Siliconix' mixed process and a digital controller (the LD 121) made with standard depletion-load p-channel metal-oxide-semiconductor technology. In quantities of 100 or more, the price of the chip set is \$14.81. Purchased separately, the LD 120 costs \$6.43 each and the LD 121 \$8.38 each in 100-up quantities.

According to Marvin Vander Kooi, manager of IC product marketing, the LD 120/121 can sample over a range from one to five samples per second and has 0.5-count stability on a 2-volt range. Intrinsic features of the chip set are auto-polarity, auto-zero, and ratiometric operation. "No critical components are required externally except for a stable voltage reference," says Vander Kooi. Unlike other converter products on the market, he adds, the integrator output voltage is never more than 100 counts. "Thus, critical, high-resolution performance is not required of either the integrator or the comparator."

The proprietary quantized feedback gives the Siliconix chip set superior linearity and normal-mode rejection and stability, according to Vander Kooi, because of the simultaneous integration of the unknown input voltage and the reference voltage. The technique is charge-balancing, like the dual-slope method. But

where dual slope measures and counts in sequence, quantized feedback allows the two operations to be done simultaneously. Additional benefits of this approach are reduced sensitivity to frequency drift and comparator errors, plus a fixed conversion time.

Incorporated on the LD 120 analog processor are five amplifiers and some control logic fabricated with a combination of p-MOS FETs and bipolar transistors. The input buffer amplifier, the auto-zero buffer amplifier, and the analog switch control logic are MOS FET, while the reference buffer, integrator, and comparator are bipolar. The reference voltage input is fully buffered on the LD 120 to eliminate the reference-switch resistance as a source of error. All the amplifiers are internally compensated.

The LD 121 contains all the digital circuitry for the quantized feedback system. Device outputs supply two over-range signals, under-range, sign, and 4½ digits of multiplexed binary-coded-decimal data. All outputs are TTL-compatible. Overrange above 20,000 counts is indicated by blinking digit strobes. An output is provided to inhibit this feature at user option. Microprocessor-controlled operation is simplified by a start-conversion input that allows conversion on command. An external capacitor provides frequency control for the internal timing generator.

Available now, the LD 120 has 16 pins, the LD 121 has 18. Both are

supplied in 300-mil dual in-line plastic packages.

Siliconix Inc., 2201 Laurelwood Rd., Santa Clara, Calif. 95054 [411]

12-bit d-a converter
settles within 100 ns

The HI562A monolithic 12-bit digital-to-analog converter from Harris Semiconductor division settles to within half a least significant bit in only 100 nanoseconds. Ernest Thibodeaux, the division's marketing manager for data-acquisition systems, attributes this unprecedented speed to the low capacitance of the device—a direct result of using the company's proven dielectric isolation process to build it, instead of the junction isolation used in competitive devices. He looks for the HI562A to be used in high-speed analog-to-digital converters, in cathode-ray-tube graphics applications, and in other video systems.

The converter can be considered a faster one-chip version of the two-chip AD562 made by Analog Devices Inc., Norwood, Mass. Like the AD562, it consumes 400 milliwatts, but its 100-ns conversion time is 1/15 of the AD562's 1.5 microseconds.

Harris guarantees that the HI562A is linear to within half an LSB over the full -55°C to 125°C military temperature range.

Four versions are available from stock. The HI562A-2, which covers

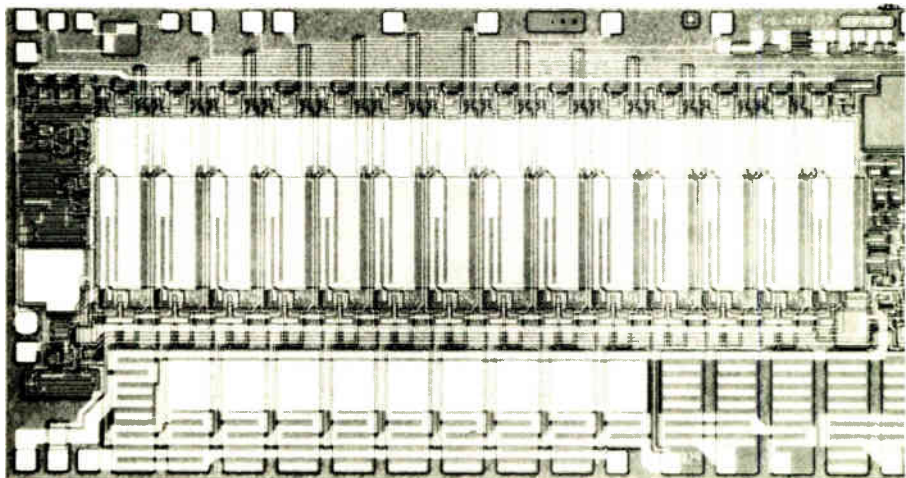

International Rectifier "Function Fit" Power Transistors will enhance your circuit design and increase its reliability.

It's unlikely that you'll find a Power Transistor line with as many types as ours, or with functional characteristics that fit specific applications so well . . . to improve reliability.

For example, for **Switching Power Supplies**, our 2N6542-2N6547 and IR6002's will switch up to 600V $V_{CE(sus)}$ with optimum t_f and E_s/b .

For **Display Terminal** horizontal and vertical deflection, you can get up to 900V V_{CBO} with a sharp breakdown (from hard-glass passivation) for added reliability . . . coupled with low $V_{CE(s)}$.

For **Automotive Ignition**, count on higher $V_{CE(sus)}$ and higher inductive energy capability with the reliability you need. Clamped or unclamped performance in a TO-3 package, on a chip, or a chip on a Beryllia substrate.

For **High Current Applications** our BUX-20 not only switches 125V and 50A at 20KHz, but does it at commercial prices. Also try our 2N6274-2N6277.

For **Amplifiers**, try our high energy EPI base discretes and Darlingtons. You'll get the SOA you need plus better frequency response than you'll find in other companies' diffused types.

For **Motor Drives**, our rugged Darlingtons will provide the inductive energy, high $V_{CE(sus)}$, and high gain needed for reliability in these tough applications.

Whatever your application, chances are good that we have a "Function Fit" Power Transistor that will give you extra-margin reliability without changing your circuit . . . or costs!

Contact your local IR Sales Office or Distributor for data or write to
International Rectifier,
 233 Kansas Street,
 El Segundo, CA 90245
 (213) 322-3331, Telex 67-4464

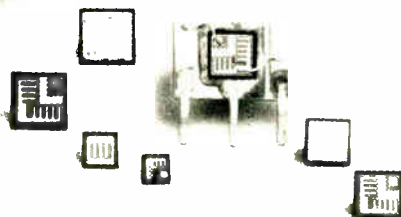
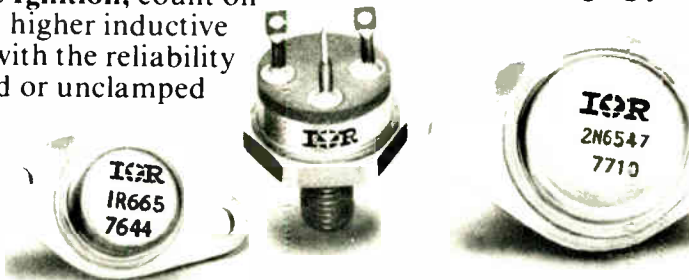

International Rectifier

... the innovative semiconductor people



S E M I N A R

NEW PRODUCT OPPORTUNITIES IN POS AND CBCT EQUIPMENT

An intensive 2-day conference covering new product opportunities in the point-of-sale and bank terminal fields at which new requirements for semiconductors, microprocessors, storage media, and ground and satellite communications electronics will be discussed.

Major topics for discussion:

- Point-of-Sale Data Bases
- Credit Authorization Systems
- Paper Truncation Systems
- Fraud Countermeasures
- Simplified Terminal Electronics
- Satellite and Ground Radio Applications
- Video/Disc Technology Applications

PLACES: Statler Hilton Hotel, New York City
Hilton Hotel, San Francisco

DATES: June 20/21, 1977 (NYC)
June 23/24, 1977 (SF)

PRICE: \$375. (Includes all sessions, a copy of the visuals, two luncheons and a cocktail reception.)



FROST & SULLIVAN, INC.
106 Fulton Street
New York, New York 10038
(212) 233-1080

Circle 168 on reader service card

DESIGN IN

**EMI/RFI/EMP
SHIELDING,
GROUNDING
AND STATIC
DISCHARGE
PROTECTION
INTO YOUR
EQUIPMENT
PERFORMANCE**

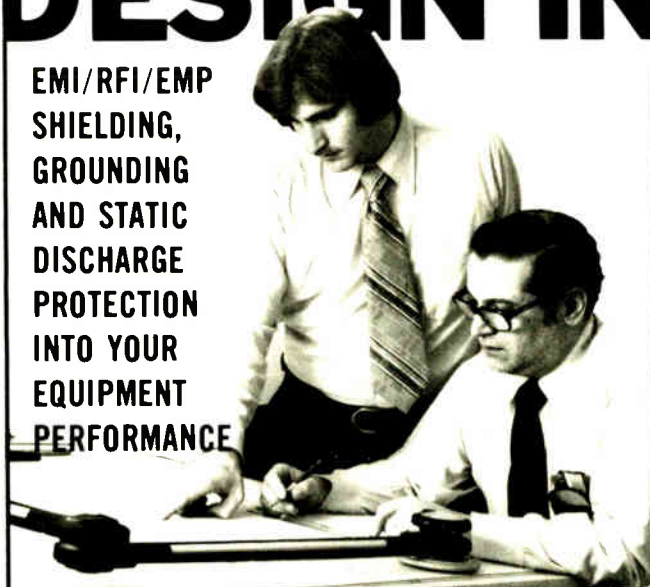

**WITH TECKNIT SHIELDING PRODUCTS
AND CONDUCTIVE MATERIALS.**

We are a leader in manufacturing fabricated gaskets and materials, shielded vent panels, optical display windows, conductive paints and sealing materials.

See us at the *Design Engineering Show* in Chicago at **Booth No. 1596**

Eastern Division • 129 Dermody St., Cranford, NJ 07016 (201) 272-5500
Western Division • 427 Olive St., Santa Barbara, CA 93101 (805) 963-1867

168 Circle 225 on reader service card

New products

the full military temperature range, sells for \$108 in quantities of 100. An industrial version, the HI562A-4 (-25°C to 85°C), is priced at \$43, while the commercial HI562A-5 (0°C to 70°C) carries a \$29 price tag. Finally, prices are available on request for the HI562A-8, which is processed to MIL-STD-883.

Harris Semiconductor Division, P.O. Box 883, Melbourne, Fla. 32901. Phone Ernest Thibodeaux at (305) 724-7217 [412]

Switching transistors drop only 0.7 V at 70 amperes

A family of double-diffused npn switching transistors is characterized by a saturation voltage of only 0.7 volt at a collector current of 70 amperes. The devices have a cutoff frequency of 30 megahertz at a collector current of 10 A, plus a typical beta of 10 at an I_c of 70 A. Voltage ratings from 80 to 150 volts are offered. Available package configurations include TO-3, TO-59, TO-61, and TO-63—either standard or isolated.

Semicoa, 333 McCormick Ave., Costa Mesa, Calif. 92626. Phone (714) 979-1900 [413]

4-k static RAM retains data while pulling only 1.2 mW

The MK 4104P-3 is a 4,096-bit static random-access memory with a maximum access time of 200 nanoseconds, a maximum cycle time of 310 ns, a maximum power dissipation of 165 milliwatts, and a typical standby power requirement of only 0.3 microwatt per bit, or about 1.2 mw total.

The low-power memory actually has two standby modes. If its chip-enable line is forced to an inactive state, the power consumption drops to a maximum of 27 mw. To cut power consumption further, the supply voltage must be reduced.

Housed in an 18-pin ceramic DIP, it sells for \$18.75 each in hundreds. Mostek Corp., 1215 W. Crosby Rd., Carrollton, Texas 75006. [414]

Electronics / April 28, 1977

FROM THE WORLD'S LARGEST SWITCHER MANUFACTURER ...

NEW *Tiny-MITE* Open-Frame Switchers

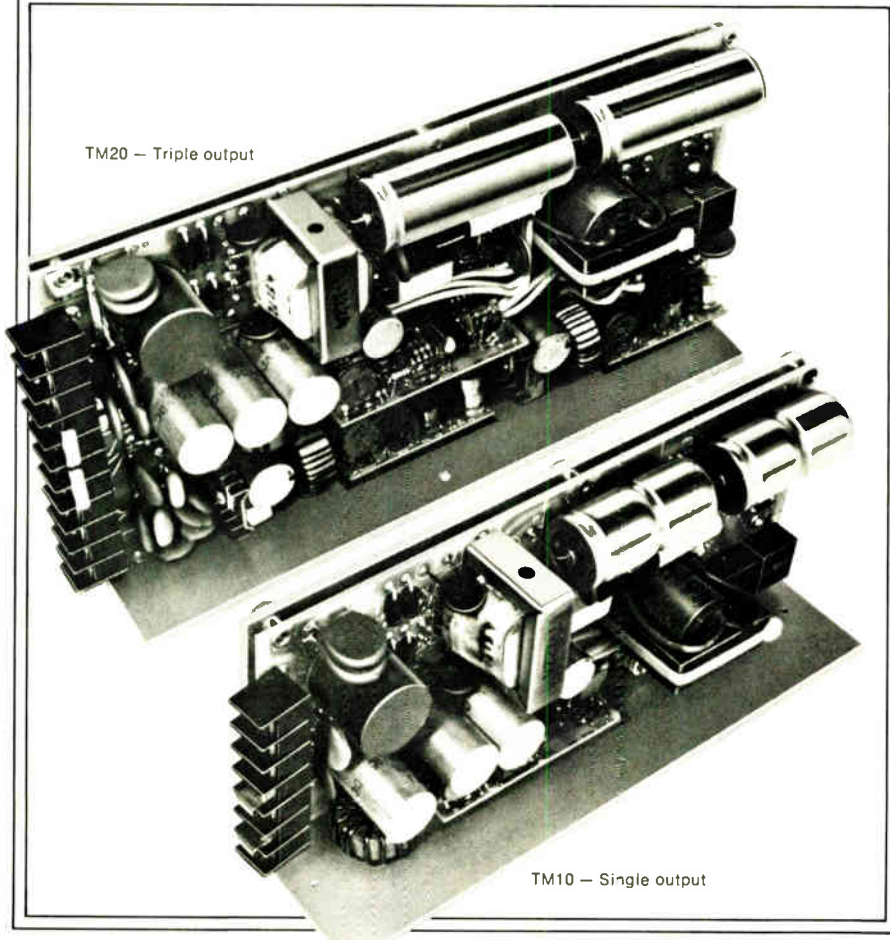

Single- and multiple-output switchers for OEM computers and terminal systems.

Power density of 1w/in.³

With L.H.'s Tiny-MITE switchers you get power density of 1 watt/in.³ in small, open-frame packages offering up to 75-percent efficiency — at a price much lower than switchers usually sell for.

The single-output TM10 packs 100 watts in a package that's only 9.5 in. L x 4.0 in. W x 2.5 in. H and weighs only 3 lbs. The triple-output TM20 produces 150 watts in a package that's 12.0 in. L x 5.0 in. W x 2.8 in. H and weighs less than 4 lbs.

Single- and triple-output units

TM10's single-output voltage is 5 volts adjustable ± 5 percent at 100 watts; other

outputs are available including 12, 15, 18, 24, and 28 volts standard. The TM20's primary output is 5 volts adjustable ± 5 percent at 20 amperes with second and third outputs in any of the following combinations: 5 volts at 5 amps, 12 volts at 5 amps, 15 volts at 5 amps, 18 volts at 3 amps, 24 volts at 2 amps, or 28 volts at 2 amps. (Combined power outputs may not exceed 150 watts.)

More power, less space

TM10 and TM20 are perfect choices for OEM computer and terminal system applications. Why? Because the new Tiny-MITE switchers were specifically designed

for high volume, low cost production and to pack more power in less space. This high power density is especially important when circuit redesign demands more power and there is no more space in your package.

Technology used in the new TM Series was developed by LH and has been proven in over 30,000 switchers now in the field. And to further assure reliability, every LH switcher is tested and burned-in before shipment.

Advanced circuitry = versatile specs

- Wide input variation standard — 92-130 VAC and 180-260 VAC, 47-450 Hz.
- 50 mv or 1% peak-to-peak ripple and noise on output.
- 0.4% line regulation over entire input range.
- 0.4% load regulation from no load to full load.
- Power failure signal and remote on/off control standard.
- Response time of 200 μ sec to 1% after 25% load change at 5 amps/ μ sec.
- 0°C to 50°C operating temperature range in natural convection. Derated to 50% load at 70°C.
- Designed to meet UL 478.
- 1-cycle ride-through (16 msec) before power fail is signaled.
- Fold-back current limit on outputs.
- Overvoltage protection standard (on main output) — factory-set at 125% ± 5 %.
- Remote sense (main output only) compensating for load cable loss up to 250 mv.
- — and a whole lot more.

Call or write today to learn how LH's Tiny-MITE Series will fit your needs.



LH RESEARCH, INC., 1821 Langley Avenue, Irvine, CA 92714 (714) 546-5279 • TWX 910-595-2540

FEATURE ARTICLES FROM *ELECTRONICS* AVAILABLE IN REPRINT FORM

No. of
copies
wanted

New reprints

- ___ R-703 Special report—memories 16 pp \$3.00
- ___ R-702 World market report 1977 24 pp \$4.00
- ___ R-616 Special issue—technology update \$4.00
- ___ R-614 Power supply choices for sophisticated designs 8 pp \$3.00
- ___ R-612 Fiber-optic communications special report 24 pp \$3.00
- ___ R-610 Special report on hybrid-circuit technology 19 pp \$3.00
- ___ R-606 Special issue—microprocessors \$4.00
- ___ R-526 How reliable are today's components 16 pp \$3.00

Charts

- ___ R-516 Electronic symbols \$2.00
- ___ R-213 Electromagnetic spectrum (updated 1976) \$3.00
- ___ R-326 Optical spectrum (6-page report and chart) \$3.00

Books

- ___ R-704 Thermal design in electronics \$5.00
- ___ R-701 Applying microprocessors—Electronics Book Series \$9.95
- ___ R-608 Basics of Data Communications—Electronics Book Series \$12.50
- ___ R-602 Large Scale Integration—Electronics Book Series \$9.95
- ___ R-520 Microprocessors—Electronics Book Series \$8.95
- ___ R-011 Computer-aided Design 135 pp \$4.00
- ___ R-032 Active Filters 88 pp \$4.00
- ___ R-031 Circuit Designer's Casebook 182 pp \$5.50 (outside U.S. \$12.00)

Other Reprints

- ___ R-600 World market report 1976 24 pp \$4.00
- ___ R-524 Special report on bipolar large-scale integration 12 pp \$3.00
- ___ R-522 Special report on power semiconductors 12 pp \$3.00
- ___ R-518 Special issue—productivity \$4.00
- ___ R-514 Eight ways to better radio receiver design 6 pp \$3.00
- ___ R-512 Design of circuits for dangerous environments 4 pp \$2.00
- ___ R-510 Bipolar integration advances with I'L microprocessor 8 pp \$2.00
- ___ R-508 Designing microprocessors with standard logic 12 pp \$3.00
- ___ R-506 The case for component burn-in 7 pp \$2.00
- ___ R-434 Designing automated systems with the new standard interface 12 pp \$3.00
- ___ R-432 An update on communications satellites 8 pp \$2.00
- ___ R-430 Choosing the right bipolar transistor model for computer-aided design 20 pp \$3.00
- ___ R-428 Designing with low-cost lasers 6 pp \$2.00
- ___ R-424 Microprocessor applications 28 pp \$3.00
- ___ R-422 A microprogrammable minicomputer 8 pp \$2.00
- ___ R-420 Computerized text-editing and typesetting 8 pp \$2.00
- ___ R-418 Computer analyses of rf circuits 8 pp \$2.00
- ___ R-414 The ion-implanted n-channel process 6 pp \$2.00
- ___ R-412 Liquid cooling of power semiconductors 6 pp \$2.00
- ___ R-410 Special report on passive components 16 pp \$3.00
- ___ R-406 Designing with the new logic, C-MOS and bipolar 16 pp \$3.00
- ___ R-324 Semiconductor memories are taking over data-storage applications 16 pp \$3.00
- ___ R-322 Special report: new displays complement old 10 pp \$2.00
- ___ R-320 Special report on designing with flat cable 14 pp \$3.00
- ___ R-318 Special report on auto electronics 16 pp \$3.00
- ___ R-316 Hybrid circuits solve tough design problems 16 pp \$3.00
- ___ R-310 Penetration color tubes are enhancing information displays 6 pp \$2.00
- ___ R-308 Program for transition from nonlinear to linear transistor model 6 pp \$2.00
- ___ R-306 Charge-coupling improves its image, challenging video camera tubes 8 pp \$2.00
- ___ R-211 Electromagnetic spectrum 16-page report \$2.00
- ___ R-209 Semiconductor RAMs land computer mainframe jobs 15 pp \$2.00
- ___ R-207 Technology gap starts to close for computer peripherals 16 pp \$3.00
- ___ R-205 Bridging the analog and digital worlds with linear ICs 16 pp \$3.00
- ___ R-133 Optoelectronics makes it at last 34 pp \$4.00
- ___ R-104 The new concept for memory and imaging: charge-coupling 12 pp \$2.00

Payment must accompany your order

Make check or money order payable to Electronics Reprints. All orders are shipped prepaid by parcel post. Allow two to three weeks for delivery.

Back issues now available:
1960 to 1969, \$5.00 each
1970 to 1973, \$3.00 each
1974 to 1976, \$4.00 each

USE THIS PAGE AS YOUR ORDER FORM

Cost of orders \$ _____
Plus 10% handling charge \$ _____
TOTAL AMOUNT ENCLOSED \$ _____

Mail your order to:
Janice Austin
ELECTRONICS REPRINTS
P.O. Box 669
Hightstown, N.J. 08520

SEND REPRINTS TO

Name _____
Company _____ Dept. _____
Street _____
City _____ State _____ Zip _____

HERE'S HOW TO...

Up-date your electronics know-how
with minimum cost, time,
and effort ...
for top potential return in
job opportunities ...

The brand-new McGraw-Hill Course in Continuing Education for Electronics Engineers **ELECTRONIC CIRCUIT DESIGN WITH SOLID-STATE DEVICES**

8 no-frills self-study lessons do it!

Let a panel of top electronics experts help put you up front in the newest, hottest areas around today ...

- ▶ How to bring yourself up to date with actual information you can use on the job
- ▶ How to design electronic circuits for various applications with the use of solid-state devices and the design data the Course gives you
- ▶ How to understand and design linear, differential, and operational amplifiers
- ▶ How to apply digital and linear integrated circuits in many fields



PLUS these special extras:

- ▶ Master Outline & Course Guide
- ▶ Study Guides for Each Lesson
- ▶ Self-checking Quizzes
- ▶ Electronic Circuits Portfolio (with Lesson 5)
- ▶ Final Exam and Course Completion Certificate

You Can Examine Lesson One and the Master Outline and Guide FREE for 10 Days Before You Decide You Want to Take the Whole Course!

EXTRA VALUE IN THIS SPECIAL BONUS!
With Lesson Five—at the midpoint in your Course—we will send you FREE a 32-page

ELECTRONIC CIRCUITS PORTFOLIO

containing some 150 illustrated circuits! Each of these circuits relates to a specific point made in the Course and gives you additional specific know-how in solving problems right on the job! This valuable Bonus is something you will keep by your side as a handy source of helpful information when you need it!

Simply complete and return the "Operation Update" Reply Card and McGraw-Hill will send you LESSON ONE and the Master Outline & Guide—with the Study Guide materials, the Reading Reference List, and your Quiz. Put these materials to the test for 10 days. Apply what you learn from them on any design problem you're grappling with. Then—at the end of the 10 days—and *only* then, need you decide to take the whole course. If, at the end of that time, you decide you do *not* want the course, all you need do is return the Lesson and the Outline and that's the end of any obligation whatsoever on your part.



MAIL YOUR "OPERATION UPDATE" COUPON TODAY!

Be sure to return your Free Examination Coupon today! The sooner you receive Lesson One and the Master Outline and Guide, the sooner you will accomplish a thorough updating of your highly valuable professional skills and the sooner you will steer yourself in the direction of bigger and better professional advantages!

TAX DEDUCTIBLE!

Just a reminder—you are entitled to deduct tuition fees (and the McGraw-Hill Course in ELECTRONIC CIRCUIT DESIGN WITH SOLID-STATE DEVICES applies here) from your U.S. Federal Income Tax when you take any course to maintain your professional skills!

Your "Operation Update" Coupon

McGraw-Hill Book Company, 1221 Avenue of the Americas, New York, New York 10020

Please send me for 10 days' free examination Lesson One plus the Master Outline and Guide for the NEW McGraw-Hill Course in Continuing Education for Electronics Engineers—ELECTRONIC CIRCUIT DESIGN WITH SOLID-STATE DEVICES.

At the end of ten days, if I want to continue in the Course, I will make my first payment of \$6.95 plus local tax, postage and handling. And I understand that each subsequent Lesson will be accompanied by an invoice for \$6.95 plus local tax, postage, and handling ... for a total cost of \$55.60 for the eight Lessons. (The Lessons will be shipped at six-week intervals.)

If I decide not to continue in the Course after the ten-day examination period, I will return the Master Outline and Lesson One and the matter will be closed.

Our Policy: If you're disappointed in the Course at any stage, just notify us and we will stop sending the Lessons and invoices. If you have paid in advance, we will refund the difference between the value of the lessons you have received and the payments you have made.

Name _____

Home Address _____

City _____

State _____ Zip _____

There is no finance charge for monthly payments. This offer is subject to acceptance by McGraw-Hill.

41-19097

The Electronics Book Series offers you:

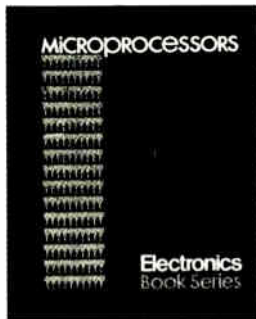

1

MICROPROCESSORS

This book cuts through the confusion, presenting the design and application potential of this exciting technology in a manner that will appeal to the design engineer who needs to know how to use microprocessors as well as the system analyst who must assess the tradeoffs between microprocessors and other techniques to accomplish his system goals.

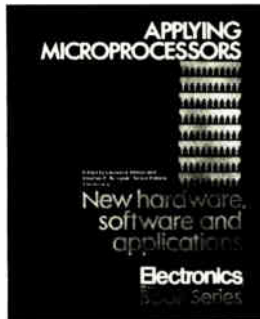

2

APPLYING MICROPROCESSORS

This new book completes the engineer's transition from the old methods of electronic design to the new world of microprocessor engineering. The book contains the up-to-date and ready-to-use information that every designer needs to know about the new technology.

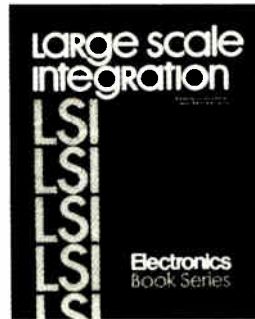

3

LARGE SCALE INTEGRATION

"Large Scale Integration" deals with the entire range of design applications main memory systems, peripheral memories, memory controllers, on-line industrial controllers, data acquisition boards, communication systems, calculators, watches, etc.



4

BASICS OF DATA COMMUNICATIONS

Chances are you are going to be a part of the data communications market. There's no better place to start than getting a copy of "Basics of Data Communications"—a 316-page compilation of essential articles which have appeared in Data Communications magazine.

Use form below to order your copy. Prices on 10 copies or more, available upon request.

Electronics Book Series

1221 Avenue of the Americas, New York, New York 10020



- 1** Send me _____ copies of "Microprocessors" at \$8.95 per copy.
- 2** Send me _____ copies of "Applying Microprocessors" at \$9.95 per copy.
- 3** Send me _____ copies of "LSI" at \$9.95 per copy.
- 4** Send me _____ copies of "Basics of Data Communications" at \$12.50 per copy.

Full payment must accompany my order.

I must be fully satisfied or you will refund full payment if the books are returned after ten-day trial examination.

Name _____ Title _____

Company _____

Address _____

City _____ Country _____

Signature _____

At +125°C you can burn your fingers on some DAC's our 4058 stays cool



Because this new, hybrid 12 bit DAC was specifically designed for the temperature range -55 to +125°C. It is not merely a top-end selection of commercial DAC's, where you don't know today what tomorrow's yield will be.

Your application may not need the full temperature range nor the hermetically sealed metal DIP. But for a lot of industrial applications these and other features of the new DAC offer you vital safety factors.

For example, it is produced to MIL Std 883 giving extremely high reliability. It has a very low temperature drift of 5 ppm/°C gain, 10 ppm/°C max. offset.

And if you want to fly with it, the 4058 is shock, vibration and acceleration tested - its already being used in the new MRCA.

 **TELEDYNE PHILBRICK**

Allied Drive at Route 128
Dedham, Massachusetts 02026
Tel: (617) 329-1600

TWX: (710) 348-6726
Telex: 92-4439
Cable: TELEPHIL

Circle 173 on reader service card

Record with Hewlett-Packard

If you're in pursuit of small quick changes in data, look how Hewlett-Packard's XY Recorder accelerates.

Ordinarily, XY recorders are considered to be very low frequency devices. But Hewlett-Packard doesn't build ordinary XY's. Ours give you the definite advantage of high speed combined with acceleration to almost 10G. To demonstrate, we took our model 7045A and swept frequencies from below 5Hz to

15Hz at 1cm amplitude. Acceleration like this means you can capture small quick transients directly with an HP XY recorder.

Hewlett-Packard builds this kind of acceleration into both one and two pen XY recorders. We've just published a new technical note that explains this extraordinary dy-

namic response in detail. Send for it and see why small quick changes are easy to catch with HP.

HEWLETT  PACKARD

1507 Page Mill Road, Palo Alto, California 94304

For assistance call: Washington (301) 948-6370, Chicago (312) 255-9800, Atlanta (404) 955-1500, Los Angeles (213) 877-1282

Classified section FOR ENGINEERING/TECHNICAL EMPLOYMENT OPPORTUNITIES

CLASSIFIED SALES REPRESENTATIVES

Atlanta Joe Lane 404/892-2868
 Boston Holt Buchanan 617/262-1160
 Chicago Bill Higgins 312/751-3733

Cleveland Mac Huestis 216/781-7000
 Dallas Mike Taylor 214/742-1747
 Denver Shirley Klotz 303/837-1010
 Detroit Mac Huestis 313/873-7410

Houston Mike Taylor 713/659-8381
 Los Angeles Stan Kassir 213/487-1160
 New York Dave Hawksby 212/997-3594
 Philadelphia Dan Ferro 215/568-6161

Pittsburgh Dan Ferro 412/391-1314
 San Francisco M.E. Kenny 415/362-4600
 Stamford Holt Buchanan 203/359-2860
 XEROX 400 TELECOPIER 212/997-6800

SEMICONDUCTOR MANUFACTURING ENGINEERS

The Allentown Works of the Western Electric Company's Electronic Components Division has a need for Engineers with experience in semiconductor manufacture. Superior candidates with demonstrated ability and expertise will be considered for openings in the following typical areas:

Integrated Circuit Development Engineer

Positions open for creative individuals to develop, characterize and introduce new production techniques for volume manufacture of large scale MOS and Bipolar integrated circuits. These openings are in the fields of diffusion, photolithography, chemical treatment, metal and insulator deposition also testing and failure mode analysis. Applicants should have BS or MS degree in EE, ME or Ch.E. plus minimum 3 years of experience in semiconductor manufacture.

Integrated Circuit Product Engineer

Positions involve engineering responsibility for introducing new LSI I.C.'s into manufacture. Individuals will work in close liaison with device designers and with process development engineers to optimize and improve processes. A working knowledge of LSI technology is essential. Applicants should have BS or MS degree in EE plus minimum 3 years of experience in MSI/LSI manufacture.

SIC Test Engineer

Position includes testing of high volume complex silicon devices involving the development of software for programming large commercial test systems to completely exercise the devices including speed and high temperature performance. Also included is the failure mode analysis of defectives and the association of the fault with specific manufacturing processes. Candidate should have familiarity with the application of logic and memory devices. A background in solid state device processing would be helpful. Applicants should have a BSEE degree plus minimum 3 years of experience in integrated circuit manufacture.

SIC Packaging Engineer

Position involves the development of mechanical assembly processes associated with the packaging of silicon integrated circuit chips. Experience is required in such areas as high volume machinery, quality control and possess ability to diagnose and resolve production problems. Applicants should have a BS or MS degree in EE or ME plus minimum 3 years of experience.

Microprocessor Systems Engineer

Position open for individual who will have engineering product line responsibility for microprocessors. This position encompasses areas such as telecommunications systems applications, device architecture, development of test programs, and test result analysis. Applicant should have BS or MS in EE, plus appropriate experience.

W.E. offers excellent salaries and professional growth potential plus comprehensive benefits and relocation assistance. Please send resume, including salary history and requirements to: **Engineering Personnel Dept. #41, Western Electric Company, 555 Union Boulevard, Allentown, Pa. 18103.**



Western Electric

ALLENTOWN WORKS
 An Equal Opportunity Employer

Wescom has an extraordinary history of growth in the design, development, and manufacture of electronic telecommunications systems and lists the following career opportunities in their plants in West Suburban Chicago:

SOFTWARE DESIGNERS

We require Design Engineers to assist us in the design and development of software for our telephone switching systems.

You will design and develop the software for a system that is operated by stored program control. This includes the design and implementation of computer programs to operate in a real time environment.

Requirements: B.S. or M.S. in electrical engineering or computer science coupled with a minimum of one (1) year experience with real time systems programming.

HARDWARE DESIGNERS

We are seeking Hardware Designers to join our engineering organization.

To qualify you must be experienced in the design of micro-processor systems, memories and associated interfaces. We require a BS or MS in electrical engineering or computer science and a minimum of 3 years related experience.

Wescom offers a liberal starting salary and full fringe benefit package. If you meet or exceed these requirements, please submit a detailed resume, including salary history in confidence to:

Christine Rosenbach
 Employment Manager



WESCOM

8245 S. Lemont Road, Downers Grove, IL 60515

An Equal Opportunity Employer M/F

RATES \$46 per advertising inch (1/8"). Commissionable.
 SIZES 1/8" to 10" deep in widths of one column (1 3/8"), two (3 3/8"), three (5 1/8"), and four (7").
 CLOSING Two weeks prior to mailing.
 MAILING One week prior to issue date.
 ISSUE DATE Every other Thursday.
 AD ORDERS/BOX NUMBER ANSWERS Send to Electronics, Post Office Box 900, New York, N.Y. 10020.

RF ENGINEERING OPPORTUNITIES

Successful commercial electronics growth Company, located in lovely suburban Maryland, has career opportunities for 2 MANAGERS and several RADIO FREQUENCY ENGINEERING SPECIALISTS.

For the past 2 decades, our organization has promoted several innovative and financially successful product lines—now we are adding new emphasis to our RF organization.

MANAGER, RF DESIGN ENGINEERING

Position calls for strong, creative involvement in the design of marine band synthesized HF exciters, RF receivers, and remote control of exciters—also products utilizing FSK Demodulation techniques.

Successful applicant will have management opportunities to select and direct a team involved in our expanding, currently proven line of communications products.

PRODUCT MANAGER, RF PRODUCTS

Experienced Product Line Manager familiar with RF radio systems, needed to direct product management organization. Responsibilities include development and implementation of business plans, new product proposals, and marketing support.

RF ENGINEERING SPECIALISTS

Excellent opportunities for experienced BS/MSEES for design of State-of-the-Art Product development. Experience in synthesizers, exciters and receivers desired.

Please submit relevant experience by letter or resume to arrange for personal interview. Our organization is expanding and these openings will be filled shortly! Confidentiality assured. Reply to Personnel Manager, Dept. T, P.O. Box 2351, Sunnyvale, CA 94087.

BOEING Engineers

The Boeing Company in Seattle, Washington has immediate requirements for experienced engineers in a variety of important assignments on a wide range of products as follows:

AVIONICS ENGINEERS for:

- Antennas and Radomes
- Crew Systems
- Digital Avionics
- Electronic Countermeasures
- Fire Control Systems
- Navigation Systems
- Radar and Optical Avionics
- Software Data Processing

ELECTRICAL/ELECTRONICS ENGINEERS for:

- Analog and Digital Circuits
- Electrical Power Systems Design
- Electronic Packaging
- Electromagnetic Compatibility
- Flight Control Systems
- Ground Support Equipment
- Instrumentation Subsystems
- Micro Electronics

LOGISTIC SYSTEMS ENGINEERS for:

- Maintenance/Maintainability
- Spares
- Technical Publications

SOFTWARE & COMPUTING SYSTEMS ENGINEERS for:

- Computers & Displays—Design and Development
- Microprocessor Software/Firmware Design and Development
- Real-Time Operational Software Development
- Signal Processing Software Development
- Software/Computing Systems Design Analysis
- Software & Computing Testing and Evaluation
- Support Software Design and Development

SYSTEMS ENGINEERS for:

- Product Systems
- Systems Analysis
- System Configuration Development

VEHICLE TEST ENGINEERS for:

- Electrical/Electronic Testing
- Flight/Mission/Systems Testing
- Test Program Requirements & Planning

MANUFACTURING TEST ENGINEERS for:

- Analog and Digital Circuit Analysis
- Automatic Test Development
- Custom Hybrid Microcircuit Assembly and Test
- Photo-Voltaic Cell Process and Test Procedure Development
- Test Equipment and Component Design

Candidates must have U.S. citizenship and an appropriate BS degree or higher. Attractive salary, fringe benefits and moving allowances will be offered qualified candidates. And living is a pleasure in the unspoiled Northwest with its many recreational and sports activities and relaxed life-styles.

Look into these outstanding opportunities.

Send your detailed résumé now to The Boeing Company, P.O. Box 3707-LDU, Seattle, WA 98124.

An equal opportunity employer.

BOEING
Getting people together

MAKE YOUR
NEXT
MOVE A STEP
IN THE
RIGHT
DIRECTION



The road to professional fulfillment can be a real jungle. We can help you find the right path. Our affiliation with

National
Personnel
Associates®

keeps us informed of opportunities in the ELECTRONICS industry from coast to coast as they occur. Together with over 175 associates, we offer our knowledge and expertise at no charge to you. Fees are company paid.

ANDERSON-TAYLOR
P.O. Box 21
Exton, Pennsylvania 19341
(215) 363-1600

AVAILABILITY, INC.
Engineering Consultants
1300 N. Westshore Blvd.
Tampa, Florida 33607
(813) 872-2631

STAFF DYNAMICS, U.E.
26 Sixth Street
Stamford, Connecticut 06905
(203) 324-6191

**ALFRED J. ALLEN
& ASSOCIATES, INC.**
999 N. Sepulveda Blvd.,
Suite 704
El Segundo, California 90245
(213) 776-6852

**CAREER SPECIALISTS
PERSONNEL SERVICES**
4600 El Camino Real, Suite 206
Los Altos, California 94022
(415) 941-3200

PERSONNEL INC.
Jim Trexel
836 National Road
Wheeling, West Virginia
26003
(304) 233-3000

THIS MAN IS DETERMINED TO SEARCH FOR THE ENGINEERS DESCRIBED BELOW



until he finds them and advises them of the outstanding career opportunity waiting for them with one of the nation's Top-10 electronics and systems companies. Senior positions related to a series of long term, state-of-the-art projects must be filled. His mission: . . . fill them.

DIGITAL DESIGN ENGINEERS

You will need a BSEE or technical degree in a related area plus 3-7 years' experience in GENERAL PURPOSE LOGIC DESIGN using high speed integrated circuit logic devices and familiarity with State-of-the-Art digital devices and computer aided design techniques. You should also have experience in DIGITAL CIRCUIT DESIGN, including A/D and D/A Converters and Worst Case Design

SIGNAL PROCESSING DESIGN ENGINEERS

Background should include a BSEE and 8-15 years' experience in Digital Logic Design (emphasis on Signal Processing techniques) and a thorough knowledge of Digital Hardware, Radar Principles, Timing, Coding/Decoding, Formatting, Data Transfer and Control Logic, including Worst Case Analysis

MICROWAVE DESIGN ENGINEERS

Background should include conceptual definition through design and development of microwave circuits & components necessary in design of antennas (including phase arrays), knowledge of computer applications and a familiarity with RF amplifier design, various type microwave and solid state devices, pulse modulator circuit design, fault sensing logic design.

If your qualifications meet the above specifications, please forward your resume, including salary history, in complete confidence to LRK ASSOCIATES, 6845 Elm Street (EL-6), McLean, Virginia 22101. Or call us, Monday through Friday, at (703) 790-8640. U.S. Citizenship required. Representing an equal opportunity employer m/l/h.

LRK
ASSOCIATES

STILL LOOKING FOR YOUR DREAM JOB?



Then be sure to check out the employment opportunities contained in ELECTRONICS' Classified Section.

Or, why not consider placing a Position Wanted ad? The cost is low (only \$1.25 per line) and the results are often rewarding. For more information call or write:

ELECTRONICS Post Office Box 900
New York, N.Y. 10020 • Phone: 212/997-2556

PRINCIPAL ELECTRONICS ENGINEER

Experienced in new product design and development with heavy emphasis on semiconductor power control circuitry—inverters/converters. Requires successful engineering track record for high quality commercial/industrial electronic products—medium to large volume. Total design responsibility from concept to finished product.

NEW ENERGY SAVING TECHNOLOGY

Lutron Electronics is the established leader in solid state light dimming systems utilizing both thyristor and high power transistor control technology. New energy saving/energy management systems for lighting control are essential to power saving in modern office and industrial buildings. Energy saving technology offers unique challenges, rewards and innovative opportunities.

Live and work in the beautiful Allentown, Pennsylvania area—an award winning All-American City. Two hours from New York City, 1 hour from Philadelphia.

Excellent salary and benefit package including profit sharing and incentive bonus programs. Send complete resume to: Don Mershon, Vice President, Lutron, 205 Suter Road, Coopersburg, Pa. 18036.

LUTRON®

COOPERSBURG PA 18036

PHONE (215) 282-3800

We have opportunities for Engineers . . .

Instrumentation Engineer

An MS/EE with at least five years experience. Requirements are hardware experience with high voltage, high power circuit design for pulse and dc systems. A knowledge of analog instrumentation problems associated with high power equipment is required.

rf Circuit Design Engineer

A challenging position in rf circuit design and fabrication in a growing R&D electronics laboratory. Knowledge of useful VHF and UHF rf components in discrete and chip form is required. Design and fabrication of hybrid printed circuit board and thick film circuits will be carried out for operation in the 10 to 1000 MHz range. Advanced fabrication and computer aided test equipment will be provided. State-of-the-art hybrid subsystems will be the end product.

These openings provide a chance to join the company ranked seventh in the U.S. in private R&D spending, and live in an attractive New England setting. Please submit your detailed resume with salary history to: E. Marcin, Professional Placement, Silver Lane, East Hartford, Conn. 06108

UNITED TECHNOLOGIES RESEARCH CENTER



An equal opportunity employer

Electronics Engineers

Are your goals as unique as ours?

Join IITRI for career advancement in **ELECTROMAGNETIC COMPATIBILITY**

The most advanced work in this critical, far-reaching field continues to be done at the Electromagnetic Compatibility Analysis Center in Annapolis, Md. In a creative environment that spurs our top-rank staff to continuing achievements, you will find a satisfying combination of stability, recognition and personal growth potential. If you qualify for one of these current openings, we urge you to contact us for details that will be of great interest to you.

PROJECT ENGINEERS

... with interest in EMC problems and in the frequency allocations and assignment processes which affect communications, radar, navigation and other electronic systems. Must be capable of using validated digital computer models and computer data bases to solve specific EMC problems encountered on various projects and/or capable of validating untested digital computer models by comparing model predictions with measured data. BSEE required.

ELECTRONICS ENGINEERS

... with interest in communication system modeling. Must be capable of developing digital computer adaptable models of digital detection processes, analog detection processes, interfering signal voltages, or unintentional man-made radio noise voltages encountered in modern day communication systems. An understanding is required of one or more of the following areas: time domain analysis of realizable linear filter responses, random variables, transformation of probability density functions, advanced modulation techniques involving frequency hopping or spread spectrum schemes, and formulation of digital detection schemes which are optimum according to given criteria. BSEE required. MSEE desirable.

Attractive salaries and benefits. U.S. Citizenship required. Please send resume, and salary requirements to: Mr. J.J. Powers, or Call Collect (301) 267-2458.

IITRI IIT
Research
Institute

P.O. Box 1711
Annapolis, Maryland 21404

An Equal Opportunity Employer. M/F

ENGINEERS—JOIN AEL IN SUBURBAN PHILADELPHIA: Now More A Leader Than Ever!

AEL—American Electronic Laboratories, Inc.—is a longtime, well-established leader in electronics design and manufacture. Our continuous R&D and new-product marketing activities have resulted in a current backlog of orders that is very substantial. They've also resulted in the following rewarding career opportunities.

QUALITY CONTROL GROUP LEADER. ASQC quality engineering certification required, along with appropriate technical degree. (E-1)

MICROWAVE COMPONENT DESIGN ENGINEERS. Must be familiar with micro-strip and stripline design techniques. (E-2)

HYBRID PROCESS ENGINEER. Must be familiar with processing techniques used in the manufacture of thick film hybrids. (E-3)

HYBRID DESIGN ENGINEER. Experience in both analog and digital design is required... plus additional experience in thick film and LED display design. (E-4)

DESIGN ENGINEER. Must be familiar with logic design of A/D converters, micro-processors, and digital memories. (E-5)

DESIGN ENGINEER. Must be familiar with the design of image transmission and display equipment, and A/J techniques in TV transmission systems. (E-6)

DIGITAL DESIGN ENGINEER. Digital design experience must include CMOS, TTL, and ECL. (E-7)

SECTION HEAD/RECEIVER GROUP. Must have heavy experience in receiving systems technology, with direct experience in customer interface, proposal writing, and supervision of technical personnel. (E-8)

MICROWAVE/GASSET DESIGN ENGINEER. Must have experience in microwave component development, with two or more years of experience in the design and development of gasset amplifiers. (E-9)

SENIOR ANTENNA STAFF CONSULTANT. Ten or more years of direct design and development experience on military antennas is required. (E-10)

RF ENGINEER. Must have experience in design and development of RF circuits in VHF and UHF spectrums. (E-11)

SOFTWARE ENGINEER. Ten or more years of experience is required in software engineering on large-scale, computer-controlled systems. (E-12)

SYSTEMS ENGINEER. Must have broad sensor and/or communications experience coupled with implementation of real-time computer-controlled systems. (E-13)

SYSTEMS ENGINEER. Systems work background required in the areas of digital hardware and RF/analog hardware. (E-14)

DESIGN ENGINEER-RECEIVERS. Must have experience in RF microwave techniques, with design experience in UHF/VHF and microwave receivers and/or receiver components. (E-15)

BROADCAST TRANSMITTER DESIGN ENGINEER. Required is direct design experience in AM/FM broadcast transmitters and related broadcasting systems equipment. (E-16)

SENIOR ADVANCED CONCEPTS ENGINEER. Your experience must include background in mission and systems threat analysis, with emphasis on new techniques and components in passive surveillance, signal processing, and related EW technology. (E-17)

In these positions you'll enjoy attractive, competitive salaries... many worthwhile benefits (including a dental plan)... totally professional working conditions... and definite career growth potential.

To apply, please send your resume, complete with salary history and the number of the position you're applying for, to: Mr. Peter Hasse, American Electronic Laboratories, Inc., PO Box 552, Lansdale, Pa. 19446. We're an equal opportunity employer.

AMERICAN ELECTRONIC LABORATORIES, INC.

ALL THE ABOVE POSITIONS REQUIRE U.S. CITIZENSHIP

MECHANICAL ENGINEERS

Power Supply Packaging Specialist

The Aerospace Division of Control Data is seeking a Mechanical Engineer experienced in the mechanical packaging of power systems/power supplies.

This position entails:

- The designing of power supplies to meet Aerospace's standards of productability and maintainability as well as compliance with performance specifications required by military environmental conditions.
- Providing the packaging expertise to incorporate both electrical and thermal performance factors.
- Ideally this individual should have a knowledge of military specs. as well as thermal design.

If you desire to be a key member of an engineering staff, to work on both a functional and project basis, to occasionally supervise professional and non-professional personnel and to be constantly challenged in a technologically advanced environment, send your resume and salary history or call collect:

D.T. Caskey
CONTROL DATA CORPORATION
Aerospace Division
3101 E. 80th Street Box 609
Minneapolis, Minnesota 55440
(612) 853-4631



An Affirmative Action Employer M/F

SOUTHEASTERN OPPORTUNITIES

Fox-Morris Associates, a leader in professional engineering placement, presents a partial listing of lucrative career opportunities currently available with our prestige client cos.

Sr. Project Engr—LA	\$25,000
Sr. Inst. Engr—N.C.	\$28,000
Process Control Engr—GA	\$22,000
Product Design Engr—Miss	\$18,000
Project Engr—Tenn	\$20,000
Inst Supv—Houston	\$22,000
Power Dist Engr—S.C.	\$22,000
Mfg Engr—Alabama	\$20,000
Inst Engr—Atlanta	\$18,000
Design Engr—GA	\$16,000
Power Dist Engr—GA	\$17,000
Electronics Engr—Atlanta	\$18,000

All employment costs paid by client cos. No applications or contracts reqd. Reply in conf. to K. Schauer, Mgr, Technical Placement, by resume including present salary.

FOX-MORRIS
PERSONNEL
CONSULTANTS
2200 CENTURY PARKWAY,
N.E.
ATLANTA, GA 30345

★ MICROPROCESSORS ★
ANALOG/DIGITAL
Design & Project Eng'rs
• BS, MS, PH.D. •
Nat'l Unadvertised Positions
• \$16-30K •
P'nB Consultants, Box 261 (M)
Wayne, Pa 19087
The Engineers Who
Talk Your Language

We have been placing graduate ENGINEERS

in FEE-PAID positions
THROUGHOUT THE U.S. since
'59. Over 1,000 client companies.
We are graduate engineers working
full-time for you. Send resume
& salary history today or request
confidential application.
ATOMIC PERSONNEL, INC.
Suite L, 1518 Walnut St., Phila., Pa. 19102
An Employment Agency
For All Technical Fields

BUSINESS OPPORTUNITIES

How To Earn Money As A Consultant
(including specimen contracts) \$17
Business Psychology Int'l 2407/44
Pacific Virginia Beach, Va. 23451.

Patented and proven Automotive
Device, Box 223, Naperville, Ill.
60540.

POSITION WANTED

Engineering technician with 10 years
hands-on experience in analog,
digital, rf, prototype design or
assembly and troubleshooting, Mark
Worley 1710 Arizona Flint, MI 48506
(313) 785-2602.

OVERSEAS JOBS GUIDE

Job Hunters Guide & Directory of
600 firms. \$6.00 +\$.50 P&H (US \$
check or MO only). foreign—add
\$2.00. Friar Books, Dept. EL, 8956
E Ardendale, San Gabriel, CA 91775.

Aeret Corporation	129	Frost & Sullivan	168	* Philips Eicom	9E,23E
Advanced Micro Devices	12-13	Fujitsu Limited	54-55	* Philips TMI	2E-3E
≡ Allen-Bradley	4D-5D	‡ Galileo Electro-Optics Corporation	72-73	Plessey Company, Ltd. (Radar)	149
AMF - Potter & Brumfield	11	GCA Sunnyvale	137	■ Precision Monolithics, Inc.	15
Amp, Inc.	142-143	■ General Electric, A & Sp Operation, Semiconductor Products	134	* Procond S.P.A.	22E
Amphenol North America Division Bunker Ramo Corporation, RF Operation	24	General Electric Panel Meter	114	RCA Solid State	7
Analog Devices	62-63	■ General Instrument, Microelectronics	40-52	Reticon Corporation	91
≡ Analogic Corporation	35	Georgia Dept. of Community Development	164	* Rhone Poulenc - Chimie Fine	6E
■ Augat, Inc.	155	■ Grayhill, Inc.	82	■ Rockland Systems Corporation	6
■ Ballantine Laboratories	76	‡ Hammond Electronics	22D	Rockwell International, Collins Commercial Telecommunications Division	16
Bartow Chamber of Commerce	180	■ Hewlett-Packard,	1,2,2nd C, 138-139 154, 162-163, 173	* Rohde & Schwarz	1E
* Bayer AG	11E	Intel-Microcomputer Components	18-19	* S. E. Laboratories Ltd.	27, 19E
≡ Beckman Instruments, Hellpot	64	International Electronic Research Corp.	146	■ Semiconductor Circuits	86
‡ Belden Corporation	11E	International Rectifier Corp., Semi, Div.	167	* Sernice	13E-15E
■ Bourns, Inc.	4th cover	ITT Semiconductor	66	* Siemens AG Munich	64
≡ B&K Precision, Div. Dynascan Corp.	20D-21D	■ Johanson Manufacturing Corp.	20	Sprague Electric	59
* Carlo Erba S.P.A.	16E	■ Kay Elemetrics Corp.	150	S.R.D. Corporation	152
■ Centralab Electronics Division	153	Keithley Instruments	37	Stackpole Components Company	79
* Centronics	9	* Kienzle, Apparatebau Gmbh Villingen	4E-5E	Synertek	109
‡ Cherry Electrical Products	13D	■ Krohn-Hite Corp.	5	* Teec Corporation	56
‡ Chicago Miniature Lamp Works	23D	≡ Kulka Electrical Corp.	24D	Tecknit (Technical Wire)	168
Computer Automation, Inc., Naked Mini Division	69	LH Research, Inc.	169	■ Tektronix	33
Continental Rentals	8	‡ Licon, Div. of Illinois Tool	7D	Teledyne Philbrick	173
■ Continental Specialties	122	≡ Magnecraft Electric	2D-3D	Texas Instr., Components	151
Magnetic Components Group,	180	Mallory Capacitor Company	17, 158	Texas Instruments, Inc., Digital Systems Div.	74-75
Control Data Corp.	160	* Matsushita Electric Trading Co.	35	* Trio Kenwood Corporation	35
Coors Porcelain	160	Mektron NV	24E	* Triplet Corporation	38
≡ Corning Glass Works, Fotoform / Fotocerem Div.	38-39	MFP Corp.	115	≡ TRW Div. Cinch Connectors	9D
Crown Industrial	156	Micro Power Systems	87	≡ TRW ECD	16D
Data General Corp.	27	Microwave Power Devices	192	■ TRW LSI Products	147
■ Dialight Corp.	157	Molex, Incorporated	140	■ Vectec, Inc.	159
Echlin Manufacturing Co.	148	McGraw-Hill Book Co.	171	Varian	112
EECO - Electronic Engineering Co. of Calif.	144	National Semiconductor Corp.	125-128	Wavetek San Diego	92
Electronic Memories & Magnetics	22	‡ NEC America, Inc., Electron Devices Division	70-71	Zilog	21
Electronic Navigation Industries	3rd Cover	NEC Microcomputers	88-89		
■ Electronic Product Associates, Inc.	146	* NEOHM SPA	23		
‡ Electronic Representative Assoc.	19D	≡ Nicolet Instrument Corp., Oscilloscope Div.	22-23		
‡ Essex Group, Sub. of United Tech.	15D	Norden Division, United Technologies Corporation	168		
Esterline Angus	150	Nucleonic Products Co., Inc. (Div. Thomson CSF)	28		
Everett/Charles, Inc.	146	‡ Oak Industries	9		
Fairchild (Semiconductor Operations Division)	60-61	Optron, Inc.	14		
‡ Ferroxcube Corp., A Div. of North Amer. Philips	56	* Oscilloquartz	66		
Figaro Engineering, Inc.	152	* Philips ELA	21E		
■ John Fluke Mfg. Co., Inc.	81,83,85				

Classified and employment advertising

F. J. Eberle, Manager 212-997-2557

AEL Laboratories	178
Atomic Personnel	178
Boeing	175
Control Data	178
Fox Morris Personnel	178
ITT Research Institute	177
LARK Associates	176
Lutron Electronics Inc.	177
National Personnel Assoc.	176
P'N B Consultants	178
E. Jack Shannahan Assoc.	175
United Technologies	177
Wescon	174
Western Electric	174

■ For more information of complete product line see advertisement in the latest Electronics Buyers Guide
 * Advertisers in Electronics International
 ‡ Advertisers in Electronics domestic edition

LOW NOISE MODULAR DESIGN

Switching Power Supplies!



A new line of compact, modular-design switchers that simplify design for 300-600 watt applications and sell for less than 90¢ per watt! End users benefit from low EMI noise levels and highly reliable operation plus easy add-on and maintenance features. Get everything you need to know to evaluate this high quality, money-saving line from:

Jim Daly
phone (612) 830-5800
TWX 910 576 2978
or write: 7801
Computer Ave. So.
Minneapolis, MN 55435.



CONTROL DATA CORPORATION

Circle 180 on reader service card

"On a map of Florida, draw a 100 mile radius around Bartow. Then watch what you catch in terms of oceans, civic centers, international airports, and the like. Then make a list of the ideal qualities you're looking for... if Bartow doesn't meet each one, it's just simply an oversight."

*D. E. Black, President
Florida First National Bank in Bartow.*



This short message is being brought to you by a select group of some of the Nation's top executives. Each has contributed his time and expertise on a portfolio of pertinent facts about the advantages of site location in and around Bartow.

The portfolio is yours free for the asking. Write for one today and let the Committee show you a side of the Florida sun you've never seen.

*Director of Economic Development
Committee of '76 Greater Bartow Chamber of Commerce
P. O. Box 956AD Bartow, Florida, 33830 Phone: 813-533-7125*

180 Circle 226 on reader service card

World Radio History

Advertising Sales Staff

Advertising sales manager: Paul W. Reiss
1221 Avenue of the Americas, New York, N.Y. 10020
[212] 997-4371

Atlanta, Ga. 30309: Glen N. Dougherty
100 Colony Square, 1175 Peachtree St., N.E.
[404] 892-2868

Boston, Mass. 02116: Frank Mitchell
607 Boylston St.
[617] 262-1160

Chicago, Ill. 60611
645 North Michigan Avenue
Robert W. Bartlett [312] 751-3739
Robert M. Denmead [312] 751-3738

Cleveland, Ohio 44113: William J. Boyle
[716] 586-5040

Dallas, Texas 75201: John J. Uphues
2001 Bryant Tower, Suite 1070
[214] 742-1747

Denver, Colo. 80203: Harry B. Doyle, Jr.
123 Speer Blvd. #400
[303] 837-1010

Detroit, Michigan 48202: Robert W. Bartlett
1400 Fisher Bldg.
[313] 873-7410

Houston, Texas 77002: John J. Uphues
601 Jefferson Street, Dresser Tower
[713] 659-8381

Los Angeles, Calif. 90010: Robert J. Rielly
Bradley K. Jones, 3200 Wilshire Blvd., South Tower
[213] 487-1160

Minneapolis, Minn. 55435: Robert M. Denmead
4015 W. 65th St.
[312] 751-3738

New York, N.Y. 10020
1221 Avenue of the Americas
Michael J. Stoller [212] 997-3616
Matthew T. Reseska [212] 997-3617

Philadelphia, Pa. 19102: Matthew T. Reseska
Three Parkway
[212] 997-3617

Pittsburgh, Pa. 15222: Matthew T. Reseska
4 Gateway Center
[212] 997-3617

Rochester, N.Y. 14534: William J. Boyle
1175 Pittsford-Victor Rd., Pittsford, N.Y.
[716] 586-5040

San Francisco, Calif. 94111: Don Farris
Robert J. Rielly, 425 Battery Street.
[415] 362-4600

Paris: Alain Offergeld
17 Rue-Georges Bizet, 75116 Paris, France
Tel: 720-73-01

Geneva: Alain Offergeld
1 rue du Temple, Geneva, Switzerland
Tel: 32-35-63

United Kingdom & Scandinavia: Robert Ghey
34 Dover Street, London W1
Tel: 01-493-1451

Scandinavia: Andrew Karnig and Assoc.
Kungsholmsgatan 10
112 27 Stockholm, Sweden
Tel: 08 51 68 70 Telex: 179 51

Milan: Luigi Rancati
1 via Baracchini, Italy
Phone 66-90-656

Brussels: Alain Offergeld
23 Chaussee de Wavre
Brussels 1040, Belgium
Tel: 13-73-95

Frankfurt/Main: Fritz Krusebecker
Liebigstrasse 27c, Germany
Phone 72 01 81

Tokyo: Tatsumi Katagiri, McGraw-Hill
Publications Overseas Corporation,
Kasumigaseki Building 2-5, 3-chome,
Kasumigaseki, Chiyoda-Ku, Tokyo, Japan
[581] 9811

Business Department

Thomas M. Egan
Production Manager [212] 997-3140

Gayla Black
Production Manager [212] 997-2044

Carol Gallagher
Production Manager International
[212] 997-2045

Dorothy Carter
Production Manager Domestic
[212] 997-2908

Frances Vallone
Reader Service Manager
[212] 997-6057

Electronics Buyers' Guide

H.T. Howland, General Manager
[212] 997-6642

Regina Hera, Directory Manager
[212] 997-2544

Gayla Black, Production Manager
[212] 997-2044

Frances Vallone, Reader Service Manager
[212] 997-6057

Classified and Employment Advertising

Frank Eberle, Manager
[212] 997-2557

Electronics / April 28, 1977

Tomorrow ideas today.



Using solid-state technology to replace bulky tube-type equipment, ENI's broadband amplifiers are tomorrow ideas available today.

ENI's Class A power amplifiers already cover the frequency spectrum of 10 kHz to 1 GHz, with power outputs ranging from 300 milliwatts to over 4000 watts. And we're still climbing. Driven by any signal generator, frequency synthesizer or sweeper, ENI's compact portable amplifiers are completely broadband and untuned. Amplifying inputs of AM, FM, SSB, TV and pulse modulations with minimum distortion, these rugged units are

versatile power sources for general laboratory work, RFI/EMI testing, signal distribution, RF transmission, laser modulation, data transmission, NMR, ultrasonics and more.

Designed to be unconditionally stable and failsafe (impervious to severe load conditions including open or short circuit loads), ENI power amplifiers will deliver their rated power to any load, regardless of match.

For information write: ENI, 3000 Winton Rd. So., Rochester, New York 14623. Call 716-473-6900. TELEX 97-8283 ENI ROC.

ENI

World's Leader in Solid State Power Amplifiers

Circle 90 on reader service card

World Radio History

Highest Honors for Mil-Spec Trimmers

Only Bourns is qualified to all 18...

A medal to Bourns from Bourns — slightly arrogant, but well deserved. We examined all competitive Mil-Spec Trimmer capabilities and found that no one even came close to the sheer number of approvals we've achieved... eighteen in all! And they're manufactured with the same dedication to quality, service and value that has made Bourns Number One in trimmers for twenty-five years!



... and at a new level of reliability

Not only did we invent the trimming potentiometer in 1952, but we're reinventing it all the time. Patented design innovations incorporated into our Mil-Spec line have brought a new level of reliability unequalled in the industry:

NEW DRIVE SYSTEM — Substantial reductions in material wear and increased rotational life are derived from this "pin-free, lock-free" construction.

SWAGE BOND—High energy "sonic swaging" transforms the cermet element and the termination into an integral one piece unit, providing a connection that is electrically and mechanically more reliable.

CHEVRON SEAL—This unique shaft-to-housing environmental seal is "O-ringless," resulting in uniform torque without any springback.

WRAP-AROUND WIPER — With this feature, wiper pressure is consistent, allowing for better "setability" and lower CRV.

Find out for yourself why we're number one, send for complete technical information from the award winner — Bourns, direct or through your local distributor.

TRIMPOT PRODUCTS DIVISION, BOURNS, INC. • 1200 Columbia Ave. Riverside, CA 92507 • Phone: (714) 781-5050. TWX 910 332-1252.

WIREWOUND

Style	Characteristics	Qualified Terminals	Description
MIL-R-27208			
RT10	C2	L,P	1" long
RT12	C2	L,P,Y	1 1/4" long
RT22	C2	L,P,W,X	1/2" square
RT24	C2	L,P,W,X	3/8" square
RT26	C2	W,X	1/2" square

MIL-R-39015

RTR12	D	L,P,Y	1 1/4" long
RTR22	D	L,P,W,X	1/2" square
RTR24	D	P,W,X	3/8" square

CERMET

Style	Characteristics	Qualified Terminals	Description
MIL-R-22097			
RJ12	C,F	L,P,Y	1 1/4" long
RJ22	C,F	L,P,W,X	1/2" square
RJ24	C,F	L,P,W,X	3/8" square
RJ26	C,F	P,W,X	1/4" square
RJ50	C,F	P	1/4" round

MIL-R-39035

RJR12	C,F	L,Y	1 1/4" long
RJR24	C,F	P,W,X	3/8" square
RJR26	F	P,W,X	1/4" square
RJR28	C,F	P	1/2" long
RJR32	C,F	D	3/4" long DIP



International Marketing Offices: European Headquarters — Switzerland 042/23 22 42 • Belgium 02/218 2005 • France 01/2039633 • Germany 0711/24 29 36 • Italy 02/32 56 88 • Netherlands 70/37 44 00 • United Kingdom 01/572 6531 • Norway 2/71 18 72 • Sweden 764/20 110 • Japan 075/921 9111 • Australia 02/55-0411, 02/35-9566 • Israel 77 71 15/6/7

Circle 902 on reader service card