

MAY 10, 1979

THE SPECIAL PROBLEMS OF BUBBLE MEMORY TESTING/117

Backplanes taking a back seat to zero-insertion-force connectors/ 133

Fast electrically erasable memory acts like nonvolatile RAM/ 128



FOUR DOLLARS

A MCGRAW-HILL PUBLICATION

Electronics®



**MONOLITHIC
ICs TAKE
A BITE**

1420 SW1105 CASAO DEC80
SE SAWICKI
DATA ACQUISITION SYSTEMS
105 N CHAPEL ST
TORRINGTON CT 067

SK=NA

Bourns SIP Trimmers Come in Small Packages...



And save you valuable space.

Model 20 SIP trimmers save you precious PC board space, yet don't cost a fortune. Only .785" X .185" X .079" in size, the Model 20 SIP trimmer occupies just 25% of the board space used by comparable DIP configurations and 50% of that used by conventional 3/4-inch rectangular trimmers. The low board profile of .185-inches and .100-inch spacing are ideal for meeting all of your high density PC board trimmer needs.

Priced at only 75¢* in 1,000 to 4,999 quantities, Model 20 SIP trimmers are available in 18 standard resistance values ranging from 10 ohms to 5 megohms. Options of either hand or machine insertion, plus compatibility with automatic test equipment add up to more cost savings yet.

There's no sacrifice in performance either. Sealed to withstand industrial cleaning processes,

Model 20 SIP trimmers have a low tempco of 100 ppm/°C over -55°C to +125°C temperature range. Power rating is 0.50 watts at 70°C. The stable cermet element offers infinite resolution. The wiper assembly idles at both ends of travel, eliminating damage from forced adjustment.

Put these little jewels to work for you. Dramatic space savings, the ring of Bourns quality, and sparkling performance, too. Contact your local Bourns representative for evaluation samples or send today for complete details. Or, see EEM directory, Volume 2, pages 3804, 3805.

TRIMPOT PRODUCTS DIVISION, BOURNS, INC.,
1200 Columbia Avenue, Riverside, CA 92507,
Phone: 714 781-5050, TWX: 910 332-1252.

European Headquarters: Bourns AG, Zugerstrasse 74 6340 Baar,
Switzerland. Phone: 042 33 33 33 Telex: 78722.

*Domestic U.S.A. quantities.



BOURNS®

For Immediate Application—Circle 120 For Future Application—Circle 220

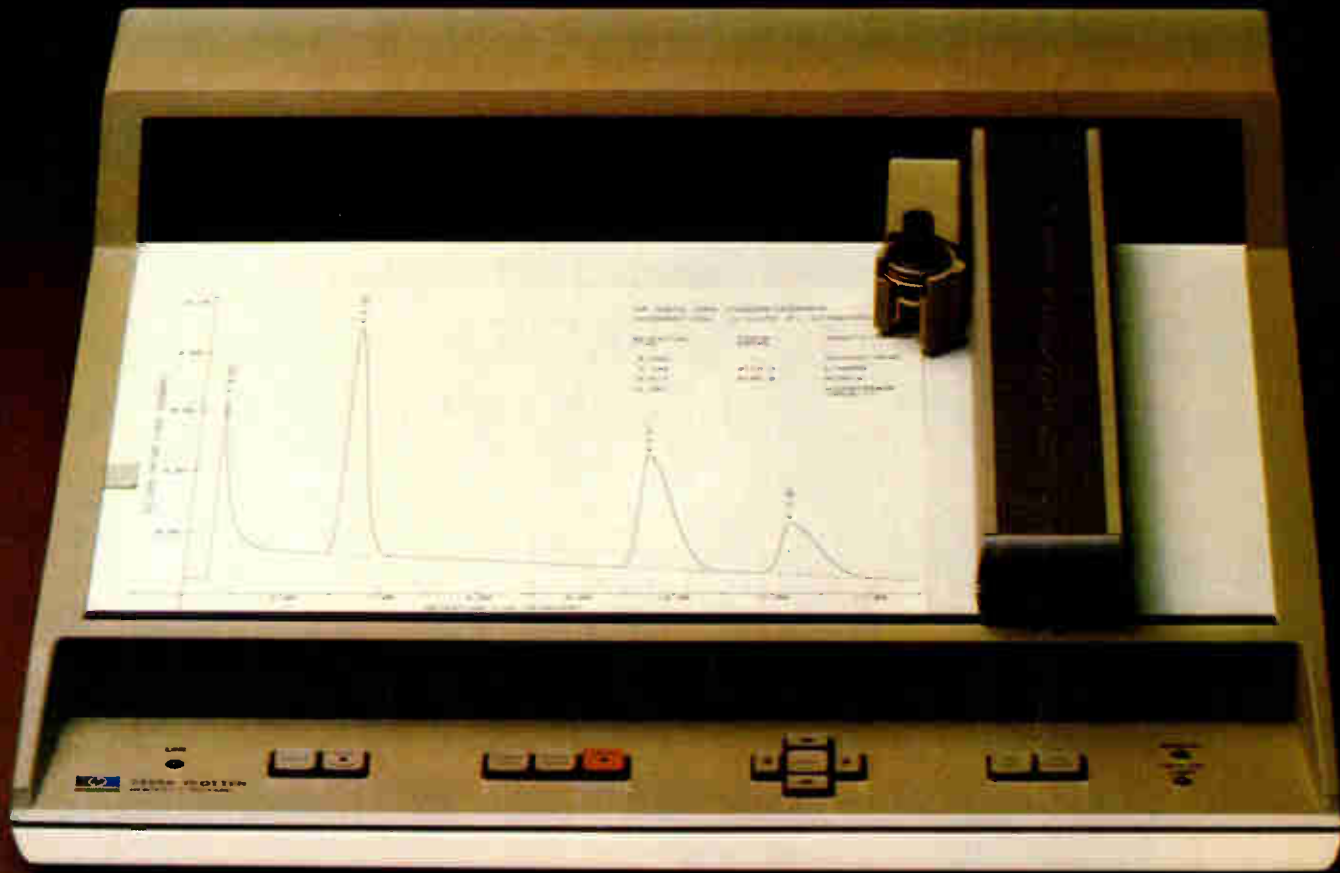

Now OEMs can draw high quality graphics even when the bottom line is price.

Graphics gives you the best way to analyze and communicate data. But cost has been keeping it out of the picture for many OEM systems. That's why Hewlett-Packard is offering the new Model 7225A Graphics Plotter.

The price: \$1750 (domestic USA price with 17602A general purpose "personality" module), in quantities of five. With further OEM discounts from there.



Plug-in "personality modules" customize the plotter for you.

HP's versatile 7225A converts the output of processor based systems into high quality charts and graphs in any size up to 8½ x 11" (A4). A wide selection of plug-in "personality modules" lets you adapt the plotter to suit your needs. Different modules determine interface hardware, language, and capabilities such as internal character sets, axis generation, labeling and scaling.

Simple linear stepping motors eliminate many moving parts to assure reliability. Visually smooth, high resolution ink lines of any length and angle are generated, requiring only end point data.

And you give your customers the confidence of Hewlett-Packard's worldwide service network.

So if you want high quality graphics but you draw the line at price, look into the Model 7225A Graphics Plotter. For a detailed 24-page OEM brochure, contact Hal Phillips at Hewlett-Packard, 16399 West Bernardo Drive, San Diego, CA 92127; (714) 487-4100.

11901

HEWLETT  PACKARD

1501 Page Mill Road, Palo Alto, California 94304

For assistance call: Washington (301) 948-6370, Chicago (312) 255-9800, Atlanta (404) 955-1500, Los Angeles (213) 877-1282

Circle 1 on reader service card

HP's spectrum of power measurements

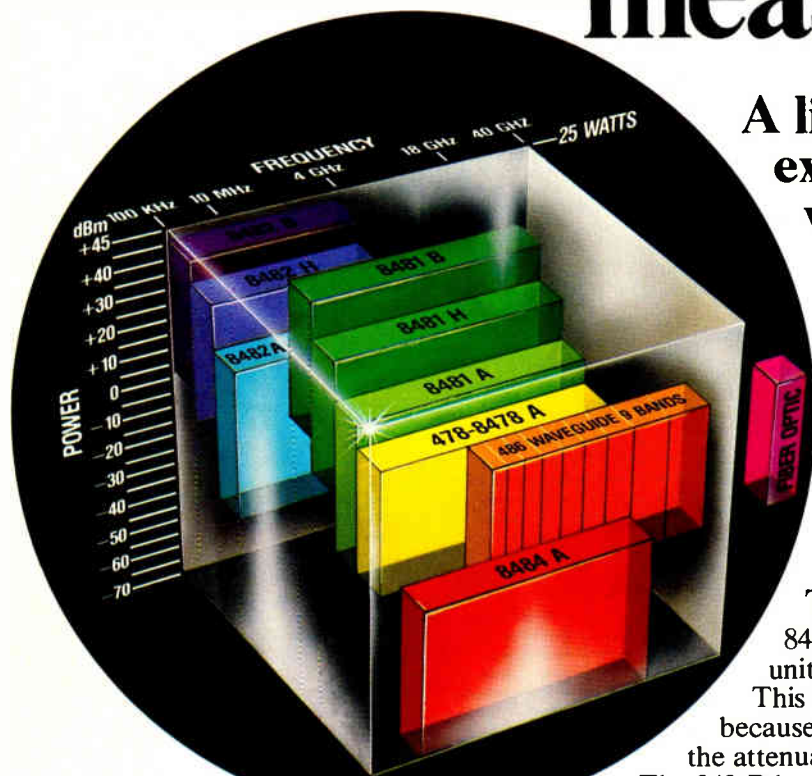

A line of power meters expands again with three new power sensors designed to meet your growing needs.

HP sensors now range from -70 dBm (100 pW) to $+44$ dBm (25 watts), and from 100 kHz to 40 GHz (plus fiber optics).

Two 25 watt sensors: In HP's new 8481B and 8482B Power Sensors the sensor unit is combined with the 25W attenuator. This sharply reduces measurement uncertainties because the attached calibration factor includes the attenuator.

The 8481B has a frequency range of 10 MHz to 18 GHz. The 8482B covers 100 kHz to 4.2 GHz. Use them with your present HP 435A and 436A Power Meters.

A fiber optic sensor: Plug the new 84801A Sensor into any HP432 Series Power Meter for accurate, reliable measurements. Range 600 to 1200 nm (calibration available from 500 to 2000 nm).

Get our latest data: Call your nearby HP office or write for our new power Application Note 64-2, "Extended Applications of Automatic Power Meters" as well as complete data on all our power meters.

432B Digital Meter
(432C programmable)

436A Digital Meter
(HP-IB programmable)



432A Analog Meter

435A Analog Meter

8484A

X486A

84801A

8481B

HEWLETT  PACKARD

1507 Page Mill Road, Palo Alto, California 94304

- 39 Electronics Review**
COMMUNICATIONS: Light-powered phone has no internal source, 39
PERIPHERALS: 8-inch disks begin to mushroom, 40
RADAR: Hughes processor has lots of programmability, 41
MEMORIES: Mostek to sell IBM add-ons, 42
SOLID STATE: C-MOS touch given microprocessors, op amps, 44
TRADE: China seeks technology from the West, 44
COMPANIES: Fairchild's situation attracts takeover, 46
SOFTWARE: TI offers executive routines in plug-in ROM, 48
NEWS BRIEFS: 50
AIR TRAFFIC CONTROL: Sanders to replace FAA's paper strips, 50
COMPUTERS: Barton receives architecture award, 52
- 63 Electronics International**
GREAT BRITAIN: Unit multiplies two 64-bit numbers in 284 ns, 67
WEST GERMANY: X-ray process shows blood rate on color TV, 68
FRANCE: Hypercube 'federates' eight microcomputers, 70
GREAT BRITAIN: One-board color TV chassis fits 14- to 20-in. sets, 72
- 81 Probing the News**
COMPUTERS: French firm is out to topple IBM, 81
SOFTWARE: TI attacks programming across broad front, 85
INVESTMENT: Venture capital booming again, 88
SOLID STATE: TI foresees continued domestic strength, 90
ABROAD: South Korea starts a Silicon Valley, 92
- 105 Technical Articles**
SPECIAL REPORT: Monolithic data-conversion approach bears fruit, 105
INSTRUMENTS: Bubble memories demand unique test methods, 117
DESIGNER'S CASEBOOK: V-I converter handles bilateral signals, 124
Cascaded C-MOS blocks form binary-to-BCD converters, 125
Bidirectional optoisolator puts two LEDs nose to nose, 127
SOLID STATE: EE-PROM acts as fast, nonvolatile RAM, 128
PACKAGING & PRODUCTION: ZIF connector ousts backplane, 133
ENGINEER'S NOTEBOOK: Notch filter, meter measure harmonics, 140
Resistor snipping trims regulator voltage to within 1%, 141
8080 program computes 32-by-16-bit quotient, 143
- 153 New Products**
IN THE SPOTLIGHT: A-d converter has 16-bit accuracy, 153
COMPONENTS: Contactless keyboard senses body capacitance, 156
MICROCOMPUTERS & SYSTEMS: DMA boards wait for LSI-11/23, 162
SEMICONDUCTORS: CRT controller avoids contention, 171
POWER SUPPLIES: Efficient power supplies like it hot, 181
PACKAGING & PRODUCTION: Crystal plater ups throughput, 196
- Departments**
Publisher's letter, 4
Readers' comments, 6
People, 14
Editorial, 24
Meetings, 26
Electronics newsletter, 33
Washington newsletter, 57
Washington commentary, 58
International newsletter, 63
Engineer's newsletter, 144
Products newsletter, 201
- Services**
Employment opportunities, 220
Reprints available, 234
Reader service card, 235

Highlights

Cover: Chip converters take big 12-bit bite, 105

Now reaching 12 bits of resolution in several solid-state technologies, single-chip data converters are eating into a traditionally hybrid market. But hybrid devices still have the edge in performance, says this special report.

Cover is by Art Director Fred Sklenar.

Will IBM stay No. 1 in France? 81

Not if CII-Honeywell Bull has its way. Next year, aided by the \$100 million and more it spends each year on research and development, it hopes to deliver more computers to French customers than any other company.

Bubble memories rate their own test system, 117

If the arrival of specially designed test instrumentation is proof of a technology's maturity, then bubble memories have definitely made the grade. A new tester thoroughly analyzes quarter-megabit devices in a matter of minutes.

ZIF connectors oust standard backplanes, 133

Zero-insertion-force connectors can be mounted on motherboards to create an excellent package for bus-structured microprocessor systems.

. . . and in the next issue

Special report on new computer architecture . . . preview of the National Computer Conference . . . introducing a new 16-K static RAM.

EDITOR-IN-CHIEF: Kemp Anderson

EXECUTIVE EDITOR: Samuel Weber

MANAGING EDITORS: Arthur Erikson,
Gerald M. Walker

ASSISTANT MANAGING EDITORS: Howard Wolff,
Alfred Rosenblatt

SENIOR EDITORS: William F. Arnold,
Ray Connolly

ART DIRECTOR: Fred Sklenar

DEPARTMENT EDITORS

Aerospace/Military: Ray Connolly
Circuit Design: Vincent Biancomano
Communications & Microwave:

Harvey J. Hindin

Components: Nicolas Mokhoff

Computers: Anthony Durniak

Consumer & Industrial: John Javetski

Instrumentation: Albert F. Shackil

Microsystems & Software: John G. Sosa

New Products: Michael J. Riezenman,

Richard W. Comerford

Packaging & Production: Jerry Lyman

Solid State: Raymond P. Capece

CHIEF COPY EDITOR: Margaret Eastman

COPY EDITORS: Mike Robinson,
Charlotte Wiggers, Jeremy Young

ART: Charles D. Ciatto, *Associate Director*
Paula Piazza, *Assistant Director*

EDITORIAL SECRETARIES: Janet Noto,
Penny Reitman, Maryann Tusa

EDITORIAL ASSISTANT: Marilyn B. Steinberg

REGIONAL EDITORS

New York: Benjamin A. Mason (212) 997-2245

Boston: James B. Brinton,

Pamela Hamilton (617) 262-1160

Chicago: Larry Marion (312) 751-3805

Dallas: Wesley R. Iversen (214) 742-1747

Los Angeles: Larry Waller (213) 487-1160

Palo Alto: William F. Arnold,

Robert Brownstein (415) 968-2712

Washington: Ray Connolly (202) 624-7592

Frankfurt: John Gosch 72-5566

London: Kevin Smith 493-1451

Paris: Arthur Erikson,

Kenneth Dreyfack 720-20-70

Tokyo: Charles Cohen 581-9816

McGRAW-HILL WORLD NEWS

Editor: Michael Johnson

Brussels: James Smith

Milan: Jeff Ryser

Moscow: Peter Hann

Stockholm: Robert Skole

Tokyo: Robert E. Lee

PUBLISHER: Paul W. Reiss

GENERAL MANAGER, DIRECT MARKETING
OPERATIONS: Horace T. Howland

CIRCULATION MANAGER: Herbert A. Hunter

RESEARCH MANAGER: Margery D. Sholes

READER SERVICE MANAGER:

Frances M. Vallone



In developing new technologies, talent may be more vital than size," comments Steve Bisset, president of tiny Megatest Corp. in Santa Clara, Calif. The test of this statement came when Megatest, started by two people in 1975 and now 85 to 90 strong, persuaded giant Rockwell International Corp. to give the go-ahead for the small firm to develop a general-purpose characterization system for the larger firm's upcoming bubble memory.

Megatest worked on the project on a crash basis for a year. Aided by close cooperation from Rockwell, it developed the bubble memory test system described on page 117 by Bisset and Rockwell coauthors Steve Bristow, technical staff engineer, and Tom Chen, manager of research engineering.

Was Rockwell nervous about assigning such an important project to a small company with no background in bubble memory testing? "They were concerned at the beginning, in the middle, and up to the end," Bisset admits. "But apparently they're satisfied—it works."

For its part, Rockwell considers the smooth interface between the companies a key factor in the success. Company size was not the main problem, according to Bristow. "Megatest was the most qualified of those interested in bubble memory testing at the time. It takes a small company to take the risk."

Besides making an important contribution to electronics technology, the bubble memory tester project added a new dimension to Megatest. The firm found its original niche in designing instruments for high-

volume production testing of large-scale integrated circuits. But in the bubble memory field, there is no high-volume production testing niche as yet. So the company took a new direction: general-purpose equipment for engineering characterization. Megatest sponsored the development entirely with its own capital, taking all the risks in order to retain all the rights.

The advanced software technology laboratory set up by the Texas Instruments equipment group in 1978 is an unusual example of the transfer of technology from military to civilian uses. The nucleus of the lab, headed by Roger Bate, was formed by a group that had worked on a TI contract with the Army Ballistic Missile Advanced Technology Center in Huntsville, Ala., from 1972 to 1977.

The unusual aspect of this military project was that the team turned from writing software to designing methods of writing software. In short, the result was a software methodology that is now being used internally by TI. And it's significant. As Dallas bureau manager Wes Iversen points out in the story on page 85, the corporate-wide goal is a 25% improvement in programmer productivity by 1985 using the techniques defined during the Huntsville project. It could add up to a \$379 million savings in that year alone.

May 10, 1979 Volume 52, Number 10

101,931 copies of this issue printed

Electronics (ISSN 0013-5070) Published every other Thursday by McGraw-Hill, Inc. Founder: James H. McGraw 1860-1948. Publication office 1221 Avenue of the Americas, N.Y., N.Y. 10020; second class postage paid at New York, N.Y., and additional mailing offices.

Executive, editorial, circulation and advertising addresses: Electronics, McGraw-Hill Building, 1221 Avenue of the Americas, New York, N.Y. 10020. Telephone (212) 997-1221. Teletype 12-7960 TWX 710-581-4879. Cable address: MCGRAW HILL NEW YORK.

Subscriptions limited to professional persons with active responsibility in electronics technology. No subscriptions accepted without complete identification of subscriber name, title or job function, company or organization, and product manufactured or services performed. Based on information supplied, the publisher reserves the right to reject non-qualified requests. Subscription rates: in the United States and possessions \$17 one year, \$29 two years, \$43 three years; company addressed and company libraries \$23 one year, \$41 two years, \$58 three years; APO/FPO addressed \$35 one year only; Canada and Mexico \$19 one year, \$32 two years, \$47 three years; Europe \$46 one year, \$78 two years, \$110 three years; Japan, Israel and Brazil \$70 one year, \$115 two years, \$165 three years; Australia and New Zealand \$95 one year, \$170 two years, \$240 three years, including air freight; all other countries \$50 one year, \$85 two years, \$125 three years. Limited quota of subscriptions available at higher-than-basic rate for persons allied to held served. Check with publisher for these rates. Single copies: \$4.00. Please allow four to eight weeks for shipment.

Officers of McGraw-Hill Publications Company: Gordon L. Jones, President; Group Vice-President: Daniel A. McMillan, Senior Vice-President; Russell F. Anderson; Ralph R. Schulz, Editorial; Vice-Pres-

idents: James E. Hackett, Controller; Thomas H. King, Manufacturing; Robert L. Leyburn, Circulation; John W. Patten, Sales; Edward E. Schirmer, International

Officers of the Corporation: Harold W. McGraw, Jr., President, Chief Executive Officer, and Chairman of the Board; Robert N. Landes, Senior Vice President and Secretary; Ralph J. Webb, Treasurer.

Title registered in U.S. Patent Office. Copyright © 1979 by McGraw-Hill, Inc. All rights reserved. The contents of this publication may not be reproduced in whole or in part without the consent of copyright owner.

Where necessary, permission is granted by the copyright owner for libraries and others registered with the Copyright Clearance Center (CCC) to photocopy any article herein for the base fee of \$0.50 per copy of the article plus \$0.25 per page. Payment should be sent directly to the CCC. Copying done for other than personal or internal reference use without the express permission of McGraw-Hill is prohibited. Requests for special permission or bulk orders should be addressed to the publisher. ISSN 0013-5070/79\$0.50+.25.

Subscribers: The publisher, upon written request to our New York office from any subscriber, agrees to refund that part of the subscription price applying to copies not yet mailed. Please send change-of-address notices of complaints to Fulfillment Manager; subscription orders to Circulation Manager, Electronics, at address below. Change-of-address notices should provide old as well as new address, including zip codes. Attach address label from recent issue. Allow one month for change to become effective. Subscriber Service: call (609) 448-8110, 9 a.m. to 4 p.m. EST.

Postmaster: Please send form 3579 to Fulfillment Manager, Electronics, P.O. Box 430, Hightstown, N.J. 08520.

think SMALL SMALL SMALL

If you think switching power supplies useful only above 300 Watts, we have some good news...switch-mode power supplies in the 30 to 300 Watt class.

SMALL SWITCHING POWER SUPPLIES from KEPCO/TDK

In the popular 5 Volt design, for example, you can choose models ranging from 6 to 60 Amperes. The littlest one is only 40.5 cubic inches, (1-3/8" x 5-1/8" x 5-3/4"). It weighs a mere 19-1/4 oz. You can get them in most voltages, ranging up to 28 Volts d-c output.

We also have some nice, small, triple-output models: 5 Volts, combined with $\pm 12V$, $\pm 15V$ etc., as well as single-output d-c to d-c converters.

When your design needs a small high efficiency switching power supply, look to KEPCO/TDK and **THINK SMALL.**

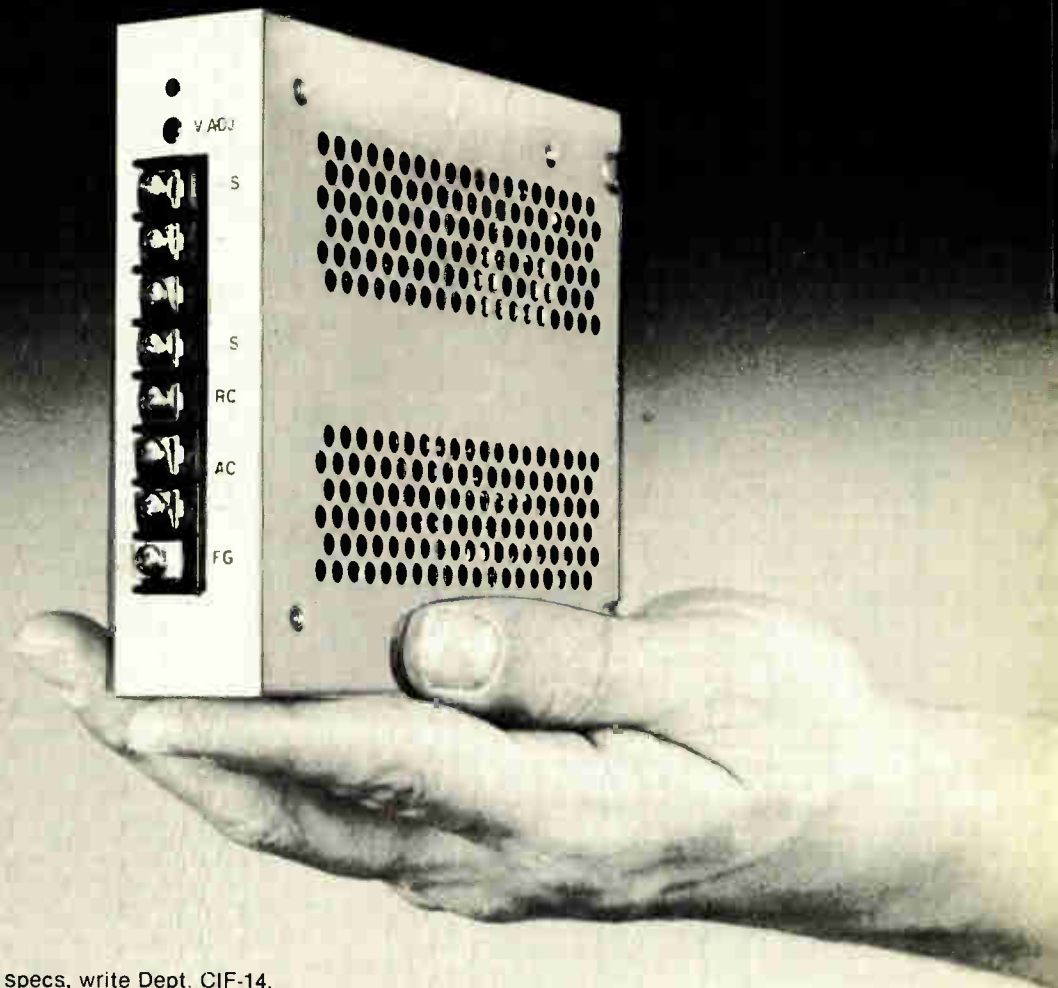

KEPCO® For complete specs, write Dept. CIF-14.

KEPCO, INC. • 131-38 SANFORD AVENUE • FLUSHING, N.Y. 11352 U.S.A. • (212) 461-7000 • TWX # 710-582-2631 • Cable: KEPCOPOWER NEWYORK

Circle 5 on reader service card

THERMISTORS

OBTAIN STATE-OF-THE-ART PERFORMANCE AT COSTS LOWER THAN YOUR PRESENT COMMERCIAL PRODUCT:

**BEADS
PROBES
FLAKES
RODS
ASSEMBLIES**

FAST RESPONSE ASSEMBLIES (TO 3ms)

HI-TEMP UNITS (TO 450°C)

SPECIAL CURVE MATCHES

0.05% TOLS. AND INTER-CHANGEABILITY

PRECISION CALIBRATIONS

DESIGNED TO MEET MIL-T-23648

QUICK REACTION TO SPECIAL APPLICATIONS AND ASSEMBLIES!

THERMOMETRICS INC.
808 U.S. HIGHWAY #1
Edison, N.J. 08817
(201) 287-2870

Readers' comments

Leave well enough alone

To the Editor: Though I agree in general with the ideas expressed in Pat Caudill's "Using assembly coding to optimize high-level language programs" in the Feb. 1 issue [p. 121], I should like to point out a few problems.

To support his contention that certain simple loops and data manipulations should be coded in assembly language, the author shows three examples of optimizing with assembly code. All three contain errors such that none will work. In just 22 lines of code there are four errors. I think an error every six lines is rather excessive, but this does indicate one of the normally hidden costs of assembly language.

The errors in Fig. 1 are: JR NC,LP1 should read JR C,LP1. Also the logic used is not the same as in the Fortran original—128 loops \times 1 input, instead of 64 loops \times 2 inputs. This difference could be important if reading the status port cleared the ready flag.

In Fig. 2, line 18 should read MOV M,C ; STORE LOW BYTE. In Fig. 3, line 6 should read LD A,(BVALUE).

In contrast, the high-level language equivalents are all error-free. In rewriting these routines the total memory saved was 90 bytes—about \$1 in 2708. Correcting each of those four errors will take at least, say, half an hour. Is it worth it? Frankly it is unlikely unless large quantities are being made or unless, as in the first example, a high-level language routine is not fast enough to keep up with hardware.

As memory prices continue to plummet, it becomes less and less attractive to optimize high-level language programs with assembly language, with the exceptions noted.

Chris Lusby Taylor
Brussels, Belgium

■ **The author replies:** *Perhaps I should have pointed out more strongly that "if it ain't broke, don't fix it." These techniques should be used when the product is out of spec and needs to be brought into line. Usually this is because of a need to increase execution speed rather than to decrease memory requirements.*

Examining the examples, I found

DRIVING AN ULTRASONIC TRANSDUCER?

The ENI Model 1040L Power Amplifier was designed as the ultimate wideband power source for ultrasonic applications. Capable of producing more than 400 watts of continuous output into any ultrasonic transducer, the Model 1040L covers the frequency range of 10kHz to 1MHz without tuning.



Its exclusive true reading power meter, make matching and ultrasonic system calibration easy and accurate. With fail-safe reliability, unconditional stability, 100% solid state componentry and extremely rugged construction the 1040L is the best ultrasonic power source you can buy.

For detailed information or a no obligation demonstration contact:

Electronic Navigation Industries, Inc.
3000 Winton Road South
Rochester, New York 14623
Tel. (716) 473-6900
Telex 97-8283 ENI ROC

ENI

The World's Leader
in Power Amplifiers

MICRO SWITCH DEFIES INFLATION.

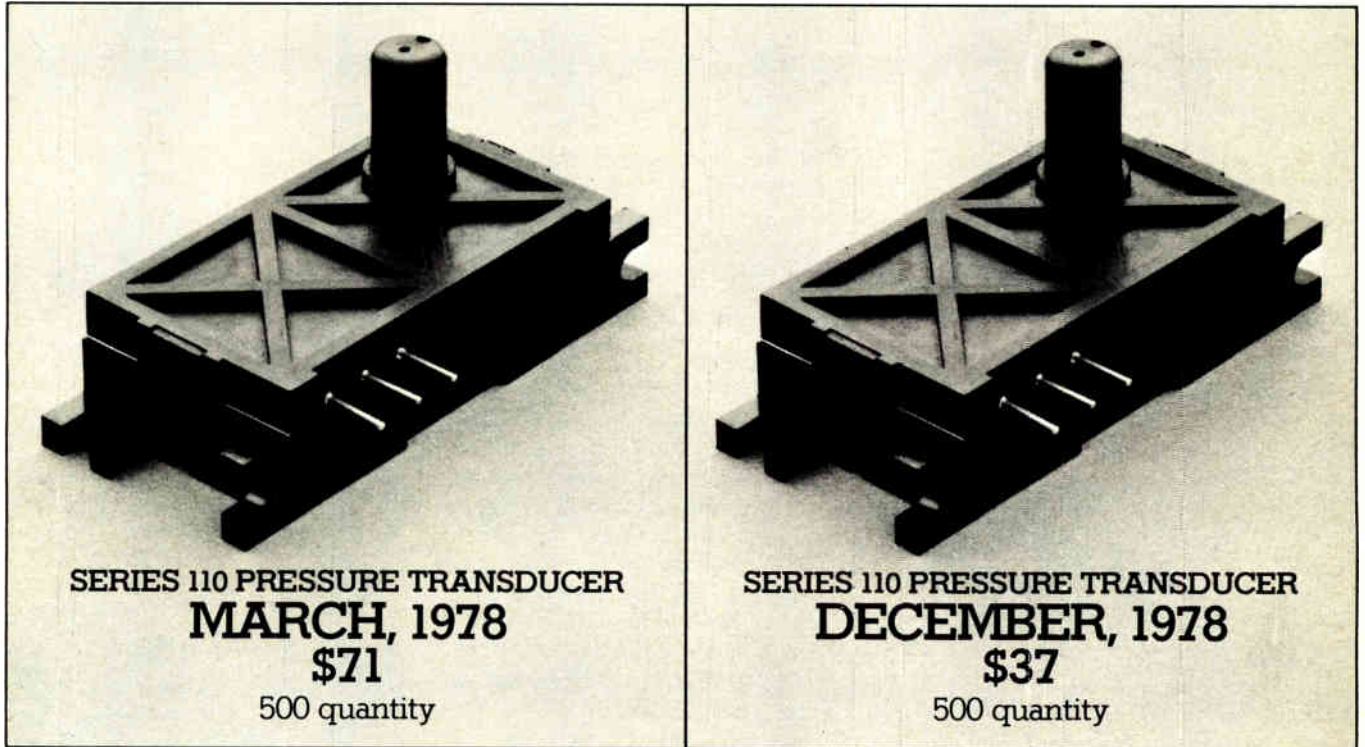

These days, it seems like everywhere you look, prices are going up.

Not so with MICRO SWITCH pressure transducers.

We've just reduced the price of our Series 110 PC pressure transducers by 48%.

And the Series 110 PC is the industry's finest example of solid state technology. Each amplified Series 110 PC is temperature compensated to provide an accuracy of $\pm 1\%$ over a 140° Fahrenheit range. With pressure ranges from 0-30 psi. Fast response. Consistent output. And a small rugged package.

Why the big price reduction? Simply because we found a better way to build a good product, for less. And that's what fighting inflation is all about.

To take advantage of this uninflated price, or for more product information, call 815-235-6600.

MICRO SWITCH

FREEPORT, ILLINOIS 61032
A DIVISION OF HONEYWELL

New possibilities for your Printed Circuit Board

WIMA Miniature Capacitors

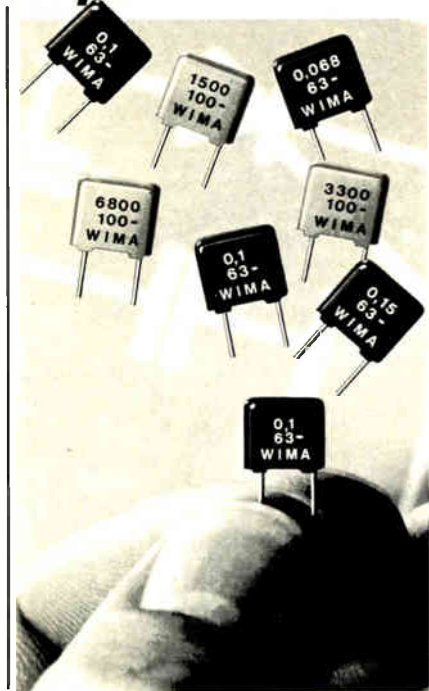

WIMA MKS 2 with a PCM of 5 mm

The new miniatures from WIMA help you to save space on your Printed Circuit Boards and can be utilised everywhere. They are the smallest plastic cased, metallised polyester Capacitors available.

Capacitance values 0.01 — 0.47 μ F (1 μ F with 7.5 mm PCM.)

WIMA FKS 2 from 1000 pF.

All capacitors are resistant to moisture.

Please ask for our special catalogue.



WILH. WESTERMANN

Spezialvertrieb elektron. Bauelemente
P. O. Box 2345 · D-6800 Mannheim 1
Fed. Rep. of Germany

U.S. Sales Offices:
BOSL & ROUNDY · 3333, Delray Drive
Ft. Wayne · Indiana 46815
(219) 483-3378

THE INTER-TECHNICAL GROUP INC.
North Dearman Street · P. O. Box 23
Irvington · New York 10533
(914) 591-8822

TAW ELECTRONICS CO.
4215 W. Burbank Blvd., Burbank
California 91505 · (213) 846-3911

8 Circle 8 on reader service card

Readers' comments

two mistakes in the assembly language versions in Figs. 1 and 2. In Fig. 1, it is the Fortran program that is incorrect. The conditional statement in line 10 should be:

10 IF (IMP(8) .AND 1) .EQ.0) GO TO 10

This routine was subjected to one level of loop unwinding to lower the loop overhead. Its actual time per byte is only 43.63 microseconds. This loop unwinding is also required on a 2-megahertz 8080 assembly language routine.

I would like to thank Mr. Taylor for pointing out the other mistakes.

Switch the track

To the Editor: D. C. Mitchell's program in "HP-67/97 tracks communications satellites" [March 1, p. 146] contains a fault. Using the inputs of his example, the program generates elevation (E) and straight-line distance (d) numbers that differ from those in the Oscar 7 tracking-data table. Either Mr. Mitchell used different coordinates than those stated for Milan, Mich., or there is a bug. Also, the STO C instruction in line 008 is not necessary.

Aside from these comments, I'd like to thank Mr. Mitchell for sharing a really useful program. I can recall several occasions when I tried in vain to calculate series of azimuths and elevations for real-time manual tracking of communications satellites (especially non-synchronous ones!). The old HP-35 just wasn't up to the task. How I wish I had had my HP-67 and Mr. Mitchell's program then.

Robert G. Savage
Aiea, Hawaii

■ The longitude and latitude of Milan were inadvertently switched in the text. Exchanging these two values in the appropriate program registers should yield values in substantial agreement with the figures that were given in the table. — ED.

Correction

A typographical error in the Electro79 preview drastically lowered the \$3,300 price of Rockland Systems Corp.'s new model 751A Brickwall bandpass filter [April 12, p. 182].

COMPUTER AIDED DRAFTING—ADVANCED STATE OF THE ART

Between \$18,000 to \$45,000

Simply input ideas with Joystick or Graphic tablet



Computer does work, you do the thinking



Instant Recall: Add or delete entire blocks of drawings with one command



Plotter gives camera ready art in minutes

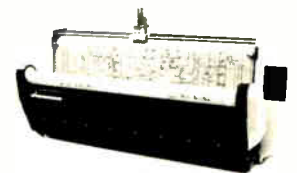

Only at I Corporation
Order yours today!

- * PC Layout
- * Schematic
- * Mechanical
- * Hybrid

(415) 848-6600

I Corporation

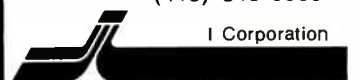

835 Addison Street
Berkeley, CA 94710

Circle 16 on reader service card



Presents the NEW digital 11/03-L Systems



FLOPPY 11V03-L



VT100



HARD DISK 11T03-L

Standard 11/03-L systems are available as 1 Megabyte Double Density Floppy Disk based or

10 Megabyte Hard Disk Cartridge based RT-11® systems.

These systems are available with choice of LA36, VT52 or VT100 as consoles.

Order Number	11V03-L			11T03-L		
	SRVXSSA		SRVXSSB	SRVXLLA		SRVXLLB
Backplane	KD11-H CPU		KD11-HA CPU	KD11-H CPU		KD11-HA CPU
	MSV11-CD, 16KW Memory		MSV11-DD 32KW Memory	MSV11-CD 16 KW Memory		MSV11-DD 32KW Memory
	Floppy Interface		Floppy Interface	MSV11-CD 16KW Memory		RL01 Controller
	DLV11-F Serial		DLV11-J Serial (4)	RL01 Controller		RL01 Controller
	BDV11 Bootstrap		BDV11 Bootstrap		RL01 Controller	
	Open		Open		DLV11-F Serial	BDV11 Bootstrap
	Open		Open		BDV11 Bootstrap	
	Open		Open		Open	
	Open		Open		Open	
Price	\$9,475.00		\$10,325.00	\$16,265.00		\$17,075.00
Delivery	30 Days		60-90 Days	30 Days		60-90 Days
Installation And 90 Day On-site Warranty	Included		Included	Included		Included
Operating System	By Digital Equipment Corporation RT-11® V3B Plus Enhancements					
MOS Memory	16KW		32KW	32KW		32KW
Mass Media Storage	Dual RX02 Double Density Floppy		Dual RX02 Double Density Floppy	Dual RL01 5 Megabyte Cartridge Disk		



TWX NUMBER 910-651-1916

computer corporation

corporate square / 825 north cass avenue / westmont, illinois 60559 / (312) 920-1050

* Registered trademark of Digital Equipment Corporation, Maynard, Mass.

** Registered trademark of First Computer Corporation

NEW FROM INTERSIL: .01% LINEARITY IN A 12-BIT

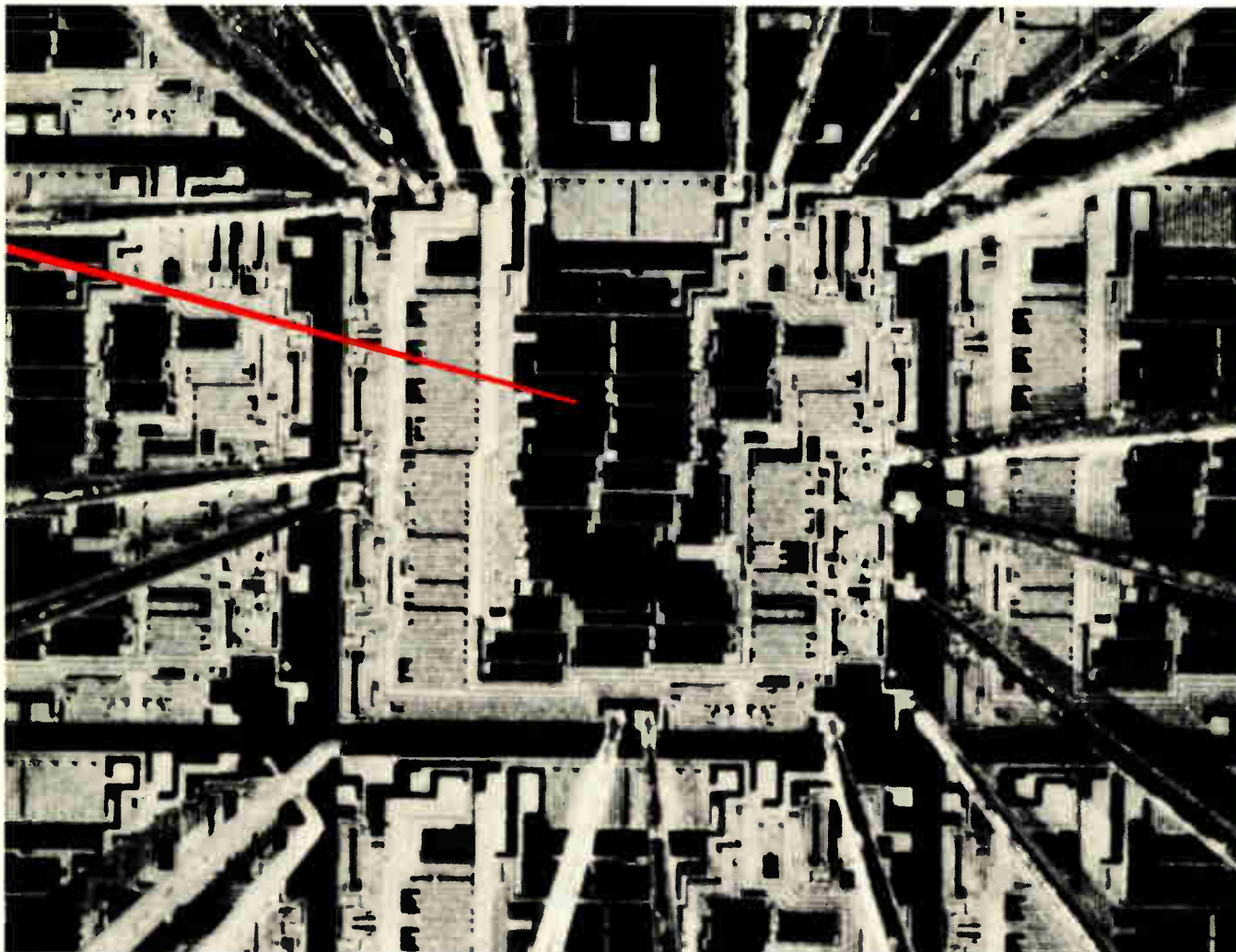

Active Laser Trimming at the Wafer Level

.01% LINEARITY

Intersil's XDAC, the ICL7112, combines active laser trimming, absolute positioning, and state-of-the-art thin film resistor technology to give you .01% linearity in a 12-bit four-quadrant multiplying DAC: The XDAC. It's ideal for applications such as: CRT graphics generators; "Fly-by-wire" control systems; Synchro-to-digital converters; High accuracy low power A/D converters; Digitally programmable gain or attenuator systems; Digitally controlled power supplies. You name it.

ACTIVE LASER TRIMMING

Other people laser trim. So do we. But, we take

laser trimming out of the laboratory into high volume production.

ABSOLUTE POSITIONING

Intersil's computer controlled positioning system directs the laser. Precisely. Quickly. Automatically. That means we trim each device in exactly the same location. Every time. Result: Dependability. Repeatability. Volume.

"TRIM-TAB" RESISTOR TECHNOLOGY

Other people directly trim the "ladder" resistors. We trim special, low tempco "trimmer" resistors. On critical resistors like the MSB, we trim a separate "trim-tab" resistor in parallel with a small

THE XDAC.

MULTIPLYING DAC: \$12.00*

portion of the main resistor body. Result: A great improvement in the tempco, aging and reliability characteristics by maintaining constant current density in the main resistor. It works like this:

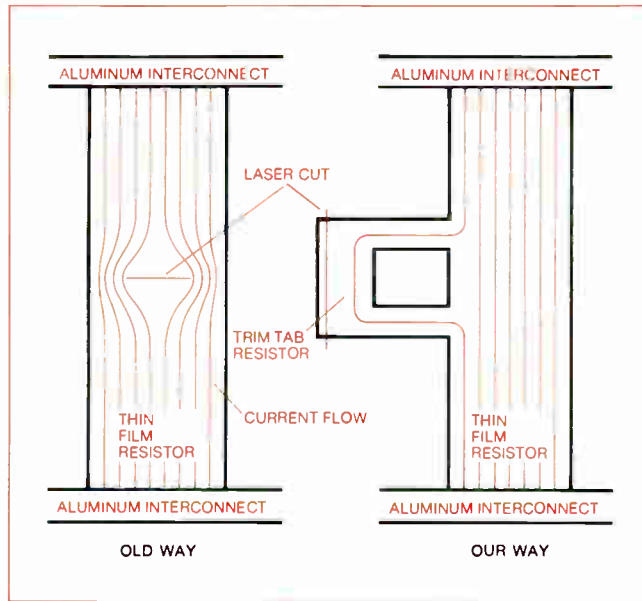

AND MORE...

Output protection. To prevent CMOS latch-up conditions and eliminate the need for external Schottky clamp diodes at the output terminals, Intersil places an extra isolating PN junction between components. Result: Built-in protection.

Compensating feedback switch. The XDAC includes a normally closed CMOS switch in series with the feedback resistor to compensate for similar switches in the R-2R ladder. Result: Improved gain matching, temperature tracking (tempco) and power supply rejection.

HERE ARE THE RESULTS:

- Resolution: 12-bit binary
- Linearity: 0.01% guaranteed
- Full four-quadrant multiplying operation
- Gain tempco: 5ppm/°C (Max)
- Monotonicity: Guaranteed (ICL7112L)
- Settling time: 1μsec to 0.01%
- CMOS/TTL/DTL compatible
- Single supply operation: +5 to +15V
- 3 digit BCD model available (ICL7113)
- Pin-for-pin compatibility with the AD7541

Linearity	Coding	Part No.	100 pc	1000 pc
0.02%	Binary	ICL7112JPN	\$16.50	\$11.00
0.01%	Binary	ICL7112KPN	\$18.00	\$12.00
0.01% Guar.				
Monotonic	Binary	ICL7112LPN	\$27.00	\$18.00
0.2%	BCD	ICL7113JPN	\$11.25	\$ 7.50
0.1%	BCD	ICL7113KPN	\$13.50	\$ 9.00
0.05%	BCD	ICL7113LPN	\$17.25	\$11.50

Prices are for 0/70° operating range in plastic DIP. Military temperature range available, including 883B processing.

WE'RE IN LEAGUE WITH THE FUTURE

The ICL7112 combines laser trimming, absolute positioning, "trim-tab" technology, output protection and compensating feedback switch in a CMOS four-quadrant multiplying DAC: The XDAC. Add up the advantages. Draw your own conclusions. Then, call your Intersil Sales Office, Franchised Distributor, or, return the coupon below.

INTERMIL SALES OFFICES:

CALIFORNIA: Sunnyvale (408) 744-0618, Long Beach (213) 436-9261 • COLORADO: Aurora (303) 750-7004
 • FLORIDA: Fort Lauderdale (305) 772-4122 • ILLINOIS: Hinsdale (312) 986-5303 • MASSACHUSETTS: Lexington (617) 861-6220 • MINNESOTA: Minneapolis (612) 925-1844
 • NEW JERSEY: Englewood Cliffs (201) 567-5585 • OHIO: Dayton (513) 866-7328 • TEXAS: Dallas (214) 387-0539
 • CANADA: Brampton, Ontario (416) 457-1014

INTERMIL FRANCHISED DISTRIBUTORS:

Advent/Indiana • Alliance Electronic • Arrow Electronics • Bell Industries/Century Electronic Division • CESCO • Component Specialties Inc. • Components Plus • Diplomat Electronics Inc., (FLA) • Diplomat Electronics Inc., (NJ) • Harvey Federal Electronics • Intermark Electronics • Kierulff Electronics • LCOMP • Parrott Electronics • R.A.E. Ind. Elect. Ltd. • RESCO/Raleigh • Schweber Electronics • Sheridan Associates • Summit Distributors Inc. • Wyle Distribution Group • Zentronics Ltd.

*1000 pc. price

INTERMIL

E51079

10710 No. Tantau Ave., Cupertino, CA 95014
 Tel: (408) 996-5000 TWX: 910-338-0228
 (800) 538-7930 (outside California)

Gentlemen:
 XDAC?
 Send me your Literature.
 Please send me your Ibsen poster.

Name _____
 Company _____
 Address _____
 City _____ State _____ Zip _____
 Country _____

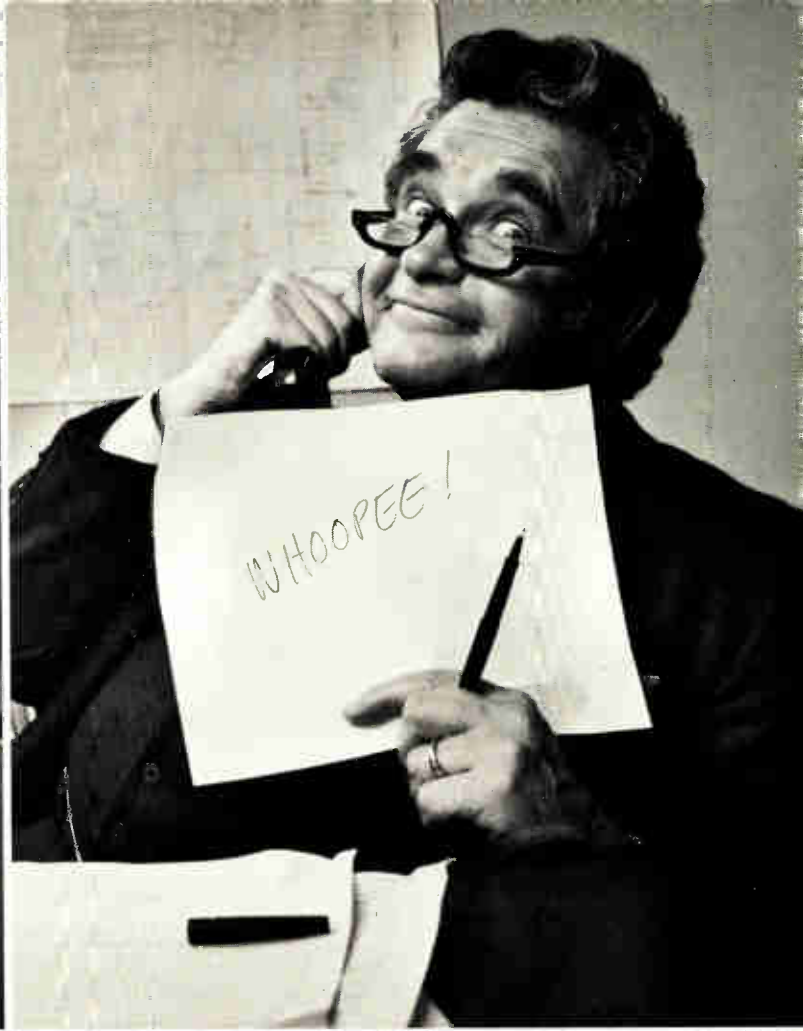

OUR CUSTOMERS' REACTION TO THE NEW NOVA 4 DIDN'T SURPRISE US.

After the success we've had with the Data General NOVA computer line (in the 10 years since its introduction, over 60,000 have been shipped), who could blame them? But what really counts is your reaction to our latest NOVA—NOVA 4.

The new NOVA 4 gives you three ways to sell. It's the one computer system that's really a family of three. It's the one computer that will give you so wide a range of capability and options it will meet the price and capability needs of all your customers.

NOVA 4/C. The component OEM's dream.

The speed and performance you get in the NOVA 4/C, for \$3500* (complete), is the best deal ever offered a customer needing a basic computer to integrate in his terminals, test instruments or business applications. And it includes a unique self-diagnostic capability that lets the computer trouble-shoot itself to cut service time and cost.

NOVA 4/S. An important part of your process.

Whatever data your customers process now—from blood analysis to pipeline flow—the new NOVA 4/S can cut processing time in half. Outstanding processing throughput comes from its new high speed floating point and character manipulation capabilities. Plus, it includes NOVA 4 self-diagnostic features.

NOVA 4/X. The business end of the line.

For the business computer customer, or the technical one, the 4/X will do the job. All the capabilities of the 4/S with memory up to 256K bytes, with self-diagnostic capability.

NOVA 4. The multi-customer mini.

4/C, 4/S, 4/X—all three are fully compatible with the NOVA 3 computers now in use. And there's one that's right for your customer's application.

And they match the 10 year NOVA tradition of increasingly high performance (NOVA 4 achieves up to twice the speed of competitive systems as well as the NOVA 3), newsworthy price (lower than competitive units; 43% lower than NOVA 3) and reliability and maintainability features unheard of in competitive systems.

The all new NOVA 4. It's the brand new computer with 10 years of proven performance that will leave your customers smiling. Mail the coupon for full information.



*NOVA 4/C with 64K bytes of MOS Memory, asynchronous interface, automatic program load, power fail/auto restart, and 5-slot chassis with power supply. Domestic U.S. price, quantity one. OEM and quantity discounts available.

Mail to: Data General Corporation
Westboro, MA 01581

Send me full information on the NOVA 4.

Name _____

Title _____

Company _____

Address _____ Tel. _____

City _____ State _____ Zip _____

E510

 **Data General**
We make computers that make sense.

Data General Corporation, Westboro, MA 01581. (617) 366-8911. Data General (Canada) Ltd., Ontario, Canada. Data General Europe, 61 rue de Courcelles, Paris, France, 766.51.78. Data General Australia, (03) 89-0633. Data General Ltda., Costa Rica, Latin America, 22-79-42. Data General Middle East, Athens, Greece, 952-0557. (c) Data General Corporation, 1979.

Circle 13 on reader service card

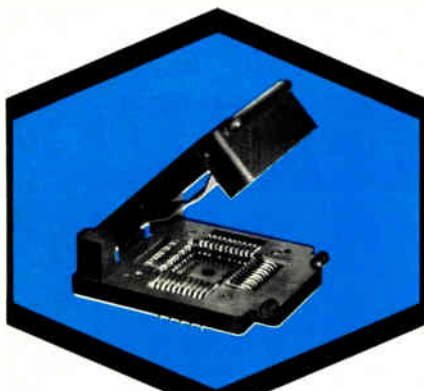

NEW JEDEC Standard "Chip Carrier" Test Sockets

VERSATILE TEXTOOL SERIES
ACCEPTS ALL JEDEC STANDARD
CHIP CARRIERS

This versatile new TEXTOOL "chip carrier" test socket series includes off-the-shelf models to accept all JEDEC Standard carriers with from 16 to 84 leads and body sizes up to and including 1.250" square on .050" centers.

In addition, only minor tooling changes allow the socket also to accept JEDEC Standard .040" center packages or virtually any other non-standard chip carrier.

A positive locking system enables loading and unloading literally with the fingers.



A new lid design allows the same socket to accept packages ranging from .050 to .100" thick, interchangeably.

Other significant features of TEX-

TOOL'S new "chip carrier" sockets include a lid design that eliminates shorting against contacts or P.C. board and which will not separate from the socket body under normal usage, integral mounting holes and minimum lid overhang at the back of the socket to permit maximum P.C. board mounting density.

All TEXTOOL "chip carrier" sockets are ideally suited for both test and burn-in applications and are available in a wide variety of materials to meet specific test requirements.

Detailed information on these and other products in a wide choice of materials from TEXTOOL . . . IC, MSI and LSI sockets and carriers, power semiconductor test sockets, and custom versions . . . is available from your nearest TEXTOOL sales representative or the factory direct.



PRODUCTS, INC.

1410 W. Pioneer Drive • Irving, Texas 75061
214/259-2676

People

New Bell Labs president sees LSI, software causing changes

"Exciting times in an era of the rapid introduction of new technology" is the prediction of Bell Telephone Laboratories' new president, Ian M. Ross. He expects a burst of new growth in the research and development efforts of the world's largest industrial laboratory.

In particular, he foresees the addition of many new features to the telephone communications system once digital technology and stored program control spread beyond the exchange level down to the private branch exchange and farther.

In telephone equipment, the major technological thrust has been the development of large-scale integration and software to implement the stored program control that will provide more flexible and varied services, Ross says. When it started some years ago with the No. 1 electronic switching network, it was economical only in big systems. Now, he says, "we can afford it for the small switches and private branch exchanges—we even have microprocessors in telephone terminal equipment."

One catch. Still, there is a catch: software, so important to stored program control, cannot be patented. "We are very interested in protecting our proprietary interests in software," says Ross, who was trained as an electrical engineer. He would prefer to see patents in software, noting that it is not Government policy at present.

In addition, as more Bell people work with software, there is another catch: the number of patent applications goes down. Since some people measure productivity by that figure, it seems as though Bell scientists are not inventing as much as before. This is not unique to Bell, Ross notes. It also applies to the country's overall research and development effort, which has a larger software content than ever.

Ross, 51, has been with the laboratory since 1952 and was executive vice president before being named to



Software boom. Ian M. Ross looks for software inventions to multiply at Bell Labs.

his new post. In observing still another way in which Government policies have an impact on Bell's operations, he looks upon the "unlikely" divestiture of Western Electric "with alarm" because, among other things, the free flow of information between the labs and Western's very practical inputs to Bell scientists on the potential cost of a product would be jeopardized.

Noting that the laboratories' budget this year for its 18,200 employees is in the neighborhood of \$1 billion (up a thousand employees and \$100 million from the year before), Ross feels that "our owners are giving us very good encouragement to do our work." He hopes the Federal government "won't do anything to impede that support."

Motorola's Katzir to focus on the auto aftermarket

When Levy Katzir was vice president of Motorola Inc.'s multinational operations in 1977, its Italian car radio and television manufacturing division was losing lots of money. Within two years, though, the 14% market share for car radios was increased to 30% by "paying more attention to the customer," he says. New products, such as pull-out radios to foil thieves, were matched to customer interest, and decentralized distribution introduced.

Now Katzir, 47, is the new gener-

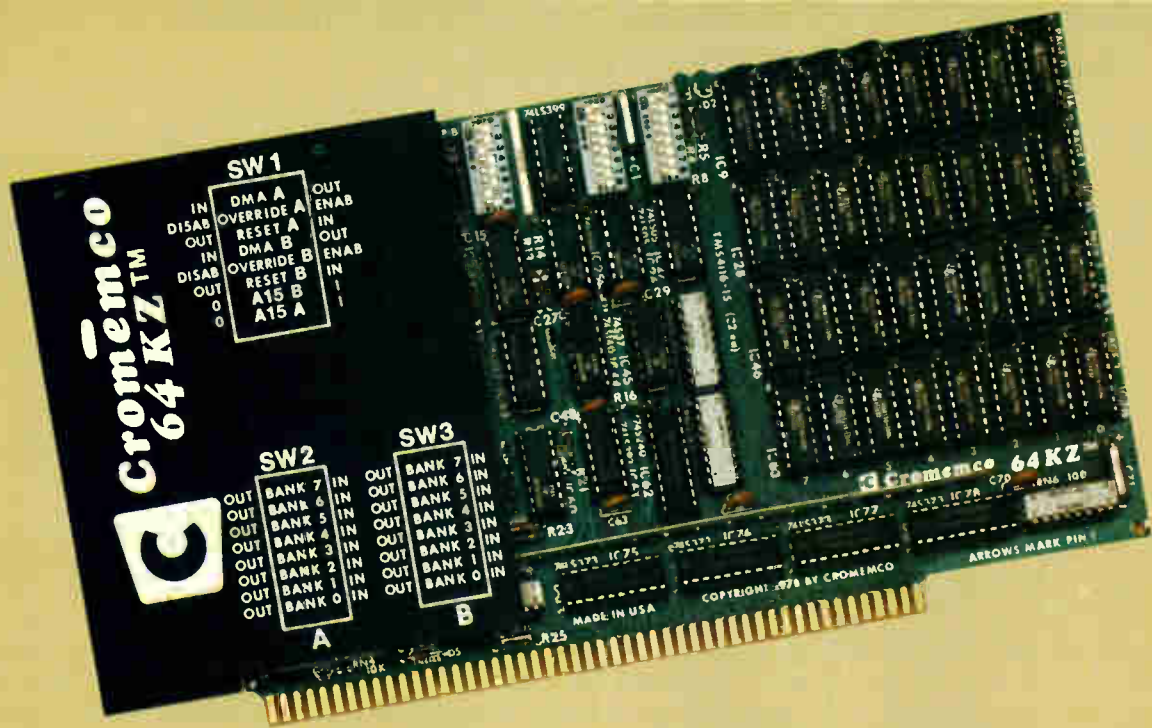

You can do surprising things when you have 64 kilobytes of fast RAM on one card

4 MHz FAST—AND EXPANDABLE

Here's 64 kilobytes of memory on one RAM card. Yes, we mean 512K bits of read/write memory on this single card.

And, yes, we mean it's fast. With 150-nanosecond chip access times — so the card can operate in fast Z-80 systems with no wait states. Repeat, no wait states.

EXPANDABLE ON TWO LEVELS

Not only does the new Model 64KZ give you a large, fast RAM but it is expandable on two levels.

First, through our Cromemco Bank Select feature, you can expand to 512 kilobytes in eight 64K banks.

Or, with our Extended Bank Select feature, you can expand memory space to as much as 16 megabytes.

This expandability we call your obsolescence insurance.

The legend on the card's heat sink is an easy reference for address and bank selection.

BENCHMARK IT

Obviously, the speed and memory capacity of this new card give you a lot of power.

You can see that for yourself in our new 7-station Multi-User Computer System which uses these Model 64KZ cards. This S100-bus system outperforms the speed of many if not most timesharing systems of up to 10 times the Cromemco price.

And yet where some of these much more expensive and cumbersome systems clearly slow to a snail's pace when timesharing, the Cromemco system using Bank Select switching runs surprisingly fast.

SEE IT NOW

See the new Model 64KZ at your computer dealer now. Study the literature on it. See how for only \$1785 you can get around that ever-present barrier of memory that's too little and too slow.



For high reliability all Cromemco memory cards are burned in at the factory in these temperature-controlled ovens.



Cromemco Multi-User System shown with 7 stations



Cromemco
i n c o r p o r a t e d

280 BERNARDO AVE., MOUNTAIN VIEW, CA 94040 • (415) 964-7400
Tomorrow's computers now

You can have our Type 105 metallized polyester capacitors taped and reeled, in special values or tolerances, with higher voltage ratings or special leads — or standard, off the shelf.



We're nothing if not accommodating.

Our Type 105 metallized polyester capacitors are inexpensive and very very good. Little tubular jobs with axial tinned copperweld or tinned copper leads. In standard values from 0.01 to 10 mfd $\pm 20\%$, 10%, 5%. WVDC 100, 250, 400, 630. Self-healing, extended foil construction, non-inductive. Etc.

Our Type 105 manufacturing process is so flexible that "specials" are easily produced to your specs without either long delivery or breathtaking prices.

Standard Type 105 capacitors are at least as good as the very best on the market (we secretly think they're a little better) and "specials" are normally no problem at all.

Need a quote? We'd be delighted. Samples? Please ask.

SEACOR INC., 123 Woodland Ave., Westwood, N.J. 07675
Tel. (201) 666-5600 ■ Telex 135354

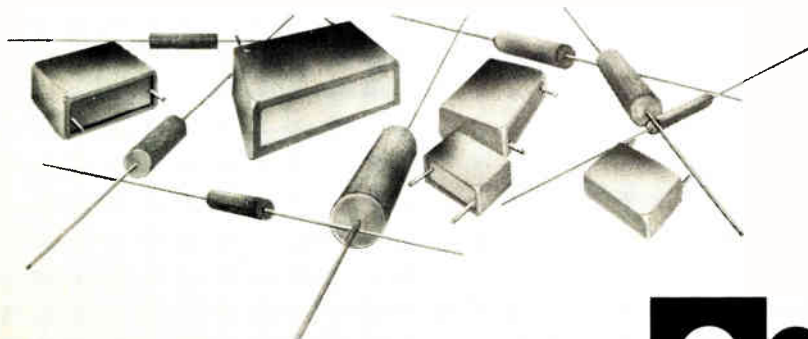

Everything in Film Capacitors

Circle 16 on reader service card



People

al manager of Motorola's Automotive Products division and the same increased attention to the customer is behind its reorganization. Operating losses at its Angers, France, automotive alternator and electronic ignition plant and at its British and its U. S. car radio businesses dragged the division's 1978 earnings down to \$9.5 million on sales of \$202 million.

The reorganization, Katzir says, gives greater power to product-line managers developing items like auto radios and electronic controls, as well as diagnostic systems for the microprocessor-based controls. They will be able to respond more quickly to what the market seems to want either by increasing production in key areas or by introducing new products and have therefore been given responsibility for distribution and sales departments, as well as for manufacturing. Katzir's structuring went into effect in late March and has already resulted in the departure of several executives.

New concentration. But perhaps the biggest change is Katzir's new direction for the division: it will concentrate on the automotive after-market. This is a break with almost 50 years of tradition for Motorola, which was built selling radios to Detroit auto makers and their dealers. But sales to original-equipment manufacturers like Ford Motor Co., are shrinking to "insignificant levels," says Katzir. That's why he is resorting to what is, for Motorola, "unconventional" strategy: emphasizing the consumer, not the OEM.

Born in Antwerp, Belgium, he grew up in Israel where he lived for 37 years. Not a holder of a college degree, he gained his knowledge of communications and electronics in Israeli army schools and at the British Institute of Engineering.

He started his own company and, under license, manufactured Motorola's two-way communications gear in Israel beginning in 1955. Motorola bought his business in 1964 and made him its managing director. Katzir remained there until called in 1971 to Motorola's Chicago headquarters to run its foreign operations. □

Maglatch TO-5: The little relay that never forgets



That's literally true. Once set with a short pulse of coil voltage, Teledyne's magnetic latching TO-5 relay will retain its state until reset or reprogrammed – even if power fails completely. And because it never forgets its last instruction, holding power is not required.

This inherent power conservation makes the Maglatch TO-5 ideal for any application where power drain is critical. In addition, its subminiature size fits it perfectly to high density pc board packaging. And for RF switching applications, the low inter-contact capacitance and contact circuit losses provide high isolation and low insertion loss up through UHF.

The Maglatch TO-5 is available in SPDT, DPDT and 4PST versions, and includes commercial/industrial types as well as military types qualified to "L," "M" and "P" levels of MIL-R-39016.

If you need more information about the little relay with the non-destructible memory, call or write today.

 **TELEDYNE RELAYS**

12525 Daphne Avenue, Hawthorne, California 90250 • (213) 777-0077

U.K. Sales Office: Heathrow House, Bath Rd. MX, TW5 9QQ • 01-897-2501

European Hqtrs.: Abraham Lincoln Strasse 38-42 • 62 Wiesbaden, W. Germany • 6121-700811



In Semiconductor Lasers

... for Counsel, Service and Delivery that will make your Design Idea a Reality!

MASS PRODUCTION

General Optronics has total mass production capability — domestically, not offshore, so any size order large or small is delivered on time. Ask us about quantity prices.

PROVEN RELIABILITY

General Optronics offers 100% Quality Control for unmatched reliability — with laser chips *guaranteed* to 10,000 hours — and projections are they'll last for 100,000 hours.

APPLICATION ASSISTANCE

General Optronics invites you to discuss your design ideas with us. We have more application expertise than anyone, so you know you'll get the best answer, directly from us.

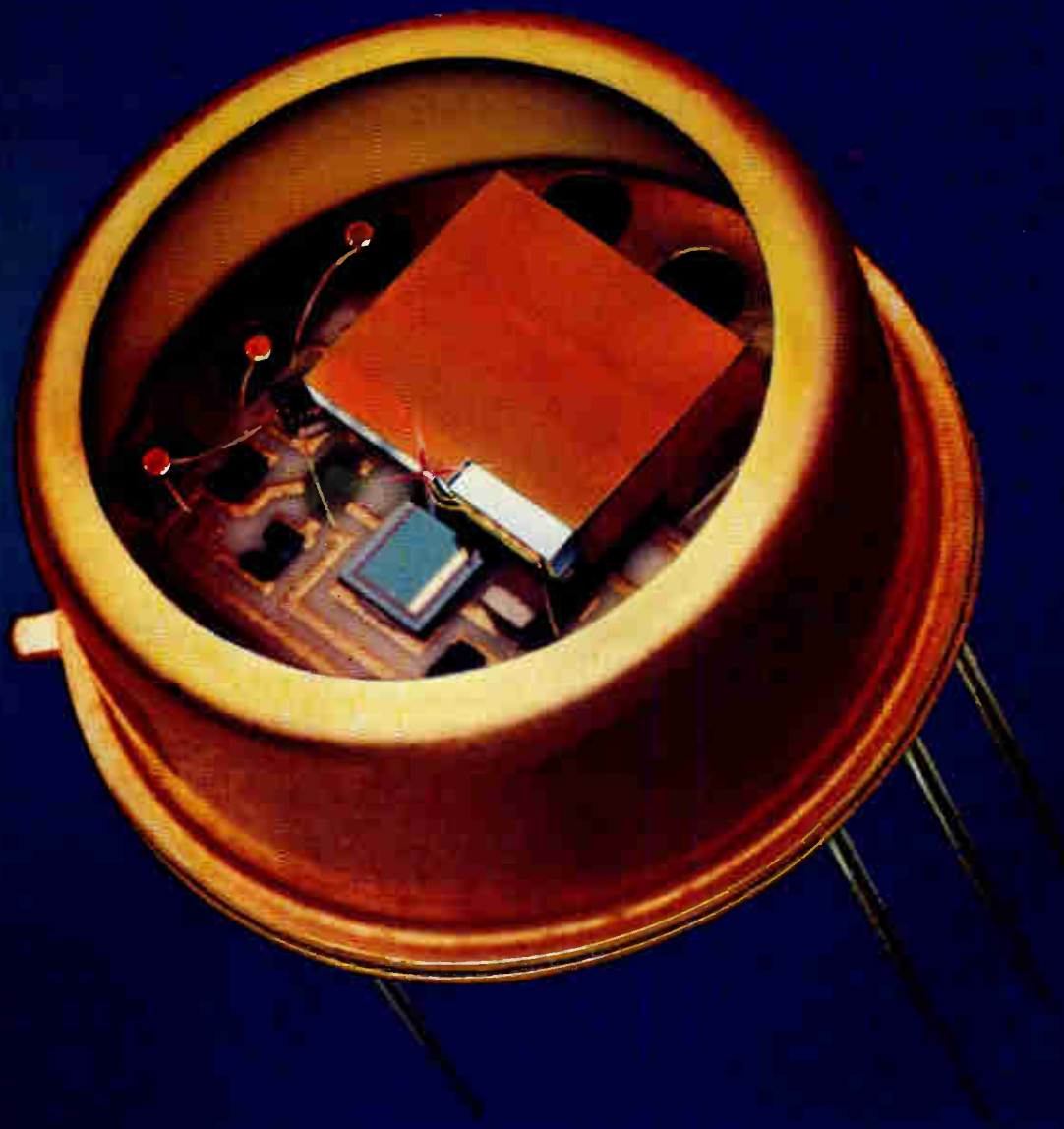

Look To General Optronics

TYPICAL APPLICATIONS

Typical Applications for General Optronics Lasers, Optical Components, Modules and Sub Systems Include:

- Fiber Optic Communication Systems • Optical Memories • Video discs • Scanners • Non Impact Printers and Facsimilies • Distance Measurement Instruments • Security Systems • Level Monitoring and much, much more. Let us help you with your applications.

100,000 HOUR LASER PRODUCTS

• Optical Transmitter
Illustrated 2/5 Actual
Size



• Laser Chip On Heat
Sink Illustrated —
5 x Actual Size



• Optical Hybrid Transmitter
in TO-8 Package illustrated
Actual Size.

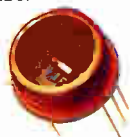

**general
optronics** 

3005 Hadley Road, S. Plainfield,
N.J. 07080 • (201) 753-6700

Circle 19 on reader service card



The Future Has Arrived.

Intel delivers the 8086. Powerful. Practical. And the Architecture of the Future. Here today.

We have seen the Future and it is called 8086.

Even better, it's here today. Our new 16-bit microcomputer is an

architectural triumph, introducing designers to a new world of system expansion capability, high-level language programming and dramatically increased system thrupt.

Why we call it "The Future"

To deliver the Future, we designed the 8086 with a totally new architecture, super-efficient for implementing high-level, block-structured languages such as Pascal and PL/M-86.

The 8086 addresses up to a full megabyte of system memory with new addressing modes and efficient register utilization that totally support such minicomputer-like capabilities as relocatable and re-entrant code and instruction look ahead.

And the 8086's powerful new instruction set includes both 8-bit and 16-bit multiply and divide in hardware, with efficient byte string operations and improved bit manipulation.

We're committed to delivering the industry's highest performance, today and into the future. The 8086's architecture maximizes system thrupt today by delivering ten times the processing power of its 8-bit predecessors. Planned expansion promises another order of magnitude increase in performance through the addition of

I/O processors, special instruction set extension processors, memory management and distributed intelligence configurations.

System components for expanded multiprocessor applications are available right now, supporting the Multibus™ architecture in timing, control and drive levels. They include 8288 Bus Controller, 8282/8283 Octal Latches and 8286/8287 Octal Transceivers.

Get a jump on the future.

8086 is the most successful new microcomputer ever. The list of major market leaders who have evaluated 16-bit machines and chosen the 8086 is staggering.

One reason for the 8086's success is our commitment to *your* success. We've made the 8086 the industry's best-supported microcomputer. The cpu, interrupt controller and six additional support circuits are on distributors shelves, with more on the way. You can take advantage of the 28 existing Intel® peripheral interfaces. Our 2716 (16K) and 2732 (32K) EPROMS provide programming

flexibility and unique features for 8086 users, including protection against bus contention.

And we complete your system with a variety of off-the-shelf +5 volt MOS RAMs.

You can begin hardware/software development today, using the Intellec® Microcomputer Development system with ICE-86™ in-circuit emulation, PL/M-86 and ASM-86 for assembly language programming and 8080/8085 software conversion.

SDK-86, a complete system design kit including all essential components, makes it easy to begin prototyping without delay.

For an additional head start, iSBC 86/12™ single board computer brings the power of the 8086 to the Multibus with a fully assembled and tested 16-bit system.

The Future belongs to you.

Get to market first and capture a piece of the future for your product. You can order the complete 8086 family from your distributor. Or, for more information, contact your local Intel sales office or write: Intel Corporation, Literature Dept., 3065 Bowers Avenue, Santa Clara, CA 95051.

intel® delivers.

Europe: Intel International, Brussels, Belgium. Japan: Intel Japan, Tokyo. United States and Canadian distributors: Arrow Electronics, Alliance, Almac/Strom, Component Specialties, Cramer, Hamilton/Avnet, Harvey, Industrial Components, Pioneer, Sheridan, Wyle/Elmar, Wyle/Liberty, L.A. Varah and Zentronics.

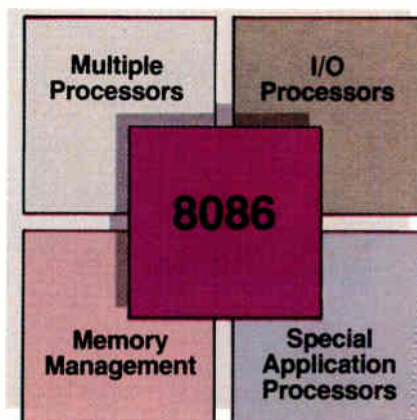

Circle No. 21 for information

"See us at NCC , June 4-7, New York City." Booth #1420

PROJECTION MASK ALIGNER

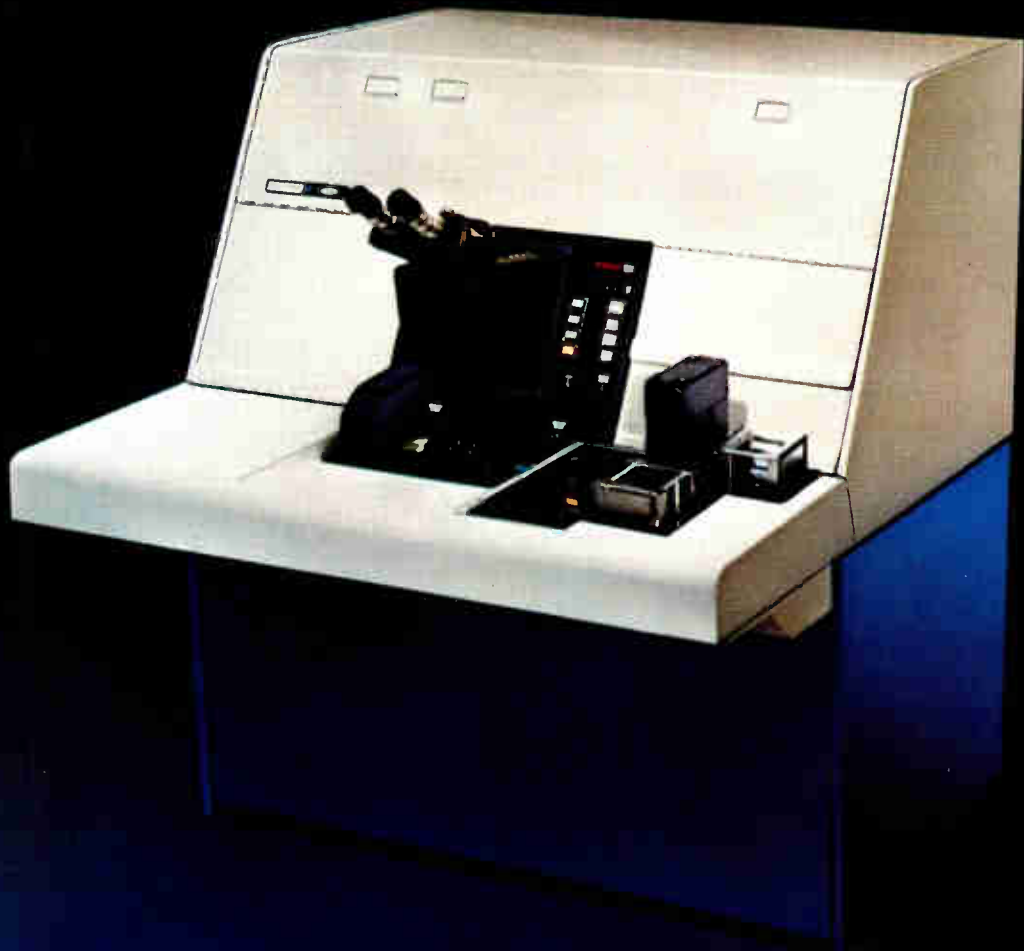

Introducing the Micralign[®] 200 Series. Higher throughput than step-and-repeat at a much lower price.

Perkin-Elmer designed the new Micralign Model 200 to be the most cost-effective projection mask aligner available. In performance, it achieves 2-micron geometries or better in production, distortion/magnification tolerance of 0.25 micron, and 4 percent uniformity of illumination. Options available include automatic wafer loading and automatic alignment. Soon to be available: deep UV optical coatings for still smaller geometries.

Compared to the leading step-and-repeat aligner, the Micralign Model 200 delivers outstanding performance for not much more than half the cost. It takes about a quarter of the floor space. It provides consistently higher throughput regardless of die size.

The Model 200's remarkable performance is the result of a number of major innovations.

Improved optical design and fabrication

We improved the optical design to provide increased resolution

and depth of focus. Optical manufacturing tolerances are five times tighter to ensure precise overlay from aligner to aligner.

Near-zero vibration

We minimized vibration. We constructed the Model 200 with two frames—one inside the other. The inner frame, which carries the projection optics and carriage drive, is completely isolated from the outer frame.

We incorporated a superb linear motor carriage drive with air bearing slide. This drive does more than eliminate vibration. With the air bearing feature there's no contact and no wear. And no limit to carriage drive durability.

Built-in environmental control

We provided the Model 200 with a built-in environmental chamber. External air, supplied by you or from our optional air conditioning system, is blown through a HEPA filter and heating elements built into the Model 200 top cover. A positive-pressure, class 100 environment is carefully controlled to better than 1°F.

We included a separate thermal control for the mask, to compensate for mask run-out.

No mask contamination

We designed a sealed mask carrier for the Model 200. You put the mask in the special carrier right in the mask department. Seal it. When you load the sealed carrier in the Model 200, the cover plates are automatically removed. After use, the cover plates are automatically replaced.

Proven production capabilities

Perkin-Elmer, the leader in projection mask alignment systems, offers six years of proven production capability, with an excellent training and service record.

Get all the facts

These are just a few of the features that make the Micralign Model 200 Series a completely new concept in projection mask aligners. Get more details on how these and other improvements in design can translate into improvements in your production. For literature, write Perkin-Elmer Corporation, Electro-Optical Division, 50 Danbury Road, Wilton, CT 06897. Or phone (203) 762-6057.

PERKIN-ELMER

Circle 23 on reader service card

The big little world of electronics . . .

There occurred at Electro79 one of those unusual and fortuitous confluences of electronic heavy hitters. Gathered in New York last week along with the thousands of engineers, sales people, and peripheral personnel attending the annual conference was a clutch of top executives from companies around the world. They were in the city to take part in an Electro panel session on no less compelling a subject than worldwide problems and opportunities for the electronics industries.

From Japan, China, West Germany, France, Britain, the Netherlands, the United States, and even Texas they came, men having in common a global outlook, a sense of electronics as a kind of technological Esperanto.

The conclusion to be drawn from their presentations is that the business of electronics is truly international, and that the obstacles, aspirations, and aims are strikingly similar.

. . . still offers opportunities for the entrepreneur

One message coming through loud and clear at the session on electronics worldwide is that Europe and Japan have their sights set on overhauling the U. S. lead in advanced electronics. That's hardly news; but another Electro seminar carried a counterpoint message.

A group of corporate venture capitalists told an audience of over 100 that U. S. electronics entrepreneurs are in the clover. After a mid-1970s drought, venture capital is available in some abundance (p. 88).

All well and good, but where are the bold souls who will exploit this bonanza? Where are the men and women with the ideas, the guts, and the managerial abilities to break new ground in the electronics industries?

One place we suspect they may be found is among our readership. Should you be pondering the prospects of entrepreneuring, we suggest that it is time to reach a decision. Not only are the potential personal rewards

But there are still some differences in execution, some approaches that defy homogenization.

For example, while Japan, France, and West Germany must all sell their electronic products around the world, each nation goes about the business of competing in a different fashion. Consider how each pursues the VLSI solution. For the Japanese, it means a strong government hand. For the French, it entails a search for joint ventures with foreign companies. For the West Germans, it is a reliance on the expertise of its big three semiconductor manufacturers.

One other impression drawn from the session is that a potentially big new force is waiting anxiously to make its entrance: China. The message from that rapidly opening society is "Give us the broad, across-the-board know-how, and we will manufacture our own products. We are ready."

Midas-like, but—as the past 20 years of the electronics industries show—you can make a significant contribution to technology.

One point that needs underlining: you need more than a good idea to convince venture capitalists to support you. Those Brooks Brothers suits and Ivy League manners at the Electro seminar failed to disguise the bottom-line brains within. Of course, there is good reason for the hardheaded approach. Innumerable venture-capital units have foundered on the rocks of ill-advised investments.

To get an idea of what venture capitalists want, look at publications like Capital Publishing Corp.'s "Guide to Venture Capital Sources." Essentially, these investors are gambling on the abilities of the entrepreneurs they back, and the question such guides can answer is what these abilities are. Then you must decide if you measure up.

PRO-LOG makes it easy to board the STD BUS.

Introducing the STD BUS, the simplest based microprocessor system ever made. STD means **Simple To Debug, Simple To Develop, Swift To Deliver.**

The new STD BUS—8-bit microprocessor systems built around a standard based motherboard which allows any card to work in any slot. Thus you can change the function of your system, the memory type, even the



microprocessor type by simply exchanging one card for any other. The STD BUS is 56 lines wide and is compatible with Pro-Log's standard 4½-inch by 6½-inch edge-connected cards.



Buy 250 of any one card, and we give you free the plans for that card and non-exclusive manufacturing rights so you can build it yourself.

In addition to cards, we also make a ½ or ¼ rack card cage. It includes motherboard, card edge connectors and mounting brackets.

Every part in our systems is or soon will be a second-sourced industry standard which means that if you produce our systems yourself, you'll never have to worry about the availability of sole-sourced parts. Through cross licensing arrangements, MOSTEK will also be building most of our cards giving you yet another source of supply.

It's supported by both Pro-Log and MOSTEK and freely available to the industry.

A whole new card series available for use with the STD BUS.

Our new 7000 Series 8-bit systems were specifically designed for use with the STD BUS. We have cards in limited quantities now, in production quantities in January.

Learn about the STD BUS and our 7000 Series Systems.

Send for our Microprocessor User's Information Packet. Pro-Log Corporation, 2411 Garden Road, Monterey, CA 93940. Phone (408) 372-4593.

CARDS AVAILABLE NOW
Z-80 PROCESSOR • 8085 PROCESSOR
16K BYTE 2716 EPROM MEMORY • 16K BYTE STATIC RAM MEMORY
TTL INPUT PORT CARD • TTL OUTPUT PORT CARD
TTL INPUT/OUTPUT PORT CARD
TRIAC OUTPUT CARD
MOTHERBOARD ½ RACK • MOTHERBOARD ¼ RACK
• CARD EXTENDER • GENERAL UTILITY CARD • UTILITY DIP CARD
WE ARE DEVELOPING ADDITIONAL CARDS IN THESE CATEGORIES
PROCESSOR • MEMORY • DIGITAL I/O • SERIAL I/O
ANALOG I/O • PERIPHERAL I/O • INDUSTRIAL I/O

Watch for announcements as new cards become available.



Microprocessors at your fingertips.



PDP-II and LSI-II bus

displays

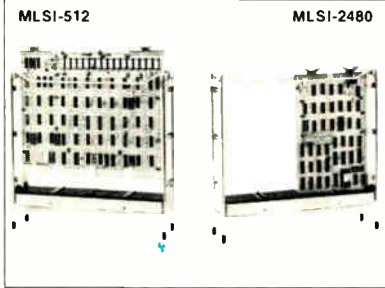

MATROX has the most complete line of CRT display boards for DEC's PDP-II and LSI-II bus in the industry. We have alphanumeric; graphics; color; black and white; variable resolution; external/internal sync; 50/60 Hz; software and much, much more. Just plug the board in any PDP/LSI-II bus connect video to any standard TV monitor, and presto, you have added a complete display to your system at a surprisingly low cost.

LSI-II BUS

MLSI-2480	24 x 80 alphanumeric	\$ 350 *
MLSI-256	256 x 256 dot graphics	\$ 650
MLSI-512 x 256	512 x 256 graphics	\$ 850
MLSI-512	512 x 512 graphics	\$1150
MLSI-1024	1024 x 256 graphics	\$1150

PDP-II BUS

MDC-2480	24 x 80 alphanumeric	\$ 350
MDC-256	256 x 256 dot graphics	\$ 650
MDC-512 x 256	512 x 256 graphics	\$ 850
MDC-512	512 x 512 graphics	\$1150
MDC-1024	1024 x 256 graphics	\$1150

And we have other uP displays and display controllers. These include state of the art OEM alphanumeric LED displays, alphanumeric video RAM's and CRT graphics controllers. They come as complete, ready to use sub-systems (single chips, modules, PCB's). Many of them are plug-in compatible with other buses Multibus SBC-80, S-100, Exorciser, STD as well as custom design capability.

*100 quant.



The Visible Solutions Company

5800 ANDOVER ROAD, MONTREAL, QUE H4T 1H4
TEL (514) 481-6639
U.S. ONLY. TRIME > BUILDING MODERS, N.Y. 12958

Meetings

University/Industry/Government Microelectronics Symposium, IEEE, Texas Tech University, Lubbock, Texas, May 21-23.

Semicon/West, Semiconductor Equipment and Materials Institute (Mountain View, Calif.), San Mateo Fairgrounds and Dunfey Hotel, San Mateo, Calif., May 22-24.

Huntsville Electro-Optical Technical Symposium and Workshop, Society of Photo-Optical Instrumentation Engineers (Bellingham, Wash.), Huntsville Hilton, Huntsville, Ala., May 22-25.

Failure Avoidance Seminar, Integrated Circuit Engineering Corp. (Scottsdale, Ariz.), Hilton Inn, Jamaica, N. Y., May 23-24.

International Television Symposium and Technical Exhibition (Montreux, Switzerland), Montreux Palace Hotel, May 27-June 1.

International Symposium on Multi-Valued Logic, IEEE, Beaufort Hotel, Bath, England, May 29-31.

15th Symposium on Electron, Ion and Photon Beam Technology, IEEE, Sheraton Boston Hotel, Boston, May 30-June 1.

Conference on Laser Engineering and Applications, IEEE and Optical Society of America, Washington Hilton Hotel, Washington, D. C., May 30-June 1.

1979 International Summer Consumer Electronics Show, Electronic Industries Association, McCormick Place, Chicago, June 3-6.

NCC '79-1979 National Computer Conference, IEEE, American Federation of Information Processing Societies, *et al.*, New York Hilton and Americana Hotels, New York, June 4-7.

Automated Testing for Electronics Manufacturing, Benwill Publishing Corp. (Boston), Radisson Ferncroft Hotel, Danvers, Mass., June 4-7.

ICC '79-International Conference on Communications, IEEE, Sheraton Boston Hotel, Boston, Mass., June 10-14.

Symposium on Applications of Ferroelectrics, IEEE, Sheraton-Ritz Hotel, Minneapolis, Minn., June 13-15.

Joint Automatic Control Conference, IEEE and American Institute of Chemical Engineers, University of Washington, Seattle, June 16-21.

Power Electronics Specialists Conference, IEEE, Bahia Hotel, San Diego, Calif., June 19-21.

33rd Annual Convention of the Armed Forces Communications and Electronics Association, Afcea (Falls Church, Va.), Sheraton Park Hotel, Washington, D.C., June 19-21.

Second Joint InterMag-Magnetism and Magnetic Materials Conference, IEEE and American Institute of Physics, Statler Hilton Hotel, New York, July 17-20.

Short courses

Machine Vision, Automatic Assembly, and Productivity Technology, summer session, Massachusetts Institute of Technology, Department of Electrical Engineering and Computer Science, MIT, Cambridge, Mass., June 11-15.

First Annual National Conference on Recent Advances in Microcomputers, sponsored by Clemson University and the University of South Carolina, June 19-21. For program information, contact John Gowdy, Continuing Engineering Education, College of Engineering, Clemson University, Riggs Hall, Clemson, S. C. 29631.

Microprocessors and Microcomputers, George Washington University, July 30-Aug. 3. For information, write to Director, Continuing Engineering Education, George Washington University, Washington, D. C. 20052, or call toll-free (800) 424-9773.

64K ROMs. The cold, hard facts.

 The cold, hard facts about 64K ROMs add up to proven performance. A level only Mostek's MK36000 has achieved with features like efficient program code turnaround, design superiority and volume production.

Since its introduction in early 1978, Mostek's 64K ROM has easily become the industry standard. And here are the facts to prove it.

Fact 1:

Mostek has processed more than 200 codes with an average delivery of just seven weeks for customer prototypes after data verification.

Fact 2:

Its compatibility with EPROMs and RAMs provides exceptional system design flexibility.



Fact 3:

Even late-comers can't match the 36000's fast access time of 250ns (max) or low power of 220mW (max) active and 35mW (typ) standby.

Fact 4:

The MK36000 has been in volume production for over a year, with demonstrated ability to meet delivery commitments.

Fact 5:

Mostek can accept code input by EPROMs, ROMs, card decks, paper tapes

or magnetic tapes with no delay in generating verification data.

Fact 6:

The MK36000 is available in a full range of speeds, operating temperatures and processing options, including strenuous military specifications.

The fact is, you can get promises from a lot of people. But when you want the leading 64K ROM all the facts point to Mostek.

Write to 1215 West Crosby Road, Carrollton, Texas 75006. Or call 214/242-0444. In Europe, contact Mostek Brussels; Phone (32) 02/660.25.68.

MOSTEK®

THE MOSTEK

Because even engineers

When was the last time you had the "perfect" hardware design only to learn it now needs three serial I/O ports?

Our new Micro Design Series minimizes these problems and lets you quickly respond to changing product definition and market conditions. Here's how:

Any Card. Any Slot. Any Time.

First, decide what functions your system needs. Match the Z80-based, MDX functional modules to your design. Plug

those modules into an MDX card cage. Then start writing your software.

Need to modify your system? Simply exchange, add or delete MDX modules at any time. The small 4.5" x 6.5" board size makes system packaging easier. And both 2.5 and 4.0 MHz versions are available.

You get this versatility because all MDX modules are STD-Z80 BUS compatible. This second-sourced, motherboard

MDX-SIO

MDX-DRAM 8K, 16K, 32K

MDX-CPU1

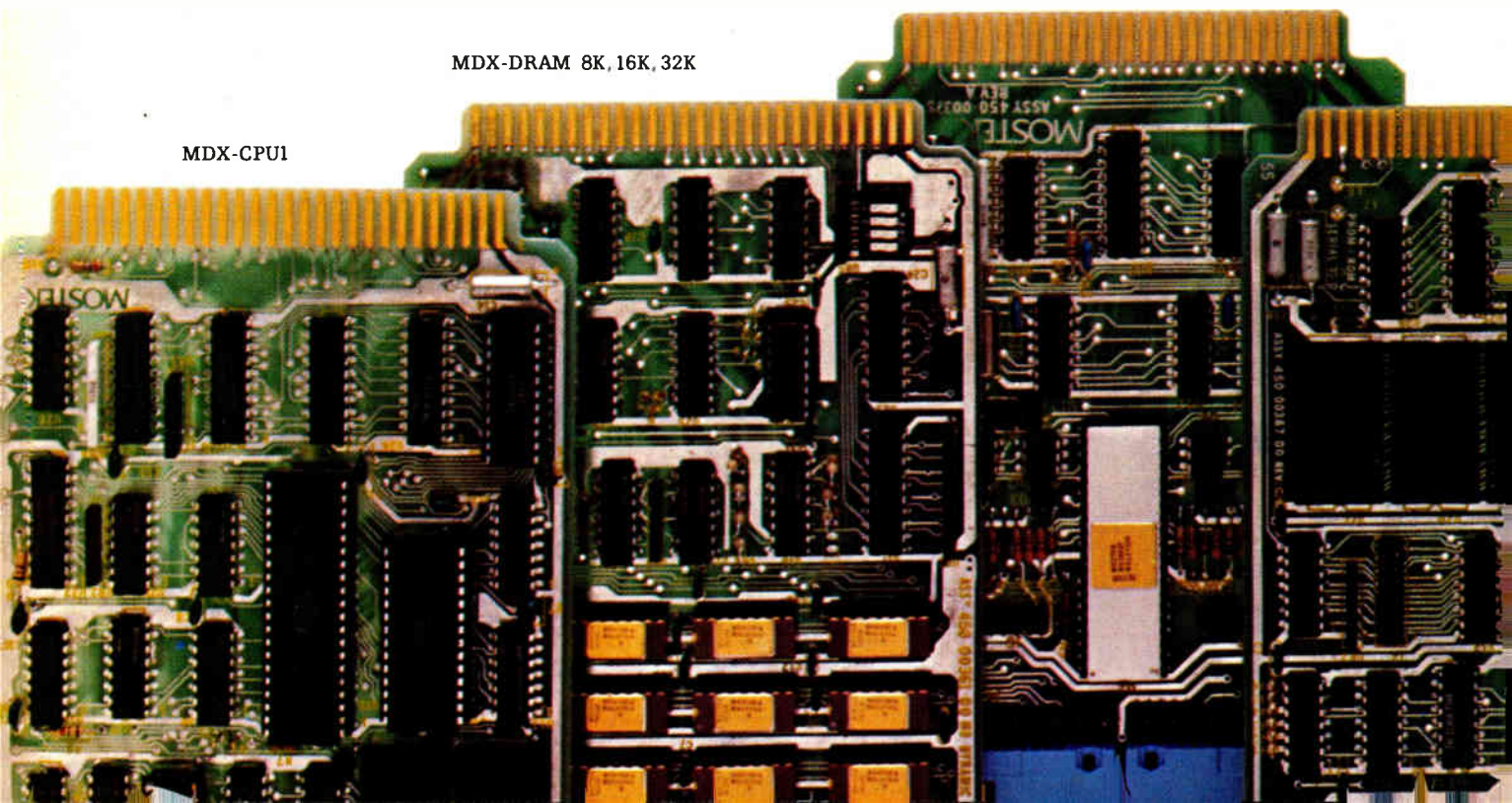

MD SERIES™

can't predict the future.

interconnect system lowers system cost two ways: you buy only what you need, and you reduce hardware development time.

A Wide Choice of Z80-Based Systems.

Need a small but powerful single-board computer? In addition to the broad family of MDX modules, Mostek's MD Series includes a separate family of stand-alone boards designated MD. The MD single-board computers are also Mostek Z80-based and the same small size as the MDX modules.

More Coming in '79.

For even greater design flexibility, the MD Series will expand to include a hardware single-step module, 2-channel programmable serial I/O module, 32-bit programmable parallel I/O module, floppy-disk controller module, plus more MD single-board computers.

Start designing your MDX system with the MDX-PROTO kit. This powerful evaluation/prototyping kit is available now for only \$1095.

Call or write us today for more information. Mostek, 1215 West Crosby Road, Carrollton, Texas 75006; phone 214/242-0444. In Europe, contact Mostek Brussels; phone (32)02/660.25.68.

MDX-EPROM/UART

MDX-PIO

MD-SBC1

MDX-DEBUG

MOSTEK®

Circle 29 on reader service card

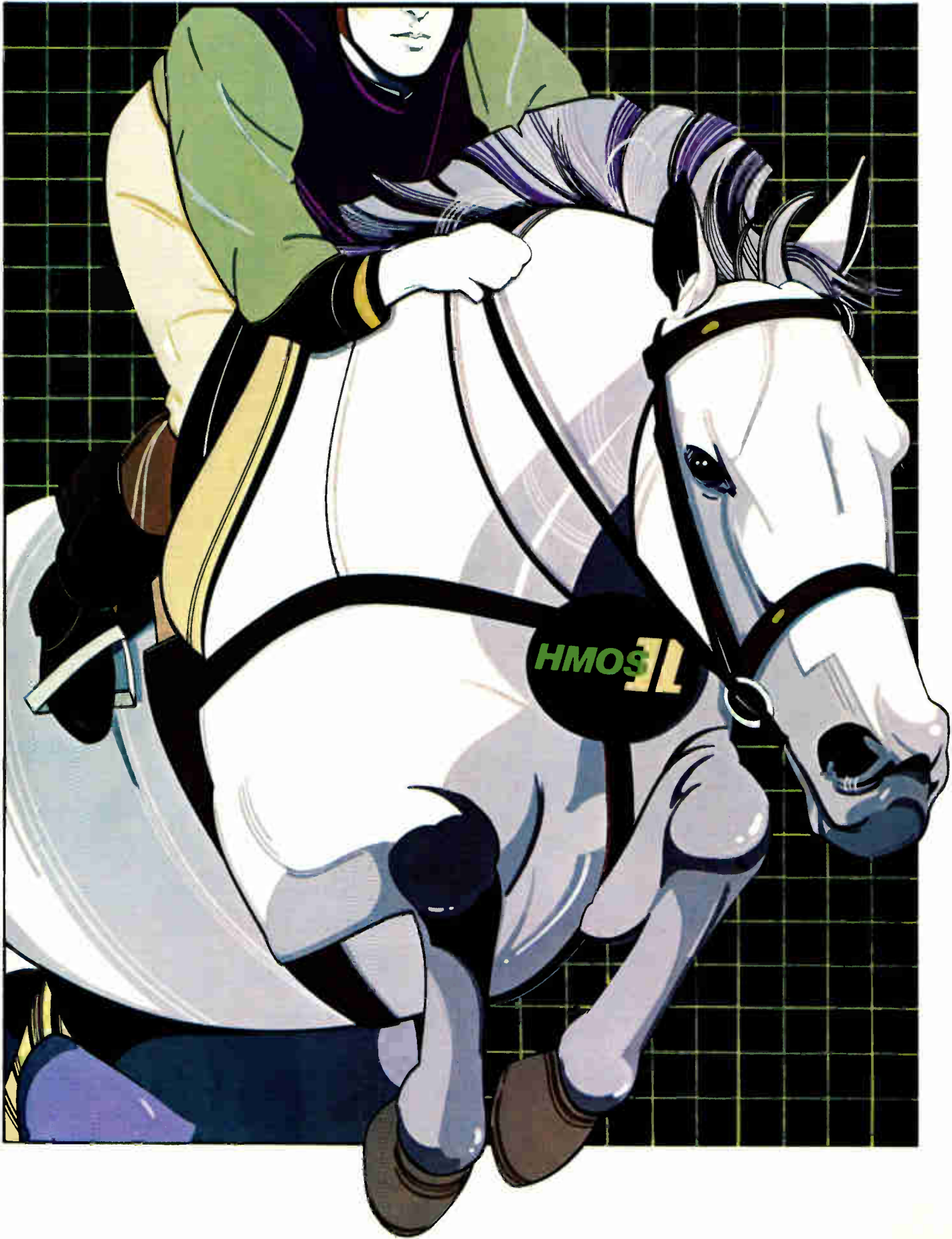

New Breed of MOS.

Intel introduces HMOS II*—and a new family of static RAMs that cross the finish line in 20 ns.

Intel just set a new pace for high performance memory with HMOS II. It's our patented next generation MOS technology so advanced it delivers speeds faster than bipolar and even our own first generation HMOS process. HMOS II gives designers the fastest, lowest power static RAMs ever—plus traditional MOS economy and reliability. Our new

History of MOS speed

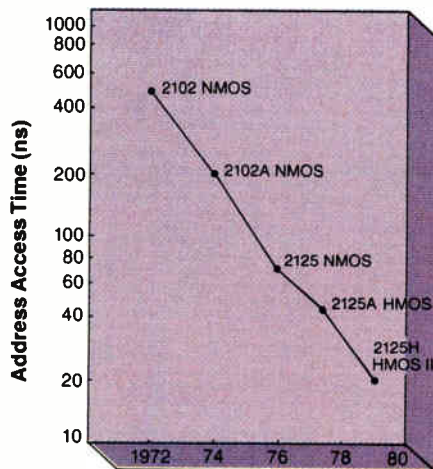

Intel's continued process and scaling improvements have doubled MOS speeds every two years. The above graph demonstrates this trend with Intel's 1K x 1 static RAMs.

1K and 4K RAMs are fully compatible, higher speed upgrades of Intel's time-tested 2115A/2125A and 2147 devices.

1K fast statics that leave bipolars behind

Designers building cache, writeable control store or buffer memories will find our 16-pin

2115H/2125H 1K RAMs ideal. For new designs, two versions deliver record access speeds of 20 ns and 25 ns, with a speed/power product twice as good as slower bipolar RAMs.

Our 35 ns and low power 30 ns models can be used as direct plug-in replacements for 93415A and 93425A bipolar RAMs. They'll cut power dissipation up to 36%. And, best of all, they're available now.

New, faster 4K with no power increase

Intel's new 2147H gives you all the advantages of our 18-pin 4K x 1 industry standard 2147, with twice the speed and no increase in power. With access times as fast as most 1K RAMs, it's important news for anyone designing buffer, cache, control store and main memory systems. If you're presently working with 1K RAMs, you can increase density or reduce board space by a factor of four. In a 4K format, the 2147H makes possible a new dimension of higher performance systems.

The 2147H's low active power dissipation and automatic power down on deselection also mean dramatically reduced power consumption compared to constant current static RAMs. In fact, because most devices are deselected at any given time, the larger your system, the lower your power dissipation per bit. It all adds up to simplified designs and major

HMOS II fast static RAMs

Part No.	Maximum Access Time (ns)*	Power Consumption (mA)*	
		Active	Standby
4096x1			
2147H-1	35	180	30
2147H-2	45	180	30
1024x1**			
2125H-1	20	125	
2115H-2	25	125	
2125H-2			
2115H-3	30	100	
2125H-3			
2115H-4	35	125	
2125H-4			

*Over full 0° to 75°C operating temperature range.

**All 2115H versions have open-collector outputs, all 2125H versions have tri-state outputs.

savings in cooling and power supplies.

All HMOS II components are fully static and can be used in clocked and unclocked systems. They are directly TTL compatible in all respects: inputs, outputs and operation from a single +5V supply.

Order 2115H/2125H and 2147H RAMs from your Intel distributor. Or, for more information, contact your local Intel sales office or write: Intel Corporation, 3065 Bowers Avenue, Santa Clara, CA 95051.

intel® delivers.

Europe: Intel International, Brussels, Belgium. Japan: Intel Japan, Tokyo. United States and Canadian distributors: Arrow Electronics, Alliance, Almac/Strom, Component Specialties, Cramer, Hamilton/Avnet, Harvey, Industrial Components, Pioneer, Sheridan, Wyle/Elmar, Wyle/Liberty, L.A. Varah and Zentronics.

EXPANDABILITY

PLUG-INS

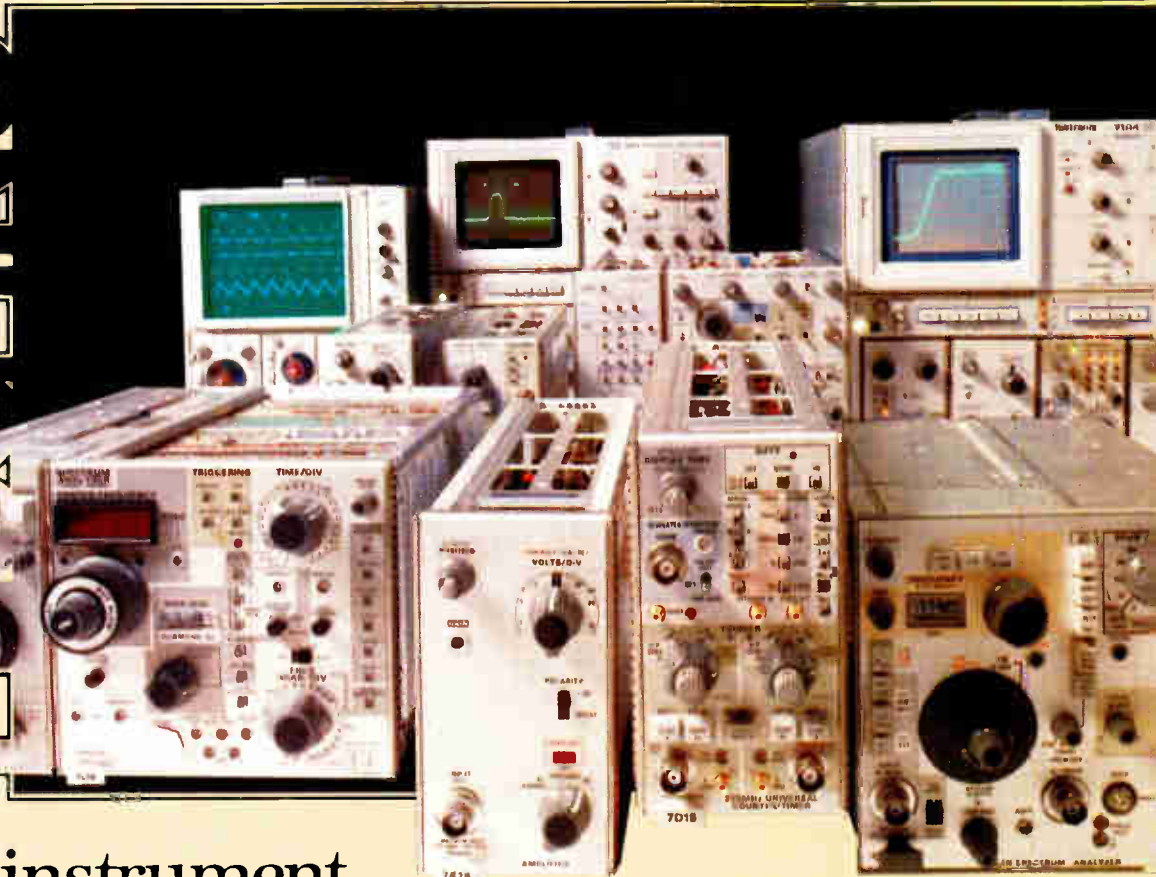

An instrument for today...and beyond.

Tektronix has made a commitment that gives you a systematic pathway into tomorrow's technology. Here's how. As more advanced measurement techniques are developed, each is adapted to the Tektronix Plug-In oscilloscope you own today.

So, the plug-in units you are using now will fit the mainframes we build tomorrow. Compatibility is assured.

Currently our Plug-In scopes family includes 14 mainframes and 21 plug-in units in the 5000-Series, and 19 mainframes and 35 plug-ins in the 7000-Series. (With them, you can use compatible logic and spectrum analyzers and other special purpose plug-ins.) Among the newer arrivals: a logic analyzer with 16 digital acquisition and display channels. A calibrated 60 GHz spectrum analyzer that's transportable. And the newest: A 1 GHz real time oscilloscope

with 10 mV/div sensitivity and 20 cm/ns photographic writing rate. Plus more milestones just ahead.

Our commitment to superior research and engineering and to performance and reliability extends to each new 5000 and 7000 Plug-In scope we produce.

Tektronix Plug-In scopes meet your critical measurement demands. From circuit design to plasma physics research. From balancing rotating machinery to measuring the accuracy of D to A converters.

What measurement challenges are on your horizon? Contact us. We can help you plan to meet them successfully with our Plug-In scopes. At Tektronix, our commitment goes with our name.

Tektronix[®]
COMMITTED TO EXCELLENCE

For literature, call (800) 547-1512 toll free.

For Technical Data circle #32 on Reader Service Card

For Demonstration circle #208 on Reader Service Card

Run-time operating system for 16-bit micros to be unveiled

Data General Corp. of Westboro, Mass., is about to introduce what's billed as the first native run-time operating system for 16-bit microcomputers. Called Micron, it may mark a major industry transition from emphasis on hardware to one on software, according to Data General spokesmen. The operating system is the basis of the company's new software thrust, including seven utility programs written in Pascal. Micron is an executive software package for single-user, multitask environments; normally disk-based, its programs can be burned into programmable read-only memory for dedicated applications. The new software also is compatible with Data General's advanced operating system, making Pascal available even to time-sharing users of the firm's Eclipse large minicomputer.

Data General's announcement, expected later this month, may be the largest commitment yet by a major computer maker to powerful, highly structured, high-level Pascal and could influence ANSI's Pascal standardization effort. Deliveries are scheduled for midsummer.

Computer 'speaks' on phone—no matter who's calling

Computers that answer telephones? At next month's National Computer Conference, Dialog Systems Inc. of Belmont, Mass., will show a vector-processor-based system that answers up to eight incoming calls, understands single-word instructions put to it over the telephone, and responds to those orders. Called the model 1800, the system sells for less than \$100,000, is speaker-independent (works with any caller), and will find use in areas such as banking, retailing, government, and automatic telephone-switching networks. The company designed its own vector processor for the system; with a machine cycle time of 120 ns and three parallel buses operating independently and simultaneously, speech can be processed in real time.

National eyes fiber optics for Industrial uses

Already making light-emitting diodes, National Semiconductor Corp. of Santa Clara, Calif., plans to use them in a series of low-cost, LED-fed fiber-optic transmitter-receiver pairs for short-haul industrial communications or distributed-processing systems. The family is expected to include a receiver packaged as an interface device for less than \$50 and a hybrid pair at less than \$50 for data rates up to 100 Mb/s and distances up to 3 km, followed by a monolithic receiver for shorter distances and data rates below 1 Mb/s targeted to sell for less than \$10 in volume. National is designing the packages to plug into standard optical connectors to help hold down system costs. Another design feature is the use of a high-performance p-i-n diode for detection.

TI to apply 32-K technology to 8-K E-PROM

Look for Texas Instruments Inc. to extend its family of single-supply erasable programmable read-only-memory parts later this year with introduction of an 8-K device. To be designated the TMS2508, it will use the single 5-v supply technology developed by the Dallas company for its higher density 2532 and 2516 E-PROMs. Because of its 32-K technology roots, performance characteristics of the pin-compatible 8-K part are expected to be strong, with access times in the 300-to-350 ns range. In today's market, the only other single-supply 8-K devices available come from Intel Corp., which supplies partials of its single-supply 16-K E-PROM parts. Availability of the new 8-K memory could come as early as June.

Cosmic rays cause soft errors, warns IBM researcher

The semiconductor industry is no longer laughing at the soft errors in random-access memories caused by alpha particles [*Electronics*, June 8, 1978, p. 42]. But as they research very large-scale integration, they had better prepare to handle a more cosmic problem, an International Business Machines Corp. researcher warns. J. Ziegler of IBM's Thomas J. Watson Research Center, Yorktown Heights, N. Y., says cosmic rays produce a variety of elementary atomic particles when they strike silicon, including muons, **which in turn produce the largest number of electron-hole pairs in the silicon.** These pairs cause the soft errors. The cosmic radiation will apparently cause the most trouble when minimum line widths approach 1 μm .

Heart attack may curtail Feerst's IEEE campaign

Irwin Feerst, perennial petition candidate for president of the Institute of Electrical and Electronics Engineers, may not be able to pursue his campaign this year until he recovers from a heart attack sustained late last month while vacationing in Florida. **Or ill health could force him to drop out entirely** from a three-way race developing among Feerst, board of directors candidate Burkhard H. Schneider, and another petition candidate, Leo Young.

Texas inventor says diode idea was his

Claiming origin of the concept of a semiconductor diode as receptor-detector in a fiber-optic communications system, Texas inventor and freelance writer Forrest M. Mimms III is planning legal action against Bell Laboratories. **Mimms says he did work on the concept as early as 1966 and can point to an outline of the idea in a 1973 book he wrote.** He says he offered the idea to Bell Labs the same year, only to be rejected. The labs' light-powered telephone [*Electronics*, Nov. 23, 1978, p. 38] uses the concept. Bell will say only that it has discussed Mimms' claim with him and that the light phone is based primarily on a high-efficiency photodiode developed at the labs.

Addenda

If minicomputer maker Computer Automation Inc. has its way, a 16-bit machine that is **cheaper to throw away than repair** will hit the market in several months. Called the Scout and billed as a "consumable" unit, it splits functions among 11 separate cards (6.25 by 8.30 in.) instead of putting them on a single board. The key feature is a self-diagnostic go/no-go light-emitting diode on each card. In a typical four-card configuration, the unit should sell for less than \$1,000 in quantity, says the Irvine, Calif., firm. . . . Energy Conversion Devices Inc., Troy, Mich., has announced an agreement with Arco Solar Inc. for a joint 18-month program to develop solar cells. **Arco will pay Energy Conversion \$3.3 million** for product development and the right to a nonexclusive license. The program will be based on Energy Conversion's recent development of a new alloy potentially suitable for low-cost solar cells. . . . Now that the year is well into the second quarter, companies are beginning to look for the softening of the economy predicted for the second half of the year. Leslie Alperstein, director of research for the New York investment firm of Bache Halsey Stuart Shields Inc., says the economy is at the turning point, which is the reason for "a wide discrepancy in the estimates" for the future. **His firm feels that the dip will start in the third quarter and last for three quarters.**

Relax!

We can get HP's 1610A Logic State Analyzer on its way to you in minutes.

Whether your requirement is for a week, a month, a year or longer, there's one way to get HP's 1610A logic state analyzer without waiting. Rent it from Leasametric.

Instantly, our nationwide on-line computerized inventory system will check our dozens of regional inventory centers to pinpoint the unit closest to you. Within minutes, your order will be processed and moving on its way. In most cases, your analyzer will be in your hands in less than 24 hours.

Need other test equipment? Don't waste time and energy calling everyone in the book. One phone call to Leasametric is the fast, simple way to end your equipment worries and start relaxing. And, rental means more than immediate possession. It's the one effective way to get the new equip-

ment you need without going back to management for more money. There's no major capital investment with a Leasametric rental.

Leasametric, of course, means more than general-purpose test equipment. We stock the latest terminals, acoustic couplers, modems, development systems, and communications test equipment... just about anything you might conceivably need. Our growing inventory includes over 23,000 items from 500 of the top electronic manufacturers—including almost the entire HP catalog.

Need it now? Why wait? To order, or for our

latest rental catalog, pick up the phone and call one of the relaxing, nationwide numbers shown below. They're toll free. Or call your local Leasametric office. There's one in every major city.

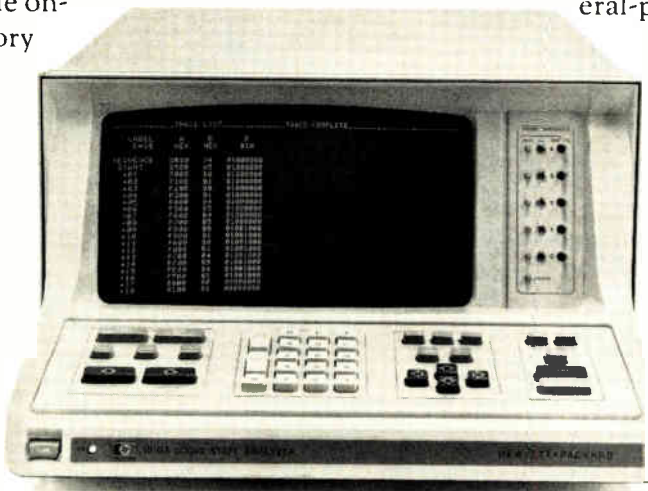

Rent it and relax.

In the West

Call 800-227-0280

In California, call (415) 574-4441

In the Central U.S.

Call 800-323-2513

In Illinois, call (312) 595-2700

In the East

Call 800-638-4009

In Maryland, call (301) 948-9700

Leasametric

1164 Triton Drive, Foster City, CA 94404

A Trans Union Company

Talk is

cheap.

Introducing our DS3680 Quad Telephone Relay Driver.



Here's a relay driver that'll drive down operation costs and drive home design efficiency on all your telephone systems.

Input current requirements for the DS3680 are extremely low, typically 10 microamps. The relay driver interfaces with TTL and CMOS logic and can be operated from a -10 to -56 volt battery.

The DS3680 is an ideal alternative to standard TTL and opto-coupler relay drivers. It does a superbly dependable job of isolating a noisy central office battery from your logic power supply.

It also has a fail-safe disconnect, so if the input is open, the driver is off. The "stand-off" voltage between any two pins is 70 volts. In "stand-by" mode, power is only 50 microwatts/driver. A built-in diode clamp resists high voltage "back swing" when the relay is switched off.

The DS3680 accepts 50 mA loads. Comes in fourteen pin dual in-line packages. And has a ± 20 volt common mode input range (excellent level shifting plus high noise immunity).

So call your local National rep about our new DS3680 Quad Telephone Relay Driver, and be sure to ask about the rest of our growing line of telecommunications products including, CODEC's, filters, SLIC's and telephone dialers.

And put less money where your mouth is.

National Semiconductor
2900 Semiconductor Drive, Santa Clara, CA 95051

I'd like to talk about reduced phone rates. Give me the information on National's new DS3680 Quad Telephone Relay Driver.

Name _____ Title _____

Company _____

Address _____

City _____ State _____ Zip _____

E 5/10 9-6

 **National Semiconductor**

5 DAY DELIVERY

Microcomputer Analog I/O Systems

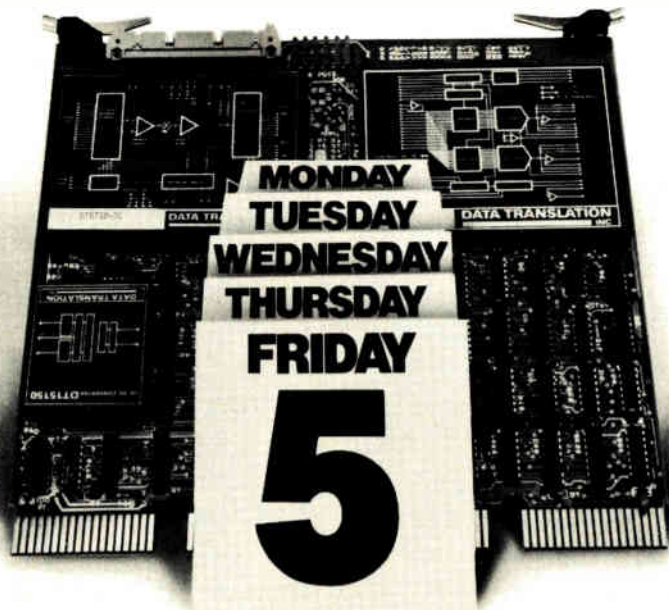

For:

DEC LSI-11 & LSI-11/2 (FORTRAN SUBROUTINES AVAILABLE for RT-11)

DEC PDP-11 UNIBUS

INTEL SBC-80 Series & NATIONAL BLC-80 Series

ZILOG MCB Series (Z-80)

MOSTEK/PROLOG STD BUS

COMPUTER AUTOMATION LSI 2, 3, & 4 Series

Precise analog I/O for any micro.

Data Translation manufactures the largest array of analog I/O modules and systems in the industry.

Standard interfaces for every major micro-computer. From isolated inputs to extremely high-speed inputs. Designed to meet your most stringent data acquisition needs in a wide range of measurement and control applications.

Highly reliable systems in only 5 days.

Our goal is to ship the most reliable analog I/O

systems available anywhere. That's why we go to such great lengths to ensure the highest reliability.

Delivery? We doubt that you'll find any company faster than **DATA TRANSLATION**.

We assure five-day delivery. When you order on Monday, we deliver by the next Monday. No excuses. No delays.

SEND for Full Technical Data or Call us.

GSA Contract No. GS-005-64219

DATA TRANSLATION

INC
4 Strathmore Rd., Natick MA 01760
(617) 655-5300 Telex 948474

Circle 38 on reader service card

U.S. SALES OFFICES: AL (404) 455-7222; AZ (602) 944-5400; CA (408) 244-5508, (213) 681-5631; CO (303) 371-2422; CT (203) 622-9191; DC (301) 636-1151; FL (305) 274-4899, (813) 725-2201; GA (404) 455-7222; ID (801) 466-6522; IL (312) 297-2616; LA (713) 780-2511; MD (301) 636-1151; MN (612) 488-1129; NC (919) 723-8102; NJ (516) 488-2100, (609) 428-6060; NM (505) 292-1212, (505) 523-0601; NY (516) 488-2100; OK (405) 528-6071; PA (609) 428-6060, (412) 327-8979; SC (803) 233-1469; TN (404) 455-7222; TX (512) 451-5174, (214) 661-0300, (505) 523-0601, (713) 780-2511, (512) 828-2251; UT (801) 466-6522; WI (414) 567-0444; CANADA (416) 625-1907, Authorized Distributor - First Computer, Chicago (312) 920-1050

Light-powered phone operates without an internal light source

by John Gosch, Frankfurt bureau manager

Siemens researchers rely on vibrating plastic membrane to modulate laser light piped in from central point

Laboratory scientists at Siemens AG are hard at work on a radically simplified type of laser-powered telephone handset.

"We expect to have a prototype light-powered phone for analog voice communications ready in less than two years," says Ingrid Fromm, a physicist who heads the development effort at the Siemens labs in Munich. Appropriately called the Optophon, the laboratory prototype Siemens has developed is the basis for a later device that will undergo field tests, possibly in West Berlin,

she says. The West German post office there is already service testing a number of optical-fiber links from various firms in West Germany [*Electronics*, Nov. 13, 1975, p. 56, and Sept. 28, 1978, p. 72].

By developing a so-called "optical microphone" for the transmitter portion of their phone, the Germans are aiming at a unit that will have far fewer parts than Bell Labs' fiber-optic telephone [*Electronics*, Nov. 23, 1978, p. 39]. The microphone, incorporating a thin, mirrored membrane, uses the voice to modulate laser light directly. The transmitter does not need the transducer and modulator of a more conventional fiber-optic voice link, in which the transducer converts the voice to an electrical signal and the modulator electrically modulates the light source.

Moreover, the Siemens handset

will not even have a light source, reducing parts count still further. The light source would be housed instead in the central exchange that sends the light to the handset over an optical fiber cable.

At the receiver end, the modulated light strikes a photoelectric element that converts the light into electrical signals. These are fed to an electromagnetic earpiece of the kind used in an ordinary phone receiver to produce sound. Another photo element in the receiver serves as the input for an electronically driven horn that constitutes the ringer for the telephone. Light striking the element is converted into electrical pulses and applied via a multivibrator circuit to piezoceramic plates. These, in turn, produce a 2-kilohertz acoustic "ring" signal.

Siemens' laboratory version of the

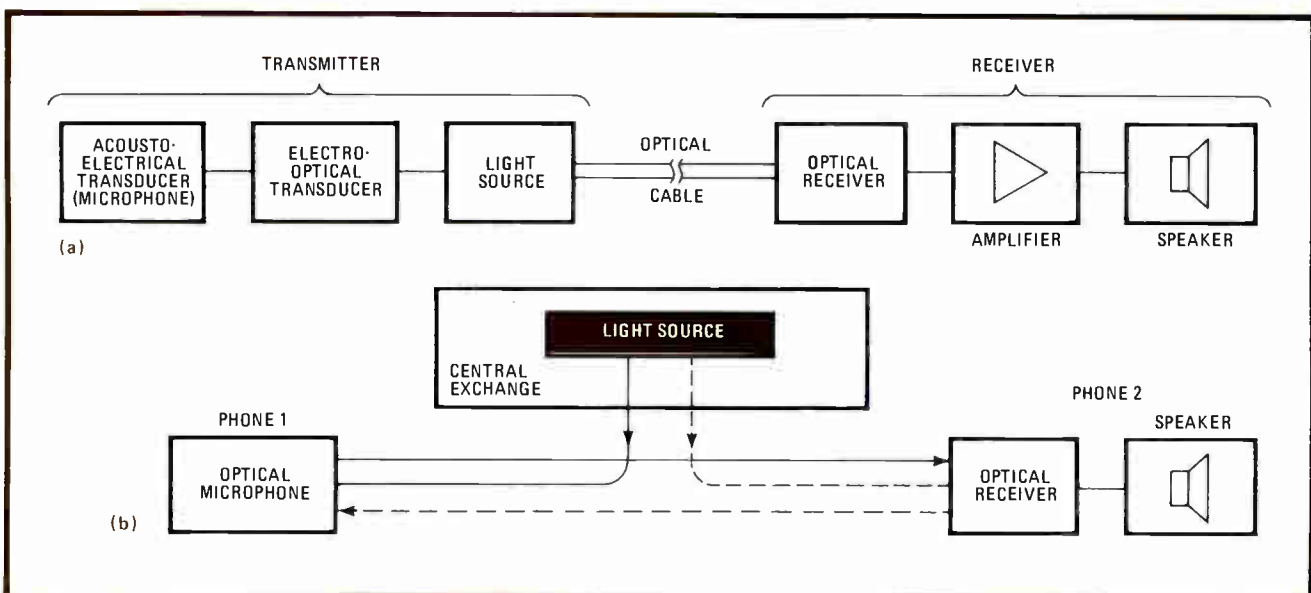

Central source. Separate transmitter elements of usual fiber-optic phone system (a), are replaced in Siemens' Optophon (b), by "optical microphone." Single light source at central exchange would provide signal carrier for phones in the system.



Light listener. Siemens' Ingrid Fromm tries out laboratory setup of light-powered telephone. She is speaking into vibrating membrane developed to modulate light.

phone carries duplex voice communications over a 20-meter-long fiber-optic cable linking two Optophon sets in different rooms. The light source is a 25-milliwatt helium-neon laser, although in future systems a smaller laser diode could supply sufficient light, according to Fromm. The laser supplies light to the phone only when a call is made.

Membrane. The light strikes the optical microphone's thin membrane made of a soft plastic that has a good surface for holding the aluminum coating. Siemens has made its membranes of Teflon and Kapton but has had the most success with Hostaphan, a polyethyleneterephthalate with elasticity constant in all directions made by the German firm of Kalle in Wiesbaden.

In the lab setup the membrane is 30 millimeters in diameter, 8 micrometers thick, and coated with a reflective layer of aluminum. As words are spoken, the sound waves cause the membrane to vibrate and to vary the angle of reflection of the light. The reflected light is coupled into a second glass fiber in the transmitter, but the movement of the membrane varies the degree of

coupling and hence the light intensity in the fiber.

Fromm points out that the two fibers must be precisely aligned with respect to each other if the membrane is to work. This is achieved by placing the fibers along minute guide grooves in the microphone assembly, she says.

The frequency range of the system is from 300 to 3,000 hertz, the common range in telephony. The microphone modulates between 80% and 100%, and modulation distortion is less than 5% over the band.

The Siemens engineers estimate they could build an Optophon link about 2 kilometers long without repeaters, judging from the values they have obtained for fiber attenuation and losses in the optical components. Fromm believes such links would be attractive in short-haul private and military networks. For local public telephone networks, links must be longer—between 1.5 and 3 km without repeaters, the range of line lengths to an average subscriber. Such links will be possible when light sources increase in power and fiber attenuation decreases, she says. □

Peripherals

8-inch disks begin to mushroom

If hardware appears on schedule later this year to back up promises, the on-line memory-storage business for small computers will shape up as a new ball game. The cause: arrival of the 8-inch-diameter, fixed-media (hard) disk drive—an eagerly awaited peripheral that offers several advantages.

Physically the same size as a floppy-disk drive, the new 8-inch hard-disk units offer some 5 to 60 times the storage capacity and generally can access data 4 times faster than floppies. Though, at an expected price of \$1,350 to \$3,000, the new drives are anywhere from 3 to 5 times as expensive as floppies, they appear to be an answer to the prayers of small-computer builders for a larger-capacity memory that takes up less cabinet space than current 14-in. hard disks. Based on current Winchester-technology the new drives promise higher reliability, too.

Bowing. New hard drives will surface at next month's National Computer Conference, from Pertec Computer Corp.'s Peripherals division. And other suppliers such as Micropolis Corp., Shugart Associates Inc., Control Data Corp., and Kennedy Corp. will be introducing drives, though not at the NCC.

"It's an onslaught," remarks Stuart Mabon, president of Micropolis in Canoga Park, Calif. "I expect to see as many as 10 companies with them this year. It's the biggest thing in magnetic recording since floppies came on in 1973-75."

Why are hard 8-in. drives bursting out all over in the spring of 1979? In Mabon's opinion, two factors spur the timing. One is IBM's validation of the technology with its own "Piccolo Drive," already being shipped in its small-business System/34 and /38, he says.

Strong user demand is the other factor since the newer 16-bit micro-

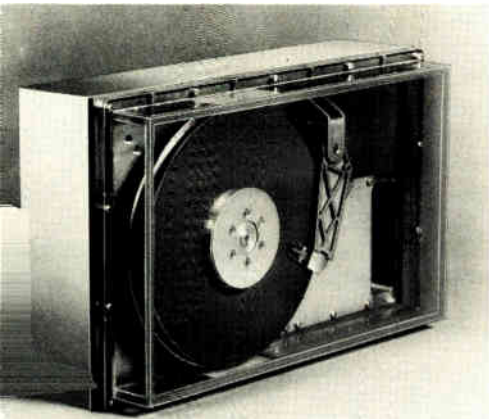

Shrink. Rotary position arm helps cut size of Perotec's 8-in. hard disk.

computers require much more memory than floppies can provide.

Also influencing the timing is the improved availability of the disk media itself, adds Lee Benedict, product marketing manager at the Perotec division in Chatsworth, Calif. He points out that the "IMI debacle" slowed other manufacturers by making them more cautious: International Memories Inc., Sunnyvale, Calif., announced the first 8-in. unit last year [*Electronics*, April 27, 1978, p. 40], but was unable to begin deliveries until this January.

Says IMI's director of market support, George Campbell, "Our original plans were on the ambitious side." But now he says IMI is shipping more than 100 a month of its \$1,500, 11-megabyte model 7710.

Two directions. The new disk drives seem to be falling into two camps. Some are aimed at directly replacing flexible-disk units. With the same cabinet dimensions as a floppy drive, such units employ conventional stepping-motor positioning, have a typical access times of 80 milliseconds, and limit storage capacity to 5 megabytes or so. In comparison, the floppies have an average access time of 280 to 350 ms and currently store a maximum of 1.6 megabytes.

The other approach follows IBM's lead with its model 62PC 8-in. drive, which has the latest rotary voice-coil positioning, 27-ms average access, and capacities up to 64.5 megabytes and is somewhat more expensive.

Micropolis' Mabon and Perotec's Benedict opt for this tack because they see as the heavyweight demand area on-line uses that floppy units never had the performance to meet.

The Perotec drive, model D8000, with 50-ms average access time and up to a 20-megabyte capacity, will be ready for evaluation in August. Samples go for \$3,000, and production quantities for \$1,800 to start out, with reductions expected as competition heats up.

Micropolis offers its new hard-disk drive, called the Microdisk, for about the same sample price, beginning in June. Access time is 32 ms, in 9- to 45-megabyte configurations. Volume manufacturing is expected by late 1979 at an OEM cost of \$1,350 for 1,000 or more.

Kennedy Corp. will have its first drives, yet unpriced and with 4 to 12 megabytes, in late summer, and Shugart's new unit may come in September. Control Data, though, won't name a date. **-Larry Waller**

Radar

Hughes processor has programmability

For the military, putting large-scale integrated devices into airborne gear has been a tough act to get off the ground. Device technology moves so fast that government procurement agencies cannot freeze it into hardware specifications. And development cycles for avionics equipment are long, and, for LSI, there are perennial second-sourcing problems. But an advanced airborne signal processor currently undergoing flight testing in one of the newest multimode radar systems, the AN/APG-65, bids to bring the services up to date fast in the flashy digital LSI world.

Called a programmable signal processor, it was developed by Hughes Aircraft Co., Culver City, Calif., where a team of designers and software specialists have spent years on it. Their aim is to give the U. S. Navy and Air Force a previously

unheard of radar capability: the flexibility to reprogram quickly in the field with tape for different tasks. Present radar systems are locked into hardware that essentially cannot be changed without undergoing extensive redesign.

If coupled with improved radar-beam technology, the new processor could help pick up targets at much longer ranges than at present, and its multimode nature could control firing missiles at many targets simultaneously, rather than singly. The importance of the new radar is underscored by its being rushed into the hottest U. S. aircraft around: the Navy's F-18 Hornet strike fighter. It will also be retrofitted into the Air Force F-15. First units will go into aircraft beginning in the middle of 1980.

A combination of advanced LSI devices and innovative computer architecture allows Hughes to build the programmable machine to perform 7.2 million operations per second, much faster than mainframe general-purpose computers. Generally, in signal processing the radar analyzes the return and picks out real airborne targets using special algorithms that sort through such spurious data as unimportant movement on the ground, general clutter, and enemy countermeasures.

Pipelines. Hughes considered that signal processing has a "structured nature, so data and control paths can be kept almost completely separate from one another with little or no penalty," explains Richard R. Fachtmann, assistant manager of the signal processing laboratory at the Hughes Radar Systems Group. This, in turn, allows what he calls the equivalent of "simultaneous fetch" of instructions from separate memories and results in great flexibility for the order in which data is stored and manipulated. The architecture of the Hughes processor, therefore, bears little resemblance to that of a conventional computer, being laid out in separate pipelines for virtually simultaneous parallel execution of instructions.

As many as nine instructions in different phases of execution can be

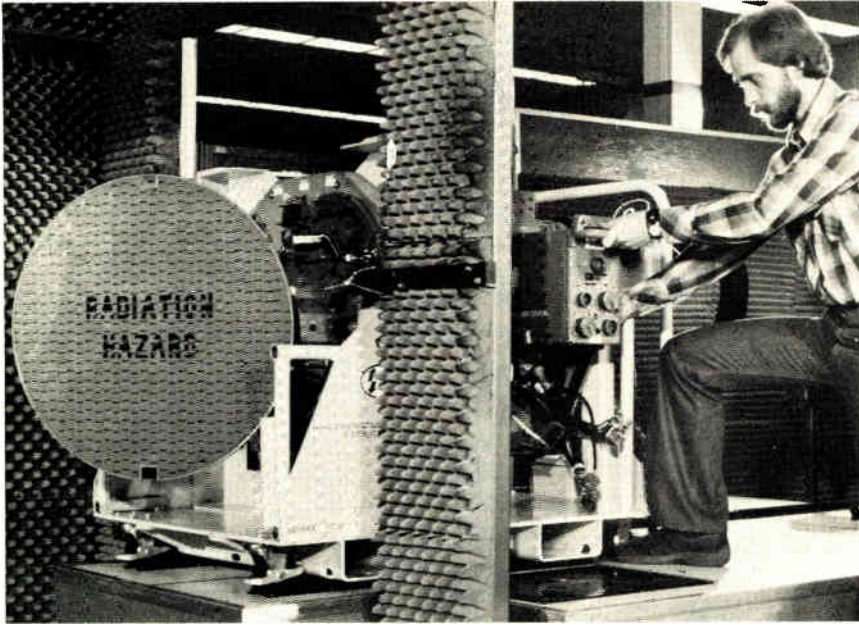

Extractable. Technician adjusts programmable signal processor developed by Hughes in its position aboard AN/APG-65 radar being set up within an anechoic chamber.

performed at the same time," he explains. The processor is "an ensemble of high-speed pipelined structure, distributed memories, and multiple parallel arithmetic circuits configured to perform particular types of processes."

A mixture of semiconductor LSI technologies chosen for speed implements the processor architecture, including Schottky transistor-transistor logic clocked at 150 nanoseconds and emitter-coupled logic at an even faster 50 ns. This approach puts the parts count at about 12,000, of which 5,000 or so are ICs.

The all-digital nature of the radar and the new processor should yield what the Air Force calls "a new level of reliability," or a mean time between failures of more than 106 hours. Hughes says this is approximately three times better than the best existing radar system, and 10 times that of most of the radars now being used. Such reliability should make the units cheaper for the services in the long run, despite higher initial acquisition costs.

A big contributor to the reliability advance is the proven nature of all its semiconductors, which, Fachtmann says, "come from outside vendors, standard suppliers, all second-sourced." Furthermore, because

the unit is divided into 11 plug-in card modules, replacement and repair should not be difficult to perform.

-Larry Waller

Memories

Mostek to sell IBM add-ons

At a time when suppliers of add-on memory systems for IBM mainframes are being severely squeezed by the late-1978 round of IBM price cuts, Mostek Corp. is quietly making plans to jump into the market with a series of add-ons designed for the top-of-the-line 303X machines.

Officials at the Carrollton, Texas, company say they have already completed advanced tests on the new Mostek 830 series and are now ready to begin marketing the systems to original-equipment manufacturers. The new product line, which also includes an IBM 370/168-compatible system, is scheduled to bow at the National Computer Conference in New York next month.

Ready. Despite one-time industry fears that 16-K dynamic devices would not be fast enough for use with IBM's high-speed 3033 proces-

sor [*Electronics*, June 22, 1978, p. 48], the potential timing problems have now been overcome by various interfacing techniques, says Gene Kruschke, large systems program manager for Mostek's memory systems group.

Mostek's 832, 833, and 868 systems will use MK4116 dynamic random-access memories built by Mostek to provide up to 16 megabytes of memory within a single 26-by-30-inch unit for use with System/370 models 3032, 3033, and 168 machines, respectively. Maximum 831 system capacity for use with the IBM 370 model 3031 processor is pegged at 8 megabytes using the same 16-K chips.

Among other things, Mostek is counting on a system design optimized for both easy field maintenance and easy upgrading to next-generation station chips to give its product line staying power in the \$500 million IBM add-on marketplace. By selling only to OEMs, the firm will be going head to head against Intersil Inc. The Cupertino, Calif., company is the prime force in the OEM add-on market, since National Semiconductor reportedly lost much of its OEM base following its move to begin marketing to end users last year.

Homegrown. Kruschke contends that by building its own chips, Mostek will have an edge over Intersil, which also has a new family of add-on systems that use 16-K dynamic chips. Unlike Mostek, Intersil is expected to purchase its 16-K RAMs from an outside vendor.

As Kruschke sees it, Mostek's major competition in the 303X add-on market will come from Intersil and from Intel Corp., which markets its systems directly to end users. Other competitors, he believes, will become less of a factor in part because of continuing downward price pressure, which followed IBM's cutting of end-user prices by 30% to \$75,000 per megabyte last year [*Electronics*, Dec. 21, 1978, p. 38].

Because Mostek will market only to OEM customers, prices for the 830 series, to be competitive with Intersil's, are unavailable.

For the end user, Intel says it is

Hybrid Systems ADCs: Unbeatable



Outperforms ADC82.

A $2.5\mu\text{S}$, 8 bit, ready-to-use replacement. ADC542 is the only available low-cost, high-speed design for Hi-Rel needs. $\frac{1}{3}$ less power consumption than ADC82. Operates from -55°C to $+125^\circ\text{C}$.



70% less power than ADC85.

And ADC581-12 operates over the full MIL temperature range. 12-bit conversion in $17\mu\text{S}$. Directly replaces ADC85/84.

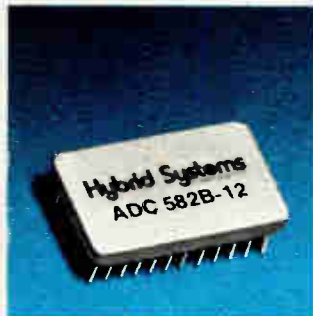

Replacement for MN5200, converts in $10\mu\text{S}$.

Totally adjustment free. ADC582-12 operates over the full MIL temperature range. Features low power, 12 bits, small size.



Replacements for 4132-22 and 4133-22.

ADC593-12 — converts 12 bits in $3.5\mu\text{S}$; drop-in replacement for the 4132-22 — at 25% less cost. ADC594-12 — no missing codes 12-bit conversion in $2\mu\text{S}$; replaces 4133-22; tri-state outputs.

Backed by more than a decade of leadership in data conversion, these five ADCs from Hybrid Systems represent significant advances in Hi-Rel and commercial design.

We use proprietary thin-film networks in our data converters to assure top performance. And to guarantee the finest quality available, nearly one third of our manufacturing labor is devoted to inspecting and testing at various stages of production.

From satellite systems to navigation and guidance equipment to demanding industrial and commercial requirements — whatever the application — Hybrid Systems products meet the highest standards for performance and reliability.

For fast results, call or write. Or circle the number(s) on the reader inquiry card.

When the chips are down . . .

Hybrid Systems

CORPORATION

Crosby Drive,
Bedford, MA 01730
Phone (617) 275-1570
(TWX 710-326-7584
HYBRIDSYS BFRD)

In Europe: Hybrid Systems GmbH,
61 Darmstadt, Luisenplatz 4, Germany
Tel. 6151-291595
(TELEX 419390 HYSY D)

In the United Kingdom:
Hybrid (Component) Systems U.K. Ltd.
12A Park Street, Camberley, Surrey
Tel. (0276) 28128
(TELEX 858720 HYBRID G)



Circle 43 on reader service card

currently selling 1 megabyte of memory for \$50,000. The systems are built with 4-K static devices. According to Kent Mueller, marketing director for Intel's Commercial Systems division in Phoenix, the company has no plans to go to higher density chips this year. Instead, Mueller indicates, it will wait until 16-K static chips are available, rather than changing current board designs to accommodate 16-K dynamic parts. —Wesley R. Iversen

Solid state

C-MOS touch given micros, op amps

Operational amplifiers are usually built with bipolar transistors, and microcomputers most often use n-channel devices, but Intersil Inc. says one technology can do both well: complementary MOS. In fact, with the addition of a one-chip microcomputer family and a line of operational amplifiers, the Cupertino, Calif., company will have nearly reached its goal of across-the-board

C-MOS alternatives to analog and digital integrated circuits.

Each of the two latest product announcements (see "Intersil's C-MOS drive")—which include 11 op-amp offerings spun off a single design and the first members of a microprocessor family that mirrors in C-MOS the popular MCS-48 line from Intel Corp. in nearby Sunnyvale—is significant beyond the lower power requirement inherent in this technology. The op amps, for example, can operate with a supply of as low as ± 0.5 volt—significantly less than the ± 1 -V bipolar op-amp design touted by National Semiconductor Corp. [*Electronics*, March 29, 1979, p. 115].

Other phases. Also, the C-MOS op-amp design offers a programmable quiescent current that may be set between 10 microamperes and 1 milliamperes, according to the bandwidth and current-drive capability required. Further, the devices have an input impedance even higher than that of op amps built with junction field-effect transistor— 10^{12} ohms.

The first microprocessor part, Intersil's IM87C48, has erasable programmable read-only memory

(E-PROM) on chip and is therefore equivalent to Intel's 8748 prototyping version of the ROM-based 8048 microcomputer. Making it is to Intersil's credit, since the E-PROM process, a tough one by any measure, is even more difficult to combine with a microcomputer circuit.

The company's E-PROM expertise comes from experience with its 6653 and 6654, 4-kilobit devices that are the only C-MOS E-PROMs on the market. Its 87C48 is not only pin- and function-compatible with the Intel part, but offers an extended operating temperature range—also inherent with C-MOS—of -40° to $+85^{\circ}$ C.

The main attraction of Intersil's latest C-MOS efforts, however, is in the low power. "We can now offer a complete data-acquisition system—from analog-to-digital converter, sample-and-hold circuits, amplifiers, and multiplexers, all the way to the digital controller—in C-MOS," says Jerry Zis, director of analog product marketing, "and the entire system can be battery-operated."

The one-chip microcomputer is a natural in C-MOS—battery-operated equipment such as handheld data loggers which cannot afford the $\frac{1}{2}$ -watt consumption of the 8748, can serve the 50-milliwatt worst-case dissipation of the 87C48. Moreover, the C-MOS part can operate in a standby mode with its clock stopped, drawing a scant 500 microwatts.

Prices. Since it is a prototyping part, the 87C48 carries a high price tag of \$82.50 in unit quantities, but that is not much more than the Intel equivalent. Other parts in the microcomputer family will be priced at a 10% to 20% premium over n-channel equivalents. —Raymond P. Capece

Intersil's C-MOS drive

The goal of Intersil is shared by both analog and digital product areas: to establish complementary MOS in those standard products where the low-power technology was not exploited before. Here are the new families.

As for linears, in all, 11 op-amp products are available, all built around one basic design. Variations in the 76XX family, packaged as single, dual, triple, and quad versions, include:

- Programmable quiescent currents of 10 microamperes, 100 μ A, or 1 milliamperes.
- Externally compensated versions for optimizing ac characteristics.
- Versions with common-mode input protection to 200 volts.
- A version that allows input voltage swings to exceed supply voltages.

In the digital area, Intersil will at first closely parallel Intel Corp.'s MCS-48 and MCS-41 families of microcomputer chips, then will branch off to proprietary products that best serve the low-power market. To begin:

- The 87C48, equivalent to Intel's 8748, single-chip microcomputer with 1 kilobyte of erasable programmable read-only memory and 64 bytes of random-access memory. Samples are being shipped now.
- The 87C41, equivalent to Intel's 8741 programmable peripheral interface chip. Samples are being shipped now.
- The 80C48 and 80C41, masked-ROM versions of those two parts, due at year-end. Also coming is a proprietary 2-kilobyte version of the 80C41.
- The 80C49, equivalent to Intel's 8049 one-chip microcomputer with 2 kilobytes of ROM and 128 bytes of RAM. Samples will be ready by year-end.
- The 80C35, equivalent to Intel's 8035, which has 64 bytes of RAM but uses outboard ROM for program storage, due at year-end.

Trade

China seeks Western technology

China needs the help of advanced Western nations if it is to launch itself into the computer, communications, and semiconductor advances

Amperex SOT 23 and SOT 89 microminiature semiconductors give you higher yields with maximum flexibility.

Amperex offers a broad line of highly reliable fully characterized semiconductors in two standard microminiature plastic packages... SOT-23 and the slightly larger SOT-89. Both packages are ideally suited for reflow soldering and are equally adaptable to automatic or hand-assembly on thick or thin film and on conventional PC boards.

The Amperex line of SOT-23 and SOT-89's has grown to include just about everything needed by today's circuit designer: ■ Single and dual switching diodes ■ Schottky diodes ■ zeners ■ varicaps ■ general purpose NPN and PNP transistors ■ high frequency and wide-band transistors ■ N-channel FET's ■ high speed switches ■ high voltage and high current types.

Amperex SOT-23's and SOT-89's can be intermixed on all hybrid IC substrates—thick or thin. And, to further enhance design flexibility, all of our SOT-23 bipolar transistors are available in your choice of standard or reverse pin-out polarity at no extra charge.

An exclusive metallization system eliminates all three

of the major failure mechanisms that once caused reliability problems for 'plastic semiconductors'; intermetallics... electromigrations... and corrosion do not occur in Amperex SOT-23's and SOT-89's. These microminiature semiconductors are projected to provide life expectancies up to ten times longer than conventionally-manufactured 'plastic' microminiature components.

For your free copy of our 280-page data book covering nearly 150 devices in the industry's original and most extensive line of plastic-packaged microminiature semiconductors, contact: Amperex Electronic Corporation, Slatersville, Division, Slatersville, Rhode Island 02876. Telephone: 401-762-3800.



Amperex®

TOMORROW'S THINKING IN TODAY'S PRODUCTS

A NORTH AMERICAN PHILIPS COMPANY

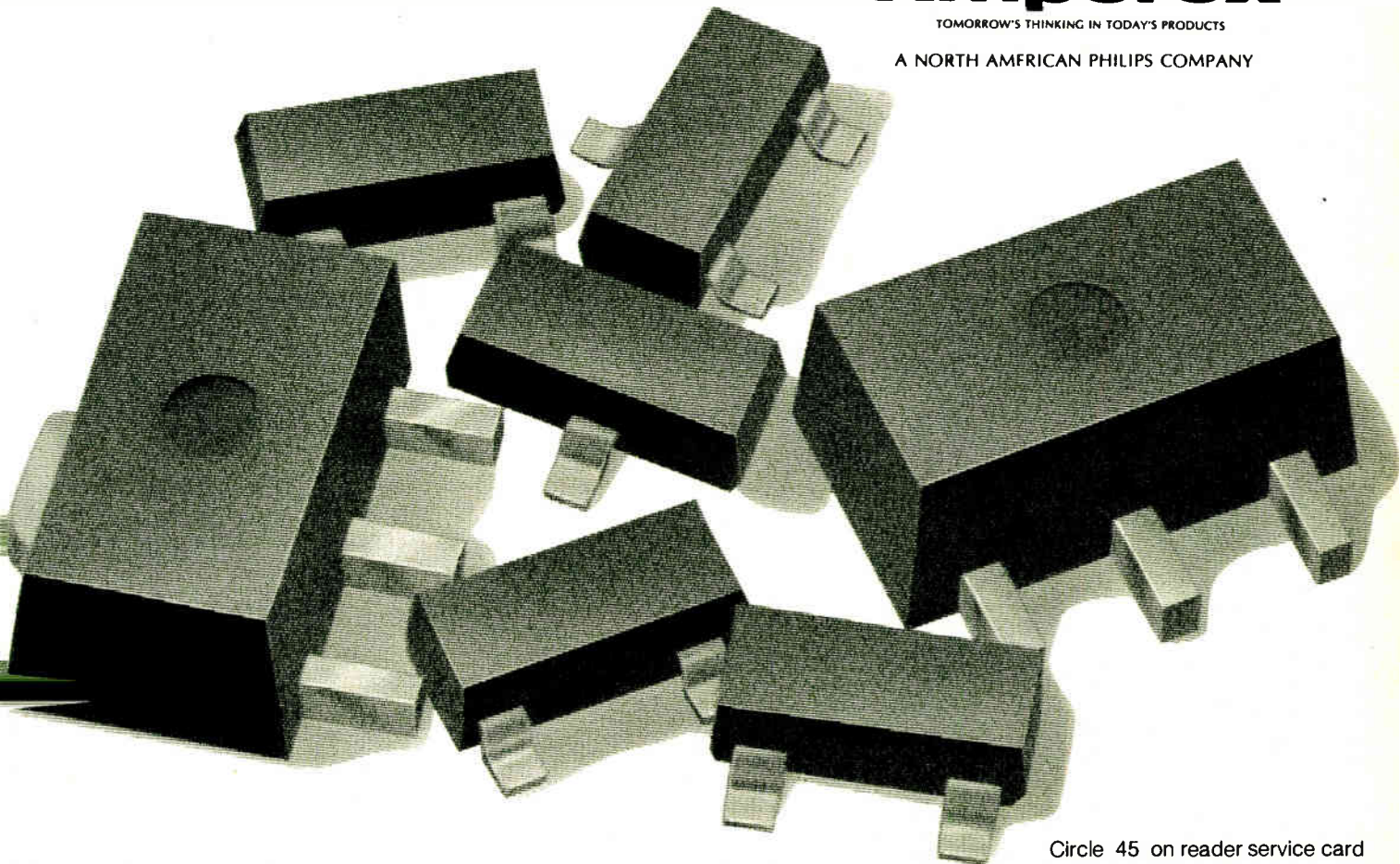

Circle 45 on reader service card



At Electro. China's Luo Pei-lin spoke of technological partnerships.

now leading the Western world into a second Industrial Revolution. That is the thrust of the message delivered by Luo Pei-lin, vice president of the Chinese Electronics Society, late last month at Electro79, the annual convention of the Institute of Electrical and Electronics Engineers held in New York City.

At a panel discussion on electronics problems and opportunities around the world, Luo made clear China's interest in technological partnerships. It wants external assistance—initially as imports to meet the demand for products, but also as help in building up domestic industries quickly to meet that demand. He called self-sufficiency China's most important goal. There is little interest in developing an export industry, he said.

The Chinese also want to improve engineering education. While not mentioned at the Electro session, the Chinese Electronics Society has asked the IEEE about ways to sponsor study in the U.S. (The CES corresponds to the IEEE's elective societies, the Chinese Electrical Engineering Society corresponds to the IEEE's power society.)

Prominent in the work going on in China are space electronics and computer projects. Seven domestic satellites have already been launched and plans are under way for satellite communications systems. In computers, the Chinese have a series of million-instruction-per-second mainframes and Nova- and PDP-11-compatible minicomputers in

production. Chinese semiconductor makers are just now going to medium-scale integration, Luo said, with work under way in all major processes. Research has also begun in fiber optics and bubble memories.

An IEEE delegation to China last year reported that electronics manufacturing needs considerable modernization [*Electronics*, Jan. 4, 1979, p. 92]. Luo confirmed at Electro that production is definitely one area where China needs outside expertise.

Other speakers at the panel of top executives, chaired by Texas Instruments' president J. Fred Bucy, emphasized how determined their nations are to overtake the American lead in advanced electronics technology. Among the points made:

- Japan's VLSI project, due to end next March, will see the basic technology it has developed applied by the six semiconductor firms that worked with the government, said Michiyuki Uenohara of Nippon Electric Co. It looks as though each firm will go its own way in designing the mainframe computers that are the project's ultimate goal.

- Germany is about to launch a major program to strengthen domestic VLSI programs, said Hans Reiner of Standard Elektrik-Lorenz. In part, the effort is spurred by the failure of U.S. semiconductor makers to provide adequate design assistance to overseas system houses and to match the low reject rates of similar Japanese products, he said.

- The British government is acting as a venture capitalist in funding Inmos Ltd., the new semiconductor maker, because the country has done so poorly in translating its impressive research and development efforts into products, said Ian Mackintosh of Mackintosh Consultants Ltd. of England. Also planned is an office-electronics project.

- France is bent on strengthening all its electronic industries as replacements for other, dying industrial sectors, said Pierre Bonelli of Sema-Metra. Semiconductor advances are the key, he says, so the government is encouraging technology exchanges and joint ventures with American firms.

-Benjamin A. Mason

Companies

Fairchild's situation attracts takeover

It should come as no surprise that Fairchild Camera and Instrument Corp. would be a takeover target for a company like Gould Inc., a \$1.8 billion conglomerate headquartered in Rolling Meadows, Ill., near Chicago. Fairchild, in Mountain View, Calif., reportedly has been closely scrutinized by several companies with a takeover in mind the last few years.

Buy in. "Basically, there's a lot of interest out there in semiconductor manufacturing and technology," observes one industry analyst. He points out that the easiest way for a nonelectronics company to get into the business is by acquisition. Fairchild, with \$534 million in 1978 net sales, has a reasonable enough size and reputation to be attractive.

But Silicon Valley neighbors speculate about other factors that may be sparking interest in Fairchild. One obvious one is that "there aren't a whole lot [of semiconductor makers] available to buy," as an industry analyst notes. He points out that large companies that are not growing very fast often become takeover candidates partially because prospective buyers think they can improve operations.

Fairchild, long the spawning ground for new companies, technology, and talent, has not matched the brisk growth rate of some of its newer competitors. Intel and National Semiconductor, for example, are growing some two to three times faster.

Moreover, Fairchild's net 1978 income was only \$24.8 million, and royalties from patents, which contributed \$10.8 million to pretax profits, are due to stop at the end of this year, according to a spokesman for the company.

Some observers blame this performance on unfocused management. Responds a Midwestern executive who buys quantities of Fair-

THE DSW WAFER STEPPER.™

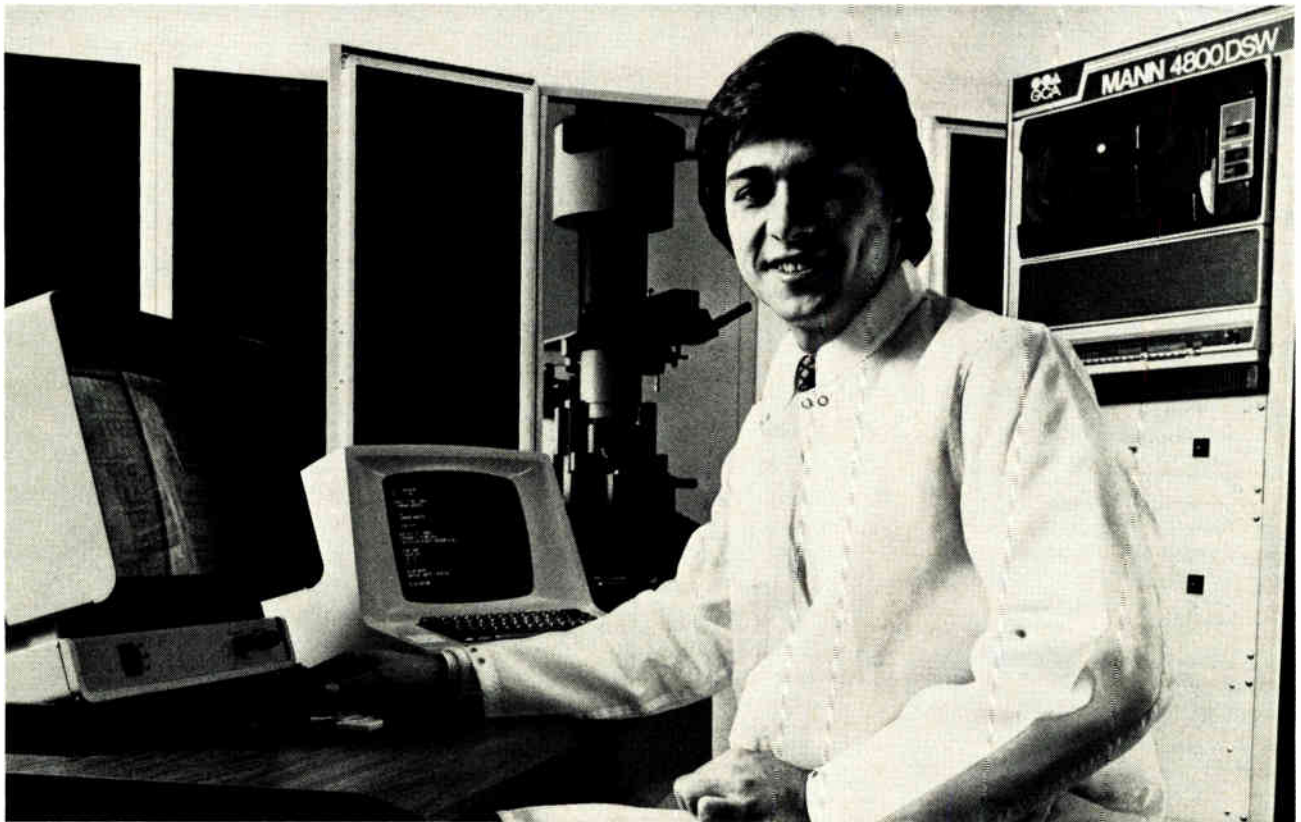

Funny thing about micro-imaging systems. A lot of them need daily adjustments. Which tend to be a daily pain.

But the DSW is painless. Once it's set to go, you can forget about daily adjustments. And because wafer handling is automatic, you can forget about that, too.

The DSW is a complex, state-of-the-art system. But for all its sophistication, it's a high throughput, high yield, day-in and day-out production tool.

It's also simple to operate and easy to

maintain. We can give you immediate, on-the-spot service, no matter where you're located. Or we can train your own people to maintain it.

Over fifty systems have already been ordered by over twenty-five IC manufacturers. If you'd like to know why, ask us for literature. If you'd like to see why, ask for a demonstration. Write Bill Tobey at GCA/Burlington, 174 Middlesex Turnpike, Burlington, Massachusetts 01803. Or call him at 272-5600. Telex: 94-9352.



GCA CORPORATION
Burlington Division

174 Middlesex Turnpike
Burlington, Mass. 01803
(617) 272-5600
Telex: 94-9352

Part of the
GCA/IC Systems Group

ONCE YOU ADJUST IT, IT JUST WON'T STOP

For Rent Now

Rental Electronics rents all kinds of Amplifiers, Analyzers, Calibrators, Counters, Couplers, Generators, Meters, Micro-computer Development Systems, Modulators, Oscillators, Oscilloscopes, Power Supplies, Printers, Probes, Recorders, Synthesizers, Terminals, Test Sets... and much more.

Rental Electronics rents equipment from ADDS, Ailtech, Associated Research, Beehive, Biomation, Boonton, Brush, Dana, Data I/O, Digitek, Doric, Dranetx, Elgar, Esterline-Angus, Fluke, GenRad, Halcyon, Hewlett-Packard, Honeywell, Hughes, Intel, Keithly, Krohn-Hite, Lambda, Lear Siegler, Marconi, Monsanto, Narda, Nicolet, Northeast, Power Design, Programmed Power, Singer, Sorenson, Tally, Techni-Rite, Tektronix, Tenney, Texas Instruments, Wavetek...and many more.

Rental Electronics, Inc. Rental Centers **In the U.S.:** Anaheim, CA (714) 879-0561 • Mountain View, CA (415) 968-8845 • Northridge, CA (213) 993-7368 • Ft. Lauderdale, FL (305) 771-3500 • Orlando, FL (305) 351-3015 • Des Plaines, IL (312) 827-6670 • Burlington, MA (617) 273-2770 or (800) 225-1008 • Gaithersburg, MD (301) 948-0620 • Greensboro, NC (800) 638-4040 • Oakland, NJ (201) 337-3788 or (800) 452-9763 • Rochester, NY (800) 631-8920 • Cleveland, OH (800) 323-8964 • Dallas, TX (214) 661-8082 • Houston, TX (800) 492-9021 • Seattle, WA (206) 641-6444 • **In Canada:** Vancouver, BC (604) 278-8458 • Rexdale, Ontario (416) 675-7513 • Montreal, Quebec (514) 681-9246.

Call one of our rental centers today for immediate action. Or return this coupon to Rental Electronics, Inc., 19347 Londelius St., Northridge, CA 91324.

- Send me your Rental Catalog.
- Send me your Equipment Sales Catalog — I may be interested in buying some of your "previously owned" equipment.
- I have an immediate need for the following rental equipment:

Please have someone from your nearest Inventory Center phone me at _____

Name _____
Title _____
Company _____
Address _____
Mail Stop _____
City _____
State/Zip _____
Phone _____



**Rental
Electronics, Inc.**

EL 5/10/79

GSA # GS-045-21963 Neg © 1979 Rental Electronics, Inc.

Electronics review

child microprocessors on hearing of Gould's \$300 million offer in cash and common stock: "It's great news for us because Gould has a reputation as a good manager, and that's what Fairchild needs."

Strong points. To be sure, at over half a billion dollars in sales, Fairchild is making its mark. Its well-respected Sentry and Xincom automatic tester lines, for example, are selling very well, pouring in more than 23% of the total 1978 sales. Its bipolar technology is an industry leader, and its military business is a good deal larger than is commonly realized, according to one company executive.

However, some believe that Fairchild's future as a strong electronics company will depend on key changes. "In my mind, one big mistake for the last decade now is in the MOS area," observes Mel Eklund, vice president of Integrated Circuit Engineering Corp., a Scottsdale, Ariz., consulting firm.

"They're not really pushing MOS with their heart in it," he continues. "They apparently seem to feel that their bipolar prowess will pull them out of it." He says that Fairchild's bipolar capability is good, especially the 100K emitter-coupled-logic family, but wonders how large that market really is.

Gould, though primarily known for its battery technology, has been expanding its production base the last several years through mergers and acquisitions that include electronics-oriented firms. A company like Fairchild would position it to capture a bigger share of the growing electronics marketplace, Gould executives believe.

In 1977, Gould bought Modicon Corp., a leader in processor-based programmable controllers. It followed with two other electronics company purchases in 1978: Hoffman Electronics Corp., an El Monte, Calif., maker of navigation and communications gear; and Biomation, a Santa Clara, Calif., leader in digital logic analyzers. Gould also developed the ink-jet printer used by IBM that has been licensed to other vendors.

-William F. Arnold

Software

TI offers routines in plug-in ROM

With more of its new products aimed at industrial process control and other applications, Texas Instruments Inc. is offering a series of executive software routines. The series is packaged in plug-in erasable-programmable read-only memories that offer sophisticated program development to a not-so-sophisticated computer user.

Referred to as Timber (for TI Modular Based Executive in ROM), the new package was announced last week. Timber is housed in four 2716-type E-PROMs used in conjunction with TI's low-priced TM990/302 module-level development system [*Electronics*, Dec. 7, 1978, p. 82]. With user-summoned routines that can be employed in building-block fashion, Timber is a subset of TI's earlier TIPMX package (TI Pascal Microprocessor Executive) announced last year.

But unlike its predecessor, Timber does not require a 990 minicomputer development system. With a Timber package, a 302 development module, a 990/201 memory expansion board, and a terminal, a user can have—for as little as \$3,200—a system capable of developing a typical industrial-process applications program using assembly language routines and with a minimum of programmer effort, according to TI officials.

Timber routines packaged in ROM provide end-application capabilities including memory management, interrupt servicing, real-time clock handling, interprocess communication, and synchronizing priorities in multitask environments. With the plug-in ROMs and the 302 module, the link-edit abilities associated with sophisticated software development systems are not required. The configurable Timber package comes with documentation that helps take the inexperienced user through a demonstration process in the erasable ROM, which is later erased and

How Rental Electronics helps you avoid terminal obsolescence.

As soon as you take delivery on a new printer or data terminal these days, it seems the next generation is already being announced. Chances are, it has capabilities that begin to make your "new" equipment obsolete. Now, thanks to Rental Electronics, you can have your terminals and highest technology, too.

Renting electronic equipment instead of buying gives you immediate delivery of state-of-the-art products with no capital investment. And since our rental prices are so low, you can easily afford to upgrade to the latest in printers and terminals as new technology arrives.

Rental Electronics means the highest quality equipment, too. Choose your terminal or printer from our multi-million dollar selection of leading industry brands.

Above all, renting means flexibility. That's why

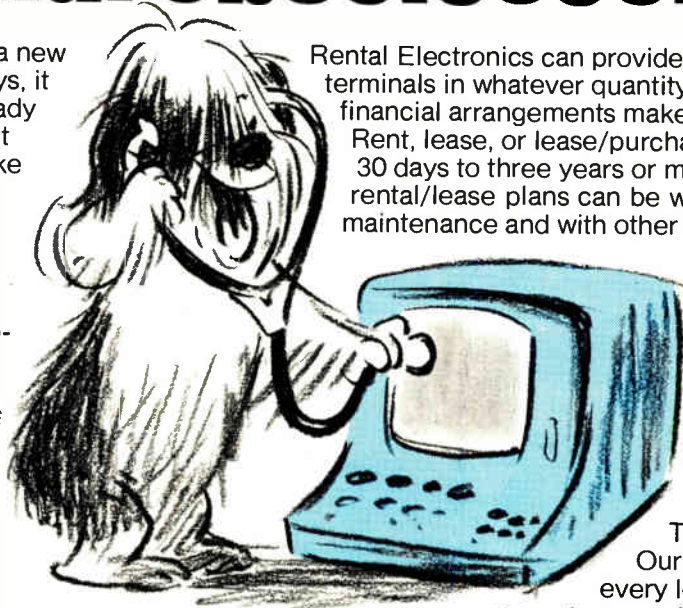

Rental Electronics can provide you printers and terminals in whatever quantity with whatever financial arrangements make best sense for you. Rent, lease, or lease/purchase one to 1,000... for 30 days to three years or more. You tell us. Our rental/lease plans can be written with or without maintenance and with other special features tailored to your needs.

If you're interested in more information on renting printers or terminals from Rental Electronics, call one of our local rental centers today.

They're listed opposite. Our on-line computers at every location let us give you price and availability information instantly, while you're still on the phone. In the meantime, check some of our featured rental offers below.

Printers and Data Terminals

Here is a sampling of the printers and data terminals available from Rental Electronics. Call or write today about your specific needs.

TI Model 820 Keyboard Send-Receive Data Terminal/Printer

Printer operates at 150 cps on 9 x 7 wire matrix assembly printhead. Full ASCII Keyboard (ANSI-compatible) with N-key roll over. Operates in Asynchronous, USASCII, RS232C interfaces and is compatible with Bell 103, 113, 202 and 212 units. Selectable baud rates of 110 to 9600.



Hewlett-Packard 2621A/P Terminals

Enhanced 9 x 15 dot character cell, full 128-character ASCII character set in 24 80-character lines. Two pages of continuously scrolling memory. RS232C and Bell 103A compatible. 110 to 9600 baud. 2621/P includes built-in printer operating at 120 cps.



Tally T-2000 Hush-Tone Line Printer

Acoustically designed enclosure. Operates at 125 (Model 2100) and 200 lines/minute (Model 2200) with standard 64 character USASCII. Line spacing switch selectable, 6 or 8 per inch.

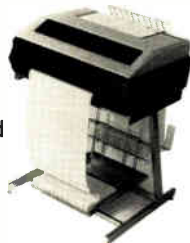

ADDS Regent 200 Terminal 24 lines x 80 characters, 25th "status" line shows operating mode. 128 character ASCII. RS232C/CCIT V.24 communications interface operating 75 to 19.2 BPS, switch selectable. Buffered transmission, auxiliary ports.

Beehive Micro B 1A Terminal 128 ASCII character set; switch selectable scroll/non-scroll mode; X-Y addressing; 24 x 80 display format; single key memory lock; fully buffered communications to auxiliary peripheral device.



Lear Siegler ADM-3A Data Entry Display Terminal 12" diagonal, 24-line screen. 64 ASCII characters. Full or half duplex operating modes, switch selectable, baud rates from 75 to 19,200. RS232C interface, 20mA current loop.

Rental Electronics, Inc.

An AMERICAN company

... a different breed.

MULTIBUS compatible data acquisition and control systems.

The ADAC 700 Series of data acquisition systems plug directly into the MULTIBUS of single board computers from Intel and National. The 710 Series is the first low level analog to digital system available that includes such unique features as the capability to withstand common mode voltages of up to 250V while digitizing low level outputs from bridges, thermocouples and other low level transducers. A software programmable gain amplifier with optional cold junction compensation circuit can be programmed on a channel to channel basis. The low level analog to digital card and low level multiplexer expander card can be supplied with either 8 or 16 differential inputs per card. Resolution is 12 bits.

The 735 A/D high level analog to digital series is supplied with 16 to 64 single ended or pseudo differential inputs. It also is jumper selectable for 8, 16, or 32 differential analog inputs. The inputs can be either voltage or current loop. The 735 A/D features a 12 bit high speed analog to digital converter with throughput rates of 35 KHz basic and 100 KHz optional. The series include bus interfacing with a software selection of program control/program interrupt and a jumper selection of memory mapped I/O or isolated I/O. Up to 2 channels of 12 bit digital to analog converters can be supplied.

The extensive series of MULTIBUS compatible analog I/O boards is further complemented by the 735 DAC Series. They are supplied with up to 4 channels of 12 bit digital to analog converters, MULTIBUS interfacing, 2 scope/recorder pen control circuits, 8 discrete digital outputs with 8 high current sinks, 8 discrete digital inputs, and memory mapped or isolated I/O interfacing. Optionally available are third wire sense for ground noise rejection and 4 to 20 ma current loop outputs.

Send for full technical data:

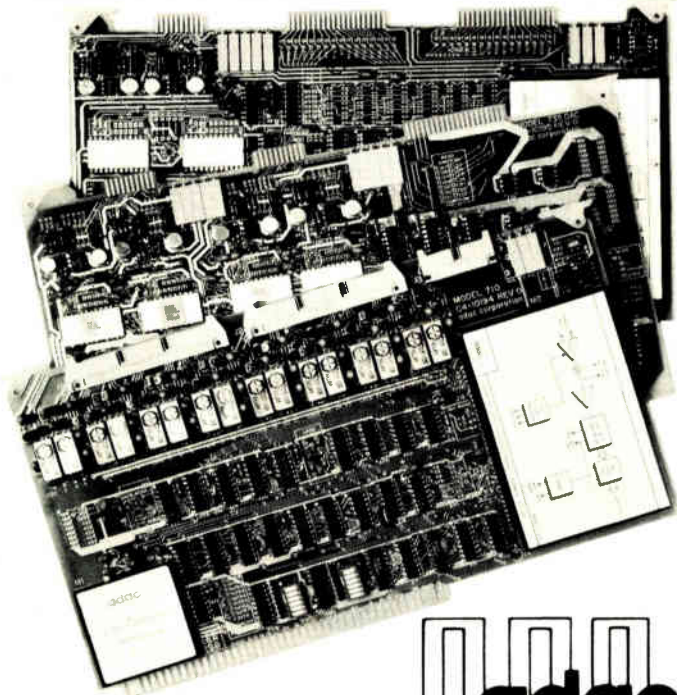

adac
CORPORATION

70 TOWER OFFICE PARK • WOBURN, MA 01801 • 617-935-6668

Electronics review

display it first showed last summer as the keyboard for the system. The flight progress strips are, in effect, displayed on this CRT terminal, together with a list of commands for moving and changing the data.

Matrix. An array of infrared beams crisscrosses the face of the CRT from the top, bottom, and sides. The beams are produced by light-emitting diodes placed about a half inch apart. The controller selects information displayed on the screen by touching it with a finger and breaking the beams. The beams are aimed to overcome parallax problems common to a curved viewing area. Logic determines the selection.

Sanders will deliver a computer subsystem and six consoles, each consisting of two 25-inch CRTs, the interactive display, and data-entry devices, to the FAA's National Aviation Facilities Experimental Center in February 1980. If the system proves satisfactory, all 20 en-route traffic control centers around the nation should have the system in place by 1984, according to Edwin J. Rearnick, Etabs systems manager at Sanders.

-Pamela Hamilton

Computers

Barton receives architecture award

As electronics technology has gotten more complex, it has bred specialties among its practitioners. One of the newest coming into prominence is computer architecture. Now it is important enough to have its own award for excellence.

The Institute of Electrical and Electronics Engineers' Computer Society and the Association for Computing Machinery created the award—which includes a \$1,000 check—this year and appropriately enough named it after John Mauchly and J. Presper Eckert, the inventors in 1946 of Eniac, the first electronic digital computer.

Late in April, at the Sixth Annual Symposium on Computer Architecture in Philadelphia, the two pio-

“At MCT, We Take The Sweat Out of Buying a Hot Handler...”



... With Our Model 2608E”

Considering elevated temperature DIP testing? Our MCT* Model 2608E Elevated Temperature Handler provides accurate ($\pm 1^\circ\text{C}$) hot handling at temperatures up to 125°C and eliminates the installation, performance and maintenance worries of other handlers. no sweat.

We install every Model 2608E, and we train your operators and service personnel at the time of installation. Our selection of universal logic interfaces and our comprehensive library of tester interfaces assure you that the Model 2608E will be easily integrated into your testing operation.

Key performance features like 7000 DPH speed . . . 13-track input and 8 programmable output categories . . . the ability to handle .3, .4, and .6-inch wide devices and devices with 8 to 40 leads . . . all combine to make the Model 2608E the ideal handler for incoming inspection.

Durable mechanical assemblies; five-million cycle contact life, and 'leads up' cycling of devices assure that the Model 2608E will be up and running so you won't be running to call your serviceman.

When you purchase an MCT Model 2608E from us, you benefit from our expertise as the major supplier of elevated temperature handlers to the semiconductor industry worldwide. With our strong support programs in the areas of installation, service and operator training, we can give you top-notch hot handling . . . no sweat.

For more information on the Model 2608E and our other handlers, contact Micro Component Technology, Inc., P.O. Box 43013, St. Paul, MN 55164 or call (612) 482-5170.

*MCT is a trademark of Micro Component Technology, Inc.

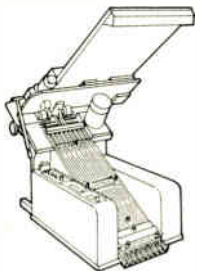

Model 2608M
8,500 DPH
Expanded Input
DIP Handler

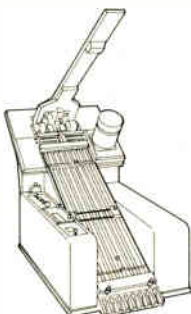

Model 2608
10,000 DPH
DIP Handler

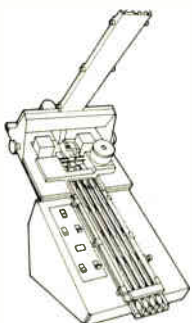

Model 2604
5,000 DPH
DIP Handler

MCT™

Circle 53 on reader service card

Johanson

SEAL-TRIMTM CAPACITORS SEAL OUT PROBLEMS

Seal-Trim Ceramic Capacitors are a new, innovative outgrowth of the popular Johanson "THIN TRIM"TM capacitor family. These sealed miniaturized variable ceramic capacitors are intended for microwave, RF, video and digital applications, where small size and contamination-free operation are required.

The sealed capacitor body is designed to prevent the intrusion of solder flux, cleaning agent and atmospheric contamination.

FEATURES:

- Conforms to Specification MIL-C-81.
- Impervious to all Standard P.C. Board Cleaning Solvents.
- Tamper Proof, Non-Slip Adjustment with Unique Square Drive Tuning.
- Low Temperature Coefficient and Drift Rates.
- High Q Factor and Frequency Response.
- Withstands Wave Soldering.

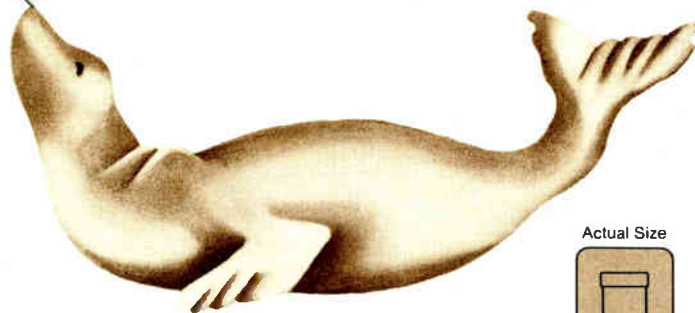

Actual Size



Patent Pending

SPECIFICATIONS:

Part Number	9610	9611	9612	9613	9614	9615
pF Range	1-4.5	2.5-10	4-18	6-35	7-40	5-25

Working Voltage: 250 VDC (500 VDC TEST)

Johanson Manufacturing Corporation Boonton, New Jersey 07005
(201) 334-2676

ELECTRONIC ACCURACY THROUGH MECHANICAL PRECISION

Electronics review



Architects. Computer system designer Robert Barton of Burroughs Corp., right, received his award for achievement in architecture last month from computer pioneers John Mauchly, left, and J. Presper Eckert.

neers presented a certificate and the check to the first winner of the Eckert-Mauchly award to Robert Barton, director of systems organization research at Burroughs Corp.

Leader. Barton lead the team that designed Burroughs' first large computer system some 20 years ago. Labeled the B5000, it was one of the first commercial computers to feature virtual memory, a master control program operating system and a multiprogramming capability that allowed more than one program to be executed simultaneously—items that have since become commonplace.

Also, as the award noted, Barton pioneered in the concept of designing computer hardware and software at the same time. Summing up, the award credited Barton with helping to make "computers simpler to understand, simpler to engineer and construct and easier to use for everyone's benefit."

In accepting the award, Barton noted that it was an article on Eckert and Mauchly's Eniac that first hooked him on computers. "I'm honored to receive this award because these two are as close to being my heroes as anyone."

Barry Borgerson, director of research and technical planning at Sperry Rand's Univac division, Blue Bell, Pa., and chairman of the conference, said that the symposium was evidence that "architecture is growing as a field of preference. Now it has established an award to recognize accomplishment in that field."

-Anthony Durniak

SCIENCE/SCOPE

The first production model of a radar that can track an artillery shell in flight and determine its origin before it hits has been delivered to the U.S. Army for tests. The Hughes-built system, called the AN/TPQ-37 artillery-locating radar, is designed to let crews return hostile fire more quickly and accurately than ever before. The system erects a sensitive electronic barrier over a broad area and can detect any projectile piercing the screen. After tracking a shell and plotting its path, the system's computer backtracks the trajectory to the firing location. The TPQ-37 is similar to the smaller, highly mobile TPQ-36 that Hughes developed for locating hostile weapons.

Communications via satellite continue to cost less every year despite inflation. The International Telecommunications Satellite Organization, crediting improved technology and efficiency of its Intelsat network of satellites, has cut its monthly charge for a full-time, two-way telephone circuit by 16 percent to \$960. The same service in 1965 initially cost \$5334. If that charge had risen with inflation, the cost today would be about \$11,000. Intelsat, a consortium of more than 100 nations, has lowered its rates for nine consecutive years. The satellites presently providing the service were designed and built by Hughes.

Are you a graduate EE, ME, or physicist with experience in project or systems engineering, optics, product design, reliability and test? Can you fit in with a very bright scientific team working on long-term high technology projects that are advancing the state-of-the-art in: lasers, electro-optics, automatic test systems, digital and analog computers, airborne space sensors, electronic/electromechanical components and devices, and a myriad of other far-sighted technical and strategic systems? If so, and if you seek challenge and just reward, contact Hughes Aircraft Company, Professional Employment, Dept. SE, Electro-Optical & Data Systems Group, 11940 W. Jefferson Blvd., Culver City, CA 90230.

A newly developed closed-cycle cooler that chills the Sidewinder missile's infrared sensor to -320 degrees F will simplify logistics support and reduce life cycle costs. The air-to-air missile's infrared eye must be super-cooled to increase its sensitivity to a target aircraft's engine heat. In the past, the Sidewinder has used an open-cycle nitrogen or argon gas cooling system that needed complex logistics support and could be turned on only for limited intervals before needing recharging. With the new closed-cycle cooler, a combat pilot may leave the missile sensor on throughout a mission with no concern for mission duration.

Under contract to the U.S. Air Force, Hughes built 10 advanced development models of the closed-cycle cooler, which are now undergoing tests. An additional 42 coolers are being built for evaluation and flights tests under an AIM-9L product improvement contract (AIM-9M) with the Navy.

Creating a new world with electronics

HUGHES

HUGHES AIRCRAFT COMPANY
CULVER CITY, CALIFORNIA 90230

GROWTH SPURS HIRING

Rockwell Plans For Continued Avionics Growth In 1979.

CEDAR RAPIDS — Rockwell International is anticipating another year of growth and new developments for its avionics and telecommunications businesses, according to sources in Cedar Rapids where Rockwell's Avionics and Missiles Group is headquartered. Rockwell's Collins Divisions have helped place the company among the largest electronic firms in the world. The company is now gearing up for development of the next generation of electronics products. Among the systems produced in Cedar Rapids are the Rockwell-Collins Pro Line and Micro Line avionics for general aviation aircraft, and a complete line of air transport avionics. Government avionics products and systems include the U.S. Air Force standard tactical air navigation system, and the complete avionics system for the new U.S. Coast Guard Medium Range Search Aircraft.

Rockwell-Collins digital flight control systems to guide new generation of commercial aircraft through the turn of the century.

CEDAR RAPIDS — A new multimillion-dollar contract awarded to Rockwell International's Collins Air Transport Division is expected to provide a baseline business for the Division through the turn of the century. The contract is for digital flight control systems to guide a new generation of commercial aircraft. It's the firm's largest single avionics project ever, surpassing even their work on the U.S. space program. The Division has immediate openings for additional engineers to help handle the increased work load.

General Aviations' new product introductions help provide continued market leadership.

CEDAR RAPIDS — The availability of exciting new technology, combined with healthy sales projections for general aviation aircraft, has helped stimulate a wave of new product introductions by Rockwell International's Collins General Aviation Division. Typical of the energetic product development efforts of the Division was the introduction this year of six new general avionics products. Among them: the first Rockwell-Collins Pro Line color weather radar and a Pro Line navigation processor which displays checklist and map information of the radar indicator; and the new Micro Line DCE-400 distance computing equipment which uses the bearing information

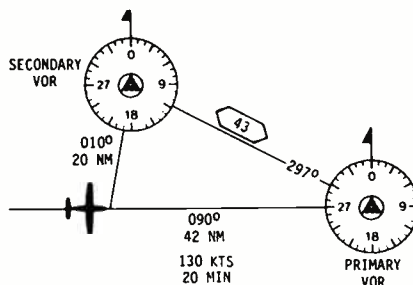

from two VOR stations to compute distance and groundspeed. (The engineer who developed the latter product was named Engineer of the Year for the Division.) The thrust of the new product development work for both product lines will be to further increase the momentum that has propelled the Division to market leadership.



New products and systems under intensive development at Rockwell's Collins Government Avionics Division.

CEDAR RAPIDS — The GPS generalized development model user equipment being developed by Rockwell's Collins Government Avionics Division continues to perform well beyond expectations in USAF Avionics Lab tests. Meanwhile, the Division continues work on the USAF standard TACAN, standard AM/FM comm transceiver, the avionics system for the USCG HU-25A and an entire new family of cockpit control and display systems. The Division is also engaged in a series of major new product and system development programs for the government avionics market, creating a requirement for engineering and technical personnel to help the Division expand its share of this growing market.

Professional Rockwell employees enjoy a wide range of benefits, including life, medical, dental and accident insurance; paid vacations/holidays; reimbursement for relocation; and excellent savings and retirement plans.

For full details, write Loren Wells, Mgr., Professional Employment, Avionics and Missiles Group, 400 Collins Road NE, M/S 120-145, Cedar Rapids, IA 52406. Attention: Dept. (E-3).



Equal Opportunity Employer M/F

Five-year plan of FAA held inadequate . . .

The Federal Aviation Administration's proposed 40% boost in fiscal 1981 spending to \$350 million for airport facilities and equipment is already drawing fire from Congress and some segments of the general aviation community—as well as from avionics makers who would be the principal beneficiaries and feel the increase is inadequate. The five-year program, called the Airport and Airway Improvement Act of 1979, calls for expenditures of \$6.6 billion beginning with the fiscal year starting Oct. 1, 1980. Facilities and equipment budgets would be increased by annual increments of \$35 million, raising funding to \$490 million in 1985. But critics note that even the FAA concedes that **the bulk of the \$1.2 billion for facilities and equipment would be used only to modernize existing physical facilities**, with the remainder going for air traffic control.

. . . as proposed 6% avionics tax irks Congress

Lobbyists for makers of avionics are upset with the FAA proposal to levy a 6% excise tax on sales of new avionics and aircraft for noncommercial aviation. So are general aviation users, already unhappy with the FAA's proposal of a 10% tax on retail fuel for general aviation only, replacing an existing tax of 7 cents on each gallon. The FAA defends the changes by noting that the new taxes **would raise general aviation's contribution to FAA service costs to only 25% from the present 14% level.**

FAA money for research, engineering, and development in Transportation Secretary Brock Adams' proposal would start at \$90 million in fiscal 1981 and rise \$5 million per year for a five-year program totaling \$500 million. Congressional committee staffers are critical of this aspect of the plan and of its provision permitting the FAA to carry over unspent funds to future years. "Both the carry-over provisions and the neat incremental increases for both R&D and facilities and equipment clearly indicate that [the] FAA has no firm program plan," says one House committee analyst. "They are simply guessing at costs. And the carry-over provisions would only give them a bankroll to cover whatever they finally decide on."

FCC may simplify licensing rules for Satcom receivers

The Federal Communications Commission is considering dropping its licensing requirement for receiver-only satellite earth stations after another Government agency protested that the process is unnecessary, costly, and time-consuming and slows technological growth. The Commerce Department's National Telecommunications and Information Administration (NTIA) wants the FCC to replace licensing with a requirement that **earth station owners file geographical coordinates and proposed use of terminals.** Prior notice would allow communications carriers like telephone companies to protest possible microwave signal interference by earth stations and protect against unauthorized use of broadcast satellite signals.

Satcom scanner, digital TASI readied by AT&T

Bell Laboratories is pushing to improve communications satellite capability and efficiency with a system "that would concentrate a satellite's transmission in a narrow beam sweeping across the country, **somewhat as an electron beam in a television set scans a screen,**" according to Billy B. Oliver. The vice president for planning and design for AT&T's Long Lines division told a Senate hearing that the satellite scanning transmitter would be in addition to a system's several fixed beams to serve major metropolitan areas.

AT&T is also researching an advanced digital version of the time-

Washington newsletter

assigned speech interpolation (TASI) technique for domestic use that **"would nearly quadruple the call-handling capacity of a group of circuits without degrading quality."** The initial analog version of TASI, introduced into overseas calling in the early 1960s, interjects other transmissions into the natural conversational pauses that account for 60% of a circuit's time. Oliver says AT&T expects to begin offering the benefits of such technologies to private-line customers after July, when the Federal Communications Commission moratorium is lifted on direct AT&T competition in the domestic satellite market.

White House using Congress as lever on Japan trade

Growing congressional threats to impose trade sanctions against Japan are privately delighting the White House. Chairman Charles A. Vanik of the House Ways and Means subcommittee on trade says **the group's consensus is to prohibit Japanese companies** from competing for some \$10 billion in U. S. Government procurement of electronics, office machines, and automobiles unless Japan opens purchases by Nippon Telegraph and Telephone Public Corp. to U. S. competition. "We're really upset about NTT's policy," says the Ohio Democrat, whose subcommittee will get first crack at the multilateral trade treaty now in final negotiations. Although Ambassador Robert S. Strauss, special trade representative for President Carter, outwardly opposes congressional action that would limit his freedom to negotiate, one White House staffer sees the threat of congressional sanctions as "the best lever we've got. Vanik's proposal makes our plan much more palatable by comparison."

Engineering foundation proposed for U. S. by IEEE's Weinschel

The creation of a National Engineering Foundation to help accelerate U. S. productivity and innovation was proposed to the Institute of Electrical and Electronics Engineers by Bruno Weinschel, president of Weinschel Engineering Co., Gaithersburg, Md., and an IEEE vice president. Weinschel says an engineering parallel to the National Science Foundation (NSF) is necessary **because NSF's orientation to basic research limits its usefulness in areas of productivity and innovation** with applications appearing only "after a delay of one or two decades." He also believes universities must offer more applications-oriented courses so the U. S. can "reestablish our competitiveness in sophisticated manufacturing engineering." He also wants increased support of research and development by companies with less than 1,000 employees.

California tests of energy control set for July

Southern California Edison Co., working with AT&T, is to begin tests in July using residential telephone lines that will not only read electric meters and monitor peak demand but will also permit the utility to prevent overloads by remotely cycling down power to individual users. This was disclosed to a Senate hearing at the end of April by AT&T vice president Dennis Sullivan, who is responsible for residential market management, planning, and product management. Sullivan told the Commerce, Science, and Transportation communications subcommittee that the tests in Southern California's Valencia-Newhall area will let the utility **"remotely cycle down power to swimming-pool heaters, pumps, air-conditioners and the like."** To obtain customer evaluations of two-way home-information systems using telephone lines, AT&T also is readying a six-month test involving 160 customers in the second 1980 quarter.

The tiny ones that are making it big in the reel world.



You're looking at Sprague Type 292C MONOLYTHIC® Ceramic Capacitors. They're the best-constructed in their class available anywhere. That's because Sprague started making molded, axial-lead ceramic capacitors over 10 years ago, and other manufacturers have been playing catch-up ever since.

Today, these low-cost, miniature capacitors benefit through MFT*, a closely-monitored material modification of electrode metal and ceramic reacted with glass. The results: less capacitance change with temperature change, improved stability with life, and improved impedance with frequency characteristic.

*Modified Formulation Technology

In addition, dimensionally-precise molded construction makes Type 292C Capacitors ideally suited for automatic insertion. As you can see, they're readily available taped and reeled for use with high-speed assembly equipment. Other options include a choice of body formulations to meet characteristics Z5U (general application), X7R (semi-stable), and COG (NPO).

For complete technical data, write for Engineering Bulletin 6250B to: Technical Literature Service, Sprague Electric Company, 35 Marshall Street, North Adams, Mass. 01247.

THE BROAD-LINE PRODUCER OF ELECTRONIC PARTS



45Z-8103

a
**General
Cable**
subsidiary

Program into your bookshelf the ...and retrieve them instantly

As easy to read as any professional publication in electronics

Sample Listing

① **Jones, John J**

② Chmn & CEO, Microprocessor Div of Computers Inc, 1023 W Warner Ave, Dayton, OH 45479, Tel (513) 555-2000. ③ **Born:** Mar 26, 1926, Philadelphia, PA. ④ **Education:** MBA, Harvard Business School, 1950; BSEE, Univ of Ill., 1946; PhD (Hon), Yale Univ, 1977. ⑤ **Professional Experience:** Natl Bur of Standards, 1956-74, Adm Eng; Litton Ind, 1954-56, Sr Eng; NCR Corp, 1950-54, Eng. ⑥ **Directorships:** Computers Inc since 1975. ⑦ **Organizations:** IEEE since 1946, Sec Head 1972-73; AAAS since 1971; Midwest Ind Mgt Assn since 1974. ⑧ **Awards:** Fellow, IEEE, 1977; Public Service Award, City of Dayton, 1976. ⑨ **Patents Held:** 8 in computer circuits, incl Special Circuit for Microcomputer Chip Design 1975. ⑩ **Achievements:** founded Microprocessor Inc 1974; project manager on first application of microprocessors for standard interfaces 1975. ⑪ **Books:** 4 incl *Small Circuits and Their Applications* (editor), McGraw-Hill, New York, 1975. ⑫ **Personal:** married 1950 to Mary (Smith), children John Jr, Jane Anne, Kevin. ⑬ **Residence:** 344 W 34th St, Dayton, OH 45403, Tel (513) 555-4343.

- ① Name
- ② Current title/organization/address/phone
- ③ Date, place of birth
- ④ Degrees earned/institutions/dates
- ⑤ Previous affiliations/dates/highest positions
- ⑥ Current directorships/starting dates
- ⑦ Current organization membership/starting dates/highest offices/dates
- ⑧ Honors, awards, prizes/granting group/dates
- ⑨ Fields of patents/key patents/dates
- ⑩ Noteworthy products, designs, accomplishments/dates
- ⑪ Published book titles/publishers/dates
- ⑫ Personal data
- ⑬

Unique Convenience Feature *Index of biographees by affiliation*

A special 80-page index lists individual organizations, complete with the names and titles of top employees. By looking up the names in the general biography listing, you can get a complete profile of the organization's top management in a matter of minutes. **Plus** an easy-access listing of independent consultants in every electronics specialty.

Contents

Preface
Key to Information in the Biographies
Table of Abbreviations
Alphabetical Practices
Biographies
Index of Biographees by Affiliation

biographies of 5,240 of your colleagues... any time you choose!

Profiles the Top Management of Major Electronics Firms throughout the World—and more

McGraw-Hill's

Leaders in Electronics

Prepared by the Staff of
Electronics Magazine

651 pages

This is the only reference devoted solely to biographies of the most influential people in electronics. Worldwide in scope, it focuses on 5,240 individuals: executives... technical managers... designers and developers of important products and processes... government and military officials... academics... editors and publishers... securities analysts... directors of trade and professional groups... and consultants.

With LEADERS IN ELECTRONICS on your bookshelf, you no longer have to search through many different sources for biographical data on your colleagues. What's more, you don't have to strain your eyes reading minuscule type, nor do you have to waste valuable time trying to decipher seemingly endless paragraphs of abbreviations. Boldface type spotlights the various information categories so that you can scan entries rapidly to pinpoint what you need.

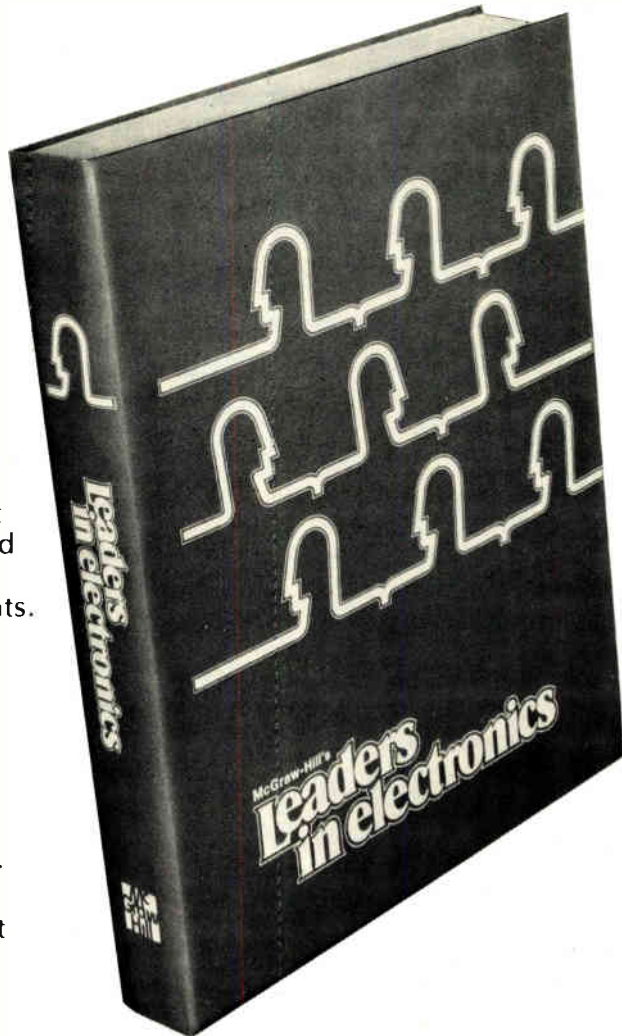

Order today using this coupon!

Return coupon to:
Leaders in Electronics
P.O. Box 669
Hightstown, New Jersey 08520
(609) 448-1700, ext. 5494



Send me _____ copy (copies) of Leaders in Electronics on a 10-day money-back guarantee. I understand that if I am not absolutely satisfied, I may return the book(s) within ten days at no further obligation. Otherwise, McGraw-Hill will bill me \$39.50 for each copy, plus applicable sales tax, shipping and handling charges.

Name _____
Title _____
Company _____
Address _____
City _____ State _____ Zip _____

SAVE MONEY! Enclose payment in full, plus local sales tax, and McGraw-Hill pays all regular shipping and handling charges. Ten-day money-back guarantee still applies.

Check enclosed Bill me Bill my company Company purchase order # _____

This offer subject to acceptance by McGraw-Hill.

EL2

Opening new frontiers with electro optics

Solid-state photodetectors: doing more jobs better.

UV detectors give enhanced response below 250 nm.

If you're in spectroscopy, colorimetry, densitometry or blood analysis, these UV enhanced N-type silicon p-i-n photodetectors will be of special interest. Besides excellent UV response, they offer very high speed: 6 ns rise and fall times, when operated at 45 V. Two hermetically sealed photodiodes are available: the low-profile TO-5 package C30839 with UV transmitting glass window (slightly less responsive at the low end), and larger C30842 with quartz window.

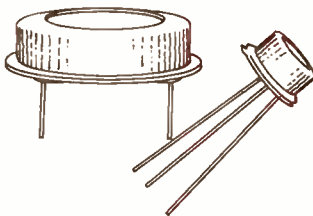
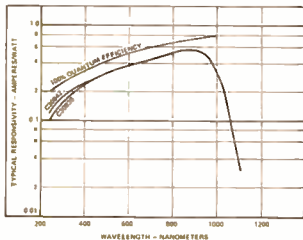

Circle 61

Quadrant detectors: military precision at very low cost.

Lower-cost than military target-sensing versions, these detectors are very practical for position sensing and machine alignment, for example. They take information from either focused small spots or defocused large spots, high-speed pulsed or CW sources. Spectral range is 400 to 1100 nm, and they feature very low crosstalk, signal loss and transition region. A choice of types (C30843/44/45/46) offers sensitive areas ranging from 5 to 100 mm².

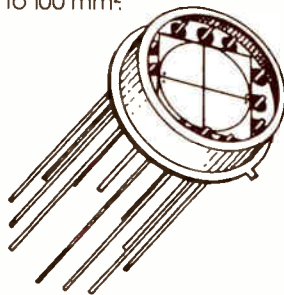

Circle 62

New avalanche detectors have recovery times as fast as 0.5 nanosecond. Optimized at 800-850nm.

We called earlier versions "fastbacks" and the name still holds. These new fast-recovery photodetectors are useful in such applications as distance measurement, point-of-sale reading equipment, and optical communications. They feature RCA's double-diffused reach-through structure, which also gives them high quantum efficiency, high gain, and wide spectral response. Select from C30817 for general purpose use, C30902E for high-speed, wide bandwidth applications, and C30884 which falls in-between.

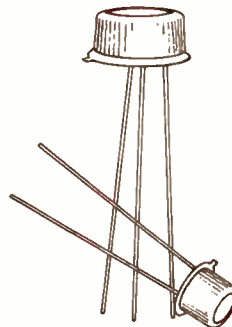

Circle 63

Detector/preamp packages. We put the chips together for better performance.

RCA silicon p-i-n photodetectors are available prepackaged with dual gate MOS-FET amplifier chips. What you get is an unconditionally stable configuration that optimizes sensitivity and bandwidth. A typical module is shown below in schematic form. Many variations and trade-offs are available to meet special requirements—just send us your requirements.

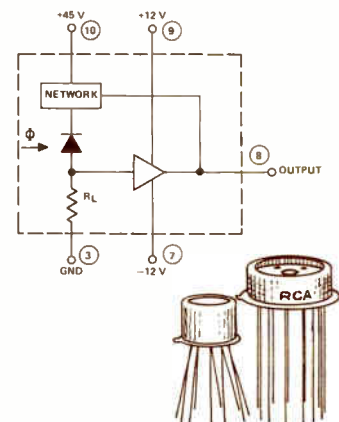

Circle 64

If electro optics can solve your problem, remember: EO and RCA are practically synonymous. No one offers a broader product spectrum. Or more success in meeting special needs. Call on us for design help or product information. RCA Electro Optics, Lancaster, Pennsylvania 17604. Telephone 514-457-9000. 1130 Brussels, Belgium; Sunbury-On-Thames, Middlesex TW16 7HW, England; Ste.-Anne-de-Bellevue, Quebec, Canada; Belo Horizonte, Brazil; Hong Kong.

Fax system uses Ink-jet printer

Noiseless ink-jet recording on plain paper is one feature of a facsimile transmission system that West Germany's Siemens AG has introduced and will deliver shortly. Another is that **the equipment allows automatic reception**, which means an operator need not be present when messages are coming in. Designated the HF2050 and about the size of a normal typewriter, the equipment uses an ink-jet printer with 12 nozzles. When printing at 3 minutes per page, the printer records messages with a density of 3.85 lines/mm. The density at two minutes per page is 3.08 lines/mm. Price of the system is approximately \$6,300.

Phillips sees small overall growth for color TV sales

The world market for color TV sets will rise 3% this year, and the developing countries will help stabilize the market for black-and-white receivers. That's the gist of a forecast made by NV Philips Gloeilampenfabrieken in the Netherlands. Breaking down the total market (without the Eastern Bloc and China) into major areas, Philips sees Europe and Japan scoring an increase in color set sales of 7% and 5%, respectively, this year. **Latin America should come in at 14%**, it predicts. The U. S., on the other hand, will register an unspecified decline. As for the 1979 black-and-white receiver market, sales in Europe will drop by 2% to 3%, while those in Japan and the U. S. will go down by 5% and 8%, respectively. Offsetting these declines will be rising sales in the Third World.

GEC, Phillips eye private office information market for viewdata systems

Convinced that the business sector will be the first to pay off, Britain's General Electric Co. Ltd. and now Philips Data Systems Ltd. are offering private office information systems using low-cost viewdata terminals and accessing the customer's own computer-controlled disk data base. **Such systems, using privately developed viewdata software, would be one tenth the cost of conventional on-line cathode-ray-tube terminals** and would meet a general requirement for recording, storing, and accessing office and shop-floor information. GEC Private Viewdata Systems Ltd. will use Data General's NOVA minicomputers for small office systems of up to 32 data ports and its own GEC 4060 for larger installations. Its 4000 series computers are already used in the now public Prestel service, the British Post Office's viewdata service, and in the first private viewdata system supplied to a Dutch publisher. Philips plans to use its P857 office minicomputer with magnetic disk but will later add its optical disks [*Electronics*, Nov. 23, 1978, p. 75] as a low-cost archival store and is preparing a viewdata interface for its WP5000 word processor.

SEMS expanding both ends of its two mini lines

SEMS, the minicomputer subsidiary of France's Thomson-CSF in the Paris suburb of Louveciennes, is enlarging its Mitra and Solar lines at both the top and the bottom. The company says the unveiling in late April of its Mitra 225 is only the first in a series this year. François de Villepin, director of Thomson's computer group, says the Paris-based conglomerate is placing an especially high priority on the low end of both lines in order to **cash in on what he believes will be a burgeoning market for office computers in Europe**. The Mitra 225, which fits in at the top of its line, is built around what SEMS calls a "Monobus," capable of handling 1,200 16-bit words per second. Main memory capacity is 512,000 16-bit words; the central processing unit uses four 4-bit-slice microprocessors. The basic unit, with 32,000 words of MOS memory, costs about \$20,000.

West Germans make blue LEDs using silicon carbide

Using a technology worked out at the Technical University of Hanover in West Germany, researchers at Siemens AG have developed experimental blue-light-emitting diodes based on silicon carbide. **The diodes' forward voltage is 4 v at 50 mA.** Their external quantum efficiency at an emission wavelength of 480 nm is 4×10^{-5} —about one hundredth that of commercial nitrogen-doped gallium-arsenide-phosphide LEDs. Although lab samples have already been made, Claus Wehrich, who heads the LED development team at Siemens' research labs in Munich, cautions that "volume production of blue LEDs cannot be expected in the near future because large-area single-crystal silicon-carbide substrates cannot be made." Even so, the company is convinced that silicon carbide is a more promising material for blue LEDs than gallium nitride or zinc sulfide, which other firms are working with.

British Post Office to set up experimental teleconferencing system

The British Post Office is planning an experimental teleconferencing service for 1981 that would provide for meetings of up to four people on a customer's premises together with slow-scanning 625-line transmission of documents and sketches ("scribble pad"). At present, the post office provides a 625-line, 5-MHz "Confravision" service—similar to the Bell System's Picturephone service in the U.S.—between studios in five cities using broadband trunk microwave links. But by reducing TV standards to a 313-line, 1-MHz bandwidth, engineers at the BPO's Martlesham, Ipswich, research center aim to **pipe the signal over the local telephone network using existing twisted-pair telephone lines.** Document and scribble-pad transmission will be provided via a 4.8-Kb/s modem over the switched telephone network, allowing a refreshing rate of 50 seconds and 5 seconds, respectively. Use of a private 48-Kb/s modem and line cuts these times by 90%. The year-long trial, to involve 50 terminals, will determine the need for and requirements of such a public service.

Implant-isolation technique moving to device stage

High-density n-MOS electrically alterable read-mostly memories and high-reliability discrete transistors with extremely low leakage currents are just two applications slated for a novel technique of dielectric isolation in which oxygen is implanted into silicon. The technique is now being developed at the University of Kent at Canterbury in collaboration with Middlesex Polytechnic, with the help of a small \$8,000 grant from Britain's Science Research Council. It works by **implanting oxygen into a silicon substrate to form a buried silicon-dioxide dielectric layer.** After annealing, the top layer of silicon is of sufficiently good quality to grow an appropriately doped epitaxial layer, thus forming an isolated silicon pocket as in a silicon-on-sapphire structure. The researchers have proved the feasibility of the technique and now want to produce working devices.

Thomson-CSF unit to make memories for Amdahl computers

Thomson-CSF, the French electronics conglomerate, will be making MOS memories for Sunnyvale, Calif.-based Amdahl Corp.'s mainframe computers at its new plant in Ireland. The three-year contract, rumored for months, is with Thomson's Citec (Compagnie Industrielle pour les Techniques Electroniques) subsidiary, which will manufacture memories of up to 16 megabytes at its plant in Toulouse. Thomson says **the contract will give Citec experience in high-density, multilayer printed circuits** that could enable Thomson to compete in the U. S. market.

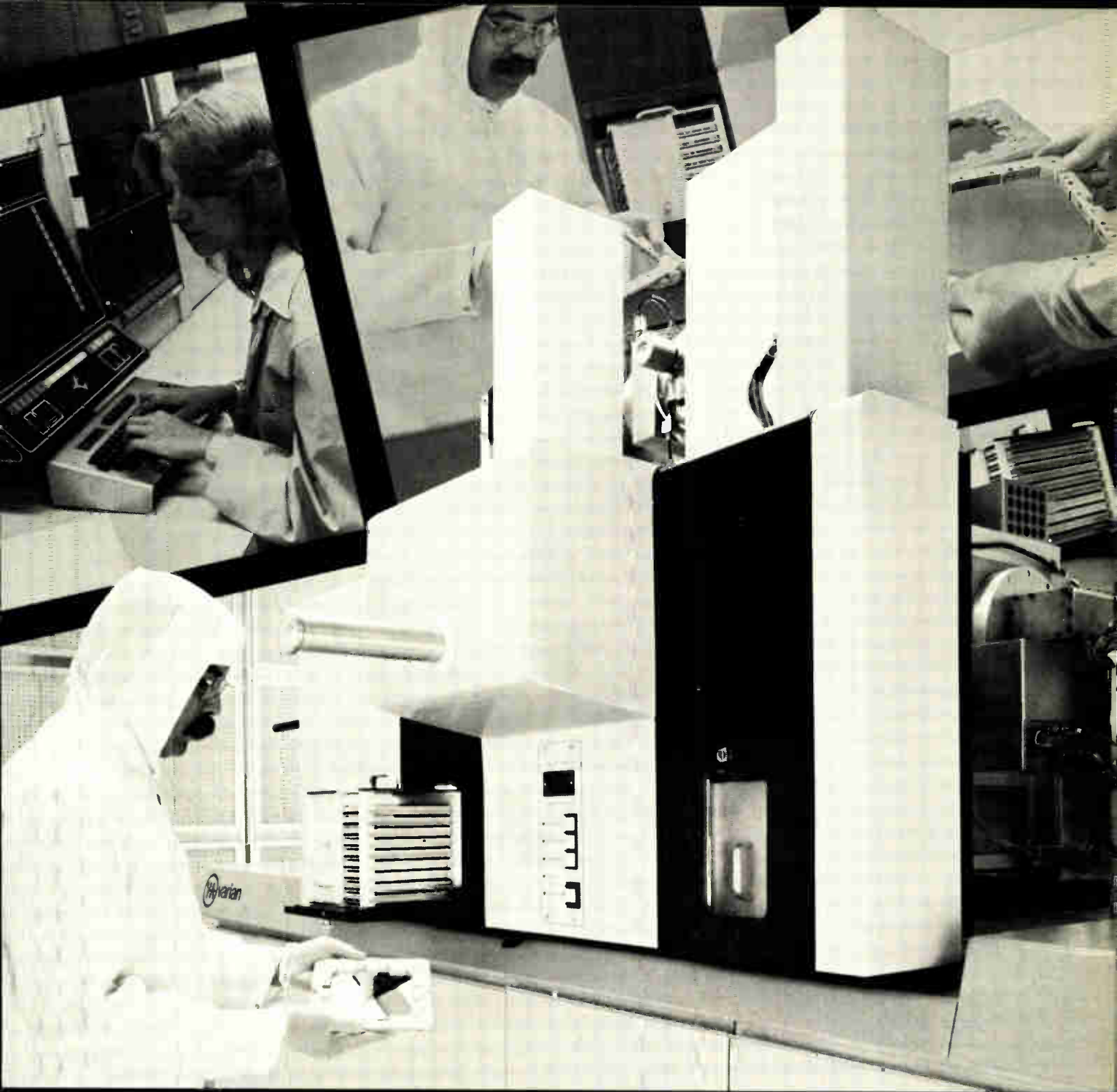

This is the most technically advanced Electron Beam Lithography System you can buy.

The Varian Ee[®]BES-40 etches patterns so fine you can fabricate 15,000 circuits on a 4-inch wafer. It is the only fully automated machine of its kind designed for production. With a 40 MHz data rate, it writes masks twice as fast as previous machines and 10 times



faster than optical systems. It can handle 7-inch masks.

We add Varian training and service for a package unmatched worldwide. Call or write Varian Extrinsic Division, Gloucester, MA 01930, 617-281-2000.

Analog LSI testing

Measuring Apples and Oranges together.

According to the ancient wisdom, one can't mix apples and oranges in the same operation. But, as you well know, recent advances in integration techniques, by combining both linear and digital circuitry on the same substrate, have created just such a mix.

Moreover, the new technology promises to spawn a revolution every bit as dramatic as the growth of EDP. So measurement or testing of these exciting yet complex devices will soon have to be achieved consistently in high-volume production.

Expectations of explosive growth derive from the fact that analog LSI has now made possible efficient and economical Analog Signal Processing (ASP). Demand for ASP in electronic control applications is already high, pent up for many years in such major markets as telecommunications, home, automotive, and industrial controls.

After all, we live in an analog world. Nature-generated phenomena like temperature, pressure, speed, and sound produce analog indications. Now those indications can be cheaply converted for digital processing, and digital signals reconverted for useful work applications. And the race is on.

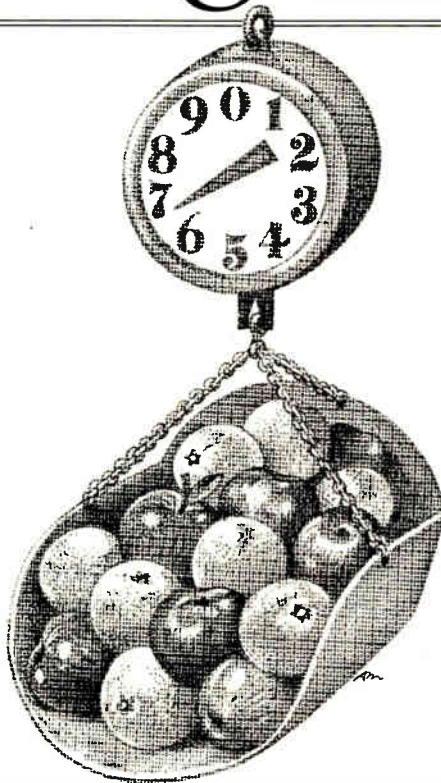

Consider, for example, just one area — telecommunications — in which the industry is moving toward voice transmission in digital form. ASP devices such as codecs and filters will be installed, one to a telephone line, to help make that changeover. Since there are presently some 200 million phones in the U.S. alone, and world-wide demand is expected to add about 60 million more each year by the mid-1980's, the potential magnitude of this single market segment is conservatively upwards of a quarter-billion units.

In the home, automotive, and general industrial markets, ASP growth should be equally

spectacular for the next decade and more, with literally thousands of high-volume applications and replacements.

Happily, testing analog LSI devices need not become a stumbling block in any case. The techniques which are drawn together in this new apples-and-oranges world — complex ac testing, high-speed logic testing, discrete-device testing and laser trimming — have long been areas of expertise and leadership for Teradyne.

And with the development of the A300 family of analog LSI test systems, Teradyne has combined the broader test capability, higher accuracy, greater throughput, and added software-evaluation tools that the new devices require.

Teradyne's A300 Analog LSI Test and Trim Systems are the only high-volume systems specifically designed for the apples-and-oranges technology. As such, they provide a vital link to high-volume production and usage of present and planned analog LSI devices.

Once again, Teradyne has developed an important set of tools to help further the device technology critical to your future.

So let the revolution begin.

For more information on the A300 Series, write Teradyne, 183 Essex Street, Boston, MA 02111.

TERADYNE

Unit multiplies two 64-bit numbers in 284 nanoseconds

by Kevin Smith, London bureau manager

'Twin-beat' technique, use of carry-save adders, and multiplier recoding all contribute to high speed

Most present-day small minicomputers use microcode to tackle multiplication tasks because faster, hardwired multipliers are too expensive. But at least one computer design group has now demonstrated that fast multipliers can be produced economically on a single printed-circuit board by the use of large-scale integrated bit-slice multipliers.

Manchester University's computer science department is developing a single-board multiplier for its projected MU6-G super-minicomputer that will give the product of two 64-bit numbers in 284 nanoseconds [*Electronics*, April 26, p. 63].

Says J. B. Gosling, who designed the unit, "The 64-bit MU6-G will have a conventional software multiplier, but for those uses like computer graphics and scientific number crunching that need a fast multiplication capability, the hardwired multiplier will be available as an option that plugs directly into the central processing unit." In fact, the multiplier could find many uses where the program speed is dependent on the multiplication time—computerized tomography, for one.

Arrayed. Key to the unit's high performance and projected low cost is a 2-bit-slice multiplier chip engineered in an uncommitted logic array (ULA) from Plessey Ltd.'s Allen Clark Research Centre in Caswell, Northants. Made with a

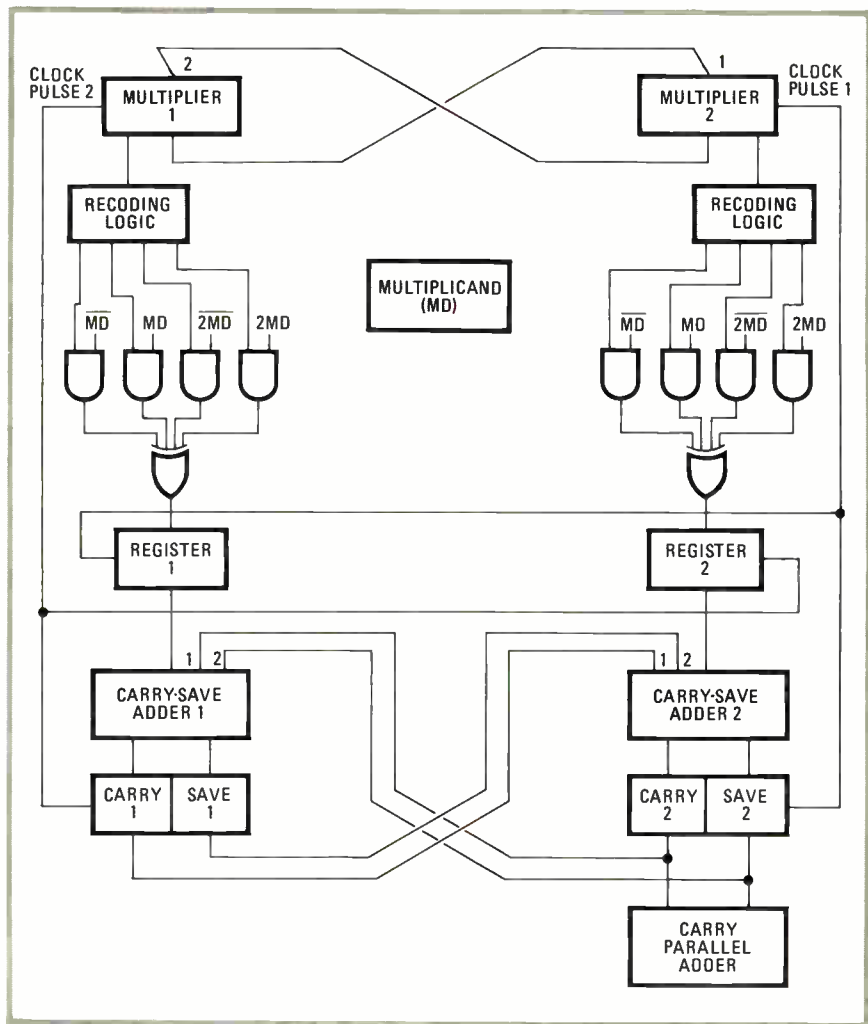

Speedy. Manchester University multiplier achieves noteworthy speed by performing two carry-save additions during one register-latching cycle, using carry-save adders, and recoding the multiplier so that the adders accept 2 bits at a time. Use of ULAs reduces the chip count.

speedy emitter-coupled-logic process, it has gate delays of 1.5 ns.

Use of the ULA chip, Gosling says, "offers at least a tenfold reduction in component count compared with multipliers constructed from standard Schottky TTL and ECL while

providing a hundredfold improvement in speed compared with software multipliers." It was also chosen to avoid the high design costs of a fully custom design.

The Plessey array consists of 100 logic cells, each equivalent to a two-

input AND or NAND gate. These can be customized by a double-layer metalization. The problem, says Gosling, "was to hit on a design that offered high performance yet could fit in a low-cost 24-pin package."

The group opted for the "twin-beat" multiplier design—so called because it packs two carry-save additions into one register-latching cycle—that was used in their earlier MU-5 computer and in a modified form in the IBM 360/91 but has otherwise gone unnoticed by the computer industry. Yet, Gosling claims, "the twin-beat multiplier is the most cost-effective technique available and is one of the fastest in both theory and practice."

The twin-beat technique exploits the fact that a carry-save multiplication can propagate through a carry-save adder in 5 nanoseconds, whereas it takes 10 ns to latch the result into a storage register for each stage. By passing the output from one adder to the second during the 10-ns latching cycle, the number of operations per cycle is doubled.

Speedup. In addition to the twin-beat technique, two other features give the multiplier its high speed. First, the use of carry-save adders cuts out the propagation delays associated with the earlier carry parallel adders.

Second, multiplier recoding increases speed by grouping the multiplier into units of 2, 3, or more bits for the adder, but at the expense of additional logic. In this case, recoding is into 2-bit units, halving the number of cycles.

The twin-beat technique also lends itself to large-scale integration. Gosling was able to use most of the ULA, employing 98 of the 100 available cells and 21 of the 24 available pins. The resulting chip has a 1.3-ns internal gate speed and a clock period of 12 ns, or 6 ns per multiplication.

Using nine of these ULAs and 32 additional 10K logic family circuits to implement the final-stage carry parallel adder and the setup logic, he has assembled a 16-bit unit that multiplies in 115 ns. The total delay comprises nine 8-ns delays in the carry-save adders plus a 25-ns delay

in the carry-parallel adder and a 18-ns delay in the setup logic. Use of 100K logic chips in the peripheral circuitry, Gosling adds, would cut the multiplication time to 88 ns.

The more, the better. At the 16-bit level the technique, though fast, is not the fastest around. But as bits are added, it becomes increasingly attractive, and for a full 64-bit multiplier using 33 ULAs, the 284-ns multiplication time is truly impressive. Process improvements from Plessey would further enhance the figures. In particular, a small array of subnanosecond gates will soon be available that could reduce the peripheral logic by 15 packages.

Further out, a 144-cell array is under development that would cut the multiplier's "beat," or 2-bit multiplication, time to 3 or 4 ns, giving a total multiplication time of 148 ns. This figure could be cut to 94 ns for a split multiplier, in which the multiplicand is split and both halves are multiplied simultaneously.

Use of the Macrocell array developed by Motorola Inc. [*Electronics*, Feb. 15, p. 113] would make a bigger, 64-pin package available and allow more bits to be packed on chip, Gosling notes. Either way, he claims, hardwired multipliers are now economical for the smallest minicomputers and even microcomputers.

West Germany

Computerized X-ray process shows blood rate as color TV picture

Though West Germany's DESY electron-synchrotron center in Hamburg generally investigates high-energy physics and other areas of research remote from everyday needs, occasionally it does come up with a highly practical idea. The latest one aids medical diagnosis.

Together with researchers at

Hamburg University's Institute for Mathematics and Medical Data Processing, engineers at DESY—the acronym for Deutsches Elektronen-Synchrotron—have developed a computer-based X-ray technique that shows a doctor in full color how well blood circulates in organs.

In conventional diagnostic radiolo-



Colorful. Computerized angiography technique from DESY aids diagnosis of organ disorders by combining 128 X-ray pictures into one TV picture whose colors are a function of the rate of blood flow. Color scale at top (barely visible) eases interpretation.

If you design CRT Power Supplies,



X-Ray Power Supplies,



Electro-Static Precipitators or

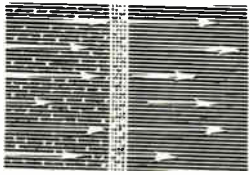

other high voltage circuits—

our **high voltage silicon rectifier**,

MINISTIC[®],



is for you!

Now only .84¢*

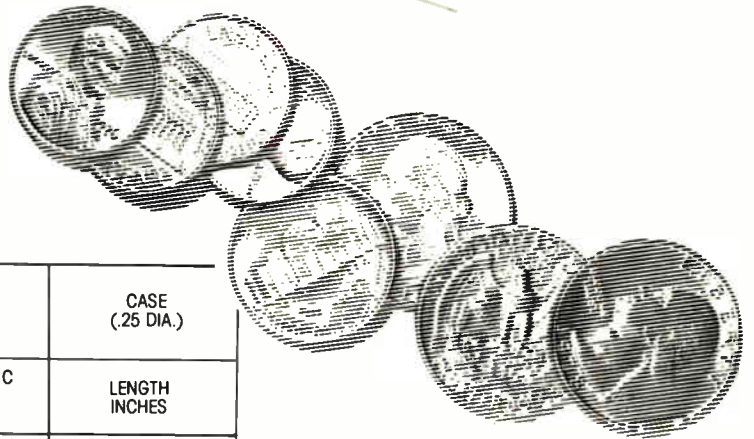

TYPE NUMBER	PEAK INVERSE VOLTAGE	AVERAGE RECTIFIED CURRENT	CASE (.25 DIA.)
	VOLTS	IN OIL @ 55°C MA	LENGTH INCHES
SMHR10K	10,000	200	1.375
SMHR15K	15,000	150	1.375
SMHR22.5K	22,500	100	2.0
FAST RECOVERY 150 NANOSECOND TYPICAL (300 NS MAX.)			
SMHF10K	10,000	200	1.375
SMHF15K	15,000	150	1.375
SMHF22.5K	22,500	100	2.0
*SMFR15K	15,000	100	1.375
SMFR20K	20,000	100	1.375
SMFR30K	30,000	60	2.0

MANUFACTURED IN THE U.S.A.

Contact the sales office nearest you to discuss your individual application with our sales engineer.

CALL TODAY!



652 Mitchell Road, Newbury Park, California 91320
 (805) 498-2111 • (213) 628-5392 • TWX: 910-336-1264
 CHICAGO: (312) 352-3227 • DALLAS: (214) 661-2217
 FLORIDA: (305) 644-5404 • MARYLAND: (301) 937-0070
 NEW YORK / NEW JERSEY: (201) 964-9305
 SAN FRANCISCO: (415) 494-0113 • SEATTLE: (206) 455-4807
 CANADIAN SALES: Avotronics, Ltd. (416) 493-9711
 EUROPEAN SALES: Bourns AG Zug, Switzerland (042) 232-242

Operating Temperature -55°C to +150°C

Recovery conditions: 5 MA forward current to 10 MA reverse current.

*MINISTIC is a Registered Trademark of the Semtech Corporation

* 1000 piece price for part #SMFR15K.

Circle 69 on reader service card

gy, even as improved by computerized tomography [*Electronics*, Oct. 14, 1976, p. 89], the diagnosis is based solely on the size, form, and structure of organs shown in one or more X-ray projections. But an organ's behavior as a function of time, which can give an earlier indication of an impending or already existing disorder, can only be inferred from a laborious analysis of a series of X-ray pictures. In essence, DESY's technique does this analysis automatically, encoding the result in color.

Called computerized angiography, DESY's approach starts out like conventional angiography: a contrast medium is injected into an organ by way of a catheter inserted into an artery. The medium's density, as shown in the X-ray picture, indicates the rate of blood flow through the vessels. Any blockage or too slow a propagation rate reveals that something is wrong in the organ.

Outcome. The examiner analyzes only one image of the organ. Shown on a color-TV monitor (see photo), the image has above it a scale with color tones ranging from red at one extreme to yellow at the other and corresponding to blood-propagation delays of up to about 3 seconds. Equal colors represent equal rates of propagation. By comparing image with scale, the examiner can tell virtually at a glance where the blood is being slowed down. The rate can be determined to within ± 200 milliseconds, says Gregory C. Nicolae, the Roumanian-born DESY engineer responsible for the technique's hardware development.

A DESY-built microprogrammed multiprocessor system implements the technique with any existing combination of medical X-ray machine and TV picture amplifier. It exposes the patient to X rays for about $2\frac{1}{2}$ seconds—the normal period used in human radiology—taking a series of 128-by-128-millimeter pictures at about 50 per second for a total of 128.

The system digitizes all pictures in real time. Each full picture or a selectable rectangular area within the picture is handled as a matrix

with a maximum of 65,536 picture elements, or pixels. The horizontal resolution can be set to either 256 or 512 pixels per line. Each pixel is 0.5 mm^2 and is represented by 8 bits. This means that each can be assigned one of 256 different intensity, or gray, levels.

Next, the system compares the gray level of a pixel in one picture with that of the corresponding pixel in the successive pictures in the 128-image series. The results are combined into 65,536 intensity-vs-time curves, each having 128 values. The wanted parameter—in this case, the delay in the spread of the contrast medium—is then extracted and assembled into a new picture, called the function image, which contains all the information on blood flow of interest to the examiner.

Finally, using a raster-scan display processor, the system converts the function image into color signals in a process similar to that used in color television. (Color pictures are of course easier to analyze than gray ones.) These signals are then fed to the TV monitor.

It takes about 2 minutes to process the 128 X-ray pictures into a single color TV picture, Nicolae says. Alternatively, the pixels' values can be stored and processed later to produce picture information on video tape, for example.

The components for the multiprocessor system come from various U.S. suppliers. Among the most notable parts are bit-slice processors of Advanced Micro Devices' Am2900 family and Z80 microprocessors from Zilog. **-John Gosch**

France

Hypercube 'federates' eight microcomputers

To launch a new component in France, the obvious choice is the annual Salon des Composants in Paris. But it was the wrong show at which to arouse interest in a new concept in array computers, laments Roger Dupuy, a professor of com-

puter technology at Pierre and Marie Curie University, part of the University of Paris.

Dupuy put a prototype board for the Hypercube F8 array computer on display at the early April show at the Fairchild Camera and Instrument Corp. stand, hoping to find a firm that will follow through and market the machine, which was developed by his group at the university's Institut de Programmation with research funds from the government. He turned up no prospects, but he plans to try again in Paris at next week's Micro-Expo '79 show.

Dupuy, a software specialist who turned his hand to hardware as well with the advent of microprocessors and low-cost semiconductor memories, maintains that a Hypercube F8 with 512 kilobytes of main memory could be built to sell for about \$23,000. He says that it is roughly the equivalent of a low-end IBM System/370, with full-fledged computer features like master-slave operation, parity checks, memory mapping, memory protection, and forbidden instructions.

What's more, two high-level languages are available: Basic and Minibol. "The Hypercube would be ideal for computer service houses that handle bookkeeping and inventory for their clients," he says.

Eight. Dupuy describes the Hypercube F8 as "a federation of microcomputers." There are eight of them, each on a single board with its own F8 microprocessor, 64 kilobytes of random-access memory, and 1 kilobyte of programmable read-only memory to initialize operation. Communications among the eight microcomputers, each of which also has its own operating system, are handled by a fast bipolar processor—a Signetics Corp. 8X300.

Also crucial to the system is a Control Data Corp. 100-megabyte disk drive, split up so that each microprocessor has its own specified zone to work with. Each microcomputer thus has a sizable on-board RAM backed up by its "own" disk memory. This arrangement is an important departure, Dupuy maintains, from earlier array computers,

With the new improved bandstacking feature in our Model 2002A sweeper, you can now cover the entire 1 to 2500 MHz range in one fell swoop. You can also start and stop anywhere in between. Anywhere.

Try to find another stand-alone sweep-signal generator that has this capability. Or one with a front-panel meter on which you can easily set and read the output over its +13 to -77 dBm range.

Flatness is ± 0.5 dB at the 20-milliwatt output; display linearity is

$\pm 1\%$. For compensation of frequency-dependent variations in test set-ups, a ± 2 dB slope adjustment is right there on the front panel. There's also a provision for external leveling.

Besides all this standard equipment, the 2002A has options. Like a deluxe harmonic marker system that provides 1, 10, 50 and 100 MHz markers over the entire frequency range. Or you can order specific single-frequency markers when you buy your

2002A, or whenever a specific application comes along.

But the important thing to remember is that the Model 2002A gets you from 1 to 2500 MHz in a single sweep. And you can't get this anywhere for just \$3,400. Not anywhere. Wavetek Indiana, P.O. Box 190, Beech Grove, Indiana 46107. (317) 783-3221. TWX 810-341-3226.

WAVETEK®

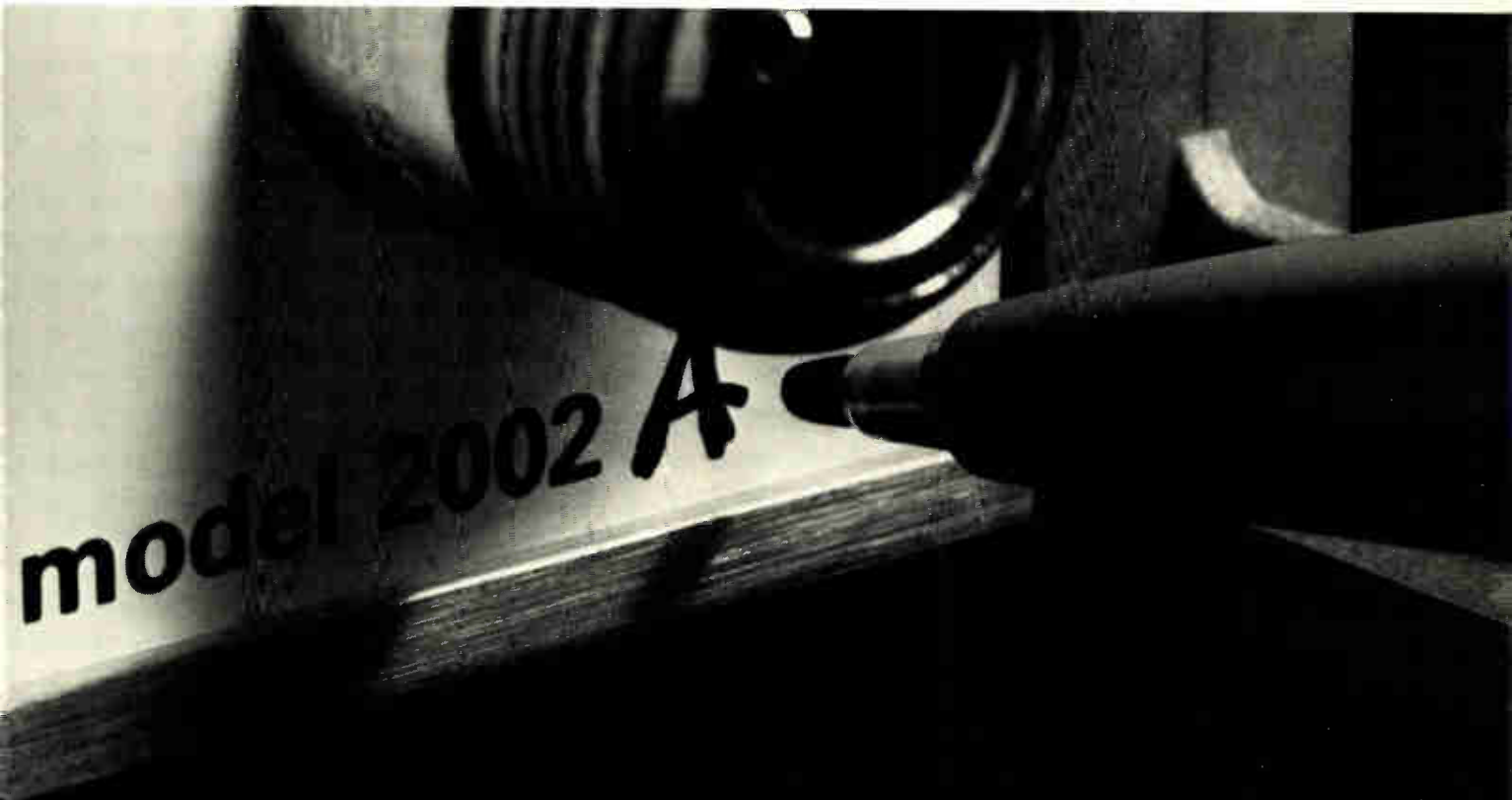

The A stands for anywhere.

which tied processors to a single giant memory.

In the Hypercube setup, some of the microcomputers do the actual data processing and the rest take care of running the peripherals. One is assigned to controlling the disk file and is heavily buffered to prevent long lineups for access to the disk. When a data stream enters the system from a microcomputer that controls an input/output peripheral, it is fed to a free microcomputer for processing.

The microcomputers signal when they are free by putting a request for inputs into a section of their RAM that is scanned continuously by the 8X300. This is done without stealing cycles from the microprocessors, which would slow them down.

Time enough. Each F8 has access to the on-board RAM during the first half of its 2-microsecond machine cycle. The fast-stepping 8X300, with

its 250-nanosecond cycle, therefore has time to read or write a byte into the memory during the second half of the F8's machine cycle.

The control bus that ties the microcomputers to the 8X300 is a standard Signetics bus with eight lines for data and two lines for control signals. Data transfers between microcomputers are made over a separate data bus at a rate of 2 megabits per second. Each memory block is thus ported to its companion F8, the Signetics bus, and the data bus.

With this arrangement come substantial advantages over classic multiprogrammed computers. For one thing, the hardware is relatively straightforward, since it is built around standard chips. For another, because the one-board modules are all the same, maintenance is simplified—mostly a matter of changing boards.

-Arthur Erikson

Great Britain

One-board color TV chassis fits four different-sized receivers

As a wall against the mounting wave of competition from Japan and the Far East, which could rise to tidal proportions when the first PAL patents expire in 1981, Thorn Consumer Electronics Ltd. has come out with a single-board chassis that it is billing as the ultimate in color television standardization.

In readiness for the coming free-for-all, R. V. Arnaboldi, the firm's engineering director, and his design team have long been laying plans for a highly integrated one-board color TV chassis that makes maximum use of automated component-insertion techniques. The result is the TX9, a single 156-square-inch board carrying all the set's electronics—just 410 components, versus 618 previously—that will replace four earlier models and will drive Thorn's new range of 14-, 16-, 18-, and 20-inch TV receivers without the need for any component or electrical change.

"The concept of a single-board

chassis common to sets of several different screen sizes is," the London-based subsidiary of Thorn Electrical Industries Ltd. says, "an innovation in color TV technology."

Automation. One big advantage is that it gives Thorn the critical volume to justify automated assembly techniques. At its Gosport factory, the company has installed a \$20 million automated assembly line that inserts 70% of all components, but such is its output that Thorn has had to close one of its three UK plants, laying off over 2,000 workers.

Several factors contribute to the shrinkage in chassis size down to one board. The intermediate-frequency filter section is made smaller by the use in all models of surface-acoustic-wave filters. To develop them, Thorn worked closely with Plessey Ltd.'s Allen Clark Research Centre. It also worked later with Mullard Ltd., to guarantee two sources.

The use of i-f filters, says chief

engineer Alan Yarker, gives more permanent i-f alignment than mechanical i-f stages using coils and capacitors. It also cuts production setup operations by one third. Further, different European frequency standards can readily be met by plugging in suitable SAW filters.

Help. Though Arnaboldi claims the new line of TV receivers is more than competitive with Japanese products, it nonetheless relies heavily on Japanese technology. The tube is a bipotential high-brightness design made by Hitachi Ltd. and based on its 90°-neck in-line tubes. Mullard is gearing for 90° in-line tube production and hopes eventually to make the new tube.

Also, one of the seven color-processing integrated circuits was developed in collaboration with Nippon Electric Co. This bipolar circuit, the luma-chroma-video processor, replaces three ICs in a conventional television and is used by NEC in its NTSC sets. It developed a PAL version for Thorn, which Philips will produce with the fast blanking time needed for teletext and viewdata.

Extensive use of ICs has eliminated more than 400 solder joints, with big increases in reliability, says Yarker. It has also simplified the design of the low-voltage power supply, which has to deliver an extremely low 40 watts to the chassis. A large output choke in the thyristor-controlled supply damps current spikes, and a regulator IC allows for fluctuations between 185 and 285 volts.

Also novel is the use of a diode-split transformer secondary to provide a compact high-voltage supply delivering 1 milliampere at 24 kilovolts, sufficient to drive even the largest tube in the range.

But consumers looking for instant price reductions when the new sets are ready in September will be disappointed. In common with other British manufacturers, Thorn—the largest indigenous manufacturer—has been facing diminishing margins for some time. It is therefore pinning its hopes on increasing profits and a short breathing space before the real competition begins.

-Kevin Smith

Statek 10-350kHz QUARTZ CRYSTALS...

best for frequency control

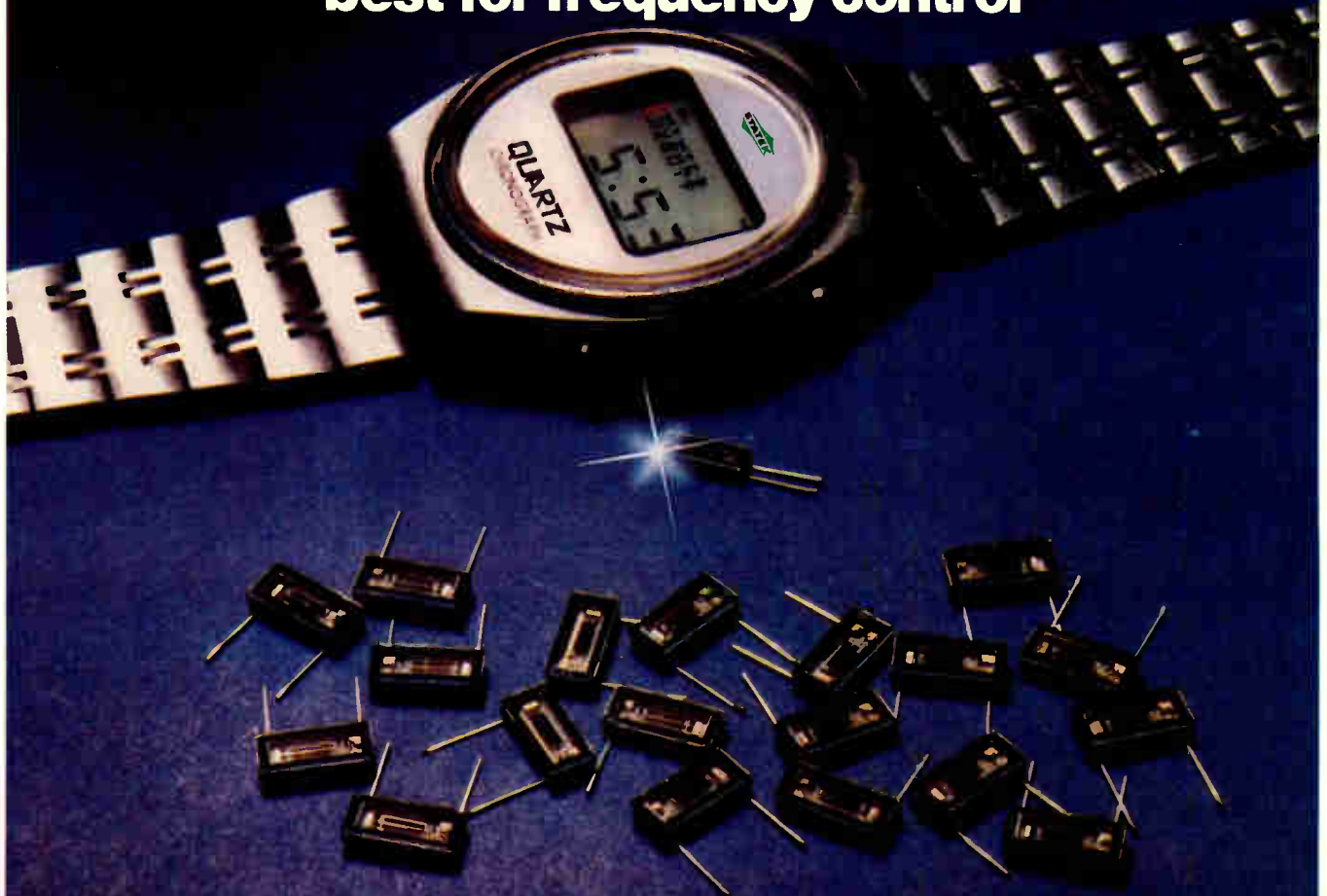

**One fits the watch...
the 19 standards and over 350,000 others
fit wherever you imagine**

First, imagine small. Because Statek Crystals are small . . . approximately 1/10 the size of conventional low frequency crystals. They employ the tuning fork crystal technology Statek introduced, then perfected for the watch industry. Thus, the small 68¢* cost . . . the lowest cost, high volume, crystals available for discrete or hybrid use . . . world-wide.

Next, they're accurate. Much more accurate than any LC or RC oscillator or frequency control network

. . . today, next year or long-term. In fact, the 100x improved aging and accuracy of the CX series eliminates costly alignment and "zeroing-in" . . . for a life-time.

And you won't have frequency selection problems either . . . 19 standard frequencies, plus Statek's precision laser tuning that lets you pick from over 350,000 others.

If you have an immediate volume application, contact the factory for samples or specific information. Or

consult EEM/GOLD BOOK for specifications.

Statek Corporation, 512 N. Main,
Orange, California 92668, Telephone:
(714) 639-7810 TELEX 67-8394

* 100k qty



INNOVATORS IN FREQUENCY CONTROL

The friendly desktop computer system...

Now, even more problem Introducing HP's

Here's the power to solve big problems combined with traditional desktop-computer friendliness. Our new System 45B is a neat, powerful problem solving package that can put as much as 449K bytes of Read/Write memory right on your desk. And you can use it all.

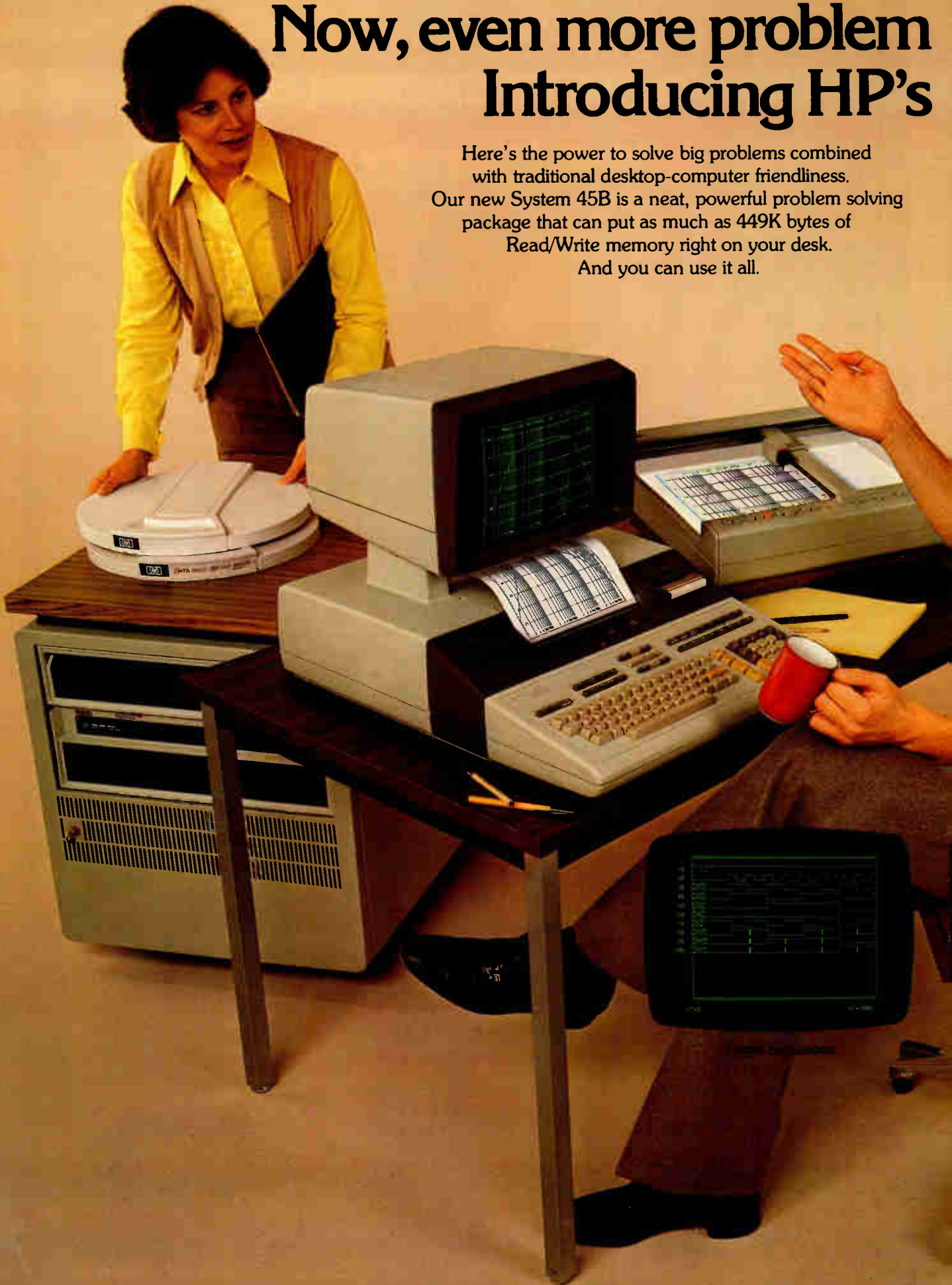

solving power at your fingertips. new System 45B.

The operating system (120K bytes) resides in its own ROM, which means the entire Read/Write memory (56K to 449K bytes, depending on the option you choose) is available for your programs and data. And since System 45B is friendly and easy to use, it puts you in charge of solving your problems.

It has no complicated start-up procedure, no operating system to load and no compiling to do.

System 45B gives you powerful graphics capabilities: plotting, digitizing, charts, graphs, histograms, window plotting and more. It lets you add a wide range of plug-compatible HP peripherals such as the HP cartridge disc drive (7906M/S) and the 4-color HP plotter (9872A) shown. With the System 45B and its full line of input, storage and output peripherals, you can configure a system that will solve today's big problems and adapt to your needs in the future.

To help you fully utilize the power and versatility of the System 45B, an extensive array of software is available, including new programs in the areas of statistical and numerical analysis, engineering design, structural engineering and business management.

Because it uses HP Enhanced BASIC language, System 45B provides a conversational style of problem solving that lets you interact with the system in a way that parallels human communication. Beginner or experienced programmer, you'll find HP Enhanced BASIC as friendly as it is powerful.

For more information on how the new System 45B can put problem-solving power and flexibility at your fingertips, call the HP Literature Center toll-free day or night.

The number is 1-800-821-3777. Extension 131 (Alaska and Hawaii included). (In Missouri, call 1-800-892-7655, Extension 131.) Or, call your nearest HP office for a demonstration.

OEM discounts available.



Probability Plot

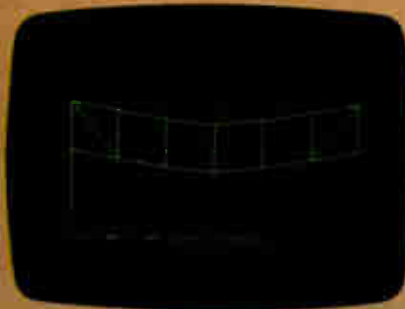

Structural Analysis



GANTT Chart

HEWLETT  PACKARD

3404 E. Harmony Road, Fort Collins, Colorado 80525

For assistance in U.S. call: Washington (301) 948-6370, Chicago (312) 255-9800, Atlanta (404) 955-1500, Los Angeles (213) 877-1282. In Canada call: Mississauga, Ontario (416) 678-9430. Ask for an HP Desktop Computer representative.

4091ZE

Circle 75 on reader service card

The HP 2621: simple

Simple doesn't have to mean unsophisticated. The proof is in our new CRT terminal, the HP 2621.

Before building it, we took a long, hard look at the way you use a simple terminal. Then we took the knowledge gained in more than 10 years designing computer products and applied it to engineering an interactive character-mode CRT terminal from the user's point of view.

The outcome was actually two models. The HP 2621A, which sells for \$1450. And the HP 2621P, which has a built-in printer, costs \$2550. You obviously want the sharpest display made. So we used the 9x15 character cell you see on every HP CRT terminal, including the top-of-the-line. And, to help you look back at the data you've entered, we provided two full pages of continuously scrolling memory.

We designed the keyboard like the familiar typewriter, so you don't have to waste time relearning it. We built in eight function keys, too. These control the cursor, rolling and scrolling. And, to make life easier, they're labeled on the screen for self-test, configuration, display and editing.

Editing? On a simple terminal? Certainly. We included character and line insert and delete, clear line and clear display. And, since the 2621 keeps your input separate from your CPU's, you can edit data before sending it to the computer. All without writing a line of system software.

Since flexibility is important in interfacing, we included a user-definable return key that will send your computer whatever code it expects. We also made our terminals compatible with RS232C and Bell 103A, and

able to communicate with your CPU at 110 to 9600 baud.

If you need hard copy at your fingertips, take a look at the HP 2621P. With a keystroke, its built-in 120 cps thermal printer will deliver a printout from the screen in seconds.

So why don't you check out the HP 2621 by calling the nearest HP sales office listed in the White Pages. Or send us the coupon. Then see for yourself how sophisticated a simple CRT terminal can be.



Try this on your favorite CRT! With the 2621P, you just hit a key and in seconds you have hard copy of your CRT display. The built-in thermal printer prints upper and lower case at up to 120 cps.

The 2621's bright, high-resolution CRT, with enhanced 9x15 character cell, displays the full 128-character ASCII character set, including upper and lower case, control codes, and character-by-character underline, in 24 80-character lines.

Eight screen-labeled preprogrammed function keys magnify the power of the 2621's keyboard. Preprogrammed functions include editing, terminal configuration, printer control and self-test.

To make numeric data entry faster and easier, we put the 2621's numeric keypad right in the middle of the keyboard. And the 2621's familiar 68-key keyboard is almost as easy to use as a typewriter.

- I'd like to know more about HP's new 2621A and 2621P with built-in hard copy.
- I'd like to see HP's new 2621A and 2621P with built-in hard copy.
- I'd like to know more about HP's complete family of terminals.

Name _____

Title _____

Company _____

Address _____

Phone _____

Mail to Hewlett-Packard, Attn: Ed Hayes,
Marketing Manager, Data Terminals Division, Dept. 647,
19400 Homestead Road, Cupertino CA 95014.

HEWLETT  PACKARD

All prices are U.S. list.

Available on GSA Contract #GS-00C-01529 from 12/8/78 through 9/30/79.

Circle 79 on reader service card

Simple sophistication.



..... HP 2621
FEATURES

DISPLAY

- High resolution CRT
- Character-by-character underline
- Tabulation and margin control

MEMORY

- Two full pages (48 lines)

HARDCOPY (2621P ONLY)

- 120 character-per-second thermal printing
- UPPER/lower case letters, control codes, underline
- Automatic data logging

EASE OF USE

- 8 screen-labeled control keys
- Soft configuration

EDITING

- Character mode editing (Modify Mode, Line Mode)
- Character and line, insert and delete
- Clear line, display

MODIFY UNDERLINE DEL LINE DEL CHAR INS LINE DEL LINE INS CHR DEL CHAR

Teradyne finds the practical solution.
No. 10 in a series.

The chroma generator

Color it clever.

Converting a color television signal into a screen full of "The Muppets" is only slightly less complicated than unscrambling an egg. The rf signal appearing at the receiver front end is a jumble of modulated subcarriers and synchronizing signals, all of which must be delicately picked off and converted into information the picture tube can handle.

The toughest unscrambling job of all falls to the chroma demodulator, whose synchronous detectors must pull the color information out of a phase-modulated subcarrier and combine it with brightness information to create the proper mixtures of primary colors at the video output stage.

To test the chroma demodulator (in today's TV sets, integrated circuits), it is necessary to apply a modulated test signal at the appropriate subcarrier frequency and then accurately measure a number of phase-sensitive output voltages at the device output.

In practice, most of today's chroma demodulators are tested on Teradyne J273 Linear IC Test Systems equipped with a "chroma generator" specially designed to develop the convoluted waveforms that are required. The output of the chroma generator's output consists of 16 segments, each of which is programmable in time, dc level, and subcarrier level. In addition, three separate "event" outputs can be programmed to provide keying pulses whenever they are needed. Finally, a gated voltmeter can be programmed to measure, in any given segment,

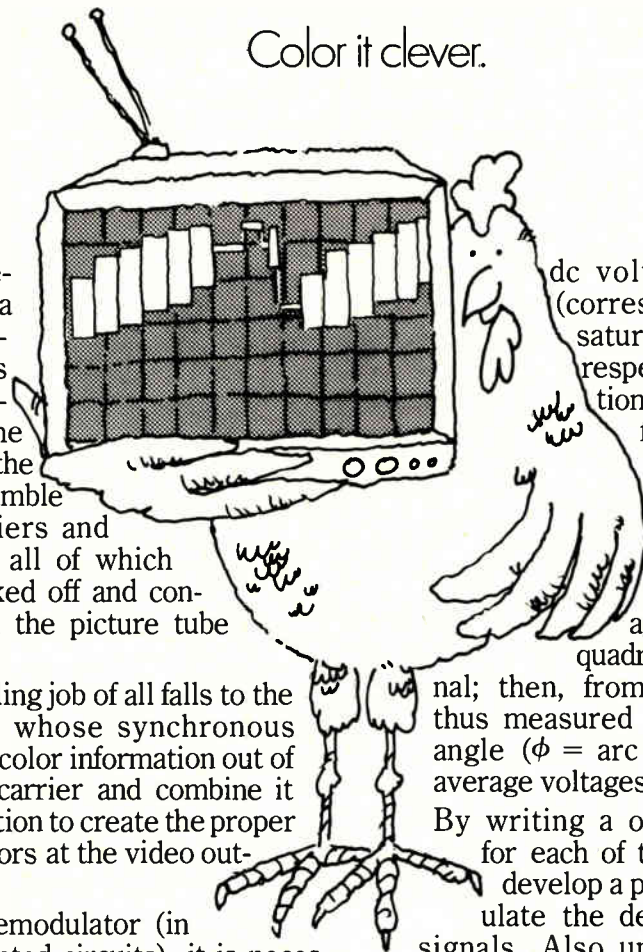

dc voltage, ac voltage, or phase (corresponding to brightness, color saturation, and color information, respectively). Since color information is actually transmitted in the form of phase angles, phase measurement is especially critical in chroma testing.

The chroma voltmeter is more than equal to the task.

First it measures the average values of the in-phase and quadrature components of the signal; then, from the ratio of the two values thus measured the voltmeter derives phase angle ($\phi = \text{arc tan of the ratio of the two average voltages}$).

By writing a one-line software instruction for each of the 16 segments, the user can develop a periodic waveform that will simulate the desired range of chroma input signals. Also under software control are a number of other variables, including voltmeter operating modes, subcarrier frequency and amplitude, and scale factor and attenuation of the video waveform. Test procedures differ for the American and European systems (NTSC and PAL), and this choice is also made in software.

Thanks to the J273 and its chroma generator, today's chroma demodulator can be rigorously tested on the production line in well under a second. The story doesn't end there, of course, for device designers are now busy adding more circuits to the same chip, while Teradyne's linear-test engineers are just as busy developing new automatic test techniques.

After all, once you have unscrambled an egg, why not build a hen?

CII-HB aims at IBM's spot in France

Spearhead is R&D group that spends \$100 million a year, with new advanced research unit roaming computer frontiers

by Arthur Erikson, Managing Editor, International

In the computer business, *chutzpah* can be defined as trying to match market shares with IBM. And CII-Honeywell Bull's president and director general, Jean-Pierre Brulé has it. Now that he has managed to turn the "French-computer" company into a money-maker, he is aiming to oust IBM by the end of 1980 as the market leader for deliveries in France.

If CII-HB does not manage that formidable feat, it won't be because the company scrimped on spending for research and development. Its budget for R&D currently runs more than \$100 million a year, enough to support some 2,500 employees. That puts it at the top of the list in the computer sector for France. Worldwide, of course, IBM is far and away the biggest R&D spender, with outlays of more than \$1.1 billion in 1977, according to *Business Week*, an American magazine.

But CII-HB can stake a fairly legitimate claim to second place. It swaps research results with Honeywell Information Systems Inc., which owns 47% of CII-HB, and the combined R&D spending for the two tops \$200 million.

Even at that level, CII-HB cannot afford to do the wide-ranging basic research that IBM does. Nonetheless, it can and does patrol the frontiers of computer technology selectively. The patrol leader is 40-year-old François Maison, the company's scientific director, who also heads a new 80-person advanced-research center started up this spring at Louveciennes, some 15 miles west of Paris. Most of CII-HB's 2,500 R&D people spend their working days developing new hardware. The new group, in

contrast, will have no specific product goals. "It will work only on new technologies," Maison explains.

Major thrusts. But it will not work on all technologies, obviously. There will be a considerable effort in integrated circuits and magnetics, where CII-HB already has considerable expertise. The other major thrusts in hardware will be fiber optics and printers. To no one's surprise, there will be a lot of work going on, too, in advanced programming languages and in new architectures for computers, mainly multiprocessors.

Still another mandate for the new center is to set up an effective dialogue with the 1,000-odd scientists and engineers working on computer-related technologies in government and university laboratories. That way, CII-HB can get basic research done that it cannot do itself. Also, of course, the Louveciennes crew will coordinate all the advanced research throughout the firm. "The hardest job in research management is to stop a project when you realize it is going bad," Maison maintains.

Like every other computer maker, CII-HB has to stay on the leading edge of semiconductor technology. So Maison has his people out there, too, although he studiously eschews the character-string "VLSI" that most people in the business use when talking about new generations of integrated circuits. "I don't see any real dividing line between large-scale integration and very large-scale integration," is the way the R&D chief explains it.

Chief researcher. François Maison heads CII-Honeywell Bull's 2,500-person R&D establishment that is budgeted at \$100 million.

Whatever you call it, CII-HB is continuously updating its facilities for computer-aided design (CAD) of integrated circuits with up to tens of thousands of transistors on a chip. When it does a design, CII-HB carries the job all the way through to a set of tapes for making masks. Although it tracks all the major processing technologies, most often its designs are for n-channel silicon-gate MOS circuits or for bipolar current-mode logic (CML). The n-MOS ICs are usually microprocessors or custom designs for peripherals; the mainframes for the company's next generation of computers will be based on CML, actually a variant of emitter-coupled logic but having a voltage level of only 400 millivolts instead of the 800-mV levels typical of ECL circuits.

With its CAD, CII-HB has three



Probing the news

basic attacks on integrated-circuit designs. One uses a library of building blocks like gates and flip-flops to build up circuits, which "is fast, but wastes chip real-estate," observes Maison. A second method is to use an uncommitted logic array, which is the technique the company is using for CML.

The third way to accomplish it is to design the circuit from scratch using random logic. This, Maison feels, is suitable only for mass-produced circuits like random-access memories. CII-HB uses industry standards for its RAMs, but is good enough at designing them to have to its credit a 16-K memory chip done for a semiconductor house (Maison will not name it) that was having trouble doing the job itself.

Not too much. Maison's crew, though, is not driving willy-nilly toward the biggest possible chips with the largest number of gates packed onto them. When everything is factored in—chip size, wafer size, component density, packaging, and the like—a plot of cost versus the number of gates takes on a U shape, according to his calculations. Carrying the integration on a single chip

Onward and upward. CII-Honeywell Bull's R&D effort is paying particular attention to new frontiers in integrated circuits and magnetics, as well as in fiber optics and printers.

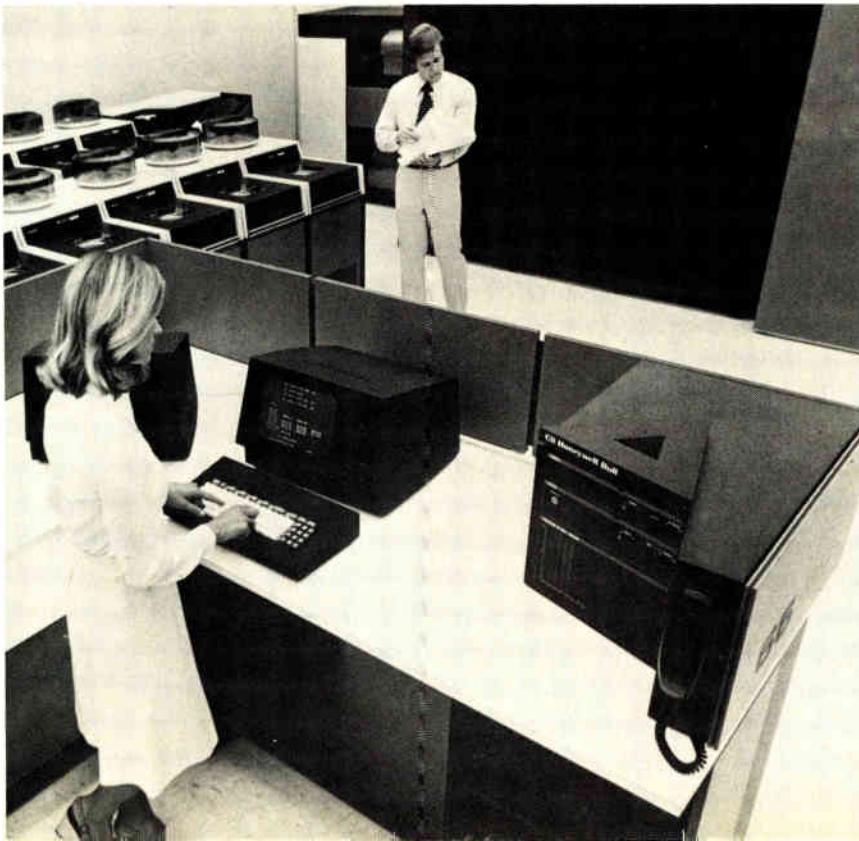

Moving toward natural language

Research and development is not all hardware at CII-Honeywell Bull, of course: there is the push to higher-level programming languages. "We are trying to move the boundary between the outside world and the computer as close to natural language as possible," says Etienne Morel, who is spearheading the effort as part of the company's accelerated R&D drive. At the same time, Morel says, there is a drive to make programs more efficient and more reliable. An optimizer that cleans up loosely written programs has already been developed. Also, Morel's group now is working on a verifier that will analyze programs and spot logical shortcomings.

CII-HB software-development teams have already scored with a high-level language it calls LIS (an acronym for the French phrase for systems implementation language). LIS will be the basis for a system language that will be implemented for the nine-nation European Community and it is essentially the "green" language that was one of the two left in the running for the U. S. Department of Defense's universal language for programming real-time systems.

too far, then, does not make sense.

"It is a pin problem," he explains. "For a really large chip, you need more than 140 pins to connect with the outside world and 80 is the limit now." Thus, Maison does not see any one-chip substitutes for the boards now used in big computers—Amdahl Corp.'s 470V6, for example, has some with 3,000 gates and 700 pins. As a rough rule of thumb, he hazards a limit of 1,000 gates per chip for MOS circuits for large computers, with more possible for minicomputers.

As for data storage, Maison sees no real competition between semiconductor memories and disk memories. Semiconductor memories get faster and cheaper, but disk memories get denser—and thus cheaper—following much the same curve. So CII-HB is pushing magnetics, particularly the integrated thin-film recording heads it has developed. Only 10 micrometers thick, they are about one tenth the size of a classic ferrite head. They can also be mass-produced: using lithography techniques similar to those for semiconductor fabrication, CII-HB produces 912 at a time on the substrate. Presumably, there is even better to follow: work has already started on a magneto-resistive-film read-only head that has a signal output some 10 to 15 times higher than the integrated heads and is independent of the disk speed.

A fiber future. Still other hardware needed for future generations of computers, Maison is convinced, are fiber-optic links. Here, CII-HB sees a need for bandwidths of at least 200 megahertz to interconnect computer cabinets with 100 or more simultaneous links multiplexed onto the fiber. The electronics for the multiplexer and for the driver, which will have to adapt automatically to the gain of a laser source, look so difficult that Maison expects not to see optical links between computer cabinets for some time. Before them, there will be slower links to connect low-speed peripherals to central processors. □

Close encounters of the best kind,



With Spectrol Special Pots!

Anyone who has had first-hand experience with Spectrol special potentiometers knows that he has encountered a component of the best kind. Best in design, construction, and performance. That's why a jet engine manufacturer asked Spectrol to design and build the industry's first 1000° pot. That's why a Spectrol pot helped our Astronauts control their Moon Rover. That's why a Spectrol special was there when Viking explored Mars. Whether you're building a luxury car or weighing a truck on earth, measuring the wind on the sea, or shooting for the moon—bring your special pot problems to Spectrol. We'll design, build and package a special to meet your toughest applications. At Spectrol, our special capability is—in fact—special!

Spectrol

SPECTROL ELECTRONICS GROUP

UNITED STATES Spectrol Electronics Corporation P.O. Box 1220, City of Industry, Calif. 91745, U.S.A. • (213) 964-6565 • TWX (910) 584-1314
UNITED KINGDOM Spectrol Reliance Ltd. Drakes Way, Swindon, Wiltshire, England • Swindon 21351 • TELEX: 44692
ITALY SP Elettronica SpA Via Carlo Pisacane 7, 20016 Pero (Milan) Italy • 35 30 241 • TELEX: 36091
GERMANY Spectrol Electronics GmbH Oberauerstrasse 15, 8000 Munich 70 West Germany • (089) 7145096 • TELEX: 05-213014

Circle 83 on reader service card

Meet the Analyst.

An improved version of an old friend.

Since its introduction, the Fluke 8020A has virtually become the industry standard for value in hand-held digital multimeters. And now the 8020A boasts a new set of features making it an even better buy—and a more powerful performer. So powerful, we call it the Analyst.

Now **0.1% benchtop DMM accuracy in a hand-held instrument.** A crystal-controlled A/D converter insures accurate, steady, noise free measurements and a basic dc accuracy of 0.1%. That's 25 times better than you'll find in most analog VOM's.

Here's something new that won't shock you. The Analyst boasts a new Fluke-designed test lead system with finger guards on the probe and shrouded contacts on the connectors to discourage accidental contact with circuit voltages.

We prove our reliability with a **two-year confidence warranty.** With well over 100,000 8020A's in the field, we know the Analyst is rugged and reliable. So we now back the Analyst with an exclusive limited two-year warranty and NBS traceable calibration with prompt service from over 45 factory authorized service centers worldwide.

There's more to the price than you might expect. You'd expect to

pay more money for the Analyst's added features. After all, the 8020A already boasts 26 ranges for seven functions including conductance. This capability is a unique way to measure high resistance—a must for checking leakage in capacitors, pcb's, cables and insulators, and general use above 20 MΩ. High and low-power ohms functions, easy one-hand push button operation and full over-voltage and over-current protection are all included. In fact, over 20% of the instrument's components are devoted to input protection.

But the price is still \$169*. And it now includes a deluxe carrying case and an improved operator's manual. The kind of value in performance, features, and accessories that only the industry leader can provide.

Here's how to get your hands on one. Contact the Fluke office,

representative, or authorized distributor in your area. In the U.S., CALL TOLL FREE (800) 426-0361. (For residents of Alaska, Hawaii, and

Washington, the number is (206) 774-2481.)

In Europe, contact: Fluke (Nederland) B.V., P.O. Box 5053, Tilburg, The Netherlands. Telephone (013) 673973. Telex: 52237.

For immediate response, fill out the attached coupon.

FLUKE®

John Fluke Mfg. Co., Inc.
P.O. Box 43210
Mountlake Terrace, WA 98043

- Please have a salesman call.
 Please send 8020A Analyst data.

Name _____

Title _____ Mail Stop _____

Company _____

Address _____

City _____ State _____ Zip _____

Telephone () _____ Ext. _____

E1 5/79

*U.S. Price Only

For Technical Data circle 84 on Reader Service Card
For Demonstration circle 85 on Reader Service Card

Software

TI tackles programming on broad front

Its Advanced Software Technology department operates as a corporate-wide group tackling all parts of the problem

by Wesley R. Iversen, Dallas bureau manager

It's a technology seesaw. As the cost of today's increasingly complex computer hardware continues to come down, the cost of the software for driving that hardware is pushing upward at an alarming rate.

Electronics executives everywhere express a growing concern over the so-called software problem. But perhaps nowhere in the corporate world is the problem being attacked as methodically as it is at Texas Instruments Inc.

"A lot of companies are doing things like what we're doing. But there aren't many, if any at all, that have tried to put it together into one organization as we have," observes Roger R. Bate, a 56-year-old Ph.D. who rides herd over what the Dallas company calls its Advanced Software Technology department (AST).

Formed in 1976, AST is responsi-

ble for the development of methodologies, tools, standards, and equipment aimed at holding costs down by improving software productivity and reliability. In particular, says Bate, the development of procedures to keep TI software projects running on schedule is of central importance.

Though formally a part of TI's Equipment Group, which handles most of the company's large Government and military contracts, AST is increasingly providing a broad range of software and software support services to other TI operations.

With some 100 software specialists on its payroll, AST is divided into 10 operating branches, each with specific functions. One branch provides support to various projects in the form of borrowed software specialists who serve as consultants, troubleshooters, and, in some cases,

project software managers. Another group offers a curriculum of in-house software education courses and has trained more than 1,500 TI employees over the last two years with offerings ranging from Pascal programming to the DX-10 operating system used on the company's family of 990 minicomputers. Still another branch develops specific language processors such as Pascal and Jovial compilers, while others concentrate on leading-edge research in computer software, architectures, and systems.

Weighing productivity. In terms of concrete measurement of AST's value to Texas Instruments, Bate says the numbers collected to date are inconclusive because of the well-known vagaries of gauging software productivity. But Bate says he is certain of one thing: the software projects that

Saying it softly. Programmers at work in TI's Advanced Software Technology department serve the entire corporation. The 100 software specialists on the department's payroll are split into 10 branches that handle such functions as troubleshooting and in-house education.



World's most popular —



MONOBLOC® Ceramic Capacitors



Temperature Compensating Stable and General Purpose

ERIE Red Cap Monobloc® Ceramic Capacitors are in a quality class by themselves and today represent a standard of excellence unequalled in the industry.

Monobloc capacitor elements, solid structures of fused ceramic, are produced in a wide range of capacitance values, characteristics and sizes. They offer inherent stability with conservative voltage ratings for long, trouble-free life.

The combination of Monobloc and "Weecon®" capacitors, under the famous Red Cap name, provide circuit engineers with unlimited design flexibility.

Best delivery in the industry for these popular Z5U values . . .

.1 .47 .68 1.0 2.2 4.7 μ F.

- Capacitance range
100 pF. thru 7.5 μ F.
- 25, 50, 100, 200, 500 Volts
- Broadest range of TC
materials and tolerances

Write for catalog 8100



ERIE TECHNOLOGICAL PRODUCTS, INC.
State College, Pa. 16802
814-237-1431

Probing the news

adhere from the beginning to AST's recommended disciplines, techniques, and methodologies tend to run on schedule. Those that do not tend to fall behind. "That's the one thing that's been more important than anything else we've done," Bates declares.

Tom Miller agrees. As strategy manager for TI's TMS9900 micro-processor family in Houston, Miller notes that AST has "participated in both the definition and development of all of our Pascal-oriented products," including Timber (for TI Modular-Based Executive in ROM) introduced by the company last week (see p. 48). In all of those projects, Miller continues, the "review and formalization procedures" required by AST methodologies were valuable in "identifying problem areas very early," thus preventing schedule slips caused by false starts.

The fact that the 9900 group's software technicians have been trained in standard AST methods is also a significant help when project personnel leave or are transferred, Miller points out. "If you have discontinuities where someone works on a project for three months and then quits and another person comes in and has to reinvest those three months, plus three months of his own . . . that sort of thing is almost completely minimized by the AST organization and the influence it has in the company," Miller observes.

Indeed, AST influence is growing. Bate has been named chairman of a corporate-wide steering committee for a TI project approved last January known as the Integrated Software Support System (ISSS). As explained by Douglas S. Johnson, an AST employee who is heading a working group for the initial phase of the ISSS project, the goal is to improve programmer productivity all over TI by 25% using methodologies, software tools, and equipment defined and developed by AST. The 25% goal is not unreasonable, Johnson says, adding that the savings to TI could amount to as much as \$379 million cumulatively by 1985.

Among initial ISSS tasks to be completed this year is a definition of

software productivity. "We're not convinced that source lines of code per man-month are really the best thing we've got, or that they're even believable," says Johnson of today's most widely used yardstick.

Universal methodology. Also scheduled for this year is the establishment of a single TI software methodology applicable across the entire corporation. Applications will extend from conventional corporate data-processing tasks, such as handling personnel and payroll, to such diverse software areas as semiconductor component design automation, automated manufacturing with robots, and development of the powerful software packages needed by TI's Equipment Group for large military contracts and by the geophysical services operation for seismic data processing. Software development for TI products ranging from 990 minicomputers to appliance-controlling microprocessors to industrial control and consumer products will also fall under ISSS.

"The idea is to build a methodology that can be tailored easily to any one of those applications, but still have many consistent features," Johnson explains. "We won't insist that everyone use a particular programming language, for example. But we will insist that there be some common characteristics to the design documentation produced."

More tools. Once the methodology is in place and the measure of productivity is defined, remaining steps in the project include AST development of new software tools, as well as hardware and equipment necessary to move TI incrementally toward the 25% productivity goal by 1985. Such equipment could include individual terminal-like work stations on every programmer's desk, for example, that would have all necessary capabilities for text editing and might even be portable enough for a loyal TI programmer to take it home for after-hours work.

In addition to the gain of internal efficiencies, there is, of course, another potential benefit of the ISSS project to be had by TI. Included as part of the program tasks are a series of analyses to determine cost and other requirements for eventual marketing of an ISSS system. □

Power supply engineers

design

and build

with Cirkitblock® modules

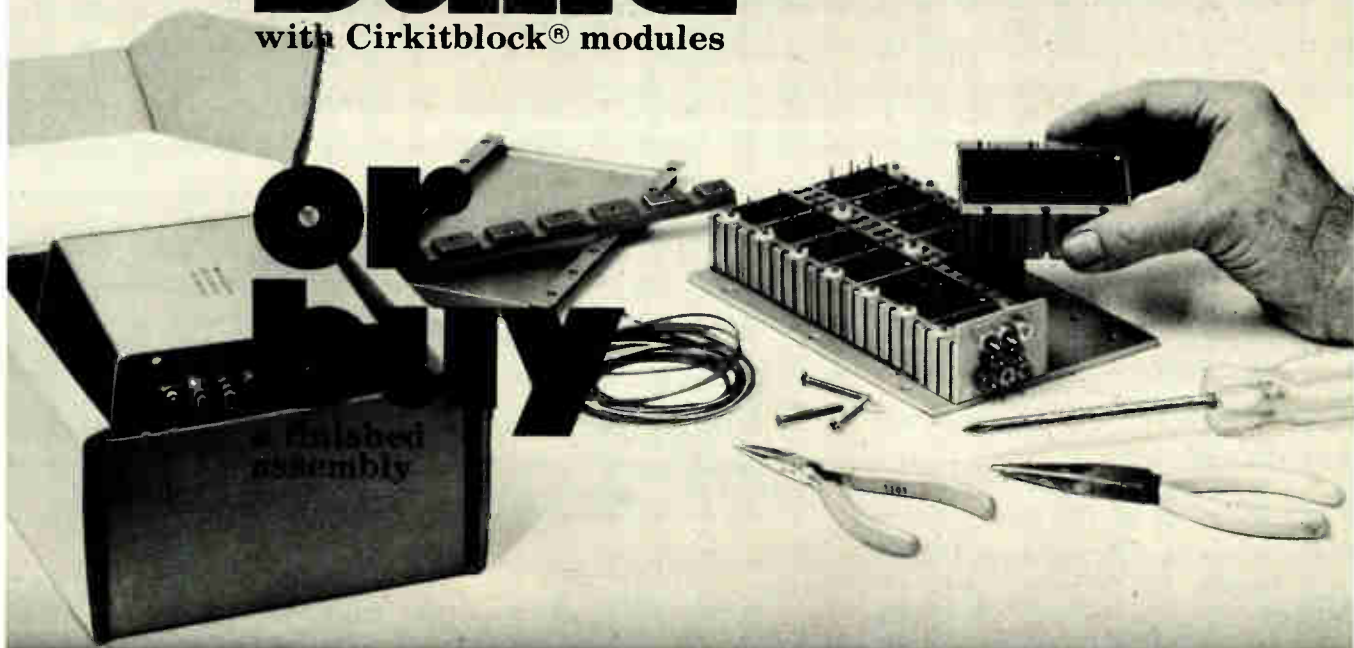
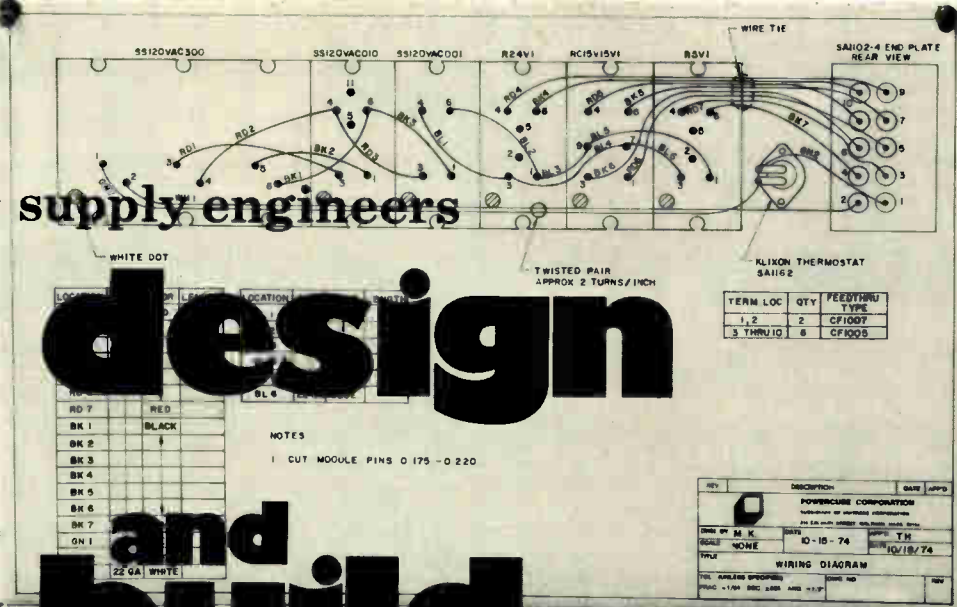

MIL standard Cirkitblock modules give you the option to design and build your own custom power supply. Or put us to work building a finished supply for you. You'll spend your time maximizing design and performance without getting bogged down in component selection, vendor delays and time consuming breadboarding. These pre-engineered modules meet the most demanding specs for sophistication, weight, environment, ruggedness, reliability

and performance (i.e., MIL-STD-704A, MIL-STD-461 and environmental conditions of MIL-E-5400). They allow you to synthesize an infinite variety of power supplies while providing all you need for your finished power source. Next time your program calls for a MIL standard power supply, contact Powercube and find out how you or we can optimize the design and save money using Powercube® Cirkitblock modules.

POWERCUBE
A SUBSIDIARY OF UNITRODE CORPORATION

POWERCUBE CORPORATION
EIGHT SUBURBAN PARK DRIVE
BILLERICA, MASSACHUSETTS 01821
(617) 667-9500

Investment

Venture capital booming again

More money is available than there are deals;
new firms with \$250 million have doubled the market in past year

by Benjamin A. Mason, New York bureau manager

After several years of lying low, the U. S. venture capital community is on the prowl again. Responding to massive infusions of new capital, venture capital companies of all sizes and descriptions are hunting for entrepreneurs to finance.

Long a prime area for venturing (as the cognoscenti call it), the electronics industries can expect another round of funding. Indeed, from the standpoint of the electronics entrepreneur, it may be something of a seller's market. "There's a lot of money chasing a very few deals," said one participant in a venture capital seminar late last month at Electro79 in New York City.

"Over the past 12 months, some 15 to 20 new funds with over \$250 million in capital have been formed," says seminar participant Yung Wong, the investment manager for Time Inc.'s venture investment program. "For those who have been bitten by the entrepreneurial bug, this is a good time to obtain venture capital."

Moreover, new companies are only half the story. Venture Capital, a monthly publication that watches the industry, estimates that in 1978 between \$525 million and \$560 million in new money became available from newly established and existing venture capital firms. "Also, there are probably another 20 groups looking for money [to invest], and that means another \$250 million available," says Jane E. Koloski, assistant publisher of the Wellesley Hills, Mass., publication.

Equally telling is the jump in the amount of money actually invested. The figure tells the story of investment by what are known as small

business investment companies (SBICs), a major factor in the venture capital industry. In terms of constant dollars, SBIC disbursements are still below their levels in the early years of the decade—but they are continuing to rise.

Early in the cycle. How long the rise will continue is open to question—for as the figure suggests, venture investments tend to be cyclical. However, the venture capitalists at the Electro seminar clearly believe the current boom is still young.

The seminar participants were from corporate venture capital efforts (that is, arms of existing businesses, usually large ones), and they cited a resurgence of interest among such companies as a key factor in the boom. Seminar organizer Kenneth W. Rind, a principal in Xerox Devel-

opment Corp. of Los Angeles, noted that the venture capital cycle mimics the cycle of new stock issues for small companies.

While that cycle has shown an upturn, it is providing nowhere near the amount of capital it did before 1973. Less of the available money is going into the stock market, and more if it is going into venture investment companies. Add increasing U.S. corporate liquidity and the growing presence of foreign companies seeking investment opportunities, and the result is an increasing corporate presence in venturing.

Corporate investors often are in venturing as much for access to new technologies, markets, and potential acquisitions as for profits. Other types of venture capital firms are in the game strictly for the bottom line.

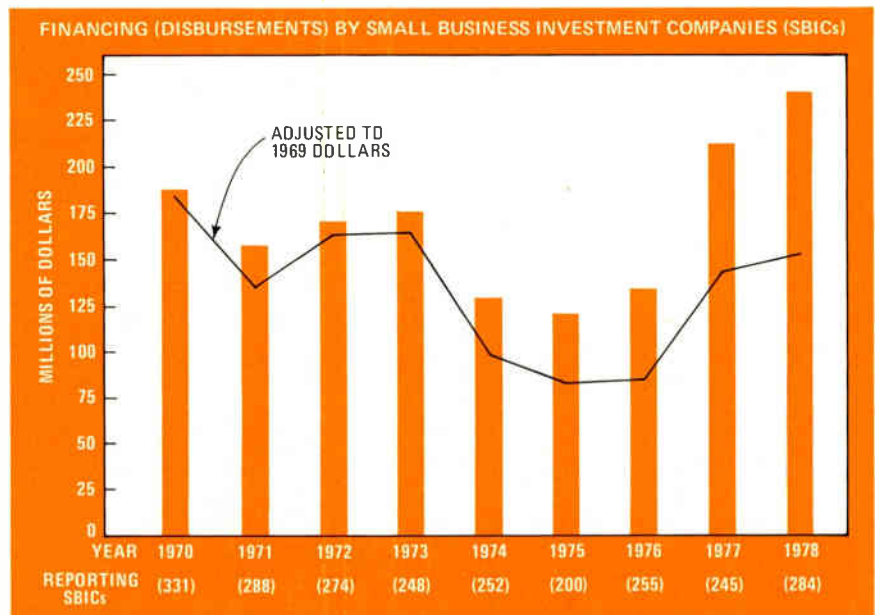

Making a comeback. The cyclical venture capital industry, like the economy, has made a strong comeback since it declined in 1974-75. Table shows activity of SBICs.

Individuals or small conclaves of partners that invest their own money fall in the latter group. The Arthur Rock Co. of San Francisco is an example well known in the electronics industries. Its president, Arthur Rock, reports, "I'm more busy now than I've ever been." Another type is the firm that pools investment funds from several sources, often from institutions like retirement funds. The influence of banks, insurance companies, and the like is burgeoning here, as well as in the corporate sector, reports Jane Koloski of Venture Capital.

Eye electronics. Whatever the type of investment company, there is no doubt about the interest in electronic ventures. Xerox's Rindt says that the track record of electronic venturing includes many sparkling successes, beginning with IBM Corp. One reason for the current interest, he says, is the passel of strong survivors of the late 1960s' explosion of electronic ventures—like Intel, Data General, and Mostek.

However, venture capitalists almost invariably want the profits to start flowing within a couple of years after they make their investment. They are seeking at least 20% pretax profits and 30% return on investment, said seminar participant Reuben Wasserman, vice president of advance planning for Gould Inc.'s Instrument and Controls group in Burlington, Mass.

One result of these goals is the venture capitalists' interest in companies that are past the initial stages of research and development. "There is very little money for startups that require a whole new technological or market development," says Donald T. Valentine, president of Capital Management Services Inc., Menlo Park, Calif. An example of a startup situation that does build on existing technology and a known market base is the one in 8-inch Winchester disk drives. "There's almost no one visible now, but in two years, there will be half a dozen new companies with these products," he says.

The condition of the industry sector is also important, Valentine points out. "For the last five years and for the next five, the businesses being financed are systems companies," he says. □

We see a small filter in your future.

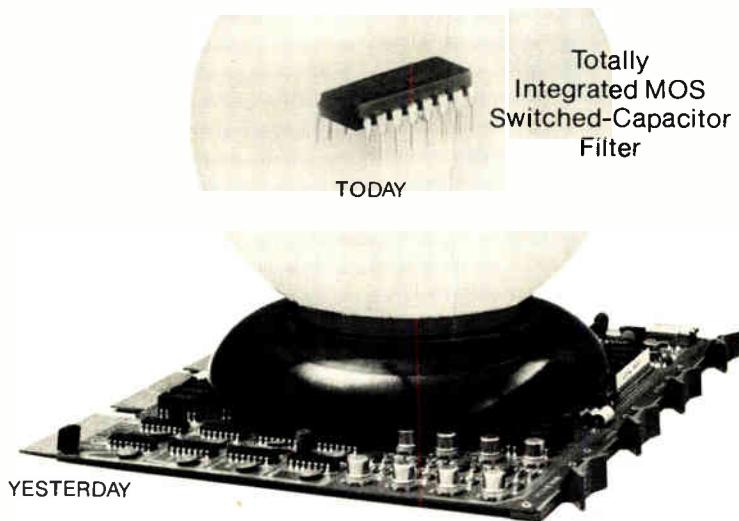

Now, classical polynomial and ladder network filters available in monolithic integrated circuits using MOS switched-capacitor technology.

Benefits:

- Save circuit board real estate
- Save manufacturing costs
- Save testing costs
- Save inventory costs

Features:

- Tunable center/corner frequency by external clock.
- Temperature stable (10 ppm/°C).
- No tight tolerance components and trim pots required.
- Standard 1/3, 1/2, full octave (6-pole Chebyshev; meets ANSI S1.11 specs) bandpass filters available from stock (R5604, R5605, R5606 respectively.)
- Custom designs available with multiple filters on a single device (up to 30 poles).
- Center/corner frequencies up to 50KHz.

For complete details on this important development in filter technology and how it can improve your product and reduce costs, call your nearest Reticon field office now.

 **EG&G RETICON**

345 POTRERO AVENUE
SUNNYVALE, CA 94086
TWX: 910-339-9343

For assistance call: Boston (617) 745-7400, Chicago (312) 640-7713, San Francisco (408) 738-4266, Los Angeles (213) 995-4663, Yokohama, Japan 045-471-8811, Regensdorf, Switzerland (01) 840-5305

The Personal Computing Book

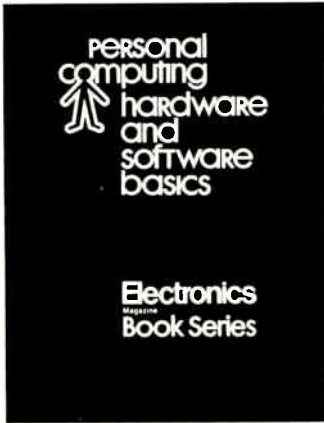

Take the computer revolution into your own hands!

More than 50 articles are presented from leading publications in the field to give you this up-to-date guide that answers all your questions on personal computing precisely and reliably.

Hardware • Software • Theory
• Applications • Helpful Hints

Order today, and don't forget the other valuable Electronics Magazine Books listed in the coupon below.

Electronics Magazine Books
P.O. Box 669, Hightstown, NJ 08520

Send me...

- _____ copies of *Microprocessors* @ \$8.95
- _____ copies of *Applying Microprocessors* @ \$9.95
- _____ copies of *Large Scale Integration* @ \$9.95
- _____ copies of *Basics of Data Communications* @ \$12.95
- _____ copies of *Circuits for Electronics Engineers* @ \$15.95
- _____ copies of *Design Techniques for Electronics Engineers* @ \$15.95
- _____ copies of *Memory Design: Microcomputers to Mainframes* @ \$12.95
- _____ copies of *New Product Trends in Electronics, No. 1* @ \$14.95
- _____ copies of *Personal Computing: Hardware and Software Basics* @ \$11.95

Discounts of 40% on orders of 10 or more copies of each book.

I must be fully satisfied or you will refund full payment if the book is returned after ten-day trial examination.

Payment enclosed Bill firm Bill me
Charge to my credit card: American Express
 Diners Club Visa Master Charge

Acct. No. _____ Date Exp. _____

On Master Charge only,
first numbers above name _____

Name _____ Title _____

Company _____

Street _____

City _____ State _____ Zip _____

Signature _____

Probing the news

Solid state

Sales strength seen

TI says U. S. semiconductor sales will rise 16% to 26% in major markets with computers leading the way

by Wesley R. Iversen, Dallas bureau manager

Despite an expected slowing of the economy later this year, Texas Instruments Inc. is projecting continued strength in the U. S. semiconductor market during 1979, with growth rates in major equipment market segments ranging from 16% to 26%.

Sales to small- and medium-size computer customers will be down during the second half due to higher interest rates and the slowing economy, the company says. But according to figures prepared by TI's U. S. semiconductor marketing vice president, Ed O'Neill, the computer segment overall is expected to lead the way in 1979 with 26% growth over 1978 to \$970 million. Including all segments, the overall U. S. semiconductor market is seen growing at a hefty 20% rate to \$4 billion this year. This would outstrip the 17% rate, to \$9.6 billion, projected for worldwide semiconductor sales by TI president J. Fred Bucy at the Dallas company's annual meeting last month [*Electronics*, April 26, 1979, p. 33].

As the biggest semiconductor manufacturer of them all, TI's crys-

tal ball reading for the \$4 billion U. S. market is less than the projected \$4.043 billion market reported as the industry consensus at the beginning of the year [*Electronics*, Jan. 4, 1979, p. 112]. But O'Neill puts last year's U. S. semiconductor sales at \$3.33 billion, whereas the industry consensus was a \$3.581 billion figure. This accounts for his 20% growth prediction, which tops both the 12.9% growth prediction reached by industry consensus and the 15.3% growth predicted by the Semiconductor Industry Association.

Slow spots. TI projects the slowest U. S. semiconductor growth rates in the consumer and Government markets, where the company says sales will increase by 16% to \$1.01 billion and \$670 million, respectively. Contributing to the slower consumer growth will be a flat year for automobile production at 9.3 million units and an 8% drop in color TV sales from the 10.3 million units moved in 1978, TI expects. The government end of the business will be boosted by continuing strength in the tactical equipment category with

MAJOR U.S. SEMICONDUCTOR EQUIPMENT MARKETS
(IN MILLIONS OF DOLLARS)

	1978	1979	Increase
Consumer	870	1,010	16%
Computer	770	970	26%
Industrial	1,110	1,350	22%
Government	580	670	16%
Total U.S.	3,330	4,000	20%

Source: Texas Instruments Inc.

the use of JAN (joint Army-Navy) devices.

The industrial market—which TI says will be paced by as much as 24% growth in telecommunications with the continued conversion from electromechanical to electronic switching—is expected to weigh in with a 22% growth overall to \$1.35 billion.

Continuing escalation in customer demand through the first four months of 1979 has extended lead times to 16 to 20 weeks for low-power Schottky logic and bipolar and MOS memory products. Despite this, TI officials note that double ordering has not become a major problem. O'Neill credits that in large part at TI to an allocation program begun by the company during the second half of last year that assures customers of product delivery. Though demand currently exceeds capacity, product pricing has not gone up, the TI marketing official says.

Ups and downs. In terms of semiconductor product types, TI sees sales of discrete devices rising by 11% this year, with drops in the silicon transistor market being partially offset by increasing sales of power and optoelectronics products. Integrated functions are projected to grow at 17%, paced by low-power Schottky as the preferred logic for new designs and by strong growth in linear circuits such as bipolar-field-effect-transistor operational amplifiers, plasma display drivers, and switching regulators, in which TI has been active.

With a 31% growth projected for sales of integrated systems, the trend toward higher complexity and lower costs in semiconductor memory will continue, TI says. Continued rapid growth in microcomputers is also seen. Applications for 4-bit devices such as the popular TMS1000—the Dallas company says it has now produced more than 12 million—will continue to proliferate in toys and games and in the home telephone market, among others. Automotive engine control will be one of the markets for 8-bit devices, while TI expects its 9900 family of 16-bit machines to continue finding important niches in instrumentation, industrial controls, and other uses.

You know Hamlin reed switches Now get to know Hamlin reed relays.

Hamlin has long been Number One in reed switches. Now make Hamlin your Number One choice for PCB and dual in-line packaged reed relays.

Hamlin reed relays are hermetically sealed in epoxy with a choice of Form A, B or C contacts; diode or electrostatic shielding optional. These are available as dry reed or mercury-wetted, no-bounce operation. One mercury model permits operation in any position—a Hamlin first!

All Hamlin reed relays can be driven directly with TTL and CMOS logic and provide total isolation between input and output circuits. The epoxy encapsulation provides high vibration and shock immunity and gives total protection to the coil and contacts in hazardous environments.

For More information, write or call:
Hamlin, Inc.,
Lake & Grove Streets,
Lake Mills, WI 53551
Phone: 414/648-2361
TWX 910/260-3740

HAMLIN
INCORPORATED

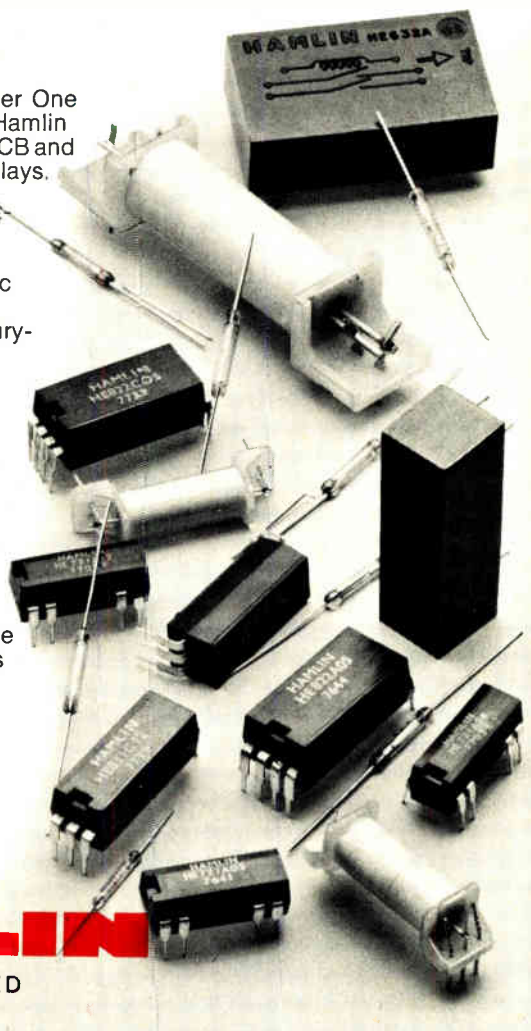

1448

Circle 90 on reader service card

From Electronics Magazine Book Series. Zero-risk trial offer.



New Product Trends in Electronics, Number One

From "New Products," state-of-the-art materials and equipment, arranged according to function. \$14.95

Electronics Book Series

P.O. Box 669, Hightstown, N.J. 08520

Send me _____ copies of "New Product Trends in Electronics, Number One" at \$14.95 per copy

Discounts of 40% on orders of 10 or more copies. I must be fully satisfied or you will refund full payment if the book is returned after ten-day trial examination.

Payment enclosed Bill firm Bill me

Charge to my credit card:

American Express Diners Club
 Visa Master Charge

Acc't No. _____ Date exp. _____

On Master Charge only,
first numbers above name _____

Name _____ Title _____

Company _____

Street _____

City _____ State _____ Zip _____

Signature _____

Electronics abroad

South Korea starts own Silicon Valley

Institute in industrial park has five-year charter to start domestic industry by providing technical backup

by William F. Arnold, San Francisco regional bureau manager

Eyeing the growing electronics marketplace, countries across the world are attempting to emulate the success of the U.S. and Japan. European schemes, for example, include direct investment by multinational companies, joint ventures between domestic and overseas corporations, acquisition of U.S. companies, government seed money to spur research and new markets, and even direct government formation of new com-

panies dealing in high-technology.

South Korea has some rather different ideas on how to become the next big electronics manufacturing country—one that will produce both semiconductors and computing systems, government officials say. In so doing, the country is finally abandoning its role as an offshore assembly area, which rising labor costs, coupled with advancing industrialization and the attendant large

consumer electronics market, is fast making untenable anyway.

To get into the act, the Korean government is taking two major thrusts to help its local companies, which are mostly oriented toward consumer electronics. Conventionally enough, it is encouraging the popular joint-venture route, such as the \$10 million deal to set up a cooperative plant between American Microsystems Inc. of Santa Clara, Calif., and Gold Star, described as Korea's General Electric. Much less conventionally, the government has created a novel catalyst in the form of the Korean Institute of Electronics Technology (KIET).

Funds. Armed with a just-approved \$29 million loan from the World Bank and another \$30 million from the Korean government, KIET plans to offer companies the training, research and development, mask making, software development, testing, and whatever else it takes to help a modern electronics industry get off the ground.

The institute's technology service center will be part of a new 2,000-acre electronics park in Gumi, in the south, according to KIET president Sang Joon Hahn. He says the first 100,000-square-foot building, housing 4-inch-wafer-fabrication lines for both linear and MOS devices, is due to be finished in September. When the entire eight-building complex is completed in 1981, it will house production lines, test equipment, and development teams and include dormitories to house technicians undergoing training. KIET's staff also will have grown by then from 150 to about 500.

KIET is expected to be self-



THE FIVE BEST WAYS TO ISOLATE A PROBLEM.

We've developed the industry's broadest line of 6 and 8-pin optoisolators because you can't solve all electrical noise problems with one product.

For instance, we took care of data rate problems with our 1 Mbit 6N series, which also offers 400% CTR at a .5mA input current.

Or if you need to switch SCRs or TRIACs, our SCR is rated at 300V (peak), and features up to 5000 VDC isolation.

Our SPX 7000 series provides 1, 5, or 10mA controlled gain at percentages ranging from 10-50% (1mA), 30-200% (5mA) and 10-250% (10mA).

And for TTL interface, our SPX 74A1 offers guaranteed logic level compatibility and 4000V RMS isolation over the full 0°C to 70°C operating range.

Finally, we supply industry standard 4N optoisolators including transistors and darlington off the shelf.

The choice is yours for replacing pulse transformers, twisted wires and coaxial cables in computer peripherals, data terminals, home appliances and telephone systems. And for providing protective isolation between microprocessor and 120-240V power lines.



NO CHARGE

Please send me free samples of all your optoisolators so I can design the noisy electrical charge out of my next application.

Name _____ Street _____

Company _____

City _____ State _____ Zip _____

Application _____ Annual Usage _____

New Design Current Design

E

The point is, no two electrical noise problems are exactly alike. That's why we offer more ways to isolate them than anybody else.

For more information on our optoisolators and other optoelectronic products, call us at 214/234-4271. Or write to 830 East Arapaho Road, Richardson, Texas 75081.

Spectronics
A Division of Honeywell

Probing the news

supporting in five years. As Sang says, "Otherwise people could become stagnant. With continued government support, no one would want to work very hard." KIET has an independent board of directors because the South Korean government does not want to add to its state agencies. Observes Glen R. Madland, president of Integrated Circuit Engineering Corp., Phoenix, which has done consulting work in Asia, "The South Koreans are an interesting combination of Asian thinking and Western entrepreneurial practice." He notes that South Koreans make decisions quickly in contrast to the sometimes drawn-out group consensus process that is characteristic of the Japanese.

Sang is aware that KIET "will have to develop capabilities step by step, not just jump to something new for its own sake." This means that at first it will be tied to the heavily consumer-oriented linear bipolar

technology. Korea "is not a great manufacturer of digital equipment yet," he says. But Sang indicates that, in 18 months or so, after KIET has established a basic capability, it will bring in equipment like electron-beam mask-making machines to prepare for more advanced circuits.

Gradually or not, KIET officials hint that Korea could be producing microprocessor chips and memories by 1981. They also express interest in microcomputer and minicomputer systems. Trends elsewhere in the world, notably in Japan, show that progressive electronics companies usually graduate from consumer to more sophisticated wares.

In training. The better to train local engineers, KIET has about 50 engineers scheduled to come to U.S. companies. Of these, 9 will be in semiconductor processing, 12 in IC design, 15 in software, and 7 in systems hardware, states Young D. Kwon, director of KIET's U.S. branch in Cupertino, Calif., in the heart of Silicon Valley. Moreover, the South Korean government has



backed the Kyungbook National University near Gumi that will be producing 600 electrical engineers a year on top of the 100 or so from Seoul University, Kwon says. Also, Gold Star recently had 10 engineers being trained at American Microsystems Inc., Santa Clara, Calif.

Gold Star and Taihan are two broad-based conglomerates that are

General Purpose Relays

No one delivers
like P&B

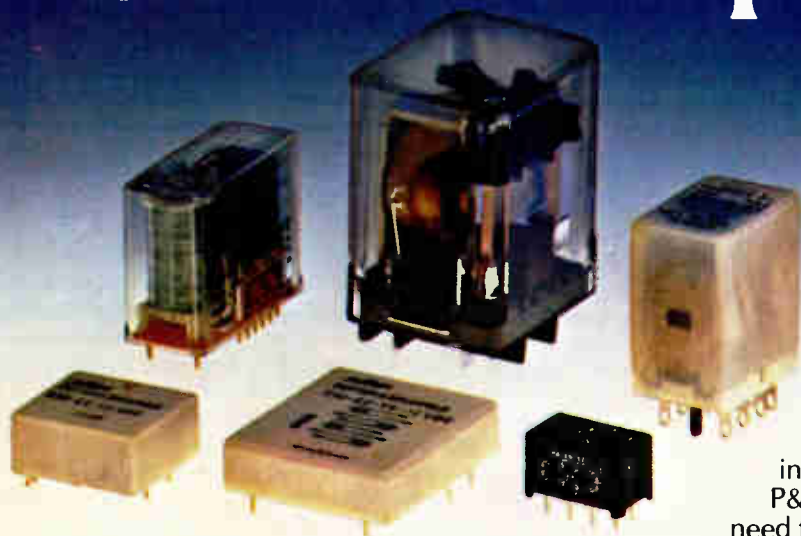

P&B is the largest manufacturer of general purpose relays in North America. We have the broadest line and the greatest number of design options in standard models or specials. With 45 years experience, we pioneered relays that are now industry standards...like our KH and PR series. We also have seven plants and the broadest distributor network in the business. This means you can rely on P&B to deliver the relays you need when you need them.

Potter & Brumfield Division AMF Incorporated, 200
Richland Creek Dr., Princeton, IN 47671. 812/386-1000.

Potter & Brumfield



Capital city. Seoul, South Korea's capital, is a bustling metropolis whose population has soared to more than 7.5 million.

as on the semiconductor side, although the exact figures have not yet been compiled.

Sensible? How sound is the South Korean approach? Kenneth Zerbe, who was AMI's senior vice president, secretary, and treasurer before he recently left to become Apple Computer Inc.'s vice president of finance and administration, says that AMI's first joint venture "made good economic sense—the market in Korea is large enough to support the investment." Also, he says, "there is export potential, although the venture initially will support the local consumer market first."

Zerbe says that AMI will have as many as six circuits under joint development with Gold Star. Although starting an advanced electronics industry is far from easy, ICE's Madland avers that the Gumi electronics park alone could eventually be as big as TI. □

already building their first semiconductor plants at Gumi, Kwon reports. Once in operation, they will join Samsung, which up to now has been Korea's only source, Kwon says. Samsung's Seoul plant currently produces 1,000 complementary-MOS wafers a day. KIET expects "at least" five IC plants in Gumi in the next two years, Kwon continues.

On the computer side of Gumi park, a joint venture of Hyosung and Japan's Hitachi Ltd. has bought land for a plant, and Kwon says that Gold Star, Samsung, and Taihan are negotiating with U.S. companies to build computing systems under license. Kwon estimates that the South Korean government will invest three times as much on the computer

...and other solutions to your tough design problems are found in P&B's growing product line.

AMF
Potter & Brumfield

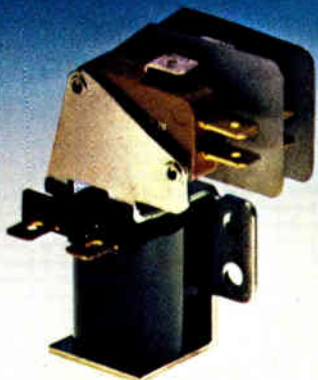

Low-cost S87R Industrial Relay. UL recognized. Contacts rated to 20 amps, 277V AC, 50,000 operations at rated load. Contact forms to DPDT. Ideal for vending machines, HVAC, home appliances and machine tool controls.

Circle 95



EOM Opto-coupled Solid State Relays. Long life interface between the logic output of TTL, HTL, or MOS circuitry and AC loads to 20 amps. Medium power, 120/240V. AC 50/60Hz. Zero voltage turn-on. Zero current turn-off.

Circle 264

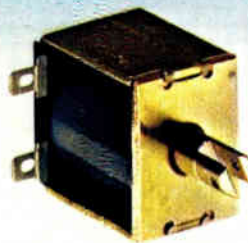

NEW S28 Box-Frame Solenoid. New compact, general purpose solenoid has enclosed coil for extra protection. Pull-on operate 6, 12, 24, 120 and 240V AC; and 6, 12, 24, 110 and 220V DC coils. Approximate coil power is 5.5 watts or 8 VA at continuous duty and 11.5 watts or 16.5 VA at 25% duty. UL recognized materials.

Circle 265



NEW Industrial Screw Terminal Sockets. UL recognized. Molded of rugged glass filled polyester with a compact unibody structure. Spring-action pin retainers assure positive electrical contact. Formed bus connections within socket for maximum trouble-free life. Can be used in track mounting systems.

Circle 266

"You want to have your own farm. You're prepared to work very hard to make it a success, but you don't have much money. That means you have to plant something that brings a cash crop quickly.

"You'd better not plant asparagus. It takes two years to grow. If you run out of money before you've got a crop to sell, you've lost the farm.

"That's why we started as a second source. We needed a fast-growing crop. We worked very hard. We built a lot of great products and a company to be proud of. That was our first decade.

"Now we're ready to challenge anybody at the design and process level. We're ready for the asparagus business."

W. J. Sanders III, President

Advanced Micro Devices is ten years old, and—because you may want to run out and start your own \$150 million company some day—we'll tell you how we did it.

First, we learned how to make high-quality parts.

We learned to make them better than anyone else. We made MSI and complex linear. (No gates, no flip flops, no 709's. Just the hard-to-make, easy-to-use, leading-edge parts.) And from the day we opened for business, we threw in a freebie with every order: MIL-STD-883.

After a couple of years, we added MOS/LSI. And we've done quite well at it, thank you.

By the mid 70's, we saved enough money to try some proprietary ideas:

We created the bipolar microprocessor business. The Am2901 and the whole first family of 2900 peripherals remain the hands-down, sales-up leaders in microprogrammable micro-processing.

We created a full line of proprietary MOS microprocessor peripherals. The star of the show was the world's first arithmetic processor: the Am9511. It works with all the commonly used microprocessors. And it works like a dream.

And now, of course, there's our new, industry-leading

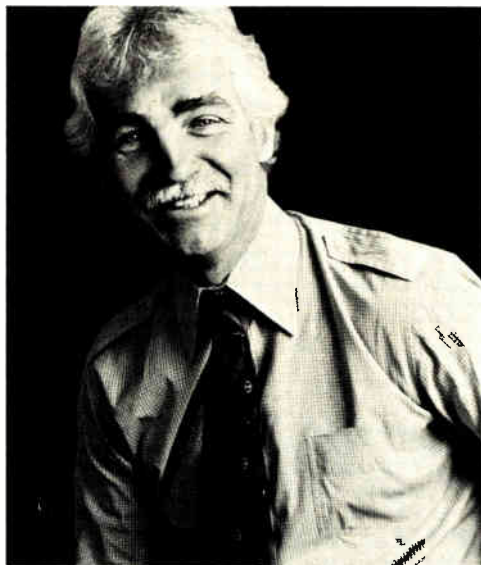

**"We're ready for the
asparagus business."**



16-bit microprocessor family, the AmZ8000. With all due respect to the 8086, it's just not in the same generation as the AmZ8000.

Along the way, we created a separate company: Advanced Micro Computers. It builds development systems. Our System 29 supports the 2900 family. Our new System 8/8

supports the AmZ8000 family. Look for Advanced Micro Computers to make additional, appropriate market entries with software, design aids and board-level components.

While we've been very busy being the fastest-growing integrated circuit company in the nation, we've suddenly become one of the very largest.

Right now, we're #7 and hot on the heels of Signetics and Fairchild. And National and Intel and Motorola and TI know we're there. And for the first time in our short history, there's money around to do some long-range things:

Twenty million dollars is going into the Advanced Micro Devices Technology Development Center. Ten for bricks and mortar. Ten for the best equipment. (We're going to furnish the AMD/TDC with the best brains in this business. If you're interested, call us. It's going to be a very nice place to visit your imagination.)

The past decade has been a swift millenium. We remember the Sixties when Fairchild was first and no one was second.

We remember the Seventies when Intel went from nowhere to Number One.

The conclusion we come to is unmistakable.

Every place has its time. Ours is now.

ADVANCED MICRO DEVICES

901 Thompson Place · Sunnyvale, CA 94086 · Telephone: (408) 732-2400

In logic design, production or service,



Design

Service

Production

If your product or service depends on logic, you should know about HP's constantly expanding family of logic-test equipment.

You'll find a wide choice of measurement solutions designed to make logic analysis, testing, troubleshooting and servicing easier, more effi-

cient and more cost effective than ever before.

HP logic-test equipment offers capabilities ranging from hand-held troubleshooting tools to automated instrument systems . . . instruments for stimulus and instruments for monitoring . . . dedicated instruments and multipurpose in-

depend on HP for your testing and troubleshooting solutions.

struments. In fact, HP has logic-test equipment to support products in every phase of your operation, including **design, production and service.**

That's why you should have a *free* copy of our new Logic Brochure—complete with many useful product descriptions and selection guides. It can help you pick the right instruments for your organization's particular logic testing and troubleshooting needs.



In design, HP's logic family gives you the tools to speed the transition from concept to product. They put you on critical system buses as well as key circuit nodes for a real-time view of system operation. That can mean faster troubleshooting, shorter development time and greater design reliability.



In production, HP has a choice of instruments and systems for each of the three important levels of production test: incoming inspection, board test and system test. These logic testers are designed to help you verify performance and quickly

isolate faulty components and assemblies. They're your assurance of component quality, board test efficiency and system reliability. And they can help you maintain high product quality, meet delivery schedules and control production costs.



In service, HP offers an array of portable instruments to arm field service personnel, plus versatile bench instruments for plant and depot service facilities. Put these vital logic-testing and troubleshooting tools in the hands of your service engineers and technicians for easy detection and isolation of logic malfunctions. You'll speed installation, maintenance and repair in a wide variety of digital systems.

Find out more about HP's logic family by sending for our *free* Logic Brochure today. It includes product application descriptions plus selection guides so you can zero in on the required instrumentation for your organization. Just fill out and return the reply coupon. Or, for immediate assistance, contact your local HP field engineer.

HP—When you depend on logic



HEWLETT *hp* PACKARD

1507 Page Mill Road, Palo Alto, California 94304

For assistance call: Washington (301) 946-6370, Chicago (312) 255-9800, Atlanta (404) 955-1500, Los Angeles (213) 877-1282

068/11



Please send me a free copy of the HP Logic Brochure.

Name _____

Title _____

Company _____

Address _____

City/State/Zip _____

Mail to: Hewlett-Packard, 1507 Page Mill Road, Palo Alto, California 94304

E5/10/79

Circle 99 on reader service card

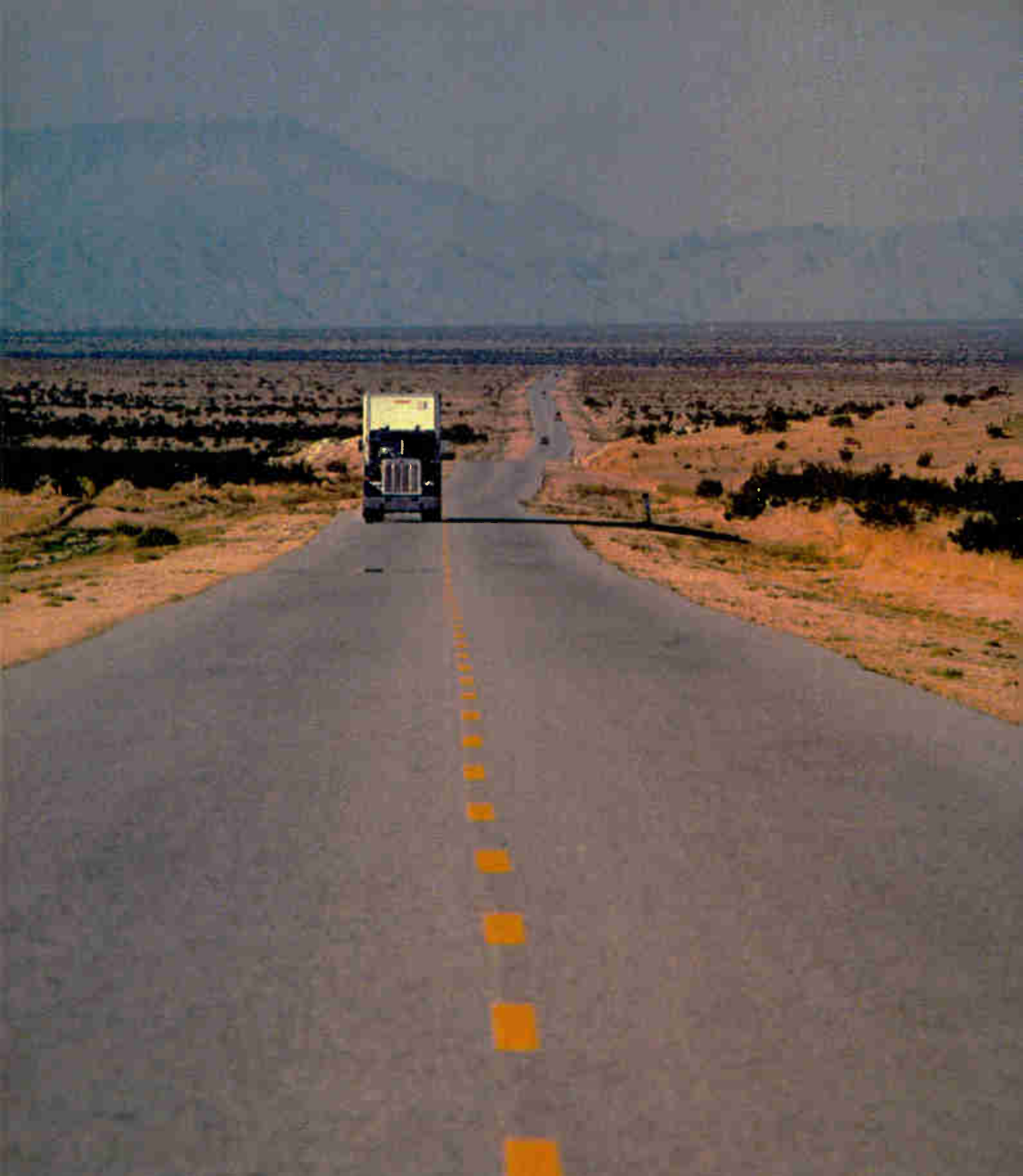

**We know exactly what's happening to the
OEM computer inside this truck's 140° interior.
Absolutely nothing.**



All computer manufacturers are concerned about how their products cope with heat while they're running.

At Digital, we also take a good hard look at how computers react to heat even before you turn them on.

Because we know you may have to ship product anywhere in the world, often under less than ideal conditions. And for a computer, high storage temperatures can be just as bad as high operating temperatures. So we test for both.

Our storage temperature testing is just part of the most comprehensive physical and mechanical test program in the industry. A program that subjects our products to drop forces up to 40Gs. Vibration forces far greater than those encountered on the average factory floor. Heat, humidity, static electricity, electromagnetic and RF interference.

At Digital, our approach has always been to give OEMs more than just great product. Just as important are the extra quality features, the extra testing that can make your design and marketing job easier. The software compatibility that can take you from micros to 32-bit large-scale computers, from one generation to the next. The worldwide service capability that can be tailored exactly to the way you run your business. It's an approach designed to help you meet a wide range of computer strategies.

You probably already know a lot about Digital performance. To find out the rest, send for our new brochure, "The Thinking Behind the Industry's Largest Selling Line of OEM Computers."

Digital Equipment Corporation,
(PK3/M-86), Maynard, MA 01754. (617)
493-6253. In Europe: 12 av. des Morgines,
1213 Petit-Lancy/Geneva. Tel. 93 33 11. In
Canada: Digital Equipment of Canada, Ltd.

**We build a lot more than performance
into an OEM computer.**

digital

Got Digital/Analog Boards to Test Get a NEW FLUKE MODULAR 3040 Test System!

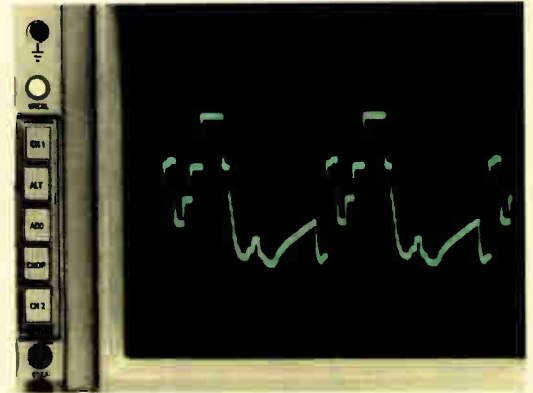
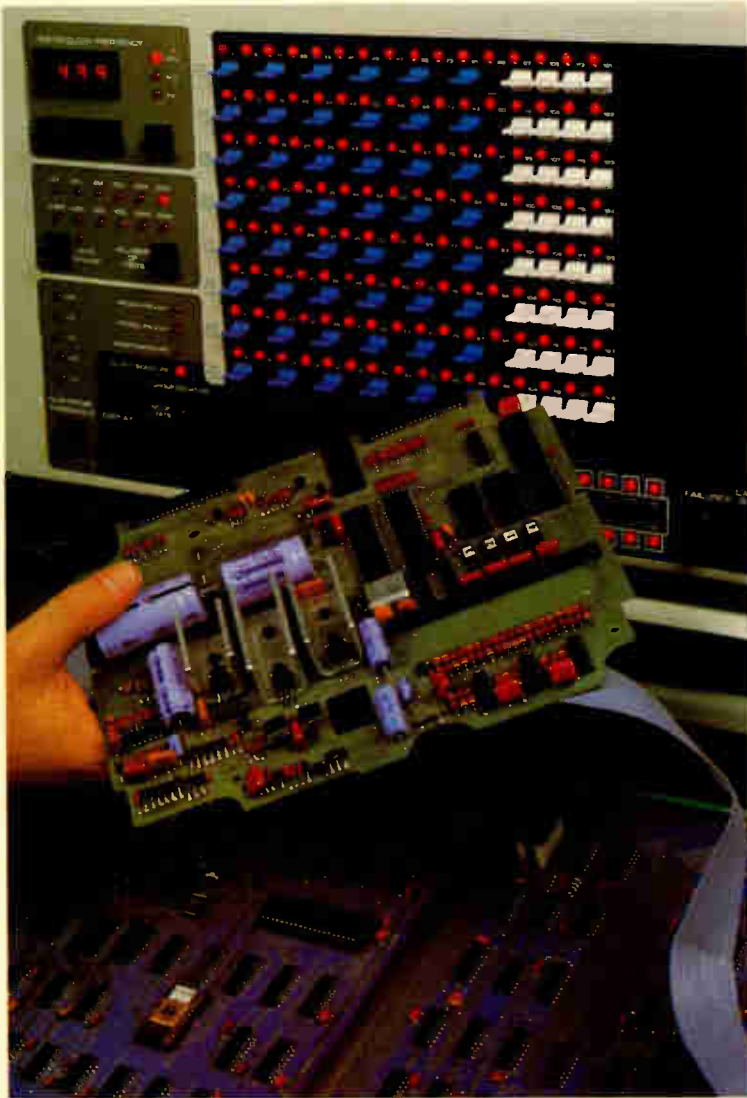

The new Fluke 3040 now adds REAL TIME PARALLEL analog testing to its already unsurpassed high speed digital capabilities.

A newly implemented technique called Complex Waveform Conformance provides significantly extended test capability for digital, analog and hybrid (combination digital/analog) printed circuit boards.

The new Fluke 3040 provides this capability coupled with:

- *Very Low Test Programming Cost*
- *Very High Production Test Throughput*

The new analog testing capability, along with other proven features like AUTOTRACK, Fault Emulation and 5 MHz test pattern rates makes the new Fluke 3040 the right testing solution for you.

and Diagnose?

Complex Waveform Conformance is a method for verifying, in real time, whether or not the signal under test stays within the programmed window.

Limit Window programming is extremely fast and simple. A resistance or DC voltage applied to the limit window input pin for each signal under test is normally all that is required.

For added sophistication, the new 3040 also provides for step by step masking of any channel and for changing of the limit window on-the-fly.

If you've got digital/analog boards to test, especially boards with microprocessors and other LSI devices on them, the new Fluke 3040 is designed just for you.

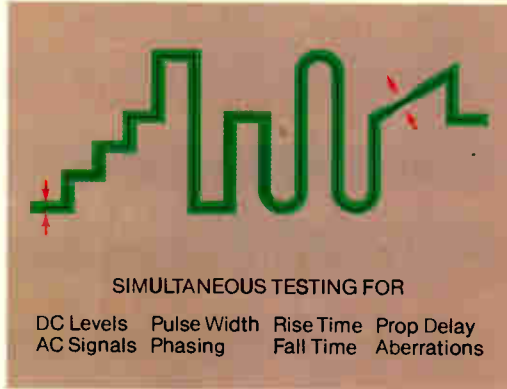

There are more microprocessor board types being tested on FLUKE 3040's than on any other dynamic PCB tester. WHY? It is the lowest priced tester in its class, and test programming costs are from one-third to one-tenth the costs encountered with other testers.

Want more information on how the new FLUKE 3040 works to save you time, money and aggravation?

CALL COLLECT to (415) 965-0350 for details. Or contact your nearest FLUKE office.

Circle No. 274 for demonstration.
Circle No. 275 for literature.



See us at booth 113.
ATE Seminar/Exhibit



FLUKE AUTOMATED SYSTEMS

USA — Boston (617) 890-1600; Burbank (213) 849-7181; Chicago (312) 398-0850; San Francisco (415) 965-0350; Seattle (800) 426-0361
WORLDWIDE — England (0923) 40511; Germany (München) 089-404061, (Düsseldorf) 0211-450831; Japan 045 473-5425;
Netherlands 013-673973; South Africa 011 786-3170

For a product as critical as custom I²L circuits...

you need a company as reliable as **CHERRY**

Cherry has been combining both digital and linear functions on the same chip since the infancy of I²L logic. Long experience, integrity of design, technological innovation and manufacturing excellence are only the beginning. You'll never meet a group of engineers more eager to work with you to solve **YOUR** problems. Engineers ready for the challenge of new design concepts. Eager for your business.

It really doesn't matter what your IC problem is. Whether the solution is one of our standard digital or linear bipolar ICs—or the most sophisticated custom design—Cherry *has* or can *provide* the right solution. At the right price. With the right delivery date.

All this from the folks at Cherry: A trusted name in industry for more than 25 years.

SEND FOR OUR FREE 36 page catalog of digital and linear ICs. Includes low level amplifiers—differential amplifiers—level detectors—DC to DC converters—timing circuits—motor speed controls—optical detector systems—camera controls—flip chips.



CHERRY **SEMICONDUCTOR**

CHERRY SEMICONDUCTOR CORPORATION
99 Bald Hill Rd., Cranston, Rhode Island 02920 / (401)463-6000 / TWX 710-381-1757

Circle 104 on reader service card

Monolithic approach bears fruit in data conversion

Improved circuit design and processing are boosting chip resolution, though hybrids still yield best performance, says this special report

by Nicolas Mokhoff, *Components Editor*

□ Another monolithic incursion is at hand as the big digital semiconductor companies move in on a data-conversion market that since its inception has been nurtured by hybrid circuit and module makers.

Large solid-state houses like Texas Instruments, Motorola, and National Semiconductor are making serious efforts at incorporating most, if not yet all, the functions of the analog-to-digital or digital-to-analog converter on a single piece of silicon. Twelve-bit resolution seems almost within their grasp. Yet the only traditionally analog house to be attempting to do likewise is Analog Devices.

The technologies involved are not unfamiliar to hybrid stalwarts like Burr-Brown and linear chip specialists like Precision Monolithics. Standard bipolar, standard complementary-metal-oxide-semiconductor, and mixtures of the two kinds of process are mostly what are being tried. But since the big digital houses can pick and choose among the various semiconductor technologies and opt for the one that yields inherently less expensive and more reliable products, they are a definite threat to those whose resources are more limited.

In a nutshell:

- National Semiconductor Corp., Santa Clara, Calif., is attacking the 8- and 12-bit precision a-d market with innovative design techniques in C-MOS that will be truly stand-alone microprocessor-compatible parts.
- Motorola Semiconductor Products division in Austin, Texas, is making not only 8-bit a-d C-MOS converters



compatible with its upcoming MC 146805 C-MOS microprocessors but are also supplying samples of very fast ("flash") converters—an 8-bit d-a, for instance, with a 25-megahertz speed due solely to its being a bipolar part.

■ Texas Instruments Inc. of Dallas, Texas, the biggest semiconductor manufacturer in the world, is also waking up from a long digital hibernation and threatening to take a chunk out of the data-converter field; specifically, it is carving away at the 8- to 12-bit a-d market with both special-function and low-cost standard devices.

■ Signetics Corp., Sunnyvale, Calif., is pushing ahead with its bipolar specialty, integrated injection logic, expanding from 8-bit to 10-bit and 12-bit microprocessor-compatible d-a converters.

■ Advanced Micro Devices., Sunnyvale, Calif., is using untrimmed diffused resistors instead of thin-film networks to achieve 12-bit monotonicity in its Am 6012 d-a converter. Eliminating thin films from integrated converter circuits allows AMD to tag the part at under \$10 in large quantities, a breakthrough for monolithic 12-bit d-a devices.

■ Not to be upstaged, Analog Devices Inc., Norwood, Mass., the barometer of the converter industry from the module products of its earliest years to its present-day chips, is using all of its available technologies and circuit ingenuity to offer a potpourri of devices including microprocessor-compatible parts. It is soon to release an 8-bit successive-approximation C-MOS a-d converter, the AD

TABLE 1: HOW BIPOLAR AND MOS MONOLITHIC DATA CONVERTERS COMPARE

Functions	Bipolar	MOS
Passive elements	diffused, implanted, or thin-film resistors	diffused, implanted, or thin-film resistors; MOS capacitors
Untrimmed accuracy	~0.2%	~0.1%
Long-term stability	~0.01%	~0.01%
Trimming	zener zap, Nichrome fuse, or laser wafer trim	polysilicon fuse, electrically programmable read-only memory, or laser wafer trim
Analog switching	current	current, voltage, or charge
Amplifiers and comparators		
Gain (internally compensated)	80 – 100 dB	60 – 80 dB
Dc offset (untrimmed)	~ 1 mV	~ 20 mV
Gain-bandwidth product	1 – 10 MHz	1 – 10 MHz
Rms noise, audio band	0.1 – 10 μ V	10 – 100 μ V
Dynamic range	120 – 140 dB	80 – 100 dB
Die area per amplifier	400 – 1,000 mil ²	150 – 500 mil ²
Voltage reference	band gap, zener diode	$V_{TE} - V_{TD}$, zener diode
Temperature coefficient (untrimmed)	50 – 100 ppm/ $^{\circ}$ C	10 – 20 ppm/ $^{\circ}$ C
Long-term stability	0.1%	0.1%
Implementation of other functions		
Sample-and-hold	complex	simple
D-a conversion	simple	simple
Monolithic filters	frequency-locked	switched capacitor, charge-coupled devices, or bucket-brigade device
Combined analog and digital circuits	I^2L + analog, EFL + analog	n-MOS, C-MOS
Strongest points	low-noise; high current and voltage compatibility; design experience; proven stability; -55° to $+125^{\circ}$ C	low-cost; filters available; microprocessor and memory compatibility; technology investment

7574, which is compatible with 6800 and 8080 microprocessors, and is also introducing bipolar converters, both a-d and d-a, in monolithic and hybrid forms.

- The higher-performance market continues to be dominated by hybrid converters not only from Analog Devices but also from hybrid specialists like Beckman Instruments Inc., Fullerton, Calif., and Harris Semiconductor Products division, Melbourne, Fla. What makes these two companies unusual is the breadth of their resources, in terms both of pure technology and of the products bred from the cross fertilization of these corporations' interests.

- Although committed to integrated circuits, RCA Corp.'s Solid State division, Somerville, N. J., enjoys the same advantages. Few commercial converter products are available from RCA at present, but the first of many C-MOS and bipolar ICs is expected to emerge towards the end of the year.

Meanwhile, makers of strictly monolithic converters are all busy exploring different combinations of process technologies and sophisticated analog and digital circuit

designs, to discover which approaches best fit which converter requirements. For instance, at this year's International Solid State Circuits Conference [*Electronics*, Feb. 15, 1979, p. 129], two full sessions were devoted to data acquisition, with engineers from prominent semiconductor manufacturers describing how clever circuit techniques in a proper process can be made to enhance functions needed for conversion. Moreover, their papers were not reports of blue-sky laboratory adventures but of products that are already being tried out as samples by key customers.

MOS versus bipolar

One strong advocate of using MOS technology for precision analog functions is David Hodges, professor of electrical engineering and computer sciences at the University of California at Berkeley. In Table 1 he trades off its advantages for this purpose against those of bipolar processes. He concedes to bipolar enthusiasts their accumulated design experience and the proven stability as well as the large dynamic range, lower noise and dc offset, and high-frequency response of bipolar devices. He also admits that MOS designers have still a large investment to make in developing a technology relatively untried in this area. On the other hand, he points out that MOS is a low-cost process, compatible with most microprocessors and memories and also well able to implement the filtering functions needed to counter the high noise of MOS transistors.

Other MOS advantages are that voltage references exhibit a fivefold improvement in temperature coefficients over bipolar. Also, analog switching may be implemented by current, voltage, or charge methods, whereas bipolar devices can use only current switches. As for the ability of dense MOS devices to pack more functions on each chip, it is to be noted that amplifiers and comparators occupy half the die area they do on bipolars; sample and hold circuits are simple, and there is even a choice of ways in which to implement monolithic filters.

The variety of approaches to the fabrication of monolithic converters has led to another phenomenon—two manufacturers specifying one converter characteristic in two different ways. The semiconductor houses, in addition to taking the most cost-effective approach, are cashing in on the specmanship game that prevails throughout the data-converter community. As far as resolution, accuracy, and linearity are concerned, specifying a-d and d-a converters is open to a good deal of individual interpretation. As when transistor-transistor logic (TTL) first became popular, it is a follow-my-leader situation. The first TTL makers specified the on- and off-voltage and everyone else pretty much took that as the industry standard. In monolithic data converters, the leader was Analog Devices, and its definitions are taken as the ball park for companies specifying the parameters of their often rather different devices.

What this basically means is that if companies A and B both say a part can resolve an analog signal to 10 digital bits, the device of company A may be 10-bit accurate but company B's may only be accurate to within 8 bits, due to the interpretation of the converter's linearity. The interpretation, or misinterpretation, of

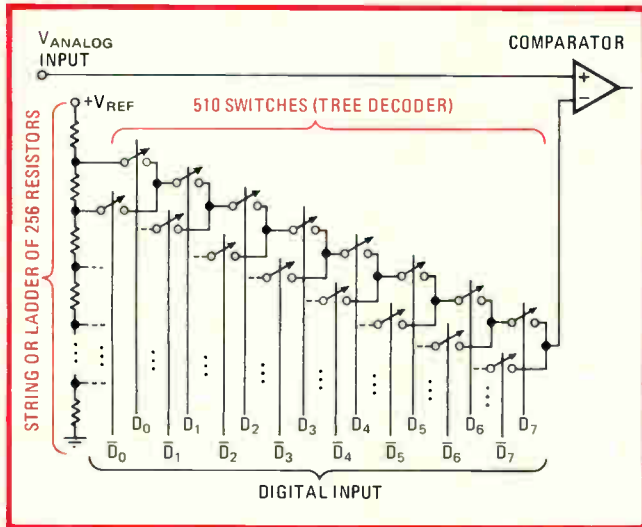

1. The big tree. Making analog-to-digital conversions with the usual MOS potentiometric technique is cumbersome. At 8 bits, 256 resistors and 510 analog switches are needed for the tree-decoder configuration. In addition, placing 8 switches from each tap to the comparator input results in a prohibitive total switch on-resistance.

these and other specifications avalanche through other parameters as well, much to the chagrin of a potential user. Yet divergent specifications for the same type of part cannot be attributed solely to the manufacturer's desire to accumulate profit. It is part of a growth syndrome that every new segment of the semiconductor industry goes through before the emergence of clearcut leaders that set de facto standards.

Be that as it may, the new semiconductor makers in the field have a bag of circuit designs that reflect the state of the art in both MOS and bipolar technology. Leading the charge for the MOS side is National Semiconductor. A unique circuit design approach enables National to halve the area occupied by analog switches in a typical 8-bit d-a converter [*Electronics*, March 15, 1979, p. 39]. "The MOS technologies offer many new basic circuit approaches that can be applied to converter products," says Thomas Frederiksen, design manager of data-acquisition products. "One example is the auto-zeroed MOS sampled-data comparator, which consists of a cascade of capacitor-coupled gain stages, where each stage is a slightly modified logic inverter."

The 2ⁿR ladder . . .

To go back a year or two, this sampled-data comparator was first used in a National p-channel MOS a-d device, the first monolithic successive-approximation converter. Here a sampled-data comparator switched in known voltage values from a multiply tapped string (ladder) of diffused resistors connected between a reference voltage and ground. This resistor string (itself a relative of the classical R-2R ladder) was equipped with a tap for each of the 2⁸ possible analog output voltage levels. It was therefore known as the 2ⁿR potentiometric technique and became the optimum method of voltage scaling in MOS a-d converters. For instance, it has been used in several monolithic 8-bit a-d converters, including the National ADC0816 C-MOS 8-bit 16-input-

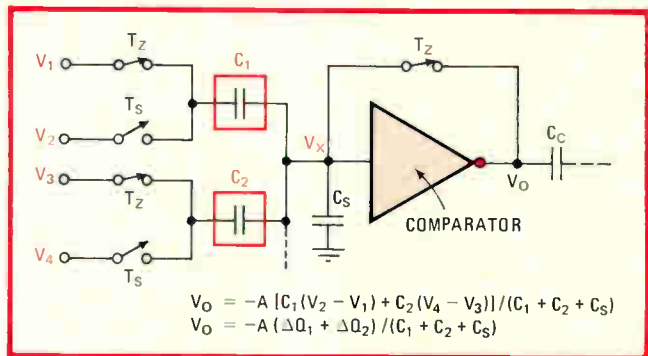

2. Comparator is the key. Modifying the input circuits to the comparator allows multiple differential input voltage pairs to use the same node (V_x) as summing point. In National Semiconductor design, charge instead of voltage is measured, amplified, and later summed with other input charges on in effect a real-time basis.

channel data-acquisition chip, and also in Intel Corp.'s 8022, a microprocessor complete with a unique on-board 8-bit a-d converter.

To National, however, it appeared that the MOS potentiometric a-d had no future beyond 8-bit designs. Even at 8 bits the converter needs 256 (2⁸) resistors and 510 (2⁸⁺¹ - 2) analog decoding switches, laid out in a tree decoder to reduce the number of drive lines needed for the switches (Fig. 1). Such a configuration eases the layout problem, but places eight switches in series from each tap on the resistor ladder to the comparator input and therefore greatly increases the total switch on-resistance. Worse yet, this many resistors and switches have typically occupied up to 50% of the total die area. Evidently, a simple application of the 2ⁿR potentiometric technique to 10- and 12-bit a-d converters would roughly double and quadruple their numbers, demanding a monstrously large chip.

. . . with a difference

To avoid this, Frederiksen and his team have modified the 2ⁿR approach, essentially by expanding the input capabilities of the comparator, the key element in any a-d converter. The new design uses a combination of capacitors and resistors allowing a multiplicity of differential input voltage pairs (Fig. 2). Using input capacitors enables the comparator to compare the directly differential input voltage with the sum total of the effects at the other differential inputs. This is because what is measured is the change in charge, not voltage, at the comparator input. And this charge at input node V_x is amplified, so that many inputs are available for both the input analog signal and the known digital-to-analog converter inputs. If the charge transfer to the input by the d-a is equal and opposite to the charges transferred by the analog differential input, a comparator equilibrium is obtained. At equilibrium, there is no net change in charge at node V_x , a charge-balanced condition. When the sampled analog input value exceeds or is less than the known quantity, the comparator's output is one definite logic state. These states then are summed to come up with the equivalent digital code. The successive-approximation technique then can be implemented with a fast real-time comparison, instead of having to run

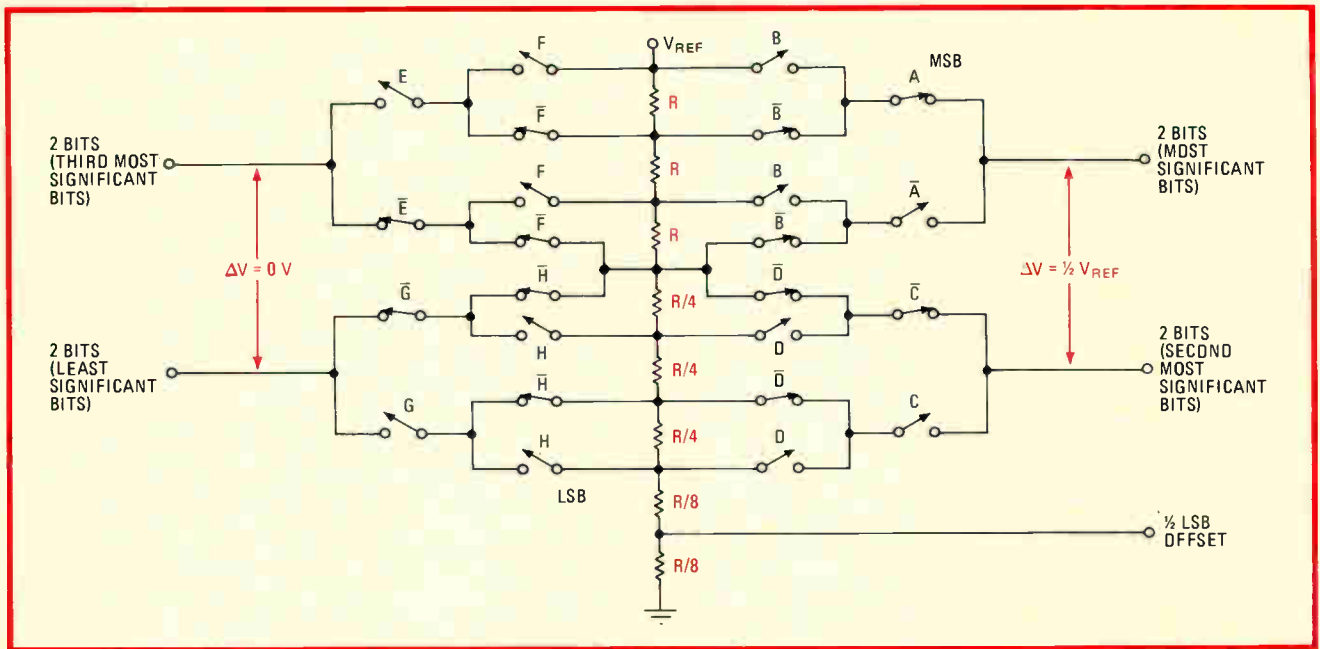

3. The result. This innovative circuit allows successive-approximation searches to be made on the same eight resistors by switching in proper taps through 32 switches and measuring the charge across one of four capacitors. Resolution of the ADP0801 converter thus is 8 bits, linear to within $\pm 1/4$ least significant bit above the quantization error level. A compatible C-MOS and silicon-chrome process is utilized.

through 256 resistors looking for the proper values.

The novelty consists in the capacitor being used to convert voltage into charge and then algebraically summing these charges. Along with the increase in density achieved through a modified MOS comparator comes an additional die area savings made by a resistor ladder of unique design.

In context

The ladder and the new charge-balancing comparator is being used in a 8-bit a-d IC. A single resistive ladder (shown in Fig. 3) is divided into four coarse MSBs and four fine LSBs by the taps of $1/4 V_{REF}$ in its upper portion and taps of $1/16 V_{REF}$ in its lower portion respectively. The two most significant bits, A and B, increment in $1/4 V_{REF}$ steps and the second 2 bits (C and D) increment in $1/16 V_{REF}$ steps. By also using voltage scaling, which is provided by ratio-ing the input capacitors, this same ladder is used for the 4 least significant bits (LSBs). The

comparator then properly combines all 8 bits over the full dynamic range that 8 bits will provide. Figure 3 shows the first interval of a successive-approximation search when the known d-a input is generating voltage differences of $1/2 V_{REF}$ and 0 v. At that time the switches are set for ABCDEFGH. Each of the subsequent steps of the successive approximation uses the same set of capacitors and resistors over and over again.

The complete 8-bit a-d converter requires only 8 resistors, 4 capacitors, and 32 switches and is fabricated from a compatible C-MOS and silicon-chromium process. It has achieved linearity to within $\pm 1/4$ LSB and can in fact offer 8 bits of linearity with a 100-millivolt input signal.

Resolution = accuracy

"For the first time a user can buy an 8-bit monolithic and expect to have 8 bits of accuracy," says Frederiksen. "Underspecifying a converter becomes a thing of the past: now we have a $\pm 1/4$ LSB linearity, which basically means that the error is only due to the inherent quantization error any converter exhibits, with an additional $\pm 1/16$ of a bit."

The same approach is being used in a 12-bit a-d part that National has in the wings. There, four 3-bit a-d converters require a total of only 33 resistors and 64 switches. Besides the 12 bits, there is a sign bit with the polarity of the input voltage handled by interchanging the input switch timing for a negative differential input. This provides an extra bit of resolution without doubling the ladder size. The completely microprocessor-compatible device will contain on-board logic that automatically provides a 2's complement digital output code. To top it off, the 13-bit device will have half the conversion time of the 100-microsecond ADP0801. The 40-pin package will owe its density and speed to silicon-gate C-MOS processing, which produces circuits one half to one third

TABLE 2: PRESENT AND FUTURE a-d CONVERTERS FROM TEXAS INSTRUMENTS INC.

Resolution (bits)	Accuracy (%)	Speed	Model number	Application
4 - 7	3 - 4%	< 200 μ s	TL 507	appliance and oven control
		> 1 ms		low-cost automotive
8 - 10	0.2 - 0.05%	< 200 μ s	ADC0816/TMS9913	computer and micro-computer interface
		> 1 ms	TL 505 A	TMS 1000 microprocessors (5-V, single-polarity bi-MOS technology)
10 - 12	0.2 - 0.01%	< 200 μ s	to come	computer and micro-computer interface
		> 1 ms	TL 501/TL 502	3 1/2-digit panel meter
> 13	$\leq 0.005\%$	< 200 μ s	to come	instrumentation
		> 1 ms	TL 500/TL 502	4 1/2-digit multimeter

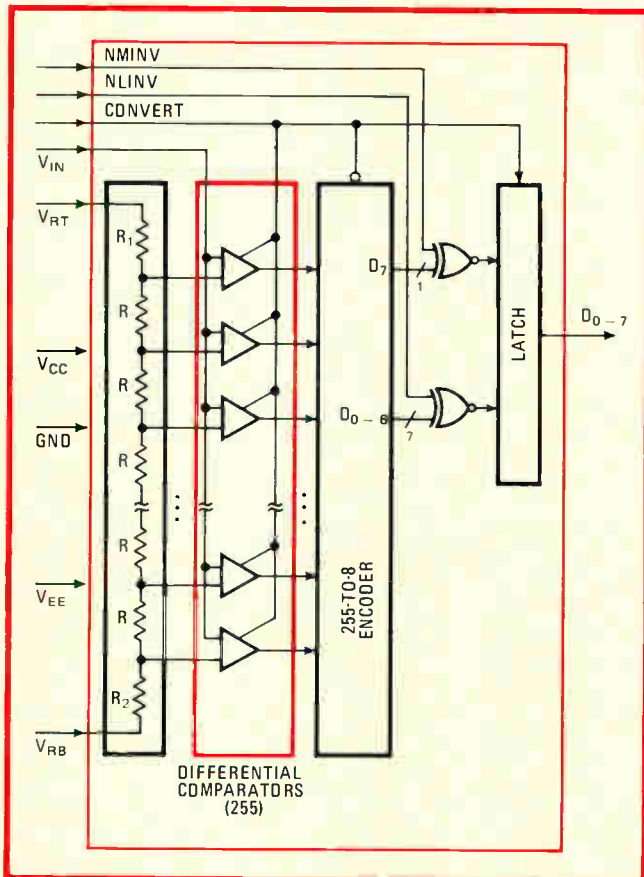

4. Completely parallel. Triple-diffused bipolar technology from TRW enables 255 strobed comparators, clock buffers, combinational logic, and an output buffer register to be placed on a 261-by-264 mil² die. Parallel comparisons of reference and input voltages yield the dazzling 35 million samples per second of an 8-bit a-d conversion.

the size of their metal-gate equivalents.

Silicon-gate C-MOS is also around the corner at Motorola's Integrated Circuit division in Austin, Texas. "We're looking for an order of magnitude improvement in speed using silicon gate over metal gate," says Mike Hadley, manager of C-MOS product planning and applications. "We plan to use it in our upcoming line of C-MOS digital logic as well as for our converters."

Why C-MOS

Microprocessor compatibility is the key to Motorola's work in data converters. Its first C-MOS 8-bit a-d part in the 10- to 30- μ s conversion range will be bus-compatible with C-MOS 8-bit microprocessors, and the company is pushing the work in that converter as hard as it is the work in the MC146805 microprocessor. A final a-d design strategy is just now being defined, with the choice hanging between a charge-balancing technique like National's and a capacitive switching network like the one used in the Touch-tone multiple-frequency receiver chip from Silicon Systems Inc. of Irvine, Calif. [*Electronics*, Feb. 15, 1979, p. 105].

Switched capacitors, which function much like resistors, are one of the most exciting interactions between circuit design and process development to have happened in a long time. So far used mainly for filters, they are

distinctly attractive for use in C-MOS converters, where they offer even greater density.

In relation to bipolar converters, the low power consumption of C-MOS is almost always to its advantage but its far higher density is less so. At present, placing more functions on the converter IC is not in its maker's best interests, since that limits the generality of the chip. Ultimately, though, dedicated microprocessors with a-d devices on board will undoubtedly emerge, since the real estate is available—it is only a matter of designing the two separately and, time and experience permitting, putting them both on a single piece of silicon. Motorola is pursuing this line of thought persistently but cautiously and is looking towards a next generation of microprocessors with on-board converters like the Intel 8022, only at higher resolutions.

Meanwhile, however, one function it will definitely incorporate in its converters is the band-gap reference. Although not far enough along the learning curve to compete effectively with the bipolar zener type, C-MOS band-gap references are superior to n-MOS band-gap references, say the Austin engineers.

Dealing with noise

In addition, inherent noise is being minimized in Motorola's upcoming part by clever design—the comparator used in the a-d samples the input data at 100 kilohertz, well above the 10-kHz noise frequency inherent in the MOS transistors, which makes for a very quiet comparator. In fact, its proprietary C-MOS circuits will be running 30% faster than the n-MOS devices, which effectively eliminates noise infringement problems.

Another type of noise that could be a threat, however, is the interference picked up when a converter is located far from what is being measured. For instance, Hadley foresees a system interface generation where an a-d converter on board a microprocessor will be located at a distance from a central processor. Though noise between the a-d and microprocessor would be negligible, noise from the transmission path could be significant. But that hurdle will be jumped when its time comes.

In the meantime, Motorola has parallel efforts going for the various parts of a full C-MOS system. Besides the stand-alone microprocessor and a-d converter, this includes latches, decoders, and transceivers, all designed to work at 4.5 volts at worst-case temperatures at full speed, yet meet all the internal timing requirements. Such an ambitious goal makes 12-bit C-MOS converters a remote possibility with 8-bit types evolving as winners. The company feels that the user's cry for 12-bit parts seems to be for dynamic range rather than accuracy. Besides, at present, the projected volume does not justify a plunge into the 12-bit area in C-MOS.

If the MOS converters are on one schedule at Motorola behind most other MOS participants, the bipolar versions adhere to a different timetable with their own distinct objectives at the division in Phoenix, Ariz. There the MC3508 and MC3510, a couple of 8- and 10-bit digital-to-analog converters, are being manufactured and the MC3512, a 12-bit d-a, is scheduled to be introduced in the fourth quarter of this year.

Bill Carns, of linear marketing, sees Motorola attack-

ing the high end of the precision market in a different manner. He observes that many high-technology hybrid houses, for instance, have pursued the thin-film-on-monolithic-substrate for quite a while, but in the end resort to hybrids in which the active circuits are put on one chip, separate from the thin-film resistor ladders on a second chip. This makes for easier testing of two single chips, as well as for convenience in passively laser-trimming the resistors.

Commitment

Carns emphasizes that Motorola is committed to thin-film resistor technology, applied to single silicon substrates. With expertise achieved in laying down matched resistors on the same silicon substrate as the current switches, methods of actively trimming the network can be developed to achieve better accuracy. The advantage a manufacturer like Motorola has is a broad base of technologies and processes from which to choose the combination best suited to the intricacies of a 12-bit a-d or d-a converter.

Motorola is even prepared for the high-speed video market. Its 10318 d-a "flash" converter operates at up to 25 MHz, an amazing feat in view of the fact that thin-film resistors on board the chip also provide 8 bits of linearity. Here, the settling time is within 10 ns. This kind of very high-frequency performance cannot be touched by MOS converters and may be the last significant bastion left to bipolar devices.

Signetics Corp., however, is concentrating on getting density rather than speed from its high-density bipolar process, integrated injection logic (I²L). Developed by its parent company, NV Philips Gloeilampenfabrieken of

5. Segmented d-a converter. By dividing the 4,096 output levels of a 12-bit unit into 8 groups of 512 steps each (a), AMD assures monotonicity without using precision thin-film resistors. Diffused resistors of the 9-bit d-a unit (b) determine monotonicity, while linearity is assured by the eight main diffused resistors of equal value.

the Netherlands, the process readily puts digital and analog functions on one chip, and Signetics is using it exclusively for its line of 5018 microprocessor-compatible monolithic d-a converters.

"We don't see anything coming near the speed-power product of I²L," says Phil Marcoux, interface product marketing section head. "The process that comes closest is C-MOS, but the die is about half again as large as for an I²L circuit."

The 5018 family, which consists of voltage and current output models, both with ± 0.2 and $\pm 0.1\%$ accuracies, will be extended into the 10-bit area before midyear. Beyond that, 14-bit converters in a two-chip configuration are a possibility.

Texas Instruments also is aiming at the low and high end of the converter market but unlike Motorola does not segregate the MOS and bipolar technologies corre-

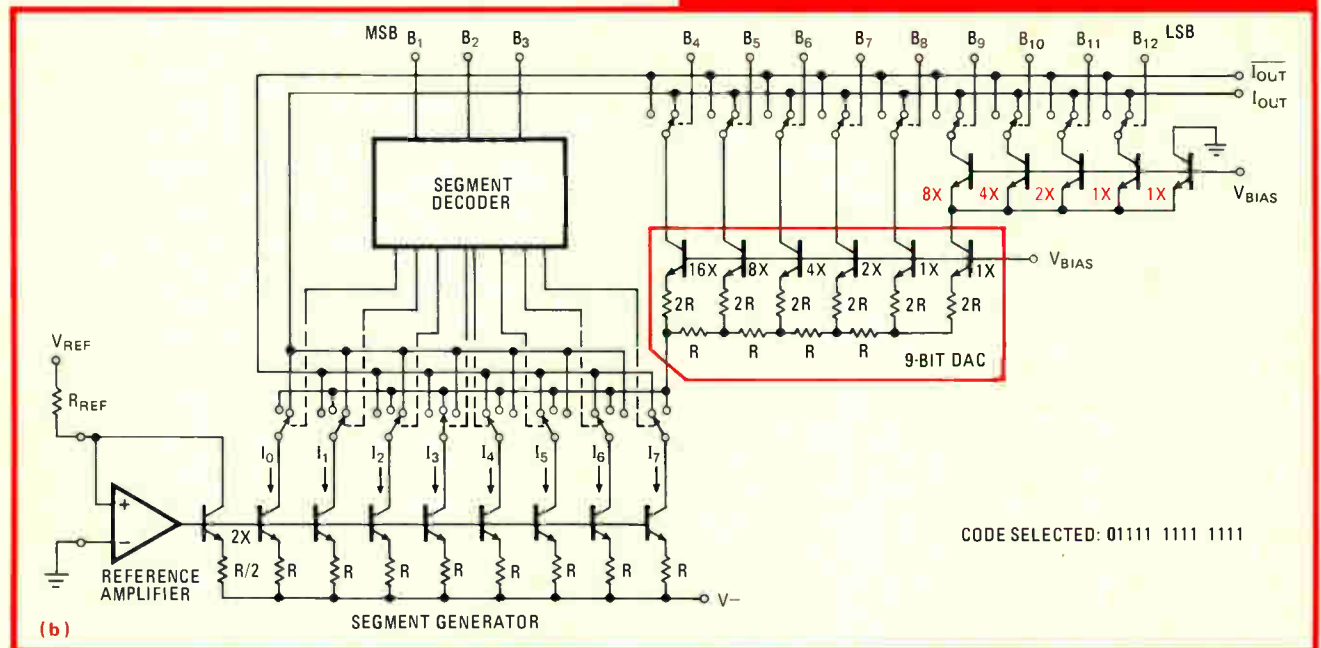
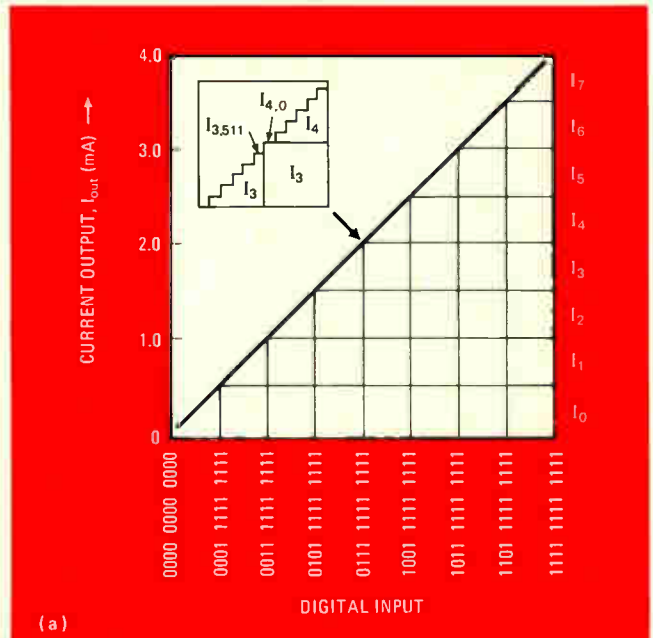

spondingly. "There is a very large market for the inexpensive and flexible type of IC converters," says Mary Perkins, applications engineer for linear interface products, "but we also see ICs being used for 10 and 12 bits of precision in certain applications. The amount of effort spent in any area will depend upon the volume of the individual markets."

TI will fill only large orders but, when it does decide upon a market, it can pick and choose from a wealth of technologies and designs to come up with an optimum price/performance profile for the device. Its present roster of parts (Table 2) is not impressive for its variety, but it is evidence of the two directions this giant is heading in the converter field: toward low cost, low speed and 4-to-8-bit resolution, and toward high speed and 12-bit and higher resolutions.

A mixture of products does not necessarily reflect a need for mixture of technologies. According to Perkins, if a design goal can be met with a single standard technology, then that will be the road to take, for in the end the product will be more reliable and cost less. However, TI thinks nothing of combining bipolar and MOS on its 8-bit-accurate TL 505 a-d or using integrated injection logic (I²L) for its 507 microprocessor-compatible 7-bit converter. Also not ruled out is the possibility of placing a 505 converter on board a TMS 1000 4-bit microprocessor, as Intel did with its 8-bit 8022.

Enter switched capacitors

For future MOS-based converters, TI is pursuing switched capacitors, which, for one thing, take up less area than resistors. Consequently, TI's version of National's 0816 data-acquisition system chip measures only 100 by 100 mils, about a quarter of the area of the 0816.

This successful National part has just begun being second-sourced by TI as TMS9913. It uses a 4-bit address code in effect to multiplex its 16 analog inputs, each of which it resolves into 8 bits in 100 μ s—a moderate conversion speed. The address input is latched, as is the three-state output. (Another company looking at

second-sourcing the bipolar 0816 is Mostek Corp. of Carrollton, Texas, which is further adding to the device's reputation by contemplating a C-MOS version.)

How will TI mix technologies on the same chip? Thus far, it has adopted a split of 95% bipolar, 5% MOS—though the ratio could as easily be the reverse. Its choice reflects what it sees as demanded by the market, for other proportions are technologically possible.

Bipolar speed

Also proving that nothing beats bipolar for very high-frequency conversion is the TDC 1007J, a 35-MHz 8-bit a-d converter made with emitter-coupled logic (ECL) by TRW's LSI Products, Redondo Beach, Calif. Here, it was a matter of optimizing a comparator design and building 255 identical comparators into a fully parallel converter, a most efficient means of achieving high speed (Fig. 4).

As at National, TRW spent a lot of midnight oil on optimizing the comparator circuitry. Each comparator is provided simultaneously with a different reference voltage and input voltage. When the clock switches the device from the sample to a hold mode, each comparator produces a logic level output. The latched AND gates use these results to develop a 1-out-of-256 code, which then is ORED to form an 8-bit word.

Such a pipelined operation yields a 35-MHz speed only when combined with a bipolar derivative of the current-mode form, like ECL. TRW processes the circuits in a triple-diffusion step-down procedure, a five-mask process unique in the industry. The converter's differential nonlinearity is within $\pm 1/2$ LSB. Its drawback is a power dissipation of 2.5 watts. Even Motorola's d-a buzzer, the MC 10318, uses 500 milliwatts. But such power figures must be endured when speed is the goal.

A different goal, one of low differential nonlinearity, is being pursued at another bipolar stronghold, Advanced Micro Devices. Having achieved microprocessor compatibility with its 8-bit Am 6008 d-a converter a couple of years ago, the company is just starting to deliver a 12-bit Am 6012 that is based on the same

TABLE 3: PERFORMANCE OF MONOLITHIC 12-BIT d-a CONVERTERS

	Part number	Settling time (ns, typical)	Differential nonlinearity (maximum over temperature)	Price (quantities of 100 and up)	Speed-accuracy-price product	
					(raw)	(normalized)
top grade, military temperature range	Am 6012 ADM	250	$\pm 0.012\%$	\$ 49.95	150	1.0
	HI 562-2	200	$\pm 0.025\%$	\$ 70.00	350	2.3
	AD 7541 TD	500 (estimated)	$\pm 0.025\%$	\$ 69.00	863	5.8
	MP 7621 TD	1,000 (estimated)	$\pm 0.025\%$	\$ 79.50	1,988	13.3
	HI 5612-2	150	$\pm 0.025\%$	\$ 128.00	480	3.2
	AD 565 TD	200	$\pm 0.025\%$	\$ 85.00	425	2.8
low grade, commercial temperature range	Am 6012 DC	250	$\pm 0.025\%$	\$ 9.95	62	1.0
	HI 562-5	200	$\pm 0.025\%$	\$ 19.50	98	1.6
	AD 7541 JN	500 (estimated)	$\pm 0.05\%$	\$ 16.50	413	6.7
	MP 7621 JN	1,000 (estimated)	$\pm 0.05\%$	\$ 16.00	800	12.9
	HI 5612-5	150	$\pm 0.025\%$	\$ 36.50	137	2.2
	AD 565 JN	200	$\pm 0.025\%$	\$ 16.00	80	1.3

SOURCE: ADVANCED MICRO DEVICES

TABLE 4: RESISTOR LADDER COMPARISONS

Ladder type	Number of resistors	Initial accuracy required for monotonicity (%)	Tracking required for monotonicity (ppm/°C)		Tracking required for $\pm \frac{1}{2}$ LSB differential nonlinearity (ppm/°C)
			0 initial error	$\frac{1}{2}$ LSB initial error	$\frac{1}{4}$ LSB initial error
Straight R-2R	37	± 0.05	5	2.5	1.25
Segmented 3 bits + 9 bits	24	± 0.4	40	20	10

technology. This part is unique in that it is the first single-chip 12-bit d-a that yields 12 bits of accuracy without individual trimming of its resistors. That is because the circuit design permits the use of boron (in place of thin-film) resistors, which are diffused into the silicon substrate along with the boron transistor bases and need no further modification.

The bottom line is that for the first time a major semiconductor manufacturer can offer a single-chip 12-bit d-a converter for under \$10 apiece in quantities of 100. On top of that, the Am 6012 settles within a comfortable 250 ns and displays a differential nonlinearity of $\pm 0.012\%$, giving it the best speed-accuracy-price product on the market for comparable 12-bit d-a converters (Table 3).

A matter of preference

According to AMD's linear IC design manager, John Schoeff, few transducers are more linear than $\pm 0.1\%$, so "we found that most people aren't buying converters for straight-line accuracy but for the amount of resolution that will give fine-tuned control to the system the DAC is being used in." This shifts the emphasis from high linearity to differential nonlinearity—in other words, from close conformance with an ideal straight line to a measure of the uniformity of each step in the transfer characteristic between the digital code input and the analog current output.

To guarantee differential nonlinearity, or monotonicity, all classical binary-weighted (R-2R) 12-bit d-a converters require a linearity of $\pm \frac{1}{2}$ least significant bit ($\pm 0.012\%$) that in turn demands very tight resistor matching and tracking. Table 4 shows the maximum tracking error that can be allowed over a 100°C range to maintain monotonicity. With an R-2R ladder, $\pm \frac{1}{2}$ LSB differential nonlinearity requires a tracking temperature coefficient of ± 1.25 parts per million per °C.

The technique used in the Am 6012 therefore trades off these advantages of the R-2R and the 2^n R network. The 2^n R approach provides monotonicity without requiring high linearity, but if used alone to implement a 12-bit d-a converter would be too dense and too slow. It would require 4,096 low-tolerance resistors, as against the minimum number of high-tolerance resistors of the R-2R approach; its switch decoder tree would also make it much slower than the other approach. The 2^n R and R-2R combination, however, actually requires fewer resistors, and those untrimmed, than does the classic thin-film R-2R network.

Figure 5a shows the transfer characteristic for the segmented d-a converter, as the Am 6012 is described. The 4,096 output levels are composed of eight groups of 512 steps each. Each group is generated by a 9-bit d-a and each of the segment slopes is determined by one of eight equal current sources (Fig. 5b). The resistors that determine monotonicity are in the 9-bit d-a. The major carry of the 9-bit d-a is repeated in each of the eight segments and, to maintain a given differential nonlinearity over temperature, requires eight times lower initial resistor accuracy and tracking than the MSB resistor of a 12-bit R-2R device (Table 4).

All this is achieved with untrimmed resistors, which AMD is able to match simply by diffusing boron into silicon at 1,000°C. In addition, compared to d-a parts using thin-film resistors, the Am 6012 took half as long to design and testing has been greatly simplified.

Resistor pros and cons

Indeed, by going to diffused resistors, Schoeff feels that a number of major pitfalls in the design of d-a converters were entirely avoided. First, thin-film resistors are hard to work with because of the basically amorphous nature of their material; also, even when made of silicon chromium instead of nickel chromium, they are vulnerable to moisture seeping into the package. Second, no expensive laser trimming equipment had to be bought and set up.

Finally, even zener zapping would have worked less well. As is evident from the precision achieved in linear ICs by Precision Monolithics Inc., in which all trimmable resistors are zener-zapped, it is a superior technique of adjusting resistor values because it takes place in the silicon bulk and is not prone to long-term fluctuations due to oxidation at the surface level. But in the case of the Am 6012, it would have complicated the overall system design with its very stringent design rules, according to Schoeff.

How does this new bipolar approach stack up against a 12-bit monolithic C-MOS device that has laser trimming done straight on the wafer? Table 5 compares the Am 6012 with Analog Devices' AD 7541, a full four-quadrant multiplying C-MOS d-a, two converters that exhibit major functional commonality. Besides listing key parameters, the table attempts to highlight what it is about the bipolar and C-MOS technologies that most strongly influences products made in either of them.

Can we expect a similar effort in bipolar a-d devices within AMD? The answer is yes, and the company's first step is to produce an 8-bit part with a conversion time of 1 to 2 μ s using a double-layer metal design. More characteristically, 12-bit a-d devices using a low-level current-mode logic are soon to follow and can be produced cost-effectively primarily because of the circuit design innovations applied from the d-a designs.

Meanwhile, Analog Devices is bringing out a micro-processor-compatible successive-approximation 8-bit a-d part for \$5. The C-MOS AD 7574 converts in 15 μ s and purports to guarantee no missing codes over the full operating temperature range. The device is mentioned here only to show how flexible the converter giant can be, enhancing any parameters it wants to by dipping into

TABLE 5: COMPARING BIPOLAR AND C-MOS 12-BIT d-a CONVERTERS

Specifications (maximum over temperature range)	Am 6012	AD 7541
Resolution	12 bits	12 bits
Differential nonlinearity (DNL)	$\pm 0.012 / \pm 0.025\%$	not specified
Nonlinearity (NL)	$\pm 0.05\%$	$\pm 0.012 / \pm 0.024\%$
Full-scale temperature coefficient	$\pm 20 / \pm 40$ ppm/ $^{\circ}$ C	not specified
Zero scale error	$\pm 0.05 / \pm 0.1$ LSB	± 0.8 LSB
Setting time to $\pm 1/2$ LSB	450 ns	1 μ s
Propagation delay	60 ns	not specified
Output voltage compliance	+10 to -5 V	0 V
Full-scale current	4 mA	1 mA
Output capacitance	25 pF	200 pF
Power supply sensitivity	$\pm 0.001\% / \%$	$\pm 0.02\% / \%$
Power supply range for full accuracy	+5, -12 to ± 18 V	+15 V only
Power supplies required	2	1
Power dissipation	312 mW	40 mW
Features		
Outputs	differential, complementary	differential, complementary
	R _{out} high for all codes	R _{out} low, varies with code
	C _{out} constant for all codes	C _{out} varies with code — needs op amp phase comparators
	high compliance	no compliance
	no latchup	Schottky clamp needed on output
	no op amp null required	must null op amp V _{OS}
Supply variation	linearity and gain error independent of supply	linearity and gain error highly supply-sensitive
Reference input	2-quadrant multiplying; high-Z input available	4-quadrant multiplying; low input Z
Output range	flexible — two external matched resistors	10-V full-scale for 10-V reference; includes output and reference resistors
Logic threshold	adjustable	fixed
Reliability	no static protection needed	anti-static handling required
Process	standard bipolar diffused resistors no trimming	C-MOS, double-layer metal thin-film resistors laser-trimmed
Package	narrow, 20-pin	narrow, 18-pin

any technology and coming up with 8-, 10-, 12-, and even 18-bit devices packaged in monolithic, hybrid, or modular form. Table 6 reflects this flexibility with a preview of products to come from Analog Devices.

ECL to the fore

In fact, a module using ECL is the first device to be released by Analog Devices as a result of its acquisition last year of Computer Labs Inc., Greensboro, N. C., a supplier of those high-resolution, high-precision converters that can still only be implemented in modular designs. The MOD-1205 printed-circuit card is a 12-bit a-d converter, linear to 13 bits, that converts at a 5-MHz rate. It operates off ± 15 , -5.2 and -6 v, uses 10 K ECL internally, and produces digital words at Schottky TTL levels. This kind of device is not bought for hooking up to a microprocessor. Mostly for radar-oriented applications, the card sells for a hefty \$3,995.

Another noteworthy entry in Table 6 is Analog Devices' second-sourcing of Burr-Brown's ADC80, the successful 12-bit a-d counterpart to that company's 12-

bit d-a DAC-80, also second-sourced by Analog Devices.

The developer of the DAC-80 family of hybrids, however, is not idling in the wings. The Tucson, Ariz., company is expanding into high-reliability converters built to military specification.

As a first step, there is its DAC 87-CBI-V/MIL 12-bit d-a device (Fig. 7). This is a souped-up version of the DAC-80, qualified to MIL-M-38510 in accordance with the testing procedures prescribed in MIL-STD-883. This means that the $\pm 0.3\%$ full-scale range is guaranteed over the full -55° C to $+125^{\circ}$ C temperature range. Also linearity error of $\pm 1/2$ LSB and monotonicity is also good over that range, rather than just 0 to 70° C.

Other ventures

The company's military venture does not stop there. Precision op amps, voltage-to-frequency converters, and multiplier/dividers are in the offing as well in both bipolar and MOS technologies, depending on which technology does more to enhance the highest-precision parts.

The success of these Burr-Brown bipolar hybrids is

TABLE 6: FUTURE DATA CONVERTERS FROM ANALOG DEVICES

Conversion function	Resolution (bits)	Speed/throughput rate	Approximate price (quantities of 100)	Technology	Construction	Other comments
a-d	12	5 MHz	—	ECL	board	5 x 5 x 0.4 in. printed-circuit board
a-d	12	3 μ s	under \$100	I ² L	hybrid	geared to be price/performance leader
a-d	12	—	—	bipolar	—	second source to Burr-Brown
16-channel data-acquisition system	12	35 kHz	under \$100	I ² L	hybrid	TTL-switchable between single-ended and differential inputs
8-channel data-acquisition system	12	—	under \$12	C-MOS	monolithic	integrating type
a-d	4½ digits	—	—	C-MOS	monolithic	quad-slope, low-cost
d-a	12	200 ns	\$17.50	I ² L	monolithic	562-pin-compatible
d-a	12	—	—	bipolar	hybrid	includes output amplifier
d-a	12	—	—	bipolar	—	low power
d-a	12	500 ns	under \$15.00	C-MOS	monolithic	serial or 2-byte load
d-a	12	400 ns	—	C-MOS	monolithic	untrimmed
a-d	10	30 μ s	—	I ² L	monolithic	complete microprocessor interface
a-d	8	15 μ s	\$7.50	C-MOS	monolithic	complete microprocessor interface
8-channel data-acquisition system	8	—	—	C-MOS	monolithic	includes on-chip RAM
d-a	8	—	—	bipolar	monolithic	complete microprocessor interface, voltage output
d-a	8	—	—	bipolar	—	second source to Burr-Brown

due largely to their function completeness. They require a minimum amount of external circuitry for efficient operation. They have become so popular that Beckman Instruments, another high-volume hybrid manufacturer, is second-sourcing a C-MOS version of the d-a and plans eventually to do the same for the a-d counterpart.

Meanwhile, though, Beckman is giving priority to a couple of other 12-bit C-MOS d-a products. One second-sources Analog Devices' 7521 multiplying d-a that exhibits a low 20 mW of power dissipation. The other is a Beckman original, the C-MOS 12-bit 7545 d-a converter. Although labeled a microprocessor-compatible part, it lacks the proper on-board timing and control circuitry to be used in a two-chip configuration with 8-bit processors. The advantage is on-board latches that accept the digital data in a 4-bit followed by an 8-bit operation, two steps that yield 12-bit accuracy for the output analog signal.

An alternative version of the 7545, the 7546 d-a has extra output amplifiers on board for both unipolar and bipolar adjustable by ± 500 mV. Settling time suffers in return, being 10 μ s for the 7546 as against 2 μ s for the 7545, both within the full scale of 0.01% linearity.

In praise of hybrids . . .

"This flexibility and precision one can only achieve in hybrids," says Leroy Little, senior development project engineer at Beckman. "Hybrids have always been two steps ahead of monolithics. Whatever semiconductor technology can fit on a single chip, the hybrid can enhance and outmaneuver."

Both Little and William Miller, newly appointed product marketing manager for hybrid microcircuits, feel confident the processing problems of incorporating complex analog functions on a single substrate will keep the cost/performance balance sheet tilted against the

monolithic houses through the next couple of years.

"We haven't seen anything from Silicon Valley that comes close to offering the performance of hybrid data converters," says Miller, "and even when single chippers of equal precision hit the streets, potential users will be very cautious about designing in this new breed of converters." But when that onslaught is felt, hybrid manufacturers will be forced into the 16-bit resolution market for applications in instrumentation and measurement equipment.

. . . and their high performance

Until then Beckman expects to introduce more 12-bit parts, with 12-bit a-d C-MOS devices in the short term. Twelve bits is the magic number because of the company's long experience with thin-film resistors, both in military applications and in full line of stand-alone resistor dual in-line packages that are considered among the best. The nickel-chromium resistors are passively laser-trimmed and packaged separately from the active circuits—the only way to go to insure true 12-bit precision and linearity, according to Beckman. Beckman sees monolithics infringing upon hybrid territory only when linearity is achieved in a cost-effective manner: acceptable yields of production parts that are linear (not merely differentially nonlinear) to within $\pm \frac{1}{2}$ LSB and selling for under \$20. Anything better than $\pm \frac{1}{2}$ LSB would not be cost-effective because yields would be too low. It's all in how much precision one is willing to buy.

The hybrid approach is also practiced at Harris Semiconductor of Melbourne, Fla. The need for rapid development of microprocessor-controller input/output functions in one package such as multiplexing, gain scaling, sample-and-holds, as well as a-d and d-a conversion, will initially oblige manufacturers of both monolithic and

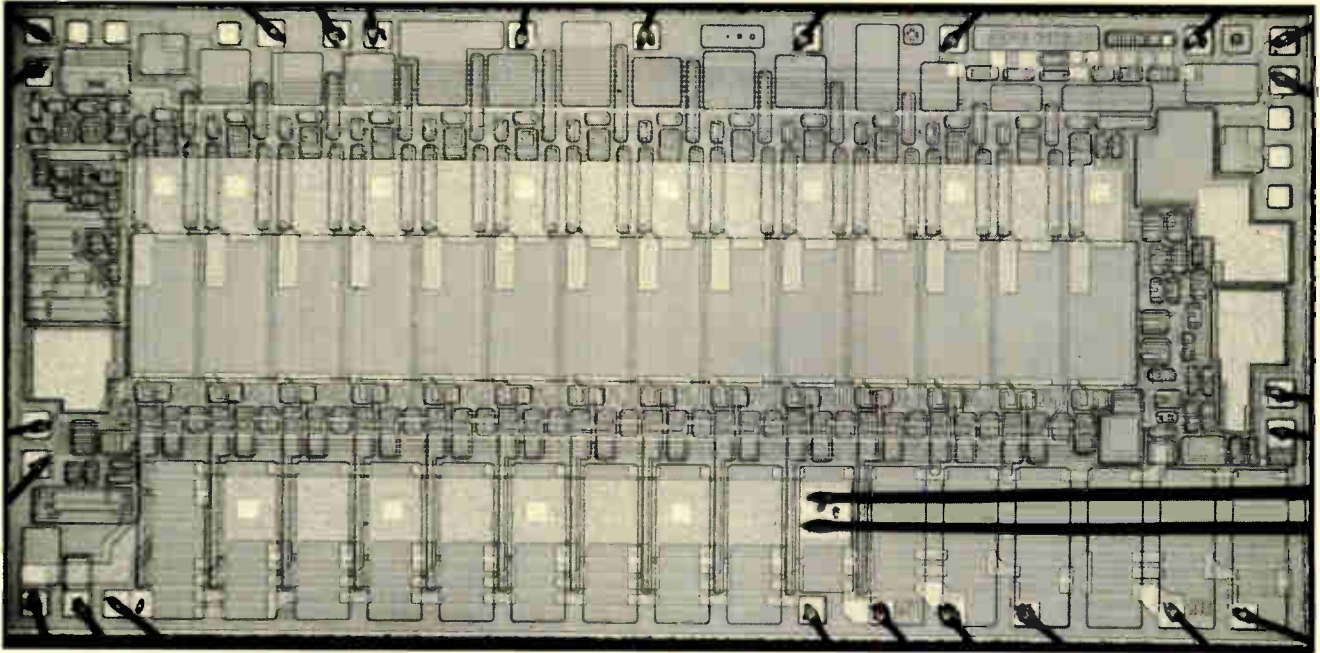

6. Fast and accurate. An output current settling time of 200 ns to 0.01% of the full-scale range is claimed for the Harris 562 thanks to a dielectric isolation process. This bipolar part has its resistors laser-trimmed on the wafer, making it a truly monolithic 12-bit d-a converter.

hybrids to go the hybrid route, according to J. Cornell, director of analog products. "These functions will initially be implemented as hybrids or board-level systems and move toward monolithic functions as appropriate VLSI analog technology emerges."

On the other hand, as Robert Webb, acting technical director for standard analog products at Harris Semiconductor, puts it: "We don't want to stack products with technology prematurely and then be forced into makeshift fixes. Right now we could implant JFET amplifiers together with high-frequency complementary bipolar transistors on silicon-gate C-MOS, if we wanted to. But at this stage of the game, the end product would not be cost-effective." Instead, Harris can go shopping in its technology supermarket and combine the proper ingredients into an ideal price/performance hybrid.

But Harris bakes the hybrid cake differently, for it is perhaps the first company with a broad line of both precision digital and analog products to have realized the cost-effectiveness of leadless chip-carriers placed in standard DIPs. "The yield of hybrids that use leadless chip-carriers is substantially higher than straight ceramic hybrids with wire-bonded integrated circuits," says Webb, "and consequently we can try many variations on mixed technologies using that concept."

Coming shortly

In addition to utilizing this leadless chip-carrier in hybrid converters, Harris will also market other converters and linear ICs that are used in data-acquisition devices in the leadless chip-carriers. Possibilities to come are the HI-5608, a 50- μ s 8-bit d-a converter, and two 10-bit a-d converters in the 6- μ s conversion range that are microprocessor-compatible. Where the leadless chip-carrier concept will come into big play is in producing the HI-5900, a 16-channel data-acquisition system front-end that includes a C-MOS multiplexer, JFET bipo-

lar gain-programmable amplifier, and bipolar sample-and-hold chips.

The monolithic objective, though, is to find ways of taking advantage of the low power dissipation and high density offered by C-MOS and increase the speed by innovative circuit designs. Harris's dielectric isolation technique seems to be one way of getting there (Fig. 6).

The company can enhance the performance of a competitor's successful part by using this technique, which apparently reduces internal parasitics, so that rise and fall times during switching become faster and settling time is reduced.

One-upmanship

A case in point is the ubiquitous 12-bit d-a 562 originated by Analog Devices some time ago and specified for a settling time of 1.5 μ s. Precision Monolithics Inc., which is second-sourcing the Analog part in a monolithic version, is also specifying 1.5- μ s settling time. But Harris slashed the settling time to 0.2 μ s, thereby booking its version into wide applications in CRT displays, precision instruments, and full-blown video data-acquisition systems. Linearity is also guaranteed for 12 bits ± 1 LSB over the full temperature range of -55°C to $+125^{\circ}\text{C}$ by laser-trimming the film resistors. Such a combination of speed and accuracy is comparable to the developments now making their debut from purely monolithic houses, like AMD and its 12-bit Am 6012.

RCA Corp.'s Solid State division has another, if not better way. Known as a prime mover of silicon-on-sapphire technology for digital circuits and microprocessors, RCA may also be leading the linear world into the VLSI era with C-MOS on sapphire. There was a hint of this at the ISSCC, where Andrew Dingwall, leader of the technical staff at the company's Solid State Technology Center, described a C-MOS-on-sapphire 6-bit a-d converter that operates at 15 MHz. As a direct counter to

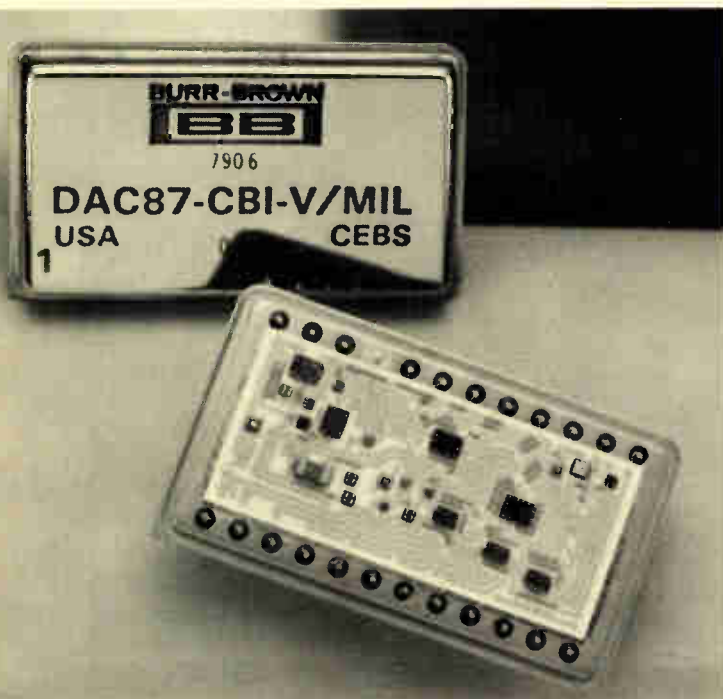

7. Rough and tough. The first of many hybrids from Burr-Brown designed for the rugged military environment is the DAC-87-CBI V/MIL. The functionally complete 12-bit device withstands -55°C to $+125^{\circ}\text{C}$ with a total untrimmed error of $\pm 0.3\%$ of full-scale range.

20-to-40-MHz hybrid a-d types, traditionally high-cost items, it could be a cost-effective answer to video needs.

There is nothing magical about silicon on sapphire. It is simply another dielectric isolation technique and as such provides high-speed performance because it keeps parasitic capacitance very low. In RCA's process, C-MOS devices with dielectrically isolated silicon-gate MOS transistors are formed over insulating sapphire substrates. This allows complex logic operations to be carried out at the 40-MHz clock rates necessary to "flash"-convert parallel streams of data.

A crowd of comparators

On board are 65 auto-zeroed sample-and-hold matched comparators occupying 24 square mils each, a density that RCA claims could only be achieved on sapphire. As shown in Fig. 8, the applied analog voltage is compared simultaneously with taps from a reference-voltage resistor ladder. The ladder-tap voltage value that comes closest to the input signal value is then selected by testing the output of each comparator immediately above and below it. Finally a programmed logic array translates the selected value into a binary output.

The comparator is so designed as to maintain a constant charge on the sample-and-hold capacitor, thus keeping input signal loading capacitance to a tiny 0.1 picofarad per comparator stage. The a-d converter can therefore operate from a 75-ohm source at 15 MHz without special buffering.

The converter is not slated for commercial applications at this time. Nevertheless, the part has been successfully tried out in a flat-panel television set operating at 9.55 MHz, or twice the subcarrier sampling rate of

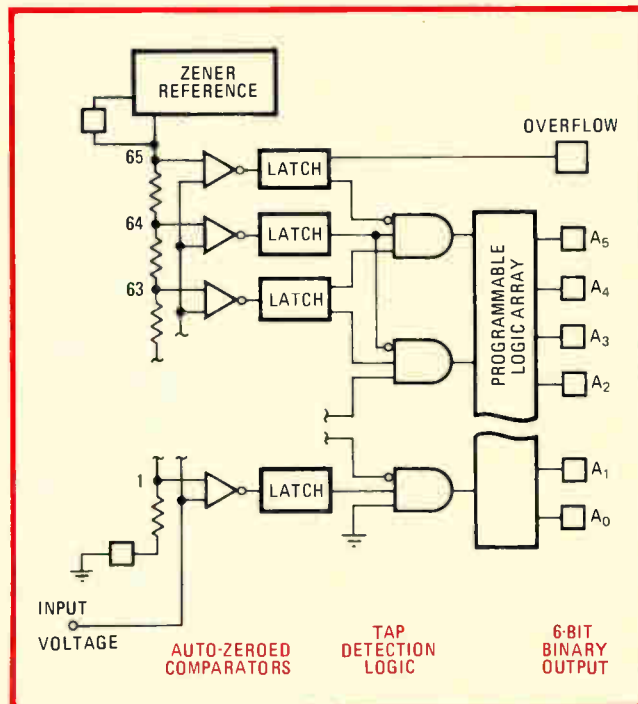

8. A great combination. This experimental 6-bit a-d converter from RCA combines parallel conversion techniques and dielectric isolation processing techniques in a "flash" 15-MHz C-MOS chip. The sapphire substrate isolates MOS parasitics.

a color TV, suggesting an important future application.

As for more down-to-earth parts, RCA is only just feeling the converter market out. "Our converter contribution consists of the CA 3161 and CA 3162," says George Granieri, product marketing manager of industrial bipolar integrated circuits. "They are a decoder/driver and a 3-digit a-d converter and together make up a low-cost a-d readout system the user can put together himself."

Granieri states that RCA is on the brink of having numerous mixes of technologies fall out into interesting products. A simple 8-bit a-d converter that will be compatible with the company's C-MOS microprocessor, the 1802, should be available as a sample before midyear, with gradual sophistication of additional functions placed on board later.

Onward with bi-MOS

RCA, of course, has at its disposal its technology center where new technologies, and circuit techniques can be discriminately picked and incorporated for commercial consumption. In the linear area, it is banking on the mixed bipolar and MOS linear technology, bi-MOS. Operational amplifiers and comparators in bi-MOS with impressive input bias current characteristics, typically on the order of 50 picoamperes, are just some of the functions to be included on board future data converters. Although said to exhibit higher noise, Granieri says that the 40 nanovolts-hertz^{1/2} measured is no worse than for some rival bi-FET devices. Competition between bi-FET and bi-MOS linear parts has been growing rapidly and could be discussed at some length, but that is the subject of another story. □

Bubble memories demand unique test methods

Complex test system must adjust magnetic fields, find operating margins, and map bad loops

by Steve Bisset, *Megatest Corp., Santa Clara, Calif.*, and Steve Bristow and Tom T. Chen, *Rockwell International Corp., Richardson, Texas*

□ Reliable, reasonably priced test procedures play a vital role in the commercial acceptance of any new microelectronic technology. Bubble memory devices are no exception. They bring with them a fresh rash of characterization problems requiring specially designed test systems, for the varying magnetic fields that manipulate the bubbles must be carefully timed and balanced, while their high-density shift-register architecture and submegahertz clock rates result in test times of several minutes per device. Between them, all these requirements exert a significant upward pressure on high-volume testing costs.

There are four stages in the bubble memory manufac-

turing process at which tests are typically needed, exclusive of quality assurance testing:

- Wafer probing is carried out before the individual memory chips are separated. This must be done without the drive-field coils that will later be wound around each die. The drive field is approximated using coils placed above and below the wafer; several hundred watts are required to drive these coils.

- A bias search is done before the device's bias field magnets are installed. An electromagnet supplies the bias field so that operating regions may be checked at several field levels and an optimum level found.

- After the permanent bias-field magnets are mounted

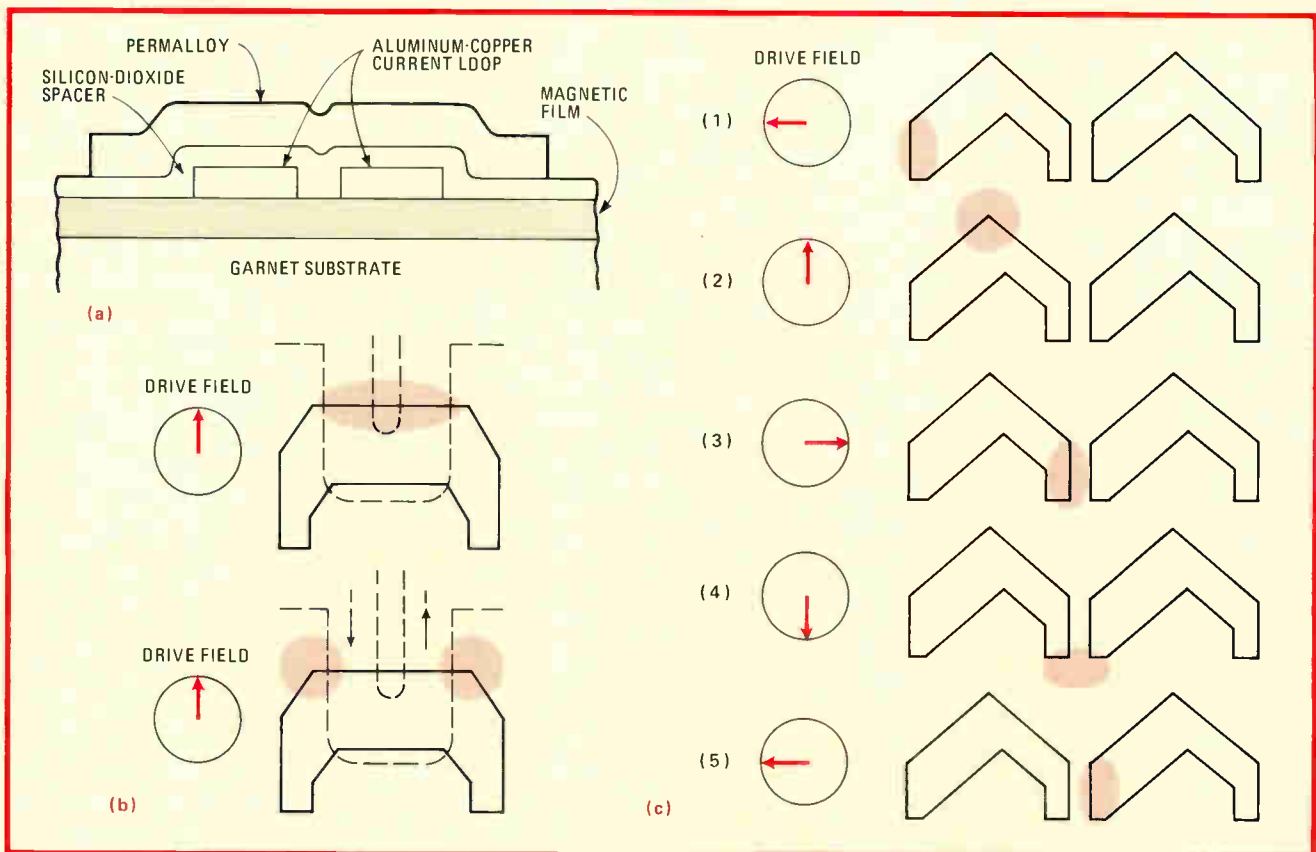

1. Internal operations. The cross-sectional view (a) is that of a bubble gate component. The replication operation, viewed from above in (b), is achieved by providing a sharp current pulse to the gate's loop to collapse the bubble domain in the center. The drive field's magnitude and phase can be varied to test for proper pattern spacing and processing as well as bubble propagation (c).

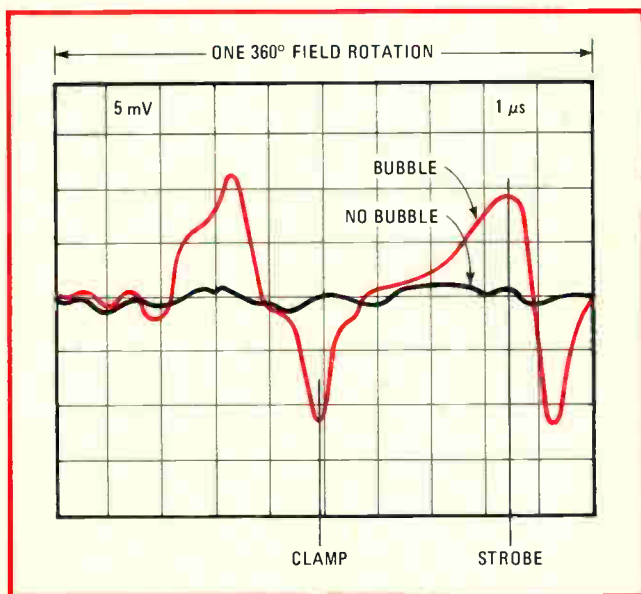

2. Differential detection. The voltage across the detector at two points—clamp and strobe—during a cycle is compared to sense a bubble passing under it. Detector sensitivity is tested by varying the clamp and strobe points and the comparator thresholds.

above and below the memory chip, magnetization must be checked and precisely adjusted to compensate for variations in packaging and processing.

■ Following installation of the magnetic shields the memory is subjected to rigorous final testing under many variations of worst-case operating conditions. Defective storage loops are identified and mapped, in some cases on a special extra loop, in others on some external medium, such as a specification sheet or electrically programmable read-only memory.

Interface circuits

The active sections within a bubble memory device include current-loop circuits (gates), detectors, drive-field coils, and bias-field magnets. A test system for bubble devices must have interface circuits capable of altering the control parameters associated with these sections so as to permit device characterization as well as fault analysis.

The gates are formed by depositing a conductor loop beneath a permalloy pattern; the loop, when energized, creates a local magnetic field. The gates are responsible for generating (or nucleating), transferring, replicating, and annihilating bubbles (Fig. 1a). Each operation is dependent upon the phase, width, and amplitude of the current pulse through the gate's loop.

A very strong current pulse can reverse the magnetization within the loop and nucleate or generate a reversed magnetic domain—a bubble. A strong current pulse in the opposite direction can be used to collapse or annihilate a bubble that is within the loop. The field generated by the loop can also be used to attract or repel a bubble, steering it from one path to another; this is the basis of the transfer and swap functions. Replication is implemented with a narrow current loop. In this case a strong current pulse will cut or split the bubble domain into two separate bubbles as shown in Fig. 1b.

A bubble memory test system must be capable of supplying pulse waveforms adjustable in amplitude, phase, and width. These parameters should be very flexibly programmable to fully characterize the device's operating margins. Some of the pulses must be greater than 360° in width; they must be able to overlap propagation cycle boundaries (see Fig. 1c).

Reading output

The tester must also sense or read the bubble memory device's output of stored data, so it needs circuitry that interfaces the device's bubble detector. A bubble is sensed by measuring the change its presence causes in the permalloy detector's resistance. The magneto-resistive effect is responsible for this change. The resistivity of a permalloy film varies as a function of the angle between the magnetization vector and the direction of the current flow through the film.

The resistance of the permalloy film is also influenced by the direction of the rotating bubble-propagation drive field. This effect is much larger than that caused by the presence of a bubble; the actual bubble signal would appear as a small perturbation on the overall output signal. This is dealt with by using a dummy detector circuit in close proximity to the first detector. The rotating field signal appears as a common-mode signal in both detectors. It is easily eliminated, leaving the differential bubble signal standing alone.

Typically, the tester's sensor samples the differential output voltage at one point as the bubble passes under the bubble detector—the clamp point—and compares it to the voltage at a second point as the bubble continues passing under the detector—the strobe point (Fig. 2). This provides an indication of detector sensitivity. The tester should also have dual comparators to test for the noise margin on the outputs. The phase of the clamp and strobe points must be programmable, as must be the threshold of each comparator.

A bubble memory's permanent bias magnets generate a uniform field nearly perpendicular to the plane of the magnetic film in which bubbles define themselves by their reversed polarity. The bias field is set at a slight tilt with respect to the perpendicular in order to create a small in-plane field component that insures bubble nonvolatility when the device is not in operation.

The bubble-propagation drive field is generated in the plane of the magnetic film by two coils wound around the device at 90° to one another. The two coils are driven by currents with triangular, trapezoidal, or sinusoidal waveforms; the two drive currents are 90° out of phase with one another. The magnetic fields generated result in an in-plane field vector that rotates to drive the bubbles along the permalloy pathways.

Field margin testing

The tester must be able to vary the magnetic environment it generates in order to determine the performance margins of the bubble devices at various production stages. More specifically, it needs to vary the magnitude of the drive field from a peak current of a few hundred milliamperes in the device's own coils to several amperes in the big wafer-probing coils. At the wafer probing and

bias search stages, before the device's own permanent bias magnets are mounted, the tester must drive bias magnet coils as well.

An overly strong bias field will tend to collapse the bubbles; too weak a value may allow spontaneous nucleation of extra bubbles, or cause bubbles to revert to stripe domains (stripeout). Either case is a data loss. Figure 3a is a typical operating margin limit curve for the bias field (H_B) and the drive field (H_D). Within the range of bubble stability between collapse and stripeout, the size of the bubble is determined by the strength of the bias field. Most of the permalloy patterns that direct bubble propagation require a specific bubble size to operate properly.

There is a minimum value of drive field strength below which the bubbles will move unreliably or not at all. If the drive field is too strong, the magnetic field under the permalloy patterns will cause stripeout or bubble nucleation at low bias-field values. At elevated temperatures, an overly strong drive field may also cause spontaneous nucleation. This is worsened by the excessive device temperature caused by increased power dissipation in the drive coils at high drive currents.

Each chip function exhibits a different operating region. The gates have multidimensional margins: they are affected by the amplitude, phase, and width of the loop current pulse as well as by the strength of the bias and drive fields.

Once a nominal set of pulse parameters is found, the operating regions for the various functions can be compared. Figure 3b shows typical operating regions for bubble propagation, transfer-out, replication, transfer-in,

generation and detection functions. The overall operating region of the chip is the intersection (shaded area) of all these regions. Chip design is optimized in part by designing each function so as to maximize the intersection of the various operating regions.

Isolating the functions

To analyze factors limiting chip performance, it is necessary to isolate the operating region for each function. Since the bubble device is serial, it would appear to be impossible to determine which circuit function failed in response to a change in bias or drive field. However, fault isolation can be achieved by making a momentary change in the field.

For example, to analyze the operating region of the transfer-in function, operating conditions under which all chip functions work must first be established. Then, during the cycle in which the transfer-in function occurs, the tester steps the amplitude of the bias field and/or the drive field to an alternate value; when the transfer-in cycle is over, it returns the fields to nominal values. The alternate value can be varied to characterize the transfer-in function without greatly affecting the operation of any other function.

Thus, to be capable of device characterization, it is necessary for the test system to be able to switch bias and drive field values on the fly. A portion of the test system is devoted to controlling the interface circuits in the complex manner required (see Fig. 4 for a functional block diagram).

Unlike semiconductor devices, bubble devices have no residual or background charge problems. Data storage is

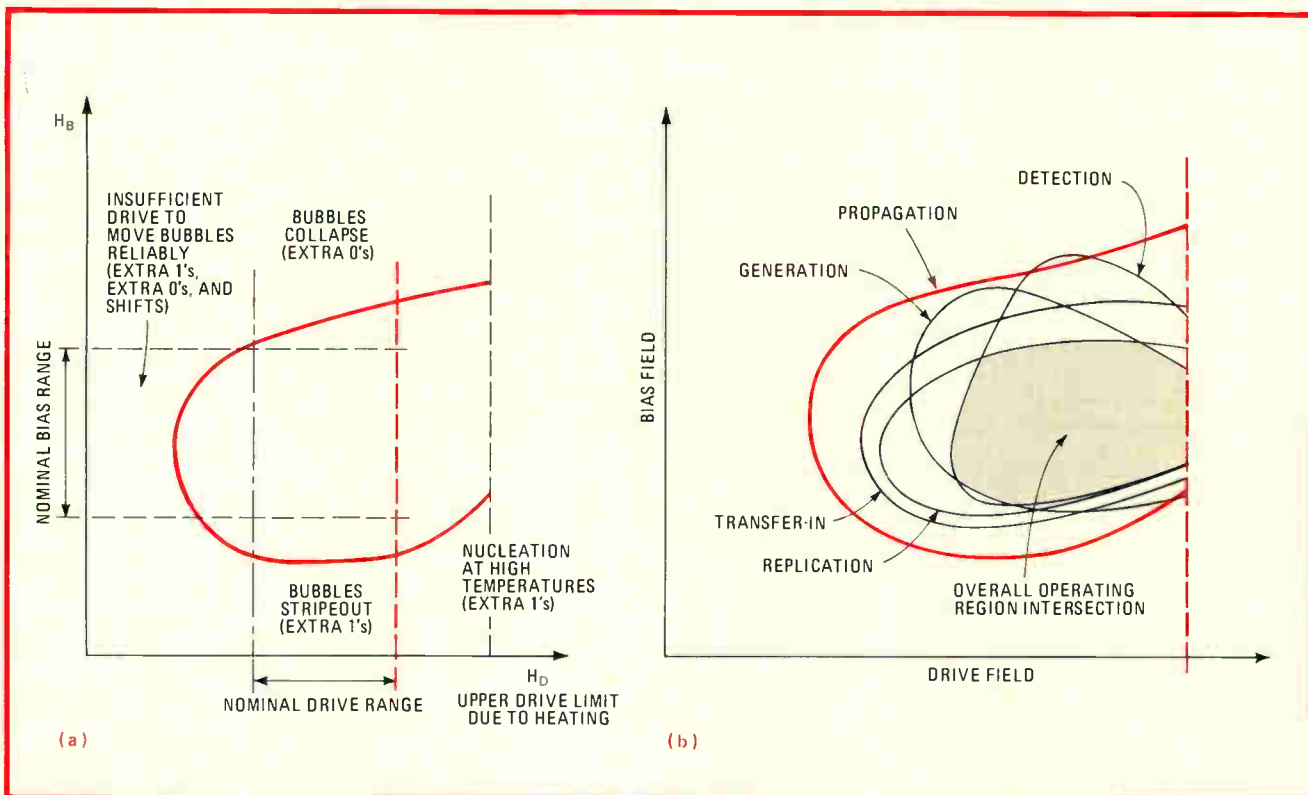

3. Operating margins. The magnitude of the drive field (H_D) and bias field (H_B) limit the operating margins (a) of a bubble device. Each function exhibits a different operating region (b). The intersection of all these regions determines the device's overall operating region.

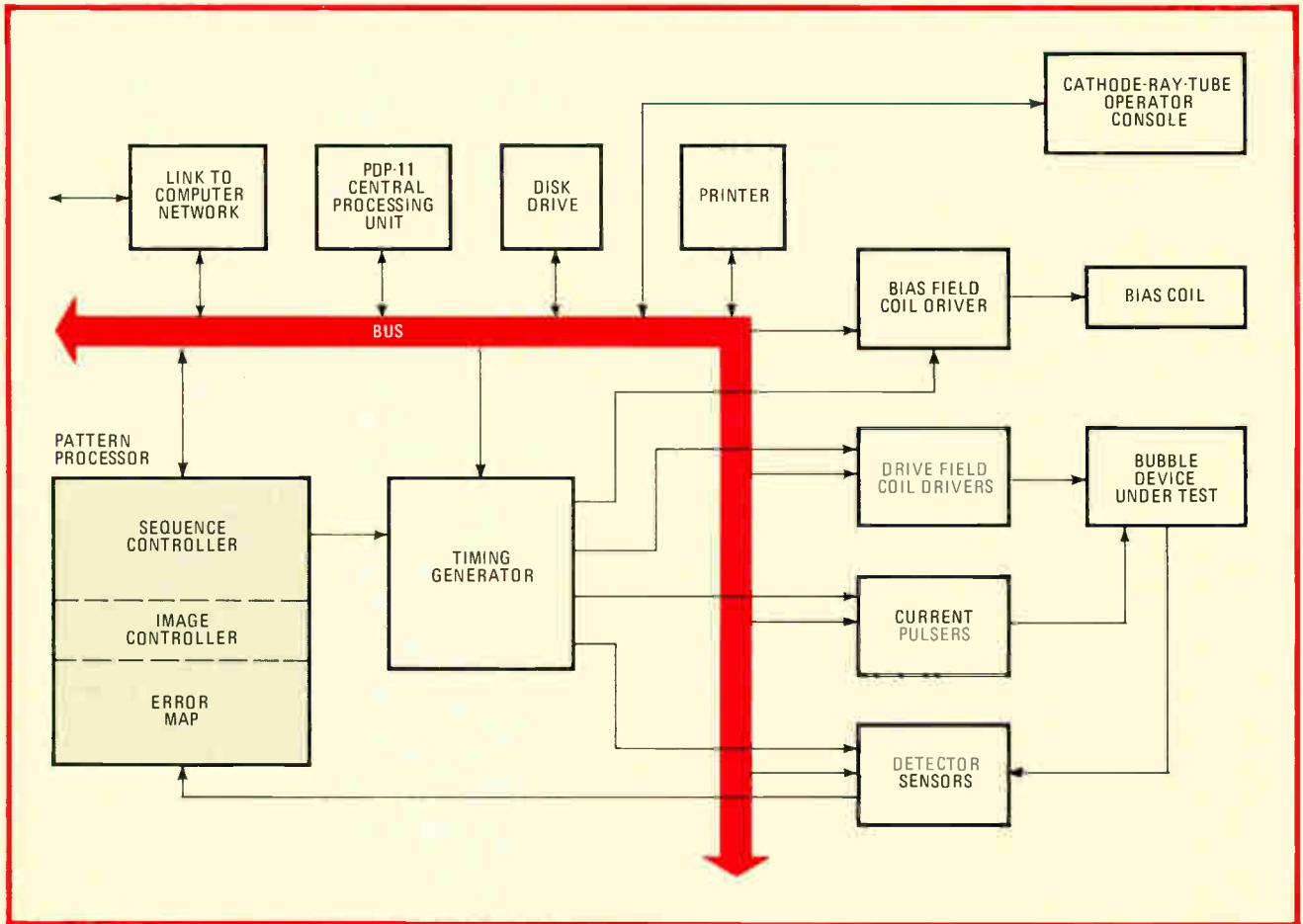

4. Tester architecture. Putting a magnetic-bubble memory through its paces calls for a machine made up of many functional subsystems. Circuits that interface the device, on right-hand side of diagram, are controlled by the processors and computer on left-hand side.

in terms of discrete units; there is no such thing as half a bubble. But there is a potential problem of bubble pattern sensitivity, involving the interaction between bubbles. This sensitivity is of a localized, two-dimensional nature. Two nearby bubbles will repel each other; if a bubble is surrounded by other bubbles, the resultant increased field may tend to cause a collapse. The interaction between bubbles is quite significant. In fact, experimental devices have been made where the presence or absence of one bubble is used to control the propagation path of another.

Pattern sensitivity testing

In order to test for problems caused by this sensitivity, the test system programmer can load the memory device with various patterns of 1s (represented by bubbles) and 0s (array spaces without bubbles) and check to see that they emerge unchanged. Any changes in the patterns when read from the device being tested are stored in the tester's error map. Errors can then be analyzed to locate problems and identify faulty storage loops.

Since bubble devices may exceed megabit storage capacity in the not-too-distant future, it is impractical to specify each bit of data stored on the chip for each type of test performed. Fortunately, it is not necessary to do this. The image controller permits the programmer to specify a topological image of the data to be written into

the device. He need only specify the pattern as a two-dimensional array of 1s and 0s.

The image controller also allows him to specify the status of each block location on the minor (storage) loops—e.g., full, empty, written, read, blank, etc. (A block is the string of locations, one on each storage loop, that are lined up such that they all reach the transfer-in or transfer-out gates at the same time.)

As there is negligible interaction between bubbles spaced more than a few periods apart, it makes sense to repeat the same test pattern after every few minor loops. The loops are divided into a series of equally sized groups (generally no larger than 16 loops wide) that store identical patterns.

It is usually unnecessary to fully load each loop with bubble patterns, since a pattern a few bubbles long is shifted around the entire loop, eventually passing through each site. It is, however, desirable to write in two or more patterns at locations widely spaced along the minor loops, to determine, for example, the extent to which bubbles passing on opposite sides of a loop will interact. Figure 5 portrays the data image as a cylinder that revolves as the bubbles propagate around the storage loops. The example has individual patterns A and B repeated across the chip's storage loops.

The architecture of a bubble memory requires that the test pattern as it ultimately appears topologically on the

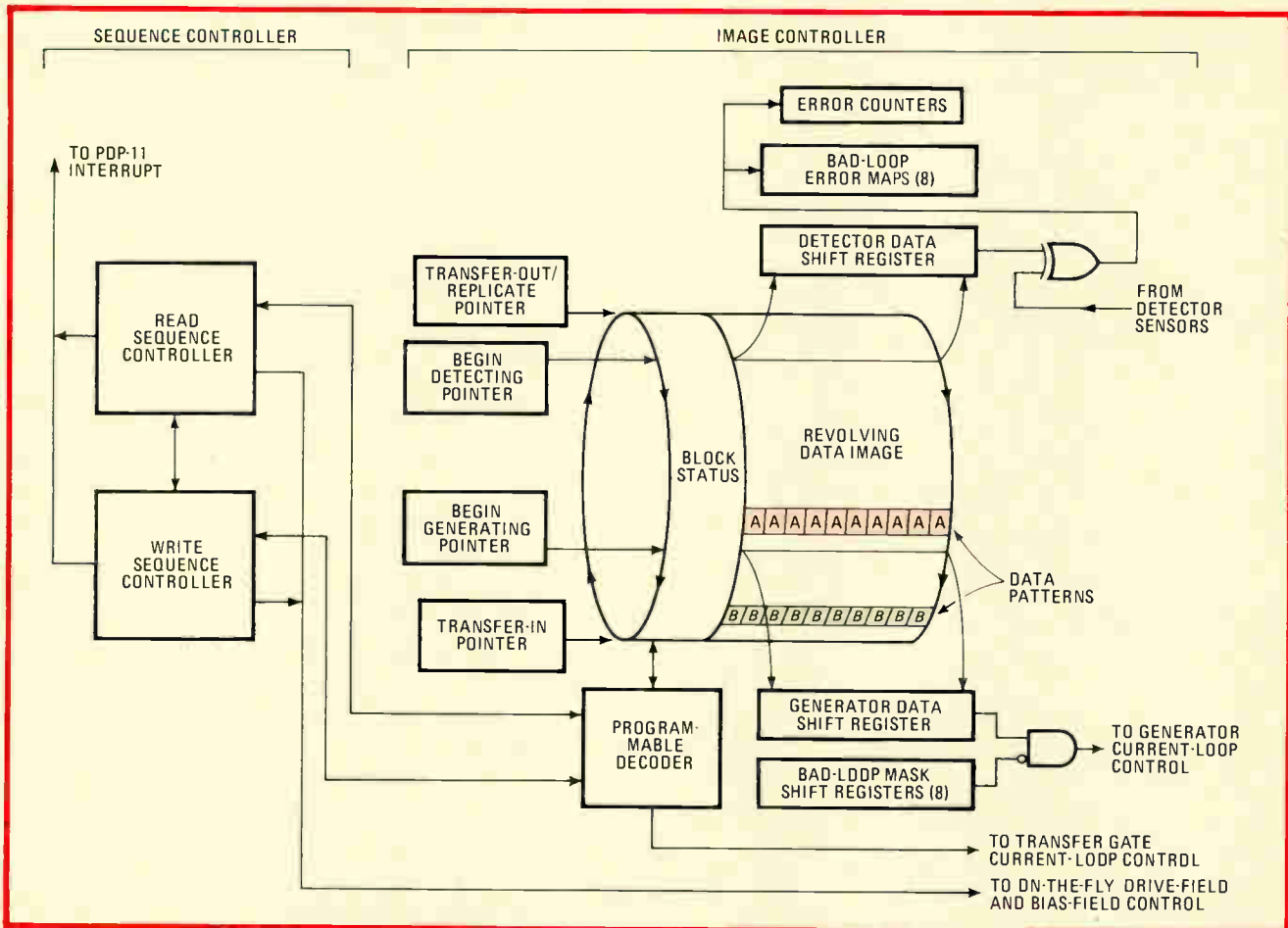

5. Pattern processor. Data blocks are generated and monitored to test data-propagation pathways, bubble pattern sensitivity, and various gate operations—and to locate bad loops and mask them out. Extra loops compensate for defects, to keep yields high.

chip be written sequentially, block by block. The sequence can be looked at either as the order in which data blocks are written into their storage loop locations or in terms of the time delay between events, as measured in clock (drive field rotation) cycles.

Pattern sequencing

The test system's sequence controller provides cycle-by-cycle pulse control in addition to on-the-fly changes in bias and drive field. The sequence controller (a part of the pattern processor, which also contains the image controller and error map) does its job using software suited to high-speed manipulation of clock cycles. Program routines controlling the writing order of data blocks can be constructed as functions of clock cycle manipulation.

The delay between various events is determined by chip architecture. For instance, before transferring a block of data into the storage loops, the block must be generated one bit at a time and shifted along a "leader" track onto the generate track that runs along the transfer-in gates. With some architectures, the delay between the generation of the first bit of a block and the transfer-in pulse that moves the block into the storage loops may be given by $P(N + L)$, where P = the drive cycle period, N = the number of storage loops (block width), and L = the number of locations on the leader track. The delay

between transfer-in and transfer-out is determined by the length of the storage loops; a block must travel halfway around the loop in order to reach the transfer-out gates.

The test system may use four image windows or pointers to keep track of data blocks during read and write operations. The windows shown in Fig. 5 are actually incrementing pointers that access a four-port memory containing the data image and block status. One window points to the block positioned at the transfer-out/replicate gates on the current cycle. If a block is transferred out, another window points to that block when its first bit approaches the detector. Another window monitors the block positioned at the transfer-in gates, and a fourth window indicates when the first bit of the block must be generated prior to transferring in.

Sequence control

To write a data block, the sequence controller produces an "access request." This essentially transfers the appropriate block of data into a shift register, from which it is shifted serially into the chip's bubble generator. The block status is set as "block generation initiated, but block not yet transferred." When the transfer-in window encounters this status the transfer-in pulse is generated. In this way the sequence controller program tracks events on a block-by-block basis, with the image

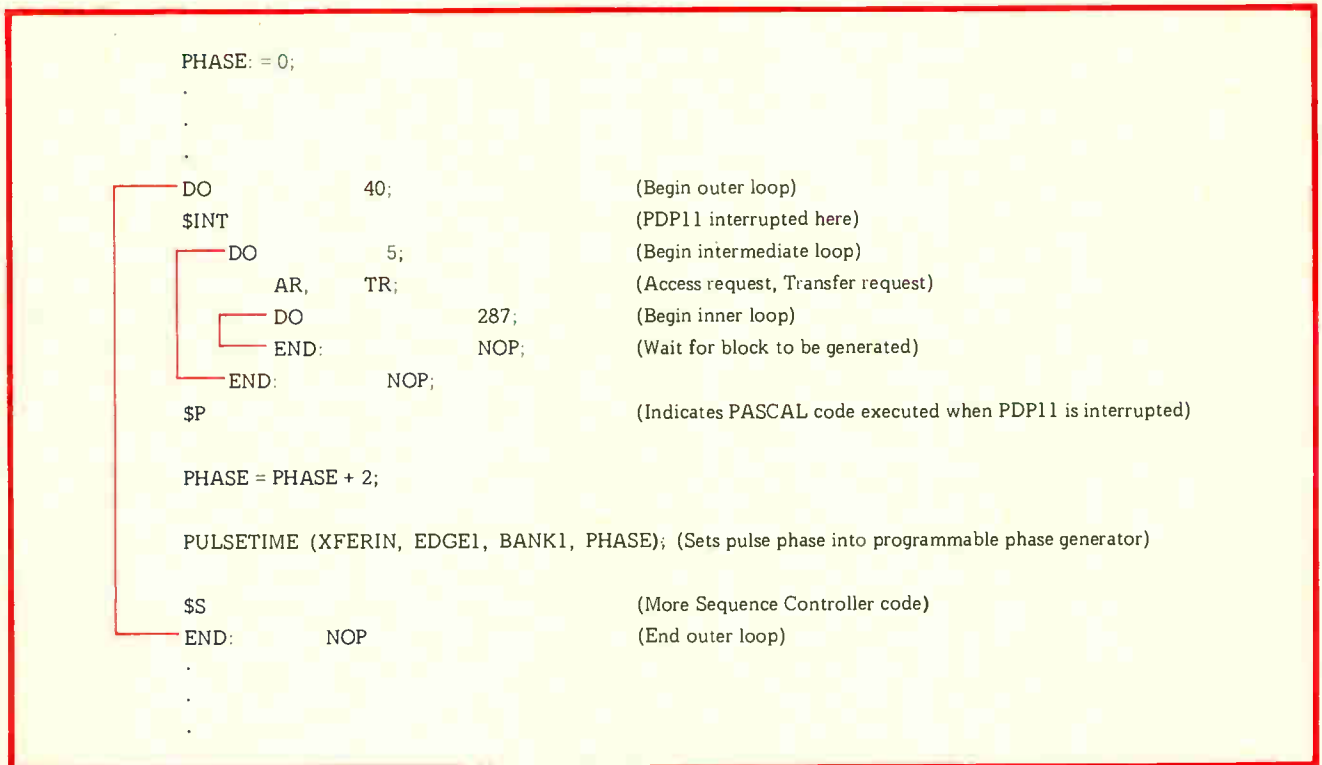

6. Enter Pascal. The sequence controller is programmed with a block-structured language that uses nested loops to produce a serial data stream. This printout shows the PDP-11's Pascal coding mixed in to test the effects of varying transfer-in pulse phase.

controller completing block write and read operations as a function of chip architecture.

Sequence control is simplified somewhat by making the write and read functions simultaneous but independent. This is performed by a separate generator sequence controller and detector sequence controller. These controllers should be programmed in a simple but powerful block-structured language that expresses events as a series of nested loops.

The Megatest Bubble Memory Test System [*Electronics*, April 26, 1979, p. 167] incorporates a PDP-11 mini-computer using an extended version of the high-level language Pascal to control the complex operations of the pattern processor. Figure 6 shows how the programmer interleaves Pascal source code with the sequence controller's block-structured code in order to synchronize the simultaneous operation of the PDP-11 and the sequence controller. This program section writes 200 blocks of data, with the phase of the transfer-in pulse being incremented 2° for every 5 data blocks. It is then possible to see how a stream of data being written into bubble storage is affected by the phase shift of the transfer-in gate's waveform over an 80° test span with respect to the drive field. This is done to determine the optimum phasing of the transfer-in pulse.

To achieve reasonably high yields in the production of these dense devices, a certain percentage of the storage loops are allowed to be defective. The memory chip is made with extra loops to compensate for the defective loops. The test system locates the bad loops and stores the information in a map. It also keeps track of the overall error rates, the number of errors on each loop, and the total number of bad loops.

When a bubble memory is put into service, a mask register permits selective masking of bad loops, so that bubbles are not written into them. Some bubble chips have an extra loop with independent transfer gates that is used to store a map of the bad loops.

Economics

Final test times for quarter-megabit devices generally range from over a minute to several minutes. Since bubble devices are serial, the increase in test time as storage capacity rises will be more linear than exponential. Nevertheless, it is obvious that testing will be a significant manufacturing cost.

Tester accuracy and test sequence flexibility requirements make it impractical to create a production test system that is significantly less expensive than a system designed for device analysis. Therefore, other means of cost reduction must be used.

Bubble devices will be the first large-scale integrated devices for which parallel testing is truly cost-effective. This is so because the yield at final test should be very high, because of the rejection of most bad devices at the three previous testing stages. The test system must be able to support a large number of device interface circuits, and must simultaneously provide individual error mapping and bad loop masking for at least eight memory devices.

Throughput is further optimized if the tester has a flexible pattern processor that allows any required test sequence to be generated with minimum software overhead, simultaneous write and read capability, and a pattern processor that can be operated in parallel with the general-purpose computer. □

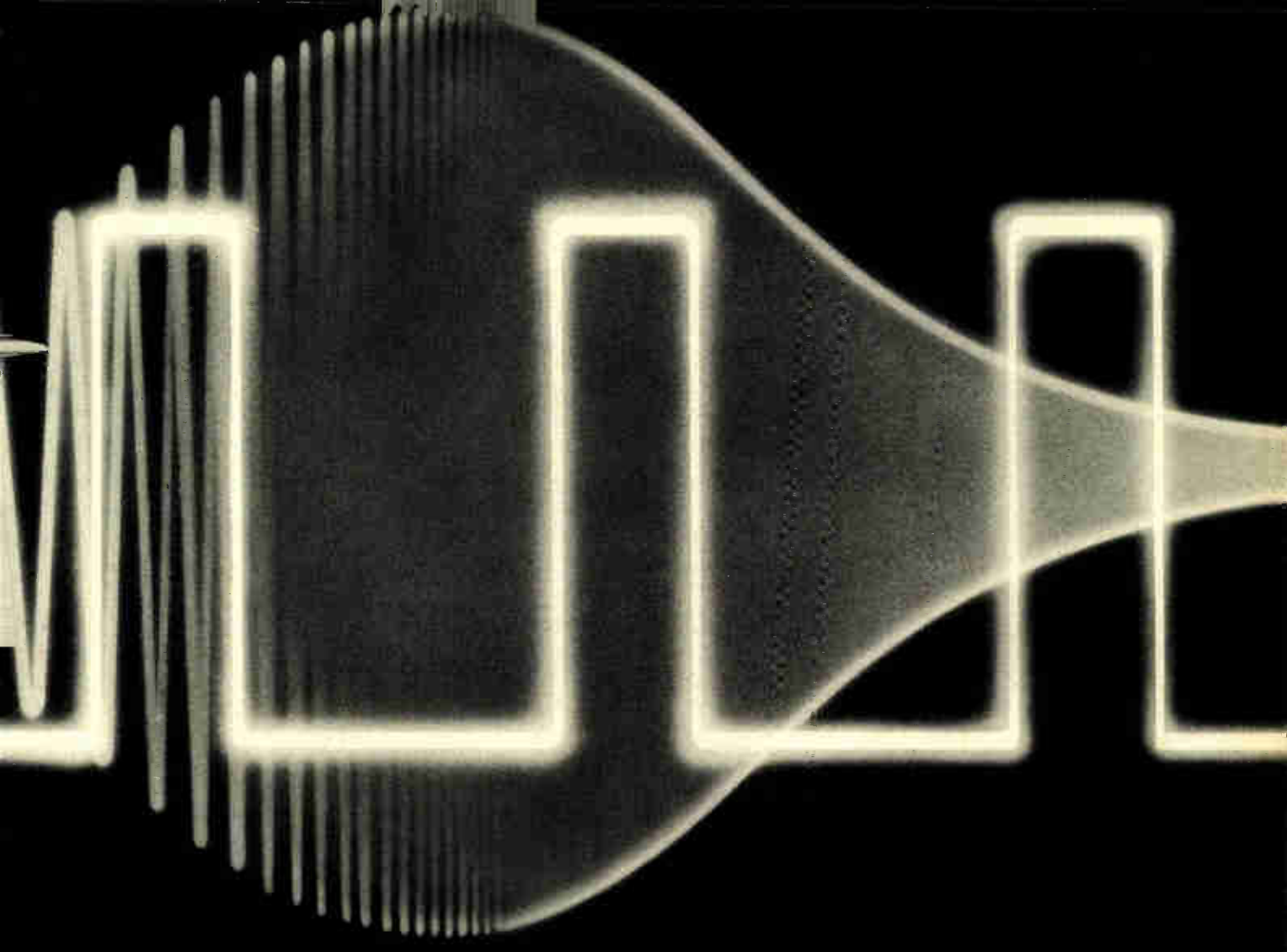

Booth 1432 at Electro '79

We've had longer to perfect the Function/Pulse Generator. After all, we offered it first.

In 1975 we combined a true pulse generator capability and a function generator. In Interstate's Series 70.

Today, many of our competitors are showing us the sincerest form of flattery.

But don't settle for an imitation when you can have the original for about the same price.

Our Series 70 Function/Pulse Generators are true pulsers. The F-77, for example, produces a precise, stable 15 nanosecond rise time pulse with constant width adjustable down to 30 nanoseconds, unipolar or with full offset and amplitude flexibility, and triggered or gated.

And Series 70 offers something very few of our competitors have caught up with: a choice of constant width or constant duty cycle pulses.

And all Series 70 models produce sine, square, triangle and dc-level waveforms with 5 to 95% waveform variable symmetry control, and calibrated coarse/fine frequency tuning.

Sweep start and stop limits are easily set with direct reading sweep dial.

Frequency ranges are the most usable—from 0.00002 Hz to 20 MHz—from infrasonics through video and beyond.

Series 70 also gives you FM Capability—externally applied voltages provide frequency control over each 1000:1 frequency range for sweeping frequency-sensitive devices, test programming, and other voltage-to-frequency and frequency modulation applications.

Before you buy any Function/Pulse Generator, take a long hard look at the original Series 70 from Interstate Electronics.

We've had longer than anyone to perfect our electronics and prove our reliability.

For our catalog including the Series 70, and our other bench and programmable test equipment write: Don Leach, Interstate Electronics Corporation, 707 E. Vermont Ave., Anaheim, CA 92803. Or Call: (714) 772-2811.



**INTERSTATE
ELECTRONICS
CORPORATION**

SUBSIDIARY OF **ATO**

Information Processing and Display.
Systems. Products. Services.

Circle 123 on reader service card

Voltage-to-current converter handles bilateral signals

by Kelvin Shih
General Motors Proving Ground, Milford, Mich.

Sending an analog voltage from one point to another via a slip ring and brush assembly often causes disaster in instrumentation applications, because of the attendant voltage drops across the variable resistances encountered and also because of induced noise. By converting the voltage to a current before transmission (and back to a voltage at the receiving end), however, these circuits eliminate those problems. And unlike converters that generate a problem of their own—their inability to handle bilateral input signals—this one will transform a ± 10 -volt signal into a ± 10 milliamper current at the

transmitter and recover the ± 10 -v signal at the receiver.

At the transmitter, input voltage V_1 is applied to one branch of a summing-amplifier circuit consisting of A_1 , R_1 – R_3 , and R_7 . The other branch is driven by V_2 , which is the transmitter's output voltage. As a consequence of this feedback arrangement, the voltage from inverting amplifier A_2 is $V_1 + V_2$.

Current booster Q_1 – Q_2 , which is part of A_2 's feedback resistor network, provides a low-impedance source for generating a current, I_o , with Q_1 becoming active for positive input voltages and Q_2 active for negative input voltages. Thus, $I_o = [(V_1 + V_2) - V_2]/R_6 = V_1/R_6$, and therefore the output current is a function of input voltage V_1 only.

At the receiver, A_4 , Q_3 , and Q_4 detect input current I_o and convert it to a voltage, $-V_1$. Note that the two-transistor arrangement similar to that employed in the transmitter is again required to process the bilateral input currents encountered. A_5 acts as an inverting amplifier so that the output signal, V_1 , is recovered. □

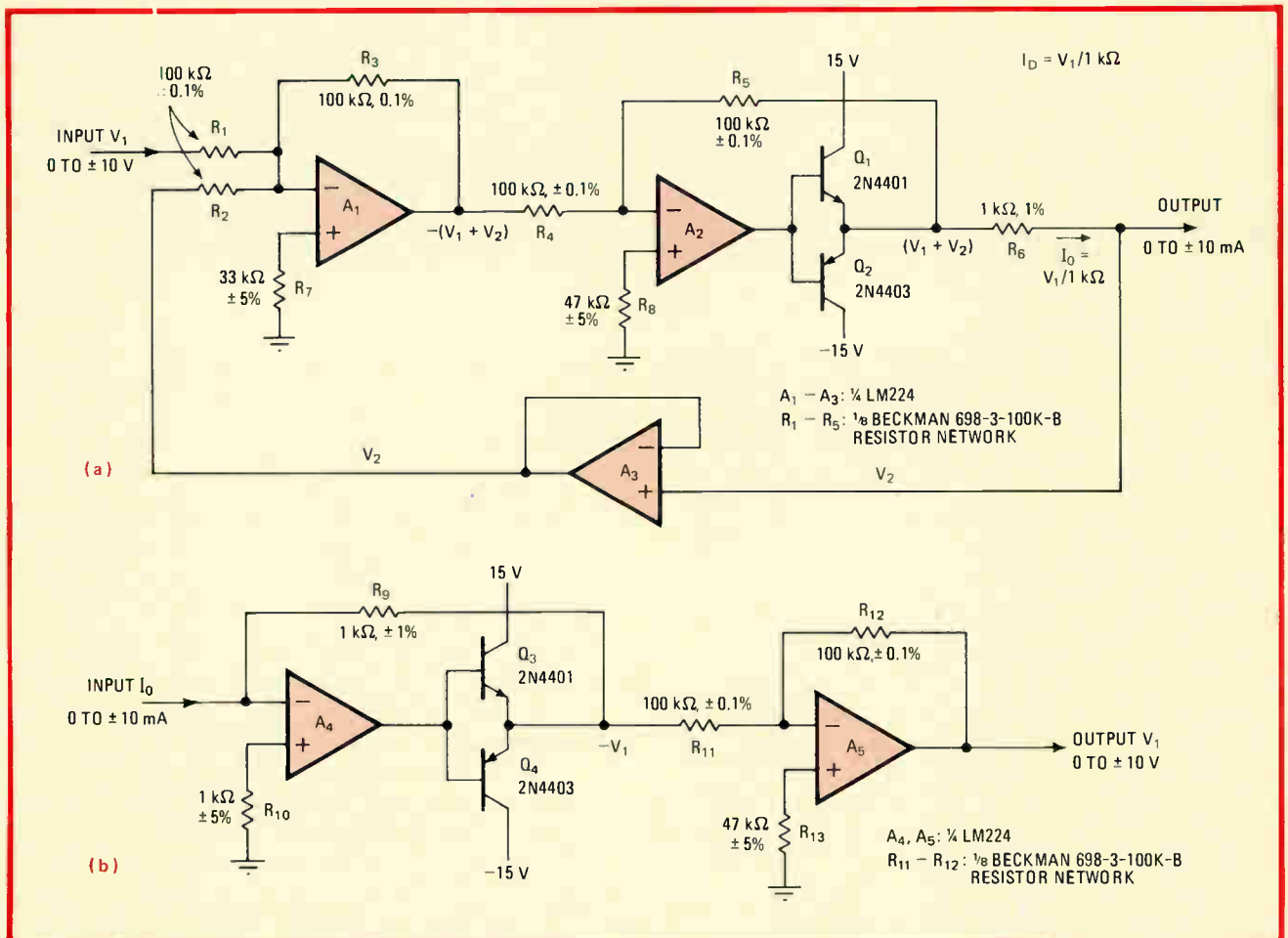

Communicating current. Converter (a) transforms bilateral analog voltages into corresponding currents for high-accuracy transmissions over high-resistance networks. Receiving converter (b) performs inverse operation to recover input voltage. Low-cost op-amps and transistors are used throughout. Beckman package in (a) and (b) provides low-cost source of matched resistors required for very precise conversions.

Cascaded C-MOS blocks form binary-to-BCD converters

by Haim Bitner

Seforad-Applied Radiation Ltd., Emek Hayarden, Israel

Low-power complementary-metal-oxide-semiconductor adders and comparators are easily combined to form this 4-bit binary-to-BCD converter. When the basic adder-comparator blocks are cascaded, the converter can be expanded to turn n binary input bits into a binary-coded-decimal output. The circuit is simpler than one using counters, and read-only memories are eliminated.

Comprising the basic 4-bit converter block (a) are the 4008 full adder and the 4585 comparator. The binary inputs are introduced at A-C, with A being the next to least significant bit, and D grounded. The BCD output appears at X_1 - X_3 and Y of the 4008. The LSB input

bypasses the unit and becomes the LSB output.

The 4585 compares the input bits to a binary number (0100) which is hard-wired to pins B_0 - B_3 . Thus the output of the 4585 is low if the number at A-D is less or equal to 4. The X_1 - X_3 outputs of the 4008 are then identical to the input bits.

If the input number becomes greater than 4 (that is, greater than 0100), the 4585's output moves high, and so binary number 0011 is placed on the B_1 and B_2 inputs of the 4008 adder. Thus, 3 is added to the input number and the Y output of the 4008 goes high, indicating the most significant digit is active.

By cascading units, 5-bit (b), 6-bit (c) and 7-bit (d) converters can be built. The method can be used to extend indefinitely the number of bits processed. Note that the value of the least significant input bit (a_0) is numerically equal to its BCD-equivalent and so passes straight from input to output in all cases. □

Designer's casebook is a regular feature in *Electronics*. We invite readers to submit original and unpublished circuit ideas and solutions to design problems. Explain briefly but thoroughly the circuit's operating principle and purpose. We'll pay \$50 for each item published.

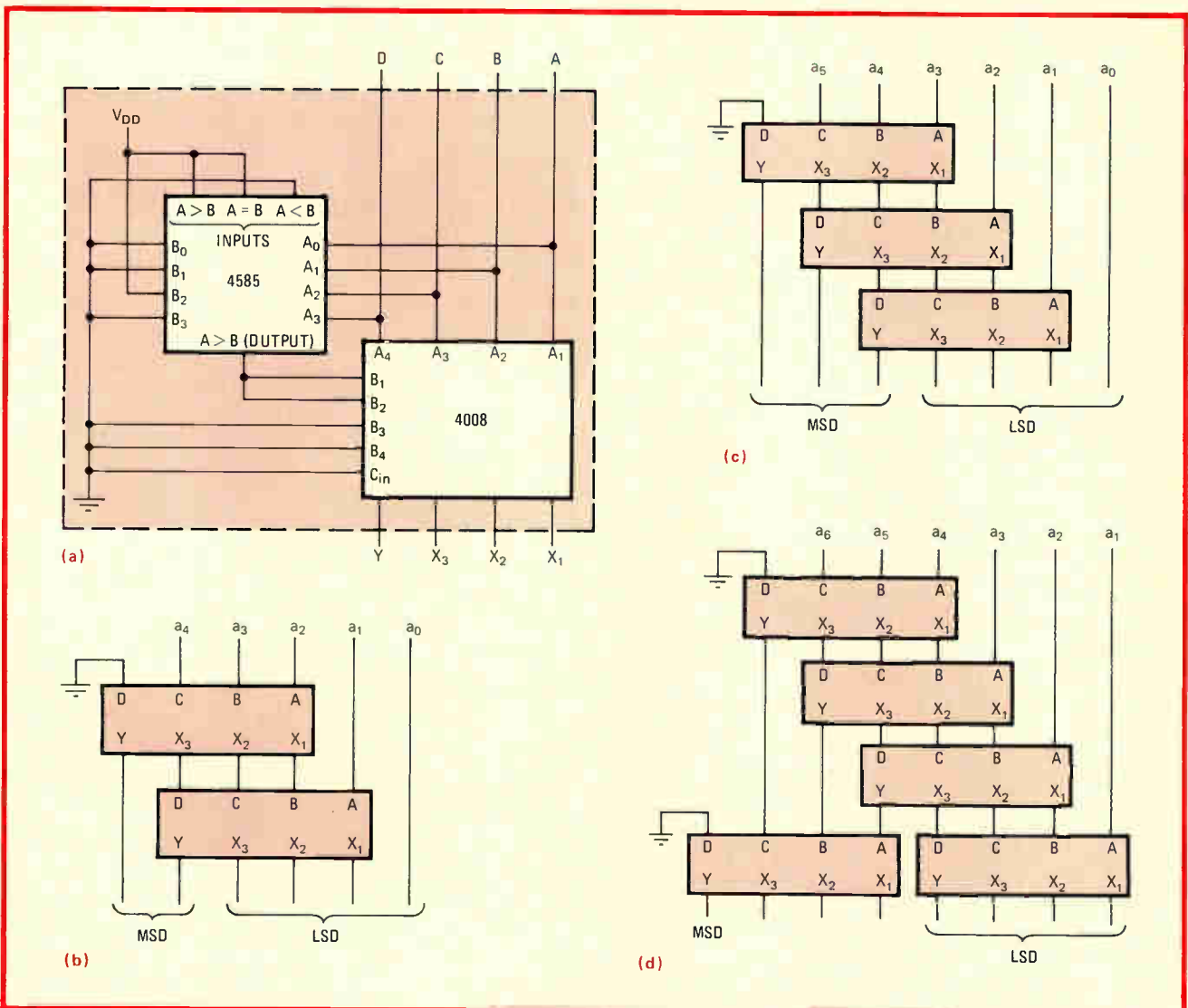

Add infinitum. Low-power binary-to-BCD converter (a) requires only C-MOS adder and comparator for processing 4 bits. Unit is so configured that basic building blocks can be easily combined to form 5-bit (b), 6-bit (c), and 7-bit (d) converters.

Coming through...

with better ways
to interface

NEW "GPIB" CABLES

Interface computer power with test and measurement hardware—without lots of time-consuming patchwork wiring.

Belden's new "General Purpose Interface Bus" cable assemblies will become essential tools for you in R/D, quality control and on-the-job trouble-shooting.

Interconnect up to 15 programmable instruments at once. In star or daisy chain networks. Cables work with counters, signal generators, calculators, digital multimeters—in fact, they can be used with any instrument equipped with standard IEEE 488 interfaces. That means hundreds of compatible products today and the hundreds more coming on-stream soon.

These new 24 conductor cables are built to last, too. Semi-rigid PVC insulation and PVC jacket offer good flex life. U.L. recognized self-extinguishing plastic connectors are designed to withstand constant make/break cycling. Contact pins featuring gold over nickel-plated beryllium copper deliver far better conductivity than designs using plain copper. Belden U.L. approved "GPIB" cable assemblies (with metric cadmium plated screws) are available right now in five standard lengths up to 16 m (52.5'). U.L. approved and CSA certified bulk put-ups are also available. Let Belden come through for you. Contact your local Belden distributor or Belden Corporation, Electronic Division, P. O. Box 1327, Richmond, Indiana 47374; 317-966-6661.

BELDEN

Coming through...

with new ideas for moving electrical energy

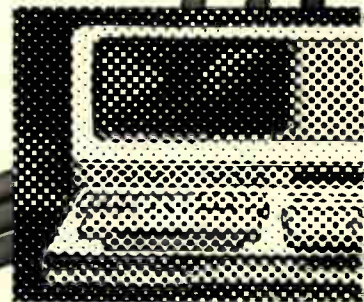
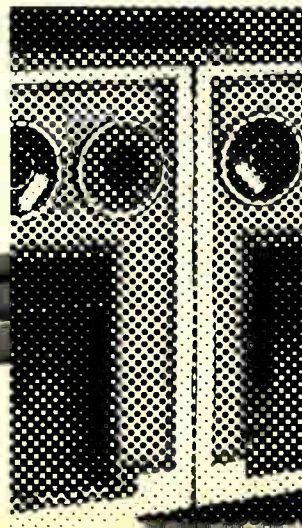
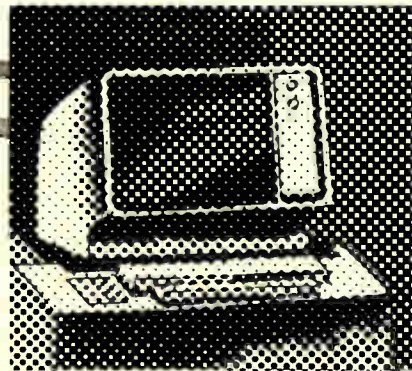
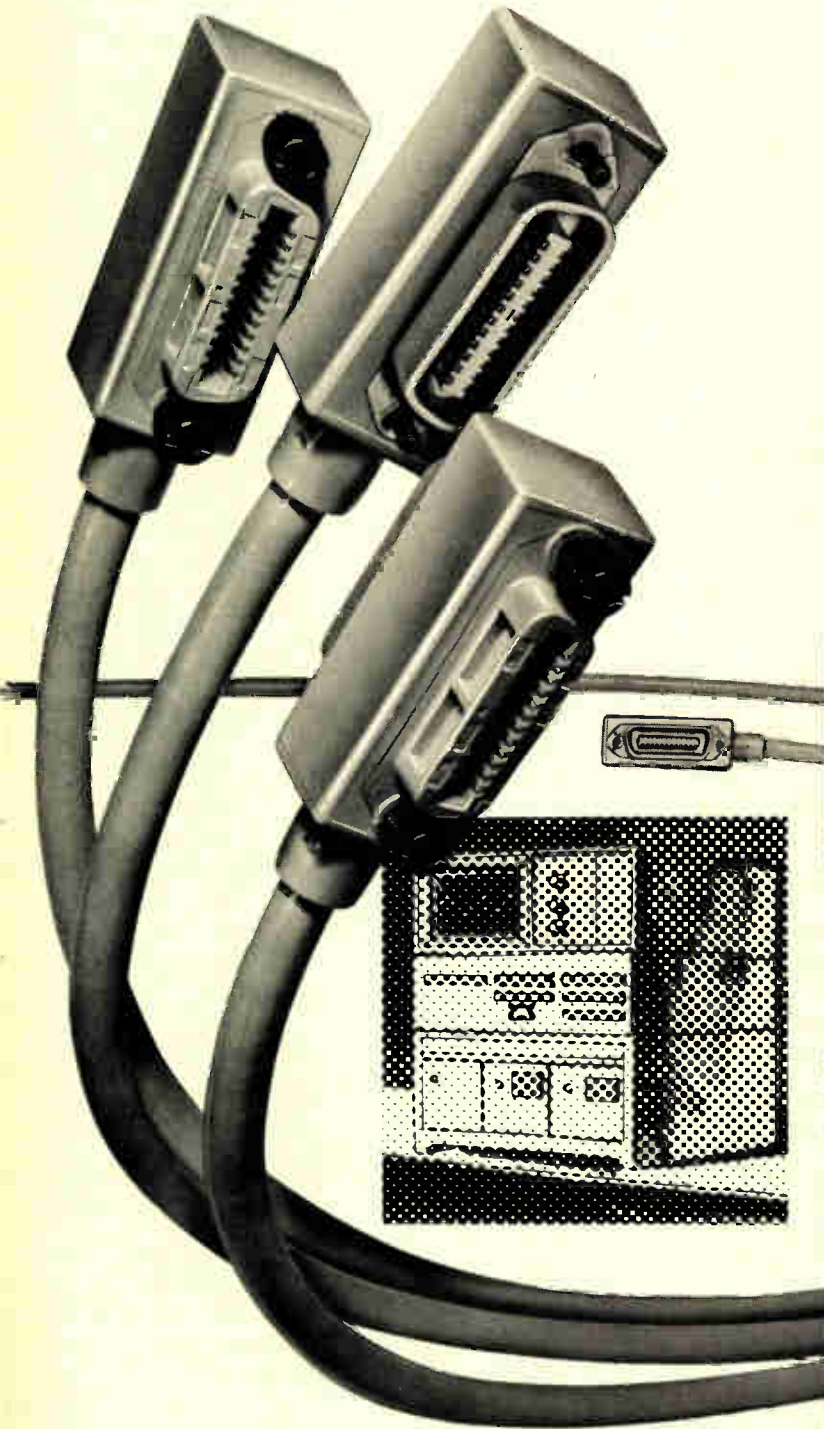

Bidirectional optoisolator puts two LEDs nose to nose

by Forrest M. Mims III
San Marcos, Texas

As conventional optoisolators employ a separate source and sensor, they can transfer current in only one direction. A few photodetectors and electroluminescent diodes can double as both a source and sensor, however, and when they are suitably connected they offer users a convenient way to build a low-cost bidirectional optoisolator, as shown here.

Two OP-195 LEDs, which have gallium-arsenide-silicon infrared emitters, can be made to transfer signals in either direction if they are placed nose to nose in a short length of heat-shrinkable tubing and secured in place by heating the tubing. Alternatively, the LEDs may be quite far apart if they are coupled by a plastic or glass-fiber waveguide.

In either case, the current transfer ratio (I_o/I_{in}) for the pair, with proper biasing, will be 0.06% for an input current of 20 milliamperes. This ratio is far too low for many applications but is good enough for some specialized roles where a bidirectional path is required. In any case, the output signal can be amplified or buffered, as necessary.

A logic-control voltage and two H11A1 optoisolators serve as the input/output port selector. Whichever of the OP-195 devices is designated the output diode may be

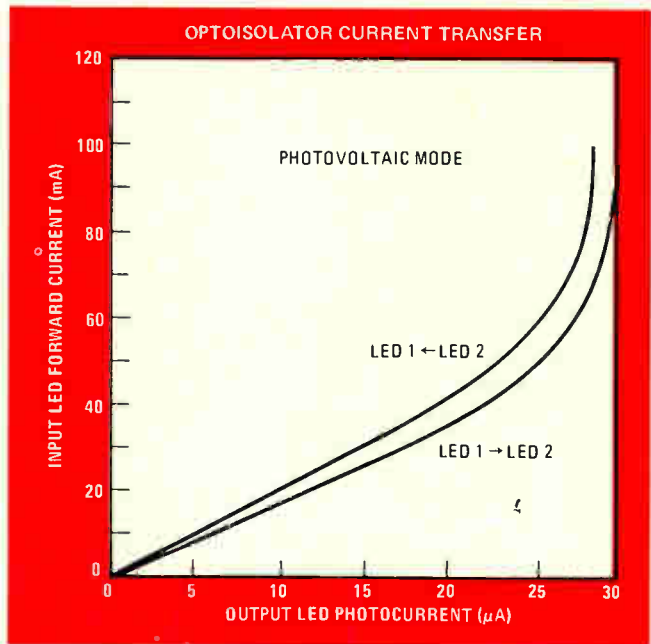

connected in the reverse-biased photo-conductive mode or the unbiased photovoltaic mode. In the latter case, the output device is not biased. The response of the optocoupler operating in this mode for a given signal-input current is shown in the plot. Note the device linearity is completely adequate for duplex voice communication.

The photovoltaic current transfer ratio is virtually identical to that for photoconductive operation up to an input current of 20 milliamperes. The ratios begin to depart considerably above 40 mA. □

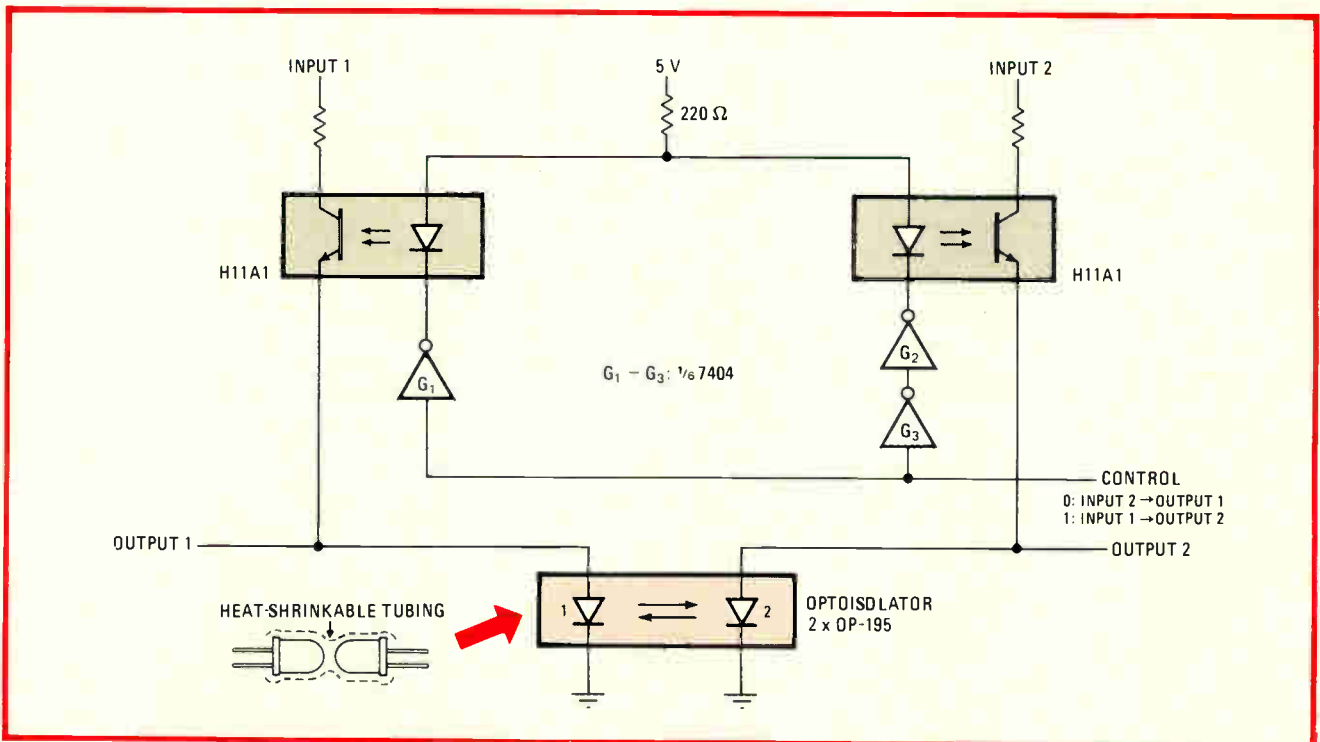

Either way. Standard light-emitting diodes encased in heat-shrink tubing can be made to function as a bidirectional transmission link. Alternatively, LEDs may be coupled through optical fibers. Control circuit for selecting input/output port arrangement is simple, using two optoisolators and three inverters. Circuit's current-transfer ratio suffices for many small-signal applications.

Electrically erasable memory behaves like a fast, nonvolatile RAM

It takes a processor only 300 nanoseconds to trigger a data modification in a 1,024-bit alterable read-only memory

by Chris Wallace, SGS-ATES Componenti Elettronici SpA, Milan, Italy

□ In speed and size, semiconductor memories have kept pace with today's powerful microprocessors, so that both are finding their way into an ever-widening range of applications. From the system designer's viewpoint, however, the ideal semiconductor memory would be both flexible and easy to design with, as well as fast. But till now every device has had to sacrifice one of these characteristics to the exigencies of the other two.

The exception is the M 120, a 1,024-bit part that is the first of a new breed of memory chips descended from electrically erasable programmable read-only memories, or EE-PROMs. (EE-PROMs are also known as electrically alterable ROMs, or EAROMs.)

Like earlier EE-PROMs, the M 120 is flexible and simple to use, being a nonvolatile memory that can be reprogrammed by electrical signals while in place in a system. But unlike the others, the M 120 looks to a processor like a fast, nonvolatile, random-access memory. Whereas a processor typically takes 22 milliseconds to modify the data in other EE-PROMs, it need spend only 300 nanoseconds or one machine cycle on starting the data modification in the M 120. That period of time is much more in keeping with the 150-to-300-ns processor cycle times of bus-oriented mainframe systems.

The M 120 has other advantages, too. It can be erased with a relatively low, single-polarity voltage, whereas many others can only be erased with potentially damaging large voltages. It is also bit-alterable, whereas currently available large-capacity EE-PROMs are only erasable in bulk or at best by the word.

The other semiconductor memory types available are also fast but lack either flexibility or design simplicity. By way of proof:

- Random-access memories (RAMs) have data that can be changed quickly and easily but require a dedicated backup power supply to preserve their volatile contents when power is removed from the system.
- Read-only memories (ROMs) and programmable ROMs are nonvolatile, but their contents cannot be changed once they are mask-programmed.
- Erasable PROMs (E-PROMs) are nonvolatile and alterable, but require removal from the system for reprogramming by ultraviolet light.

A change in process

The reason the M 120 is so much faster than its predecessors lies in its processing technology, which integrates fast, intelligent peripheral circuits with the memo-

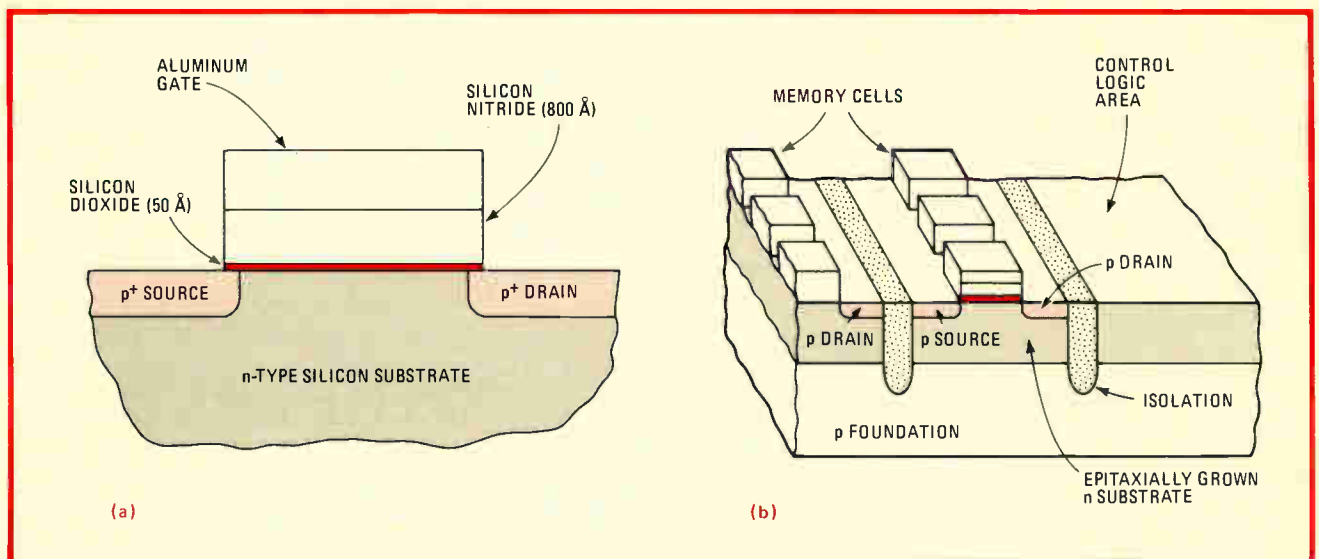

1. Layered. Typical MNOS memory cell requires opposite-polarity gate voltages to write and erase data; thinness of oxide layer complicates fabrication (a). To protect the sensitive control logic from the high cell voltages, MNOS EE-PROMs require intervening epitaxial layers (b).

ry array. Earlier EE-PROMs employed either a double-dielectric, or metal-nitride-oxide-semiconductor (MNOS), process or a stacked polysilicon-gate approach. The M 120 uses an improved version of the latter.

MNOS devices rely on electrons' ability to cross a thin oxide barrier if given enough energy. In a typical MNOS memory cell (Fig. 1a), if a high enough voltage (25 to 30 volts) is applied to the gate, electrons in the substrate tunnel through the silicon-dioxide to its interface with the silicon-nitride layer. Since both layers are good insulators, the electrons remain trapped there for a very long time—as long as 10 years. To erase the cell, an equally high negative voltage is applied to the gate to drive the electrons back into the substrate.

Two problems, in addition to production of a 50-angstrom oxide layer, plague MNOS memories. One is the tendency for electrons to recross the silicon-dioxide layer and cause a loss of data. The other relates to the need to reverse the polarity of the cell's gate-substrate voltage to erase it. Since the sensitive memory control logic is on the same substrate, several manufacturers have used an epitaxial construction like that shown in Fig. 1b to isolate the logic from the cells. While this arrangement helps prevent damage, the epitaxial layer and substrate constitute a high-leakage-current diode during erasure, which makes it necessary to use off-chip drivers with voltages as high as 40 v.

Compounding both problems is the time required for the complex modification sequence, which consists of applying the erase voltage, a delay, termination of erasure, applying the write voltage, another delay, and a final termination. Should either termination be omitted, the memory would be destroyed.

The second class of EE-PROMs is the polysilicon-gate type shown in Fig. 2. The cell configuration is that of a standard flip-flop, but the bottom two transistors have two control gates. At low supply voltages, this cell is volatile. But if V_{DD} is raised to a high level to "firm" the data, electrons on the conventional control gate with a positive potential migrate to the intermediate control

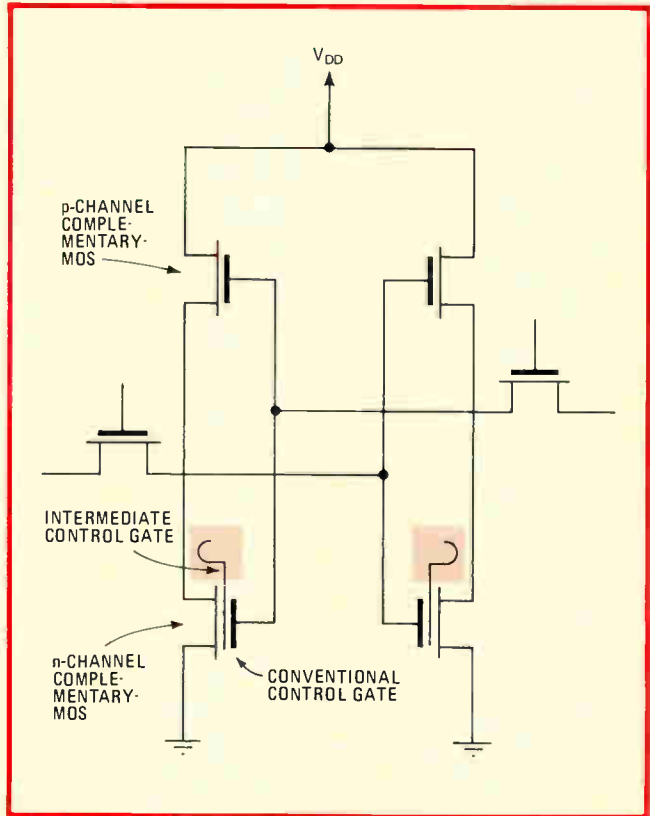

2. Extra gates. This flip-flop represents a typical polysilicon-gate EE-PROM cell. At low voltages, the cell is volatile. But raising V_{DD} to 20 V transfers charge from the drain to the intermediate control gate of the lower on-transistor, where it stays for up to 100 years.

gate and remain there when power is switched off. When power is reapplied, the difference in charge between the two intermediate gates toggles the flip-flop, reversing the cell's state predictably. That effect is conventionally overcome by large-scale integration of exclusive-OR logic on the chip, which complicates production. Another drawback to the use of polysilicon-gate parts as nonvola-

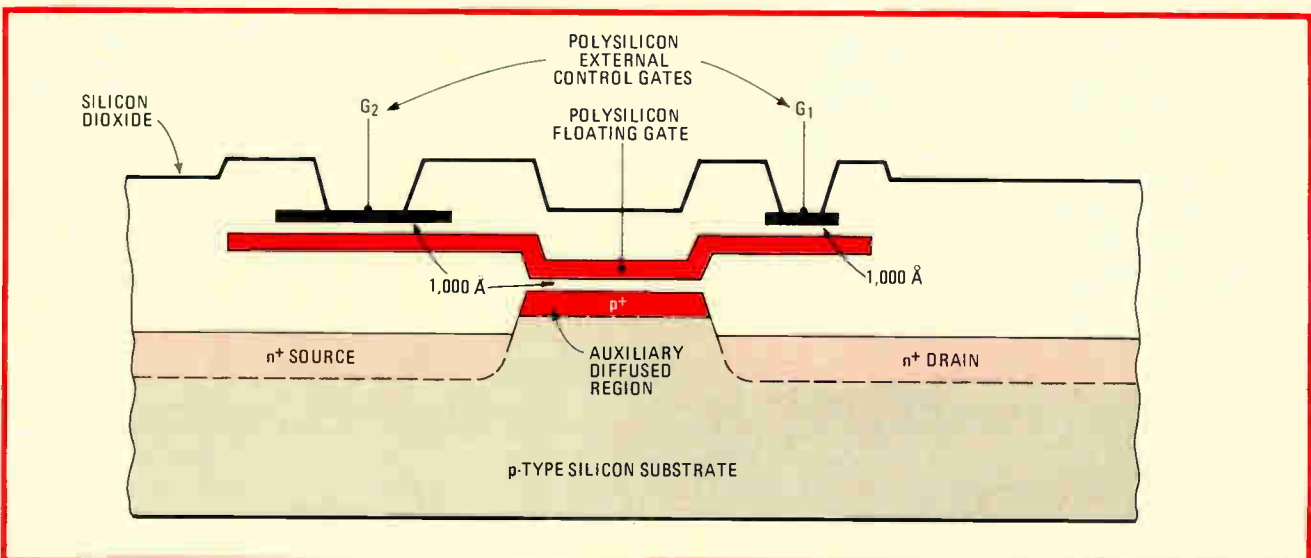

3. Floating. In the M 120, application of 20 V to G_1 and G_2 raises the potential of the floating gate, which then attracts and traps electrons flowing between the source and drain. Note thickness of oxide layer, which makes it easy to manufacture.

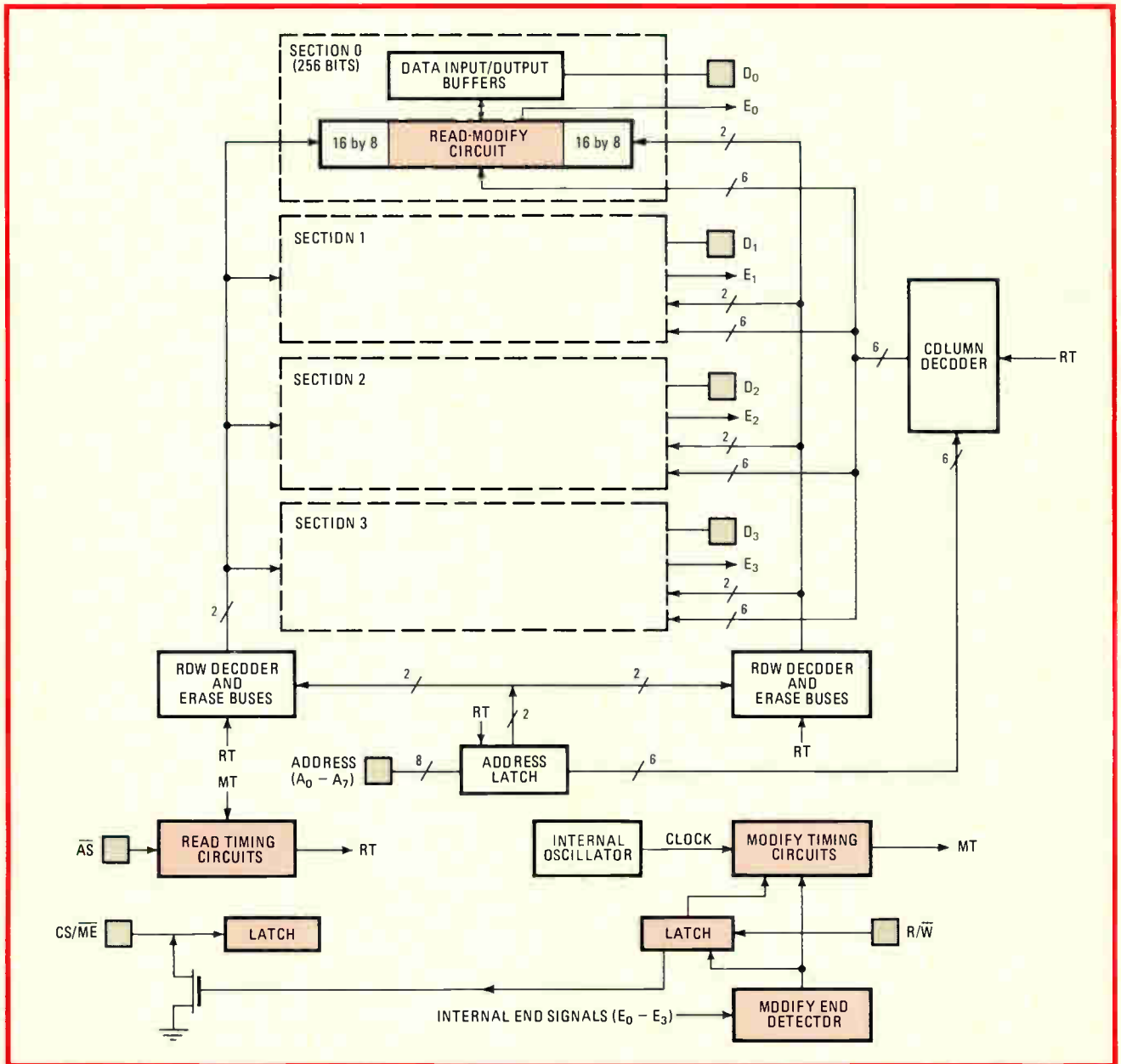

4. Intelligent approach. Block diagram of M 120 electrically erasable PROM shows memory organization and relationships to the on-chip control circuits. Function of internal logic is to compare each stored bit to incoming bit before changing cell content, if necessary.

tile memories is the need to detect voltage failures via complex integrated circuitry.

The M 120 solves the preceding problems—the need for very thin oxide layers in MNOS devices and for extra logic in stacked-gate parts—by adding an extra gate to the latter approach.

Adding a gate

Figure 3 shows the cell construction: two control gates G_1 and G_2 , a floating gate, and a thick (greater than 1,000 angstroms) layer of silicon dioxide on a conventional n-channel transistor with an auxiliary p-diffused region. Area of the cell is 3 by 2 mils, line width is 6 micrometers, and overall chip area is 216 by 131 mils.

To write data into the cell, 25 v is applied to both G_1 and G_2 with 15 v between the source and drain. With

conduction between the source and drain, the high potential induced on the floating gate attracts electrons to it across the oxide layer. Once the electrons reach the floating gate, they are trapped in a deep potential well, where they can stay for as long as 100 years. To erase the cell, G_2 is grounded when G_1 is pulsed with a positive voltage, which creates an electric field that is of sufficient intensity to drive the electrons across the oxide layer to G_1 .

Like other EE-PROMs, the M 120 has disadvantages. First, as the oxide layer between G_1 and G_2 captures ever more electrons with use, erasure time becomes longer, deteriorating to 100 milliseconds after 10,000 cycles. And since the transfer mechanism is a secondary effect, writing is slow compared with processor cycle times, even for new parts.

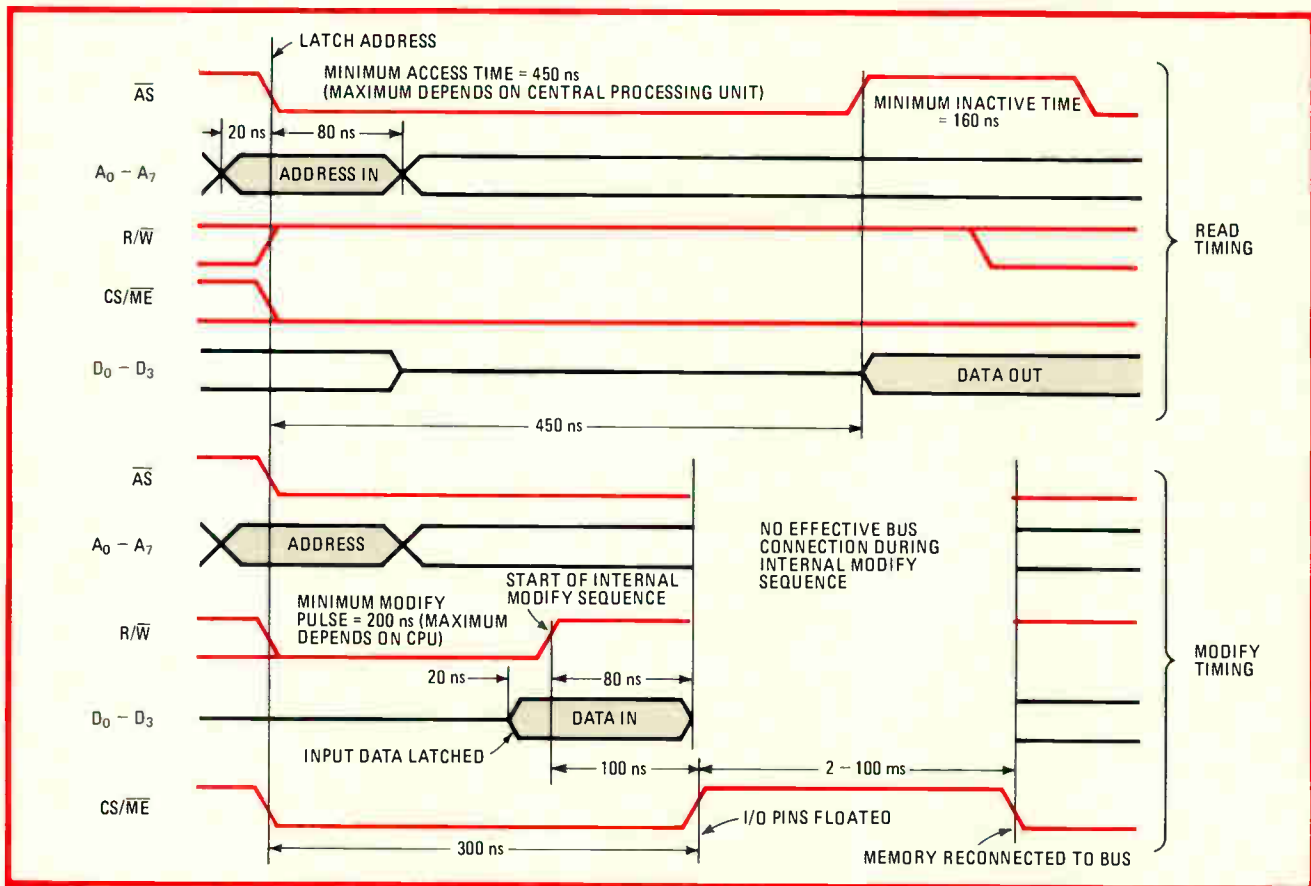

5. Otherwise engaged. Timing sequence for readout is conventional, yielding access time of 450 ns. Modification is a two-part procedure: 300 ns to latch the input word, followed by internal sequence of indeterminate length while the memory is off the bus.

But since EE-PROMs are normally used where data is changed only occasionally, rather than during every cycle, a solution to the modify-time dilemma is a design that allows a processor to present data to the memory when a change is required, and then remove the memory from the bus. The processor then can occupy itself elsewhere, while the memory completes the modification internally. The M 120 incorporates this feature in an on-chip intelligent modify system.

Figure 4 is a block diagram of the chip. It is arranged in four 256-bit sections, each of which is further divided into two 16-by-8-bit parts. Each section has a dedicated read-modify circuit and input/output buffers. Common to all sections are address and control latches, row and column decoders, and timing and control circuitry.

Read, modify

To read a 4-bit word from memory (Fig. 5, top), the processor applies the 8-bit address to address pins A₀-A₇ while keeping the read-write pin R/ \bar{W} high and the chip-select pin CS low. At the negative transition of the address-select pin AS, the read timing circuits generate the RT signal, which latches the address and applies it to the row and column decoders. After 450 ns, the stored word appears at pins D₀-D₃. Total power consumption for a read cycle is 300 milliwatts.

During a modify sequence (Fig. 5, bottom), D₀-D₃ become input pins. Again, but now with R/ \bar{W} low, the negative transition of AS latches the address, but the

input data is not applied to the internal latches until R/ \bar{W} goes high not less than 200 ns later. At this time, the internal modify sequence begins; 100 ns later, the memory removes itself from the bus by floating its I/O pins and holding the CS/ $\bar{M}\bar{E}$ pin low.

The modify sequence starts with a comparison of each bit in the new word with its stored counterpart. On the basis of this comparison, each section's modify circuit decides whether to write (write a 1), erase (write a 0), or do nothing (if the bits are equal). Those decisions are made during an initial 15- μ s pulse. Longer pulses, to a maximum of 200 μ s, and comparisons follow until each bit is modified. As each stored bit compares favorably with its corresponding input, that section's modify circuit raises an end signal (E₀-E₃) that goes to the chip's modify end detector. When all four end signals are high, the detector resets the internal read/write latch and floats the CS/ $\bar{M}\bar{E}$ pin, signifying that the memory is again ready to be read or written into. In this way, no cell is ever written into or erased unnecessarily. Power consumption for modification is a mere 400 mw.

Applications

Possible applications for the M 120 include storage of infrequently changed data like dimensions or production sequences in industrial control systems. SGS-ATES is at present working on a 4,096-bit part, and producing an integrated circuit that combines 272 bits of this type of memory with automatic tuning circuits for a TV set. □

NEW!

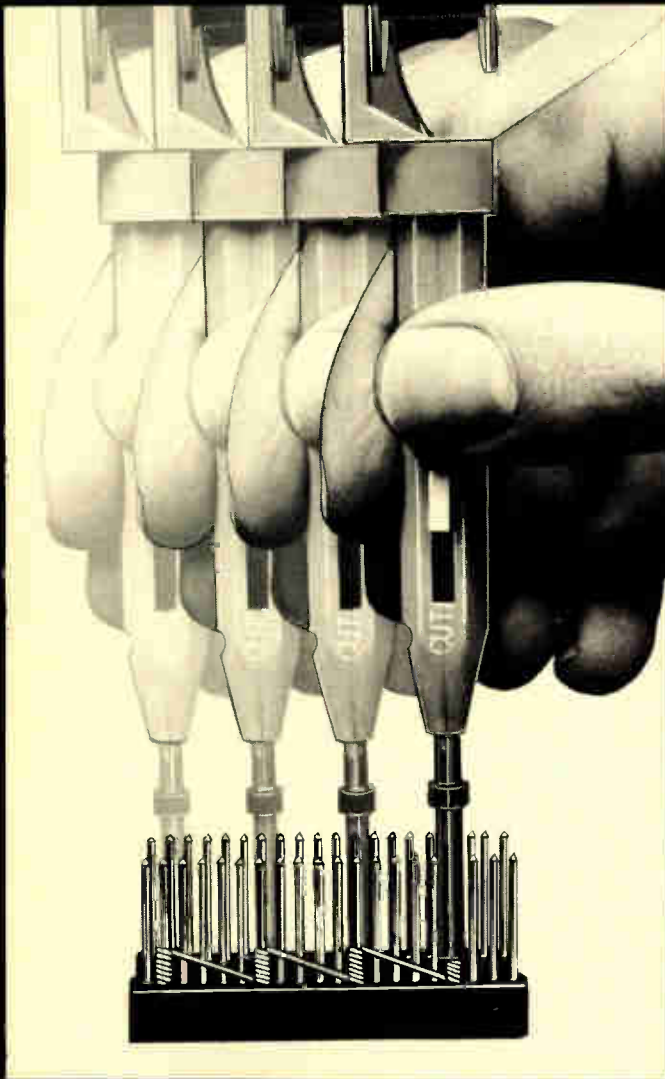

**WHY CUT?
WHY STRIP?
WHY SLIT?**

WHY NOT...

JUST WRAP™

U.S.A.
FOREIGN
PATENTS
PENDING

- AWG 30 Wire
- .025" Square Posts
- Daisy Chain or Point To Point
- No Stripping or Slitting Required
-JUST WRAP™....
- Built In Cut Off
- Easy Loading of Wire
- Available Wire Colors:
Blue, White, Red & Yellow

***\$14⁹⁵**

JUST WRAP TOOL WITH ONE 50 FT. ROLL OF WIRE		
COLOR	PART NO.	U.S. LIST PRICE
BLUE	JW-1-B	\$14.95
WHITE	JW-1-W	14.95
YELLOW	JW-1-Y	14.95
RED	JW-1-R	14.95
REPLACEMENT ROLL OF WIRE 50 FT.		
BLUE	R-JW-B	2.98
WHITE	R-JW-W	2.98
YELLOW	R-JW-Y	2.98
RED	R-JW-R	2.98

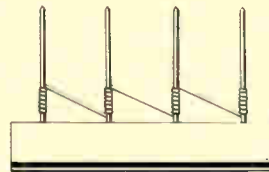

DAISY CHAIN

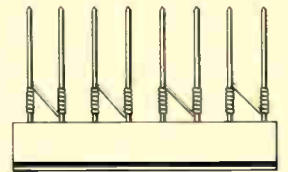

POINT TO POINT



MACHINE & TOOL CORPORATION 3455 CONNER ST., BRONX, N.Y. 10475 (212) 994-6600/TELEX 125091

*MINIMUM BILLING \$25.00 / AD SHIPPING CHARGE \$2.00 / NEW YORK CITY / STATE RESIDENTS ADD APPLICABLE TAX.

Circle 132 on reader service card

Zero-insertion-force connector ousts conventional backplane

Structural connector opens up new packaging configurations like side entry and tandem stacking

by James Taylor, AMP Inc., Harrisburg, Pa.

□ Selecting a cost-effective and reliable package for microprocessor systems has become as vital as choosing the right microprocessor. With the change in circuit topologies brought about by the bus-structured microprocessors and the arrival of the zero-insertion-force (ZIF) connector, engineers are turning to some novel packaging schemes that have been able to dispense with the conventional backplane.

Composed of a motherboard with an array of printed-circuit connectors to receive the daughterboards, the backplane is still the predominant circuit-packaging structure today and is common to both digital and telecommunication systems. But traditional backplanes are increasingly unsuitable for several reasons:

- Microprocessor architecture, based on 40-pin-or-over integrated circuits, is driving the number of contacts required by the daughterboard to 100 or more.
- Backplane cooling problems have been aggravated by dense concentrations of large-scale integrated circuits that increase the amount of power that has to be dissipated per backplane.
- Gold contact systems, so prevalent in backplane architecture, have become prohibitively expensive.

The most significant component in every backplane system is the interconnection of backplane and daughterboards. This function has been performed most frequently by what are known as cantilever-beam, card-edge connectors, which have significant limitations.

Big-board problems

One drawback is that when the printed-circuit-board span approaches 17 inches along the board and connector interface, warping is likely. If a long board bows, it causes the contacts to deflect abnormally and they may take on a permanent set. Then, if the warped board is replaced by one that is not bowed, or is bowed in the opposite direction, some of the abnormally deflected contacts may fail to contact the fingers on the card.

For example, when the number of contacts required at the interface between daughterboard and motherboard approaches 50, the performance of a conventional card-edge connector becomes marginal because of the physical length of the connector and the large insertion and withdrawal force required. This force is a linear function of the number of contacts. If each contact-pair (pin and socket) requires 1 pound of force to mate or unmate,

then an interface that contains more than 50 contacts becomes generally impractical.

One solution seems to lie in reducing the contact force. But, ironically, designers want to raise contact force so that they can replace gold-to-gold contact interfaces with far less costly non-noble tin and tin-alloy systems.

Thus the challenge is to lower the insertion/withdrawal force while raising the contact force. Fortunately, there is an answer to this dilemma in the recently introduced zero-insertion-force (ZIF) connector.

The term "zero insertion force" identifies a family of connectors in which the force of insertion or removal of the mating part is essentially zero (see "Getting

Stacking. Configuring daughterboards with stacking ZIF connectors eliminates the backplane and card cage entirely. This packaging architecture lends itself to large printed-circuit boards. Interfacing with flexible cable connectors is possible in this method.

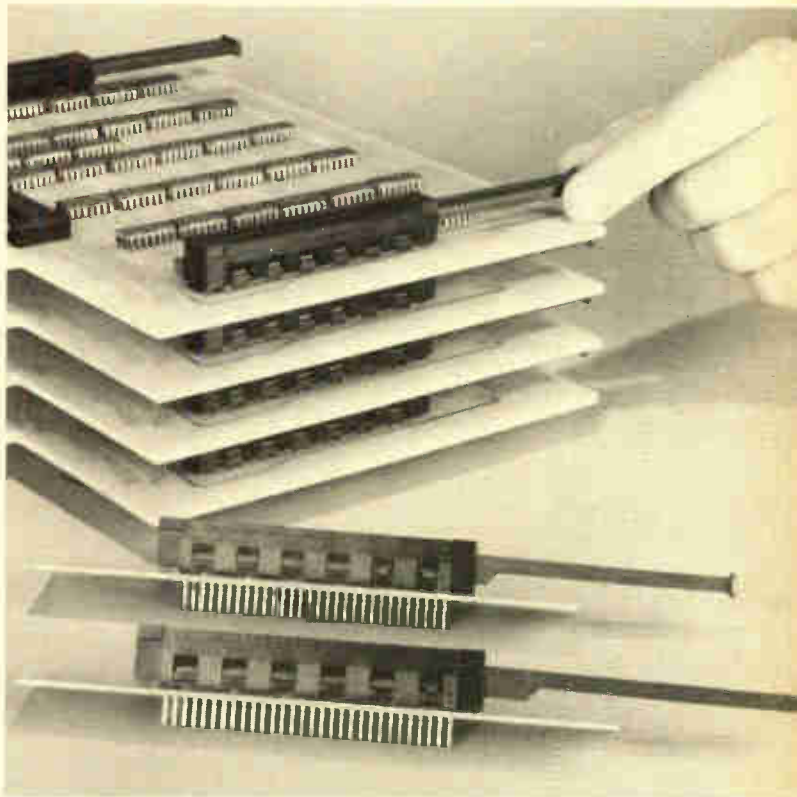

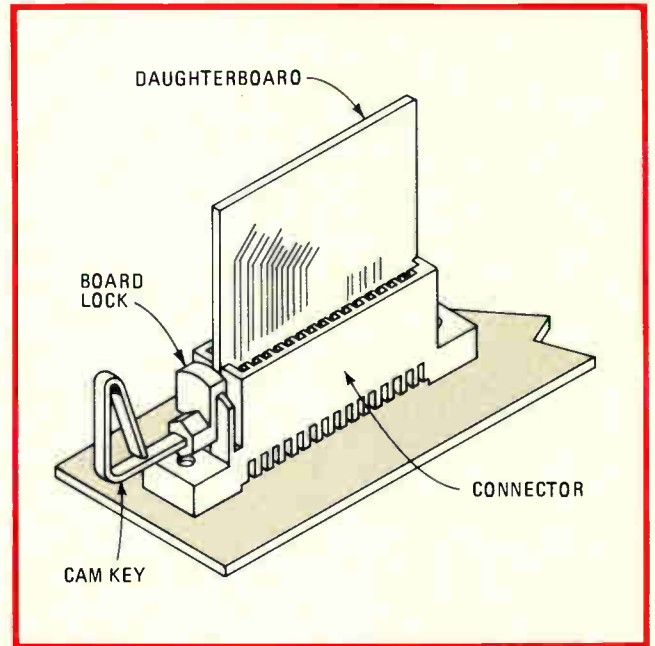
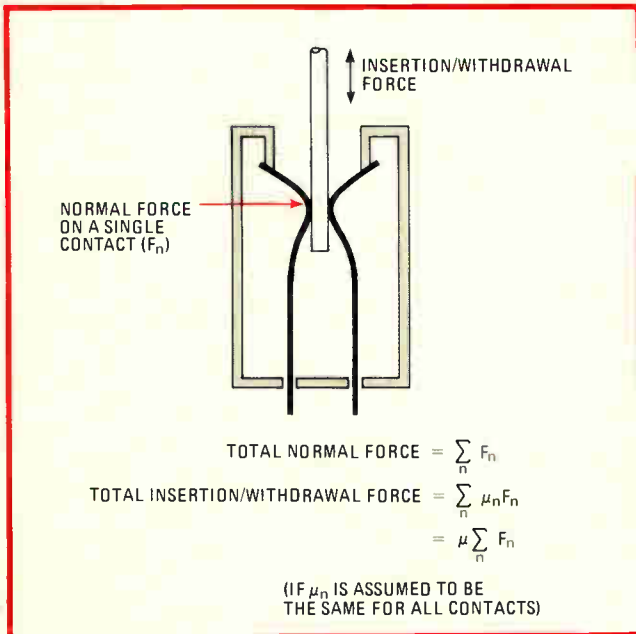

1. Sliding friction. In a card-edge connector, insertion or withdrawal force is due to the friction encountered as the circuit board enters or leaves the connector. The insertion-withdrawal axis is at right angles to the axis of force at each contact interface.

3. Key-operated. Rotating cam key on this ZIF connector counterclockwise opens contacts and board lock at near end. This enables easy withdrawal of the daughterboard. The key can be made removable to prevent tampering by unauthorized personnel.

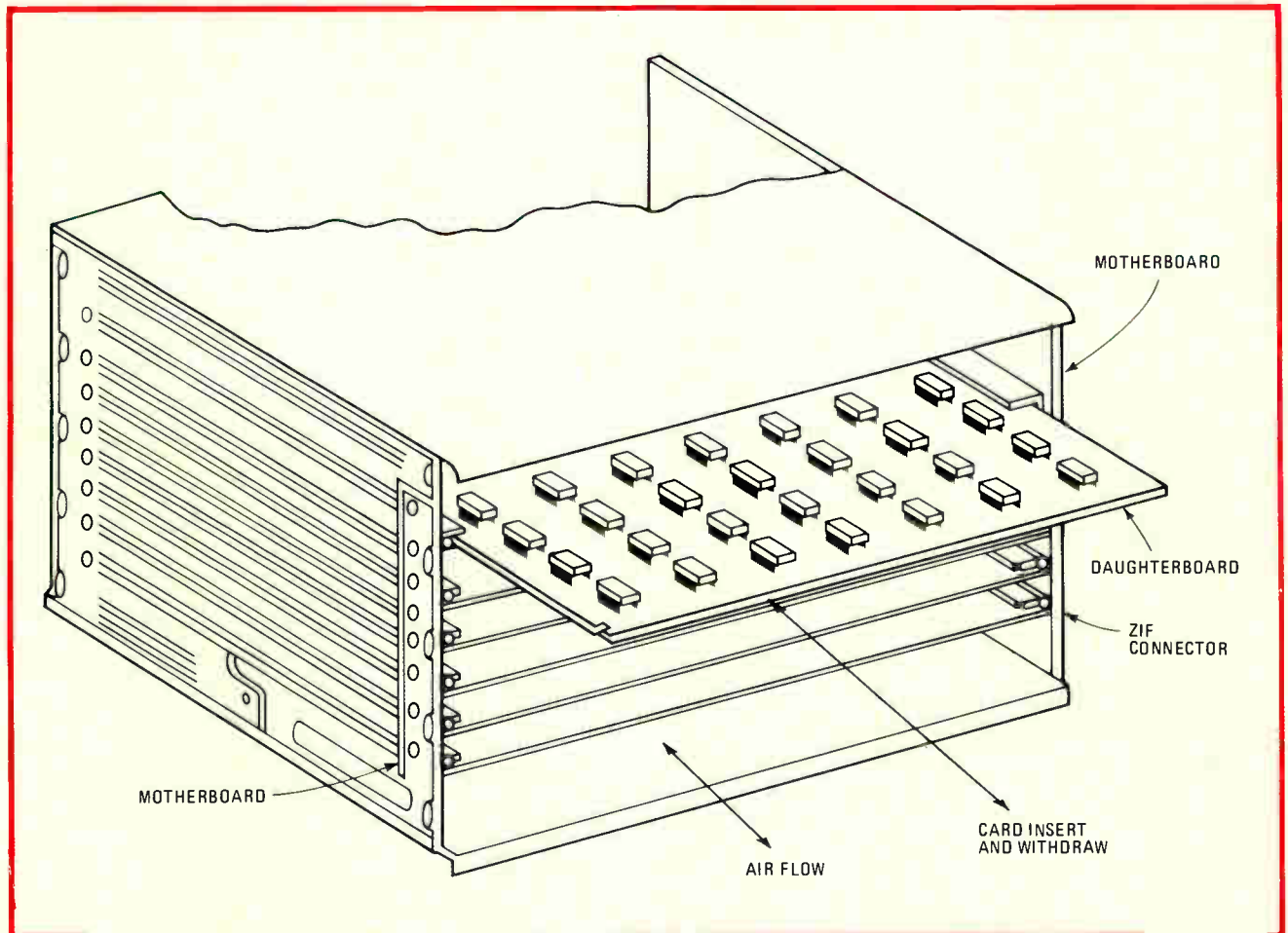

2. Side entry. By using zero-insertion-force connectors, the designer can configure two backplanes with each, so that they perform both interconnection and structural support roles. This type of packaging is well-suited to bus-oriented circuitry.

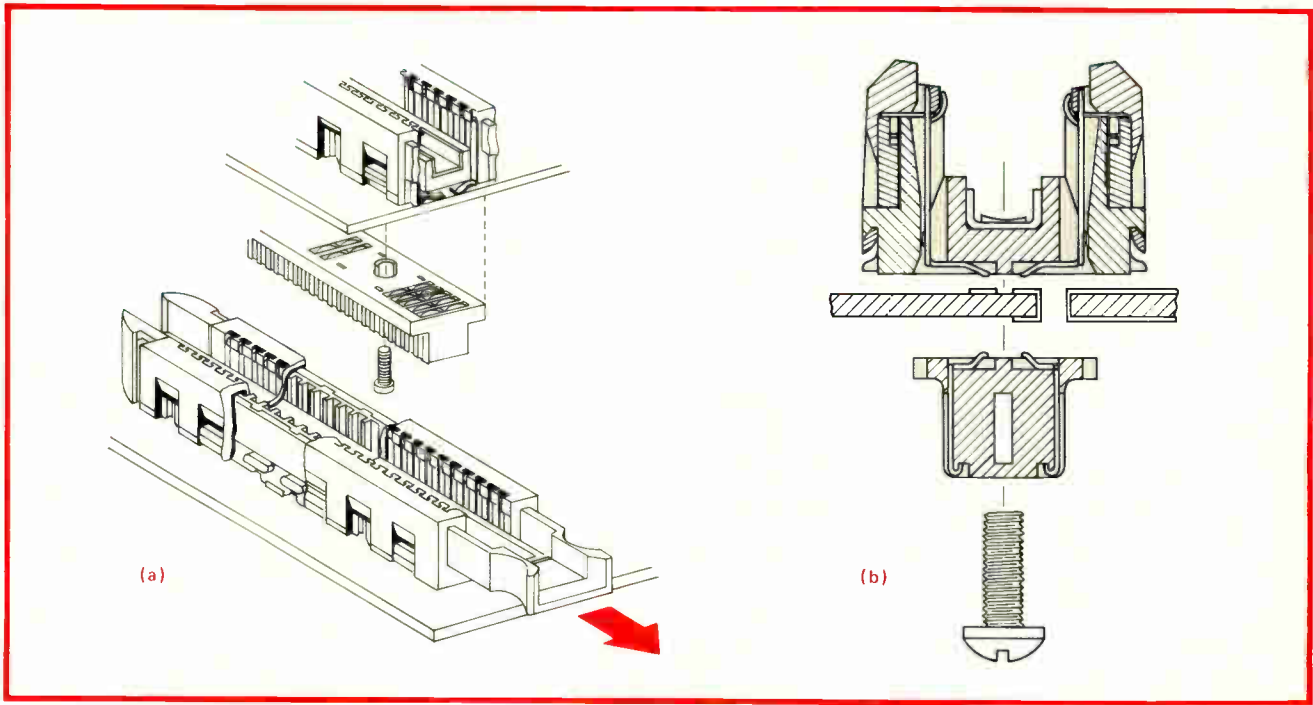

4. Surface mount. Another version of tandem stacking uses surface-mounting ZIF connectors that require no soldering, shown in (a). In (b), protruding tabs contact the pc board. Male and female portions are bolted together, forcing the tabs against the pc traces.

acquainted with ZIF" on p. 136). The most common mating part is a printed-circuit board, which usually plugs into a card-edge connector.

When the board is inserted, each contact deflects and develops a force at the contact interface that depends on the amount of deflection. The force at each contact interface must be sufficient to ensure a reliable electrical interconnection.

What results from insertion or removal of a daughterboard is not the sum of these forces ($\sum_n F_n$ in Fig. 1), but the sum of the frictional forces that develop from the normal forces ($\mu \sum_n F_n$). The reason is simply that the insertion/withdrawal axis is at right angles to the axis of force developed at each contact interface.

This insertion/withdrawal force serves a second vital role. It acts to retain the board, keeping it securely seated in the connector.

The ZIF two-step

With a ZIF connector, insertion becomes a two-step process. First, the circuit board is mated, and since no force is required, it is seated effortlessly. Second, the engagement is performed mechanically. This may take the form of pushing a lever or rotating a shaft to engage the contacts. Removal is performed in the reverse order.

A major advantage of ZIF is that there is no limit to the number of contacts because insertion force is zero regardless of how many there are. These connectors can be finger-actuated (engaged or disengaged) for up to 120 contact pairs, or lever or bell-crank operated for up to 280 contact pairs. Equally important, ZIF connectors allow the designer to try out desirable packaging alternatives to the backplane configuration.

One such alternative is side-entry packaging, which eliminates the card guides common with traditional

backplanes. With card guides, as with card-edge connectors, insertion and withdrawal forces develop because the daughterboard must fit snugly in the guides to stay securely in place.

The alternative configuration is shown in Fig. 2. Two ZIF connectors support each daughterboard, performing both structural and interface roles, one along each side. Moving the daughterboard interface from the rear to the sides of the board doubles the interconnection capacity. A natural circuit isolation also occurs because of the dual daughterboard structure. For example, signals and power buses can be distributed on alternate sides, or a designer might run certain signals and power along one side and confine other sensitive signals to the opposite.

A second advantage of this approach is that a clear air flow is created from front to rear. Hence an air plenum can easily be affixed to the rear to move the air in a laminar motion across the board surfaces.

ZIF connectors used in side-entry packaging can very easily provide 175 dual positions (350 contacts) with contacts on 0.100-inch centers. The connector housing is sufficiently narrow to allow adjoining circuit boards on centers as close as 0.6 in.

Key rotation

One manner of actuating a ZIF connector is shown in Fig. 3. Rotating the key causes all contacts to move approximately 0.030 in. along axes perpendicular to the daughterboard. The objective is to open each contact pair beyond the maximum board thickness, thereby ensuring that no force is encountered and no contact abrasion occurs during insertion/withdrawal cycles.

Variations of the cam-actuated connector, shown in Fig. 3, are available with a variety of actuating levers, rods, or a hex-shaped cam key. The cam key, which is

Getting acquainted with ZIF

The basic distinction between the traditional cantilever-beam, card-edge connector and the zero-insertion-force connector is shown in (a). With the cantilever-beam card-edge connector, the printed-circuit board itself deflects the beam contacts upon entrance. The insertion force it encounters upon entering is a result of the combined frictional and normal insertion force developed by the deflected contacts.

With the ZIF connector, the board is inserted into the connector housing, and because the contacts are held open (deflected) by an actuating device, it encounters no resistance and sets itself in the bottom of the connector body. Once the board is seated, the actuator (in this case, a rotary cam) is rotated 90°, allowing the contacts to engage the mating surfaces on the circuit-board fingers.

ZIF connectors can be configured in many ways. The objective is always to eliminate insertion/withdrawal force

and at the same time to establish a sufficient normal force at each contact once the mating printed-circuit card or connector is put in place.

Shown in Fig. 3 on page 134 is a rotary, cam-actuated ZIF connector that may be operated by a key or a conventional nut driver. It is available with up to 65 dual positions (130 contacts) on 0.100-by-0.200-inch, 0.125-by-0.250-in., or 0.156-by-0.200-in. centers. Both sequential and nonsequential versions are manufactured.

A second type of ZIF connector, termed board-actuated, is shown in (b) and (c). In both cases, the board actuates the contact engagement. Not shown in either figure are latches or other devices to keep the board firmly mated with the contacts.

The sliding-ramp connector shown in (d) is yet another ZIF design, with a sliding bar configured as a sawtoothlike series of inclined ramps to engage and deflect the

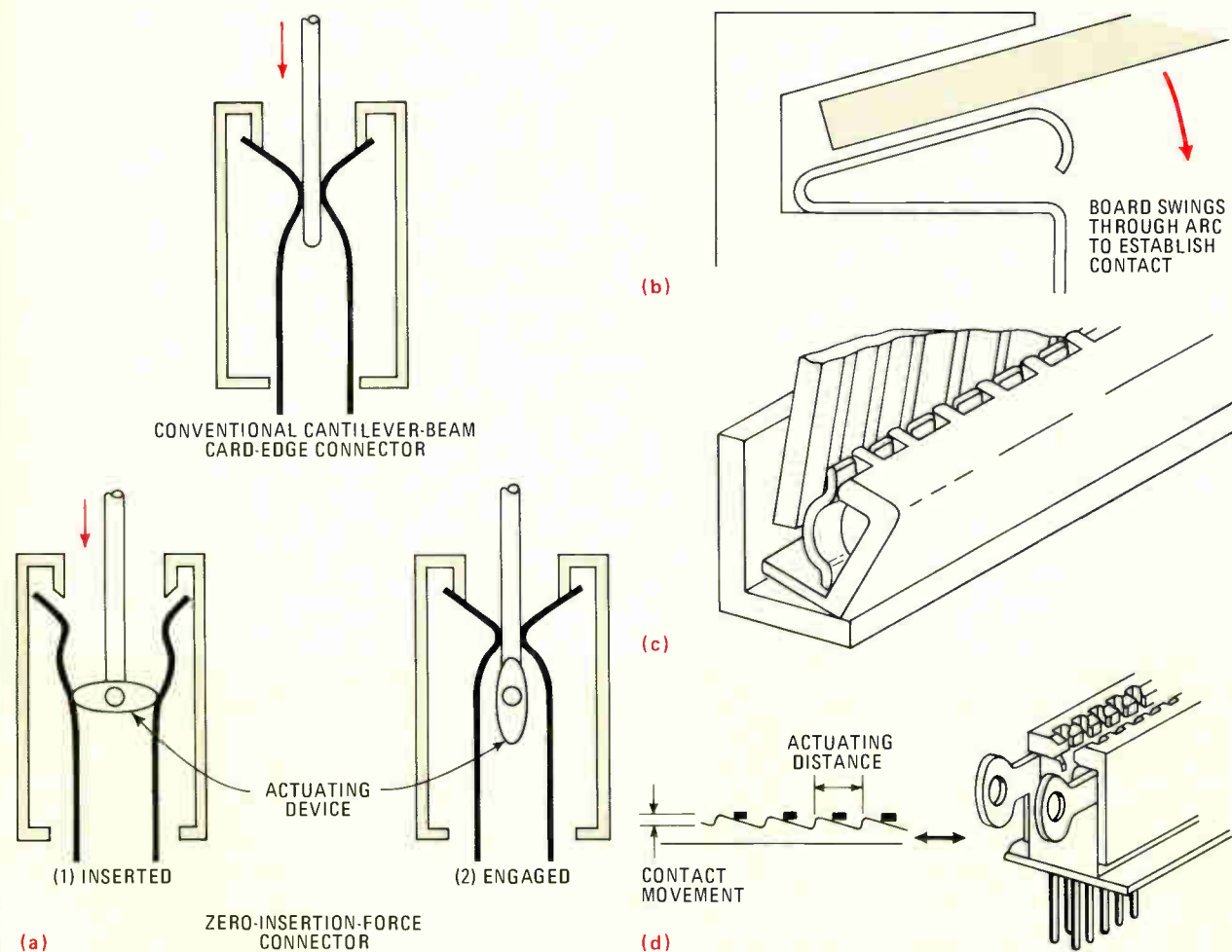

shown in Fig. 3, can be made removable, in order to prevent unauthorized personnel from removing printed-circuit boards.

A further advantage of side-entry architecture is that it enables a packaging designer to think in terms of sequentially operated ZIF connectors. For instance, sequential versions of the rotary, cam-action ZIF con-

connector, shown in Fig. 3, execute a "2-4-remainder" contact sequence upon closing. This means that when the cam handle is actuated, first two, then four, and then the remaining contacts mate with the fingers on the board. Upon opening, the sequence is reversed. An appropriate circuit assignment would connect ground to the first two contacts, power to the next four, and signals and miscel-



YOURS FREE

when you subscribe
to Electronics.

This Designers Casebook— Number 2

NAME Mr. _____ Mrs. _____ Ms. _____ TITLE _____ 53880-G
 COMPANY _____ DIV. or DEPT _____
 COMPANY ADDRESS _____
 CITY _____ STATE _____ ZIP _____

Check here if you wish publication to be sent to home address STREET _____ CITY _____ STATE _____ ZIP _____

Qualification for above rates is based on answers to all questions listed below. Those not qualifying may pay higher than basic price of \$30 one year or \$75 for three years.

PLEASE ENTER MY SUBSCRIPTION TO ELECTRONICS FOR:

ONE YEAR AT \$17 TWO YEARS AT \$29 THREE YEARS AT \$43
 Payment Enclosed Bill My Company Bill Me

CHARGE MY
SUBSCRIPTION
TO ...

American Express Diners Club Visa
 Master Charge _____ Interbank No. _____
 Acct. No. _____
 Date Card Expires _____
 Signature _____

2. 1 PLANT 2 DEPARTMENT

- A. Large computers
- B. Mini-computers
- C. Computer peripheral equipment
- D. Data Processing Systems (systems integration)
- E. Office and business machines
- F. Test and measuring equipment
- G. Communications systems and equipment
- H. Navigation and guidance or control systems
- I. Consumer entertainment electronic equipment
- J. Other consumer electronic equip. (appliances, autos, hand tools)

Indicate the primary product manufactured or service performed at your plant (Box 1) and in your department (Box 2). Be sure to indicate applicable letter in each of the two boxes even if they are the same letter.

- K. Industrial controls, systems and equipment
- L. Sub-assemblies
- M. Passive electronic components
- N. Active electronic components
- O. Materials and Hardware
- P. Aircraft, Missiles, space and ground support equipment
- Q. Oceanography and support equipment
- R. Medical electronics
- S. Industrial equipment containing electronic components or products
- T. Independent R&D laboratory and consultant

- U. Research and development organizations which are a part of an educational institution
- V. Government Agency and military
- W. Industrial companies using and/or incorporating electronic products in their mfg., research or development activities
- X. Utilities
- Y. Broadcasting, sound and motion pictures and recording studios
- Z. Commercial users of electronic equipment (railroads, pipelines, police, airlines)
- 9. College, University

3. Indicate your principal job function (place applicable number in box. If numbers 9, 10, or 11 are used, fill in name of college or university)

- 1. General and corporate management
 - 2. Design and development engineering
 - 3. Engineering services (evaluation, quality control, reliability, standards, test)
 - 4. Basic research
 - 5. Manufacturing and production
 - 6. Engineering support (lab assistant, technician)
 - 7. Purchasing and procurement
 - 8. Marketing and sales
 - 9. Professor at _____
 - 10. Senior student at _____
 - 11. Graduate student at _____
- Senior and graduate students are eligible for professional rate for one year subscription only.

4. Indicate your principal job responsibility (place applicable number in box)

- 1. Management
- 2. Engineering

5. Your design function: (Insert each letter that applies)

- A. I do electronic design or development engineering work
- B. I supervise electronic design or development engineering work
- C. I set standards for, or evaluate electronic design components, systems and materials

6. Estimated number of employees at this location. (check one)

- 1 to 49 50 to 249 250 to 999 over 1,000



NO POSTAGE
NECESSARY
IF MAILED
IN THE
UNITED STATES

BUSINESS REPLY MAIL

FIRST CLASS PERMIT NO. 42 HIGHTSTOWN, N.J. 08520

POSTAGE WILL BE PAID BY ADDRESSEE



Electronics

McGRAW-HILL Inc.
Subscription Department
P.O. Box 514
Hightstown, N.J. 08520

contacts. With contacts on 0.100-in. centers, though, the ramps cannot exceed that length. Thus a steep pitch is needed to develop momentum. This creates several design problems that discourage its use.

However, the interposer technique shown in (e) is a refinement of the sliding ramp technique and is satisfactory for gang-deflecting the contacts in a ZIF connector. Using this technique, a 175-position (350-contact) connector is entirely practical, even with contacts on 0.100-in. centers. The cam can generate a 0.030-in. contact movement connector. The role of the interposer is to lift the contacts off the printed-circuit board. Thus the contacts are stressed maximally when the connector is in its open position—a small portion of a connector's useful life. This arrangement contrasts with a card-edge connector where the contact stress is at the maximum with the board securely seated in the connector.

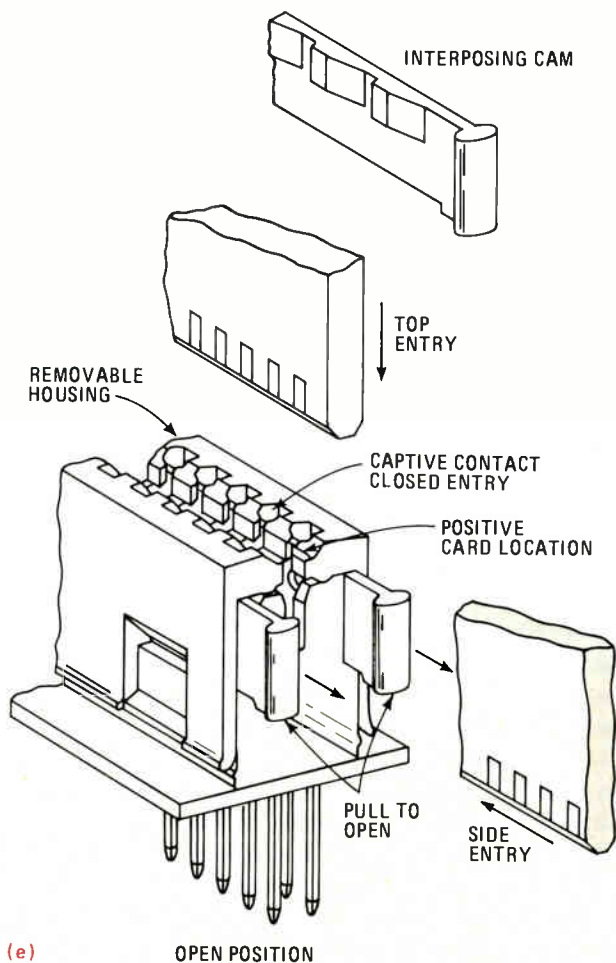

laneous circuits to the remaining contacts.

Though power-sequencing is attractive in many applications, it is particularly valuable in digital and communications systems where it is essential to remove or insert a daughterboard without draining power from the entire system. In these systems, the connectors serve as sequencing switches.

Another advantage of a two-sided backplane geometry is that signal and power routing on the daughterboard are eased. Paths become shorter and fewer dog-legs are necessary in the daughterboard circuit pattern, as the designer has added interfaces along the two opposite edges of the board.

Another alternative to the backplane is illustrated in the photograph on page 133. The outstanding feature of this novel design is the complete absence of any card-cage structure. In this packaging architecture, boards are stacked with a stacking ZIF connector, which mounts on 0.025-in. square posts on a standard 0.100-by-0.100-in. matrix. The posts extend 0.288 in. beyond a 0.0625-in. printed-circuit board. Organization of the buses, if so desired, is developed transverse to the boards through the mating connectors.

Tandem stacking

Stacking-type connectors of the type illustrated have contacts with square, 0.025-in. posts that have been press-fitted into a printed circuit board, like many card-edge connectors and other wrapped-wire post assemblies. The pins are, in addition, completely compatible with a variety of other connectors, including the popular flat-cable connector types.

With tandem stacking, the connectors can be located arbitrarily along the perimeter of the mating boards. In fact, the ZIF connectors need not be confined to the board perimeter so long as actuating levers are accessible for assembly and disassembly.

A further advantage is the ability to add boards when more options are needed, so long as the housing, or envelope, for the overall assembly is ample. The designer simply confines each option to one or more of the stacking circuit boards.

By spanning the connector near the center of the board, tandem stacking lends itself to the configuration of relatively large boards. In this case, the additional stacking connectors are located so as to stiffen an otherwise flimsy structure.

In addition to the ZIF stacking connector, there is a surface-mounted ZIF intercard connector, shown in Fig. 4. In this configuration the male and female portions are bolted to a printed-circuit board so that the spring-loaded, tin-alloy-plated ears of each connector are compressed against corresponding traces on the board. A normal force of 260 grams minimum at each contact will provide a highly reliable interface with tin-lead-plated pads. Stainless-steel support members are contained in each mating connector. By connecting them to a ground plane on the circuit board, a 90-ohm nominal-impedance connector system can be created.

Maintainability is another attractive feature of the tandem-stacking geometry. Once a defect is traced to a single board, the stack can be disassembled and reassembled with the suspected board at the top, giving a technician access to all components on its surface.

The system is bus-interruptible in two ways: first, a connector can be omitted from a series of boards; second, as in the case of the connector shown in Fig. 4b, the 0.25-in. posts can be cut off where desired.

Circuit-board connectors are seldom designed to carry

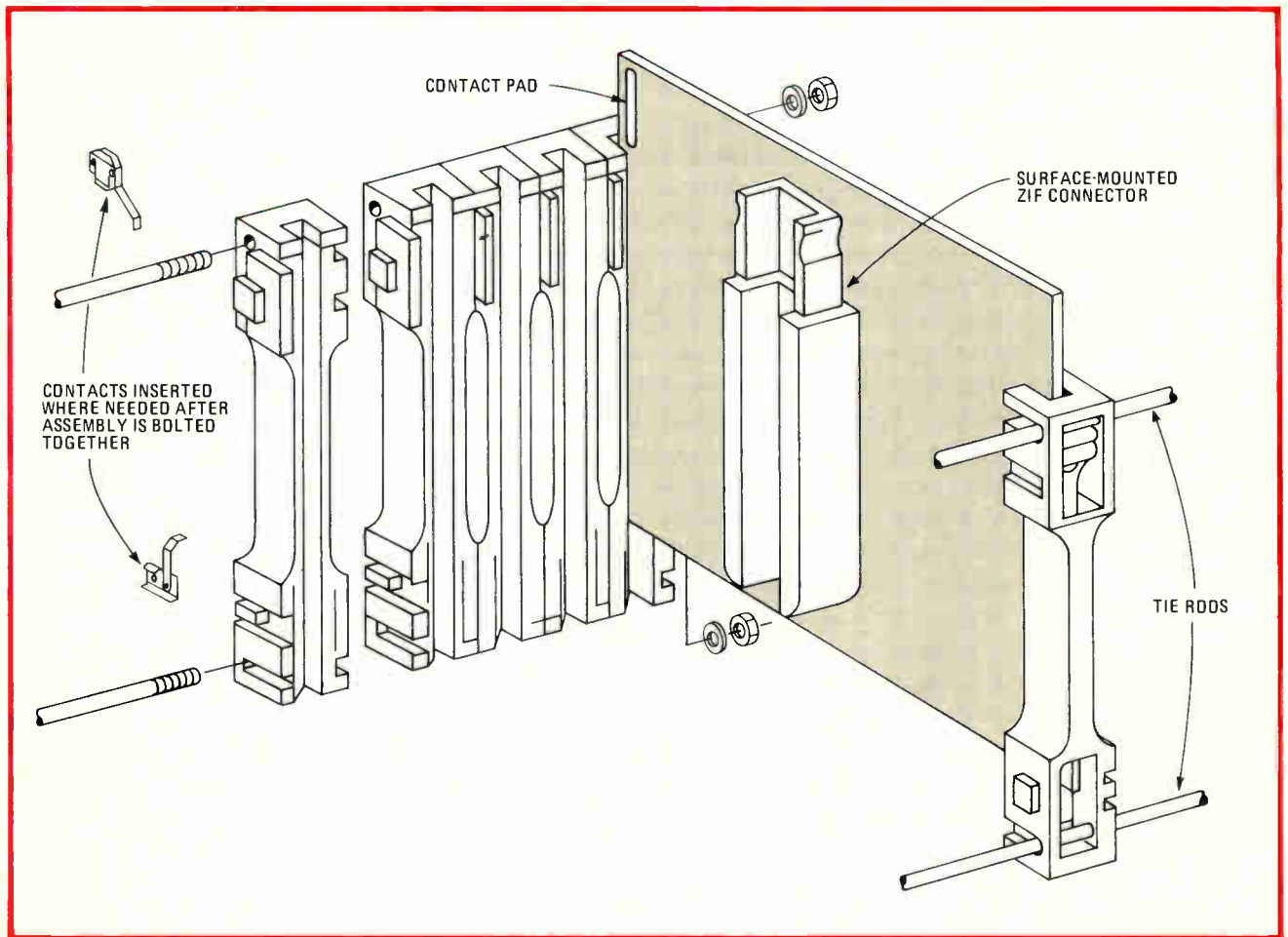

5. High-current stacking. Power-distribution card guides team with surface-mounted ZIF connectors to build an assembly able to handle both low-level signals and supply currents as high as 50 amperes. The tie rods distribute high currents with a negligible voltage drop.

more than 3 amperes. However, in many circumstances a much larger current is needed to drive a number of power-consuming circuit boards. One way to increase a connector's current-carrying capacity is illustrated in Fig. 5, where card guides (rods) at each end of the circuit board also serve as high-current connectors. The tie rods are each capable of distributing 50 amperes with negligible voltage drop.

Dividing signal and power

The ZIF connector in the middle of the board enables circuits to be interconnected on a card-to-card basis and provides a natural division between signal and power. Contacts can be inserted after assembly of the card guides to provide an electrical interface between the contact pad shown in Fig. 5 and the tie rods. By selecting the positions and lengths of the contact pads, power sequencing can be designed to ensure that a prescribed connecting and disconnecting sequence occurs at each card insertion or withdrawal.

Particularly attractive in the architecture shown in Fig. 5 are the short paths followed by signal and power traces to reach components on the board. The fact that signal traces from any component on each board are routed toward the center surface-mounted ZIF connector, whereas power traces fan out toward the periphery of

the board, eases the designer's layout problems by a significant amount.

A crucial consideration in many products with digital circuitry is how to interconnect subsystems successfully via buses. Bus architecture has separate lines for data, addressing, and control, and enables a number of modules to communicate. In the traditional backplane there is virtually no isolation of the data signals. These must interface along the only surface available—the connector interface between daughterboard and motherboard. All the ZIF packaging schemes previously discussed are suitable for data buses, since they provide isolated alternatives to backplane routing.

Packing and bus architecture

In the side-entry geometry of Fig. 2, the bus may be routed along one side while power is distributed along the other. Tandem stacking offers the designer of bus architecture even more flexibility. Here the bus connector can be located virtually anywhere on the surface of the board. Also, in power distribution (Fig. 5), ZIF connectors can be anywhere on the board.

A noteworthy feature of both tandem-stacking and power-distribution techniques is the unusually direct transverse path of the bus. It must be routed to the board's circuitry from the intercard connectors. □



Is there life on Germanium?

Plenty.

The demand for our Germanium semiconductors continues to grow.

Germanium has advantages over Silicon for many applications; low saturation voltage, low battery drain for example. And we've just announced the world's first single-chip 100A power transistor, based of course on Germanium technology.

At GPD we make devices to all the well-known specs: JAN, EIA, and PRO-ELECTRON AD, ADY, ADZ, ASZ, AU, AUY and ASY.

And we can now replace practically all the Germanium products you used to buy from Motorola (MP500-506, 2N4276-4283, 4048-4053), Delco (DTG110, 2N1100, DTG2000-2400A), GE (2N319-324, 524-526, 1370-1381, 1413-1415, 1924-1926), Siemens, Mullard, SGS-ATES, and Thomson.

Our range goes from 150mW small signal to 100A power, in packages of all shapes and sizes.

Germanium is here to stay.

We'll be making Germanium devices as long as you, the customer want them.

Send for our latest catalogue or let us know your specific problem.

GPD, Box 65, Shawsheen Village Station, Andover, Mass, 01810.

Tel: (617) 475-5982.

Telex: 94-7150 GPD Andr.

Germanium Power Devices Corporation

The Germanium Manufacturers

Circle 139 on reader service card

UK Representative Wintronics PO Box 24 E. Grinstead, Sussex. 034287-277 UK Agents Jermyn Industries Sevenoaks, Kent. Sevenoaks (0732) 50144 Tlx 851-95142/Consort Electronics Ltd Rosebank Parade, Reading Road, Yateley, Camberley, Surrey. Yateley (0252) 871717 Tlx 851-858809 Norway Nordisk Elektronik (Norge) A/S Mustadsvei 1 Postboks 91-Lilleaker, Oslo 2. 0752-13800 Tlx 856-16963 Italy Syscom Elettronica Spa, Via Gran Sasso 35, 20092 Cinisello Balsamo, Milano 92.89.251/2/3 and 92.89.159 Tlx 843-36118 (Syscom)/Eurelettronica S.r.L. Sede: 20145 Milano, Via Mascheroni, 19. 4981851/2/3/4/5 Tlx 39102 Thomelec/Uff. Regionale: 00197 Roma, Via B. Oriani, 32. 895394 Tlx 61358 Thomelec/Uff. Regionale: 40138 Bologna, Via. Massarenti, 410/3. 534062 Belgium, Holland, Luxembourg B.V. Laboratorium Voor Elektronentechniek Diode. Hollantlaan 22 Utrecht. 030-884214 Tlx 844-47388/ Rue Picard 202 Picardstraat 1020 Bruxelles. (02) 4285105 Tlx 846-25903 Austria, Hungary, Czechoslovakia, Yugoslavia Rieger GmbH Marxergasse 10 A-1030 Wien 3. (0222) 734684-0 Tlx 847-1-1087 Republic of South Africa L'Electron (Pty) Limited 704 Main Pretoria Road/Hoofweg Wynberg P.O. Box 10544 Johannesburg 2000 Tel: 406 290 Tlx: 8-2333 Denmark E. V. Johanssen Elektronik A/S Svanevej 12 DK-2400 Copenhagen NV. 451839022 Tlx 855-16522/GDS-Henckel Elektronik ApS Fyrrevangen 4 DK-4622 Høvdrup. (03) 38-5716 Tlx 855-43168 Portugal Diltram Componentes Electronica, Lda Av. Miguel Bombarda 133, I.D.Lisboa 1. 45313 France TMC 11 Rue Racine 93121 La Courneuve, 836-84-01 ext. 109 Tlx 842-210311F (Publi) Sweden Integretrad Elektronik P.O. Box 43 S-182 51 Djursholm. (08) 753-03-30 Tlx 854-10282 Switzerland GDC Müller S.A. 8 rue de l'Aubepine C.P.77 1211 Geneva 9. 215977 Tlx 845-5943/Omni Ray AG 8008 Zurich Dufourstrasse 56. (01) 478200 Tlx 845-53239 West Germany Solicom Elektronik GmbH Mondstrasse 10 8000 Munich 90 Tel: 089 61027 Tlx: 841 0522870.

Notch filter and meter measure power-line harmonics

by Henno Normet
Diversified Electronics Inc., Leesburg, Fla.

Valid measurements of core loss in power-line transformers and various other magnetic devices require total harmonic distortion (THD) levels under specified limits—usually 3%. This inexpensive circuit determines the THD present in a 60-hertz waveform, over the range of 0 to 10%. Here, a notch filter is used to eliminate the voltage source's 60-Hz fundamental component, allowing an ac voltmeter to measure the remaining harmonic components.

The adjustable-Q Wien-bridge notch filter discussed in a previous article¹ proved to be best adapted for this application. Resistors R_{11} and R_{12} of the bridge (see shaded portion of figure) are selected to give the notch filter a Q of 10. The resulting null is sharp enough to pass a 180-Hz signal without attenuation, the lowest harmonic to appear as a component of distortion.

Component selection for the rest of the filter is also important to the achievement of good notch depth. C_1 and C_2 should be matched within 1%, and high-accuracy resistors used where indicated by asterisks. Metal-film

resistors and polycarbonate capacitors help keep frequency drift and aging to a minimum.

For initial balancing of the bridge, a low-distortion 2-v signal at 60 Hz is applied at point A. With SW_1 in the test position, R_8 and R_{10} are adjusted for a zero reading on the meter, M. If an audio oscillator is not available as a signal source, full line voltage may be applied to the input terminals, in which case R_8 and R_{10} are adjusted for a minimum reading on the meter.

In operation, SW_1 is first placed in the calibrate position and line voltage applied at the circuit input, V_{in} . R_2 is then adjusted for a maximum (full-scale) reading.

The switch is then placed in the test position, whereupon the input signal passes through the notch filter. Percent of THD may then be read directly. Note that the accuracy of the reading depends upon the accuracy of the 10:1 voltage divider, R_3 and R_4 .

The definition of THD requires that both the calibration and measurement procedure be carried out with a root-mean-square-responding meter. However, in the 0–10% distortion range, a less costly average-responding meter will provide 10% accuracy, which is acceptable in most applications. □

References

1. "Wien bridge and op amp select notch filter's bandwidth", *Electronics*, Dec. 7, 1978, p. 124.

Engineer's notebook is a regular feature in *Electronics*. We invite readers to submit original design shortcuts, calculation aids, measurement and test techniques, and other ideas for saving engineering time or cost. We'll pay \$50 for each item published.

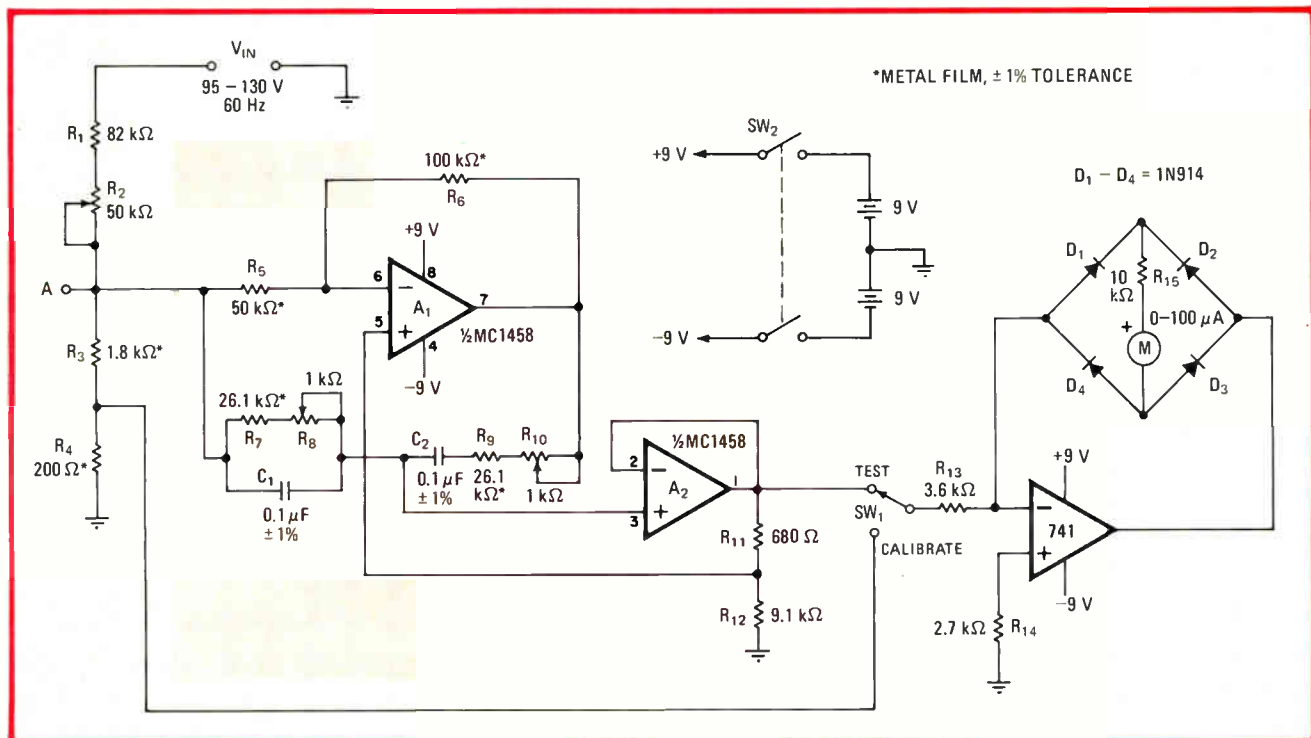

Handling harmonics. Wien-bridge notch filter rejects 60-Hz power-line fundamental frequency so that total harmonic distortion present in signal can be measured. Meter measures THD over 0-to-10% range. An rms-responding meter should be used, but an average-responding meter is acceptable. Results are displayed in percent, with an accuracy directly proportional to the tolerance of resistors in divider R_3 - R_4 .

Resistor snipping trims regulator voltage to within 1%

by Robert A. Pease
National Semiconductor Corp., Santa Clara, Calif.

Five low-cost resistors are used in this production-line technique for setting the output voltage of a three-terminal regulator to within $\pm 1\%$ of the desired output voltage. Thus, expensive and often unreliable potentiometers can be eliminated by this iterative trimming procedure, which removes up to three resistors until the output voltage is within tolerance.

In a typical three-terminal adjustable regulator such as the LM117 (a), the output voltage will be:

$$V_{out} = V_{REF}(R_2/R_1 + 1) + R_2 I_{ADJ}$$

where V_{REF} is nominally 1.25 volts, R_1 and R_2 are the regulator's external voltage-programming resistors, and I_{ADJ} is 100 microamperes maximum. Generally, V_{REF} will vary less than $\pm 3\%$ under normal operating conditions; if R_1 and R_2 each have a tolerance of $\pm 1\%$, the regulator's overall accuracy then becomes $\pm 5\%$.

The standard method for attaining a 1% tolerance is to substitute a trimming potentiometer, R_T , and some fixed resistor, R_F , for R_2 , where in general $R_{Tmax} + R_F$ will exceed the value of R_2 previously used by a factor of 10% or so. But this scheme may be superseded with the circuit shown in (b) to avoid the disadvantages of using a trimming potentiometer, one of which is a tendency to misadjust it sooner or later.

In this particular case, a 22-v output voltage is sought for a 28-v source input. When first measured, V_{out} will be 4% to 6% higher than the 22v target no matter what conditions exist within the regulator, because the effective value of R_1 is lowered (see equation). R_3 , R_4 , and R_5 are selected so that one or more may be systematically removed to bring V_{out} within limits.

The method is as follows:

- If $V_{out} \geq 23.08$, cut out R_3 .
- If V_{out} is or then becomes ≥ 22.47 , cut out R_4 .
- If V_{out} becomes ≥ 22.16 , cut out R_5 .

Note that the values of R_3 , R_4 , and R_5 are independent of the output voltage desired; it is only necessary to select a new value of R_2 so that $V_{REF}(R_2/R_1 + 1)$ is a few percent below the desired output voltage, assuming a V_{REF} of 1.25. In practice, this means selecting R_2 to be proportional to the output voltage desired.

An alternative trimming scheme is shown in (c), whereby R_3 , R_4 , and R_5 , placed in the R_2 line, are initially shorted by jumpers. Here V_{out} is initially lower than the target value and never exceeds that voltage during trimming.

In this procedure:

- If $V_{out} \leq 20.90$, snip link 1.
- If V_{out} is or becomes ≤ 21.55 , snip link 2.
- If V_{out} is or becomes ≤ 21.82 , snip link 3.

When the output voltage is other than 22, R_3 - R_5 need to be chosen in the same proportion to R_2 . Thus if the

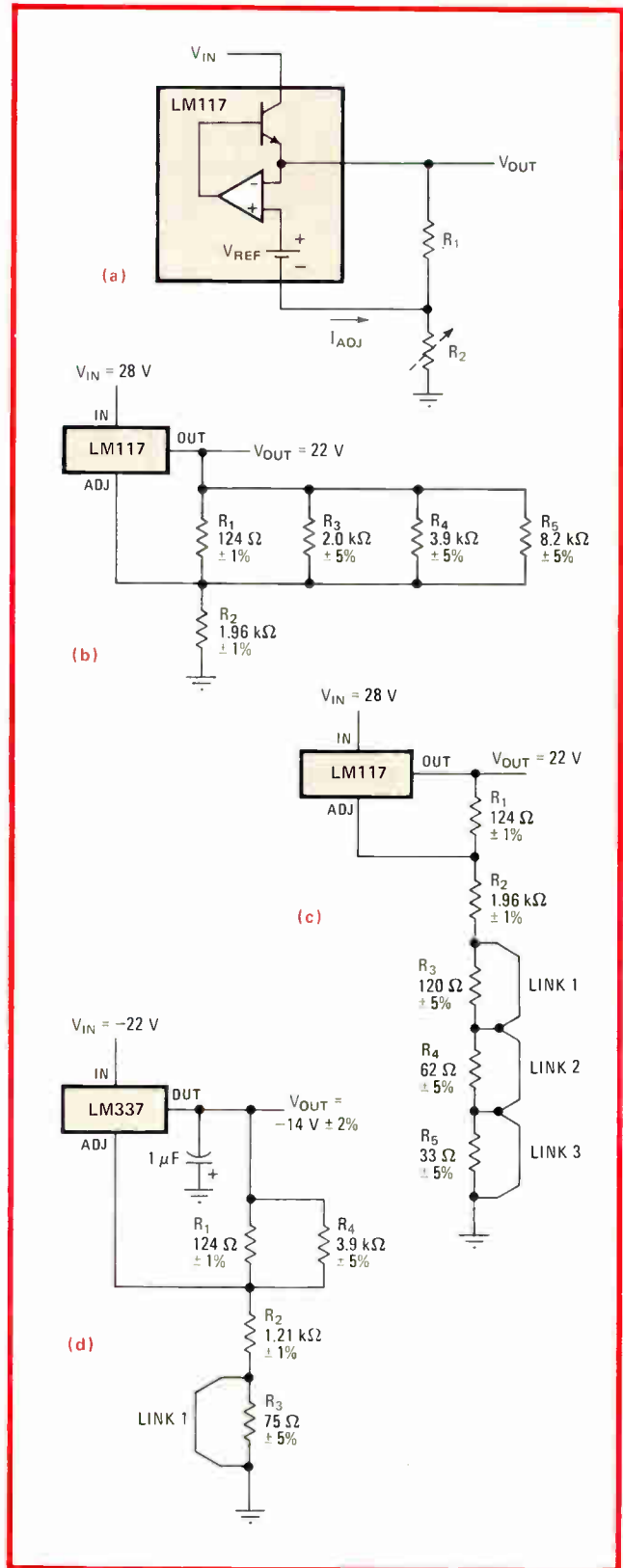

Tolerance. Programmable regulator's trimmer (a), which is costly and may drift, may be replaced with low-cost, fixed resistor network R_3 - R_5 (b) for production-line trimming. Each resistor is systematically removed to bring V_{out} to within 1% of desired value. Alternate scheme uses resistors in series (c). If 2% tolerance is acceptable, one less resistor (d) and simplified procedure accomplishes task.

"We needed a software tool that would give us direct control of a highly interactive system."

"We build Remote Switched Access Systems which provide circuit testing for Bell and Independent telephone companies nationwide. Our SAS is a microprocessor-based interactive test system with sophisticated diagnostic capabilities. The operator uses the terminal to call and test any circuit in the network. The software we developed to run our SAS was originally written in assembly language. It took a very talented programmer six months, 80 hours a week to write. Plus six months additional staff time. It hadn't been out in the field very long before our customers started requesting special routines and tests, all sorts of modifications. We tried every assembly language trick we could, but we couldn't modify the program economically."

—Gambera

"We had a crisis on our hands."—Morris

"We looked at Basic, Fortran, Pascal. They were all too complex. Then we looked at FORTH's micro package. At first we were skeptical. But we were faced with an urgent need. We figured 'What do we have to lose? If FORTH can do what they say, we can make it'."



Armand Gambera, Engineering Supervisor/Portable Products. Larry Morris, Engineering Supervisor/SAS Systems. Telecommunications Technology, Inc., Sunnyvale, CA.

"Within two days we were writing routines in FORTH that would have taken two to three weeks to write in assembler."—Morris

"That's when we decided to use FORTH. We were impressed by how quick and easy it is to use. A good programmer should be up on it in two days. We had all kinds of fun. Inside a month we were really confident with it."

"In three months, two of our people completely rewrote the program with significant enhancements."—Gambera

"We couldn't have delivered on our commitment without FORTH. Everyone in our organization is now using it for all but the most trivial routines."

"It's amazing the impact programming speed has had on our ability to work with customers."—Gambera

"FORTH programming is fast. We can be much more responsive now. FORTH's programming speed more than offset the cost of rewriting our first program. Target-compiling and de-bugging are quicker too. We target-

compiled FORTH in one day. It would have taken a week in assembler. And something that might take 30 hours to debug in another language takes two hours in FORTH. Editing is extremely simple."

"FORTH gives us the nuts-and-bolts control of Assembler without all the tedious coding."—Morris

"FORTH gives us better control over run time. It's very close to the micro-processor in terms of definitions so you can configure as you like, right at the hardware level. That's especially important to us since we have a lot of interfaces, a lot of driver routines.

"My advice to others is: 'Try It!'"—Gambera

"You won't believe it until you do. We all know how stubborn people can be when it comes to trying something new. Engineers can't afford to be. If a tool works, you use it. FORTH works for us. We wouldn't consider going back to assembler or switching to some other high-level language. We're sold on FORTH. We only wish we'd tried it sooner."

"Engineers can't afford to be stubborn about trying new tools. If it works, you use it!"

FORTH is a stand alone operating system and multi-level language for minis and micros. We also offer contract programming services. For full details or for information on a FORTH seminar in your area call (213) 372-8493 or send the coupon attached on your company's letterhead.

OK, I'm interested!
 Please rush full details on:
___microFORTH for μ P development
___miniFORTH for minicomputers
___fixed price applications programming services
 Contact us for immediate requirements
Phone: () _____
 Send dates and locations for your FORTH Seminars.

Name _____

Title _____

FORTH, Inc., 815 Manhattan Avenue,
Manhattan Beach, CA 90266.

FORTH, Inc.

scheme in (c) is used for $V_{out}=12$, then $R_2=1.0\text{ k}\Omega$, $R_3=62\Omega$, $R_4=31\Omega$, and $R_5=16\Omega$. Note too that when approach (b) is used, some care must be taken that all the snipped resistors be removed without shorting anything out. If (c) is used, one end of the cut link should be curled back to prevent shorting.

If 2% tolerance is acceptable, the circuit in (d) will provide trimming with one less resistor and fewer itera-

tions. In this instance, the configuration is shown for the LM337 negative-voltage regulator, where the desired $V_{out} = -14\text{ v}$. If the magnitude of $V_{out} \leq 13.75\text{ v}$, link 1 is snipped. Then if $V_{out} \geq 14.20\text{ v}$, R_4 is cut out.

In most cases, no trimming at all will be required, because most $\pm 1\%$ resistors are well within a tolerance of $\pm 1/3\%$, and most often the LM337's V_{ref} term is within $1 1/2\%$ of its nominal value. □

8080 program computes 32-by-16-bit quotient

by G. W. Swift and J. P. Eisenstein
Department of Physics, University of California, Berkeley

It is sometimes necessary to perform a 32-bit-by-16-bit division in order to obtain two 16-bit numbers that may be multiplied by a third in the often used 16-bit-by-16-bit multiplication programs. This short subroutine does such a division, returning a 16-bit quotient and a 16-bit remainder. The execution time is about 2 1/2 milliseconds.

The program works much like ordinary long division.

It begins by trying to subtract the divisor from the most significant 16 bits of the dividend. The appropriate bit of the quotient will be set or cleared, depending on whether or not the subtraction process yields a 0 or 1 for that bit. The dividend is then shifted 1 bit with respect to the divisor, and the process is repeated. Sixteen such subtractions are necessary to generate the quotient and the remainder.

The dividend is introduced in register pairs HL-BC, with the high-order bytes in HL. The divisor is placed in register pair DE. If the quotient is greater than $2^{16}-1$, the routine will set the carry bit. Otherwise, it returns the quotient in register pair HL, the remainder in register pair BC, the 2's complement of the divisor in register pair DE, and then clears the carry bit. Intermediate results are stored on the stack, so that random-access memories are not required. □

8080 PROGRAM FOR 32-BY-16 DIVISION

Location	Op code	Source statement	Comments	Location	Op code	Source statement	Comments	
5000		SP EQU 6		5021	DA 33 50	JC SURE		
5000	E5	DIVIDE PUSH H	} initialize answer location on stack	5024	E5	PUSH H		
5001	21 01 00	LXI H, 1			5025	19	DAD D	
5004	E3	XTHL		5026	33	INX SP		
5005	7A	MOV A, D		5027	33	INX SP		
5006	2F	CMA	} form 2's complement of divisor	5028	DA 34 50	JC ANSFX		
5007	57	MOV D, A			502B	E1	POP H	} append "0" to quotient
5008	7B	MOV A, E			502C	29	DAD H	
5009	2F	CMA			502D	E5	CONT PUSH H	
500A	5F	MOV E, A		502E	3B	DCX SP		
500B	13	INX D		502F	3B	DCX SP		
500C	E5	PUSH H		5030	C3 11 50	JMP LOOP		
500D	19	DAD D		5033	19	SURE DAD D		
500E	DA 41 50	JC ERROR	} jump if overflow	5034	E5	ANSFX PUSH H	} append "1" to quotient	
5011	E1	LOOP POP H		5035	33	INX SP		
5012	DA 3D 50	JC EXIT	} jump if done	5036	33	INX SP		
5015	79	MOV A, C		5037	E1	POP H		
5016	17	RAL		5038	29	DAD H		
5017	4F	MOV C, A		5039	23	INX H		
5018	78	MOV A, B		503A	C3 2D 50	JMP CONT		
5019	17	RAL		503D	E3	EXIT XTHL	} return with quotient and remainder	
501A	47	MOV B, A	} rotate HL-BC left 1 bit	503E	C1	POP B		
501B	7D	MOV A, L			503F	AF	XRA A	
501C	17	RAL		5040	C9	RET		
501D	6F	MOV L, A		5041	E1	ERROR POP H	} return with carry set	
501E	7C	MOV A, H		5042	33	INX SP		
501F	17	RAL		5043	33	INX SP		
5020	67	MOV H, A		5044	C9	RET		

Making one bus troubleshoot another bus

Even without a bus analyzer for troubleshooting, users of general-purpose interface buses can locate errors in programming or data transmission **if a bus-responsive plotter such as the HP7225A or HP9872A is at hand.** The suggestion comes from James A. Rummell of the McDonnell Douglas Astronautics Co., Huntington Beach, Calif.

Just two steps are necessary, he says. First, command the plotter to go into the mode labeled LB. Then, add the plotter's listen address to the normal command string ("% " for the 7225A as shipped from the factory). The plotter will print out commands or data as they are transmitted, including such unwritten commands as line feed (LF). Notes Rummell, "The only limitation to this approach is that it slows down bus execution, since further commands wait until the commands are lettered."

Waste no more time— find out who's programming what

Desktop computer users who sweat out the writing of new programs always fear they are merely duplicating someone else's efforts. Now, at least for owners of the recently introduced Hewlett-Packard System 35 and System 45, there is a partial solution to the problem.

For these computers, which operate in an enhanced version of American National Standards Institute's Basic, H-P has established a **users' software club, which makes programs available on a three-for-one basis (submit one and get three in exchange).** And in case that's not enough, the club also sponsors information exchanges, area meetings, a software catalog, and a newsletter. Anyone interested in getting all these goodies is invited to contact the Basic User's Club, Hewlett-Packard Co., Desktop Computer division, 3404 East Harmony Rd., Fort Collins, Colo. 80525.

Find out about data access and protection

Both making the connection to a computer network and subsequent easy access to the net are inhibited by the variety of command languages and protocols required by different systems. This problem could be solved if all systems worked with the same commands. Of course this is not the case, but a first pass is described in the National Bureau of Standards' 32-page book, "Common Command Languages for File Manipulation and Network Job Execution: An Example." It is available as S. D. No. 003-003-01965-8 from the U. S. Government Printing Office in Washington, D. C. 20402, and costs \$1.50.

At the same time, if you are worried about computer security, NBS's Institute for Computer Sciences and Technology has a list of Computer Security Publications that are available from the Printing Office. List 91 covers **techniques, practices, and policies for protecting computers and data from unauthorized modification, disclosure, or destruction.** Write the Institute at A200 Administration, NBS, Washington, D. C. 20234.

IEEE grants advances to advanced thinkers

Industrial specialists who want to review the state of the art in their area of expertise may compete for \$5,500 grants sponsored by the Engineering Foundation. Their reports have to "provide an in-depth analysis of a specific field **including recommendations on engineering research needed to advance the state of the art** in that field" says Neil D. Pundit, the Institute of Electrical and Electronics Engineers' director of technical activities. Further details are available from him at 345 E. 47 St., New York, N. Y. 10017. Deadline for proposals is June 1. **-Harvey J. Hindin**

DC304

**You're looking at the
most PDP-11 power
ever put inside
a microcomputer.**

01710
1000000000

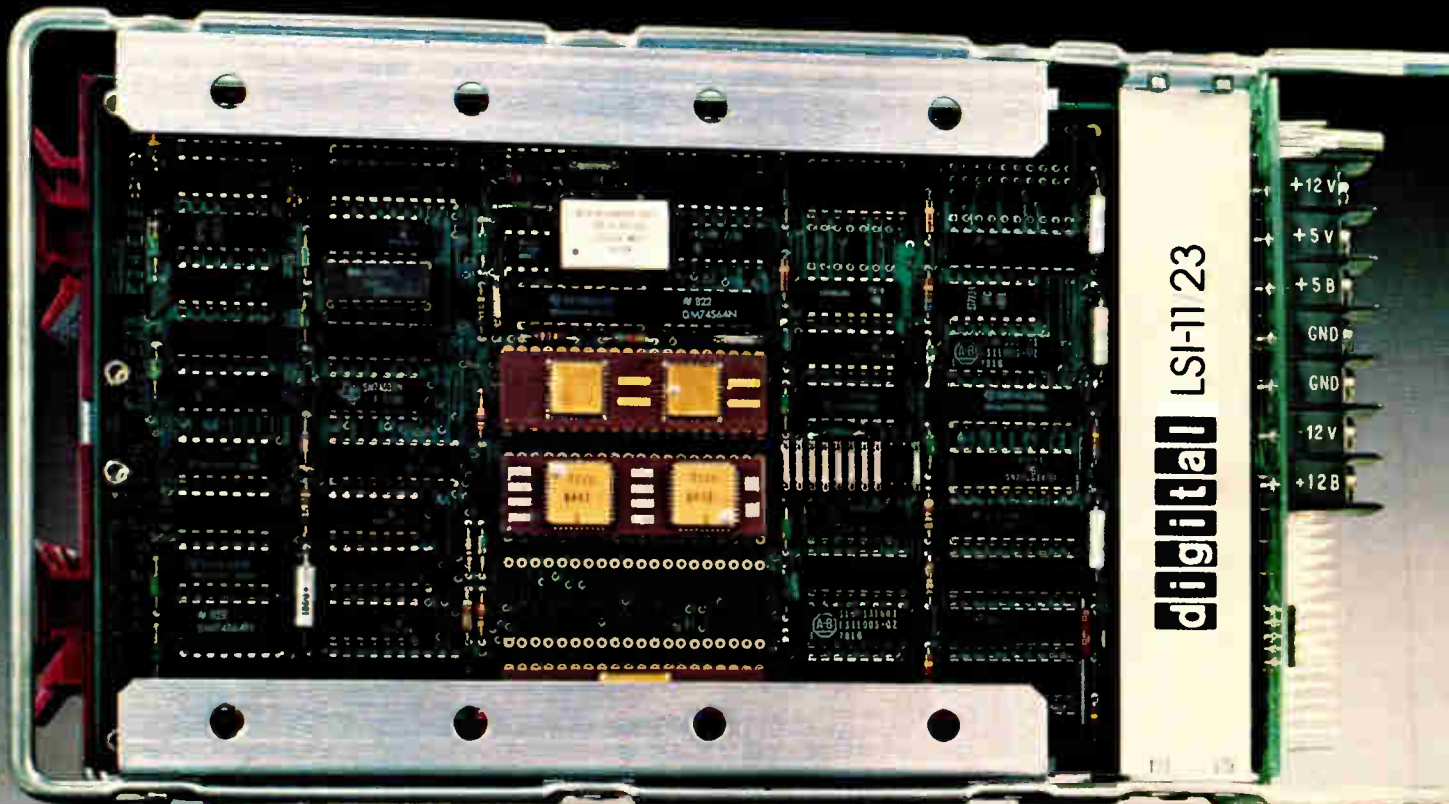

digital PDP 11/23



LSI-11/23. PDP-11/23.

Two new, more powerful choices from our growing family of 16-bit microcomputers.

Digital pioneered in 16-bit microcomputers with the top-selling LSI-11 and LSI-11/2. The first computers to deliver true systems performance at a micro size and price.

And now Digital offers you even more. With the LSI-11/23 boards. And the PDP-11/23 box.

More systems power. Execution speed approaching that of many mid-range minis with sophisticated instructions for single-precision (32-bit) and double-precision (64-bit) floating point, including arithmetic and data conversion capabilities; plus an optional single-chip floating point accelerator.

More systems capacity. Up to 256Kb of memory. Software supported memory management and protection. The flexibility of microcodable machine architecture. The ability to configure with a full range of over fifty LSI-11 bus terminals and options.

More systems software. The lowest cost entry into Digital's high performing RSX-11M/RSX-11S operating system family — the multi-tasking, multi-programming real-time package with over 300 man-years of PDP-11 development behind it. Plus RT-11 — the operating system that's the standard of the microcomputer industry. And a complete complement of languages and utilities including FORTRAN IV-PLUS, DATATRIEVE-11, Interactive Query Language, and Communications and Networking packages. This is the most powerful multi-user development system available today.

The secret behind this dramatic advance in microcomputer capability is Digital's leadership in the application of semiconductor technology. A brand-new microprocessor operating within the proven LSI-11 architecture that gives you the most compact form factor and simplest bus structure in the industry.

The LSI-11/23 and PDP-11/23 microcomputers.

More power to you.

For more information, contact Digital Equipment Corporation, MR 2-2/M70, One Iron Way, Marlborough, MA 01752. Or call toll-free 800-225-9220. (In MA, HI, AK, and Canada, call 617-481-7400, ext. 5144). Or contact your local Hamilton/Avnet distributor (boards only). In Europe: 12 av. des Morgines, 1213 Petit-Lancy/Geneva. Tel. 93 33 11. In Canada: Digital Equipment of Canada, Ltd.

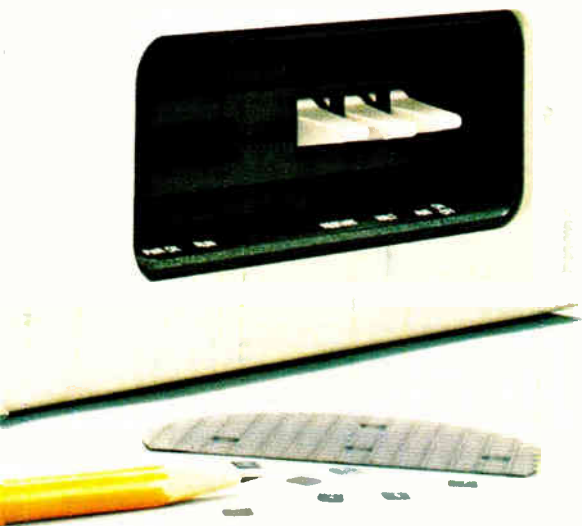

During May, Digital is conducting half-day seminars on the LSI-11/23 and PDP-11/23 in 30 cities throughout the U.S. and Canada. To find out if a seminar is scheduled in your area, contact your local Digital sales office listed in the Yellow Pages.

digital

**Can you deliver
components
from stock?**

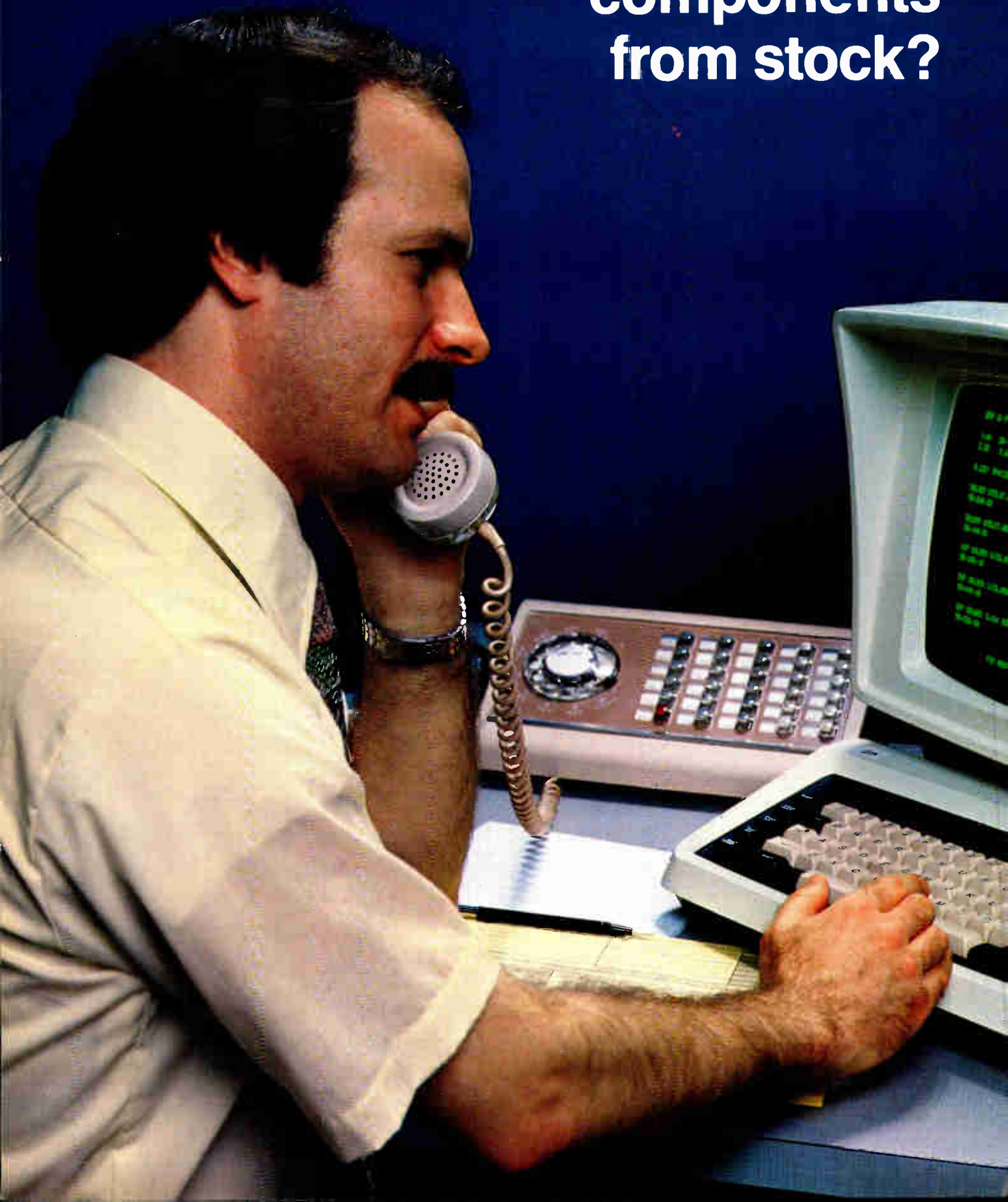

When it's TRW, the answer is yes.

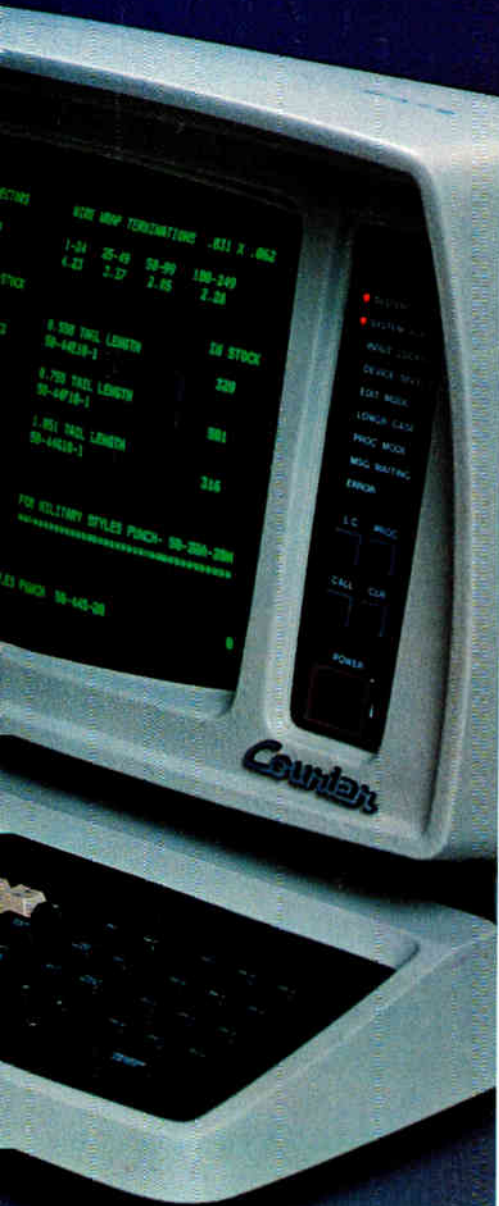

Maintaining the availability of its standard products is essential to service and that's why there is a world-wide network of TRW/ECD distributors with large stocks on hand, plus in-depth, back-up inventories at the TRW factories.

TRW distributors are selected for their positive attitudes toward customer service and their ability to stock TRW products in large enough quantities to satisfy customer needs.

TRW factory-trained distributors

know our products and can recommend the best one for your application—or they can work with our field staffs (250 people in 50 offices) or factory people to adapt to your unusual requirements.

When you want yes for an answer, call your TRW distributor, TRW/ECD sales office or Renfrew Electronics in Canada. You'll find them listed in EEM, Gold Book, Electronics Buyers' Guide, Who's Who in Electronics, the Electronic Industry Telephone Directory and the Electronic Buyers' Handbook.

TRW CAPACITORS
TRW CINCH CONNECTORS
TRW CINCH-GRAFIK
TRW CINCH-MONADNOCK
TRW ELECTRONIC FUNCTIONS
TRW GLOBE MOTORS
TRW HOLYOKE WIRE & CABLE

TRW INDUCTIVE PRODUCTS
TRW IRC NETWORKS
TRW IRC RESISTORS
TRW LSI PRODUCTS
TRW OPTRON
TRW POWER SEMICONDUCTORS
TRW RF SEMICONDUCTORS

TRW ELECTRONIC COMPONENTS

DIVISIONS OF TRW INC.

IF OUR NEW LSI LINEAR TESTER CAN'T MEET YOUR NEEDS YOU'LL HAVE A LEGITIMATE BEEF.

Free steak for a year.

If you buy Linear IC test equipment for your company, and you can prove to us that our new LTX Space Saver, the revolutionary LLSI Test System, can't test your devices better than any other system, then we'll deliver an assortment of selected prime steaks to your home every month for the next year. The same goes for proving that our LTX Space Saver is not forward or backward compatible with the high performance LTX you already have.

We don't care whether you're talking "jelly beans" or complex LLSI devices. The LTX Space Saver can simplify and optimize the testing of linear/analog circuits today, and tomorrow.

Our challenge stems from the incredible accuracy, flexibility and throughput of the LTX System. Our confidence stems from our extensive experience in LLSI applications.

The LTX Space Saver is as different from other linear (or, digital) testers as the vacuum tube

is from the semiconductor. It's unique modular architecture integrates hardware and software into a single system designed to speed up payback by speeding up throughput and improving yield. (In some cases, 20X to 30X that of the competition.)

You don't need specialized computer knowledge or experience to program, debug or update job plans thanks to LUCID, our own simplified version of Extended BASIC. In addition, LTX can integrate into its system the most precise laser positioning equipment available. This allows testing and functional trimming of thin film circuits to be performed concurrently.





So whatever your testing requirements – CODECS, telecommunication filters, automotive IC, A/D and D/A converters, audio, computer interfaces, op amps, comparators, voltage regulators, etc. – we'll "steak" our reputation on the fact that our new LTX Space Saver LLSI Test System can handle it. To qualify for this offer, you must follow the official rules available at Show.

See LTX respond at the Show. Or call Bob Baszner at (617) 244-7800.
LTX Corporation, 160 Charlemont Street, Newton Highlands, MA 02161.
SEE LTX RESPOND AT SEMICON WEST, BOOTH 965-967. (May 22-24)





Rent The Instruments You Need From General Electric

You can have the newest equipment from major manufacturers like Tektronix, Honeywell, Hewlett-Packard, GenRad, Gould Brush, Biddle, Fluke and hundreds of others. Thousands of instruments are available for rent by the week, month, or year from General Electric, and there is no need to wait. The instrumentation you need is ready for immediate shipment.

For your FREE RENTAL CATALOG call collect (518) 372-9900, or write General Electric Company, Apparatus Service Division, Building 6, Room 328, Schenectady, New York 12345.

**Quick·rental
instruments**[®]

Circle 152 on reader service card

GENERAL  ELECTRIC

A-d converter has 16-bit accuracy

Accurate to within 0.0015% of full scale, compact module with 10- μ s conversion time is guaranteed to miss no codes from 0° to 70°C

by Nicolas Mokhoff, Components Editor

The demand for high-speed, high-resolution, exceptionally stable analog-to-digital converters is growing rapidly in fields where accurate data gathering in large quantities is required, such as in medical diagnostics, audio recording, automatic testing, general scientific research, and geophysical investigation.

The desired level of performance includes 16-bit resolution, 16-bit accuracy, conversion times as low as 10 μ s, and linearity stability on the order of 0.4 ppm/°C. For the most part, converters so far available in the form of compact modules have missed these targets.

Now Zeltex Inc. is introducing its model ZAD7200 and ZAD7400 converters—a pair of 16-bit devices that are guaranteed to miss no codes over their 0° to 70°C operating temperature ranges, while also being virtually adjustment-free for life. The ZAD7200 and 7400 have conversion times of 20 μ s and 10 μ s, respectively. Other key features and specifications include a 0.4 ppm/°C temperature coefficient of differential non-linearity, accuracy to within $\pm 0.0015\%$ of full-scale range, five-sided shielding against electromagnetic interference, low noise, low gain and offset drifts, and low sensitivity of code width to clock rate.

Monobit. In order to achieve these objectives, Zeltex design engineers abandoned most of the conventional approaches that impose state-of-the-art restrictions on critical components like resistors, switches, and comparators. Drift and accuracy problems, which are always associated with binary-weighted ladder networks, are overcome through the use of a so-called monobit ladder

network of 15 identical resistors and a kind of successive-approximation configuration.

As the figure shows, an analog input, E_{IN} , is converted to an 8-bit digital word, D_1 . This rough digital approximation of the input is then applied to a nearly ideal 8-bit digital-to-analog converter, which produces a precise analog measure of the crude digital approximation of the input. This intermediate analog signal is then subtracted from the actual analog input and the difference is amplified by a gain, G , which serves to generate the analog error voltage, E_O .

The analog error signal is next converted into a 9-bit digital word. The eight least significant bits of

this word become the eight LSBs of the output. The most significant bit is carried over to D_1 , where it is digitally added to that initial eight-bit approximation to yield the eight most significant bits of the output. Thus, if the 9-bit a-d converter were perfect, the nearly ideal d-a converter were truly perfect, and all offsets and gains were accurately known, the digital output would be a precise 16-bit representation of the input.

Seeking perfection. It is relatively easy to construct the 9-bit a-d converter so that its differential-linearity errors are less than 0.1 LSB. Keeping track of the gains and offsets is also not too difficult. The problem lies in the d-a converter.

To make the d-a converter as

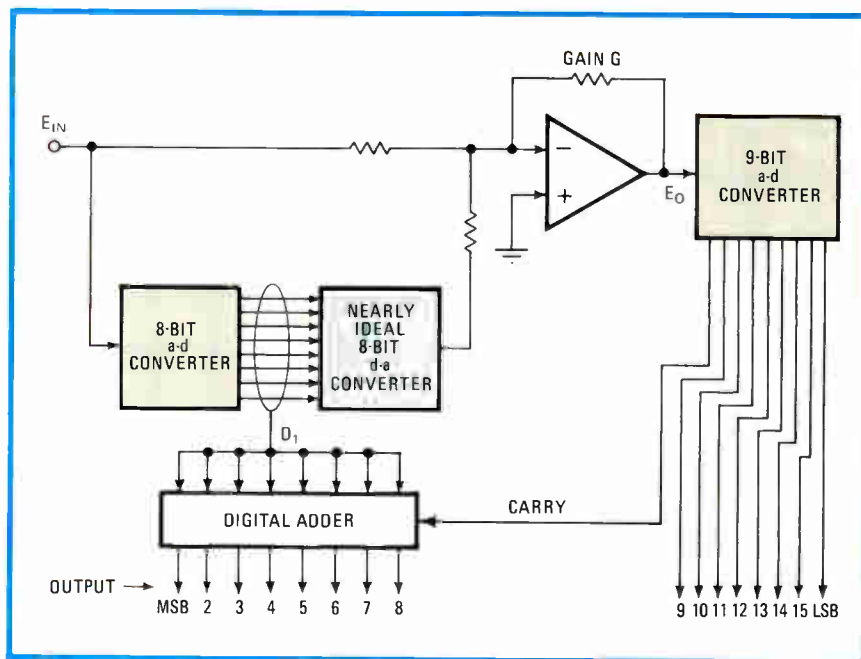

Precise. The heart of this 16-bit a-d converter is an extremely accurate 8-bit d-a converter that is built around a monobit resistive ladder network. The output of the d-a converter is subtracted from the analog input, E_{IN} , at the input of the error amplifier.



ELORG IS SOLE EXPORTER OF SOVIET-MADE ELECTRONIC COMPONENTS

Integrated circuits
Semiconductor devices
Vacuum tubes
Resistors
Capacitors
Ferrite devices

THAT BOAST HIGH RELIABILITY

thanks to well-thought out designs, neat manufacture and tough quality inspection.

ELORG

stands for tremendous scientific and industrial abilities of Soviet electronics.



32/34 Smolenskaya-Sennaya
121200 Moscow
USSR
Telephone 251-39-46, Telex 7586

New products

nearly perfect as they could, its designers came up with a circuit whose errors refer back to the input on a one-to-one basis. That is, they made the converter less sensitive to errors in its resistor-ladder network, rather than attempt to make that network unrealistically accurate. Their innovative circuit is built around the monobit ladder network, which consists of 15 equal resistors. These resistors are used to add or subtract a single unit of current to the output as the input code changes incrementally. Thus no switch or resistor can affect a current that is more than a sixteenth of full scale. By contrast, in a conventional binary-weighted ladder network, the most significant bit is half of full scale. Assuming equal resistor errors, the monobit approach is eight times less sensitive to resistor errors—that is, it allows 16-bit performance while using the equivalent of 13-bit technology. This fact is the major technological contribution of the ZAD7200 series.

But it's not the only one. The converters are extremely fast for units of their resolution. Their speed is actually inherent in the conversion technique. About 25% of the conversion time is taken up by the initial, rough 8-bit a-d conversion, 25% by d-a conversion and amplifier settling, and the remaining 50% by the second a-d conversion. To attempt to achieve the speed and precision of this device with a standard successive-approximation technique would stretch present-day circuit technology to its limits.

The price of this performance is surprisingly low. The ZAD7200 sells for \$750 each in lots of 100 or more pieces. It is contained in a 36-pin module with dimensions of 3 by 4 by 0.375 in. Delivery time is six weeks.

Zeltex plans to follow up the 16-bit a-d converters with both 14- and 18-bit units as well as with low-glitch, high-resolution d-a converters and other support devices aimed at designers of precision data-acquisition systems.

Zeltex Inc., 940 Detroit Ave., Concord, Calif. 94518. Phone (415) 686-6660 [338]



32K ROM

In quantity from the quality source.

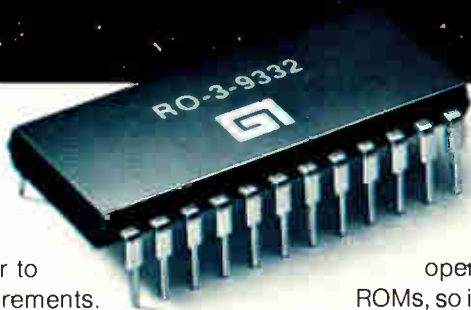

General Instrument has the answer to your "high volume" 32K ROM requirements. You can count on our service and volume production capacity to deliver the 32K ROMs you need—NOW. What else would you expect from the industry's leading supplier of ROMs?

There's no secret to GI's performance proven ROM achievements. Our extensive facilities include computerized custom programming, automated mask-making equipment and the only wafer fabrication areas devoted exclusively to ROM production. Our fully-static 4096 x 8-bit N-channel ROMs are available with maximum access times of 350ns, 450ns or 850ns. Their 24-pin packages and static

operation make them pin compatible with other ROMs, so it's easy to expand existing designs with no clocks or "triggers" required.

For more memory, two mask-programmable chip-select inputs simplify memory expansion. Or, you can plan on our pin compatible 64K ROMs which will be available later this year.

Write or call for our free 1978 Product Guide and for proven, service-supported "high volume" ROM performance, contact General Instrument Microelectronics, 600 W. John Street, Hicksville, New York 11802, Telephone (516) 733-3107.

We help you compete.



**GENERAL INSTRUMENT CORPORATION
MICROELECTRONICS**



New products

Components

Keyboard senses body capacitance

Contactless board

contains ROM that provides up to four codes per key

A solid-state keyboard from Cherry Electrical Products Corp. senses body capacitance instead of an electrical contact closure, thus achieving a lifetime estimated by the manufacturer to be in excess of 300 million operations. Built around a custom LSI circuit from American Microsystems Inc. and a read-only memory from Cherry Semiconductor, the keyboard includes proprietary noise-rejecting circuitry that prevents false keying by invalid signals, according to Cherry officials.

The LSI processor scans the keys at a rate of one every 1.5 ms and, upon sensing a capacitive contact, sends the key's address to the ROM. There are actually four addresses per key for all but two of the keys. The address chosen is determined by the remaining two, which are referred to as the shift and control keys.

Paul Kollesar, keyboard product manager, notes that the unit is "designed to be altered by the user" and includes a variety of flexibility-enhancing features, such as the ability to accept additional ICs for connection to word-processing systems. Among the options custom

programming of the ROM provides are repeat functions for any or all keys and key rollover or lockout.

The basic CB80-12AA keyboard sells for \$135 in low-volume custom orders and has 95 keys. A version with an auxiliary 15-key numeric key pad and two additional user-labeled keys is also available under the designation CB80-07AA. Delivery time is 12 weeks.

Cherry Electrical Products Corp., 3600 Sunset Ave., Waukegan, Ill. 60085 [341]

High-Q varactor sports large tuning ratio

The ZC800 is a tuning diode, or varactor, that provides a large tuning ratio and a high Q. The tuning ratio is better than 5 to 1, with a nominal capacitance of 1.8 pF

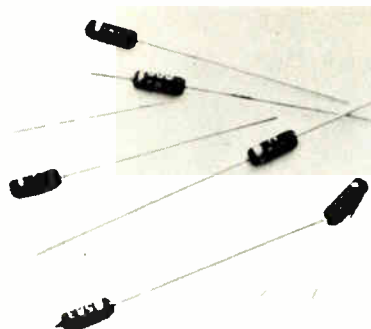

at 10 v varying to 10 pF at 2 v. The high Q of the diode (300 measured at 50 MHz) assures good selectivity even at the upper end of the very high frequency band.

With a breakdown voltage rating



Finally. Fiber optics availability.

- AZ Base, Phoenix (602) 997-6194
Moltronics, Phoenix (602) 272-7951
- CA Moltronics, L.A. (213) 773-6521
Moltronics, S.D. (714) 278-5020
Moltronics, S. Clara (408) 244-7600
Western Micro, Cupertino (408) 725-1660
- CT Arrow, Hamden (203) 248-3801
C.C.I., Wilton (203) 762-8691
- FL Arrow, Ft. Lauderdale (305) 776-7790
Arrow, Palm Bay (305) 725-1480
Hammond, Orlando (305) 849-6060
- GA Arrow, Atlanta (404) 455-4054
- IL Arrow, Chicago (312) 893-9420
Camelot, Chicago (312) 583-5588
- MD Arrow, Baltimore (301) 247-5200
- MA Arrow, Woburn (617) 933-8130
Future, Natick (617) 237-6340
Lionex, Burlington (617) 272-9400
- MI Arrow, Ann Arbor (313) 971-8220
Camelot, Livonia (313) 591-0055
- MN Arrow, Edina (612) 830-1800
Stark, Minneapolis (612) 332-1325
- NH Arrow, Manchester (603) 668-6968
- NJ Arrow, Moorestown (609) 235-1900
Arrow, Saddlebrook (201) 797-5800
Mid Atlantic, Bellmawr (609) 931-5303
- NY Arrow, Farmingdale (516) 694-6800
Summit, Buffalo (716) 884-3450
Zeus, Elmsford (914) 592-4120
- NC Arrow, Kernersville (919) 996-2039
Hammond, Greensboro (919) 275-6391
- OH Arrow, Cincinnati (513) 761-5432
Arrow, Cleveland (216) 248-3990
Arrow, Dayton (513) 253-9176
- OR Parrott, Beaverton (503) 641-3355
- PA Arrow, Moorestown (215) 928-1800
Arrow, Pittsburgh (412) 351-4000
- SC Hammond, Greenville (803) 233-4121
- TN Arrow, Knoxville (615) 587-2137
- TX Arrow, Dallas (214) 386-7500
Solid State, Dallas (214) 352-2601
Solid State, Houston (713) 772-8483
- WI Arrow, Oak Creek (414) 764-6600
Parts Mart, Milwaukee (414) 276-1212
- CAN Future, Montreal (514) 735-5775
Future, Ottawa (613) 820-9471
Future, Toronto (416) 663-5563

© 1979 Spectronics

FINALLY. A FIBER OPTIC LINK YOU CAN TAKE SERIOUSLY.

Introducing the first data link that features low cost, versatility, and high performance.

\$49.95 per module and Sweet Spot™ LED

Our unique Sweet Spot design lets you couple to a variety of cables including Siacor, Galite and Dupont plastic or glass.

2 kilometers transmission at 10 Mb/s (min) with 10⁻⁸ BER

LED performance this powerful opens the door to unlimited application ideas. And since the modules are a compact .5" x .5" x 1.3", they're easy to design into existing systems.

Full microcomputer compatibility

True TTL compatibility, 0° to 70°C operation, and a 5 volt unregulated power requirement are important features. But state-of-the-art IC design also provides single line, self clocking, optical data transmission at maximum rated performance.

The Missing Link

Now you can evaluate all the features of our modules through our special fiber optic kit, The

Missing Link. It contains modules, connectors, terminated cable and instructions. All for \$495.

Or, if you have bigger plans, you can order modules in 1000 lot quantities for \$49.95 each.

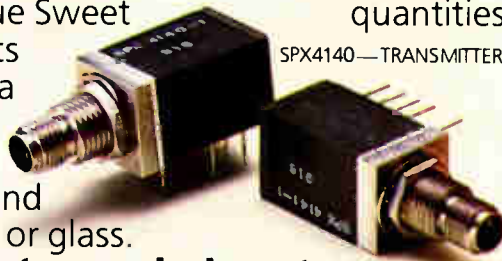

SPX4141—RECEIVER



From Spectronics, the fiber optics leader

If that sounds impressive, it should. Because Spectronics is the only company advanced enough to take this technology to the production stage.

Ask your Spectronics distributor for The Missing Link, or contact Spectronics for information at 830 East Arapaho Road, Richardson, Texas 75081; Telephone (214) 234-4271.

Spectronics
A Division of Honeywell

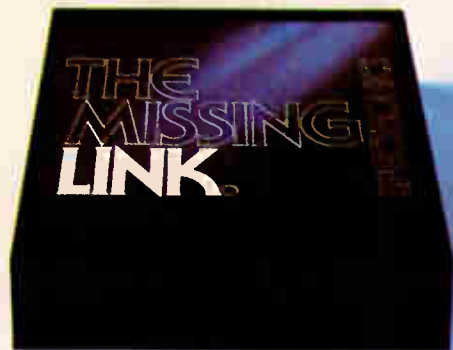

Aeroflex Hybrid Brushless DC Motors for special applications



High vacuum, high altitude... aerospace or outer space... cryogenic or special environments—for that unique application Aeroflex has a line of BDCM's that can be customized to meet your extended requirements. Their long life, high efficiency and operational performance, without downtime, provide a cost per operating hour that can't be beat.

Combining the latest in hybrid technology, solid state sensing and switching techniques that are state-of-the-art, the BDCM's from Aeroflex give you the brush-type motor benefits of high starting torque, linear speed/torque characteristics without the inherent problem of brush wear. You can have them with the electronics integral or exter-

nal; bi-directional or uni-directional; for commercial use or to meet MIL specs. You can have it your way—custom superiority at a cost productive price.

Send for our latest literature package. There's a BDCM that Aeroflex can design for you.



MAGNETIC PRODUCTS DIVISION
AEROFLEX LABORATORIES INC.
SOUTH SERVICE ROAD • PLAINVIEW, LONG ISLAND, NY 11803
TEL. (516) 694-6700 TWX: 510-224-6417

Circle 158 on reader service card

Two-Tone Audio Signal Generator

Model TTG-29
20 Hz-20 kHz



Ideal for intermodulation tests of transmitters, exciters, filters and amplifiers. Calibrated, low-distortion single or dual tones. Digital selection, 20 Hz to 20 kHz. Levels accurately calibrated up to +10 dBm. Model TTG-29 weighs less than 10 lbs., only 3½" high. Rack mount adapters supplied. Hundreds used in commercial and military communications systems.

SPECIFICATIONS SUMMARY

Digital Frequency Selection:
20 Hz to 20 kHz, single or dual tone.
Output Levels:
Calibrated +10 dBm to -60 dBm
into 600 Ω, 1 dB steps.
Harmonics, IM, Hum:
-66 dB, 100 Hz to 10 kHz
-60 dB at other frequencies
U.S. Price (Feb. '79): \$2375.00
Full specifications on request.

polarad

5 Delaware Drive / Lake Success,
New York 11040 516-328-1100
TWX 510-223-0414

New products

of greater than 25 v, the hyper-abrupt-junction ZC800 can accommodate large rf signals. The varactor is useful in industrial and military communications systems as well as in applications using temperature-compensated or voltage-controlled crystal oscillators.

Housed in a DO-7 glass package, the ZC800 sells for \$6.30 apiece in quantities from 1 to 99. Delivery time is two weeks.

MSI Electronics Inc., 34-32 57th St., Woodside, N. Y. 11377. Phone A. Lederman at (212) 672-6500 [343]

Crystal oscillator covers very low frequency range

Packaged in a metal case only 0.25 in. high, the model S14P5 crystal oscillator can drive up to 10 TTL loads at any fixed frequency chosen from the range of less than 1 Hz up to 32 kHz. Frequency tolerance is

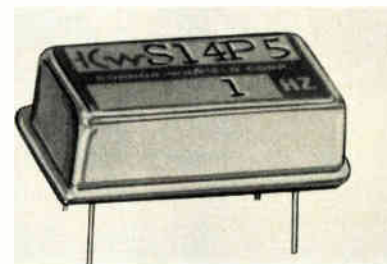

±0.005% across the temperature range from -25° to +75°C.

The device's output is a square wave with a minimum high of 2.4 v and a maximum low of 0.4 v. Units are available at prices of less than \$65 with delivery times of four to five weeks.

Connor-Winfield Corp., West Chicago, Ill. 60185. Phone (312) 231-5270 [344]

Push-button switches resist oil invasion

Designed for use in harsh environments, the 04 series consists of oil-tight units. They are available as indicators or as both illuminated and unilluminated push-button switches

New CMOS microprocessor kit: You get the terminal, power supply plus all this from RCA for only \$325.

Why is RCA offering such a terrific bargain?

Answer: To demonstrate the low power consumption and easy programming of our CMOS microprocessors.

For just \$325 (optional with distributors), you get everything you need to build a microprocessor evaluation system: CPU, RAM's,

ROM's, I/O's, passive components, p.c. board, hardware, even a micro-terminal. And we're throwing in the power supply free.

With the kit, you can discover how the RCA COSMAC architecture and a repertoire of 91 easy to use instructions give maximum performance with minimal memory.

You can also use the kit to learn

about basic system design, hardware interfacing, and programming. Or for breadboarding and prototyping your own COSMAC Evaluation System (CDP 18S025).

For more information, contact your local RCA Solid State distributor.

Or contact RCA Solid State headquarters in Somerville, New Jersey. Brussels, Belgium. Tokyo, Japan.



WANTED

Industrial electronic products for Scandinavia

Successful Scandinavian manufacturer/distributor of high technology electronics products and systems interested in new product opportunities

Our important strengths include...

A highly trained and well-motivated marketing team
"In-depth" knowledge of scandinavian markets
Qualified field service engineering and spare parts capabilities
Design engineering and production facilities

In reply please write to:

Mr. Johnson
Swedish Industrial Development Corporation
600 Steamboat Road
Greenwich, Conn. 06830

Circle 160 on reader service card

New products

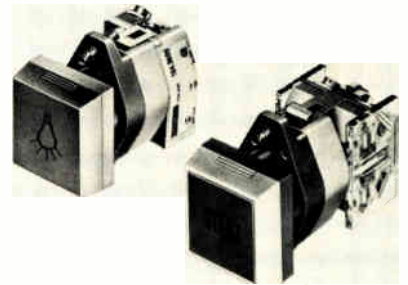

that have momentary or maintained action.

Upon operation, push-button switches in the series lock and the state of the switch is indicated. The square-faced switches consist of an actuator to which up to four contact blocks can be attached. The contact blocks snap into place without the use of tools. They may be of the quick-acting or slow-make type and have a mechanical life of three million operations.

The units conform to IEC 144/IP 65 and DIN 40050/P54 standards and come with red, blue, green, yellow, or clear lens caps that can be engraved with the switch's function. In quantities of 100, prices for the 04 series begin at \$3.

EAO Switch Corp., 255 Cherry St., Milford, Conn. 06460. Phone Robert Maier at (203) 877-4577 [345]

Economical relays provide 10-A triac output

Using a single glass-passivated triac chip, a series of solid-state relays provide a 10-A output. The TD1210 sells for \$11.10 each in quantities of 50 to 99 and the TD2410 sells for \$11.70 each in similar quantities. Both devices are for loads with less stringent surge requirements than those requiring silicon-controlled rectifiers. The nonrepetitive peak surge rating for both is 100 A for one cycle. The TD1210 can handle a nonrepetitive maximum peak voltage of 300 v; the TD2410, 500 v.

International Rectifier Corp., Crydom Division, 1521 Grand Ave., El Segundo, Calif. 90245 [346]

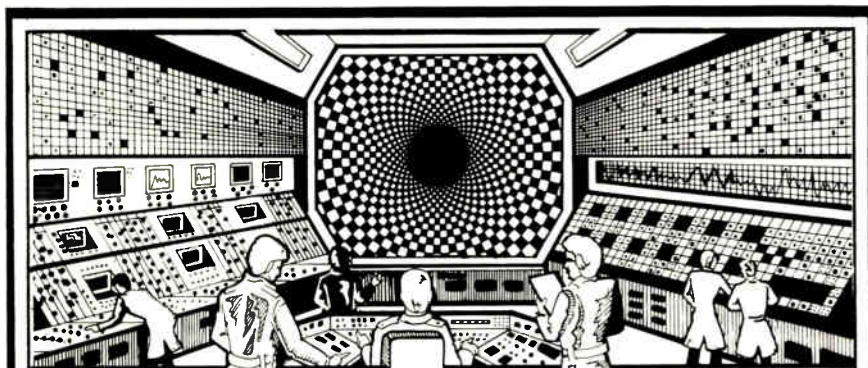

Fantastic Who Made The Lights?

Xciton of course. We have delivered tens of millions of LED Chips for use in large scale Displays and Arrays. Our *Red GaP* and *Green GaP* material, also used in our high performance *LED Lamps*, provides a superior brightness in applications where yield and predictability of performance are critical.

What About Price and Delivery?

Try Us. An integrated quality assurance and engineering support program assures timely delivery of product with an average *6 to 8 week lead time*.

Prompt quotations, competitive pricing, accessible technical assistance, plus unmatched product service with a one year warranty - is what Xciton is all about.

Catalog, spec sheet, and samples are available from the factory direct. Call us, and let Xciton make your lights.

Xciting
Xciton

Xciton Corporation
Shaker Park, 5 Hemlock Street
Latham, New York 12110
(518) 783-7726, TWX: 710-444-4962

Microcomputers & systems

DMA boards wait for LSI-11/23

Analog input and output subsystems will also work with LSI-11 and LSI-11/2

In data acquisition, as in just about every other aspect of the computer business, the name of the game is speed. Getting data into memory must often be done at rates the system bus is incapable of handling. Direct memory access (DMA) is obviously the solution, and when the LSI-11/23 microcomputer becomes available from Digital Equipment Corp. later this year, Data Translation Inc. will be waiting for it with a pair of analog input/output boards that include on-board DMA capability. The dual-height boards are the DT2782 analog-input subsystem and the DT2771 analog-output board, both of which will operate with the LSI-11 and LSI-11/2 as well as with the 11/23.

Fast in. The DT2782 is a 12-bit

subsystem with a throughput rate of 35,000 samples per second. Extra-cost versions are available with throughput rates of 100 kHz and 125 kHz, with a 14-bit analog-to-digital converter, and with software-programmable gain. Even the fastest a-d converter can run at top speed because the data outputs are double buffered, allowing fast DMA transfer of converted data while a new conversion is being performed. The DT2782 can transfer data over the LSI-11/23's full 18-bit address space, using extended-address bits.

The subsystem can be configured with either 16 single-ended or eight differential input channels. Jumpers allow the user to select one of four input ranges: 0-to-5 v, 0-to-10 v, ± 5 v, or ± 10 v. The optional programmable-gain amplifier offers a choice of four fixed gains: 1, 2, 4, and 8.

Three jumper-selectable output codes are provided: natural binary, offset binary, and two's complement. Both gain and offset errors are adjustable to zero. System nonlinearity is specified at less than half a least-significant bit, while the accuracy is within $\pm 0.03\%$ of full scale.

Fast out. The DT2771 dual digital-to-analog converter point plotter contains two independent 12-bit d-a

converters, a Z-axis control output, and a pair of power amplifiers. Buffered by the amplifiers, the converters can be connected directly to X-Y displays. Operating under programmed input/output and external-interrupt control, the DT2771 can also control a light pen, providing interactive graphics capability. Moreover, the board's DMA capability allows the entire contents of a buffer of up to 16,384 16-bit words to be displayed without program or CPU intervention.

The d-a converters are accurate to within $\pm 0.025\%$ of full scale and linear to within half a least significant bit. Jumper-selectable ranges of 0-to-10 v, ± 5 v, and ± 10 v are provided. Minimum full-scale output current is 25 mA. Driving 50 feet of cable terminated by a 470- Ω resistor, the converter outputs will settle to within 0.1% of full scale in 1 μ s and within 0.01% in 3 μ s. Over the range from 0° to 70°C, each channel has an output temperature coefficient of ± 25 ppm/°C.

The Z-axis output is a fast TTL-level pulse whose polarity and width can be adjusted.

Both DMA interface boards are priced at \$995 each in quantities of one to nine. The DT2782 with a 100-kHz throughput rate goes for \$1,295, whereas the 125-kHz version sells for \$1,395. The basic 35-kHz board, when equipped with a 14-bit converter, carries a price tag of \$1,495. When supplied with the programmable-gain option, its price is \$1,170. Shipments will begin in June; delivery time is five days.

Data Translation Inc., 4 Strathmore Rd., Natick, Mass. 01760. Phone Fred Molinari at (617) 655-5300 [371]

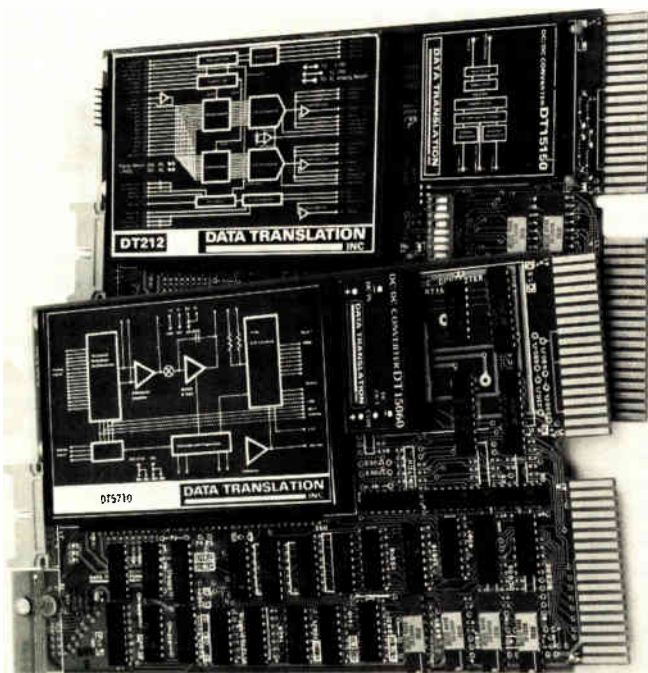

Fast controller links peripherals and memory

Systems that require a fast, direct link between a microcomputer's memory and a high-speed peripheral can now be built using either of two direct-memory-access controllers, the 8237 or the 8237-2. The former is designed for use with the 3-MHz



Tone Receivers, two ways from two sources.

Two tone receivers with versatile performance capabilities are available from two sources, ITT and Mitel.

Both offer the 88205 single package Hybrid DTMF Receiver System.

Or ITT's 3044 and 3045 DTMF group filters, along with additional limiter circuitry, can be used with Mitel's MT 8820 — or any other similar decoder chip — to design your own tone receiver.

You will find all of these components to be of high quality, and packaged with reliability to meet your most stringent demands. Specify them for your next central office, PABX, key system, mobile paging system or signaling application.

For more information, contact: ITT North Microsystems Division, 700 Hillsboro Plaza, Deerfield Beach, Florida 33441. Phone: (305) 421-8450, TELEX & TWX: 510-953-7523.

ITT North

Microsystems Division

Circle 163 on reader service card

THE MINUTE MENDER.

Eastman 910® adhesive is so strong, fast and easy to apply that it can be used for many small repair jobs as well as for product assembly. One drop bonds rubber, plastics, metals, hardwoods and



ceramics in seconds to minutes.

For more information, write Bill McGillen, Eastman Chemical Products, Inc., Plastics Division, Kingsport, Tennessee 37662.



Eastman 910® adhesive

Eastman Chemical Products, Inc., a subsidiary of Eastman Kodak Company, Kingsport, Tennessee. Eastman 910 is an Eastman trademark for cyanoacrylate adhesives.

Circle 164 on reader service card

the NO CREEP heat sink compound

ideal for circuit applications requiring a highly conductive, silicone-free thermal compound

Est. 1895

AOS

NEWARK • BUFFALO • NEW ORLEANS

Specially formulated and proven for use in electronic assemblies where excessive heat can substantially reduce service life, new PQ HEAT SINK COMPOUND contains heat-conductive, inorganic oxides that prevent creeping. And PQ's excellent lubricity permits easy, efficient application to sensitive circuit board components. Meets Western Electric spec. KS 21343
Packed in 1 lb. cans & 4 oz. tubes

American Oil and Supply Co.
238 B Wilson Ave., Newark, N. J. 07105
(201) 589-0250 • TWX 710-995-4462



164 Circle 216 on reader service card

New products

8085A, whereas the latter operates with either the 8085A-2 or the 8088, both 5-MHz microprocessors.

The 40-pin devices are pin-compatible with earlier, slower units and they offer four independent DMA channels. By cascading the devices so that the output of one becomes the input to one channel of another, the total number of channels in a system can be expanded.

Without relying on the central processing unit, the controllers can perform block transfers from one set of memory locations to another, a desirable capability for word-processing applications. The 8237-2's data-transfer rate of up to 1.6 megabytes per second reduces idle time for the CPU, suggesting it for systems that require frequent DMA operations for, to give an example, refresh of video displays or dynamic read/write memories.

The controllers may be purchased in either plastic or ceramic dual in-line packages. In plastic and in quantities of 100 or more, the 8237 and the 8237-2 sell for \$20 and \$25 each, respectively. In like quantities, Cerdip units sell for \$26.25 and \$32.85, respectively. Sample quantities are available now.

Intel Corp., 3065 Bowers Ave., Santa Clara, Calif. 95051. Phone Mike Peak at (408) 987-8080 [373]

Finder frees 6800 programmer from fixed nomenclature

Finder, a general-purpose program for data-base management, lets users employ their own terminology to define and access items. It also allows them to customize file structures for their own requirements. The software is designed to run on 6800-based microcomputers with PerCom's LFD-400 minifloppy-disk systems.

The program requires 24 kilobytes of memory, is interpreted by the company's Super Basic, and uses disks for file storage. All functions ordinarily required for management can be accomplished by the five commands provided. In addition, up

Cut First Board Lead Time.

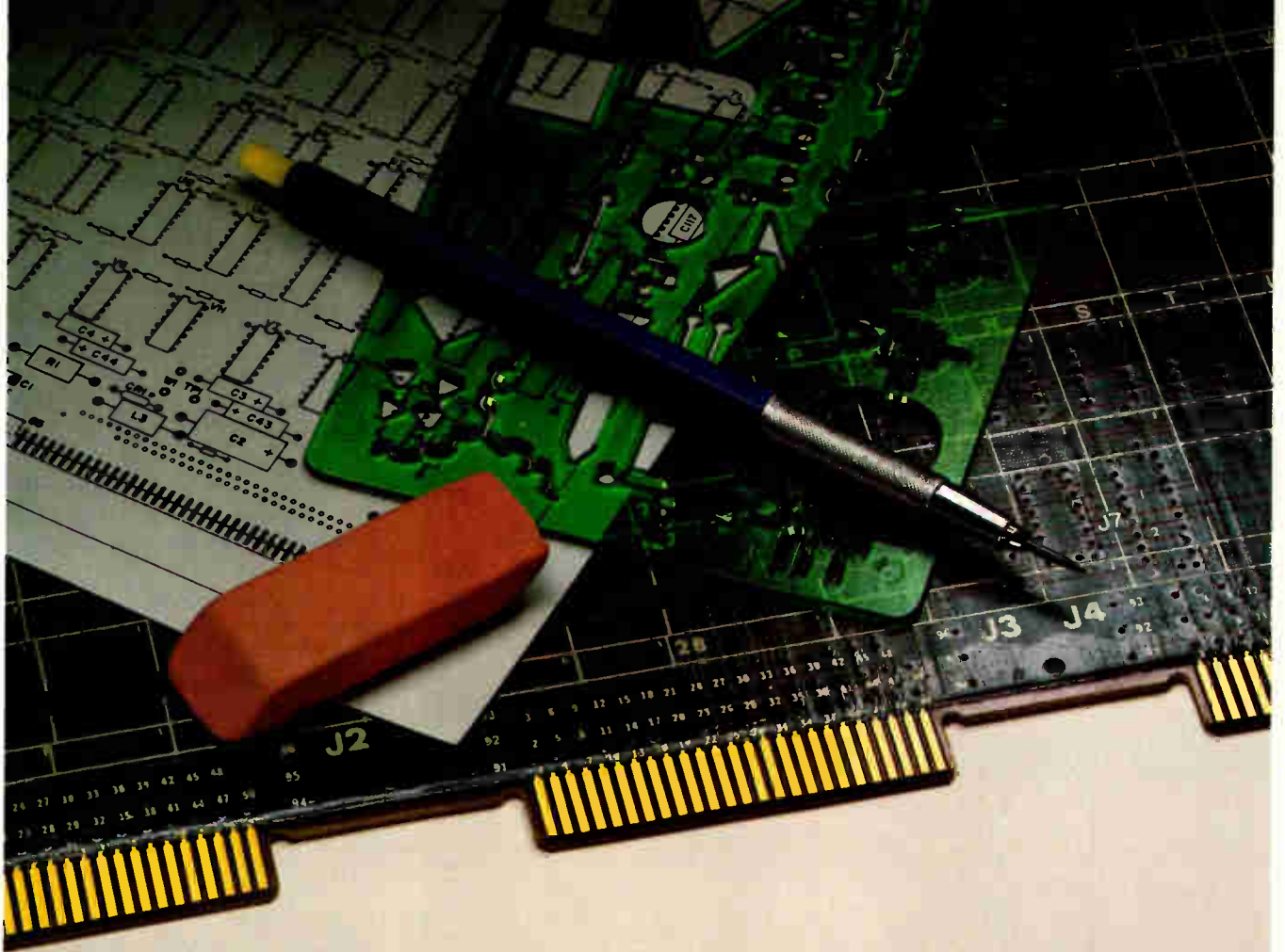

Circuit data to first board in just six weeks.

This Multiwire board, with 285 IC's and dozens of discrete components, went from circuit data to first board in just six weeks. Reason: our customer had only to supply artwork for the power and ground planes, a net list and a fabrication blueprint. No need for artwork for each of the circuit layers.

These simplified input requirements for Multiwire boards get you into production faster than conventional wirewrap or multilayer techniques. You'll get the finished product as

much as *10 weeks* sooner than other methods.

Multiwire boards also offer fast and easy circuit changes, controlled impedance, reduced inspection costs and higher production yields.

Call or write today for more details on the Multiwire system. The more you know about us, the more convinced you'll be that Multiwire is the way to go.

Multiwire, 31 Seacliff Avenue, Glen Cove, NY 11542. Phone (516) 448-1307

Multiwire is a registered trademark for Kollmorgen Corporation's discrete wired circuit boards.



magnetic memory

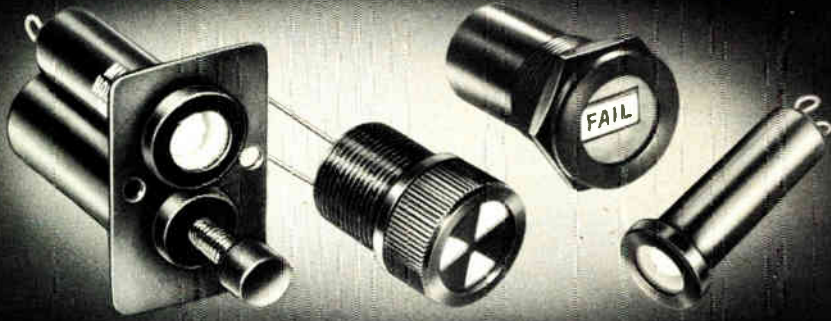

minelco's wide selection of latching indicators

Ultimate dependability in fault detection! Minelco's unique, patented magnetic latching indicators retain highly-visible fault indication, even if power fails or restores. Not subject to light or LED failures. Widest selection of ball, flag or annunciator models . . . self-restoring or manual reset . . .

in commercial or mil spec (MIL-1-83287/1-4) qualities . . . for industrial, computer, communication, aircraft, test equipment, etc. For prototypes call Minelco, A Talley Industries Company, 135 So. Main Street, Thomaston, CT 06787. Phone (203) 283-8261.

minelco
a TALLEY INDUSTRIES Company

Circle 166 on reader service card

Now, X-10, AI-250, and AI-400 piezo audio indicators from Projects Unlimited come with PC pins making mounting fast and simple.

Get great features, too! Continuous tone. Wave solderable. 2.7-4.0 KHz frequency range. -50° to $+80^{\circ}$ C operating range. 84-98 dbA at 1 foot. Minimum 1000 hours design life. And more.

For full details on these simple-to-use warning devices, write for free catalog: Projects Unlimited, 3680 Wyse Road, Dayton, Ohio 45414. Phone: (513) 890-1918. TWX: 810-450-2523.



projects[®]
unlimited

A SIMPLE WARNING.



166 Circle 218 on reader service card

New products

to three user-defined commands may be added for special functions.

Finder is supplied on a minifloppy disk for \$99.95. It comes with a user's manual.

PerCom Data Co., 318 Barnes, Garland, Texas 75042. Phone (214) 272-3421 [375]

Video controller works with series 80, 86 computers

Compatible with both series 80 and 86 single-board computers, the VMC-186 is a video monitor board that permits 20-bit addressing. The board handles five-by-seven-dot or seven-by-nine-dot ASCII upper- and lower-case characters as well as graphics.

It features memory-mapped display, underlining, and blinking, as well as reverse, half-, and zero-intensity video. It provides a hardware clear-screen command and allows memory access at any time without display interference.

Also featured are an addressable cursor, scrolling, and 60-Hz real-time-clock interrupt. Both composite and separated data and sync outputs are available, and the board can

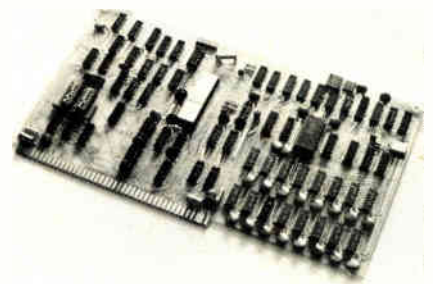

support Motorola's step-scan option. In hundreds, the VMC-186 is priced at \$380.

Interphase Corp., 13667 Floyd Circle, Dallas, Texas 75243. Phone (214) 238-0971 [376]

Basic compiler serves machine instead of assembly language

A compiler called A/Basic lets designers produce machine-language programs for 6800 applications nor-

Need Membrane Switches?

Come to Oak— The Switch Experts



For over 50 years, Oak has been designing and building switches of all types. That experience and technology now has been applied to the TIP switch—Oak's dependable membrane switch.

Fully tested through 500 million cycles, covering 21 different parameters, from life expectancy to environmental/physical stability—insuring long life and reliability.

Active, fully-operating, demonstration panels are used by your local, factory-trained Oak field sales engineer to help you in your volume TIP switch application.

For further information, contact any of the Oak sales offices listed in EEM and the Electronic Industry Telephone Directory, or call Dennis Krueger at 815-459-5000.

For further information circle #167
For a salesman to call circle #221

IN TOUCH WITH TOMORROW

oak Industries Inc.

SWITCH DIVISION / Crystal Lake, Illinois 60014

Telephone 815-459-5000 • TWX: 910-634-3353 TELEX 72-2447

Manufacturing facilities: Crystal Lake, Illinois, Emmen, Holland (Oak Holland B.V.) and Norwich, England (Diamond H Controls Ltd.)

INSTOCK
Microprocessor Crystals

NEL stocks production quantities of the most popular microprocessor frequencies. Call for immediate delivery. Request Data Sheet 7804A for listing of frequencies available. • Let our broad experience in working with the various microprocessor devices work for you in solving your design problems. Write or call for prompt service or application assistance. • For additional information write for: Technical Brochure #375 and reprints, "Writing Crystal Specifications" and "Frequency Tolerance Limitations With Logic Gate Clock Oscillators".

NEL Northern Engineering Laboratories, INC

357 BELOIT ST., BURLINGTON, WI 53105 (414) 763-3591

Circle 168 on reader service card

Our 32-channel logic state analyzer is a micro-computer. Use it with our Model 70 Serial Interface Probe to analyze RS-232 and TTY characters and handshaking signals. You can even echo messages and transmit canned and custom tests directly to your equipment. Call or write Paratronics, Inc., 122 Charcot Ave., San Jose, Ca. 95131, (408) 263-2252.

PARATRONICS INC.
Outside California - call toll free:
(800) 538-9713

SERIAL TESTING

Model 532,
\$1950* plus probes
and options.
*U.S. price only.

PARATRONICS

New products

mally performed by assembly-language software. It can run on either an EXORciser or a Tektronix 8002 with a 6800 emulator board.

Compiled outputs can be directly loaded without assembly or linking into read-only or read/write random-access memories in accordance with a user-defined map. Furthermore, such programs can run without a resident monitor program or run-time subroutine package. These attributes suggest that the compiler be used to generate programs for stand-alone systems such as single-board computers.

Extensions to standard Basic realized in the compiler can support Boolean and shifting operations, interrupt processing, extended string and character functions, and run-time memory allocation. The listing provides detailed memory assignments to simplify debugging. The program needs a 32-kilobyte slot in the development system's memory to run and a disk operating system for compilation.

Microware Systems Corp., 2035 East Ovid Ave., Des Moines, Iowa 50317 [377]

Microcomputers consume up to 35 times less power

Using its XMOS process, National Semiconductor has developed a family of 8-bit, single-chip microcomputers that includes the popular 8048 series and some proprietary designs as well. The technology results in chips that are not only 15 to 20% smaller than their competition, but consume 20 to 25% less power in operation and 12 to 35 times less during standby.

The INS8050 is one of the family's new designs. It contains 4 kilobytes of read-only memory and 256 bytes of read/write memory—more than twice the capacity of any similar device, the company says. The 40-pin devices will work with software generated for earlier 8048 systems.

National Semiconductor Corp., 2900 Semiconductor Dr., Santa Clara, Calif. 95051 [378]

ELEC-TROL VARI-PACK REED RELAYS

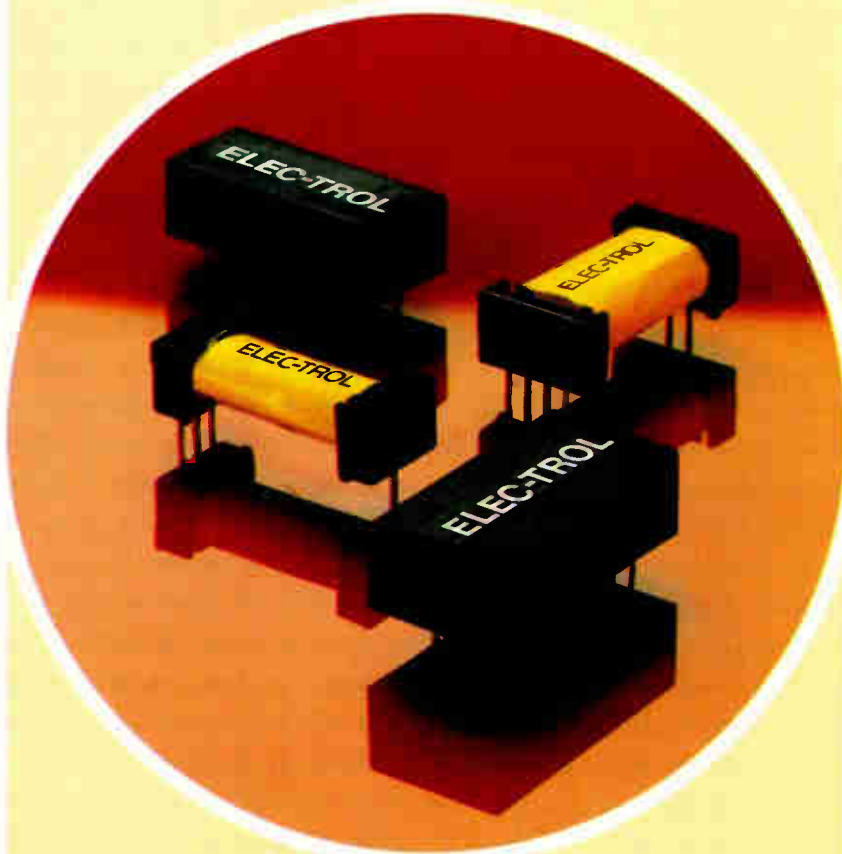

NOW! A NEW LINE OF LOW-COST OPEN AND SEALED REED RELAYS

Elec-Trol now offers a line of Vari-Pack Reed Relays featuring both low-cost open units and inexpensive sealed units.

The sealed units are about the same size as the former encased models, and the new open units have narrower bobbins and are smaller than previous models for improved packing density. Both models are available with coil ratings of 5, 6, 12, 24, and 48 VDC; and they retain all the electrical performance characteristics of Elec-Trol's former open and encased lines. Terminals are 0.1" grid by 1", center-to-center. Height: .375".

Vari-Pack relays are offered with dry reed contact forms A, B, and C, and mercury-wetted contact form A, in single and multiple pole versions. All form B relays are furnished with magnetic shielding, which is available as an option on form A and C relays. The new sealed versions sell for approximately 30% less than former encased units, and the new open versions are priced about the same as Elec-Trol's previous line of open relays.

For more information, use the reader service card. For samples or off-the-shelf delivery, contact your Elec-Trol distributor.

Elec-Trol, Inc., 26477 N. Golden Valley Road, Saugus, CA 91350. (213) 788-7292, (805) 252-8330. TELEX 18-1151.

ELEC-TROL

ELEC-TROL RELAYS



SEALED REED RELAYS AT LOWER COST

Elec-Trol's new commercial grade, form A Blue Boy Reed Relays are now offered in production quantities for as low as 59¢, and both commercial and instrument-grade units are available from distributor stock. Although completely sealed against hazardous environments, production cleaning solvents, and rough handling, these Blue Boys cost far less than standard sealed units. For more information, contact your local distributor.

Try our free samples.

AUTHORIZED DISTRIBUTORS

ALABAMA HUNTSVILLE
Component Distributors, Inc. (205) 883-7501

CALIFORNIA IRVINE
Acacia Sales, Inc. (714) 549-0954,
(213) 971-2428

CALIFORNIA SAN DIEGO
Acacia Sales, Inc. (714) 565-4365

CALIFORNIA SUNNYVALE
Acacia Sales, Inc. (408) 745-7200

CALIFORNIA VAN NUYS
Patane Avionics, Inc. (213) 988-4455

CANADA DOWNSVIEW, ONT.
Semad Electronics Ltd. (416) 663-5650

COLORADO LAKEWOOD
Acacia Sales, Inc. (303) 232-2882

FLORIDA CLEARWATER
Diplomat/ Electronics, Inc. (813) 443-4514

FLORIDA FORT LAUDERDALE
Component Distributors, Inc. (305) 971-4950

ILLINOIS ELK GROVE VILLAGE
Diplomat/ Electronics, Inc. (312) 595-1000

MASSACHUSETTS HOLLISTON
Diplomat/ Electronics, Inc. (617) 429-4121

MICHIGAN FARMINGTON
Diplomat/ Electronics, Inc. (313) 477-3200

MINNESOTA MINNEAPOLIS
Diplomat/ Electronics, Inc. (612) 788-8601

MISSOURI ST LOUIS
Diplomat/ Electronics, Inc. (314) 645-8550

NEW JERSEY EDISON
Brothers Electronics, Inc. (201) 985-3000

NEW YORK MT VERNON
Sonkin Electronic Distribution, Inc.
(914) 668-9809

OHIO SOLON (CLEVELAND)
Recco (216) 248-8900

PENNSYLVANIA
HUNTINGDON VALLEY
Shap Electronics Co., Inc. (215) 322-7150

TEXAS DALLAS
Solid State Electronics Co. of Texas, Inc.
(214) 352-2601

TEXAS HOUSTON
Harrison Equipment Co. (713) 652-4750
Solid State Electronics Co. of Texas, Inc.
(713) 772-8510

UTAH SALT LAKE CITY
Diplomat/ Electronics, Inc. (801) 486-4134

Circle 169 on reader service card

While you're searching
for component solutions . . .

Expand
your
horizon
of
choice

with Centralab pushbutton switches . . .



PBS-Series
horizontal
mounting



The secret to widening your choice of pushbutton switches is the unusual flexibility of Centralab's modular pushbutton switch systems. You'll find lighted and non-lighted switches for pc board or front panel mounting; single station or ganged assemblies with 10 to 25mm spacings; 2-4-6 or 8 pole designs for push-push, push-pull, momentary or interlocking operation with lockout options; silver or gold contacts; epoxy sealed terminals; and a variety of switch housing materials. An outstanding choice of other options include buttons, colors, lenses, filters and legends.

Our comprehensive catalog will show you how to expand your horizon of choice with Centralab pushbutton switches. For a copy, or for application assistance, call your Centralab Sales Representative listed on the opposite page or write us.



MPS-Series
vertical
mounting

Products you need from people who care.



CENTRALAB

ELECTRONICS DIVISION
GLOBE-LINCO INC.

P.O. Box 858
Fort Dodge, Iowa 50501

CERAMIC CAPACITORS • EMI/RFI FILTERS • POTENTIOMETERS • SWITCHES • THICK FILM CIRCUITS • TRIMMER RESISTORS

Circle 170 on reader service card

... call your Centralab
Sales Representative

ALABAMA
Huntsville
Cartwright & Bean, Inc.
(205) 533-3509

ARIZONA
Phoenix
Clemick-Neenan &
Assoc.
(602) 279-7649

CALIFORNIA
Palo Alto
Brooks Technical Group
(415) 328-3232

Sherman Oaks
Clemick-Neenan &
Assoc.
(213) 990-3150

Tustin
Clemick-Neenan &
Assoc.
(714) 547-0966

COLORADO
Denver
Electro-Rep. Inc.
(303) 744-2821

CONNECTICUT
Meridian
Centralab
(203) 235-0766

FLORIDA
Ft. Lauderdale
Cartwright & Bean, Inc.
(305) 735-4900

Orlando
Cartwright & Bean, Inc.
(305) 422-4531

GEORGIA
Atlanta
Cartwright & Bean, Inc.
(404) 255-5262

HAWAII
Honolulu
Dougherty Enterprises
(808) 847-4144

ILLINOIS
Des Plaines
Centralab
(312) 694-4870

INDIANA
Indianapolis
Les M. DeVoe Co.
(317) 842-3245

IOWA
Cedar Rapids
Jerry Vrbik Co.
(319) 366-8733

KANSAS
Shawnee Mission
Lowell-Kangas &
Assoc.
(913) 631-3515

LOUISIANA
Metairie
Cartwright & Bean, Inc.
(504) 834-2350

MARYLAND
Columbia
Bresson Assoc. Inc.
(215) 664-6460

Towson
Bresson Assoc. Inc.
(215) 664-6460

MASSACHUSETTS
Needham
Centralab
(617) 444-4781

MICHIGAN
Lathrup Village
Centralab
(313) 559-9095

St. Joseph
Centralab
(616) 983-0233

MINNESOTA
Minneapolis
Centralab
(612) 831-5212

MISSISSIPPI
Jackson
Cartwright & Bean, Inc.
(601) 981-1368

MISSOURI
St. Louis
Lowell-Kangas &
Assoc.
(314) 821-4050

NEW JERSEY
Paramus
Centralab
(201) 262-6716

NEW YORK
Albany
Reagan/Compar Albany
(518) 489-7408

Endwell
Reagan/Compar Albany
(607) 723-8743

Fairport
Reagan/Compar Albany
(716) 271-2230

New Hartford
Reagan/Compar Albany
(315) 732-3775

NORTH CAROLINA
Charlotte
Cartwright & Bean, Inc.
(704) 377-5673

Raleigh
Cartwright & Bean, Inc.
(919) 781-6560

OHIO
Cleveland
Centralab
(216) 526-1205

Columbus
Centralab
(614) 888-2150

OREGON
Portland
Centralab
(503) 620-1611

PENNSYLVANIA
McMurray
Centralab
(412) 941-7440

Narberth
Bresson Assoc. Inc.
(215) 664-6460

TENNESSEE
Knoxville
Cartwright & Bean, Inc.
(615) 693-7450

Memphis
Cartwright & Bean, Inc.
(901) 276-4442

TEXAS
Austin
Centralab
(512) 454-9529

El Paso
Centralab
(915) 779-3961

Farmers Branch
Centralab
(214) 243-8791

VIRGINIA
Lynchburg
Bresson Assoc. Inc.
(215) 664-6460

WASHINGTON
Bellevue
Centralab
(206) 454-7754

WISCONSIN
Milwaukee
Centralab
(414) 228-2122

PUERTO RICO
Hato-Rey
M. Anderson Co., Inc.
(809) 751-2026

CANADA
BRITISH COLUMBIA
North Vancouver
Arwin Tech Sales Ltd.
(604) 980-4346

ONTARIO
Ajax
McHugh Electronics
Ltd.
(416) 683-1540

QUEBEC
Ste. Dorothee Laval
Harnett Enterprises
(514) 689-4184

New products

Semiconductors

CRT controller avoids contention

Monolithic unit also handles
row-column addresses and
detects light-pen strokes

Look behind the cathode-ray tube of many terminals these days and chances are pretty good that you will find a microprocessor. Some time ago, Motorola recognized the growing popularity of this combination and developed for it the MC6845 CRT controller, gaining an enviable position in the marketplace. Now, Synertek has taken a hard look at that part and decided it would do much more than just develop into a second source.

Starting with that controller's chip design, Synertek's engineers added some extra registers and an address multiplexer, thus developing a pin-compatible part with value-added features. Called the SY6545, it

permits the refresh read/write random-access memory (RAM) to be isolated from the central processing unit's address and data lines, alleviating the need for external anti-contention circuitry.

"In using the 6845, both the CPU and the CRT controller must access the refresh RAM's address and data buses," says Conrad J. Boisvert, applications manager for Synertek's MPU group. "In order to prevent bus contention, you have to design in extra hardware." With the SY6545, the CPU communicates with memory through the controller, so a designer eliminates the need for that hardware. He must, of course, add some extra programming steps to accommodate the controller's new role.

The 6845 is set up for straight binary addressing only, so software routines are required to convert row-column addresses from a keyboard into sequential binary addresses. The SY6545, however, permits a designer to store characters by row and column locations, requiring less software. The price paid for this is in hardware: either the system will require more memory to store data directly in this form, or conversion

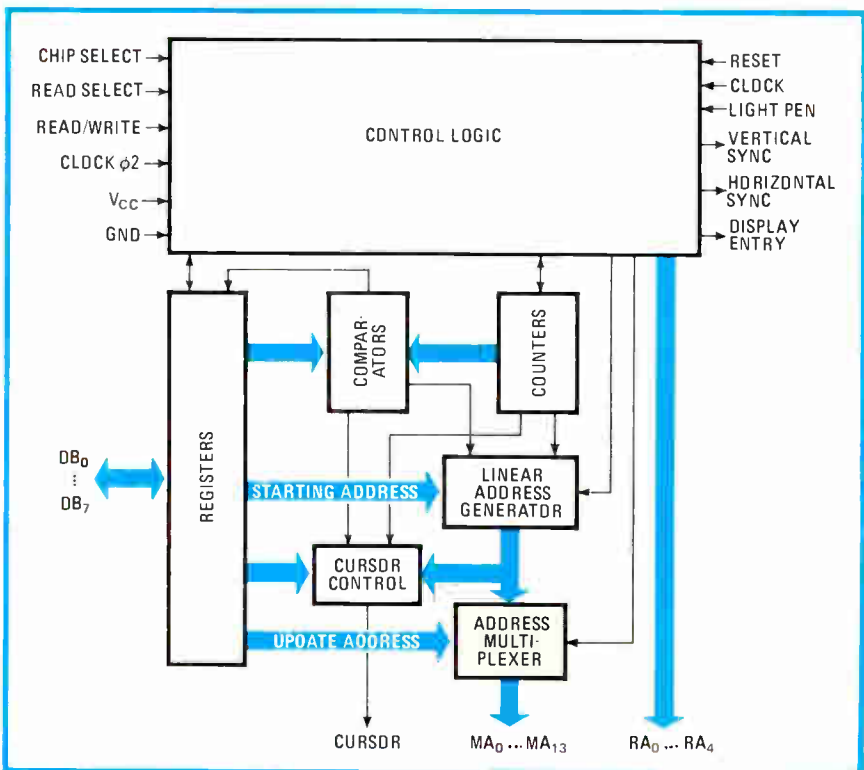



AO STEREOSTAR[®] Microscope. It has everything from A to Zoom.

**ALL ESSENTIAL FEATURES FOR AN
OUTSTANDING INDUSTRIAL MICROSCOPE**

Auxiliary Lenses: .5x, 2x

Body Rotation: 360°

Eyepieces: 10x, 15x, 25x

Field Size Range (inches): .13-2.25

Magnification: Standard 7-30x; Range 3.5-150x

UL listed Illuminator

Working Distance: Standard, 4.0 inches; Range, 1.4-5.7 inches

**Zoom Range: .7-3x; Zoom Control: Dual Side Mounted; Zoom
Ratio: 4.3-1**

These are all features you want and need for efficient assembly or inspection of microcomponents. The AO STEREOSTAR ZOOM Microscope was specifically designed for production-line applications. It's easy to use, with plenty of working distance plus coupled zoom control conveniently located on both sides. And traditional AO quality optics give very high resolution for crisp, sharp images. Send for a detailed brochure. American Optical, Scientific Instrument Division, Buffalo, NY 14215.

AO
American
Optical

New products

hardware will be required to change row-column into binary addresses to increase storage efficiency.

A third feature that sets the Synertek chip apart from the 6845 is its three-bit status register. "Instead of the CPU depending on external interrupt circuitry to know when a light-pen strobe has occurred, the light-pen bit on the 6545's status register is set when a strobe is detected on the light-pen input. The CPU then knows as soon as it examines the register that there's been a strobe," Boisvert explains.

A convenient time for the CPU to update the refresh memory without causing a glitch on the screen is during the roughly vertical retrace period; another status bit in the register tells the CPU when that retrace is in progress. When the memory has been updated, the register's "ready" status bit is set, informing the CPU that the RAM is prepared to accept more update data.

Plastic and ceramic versions of the SY6545 are being sampled now and production quantities are slated for June. The device is guaranteed to operate at any microprocessor clock rate from 1 MHz down to only 25 kHz and is priced at \$21 (plastic) or \$29.40 (ceramic) in quantities of 100 or more. A faster "A" version (maximum clock rate of 2 MHz) is being planned.

Synertek, P.O. Box 552, Santa Clara, Calif. 95052 [411]

Fast C-MOS gates crash into low-power applications

For fast analog switching at reasonably low leakage levels, designers have turned to hybrid circuits like the popular DG180 and DG190 families. Now by applying monolithic complementary-metal-oxide-semiconductor technology, Intersil Inc. product engineers are mounting some potentially strong competition to the hybrid devices with a family of analog gates that feature comparable speeds, but with lower power and leakage characteristics.

ON THE BENCH, THE MOST ADVANCED DVM. IN SYSTEMS TOO.

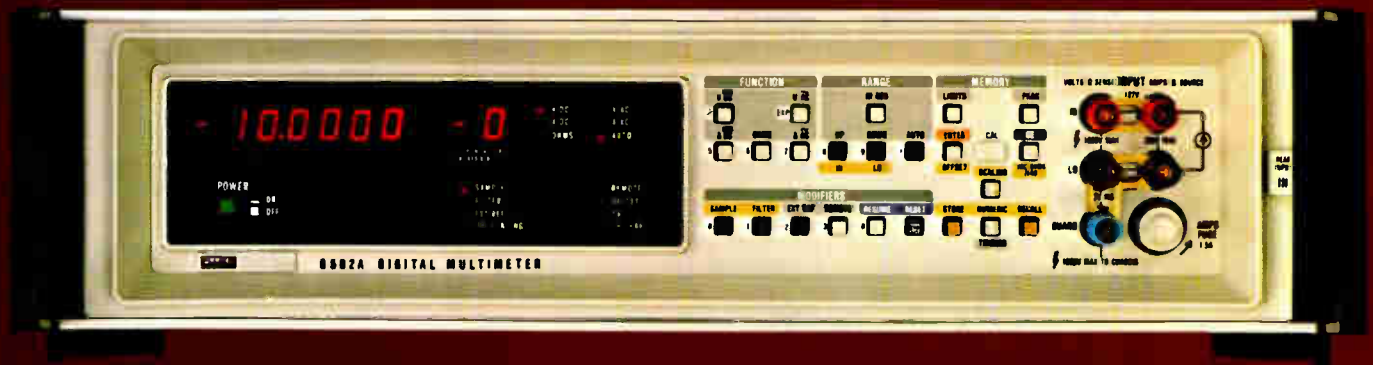

The new 8502A digital voltmeter—the precision DVM just right for both systems *and* bench applications.

It's right because it brings all the power of the 8500A, the world's most advanced system DVM, to the front panel.

Press SCALING and enter any multiplier to scale volts, ohms or amps to temperature, percent, engineering units, or any scale of convenience. Press OFFSET and add or subtract any numerical value to set your prescaled units to the right reference point.

If you're looking only for a good/bad indication, use LIMITS and key in both high and low tolerance values on any function. After that you'll get a friendly "Hi, Pass or Lo" reading at full accuracy.

The 8502A remembers its highest and lowest readings. Leave it unattended on a stability test, for example, then touch PEAK, HI and LO later to observe the amount of drift that occurred.

Want 6½-digit resolution? Press HIRERES and get it on all functions. This lets you utilize the full instrument accuracy—6 ppm on DC volts.

The 8502A is fast—up to 250 readings/second on the bench, 500/second in a system. This speed is put to work to provide noise rejection through digital averaging. Adding analog filtering gives you up to 100 dB NMR.

Calibration memory is a Fluke exclusive that saves time and money.

"Y=AX+B"

Without removing the voltmeter or taking off covers, simple recalibration is done from the front panel in a few minutes. Lab calibration is recommended only once a year if calibration memory is used.

The five FUNCTION pushbuttons are evidence of another exclusive. Besides volts and ohms, the 8502A can have AC and DC current capability installed, a feature not available in any other precision DVM.

We even provide diagnostic error codes to keep you out of trouble by identifying programming mistakes and hardware errors.

For systems use, we offer more interface options than anyone: IEEE 488, RS-232 or full parallel. And, a switchable front/rear input option is available.

U.S. base price: \$2595.

For more information, contact any one of the more than 100 Fluke offices or representatives, worldwide. In the U.S., CALL (800) 426-0361*, TOLL FREE. Residents of the U.S.A. and all countries outside Europe, contact: John Fluke Mfg. Co., Inc., P.O. Box 43210, Mountlake Terrace, WA 98043, U.S.A. Telex: 32-0013.

In Europe, contact Fluke (Nederland) B.V., P.O. Box 5053, Tilburg, The Netherlands. Telephone: (013) 673973. Telex: 52237.

*Alaska, Hawaii, Washington residents — please call (206) 774-2481.



FLUKE[®]

6104-8002

For Technical Data Circle #173 on Reader Service Card

For Demonstration Circle #226 on Reader Service Card

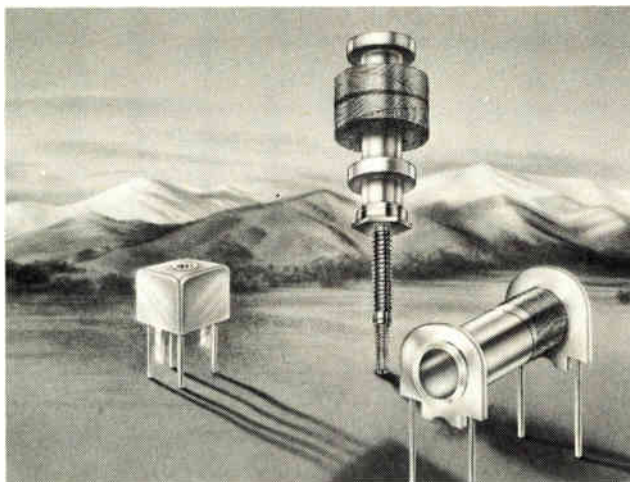

Coil well.

You've struck it rich if you need wound tunable coils with overlapping inductance ranges. CAMBION's broad standard line is immediately available from stock. Custom coils in a wide spectrum of inductances and configurations also available.

Standard micro-mini inductors, shielded and unshielded types, molded chokes, are yours for the asking. For custom needs, the difficult takes a little time. The impossible takes a little longer. Write for the best catalog in the field. Cambridge Thermionic Corporation, 445 Concord Avenue, Cambridge, MA 02138. Phone: (617) 491-5400. In California, 2733 Pacific Coast Highway, Torrance, CA 90505. Phone: (213) 326-7822.

CAMBION

Guaranteed to be the right connection.

Circle 174 on reader service card

FREE 32 pages of light reading

And a free sample too!



IDI's new 32 page off-the-shelf catalog/technical manual offers you page after page of specifications on a seemingly endless variety of LEDs, indicator lights, and lampsockets. It's chock full of data on the newly expanded line of solid state lights, as well as valuable information on relampable and non-relampable indicators. Includes a certificate for a FREE sample of your choice.



Call Toll-Free or write
Industrial Devices, Inc.
Edgewater, N.J. 07020
800-526-0488
(In New Jersey — 201-224-4700)

New products

The first hybrids to be challenged are the DG182 single-pole single-throw, DG188 single-pole double-throw, DG191 dual single-pole double-throw, and the DG185 dual double-pole single-throw circuits. Their pin and functional C-MOS equivalents are the IH5141, 5142, 5143, and 5145, respectively. But a DG191 hybrid, for example, contains five individual chips, whereas the IH5143 has only one. Thus, the monolithic chip should offer improved reliability along with C-MOS technology's low power dissipation.

"More and more designers are setting power limits on their systems designs—they are aiming at low rather than high milliwatts of power," asserts Skip Osgood, Intersil's data acquisition products marketing manager. In comparison with the DG191's 1.5-mA positive-supply and 5-mA negative-supply requirements, the IH5143 is a power miser that draws only 10 μ A on each supply over the entire -55° to $+125^{\circ}$ C military-temperature range, according to Osgood.

Current leaking through the drain-to-source "on" resistance of a field-effect transistor produces a voltage drop, hence is a major source of errors in solid-state analog switches. Whereas the on-resistances in both the hybrid and monolithic units are of the same order of magnitude (50 to 75 Ω), the C-MOS device's leakages are an order of magnitude lower. Source and drain leakages (in the "off" mode) are both 0.1 nA for the IH5143 versus 1 nA for the DG191. Drain leakage in the "on" mode is only 0.2 nA for the C-MOS device versus 2 nA for the hybrid.

It is important for the FET switches to turn on and off quickly, and both devices are fast, with the C-MOS product having an edge in turn-on time (175 versus 200 ns). Equally important is the switches' ability to turn off faster than they turn on so that two lines are not inadvertently tied together because one switch turned on before the other turned off. Both technologies provide turn-on times (125 ns for the IH5143 and 130 ns for the DG191) faster than the turn-off times. The

NOW...

obsolete decoupling capacitors

A hand is shown holding a green printed circuit board (PCB) populated with numerous small, dark, rectangular Q/PAC elements. The board is angled, showing its components and a gold-plated edge connector. In the background, a pile of obsolete, cylindrical decoupling capacitors is visible, some still in their original metal mesh packaging. The background is a light-colored, textured surface.

with Q/PAC™

New, high capacitance Q/PAC* power distribution elements are the exciting, revolutionary way to eliminate decoupling capacitors from printed circuit boards. Rugged Q/PAC elements are easy to install and increase system reliability through reduced part count.

Q/PAC elements are available in capacitance values up to $0.05\mu\text{f}$ per inch in lengths up to 16 inches. Configurations allow for either vertical mounting or horizontal installation under DIP packages.

*Patent Applied For

Q/PAC elements eliminate the need for on board power traces and extra board layers. They maximize packaging density and minimize signal interconnection problems.

Q/PAC elements feature a low dissipation factor, low inductance and low impedance.

Pack more on static and dynamic MOS memory boards, more on critical random logic boards.

Contact the Q/PAC Product Specialist at (602) 963-4584.

ROGERS

Rogers Corporation
Chandler, Arizona 85224

EUROPE Mektron NV Gent, Belgium JAPAN Nippon Mektron Tokyo

For immediate need circle #175

For information only circle #262

Temporary
Memory Loss
in your
**4K & 16K
RAMS?**



Cure it with our **BUFFERED DELAY LINES**

Data Delay Devices Inc. offers the widest variety of Digital Delay Units. 14 pins DIP and 16 pins DIP. 1 to 10 outputs and digitally programmable delay time. These units eliminate the interfacing in TTL circuits and save PC board real estate.

With the following advantages:

- TTL input and outputs
- Fast rise — Time on all taps
- Each tap isolated with TTL Fan-out capabilities
- Exact delay at each tap
- 2,000 NS total delay
- Up to 10 taps
- Totally Programmable



Request complete catalog

**DATA DELAY
DEVICES INC.**



385 Lakeview Ave., Clifton, New Jersey 07011
Telephone (201) 772-1106

New products

test conditions, however, are not identical; the C-MOS part is switching ± 10 V into a 1-k Ω , 10-pF load, whereas the hybrid's times are based on ± 3 -V swings into a 300- Ω , 30-pF load.

Although there are significant differences in characteristics between the C-MOS and hybrid families, that is not true of their prices. For example, in 100 and greater quantities the military version of the DG191 (DG191AP) sells for \$27.75 and its C-MOS equivalent, the IH5143MDE, costs \$25. However, each C-MOS device comes in a commercial temperature range plastic package at considerably lower prices. The IH5143CPE, for example, goes for only \$5.40. Military versions of the IH5141, 5142, and 5144 are all \$19.50; the IH5140 costs \$17.55; and the IH5145 is \$25. Plastic versions of each are \$4.50, \$4.05 and \$5.40, respectively, and delivery is from stock.

Intersil, Inc., 10900 N. Tantau Ave., Cupertino, Calif. 95014 [412]

Booster lets op amps drive 50- Ω cables

Designed to boost the current output of operational amplifiers such as Teledyne Philbrick's 1435, the 2035 is a high-speed unit with a slew rate of 250 V/ μ s. Able to deliver ± 5 V at ± 100 mA, the booster makes it possible for those op amps to drive 50- Ω coaxial cables at high rates.

When used with a 1435, the 2035's output settles to within 0.025% of final value in 130 ns for a 10-V step. It has a typical gain-bandwidth product of 700 MHz and a full-power bandwidth of 8 MHz.

Packaged in a TO-3 case, the unit operates over the range from -55° to $+125^\circ$ C. All units are processed to MIL-STD-833 specifications. In single quantities, the 2035 can be purchased for \$29 or, with additional burn-in and temperature cycling, for \$44. Delivery is from stock.

Teledyne Philbrick, Allied Drive at Route 128, Dedham, Mass. 02026. Phone Wah Fea Ng (pronounced Eng) at (617) 329-1600 [414]

Instant Access to All American and International

Data Communications Standards

**Presents all 89 relevant
data communications
standards promulgated by:**

- CCITT • ISO
- ANSI • EIA • FTSC

Plus... descriptions of each of the standards groups
And... relational charts of similar interfacing standards produced by each group

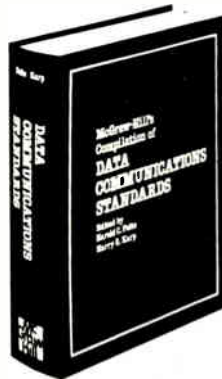

1133 pages
Edited by
Harold C. Folts
and
Harry R. Karp

Order today using this coupon!

Return coupon to:
Data Communications Standards
P.O. Box 669
Hightstown, New Jersey 08520

Send me _____ copy (copies) of **DATA COMMUNICATIONS STANDARDS** (099782-9) on a 10-day money-back guarantee. I understand that if I am not absolutely satisfied, I may return the book(s) within ten days at no further obligation. Otherwise, McGraw-Hill will bill me \$165. for each copy, plus applicable sales tax, shipping and handling charges.

_____ Check enclosed
_____ Bill me
_____ Bill my company
_____ Company purchase order #



SAVE MONEY! Enclose payment in full, plus local sales tax, and McGraw-Hill pays all regular shipping and handling charges. Ten-day money-back guarantee still applies

Name _____
Title _____
Company _____
Address _____
City _____ State _____ Zip _____

This offer subject to acceptance by McGraw-Hill ELT

Everything you need to know about flat cable/ connector systems.

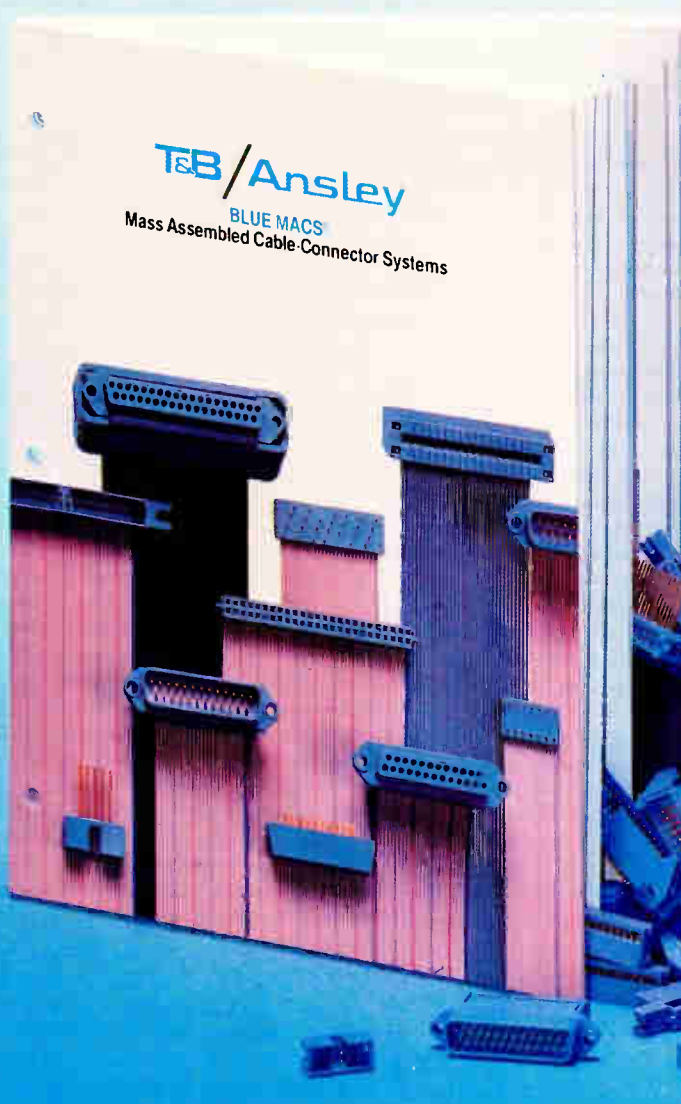

To save space. To increase circuit flexibility and reliability. To lower total installed cost. To profit from the state-of-the-art in mass termination.

T&B/Ansley offers you the industry's broadest line of flat cable/connector systems. That's because we've been flat cable specialists for decades, and we were pioneers in the development of cost effective mass-termination techniques for volume production and ease of assembly.

Now we're also offering an engineering specification bible that tells you everything you need to know about mass-termination cable/connector systems.

That includes connectors, headers, mounting hardware. It includes round and flat conductor flat cable, as well as jacketed and shielded jacketed cable. It includes our MICRO-PITCH line, which is ideal for mass termination in high density, controlled impedance applications. And our FLEXSTRIP® Jumpers, the most flexible, reliable components available for interconnecting one circuit board to another.

It includes a complete line of hand and bench tools for volume installations, small production runs, or field service applications.

And a great deal more. And it's free. So you'll never get a better offer. Call or write today.

T&B/Ansley

The mass termination company.

T&B/Ansley Corporation
Subsidiary of Thomas & Betts Corporation
3208 Humboldt St. • Los Angeles, CA 90031
Tel. (213) 223-2331 • TELEX 68-6109
TWX 910-321-3938

Stocked and Sold through Authorized
Ansley Distributors.

Circle 177 on reader service card

Send for your free copy today!

International T&B/Ansley Offices: AUSTRALIA, Brookvale, (02) 938-1713 • AUSTRIA, Vienna, (222) 645206 • CANADA, Iberville, Quebec, (514) 347-1014 • ENGLAND, Luton, (0582) 597-271 • FRANCE, Rungis, 687-23-85 • HOLLAND, Zoetermeer, (79) 214688 • ITALY, Milano, 02-4986451 • JAPAN, Tokyo, 03-354-9661 • SINGAPORE (65) 2923711 • SOUTH AFRICA, Benrose 24-8134 • SPAIN, Barcelona, (93) 212-8607 • SWEDEN, Upplands Vasby, 0760-86140 • SWITZERLAND, Hombrechtikon, (04155) 422791 • WEST GERMANY, Dreieich bei Frankfurt, 06103-8 20 21.



VECTOR-PAK ENCLOSURES

COLORFUL BEAUTY OUTSIDE – VERSATILE & ACCESSIBLE INSIDE

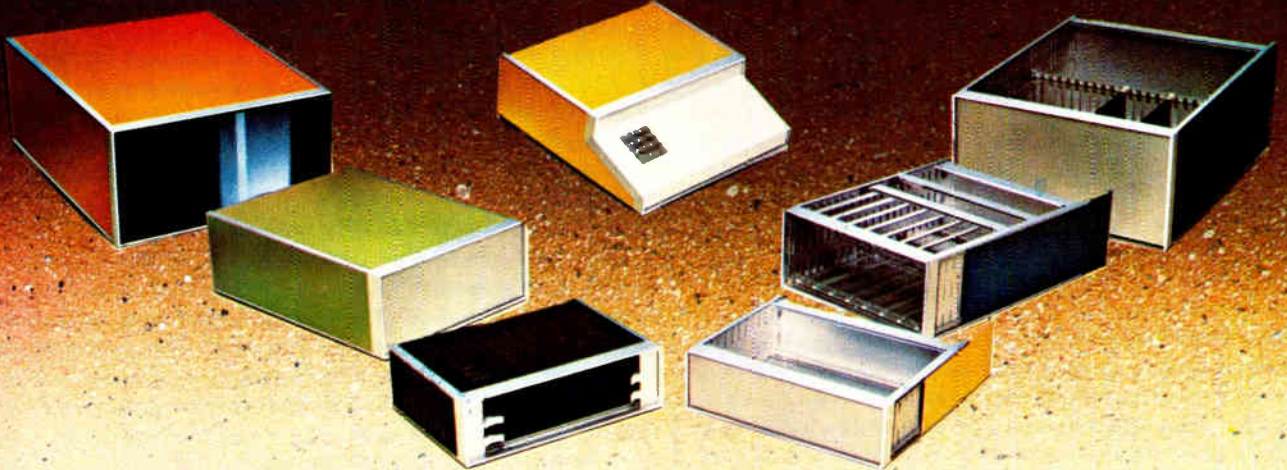

–BEST FROM EVERY ANGLE–

Beautiful and affordable cases, unmarred by screws or fasteners. Instantly accessible interiors with slip out covers. Optional ventilation, handles, stands, slides and mounting holes. Recessed front and rear panels. Styling, finish and details can be modified to make the case uniquely yours. Low in cost.

Fully adjustable interior mounting systems for any card, module or device within size limitations. Cards or modules insert from front or rear, vertically, horizontally, or top down. Circuit cards, modules, guides, connectors, ribbon cables are available. Send for catalog. Rugged—Reliable—Versatile

- 15 STANDARD SIZES, ● 11 COLORS IN TEXTURED VINYL OR ANODIZE
- 11 STANDARD INTERIOR MOUNTING SYSTEMS, ● ONE WEEK DELIVERY IN STANDARD CASES

VECTOR ELECTRONIC COMPANY, INC., 12460 Gladstone Avenue, Sylmar, CA 91342, phone (213) 365-9661, twx 910-496-1439 530577

Our toll-free number which can be used by customers outside of California is 800-423-5659.

Circle 178 on reader service card

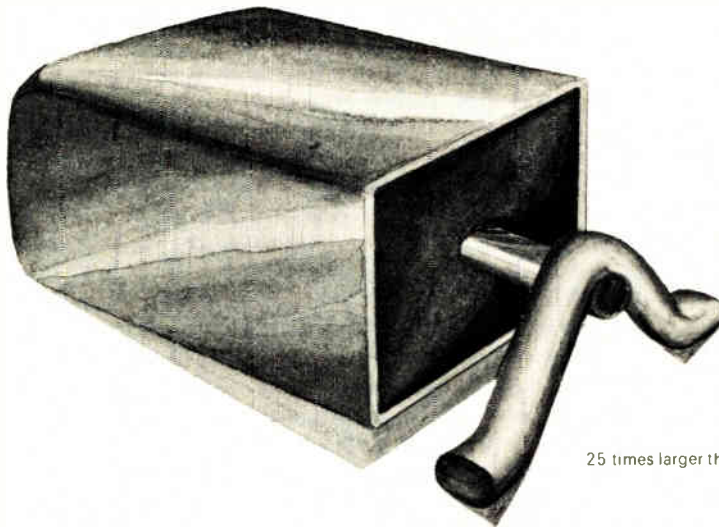

25 times larger than life

A great capacity for punishment

Designed to meet the requirements of the hybrid circuit manufacturer, the Tansitor chip tantalum capacitor is completely encapsulated in a metal case and is able to withstand handling and reflow solder-

ing at high temperature. This chip can be mechanically orientated and is consistent in size. Available in 6 sizes, with a capacitance range of 0.1 to 220 mfd; 2 to 50 Volt. Write or phone for further data.

Tansitor solid tantalum chips

Tansitor Electronics, Inc.
West Road, P.O. Box 230, Bennington,
Vermont 05201 Phone: (802) 442-5473
TWX: (710) 360-1782
Tansitor – reliable in so many ways

Circle 229 on reader service card

FREE "TV GUIDE" FOR OEM'S.

What you put on the screen is your business.
The screen you put it on is ours.

So, we've published a guide to help you choose
the best Conrac CRT monitor for your particular
system application.

If you need high-resolution graphics, for instance,
we can give you up to 1225 lines per frame.

Or, if simple alphanumeric are what you want,
we have simple monitors featuring Conrac
reliability at low cost.

For the ultimate in computer-
generated color imagery,
consider our model 5700. It's a
highly-advanced monitor
featuring superior capabilities

for sophisticated applications.

We've been producing advanced monitors for
29 years. So, no matter what you need in terms of
image display, you can depend on Conrac's
specialized experience and depth of technology.

And, since Conrac monitors are made in the U.S.,
we're always here to supply first-hand
technical assistance and parts.

Call or write today for more details and your copy
of the Conrac Video Monitor
Guide. Conrac Division, Conrac
Corporation, 600 North Rimsdale
Ave., Covina, CA 91722, Tel. (213)
966-3511, Telex: 67-0437.



CONRAC

We're more than meets the eye.

Circle 179 on reader service card



OK, the price is right.
Send the free "TV Guide" today.

NAME _____ TITLE _____
COMPANY _____
ADDRESS _____
CITY, STATE, ZIP _____
PHONE _____



Get the FACTS on our MICROPROCESSORS from

SOLID STATE SCIENTIFIC

The **MOSSOURCE**.

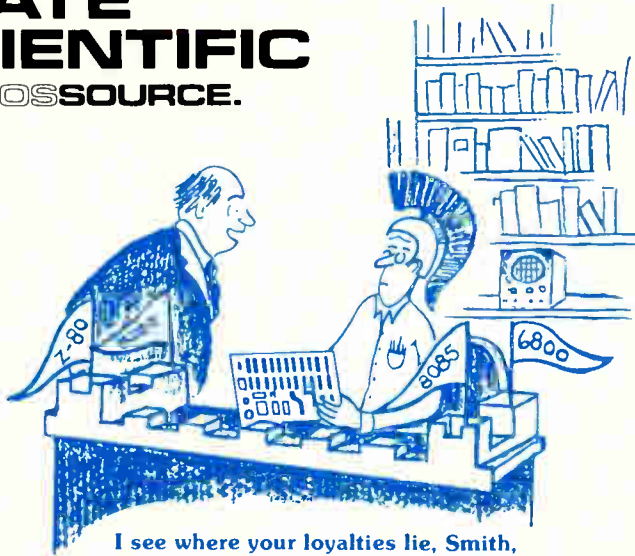

I see where your loyalties lie, Smith, but your data isn't complete if you don't have information about SOLID STATE SCIENTIFIC'S 1802 MICROPROCESSOR.

ANOTHER of the MANY SIDES of SOLID STATE SCIENTIFIC

Copy or clip coupon below and attach to your letterhead. Mail to: or Call:

SOLID STATE SCIENTIFIC
Montgomeryville, Pa. USA 18936
215-855-8400

Send me Facts about your μ MOS families.

Name _____
 Position _____
 Company _____
 Street _____
 City _____ State _____
 Zip _____
 Phone _____

Circle 182 on reader service card

Also send information about THE OTHER SIDES OF SOLID STATE SCIENTIFIC:

- DT/ μ MOS Systems
- CMOS Memories
- Custom MOS ICs
- Hi Rel MOS ICs
- Data Communications
- Display Drivers
- Security ICs
- 4000 Series
- Timekeeping

The magazine you're reading now, could be your own.

Drop off the routing list. Get your own fresh, unclipped copy mailed to your home or office. Turn to the subscription card in the back of the magazine. If somebody has beat you to it, write: Electronics, P.O. Box 430, Hightstown, N.J. 08520.

New products

voltages in two ranges: 70 to 140 and 140 to 280 v ac from 47 to 440 Hz. They also accept inputs between 200 and 400 v dc. Overvoltage protection is standard, with shutdown occurring at 150 or 300 v ac or at 420 v dc. The units can sustain maximum input voltages of 170 v ac, 350 v ac, or 500 v dc, depending on range.

Also standard is a soft-start feature that limits the input peak current to 10 A at turn-on. Output current protection is not the usual current-limiting system, but power foldback instead. A crowbar circuit protects the output against overvoltage, and, in addition, unlike many competitive units, the S1 and S2 power supplies are also protected against reverse voltage.

The units also offer remote operation with shutdown and turn-on triggered by standard TTL signals. Carry-over time—the time that the supply meets its output specifications after a power-line dropout—is 30 ms. Since most such dropouts last for one power-line cycle (about 16 ms for a 60-Hz line), this is a comfortable safety margin in the majority of cases.

The two series offer a choice of 5, 12, 24, or 48-v dc outputs with combined line and load regulation of 0.2%. Temperature coefficient is typically 0.02%/°C. Rms ripple and noise are less than 0.1% of the output voltage, while the worst-case peak-to-peak noise is less than 0.5%.

In singles, the S1 supply sells for \$249.95 and the S2 goes for \$279.95. In lots of 10, the prices drop to \$236 and \$250, respectively. Small quantities are available from stock; large orders may take up to a month.

Semiconductor Circuits Inc., 218 River St., Haverhill, Mass. 01830. Phone (617) 373-9104 [381]

Switchers take inputs from 165 to 230 V ac

A line of fan-cooled switchers accepts a nominal input of 208 v ac at 47 to 63 Hz; operating range extends from 165 to 230 v ac. Efficiency is rated at up to 80%. The



9900

New easy-to-use educational module. Your best ticket to the microprocessor world. Ideal for teaching. Yourself. Or others.

TI's new TM990/189 University Module is a stand-alone learning lab. Fully assembled and designed for maximum hands-on experience. To ease and simplify learning and teaching.

Outstanding features include powerful 16-bit microprocessor with easy-to-learn, easy-to-use minicomputer instruction set; 45-key alphanumeric keyboard and ten-digit seven-segment display for easy assembly-language programming; ROM-resident software including system monitor for program debug and symbolic assembler; audio cassette interface; easy-to-add EIA and TTY interface; 1K-byte RAM expandable to 2K; 4K-byte ROM and 2K-byte expansion EPROM socket; 16-bit

programmable I/O controller; user addressable LEDs, and sound indicator.

A 570-page tutorial text accompanies the module. It is a detailed guide for self-paced learning. Or the basis for a three-hour university course. Chapters include an

overview of microprocessors; programming exercises; assembly language; memory systems; I/O concepts and designs; software engineering; product development; a variety of lab experiments, and much more. Also with the module: a 300-page user's guide.

The University Module complete with tutorial text and user's guide is only \$299.00.

Order your University Module from your authorized TI distributor. For more information, write Texas Instruments Incorporated, P.O. Box 1443, M/S 6404, Houston, Texas 77001.

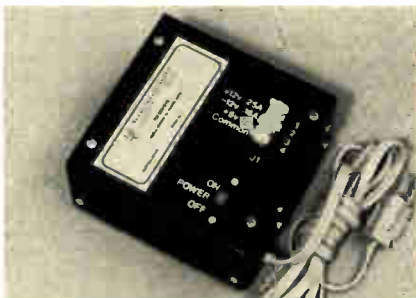

TM990/519 power supply is available for \$65.00.

**TEXAS INSTRUMENTS
MOVING AHEAD
IN MICROCOMPUTERS**



**TEXAS INSTRUMENTS
INCORPORATED**

LOOK! programmable microvolts dc calibrator/standard

EDC model 501 Series J



Programming
IEEE 488 (GP/IB).
or
Binary
or
Parallel/Serial

Range Control
 $\pm 0.1 \mu\text{V}$ to $\pm 1000 \text{Vdc}$
 $\pm 10 \text{nA}$ to 10 Amps dc

Resolution (1ppm)
24 Bits (BCD)
or
20 Bits (Binary)

Local/Remote
Program lines
remain connected.
Uninterrupted
program up-date.

Prices* start at
\$1675

Output Specifications

Range: $10 \mu\text{V}$ to 10Vdc
Accuracy: $\pm 0.005\%$
Speed: $50 \mu\text{s}$
Isolation: $10^5 \Omega$, 130pF, 500 Vdc
Stability: -0.0005%

Optional Functions

100 mV Range: $0.1 \mu\text{V}$ to 100mVdc
200 V Range: $10 \mu\text{V}$ to 200Vdc
1000 V Range: $10 \mu\text{V}$ to 1000Vdc
100 mA Range: $10 \mu\text{A}$ to 100mA
10 Amp Range: $10 \mu\text{A}$ to 10Amps dc

Programming Options

BCD or Binary, Parallel or Serial entry.
ASC II Code, IEEE 488 (GP/IB)

*U.S. Basic Price. Options, Accessories and
Auxiliary Instruments additional.

Call Bob Ross for additional information.



**ELECTRONIC
DEVELOPMENT
CORPORATION**

11 Hamlin St., Boston, MA 02127, Tel. (617) 268-9696

New products

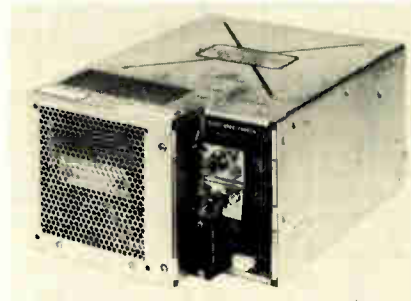

J75OP units deliver up to 840 w at voltages from 2 to 24 v dc, all of which can be adjusted over a range of $\pm 10\%$. Operating at full power from 0° to 50°C , the switchers can be derated for operation at up to 70% of full power at 71°C . They are offered with current ratings from 35 A (at 24 v) to 180 A (at 2v).

Features offered with the JF75OP series include short-circuit protection, reverse-voltage protection, and overvoltage protection. The units may also be connected in parallel. Other capabilities of the switchers are a turn-on delay time of approximately 400 ms after application of input power and a turn-off delay time of 60 ms after power shutdown. Among the available options are silicon-controlled-rectifier crowbar protection and remote programming.

General specifications include regulation to within 0.1% for any combination of line and load conditions, maximum ripple of 10 mv rms (50 mv peak to peak), and a $0.02\%/^\circ\text{C}$ temperature coefficient. In quantities of one to nine, the units sell for \$650 each and delivery is from stock.

ACDC Electronics, Division of Emerson Electric Co., 401 Jones Rd., Oceanside, Calif. 92054. Phone (714) 757-1880 [383]

Externally controlled 30-kV
supply delivers up to $400 \mu\text{A}$

Particularly well suited for electron-beam lithography and similar applications, the 612-300 high-voltage power supply is available in both positive- and negative-voltage models. They provide outputs of from 0 to 30,000 v at $400 \mu\text{A}$ that can be controlled by an external potentiometer.

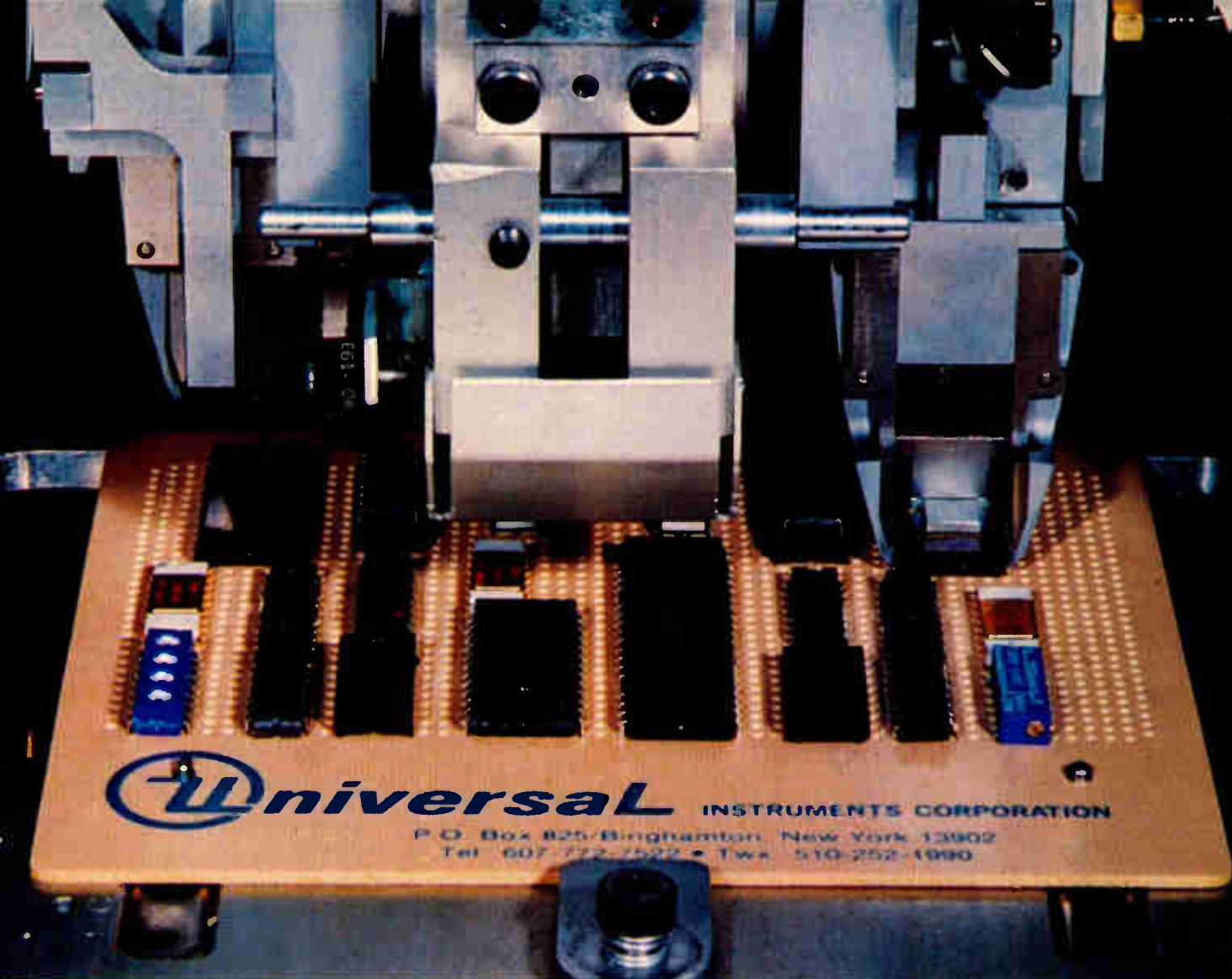

“Multi-Module” can insert all these DIPs and sockets in a single high speed sequence.

Universal's family of "Multi-Module" machines opens the door to new, far higher levels of productivity. Now a single machine can automatically insert DIPs with two different lead spans in a single high speed sequence. You can combine .300" lead span DIPs and sockets with .400" or .600" DIPs. Another member of the family combines inserting 2 and 4 lead types with conventional DIPs. Up to 72 input magazines. Plastic, ceramic or side brazed. Automatic inward/outward cut and clinch.

Call your Universal sales office for a demonstration, or send for information.



Universal Instruments Corporation
Kirkwood Industrial Park
Box 825, Binghamton, New York 13902
Tel: 607/772/7522 TWX: 510/252/1990



- See it demonstrated at NEPCON-East Booth 722

ASTRO-MED

SUPERCORDER SERIES

THE MARK OF Z

The Mark of Z is crisp, clean traces, Instant Writing, and unexcelled accuracy with the Pathfinder™ Position Feedback Galvanometer . . .

PLUS . . .

. . . The convenience of Z-fold chart supply and re-stack. **ASTRO-MED SUPERCORDERS** are available in 1, 2, 3½, 4, 6, and 8 channel O.E.M. models with optional alpha numeric printers — the most advanced recorders in the industry!

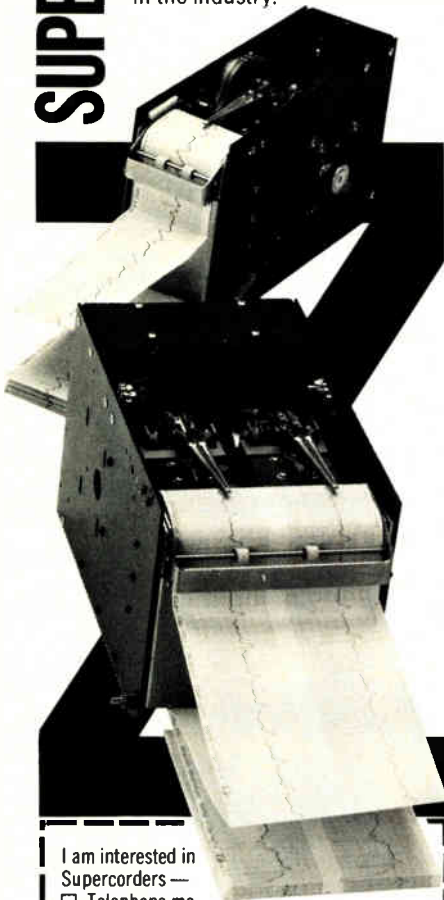

- I am interested in Supercorders —
- Telephone me
 - Arrange demonstration.
 - Send Literature

Name _____

Company _____

Address _____

Telephone _____



ASTRO-MED DIVISION

ATLAN-TOL INDUSTRIES, INC.

Atlan-tol Industrial Park/West Warwick, R.I. 02893
401-828-4000

New products



meter or voltage. Regulation and ripple are within 0.001% of full scale. Selling for \$925 each, the units are available from stock.

Bertan Associates Inc., 3 Aerial Way, Syosset, N.Y. 11791. Phone (516) 433-3110 [384]

Triple-output unit provides 2 V at 30 A for ECL circuitry

Designed for emitter-coupled-logic systems, the PM2675A and PM2676A multiple-output power supplies are intended for mainframe computer and high-speed data communications applications. The units have input-voltage ranges from 92 to 138 v rms or 184 to 250 v rms and provide an output voltage of 2 v dc with current ratings to 30 A in addition to two other outputs. Depending on the input-voltage range, the units can operate at inputs as low as 80 v ac or 140 v ac. The PM2675A and PM2676A have maximum power outputs of 375 w and 600 w, respectively. Regulation is to within $\pm 2\%$ regardless of line changes, static and dynamic load changes, ripple, noise spikes, and temperature variations. In the event of power loss, output voltage is maintained for 30 ms.

Standard features include over-

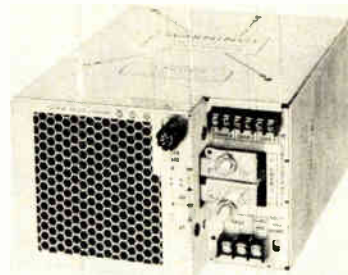

USC UPCC/REPC CONNECTORS

Draw Pull and Screwlocking. Built to MIL-c-55302 and Commercial Specifications Printed Circuit and Related Applications. REPC Connectors are Removable, Re Entrancy, Crimp Contact Types.

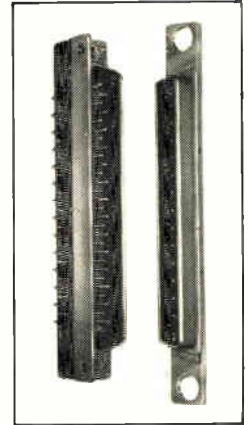

1 of over 20,000 Connector Types Manufactured. Send today for UPCC-REPC-A. Series 32-page Catalog.

U.S. COMPONENTS, INC.

Leader in advanced engineering design

35 Carlough Rd.
Bohemia, N.Y. 11716
(516) 589-8080

Cable. COMPONENTS, NYK

Circle 236 on reader service card

Free!

Booklet shows you how to save hours finding & evaluating semiconductors & ICs.



Free booklet tells how D.A.T.A. BOOKS simplify device searches and comparisons. Shows how D.A.T.A. BOOKS let you make dozens of device comparisons by looking at one page of essential electrical, physical and functional information... by flipping a page for drawings... by finding devices even if you know only a function. Describes these D.A.T.A. BOOKS: Transistors, Diodes, Thyristors; Digital, Linear, Interface and Memory ICs; Microcomputers/Microprocessors, Power Semiconductors, Optoelectronics and Microwave Tubes; and six others covering discontinued types.

D.A.T.A. BOOKS

P.O. Box 602H, Pine Brook, N.J. 07058

Send me your free booklet. I want to see how to slash device search time.

Name _____

Company _____ Title _____

Address _____

City _____ State _____ Zip _____

Mail to: D.A.T.A., Inc.,
P.O. Box 602H, Pine Brook, N.J. 07058



"Heard about the newest member of the Kodak Precision Line family—LEN7—with a 7 mil base for greater dimensional stability?"

"No, but I could use a little more stability myself!"

VERSATILITY IN REPROGRAPHICS

Kodak Precision Line film LEN7, is a pretty amazing act! Quality compares with the finest circuit negative films available at any cost...but LEN7 costs significantly less! LEN7 delivers excellent

line edge acutance, high maximum density and minimum pinholing...and the dimensional stability of a 7 mil Estar base. LEN7. You've got to see it to believe it. It's an incredibly good film for circuit-making and other applications, at a remarkably low price.

For details, write for our information packet. Eastman Kodak Company, Dept. GA014, Rochester, N.Y. 14650.



© Eastman Kodak Company, 1979

Looking For Hi-Voltage Tubulars?

ACUSHNET Transforms Your Capacitor Problems

...for any Specialty Need

For economy in size, economy in cost, and dependable corona resistance through impregnation, hi-voltage tubulars answer your capacitor needs.

And Acushnet has them. Because we specialize in specialty capacitors. We manufacture films in all popular dielectrics, micas, and aluminum electrolytics. Our experienced application team is always available, designing specialized capacitors to solve unique problems.

For years we're the capacitor company that's been growing quietly. The OEM's we service are steady customers because we offer the successful combination of excellent, dependable products and hard-working people concerned about our customers' needs.

Next time you need hi-voltage tubulars or any others... contact us.

Better yet, plan ahead for your specialized needs. Write for our new catalog today.



ACUSHNET CAPACITOR CO., INC.

720 BELLEVILLE AVE. • NEW BEDFORD, MA 02741 (617) 999-3291

At Acushnet. We're Accustomed to Solving Capacitor Problems.

Circle 238 on reader service card

\$231 PAPER-TAPE READER HAS ONE MOVING PART

This paper-tape reader comes with TTL interface and has only one moving part. It reads any standard tape at 150 cps, asynchronous. Bi-directional, the unit stops on character and automatically detects taut tape and end of tape. The reader's user-furnished clock input is a positive-going pulse that advances tape at the input's negative-going edge and

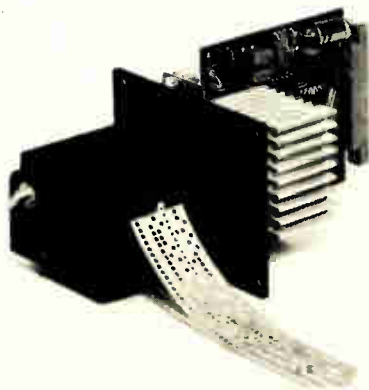

may also strobe the output data. Power requirements are +5V at 200 mA and 24V at 600mA. Stand alone versions with parallel or serial RS 232 outputs, fanfold box and spooler are also available. Price \$231 (100 units). Addmaster Corporation, 416 Junipero Serra Drive, San Gabriel, CA 91776. (213) 285-1121.

188 Circle 188 on reader service card

New products

load protection, short-circuit protection, overvoltage protection, and parallel-connection capability. Available options include a logic inhibit signal, input power-fail signal, and silicon-controlled-rectifier crowbar protection.

Pioneer Magnetics, 1745 Berkeley St., Santa Monica, Calif. 90404. Phone (213) 829-6751 [385]

Dual-output unit powers data-processing equipment

Intended to power electronic data-processing equipment, the HP 62615D dual-output power supply provides voltages of +11.4 to 15.75 V dc and -11.4 to -15.75 V dc at 17.5 A, with a maximum power output of 525 w. The unit's two output voltages are regulated to within 0.1% for full line and load variations with ripple and noise of less than 50 mV peak to peak. When the ac input is interrupted, the supply maintains the terminal voltage for a minimum carryover time of 10 ms under worst-case conditions of low line and full load. Both outputs are isolated from chassis ground and any output terminal may be grounded separately. Efficiency is rated at 67%.

Two versions, one with and one without output tracking, are available. Both types feature silicon-controlled rectifier crowbar protection, and overvoltage protection. In quantities of 100, the 62615 D sells for \$636 each. Delivery time is two weeks after receipt of order.

Hewlett-Packard Co., 1507 Page Mill Rd., Palo Alto, Calif. 94304 [387]

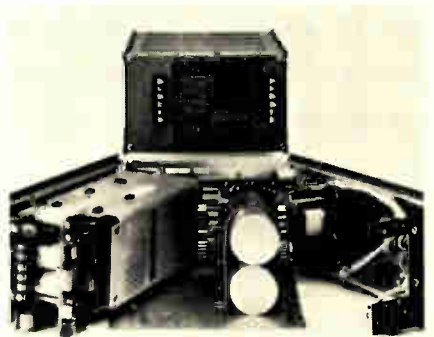

Electronics/May 10, 1979

Put Your P.C. Boards To The Test. Fast.



You make printed circuit boards. Maybe more than anybody else. Now you can test them as fast as you can make them. The Series 50 Circuit Verifiers test all types of bare boards fast — single or double-sided boards, inner-layer, multi-layer or flex circuits.

The complete test cycle time is less than one second for 2048 points. That's testing up to 8,000 points in less than 4 seconds.

The Series 50 high-speed scanning technique and easy operation allow high throughput. And, with a choice of test modes and models, the Series 50 Family allows you to do rapid "go-no-go" testing or to have full error messages printed in

numeric or alpha numeric test point identification.

Go ahead and make P.C. boards as fast as you can. We're right with you. The Series 50 Circuit Verifier line. By ATEC, an Everett/Charles Company.

ATEC

**ASSEMBLY AND TEST
EQUIPMENT CORPORATION**

2806 METROPOLITAN PLACE
POMONA, CALIFORNIA 91767

EVERETT / CHARLES, INC

Circle 189 on reader service card

Just published!

Your guide into the fascinating world of...

PERSONAL COMPUTING Hardware and Software Basics

A reliable, easy-to-use resource that tells you...

What's available in hardware and software, including costs.

Who's using it, and what they've experienced.

How it all works.

Why it's caught on so fast, including practical applications to use now.

Some of the most exciting advances in computing are taking place, not in research labs and commercial facilities, but in homes across the country. All sorts of people with a basic background in mathematics and electronics are taking the computer revolution into their own hands—experimenting with new equipment and technology, and devising their own *personal* applications.

If you've considered joining them, if you've thought about building or buying your own computer—this is a fast, up-to-date guide that answers all your questions precisely and reliably.

At your fingertips, all the most needed information on...

- what's available in personal computers
- the most popular microprocessor chips
- programming at microprocessor level and in high-level languages
- design hitches and how to prevent them
- where to buy
- plus a glossary of the most current terms in home computing

Drawn from major publications throughout the industry...

To get all the up-to-the-minute information and guidelines presented here, you'd have to read through numerous issues of...

- Electronics • Datamation • Mini-Micro Systems • BYTE
- Interface Age • IEEE Spectrum • Kilobaud • People's Computers

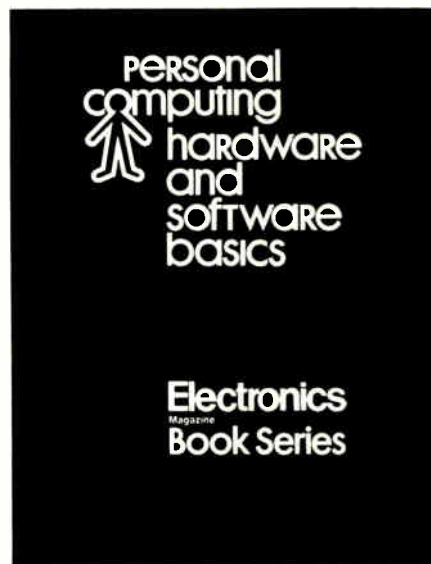

edited by
Raymond P. Capece, Solid State Editor,
Electronics Magazine
266 pages, \$11.95

Table of Contents

Part 1: Introduction to Personal Computing.
The term defined, equipment and components, costs, applications.

Part 2: Basic Computer Theory.
Microcomputer architecture with the emphasis on memory.

Part 3: Advanced Microcomputer Theory.
Board-level computers using the most popular microprocessor chips.

Part 4: Reviews of Personal Computers.
Features and capabilities of the most widely used microcomputers.

Part 5: Software for Microcomputers and Microprocessors.
Description and uses of both machine-level and high-level programming languages.

Part 6: Specifications and Other Useful Information.
Glossaries, microprocessor specs, electronics symbols, buying used equipment.

Electronics Magazine Books
P.O. Box 669, Hightstown, NJ 08520
(609) 448-1700, ext. 5494

No. of Copies	Title	Price
_____	Microprocessors	\$ 8.95
_____	Applying Microprocessors	\$ 9.95
_____	Large Scale Integration	\$ 9.95
_____	Basics of Data Communications	\$12.95
_____	Circuits for Electronics Engineers	\$15.95
_____	Design Techniques for Electronics Engineers	\$15.95
_____	Memory Design: Microcomputers to Mainframes	\$12.95
_____	Personal Computing: Hardware and Software Basics	\$11.95
_____	New Product Trends in Electronics	\$14.95



If after my 10-day free-trial examination I am not fully satisfied I understand that my payment will be refunded.

- Payment enclosed Bill firm Bill me
Charge to my credit card:
 American Express Diners Club
 Visa Master Charge*

Acct. No. _____ Date Exp. _____

*On Master Charge only, first numbers above name _____

Name _____ Title _____

Company _____

Street _____

City _____ State _____ Zip _____

Signature _____

Discounts of 40% on orders of 10 or more copies of each book.

EPROM PROGRAMMER—Model EP-2A-79



SOFTWARE AVAILABLE FOR F-8, 8080, 6800, 8085, Z-80, 6502, KIM-1, 1802, 2650.

EPROM type is selected by a personality module which plugs into the front of the programmer. Power requirements are 115 VAC, 50/60 HZ at 15 watts. It is supplied with a 36 inch ribbon cable for connecting to microcomputer. Requires 1 1/2 I/O ports. Priced at \$145 with one set of software, personality modules are shown below.

Part No.	Programs	Price
PM-0	TMS 2708	\$15.00
PM-1	2704, 2708	15.00
PM-2	2732	25.00
PM-3	TMS 2716	15.00
PM-4	TMS 2532	25.00
PM-5	TMS 2516, 2716, 2758	15.00

Optimal Technology, Inc.

Blue Wood 127, Earlysville, VA 22936
Phone 804-973-5482

Circle 191 on reader service card

Total fiberoptics (full range) Total reliability



FORT **cabloptic**
Optical fibers : from 4 dB to 800 dB
Single-fiber or bundle :
TNC and SMA connectors
Components up to 30 MHz

Why take chances ? With FORT, you've got 10 years' experience in the design of reliable optical fibers and cables tailored to your needs... plus an international user-support network at your beck and call.

FORT Z.I. de la Gaudree 5, rue Lambert 91410 DOURDAN FRANCE.
Tel. (1) 492.94.63 + Télex TXFRA 270105 F. REF. 643
Subsidiaries in Germany, England, Italy, Japan and representation in 15 countries.

Circle 239 on reader service card

Dialight rockers & toggles

ROCKER AND TOGGLE SWITCHES FOR ALL APPLICATIONS

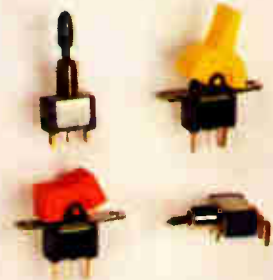

Contact Rating Information

1. Low Level: 0.4 Volt Amps Max @ 20 VAC or DC.
2. Standard: 5 Amps @ 120 VAC and 28 VDC, or 2 Amps @ 250 VAC.
3. Standard/Low Level Combination: 5 Amps @ 120 VAC/28 VDC, 0.4 VA Max. @ 20 VAC or DC.

573 SERIES PC MOUNTED TOGGLE SWITCHES

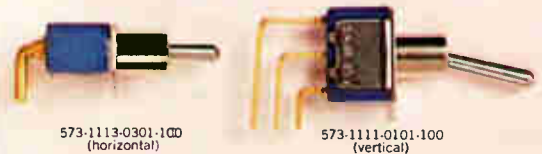

573-1113-0301-100
(horizontal)

573-1111-0101-100
(vertical)

PC Mounted Toggle Switches Easy to mount . . . terminals bent at a 90° angle. Available with and without epoxy sealing . . . and with 7 types of actuators available for low, standard or low/standard levels . . . Low cost . . . Fast delivery.

TOGGLE SWITCH ACTUATORS



Actuators made of chrome plated brass . . . anti-rotation pinning available on all actuators, and standard on all flattened actuators . . . 5 types of round handles and 2 types of flattened handles available . . . Vinyl caps, for rounded actuators available in 9 colors.

Dialight meets your needs. So talk to the specialists at Dialight, first. Send for your free copy of Dialight's current catalog today.

DIALIGHT

Dialight, A North American Philips Company
203 Harrison Place, Brooklyn, N. Y. 11237
(212) 497-7600

Circle 240 on reader service card



An introductory Electronics

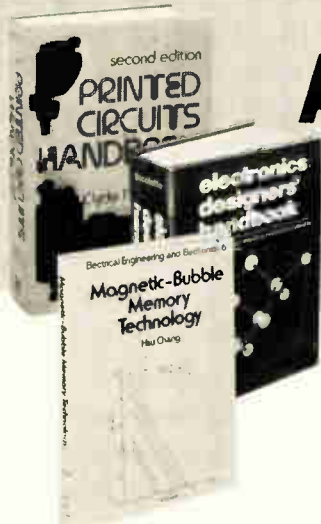

LOGIC DESIGNER'S MANUAL. By J. D. Lenk. 502 pp., 424 illus. Here's a special manual to show you how to take off-the-shelf logic circuits and interconnect them to form any logic system you want. Packed with techniques to create superior designs at less cost and with fewer components, this huge manual covers it all—from how to design networks to applying every type of logic device!
784/671 Pub. Pr., \$18.95 Club Pr., \$15.75

HANDBOOK OF OPERATIONAL AMPLIFIER CIRCUIT DESIGN. By D. F. Stout. Edited by M. Kaufman. 434 pp., 223 illus. Compact, concise, highly concentrated, and containing a storehouse of information, this one-stop volume will help you solve any op amp circuit problem!
617/97X Pub. Pr., \$29.65 Club Pr., \$17.50

ELECTRONICS ENGINEER'S HANDBOOK. Editor-in-Chief, D. G. Fink. 2,104 pp., 2,026 illus. Huge in every sense, this instant-reference volume gives you every latest essential in the field, 2,100 formulas and equations, a 2,500-item bibliography, and every illustration you need to clarify all of modern electronics!
209/804 Pub. Pr., \$49.50 Club Pr., \$35.00

MICROELECTRONICS Digital and Analog Circuits and Systems By J. Millman. 881 pp., 700 illus. This giant book takes you step by step from a qualitative knowledge of a semi-conductor, to an understanding of the operation of devices, and finally, to an appreciation of how these are combined to form micro-electronic chips.
423/27X Pub. Pr., \$24.50 Club Pr., \$19.50

ELECTRONIC GAMES Design, Programming & Troubleshooting. By Walter H. Buchsbaum and Robert Mauro. 335 pp., 338 illus. The first book to describe the new circuits, designs, and programs so that electronically minded readers will have the latest data and techniques they need in the specialized fields within electronics that make up an electronic game.
087/210 Pub. Pr., \$17.50 Club Pr., \$14.00

IC SCHEMATIC SOURCEMASTER. By K. W. Sessions. 557 pp., 1,500 schematics. All 1,500 circuits here—from the simplest to the most complex—are based on currently manufactured, inexpensively acquired ICs. Many are the equivalent of even more complex circuits containing up to several thousands of individual transistors if built with discrete components.
784/922 Pub. Pr., \$26.95 Club Pr., \$19.95

STANDARD HANDBOOK OF ENGINEERING CALCULATIONS. By T.G. Hicks. Editor-in-Chief. 1,200 pp., 428 illus. Tells you *what* to do, *when* to do it, and *how* to do it—giving step-by-step solutions to the design and application problems that engineers encounter daily. Containing some 1,000 calculation procedures accompanied by worked-out numerical examples, it also features 4,000 related calculation procedures.
287/341 Pub. Pr., \$27.50 Club Pr., \$19.95

BE SURE TO CONSIDER THESE IMPORTANT TITLES AS WELL:

- DESIGN TECHNIQUES FOR ELECTRONIC ENGINEERS.** Electronics Magazine. 191/581 Pub. Pr., \$24.50 Club Pr., \$17.50
- HANDBOOK FOR ELECTRONICS ENGINEERING TECHNICIANS.** By M. Kaufman & A. H. Seidman. 334/013 Pub. Pr., \$23.50 Club Pr., \$16.50
- PROFESSIONAL ENGINEERS' EXAMINATION QUESTIONS AND ANSWERS, 3/e.** By W. S. LaLonde, Jr. & W. J. Stack-Staikidis. 360/936 Pub. Pr., \$19.50 Club Pr., \$14.50
- GUIDEBOOK OF ELECTRONIC CIRCUITS.** By J. Markus. 404/453 Pub. Pr., \$37.50 Club Pr., \$27.50
- APPLIED ELECTROMAGNETICS** By M. A. Pionus. 503/451 Pub. Pr., \$24.50 Club Pr., \$16.50

- MICROPROCESSOR AND MICROCOMPUTER SYSTEMS.** By G. V. Rao. 783/659 Pub. Pr., \$24.50 Club Pr., \$19.50
- MICROPROCESSOR APPLICATIONS MANUAL.** By Motorola Semiconductor Products, Inc. 435/278 Pub. Pr., \$35.00 Club Pr., \$25.00
- POWER TRANSISTOR AND TTL INTEGRATED CIRCUIT APPLICATIONS.** Texas Instruments. 637/547 Pub. Pr., \$19.50 Club Pr., \$12.95
- CRYSTAL OSCILLATOR DESIGN AND TEMPERATURE COMPENSATION.** By M. E. Frerking. 784/973 Pub. Pr., \$16.95 Club Pr., \$13.50
- MASTER OP-AMP APPLICATIONS HANDBOOK.** By H. W. Fox. 784/477 Pub. Pr., \$16.95 Club Pr., \$13.50

ELECTRONICS DESIGNERS' HANDBOOK. Edited by L. J. Giacoletto. 2nd Ed. 2,344 pp., 1,686 illus. Now doubled in size and with 90% of its material new, this famous classic (first edition by Landee, Davis, Albrecht) has been thoroughly revised and updated to give you not only the *how* and the *why* of all your design work but also the *how much* of every design step you take!
231/494 Pub. Pr., \$52.50 * Club Pr., \$39.50

DIGITAL INTEGRATED CIRCUITS AND OPERATIONAL AMPLIFIER AND OPTOELECTRONIC CIRCUIT DESIGN. Edited by B. Norris. 206 pp., 400 illus. Having this vast amount of case-tested data, proven shortcuts, worked-out circuit designs, and circuit diagrams handy saves you valuable time for your other, more vital, areas of creative design—and cuts down costs in *all* areas!
637/539 Pub. Pr., \$19.50 Club Pr., \$14.50

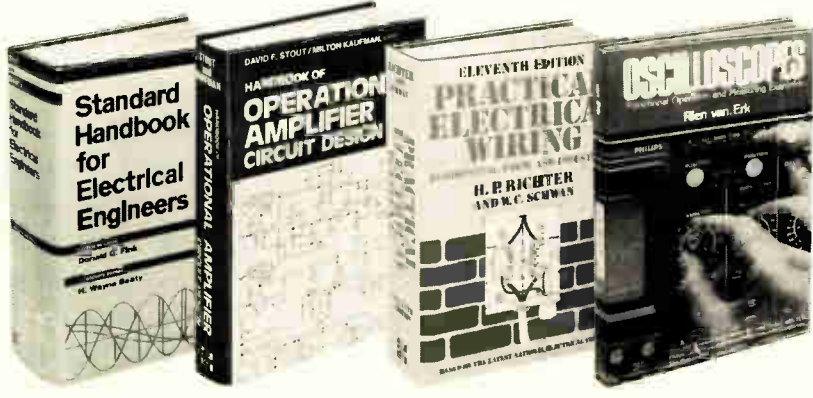

OPTOELECTRONICS Theory and Practice. By Texas Instruments Incorporated. Edited by A. Chappell. 442 pp., 475 illus. Right here is where you'll find all the knowledge and know-how you need to take any of today's optoelectric components and develop your own circuits and uses. You get both the background and the technical specifics (with all the proven circuits you want!)
637/555 Pub. Pr., \$21.50 Club Pr., \$17.00

PRINTED CIRCUITS HANDBOOK, 2/e. By C. F. Coombs, Jr. 256 pp., 327 illus. Blueprints every important phase of printed circuitry. Provides the information you need to establish a production facility and control the processes. A virtual encyclopedia in the field, five major sections cover engineering, fabrication, assembly, soldering, and testing.
126/089 Pub. Pr., \$32.50 Club Pr., \$24.50

offer to new members of the and Control Engineers' Book Club

McGRAW-HILL DICTIONARY OF PHYSICS AND MATHEMATICS. By the Staff of the McGraw-Hill Encyclopedia of Science and Technology. D. N. Lapedes, Editor in Chief. 1,074 pp., 700 illus. Look no further! Here are more than 20,000 physics and math terms, including those used in 53 related disciplines ranging from acoustics and control systems to electronics and thermodynamics! 454/809 Pub. Pr., \$19.95 Club Pr., \$16.25

PRACTICAL ELECTRICAL WIRING Residential, Farm, and Industrial, 11/e. By H. P. Richter; revised by W. C. Schwan. 664 pp., 455 illus. As you know, code-correct wiring is a must at all times. And as you also know, Richter's famous classic for professional electricians reflects in detail all the changes and all the advances in materials and techniques in each new edition *everytime a new Code is published!* 523/886 Pub. Pr., \$18.00 Club Pr., \$14.00

STANDARD HANDBOOK FOR ELECTRICAL ENGINEERS, 11/e. By D. G. Fink and H. W. Beaty. 448 pp., 1,414 illus. A giant in every sense of the word, today's most widely used source of electrical engineering information and data serves you as no other single work available anywhere when you need detailed, accurate, timely, and reliable facts and how-to on the generation, transmission, distribution, control, conversion, and application of electric power. 209/74X Pub. Pr., \$46.50 Club Pr., \$36.50

ROTATING ELECTRIC MACHINERY AND TRANSFORMER TECHNOLOGY. By D. V. Richardson. 615 pp., illus. The entire emphasis is practical in this all-inclusive book, which takes an algebraic approach to the subject and includes both the English and unified SI units information for all tables and charts. Questions and problems at ends of chapters ensure your confident use of each type of machine and transformer covered. 784/884 Pub. Pr., \$19.95 Club Pr., \$16.50

MICROPROCESSORS & SMALL DIGITAL COMPUTER SYSTEMS FOR ENGINEERS & SCIENTISTS. By G.A. Korn 390 pp. This exceptional book is your quick reference for expert advice on product selection, interfacing, and programming. Containing a huge variety of computer possibilities, system features, and costs, it's also a terrific tool for career updating. 353/670 Pub. Pr., \$27.50 Club Pr., \$18.95

ELECTRONICS DICTIONARY. Edited by John Markus. 4th Ed., 768 pp., 1,173 illus., 17,090 terms. With the new edition of this world-renowned dictionary you'll be able to quickly find the meaning and correct usage of any electronics term, no matter how obscure! 404/313 Pub. Pr., \$24.50 Club Pr., \$19.50

MAGNETIC BUBBLE TECHNOLOGY. By H. Chang. 117 pp., illus. The advent of bubble storage packages on the market has had a profound effect on the computer memory business. And here's an in-depth assessment of the technology and the possibilities for future development. 785/783 Pub. Pr., \$19.50 Club Pr., \$15.75

OSCILLOSCOPES. Applications and Uses in Electronics By R. Van Erk. 270 pp., 248 photos and diagrams. The amount of technical information it contains is stupendous, beginning with the oscilloscope's basic operations (plus additional features and their functions) and continuing with the special oscilloscopes and variants, oscilloscope probes, and measurement pitfalls. 670/501 Pub. Pr., \$16.50 Club Pr., \$13.50

MICROCOMPUTER-BASED DESIGN By J. B. Peatman. *Expanded 4th printing*, 604 pp., over 400 photos and other illustrations. Do all your best day-to-day designs, as well as your supercreative and special designs, around the new microcomputers and the specific "how-to" help you get here! 491/389 Pub. Pr., \$26.50 Club Pr., \$18.95

any one
of these great
professional books
for only \$1.89
values up
to \$52.50

Special \$1.89 bonus
book comes to you
with your first
club selection

Books are selected from a wide range of publishers

ELECTRONICS AND CONTROL ENGINEERS' BOOK CLUB saves you both time and money!

Here is a professional book club designed to meet your on-the-job engineering needs by providing practical books in your field on a regular basis at *below publisher prices*. If you're missing out on important technical literature—if today's high cost of reading curbs the growth of your library—here's the solution to your problem.

The *Electronics and Control Engineers' Book Club* was organized for you, to provide an economical reading program that cannot fail to be of value. Administered by the McGraw-Hill Book Company, all books are chosen by qualified editors and consultants. Their understanding of the standards and values of the literature in your field guarantees the appropriateness of the selections.

How the club operates: Thirteen times a year you receive free of charge *The Electronics and Control Engineers' Book Club Bulletin*. This announces and describes the Club's featured book for that period as well as alternate selections available at special members' prices. If you want to examine the Club's featured selection, you do nothing. If you prefer one of the alternate selections—or if you want no book at all—you notify the Club by returning the card enclosed with each Bulletin.

As a Club member, you agree only to the purchase of four books (including your first selection) over a two-year period. Considering the many books published annually, there will surely be at least four you would want to own anyway. By joining the Club, you save both money and the trouble of searching for the best books.

MAIL COUPON TODAY

ELECTRONICS AND CONTROL ENGINEERS' BOOK CLUB
P.O. Box 582, Hightstown, New Jersey 08520

Please enroll me as a member and send me the two books indicated. I am to receive the bonus book at the introductory price of \$1.89 plus my first selection, plus tax, postage and handling. If not completely satisfied, I may return the books within 10 days and request that my membership be cancelled. If I keep the books, I agree to take a minimum of three additional books during the next two years at special Club prices (guaranteed 15% discount, often more). I will receive the Club Bulletin 13 times a year. If I want to examine the featured selection, I need take no action. It will be shipped automatically. If, however, I want an alternate selection—or no book at all—I simply notify the Club by returning the convenient card always enclosed. I will always have a minimum of ten days in which to return the card and you will credit my account fully, including postage, if this is not the case. Membership in the Club is continuous but cancellable by me at any time after the four-book purchase requirement has been filled. *This order subject to acceptance by McGraw-Hill. Orders from outside the continental U.S. must be prepaid. All prices subject to change without notice. Offer good for new members only. Postage and handling charges are added to all subsequent shipments.*

WRITE BELOW:

Code No. of \$1.89 book Code # of 1st selection

NAME

ADDRESS

CITY

STATE ZIP

EXTRA SAVINGS: Remit in full with your order, plus any local and state tax, and McGraw-Hill will pay all regular postage and handling charges.

E33381

Packaging & production

Crystal plater ups throughput

Modular system adjusts
batches of crystals to
desired frequency tolerance

Precision quartz crystals are now standard components in wrist watches, clocks, microprocessors, and the like. Each crystal must be accurately adjusted to its nominal frequency—usually by depositing metal on it in a vacuum.

This metal-deposition process has been something of a bottleneck in crystal production, but the MPS-48 modular plating system from Transat Corp. is changing that. According to the company, the new system can produce the same number of trimmed crystals in one hour that present equipment makes in a day. The configuration in the photograph provides 2,000 crystals an hour at an accuracy of three parts per million.

The high production rate is obtained by combining several pro-

cessing modules in a sort of parallel arrangement so that they can plate several crystals at the same time. The system shown in the photograph comprises a cryogenic pumping system; two alternately pumped vacuum chambers, each with a plating frame for 24 crystals; eight six-crystal plating masks; 12 plating-rate controllers (PRCs); a filament-current supply; and a control console. The plating frames contain the mechanisms required in the vacuum chambers: filaments, crystal sockets, and crystal oscillators. The PRCs control 12 crystals at a time, plating the 48 crystals in four sequential steps. The first unit of this type was recently delivered at a price of about \$130,000. The size, cost, and throughput of the system may, of course, be scaled down by reducing the number of system modules.

The primary attraction of this system is its high throughput. Since there are multiple crystals per vacuum chamber, the pumping speed per crystal is increased over one-crystal units. Simultaneous adjustment of several crystals increases the plating speed, while a fast load and unload mechanism reduces the time required for batch handling.

The PRCs adjust crystals to within

3 ppm in about 6 seconds. The time may be reduced at some loss in accuracy or increased to improve accuracy, which is directly proportional to plating time. The overall system accuracy is enhanced by keeping the leads between the crystals and the oscillators as short as possible.

Other features of this system are its versatility and ease of maintenance. Variables such as the number of PRCs, number of vacuum chambers, and number of crystals per vacuum chamber can be adapted to customer needs. With several PRCs, several different frequencies may be adjusted simultaneously.

Ease of maintenance has been designed into the modular plating system through the use of plug-in boards in the electronic circuitry and plug-in modules in the plating frames. The frames themselves are detachable and are connected to the external circuitry by means of sockets plugged into feed-through connectors in the walls of the vacuum chambers.

Transat Corp., 3713 Lee Rd., Shaker Heights, Ohio 44120 [391]

Graphics system breaks wiring software bottleneck

Preparing software for wire-wrapping a standard integrated-circuit socket panel can be a time-consuming operation. For instance, from the time an engineer generates a schematic to the actual creation of a punched paper tape to drive a wrapping machine more than two weeks may elapse. This time is consumed in generating to-from lists, key punching cards, delivering the cards to a computer facility, and checking and creating a wiring program.

Now Wire Graphics Ltd. has designed and produced a novel \$20,790 graphics system that can do the same job in one to two days. The Wire Graphics Pen-Entry 2000 consists of a cathode-ray-tube display with a light pen, a 0.5-megabyte dual floppy-disk drive, a Z80-based central processor with 48 kilobytes of memory, a high-speed tape punch,

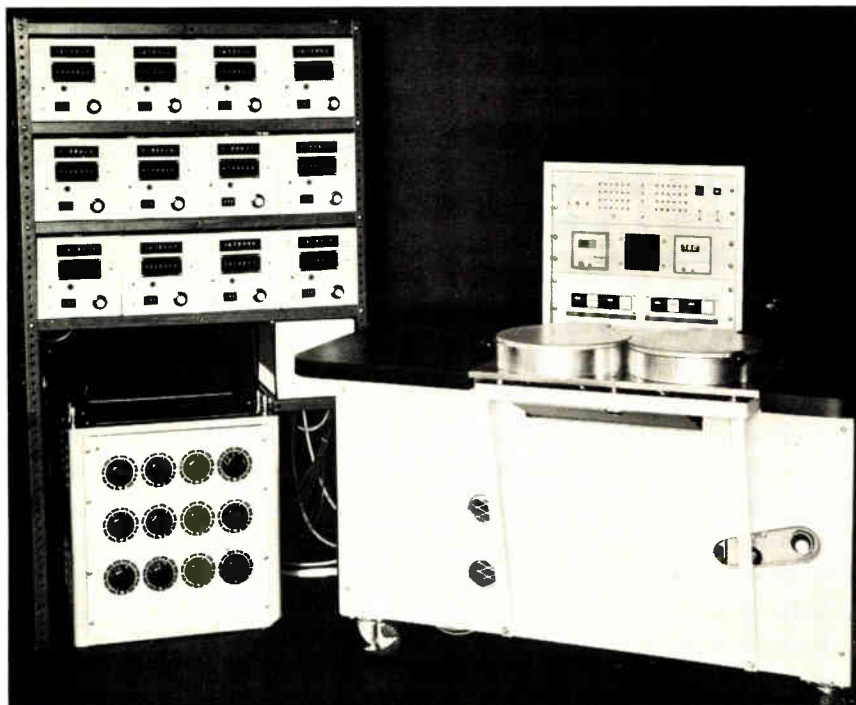

SIMPSON 260[®] VOM

Choice of Professionals for Over 40 Years!

- Fast accurate measurements on 27 popular ranges
- Rugged taut-band varistor-protected movement
- Optional 5 KV probe
- External access battery and fuse compartment
- Multi-purpose color-coded test leads with combination and screw-on alligator clips



COMPLETE LINE OF PROBES, LEADS, CARRYING CASES AND OTHER ACCESSORIES AVAILABLE
SEE THEM AT YOUR LOCAL SIMPSON DISTRIBUTOR



Audio, TV and
Communications
Service

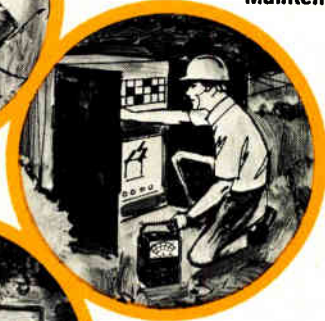

Electrical
Maintenance



Production and
Quality Control

- 260-6VOM — \$95.00
- 260-6M with mirror scale — \$98.00
- 260-6P overload protected — \$141.00
- 260-6PM overload protected with mirror scale — \$145.00
- 260-6RT in roll top case — \$106.00
- 260-6PRT overload protected in roll top case — \$153.00
- 260-6MRT with mirror scale in roll top case — \$110.00
- 260-6XL with extra ranges and features — \$111.00
- 260-6XLM with mirror scale — \$115.00
- 260-6XLP overload protected — \$152.00
- 260-6XLPM overload protected with mirror scale — \$156.00



SIMPSON ELECTRIC COMPANY

853 Dundee Avenue, Elgin, Illinois 60120
(312) 697-2260 • CABLE SIMELCO • Telex 72-2416
IN CANADA: Bach-Simpson, Ltd., London Ontario
IN ENGLAND: Bach-Simpson (U.K.) Ltd., Wadebridge, Cornwall
IN INDIA: Ruttonsha-Simpson Private, Ltd., Vikhroli, Bombay

KATY INDUSTRIES



INDUSTRIAL
EQUIPMENT
GROUP

New products



and a high-speed bidirectional impact matrix printer.

In an actual wire-wrapping tape design, the wire-wrap pins of the sockets and of a portion of the wiring side of the IC socket panel are displayed on the CRT. The engineer working from the schematic "wires" this section of the board with the light pen. As he wires, he also assigns part numbers to each DIP socket and can even wire in discrete parts like decoupling capacitors.

Upon completion of wiring, data is entered into a diskette. This stored data is then used to create a paper tape for wire-wrapping and for printing out wire and parts lists on the system's printer.

The system has many other advantages besides low cost and high speed. It can also optimize wiring paths if desired. The system can be used to wire a 2,000-point board with 4,000-point capability available as an option. A Pen-Entry 2000 can also be applied to other automatic wiring systems such as Stitch Wiring, Solderwrap, and Termipoint. This unit should be ideal for prototype work since revisions that formerly took a week can be done in seconds. In addition, if a paper tape is destroyed or lost, its data will still reside on a diskette.

Wire Graphics Ltd., 555 Broad Hollow Rd., Melville, N. Y. 11746 [392]

Multiprobe assembly fits different circuits

The IC-1000 Multiprobe is an assembly of flat-ribbon probes housed in a single molded plastic retainer. This configuration eliminates the need for bulky individual probe retainers and allows a dam-

aged probe to be easily replaced.

The assembly consists of up to 20 probes, making it particularly useful when testing hybrid circuits with multiple outer bonding pads. The flat edge of each probe maintains a continuous line of contact with the pad rather than the usual single point of contact. This extends the life of each probe. Also, the circuit that is being tested remains more visible than it is when bulky individual probes are used.

The IC-1000 is available with either 0.075-mil or 0.100-mil spacings, and other spacings can be made upon request. Each probe is 40 mils wide and 15 mils thick and has a

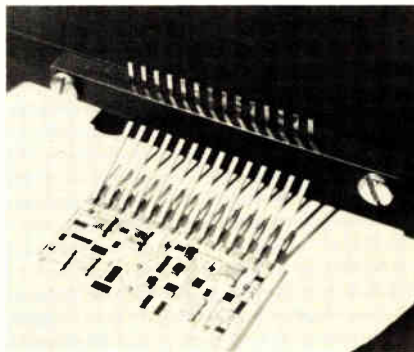

vertical travel of 0.100 in. The entire unit is priced at \$60.75. Delivery is made from stock.

IC Industries Inc., P. O. Box 104, Altamonte Springs, Fla. 32701. Phone (305) 831-9797 [395]

Sockets hold ICs with 16, 24, and 40 pins

Designed for end-user production requirements, Econo Zip sockets will accommodate integrated circuits with 16, 24, or 40 pins. The three types of sockets can be mounted on printed-circuit boards with 0.100-mil centers. By simple mechanical rotation and counter-rotation of the cam on the socket, an IC may be inserted into and extracted from the socket with zero force. These sockets will accept crooked or distorted leads.

In quantities of 1,000, the 16-pin version sells for \$1.45 each, the 24-pin device for \$1.94 each, and the

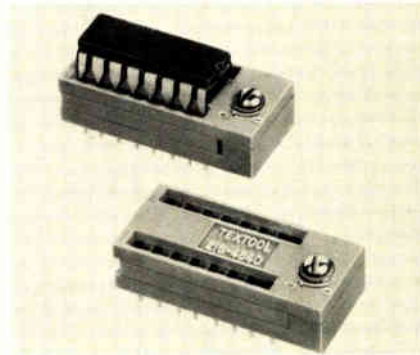

40-pin type for \$2.60 each. Delivery is from stock.

Textool Products Inc., 1410 W. Pioneer Dr., Irving, Texas 75061. Phone (214) 259-2676 [397]

Versatile prober works on line and in lab

Because it is controlled by an 8085 microprocessor, the PS50 automatic wafer prober is able to operate in any of four modes. With this capability, it can serve both in the laboratory and on the production line.

For standard production-line work it uses an X-Y die indexing system, while for matrix probing digital front-panel switches are set.

The PS50 prober comes with a 4-in. wafer chuck, an inking control system with front-panel delay control, an edge-sensing system, and a wafer-orientation system. Prices for the unit vary from \$7,000 to \$16,000 depending on the particular configuration chosen. Delivery time is currently 10 weeks.

Probe-Rite Inc., 2725 Lafayette St., Santa Clara, Calif. 95050 [398]

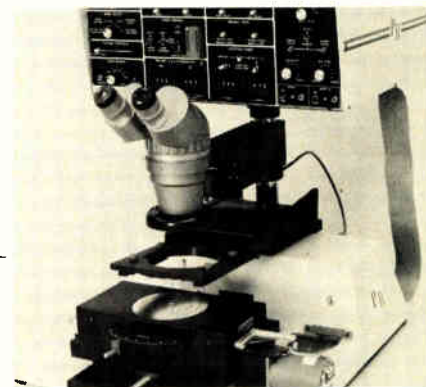

MICRO POWER

R6500 any way you like it. That's Rockwell Micropower!

Rockwell's R6500 microcomputer system consists of a family of ten software-compatible CPUs featuring 13 powerful addressing modes.

You get general-purpose I/O, communications interface, standard memory, and combination memory-I/O-timer circuits. Our intelligent peripheral controllers provide cost effective software/hardware tradeoffs. And there's even a single-chip R6500/1 microcomputer.

To give you a headstart in microcomputing, AIM 65 (R6500 Advanced Interactive Microcomputer) puts a terminal style keyboard, 20-character alphanumeric printer and display, cassette interface, and more at your fingertips for only \$375.

To put your design effort in high gear, Rockwell's SYSTEM 65 is a powerful, easy-to-use development system with two integral mini-floppy disk drives. High level PL/65 language designed to increase programming productivity is also available.

More to choose from in 1979 from the fastest selling microprocessor in 1978. That's Rockwell Micropower.

For more information, contact Department 727-F2, Microelectronic Devices, Rockwell International; P.O. Box 3669; Anaheim, CA 92803, or phone (714) 632-3729.

R6500 CPU Options

	40-Pin DIP		28-Pin DIP				
	R 6502	R 6512	R 6503 R 6513	R 6504 R 6514	R 6505 R 6515	R 6506	R 6507
On chip clock							
External Clock							
Memory Address Space	65K	65K	4K	8K	4K	4K	8K
Interrupts - Maskable	Yes	Yes	Yes	Yes	Yes	Yes	No
- Non-Maskable	Yes	Yes	Yes	No	No	No	No
SYNC - Output Indicates op code fetch cycle	Yes	Yes	No	No	No	No	No
RDY - Single step and slow memory synchronization	Yes	Yes	No	No	Yes	No	Yes
Φ_1 Clock Output	Yes	Yes	No	No	No	Yes	No
DBE - Extended Data Bus Hold Time	No	Yes	No	No	No	No	No



Rockwell International

...where science gets down to business

SOMETHING YOU CAN COUNT ON

Work seems more worthwhile, knowing that we're helping to build financial security for ourselves and our families. And there's no easier way to save for the future than U.S. Savings Bonds.

With painless, automatic payroll deductions, the Savings Bond Program is a practical method of creating a financial reserve that reflects the stable, responsible outlook of savings bond holders. It's something you can really count on.

More than that, it's an expression of confidence in ourselves and in this country.

You can help by encouraging maximum participation among employees.

Robert T. Campion, chairman and president of Lear Siegler, Inc., and chairman for the second year of the program for the electronics industry, urges you to

Support U.S. Savings Bonds



LEAR SIEGLER, INC.

3171 South Bundy Drive, Santa Monica, California 90406



64-kilobit static RAM consumes only 300 mW

It may not be a monolithic device, but the HM5-6564, which made its debut at Electro/79 in New York, is the first 64-kilobit complementary-MOS static read/write random-access memory. The unit, made by Harris Corp.'s Semiconductor Group, Melbourne, Fla., comprises 16 4-K C-MOS static RAMs arranged on 1.8 in.² of area on a ceramic substrate. **The memory consumes less than 5 mW in standby, less than 300 mW when active, and has a maximum access time of 350 ns.** Prototypes are available now, with production quantities expected to be ready for delivery by September. In hundreds, the memory sells for \$880 each.

Fairchild to spring development system at computer conference

The National Computer Conference in New York next month should see, among other things, the new microprocessor development system developed by Fairchild Camera and Instrument Corp., Mountain View, Calif. Based on the company's 16-bit Blaze general-purpose computer, **the system is designed for hardware and software development of the 16-bit Isoplanar integrated-injection logic 9440 microprocessor and a forthcoming faster version with built-in multiply and divide circuitry, the 9445.** The system features a cathode-ray-tube terminal, the Blaze central processing unit, a dual flexible-disk drive, a dot-matrix printer, and all required development software.

Printer for microcomputers to sell for below \$1 K

Look for Centronics Corp., Nashua, N. H., to introduce a microprocessor-compatible dot-matrix printer that will sell for less than \$1,000. **The lightweight machine, which is built around Centronics' free-flight head, can handle roll, cut, and Z-fold paper.** It prints at a rate of 50 characters per second.

Pascal compiler in works for VAX-11/780

A Pascal compiler is now being readied for Digital Equipment Corp.'s VAX-11/780 computer. Designed for instructional and industrial use, the VAX-11/Pascal is a **re-entrant native-mode compiler that supports standard Pascal language capabilities including scalar and structured data types and conditional statements.** The Maynard, Mass., company will license VAX-11/Pascal to non-profit institutions for \$2,500 and to others for \$5,000. Delivery is expected by the end of this year.

Logic analyzer handles 48 channels

Structured as three independent 16-channel analyzers, the LAM 4850 logic analyzer is a 48-channel instrument in which each channel is backed up by 1,024 bits of data-recording memory and an additional layer of reference memory. **Aimed specifically at microprocessor-based logic systems, the 50-MHz unit can record synchronous logic-state information and asynchronous timing signals simultaneously.** Its four-level sequential triggering scheme allows the user to start or stop a multiclock recording process simply by defining a program sequence. Made in West Germany by Dolch Logic Instruments GmbH, the analyzer is distributed in the U. S. by Kontron Electronic Inc., San Mateo, Calif.

Fast, 10-Bit Monolithic A/D Converter



The Ferranti Model ZN432 is a truly complete successive approximation A/D system with 20 μ s conversion time guaranteed.

Features:

- On-chip reference, reference amplifier, comparator, D/A converter and logic
- Bipolar or unipolar operation
- Parallel and serial binary outputs
- TTL/CMOS compatible
- Diffused resistor network, no trim required
- Guaranteed monotonic over operating temperature range
- Commercial and military temperature ranges available

FERRANTI
better by design

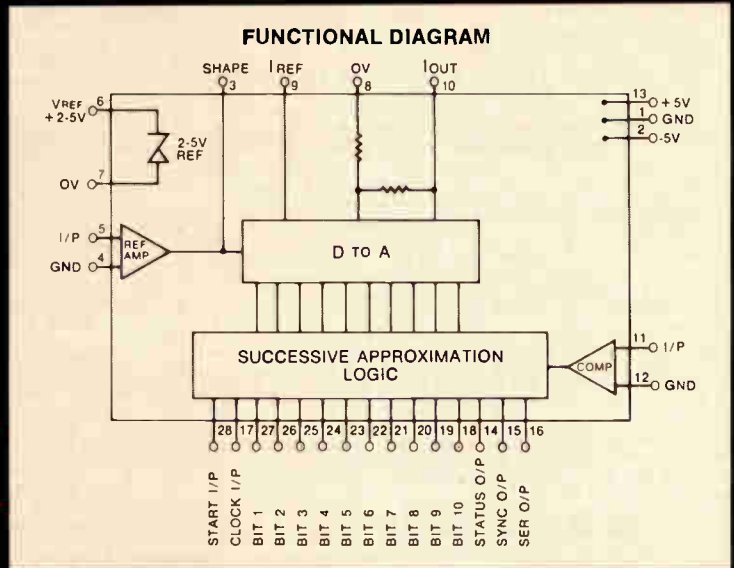

FOR COMPLETE SPECIFICATIONS, CONTACT: FERRANTI ELECTRIC, INC. / SEMICONDUCTOR PRODUCTS
87 MODULAR AVENUE, COMMACK, NEW YORK 11725 / PHONE: (516) 543-0200

Circle 202 on reader service card

LASERMARK MEANS

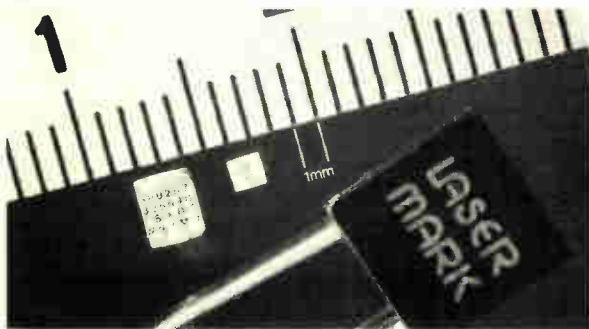

EASY INSTALLATION

Wondering how to adapt conventional marking systems to your production line? Lasermark can be installed on virtually any existing line, with the laser unit up to 10 feet from the marking position. The focussing head may be aimed up, down, sideways or at an angle.

Why not let us lighten up your marking problems! To get the full story on these unique, inkless, non-contact coding and marking systems, contact:

LASER MARK A DIVISION OF
LUMONICS RESEARCH LIMITED
105 SCHNEIDER ROAD,
KANATA, (OTTAWA), ONTARIO
CANADA K2K 1Y3
(613) 592-1460

Bringing marking and coding out of the Dark Ages

202 Circle 203 on reader service card

**UNBEATABLE
ECONOMICAL
TORQUE CONTROL**
with
hysteresis
brakes



Hysteresis torque control has everything — it's smooth, clean, quiet, precisely controllable, indefinitely repeatable, environmentally stable. And hysteresis brakes last indefinitely, because their power absorption is accomplished with no physical contact between drag cup and rotor. They're the answer for any product that requires torque control so dependable it never needs service — which makes them cost cutters, too.



Our free handbook gives hysteresis hows and whys, and describes typical OEM applications. Request it today.

see our catalog in
THOMCAT
or call us toll-free at
800-828-7844
(except New York State)



MAGTROL, INC.

70 GARDENVILLE PARKWAY WEST BUFFALO, NEW YORK 14224 716-668-5555

Circle 204 on reader service card

Circle 241 on reader service card →

FREE DARLINGTON TRANSISTOR FROM LAMBDA

**SEND US A COPY OF YOUR DARLINGTON
CIRCUIT AND WE'LL SEND YOU AN EQUIVALENT
MONOLITHIC DARLINGTON FREE.**

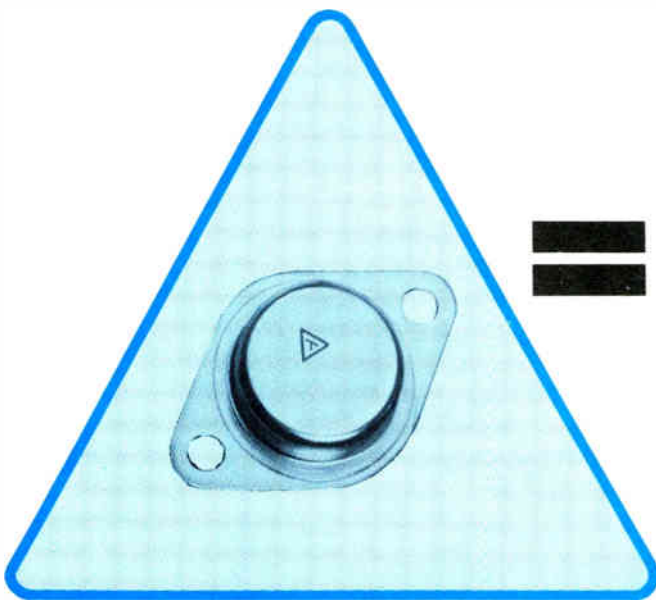

=

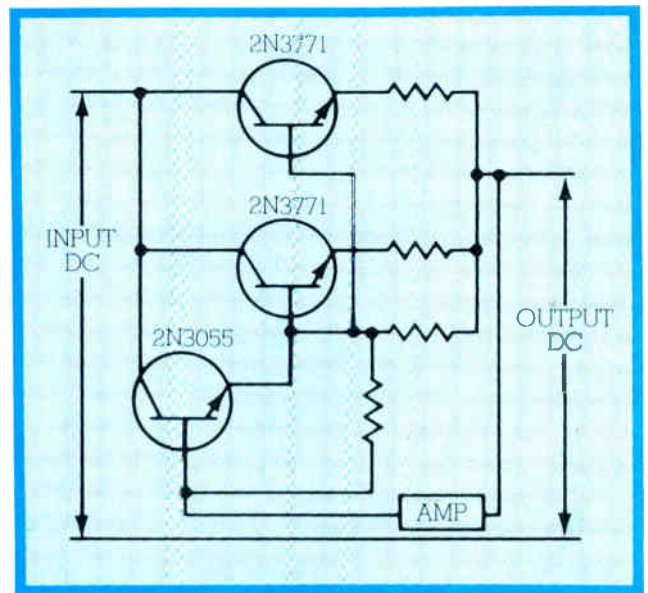

LAMBDA MONOLITHIC DARLINGTON
A SINGLE DEVICE DOES IT ALL.

THE CLASSIC DARLINGTON CIRCUIT
WITH 6 OR MORE DISCRETE PARTS.

**LAMBDA MONOLITHIC DARLINGTONS
SAVE 40% ON MATERIAL, 50% ON LABOR AND
IMPROVE OVERALL RELIABILITY.**

 **LAMBDA SEMICONDUCTORS**

POWER DARLINGTON TRANSISTORS

**Better than Motorola!
Better than RCA!**

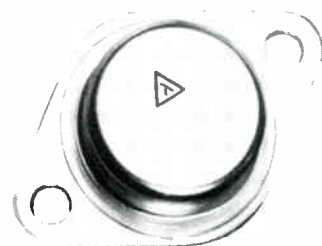

Compare these specifications!

PARAMETER	△ LAMBDA Darlington		MOTOROLA* Darlington		RCA* Darlington
	PMD-16K-60	PMD-12K-60	2N6282	2N6055	2N6384
$I_{CER@200^{\circ}C}$	7mA@40V	5mA@40V	Not Specified	Not Specified	Not Specified
Thermal Resistance $R_{\theta JC}$	0.67°C/W	1.5°C/W	1.09	1.75	1.75
h_{FEmin}	1000	1000	750	750	1000
Safe Operating Area $I_{s/b}$	7.5A@30V	3A@30V	5.3A@30V	3A@30V	2.8A@35V
Power Dissipation	225W	100W	160W	100W	100W
Derate Power Dissipation from	50°C	50°C	25°C	25°C	25°C

*From Published Specifications.

Now! With



Lambda Power Darlington Transistors

Power Circuit Designers can:

- **Use fewer components**
- **Increase reliability**
- **Save 40% on material costs alone**
- **Reduce labor by 50%**

OUTSTANDING FEATURES

- The only available 200°C operating junction temperature power Darlington in the industry.
- The only available hard glass passivated 200°C power Darlington in the industry.
- Guaranteed leakage current stability at 200°C— I_{CER} is equal to 5mA or less, up to 150 watts; I_{CER} is equal to 7mA or less, at 225 watts; I_{CER} is equal to 10 MA or less, at 240 watts.
- Guaranteed current gain vs collector current of greater than or equal to 1000 for NPN and 800 for PNP at 4, 6, 10, and 15 amps for power Darlington up to 240 watts.
- All power Darlington are guaranteed and 100% tested for $I_{s/b}$ (Secondary Breakdown Current) insuring maximum performance at high energy levels.
- Excellent thermal resistance ($R_{\theta JC}$) on all power Darlington providing for more usable power and lower operating temperatures.
- All power Darlington are hermetically sealed and are subject to leak testing.

LAMBDA PROCESS FLOW CHART

for Power Semiconductors

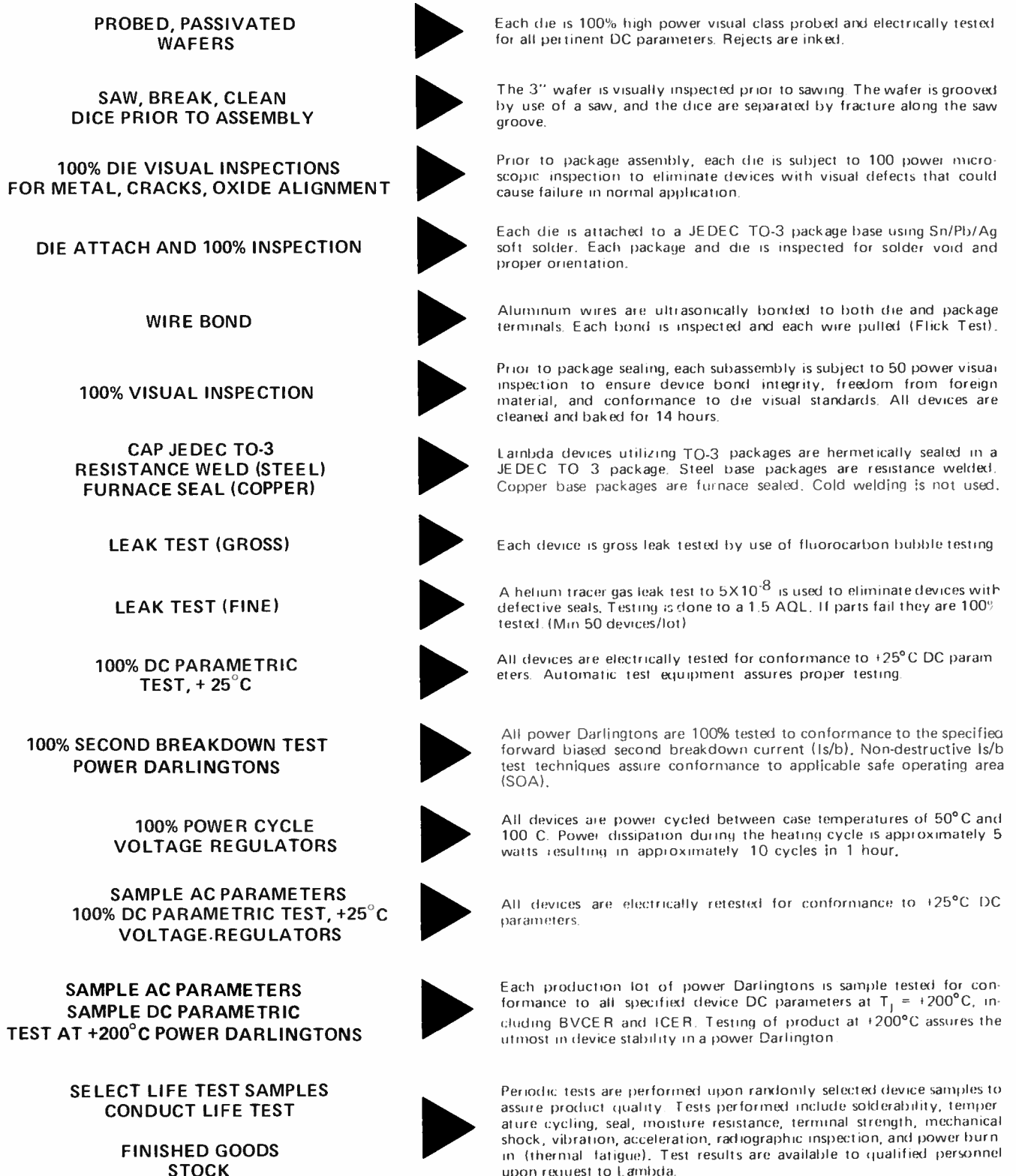

GENERAL DESCRIPTION

The PMD-10K, 12K, 16K, 1600K, and 18K series of devices are three-terminal NPN Power Transistor Darlington. The PMD-11K, 13K, 17K, 1700K, and 19K series of devices are three-terminal PNP Power Transistor Darlington. These devices are monolithic epitaxial base structures with built-in base to emitter shunt resistors. The devices are CVD glass passivated to increase reliability and provide reduced high temperature reverse leakage current. This important feature helps to enable this series of Darlington devices to meet guaranteed junction operating temperatures of 200°C. Internal diode protection (D1) of the Darlington configuration is built into the structure to limit the device power dissipation during negative overshoot.

The five different series of NPN and five different series of PNP Power Transistor Darlington devices, are available in sustaining voltages ranging from +40 to +100 volts, and power dissipation levels from 100 to 240 watts. All Darlington devices are hermetically sealed steel or copper TO-3 packages, depending on power dissipation requirements, providing high reliability and low thermal resistance, when used with appropriate heat sinks.

ABSOLUTE MAXIMUM RATINGS

RATING	SYMBOL	12K 40 13K 40	12K 60 13K 60	12K 80 13K 80	12K 100 13K 100	10K 40 11K 40	10K 60 11K 60	10K 80 11K 80	10K 100 11K 100	1600K 1700K	1601K 1701K	1602K 1702K	1603K 1703K	UNITS
Collector Emitter Voltage	V_{CEO}	40	60	80	100	40	60	80	100	40	60	80	100	Vdc
Collector Base Voltage	V_{CBO}	40	60	80	100	40	60	80	100	40	60	80	100	Vdc
Emitter Base Voltage	V_{EBO}	5	5	5	5	5	5	5	5	5	5	5	5	Vdc
Collector Current Cont. Peak	I_C I_C	8 16	8 16	8 16	8 16	12 20	12 20	12 20	12 20	20 40	20 40	20 40	20 40	Adc
Base Current	I_B	0.12	0.12	0.12	0.12	0.2	0.2	0.2	0.2	0.5	0.5	0.5	0.5	Adc
Thermal Resistance	$R_{\theta JC}$	1.5	1.5	1.5	1.5	1.0	1.0	1.0	1.0	.83	.83	.83	.83	°C/W
Total Internal Dissipation	P_D @ $T_c = 50^\circ C$	100	100	100	100	150	150	150	150	180	180	180	180	Watts
	Derate:	Derate at 0.667 W/°C, $T_A \geq 50^\circ C$				Derate at 1 W/°C, $T_A \geq 50^\circ C$				Derate at 1.2W/°C $T_A \geq 50^\circ C$				
Temp. Range Operating Storage	T_j T_{STG}	-65° to +200°C				-65° to + 200°C				-65° to +200°C				°C

RATING	SYMBOL	16K 40 17K 40	16K 60 17K 60	16K 80 17K 80	16K 100 17K 100	18K 40 19K 40	18K 60 19K 60	18K 80 19K 80	18K 100 19K 100	UNITS
Collector Emitter Voltage	V_{CEO}	40	60	80	100	40	60	80	100	Vdc
Collector Base Voltage	V_{CBO}	40	60	80	100	40	60	80	100	Vdc
Emitter Base Voltage	V_{EBO}	5	5	5	5	5	5	5	5	Vdc
Collector Current Cont. Peak	I_C I_C	20 40	20 40	20 40	20 40	30 60	30 60	30 60	30 60	Adc
Base Current	I_B	0.5	0.5	0.5	0.5	.75	.75	.75	.75	Adc
Thermal Resistance	$R_{\theta JC}$	0.67	0.67	0.67	0.67	.625	.625	.625	.625	°C/W
Total Internal Power Dissipation	P_D @ $T_c = 50^\circ C$	225	225	225	225	240	240	240	240	Watts
	Derate:	Derate at 1.5W/°C, $T_A \geq 50^\circ C$				Derate at 1.6w/°C $T_A \geq 50^\circ C$				
Temp. Range Operating Storage	T_j T_{STG}	-65° to +200°C				-65° to +200°C				°C

△ LAMBDA SCHEMATIC DIAGRAMS

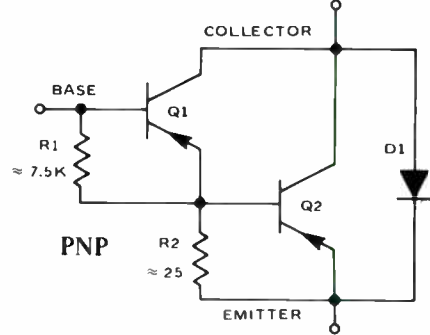
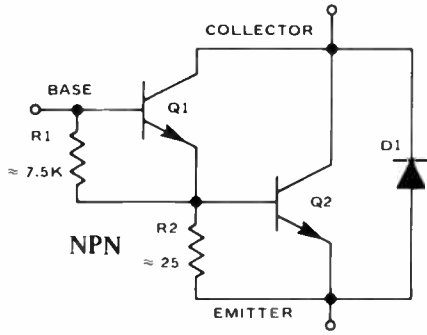

PACKAGE OUTLINE DRAWINGS AND PIN CONNECTIONS

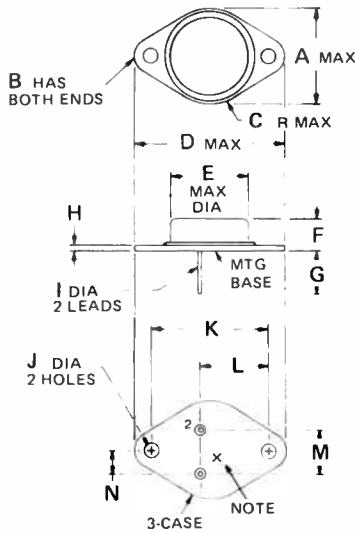

PIN	FUNCTION
1	BASE
2	EMITTER
CASE	COLLECTOR

NOTE (X): CASE TEMPERATURE MEASURED AT THIS POINT

TO-3/3 TERMINAL STEEL PACKAGE				
DIM	INCHES		MILLIMETERS	
	MIN.	MAX.	MIN.	MAX.
A	—	1.050	—	26.67
B	—	0.188	—	4.77
C	—	0.525	—	13.33
D	—	1.575	—	40.00
E	—	0.875	—	22.22
F	0.250	0.450	6.35	11.43
G	0.433	0.480	10.99	12.19
H	0.053	0.066	1.34	1.67
I	0.036	0.043	0.91	1.09
J	0.151	0.160	3.83	4.14
K	1.177	1.197	29.89	30.40
L	0.655	0.675	16.63	17.14
M	0.418	0.440	10.61	11.17
N	0.205	0.225	5.20	5.71

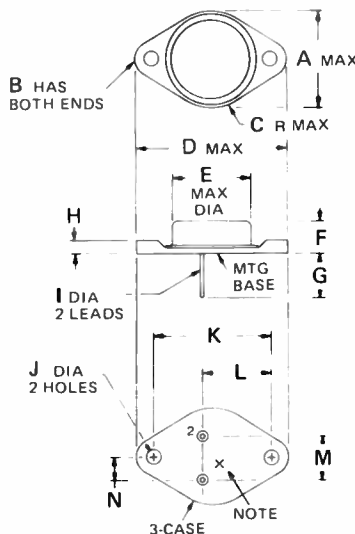

PIN	FUNCTION
1	BASE
2	EMITTER
CASE	COLLECTOR

NOTE (X): CASE TEMPERATURE MEASURED AT THIS POINT

TO-3/3 TERMINAL COPPER PACKAGE*				
DIM	INCHES		MILLIMETERS	
	MIN.	MAX.	MIN.	MAX.
A	—	1.050	—	26.67
B	—	0.188	—	4.77
C	—	0.525	—	13.33
D	—	1.575	—	40.00
E	—	0.875	—	22.22
F	0.250	0.450	6.35	11.43
G	0.440	0.480	11.18	12.19
H	0.105	0.115	2.67	2.92
I	0.036	0.043	0.91	1.09
J	0.153	0.159	3.89	4.04
K	1.184	1.190	30.07	30.23
L	0.660	0.670	16.76	17.02
M	0.425	0.435	10.80	11.05
N	0.210	0.220	5.33	5.59

*FOR PMD 18K & 19K ONLY

TYPICAL COST SAVINGS WITH LAMBDA DARLINGTONS

TYPICAL 4 AMP DC POWER SUPPLY CIRCUITS

Case 1:
1 PMD-12K-40 Darlington

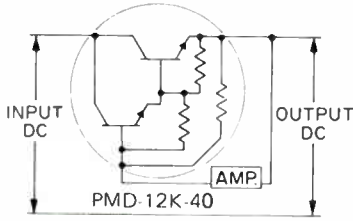

Cost: One Component \$0.81
No Assembly

Case 2:
2-2N3055, 2 Resistors

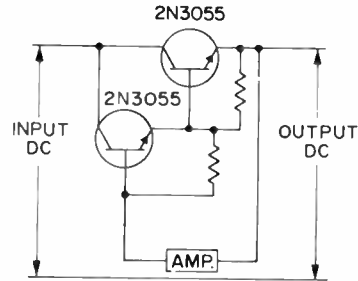

Cost: 4 Components \$1.02
Plus Assembly

TYPICAL 6 AMP DC POWER SUPPLY CIRCUITS

Case 3:
1PMD-10-K-40 Darlington

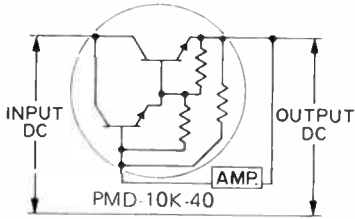

Cost: One Component \$1.39

Case 4:
3-2N3055, 4 Resistors

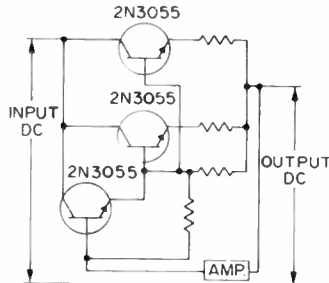

Cost: 7 Components \$2.33
Plus Assembly

Case 5:
1-2N3772, 1-2N3055, 2 Resistors

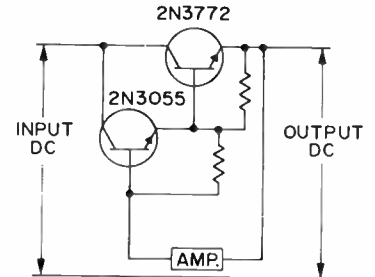

Cost: 4 Components \$2.36
Plus Assembly

TYPICAL 10 AMP DC POWER SUPPLY CIRCUITS

Case 6:
1 PMD-16K-40 Darlington

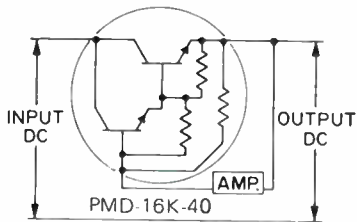

Cost: One Component \$3.24
No Assembly

Case 7:
1-2N3055, 2-2N3771, 4 Resistors

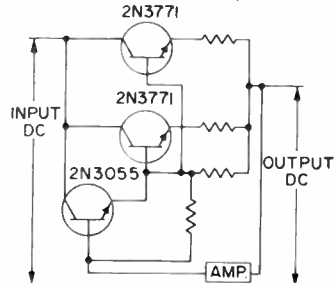

Cost: 7 Components \$4.73
Plus Assembly

Case 8:
4-2N3055, 5 Resistors

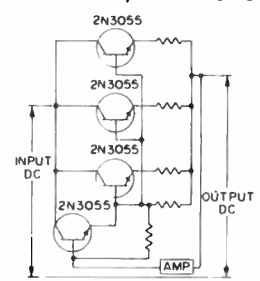

Cost: 9 Components \$3.64
Plus Assembly

Estimated parts cost in quantities of 1000 at 2/79. Circuit conditions available on request. Component cost comparisons between  LAMBDA Darlington and discrete transistor designs using 2N3055 and 2N3771. Analysis based on 1000 piece price, similar savings apply for larger quantities.

DARLINGTON TRANSISTORS

TYPICAL CIRCUIT APPLICATIONS

*LAMBDA MANUFACTURED PARTS

CR1A, B - PMR 27K 100
 CR2A, B - PMR 31K 100
 Q1 - PMD 10K 60
 IC1 - LAS 1100
 OV - L6 OV 15

LNS-Y-15
 15V @ 3.4A
 (OV added)

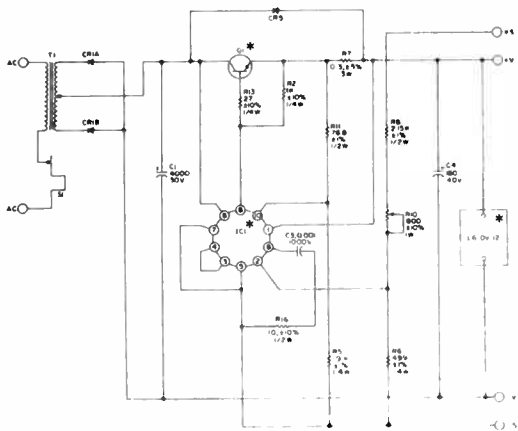
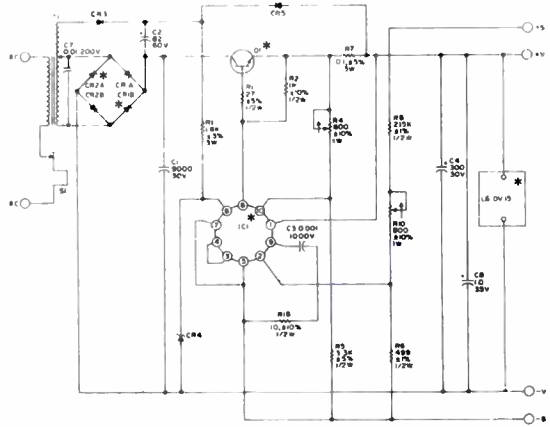

*LAMBDA MANUFACTURED PARTS

CR1A, B - PMR 31K 100
 Q1 - PMD 12K 60
 IC1 - LAS 1100
 OV - L6 OV 12

LNS-Z-12
 12V @ 1.7A
 (OV added)

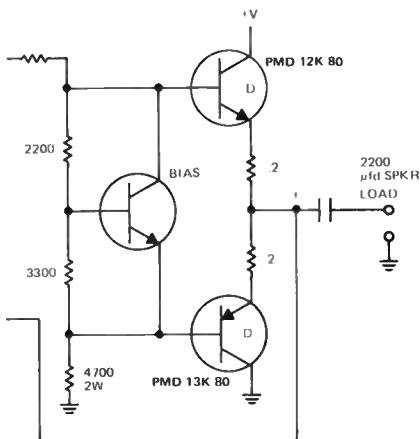

CLASS AB AMPLIFIER

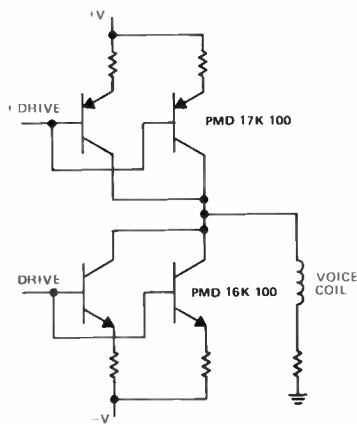

DISC DRIVE FOR COMPUTERS

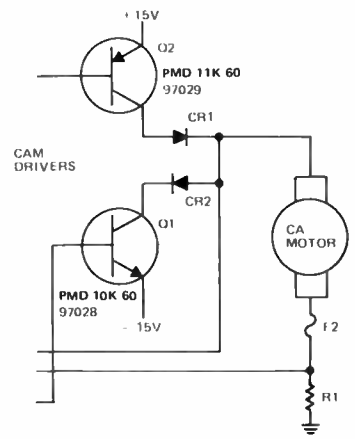

MOTOR DRIVE

△ Lambda PMD 10K, 12K, 16K, 1600K, 18K Series of NPN Power Transistor Darlington

ELECTRICAL CHARACTERISTICS

ALL PARAMETERS ARE GUARANTEED AT T_J of 0°C to 200°C, UNLESS OTHERWISE SPECIFIED

DEVICE TYPE	TEST	SYMBOL	TEST CONDITIONS	MIN.	MAX.	UNITS	NOTE
PMD-10K SERIES PMD-12K SERIES PMD-16K SERIES PMD-1600K SERIES PMD-18K SERIES	Collector Emitter Saturation Voltage	$V_{CE(Sat)}$	$I_C=6A_{dc}, I_B=24mA_{dc}$ $I_C=4A_{dc}, I_B=16mA_{dc}$ $I_C=10A_{dc}, I_B=40mA_{dc}$ $I_C=10A_{dc}, I_B=40mA_{dc}$ $I_C=15A_{dc}, I_B=60mA_{dc}$		2.0	V _{dc}	1
PMD-10K SERIES PMD-12K SERIES PMD-16K SERIES PMD-1600K SERIES PMD-18K SERIES	Base Emitter Turn-on Voltage	$V_{BE(on)}$	$I_C = 6A_{dc}$ $I_C = 4A_{dc}$ $I_C = 10A_{dc}$ $I_C = 10A_{dc}$ $I_C = 15A_{dc}$	$V_{CE} = 3V_{dc}$	2.8	V _{dc}	1
PMD-10K SERIES PMD-12K SERIES PMD-16K SERIES PMD-1600K SERIES PMD-18K SERIES	Base Emitter Saturation Voltage	$V_{BE(Sat)}$	$I_C=6A_{dc}, I_B=24mA_{dc}$ $I_C=4A_{dc}, I_B=16mA_{dc}$ $I_C=10A_{dc}, I_B=40mA_{dc}$ $I_C=10A_{dc}, I_B=40mA_{dc}$ $I_C=15A_{dc}, I_B=60mA_{dc}$		2.8	V _{dc}	1
PMD-10K SERIES PMD-12K SERIES PMD-16K SERIES PMD-1600K SERIES PMD-18K SERIES	DC Current Gain	h_{FE}	$I_C=6A_{dc}$ $I_C=4A_{dc}$ $I_C=10A_{dc}$ $I_C=10A_{dc}$ $I_C=15A_{dc}$	$V_{CE} = 3V_{dc}$	1000 1000 1000 750 1000	20,000	1
PMD-10K SERIES PMD-12K SERIES PMD-16K SERIES PMD-1600K SERIES PMD-18K SERIES	Forward Bias Second Breakdown current	$I_{S/B}$	$T_A = 25^\circ C$ $V_{CE} = 30V_{dc}$ 1 second nonrepetitive pulse	5.0 3.0 7.5 6.0 8.0		A _{dc}	1
PMD-10K, 12K, 16K, 18K-40 PMD-1600K PMD-10K, 12K, 16K, 18K-60 PMD-1601K PMD-10K, 12K, 16K, 18K-80 PMD-1602 PMD-10K, 12K, 16K, 18K-100 PMD-1603K	Collector Emitter Breakdown Voltage (Base Open)	$V_{(BR)CEO}$	$I_{CE} = 100mA_{dc}$ $T_J = 25^\circ C$	40 60 80 100		V _{dc}	
PMD-10K, 12K, 16K, 18K-40 PMD-1600K PMD-10K, 12K, 16K, 18K-60 PMD-1601K PMD-10K, 12K, 16K, 18K-80 PMD-1602K PMD-10K, 12K, 16K, 18K-100 PMD-1603K	Collector Emitter Sustaining Voltage	$V_{(BR)CER(sus)}$	$I_{CE} = 100mA_{dc}$ $R_{BE} = 2.2K \text{ ohms}$	40 60 80 100		V _{dc}	
All NPN Series	Emitter Base Leakage Current	I_{EBO}	$V_{EB} = 5V_{dc}$ $I_C = 0A$		3.0	MA _{dc}	
PMD-10K, 12K-40 PMD-10K, 12K-60 PMD-10K, 12K-80 PMD-10K, 12K-100	Collector Emitter Leakage Current	I_{CER}	$V_{CE} = 20V_{dc}$ $V_{CE} = 40V_{dc}$ $V_{CE} = 54V_{dc}$ $V_{CE} = 67V_{dc}$	$R_{BE} = 2.2K \text{ ohms}$	5.0 5.0 5.0 5.0	MA _{dc}	

continued on next page

ELECTRICAL CHARACTERISTICS (continued)

DEVICE TYPE	TEST	SYMBOL	TEST CONDITIONS	MIN.	MAX.	UNITS	NOTE
PMD-16K-40 PMD-1600K PMD-16K-60 PMD-1601K PMD-16K-80 PMD-1602K PMD-16K-100 PMD-1603K PMD-18K-40 PMD-18K-60 PMD-18K-80 PMD-18K-100	Collector Emitter Leakage Current	I_{CER}	$V_{CE} = 20V_{dc}$ $V_{CE} = 40V_{dc}$ $V_{CE} = 54V_{dc}$ $V_{CE} = 67V_{dc}$ $R_{BE} = 2.2K\text{ ohms}$		70	MAdc	
PMD-10K SERIES PMD-12K SERIES PMD-16K SERIES PMD-1600K SERIES PMD-18K SERIES	Output Capacitance	C_{ob}	$V_{CB} = 10V_{dc}$, $I_E = 0A_{dc}$ $f = 1\text{ MHz}$ $T_J = 25^\circ C$		300 200 400 400 600	pf	
PMD-10K SERIES PMD-12K SERIES PMD-16K SERIES PMD-1600K SERIES PMD-18K SERIES	Small Signal Current Gain	h_{fe}	$I_C = 1A_{dc}$ $I_C = 3A_{dc}$ $I_C = 7A_{dc}$ $I_C = 9A_{dc}$ $V_{CE} = 3V_{dc}$ $f = 1kHz$ $T_J = 25^\circ C$	300			
PMD-10K SERIES PMD-12K SERIES PMD-16K SERIES PMD-1600K SERIES PMD-18K SERIES	Common Emitter Short Circuit Forward Transfer Ratio	h_{fe}	$I_C = 1A_{dc}$ $I_C = 3A_{dc}$ $I_C = 7A_{dc}$ $I_C = 9A_{dc}$ $V_{CE} = 3V_{dc}$ $f = 1MHz$ $T_J = 25^\circ C$	4			

NOTES.

1. Pulse Tested: Pulse Width is less than or equal to 300 μ Sec. and the Duty Cycle is less than or equal to 2.0%.

DEVICE PRICES, SPECIFICATIONS, AND CONFIGURATIONS ARE SUBJECT TO CHANGE WITHOUT NOTICE.

OPERATIONAL DATA

SAFE OPERATING AREA

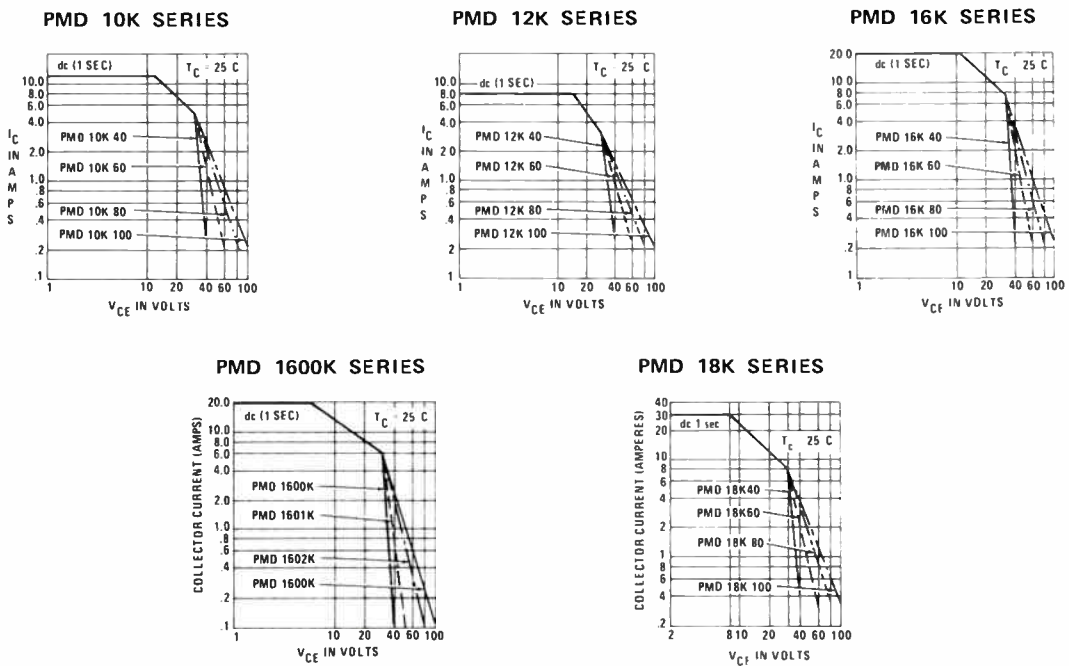

OPERATIONAL DATA (continued)

POWER DERATING

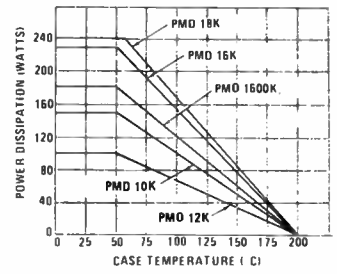
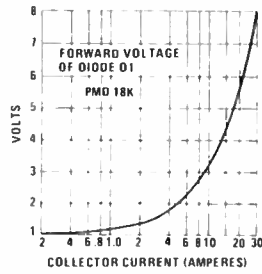
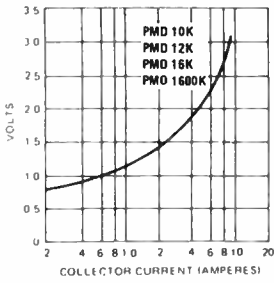

"ON" VOLTAGES VERSUS COLLECTOR CURRENT

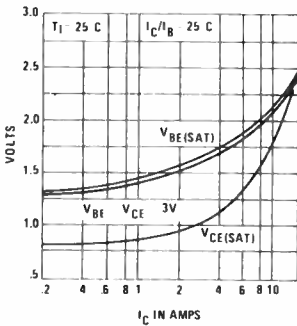

PMD 10K SERIES

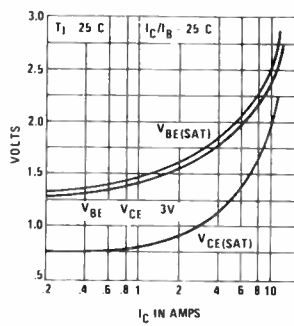

PMD 12K SERIES

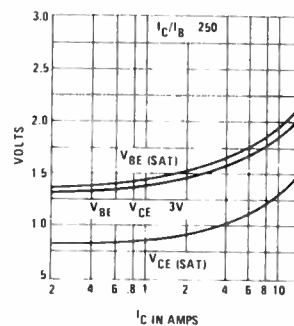

PMD 16K, 1600K SERIES

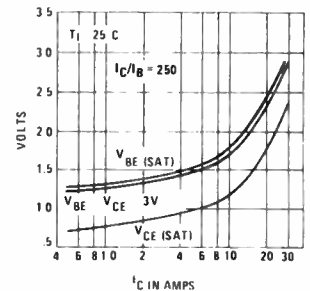

PMD 18K SERIES

DC COLLECTOR CURRENT GAIN VERSUS COLLECTOR CURRENT

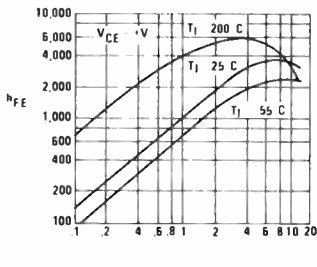

PMD 10K SERIES

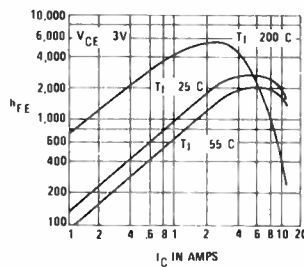

PMD 12K SERIES

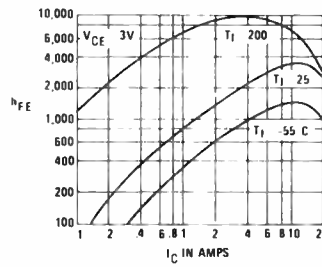

PMD 16K, 1600K SERIES

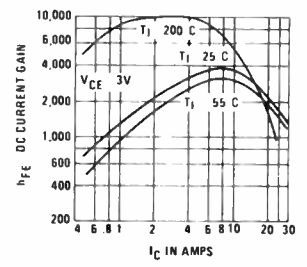

PMD 18K SERIES

COLLECTOR SATURATION REGION

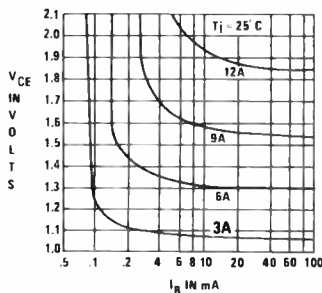

PMD 10K SERIES

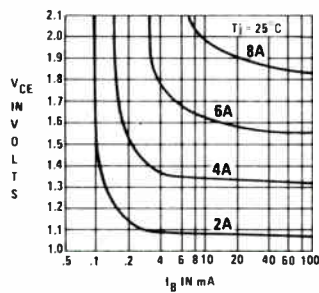

PMD 12K SERIES

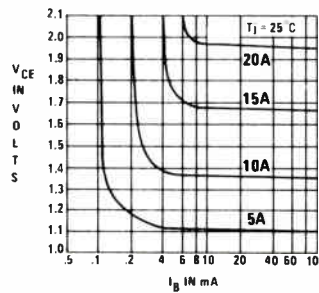

PMD 16K, 1600K SERIES

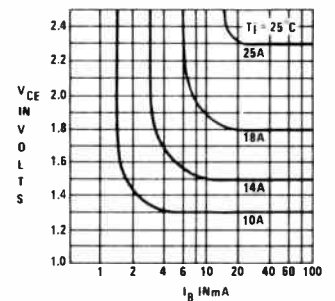

PMD 18K SERIES

△ Lambda PMD 11K, 13K, 17K, 1700K, 19K Series of PNP Power Transistor Darlingtontons

ELECTRICAL CHARACTERISTICS

ALL PARAMETERS ARE GUARANTEED AT T_J of 0°C to 200°C, UNLESS OTHERWISE SPECIFIED

DEVICE TYPE	TEST	SYMBOL	TEST CONDITIONS	MIN.	MAX.	UNITS	NOTE
PMD-11K SERIES PMD-13K SERIES PMD-17K SERIES PMD-1700K SERIES PMD-19K SERIES	Collector Emitter Saturation Voltage	V _{CE(Sat)}	I _C =6Adc; I _B =24MAdc I _C =4Adc; I _B =16MAdc I _C =10Adc; I _B =40MAdc I _C =10Adc; I _B =40MAdc I _C =15Adc; I _B =60MAdc		2.0	Vdc	1
PMD-11K SERIES PMD-13K SERIES PMD-17K SERIES PMD-1700K SERIES PMD-19K SERIES	Base Emitter Turn-on Voltage	V _{BE(on)}	I _C = 6Adc I _C = 4Adc I _C = 10Adc I _C = 10Adc I _C = 15Adc	V _{CE} = 3Vdc	2.8	Vdc	1
PMD-11K SERIES PMD-13K SERIES PMD-17K SERIES PMD-1700K SERIES PMD-19K SERIES	Base Emitter Saturation	V _{BE(Sat)}	I _C =6Adc; I _B =24MAdc I _C =4Adc; I _B =16MAdc I _C = 10Adc; I _B = 40MAdc I _C = 10Adc; I _B = 40MAdc I _C = 15Adc; I _B = 60MAdc		2.8	Vdc	1
PMD-11K SERIES PMD-13K SERIES PMD-17K SERIES PMD-1700K SERIES PMD-19K SERIES	DC Current Gain	h _{FE}	I _C =6Adc I _C =4Adc I _C =10Adc I _C =10Adc I _C =15Adc	V _{CE} = 3Vdc	800 800 800 750 800	20,000	1
PMD-11K SERIES PMD-13K SERIES PMD-17K SERIES PMD-1700K SERIES PMD-19K SERIES	Forward Bias Second Breakdown current	I _{S/b}	T _A =25°C V _{CE} = 30Vdc 1 second nonrepetitive pulse	5.0 3.0 7.5 6.0 8.0		Adc	1
PMD-11K, 13K, 17K, 19K-40 PMD-1700K PMD-11K, 13K, 17K, 19K-60 PMD-1701K PMD-11K, 13K, 17K, 19K-80 PMD-1702K PMD-11K, 13K, 17K, 19K-100 PMD-1703K	Collector Emitter Breakdown Voltage (Base Open)	V _{(BR)CE(O)}	I _{CE} = 100MAdc T _J 25°C	40 60 80 100		Vdc	
PMD-11K, 13K, 17K, 19K-40 PMD-1700K PMD-11K, 13K, 17K, 19K-60 PMD-1701K PMD-11K, 13K, 17K, 19K-80 PMD-1702K PMD-11K, 13K, 17K, 19K-100 PMD-1703K	Collector Emitter Sustaining Voltage	V _{(BR)CE(R(sus))}	I _{CE} = 100MAdc R _{BE} = 2.2K ohms	40 60 80 100		Vdc	
All PNP Series	Emitter Base Leakage Current	I _{EB(O)}	V _{EB} = 5Vdc I _C = 0A		3.0	MAdc	
PMD-11K, 13K-40 PMD-11K, 13K-60 PMD-11K, 13K-80 PMD-11K, 13K-100	Collector Emitter Leakage Current	I _{CLR}	V _{CE} = 20Vdc V _{CE} = 40Vdc V _{CE} = 54Vdc V _{CE} = 67Vdc	R _{BE} = 2.2 Kohms	5.0 5.0 5.0 5.0	MAdc	

continued on next page

ELECTRICAL CHARACTERISTICS (continued)

DEVICE TYPE	TEST	SYMBOL	TEST CONDITIONS		MIN.	MAX.	UNITS	NOTE	
PMD 17K 40 PMD 1700K PMD 17K-60 PMD 1701K PMD-17K-80 PMD 1702K PMD 17K 100 PMD 1703K PMD 19K 40 PMD 19K-60 PMD 19K 80 PMD 19K 100	Collector Emitter Leakage Current	I_{CER}	OFF Characteristics	$V_{CE} = 20V_{dc}$ $V_{CE} = 40V_{dc}$ $V_{CE} = 54V_{dc}$ $V_{CE} = 67V_{dc}$	$R_{BE} = 2.2K_{ohms}$	7.0	MA _{dc}		
		$V_{CE} = 20V_{dc}$ $V_{CE} = 40V_{dc}$ $V_{CE} = 54V_{dc}$ $V_{CE} = 67V_{dc}$		10.0					
PMD-11K SERIES PMD-13K SERIES PMD-17K SERIES PMD-1700K SERIES PMD-19K SERIES	Output Capacitance	C_{obo}	Dynamic Characteristics	$V_{CB} = 10V_{dc}$, $I_E = 0A_{dc}$ $f = 1 MHz$ $T_J = 25^\circ C$		300 200 400 400 600	pf		
PMD 11K SERIES PMD-13K SERIES PMD 17K SERIES PMD 1700K SERIES PMD 19K SERIES	Small Signal Current Gain	h_{fe}		$I_C = 5A_{dc}$ $I_C = 3A_{dc}$ $I_C = 7A_{dc}$ $I_C = 7A_{dc}$ $I_C = 9A_{dc}$	$V_{CE} = 3V_{dc}$ $f = 1kHz$ $T_J = 25^\circ C$	300			
PMD-11K SERIES PMD 13K SERIES PMD-17K SERIES PMD 1700K SERIES PMD-19K SERIES	Common Emitter Short-Circuit Forward Transfer Ratio	h_{fe}		$I_C = 5A_{dc}$ $I_C = 3A_{dc}$ $I_C = 7A_{dc}$ $I_C = 7A_{dc}$ $I_C = 9A_{dc}$	$V_{CE} = 3V_{dc}$ $f = 1MHz$ $T_J = 25^\circ C$	4			

NOTES:

- Pulse Test: Pulse Width is less than or equal to 300 μ Sec, and the Duty Cycle is less than or equal to 2.0%.

DEVICE PRICES, SPECIFICATIONS, AND CONFIGURATIONS ARE SUBJECT TO CHANGE WITHOUT NOTICE

OPERATIONAL DATA

SAFE OPERATING AREA

PMD 11K SERIES

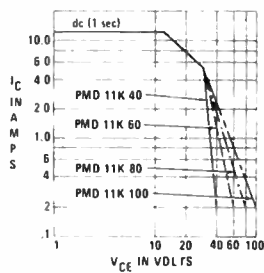

PMD 13K SERIES

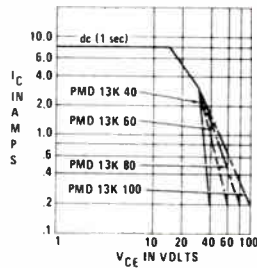

PMD 17K SERIES

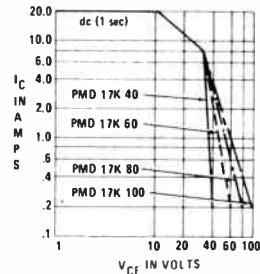

PMD 1700K SERIES

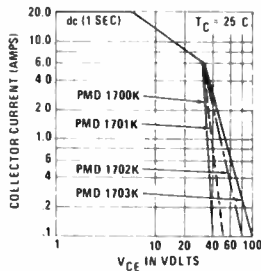

PMD 19K SERIES

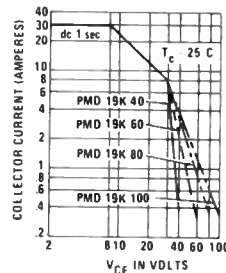

OPERATIONAL DATA (continued)

POWER DERATING

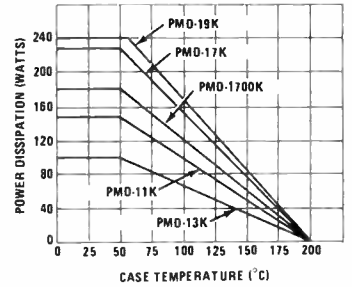
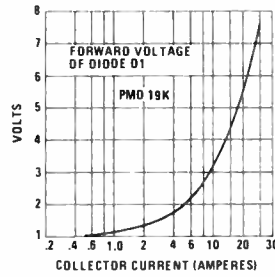
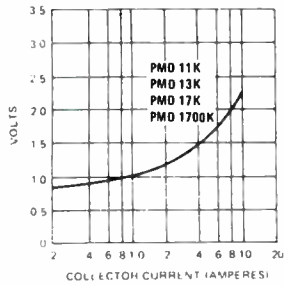

"ON" VOLTAGES VERSUS COLLECTOR CURRENT

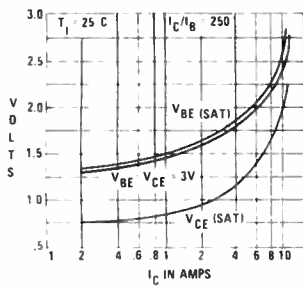

PMD 11K SERIES

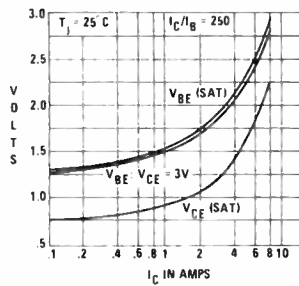

PMD 13K SERIES

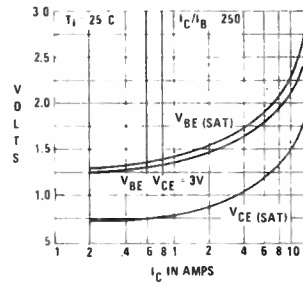

PMD 17K, 1700K SERIES

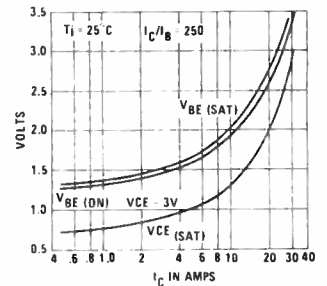

PMD 19K SERIES

DC COLLECTOR CURRENT GAIN VERSUS COLLECTOR CURRENT

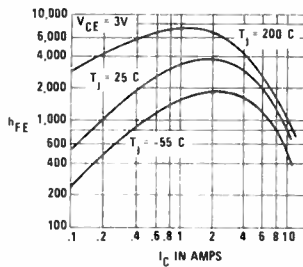

PMD 11K SERIES

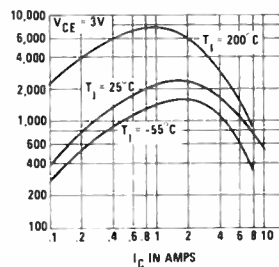

PMD 13K SERIES

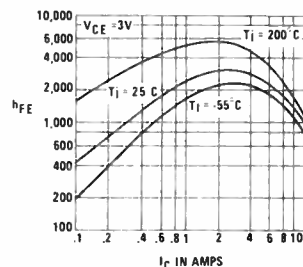

PMD 17K, 1700K SERIES

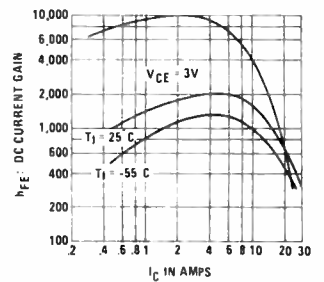

PMD 19K SERIES

COLLECTOR SATURATION REGION

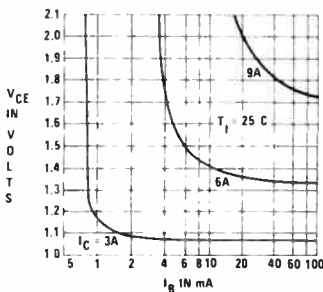

PMD 11K SERIES

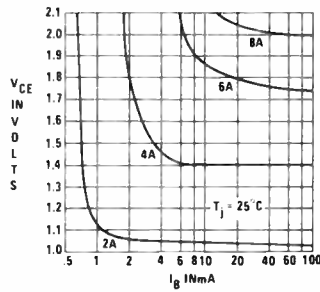

PMD 13K SERIES

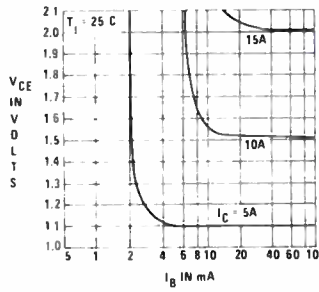

PMD 17K, 1700K SERIES

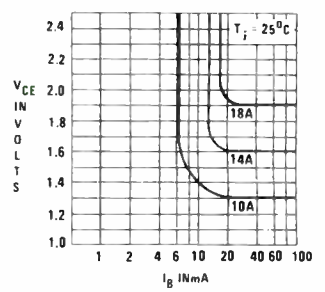

PMD 19K SERIES

△ Lambda PMD 18K and 19K series
NEW ADDITIONS TO THE POWER
DARLINGTON LINE:
h_{FE} 1000 at 15 AMP D.C.



PMD 18K-40



PMD 19K-60

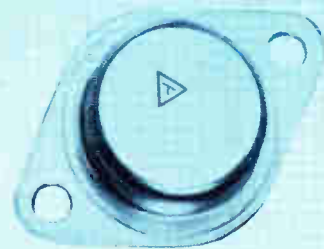

PMD 19K-100



PMD 1600K



PMD 1700K

Up to 15% price reductions
on PMD 1600K & 1700K Darlington.

△ LAMBDA SEMICONDUCTORS
 121 International Drive, Corpus Christi, Texas 78410

SOUTH WESTERN REGION
 121 INTERNATIONAL DRIVE
 CORPUS CHRISTI, TX 78410
 TEL. 512 883 6291
 TWX 910 876 1404

ATLANTIC REGION
 515 BROAD HOLLOW RD.
 MELVILLE, NY 11747
 TEL. 516 694 6200
 TWX 510 234 6484

CANADA
 VEECO LAMBDA LTD.,
 100C HYMUS BLVD.
 POINTE-CLAIRE, QUEBEC-H9R 1E4
 TEL. 514 697 6520
 TWX 510 427 3029

POWER SEMICONDUCTORS
 DESIGNED, DEVELOPED
 AND MANUFACTURED BY

FAR WESTERN REGION
 12607 HIDDEN CREEK WAY, SUITE J
 CERRITOS, CA 90701
 TEL. 213 926 0941
 TWX 910 345 7649

NORTH EASTERN REGION
 2 MILITIA DRIVE
 LEXINGTON, MA 02173
 TEL. 617 861 6038
 TWX 710 326 7558

NORTH WESTERN REGION
 599 N. MATHILDA AVE.
 SUNNYVALE, CA 94086
 TEL. 408 245 0380
 TWX 910 339 9243

MID WESTERN REGION
 2420 EAST OAKTON DRIVE, UNIT Q
 ARLINGTON HEIGHTS, IL 60005
 TEL. 312 593 2650
 TWX 910 252 2856



△ LAMBDA ELECTRONICS
 DIVISION of **Veeco** INSTRUMENTS INC.

The magazine you're reading now, could be your own.

Drop off the routing list. Get your own fresh, unclipped copy mailed to your home or office. Turn to the subscription card in the back of the magazine. If somebody has beat you to it, write: Electronics, P.O. Box 430, Hightstown, N.J. 08520.

IT'S NEW and SMARTER THAN EVER



TP-3150 Thermal Printer All you need for full Alphanumeric Thermal Printing!

- Serial or Parallel ASCII Input
- Power Supply • Bowmar's TP-3150 Printer

and it's only **\$269.⁰⁰** in unit quantity

Bowmar

Bowmar Instrument Corporation • Commercial Products Division
8000 Bluffton Road • Fort Wayne, Indiana 46809
Phone: (219) 747-3121

Circle 243 on reader service card

Electronics Magazine Books.

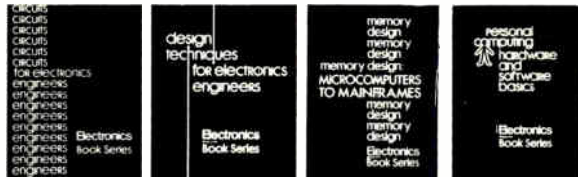

- 1. Microprocessors** What you must know about available micro-processor technology, devices, information, 4th printing. \$8.95
- 2. Applying Microprocessors** 2nd and 3rd generation technology. 26 detailed applications from data networks to video games. \$9.95
- 3. Large Scale Integration** Covers the basic technology, new LSI devices, LSI testing procedures, plus system design and applications. \$9.95
- 4. Basics of Data Communications** Includes 47 articles from Data Communications magazine covering more than 11 key areas. \$12.95

- 5. Circuits for Electronics Engineers** Contains 306 circuits arranged by 51 functions from Amplifiers to Voltage Regulating Circuits. Saves design drudgery. \$15.95
- 6. Design Techniques for Electronics Engineers** Nearly 300 articles drawn from "Engineer's Notebook." A storehouse of design problem solutions. \$15.95
- 7. Memory Design: Microcomputers to Mainframes** The technology, devices, and applications that link memory components and system design. \$12.95
- 8. Personal Computing: Hardware and Software Basics** More than 50 articles from leading publications in the field. \$11.95

Electronics Magazine Books
P.O. Box 669, Hightstown, NJ 08520

I must be fully satisfied or you will refund full payment if the book is returned after ten-day trial examination. Send me:

- _____ copies of 1. *Microprocessors* @ \$8.95
- _____ copies of 2. *Applying Microprocessors* @ \$9.95
- _____ copies of 3. *Large Scale Integration* @ \$9.95
- _____ copies of 4. *Basics of Data Communications* @ \$12.95
- _____ copies of 5. *Circuits for Electronics Engineers* @ \$15.95
- _____ copies of 6. *Design Techniques for Electronics Engineers* @ \$15.95
- _____ copies of 7. *Memory Design: Microcomputers to Mainframes* @ \$12.95
- _____ copies of 8. *Personal Computing: Hardware and Software Basics* @ \$11.95

Discounts of 40% on orders of 10 or more of each book.

- Payment enclosed Bill firm Bill me

Charge to my credit card:

- American Express Diners Club
 Visa Master Charge

Acct. No. _____ Date Exp. _____

On Master Charge only, first numbers above name _____

Name _____ Title _____

Company _____

Street _____

City _____ State _____ Zip _____

Signature _____



Classified section FOR ENGINEERING/TECHNICAL EMPLOYMENT OPPORTUNITIES

CLASSIFIED SALES REPRESENTATIVES

Sales Manager—Mary Ellen Kearns—212/997-3306

Atlanta	404/892-2868	Cleveland	Mac Huestis	216/781-7000	Houston	Mike Taylor	214/742-1747	Philadelphia	Dan Ferro	215/568-6161
Boston	Jim McClure	Dallas	Shirley Klotz	303/837-1010	Los Angeles	Ana Galaz	213/487-1160	Pittsburgh	Dan Ferro	412/391-1314
Chicago	Bili Higgins	Denver	Mac Huestis	313/873-7410	New York	Larry Kelly	212/997-3594	San Francisco	Peter McGraw	415/362-4600
		Detroit						Stamford	William Eyd	203/359-2860

ENGINEERS:

AMECOM Challenges You!

Put Your Ideas Up Against Our Best in EW/ECM Systems.

We work on the leading edge of EW and ECM systems, and our success is measured by the major programs in house with production follow-on to provide systems operating capability through the year 2000. If you are an innovative Microprocessor or EW Software Engineer we challenge you to work in the development of multifunction distributed microprocessors.

These positions range from Member of the Technical Staff to Senior Scientist with salaries to \$35,000.

Find out more about the challenges waiting for you at AMECOM. Please send your resume including salary history, or better yet, call COLLECT to:

Philip T. Foster
(301) 864-5600

AMECOM also has openings for Telecommunications and RF Engineers at our College Park headquarters. We are located in a pleasant Maryland suburb close to the Nation's capital with your choice of city, suburban, waterfront or country living.

 Amecom Division
LITTON SYSTEMS, INC.

5115 Calvert Rd., College Park, Md. 20740
An Equal Opportunity Employer M/F/H

ENGINEERS

ENGINEERS - EXECUTIVES to \$100K+. No challenge? No satisfaction? Underpaid? Maybe we can help you. Over 400 clients. Call me collect. John Ruck, CAREER ASSOC., 583 State Rd., N. Dartmouth, MA 02747 (617/997-3311).

ELECTRONIC ENGINEERS, \$18,000-\$45,000. For the electronics engineer, New England offers the widest diversity of positions available anywhere. As one of the largest, long established (15 years) technical placement organizations in the area, we can represent you with a wide variety of clients, large and small, for positions ranging from entry level to senior management. Nationwide representation is also part of our service. Contact Bob McNamara, E. P. REARDON ASSOCIATES, 888 Washington St., Dedham, MA 02026 (617/329-2660).

DESIGN ENGINEERS to \$38K. Central Penna. Design connectors/terminals, micro-processors. Outstanding relocation packages. Prompt confidential reply. MECK ASSOC. PERSONNEL, 1517 Cedar Cliff, Camp Hill, PA 17011 (717/761-4777).

BSEE / ELECTRONIC DESIGN ENGINEERS, \$15,000-\$35,000. Immediate, desirable upstate New York & nationwide. Junior to senior project management. In confidence send resume or call James F. Corby, President, NORMILE PERSONNEL ASSOC., INC., 5 Leroy St., Box 110 Westview Station, Binghamton, NY 13905 (607/723-5377).

all positions fee-paid



NATIONAL PERSONNEL CONSULTANTS

**OUR ACTIVITY IS:
PERIPHERAL
EQUIPMENT SALE
IN ITALY**

Our name is Contradata Milano, a young, aggressive and quickly growing company. Our main location is in Milan, the true heart of business in Italy. Following our expansion planning we would like to get in touch with builders and suppliers of reliable peripherals to be represented in Italy, like:

- Serial Printers
 - Small Impact Printers
 - Printer Keyboard
 - CRT
 - Mag. Tapes
 - TTY
 - Terminals
 - Hard Disks
 - Personal Computers
- Pls Contact:*

Contradata Milano, SRL
Via Dei Valtorta, 11
20127—I—Milan
Telex No. 333259 CIMIL I
Attention: G. Damian

TOLL FREE 800-426-0342
POSITIONS NATIONWIDE

Proc. Engr—Electronics design & test, mini computers, E.E. 26M.
Electroforming—Continuing embossing, M.E. metallurgy. 32M.
Electronics Market Mgr—Packaging, materials/components, E.E. pref. 34M.
Proj. Engr.—Electronic proc. control systems & eqpt. 26M.
Chemist—Elect. materials, coatings/insulation, M.S.-Ph.D. 30M.
Supr. of Appl. R&D—Electromotive, magnetics, metal/ceramics. 40M.
Design/Develop. Engr—Digital, micro-processor, E.E. 28M.
Call us to explore the market for your skills.
Fees paid by client companies.
Fred Steele, M.S. Chemistry
TOLL FREE 800-426-0342
PARKER PAGE ASSOCIATES
P.O. Box 12308, Seattle Wash. 98111

**FLIGHT TEST
DATA SYSTEMS**

McDonnell Aircraft Company has immediate openings in Flight Test Data Systems associated with the collection processing and presentation of Flight Test Data.

- **Technical Specialist**— To direct the software development of minicomputer systems. M.S. in computer science with E.E. basis. Familiarity with minicomputer operating systems, assemblers, and source file management, and the ability to deal with system hardware as well as software are required.
- **Senior Programmer and Programmer**— To write or direct the writing of minicomputer applications for Raytheon RDS-500, Data General Nova and H.P. Scientific Minicomputers. Experience with aforementioned systems is desirable but not required. M.S. or B.S. in E.E., Computer Science major. 3-5 years experience in minicomputer programming preferred.

Please send your resume in confidence to:

W. B. Kellenberger
Section Manager,
Professional Employment
(62-2A)
Department E-04
P.O. Box 516
St. Louis, Missouri 63166

MCDONNELL DOUGLAS CORPORATION



Attractive living and challenging work . . .

**This is what
Hewlett-Packard offers
engineers in
Santa Rosa, California...**

HP's Santa Rosa Division develops, manufactures, and markets state-of-the-art RF and microwave measurement instrumentation: spectrum analyzers, network analyzers, and sweep oscillators. The HP Microwave Technology Center in Santa Rosa develops devices, circuits and processes that result in the unmatched performance of these HP instruments.

Hewlett-Packard has career opportunities for engineers and scientists with 1-3 years of experience in the following areas:

- Analog/digital circuit design
- Semiconductor processing/device design
- Instrument application/product marketing
- Component applications
- Reliability engineering
- Manufacturing engineering

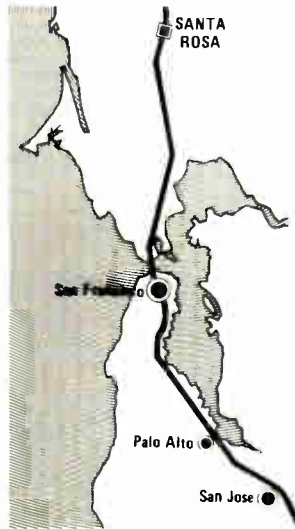

Santa Rosa — "The City Designed for Living," gateway to the Redwood Empire and the North Coast wine country, is a smog-free, modern city of 75,000 people. It offers excellent schools, affordable housing, recreational and cultural activities, and a superb climate year round. There's plenty of active living in the Santa Rosa area; it's a fun place to relax or play. It's a great place to work and a comfortable place to raise a family. And yet it's only an hour away from cosmopolitan San Francisco.

If this sounds like your kind of place, send your resume today to Hilary Hollister.

HEWLETT  PACKARD

1400-8 Fountain Grove Parkway, Santa Rosa, CA 95404
An equal opportunity employer dedicated to affirmative action

Product Development & Design Engineers BSME/EE

General Electric specializes in producing high quality appliances for the home. We offer engineers the opportunity to make original contributions . . . while working within a top professional team.

ELECTRONIC PRODUCT DEVELOPMENT ENGINEERS: BSEE

3-5 years product development experience. Background must include applying the latest circuit design and microelectronic design techniques.

DESIGN ENGINEERS:

BSME/EE 3-5 or more years of experience with mass produced products —preferably consumer—and knowledge of heat transfer, strength and cost of materials, UL Standard, design experience should include die casting, thermoplastics, thermostats, heaters, motors, and related devices.

Join us, and we'll provide you with a fully commensurate salary. Famous General Electric benefits, and an environment where individual success is seen and recognized.

Please send resume with salary requirements, identifying area of interest, to Ms. C. C. St. Mark, Ref. 78-D, General Electric Housewares & Audio Business Division, 1285 Boston Ave., Bridgeport, Ct. 06602.

GENERAL  ELECTRIC

an equal opportunity employer m/f

Electronics

If you know where you're going, you've got a good start... but that's all you've got.

The Woodward Governor Company manufacturer of prime mover controls exclusively since 1870 has immediate need for:



TECHNICAL WRITERS

Position requires individuals with understanding of discrete, integrated circuit, and micro-processor components, to generate technical manuals and other product support materials for new electronic controls used on broad range of prime mover applications.

Become a member of our well established, stable organization which offers an outstanding profit sharing plan, benefit program and excellent working conditions. Send your resume in complete confidence to: The Woodward Governor Company, Dept. KD, 1000 East Drake, Fort Collins, Colorado 80525. We are an equal opportunity employer m/f.

WOODWARD

ELECTRONIC

Our national reputation can be your avenue to advancement. We are currently conducting searches for staff and management persons at several levels from \$20,000—45,000. Confidentiality and professionalism are our trademarks. Call or write.

Q.A./Q.C.

All fees and costs paid.

**Dick Ray, President
Career Consultants**
540 Meadow St. Ext. Agawam, Mass. 01001
413-789-0907

**ENGINEERS
ELECTRONICS & ELECTRICAL**

Let our ENGINEERING professionals work with you in strict confidence
Free NATIONWIDE service-140 offices

RPM Technical Div (agency, div. of RPM Affiliates Ltd)
6 E 45 St NYC 212-692-6150

**NATIONWIDE ELECTRONICS
PLACEMENT**

Digital Ckt Dsgn * Hardware Sys Dsgn
Analog Ckt Dsgn * Software Sys Dsgn
Quality Reliability * Test Equipment Mtnce

Entry Level through Management
All Fees are Exclusively Employer Paid
Resume Format Guide
Available Upon Request

E. J. STEPHEN ASSOCIATES
1601 Concord Pike, Suite 86, Wilmington, DE 19803
(302) 654-5350

DESIGN ENGINEER—(3) career opportunities and professional challenges in Houston, Texas with our high-growth medical equipment division. BS, EE and experience in design of analog circuits in medical devices, radar systems, microwave, DC to DC converter, power supply, etc: UL experienced. Send resume and salary history, in confidence, to E. France, **NARCO SCIENTIFIC, INC.**, Commerce Drive, Ft. Washington, Pa. 19034. Equal Opportunity Employer. M/F.

BRAZIL RESEARCH AND DEVELOPMENT MANAGER TELECOMMUNICATIONS

The company is part of a highly respected and successful multi-national corporation. Telecommunications is one of our main areas of involvement and we believe it to have considerable potential particularly in South America. We intend to expand our activities in this continent in close cooperation with the official authorities and with full regard for national interests.

An integral part of this plan is to develop and expand a Telecommunications R & D department. This activity will correspond closely with the worldwide R & D strength of the corporation and will be located and affiliated with our existing manufacturing organization in Brazil which has some thousand employees.

We are looking for the expert who will direct this department. Brazilian citizenship or a similar background is desirable. In addition we expect fluency in English or French.

The department head will report directly to the regional Telecommunications Division manager and within a few years will be responsible for about 100 employees. A qualified college degree and at least 5 years broad experience in Telecommunication or equivalent fields, such as digital techniques or composition, are considered essential for this assignment.

Remuneration including company car and pension plan will satisfy the most demanding requirements. For a first contact please call our consultants— Mr. Apostel in Sao Paulo (for applications in South America)—Dr. Bartels in Munich (for applications from Europe and other countries) or send them your complete resume.

ROLAND BERGER ASSOCIADOS (Consultoria Internacional Ltda.)
Rua Marechal Deodoro, 543 • 047388 Sao Paulo— Alto Da Boa Vista 10'
(Caixa Postal 21370) • Tel. (011) 347 3657

ROLAND BERGER U. PARTNER GMBH (BDU) International Management Consultants
Truderinger StraBe 13 • D-8000 Munchen 80 • Telefon 089/47 10 73
Geschäftsbereich Personalberatung

BRUSSEL • LONDON • MAILAND • MUNCHEN •
NEW YORK • PARIS • SAO PAULO • UTRECHT • ZURICH



EECO

ENGINEERS

Are You Ready For Us?

EECO

Is On The Move!

ELECTRONIC ENGINEERS

EECO is a growth oriented multi-product company in the computer/electronics industry. EECO has such innovative products as broadcast editing systems, airline entertainment products, hotel computer systems and other electronic products. We are presently building our systems design group and are seeking electronic engineers with minicomputer/microprocessor experience for the following positions:

- **Engineering Supervisor**
- **Sr. Electronic Engineer**
- **Sr. Engineer Programmer**
- **Electronic Engineer**
- **Engineering Programmer**
- **Associate Engineer**

At EECO, you will have the opportunity to help design new and innovative products.

Please send resume or contact
DAYNE C. BURNS collect
for more information.

1601 East Chestnut
Santa Ana, California 92701
(714) 835-6000, Ext. 370

EECO

ELECTRONIC ENGINEERS

IMMEDIATE CAREER OPPORTUNITIES

Contact in Confidence:



Engineers—SE Locations, Process, Power Light, Software, Hardware, Systems, Instrumentation, Facilities. Fee Paid, No Contracts, 12 yrs. experience. Send resume to Ted McCulloch.

Beall Associates
P.O. Box 5042
Spartanburg, S.C. 29304

ENGINEER-DEVELOPMENT ENGINEER—Outstanding career opportunity with our high-growth medical equipment division located in Houston, Texas. Requires background in product design and development with experience in analog circuit design, RF, UHF, telemetry modulation, etc. Advanced EE degree, first class FCC license. Send resume and salary history in confidence, to E. France, **NARCO SCIENTIFIC INC.**, Commerce Drive, Ft. Washington, Pa. 19034. Equal Opportunity Employer, M/F.

NOTICE TO EMPLOYERS:

Why we can recommend our readers for the top jobs

The subscribers to this magazine have qualified professionally to receive it. They are also paid subscribers—interested enough in the technological content to have paid a minimum of \$15 for a subscription.

As subscribers to **ELECTRONICS**, our readers have told you several things about themselves. They are ambitious. They are interested in expanding their knowledge in specific areas of the technology. And they are sophisticated in their need for and use of business and technology information.

Our readers are now in senior engineering or engineering management, or they are on the road toward those levels. In either case, they are prime applicants for the top jobs in almost any area.

If you are interested in recruiting the best people in electronics, these pages are open to you for your recruitment advertising.

Our readers are not “job-hoppers”. To interest them you will have to combine present reward with challenge and opportunity for future career advancement.

The cost of recruitment advertising on these pages is \$65 per advertising inch. For information call or write:

Electronics

Post Office Box 900, New York, NY 10020
Phone 212/997-2556

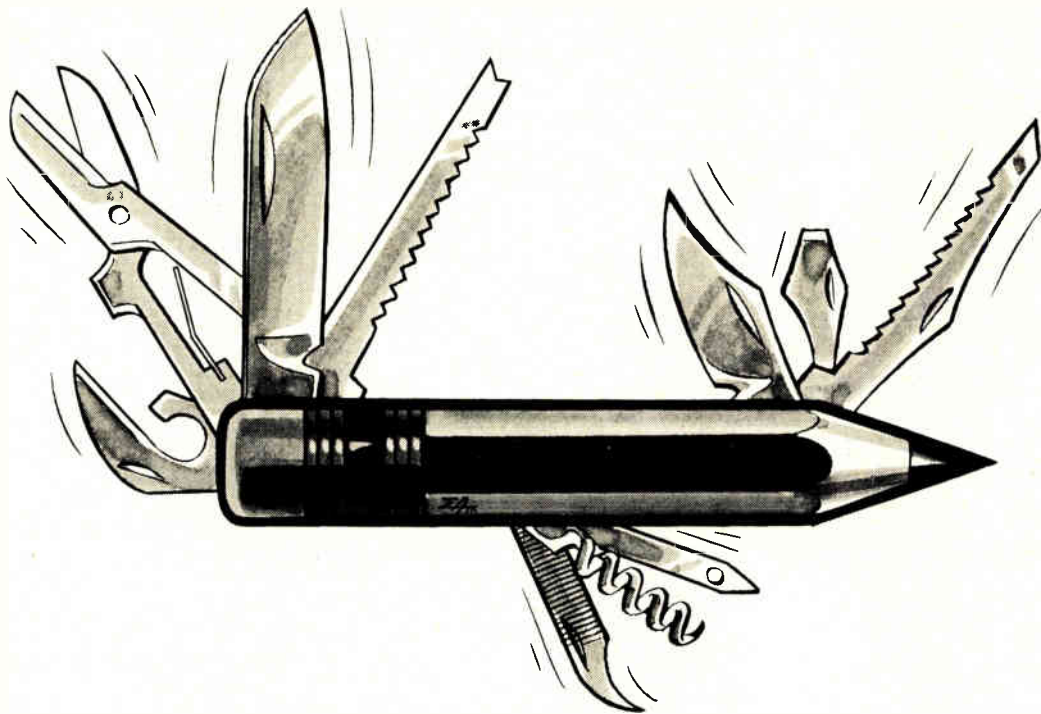

Versatility

The ability to work on several aspects of a tough problem — that's versatility. And at the ITT LSI Systems Support Center, it's the name of the game.

In fact, every member of our small, high-caliber staff has the opportunity to play every position on the design and development team.

The atmosphere is informal and stimulating. Ideas are freely exchanged. Head-to-head sessions can happen anytime.

And while the work we're doing is so proprietary we can't give specifics, we can tell you that we're handling the more complex large scale integrated circuit design assignments for telecommunications, space, defense, commercial, industrial, and automotive product areas throughout International Telephone and Telegraph Corporation.

This spring we'll be moving into new quarters near Milford, Connecticut, where we'll have 20,000 square feet all to ourselves and the latest resources at our command — including digital and linear test systems, SEM for failure analysis, environmental test equipment, computer and graphic systems... and wafer fabrication facilities at ITT's nearby Corporate Technology Center.

Our new location also offers the best in Connecticut living, near Long Island Sound and New Haven — and almost midway between New York and Boston.

So, if you're looking for hands-on, end-to-end involvement and the opportunity to work closely with some of the most versatile minds in the LSI field, get in touch with us.

We have opportunities at various levels for:

- **Process & Device Specialists**
- **LSI and VLSI Design Engineers**
- **Linear IC Designers**
- **LSI Layout Designers**
- **LSI Applications Engineers**
- **Digital & Linear IC Test Engineers**
- **Reliability & Quality Engineers**

**Call collect to arrange interview:
(203) 348-8855, Monroe Weiant,
Assistant Director — Operations.**

Or send resume including salary history in confidence to Mr. Eugene Edwards.
Caller Service 1-14, Milford, Connecticut 06460

**ITT LSI SYSTEMS
SUPPORT CENTER**

An Equal Opportunity Employer, M/F

The Optimum System Approach.

It's the concept that we base our engineering on at the Space Information Systems Operation... a dynamic approach to design that allows us to build in specific capabilities and maximize flexibility and cost efficiency. Within the Space Information Systems Operation we have all the necessary resources to build and deliver an optimum system. We can provide requirements analyses, system design and engineering, hardware and software design and development, manufacturing, procurement, logistics support, system maintenance, system operation, maintenance and user documentation, and programmer, operator and analyst training.

We have this same attitude toward our employees, giving them maximum responsibilities across the entire development cycle, in a growth oriented environment. Additionally, we offer highly competitive salaries, outstanding benefits, and an uncongested working community... the optimum employment opportunity. What's more, Texas does not have a state income tax. Our current openings are for experienced Digital and Analog Design engineers and Minicomputer Systems engineers. For more information CALL COLLECT or send a resume to: John Brown, Space Information Systems Operation, P.O. Box 58487, Houston, Texas 77058, (713) 488-1270.

We are an equal opportunity employer, m/f.



Ford Aerospace & Communications Corporation

Electronics

If you know where you're going, you've got a good start... but that's all you've got.

The Woodward Governor Company manufacturer of prime mover controls exclusively since 1870 has immediate need for:

ELECTRONIC DRAFTERS DRAFTING CHECKERS

Positions require individuals with electronic and mechanical drafting experience. Should have minimum 2 years drafting training and/or several years experience. Checkers must have the above experience plus a minimum of 2 years checking experience.

Become a member of our well established, stable organization which offers an outstanding profit sharing plan, benefit program and excellent working conditions. Send your resume in complete confidence to: The Woodward Governor Company, Dept. KD, 1000 East Drake, Fort Collins, Colorado 80525. We are an equal opportunity employer m/f.

WOODWARD



ELECTRONIC ENGINEERS ARE YOU WORTH A 17.5% INCREASE IN SALARY?

That is the average increase in salary for the technical professionals who we placed in new positions in 1978. Some received more! Most relocated to a more desirable geographic location or stayed in the same city in which they lived. Most importantly, all of them went into a position of either increased technical challenge, more responsibility, or better opportunity for career growth.

RCI is a technical search firm with an outstanding reputation representing a broad base of nationwide clients serving the Electronics Industry. If you are interested in advancing your career, call us or send your resume or a brief hand written description of your background including present salary and geographic preferences, in confidence to:

**Manny Rao, Search Director-Room K
REGIONAL CONSULTANTS, INC.**

213 West Ninth Street
Cincinnati, Ohio 45202
513/579-1513

The "Local National" — Technical Search Firm
(representing EEO clients only)

Build a career.

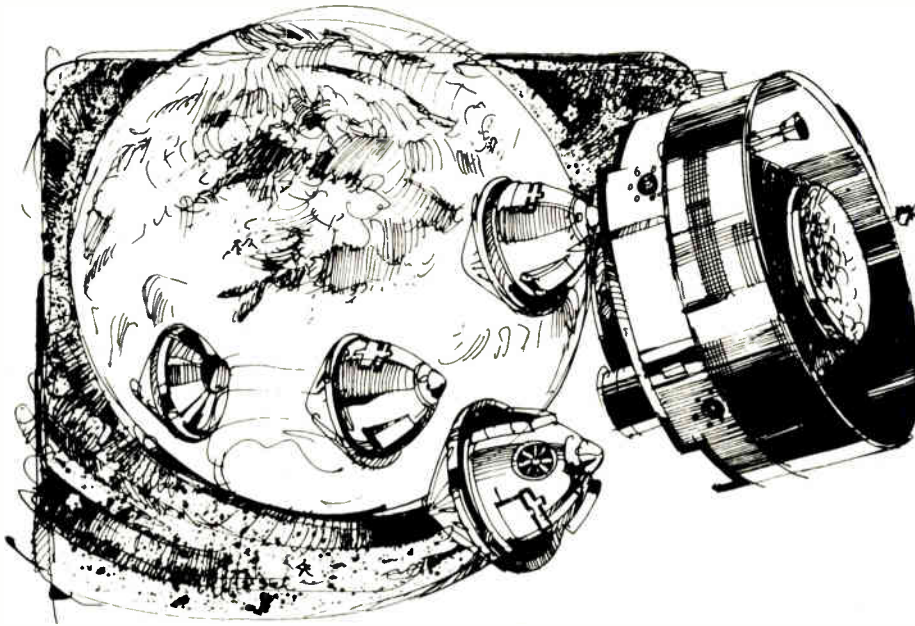

With the people who built Pioneer Venus.

In February, 1974, Hughes Space & Communications was assigned one of the most epochal missions in space exploration. It was to build two different kinds of spacecraft. To take two different flight paths to Venus. And send back to Earth streams of invaluable new information.

In May, 1978, the first phase of Pioneer Venus was launched. And today, NASA officials are still marveling at the mission's success. In 90 minutes, Pioneer Venus told scientists more about Venus than mankind had learned since the days of Galileo.

At Hughes Space & Communications, the success of Pioneer Venus is already gearing us up for new programs now underway.

That's why, when you build a career at Hughes Space & Communications, you join much more than our stellar accomplishments. You join our future.

And if you take a college course after hours, we pay for 100% of it.

If building a career in this kind of environment appeals to you, join top-notch engineers and computer scientists working on top-priority programs.

Other communications and scientific spacecraft by Hughes: Syncom; ATS; Tacsat; Intelsats I, II, IV and IV-A; OSO-8; GMS-1; Marisat; Anik; Westar; Comstar; Palapa I.

Applications Software Development.

- Software Development (Fortran, Compass, Macro 11).
- Top-Down, Structured Software Design and Programming.

DP Systems Engineering and Analysis.

- Software Requirements Engineering.
- Resource Requirements Analysis.
- Software Design.

DP Systems Integration, Test and Evaluation.

- Test/Evaluation across DP life-cycle.
- Programming/Checkout of Test Driver Software.
- DP Software and Hardware Testing.

Communications Systems and Components.

- R.F. Circuit Design and Development.
- Solid State Transmitter and Receiver Design.
- Power Supply Design, Lo and Hi Voltage.
- R.F. Packaging and Product Design.

Microwave Systems, Antennas and Components.

- Antenna Design and Fabrication.
- Microwave Circuits, Filters, Solid State Design and Development.
- Spacecraft Communications Receiver Engineering.

Digital Communications and Control Systems.

- Telemetry and Command Analog/Digital Circuit Design.
- Advanced LSI Custom SOS/CMOS Design.
- Test Equipment and Packaging Design.

Please send your resumé to T. W. Royston, Space & Communications Group, Department EL, Building 373, Mail Station 170, P.O. Box 92919, Los Angeles, CA 90009.



U.S. Citizenship required.
Equal Opportunity M/F/H/C employer.

CAREER OPPORTUNITIES AT GOULD

Join The Search For The Technology of Tomorrow

Gould Ocean Systems is the world's leading pioneer in the field of oceanic technology, and is continually striving to stay #1. Significant growth coupled with forecasted expansion and a solid commitment to new product development has created exciting professional opportunities for imaginative engineering talent with Gould's fast-moving Ocean Systems Division. Immediate openings are now available for professionals with U.S. Citizenship in the following areas:

ELECTRICAL ENGINEER

To qualify, candidates must have at least 5 years experience in the design of test circuits for use in complex digital and analog systems. Primary responsibility will involve the design and development of test circuits and specifications for performance testing. A BS in Electrical Engineering is required.

SENIOR ENGINEER

Prior work experience should include at least 7-10 years of power control engineering demonstrating strong leadership abilities as well as solid experience in Fortran IV and other computer aided analysis. Areas of responsibilities will include analyzing power systems used for undersea propulsion, generating system requirements and overseeing design integration and evaluation processes. A BSEE, MS or PhD in Electrical Engineering is required.

ELECTRICAL ENGINEER

For consideration, candidate must have experience in either hardware design or test program development, plus a background in automatic test equipment. Primary responsibilities will involve the analysis and synthesis of circuits for prototype development, the development of software and hardware test programs, as well as the generation of engineering documentation. A BS in Electrical Engineering is required.

ELECTRICAL ENGINEER

For consideration, candidates must have 0-3 years electronic experience in either hardware design or test program development, plus a solid background in automatic test equipment. Primary responsibilities will involve the analysis and synthesis of circuits for prototype development and the development of software and hardware test programs, as well as providing liaison with other departments to expedite realization of hardware and software products. A BS in Electrical Engineering is required.

If you're up to the large scale challenges and the exhilarating growth pace that have established Gould as an integrated technology company... you'll be rewarded with an exceptional salary, a full benefits package and highly-visible advancement opportunities. Submit letter or resume in confidence with earnings history and salary requirements to:

GOULD OCEAN SYSTEMS DIVISION
18901 Euclid Avenue
Cleveland, Ohio 44117

An Equal Opportunity Employer, M/F/H.

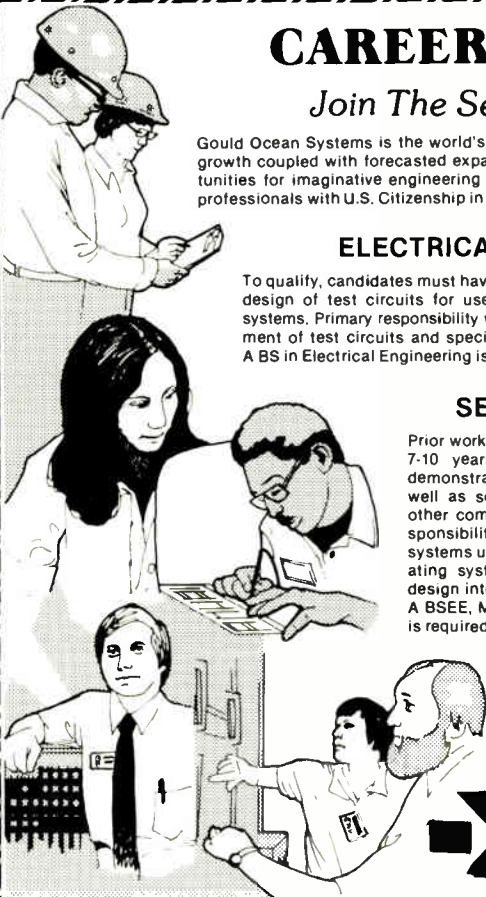

EXECUTIVE SEARCH CONSULTANTS

213 WEST 9TH STREET

CINCINNATI, OHIO 45202

PHONE 513/579-1513

Frank Eberle, Manager
Classified Advertising Dept.
McGraw-Hill Publications Company
Post Office Box 900
New York, N.Y. 10020

Dear Frank:

After two years of advertising in Electronics and dealing with McGraw-Hill, this letter is long overdue. The success we have attained through the usage of Electronics classified has been heads above that of any other advertising medium.

Like most effective search firms, RCI has always relied on personal contacts and general industry knowledge when recruiting specialized electronics professionals. We don't rely on a heavy advertising campaign when recruiting; consequently, when we do advertise the objective is to reach the largest number of the specialized electronics talent which we are pursuing. The past two years of advertising in Electronics has been a true boon to our business providing us with a high return on ad money spent. The most fruitful benefits, however, have been in the name recognition gained and the status achieved by name association with Electronics. It is obvious that your magazine is highly respected in the electronics community.

RCI, together with our clients, is continually conducting recruiting trips to all the areas of the country where there is concentration of electronics talent. We want electronics professionals to think of us as a "local-national" recruiting firm because chances are we are visiting their city on a regular basis. Electronics gives us this "local national" exposure.

RCI, Electronics, and McGraw-Hill share a common business outlook: Seeking a high degree of professionalism along with maintaining interpersonal relationships. We hope to continue this superior and profitable association.

Cordially,

Manny Rao

Manny Rao
Search Director

"The past two years of advertising in Electronics has been a true boon to our business, providing us with a high return on ad money spent."

An unsolicited letter from Manny Rao,
Search Director
RCI Executive Search
Consultants



Electronics Classified

where good employers and good engineers meet

ENGINEERS

ELECTRONICS ENGINEERS, \$15,000-\$45,000. Choice entry-level to management positions immediately available in Pennsylvania & national locations. We have been placing electronics engineers for more than 14 years, and have established contacts with many of the leading companies in the nation. Reply in strict confidence to J. G. Weir, President, WEIR PERSONNEL SERVICES, 535 Court St., Reading, PA 19603 (215/376-8486).

ELECTRONIC ENGINEERS, \$21,000-\$42,000. Minneapolis, the electronic capital of the World. Immediate openings in engineering and mfg. Reply in confidence to B. G. Gray, ABC EMPLOYMENT SERVICE, 401 Second Ave., Minneapolis, MN 55401 (612/339-1453).

ENGINEERS, \$18,000-\$34,000. Sunbelt. Nationwide. Leading companies. Analog, digital, microprocessor, instrumentation, application. Entry & management. Reply in confidence to J. F. Halloran, President, NATIONAL SEARCH, P.O. Box 73006, Houston, TX 77090 (713/376-9383).

ENGINEERS, \$15K-\$40K. West Coast & nationwide positions entry level thru mgmt. Design, Inst., Application, Test, etc. Reply in confidence. Call or send resume to GLENN ENGLISH AGENCY, 7840 Mission Center Ct., San Diego, CA 92108 (714/291-9220).

ENGINEERS. WHY not LIVE, WORK and PLAY in tax-free New Hampshire? Numerous career opportunities at all levels with salaries form \$15,000 to \$30,000+-. Contact AVAILABILITY PERSONNEL CONSULTANTS, 160 South River Rd., Bedford, NH 03102 (603/669-4440).

all positions fee-paid

inpc NATIONAL PERSONNEL CONSULTANTS



Systems Engrs. Data Processing Electronics

Salaries to \$46,000

Manufacturing Engrs.

ECM Engrs.

Tool Design Engrs.

Air Traffic Contrl. Syst. Engrs.

Rotating Devices Engrs.

Thermometric Engrs.

Digital CKT Design Engrs.

Power Systems Engrs.

Sr. Military Systems Engrs.

Field Engrs.(Electronic Equip.)

Digital Systems Engrs.

Production Control

Programmers/Mgrs.

QA and/or QC Engrs.

Technicians

Companies Assume Our Fees.

Submit Resume, Call or Visit.

THE ENGINEER'S INDEX

133 Federal Street, Suite 701

Boston, Massachusetts 02110

Telephone (617)482-2800



DALMO VICTOR

Engineer

Dalmo Victor Technology

provides the world's most advanced Digital Radar Warning Systems.

Lock in Your Career Path to Dalmo Victor
on the beautiful San Francisco Peninsula

Call Our TOLL-FREE, 24-Hour Number
(800) 821-3777, ext. 710
(Missouri residents, 800-892-7655, ext. 710)

Dalmo Victor continues to excel as the leader in the design and manufacture of state-of-the-art Digital Radar Warning Systems. If you've been anxious to expand your career with a company on the move, perhaps now is the perfect time to investigate the exciting opportunities available with us. We invite talented professionals to join us in the most advanced aircraft defense system available in the free world today. Immediate opportunities exist in the following disciplines.

Component Engineers

This position requires experience in selecting and analyzing MIL-SPEC semiconductor, IC and hybrid modules. You will prepare specifications, analyze data groups (A, B, & C), assist in failure analysis and coordinate with Engineering, Procurement, and Manufacturing.

Reliability Engineers

Successful candidates must be capable of performing and/or supervising preparation of reports on circuit stress analysis, reliability predictions, program plans, proposals, design review and failure analysis. Our expanding programs in our Integrated Logistics Support Department offer key opportunities for individuals with BS/MSEE and minimum 4 years' experience on aerospace programs.

Benefits

Lock in your career path to Dalmo Victor now and enjoy an excellent salary and benefits package that includes RELOCATION ASSISTANCE, company-paid medical/dental (for you and your dependents); company-paid retirement program; stock purchase plans; 13 paid holidays; and educational reimbursement. You'll enjoy western living at its best with fine schools, pleasant year 'round weather, beaches and mountains nearby, plus easy access to San Francisco and San Jose.

Come enter Dalmo Victor's World of Innovation now. For immediate consideration, please call our TOLL-FREE number (800) 821-3777 ext. 710, (Missouri residents please call 800-892-7655 ext. 710). If unable to call, please submit your resume (or letter of interest) to the Director of Product Assurance, Dept. 862, Dalmo Victor, 1515 Industrial Way, Belmont, CA 94002. U.S. citizenship required. An equal opportunity employer, M/F.

People & Products Dedicated to Leadership

DALMO VICTOR OPERATIONS
Bell Aerospace **TEXTRON**

Microcomputer Applications Engineers

At Intel, we don't wait for technological change to happen—we make it happen—almost everyday! So, once again, our fast-growing, highly respected Microcomputer Components Division is breaking new ground. If you want to work with the people who brought you the 8080, the 8085, and the new 8086 in the continuing development of state-of-the-art microcomputer components, consider this opportunity as a Microcomputer Applications Engineer.

You will be responsible for developing hardware and software applications for existing and newly designed microcomputers to support OEM manufacturers' needs. You will interface extensively with customers, participate in technical conferences and prepare articles for trade publications. To qualify for this highly visible position, you must have a BSEE or equivalent combination of education and experience and at least 3 years' experience in microcomputer hardware and software development. Some experience in automotive control applications is desirable.

For immediate consideration, please send your resume to Joyce Cordi, Intel Corporation, Dept. 17BD, P.O. Box 3078, Santa Clara, CA 95051. An equal opportunity employer m/f/h.



ELECTRICAL ENGINEER

Immediate opportunity exists with leading electronics firm to assist the Project Manager in designing and building prototypes in a new product development effort. Will direct technicians in this challenging project.

BSEE with 7 years experience required. Knowledge of antenna and preamp design plus R. F. techniques with 1-10 KW transmitters and receivers necessary. Ability to interface signals with computers a real plus.

Excellent fringe benefit program plus salary commensurate with experience and ability is offered.

Send resume, including salary requirements, in confidence, to:

**P- 8958
Electronics**

Class. Adv. Dept., P.O. Box 900, NY, NY 10020
An Equal Opportunity Employer M/F/H

POSITIONS VACANT

Engineers and Designers—Florida positions urgently need electronic experience. PCB, Analog, Electronic Packaging, and logic design experience desired. Permanent or long term contract positions. All fees paid. Salaries 15K to 30K. Rush confidential resume and earnings history to: J. C. Dayvault, President, R. P. Rita Inc., 1211 N. Westshore Blvd #107, Tampa, Florida 33607.

Electronic Engineer, Sun Belt, excellent opportunity, salary & benefits. Murkett Assoc., Box 527, Montgomery, AL 36101.

EMPLOYMENT SERVICES

Electronic engineering growth positions with clients located nationally. Our service is enhanced by the fact that I am an EE with 20 years in industry and over 10 years in placing professionals on an employer fee paid basis. Send your resume to Joe Torcassi, Director, J. Anthony & Associates, PO Drawer AD, Lynchburg, OH 45142. 513/364-2305.

M.E.s, I.E.s, E.E.s, Ch.E.s—Let our search firm represent you to our clients in Northern Calif. If you are seeking a more prestigious position with increased responsibilities and a better Future, send a resume or request a position profile and at no charge we will provide you with interview opportunities. Register in our exclusive Executive Search Program. All replies strictly confidential. All Fees employer paid at Management Recruiters, 1900 Point West Way, Suite 281, Sacramento, CA 95815 (916) 920-0441.

BUSINESS OPPORTUNITIES

Electronics/Executive. Top overseas electronics executive seeks opportunity for participation in U.S. industry. Outstanding proven skills in developing sophisticated products. Applicant progressed from electronics R&D work through all levels of management to position of managing director (President) of highly successful diversified manufacturing company (military and civilian) employing approximately 5000 people. Available for interview. BO-9490. Electronics.



Would you hire an engineer who couldn't understand this magazine?

Of course not. ELECTRONICS is the technical publication for technical people. If they can't understand it, they can't receive it. That's why, when you're looking for qualified engineers, you should consider our Classified Section.

For only \$65.00 per inch your recruitment advertising will reach over 90,000 pre-screened engineers as they're reading to combat job obsolescence, while they're thinking about their future and bettering themselves.

There's no charge for typesetting and free layout service is provided.

For more information call or write:

ELECTRONICS

Post Office Box 900
New York, N.Y. 10020
Phone: 212/997-2556

• ACCEL	14E	■ Data Precision	233	Hybrid Systems	43
Acushnet Capacitor	188	■ Data Translation	38	I Corporation	8
ADAC	52	■ Dialight	191	Industrial Devices Inc.	174
Addmaster Corporation	188	Digital Equipment Components	145-147	Intel Memory Systems	30, 31
Advanced Micro Devices	96, 97	Digital Equipment Corp. OEM 11 Group	100-101	Intel-Microcomputer Components	20, 21
Aeroflex Laboratories, Inc.	158	Eastman Chemical Products	164	Interall	10, 11
American Oil and Supply Co.	164	Eastman Kodak Co. Graphic Markets Division	187	Interstate Electronics	123
■ American Optical Scientific Instrum. Div.	172	• EIP, Division of Danalab	4E, 5E	• Intelit/SIT	165, 170
AMF Potter and Brumfield	94, 95	Elec-Trol Inc.	169	ITT North Microsystems Division	163
‡ Ampere Electronics	45	Electronic Development Corporation	184	• Jepico Co. Ltd.	48
Anslay (Thomas & Betts)	177	■ Electronic Navigation Industries	6	■ Johanson Manufacturing Corporation	54
Assembly & Test Equipment Corp.	189	Elorg Electronorgtechica	154	■ Kepco Inc.	5
Astro-Med	186	Emerson & Cuming Inc.	181	‡ Kollmorgen Multiwire Division	165
• B & K Precision Dynascan Corp.	9	• EMI Technology Data Recording Division	2E, 3E	■ Lambda Electronics Corporation	203-218
Belden Corporation	126	• Enertec Schlumberger	9E	■ Lear Siegler	200
Bendix Corporation Electrical Comp. Div.	180	Erie Technological Products	86	‡ Leasametric	35
• Boschert	7E, 8E-AB	• FEME S.p.A.	171	‡ LTX	150-151
■ Bourne Inc.	2nd Cover	Ferranti Electric Inc.	202	Lumonics Research	202
■ Bowmar Commercial Products	219	‡ First Computer Corporation	9	Magtrol	202
• Burr Brown Research Corporation	15E	■ John Fluke Mfg. Co.	84, 102, 103, 173	Matrox Electronic Systems	26
■ Cambridge Thermionic Corp.	174	Forth Inc.	142	M.C.P.	161
‡ Centralab Electronics Division	170-171	GCA Burlington	47	• Memory Devices Ltd.	56
■ Cherry Electrical Products	104	‡ General Electric Instrument Rental Division	152	■ Micro Component Technology	53
■ Clairex Electronics	4th Cover	■ General Instrument Microelectronics	155	Microswitch Division of Honeywell	7
Conrac Div/Conrac Corporation	179	General Optonics	18, 19	Mineico	166
■ Continental Specialties	51	■ Germanium Power Devices Co.	139	Mitel Semiconductor Inc.	50
Cromemco	15	Guardian Electric Mfg. Co.	3rd Cover	Mostek Corporation	27-29
■ D.A.T.A. Inc.	186	■ Hamlin	91	Electronics & Control Engineers Book Club	192-195
Data Delay Devices	176	■ Hewlett-Packard	1, 2, 74, 75, 78, 79, 98, 99	• Murata Mfg. Co. Ltd.	202
Data General Corporation	12, 13	■ Hughes Aircraft	55	■ National Semiconductor Corp.	36, 37

•	NEOHM SPA	152	•	SSC Div. of Thomson Group	45
	Northern Engineering Laboratories	168		Statak Corporation	73
‡	Oak Industries Inc.	167		Swedish Industrial Development	160
■	O.K. Machine & Tool Co.	132		Transistor Electronics	178
	Optimal Technology Inc.	191		Tektronix	32
	Paratronics, Inc.	168		Teledyne Philbrick	233
	Perkin-Elmer Corp.	22, 23	■	Teledyne Relays	17
•	Phillips ELA	16E		Teradyne, Inc.	66, 80
■	Polarad Electronics	158		Texas Instrument Components	183
	Powercube Corporation	87		Textool Products Inc.	14
■	Projects Unlimited	166		Thermometrics	6
	Pro-log	25	•	Thomson Sescosem	12E, 13E
	Rental Electronics	48-49	•	Trio Kenwood Corporation, Test Inst. Div.	35
	RCA Solid State	62, 159		TRW Electric Components	148, 149
	E. C. & G. Reticon	89		Universal Instruments	185
	Rockwell Microelectronic Device Division	199		U.S. Components Inc.	186
‡	Rockwell International	56		Varian Vacuum	65
	Rogers Corporation	175		Vector Electronics	178
•	Rohde & Schwarz	1E	■	Wavetek Indiana	71
	Rolm Corp.	176A-B		Wilhelm Westermann	8
	Seacor Inc.	16	■	Xciton	160
•	Sfernica	10E	Classified and employment advertising		
	Semtech Corporation	69	F. J. Eberle, Manager 212-997-2557		
•	Siemens AG Munich	11E, 60		Beall Associates	225
	Signetics Corporation	76, 77		Berger & Partners, Roland	223
	Simpson Electric	197		Career Consultants	222
	Societe Fort	191		Contradata Milano	221
	Solid State Scientific	182		Dalmo Victor	229
	Spectronics	93, 156, 157		EECO	224
	Spectrol Electronics	83		Engineers Index, The	229
	Sprague Electric	59		Ford Aerospace & Comm.	226
				Fortune Personnel Agy.	224
				General Electric	222
				Gould Ocean Systems Div.	228
				Hewlett-Packard	221
				Hughes Aircraft Co.	227
				Intel	230
				ITT LSI Systems Support Center	225
				Litton Systems Inc., Amecom Div.	220
				McDonnell Douglas	221
				National Personnel Consultants	220, 229
				Narco Scientific Inc.	222, 224
				Parker Bros.	221
				Regional Consultants Inc.	226
				RPM Technical Div.	222
				Stephen, E.J. Associates	222
				Woodward Governor	222, 226

Classified and employment advertising

F. J. Eberle, Manager 212-997-2557

	Beall Associates	225
	Berger & Partners, Roland	223
	Career Consultants	222
	Contradata Milano	221
	Dalmo Victor	229
	EECO	224
	Engineers Index, The	229
	Ford Aerospace & Comm.	226
	Fortune Personnel Agy.	224
	General Electric	222
	Gould Ocean Systems Div.	228
	Hewlett-Packard	221
	Hughes Aircraft Co.	227
	Intel	230
	ITT LSI Systems Support Center	225
	Litton Systems Inc., Amecom Div.	220
	McDonnell Douglas	221
	National Personnel Consultants	220, 229
	Narco Scientific Inc.	222, 224
	Parker Bros.	221
	Regional Consultants Inc.	226
	RPM Technical Div.	222
	Stephen, E.J. Associates	222
	Woodward Governor	222, 226

■ For more information of complete product line see advertisement in the latest Electronics Buyers Guide
 • Advertisers in Electronics International
 ‡ Advertisers in Electronics domestic edition

Advertising Sales Staff

Advertising sales manager: Paul W. Reiss

1221 Avenue of the Americas, New York, N.Y. 10020
 [212] 997-4371

Atlanta, Ga. 30309: Michael Charlton

100 Colony Square, 1175 Peachtree St., N.E.
 [404] 892-2868

Boston, Mass. 02116: Frank Mitchell

607 Boylston St.
 [617] 262-1160

Chicago, Ill. 60611

645 North Michigan Avenue

Jack Anderson [312] 751-3739

Robert M. Denmead [312] 751-3738

Cleveland, Ohio 44113: William J. Boyle

[716] 586-5040

Costa Mesa, Calif. 92626: Robert E. Boedicker

3001 Red Hill Ave. Bldg. #4 Suite 242

[714] 557-6292

Dallas, Texas 75201: John J. Uphues

2001 Bryant Tower, Suite 1070

[214] 742-1747

Denver, Colo. 80203: Harry B. Doyle, Jr.

123 Speer Blvd. #400

[303] 837-1010

Detroit, Michigan 48202: Jack Anderson

1400 Fisher Bldg.

[313] 873-7410

Fort Lauderdale, Fla. 33306: Michael Charlton

3000 N.E. 30th Place

[305] 563-9111

Houston, Texas 77002: John J. Uphues

601 Jefferson Street, Dresser Tower

[713] 659-8381

Los Angeles, Calif. 90010: Robert J. Rielly

Robert E. Boedicker, 3200 Wilshire Blvd., South Tower

[213] 487-1160

Minneapolis, Minn. 55435: Robert M. Denmead

4015 W. 65th St.

[312] 751-3738

New York, N.Y. 10020

1221 Avenue of the Americas

John Gallie [212] 997-3616

Matthew T. Reseska [212] 997-3617

Philadelphia, Pa. 19102: Matthew T. Reseska

Three Parkway

[215] 997-3617

Pittsburgh, Pa. 15222: Matthew T. Reseska

4 Gateway Center

[212] 997-3617

Rochester, N.Y. 14534: William J. Boyle

Power Mill Office Park, 1163 Pittsford-Victor Rd.,

Pittsford, N.Y. 14534

[716] 248-5620

San Francisco, Calif. 94111: Don Farris

Dean Genge, 425 Battery Street,

[415] 362-4600

Paris: Patrick Mouillard

17 Rue-Georges Bizet, 75116 Paris, France

Tel: 720-73-01

United Kingdom & Scandinavia: Robert Ghey

34 Dover Street, London W1

Tel: 01-493-1451

Scandinavia: Andrew Karnig and Assoc.

Kungsholmsgatan 10

112 27 Stockholm, Sweden

Tel: 08 51 68 70 Telex: 179 51

Milan: Ferruccio Silvera

1 via Baracchini, Italy

Phone 86-90-656

Brussels:

23 Chaussee de Wavre

Brussels 1040, Belgium

Tel: 13-73-95

Frankfurt/Main: Fritz Krusebecker

Liebigstrasse 27c, Germany

Phone 72 01 81

Tokyo: Akio Saijo, McGraw-Hill

Publications Overseas Corporation,

Kasumigaseki Building 2-5, 3-chome,

Kasumigaseki, Chiyoda-Ku, Tokyo, Japan

[581] 9811

Business Department

Thomas M. Egan

Production Director

[212] 997-3140

Carol Gallagher

Production Manager International

[212] 997-2045

Betty Preis

Production Manager Domestic

[212] 997-2908

Thomas Kazich

Production Manager Related Products

[212] 997-2044

Marianna Meissner, Production Assistant

(212) 997-2843

Frances Vallone

Reader Service Manager

[212] 997-6057

Electronics Buyers' Guide

H.T. Howland, General Manager

[212] 997-6642

Regina Hera, Directory Manager

[212] 997-2544

Thomas Kazich, Production Manager

[212] 997-2044

Marianna Meissner, Production Assistant

[212] 997-2843

Frances Vallone, Reader Service Manager

[212] 997-6057

Classified and Employment Advertising

Frank Eberle, Manager

[212] 997-2557

300 NANOSECONDS VOLTAGE DAC

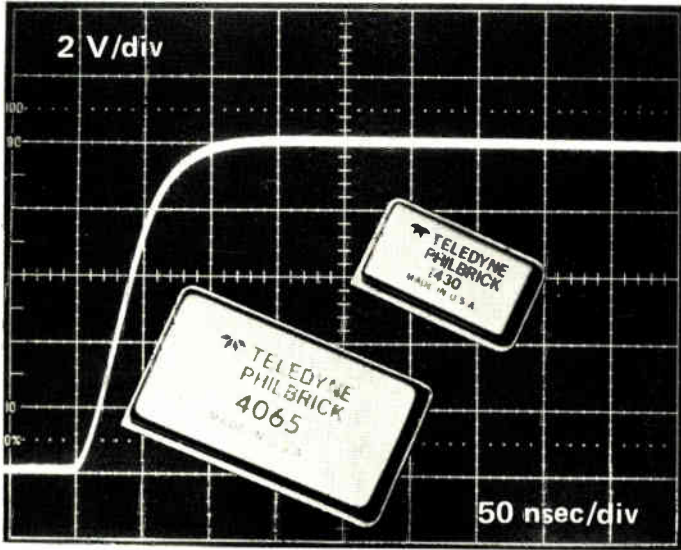

True 12-Bit D To A Conversion

... is achieved by combining our 4065 current DAC and our 1430 fet operational amplifier. The result is a 12-bit hybrid voltage DAC system with a voltage settling of under 300 nsec to 0.01%. In addition, these units offer operation from -55°C to $+125^{\circ}\text{C}$ and the high reliability that is inherent in MIL-STD-883 screening.

Just one more reason why...
No One Does It Better Than Philbrick

TELEDYNE PHILBRICK



DATA CONVERTERS, V/F/V CONVERTERS, LINEARS, NONLINEARS, POWER SUPPLIES
 Allied Drive at Route 128, Dedham, Massachusetts 02026
 Tel: (617) 329-1600 TWX: (710) 348-6726 Telex: 92-4439

Circle 233 on reader service card

TRUE RMS Only \$20 More.

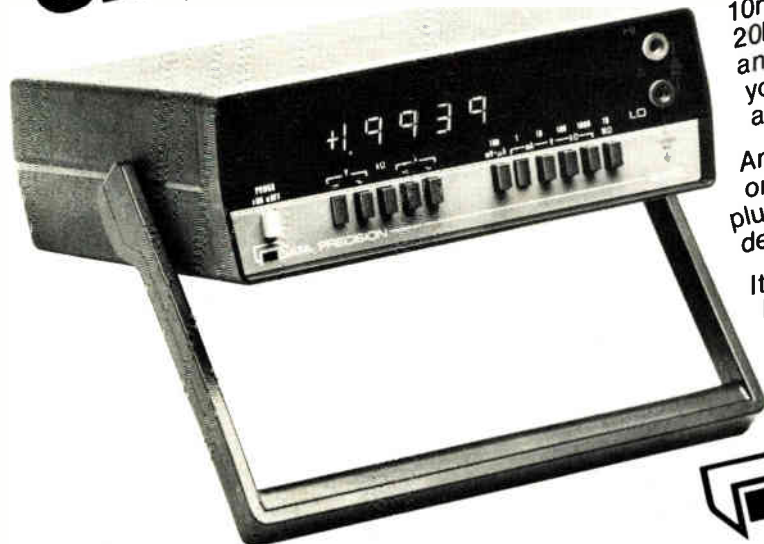

When you buy a Data Precision Model 2480 for just \$279, you get a full function, $4\frac{1}{2}$ digit digital multimeter with 0.03% basic accuracy. Its wide measurement ranges on all functions ($10\mu\text{V}$ to 1000V, ac or dc, 10nA to 2A, ac or dc, and 100m Ω to 20M Ω), make it an ideal benchtop DMM, and its built-in battery charger allows you to drop in an optional battery pack and carry this same meter into the field.

And when you buy the Model 2480R for only \$20 more at \$299, you get all this, plus true RMS. It's far and away your best deal on true RMS.

It's only what you'd expect from Data Precision.

Available from stock at all Data Precision representatives.

PRICE USA

DATA PRECISION[®]
 The best on the bench.

Data Precision Corporation, Electronics Avenue, Danvers, MA 01923. Telephone: (617) 246-1600, Telex 921819.

Circle 234 for demonstration

Circle 235 for additional information

REPRINTS AVAILABLE FROM *ELECTRONICS*

No. of
copies
wanted

Books

- ___ R-903 Personal Computing: Hardware and Software Basics—Electronics Book Series 266 pp \$11.95
- ___ R-819 McGraw-Hill's Compilation of Data Communications Standards—89 standards from 5 organizations 1133 pp \$165.00
- ___ R-803 New Product Trends in Electronics 1977—Electronics Book Series 333 pp \$14.95
- ___ R-732 Memory Design: Microcomputers to Mainframes—Electronics Book Series 180 pp \$12.95
- ___ R-726 Design Techniques for Electronics Engineers: 293 time-saving ideas in 48 chapters—Electronics Book Series 370 pp \$15.95
- ___ R-711 Circuits for Electronics Engineers: 306 circuits in 51 functional groups—Electronics Book Series 396 pp \$15.95
- ___ R-31D Designer's Casebook Number 1 106 pp \$5.50
- ___ R-704 Thermal Design in Electronics 52 pp \$5.00
- ___ R-701 Applying Microprocessors—Electronics Book Series 191 pp \$9.95
- ___ R-608 Basics of Data Communications—Electronics Book Series 303 pp \$12.95
- ___ R-602 Large Scale Integration—Electronics Book Series 208 pp \$9.95
- ___ R-520 Microprocessors—Electronics Book Series 154 pp \$8.95
- ___ R-011 Computer-aided Design 135 pp \$4.00

Articles

- ___ R-901 1979 world market survey and forecast 24 pp \$4.00
- ___ R-829 Special report: New networks tie down distributed processing concepts 16 pp \$3.00
- ___ R-827 Tackling the very large-scale

problems of VLSI: a special report 15 pp \$3.00

- ___ R-825 1978 technology update special issue \$4.00
- ___ R-821 Codecs answer the call 18 pp \$4.00
- ___ R-817 How bit-slice families compare 18 pp \$3.00
- ___ R-816 Packaging technology responds to the demand for higher densities 9 pp \$3.00
- ___ R-815 Higher power ratings extend V-MOS FETs' dominion 8 pp \$2.00
- ___ R-813 Data-link control chips: bringing order to data protocols 10 pp \$3.00
- ___ R-811 Multiplexing liquid-crystal displays 10 pp \$3.00
- ___ R-809 New methods and materials stir up printed wiring 10 pp \$3.00
- ___ R-807 Here come the big, new 64-K ROMs 14 pp \$3.00
- ___ R-805 Why and how users test microprocessors 8 pp \$3.00
- ___ R-801 World market report 1978 24 pp \$4.00
- ___ R-734 Microcomputer families expand 20 pp \$4.00
- ___ R-730 Special report—Automotive electronics gets the green light 10 pp \$3.00
- ___ R-728 Flexible circuits bend to designers' will 10 pp \$3.00
- ___ R-724 Special report—Technologies squeeze more performance from LSI 22 pp \$3.00
- ___ R-722 Demands of LSI are turning chip makers towards automation 12 pp \$3.00
- ___ R-720 How EEs feel about engineering—3-part series 26 pp \$5.00
- ___ R-718 Display makers strive to refine their technologies 8 pp \$3.00
- ___ R-716 Special report—Japanese wave in semiconductor technology 24 pp \$3.00
- ___ R-714 Special report—active filter technology 6 pp \$3.00
- ___ R-713 Electron-beam lithography draws fine line 10 pp \$3.00

- ___ R-712 Special report—large-scale integration 16 pp \$3.00
- ___ R-710 Personal computers mean business 8 pp \$2.00
- ___ R-708 So you want to be a consultant 6 pp \$2.00
- ___ R-706 Low-cost dual delayed sweep method 6 pp \$2.00
- ___ R-705 Powering up with linear ICs 12 pp \$3.00
- ___ R-703 Special report—memories 16 pp \$3.00
- ___ R-702 World market report 1977 24 pp \$4.00
- ___ R-616 Special issue—technology update \$4.00
- ___ R-614 Power supply choices for sophisticated designs 8 pp \$3.00
- ___ R-612 Fiber special report 24 pp \$3.00
- ___ R-610 Special report on hybrid-circuit technology 19 pp \$3.00
- ___ R-606 Special issue—Making it with microprocessors \$4.00
- ___ R-526 How reliable are today's components 16 pp \$3.00
- ___ R-524 Special report on bipolar large-scale integration 12 pp \$3.00
- ___ R-522 Special report on power semiconductors 12 pp \$3.00
- ___ R-518 Special issue—productivity \$4.00
- ___ R-514 Eight ways to better radio receiver design 6 pp \$3.00
- ___ R-512 Design of circuits for dangerous environments 4 pp \$2.00
- ___ R-510 Bipolar advances with 1¹/₂L microprocessor 8 pp \$2.00
- ___ R-508 Designing microprocessors with standard logic 12 pp \$3.00
- ___ R-506 The case for component burn-in 7 pp \$2.00

Charts

- ___ R-823 Communications satellites \$3.00
- ___ R-516 Electronic symbols \$2.00
- ___ R-213 Electromagnetic spectrum (updated 1976) \$3.00
- ___ R-326 Optical spectrum (6-page report and chart) \$3.00

Payment must accompany your order

Make check or money order payable to Electronics Reprints. All orders are shipped prepaid by parcel post. Allow two to three weeks for delivery. For additional information call (609) 448-1700 ext. 5494.

Back issues now available:
1960 to 1969, \$5.00 each
1970 to 1973, \$3.00 each
1974 to 1978, \$4.00 each

USE THIS PAGE AS YOUR ORDER FORM

Cost of orders \$ _____
Plus 10% handling charge \$ _____
TOTAL AMOUNT ENCLOSED \$ _____

Mail your order to:
Janice Austin
ELECTRONICS REPRINTS
P.O. Box 669
Hightstown, N.J. 08520

SEND REPRINTS TO

Name _____
Company _____ Dept. _____
Street _____
City _____ State _____ Zip _____



YOURS FREE

when you subscribe to Electronics.

**This Designer's Casebook—
Number 2**

Mr. Mrs. Ms. NAME _____ TITLE _____ 53890-G

COMPANY _____ DIV. or DEPT _____

COMPANY ADDRESS _____

CITY _____ STATE _____ ZIP _____

Check here if you wish publication to be sent to home address STREET _____ CITY _____ STATE _____ ZIP _____

Qualification for above rates is based on answers to all questions listed below. Those not qualifying may pay higher than basic price of \$30 one year or \$75 for three years.

PLEASE ENTER MY SUBSCRIPTION TO ELECTRONICS FOR:
 ONE YEAR AT \$17 TWO YEARS AT \$29 THREE YEARS AT \$43
 Payment Enclosed Bill My Company Bill Me

CHARGE MY
SUBSCRIPTION
TO...

American Express Diners Club Visa
 Master Charge _____ Interbank No. _____
Acct. No. _____
Date Card Expires _____
Signature _____

Signature _____

2. 1 PLANT 2 DEPARTMENT

- A. Large computers
- B. Mini-computers
- C. Computer peripheral equipment
- D. Data Processing Systems (systems integration)
- E. Office and business machines
- F. Test and measuring equipment
- G. Communications systems and equipment
- H. Navigation and guidance or control systems
- I. Consumer entertainment electronic equipment
- J. Other consumer electronic equip. (appliances, autos, hand tools)

Indicate the primary product manufactured or service performed at your plant (Box 1) and in your department (Box 2). Be sure to indicate applicable letter in each of the two boxes even if they are the same letter.

- K. Industrial controls, systems and equipment
- L. Sub-assemblies
- M. Passive electronic components
- N. Active electronic components
- O. Materials and Hardware
- P. Aircraft, Missiles, space and ground support equipment
- Q. Oceanography and support equipment
- R. Medical electronics
- S. Industrial equipment containing electronic components or products
- T. Independent R&D laboratory and consultant

- U. Research and development organizations which are a part of an educational institution
- V. Government Agency and military
- W. Industrial companies using and/or incorporating electronic products in their mfg., research or development activities
- X. Utilities
- Y. Broadcasting, sound and motion pictures and recording studios
- Z. Commercial users of electronic equipment (railroads, pipelines, police, airlines)
- 9. College, University

3. Indicate your principal job function (place applicable number in box. If numbers 9, 10, or 11 are used, fill in name of college or university)

- 1. General and corporate management
- 2. Design and development engineering
- 3. Engineering services (evaluation, quality control, reliability, standards, test)
- 4. Basic research
- 5. Manufacturing and production
- 6. Engineering support (lab assistant, technician)
- 7. Purchasing and procurement
- 8. Marketing and sales
- 9. Professor at _____
- 10. Senior student at _____
- 11. Graduate student at _____

Senior and graduate students are eligible for professional rate for one year subscription only.

4. Indicate your principal job responsibility (place applicable number in box)

- 1. Management
- 2. Engineering

5. Your design function: (Insert each letter that applies)

- A. I do electronic design or development engineering work
- B. I supervise electronic design or development engineering work
- C. I set standards for, or evaluate electronic design components, systems and materials

6. Estimated number of employees at this location. (check one)

- 1 to 49
- 50 to 249
- 250 to 999
- over 1,000



NO POSTAGE
NECESSARY
IF MAILED
IN THE
UNITED STATES

BUSINESS REPLY MAIL

FIRST CLASS PERMIT NO. 42 HIGHTSTOWN, N.J. 08520

POSTAGE WILL BE PAID BY ADDRESSEE

Electronics

McGRAW-HILL Inc.
Subscription Department
P.O. Box 514
Hightstown, N.J. 08520



Electronics

Reader Service

For additional information on products advertised, new products or new literature, use these business reply cards.

Complete entire card.

Please print or type.

Circle the number on the Reader Service postcard that corresponds to the number at the bottom of the advertisement, new product item, or new literature in which you are interested.

To aid the manufacturer in filling your request, please answer the three questions.

All inquiries from outside the U.S. that cannot reach Electronics before the expiration date noted on the Reader Service postcard must be mailed directly to the manufacturer. The manufacturer assumes all responsibilities for responding to inquiries.

Subscriptions & Renewals

Fill in the subscription card adjoining this card. Electronics will bill you at the address indicated on the card.

Electronics May 10, 1979 This reader service card expires August 10, 1979

NAME _____ TITLE _____

PHONE (_____) _____ COMPANY _____

STREET ADDRESS (Company or home check one) _____

CITY _____ STATE _____ ZIP _____

Was This Magazine Personally Addressed to You? Yes No

Industry classification (check one):

- | | | |
|--|--|--|
| <input type="checkbox"/> a Computer & Related Equipment | <input type="checkbox"/> e Test & Measuring Equipment | <input type="checkbox"/> j Independent R&D Organizations |
| <input type="checkbox"/> b Communications Equipment & Systems | <input type="checkbox"/> f Consumer Products | <input type="checkbox"/> k Government |
| <input type="checkbox"/> c Navigation, Guidance or Control Systems | <input type="checkbox"/> g Industrial Controls & Equipment | |
| <input type="checkbox"/> d Aerospace, Underseas Ground Support | <input type="checkbox"/> h Components & Subassemblies | |

Your design function (check each letter that applies):

- x I do electronic design or development engineering work.
 y I supervise electronic design or development engineering work.
 z I set standards for, or evaluate electronic components, systems and materials.

Your principal job responsibility (check one)

- t Management
 v Engineering

Estimate number of employees (at this location): 1. under 20 2. 20-99 3. 100-999 4. over 1000

1 16 31 46	61 76 91 106	121 136 151 166	181 196 211 226	241 256 271 348	363 378 393 408	423 438 453 468	483 498 703 718
2 17 32 47	62 77 92 107	122 137 152 167	182 197 212 227	242 257 272 349	364 379 394 409	424 439 454 469	484 499 704 719
3 18 33 48	63 78 93 108	123 138 153 168	183 198 213 228	243 258 273 350	365 380 395 410	425 440 455 470	485 500 705 720
4 19 34 49	64 79 94 109	124 139 154 169	184 199 214 229	244 259 274 351	366 381 396 411	426 441 456 471	486 501 706 900
5 20 35 50	65 80 95 110	125 140 155 170	185 200 215 230	245 260 275 352	367 382 397 412	427 442 457 472	487 502 707 901
6 21 36 51	66 81 96 111	126 141 156 171	186 201 216 231	246 261 338 353	368 383 398 413	428 443 458 473	488 503 708 902
7 22 37 52	67 82 97 112	127 142 157 172	187 202 217 232	247 262 339 354	369 384 399 414	429 444 459 474	489 504 709 951
8 23 38 53	68 83 98 113	128 143 158 173	188 203 218 233	248 263 340 355	370 385 400 415	430 445 460 475	490 505 710 952
9 24 39 54	69 84 99 114	129 144 159 174	189 204 219 234	249 264 341 356	371 386 401 416	431 446 461 476	491 506 711 953
10 25 40 55	70 85 100 115	130 145 160 175	190 205 220 235	250 265 342 357	372 387 402 417	432 447 462 477	492 507 712 954
11 26 41 56	71 86 101 116	131 146 161 176	191 206 221 236	251 266 343 358	373 388 403 418	433 448 463 478	493 508 713 956
12 27 42 57	72 87 102 117	132 147 162 177	192 207 222 237	252 267 344 359	374 389 404 419	434 449 464 479	494 509 714 957
13 28 43 58	73 88 103 118	133 148 163 178	193 208 223 238	253 268 345 360	375 390 405 420	435 450 465 480	495 510 715 958
14 29 44 59	74 89 104 119	134 149 164 179	194 209 224 239	254 269 346 361	376 391 406 421	436 451 466 481	496 701 716 959
15 30 45 60	75 90 105 120	135 150 165 180	195 210 225 240	255 270 347 362	377 392 407 422	437 452 467 482	497 702 717 960

Electronics May 10, 1979 This reader service card expires August 10, 1979

NAME _____ TITLE _____

PHONE (_____) _____ COMPANY _____

STREET ADDRESS (Company or home check one) _____

CITY _____ STATE _____ ZIP _____

Was This Magazine Personally Addressed to You? Yes No

Industry classification (check one):

- | | | |
|--|--|--|
| <input type="checkbox"/> a Computer & Related Equipment | <input type="checkbox"/> e Test & Measuring Equipment | <input type="checkbox"/> j Independent R&D Organizations |
| <input type="checkbox"/> b Communications Equipment & Systems | <input type="checkbox"/> f Consumer Products | <input type="checkbox"/> k Government |
| <input type="checkbox"/> c Navigation, Guidance or Control Systems | <input type="checkbox"/> g Industrial Controls & Equipment | |
| <input type="checkbox"/> d Aerospace, Underseas Ground Support | <input type="checkbox"/> h Components & Subassemblies | |

Your design function (check each letter that applies):

- x I do electronic design or development engineering work.
 y I supervise electronic design or development engineering work.
 z I set standards for, or evaluate electronic components, systems and materials.

Your principal job responsibility (check one)

- t Management
 v Engineering

Estimate number of employees (at this location): 1. under 20 2. 20-99 3. 100-999 4. over 1000

1 16 31 46	61 76 91 106	121 136 151 166	181 196 211 226	241 256 271 348	363 378 393 408	423 438 453 468	483 498 703 718
2 17 32 47	62 77 92 107	122 137 152 167	182 197 212 227	242 257 272 349	364 379 394 409	424 439 454 469	484 499 704 719
3 18 33 48	63 78 93 108	123 138 153 168	183 198 213 228	243 258 273 350	365 380 395 410	425 440 455 470	485 500 705 720
4 19 34 49	64 79 94 109	124 139 154 169	184 199 214 229	244 259 274 351	366 381 396 411	426 441 456 471	486 501 706 900
5 20 35 50	65 80 95 110	125 140 155 170	185 200 215 230	245 260 275 352	367 382 397 412	427 442 457 472	487 502 707 901
6 21 36 51	66 81 96 111	126 141 156 171	186 201 216 231	246 261 338 353	368 383 398 413	428 443 458 473	488 503 708 902
7 22 37 52	67 82 97 112	127 142 157 172	187 202 217 232	247 262 339 354	369 384 399 414	429 444 459 474	489 504 709 951
8 23 38 53	68 83 98 113	128 143 158 173	188 203 218 233	248 263 340 355	370 385 400 415	430 445 460 475	490 505 710 952
9 24 39 54	69 84 99 114	129 144 159 174	189 204 219 234	249 264 341 356	371 386 401 416	431 446 461 476	491 506 711 953
10 25 40 55	70 85 100 115	130 145 160 175	190 205 220 235	250 265 342 357	372 387 402 417	432 447 462 477	492 507 712 954
11 26 41 56	71 86 101 116	131 146 161 176	191 206 221 236	251 266 343 358	373 388 403 418	433 448 463 478	493 508 713 956
12 27 42 57	72 87 102 117	132 147 162 177	192 207 222 237	252 267 344 359	374 389 404 419	434 449 464 479	494 509 714 957
13 28 43 58	73 88 103 118	133 148 163 178	193 208 223 238	253 268 345 360	375 390 405 420	435 450 465 480	495 510 715 958
14 29 44 59	74 89 104 119	134 149 164 179	194 209 224 239	254 269 346 361	376 391 406 421	436 451 466 481	496 701 716 959
15 30 45 60	75 90 105 120	135 150 165 180	195 210 225 240	255 270 347 362	377 392 407 422	437 452 467 482	497 702 717 960

Electronics

Reader Service

If the cards below have already been used, you may obtain the needed information by writing directly to the manufacturer, or by sending your name and address, plus the Reader Service number and issue date, to Electronics Reader Service Department, P.O. Box No. 2530, Clinton, Iowa 52734.

Affix
Postage
Here

Electronics

P.O. Box No. 2530
Clinton, Iowa 52735

Affix
Postage
Here

Electronics

P.O. Box No. 2530
Clinton, Iowa 52735

ANOTHER MYTH EXPLODED:

All solenoids are NOT created equal.

No. 28
Solenoid

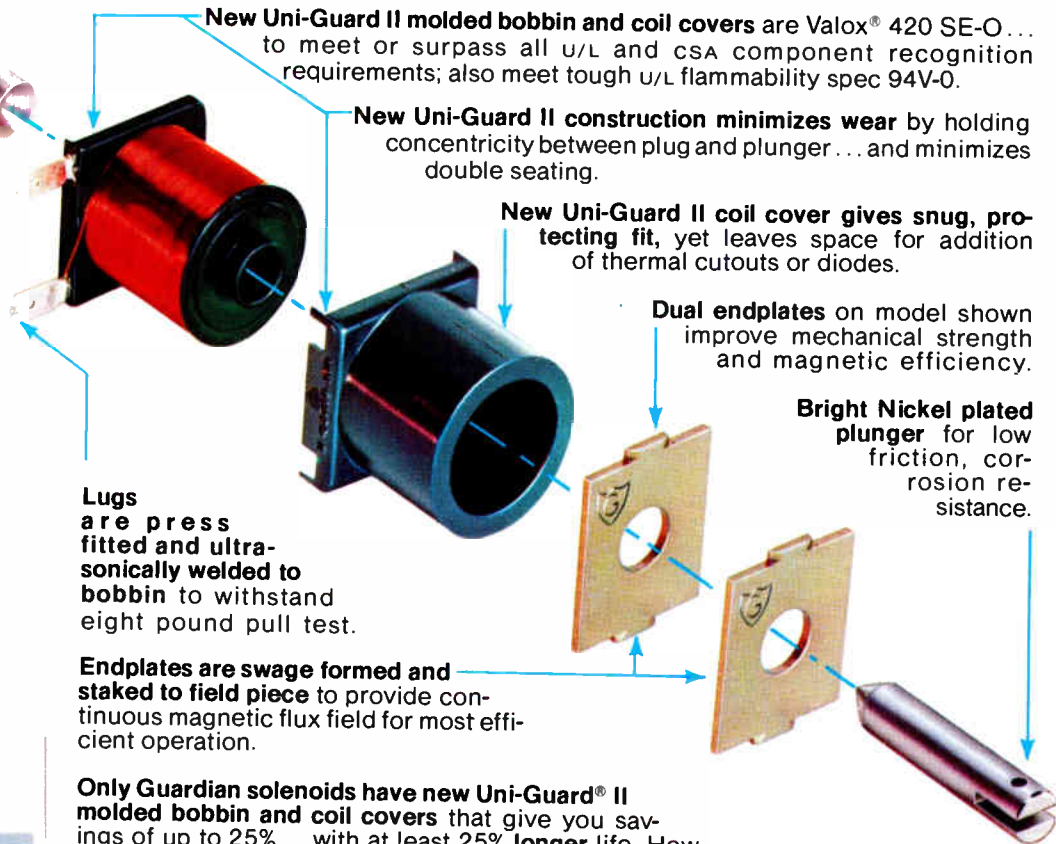
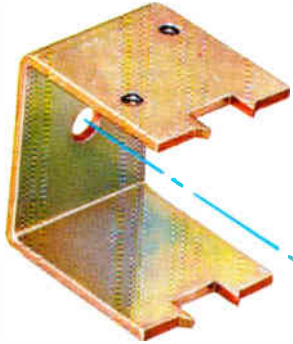

Only Guardian solenoids have new Uni-Guard® II molded bobbin and coil covers that give you savings of up to 25%... with at least 25% longer life. How long? Up to 5 million operations. This new construction is now available on nearly all Guardian box frame and U-frame solenoids. Including pull type, push type and solenoid switches. All have .187" or .110" QC lug or solder lug termination for easier, faster, less expensive installation. And Guardian has more types available from stock than anyone else.

Variations and options? Get them from Guardian. Return springs, plunger configurations, anti-bottoming or silencers, voltages, termination, mounting, coil finishes... you spec it and Guardian's ready to produce it.

Let the Guardian Angel show you why Guardian is No. 1 in solenoids. Send for your free copy of this 72 page catalog.



GUARDIAN SOLENOIDS



This mark indicates recognition under the component program of Underwriters Laboratories Inc.



GUARDIAN®

GUARDIAN ELECTRIC MANUFACTURING CO.

1550 West Carroll Ave., Chicago, Illinois 60607 • 312/243-1100

Circle 901 on reader service card

SILICON OPTO CHIPS from Clairex



PHOTOTRANSISTOR
CHIPS

PHOTOVOLTAIC
DIODE CHIPS

PHOTODARLINGTON
CHIPS

**Now you can make your own hybrids,
arrays, solid-state relays and special sensors.**

The Clairex line of silicon photodetector chips consists of four photodiodes, five phototransistors and one photodarlington transistor. The diodes are intended for use in the

voltaic mode. The phototransistors are each available in two sensitivity ranges. All chips from Clairex have gold backings to facilitate ohmic bonding and are 100% tested before being

packaged in glass vials filled with Freon.

Call 914-664-6602 or write Clairex,[®] 560 South Third Avenue, Mount Vernon, New York 10550.

CLAIREX ELECTRONICS

A Division of Clairex Corporation

Circle Number 902 on Reader Service Card