

VOLUME 19

JUNE, 1931

NUMBER 6

W J Malone
WFDI
WTHAM

PROCEEDINGS

of

The Institute of Radio
Engineers



Form for Change of Mailing Address or Business Title on Page XLIII

Institute of Radio Engineers

Forthcoming Meetings

ATLANTA SECTION

June 15, 1931

CINCINNATI SECTION

June 16, 1931

PROCEEDINGS OF
The Institute of Radio Engineers

Volume 19

June, 1931

Number 6

Board of Editors

ALFRED N. GOLDSMITH, *Chairman*
STUART BALLANTINE
RALPH BATCHER
G. W. PICKARD
L. E. WHITTEMORE
W. WILSON

CONTENTS

	PART I	PAGE
Frontispiece, Convention Committee.....		920
Institute News and Radio Notes.....		921
May Meeting of the Board of Direction.....		921
Radio Transmissions of Standard Frequency.....		922
Committee Work.....		924
Institute Meetings.....		926
Personal Mention.....		934
	PART II	
	<i>Technical Papers</i>	
A Device for the Precise Measurement of High Frequencies.....	F. A. POLKINGHORN AND A. A. ROETKEN	937
The Suppression of Radio-Frequency Harmonics in Transmitters.....	J. W. LABUS AND HANS RÖDER	949
Receiver Design for Minimum Fluctuation Noise.....	NELSON P. CASE	963
Low-Frequency High Power Broadcasting as Applied to National Coverage in the United States.....	WILLIAM H. WENSTROM	971
The Effective Height of Closed Aerials.....	V. E. BASHENOFF AND N. A. MJASOEDOFF	984
Automatic Time-Delay Relay.....	C. HUFF	1019
Note on the Piezo-Electric Quartz Oscillating Crystal regarded from the Principle of Similitude.....	ISSAC KOGA	1022
The Multiple Refraction and Reflection of Short Waves.....	N. H. EDES	1024
Bibliography on Radio Wave Phenomena and Measurement of Radio Field Intensity.....	BUREAU OF STANDARDS	1034
Booklets, Catalogs, and Pamphlets Received.....		1090
References to Current Radio Literature.....		1091
Contributors to this Issue.....		1099

The Institute of Radio Engineers

GENERAL INFORMATION

The PROCEEDINGS of the Institute is published monthly and contains papers and discussions thereon submitted for publication or for presentation before meetings of the Institute or its Sections. Payment of the annual dues by a member entitles him to one copy of each number of the PROCEEDINGS issued during the period of his membership.

Subscription rates to the PROCEEDINGS for the current year are received from nonmembers at the rate of \$1.00 per copy or \$10.00 per year. To foreign countries the rates are \$1.10 per copy or \$11.00 per year.

Back issues are available in unbound form for the years 1918, 1920, 1921, 1922, 1923, and 1926 at \$9.00 per volume (six issues) or \$1.50 per single issue. For the years 1913, 1914, 1915, 1916, 1917, 1919, 1923, 1924, and 1925 miscellaneous copies (incomplete unbound volumes) can be purchased for \$1.50 each; for 1927, 1928, and 1929 at \$1.00 each. The Secretary of the Institute should be addressed for a list of these.

Discount of twenty-five per cent is allowed on all unbound volumes or copies to members of the Institute, libraries, booksellers, and subscription agencies.

Bound volumes are available as follows: for the years 1922 and 1926 to members of the Institute, libraries, booksellers, and subscription agencies at \$8.75 per volume in blue buckram binding and \$10.25 in morocco leather binding; to all others the prices are \$11.00 and \$12.50, respectively. For the year 1929 the bound volume prices are: to members of the Institute, libraries, booksellers, and subscription agencies, \$9.50 in blue buckram binding; to all others, \$12.00. Foreign postage on all bound volumes is one dollar, and on single copies is ten cents.

The 1931 YEAR BOOK, containing general information, the Constitution and By-Laws, Standards Report, Index to past issues of the PROCEEDINGS, Catalog of Membership, etc., is available to members at \$1.00; to nonmembers, \$1.50.

Contributors to the PROCEEDINGS are referred to the following page for suggestions as to approved methods of preparing manuscripts for publication in the PROCEEDINGS.

Advertising rates for the PROCEEDINGS will be supplied by the Institute's Advertising Department, Room 802, 33 West 39th Street, New York, N.Y.

Changes of address to affect a particular issue must be received at the Institute office not later than the 15th of the month preceding date of issue. That is, a change in mailing address to be effective with the October issue of the PROCEEDINGS must be received by not later than September 15th. Members of the Institute are requested to advise the Secretary of any change in their business connection or title irrespective of change in their mailing address, for the purpose of keeping the Year Book membership catalog up to date.

The right to reprint portions or abstracts of the papers, discussions, or editorial notes in the PROCEEDINGS is granted on the express condition that specific reference shall be made to the source of such material. Diagrams and photographs published in the PROCEEDINGS may not be reproduced without making special arrangements with the Institute through the Secretary.

It is understood that the statements and opinions given in the PROCEEDINGS are views of the individual members to whom they are credited, and are not binding on the membership of the Institute as a whole.

All correspondence should be addressed to the Institute of Radio Engineers, 33 West 39th Street, New York, N.Y., U.S.A.

Entered as second class matter at the Post Office at Menasha, Wisconsin.

Acceptance for mailing at special rate of postage provided for in the Act of February 28, 1925, embodied in paragraph 4, Section 412, P. L. and R. Authorized October 26, 1927.

Published monthly by

THE INSTITUTE OF RADIO ENGINEERS, INC.

Publication office, 450-454 Ahnaip Street, Menasha, Wis.

BUSINESS, EDITORIAL, AND ADVERTISING OFFICES,

Harold P. Westman, *Secretary*

33 West 39th St., New York, N.Y.

SUGGESTIONS FOR CONTRIBUTORS TO THE "PROCEEDINGS"

Preparation of Paper

Form—Manuscripts may be submitted by member and nonmember contributors from any country. To be acceptable for publication, manuscripts should be in English, in final form for publication, and accompanied by a summary of from 100 to 300 words. Papers should be typed double space with consecutive numbering of pages. Footnote references should be consecutively numbered and should appear at the foot of their respective pages. Each reference should contain author's name, title of article, name of journal, volume, page, month, and year. Generally, the sequence of presentation should be as follows: statement of problem; review of the subject in which the scope, object, and conclusions of previous investigations in the same field are covered; main body describing the apparatus, experiments, theoretical work, and results used in reaching the conclusions and their relation to present theory and practice; bibliography. The above pertains to the usual type of paper. To whatever type a contribution may belong, a close conformity to the spirit of these suggestions is recommended.

Illustrations—Use only jet black ink on white paper or tracing cloth. Cross-section paper used for graphs should not have more than four lines per inch. If finer ruled paper is used, the major division lines should be drawn in with black ink, omitting the finer divisions. In the latter case, only blue-lined paper can be accepted. Photographs must be very distinct, and must be printed on glossy white paper. Blueprinted illustrations of any kind cannot be used. All lettering should be $\frac{3}{16}$ in. high for an 8 x 10 in. figure. Legends for figures should be tabulated on a separate sheet, not lettered on the illustrations.

Mathematics—Fractions should be indicated by a slanting line. Use standard symbols. Decimals not preceded by whole numbers should be preceded by zero, as 0.016. Equations may be written in ink with subscript numbers, radicals, etc., in the desired proportion.

Abbreviations—Write a.c. and d.c. (a-c and d-c as adjectives), kc, μf , $\mu\mu f$, e.m.f., mh, μh henries, abscissas, antennas. Refer to figures as Fig. 1, Figs. 3 and 4, and to equations as (5). Number equations on the right in parentheses.

Summary—The summary should contain a statement of major conclusions reached, since summaries in many cases constitute the only source of information used in compiling scientific reference indexes. Abstracts printed in other journals, especially foreign, in most cases consist of summaries from published papers. The summary should explain as adequately as possible the major conclusions to a nonspecialist in the subject. The summary should contain from 100 to 300 words, depending on the length of the paper.

Publication of Paper

Disposition—All manuscripts should be addressed to the Institute of Radio Engineers, 33 West 39th Street, New York City. They will be examined by the Committee on Papers and by the Editor. Authors are advised as promptly as possible of the action taken, usually within one month.

Proofs—Galley proof is sent to the author. Only necessary corrections in typography should be made. *No new material is to be added.* Corrected proofs should be returned *promptly* to the Institute of Radio Engineers, 33 West 39th Street, New York City.

Reprints—With the galley proof a reprint order form is sent to the author. Orders for reprints must be forwarded promptly as type is not held after publication.

INSTITUTE SECTIONS

<i>Chairmen</i>	<i>Secretaries</i>
	ATLANTA
H. F. Dobbs	Philip C. Bangs, 23 Kensington Rd., Avondale Estates, Ga.
	BOSTON
George W. Pierce	Melville Eastham, 30 State St., Cambridge, Mass.
	BUFFALO-NIAGARA
Stanley W. Brown	E. C. Waud, 235 Huntington Ave., Buffalo, N. Y.
	CHICAGO
Byron B. Minnium	J. Barton Hoag, Ryerson Laboratory, University of Chicago, Chicago, Ill.
	CINCINNATI
D. D. Israel	Ralph P. Glover, 5737 Hamilton Ave., Cincinnati, Ohio.
	CLEVELAND
G. B. Hammon	P. A. Marsal, National Carbon Co., Inc., P.O. Box No. 400, Cleveland, Ohio.
	CONNECTICUT VALLEY
R. S. Kruse	George Grammer, 334 South Quaker Lane, West Hartford, Conn.
	DETROIT
Lewis N. Holland	Samuel Firestone, Room 615, 2000 Second Ave., Detroit, Mich.
	LOS ANGELES
T. E. Nikirk	L. Elden Smith, 340 N. Painter Ave., Whittier, Calif.
	NEW ORLEANS
Pendleton E. Lehde	Anton A. Schiele, 1812 Masonic Temple, New Orleans, La.
	PHILADELPHIA
W. R. G. Baker	G. C. Blackwood, 243 E. Upsal St., Mt. Airy, Philadelphia, Pa.
	PITTSBURGH
J. G. Allen	J. G. McKinley, West Penn Electric Co., 14 Wood St., Pittsburgh, Pa.
	ROCHESTER
Harry E. Gordon	Howard A. Brown, Rochester G. & E. Co., 89 East Ave., Rochester, N. Y.
	SAN FRANCISCO
Walter D. Kellogg	Paul R. Fenner Custom House, San Francisco, Calif.,
	SEATTLE
Abner R. Willson	L. C. Austin, Woolley and Co., Inc., 1113 Third Ave., Seattle, Wash.
	TORONTO
J. M. Leslie	R. A. Hackbusch, Stromberg Carlson Tel. Mfg. Co., 211 Geary Ave., Toronto, Ont., Canada.
	WASHINGTON
L. P. Wheeler	Herbert G. Dorsey, U. S. Coast and Geodetic Survey Washington, D. C.

GEOGRAPHICAL LOCATION OF MEMBERS ELECTED

MAY 6, 1931

Transferred to the Member Grade

California	San Francisco, 2120 Lyon St.	Bradley, John T.
Dist. of Columbia	Washington, 3166 Mt. Pleasant St., N. W.	Rietzke, E. H.
India	Bangalore, Hebbal, Indian Science Institute	Kantebet, S. R.

Elected to the Associate Grade

California	Inverness	Thomas, H. E.
	Los Angeles, 3523 Roseview Ave.	Fetterhoff, M. J.
	Los Angeles, 2739 Cochran Ave.	Shepherd, Leo
	Los Angeles, 1578 W. 50th St.	Warne, Vearn J.
	San Francisco, 140 New Montgomery St.	Blake, Robert I.
	San Francisco, 140 New Montgomery St.	Cole, C. H.
	San Francisco, 140 New Montgomery St.	Cone, Donald I.
	San Francisco, Tropical Radio Tel. Co., 1001-4th St.	Connolly, N. C.
	San Francisco, 140 New Montgomery St.	Hartz, J. E.
	San Francisco, Mackay Radio & Tel. Co., 22 Battery St.	Kirkland, R. D.
	San Francisco, 735 Larkin St.	Nicolaides, G.
	San Francisco, 140 New Montgomery St.	Sandfort, Mark
	San Francisco, 140 New Montgomery St.	Whitten, S.
	San Pedro, U. S. S. Saratoga	Bassler, C. J.
	San Pedro, U. S. S. West Virginia, c/o Postmaster	Mareck, A. J.
	Santa Monica, 925 Yale St.	Best, A. O.
	Stockton, 521 E. Washington St.	Preston, Cecil H.
Dist. of Columbia	Washington, 1414-21st St., N. W.	Kennedy, John H.
	Washington, Bureau of Standards	Lapham, E. G.
Florida	Clearwater, P. O. Box 573	Crowley, C. G.
Georgia	Atlanta, Candler Field, Eastern Air Transport, Inc.	Cochrane, N. R.
	Hapeville, Airways Radio Station, Dept. of Commerce	Frazier, H. G.
	Hapeville, 797 Virginia Ave.	Weinberg, B. L.
Illinois	Chicago, 4714 N. Spaulding Ave.	Carter, R. G.
	Chicago, 5435 W. Kamerling Ave.	Gustafson, M. F.
	Chicago, 2445 S. Spaulding Ave.	Kolar, E. F.
	Chicago, National Broadcasting Co., Merchandise Mart	Luttgens, H. C.
	Chicago, 1460 E. 57th St.	Richards, S.
	Chicago, 2017 W. Monroe St.	Wong, C. L.
	Geneva, Riverbank Laboratories	Anderson, C. A.
	Springfield, 713 S. English Ave.	Ring, E. F.
Indiana	Anderson, 1121 Central Ave.	Wend, Clyde
	Indianapolis, 3327 Washington Blvd.	Garstand, W. W.
	Valparaiso, 405 E. Monroe St.	Seese, W. B.
Kansas	Topeka, Adjutant General's Department	Mc Farland, W. E.
Maine	Houlton, 20 Park St.	Crandell, E. L.
	South Portland, 22 Angell Ave.	Cobb, Stanley W.
Maryland	Baltimore, 2810 Ailsa Ave.	Eckels, August E.
Massachusetts	Boston, RCA Photophone, Inc., 536 Statler Bldg.	Kirchhoff, W. J.
	Lawrence, Box No. 146	Montgomery, J. L.
	North Andover, 165 Railroad Ave.	Lemieux, C. J.
	Springfield, 104 Oswego St.	Sherwood, J. W.
Michigan	Detroit, 17208 Pierson Ave.	Rifenbergh, C. M.
Minnesota	Minneapolis, 2100 Fairmont St., S. E.	Knox, Martin E.
Missouri	St. Louis, 5020a Mardel Ave.	Walker, James H.
Nebraska	North Platte, R. 1, Box 499A	Flebbe, W. E.
New Mexico	Raton, Radio Station KGFL	Wolfe, C. R.
New Jersey	East Orange, 331 N. Grove St.	Lovatt, H. S.
	Harrison, Engineering Dept., RCA Radiotron Co.	Jones, Margaret C.
	Merchantville, 123 S. Lexington Ave.	Matthews, G. E.
	Paterson, 280 E. 24th St.	Weiner, Max J.
	Ridgewood, 123 S. Maple Ave.	Rouclere, Harold
	Stanhope, P. O. Box 123	Billiams, Frank J.
New York	Astoria, L. I., 30-49 Crescent St.	Lurie, Eli M.
	Auburn, 16 Parker St.	Gere, J. A.
	Brooklyn, 1807 Brooklyn Ave.	Petry, G. F.
	New York City, 32 W. 111th St.	Conviser, Harry
	New York City, 2473 Elm Pl.	Grosselinger, W. H.
	New York City, Bell Telephone Labs., 463 West St.	Mendenhall, H. E.
	New York City, 1240 Olmstead Ave.	Synnott, Burton
	New York City, c/o F. Del Carpio, 300 Reservoir Pl.	Texido, Platon
	Rochester, 654 Chili Ave.	Henry, William F.
North Dakota	Fargo, c/o WDAY, Inc.	Hetland, J. M.
Ohio	Canton, 825 Harriet Ave., N. W.	Gockatetter, G. J.
	Cincinnati, Rm. 101, Swift Hall, University of Cincinnati	Drake, Robert L.
Oklahoma	Bartlesville, Research Lab., Phillips Petroleum Co.	Eastman, Fred T.

Geographical Location of Members Elected May 6, 1931

Oregon	Corvallis, E. E. Dept., Oregon State College	Albert, A. L.	
Pennsylvania	Germantown, 6339 Homer St.	Daly, George M.	
	Philadelphia, 2002 N. Broad St.	Airston, A. J.	
Washington	Scranton, 1806 W. Gibson St.	Wilson, G. H.	
	Arlington	Murray, Henry	
Canada	Seattle, RCA Victor Co., Inc., 502 National Bldg.	Hucke, H. M.	
	Bowmanville, Ont., c/o CKGW, R. C. No. 4	Shane, W. A.	
Canal Zone	Halifax, N. S., 95 Morris St.	Martlieu, C. H. O.	
	Toronto, Ont., 338 Walmer Rd.	Harris, Edward	
	Toronto, Ont., 189 Dufferin St.	Price, L. M.	
	Toronto, Ont., 9 Cortleigh Blvd.	Stiff, G. F.	
England	Cristobal, P. O., Box 5056	Angus, G. W.	
	Bradford, 473-475 Manchester Rd.	Dobson, Jonas	
	Leeds, Yorkshire, 43 Clarendon Rd.	Fox, P. X.	
	London, N. 15, 242 High Rd.	Hogben, B.	
	London, W. 3, 18 Twyford Avenue	Merdler, L. R.	
	London, W. C. 2, British Elec. & Allied Research Assoc., 36/38 Kingsway	Oliphont, W. D.	
	Newport, Manchester, 6 Upton Rd.	Cooper, K. S.	
	Wembley, Middlesex, 7 Berkhamsted Ave.	Lince, R.	
	Hawaii	Honolulu, 1255 Rycroft St.	Morioka, G. M.
	Ireland	Bangor, Co. Down, 88 Hamilton Rd.	Taggart, D.
Japan	Hirosima, Asagun, Nagatukamura, c/o T. Ikeda	Siro, A.	
	Kojimachi, Tokyo, 22-5 Chome Hirakawacho	Sugi, C.	
Philippine Islands	Manila, Sampaloc, 408 San Anton	Eugenio, Lorenzo	
Samoa	Tutuila, U.S.N. Radio Station	Yalden, A. G.	
South Africa	Natal, Durban, Kings Kinewa	Baris, Isidore	
	Transvaal, Benoni, P. O. Box No. 208	Renshaw, J. B.	
Switzerland	Zurich, Zurich Physical Institute, E. T. H. Gloriastr. 35.	Tank, Franz	
Elected to the Junior Grade			
Arkansas	Texarkana, R. No. 3, Box 305	Mathis, C., Jr.	
New York	New York, 1825 Lacombe Ave.	Anderson, H. L.	
Ohio	Blanchester, 503 W. Main St.	Saville, H. F.	
	Conneaut, P. O. Box No. 14, Jester Station	Hirsimaki, N.	



APPLICATIONS FOR MEMBERSHIP

Applications for transfer or election to the various grades of membership have been received from the persons listed below, and have been approved by the Committee on Admissions. Members objecting to transfer or election of any of these applicants should communicate with the Secretary on or before June 30, 1931. Final action on these applications will be taken on July 1, 1931.

Eor Election to the Associate grade

California	Alameda, 1717 Versailles	Daniels, H. H.
	Culver City, 8951 B Hubbard St.	Adams, M. S.
	Culver City, 8951 B Hubbard St.	Figgins, F. M.
	Hollywood, 411 N. Curson	Klein, J.
	Los Angeles, 609 W. 104th St.	Adams, W. L.
	Los Angeles, 5963 S. Halldale Ave.	Burke, H. E.
	Los Angeles, c/o Brunswick Radio Corp., 1206 Maple	Comisaroff, L.
	Los Angeles, 415 $\frac{1}{2}$ S. Boyle Ave.	Hubbard, W. B.
	Los Angeles, 2713 N. Broadway	Lang, C.
	Los Angeles, 1576 N. Ave. 47	Neely, N. B.
	Oakland, c/o Boeing Air Transport	Klein, N. E.
	Point Reyes, c/o R.C.A. Communications, Inc.	Wood, R. A.
	San Diego, 2266 Ocean View Blvd.	Martin, W. H.
	San Diego, 1012 1st St.	Williams, R. R.
	San Francisco, U.S.S. Louisville, c/o Postmaster	Bartlett, K. R.
	San Francisco, 2475 Vallejo St.	Wolf, H.
	San Francisco, 140 New Montgomery St., Rm. 1021	Woltzen, L. J.
	San Jose, 405 Meridian Rd.	Gillmeister, F. W.
	San Pedro, U.S.S. Relief	Smith, H. L.
Colorado	Denver, 363 Clarkson St.	Johnson, H. A.
Connecticut	Fairfield, 870 Kings Highway	Green, A. A.
Dist. of Columbia	Washington, 4448 Greenwich Pkwy., N. W.	Pollock, H. B.
Illinois	Berwyn, 1237 Gunderson Ave.	Quist, W. G.
	Chicago, 1826 Diversey Pkwy.	Allen, J. M.
	Chicago, 3110 N. Damen Ave.	Graef, H. H.
	Chicago, 634 E. 51st St.	Lewis, J. H., Jr.
	Chicago, 7533 Kingston Ave.	Ostrand, A. G.
	Elmhurst, c/o WMAQ, R.F.D. No. 1, Church Rd.	Lindsay, W. R.
	Hillsboro, 106 Hunt Ave.	Fish, C. A.
	Rock Island, 2503 13th Ave.	Palmer, P. S.
Indiana	Angola, 400 S. College St.	Lemkin, H.
	Richmond, 620 Pearl St.	Worley, J. M.
Iowa	New Market, Dougherty's Radio Labs.	Doughterty, R. G.
Kansas	Topeka, 635 Poplar St.	Brubaker, J. H., Jr.
Kentucky	Hopkinsville, Campbell and 17th St.	McCormack, J. E.
Massachusetts	Boston, 68 Brookline Ave.	Kindt, M.
	Malden, 2 Park Ave.	Worthley, H. O.
	Osterville, Wianno Ave.	Chesbro, A. L.
Michigan	Detroit, 5071 Oregon Ave.	Adams, R. A.
	Detroit, 12071 Cascade Ave.	Bowman, L. F.
Minnesota	Duluth, 4309 Dodge St.	Wesanen, T. E.
Mississippi	Jackson, Route No. 1.	Drake, C. E.
Missouri	Kansas City, 4126 Prospect Ave.	McAvoy, R. A.
	Kansas City, 1014 W. 37th	Wilcox, J. V.
	Ladsonia	Stevens, C. B.
	St. Louis, 5534 Cabanne Ave.	Hardin, F. F.
	St. Louis, 5571 Chamberlain Ave.	Hicks, H. J.
Nebraska	Lincoln, 621 S. 34th St.	Garvin, C. W.
	Wahoo	Anderson, R. A.
New Jersey	Ampere, Wired Radio, Inc.	Banks, C. R.
	Ampere, Wired Radio, Inc.	Prichard, A. C.
	Collingswood, 22 Merrick Villa	Jams, H.
	East Orange, 79 Washington St.	Shive, R. L.
	Ridgefield Park, 93 Hobart St.	Fleming, J. W.
	Riverton, 608 Main St.	Goodenow, G. J.
New Mexico	State College, P. O. Box No. 103.	Pickett, H. D.
New York	Buffalo, 181 Royal Ave.	Vorojeikin, I. N.
	Garden City, P. O. Box No. 382	Marcroft, J.
	Jamaica, 143-20 Lincoln Ave.	Jaeger, H.
	Mohawk, 79 W. Main St.	Briggs, L. W.
	New York, 1290 Lafayette Ave.	Fox, B.
	New York, c/o International Tel. & Tel. Corp., 67 Broad St.	Jones, A. F.
	New York, c/o International Standard Elec. Corp., 67 Broad St.	Nelson, P. C.
	New York, 463 West St.	Reiling, P. A.

Applications for Membership

New York (cont.)	Richmond Hill, 8642 106th St.	Mayberry, R. J.	
	Riverhead, 303 Main St.	Goddard, D. R.	
	Rochester, Physics Dept., University of Rochester	Grover, H. J.	
	Rochester, 76 Rockingham St.	Tarrant, S. E.	
	Rochester, 56 Dorset St.	Tombouliau, D.	
	Snyder, 92 Washington Hghwy	Ellinger, A. E.	
	Watervliet, 940 Broadway	Barron, A.	
	Yonkers, 113 Greenvale Ave.	Petersen, R. L.	
	Ohio	Cincinnati, 4117 Flower Ave.	Crowe, M. E.
		Cincinnati, Swift Hall, University of Cincinnati	Lesikar, G.
Lima, 643 Spring (W)		Hinklin, L. G.	
Maumee, 319 W. Dudley St.		Rowe, H. N.	
Oklahoma	Oklahoma City, 2924 W. 21st St.	Eakin, A. L.	
	Oregon	Multnomah, P. O. Box No. 277	McAllister, J. D.
Pennsylvania	East Pittsburgh, Power Tube Lab., MF5, Westinghouse Electric and Manufacturing Co.	Noble, H. V.	
	Erie, 2801 Plum St.	Sterner, J.	
	New Cumberland, 321 Reno St.	Fafer, B. M.	
	Philadelphia, c/o Radiomarine Corp, 32 N. 5th St.	Wood, H. D.	
	Philadelphia, 1934 S. 56th St.	Woodcock, T. W. W.	
	Pittsburgh, Edgewood, 140 W. Hutchinson Ave.	Potter, W. S.	
	Reading, 311 W. Windsor St.	Schock, H. H.	
	Warren, 212 Liberty St.	Kieshauer, F. E.	
	Providence, 207 Rhodes St.	Ward, C. W.	
	Rhode Island	Pomaria	Hipp, R., Jr.
	South Carolina	Mount Enterprise	Furlow, J. T.
	Texas	Brattleboro, Miller Sales and Service, Inc.	Smith, W. M.
	Vermont	Seattle, 4206 Woodland Park Ave.	Halstead, C.
	Washington	Seattle, 4520 Eastern Ave.	Mitchell, W. L.
		Wisconsin	Madison, 428½ W. Gilman St.
West Allis, R. R. No. 4, Box No. 310	Meuer, A. G.		
Canada	Belleville, Ont., 245 John St., N.	Dewar, J. A.	
	Belleville, Ont., 153 Ann St.	Read, C. C.	
	Belleville, Ont., 253 William St.	Ross, L.	
	Calgary, Alberta, 210-11th Ave. W.	Clayton, W. P.	
	Cobourg, Ont., Box No. 878	Green, G. L.	
	Edmonton, Alberta, Box No. 632	Freeman, J. T.	
	Edmonton, Alberta, 10742 85th Ave.	Newton, H. B.	
	Hamilton, Ont., 108 Victoria Ave. N.	Heilig, C. G.	
	Kitchener, Ont., 23 DeKay St.	Marsland, S.	
	Montreal, Que., 2379 Mariette Ave.	Edward, A. G.	
	North Bay, Ont., 50 Main St., 1/1 Lorne Lariviere	Cochrane, I. D.	
	Oshawa, Ont., 644 Simcoe St., N.	Whittington, R. L.	
	Sarnia, Ont., 203 N. Christina St.	Buchanan, F. J.	
	Sault Ste. Marie, Ont., 180 Biggings Ave.	Smith, B. F.	
	Toronto, Ont., 59 Gormley Ave.	Boyd, J. W. G.	
	Toronto, Ont., 40 McGill St.	Clements, M.	
	Toronto, Ont., 377 Brunswick Ave.	Little, R. J.	
	Toronto, Ont., 1 Starr Ave.	Goldhamer, S. A.	
	Toronto, Ont., 1315 Bloor St. W.	Pelton, C. R.	
	Toronto, Ont., 426 King St. E.	Raycove, S. A.	
Toronto, Ont., Utah-Carter Radio Ltd., 559 College St.	Smith, W. B.		
England	Darlington, Co. Durham, 2 Skinnergate	Glover, H.	
	Feltham, Middlesex, 6 High St.	Phillips, M. M.	
	Greenford, Middlesex, 2 Station Parade	Gurney, A. A.	
	Hendon, London, International Tel. and Tel. Labs., The Hyde	Jacobsen, B. B.	
	Pontllanfraith, Mon., "Sunnycroft," Bryn Rd.	Cam, F. A.	
Philippine Islands	Sheffield, Yorkshire, 125 S. View Rd. Sharrow	Fell, H.	
	Pangasinan, San Fabian	Orjalo, A. F.	
Peru	Lima, Box No. 1789	Perez-Palacia, E.	
Spain	Madrid, Compania Telefonica Nacional DeSpana	Pelaez, C.	
Wales	Cardiff, 116 Tewkesbury St., Roath	Morris, W. J.	

For Election to the Junior grade

California	Los Angeles, 5114 Hillcrest Dr.	Estep, C. R.
Indiana	Valparaiso, 103 N. College Ave.	Mix, R. E.
New York	College Point, 25-28 122nd St.	Corbett, C. W.
Pennsylvania	Allentown, 2207 Allen St.	Lichtenwalner, H.
China	Shanghai, 81 Rue du Consulat	Wang, T. S.



OFFICERS AND BOARD OF DIRECTION, 1931

(Terms expire January 1, 1932, except as otherwise noted)

President

RAY H. MANSON

Vice President

C. P. EDWARDS

Treasurer

MELVILLE EASTHAM

Secretary

HAROLD P. WESTMAN

Editor

ALFRED N. GOLDSMITH

Managers

ARTHUR BATCHELLER

J. H. DELLINGER

LLOYD ESPENSCHIED

HARRY HOUCK

C. M. JANSKY, JR.

Serving until January 1, 1933

J. V. L. HOGAN

R. H. MARRIOTT

Serving until January 1, 1934

L. M. HULL

A. F. VAN DYCK

Junior Past Presidents

A. HOYT TAYLOR

LEE DE FOREST

BOARD OF EDITORS, 1931

ALFRED N. GOLDSMITH, *Chairman*

STUART BALLANTINE

RALPH BATCHER

G. W. PICKARD

L. E. WHITTEMORE

W. WILSON

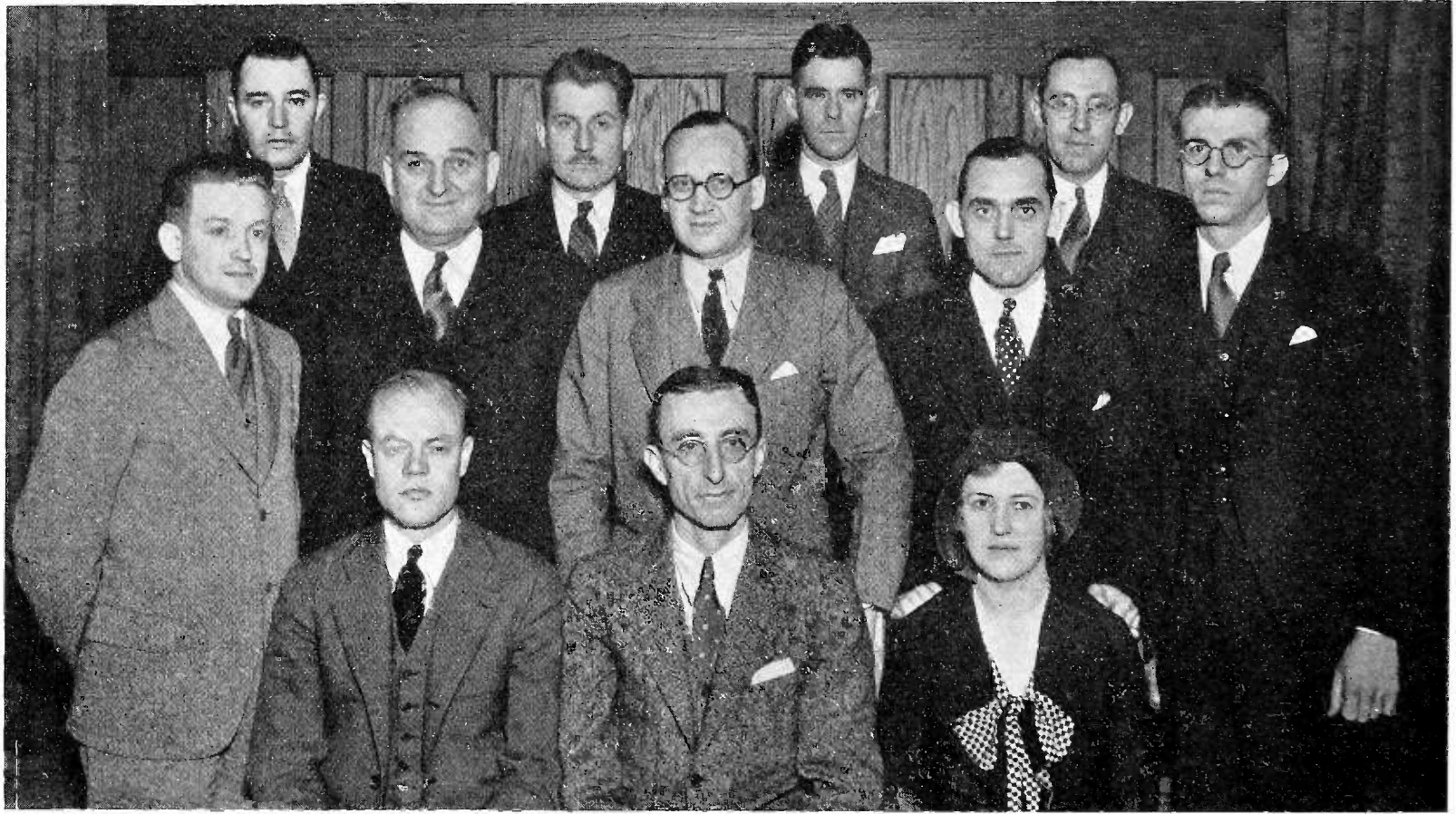

Kaufman and Fabry

The above group, comprising the Convention Committee, are responsible for the arrangements and preparations for the Sixth Annual Convention of the Institute. Those standing, reading from left to right are: R. M. Arnold, L. F. Muter, A. J. Carter, A. C. Forbes, S. E. Adair, D. H. Miller, J. F. Church, J. N. Golten and A. J. McMaster. Seated are, J. B. Hoag, Secretary-Treasurer of the Chicago Section, B. B. Minnium. Chairman of the Convention Committee and the Chicago Section, and Virginia M. Thompson.

INSTITUTE NEWS AND RADIO NOTES

May Meeting of the Board of Direction

A meeting of the Board of Direction was held on Wednesday, May 6, 1931, at the Institute office, 33 West 39th Street, New York City. R. H. Manson, president; Melville Eastham, treasurer; Arthur Batcheller, Lloyd Espenschied, J. V. L. Hogan, Harry Houck, L. M. Hull, C. M. Jansky, Jr., R. H. Marriott, A. F. Van Dyck, and Harold P. Westman, secretary, were in attendance.

Messrs. John T. Bradley, S. R. Kantebet and E. H. Rietzke were transferred to the Member grade. In addition, ninety-four applications for the Associate grade of membership and four applications for the Junior grade of membership were approved.

The Committee on Broadcasting submitted a proposed revision of General Order 91 concerning the power rating of broadcast transmitters and a proposed letter of transmittal to accompany it. These were approved.

It was agreed that summaries of papers to be presented at Institute meetings or published in the PROCEEDINGS might be made available to other publications prior to their publication or presentation for publicity purposes.

Dr. F. W. Grover of Union College was delegated the representative of the Institute at the Faraday Celebrations to be held by the Royal Institution of Great Britain in September, 1931, in London, England.

The proposed new Constitution for the Institute which has been prepared by the Committee on Constitution and Laws under the chairmanship of R. H. Marriott received final approval of the Board and will be submitted to the membership for vote at an early date.

Bound Volumes

The twelve issues of the PROCEEDINGS published during 1930 are now available in blue buckram binding to members of the Institute at nine dollars and fifty cents (\$9.50) per volume. The price to nonmembers of the Institute is twelve (\$12.00) dollars per volume.

1931 Year Book of the American Standards Association

The 1931 Year Book of the American Standards Association which was recently issued, contains many items of value to those interested in the progress of standardization in America. The reasons for standardi-

zation, the structure of the A. S. A., and the operation of the various Sectional Committees which are entrusted with the problems of setting up standards in various fields, are described. In addition, there is included an index listing all of the standards approved by the American Standards Association, and another listing all of the incompleting projects which are being considered at the present time. The constitution of the A. S. A. is given, together with many items of general interest in the standardization field.

Copies of this Year Book can be obtained by interested parties upon request made to the American Standards Association, 33 West 39th St., New York City.

Radio Transmissions of Standard Frequency, June, 1931

The Bureau of Standards announces a new and improved service of radio standard frequency transmissions. This service may be used by broadcast and other stations in adjusting their transmitters to exact frequency, and by the public in calibrating frequency standards and transmitting and receiving apparatus. The signals are transmitted from the Bureau's station WWV, Washington, D.C. They can be heard and utilized by stations equipped for continuous-wave reception at distances up to about 1000 miles from Washington, and some of them at all points in the United States. This improved service is a step in the Bureau's program to provide eventually standard frequencies available at all times and at every place in the country

Besides the usual monthly transmission of specific frequencies, the Bureau will add another type of transmission which will be much more accurate than any previous transmissions by the Bureau. This transmission will be by continuous-wave radiotelegraphy on a frequency of 5000 kc, and will consist primarily of a series of very long dashes. The first five minutes of this transmission will consist of the general call (CQ de WWV) and announcement of the frequency. The frequency and the call letters of the station (WWV) will be given every ten minutes thereafter.

Besides this service, the Bureau will also continue the transmissions once a month on scheduled specific frequencies. These are also by continuous-wave radiotelegraphy. A complete frequency transmission includes a "general call," "standard frequency signal," and "announcements." The general call is given at the beginning of each 12-minute period and continues for about 2 minutes. This includes a statement of the frequency. The standard frequency signal is a series of very long dashes with the call letters (WWV) intervening; this signal continues

for about 4 minutes. The announcements follow, and contain a statement of the frequency being transmitted and of the next frequency to be transmitted. There is then a 4-minute interval while the transmitting set is adjusted for the next frequency.

Information on how to receive and utilize the signals is given in Bureau of Standards Letter Circular No. 280, which may be obtained by applying to the Bureau of Standards, Washington, D.C. Even though only a few frequencies are received (or even only a single one), persons can obtain as complete a frequency meter calibration as desired by the method of generator harmonics.

The 5000-kilocycle transmissions are from a transmitter of 150 watts power, which may be increased to 1 kilowatt early in the year; they occur every Tuesday except in those weeks in which the monthly transmissions are given. The monthly transmissions are from a transmitter of 1/2 to 1 kilowatt power; they are given on the 20th of every month (with one exception).

5000-Kilocycle Transmissions
1:30 to 3:30, and 8:00 to 10:00, P.M., Eastern Standard Time.
June

2
9
16
30

Monthly Transmissions, Eastern Standard Time
Time June 22

10:00 P.M.	550
10:12	600
10:24	700
10:36	800
10:48	1000
11:00	1200
11:12	1400
11:24	1500

The frequencies in the 5000-kilocycle transmission are piezo controlled, and are accurate to a few parts in ten million. The frequencies in the monthly transmission are manually controlled, and are accurate to a few parts in a million.

In November, 1930, field intensity measurements were made of the 5000-kilocycle transmission from (WWV) on 150 watts between Washington and Chicago. The daytime field intensity up to a distance of about 400 miles from Washington was about 100 microvolts per meter, with fading in the ratio 3 to 1. From this distance to Chicago the field intensity gradually decreased to about 10 microvolts per meter peak values with fading the same as above. The evening transmissions had a field intensity of about 200 microvolts per meter with fading similar to that in the daytime. Around 8 P.M. the received intensity was some-

times too low to measure. This happened at distances of from 75 to 150 miles from Washington.

The Bureau of Standards would like to have detailed information on the reception of the 5000-kilocycle transmission and will appreciate receiving reports from any observers on their reception of these transmissions. Phenomena of particular interest are approximate field intensity, and fading (whether slow or rapid, and approximate time between peaks of signal intensity). The Bureau would also like to receive comments on whether or not the transmissions are satisfactory for purposes of frequency measurement or control. Reports on the reception of the transmissions should be addressed to Bureau of Standards, Washington, D.C.

Committee Work

COMMITTEE ON ADMISSIONS

At a meeting of the Committee on Admissions, held on May 6th, the following were in attendance: R. A. Heising, acting chairman; Arthur Batcheller, H. C. Gawler, R. H. Marriott, E. R. Shute, A. F. Van Dyck, and H. P. Westman, secretary.

The Committee reviewed three applications for transfer to the grade of Fellow and approved them. It also approved four applications for transfer to the grade of Member and three of four applications for admission to the grade of Member.

COMMITTEE ON BROADCASTING

Two meetings of the Committee on Broadcasting were held since the last report. The first of these was held on April 24th and was attended by C. M. Jansky, Jr., acting chairman; Wilson Aull (representing J. V. L. Hogan), Arthur Batcheller, J. B. Coleman (representing B. R. Cummings), P. A. Greene, Raymond Guy, C. W. Horn, R. H. Marriott, and E. L. Nelson.

The second meeting held on May 5th was attended by C. M. Jansky, Jr., acting chairman; Arthur Batcheller, Wilson Aull (representing J. V. L. Hogan), B. R. Cummings, Raymond Guy, C. W. Horn, R. H. Marriott, and E. L. Nelson.

These two meetings were devoted to the preparation of a proposed revision of General Order No. 91 on the power rating of broadcast transmitters. The recommendations of the Committee were presented to the Board of Direction on May 6th and approved.

COMMITTEE ON MEMBERSHIP

H. C. Gawler, chairman; I. S. Coggeshall, David Grimes, S. R. Montcalm, and A. M. Trogner attended the meeting of the Committee on Membership held on May 6th.

STANDARDIZATION

SUBCOMMITTEE ON HIGH-FREQUENCY RECEIVERS OF THE
TECHNICAL COMMITTEE ON RADIO RECEIVERS-I.R.E

A meeting of the Subcommittee on High-Frequency Receivers of the Technical Committee on Radio Receivers of the Institute was held on May 7th and attended by C. M. Burrill, chairman; H. H. Beverage, C. A. Gunther, H. O. Peterson, F. A. Polkinghorn, S. E. Spittle, and B. Dudley, secretary.

The Committee completed its report on this subject, which report will now be presented to the new Technical Committee on Radio Receivers for inclusion in the next published standardization report.

SECTIONAL COMMITTEE ON RADIO

A meeting of the Sectional Committee on Radio of the American Standards Association was held at the office of the Institute on April 29th, the following being in attendance: Alfred N. Goldsmith, chairman; C. H. Sharp, vice chairman, S. C. Bartlett (representing R. N. Conwell), J. Blanchard (representing W. Wilson), R. D. Brown, (representing W. E. Holland), J. A. Code, Jr., Edwin Ely, R. H. Langley, J. A. MacNair (American Standards Association), J. C. Warner, Irving Wolff, H. P. Westman, and B. Dudley, secretary.

During the past year the four technical committees and their several subcommittees, operating under the A. S. A. procedure, and the Sectional Committee on Radio, have prepared material to be considered for adoption as American Standard. Reports of these committees were reviewed critically by the Sectional Committee on Radio at this meeting and the material that was tentatively approved for adoption as American Standard will now be forwarded, together with a ballot, to all the members of the Sectional Committee on Radio. Upon the return of the ballots, the material will be sent to the American Standards Association for final approval. This process will require a few months time and the approved report will probably be published in the 1932 YEAR BOOK.

SUBCOMMITTEE ON DIMENSIONS OF THE TECHNICAL
COMMITTEE ON VACUUM TUBES—A.S.A.

A meeting of the Subcommittee on Dimensions of the Technical Committee on Vacuum Tubes, operating under the Sectional Committee on Radio of the American Standards Association, was held on April 15th in the office of the Institute. F. H. Engel, Chairman; M. J. Kelly, Ernest Kraus, B. E. Shackelford, P. T. Weeks, R. M. Zimber (representing A. B. Du Mont), A. Ronsey (nonmember), and B. Dudley, secretary, were in attendance.

This Subcommittee is endeavoring to set up suitable standards on the physical dimensions of vacuum tubes in present day use in order to facilitate the manufacture and design of sets requiring extensive shielding or where physical dimensions are of considerable importance.

Institute Meetings

ATLANTA SECTION

A meeting of the Atlanta Section was held on March 27 at the Atlanta Athletic Club, Chairman Harry Dobbs, presiding.

The paper of the evening by C. D. Woodyard, Professor of Physics at the Georgia School of Technology, was on the subject of "Photo-Electric Cells." A number of photo-electric cells were available for examination at the meeting and at the close of the paper the discussion was entered into by Messrs. Bangs, Davis, Dobbs, Gardberg, Reid, and Wills.

Fifteen of the eighteen members and guests who attended the meeting were present at the informal dinner which preceded it.

CINCINNATI SECTION

The 18th meeting of the Cincinnati Section was held on April 14 in the Engineers' Club in Dayton, Ohio, D. D. Israel, chairman, presiding.

A paper on "Applications of Radio to Aviation" was presented by first Lieutenant H. G. Messer, assistant to the officer-in-charge of the Signal Corps Aircraft Laboratory at Wright Field.

The speaker discussed the design limitations of aircraft radio equipment with regard to space, weight, ruggedness, and suitability for warfare. A number of interesting points were stressed such as the importance of the weight distribution of equipment and the availability of component materials required for mass production in time of war. A number of pieces of government and commercial aircraft radio equipment were displayed to illustrate various features of this equipment

and brief technical sketches were made of the various transmitters and receivers.

Present trends in the design of accessories which affect the comfort and safety of the pilot-operator were mentioned. In all, some twenty-two pieces of equipment were displayed. A demonstration was given of a highly sensitive receiver operated by remote control and employing a small rod antenna for pick-up was given. The various types of airway beacons and course indicating equipment and their effects of aerial navigation were then discussed.

The discussion was entered into by Messrs. Glover and Israel of the fifty-three members and guests who were in attendance.

CLEVELAND SECTION

The March meeting of the Cleveland Section was held jointly with the Akron Section of the American Institute of Electrical Engineers in the Y.W.C.A. Auditorium in Akron on the 25th.

A paper on "The History of the Development of the Art and Technology of Electrical Engineering" was presented by Dr. A. E. Kennelly, Emeritus Professor of Electrical Engineering at Harvard University.

The meeting was attended by three hundred members and guests of both organizations that sponsored it.

CONNECTICUT VALLEY SECTION

The April 9 meeting of the Connecticut Valley Section was held at the Hotel Garde in Hartford, R. S. Kruse, chairman, presiding.

A paper on "Frequency Standards and Measurements" was presented by James K. Clapp of the General Radio Company.

The paper dealt chiefly with piezo-electric crystal oscillators and methods of utilizing harmonics for the measurement of frequency although the characteristics of tuning forks and magnetostriction oscillators were touched upon briefly. Descriptions of primary and secondary frequency standards were given, illustrated by photographs, and several different types of frequency meters were described.

Methods of interpolation for measuring frequencies lying between those given by oscillator harmonics were explained. Typical frequency-measuring apparatus was demonstrated, and a crystal-controlled oscillator and multivibrator which produced harmonics at 10-kilocycle intervals in the broadcast band were exhibited. Reaction type wave-meters for waves having lengths from a few centimeters to ten meters were shown.

A number of the forty-two members and guests in attendance

entered into the discussion of the paper. The informal dinner which preceded the meeting was attended by seventeen.

DETROIT SECTION

The April meeting of the Detroit Section was held in the Detroit News Conference Room on the 17th and was presided over by L. N. Holland, chairman.

The paper of the evening on "Directional Receiving Antennas" was presented by J. E. Brown of the Radio Supervisor's Office of the Department of Commerce.

The speaker outlined the history of directive antennas, beginning with the early experiments performed by Hertz and later by Marconi. The systems involved were simple parabolic reflectors which were practical due to the use of extremely short waves. The work of Marconi resulted in the development of the quarter-wave radiator, variations of which have for many years been used extensively for transmitting and receiving purposes.

The early commercial applications of radio brought into use transmission by means of long waves, and the physical characteristics of the antennas involved considerably reduced the possibility of commercially practical directive transmission and reception. Due to the small pick-up of the loop antenna, the speaker pointed out, it is seldom used commercially below a thousand meters. However, from one hundred to thirty thousand meters, the loop arranged in the Bellini-Tosi manner together with an ordinary vertical antenna produces a unidirectional receiving system which is variable at the will of the operator and effective throughout 360 degrees of horizontal rotation. Such a system is in use at the government monitoring station at Grand Island, Nebraska.

A number of directive antennas applicable for use at short waves were discussed. The phasing type similar to those used in the transatlantic telephone circuits were considered. It was pointed out that this type was not suitable for general work because its efficiency was high only at the frequency for which it was designed.

The wave antenna devised by Beverage and which may be operated over a wide bank of frequencies at high efficiency was then covered. The simple theory of the wave antenna and some of the variations of this type of antenna as used in practice were discussed and the paper was concluded with a description of the wave antenna systems in use at the Grand Island monitoring station.

A number of the fifty members and guests at the meeting took part in the discussion.

LOS ANGELES SECTION

The April 14 meeting of the Los Angeles Section was held at the Warner Brothers Motion Picture Studio in Hollywood and was a joint meeting with the Los Angeles Section of the American Institute of Electrical Engineers.

R. H. Townsend, chief engineer of the RCA Photophone Company, presented a paper on "The RCA Photophone System", and H. C. Silent, a development engineer for Electrical Research Products covered "Western Electric Recording and Reproducing Systems." A third paper on "Photographic Requirements and Film Technique" was presented by Dr. J. H. Frayne of the Electrical Research Products.

In addition to these papers, demonstration films were used by the speakers to illustrate the particular features and characteristics of the recording and reproducing systems discussed. Various types of sound track were shown in a manner to enable the audience to listen to the recorded sound and observe the track simultaneously. The descriptions of the systems used by both RCA Photophone and Electrical Research Products in the reduction of background noise in film recording were given.

Members of the Institute were guests of the Los Angeles Section of the American Institute of Electrical Engineers at this particular meeting. Due to limitations of the auditorium at the studios, only two hundred and fifty could be admitted. However, a repetition of the meeting which was equally successful was held on April 21 and approximately four hundred and fifty members and guests of both organizations were present at these two meetings. Due to the length of time required in the presentation of the papers, no discussion was held.

NEW YORK MEETING

The May 6 New York meeting of the Institute, presided over by President Manson, was held in the Engineering Societies Building, 33 West 39th Street, New York City.

Two papers were presented, the first being "A Device for the Precise Measurement of High Frequencies," by F. A. Polkinghorn and A. A. Roetken of the Bell Telephone Laboratories.

The second paper of the evening, "The Suppression of R. F. Harmonics in Transmitters," was by J. W. Labus and Hans Roder of the General Electric Company.

As these papers are both appearing in full in this issue of the Proceedings they are not being abstracted.

PHILADELPHIA SECTION

The April 8 meeting of the Philadelphia Section was held at the Engineers Club in Philadelphia and presided over by D. O. Whelan, vice chairman.

Malcolm P. Hanson, radio engineer of the Byrd Antarctic Expedition presented a paper entitled "My Two Years in the Antarctic."

This paper was illustrated by over three hundred slides and dealt primarily with the radio problems, installations, equipment, and experiments connected with the expedition work. Detailed descriptions of the various short- and long-wave transmitters were given and the measurement of signal intensities was discussed. The talk was interspersed with many interesting comments on the general activities of the expedition and was followed by a general discussion which was entered into by a number of the two hundred and forty-five members and guests in attendance.

PITTSBURGH SECTION

A meeting of the Pittsburgh Section was held on April 21 at the Fort Pitt Hotel in Pittsburgh, Chairman L. A. Terven, presiding.

Prior to the introduction of the speaker, a motion was passed that the Pittsburgh Section attempt to obtain the sponsorship of the Seventh Annual Convention of the Institute to be held during 1932 and plans were made to obtain the consent of the Board of Direction in this matter.

Officers for the next year were elected as follows: Chairman, J. G. Allen; Vice Chairman, C. F. Donbar; Secretary-Treasurer, J. G. McKinley.

A report of the retiring treasurer was then given and accepted.

L. A. Terven, retiring chairman, was appointed the official representative of the Section to the Sixth Annual Convention of the Institute.

The speaker of the evening, Dr. E. D. Wilson, of the Westinghouse Research Laboratory, then presented a paper on "Different Types of Light Sensitive Devices in Practice."

The speaker specified three main classes of light sensitive devices namely; photoconductive, photo-emmissive, and photovoltaic. An example of the photoconductive device is a selenium cell and its construction, operation, adaptations and uses, working limits, and characteristics were discussed. Then followed a description of the photo-emmissive devices such as the caesium oxide cells which are considerably used at the present time. This cell was explained in detail and compared with the selenium cell. The third type, or photovoltaic de-

vice, was illustrated by discussion of the copper oxide type of light sensitive device invented in Germany. This cell also was compared with the other types of light sensitive devices and the advantages and disadvantages of each were pointed out.

The paper was discussed by Messrs. Allen, Marrison, McKinley, Sutherlin, and Terven.

Fifty members and guests attended the meeting which was preceded by an informal dinner at which twenty-five were present.

ROCHESTER SECTION

The February 5 meeting of the Rochester Section was held at the Sagamore Hotel in Rochester, in conjunction with the Rochester Sections of the American Institute of Electrical Engineers, American Society of Mechanical Engineers, and the Rochester Engineering Society.

Colonel Hugh L. Cooper presented a paper entitled "Communism in the Abstract," and covered the work he is doing in the U.S.S.R. Slides were projected to illustrate the various engineering projects which he has undertaken in that country and particularly the construction of the dam on the Dnieper River.

The meeting was presided over by H. E. Gordon, chairman of the Rochester Section of the Institute of Radio Engineers.

The attendance totaled four hundred and sixteen.

SAN FRANCISCO SECTION

The April meeting of the San Francisco Section was held on the 15th at the Bellevue Hotel in San Francisco, chairman W. D. Kellogg, presiding.

The paper of the evening on "Linear Conductors Used as Reflectors and Directors in Radio Beam Transmission" was presented by Leonard J. Black, instructor at the University of California.

The basic principles of reflection were covered and the necessary mathematical computations for the design of directive antenna structures given. The use of director wires was explained. A number of interesting graphs giving quantitative data on directive antennas were shown.

The paper was discussed by Messrs. Kellogg, Leonard, Lippincott, Fuller, and Halloran.

The attendance was forty-one, eighteen of whom were present at an informal dinner which preceded the meeting.

SEATTLE SECTION

A paper by Howard Mason on "Radio in Antarctic Exploration" was presented at the April 30 meeting of the Seattle Section held at the Guggenheim Hall at the University of Washington, Abner R. Willson, chairman, presiding at the meeting.

The paper covered in detail the part played by radio in the success of the Byrd Antarctic Expedition. The author displayed specimens of several types of equipment used in the exploration work. These included the transmitter used on the flight over the South Pole, a gasoline engine driven portable generator weighing but 31 pounds and delivering 400 watts of power, hand or bicycle driven generators and other equipment of like nature. The paper was illustrated by projected diagrams and photographs.

The discussion of the paper was entered into by Messrs. Bouson, Gunston, Hackett, and Stewart of the seventy-nine members and guests in attendance.

TORONTO SECTION

A meeting of the Toronto Section was held on March 25 in the Mining Building of the University of Toronto. The meeting was jointly presided over by President Manson and J. M. Leslie, chairman of the Toronto Section.

The paper of the evening was presented by Benjamin Olney, an acoustical engineer with the Stromberg-Carlson Telephone Manufacturing Company who spoke on "Loud Speaker Response Measurements."

The author pointed out the difficulties encountered in making measurements of the acoustic output of loud speakers and a description of the acoustic features of a particular indoor measuring system was given. Outdoor testing arrangements were described whereby double as well as single radiating loud speakers are measured with negligible ground reflection error.

It was pointed out that the over-all electrical fidelity curve of a radio receiver is an inadequate performance index and the electro-acoustic fidelity embracing the frequency response of the speaker and housing were suggested as being more informative.

The interpretation of response curves in terms of what one may expect to hear were also discussed. Various response curves were shown to illustrate the effects of the type of cone corrugation, the installation of the speaker in a radio receiver cabinet as compared with a flat baffle, and the effect of the face dimension of a box baffle as compared with the length of the front-to-rear path. The face dimension of the

box baffle was shown to be equally as important as the front-to-rear path length. The effect of the extreme length of the box baffle was also shown. The results of measurements of a sample speaker in cabinets of various sizes were given and the over-all electro-acoustic response curves of radio receivers shown together with some examples of outdoor measurements.

The paper was discussed by Messrs. Andres, Bayly, Fox, and Professor Price of the one hundred members and guests in attendance.

President Manson delivered a short address advising engineers to be good salesmen and acquaint as many people as possible with their work.

The April meeting of the Toronto Section was held on the 11th at the Royal York Hotel, J. M. Leslie, chairman, presiding.

The paper of the evening was presented by Sidney Fisher, an engineer of the Northern Electric Company who discussed the "Radio Facilities of the Royal York Hotel."

The problems in the design, installation, and operation of public address, program service, and broadcast facilities of modern hotel installations were fully described and discussed. Lantern slides showing wiring layouts, mechanical construction, and electrical circuit arrangements gave a complete insight into the extremely flexible equipment installed in the Royal York Hotel.

As a part of the discussion. Mr. Mason, chief engineer of the Royal York Hotel, pointed out some problems encountered in connection with the servicing of this type of equipment and, following the meeting, a tour of inspection was made to the control room and broadcast studios located in the hotel.

The meeting was attended by sixty-five members and guests.

WASHINGTON SECTION

The April meeting of the Washington Section was held on the 9th at the Continental Hotel in Washington, L. P. Wheeler, chairman, presiding.

A paper by A. Hoyt Taylor and H. F. Hastings of the Naval Research Laboratory on "The Determination of Power in the Antenna at High Frequencies" was presented.

It was pointed out that while the resistance of an antenna may be as low as $1/2$ ohm for frequencies in the neighborhood at 15 to 20 kilocycles, it is upwards of thousands of ohms for high frequencies.

The power in the antenna may be measured by a wattmeter at the lower edge of the radio spectrum and by a substituted resistor and the I^2R method for the frequencies up to 2000 kilocycles. However, above

these frequencies such methods are not satisfactory and the experiments outlined were undertaken to devise a reliable method of determining where losses were taking place and what per cent of the total power supplied to the plate circuit of the output tubes reached the antenna system.

A pair of water-cooled tubes nominally rated at 10 kw each were used in a push-pull circuit. By measuring the volume of water supplied the tubes and the increase in temperature of it, the power dissipated in the tube could be accurately measured. Nonoscillatory power of from 1 to 5 kw was dissipated in the tubes and the system calibrated by measurements on the water used in cooling. In the tests made a coil connected to a thermoammeter was used when the antenna was disconnected to explore for stray fields. Plate coils having various numbers of turns were used on some frequencies to determine coil losses. Plate voltages as high as 7000 volts were used with the necessary corresponding grid bias.

Tests were made at 4000, 8000, 12,000, 16,000, and 24,000 kilocycles and the losses were found to increase with frequency. The stray losses included currents induced in all-metal parts, even in the plate itself, and dielectric losses in all insulating material. Curves were shown indicating that it is reasonable to expect efficiencies of 55 per cent at 4000 kc, 52 per cent at 8000, 48 per cent at 12,000, 45 per cent at 16,000, and 35 to 37 per cent at 24,000 kc. These efficiencies might be increased if the coil turns could be varied continuously and, since there are great losses in the tubes, it will be desirable to make improvements there.

The paper was discussed by Professors Howard and Robinson of the sixty members and guests in attendance. An informal dinner preceding the meeting was attended by thirty-seven.

Personal Mention

Winiferd H. Campbell, formerly a test engineer for the Amrad Corporation is now a production engineer for the Magnavox Company at Ft. Wayne, Ind.

C. M. Burrill has left the engineering department of the RCA Victor Company to join the engineering staff of Rogers-Majestic Corporation, Toronto, Ont.

Lieutenant Commander H. H. Bouson, U. S. N., previously on the USS Colorado, is now at staff headquarters in Seattle, Wash.

Burton F. Miller has left Electrical Research Products, Inc., to become a transmission engineer in the Sound Department of the Columbia Picture Corporation in Hollywood, Calif.

L. M. Cockaday, formerly technical editor of the New York Herald-Tribune is now editor of Radio Science Publications, Inc., New York City.

L. W. Dean, previously with F. A. D. Andrea, Inc., is now a sound engineer for Paramount Publix Corporation in Dallas, Tex.

Lieutenant Commander Walter M. Wynne, U. S. N. has left the Philadelphia Navy Yard for sea duty on the USS Evans.

Formerly in the technical department of British Brunswick, Ltd., London, England, C. F. Cox has become a recording technician for Paramount News, in Paris, France.

A. B. Chamberlain, formerly vice president of the Buffalo Broadcasting Corporation has become chief engineer of the Columbia Broadcasting System with headquarters in New York City.

Lieutenant K. L. Forster is now on sea duty on the USS Augusta.

T. H. Willers, Sr. has left the Rockland Light and Power Company of Port Jervis, N. Y., and joined the staff of Electrical Research Products, Inc., in Buffalo, N. Y.

Previously with the International Communications Laboratories, K. L. Henderson has recently become a design engineer for United American Bosch, Inc., of Springfield, Mass.

G. H. Dutton has left Silver-Marshall, Inc., to become president of the Chicago Radio Institute, in Chicago.

L. F. Jones, formerly a radio engineer for the General Electric Company is now in the transmitter division of the engineering department of the RCA Victor Company at Camden.

Howard J. Tyzzer, formerly chief radio engineer of the Howard J. Power Co. has become chief engineer of the Amrad Division of the Magnavox Company of Ft. Wayne, Ind.

G. E. Maul has rejoined the Arcturus Radio Tube Company as research engineer in their photolytic cell division.

S. Gordon Taylor, former consultant, has become technical editor of Radio News, in New York City.

J. H. Homsy, radio inspector, has been transferred from the Los Angeles to the San Pedro office of the U. S. Department of Commerce.

E. L. Garceau has left the International Communication Laboratories to join the engineering staff of Wired Radio of Ampere, N. J.

John Bostad, formerly with the Bell Telephone Laboratories, has joined the engineering department of Wired Radio, of Ampere, N. J.

E. J. T. Moore has been transferred from the Rochester to the Toronto office of the Stromberg-Carlson Telephone Manufacturing Company.

Lieutenant Alfred R. Taylor, U.S.N., has been transferred from the USS Pensacola to the USS Trenton.

R. A. Lynn has left the engineering department of RCA Victor Company to enter the plant operation and engineering department of the National Broadcasting Company, New York City.

S. W. Brown, consulting engineer, has recently moved to 306 Dartmouth Avenue, Buffalo, N. Y.

George C. Crom, Jr., formerly with Bludworth, Inc., is now doing consulting work in New York City.

V. D. Landon, formerly assistant chief engineer of Radio Frequency Laboratories is now assistant chief engineer of the Grigsby-Grunow Company.



PART II
TECHNICAL PAPERS

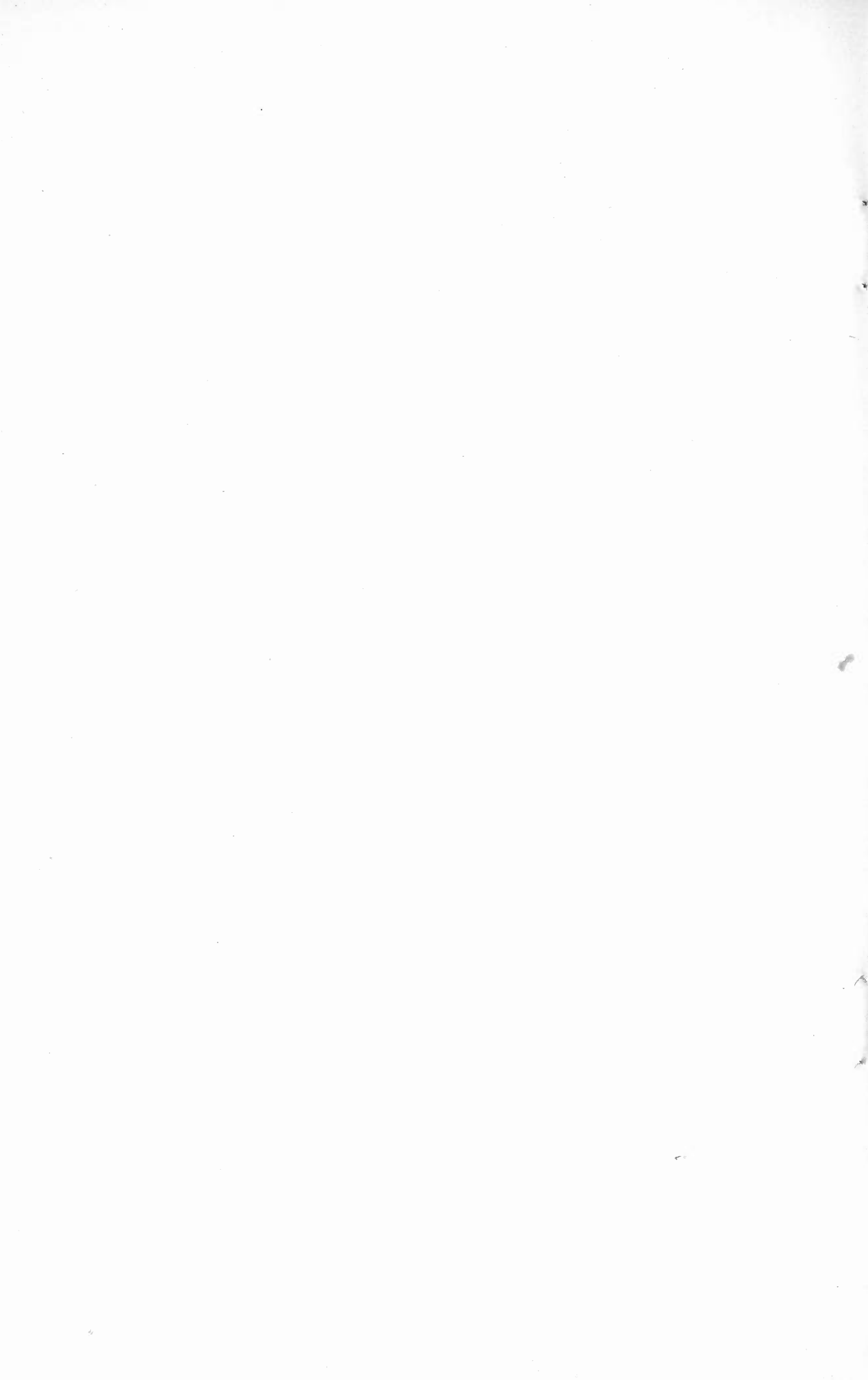

A DEVICE FOR THE PRECISE MEASUREMENT OF HIGH FREQUENCIES*

BY

F. A. POLKINGHORN AND A. A. ROETKEN

(Bell Telephone Laboratories, New York City)

Summary—A description is given of equipment which has been constructed for the measurement of radio frequencies between 5000 and 30,000 kc. The equipment consists of a million-cycle quartz-crystal oscillator as a standard of frequency, means for producing harmonics and subharmonics of this frequency, and means for combining voltages of these known frequencies with a voltage whose frequency it is desired to measure so as to produce beat frequencies in successive stages, the beat frequency produced in each stage having one less digit than that in the preceding stage. A calibrated electric oscillator is used to measure the frequency of the last stage. An indicator gives the frequency of the unknown after a series of dial adjustments. The precision of a completed measurement is estimated at better than three parts in a million.

GENERAL

PROGRESS in the radio art has now reached the point where it is necessary to make frequency measurements with a high degree of precision. A number of schemes for doing this have been devised.¹ Practically all of these require considerable skill on the part of the operator to prevent error. The device which is herein described is designed to reduce to a minimum the care and skill required to obtain a high degree of precision in the result. This end is accomplished by utilizing a number of operations for a single measurement and making these operations as nearly as possible purely mechanical. The fundamentals of the system described, with the exception of the device for automatically indicating the unknown frequency, were devised by J. F. Farrington and E. G. Ports after a study of various schemes for the measurement of high frequencies.

In this equipment an unknown frequency is combined with a known frequency to produce a beat frequency which has one less digit than the unknown. The beat frequency obtained in the first operation is then combined with another known frequency to obtain a new frequency having two less digits than the original frequency. In theory this operation could be continued until the final beat frequency was so small as to be negligible. To illustrate, suppose a frequency of 25,462,375 cycles were to be measured; if this were combined with 20,000,000 cycles a

* Decimal classification: R210. Original manuscript received by the Institute, February 10, 1931. Presented before New York meeting of the Institute, May 6, 1931.

¹ One of these schemes which differs considerably from the scheme described in the present paper will be described in a forthcoming paper by R. K. Potter.

beat frequency of 5,462,375 cycles would be obtained. This, in turn, could be combined with 5,000,000 cycles to obtain a beat frequency of 462,375 cycles. The operation could be continued in successive stages to any point desired. To obtain the value of the unknown frequency it would then only be necessary to add the list of known frequencies which were inserted in the successive stages.

Unfortunately it is impractical to construct a device quite as simple in principle as the foregoing. The range of frequencies to be covered by each circuit is too large for convenience and since there is the possibility of obtaining more than one beat frequency within the range of the succeeding stage the measuring operation would not be entirely mechanical but would require discretion on the part of the operator.

By limiting the beat frequencies generated in any stage to frequencies beginning with 5, 6, 7, 8, or 9 and making the value of the known frequencies an integer followed by zeros, an entirely practical arrangement of apparatus can be obtained. With this limitation it is sometimes necessary to use known frequencies which start with a figure one greater than the unknown frequency with which it is to beat. Taking the frequency 25,462,375 cycles previously used as an example, it would be necessary to beat it with 20,000,000 cycles, giving a beat frequency of 5,462,375 which would then have to be beaten with 6,000,000 cycles in order that the resulting beat would begin with a 5, 6, 7, 8, or 9.

Using this arrangement, it is not possible to obtain the value of the unknown frequency by adding the list of known frequencies. The unknown frequency must be computed by a series of additions and subtractions.

The apparatus which has been constructed operates on the principle just described. Fig. 1 is a block schematic of the apparatus. A quartz-crystal oscillator operating at one million cycles controls a multivibrator whose fundamental frequency is 100,000 cycles. From this stage frequencies of 500,000, 600,000, 700,000, 800,000, 900,000, and 1,000,000 cycles may be obtained. The 100,000-cycle multivibrator controls a 10,000-cycle multivibrator which in turn controls a 1000-cycle multivibrator. From each of these multivibrators the 5th, 6th, 7th, 8th, 9th, and 10th harmonics are available.

Harmonic generators operating from the million-cycle crystal oscillator give 5, 6, 7, 8, 9, and 10 million cycles in the first stage and 10, 20, and 30 million in the second stage.

For every multivibrator and harmonic generator there is a corresponding amplifier-detector whose function it is to pick the required known frequency and beat it with the signal, or beat frequency from

the preceding stage, to produce a beat frequency that will be passed by the succeeding stage. Each amplifier-detector unit is equipped with an input filter so that only frequencies beginning with a 5, 6, 7, 8, or 9 followed by the proper number of zeros are passed. The final stage produces a beat frequency which is between 500 and 1000 cycles. This frequency is measured by a visual and audible comparison with a calibrated low-frequency oscillator.

In order to prevent errors in the computation of the unknown frequency, a system of commutators, relays, and switchboard lamps have been arranged so that the process of measuring a frequency consists of

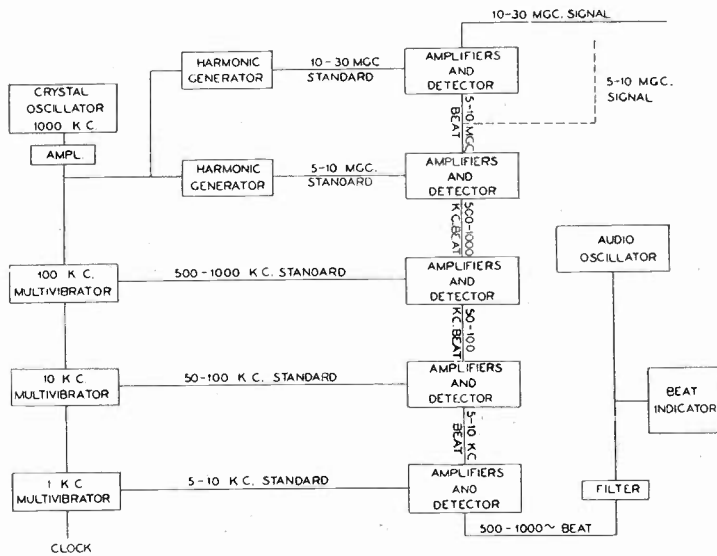

Fig. 1

turning dials in the proper succession until readings are obtained on detector meters, the frequency to be measured being indicated on a bank of switchboard lamps.

The precision of measurement obtainable with this equipment depends primarily upon the constancy of the crystal oscillator and the accuracy with which its frequency is known. A clock driven by a synchronous motor is run from a 1000-cycle potential obtained from the last multivibrator. This clock can be checked with time signals to better than one part in two million in twenty-four hours. In this way, the mean frequency of the oscillator over this period is accurately known and adjustments can be made so that no correction need be made in the indicated frequency, if an accuracy of a few parts in a million is sufficient.

DESCRIPTION OF APPARATUS

Standard Frequency System

The frequency measuring equipment is shown in Figs. 2, 3, and 4 mounted upon five standard seven-foot relay racks. The million-cycle quartz oscillator which furnishes the controlling frequency is a tuned-plate oscillator. A square, parallel-cut quartz crystal, clamped in its holder at four corners, is used in this oscillator. The temperature of the

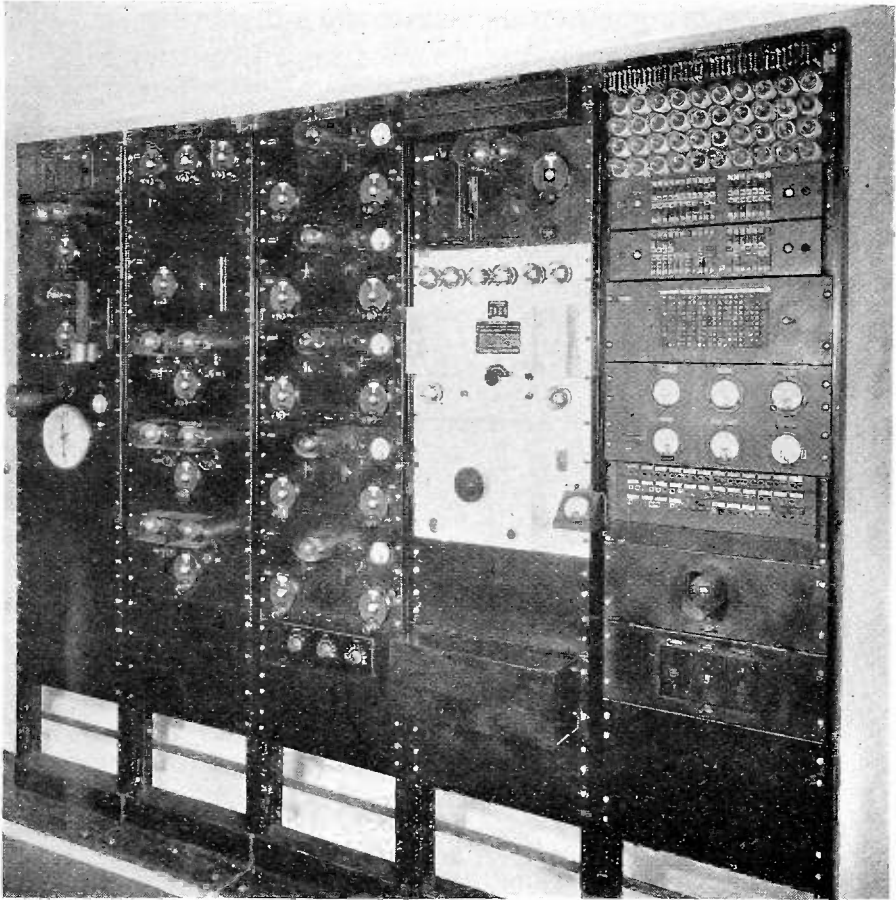

Fig. 2

crystal and that of the air surrounding the circuit are each held constant within close limits. The crystal is enclosed in a block of copper which is completely surrounded by a heating element. A mercury thermostat embedded in this block maintains the temperature of the block to within 0.01 degree C of a value near 50 degrees C. The ambient temperature is maintained at a value of 45 degrees C \pm 0.5 degree C by convection, a bimetallic thermostat and a heater coil being the control elements. Frequency adjustments are obtained over a limited range

by means of a small variable condenser connected in parallel with the crystal. To assure a minimum reaction on the oscillator circuit, the output is taken from a screen-grid amplifier tube loosely coupled to the oscillator circuit. Both oscillator and amplifier are enclosed in a heat insulated can and mounted on a panel on the first bay.

Three low-impedance transmission lines operated at 1,000,000 cycles, carry the standard frequency power from a distributing panel on

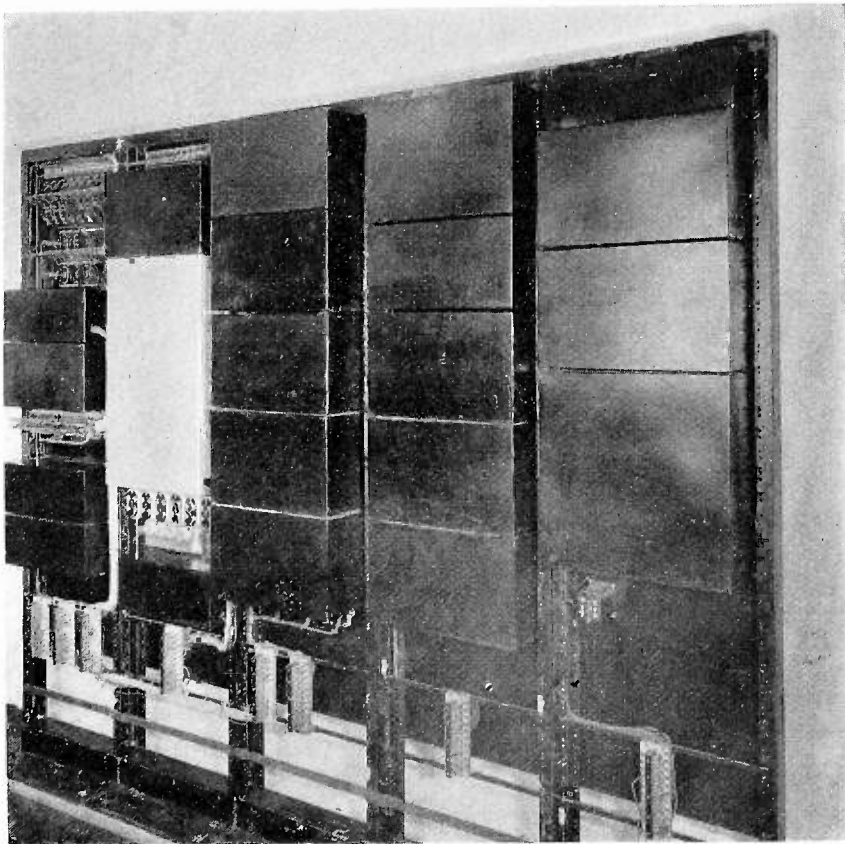

Fig. 3

the first bay to two harmonic generator panels and a multivibrator panel on the second bay. The two top panels on the second bay are negative bias harmonic generators employing screen-grid tubes, and having output frequencies of 10, 20, and 30 megacycles and 5, 6, 7, 8, 9, and 10 megacycles respectively. The third, fourth, and fifth panels on this bay are multivibrators oscillating fundamentally at 100, 10, and 1 ke, respectively.

A representative multivibrator circuit with output amplifiers is shown in Fig. 5, in which V_2 and V_3 are the multivibrator oscillator tubes, V_1 the output amplifier for supplying harmonic frequencies to

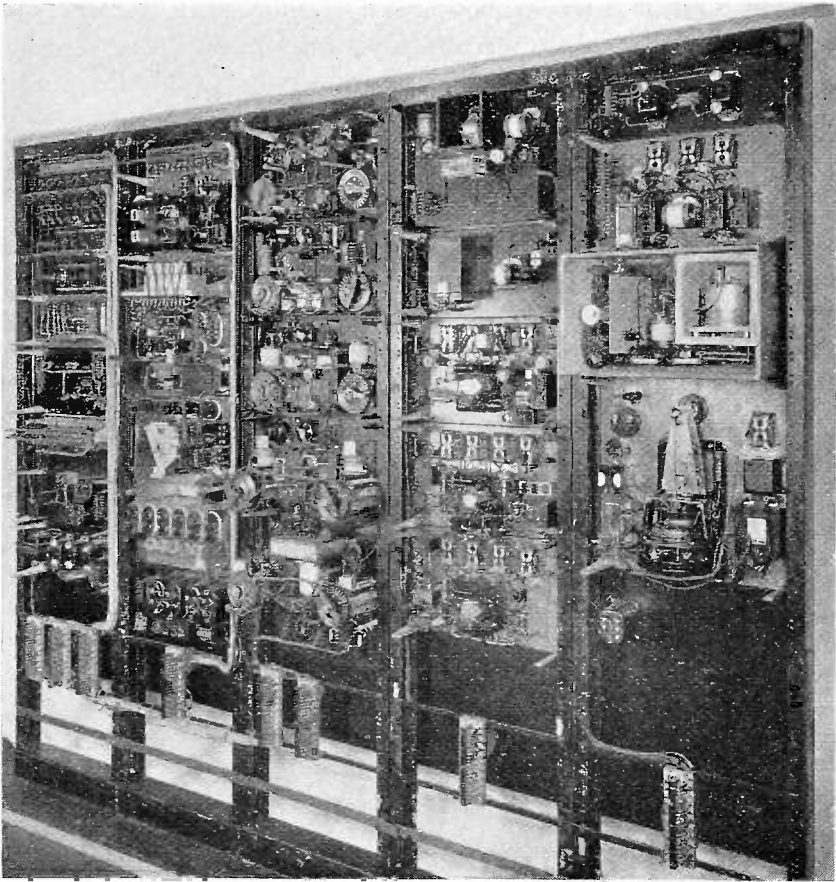

Fig. 4

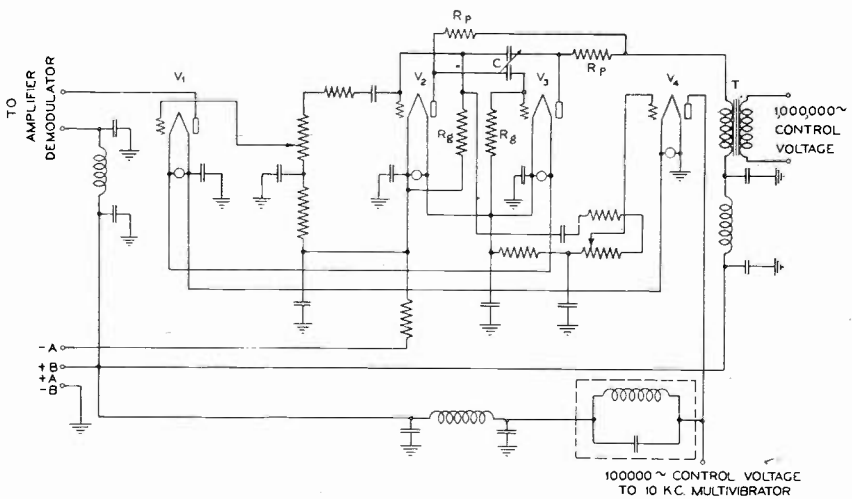

Fig. 5

the appropriate amplifier detector circuit, and V_4 the amplifier supplying the fundamental frequency of this multivibrator for control of the succeeding multivibrator stage. The first stage, which oscillates fundamentally at 100 kc, is controlled by the 1000-kc output of the standard quartz oscillator through transformer T . The following 10-kc multivibrator is controlled by the 100 kc output of amplifier V_4 of the first stage, which is directly coupled to the 10-kc multivibrator oscillator plates by a parallel circuit tuned to 100 kc. Each multivibrator is controlled from the preceding stage by the tenth multiple of its fundamental frequency.

The fundamental frequency of the 1-kc multivibrator drives a 1000-cycle synchronous clock which can be checked to a high degree

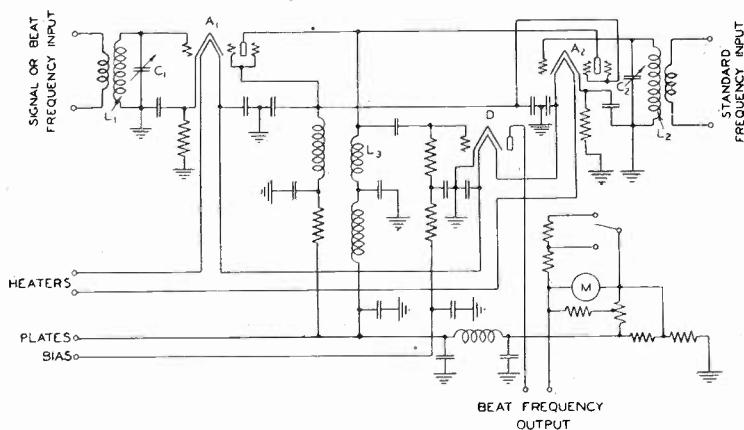

Fig. 6

of precision with standard time signals. Above the face of this clock, a small neon lamp and a slotted disk are rotated around a circular scale by the clock motor, at a speed of one revolution per second. Time signals illuminate the neon lamp and cause the slot to appear at a definite part of the scale upon each revolution, giving, in conjunction with a sweep second hand, a check on the time to one-twentieth of a second or better, or to approximately one-half part in one million per day. Longer time intervals will permit correspondingly closer checks.

Measuring System

The measurement of an unknown frequency is accomplished by a series of beating and detecting operations which take place in the five amplifier-detector panels mounted upon the third bay, a representative circuit of which is shown in Fig. 6. Two tuned input amplifiers, A_1 and A_2 , are worked into a common plate impedance L_3 . This impedance is also common to the input of the detector D . The signal frequency to be measured is impressed upon the amplifier input circuit L_1C_1 , and is

modulated in the plate circuit by a standard frequency which is selected in the second amplifier input circuit L_2C_2 . Appearing in the detector-plate circuit are the two original frequencies, the sum and difference frequencies and higher products of modulation. Only the difference frequency is desired as the output of the detector, for as mentioned before, the scheme of measurement requires that each beat frequency must contain one less digit than that of the frequency of the preceding stage.

Method of Operation

In the measurement of an unknown signal frequency, the signal is applied to the first amplifier-detector unit, resonance of the input circuit being indicated by a deflection on the detector meter. A standard frequency is then selected and beat with the signal, such that the resulting beat will be within the tuning range of the following stage, as indicated by a deflection of the detector meter in that stage. This process is repeated in each amplifier-detector stage, the input to each stage being the beat frequency from the preceding stage. For any definite value of signal frequency, there will be only one standard frequency which will produce a beat within the tuning range of the following stage. From dial calibrations, the operator will know that the standard frequency to select must be one of two possibilities, only one of which will produce the desired beat in the following stage. No attention need be paid to dial calibration, however, unless it is so desired. Each dial may be turned until an output is indicated on the proper meter.

The final difference frequency resulting from the fifth detection process must lie between 500 and 1000 cycles. This fifth detector output is passed through a 500- to 1000-cycle band-pass filter for the suppression of undesired products of modulation, and is then accurately measured by the zero beat method against a 500- to 1000-cycle oscillator, zero beat being indicated visually by a meter in a detector circuit. This meter is mounted conveniently beside the low-frequency oscillator control dial.

The dial calibrations referred to above consist of only the settings corresponding to the standard frequencies, or for positions 5, 6, 7, 8, 9, and 10 on each dial of the second, third, fourth, and fifth amplifier-detector panels, and for positions 1, 2, and 3 on each dial of the top or 10-30 megacycle amplifier-detector. Thus, if the before mentioned 5,462,375-cycle beat were tuned into the second stage, the signal selector dial would be set between the 5th and 6th calibration points, which, in the interpretation of settings for determination of the frequency, would be read as the lower of the two boundary numbers or as 5. Con-

tinuing the various beating operations, dial settings would be as tabulated below.

1st signal dial	25,462,375	} 10 ⁷ place				
standard dial	20,000,000					
2nd signal dial	5,462,375	} 10 ⁶ place				
standard dial	6,000,000					
3rd signal dial	537,625	} 10 ⁵ place				
standard dial	600,000					
4th signal dial	62,375	} 10 ⁴ place				
standard dial	70,000					
5th signal dial	7,625	} 10 ³ place				
standard dial	7,000					
Audio oscillator signal dial	625 10 ² , 10 ¹ , 10 ⁰ places					
Signal dials	$\frac{10^7}{2}$	$\frac{10^6}{5}$	$\frac{10^5}{5}$	$\frac{10^4}{6}$	$\frac{10^3}{7}$	$\frac{10^2}{625}$
Standard dials	2	6	6	7	7	-

By the proper interpretation of these dial settings, the answer can be obtained. Wherever the signal has been subtracted from the standard frequency to give the proper beat frequency, or wherever the standard dial setting is higher than that of the signal dial an inversion occurs; that is, the resultant beat frequency no longer contains the same figures which were present in the original signal but is a difference number. Hence, in obtaining the answer, reinversions must be made wherever a comparison of signal and standard dials indicates that an inversion has taken place. This is a tedious process which is overcome by the system of commutators, relays, and switchboard lamps mentioned before.

Fig. 7 is a circuit of the frequency indicator, the lamps of which appear above the meter panel on the fifth bay. Adjustable commutators are mounted on the condenser shafts of the amplifier detectors. Relays are mounted at the top of the fourth bay. It will be seen from the numerical example taken above that where no inversions occur, corresponding signal and standard selector dials will read alike, but where inversions do occur, the standard dial setting will indicate one number greater than that of the corresponding signal dial. This condition is utilized to energize relays in the positions corresponding to inversions. Referring to Fig. 7, there will be noted a group of lamps and two commutators for each place in the frequency number. The signal selector commutator applies voltage to two lamps, one corresponding to the dial setting and the other to the equivalent inverted or difference num-

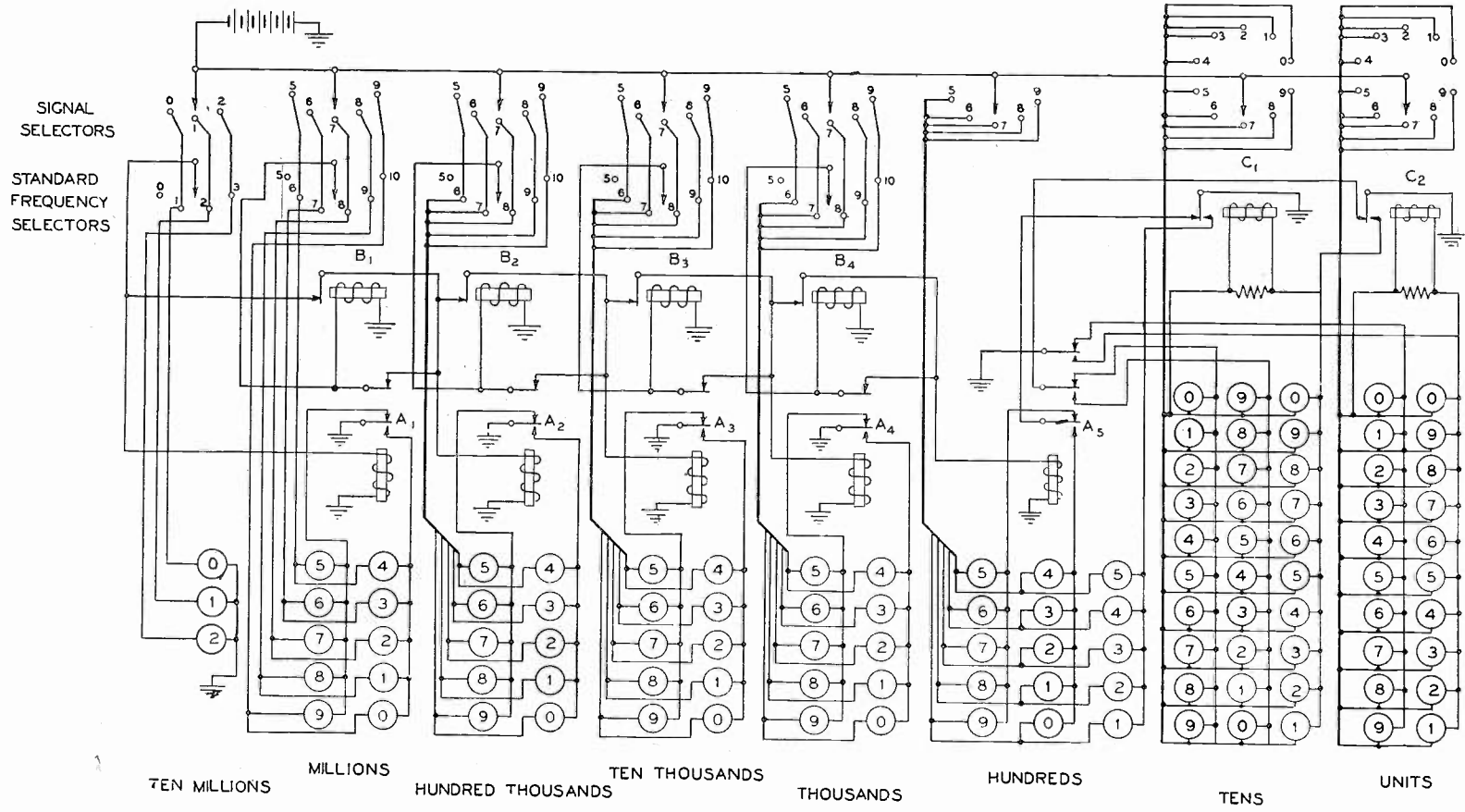

Fig. 7—The wires connecting commutator contacts and lamps are shown cabled in all except the 10^6 and 10^7 places.

ber. Which of these two lights is illuminated is determined by the position of an *A* relay, which is operated by preceding commutator combinations.

Assuming an unlike setting of dials in the "ten million" place, for example, a signal selector setting of 1 and a standard selector setting of 2, relay *A*, will be energized directly from the commutators, and all following *A* relays will be energized through closed contacts of *B* relays. Therefore, lamps in the inverted columns will operate in all following groups, until another inversion takes place. Consider the second inversion taking place in the "million" place, where signal and standard selector settings may be 6 and 7 respectively. Relay *B*₁ will be operated, which will release all *A* relays after *A*₁, thereby restoring all the following stages to the normal state. Relay *A*₂ will not be energized in this case, due to an open contact through the closed relay *A*₁. These operations are continued as selector dials are adjusted, the correct answer appearing in lamps after all amplifier-detector and audio-oscillator adjustments have been made. The last three selector switches are set separately to the frequency indicated by the audio oscillator. Relays *C*₁ and *C*₂ are used to transfer a ten due to inversion of a zero in one stage to a unit in the preceding stage.

In order to eliminate the possibility of error due to inaccuracies in circuit calibrations and commutator adjustments, additional contacts, not shown in Fig. 7, have been added to the standard frequency selector commutators, with interconnections such that a warning signal is given whenever an erroneous setting is obtained. This is possible, due to the fact that only two improper combinations can occur without the complete loss of the signal being measured, these depending only upon commutator adjustments to circuit calibrations. The warning signal consists of a red light located in the indicator lamp bank. Should the error signal be indicated at the conclusion of a measurement, it is only necessary to move the signal selector dials slightly, one at a time, until the red light is extinguished.

While this apparatus was designed for measuring frequencies between 5000 and 30,000 kc it can be adapted to measure any frequency down to 500 cycles. If the frequency to be measured is less than 5000 kc and commences with a 5, 6, 7, 8, or 9 it can be inserted into the input circuit of the proper amplifier-detector panel and measured in the usual manner. If the frequency begins with a 1, 2, 3, or 4 it will be necessary to obtain an exact multiple which does start with a 5, 6, 7, 8, or 9. This can be done by harmonic generation or by the use of a comparison oscillator which is rich in harmonics.

Precision of Measurement

Fig. 8 shows the variation in frequency of the standard oscillator over short intervals of time, which is the primary contributing error of the system. This variation is less than $\pm \frac{1}{3}$ cycle for an average frequency of 1,000,000 cycles. These data were obtained by beating the crystal oscillator frequency with the tenth harmonic of a 100-kc reference standard generated by apparatus designed by W. A. Marrison, a description of which has been published.² The 100-kc reference standard was known to be constant to within 0.01 part in one million at the time of this test.

The second contributing error lies in the calibration of the audio oscillator. The calibration of the audio oscillator can be checked at the

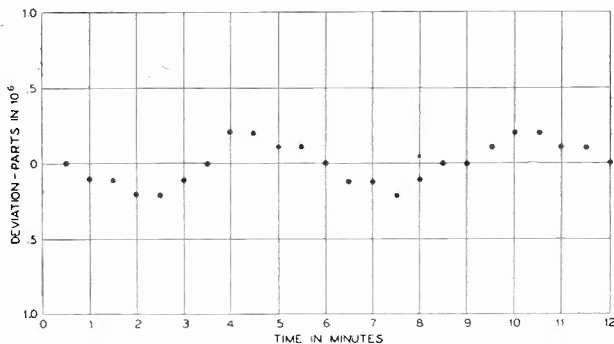

Fig. 8

two ends of the scale by standard frequencies from the multivibrators to within $\frac{1}{2}$ cycle. The scale is calibrated in divisions of five cycles each, making it necessary for the operator to estimate values lying between calibration points. This can be done reliably to within $2\frac{1}{2}$ cycles. Allowing an additional one part in a million variation in the standard frequency for battery and barometric changes, the over-all accuracy of measurement should be within 0.00015 per cent ± 3 cycles.

One important point should be mentioned here, namely, that this accuracy is possible only in the case of a frequency which is extremely constant, or whose drift occurs at a fairly constant rate of not more than several cycles per second. Frequency drifts of this nature can be easily followed with the low-frequency oscillator so that at any instant a precise measurement can be made. Considering all these factors, a conservative estimate of the error of a single measurement would be not more than three parts in a million.

² W. A. Marrison, "A high precision standard of frequency," *Proc. I. R. E.*, 17, 1103-1122; July, 1929.

THE SUPPRESSION OF RADIO-FREQUENCY HARMONICS IN TRANSMITTERS*

BY

J. W. LABUS AND HANS RODER

(Radio Engineering Department, General Electric Company, Schenectady, N.Y.)

Summary—In the present paper the harmonic components of the antenna current are determined in terms of the corresponding components of the plate current of the power amplifier of transmitters. After investigating the cause of harmonic currents and pointing out the difficulties arising in connection with an exact calculation of the harmonics of the field strength, the discussion is confined to the effect of the circuits inserted between plate and antenna circuit on the suppression of harmonics. Several types of circuits are considered and the current ratios of the harmonic antenna currents with respect to the fundamental are given. For better comparison, the results are tabulated.

It has been found that, in general, the suppression of harmonics as given by the above ratio is proportional to the product of the volt-amperes in each individual circuit of the network and to a power of the order of the respective harmonic. Moreover, a general law has been derived, according to which for a given total volt-amperes of the whole filter network the optimum number of individual circuits can be determined. Finally the advantage of the push-pull amplifier and another circuit which inherently compensates harmonics has been discussed and also the detrimental effect of the distributed capacity of the coupling device which provides an undesired path for the harmonics has been described.

INTRODUCTION

WITH THE increasing number of radio channels, the problem of harmonics being radiated in addition to the wave of fundamental frequency becomes very important. Especially the harmonics of higher order, whose wavelengths lie in the range of the short-wave stations, are detrimental to an undisturbed communication.

According to the I.R.E. recommendations¹ the field strength of any radiated harmonic at a distance of one mile from a broadcast transmitter should not exceed 0.02 per cent of the field strength of fundamental frequency. In order to set an upper limit in cases where the power of the transmitter is high, it is required that the harmonic field strength never should exceed 500 μ v per meter at the distance referred to.

Looking for the source of the harmonics, we find that the harmonics are a consequence of the distorted wave shape of the plate current in the last stage. Under certain conditions, it would be possible to operate

* Decimal classification: R146. Original manuscript received by the Institute, February 18, 1931.

¹ Proc. I. R. E., 18, 15, Report No. 6, 1930.

this stage such as to obtain a purely sinusoidal plate current. But, as it is well-known, the efficiency at the peak would not exceed 50 per cent corresponding to an over-all efficiency during the modulation of about 20 per cent. Since the maximum plate dissipation is limited by the surface of the anode, an extremely low output would result, even for large transmitting tubes. In order to enhance the efficiency of the amplifier and to decrease the plate dissipation it is necessary to increase the bias and to swing the grid far beyond the straight part of

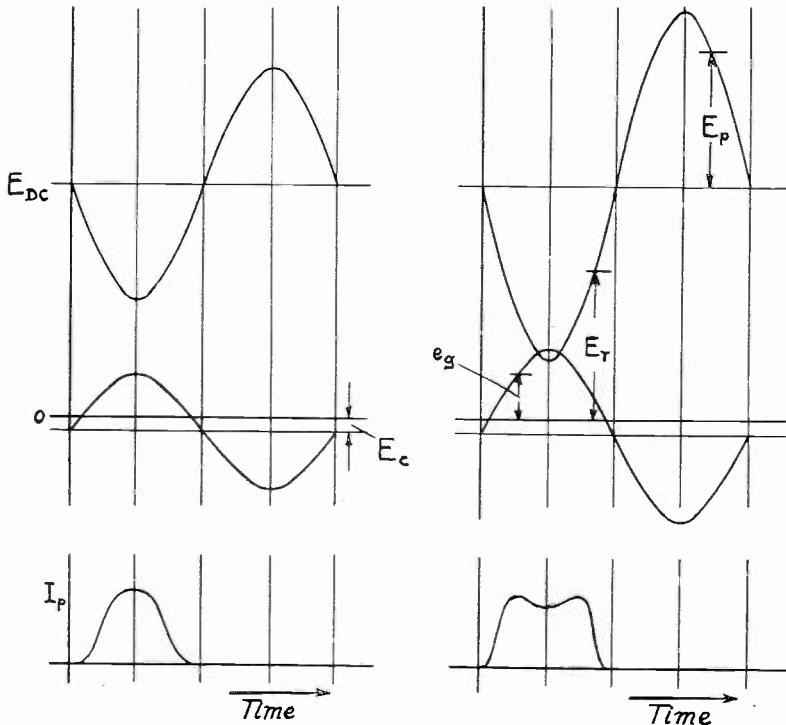

Fig. 1.

Fig. 2.

the characteristic. In so doing, the plate current will be approximately half a sine wave, and thus contain harmonic current components in addition to the fundamental frequency.

When the attempt is made to find the ratio between these harmonic components and the fundamental, a new difficulty is encountered. We know that for low plate swing, the plate current practically follows the exciting grid voltage, (Fig. 1), since in tubes with high amplification factor μ , the plate reaction is negligibly small. But if plate and grid swing are increased, the well-known dip in the plate-current curve occurs (Fig. 2), which is due to the fact that during a part of the cycle the plate potential E_r drops below the exciting voltage e_g . Now, during modulation, the plate swing and the shape of the plate current will vary

according to Figs. 1 and 2, and since in both cases the curve of the plate current is of different shape, the harmonic components in the plate current as obtained by Fourier's analysis will vary with the degree of modulation. The generation of harmonics is low for small percentage modulation, but it increases considerably during the intervals of high percentage modulation. Low percentage modulation is the rule during the average radio program, while the full obtainable range of modulation will be used only during short time intervals.

With all these facts in mind, the question arises, for which operating condition the harmonic reduction device must be designed. In the present paper we did not attempt to answer this question, though by a careful experimental and graphical investigation certain information could be obtained. However, another factor enters, which cannot be considered easily in a general analysis: The antenna is not a simply tuned circuit, but contains distributed inductance and capacitance. Therefore, it may happen that the frequency of one of the generated harmonics coincides with one of the natural harmonic frequencies of the antenna. In this case an exceedingly strong radiation for that harmonic will occur. As the radiation resistance of the antenna depends on the frequency and as the field strength is proportional to the square root of the radiated power, the ratio between the field strengths of the harmonic and of the fundamental frequency at the same distance from the antenna is given by

$$F_n/F_1 = I_{an}/I_{a1} \sqrt{\frac{R_{sn}}{R_{s1}}}$$

whereby R_{sn} and R_{s1} represent the radiation resistance of the antenna at the harmonic and the fundamental frequency.

Furthermore, it has to be taken into account that the attenuation of the electromagnetic waves varies with the frequency. As already mentioned, the harmonics may come into the range of short waves, especially in the case of broadcast transmitters. Therefore, at long distances from the transmitter, the harmonic waves, propagated through the Heaviside layer, will be far less attenuated than the ground wave of fundamental frequency.

The higher the frequency of the harmonic antenna current, the more loops of current will lie along the antenna. Inspection of vertical field patterns with such a current distribution² shows that the main part of the energy is radiated at an angle above ground, this angle being

² B. van der Pol Jr., *Jahrbuch d. drahtl. Teleg. und Teleph.*, 13, 217, 1919; Levin-Young, *Proc. I. R. E.*, 14; 675, 1926.

the larger the more wavelengths there are along the antenna. Thus the harmonic waves may be pure sky waves.

These considerations account for the fact that sometimes strong field strengths of harmonic frequencies are observed, though the corresponding currents in the antenna may be extremely small.

Summarizing the foregoing, it can be said, that it is not possible to avoid the generation of the harmonics without reducing the power output of the tubes. Moreover, it has been found, that under certain conditions an extraordinarily strong radiation of the harmonics may take place. It is evident that all available means must be used to suppress the harmonic currents before they reach the antenna.

INVESTIGATION OF CIRCUITS FOR HARMONIC SUPPRESSION

So far the scope of the problem has been outlined. On account of the two unknown factors: the generation and the radiation of the harmonics, which cannot be considered in a general analysis, we shall not be concerned in the following with the calculation of the harmonic field strength, but merely compute the harmonic components of the antenna current for a given plate current. For the purpose of comparison between the merits of different types of circuits, respective the suppression of harmonics, this procedure is of course completely sufficient (the propagation of the electromagnetic waves being independent of the circuits). If however, the field strengths are to be inferred from these results, the various factors, mentioned in the introduction have to be taken into account.

This part of the paper is subdivided as follows:

- (a) Procedure of the analysis: Current ratios for different types of circuits. Design data of these circuits.
- (b) General discussion of the results. Deduction of general laws.

(a) In the course of this analysis the ratios between harmonics and fundamental plate current are assumed to be given. The corresponding current ratios in the antenna are solely determined by the type of the network inserted between the plate of the last amplifier and the antenna. This network serves two purposes: the matching of the antenna resistance against the optimum load resistance of the amplifier, and the suppression of harmonics.

By means of Kirchhoff's equations we are now in a position to calculate the ratios between the currents of subsequent circuit elements. The analysis has been omitted because it does not involve any mathematical difficulties. As transients are excluded from the consideration, all currents and voltages have been expressed by their time vectors. The results of the analysis are laid down in Table A for various types

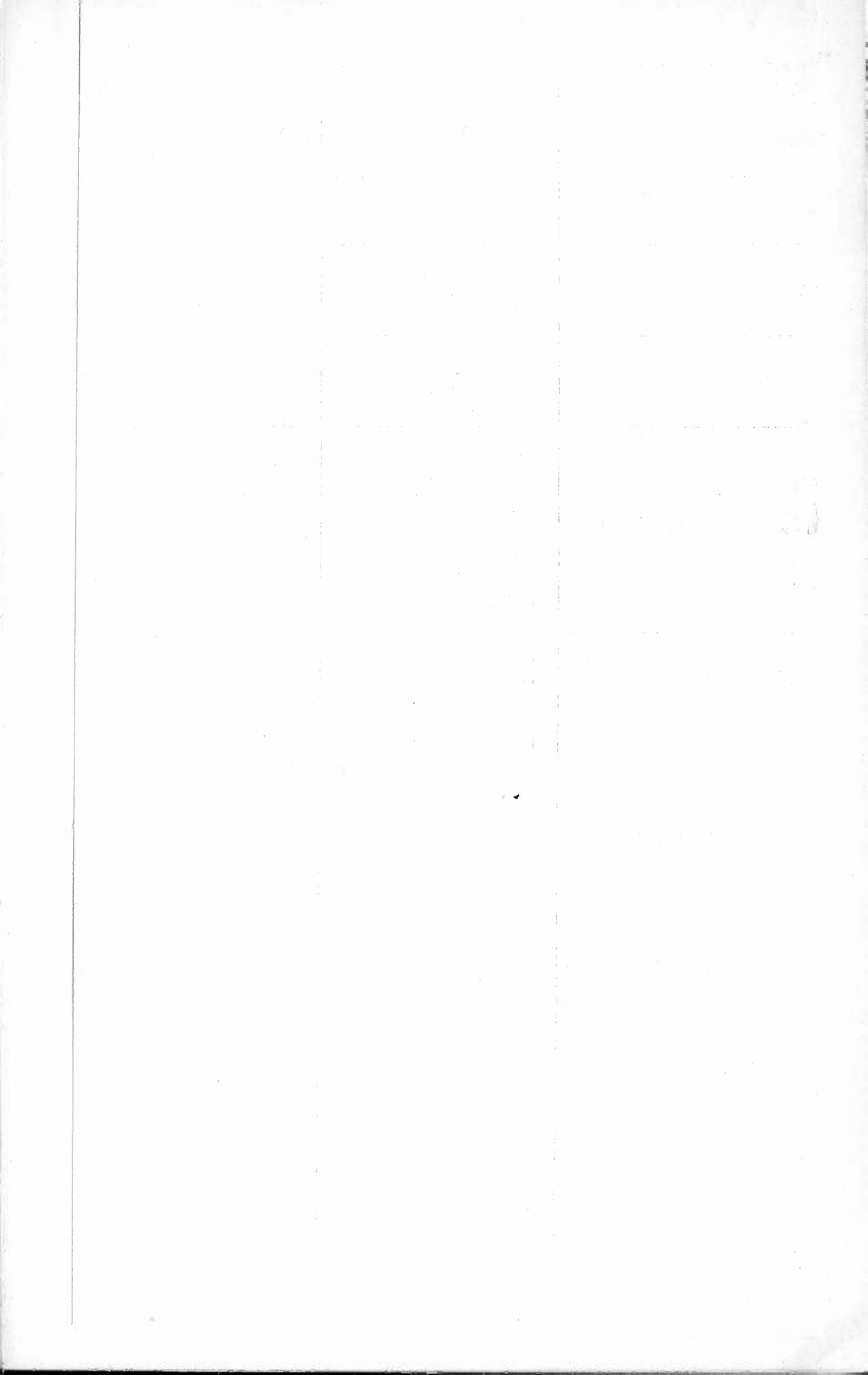

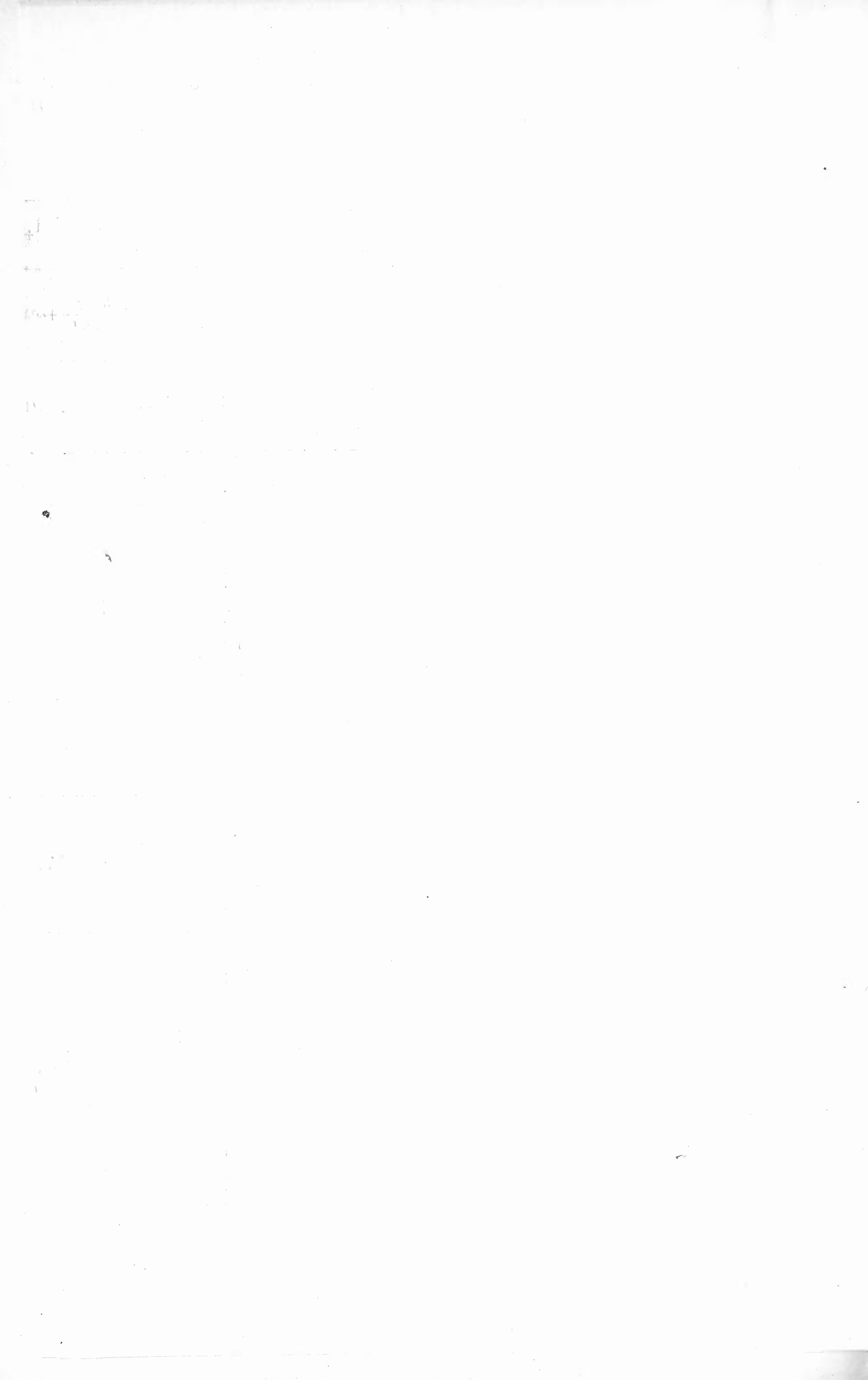

of the respective circuits. Column (I) contains their schematic diagrams. In column (II) the general expression for the ratio between antenna and plate current is given for each circuit. Substituting for $\omega = 2\pi f = n\omega_1$ [f , frequency; f_1 , fundamental frequency; n , order of harmonic ($n = 2, 3, 4 \dots$)], the current ratios referred to are obtained in terms of the order n of harmonics. Putting $n = 1$, we get the value of this ratio for the fundamental frequency, for which the transmitter is designed. In column (III) and (IV) both ratios are given.

As the last expressions contain the circuit data, the latter have been expressed in terms of given values: the power P , the a-c voltage across the plate, E , the surge impedance of the transmission line Z_0 , and the volt-amperes in the individual elements of the circuits. All these values refer to the fundamental frequency. At this frequency the antenna circuit is tuned in such a way that the total impedance is zero and $I_a^2 R_a = P$, I_a and R_a being the antenna current and antenna resistance (radiation resistance plus resistance to ground plus resistance causing dissipation in coils and condensers). P is the power, impressed on the antenna circuit. The antenna circuit has been represented by a lumped circuit consisting of concentrated L_a , C_a , and R_a . For certain conditions, mentioned in the introduction, the current ratios in the antenna may become considerably higher than those obtained by these assumptions, because these constants refer to the fundamental frequency. However, since we are chiefly concerned with the comparison of the different types of circuits regarding the suppression of harmonics, this will not affect our results.

As for the sake of maximum power transmission there should be no standing waves of fundamental frequency on the transmission line, the latter must be terminated by a resistance which is equal to the surge impedance of the line. Likewise, the $\cos \phi$ of the whole circuit across the plates of the tubes must be unity, so as to ensure maximum efficiency of the amplifier. Further conditions, determining the data of the circuits are given by the tuning of each individual circuit. Since this tuning varies with the type of the circuit, this question will be dealt with later on, when discussing the circuits under consideration. As will be seen later from Table A, the effect of suppression of harmonics is proportional to the amount of the volt-amperes stored in each individual circuit. In the course of the analysis it proved convenient to use the ratio of volt-amperes over the transmitted power instead of the volt-amperes. The ratio has been called α_n , the index n referring to the individual circuits.

The necessary explanations of the notations of the table are found in the last column.

With the conditions mentioned above, the design data of the circuit can be determined. The result is given in column (VII) of the table.

The losses in the circuits have been neglected because in practice they represent a very small fraction of the power.

Finally, the effect of the transmission line on the harmonics is considered briefly. If, at the fundamental frequency, the line is properly terminated its input impedance is an ohmic resistance. However, at the harmonic frequencies that impedance may assume values from minus to plus infinity, depending on the characteristics and the length of the line. Obviously this will enhance the desired suppression of harmonics, provided no resonance between the impedance of the line and the impedance of the input or output circuit (connected at both ends of the line) occurs.

For the sake of simplicity the impedance of the transmission line has been disregarded in determining the harmonic currents.

Substituting the values for the circuit data into the expressions of column (III) and (IV) we finally get the ratios (tabulated in column (V)) between the harmonic and the fundamental of the antenna current I_{an}/I_{a1} expressed by the corresponding ratio of the plate current I_{pn}/I_{p1} .

(b) Now let us consider the final result, given in column (V) of the table. Inspecting the diagrams (a) and (b) or (c) and (d), respectively,³ it can be discerned that with the same amount of volt-amperes (proportional to α) there is a gain of n^2 in the circuits with capacitive coupling over the circuits with inductive coupling. Furthermore, it will be noticed that the current ratio I_{pn}/I_{p1} and, therefore, the harmonic suppression is proportional to the product of the volt-amperes (i.e., to the α 's) of the individual circuits, and also to a power of n , the exponent of which depends on the number of these circuits and the type of the coupling between them. Therefore, we should anticipate a general law, holding for other types of circuits as well.

The diagrams (e), (f), and (g) represent three types of circuits frequently used in practice. Considering diagram (e) we recognize that in the only case where $\alpha_2 \gg 1/\alpha_3$, the law indicated above holds, i.e., the current ratio in column (V) is proportional to the product of the α 's of the four circuits. However, this condition is only fulfilled in cases where L_1 and L_2 are loosely coupled. If α_2 is less than $1/\alpha_1 + 1/\alpha_3 n^2$, then the current ratio contains no longer the product of the α 's. In other words the volt-amperes of the circuits are not fully utilized as far as the sup-

³ These circuits were also investigated by Hansford and Faulkner, *Jour. I. E. E.*, (London), 65, 297, 1927.

pression of harmonics is concerned. The same is true in diagrams (f) and (g). The only difference between (e) and (f) is in the kind of coupling; moreover in the latter circuit the reactance of the coupling condenser C is not tuned out. This accounts for the fact that the expression for the current ratio in column (V) becomes more complicated. It is apparent that in diagram (g) the circuits No. 2 and No. 3 can be looked upon as one circuit with the condensers C_2 and C_3 in parallel and, therefore, the current ratio will contain the sum of α_2 and α_3 instead of their product.

Beside the fact that the volt-amperes invested in the circuits (e) to (f) cannot be utilized fully for the harmonic suppression, there is another disadvantage of these circuits: The tuning of the individual circuits depends on the load and, therefore, it requires an experienced operator to perform the first tuning.

No difficulties in tuning are encountered in circuit (h). The tuning of this circuit is performed in the following way: First, circuit No. 1 is tuned with open secondary side (switch s_2 open). Then, with loose coupling and switch s_3 open, circuit No. 2 is tuned in series resonance. Likewise, the subsequent individual circuits are tuned. In this way tuning can be performed very easily.

It is typical for this type of circuit that the reflected impedance of any individual circuit into the preceding circuit always is a pure resistance and therefore the tuning is independent of the load. For the same reason it is possible in this set-up to add or take out one or more individual circuits. This exchangeability of the circuits is especially facilitated if the capacities C_{23} , C_{34} , . . . are equal. So, for instance, if we want to take out circuit No. 3 we merely have to remove L_3 , C_3 and C_{34} and connect L_4' over to circuit No. 2, and similarly we proceed when inserting an additional circuit. This proves advantageous if, after the installment of the transmitter, it becomes necessary to make such changes, so as to obtain the required minimum of harmonic field strength.

The simplicity of the network (h) becomes apparent in the expression for the current ratio in column (V). In agreement with the general law intimated at the beginning of this chapter it is readily seen that the harmonic suppression is proportional to the product of the α 's and thus proportional to the product of the volt-amperes of the single circuits.

The question may arise why in circuit (h) the plate circuit is connected inductively to the subsequent stages instead of using capacitive coupling, which as shown would add another factor (n^2) to the expression in column (V). The inductive coupling has been used because of

the difficulties encountered in supplying the d-c voltage to the plates in the case of capacitive coupling.

Now let us attempt to derive a general law which holds for any number of individual circuits.

If we consider two circuits which contain the impedance Z_1' and Z_2' , respectively, and which are coupled by a common reactance X_K (Fig. 3); then we find⁴ for the currents

$$i_3 = i_1 - i_2$$

$$i_2 = \frac{i_1 \cdot X_K}{X_K + Z_2'} \tag{1}$$

The first of these equations indicates that both i_1 and i_2 may be considered as flowing through the common reactance X_K in opposite directions and thus Fig. 3 may be redrawn as shown in Fig. 4. The

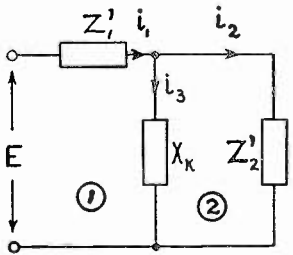

Fig. 3.

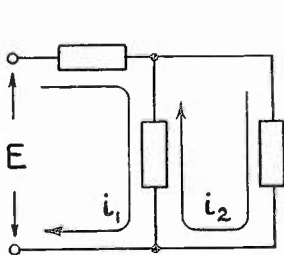

Fig. 4.

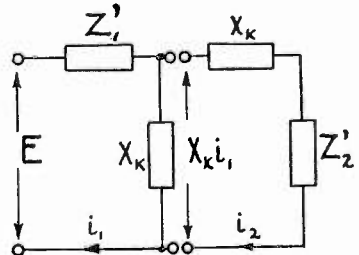

Fig. 5.

second equation can be interpreted as follows: The voltage drop $i_1 X_K$ acts as an impressed e.m.f. with zero internal impedance for circuit (II) and thus current i_2 may be considered as determined by this e.m.f. and the total impedance of the second circuit: $(X_K + Z_2')$. In Fig. 5, this interpretation is shown graphically.

Now we are going to apply these results to one of our previous networks, for instance to network (h) in Table A. According to Fig. 5, we can redraw it in the following manner by splitting it up into its individual circuits. Herein the voltage drop across the common impedance becomes the impressed e.m.f. for the following circuit.

Before proceeding let us investigate the effect upon harmonic suppression for four typical individual circuits as shown in Table B, column (I). We assume these networks consisting of two circuits to be fed by constant currents and constant voltages respectively, but at variable frequency, and solve for the ratios of the e.m.f.'s impressed upon the second circuit. The calculation is simple and may be omitted.

⁴ W. Kummerer, *Telefunken Zeitung*, No. 47, 63, 1927.

TABLE: B

(I) DIAGRAM	(II) I = CONST	(III) E = CONST
<p>(a)</p>	$\frac{ E_{12} _1}{ E_{12} _n} = \frac{ I _1}{ I _n} \cdot n\alpha\beta$	$\frac{ E_{12} _1}{ E_{12} _n} = \frac{ E _1}{ E _n}$
<p>(b)</p>	$\frac{ E_{12} _1}{ E_{12} _n} = \frac{ I _1}{ I _n} \cdot n\alpha\beta \cdot n^2$	$\frac{ E_{12} _1}{ E_{12} _n} \approx \frac{ E _1}{ E _n} \cdot n^2$
<p>(c)</p>	$\frac{ E_{12} _1}{ E_{12} _n} = \frac{ I _1}{ I _n} \cdot \frac{1}{n}$	$\frac{ E_{12} _1}{ E_{12} _n} = \frac{ E _1}{ E _n} \cdot n\alpha\beta \cdot \frac{1}{n}$
<p>(d)</p>	$\frac{ E_{12} _1}{ E_{12} _n} = \frac{ I _1}{ I _n} \cdot n$	$\frac{ E_{12} _1}{ E_{12} _n} = \frac{ E _1}{ E _n} \cdot n\alpha\beta \cdot n$

The results are tabulated in columns (II) and (III). From these results it is inferred:

(1) The volt amperes of the circuits (a) and (b), [(c) and (d)] do not contribute to the suppression of harmonics, when the impressed *voltage* [*current*] is constant.

(2) The use of capacitive coupling instead of inductive coupling increases the factor of harmonic suppression by n^2 .

Now, returning to Fig. 6, we may apply immediately the results thus obtained. We get for the intermediate voltage ratios:

$$\frac{|E_{12}|_1}{|E_{12}|_n} = \frac{|I_p|_1}{|I_p|_n} \cdot n\alpha_1\beta$$

$$\frac{|E_{23}|_1}{|E_{23}|_n} = \frac{|I_p|_1}{|I_p|_n} \cdot n\alpha_1\beta \cdot n\alpha_2\beta \cdot n$$

$$\frac{|E_{34}|_1}{|E_{34}|_n} = \frac{|I_p|_1}{|I_p|_n} \cdot n\alpha_1\beta \cdot n\alpha_2\beta \cdot n \cdot n\alpha_3\beta \cdot n$$

and finally for the ratio of voltages induced in the antenna circuit:

$$\frac{|E_{4a}|_1}{|E_{4a}|_n} = \frac{|I_p|_1}{|I_p|_n} \cdot (n\alpha_1\beta)(n\alpha_2\beta \cdot n)(n\alpha_3\beta \cdot n)(n\alpha_4\beta \cdot n)$$

Since the following relations hold:

$$|E_{4a}|_1 = |I_a|_1 \cdot R_a$$

$$|E_{4a}|_n = |I_a|_n \cdot (R_a + jx_a \left(n - \frac{1}{n} \right)) \approx |I_a|_n \cdot x_a \left(n - \frac{1}{n} \right)$$

and,

$$\frac{|E_{4a}|_1}{|E_{4a}|_n} = \frac{|I_a|_1 \cdot 1}{|I_a|_n \cdot n\alpha_a\beta} \tag{2}$$

the final expression becomes:

$$\frac{|I_a|_1}{|I_a|_n} = (n\alpha_1\beta)(n\alpha_2\beta \cdot n)(n\alpha_3\beta \cdot n)(n\alpha_4\beta \cdot n) \cdot (n\alpha_a\beta) \cdot \frac{|I_p|_1}{|I_p|_n} \tag{3}$$

which is identical with the expression (h, V) in Table A.

In the same manner we obtain, for instance, for diagram (d) in Table A:

$$\frac{|I_a|_1 \cdot 1}{|I_a|_n \cdot n\alpha_a\beta} = \frac{|E_{12}|_1}{|E_{12}|_n} = \frac{|I_p|_1}{|I_p|_n} \cdot n\alpha_1\beta \cdot n^2$$

or,

$$\frac{|I_a|_1}{|I_a|_n} = \frac{|I_p|_1}{|I_p|_n} \cdot n\alpha_1\beta \cdot n^2 \cdot n\alpha_a\beta,$$

which is in agreement with Table A.

Therefore, if we consider the effect of circuits and couplings we find: *Each individual circuit which is tuned in series resonance con-*

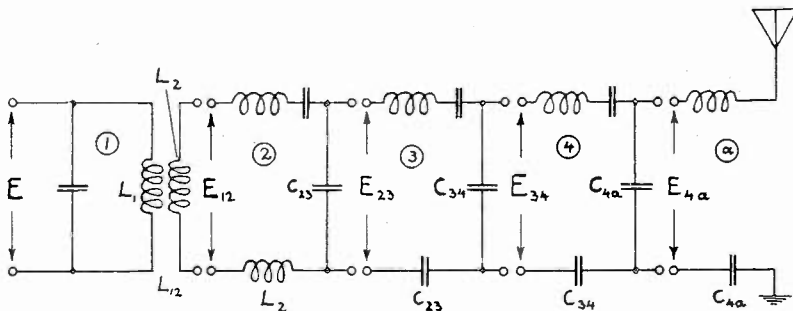

Fig. 6.

tributes to the current ratio I_{pn}/I_{p1} (as given in column (V) Table A a factor $n\alpha\beta$. Apart from the coupling between tank and the following circuit, each coupling contributes an additional factor $1/n$ if inductive, or n if capacitive.

This law cannot be applied immediately to the diagrams (e), (f), and (g) in Table A, since there the individual circuits are not tuned

to series resonance. By such a tuning a part of the installed kva is lost for the suppression of harmonics.

Since the factor of harmonic suppression depends upon the *number* of individual circuits and *the amount of their α 's*, it is obvious that both the number of circuits and the amount of kva's installed in each individual circuit must be large. On the other hand, the costs of the set-up are, within certain limits, proportional to the installed kva. Therefore, if a specified amount of total kva's is appropriated for a certain installation, the question arises for the designer, into how many circuits

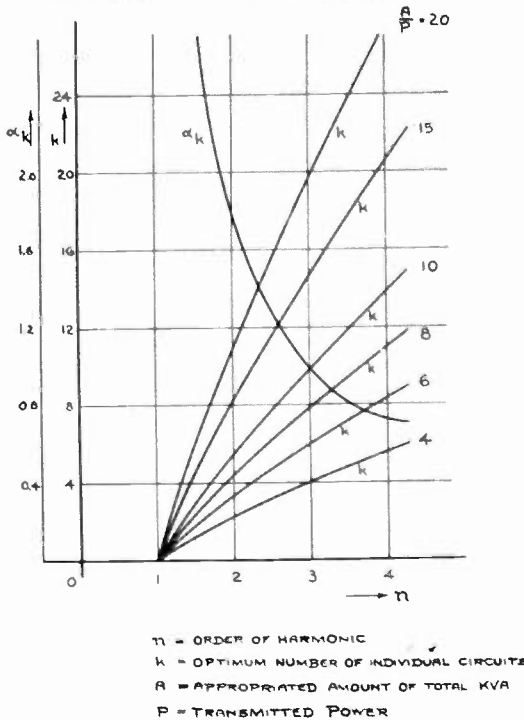

Fig. 7.

this amount must be distributed to obtain the best suppression of harmonics. Calling the transmitted power P and the total amount of assigned kva A , and further, assuming that k individual circuits are to be used, we find from (3) the factor of suppression to be proportional to

$$\left(\frac{A}{P} \cdot \frac{1}{k}\right)^k \cdot (n\beta)^k$$

whereby it is assumed that an equal amount of kva's is contained in each individual circuit. It can be readily shown that this expression assumes a maximum for

$$k = \frac{A}{P} \cdot n \cdot \beta \cdot \frac{1}{e} \tag{4}$$

(e being the basis of the natural logarithms). In this case each individual circuit has a kva ratio of

$$\alpha_k = \frac{A}{P} \cdot \frac{1}{k} = \frac{e}{n \cdot \beta} = \frac{e}{n - \frac{1}{n}} \quad (5)$$

(4) and (5) are represented in Fig. 7. A numerical example may explain it. For a 50-kw transmitter 500 kva may be assigned ($A/P=10$). To make the best use of these kva for the suppression of the second harmonic 5 or 6 circuits should be used, since k is found to be 5.5, each circuit containing 100 or 83.3 kva, respectively.

Though this rule giving the optimum number of circuits certainly is very interesting, it cannot always be realized in practice. With the increasing number of individual circuits, the costs will not stay constant with constant kva's, but will increase with the *number* of circuits. Therefore, it may be better to distribute the kva into a number of circuits which may be considerably smaller than the optimum number.

GENERAL REMARKS ABOUT SUPPRESSION OF HARMONICS

Heretofore, we investigated different arrangements by means of which the suppression of harmonics is achieved due to the filtering effect.

There are types of tank circuits which do not transfer certain groups of harmonics to the following filter circuit. One of them is the well-known push-pull amplifier. (Fig. 8). As described in the introduction each tube furnishes current during half a cycle as shown in Fig. 9 (a) and (b). The current i_{p1} when expanded in a Fourier series can be written:

$$i_{p1} = a_0 + a_1 \sin \omega t + b_2 \cos 2\omega t + a_3 \sin 3\omega t + b_4 \cos 4\omega t + \dots$$

while i_{p2} is simply obtained by substituting $(\omega t + \pi)$ for ωt in this series:

$$i_{p2} = a_0 - a_1 \sin \omega t + b_2 \cos 2\omega t - a_3 \sin 3\omega t + b_4 \cos 4\omega t.$$

Obviously the current i_0 must be the sum of $i_{p1} + i_{p2}$ and, therefore, it becomes evident that i_0 will contain only even harmonic components in addition to the d-c current.

As far as the harmonic currents in the tank circuit are concerned, we can see that i_{p1} and i_{p2} branch into currents flowing through the condenser and the coil. The amplitudes of these currents are found to be:

$$\begin{aligned} &\text{in the capacitive branch: } a_n/\beta \text{ or } b_n/\beta \\ &\text{in the inductive branch: } a_n/n^2\beta \text{ or } b_n/n^2\beta. \end{aligned}$$

Determining the voltage induced by these currents across EF , we have to take the difference $i_{p1} - i_{p2}$, because both currents flow in opposite directions in the primary coil. Therefore, if we put $\beta \approx 1$

$$(i_{p1} - i_{p2})_n = 2 \left[\frac{a_3}{9} \sin 3\omega t + \frac{a_5}{25} \sin 5\omega t + \frac{a_7}{49} \sin 7\omega t + \dots \right]$$

Hence, in addition to the fundamental frequency, only odd harmonics are transferred into the filter circuit. In these considerations, perfect

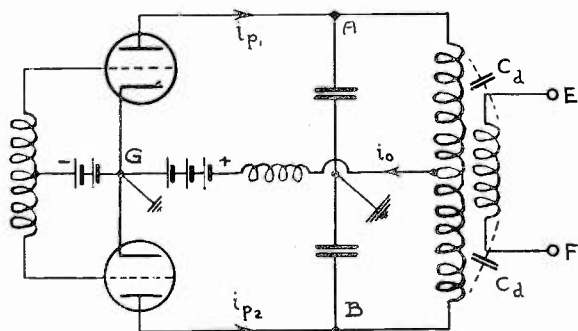

Fig. 8.

symmetry of the circuits has been assumed. Otherwise, also even harmonic are induced across EF .

However, in practice it has been found that in spite of a careful design, even harmonics are radiated by the transmission line. In fact, this

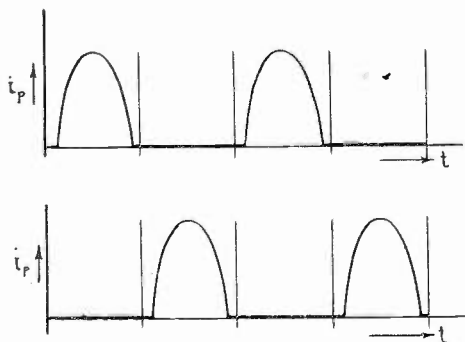

Fig. 9.

radiation was very disturbing in many cases. This phenomenon can be accounted for by the distributed capacity between the tank and coupling coil. For the even harmonics the points A and B have the same potential. On account of the distributed capacity of the coupling device, this potential causes a charging current to flow across this capacity to the coupling coil and, therefore, both leads of the connected circuit (EF) will possess a voltage of even harmonic frequency with re-

spect to ground. If the coupling coil is connected directly to the transmission line, currents of even harmonics flow in the wires in the same direction and, therefore, give rise to a radiation which is proportional to the effective height of the line above ground.

This radiation can be reduced materially by inserting a metal screen between the coils of the coupling device and by proper installation of the line.

Moreover a method has been developed, according to which the charging current of a certain harmonic, flowing to the coupling coil, can be compensated.⁵

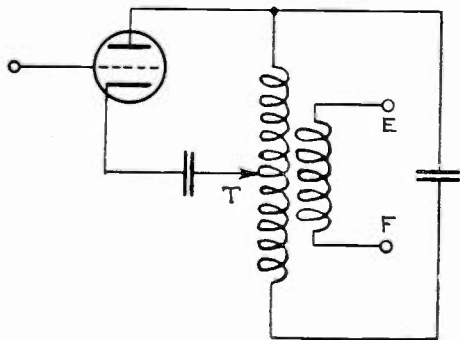
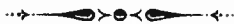

Fig. 10.

The problem of harmonic suppression can be attacked from a different angle as shown in Fig. 10.⁶ Here the tank condenser represents a very small reactance for the harmonics, and, therefore, harmonic currents will flow in opposite directions in the tank coil. By proper adjustment of the tap (*T*) or the position of the coupling coil, the harmonic voltage induced in the coupling coil can be reduced to zero. This is true for one harmonic frequency; since, however, the adequate adjustments leading to the suppression of the rest of the harmonics differ very little, it follows that in the average a good over-all suppression of harmonics can be achieved. In opposition to the push-pull amplifier, this arrangement reduces both even and odd harmonics equally well.

⁵ Patents pending.

⁶ German Patent DRP 448060, (1706030); (Telefunken.)



RECEIVER DESIGN FOR MINIMUM FLUCTUATION NOISE*

By

NELSON P. CASE

(Formerly Department of Engineering Research, University of Michigan, Ann Arbor, Mich.
Now Hazeltine Corporation, Bayside, N. Y.)

Summary—The effects of various changes in both tube and circuit conditions have been investigated with regard to their influence on the limitation which fluctuation noise sets on the sensitivity of a receiver.

It is concluded that for minimum noise the following conditions should obtain: The gas pressure in the tube should be less than 10^{-4} mm of mercury; the antenna-to-grid transfer circuit should be as efficient as possible; the plate-circuit load impedance should be high enough to give a gain of at least five for the first radio-frequency tube apart from the antenna coupling circuit; and the cathode emission should be high enough so that the tube is always operating under dense space-charge conditions.

INTRODUCTION

A LARGE amount of research has been done on the general subject of fluctuation phenomena, and more especially on those phenomena which affect the plate current of thermionic vacuum tubes. A partial bibliography is appended at the end of this paper. Most of this work has been conducted as purely scientific investigation without much reference to the actual effect of the phenomena on the performance of radio receiving apparatus. Of course, it has been generally realized by engineers that "tube noise" is the eventual limiting factor in the sensitivity of a receiver, but the question as to the elasticity, if any, of this limit, and the factors which influence it has not been seriously considered until very recently. With the advent of the screen-grid tube, however, receiver sensitivities in general have been raised to such an extent that fluctuation noise sometimes appears as a very annoying limitation on the operation of the receiver. It is the purpose of this paper to gather into one place the necessary data for designing a receiver with a minimum fluctuation noise for a given sensitivity. Accordingly, measurements were made on the mode of variation of the noise when various tube and circuit conditions were changed.

EXPERIMENTAL PROCEDURE

1. Effect of Changing Tube Conditions

A very extensive investigation was made of the effect of various tube parameters on the noise. A great many different types of screen-grid tubes were constructed and noise measurements made on them,

* Decimal classification: R161. Original manuscript received by the Institute, January 16, 1931. Publication of the Grigsby-Grunow research organization.

with the result that the conclusion may be tentatively drawn that the internal construction (spacing of elements, etc.) has only a small effect on the noise produced by the tube under service conditions, provided the tube is capable of giving a voltage amplification of at least five per stage.

The presence of excess gas in the tube has a very decided effect on the noise, as shown in Fig. 1. The experimental procedure was as follows: The tube was made up from standard -24 parts, and sealed on the manifold of a four-stage mercury pump, backed by a large oil pump.

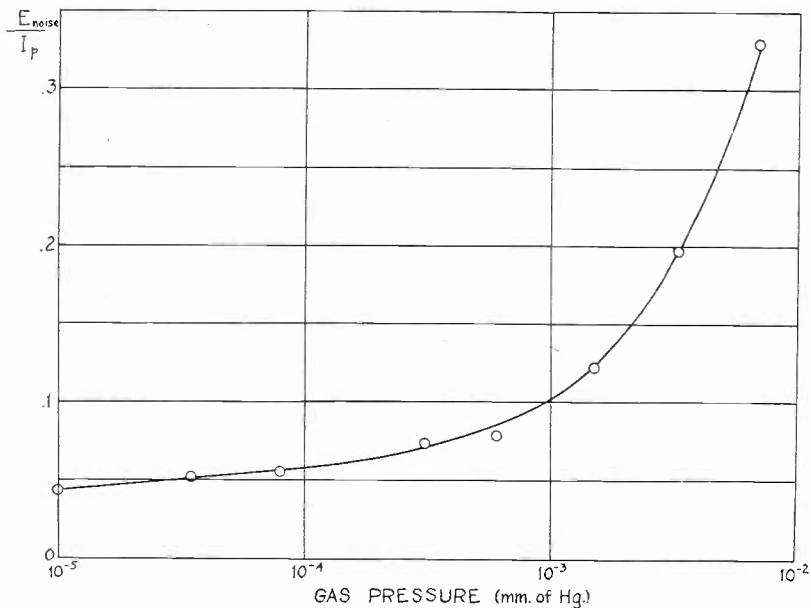

Fig. 1.—Effect of gas pressure in tube on fluctuation noise.

The tube was pumped out and the cathode activated in the usual way, except that the elements were not heated by the high-frequency furnace. A mercury cut-off was then raised, shutting off the tube and McLeod gauge from the mercury pump. The elements were then subjected to intense heating by the high-frequency furnace which liberated a considerable amount of gas. After waiting for the gas pressure to become constant throughout the sealed part of the system and for the cathode to recover its activation, a reading of the gas pressure was taken. At the same time normal operating voltages were applied to the various tube elements. No external impedances were used in either the control grid or screen circuits, but an appropriate load was inserted in the plate circuit.

Measurements of noise and of plate current were made as described below. Following this the mercury cut-off was lowered for an instant,

which permitted some of the gas to be pumped out and then another set of measurements was made and the whole process repeated until the tube was pumped to a high vacuum.

In measuring the noise voltage, the fluctuation voltage across the plate-circuit load was amplified a constant amount by a high-gain 1000-kc amplifier. It was then rectified and the audio-frequency output voltage measured by a vacuum tube voltmeter. The readings were well down on the curve of the vacuum tube voltmeter, so it is believed that the wave form error is probably not great enough to alter the shape of the curve substantially. It will be noted that the ordinates in Fig. 1 are in arbitrary units of noise voltage divided by the plate current of the tube under test. The reason for this is that, other things remaining constant, the noise voltage is proportional to the plate current; so that

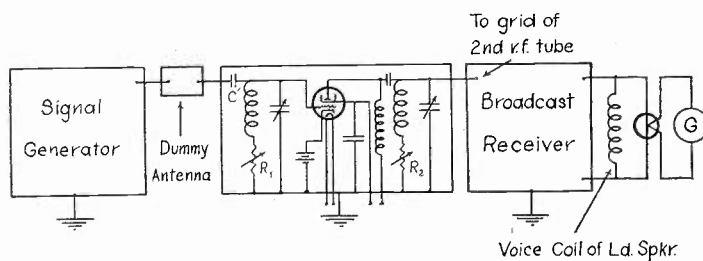

Fig. 2.—Schematic diagram of apparatus for measuring fluctuation noise under varying tube and circuit conditions.

if noise voltage alone were plotted as ordinate, the curve would rise at higher gas pressures because of the increased current as well as by reason of the extra noise due to the presence of positive ions in the space-charge region. By plotting the ratio, the curve shows the extra noise caused by the effect of the positive gas ions in the space-charge region.¹ It is evident from Fig. 1 that gas has little effect on the amount of noise so long as the pressure is kept below about 10^{-4} mm of mercury. The pressure in most high-grade commercial screen-grid tubes at present seems to be in the neighborhood of 10^{-6} mm, so very little improvement with respect to noise is to be expected from further refinements of tube exhausting machinery.

All of the other effects were investigated by means of the arrangement shown in Fig. 2. Although not shown on the figure for the sake of simplicity, means were provided for varying all the voltages applied to the different elements of the tube under test. All measurements were made with the sensitivity of the broadcast receiver adjusted so that an input of 10 microvolts, modulated 30 per cent at 400 cycles, to the

¹ See bibliography, 19 and 20.

standard dummy antenna gave an output of 0.4 watt in the voice coil of the speaker. The thermojunction used to measure the output had a resistance of about 1000 ohms, while the resistance of the voice coil was 20 ohms. For each measurement, after the over-all gain had been adjusted to the above-mentioned amount, the modulation was removed and the hiss voltage measured with the 10-microvolt unmodulated carrier present. The frequency was 1000 kc for all measurements. It is well to point out that the absolute values of the quantities involved in these measurements will vary with the type of circuit used, the characteristics of the particular tube under test, the side-band transmission characteristic of the amplifier as a whole, and the characteristics of the audio-frequency amplifier, but it is believed that the shape of the curves and the order of magnitude of the effects are generally applicable.

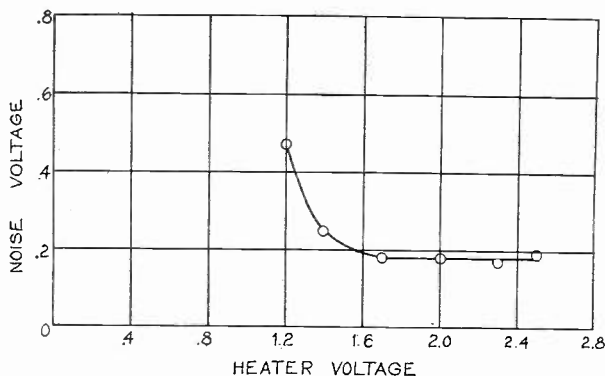

Fig. 3.—Effect of cathode temperature on noise, showing “cushioning” effect of space charge.

It was found that a variation of grid bias from -1 to -6 volts produced no measurable change in the hiss voltage, nor did the variation of screen potential from 40 to 140 volts. The plate voltage was maintained constant at 180 volts for these measurements. With a grid voltage of -3 and a screen voltage of 90, plate voltage changes from 135 to 225 produced no effect. The reason for the negative results of these three tests is that under conditions of increasing plate current, where one would normally expect an increase in noise, the mutual conductance is improving by nearly the same proportion, thereby reducing the amplification which must follow the first tube in order to maintain a constant over-all gain. In this connection it is worthy of notice that the use of tubes of different mutual conductances in the first stage does not normally affect the noise level to any great extent, since in general the factors of tube construction which result in higher mutual conductance also tend to raise the normal plate current in approximately the same ratio.

The effect of heater voltage in the normal operating region was likewise found to be negligible, for the same reason as mentioned above, but the increase in noise with heater voltages below 1.6 volts is worthy of mention (see Fig. 3). This is the region where space charge commences to disappear and the current becomes limited by the actual emission from the cathode. (It is well-known that a space charge in the absence of positive ions acts as a sort of "cushion" for the shot-effect fluctuation.)² The only case where such an effect might enter in practice is when the tube approaches the end of its useful life; under this condition, the whole curve of Fig. 3 is shifted to the right and the rise in noise voltage may then come within the operating range of heater voltage. This is especially likely to be the case when the receiver is made with much greater sensitivity than is usually required. In this case, the first tube may deteriorate a great deal and the user will merely draw on the reserve sensitivity to bring the operation up to normal. Eventually the condition may arise where the first tube gives practically no gain for the signal, but adds an abnormally high noise of its own. Moreover, unless the voltage gain of the first stage is at least five, the noise contribution from the second tube will make itself noticed.

2. Effect of Changing Circuit Conditions

The effects of changing the values of grid and plate circuit impedances were measured with the following voltages on the tube: heater, 2.5; grid, -3; screen, 90; and plate, 180. Under these conditions, the mutual conductance of the tube was 870 micromhos. Shunt feed was used for the plate circuit to facilitate coupling to the broadcast receiver. The apparent resistance of the tuned circuits at resonance was computed from the formula

$$R' = \frac{L}{R C} \quad (1)$$

where R in this case is the actual radio-frequency resistance of the coil plus the amount added by R_1 or R_2 , as the case may be.

Curve A of Fig. 4 shows the effect of the grid-circuit impedance. The actual position of this curve along the axis of abscissas is dependent on the frequency, the capacity of the small condenser C' , and, to some extent, on the antenna characteristics.

It is evident from this curve that the biggest single factor in determining the position of the noise limitation of sensitivity is the efficiency of the circuit used to transfer energy from the antenna to the grid of the first tube. If minimum noise were the only factor to be considered in the design, it would be a simple matter to provide a simple, highly

² See bibliography, 7 and 20.

efficient circuit at this point. However, two other considerations enter into the design; adequate selectivity must be provided to eliminate cross modulation in the first tube,³ and the antenna stage should be so designed that its tuning control can be ganged with those of the other tuned circuits. The designer must determine for himself what constitutes a satisfactory compromise among these three more or less conflicting aspects of the problem.

Curve *B* of Fig. 4 shows the effect of changes in the plate circuit load, or in other words, of changes in the gain of the first tube itself, considered apart from the tuned input circuit. Over the range of the

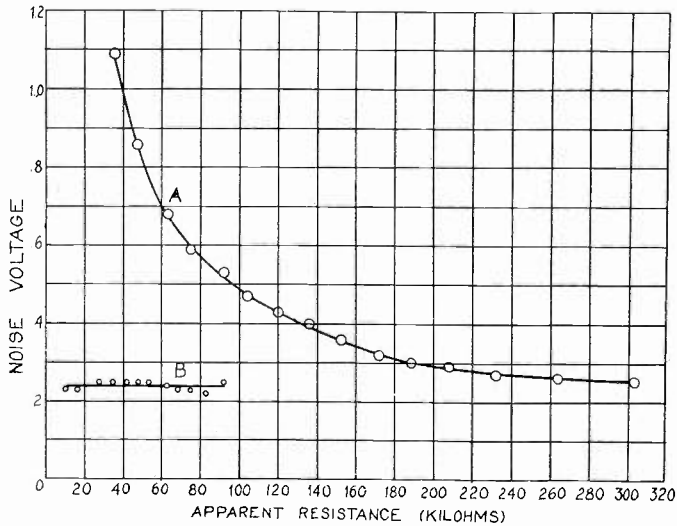

Fig. 4.—Effect of external impedances in grid and plate circuits of first r-f tube on noise voltage.

Curve *A*—Grid Circuit

Curve *B*—Plate Circuit

curve, the gain is very closely proportional to the apparent load resistance, and varies from about ten at the low end to about eighty at the high end. Although the plotted points would seem to indicate some slight variation in the amount of noise, these variations are all within the estimated probable error of measurement; therefore, there is no reason for assuming that the noise is anything but constant over this range of plate-circuit load variation. There is no doubt, however, that the curve will rise very sharply if the load resistance is reduced to very low values, giving gains of less than, say, five. Under these conditions,

³ Sylvan Harris, "Cross modulation in r-f amplifiers," *Proc. I.R.E.*, **18**, 350; February, 1930. Ballantine and Snow, "Reduction of distortion and crosstalk in radio receivers by means of variable- μ tetrodes," *Proc. I.R.E.*, **18**, 2102; December, 1930.

the noise from the second tube commences to be a noticeable factor, since more and more amplification must take place in the later stages of the amplifier in order to keep the over-all sensitivity constant. No measurements were made in this region, however, because the gain available in the broadcast receiver was not sufficient to maintain the desired sensitivity at lower values of plate resistance than those shown.

RÉSUMÉ

It has been shown that the position of the limitation on sensitivity set by fluctuation noise is dependent primarily on the efficiency of the antenna coupling circuit, and secondarily (under certain peculiar conditions not normally met with) on the heater voltage (or filament voltage in the case of battery-type tubes), and on the impedance of the plate-circuit load. It has been further shown that the noise is a function of the gas pressure in the tube when the pressure is in excess of about 10^{-4} mm of mercury.

The noise is independent of variations in the grid, screen, and plate voltages, and also of heater voltage when the electron emission from the cathode is normal or nearly so. Except for very low values, the noise is independent of the plate circuit load impedance.

Some of the curves given in this paper look quite different from curves already published on similar phenomena. In every such case, it will be found that the reason for the difference is that these measurements were taken under conditions of constant over-all sensitivity, considering the tube under test as the first tube of a receiver. This is the condition of primary interest to the engineer designing a receiver, since he knows beforehand what sensitivity he wants and must keep that substantially constant, regardless of the changes in circuit details he may wish to make.

Bibliography

1. W. Schottky, "Über spontane Stromschwankungen in verschiedenen Elektrizitätsleitern," *Annalen der Physik*, 57, 541, 1918.
2. C. A. Hartmann, "Über die Bestimmung des elektrischen Elementarquantums aus dem Schroteffekt," *Annalen der Physik*, 65, 51, 1921.
3. J. B. Johnson, "Bemerkung zur Bestimmung des elektrischen Elementarquantums aus dem Schroteffekt," *Annalen der Physik*, 67, 154, 1922.
4. W. Schottky, "Zur Berechnung und Beurteilung des Schroteffektes," *Annalen der Physik*, 68, 157, 1922.
5. R. Fürth, "Die Bestimmung der Elektronenladung aus dem Schroteffekt an Glühkathodenröhren," *Physikalische Zeitschrift*, 23, 354; September 15, 1922.
6. Ornstein and Burger, "Zur Theorie des Schroteffektes," *Annalen der Physik*, 70, 622, 1923.

7. Hull and Williams, "Determination of elementary charge e from measurements of shot-effect," *Phys. Rev.*, **25**, 147; February, 1925.
8. T. C. Fry, "The theory of the schroteffekt," *Jour. Franklin Institute*, 199, 203; February, 1925.
9. J. B. Johnson, "The Schottky effect in low-frequency circuits," *Phys. Rev.*, **26**, 71; July, 1925.
10. N. Campbell, "The theory of the 'schrot-effect'," *Philosophical Magazine*, **50**, 81; July, 1925.
11. W. Schottky, "Small-shot effect and flicker effect," *Phys. Rev.*, **28**, 74; July, 1926.
12. Williams and Vincent, "Determination of electronic charge from measurements of shot-effect in aperiodic circuits," *Phys. Rev.*, **28**, 1250; December, 1926.
13. S. Ballantine, "Shot effect in high-frequency circuits," *Jour. Franklin Institute*, **206**, 159, 1928.
14. J. B. Johnson, "Thermal agitation of electricity in conductors," *Phys. Rev.*, **32**, 97; July, 1928.
15. H. Nyquist, "Thermal agitation of electric charge in conductors," *Phys. Rev.*, **32**, 110; July, 1928.
16. Williams and Huxford, "Determination of the charge of positive thermions from measurements of shot effect," *Phys. Rev.*, **33**, 773; May, 1929.
17. F. B. Llewellyn, "A study of noise in vacuum tubes and attached circuits," *Proc. I.R.E.*, **18**, 243; February, 1930.
18. S. Ballantine, "Fluctuation noise in radio receivers," *Proc. I.R.E.*, **18**, 1377; August, 1930.
19. J. S. Donal, Jr., "Abnormal shot effect of ions of tungstous and tungstic oxide," *Phys. Rev.*, **36**, 1172; October 1, 1930.
20. Kozanowski and Williams, "Shot effect of the emission from oxide cathodes," *Phys. Rev.*, **36**, 1314; October 15, 1930.



LOW-FREQUENCY HIGH POWER BROADCASTING AS APPLIED TO NATIONAL COVERAGE IN THE UNITED STATES*

BY

WILLIAM H. WENSTROM

(1st Lieut., Signal Corps., U. S. A., Fort Monmouth, N. J.)

Summary—With P. P. Eckersley's general theory derived from north European practice as a starting point, the possibilities of broadcasting in the United States on frequencies around 200 kc are examined from the viewpoint of national coverage. It is shown that Eckersley's curves can be applied approximately to the American terrain, and that as a first approximation seven low-frequency transmitters radiating at maximum power levels between 1000 kw and 10,000 kw may be expected to cover practically the entire country with true broadcast service. Objections to and advantages of such a structure operated as a supplement to existing broadcast facilities are discussed.

PRIMARY CONSIDERATIONS

RADIO broadcasting in the United States presents an extensive and varied technology, apparently supporting many sharply divergent opinions. Among these stands out unequivocally the expressed will of Congress that there shall be "equality of radio broadcast service, both of transmission and reception." To reach a simplified viewpoint in the present paper the writer has made three basic assumptions as follow:

1. In the radio communication field broadcasting now ranks next in importance after government, sea-air safety, and primary intercontinental message services. The relative importance of broadcasting is increasing.

2. True broadcast service is defined as a ground-propagated day-and-night signal free from perceptible fading and of sufficient amplitude to override any ordinary atmospherics or interference.

3. As an ideal limit the entire United States should be covered by such true broadcast service. In practice the ideal limit should be approached as closely as technology and economics permit.

Broadly stated, the engineering problem in American radio broadcasting is the attainment of these desired results at a minimum cost.

It has long been recognized that economic coverage of large areas dictates a few large transmitters rather than many small transmitters. This conception has found practical expression in the allotment of cleared channels to transmitters employing between 10 and 50 kw of antenna power.

* Decimal classification: R550. Original manuscript received by the Institute, January 16, 1931.

FADING LIMITATIONS

P. P. Eckersley¹ has shown that the maximum service range of a broadcast transmitter employing a $\frac{1}{4}$ - λ antenna, if considered to be limited by the occurrence of first fading due to approximate equality between ground wave and reflected wave, is a function of λ and σ (effective earth conductivity) into which power does not enter. Power increase is therefore useful only to maintain adequate signal strength at the limit of a service area determined by other factors. At present broadcast frequencies desirable power limits are probably being approached by our largest transmitters. Eckersley has also shown that increase of λ will extend the first fading ring and hence the maximum true service area, and has recommended that important broadcast stations of the world operate on wavelengths higher than those in common use. It is of course true that a few European broadcast stations now operate at frequencies around 200 kc. It is the object of this paper to examine the utility of this idea as applied to broadcast conditions in the United States. While the frequencies in question are not now available, it is assumed in the present discussion that they could be made so, particularly if channel demands are kept moderate by the employment of synchronization.

The first question to arise is the extent of national coverage as it exists at present. The arbitrary assumption is made that no transmitter of power less than 7 to 10 kw need be considered. The 30 transmitters rated at more than 7 kw are located at the centers of small circles as shown in Fig. 1. Actual field strength contours are of course far from circular, but circles give a fair enough approximation of them in a generalized discussion of this kind. From data in the possession of the writer, detailed below, it has been found that the average fading radius of all American broadcast stations (taking into account various existing values of λ and σ) is in the neighborhood of 80 miles.

In the case of most American stations the critical zone occurs within ± 25 per cent of this distance. It is of course true that fading beyond this critical zone is slower and less violent, but such space-ray transmissions seldom meet true service requirements. The writer has observed violent amplitude fading and destructive side-band differential fading in the case of KDKA at 350 miles. In the case of WLW at 600 miles fading is slower and less intense, but quality is somewhat marred in transmission. It appears reasonable to assume that perfect side band alignment is rarely maintained in space-ray transmission. An interesting development of the ideas above is that our traditional

¹ P. P. Eckersley, "The calculation of service area of broadcast stations," *PROC. I.R.E.*, **18**, 1161-1193; July, 1930.

conception of day and night broadcast ranges is reversing. Judged by true service standards the day range of a station is slightly greater than

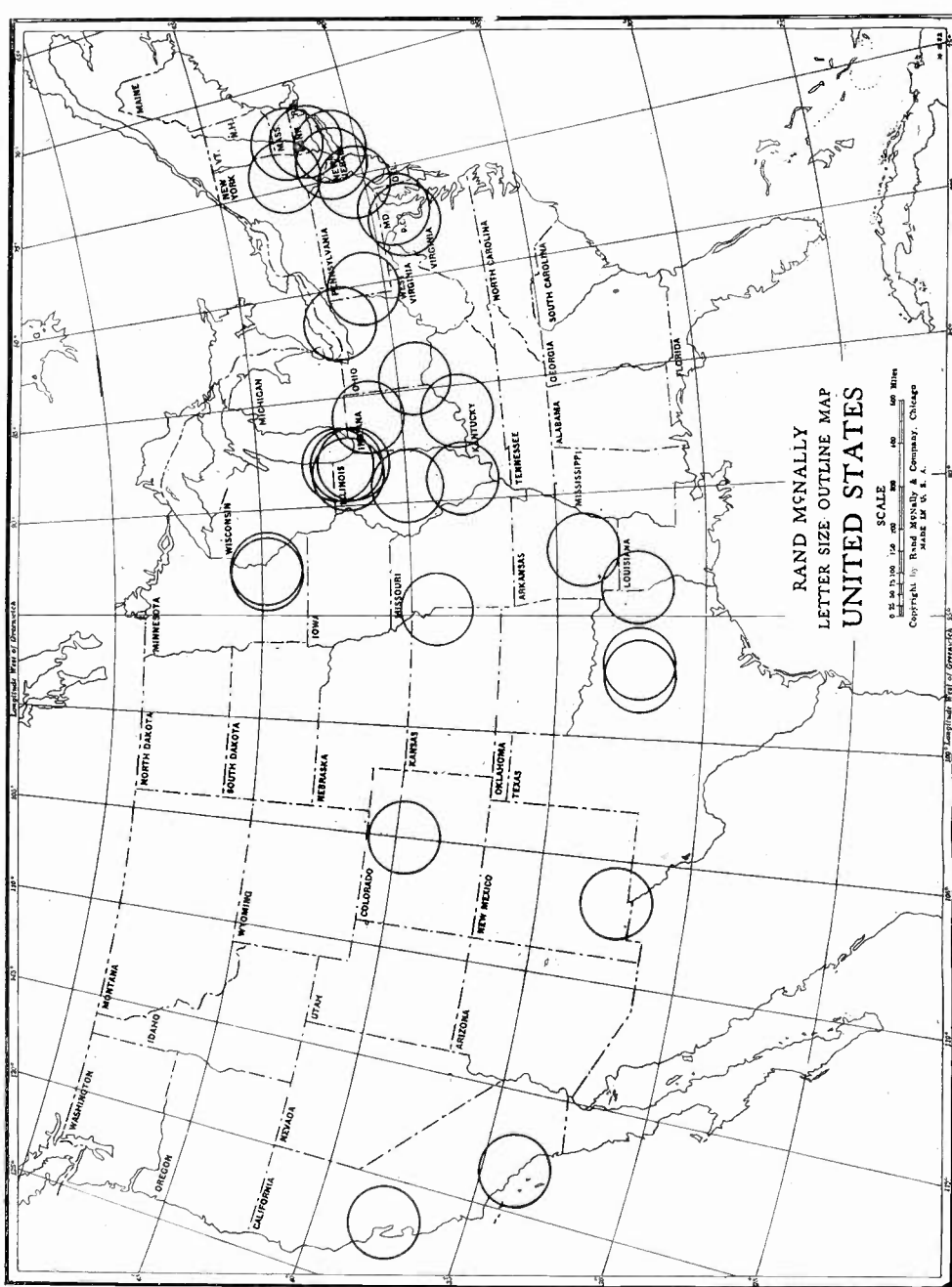

Fig. 1—Present generalized national coverage—from 30 stations of 7—50 kw each, using frequencies around 750 kc.

its night range, due to the relative absence of fading and interference in the daytime. In preparing Fig. 1, therefore, a circle of 80 miles radius was drawn from each transmitter location. Such graphic treatment is

admittedly a sweeping approximation, but little would be gained by considering terrain and power in the case of each individual station. The aggregate of these circles therefore represents the national coverage of our present higher-powered transmitters, even assuming that they are all increased in power to 50 kw or more. The figure shows at a glance that our present high power coverage is metropolitan rather than rural or truly national. Even assuming that these thirty 160-mile circles could be increased in number to 40 or 50, they would still fail to give national coverage. Further increases by the employment of synchronization would violate the fundamental economic principle of coverage by few large rather than many small transmitters.

The national coverage problem is thus to be solved, so far as we can see at present, from only two angles of attack. The first is the removal of fading restrictions at present frequencies by technical advances. Automatic gain control at the receiver is not a complete solution, particularly because it fails to compensate for differential sideband fading. Meissner² and others have shown that antenna design can, by increasing the proportion of energy horizontally radiated, enlarge to some extent the nonfading range (about 50 per cent increase where $\frac{1}{4}\lambda$ antenna is changed to $\frac{1}{2}\lambda$ antenna). Other devices, such as the frequency and phase synchronization described by Horn,³ have possibilities. Any utilization of present stations for national coverage is handicapped by the unequal metropolitan grouping of these stations.

The second angle of attack on the problem is the employment of lower frequencies proposed by Eckersley. It is not within the province of this paper to advocate this method as opposed to those mentioned above. Time alone can decide which method best meets the given requirements. The present object is only to make a preliminary survey of what the low-frequency method has to offer. It is assumed that the national low-frequency structure shall supplement the existing broadcast structure rather than supersede it.

AMERICAN DATA

The next consideration is to determine how far Eckersley's curves, drawn from data taken in northern Europe, can be applied to conditions in the United States. At the suggestion of N. I. Adams of Yale University this point has been investigated by the writer. To this end qualitative aural observations on high power eastern broadcast stations were made at New Haven by the writer and at West Point, N. Y., by

² A. Meissner, "Transmitting antennas for broadcasting," *Proc. I.R.E.*, **17**, 1178-1184; July, 1929.

³ C. W. Horn, "The importance of phase control in synchronizing," *Electronics*, **I**, 423; December, 1930.

H. W. Serig, of the United States Signal Corps. While aural observations are not in general trustworthy, they were deemed adequate in this case because the whole discussion centers about fading as observed by the average listener. The results, which represent average conditions over a period of several weeks, were as follow:

TABLE I

NEW HAVEN, CONN.			WEST POINT, N. Y.		
Station	Distance	Fading	Station	Distance	Fading
WTIC	35	0	WOR	45	0
WEAF	55	0	WABC	45	0
WBZ	55	2	WEAF	55	0
WABC	60	1	WJZ	65	1
WOR	75	1	WTIC	70	1
WJZ	95	2	WBZ	85	2
WGY	115	2	WGY	95	2
KDKA	350	2			
WLW	600	1			

Numerical fading notations: 0 little or none; 1 moderate; 2 severe.

The same general conclusion appears from both sets of observations: that there was little perceptible fading in the case of stations less than 60 miles distant, frequent fading in the case of stations 60 to 90 miles distant, and continual fading in the case of stations more than 90 miles distant (except for occasional constancy of stations several hundred miles distant).

These figures agree fairly closely with Eckersley's European predictions, which may be expressed in simplified tabular form approximately as follow:

TABLE II

Type country	APPROXIMATE RADII OF FADING RINGS					
	200	300	400	500	1200	1500 meters wavelength
Flat (open pastoral)	50	80	120	160	480	620 miles
Hilly or broken	24*	37	62	75	260	330 miles
Mountainous	10*	17*	26	34	110	160 miles

* Probably too low.

In this table Eckersley's terrain types for Great Britain are simplified into three general terrain types representative of large divisions of the United States. American flat country, such as obtains in Eastern tidewater regions and much of the midwest, is considered equivalent to English open pastoral country. As Eckersley's curves are drawn for this type of terrain, distances are read directly from his graphs. The second main type of American terrain may be classed as hilly to broken, midway between Eckersley's "hilly" and "very broken" types. As a general approximation we are probably justified in calling this type the total American average. For this type terrain the actual wavelength must be multiplied by the factor 0.58 to obtain the effective wave-

length with which to enter Eckersley's curves. The third main American type agrees with Eckersley's classification "mountainous," having a wavelength factor of 0.32. This terrain is characteristic of large sections of the Rocky Mountain and Pacific coastal range areas. Eckersley's further classification "broken mountainous" may be merged with the general mountainous type, due to its comparatively rare occurrence and only slightly lower wavelength factor.

To ascertain how well Eckersley's predictions may be applied to sections of the United States outside the Eastern area, the writer communicated with the chief engineers of several widely separated American broadcast stations. The information desired, in addition to such details as power, wavelength, etc., was the type of surrounding terrain and the observed radius of first fading ring. The results of this survey may be summarized as follow:

TABLE III

λ	Station	Power kw	Terrain	Predicted fading radius Miles	Observed fading radius Miles
*	*	5	mountainous	17	25
333	WJAX Fla.	1	flat (sandy)	95	50
344	WENR Ill.	50	flat	100	125
*	*	50	broken	55	60
361	KOA Colo.	12.5	flat (east)	105	150
361	KOA Colo.	12.5	broken (west)	55	75
394	WJZ N.J.	30	broken	60	120
405	WSB Ga.	5	broken	65	70
422	WOR N.J.	5	flat	130	100
428	WLW Ohio	50	flat	130	120
454	WEAF N.Y.	50	flat	140	100
468	KFI Calif.	5	broken-mountainous	55	80
Averages				83.8	89.2

* Permission to publish not received.

In the above table the predicted fading radii are simply interpolated estimates from Table 1, and the observed fading radii as reported by station engineers may be considered as estimates also. The accuracy in both cases, probably not over ± 10 per cent, is sufficient for the present purpose of making a first approximation towards expected national coverage on 200 kc.

It will be noted that the greatest individual divergence between prediction and observation, in the case of WJZ, is not over 2:1; and this is perhaps partly accounted for by the fact that, while the transmitter is located in broken country and is so classed, much of the terrain within the service area is flat or even marshy. Another wide divergence in Florida is perhaps a result of sandy terrain having low conductivity. The agreement between the average of predicted values (83.8 miles) and the average of observed values (89.2 miles) is very satisfactory.

200-KC NONFADING COVERAGE

The major inference, to which all this data leads, is clear. Eckerley's curves, erring on the side of conservatism if at all, can be applied approximately to the United States in the prediction of nonfading coverage to be expected with 200-kc broadcasting. At this frequency the predicted fading radius for hilly to broken terrain, the general American average, is about 330 miles. In this connection A. H. Taylor of the Naval Research Laboratory, from American transmission data in his possession, estimates in a letter to the writer that on 200 kc serious night fading will not occur very frequently inside of 500 miles. This view assumes the use of automatic receiver volume control. From another authoritative source it was learned that actual broadcast transmission on 200 kc in the United States has shown no pronounced fading ring within 300 to 350 miles, the limit of effective signal strength at the power employed (20 kw). From a consideration of all the above estimates, it is assumed that the average American fading ring of a 200-kc broadcast transmitter may be fairly represented by a circle of 400 miles radius. Along the Eastern seaboard and in the midwest this value would of course increase, and in the Rocky Mountain and Pacific mountain areas it would decrease. However, these factors may be partly compensated by the employment of lower frequencies in mountainous districts and higher frequencies in flat areas.

PROPOSED NATIONAL SYSTEM

Fig. 2 shows circles of 400-mile radius plotted on a map of the United States. It is seen that about seven stations meet the requirements. These are located respectively in the following sections: northeast, southeast, north central, northwest central, southwest central, northwest and southwest. The exact number of stations and their actual locations can be determined only by detailed topographic surveys and experimental work. The northeast station, for example, might advantageously be located at the outer tip of Long Island rather than inland where hills and other obstructions are common. Transmission which originates over water or flat ground appears to meet with less fading at all distances than radiation which is distorted at the start by unfavorable terrain factors. It will be noted that the extremities of Maine and Florida are not covered by the circles. Such omissions are not important, because the true service area of a station does not cease abruptly at its boundary, and its shape can be purposely distorted to fit a certain region by antenna design. In any case where other methods fail to cover a small blank area, a synchronized relay station can be used.

At the power levels recommended below stations must certainly be placed where population is scarce, a requirement rendered less rigorous

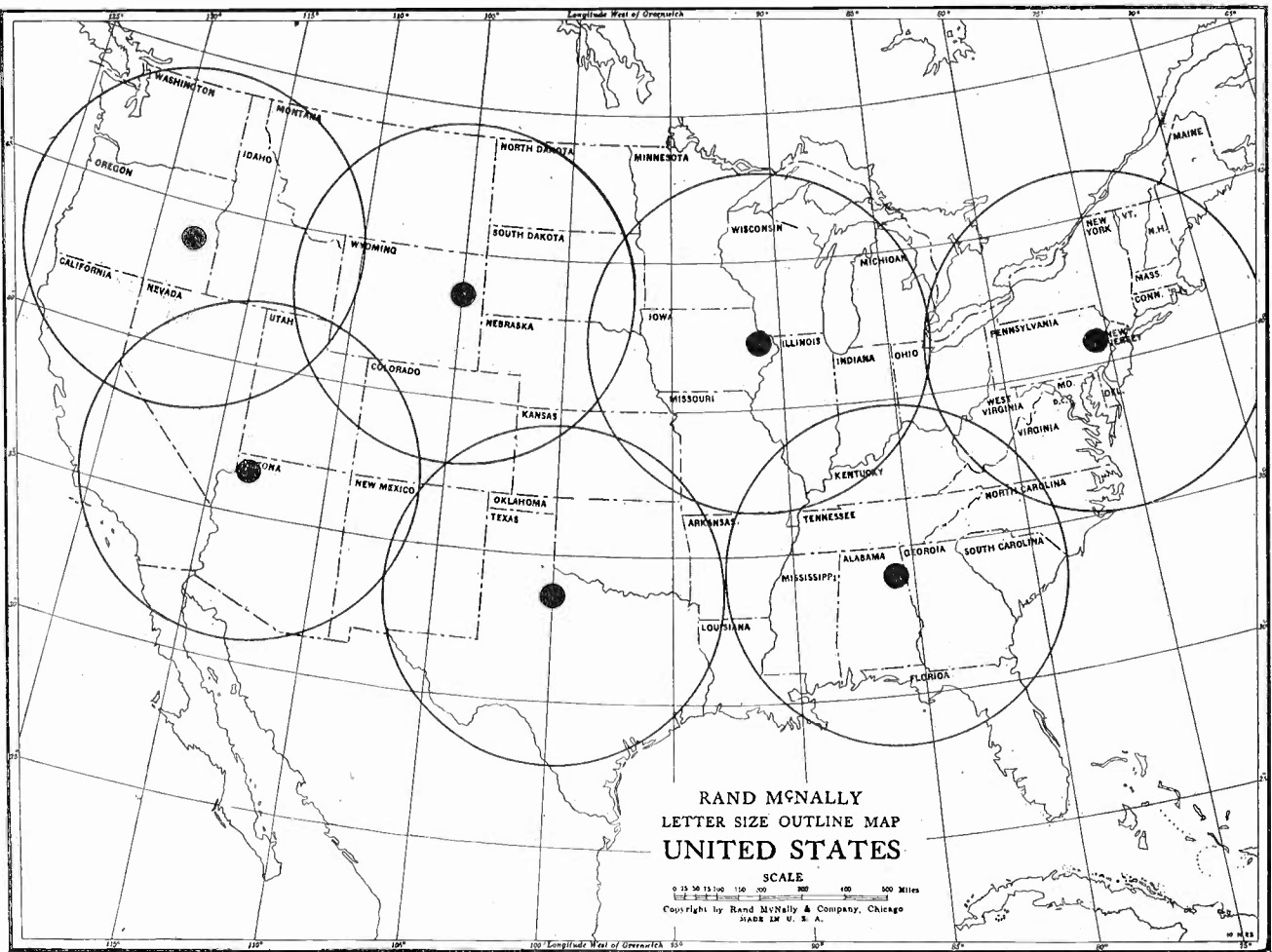

Fig. 2—Predicted generalized national coverage—from 7 stations of approximately 100—10,000 kw each, using frequencies around 200 kc.

by greatly increased service range. Extrapolating from the recommendations of Delinger⁴ it is estimated that a 1000-kw transmitter can-

⁴ "Reports I. R. E. committee on broadcasting," Proc. I. R. E., 18, 15; January, 1930.

not be located within 30 miles of a populous center. The small black circles in Fig. 2, having 30-mile radii, indicate roughly the probable extent of interference areas. One important point must be mentioned here. Many would consider it a mistake to place the southwest station, for example, so far from centers of population. But this station is designed to serve the entire southwestern United States, including cities in California and the Salt Lake City region, rather than the desert area immediately surrounding the transmitter. We must go beyond the local and sectional viewpoint of earlier years if national broadcasting is to become a reality.

In addition to wider service areas, low-frequency broadcasting offers other transmission advantages over the use of present frequencies. Taylor suggests that differential side-band fading will be relatively less severe around 200 kc. E. B. Judson of the Bureau of Standards points out that 200-kc fading will be slower than fading on present broadcast frequencies. Finally, it would appear that some of the present enormous differences in signal intensity between near-by points, such as a hilltop and a valley bottom, will be smoothed out somewhat by the greater ability of longer waves to bend around obstructions.

ATMOSPHERICS

The above seven-station structure is based solely on expected non-fading range, the arbitrary limiting factor of service area. The actual degree of coverage within these maximum ranges becomes simply a question of favorable transmitter location, suitable antenna design, and the employment of enough power to overcome atmospherics and other forms of interference.

Atmospherics are worse at 200 kc than at 600 kc. Taylor estimates that they are in general at least twice as strong at the lower frequency, with particularly intense disturbances in the southern United States, and in the midwestern states during their hot summers. L. W. Austin of the Bureau of Standards, independently interviewed by the writer, estimates that the ratio is probably greater than 2:1 and less than 4:1.

Judson states that in the Bureau of Standards' measurement work in the neighborhood of $\lambda 17,000$ where atmospherics are about 20 times as strong as at $\lambda 3000$ and below, worst average afternoon atmospherics are about 1 millivolt per meter. No interference is experienced from them in measuring with an oscillating detector the 3 millivolt per meter signals of American high power stations. While 200-kc summer atmospherics in the south and southwest regions are undoubtedly bad, it is not believed that they will prove prohibitive at the high signal levels

recommended hereafter. The writer has operated field sets around 300 kc in Texas and Arizona during the summer season. Using an antenna comparable in size to the ordinary broadcast receiving type and an oscillating detector with two stages of audio, headphones could usually be worn without discomfort.

A search of the literature reveals very little definite information on the relative intensity of atmospherics at 200 kc and at 600 kc. The writer has combined the early results of Austin⁵ on lower frequencies with the theoretical curve of Friis and Sivian,⁶ and obtains qualitative curves, as shown in Fig. 3, which agree in general with the estimates

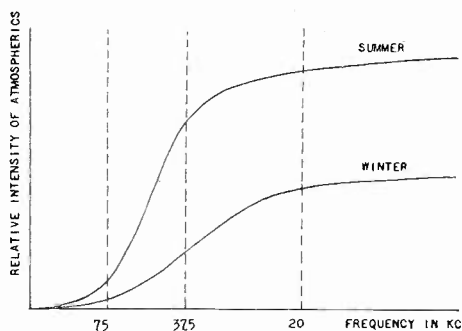

Fig. 3—Qualitative relation between frequency and intensity of atmospherics (after Friis and Sivian, and Austin).

quoted above. The curves also show that broadcast wavelengths much above λ 3000, though excellent from the viewpoint of nonfading coverage, are beyond the knee of the curve and entail very severe atmospherics increase.

There is great need for quantitative measurements of absolute intensity of atmospherics at 200 kc as well as other frequencies within the present broadcast spectrum, covering various parts of the country and all seasons of the year.

In the absence of such data, and proceeding from the estimates above, it is assumed that at 200 kc a signal intensity of 3 to 10 millivolts per meter will be sufficiently above the interference level. The lower value will probably suffice for most of the United States, while the higher value must be approached in certain parts of the South where atmospherics levels are high.

⁵ L. W. Austin, "The relation between atmospheric disturbances and wavelength in radio reception," *Proc. I.R.E.*, 9, 28-40; February, 1921.

⁶ H. T. Friis and L. J. Sivian, "Static interference as a function of wavelength," *Wireless World and Radio Review*, 10, 285-288; June 3, 1922.

REQUIRED POWER LEVELS

Referring again to Eckersley's curves, the radiated power level necessary to produce the required signal level, at the 400-mile limit where fading is assumed to begin, comes out approximately 1000 kw to 10,000 kw. It should be necessary to approach the higher limit only in the case of one or two southern stations. The American experiments mentioned above appear to indicate somewhat lower power levels on the order of 100 kw to 1000 kw. Taylor estimates that 200 kw to 500 kw will probably suffice. The writer's estimate, therefore, takes into account the probable outside limits of power requirements.

While 1000 kw seems at the present time a very large broadcast power, it is far from excessive as power values go in the various branches of applied physics. The passengers of a large transport airplane sit within a few feet of the continuous delivery of nearly 2000 kw. It must be realized also that a 400-kw broadcast station is already under construction, that large power outputs will be somewhat easier to obtain at lower frequencies, and that the trend of broadcast power has been increasingly upward.

Aside from transmitter technology, the limiting factor here is of course the economic one. Assuming power cost at 1 cent per kwh and operation for eighteen hours of each day, the electric power bill for the 1000-kw station comes out about \$500,000 per year, and that for the 10,000 kw station about \$5,000,000 per year. While the second figure is evidently excessive, it would probably be approached as already indicated only in the case of one or two stations in the southern states. The lower figure appears within reason when one recalls that the present annual cost of technical broadcast facilities is around \$30,000,000. Even seven 100-kw transmitters at the key locations, drawing total power at the rate of about \$350,000 per year, would probably provide rural coverage far above our present standards. In the natural course of events such moderate powers would be desirable at first, to be increased gradually as the advantages of higher powers became apparent and the economic basis for them became available. As an eventual possibility two or more transmitters might be operated at each station to provide alternate true-service programs.

The efficient use of such high powers would probably justify the maintenance of measurement stations located near the limits of each transmitter's true-service area. Such stations could report daily or hourly the actual signal and atmospheric intensities, so that the station engineers might reduce power and effect considerable savings under favorable conditions. It is even conceivable that research in solar and meteorological correlations may eventually be of value to

high power stations by permitting timely predictions of expected power requirements.

The design of efficient antennas at 200 kc presents some difficult practical problems. To approach $\frac{1}{4}\lambda$ dimensions, towers several hundred feet high are required. While such towers, superpower transmitters, and the necessity for building small self-supporting communities at isolated locations are all expensive, it is believed that they will be justified by the present and future importance of national broadcasting and the advantages of low-frequency service.

The channel requirements of the national system will depend largely upon how far it found desirable and technically possible to employ synchronization. With no synchronization the seven stations would require a band 70 kc wide, perhaps between 155 kc and 225 kc (1935–1330 meters). With alternate synchronization (northeast-northwest central, north central-northwest and southeast-southwest) four 10-kc channels, say between 175 kc and 215 kc (1715–1395 meters), should suffice. With more complete synchronization channel requirements might be further reduced.

It is of course not contemplated that the entire national system will be put simultaneously into effect. A single station, north central for example, might be built and operated, while measurements and portable transmitting experiments were carried out in this and other parts of the country. Under favorable conditions this station would reach practically the entire country with a space-ray signal of sufficient intensity to interest thousands of experimenters and build up the beginnings of receiver demand.

RECEIVER DESIGN AND MANUFACTURE

At first sight the opening of a new broadcast spectrum would appear to be a disturbing and unfavorable factor in receiver manufacture. It should be emphasized, however, that the proposed low-frequency facilities will not in any way injure the present structure or make present receivers less effective. In time low-frequency broadcasting would build up a demand for adapters and for combination receivers which should contribute greatly to the prosperity of the industry. It is quite certain that the receiver design problems introduced by the change are well within the bounds of present technology.

Compared with present tuner design problems, the design of low-frequency units for receiving the programs of the proposed national system is a simple matter. The frequency range to be covered is small, permitting the use of tuning condensers of limited range. Low-frequency amplification can be efficiently accomplished by simple tube

coupling methods. The selectivity requirements are not nearly so rigorous as those of the present spectrum. All the above relaxations mean that one or two tetrodes inductively or capacitively coupled ahead of the detector tube should give excellent results.

While the problems of two-band coverage in combination receivers are more complex, they can be easily and economically solved. The inductance of tuned circuits can be changed by suitable switches, particularly in the superheterodyne circuit where few changes are required. The employment of two separate tuners is economically feasible, since the low-frequency tuner may be of relatively simple design.

The sale of radio receivers rests fundamentally on the excellence of broadcast service, which must be continually improved to meet the demands of listeners educated always to higher standards. Any improvement of broadcast service, therefore, contributes eventually to the prosperity of the radio industry.

In closing the writer wishes to acknowledge the valuable criticisms and suggestions which he has received from discussions of the low-frequency superbroadcast plan with some of the foremost authorities in the communications field. They foresaw, as does the writer, many practical objections to the immediate fulfillment of the plan. However, most of them felt that it is basically sound from a technical viewpoint and that it offers enough possibilities of great public service to be well worth investigating. Thanks are also due the broadcast station engineers who coöperated in the survey detailed above.



THE EFFECTIVE HEIGHT OF CLOSED AERIALS*

BY

V. I. BASHENOFF AND N. A. MJASOEDOFF

(Electrical Research Institute of the U.S.S.R., Moscow)

Summary—In this article formulas are given for the calculation of the effective height of coil aerials with non quasi stationary distribution of current. Aerials of triangular, rhombical, rectangular, and pentagonal forms, suitable for use in radio beacons, are treated, and the method of taking account of the distribution of current along the aerial found by experiment discussed.

Graphs for facilitating numerical calculations using the formulas are given, together with examples illustrating their use. Special attention is given to the determination of those forms of aerials in which the wire is most advantageously placed for obtaining a maximum of effective height.

SINCE THE end of 1927, the closed aerial has been receiving attention in increasing measure.¹ For transmitting stations intended for transmission at intermediate values of wavelengths, such as, for example, radio beacons for directing the flight of airplanes, its simplicity, cheapness, and directional characteristics render it especially suitable. It is, therefore, of importance to consider methods for facilitating the calculation of the fundamental constants which determine the value of the field intensity, due to such a closed aerial, at any point in space. Working at a given power, these constants are (a) the effective resistance of the aerial, since this determines the current in the system, and (b) the effective height. The present paper has to do with the calculation of the effective height of a closed aerial.

The effective height is defined to be equal to the effective height of an open, earthed aerial which, placed in the same position as the closed aerial, and carrying the same current, will give rise to an electric field intensity at any point in the direction of the maximum radiation, equal to the electric field intensity created by the closed aerial at the same point. The closed aerial is assumed to be placed arbitrarily with respect to the direction of the maximum radiation of the open aerial.

The electric field of an open as well as of a closed aerial is determined by the ideal formula of radio transmission. The effective height of a closed aerial, determined in this way, depends upon the coördi-

* Decimal classification: R125.3. Original manuscript received by the Institute, December 11, 1930. This is the second paper on the subject of the "Calculation of closed aerials." The first by V. I. Bashenoff "An abbreviated method for calculating the inductance of irregular plane polygons of round wire," appeared in the PROC. I.R.E., 15, December, 1927, with a supplementary note, PROC. I.R.E., 16, November, 1928. A paper by V. I. Bashenoff and N. K. Svistoff on the theory of closed aerials with many turns will form the third paper of the series.

¹ See, for example, U. S. A. Patents 1652388 and 1708400.

nates which define the direction in question. It determines the radiation power of a closed aerial for different directions and in the case where the actual law of distribution of energy (taking into account reflection from the upper atmospheric layers, refraction of rays, and absorption of energy by the earth) is known, it permits the calculation of the intensity of the electrical field of a closed aerial at any point of space.

A. QUASI STATIONARY RÉGIME

It is assumed as already proved by the work of the authors that for transmission as well as for reception, when calculating the effective height of a closed aerial by the method of comparing the intensity of its field with the intensity of the field of an open aerial, the image of the closed aerial must be taken into consideration in the same way as is done with the image of the open aerial. In case of a quasi stationary current this leads to the calculation of the effective height of a closed aerial h_{eff} by the formula:

$$h_{eff} = \frac{2\pi S}{\lambda} \cos \phi, \tag{1}$$

where S is the area of a closed aerial, λ the received wave length, and ϕ the angle between the direction of the wave and the plane of aerial.

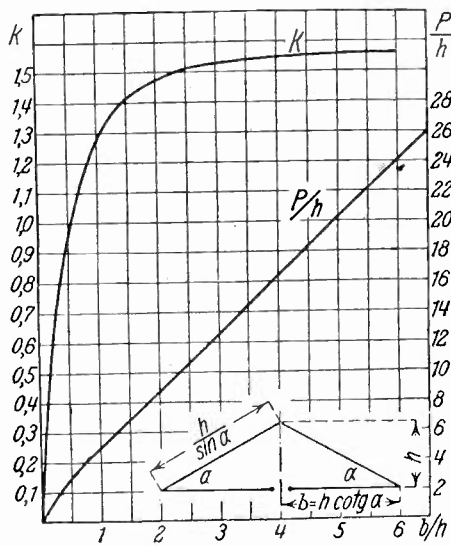

Fig. 1

Below we include in the calculation, as fundamental data, the geometrical height of the system h (see Fig. 1) and the ratio: $k = \lambda/P$ where λ is the working length of wave and P the perimeter of the closed aerial. The use of this ratio in the calculation of the effective height of a

closed aerial appears to us the more rational, since, as is proved in practice, it is the fundamental parameter which determines the value of the effective resistance of a closed aerial. Introducing the values h and k into the formula for the effective height of a closed aerial with a quasi stationary current, we obtain for the direction of the maximum radiation:

$$h_g = \frac{2\pi S}{\lambda} = \frac{2\pi Sh}{Phk} \quad (2)$$

Let us denote $2\pi S/Ph = K$, as the coefficient of utilization of the geometrical height of the system. For a given geometrical height of the system and a given value of the coefficient $k = \lambda/P$, the effective height of a closed aerial with quasi stationary current bears a linear relation to this quantity since

$$h_{\text{eff}} = \frac{Kh}{k} \quad (3)$$

The coefficient K involves all those geometrical properties of a closed aerial with quasi stationary current which, with given h and k , defines effective height. If the current is quasi stationary, the most profitable of different configurations having the same values of h and k , will be that for which K has the greatest value. By the same method it will be found possible also to compare, to a first approximation, different configurations of a closed aerial, with a non quasi stationary current in those cases when the effect of a non quasi stationary current on the value of the effective height of the closed aerial is about the same for all the configurations compared. Let us now determine the coefficient K for certain special forms of a closed aerial.

(1) Circle.

$$S = \pi r^2; P = 2\pi r; h = 2r; \quad (4)$$

$$K = \frac{\pi r^2}{2\pi r \cdot 2r} 2\pi = \frac{\pi}{2} \cong 1.57,$$

from which there follows:

$$h_{\text{eff}} = \frac{1.57}{k} h. \quad (5)$$

(2) Isosceles Triangle (see Fig. 1).

$$S = h^2 \cotg \alpha;$$

$$P = 2h \left(\frac{1}{\sin \alpha} + \cotg \alpha \right) = 2h \cotg \frac{\alpha}{2};$$

$$K = \pi \frac{\cotg \alpha}{\cotg \frac{\alpha}{2}} \tag{6}$$

The dependence of K on b/h , where b is half of the base of the triangle, is shown in Fig. 1. Increasing b/h we find that the value K will constantly increase and at $b/h = \infty$ will reach its maximum value:

$$K_{\max} = \frac{\pi}{2} = 1.57.$$

In Fig. 1 the dependence of P/h on b/h is also shown. From the latter curve, if the perimeter and height of triangle are given, it is not difficult to draw the triangle itself.

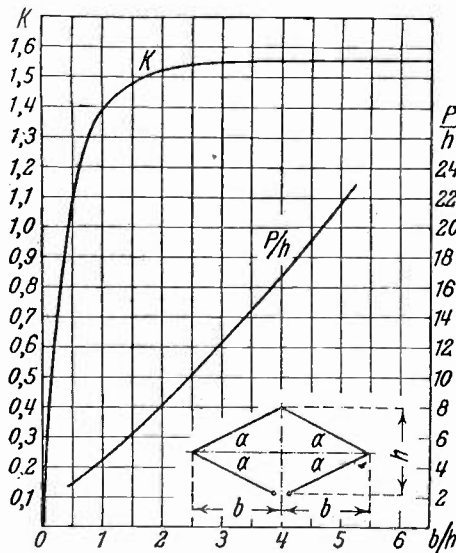

Fig. 2

(3) Rhombus (see Fig. 2).

$$S = \frac{1}{2} h^2 \cotg \alpha; P = 2h \frac{1}{\sin \alpha};$$

$$K = \frac{\pi}{2} \cos \alpha. \tag{6'}$$

If $\alpha = 0$ ($b/h = \infty$) we get:

$$K = K_{\max} = 1.57.$$

If $\alpha = 45$ degrees ($b = h$):

$$K \cong 1.1.$$

(4) Rectangle (see Fig. 3).

$$S = mh^2; P = 2h(1 + m);$$

$$K = \frac{\pi}{1 + \frac{1}{m}}$$

If $m = \infty$:

$$K = K_{\max} = \pi = 3.14.$$

If $m = 1$ (square):

$$K = \frac{\pi}{2} = 1.57.$$

(5) A considerable utilization of the geometrical height of a system with one mast can be achieved by using a closed aerial of pentagonal

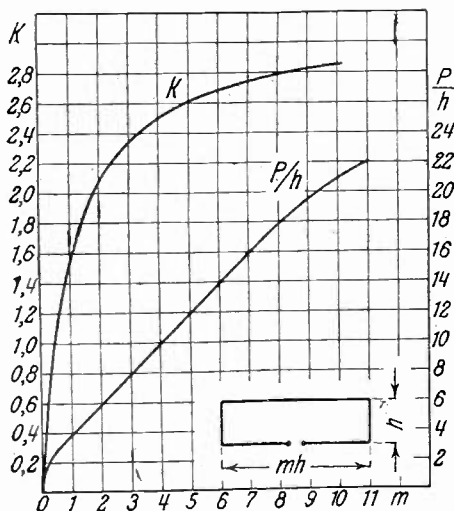

Fig. 3

form. Out of an infinite number of possible forms of a pentagon we shall examine only one group.

The pentagon $OABB_1A_1$ (see Fig. 4), symmetrical with respect to the vertical axis, with a horizontal side BB_1 , can be obtained from a triangle OCC_1 , symmetrical with respect to the vertical axis, by cutting the wires $CB, CA, C_1B_1,$ and C_1A_1 and joining points A and B with a wire AB and points A_1 and B_1 with a wire A_1B_1 . Let us prove that, whatever the triangle may be, the most useful position of the wires A_1B_1 and AB (for obtaining the greatest value of K) will be when each of these wires is perpendicular to the bisector of the acute angle α of the triangle, cut off by the wire in question.

Let the triangle OC_1C (see Fig. 4) be cut by line ab , not perpendicular to the bisector of angle α and a straight line AB , perpendicular to the bisector, be drawn through d , the point of the intersection of the bisector of angle α with the line ab . We first of all can easily convince ourselves of the fact that, when the triangle is cut by the line ab , the area of the pentagon becomes smaller than in the case when it is cut by the line AB . In fact, by replacing the first cut by the second, we lose area S_2 and gain area S_1 (see Fig. 4). The drawing, however, clearly shows that $S_1 > S_2$. Furthermore, it is not difficult to prove that the perimeter of the pentagon will also be the smaller in the case of the cutting line AB . In cutting the triangle with some line ab we reduce its perimeter by a value ΔP , which is equal to the sum of the lengths of the wires aC and bC minus the length of the wire ab . That is:

$$\Delta P = aC + bC - ab.$$

Taking

$\angle adA = \beta$ we find:

$$aC = dC \frac{\cos \beta}{\cos\left(\beta - \frac{\alpha}{2}\right)};$$

$$bC = dC \frac{\cos \beta}{\cos\left(\beta + \frac{\alpha}{2}\right)}$$

$$ab = ad + bd =$$

$$= dC \left[\frac{\sin \frac{\alpha}{2}}{\cos\left(\frac{\alpha}{2} - \beta\right)} + \frac{\sin \frac{\alpha}{2}}{\cos\left(\frac{\alpha}{2} + \beta\right)} \right]$$

$$= dC \frac{\cos \beta \sin \alpha}{\cos^2 \beta \cos^2 \frac{\alpha}{2} - \sin^2 \beta \sin^2 \frac{\alpha}{2}}$$

and therefore,

$$\Delta P = dC \frac{2 \cos^2 \beta \cos \frac{\alpha}{2} - \cos \beta \sin \alpha}{\cos^2 \beta \cos^2 \frac{\alpha}{2} - \sin^2 \beta \sin^2 \frac{\alpha}{2}}$$

Making $\partial\Delta P/\partial\beta$ equal zero and obtaining the algebraic sign of the second derivative of $\partial^2\Delta P/\partial\beta^2$, we find that ΔP has a maximum at $\beta=0$, i.e., when the cutting line ab is perpendicular to the bisector. Thus out of all possible positions of the cutting line ab , the maximum area, minimum perimeter and, consequently, the biggest value K (since $K = 2\pi S/Ph$), is given by the position of the cutting line perpendicular to the bisector of the angle at the base of the triangle cut.

Putting $BC/O_1C = n$ (see Fig. 4) and considering the angle α , as having been found, we shall now look for such a value n as shall at a

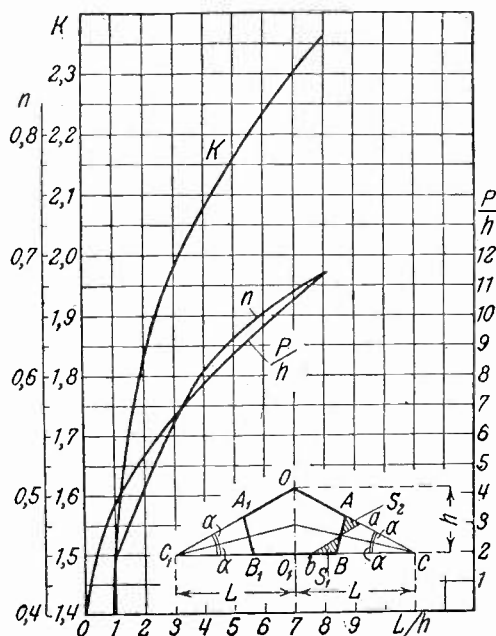

Fig. 4

given α , correspond to the maximum value K . The further condition is imposed that the straight lines AB and A_1B_1 shall be considered as perpendicular to the bisectors of the angles α .

It is easy to determine that the perimeter of the pentagon is

$$P = 2h \left[2n \cotg \alpha \left(\sin \frac{\alpha}{2} - 1 \right) + \cotg \frac{\alpha}{2} \right],$$

and its area

$$S = h^2 \left[\cotg \alpha - n^2 \cos^2 \alpha \left(\cotg \alpha + \tg \frac{\alpha}{2} \right) \right];$$

from whence

$$K = \pi \frac{n^2 \cos^2 \alpha \left(\cotg \alpha + \operatorname{tg} \frac{\alpha}{2} \right) - \cotg \alpha}{2n \cotg \alpha \left(1 - \sin \frac{\alpha}{2} \right) - \cotg \frac{\alpha}{2}}$$

Making dK/dn equal to zero, we find that K has its maximum at

$$n = \frac{\cotg \frac{\alpha}{2} \operatorname{tg} \alpha}{2 \left(1 - \sin \frac{\alpha}{2} \right)}$$

$$\sqrt{\left[\frac{\cotg \frac{\alpha}{2} \operatorname{tg} \alpha}{2 \left(1 - \sin \frac{\alpha}{2} \right)} \right]^2 - \frac{2}{\sin 2\alpha \left(\cotg \alpha + \operatorname{tg} \frac{\alpha}{2} \right)}}$$

Taking now the relation of half the base of the triangle L to its height h as a fundamental parameter (see Fig. 4) we can obtain for every L/h ($L/h = \cotg \alpha$) an n such that it will give a maximum value of K and can also determine the value K corresponding to this n .

For different L/h in Fig. 4 are given the most profitable values n and the values of the quantities K and P/h corresponding to them.

B. NON QUASI STATIONARY RÉGIME

Let us now turn our attention to the examination of the field of a closed aerial carrying a current not quasi stationary. Taking the capacity and inductance of a closed aerial as being uniformly distributed along the perimeter, and neglecting the active resistance of a closed aerial we shall naturally come to the conclusion that the existence of electromagnetic oscillations in the closed aerial could be expressed by equations:

$$-\frac{\partial e}{\partial x} = L_1 \frac{\partial i}{\partial t} \text{ and } -\frac{\partial i}{\partial x} = C_1 \frac{\partial e}{\partial t} \tag{6a}$$

where e is the potential of an arbitrary point on the closed aerial, i , the current at this arbitrary point, L_1 and C_1 , the inductance and capacity per unit of the length of perimeter.

Taking the origin of coördinates at the center O of the perimeter of the closed aerial (see Fig. 5) we can get a solution of the system (6a) in form:

$$e = E' \sin \frac{2\pi x}{\lambda} \sin \frac{2\pi t}{T}; \quad i = I \cos \frac{2\pi x}{\lambda} \cos \frac{2\pi t}{T}. \quad (6b)$$

Taking at $x = P/2 = l$, for the case of free oscillation of the closed aerial, shown in Fig. 5 as being at the bottom, where i is equal to zero, we find that its natural wavelength is:

$$\lambda_0 = 2P = 4l.$$

In practice the ratio of the natural wavelength of a closed aerial to its perimeter fluctuates between 2.3 and 2.8, and the distribution of

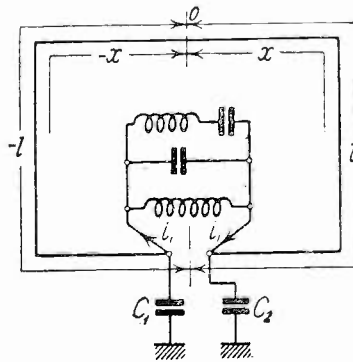

Fig. 5

the current does not fully coincide with the cosinusoidal law. See Fig. 6), in which are given the experimental curves of the distribution of current in a triangular closed aerial, and also Fig. 7 showing the theoretical relations (which are also based on practice) of the current at the top of the closed aerial to the current in the density fields, using different forms of closed aerials, with different ratios λ/P and under the condition that the density of the current actually is in the center of the perimeter of a closed aerial). For simple calculations, nevertheless, we consider it possible, in the first approximation, to look on the current as being cosinusoidal.

The familiar expressions for the distribution of the current and potential along a closed aerial, given above, prove that the loop of current and the potential node are in the center of its perimeter. For quite evident reasons this can take place only when both halves of the aerial are placed symmetrically with respect to the earth, when the capacity of the mounting, connected to one end of the closed aerial, with respect to the earth, is equal to the capacity (with respect to the

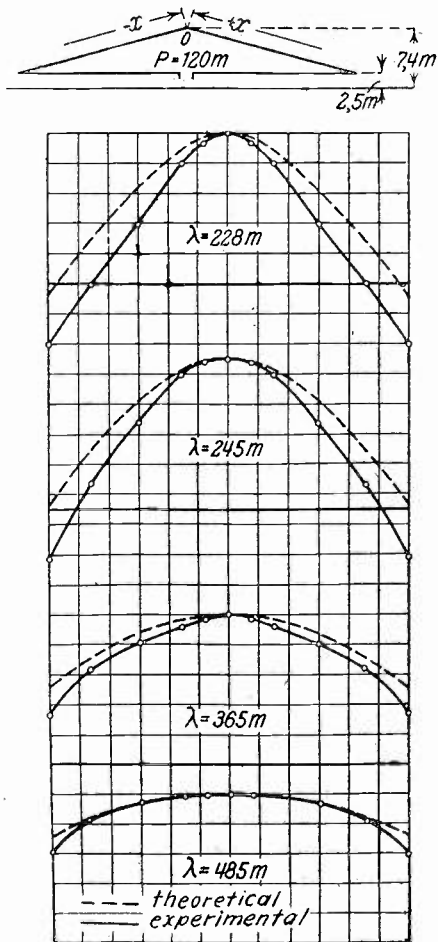

Fig. 6

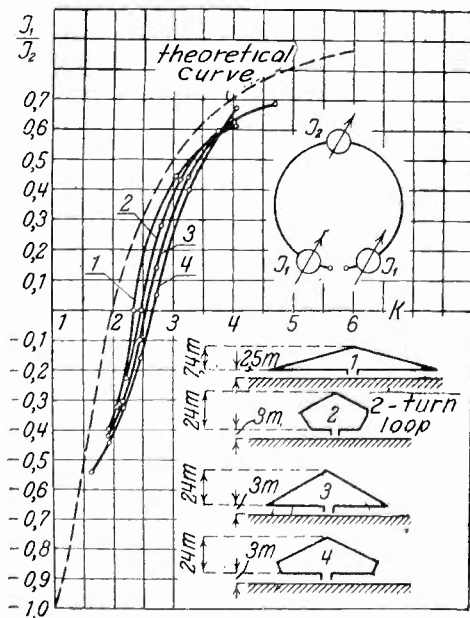

Fig. 7

of the
e form:
 $/T$ and

ed aer-

(6c)

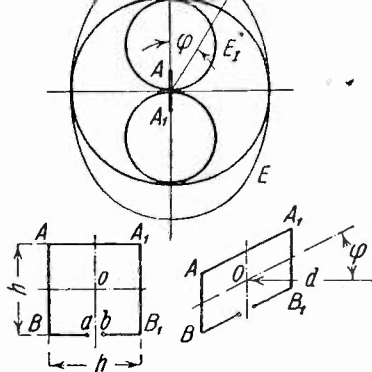

Fig. 9

..., the loop of the current is in the center of the perimeter of the electrical field of a closed aerial in a horizontal plane is in the direction, perpendicular to the plane of the aerial, the component of the vector of the intensity of the electrical field is in this direction the vertical components of the intensity, from the left and right halves of the closed aerial, are equal in magnitude and opposite in phase. The directional characteristic of the

of the electrical field, which is perpendicular to the plane under examination, only in respect to such a plane out of the ones perpendicular to the plane of the closed aerial, which is also perpendicular to the axis to which the aerial geometrically as well as electrically (distribution of current and potential) is symmetrical, and that in case of a non quasi stationary current, besides the component of the vector of the intensity of the electrical field, perpendicular to one or the other of the planes perpendicular to the plane of the closed aerial, there also exists a component of the vector which is parallel to the plane under examination.

If the closed aerial with a non quasi stationary current is not symmetrical with respect to the vertical axis, the vertical component of the intensity of its field for the direction perpendicular to the plane of the

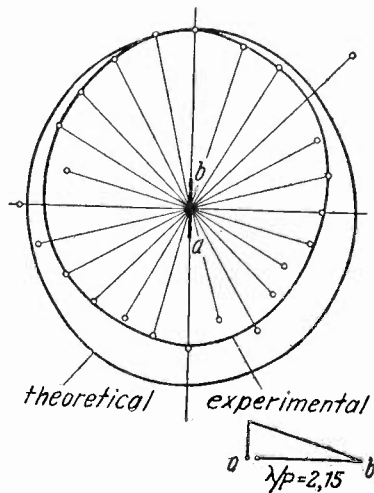

Fig. 10

aerial is not equal to zero when the current maximum is at the center of its perimeter. In this case the shape of the directional characteristic (in particular the ratio $E_{\phi=90 \text{ degrees}}/E_{\phi=0 \text{ degrees}}$) depends on the relation of the length of the wave to the perimeter, which can easily be proved by using the method adopted by us in the examination of the field of a square frame for points in the horizontal plane. In Fig. 10 are shown the theoretical directional characteristic and that obtained by experiment for a triangular unsymmetrical closed aerial for which $\lambda/P = 2.15$.

Below we shall confine ourselves to the examination of only those closed aerials which are most valuable in practice, i.e., to those which are symmetrical with respect to the vertical axis and in which the current maximum is at the central point of the upper element of the perimeter. The analysis of the field will be carried out only for points in the horizontal plane and at a given wavelength close to the theoretical

natural period, whereby the examination of the horizontal component of the vector of intensity of the electrical field will not be considered.

As the directional characteristic of the vertical component of intensity of the field for points in the horizontal plane for the cases under examination has the form of a figure-eight and is in contour similar to the curve $E = E_0 \cos \phi$, we consider it sufficient to confine ourselves to the calculation of the effective height of a closed aerial for a direction coinciding with its plane. It will be assumed that the current is distributed according to the law $i = I \cos 2\pi x/\lambda$ (taking $x = 0$ at the center of the perimeter of the closed aerial).

(1) *Isosceles Triangle*. An isosceles triangle represents the simplest and most widely adopted form of a closed aerial. We, therefore, con-

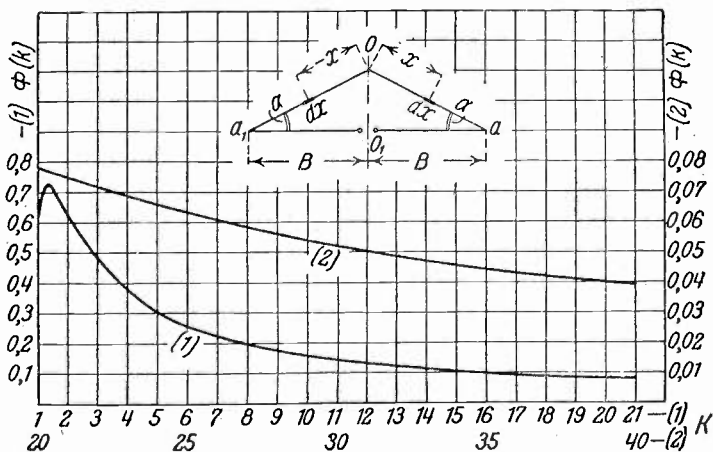

Fig. 11

sider it necessary to go into the solution of the problem of the effective height of an isosceles triangular closed aerial in some detail. Supposing the isosceles triangle oaa_1 (see Fig. 11) has a height h , a perimeter P , and the angle at the base α . Supposing the current maximum is at the central (upper) point of the perimeter of the triangle (O). This point will be taken as the origin of coördinates of the distribution curve of the current whose abscissa axis will be taken as coinciding with the sides of the triangle. Supposing that at a certain wavelength the equation of the distribution curve is $i_x = I\phi(x)$, where I is the maximum current and i_x the current at a point of the perimeter of the closed aerial which has the abscissa x , whereby $\phi(x) = \phi(-x)$, since it was decided to look on the distribution of the current as being symmetrical. Having determined the intensity of the field of the closed aerial under examination at some point of space (A) in the horizontal plane, and lying in the plane of the aerial, we shall compare it with the intensity of the field of an open earthed aerial, whose axis of symmetry coincides with the axis OO_1 of

closed aerial in a horizontal plane has in this instance the form of a figure-eight and as to its contour is more or less similar to the curve $E = E_0 \cos \phi$, where ϕ is the angle formed by the radius vector with the plane of the aerial, and E_0 a certain constant quantity. The dislocation of the loop of current will result in a deformation of the diagram and will render the aerial less directive.

In order to illustrate this point let us examine the electrical field in a horizontal plane of a square closed aerial (see Fig. 9).

Let the equation of the distribution of the current be:

$$i = I \cos \left(\frac{2\pi x}{\lambda} + \alpha \right).$$

Let the distance between the geometrical center of the aerial O and any point in space be equal d . The vertical component of the intensity of the field, created by wire A_1B_1 at this point is

$$E = - \frac{120\pi I}{\lambda d} \int_{2/h}^{3/2h} \cos \left(\frac{2\pi x}{\lambda} + \alpha \right) dx \cdot \sin \left(\frac{2\pi d}{\lambda} + \frac{2\pi t}{T} - \frac{\pi h}{\lambda} \cos \phi \right)$$

(we take as positive the direction of the current in the wire AB , and the image A_1B_1 is taken into consideration). Taking here

$$\frac{2\pi d}{\lambda} + \frac{2\pi t}{T} = F$$

and integrating, we get:

$$E_1 = - \frac{120I}{d} \cos \left(\frac{2\pi h}{\lambda} + \alpha \right) \sin \frac{\pi h}{\lambda} \sin \left(F - \frac{\pi h}{\lambda} \cos \phi \right).$$

Likewise for wire AB :

$$E_2 = \frac{120I}{d} \cos \left(\frac{\pi h}{\lambda} - \alpha \right) \sin \frac{\pi h}{\lambda} \sin \left(F + \frac{\pi h}{\lambda} \cos \phi \right).$$

The total intensity of the field is

$$E = E_1 + E_2 = \frac{240I}{d} \sin \frac{\pi h}{\lambda} \times \left[\cos \frac{2\pi h}{\lambda} \sin \left(\frac{\pi h}{\lambda} \cos \phi \right) \cos F \cos \alpha + \sin \frac{2\pi h}{\lambda} \sin \alpha \cos \left(\frac{2\pi h}{\lambda} \cos \phi \right) \sin F \right] = E_I + E_{II} \quad (6f)$$

where,

$$E_I = \frac{240I}{d} \sin \frac{\pi h}{\lambda} \cos \frac{2\pi h}{\lambda} \cos \alpha \sin \frac{\pi h \cos \phi}{\lambda} \cos F \quad (6g)$$

and,

$$E_{II} = \frac{240I}{d} \sin \frac{\pi h}{\lambda} \sin \frac{2\pi h}{\lambda} \sin \alpha \cos \frac{\pi h \cos \phi}{\lambda} \sin F. \quad (6h)$$

From the expressions (6f), (6g), and (6h) it follows that the vertical component of the intensity in a horizontal plane of the electrical field of a square closed aerial consists of two constituents E_I and E_{II} , having a phase difference of 90 degrees (since one includes $\cos F$ and the other $\sin F$). In practice the phase difference of E_I and E_2 can differ from 90 degrees. The component E_I changes with ϕ as does the radius vector of a figure-eight just as the field of an ideal closed aerial for points in a horizontal plane. For a direction perpendicular to the plane of the closed aerial ($\phi = 90$ degrees), its numerical value is zero; with $\phi = 0$ degrees it has its maximum. On the contrary E_{II} has its maximum at $\phi = 90$ degrees and its minimum with $\phi = 0$ degrees. With a sufficiently small h/x the value E_{II} changes when ϕ is changed along a curve whose shape resembles a circle, thus behaving like an open antenna.

At $\alpha = 0$

$$E_{II} = 0 \text{ and } E = E_I.$$

If in this case $h \ll \lambda$, then from the expression determining E_I (6g) after making the changes

$$\sin \frac{\pi h}{\lambda} = \frac{\pi h}{\lambda} \text{ and } \sin \frac{\pi h \cos \phi}{\lambda} = \frac{\pi h \cos \phi}{\lambda},$$

we obtain

$$E_I = \frac{120\pi I}{\lambda d} \cdot \frac{2\pi h^2}{\lambda} \cos \phi \cos F$$

i.e., the usual formula for the field of a closed aerial with a quasi stationary current. In Fig. 9 are given the curves E_I , E_{II} , and E for a square closed aerial at $\lambda = 2P = 8h$ and $\alpha = \pi/8$ (loop of current at point A_1).

All these deductions thus made with respect to the effect caused by displacement of the current maximum on the resulting electrical field of a square frame for points in a horizontal plane, can also be extended to other types of closed aerials, symmetrical with respect to the vertical. It is also easy to demonstrate the fact that, unlike the field of a closed aerial with a uniformly distributed current, the field in open space due to a symmetrical closed aerial with a non quasi stationary current, even with a symmetrical distribution of current, is free from the aerial constituent (E_{II}) of the component of the vector of intensity

of the electrical field, which is perpendicular to the plane under examination, only in respect to such a plane out of the ones perpendicular to the plane of the closed aerial, which is also perpendicular to the axis to which the aerial geometrically as well as electrically (distribution of current and potential) is symmetrical, and that in case of a non quasi stationary current, besides the component of the vector of the intensity of the electrical field, perpendicular to one or the other of the planes perpendicular to the plane of the closed aerial, there also exists a component of the vector which is parallel to the plane under examination.

If the closed aerial with a non quasi stationary current is not symmetrical with respect to the vertical axis, the vertical component of the intensity of its field for the direction perpendicular to the plane of the

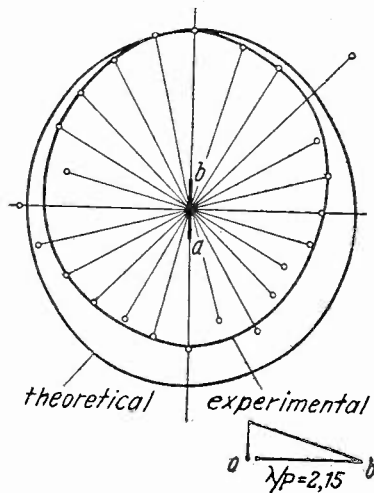

Fig. 10

aerial is not equal to zero when the current maximum is at the center of its perimeter. In this case the shape of the directional characteristic (in particular the ratio $E_{\phi=90 \text{ degrees}}/E_{\phi=0 \text{ degrees}}$) depends on the relation of the length of the wave to the perimeter, which can easily be proved by using the method adopted by us in the examination of the field of a square frame for points in the horizontal plane. In Fig. 10 are shown the theoretical directional characteristic and that obtained by experiment for a triangular unsymmetrical closed aerial for which $\lambda/P = 2.15$.

Below we shall confine ourselves to the examination of only those closed aerials which are most valuable in practice, i.e., to those which are symmetrical with respect to the vertical axis and in which the current maximum is at the central point of the upper element of the perimeter. The analysis of the field will be carried out only for points in the horizontal plane and at a given wavelength close to the theoretical

natural period, whereby the examination of the horizontal component of the vector of intensity of the electrical field will not be considered.

As the directional characteristic of the vertical component of intensity of the field for points in the horizontal plane for the cases under examination has the form of a figure-eight and is in contour similar to the curve $E = E_0 \cos \phi$, we consider it sufficient to confine ourselves to the calculation of the effective height of a closed aerial for a direction coinciding with its plane. It will be assumed that the current is distributed according to the law $i = I \cos 2\pi x/\lambda$ (taking $x=0$ at the center of the perimeter of the closed aerial).

(1) *Isosceles Triangle*. An isosceles triangle represents the simplest and most widely adopted form of a closed aerial. We, therefore, con-

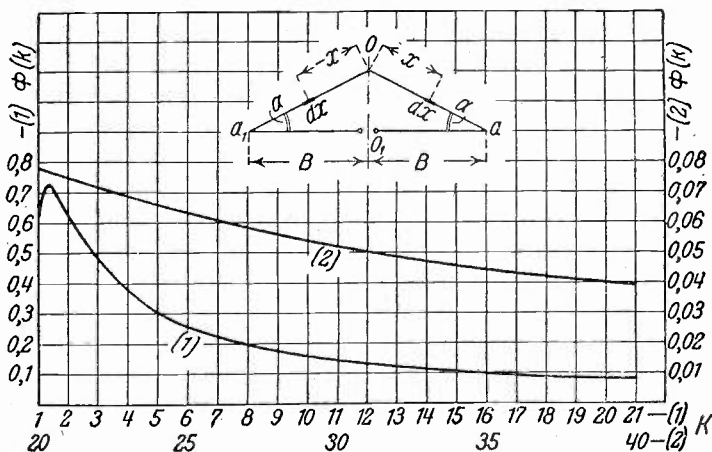

Fig. 11

sider it necessary to go into the solution of the problem of the effective height of an isosceles triangular closed aerial in some detail. Supposing the isosceles triangle oaa_1 (see Fig. 11) has a height h , a perimeter P , and the angle at the base α . Supposing the current maximum is at the central (upper) point of the perimeter of the triangle (O). This point will be taken as the origin of coördinates of the distribution curve of the current whose abscissa axis will be taken as coinciding with the sides of the triangle. Supposing that at a certain wavelength the equation of the distribution curve is $i_x = I\phi(x)$, where I is the maximum current and i_x the current at a point of the perimeter of the closed aerial which has the abscissa x , whereby $\phi(x) = \phi(-x)$, since it was decided to look on the distribution of the current as being symmetrical. Having determined the intensity of the field of the closed aerial under examination at some point of space (A) in the horizontal plane, and lying in the plane of the aerial, we shall compare it with the intensity of the field of an open earthed aerial, whose axis of symmetry coincides with the axis OO_1 of

the triangle. An element dx of the perimeter of the closed aerial, which we consider as being equivalent to a Hertz dipole, creates at point A an intensity of the electrical field

$$dE_1 = \frac{120\pi I \phi(x) dx \sin \alpha}{\lambda d} \sin \left(F + \frac{2\pi x}{\lambda} \cos \alpha \right),$$

where d is the distance between point A and the axis of symmetry of the triangle. (When calculating dE_1 the image of the element dx was taken into account).

In the same way the element dx_1 , lying opposite the element dx , creates at point A an intensity of the field

$$dE_2 = \frac{-120\pi I \phi(x) dx \sin \alpha}{\lambda d} \sin \left(F - \frac{2\pi x}{\lambda} \cos \alpha \right),$$

$$dE = dE_1 + dE_2 = \frac{240\pi I \sin \alpha}{\lambda d} \cos F \sin \left(\frac{2\pi x}{\lambda} \cos \alpha \right) \phi(x) dx.$$

The intensity of the field created by the whole aerial at point A is evidently equal to

$$E = \int_0^{0a} dE = \int_0^{h/\sin \alpha} dE = \frac{240\pi I \sin \alpha}{\lambda d} \times \cos F \int_0^{h/\sin \alpha} \sin \left(\frac{2\pi x}{\lambda} \cos \alpha \right) \phi(x) dx. \quad (7)$$

For an open earthed aerial we could write:

$$E = \frac{120\pi I}{\lambda d} h_g. \quad (7')$$

Comparing the expressions (7) and (7') we define the effective height of a triangular closed aerial as

$$h_{\text{eff}} = 2 \sin \alpha \int_0^{h/\sin \alpha} \sin \left(\frac{2\pi x}{\lambda} \cos \alpha \right) \phi(x) dx. \quad (8)$$

If the distribution of current follows the cosine law

$$i_x = I \cos \frac{2\pi x}{\lambda}; \quad \phi(x) = \cos \frac{2\pi x}{\lambda} = \cos \frac{2\pi x}{kP}$$

and then

$$h_{\text{eff}} = 2 \sin \alpha \int_0^{h/\sin \alpha} \sin \left(\frac{2\pi x}{kP} \cos \alpha \right) \cos \frac{2\pi x}{kP} dx_1$$

from which

$$h_{\text{eff}} = h \left[\frac{\sin^2 \frac{\pi}{2k} - \frac{\sin^2 \frac{\pi}{2k \cot^2 \alpha/2}}{\frac{\pi}{2k}}}{\frac{\pi}{2k}} \right] \tag{9}$$

or, since $\cot \alpha/2 = P/2h$,

$$h_{\text{eff}} = h \left[\frac{\sin^2 \frac{\pi}{2k} - \frac{\sin^2 \frac{\pi}{2k \left(\frac{P}{2h}\right)^2}}{\frac{\pi}{2k}}}{\frac{\pi}{2k}} \right] \tag{10}$$

Supposing

$$\frac{\sin^2 \frac{\pi}{2k}}{\frac{\pi}{2k}} = \phi(k) \tag{11}$$

we get

$$\frac{\sin^2 \frac{\pi}{2k \left(\frac{P}{2h}\right)^2}}{\frac{\pi}{2k \left(\frac{P}{2h}\right)^2}} = \phi(k_1) \tag{12}$$

where

$$k_1 = k \left(\frac{P}{2h}\right)^2, \tag{13}$$

and from this

$$h_{\text{eff}} = h [\phi(k) - \phi(k_1)]. \tag{14}$$

The function $\phi(k)$ is shown graphically in Fig. 11. At $k = 1.344$ it has its maximum equal to 0.732. Using Fig. 11 and the formula (14) it is not difficult to calculate the effective height of any closed aerial built in the form of an isosceles triangle.

Example. To compute the effective height of an isosceles triangular closed aerial having the following dimensions: $h = 24$ m, $P = 175$ m, $\lambda = 400$ m.

Solution.

$$\left(\frac{P}{2h}\right)^2 = \left(\frac{175}{2.24}\right)^2 = 13.3; \quad k = \frac{\lambda}{P} = \frac{400}{175} = 2.28;$$

$$k_1 = k\left(\frac{P}{2h}\right)^2 = (2.28)(13.3) = 30.4.$$

According to Fig. 11

$$\phi(k) = \phi(2.28) = 0.57; \quad \phi(k_1) = \phi(30.4) = 0.05$$

from whence

$$h_{\text{eff}} = h[\phi(k) - \phi(k_1)] = 24[0.57 - 0.05] \cong 12.5 \text{ m.}$$

Expanding the numerator $\phi(K)$, that is,

$$2 \sin^2 \frac{\pi}{2k} = 1 - \cos \frac{\pi}{k}$$

in a Maclaurin's series and then reducing, we get:

$$\phi(k) = \frac{\pi}{2k} - \frac{1}{4!} \left(\frac{\pi}{k}\right)^3 + \frac{1}{6!} \left(\frac{\pi}{k}\right)^5 - \frac{1}{8!} \left(\frac{\pi}{k}\right)^7 + \dots \quad (15)$$

Calculation shows that at $k > 7$, with an error not greater than 2 per cent, we can take

$$\phi(k) = \frac{\pi}{2k}.$$

Thus if k is great,

$$h_{\text{eff}} = h \left[\frac{\pi}{2k} - \frac{\pi}{2k \cotg^2 \frac{\alpha}{2}} \right] = h \left[\frac{\pi}{k} \cdot \frac{\cotg \alpha}{\cotg \frac{\alpha}{2}} \right].$$

This corresponds to the earlier statements, since

$$h \frac{\pi \cotg \alpha}{k \cotg \frac{\alpha}{2}} = \frac{2\pi S}{\lambda}$$

(see formulas (3) and (6), part A).

If the triangle is very obtuse angled ($B \gg h$), then $k_1 \gg k$ and $\phi(K) \gg \phi(k_1)$. In this case it is possible to take

$$h_{\text{eff}} = h\phi(k) \quad (16)$$

thus making the calculation still easier. For each value of k it is not difficult to find such a value of P/h , for which the calculation can be made according to the formula (16) with an error not exceeding n per cent. For this purpose it is sufficient to solve the equation

$$\left(1 - \frac{n}{100}\right) \phi(k_1) = \frac{n}{100} \phi(k).$$

The results of the solution of this problem for $n = 1$ per cent, 2 per cent, 3 per cent, 4 per cent, and 5 per cent are graphically shown in Fig. 12.

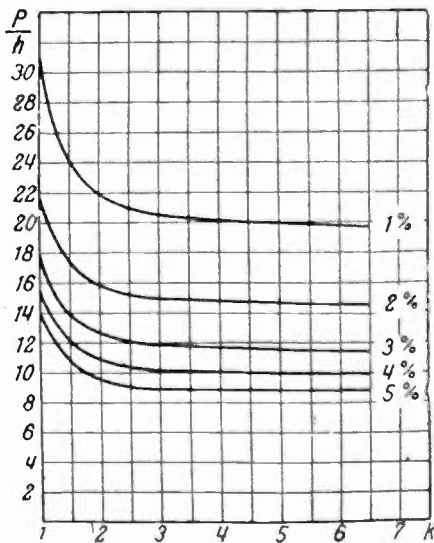

Fig. 12

This graph gives for different k the values P/h [(P/h) 1 per cent, (P/h) 2 per cent etc.] at which the calculation with a preciseness up to 1 per cent, 2 per cent, etc., can be made in accordance with (16).

Example. To compute the effective height of an isosceles triangular closed aerial on which $h = 7$ m, $P = 120$ m, $\lambda = 360$ m.

Solution. According to the graph of Fig. 12 we convince ourselves that with an error smaller than 2 per cent we can take:

$$h_{\text{eff}} = \phi(k); \phi(k) = \phi(3) \cong 0.475$$

$$h_{\text{eff}} = 7(0.475) \cong 3.33 \text{ m.}$$

Let us now try to find the conditions under which $h_{\text{eff}} = h[\phi(k) - \phi(k_1)]$ has its maximum. Making dh_{eff}/dk equal to 0 we get:

$$\begin{aligned} \frac{\pi}{k} \sin \frac{\pi}{k} + \cos \frac{\pi}{k} &= \frac{\pi}{k} \sin \left(\frac{\pi}{k} \text{tg}^2 \frac{\alpha}{2} \right) \\ &+ \text{cotg}^2 \frac{\alpha}{2} \cos \left(\frac{\pi}{k} \text{tg}^2 \frac{\alpha}{2} \right) + 1 - \text{cotg}^2 \frac{\alpha}{2}. \end{aligned}$$

This equation gives for every P/h (since P/h is a function only of α) the most useful value k , i.e., that at which h_{eff}/h has its maximum value. The solution of this equation is illustrated in Fig. 13 where for

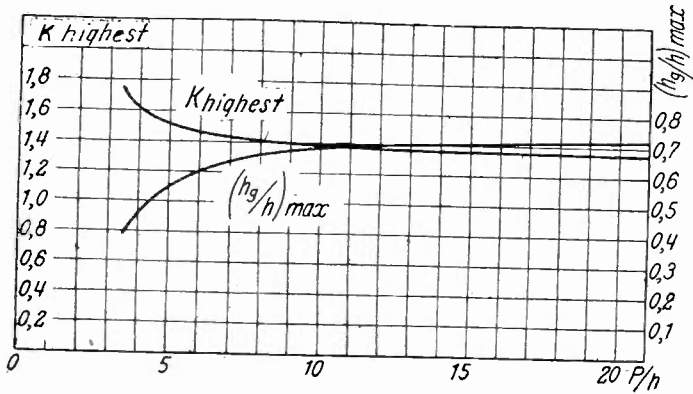

Fig. 13

different P/h are given the most useful values of k , (k_0), and quantities $(h_{\text{eff}}/h_{\text{max}})$ corresponding to them.

In Fig. 14 are given the values h_{eff}/h for different P/h and k .

All the above mentioned proves that with $k < 7$, and taking the effective height of the isosceles triangle in accordance with formula

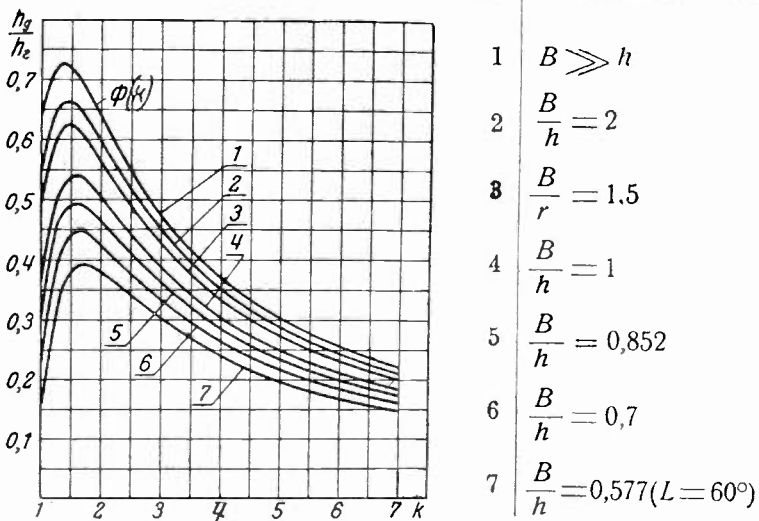

Fig. 14

$h_g = 2\pi S/\lambda$, we should make a more or less perceptible error in the direction of exaggerating h_{eff} . The formula for the effective height of an isosceles triangle, therefore, could be written also as:

$$h_{\text{eff}} = \frac{\beta 2\pi S}{\lambda} \tag{17}$$

where,

$$\beta = \frac{h_{\text{eff}}}{\frac{S}{2\pi \frac{\lambda}{\lambda}}} (\beta < 1).$$

The values β at different k for triangles with different P/h are given in Fig. 15.

As is evident from that figure the curves showing the dependence of β on the values of K for triangles of different form differ little from each other, at any rate for $k \geq 2$ and $\alpha \leq 45$ degrees. In this case, counting

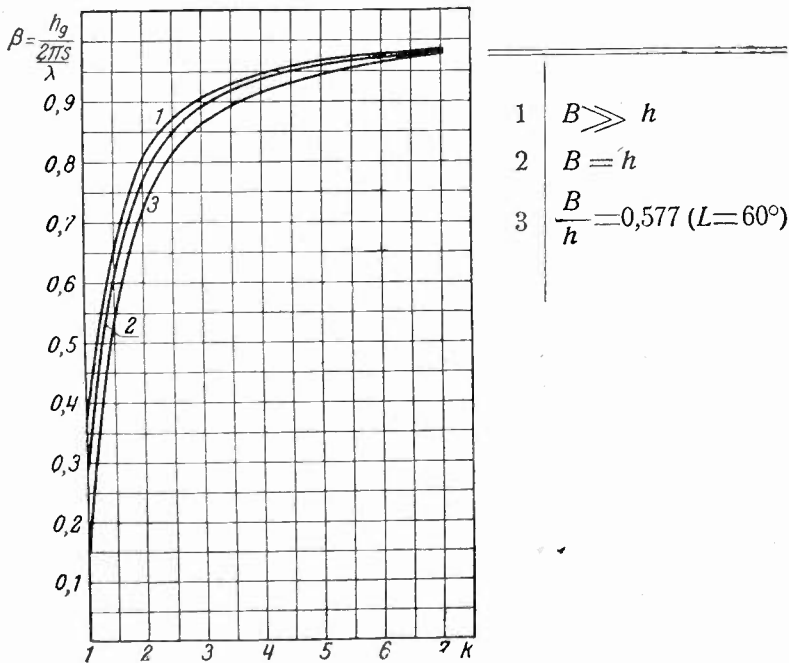

Fig. 15

along the curves 1 and 2 (see Fig. 15) we make an error not exceeding 4 per cent.

Supposing now that for our calculation of a closed system, having a given perimeter of aerial P , we are not limited with respect to the dimensions of the mast and can take h as large as is necessary. Taking into consideration that $P = 2hcot\alpha/2$, the formula for the effective height of an isosceles triangle, may be rewritten as:

$$h_{\text{eff}} = \frac{1}{2} P \operatorname{tg} \frac{\alpha}{2} \left[\phi(k) - \frac{1 - \cos\left(\frac{\pi}{k} \operatorname{tg}^2 \frac{\alpha}{2}\right)}{\frac{\pi}{k} \operatorname{tg}^2 \frac{\alpha}{2}} \right] \tag{18}$$

Making $dh_{\text{eff}}/d\alpha$ equal to zero, we find that h_{eff} has its maximum at:

$$\phi(k) = 2 \sin \frac{\pi}{k} \operatorname{tg}^2 \frac{\alpha}{2} - \frac{\sin^2 \frac{\pi}{2k} \operatorname{tg}^2 \frac{\alpha}{2}}{\frac{\pi}{2k} \operatorname{tg}^2 \frac{\alpha}{2}} \quad (19)$$

Solving this equation, we find for every k that value $(P/h)_0$, at which h_{eff}/P has a maximum and the respective value $(h_{\text{eff}}/P)_{\text{max}}$. The results are shown in Fig. 16. If, at given P and k , h is increased so as to give the maximum value h_{eff}/P possible with these values of P and k , further increase of h , results not in an increase, but in a diminution of the

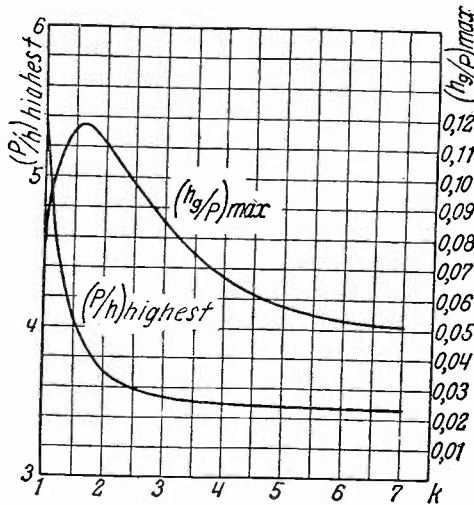

Fig. 16

effective height. The values h_{eff} obtained thus, can evidently be secured with a smaller h . The use of triangles with $P/h < (P/h)$ optimum therefore, appears to be inexpedient.

Example. For installing a closed isosceles triangular system with a perimeter $P=140$ m it is possible to use a mast suitable for an open aerial 100 m in height. To compute the height of the isosceles triangle h and the effective height of the closed aerial (h_{eff}) if the length of working a wave $\lambda=400$ m,

Solution.

$$k = \frac{\lambda}{P} = \frac{400}{140} = 2.85.$$

According to the graph of Fig. 16 we find: at $k=2.85$

$$\left(\frac{P}{h}\right)_0 = 3.55 \quad \text{and} \quad \left(\frac{h_{\text{eff}}}{P}\right)_{\text{max}} = 0.102,$$

from which:

$$h = \frac{P}{\left(\frac{P}{h}\right)_0} = \frac{140}{3.55} = 39.5 \text{ m};$$

$$h_{\text{eff}} = P \left(\frac{h_{\text{eff}}}{P}\right)_{\text{max}} = 140(0.102) = 14.3 \text{ m}.$$

The foregoing proves that in the examination of the relations between the length of the wave and the perimeter ($k \geq 1$) for any k , there exists such a value P/h , for which the perimeter of the triangle is used in the best possible way. The greatest usefulness of the perimeter $h_{\text{eff}}/P \cong 0.118$ we find at $k=1.62$ (see Fig. 16). This means that the effective height of a closed isosceles triangular aerial cannot be more than 0.118 of its perimeter.

It has already been stated above that the calculation of h for a closed aerial, assuming the distribution of the current to follow a cosine law along the length of its perimeter, can serve merely as a first ap-

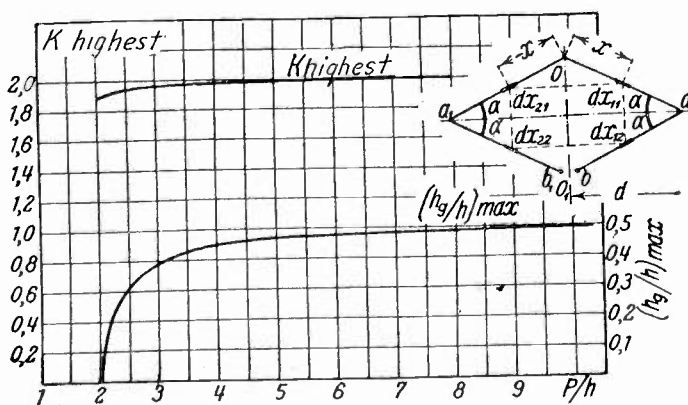

Fig. 17

proximation to the truth. The actual distribution of capacity and inductance along the perimeter of a closed aerial, of course, is not strictly uniform, and the distribution of current, therefore, obeys a more complicated law than the cosine law. To draw a true mathematical picture of the current in a closed aerial oscillating in a non quasi stationary manner is, in general, extremely difficult, as not only the geometrical form of the closed aerial but also its position with respect to the earth, is of influence. However, if the actual distribution of the current at a certain wavelength were obtained experimentally, then, using this information it would not be difficult to determine, with any desired precision, the effective height of a closed aerial at this wavelength. In the

case of an isosceles triangle it is sufficient to solve, with the required precision, the equation (7), when $\phi(x) = i_x/I$ for different x can be defined from the experimental distribution curve of the current. Using the distribution curves of the current, shown on Fig. 6 and in formula (8), (the integral being evaluated with the help of a planimeter) we determine h_{eff} and compare its value, obtained on the basis of actual distribution curves of the current, with its value obtained from the theoretical formula.

(2) *Rhombus*. Taking here, as also in the case of the isosceles triangle, the origin of the coördinates of the distribution curve of the current at the upper vertex O of the perimeter of the aerial, we locate on each side of the rhombus $baoa_1b_1$ (see Fig. 17) one element of the length of the perimeter in such a way that the elements dx_{11} , dx_{12} , dx_{21} , and dx_{22} would lie on the corners of a rectangle placed inside the rhombus, the sides of which are parallel to the axes of symmetry of rhombus OO_1 and aa_1 . If the distance of the elements dx_{11} and dx_{21} from point O are x and $-x$ (see Fig. 17) then the distances of the elements dx_{12} and dx_{22} from this spot are equal $P/2 - x$ and $-(P/2 - x)$, respectively. If the distribution of the current is cosinusoidal, the current, carried by the element dx_{11} , will be:

$$i_{11} = I \cos \frac{2\pi x}{kP},$$

where I is the current at the loop o ; the current, carried by element dx_{12} ,

$$i_{12} = I \cos \left[\frac{2\pi \frac{P}{2}}{kP} - \frac{2\pi x}{kP} \right] = I \cos \left(\frac{2\pi x}{kP} - \frac{\pi}{k} \right),$$

the sum of currents in the elements dx_{11} and dx_{12} ,

$$i_1 = i_{11} + i_{12} = I \left[\cos \frac{2\pi x}{kP} + \cos \left(\frac{2\pi x}{kP} - \frac{\pi}{k} \right) \right]$$

or,

$$i_1 = 2I \cos \frac{\pi}{2k} \cos \left(\frac{2\pi x}{kP} - \frac{\pi}{k} \right).$$

Evidently the sum of the currents, carried by elements dx_{21} and dx_{22} is the same, i.e.,

$$i_2 = 2I \cos \frac{\pi}{2k} \cos \left(\frac{2\pi x}{kP} - \frac{\pi}{2k} \right).$$

Let us determine the intensity of field E , produced by the four above mentioned elements at a certain point A , lying in the horizontal plane with the geometrical center of the aerial, as in the case of an isosceles triangle, and also in the plane of the aerial. Using the same method, as in the case of an isosceles triangle, we find that the sum of the intensities of the electrical field of the elements dx_{11} and dx_{12} at point A is:

$$dE_1 = \frac{120\pi \cdot 2I \cos \frac{\pi}{2k} \cos \left(\frac{2\pi x}{kP} - \frac{\pi}{2k} \right) \sin \alpha dx}{\lambda d} \\ \times \sin \left(F + \frac{2\pi x}{kP} \cos \alpha \right),$$

where d is the distance of point A from the center of the aerial and α , half the angle between the sides of the rhombus (see Fig. 17).

For the elements dx_{21} and dx_{22} we get in the same way:

$$dE_2 = - \frac{120\pi \cdot 2I \cos \frac{\pi}{2k} \cos \left(\frac{2\pi x}{kP} - \frac{\pi}{2k} \right) \sin \alpha dx}{\lambda d} \\ \times \sin \left(F - \frac{2\pi x}{kP} \cos \alpha \right).$$

The intensity of the field created at point A by all four elements combined is:

$$dE = dE_1 + dE_2 = \frac{480\pi I \sin \alpha}{\lambda d} \cos \frac{\pi}{2k} \cos F \\ \times \cos \left(\frac{2\pi x}{kP} - \frac{\pi}{2k} \right) \sin \left(\frac{2\pi x}{kP} \cos \alpha \right) dx.$$

Integrating this expression we determine the intensity of the field created by the whole aerial at point A :

$$E = \int_0^{P/4} dE = \frac{120\pi I}{\lambda d} h \cos \alpha \frac{\pi}{2k} \cos \frac{\pi}{2k} \\ \times \frac{\sin \left(\frac{\pi}{2k} \sin^2 \frac{\alpha}{2} \right) \sin \left(\frac{\pi}{2k} \cos^2 \frac{\alpha}{2} \right)}{\frac{\pi}{2k} \sin^2 \frac{\alpha}{2} \cdot \frac{\pi}{2k} \cos^2 \frac{\alpha}{2}}. \quad (20)$$

Comparing (20) with the formula of the field of a closed aerial (see (7')) we determine the effective height of a rhombic closed aerial with cosine distribution of the current:

$$h_{\text{eff}} = h \cos \alpha \cdot \frac{\pi}{2k} \cos \frac{\pi}{2k} \frac{\sin \left(\frac{\pi}{2k} \sin^2 \frac{\alpha}{2} \right)}{\frac{\pi}{2k} \sin^2 \frac{\alpha}{2}} \frac{\sin \left(\frac{\pi}{2k} \cos^2 \frac{\alpha}{2} \right)}{\frac{\pi}{2k} \cos^2 \frac{\alpha}{2}} \quad (21)$$

Giving the angle α in (21) certain values we seek those values for which h_{eff} at a given α , has its maximum, after which we calculate the corresponding values ($h_{\text{eff}}/h_{\text{max}}$).

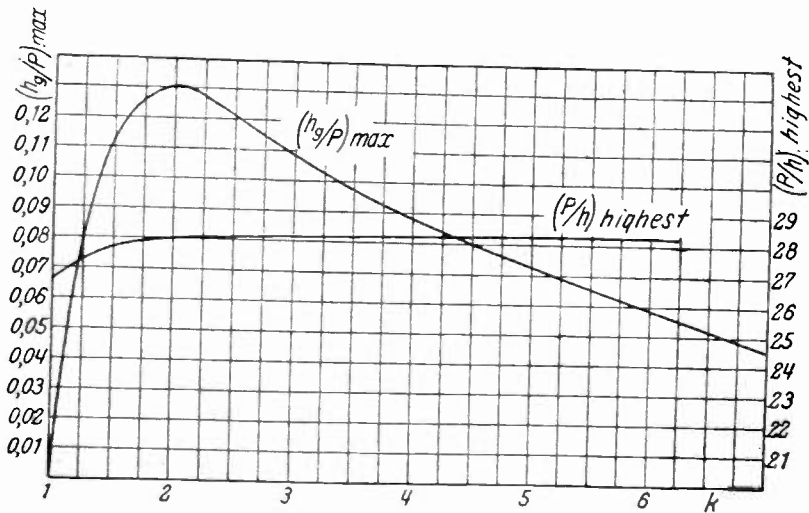

Fig. 18

In Fig. 17 the results of the solution of this problem are given. Since

$$P = \frac{2h}{\sin \alpha} \quad (22)$$

k as well as $(h_{\text{eff}}/h)_{\text{max}}$ can be presented as functions of the ratio $(P/h)_{\text{opt}}$ as is done on Fig. 17. Furthermore, taking (21) into consideration we write the formula for the effective height of a rhombic aerial

$$h_{\text{eff}} = P \frac{\sin 2\alpha}{4} \frac{\pi}{2k} \cos \frac{\pi}{2k} \frac{\sin \left(\frac{\pi}{2k} \sin^2 \frac{\alpha}{2} \right)}{\frac{\pi}{2k} \sin^2 \frac{\alpha}{2}} \times \frac{\sin \left(\frac{\pi}{2k} \cos^2 \frac{\alpha}{2} \right)}{\frac{\pi}{2k} \cos^2 \frac{\alpha}{2}} \quad (23)$$

Making use of this equation, we solve the problem of the most useful P/h at given k and P and variable geometrical height. Taking

$k = \text{const.}$ and $P = \text{const.}$ and placing equal to zero the derivative of h_{eff} with respect to α , we find that $P/h = (P/h)_0$ when

$$\cos \frac{\pi}{2k} + \frac{\pi}{2k} \cos \alpha \sin \left(\frac{\pi}{2k} \cos \alpha \right) \sin^2 \alpha - \cos \left(\frac{\pi}{2k} \cos \alpha \right) = 0. \quad (24)$$

Fig. 18 gives us the results of the calculation. This can be used in the same way as the analogous graph (Fig. 16) for an isosceles triangle.

The maximum usefulness of the perimeter of a rhombic closed aerial ($h_{\text{eff}}/P = 0.131$) is obtained when $k = 2$. Fig. 18 shows that to take $P/h < 2.67$ ($\alpha > 48$ degrees 30 minutes) is not practicable. This figure and Fig. 17 also show that there is no sense in taking $k < 1.95$.

Under these conditions ($k \geq 1.95, P/h \geq 2.67$), supposing the factor

$$\frac{\sin \left(\frac{\pi}{2k} \sin^2 \frac{\alpha}{2} \right)}{\frac{\pi}{2k} \sin^2 \frac{\alpha}{2}}$$

in (23) to be equal to one, we make an error not exceeding 0.6 per cent. In view of this we can take with sufficient precision:

$$h_{\text{eff}} = h \cos \alpha \cdot \frac{\pi}{2k} \cos \frac{\pi}{2k} \cdot \frac{\sin \frac{\pi}{2k} \cos^2 \frac{\alpha}{2}}{\frac{\pi}{2k} \cos^2 \frac{\alpha}{2}}$$

or,

$$h_{\text{eff}} = h \left(1 - \text{tg}^2 \frac{\alpha}{2} \right) \cos \frac{\pi}{2k} \sin \left(\frac{\pi}{2k} \cos^2 \frac{\alpha}{2} \right). \quad (25)$$

If $P \gg h$, then,

$$\cos^2 \frac{\alpha}{2} \cong 1; \text{tg}^2 \frac{\alpha}{2} \cong 0.$$

In this case,

$$h_{\text{eff}} = h \frac{\sin \frac{\pi}{k}}{2}. \quad (26)$$

If k is great, and

$$\cos \frac{\pi}{2k} \cong 1, \frac{\sin \left(\frac{\pi}{2k} \cos^2 \frac{\alpha}{2} \right)}{\frac{\pi}{2k} \cos^2 \frac{\alpha}{2}} \cong 1.$$

Then,

$$h_{\text{eff}} = h \cos \alpha \cdot \frac{\pi}{2k} = \frac{2\pi S}{\lambda}$$

Let us now write (21) in the following way:

$$h_{\text{eff}} = h \phi\left(\frac{P}{h}\right) \cdot \phi_1\left(\frac{P}{h}, k\right) \tag{27}$$

where,

$$\phi\left(\frac{P}{h}\right) = \cos \alpha \tag{28}$$

and,

$$\begin{aligned} \phi_1\left(\frac{P}{h}, k\right) &= \frac{\pi}{2k} \cos \frac{\pi}{2k} \cdot \frac{\sin\left(\frac{\pi}{2k} \sin^2 \frac{\alpha}{2}\right)}{\frac{\pi}{2k} \sin^2 \frac{\alpha}{2}} \\ &\times \frac{\cos\left(\frac{\pi}{2k} \cos^2 \frac{\alpha}{2}\right)}{\frac{\pi}{2k} \cos^2 \frac{\alpha}{2}} \end{aligned} \tag{29}$$

The calculations show that taking (at $k \geq 1.95$ and $P \geq 2.67$)

$$\phi_1 = \frac{1}{2} \sin \frac{\pi}{k} \tag{30}$$

We make an error of only 3 per cent in the worst case, the values being too small. In practice, therefore, it is considered safe to take for $k \geq 1.95$ and $P/h \geq 2.67$

$$h_{\text{eff}} = h \frac{1}{2} \sin \frac{\pi}{k} \cos \alpha \tag{31}$$

Figs. 19 and 20 give the dependence of $\cos \alpha$ on P/h and $\sin \pi/k/2$ on k .

Presenting the formula for the effective height of a rhombic closed aerial in form of $h_{\text{eff}} = \beta 2\pi S/\lambda$ and taking into consideration (6') (part 1) and (31) we get:

$$\beta = \frac{\sin \frac{\pi}{k}}{\frac{\pi}{k}} \tag{32}$$

(See Fig. 20)

From what has gone before we can draw the following conclusion:

(1) A rhombic aerial allows of a greater maximum usefulness of the perimeter than an isosceles triangular one.

(2) The utilization of the geometrical height of the system with an isosceles triangular system is greater than in the case of a rhombic one.

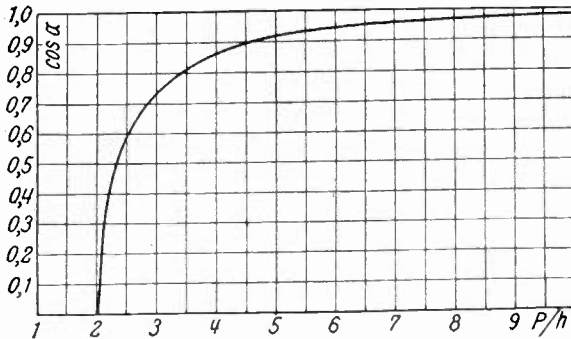

Fig. 19

(3) The effect of a non quasi stationary current on the effective height is greater in case of a rhombic system than in case of an isosceles triangular one.

In Fig. 20 are given the values h_{eff}/h of a rhombic closed aerial at different k for $P/h = 2.67$ and for $P \gg h$. The corresponding curves for the intermediate values P/h lie between the two given curves.

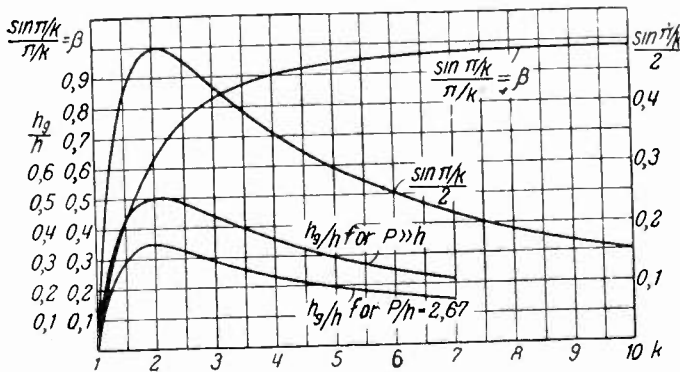

Fig. 20

(3) *Rectangle*. Making the same assumption as in the previous cases and using the same method as above, we easily find for a rectangle $oabcc_1b_1a_1$ (see Fig. 21)

$$E = \int_0^h \frac{240\pi I}{\lambda d} \cos\left(\frac{2\pi x}{\lambda} + \frac{\pi b}{\lambda}\right) \sin \frac{\pi b}{\lambda} \quad (33)$$

$$= \frac{240\pi I}{\lambda d} \cos \frac{\pi(b+h)}{\lambda} \sin \frac{\pi b}{\lambda} \frac{\sin \frac{\pi h}{\lambda}}{\frac{\pi h}{\lambda}};$$

from which and also from (7') we get

$$h_{\text{eff}} = 2h \cos \frac{\pi(b+h)}{\lambda} \sin \frac{\pi b}{\lambda} \frac{\sin \frac{\pi h}{\lambda}}{\frac{\pi h}{\lambda}}. \quad (34)$$

Supposing,

$$h = k_2 \frac{P}{2}$$

and, therefore,

$$b = (1 - k_2) \frac{P}{2} \quad (35)$$

we find,

$$h_{\text{eff}} = 2h \cos \frac{\pi}{2k} \sin \left[\frac{\pi}{2k}(1 - k_2) \right] \frac{\sin \frac{\pi k_2}{2k}}{\frac{\pi k_2}{2k}} \quad (36)$$

or,

$$h_{\text{eff}} = P \frac{\cos \frac{\pi}{2k}}{\frac{\pi}{2k}} \sin \left[\frac{\pi}{2k}(1 - k_2) \right] \sin \left(\frac{\pi}{2k} k_2 \right). \quad (37)$$

Making the derivative of the right-hand side of (37) with respect to k_2 equal to zero, we find that at given P and k the ratio h_{eff}/P has its maximum at $k_2 = \frac{1}{2}$, i.e., at $b = h$ (square). In this case the formula takes the following form:

$$h_{\text{eff}} = P \frac{\cos \frac{\pi}{2k}}{\frac{\pi}{2k}} \sin^2 \frac{\pi}{4k}. \quad (38)$$

Making the derivative of the right-hand side of the equation with respect to k equal to zero, we get

$$\frac{\pi}{2k} \left(\sin \frac{\pi}{k} - \sin \frac{\pi}{2k} \right) = \cos \frac{\pi}{2k} - \cos^2 \frac{\pi}{2k}, \quad (39)$$

and solving the equation we find that the right-hand side of (8) has a maximum at $k = 1.89$. The value h_{eff}/P corresponding to this k is:

$$\left(\frac{h_{\text{eff}}}{P_{\text{max}}}\right) = 0.1325.$$

And thus, at $b = h$ and $k = 1.89$ the perimeter of a rectangular aerial appears to be the most completely utilized. The maximum value possible of the effective height of a rectangular closed aerial is equal to 0.1325 of its perimeter. Fig. 21 shows the dependence h_{eff}/P on k under the most useful (optimal) employment of the perimeter of the aerial at every k , i.e., at $b = h$.

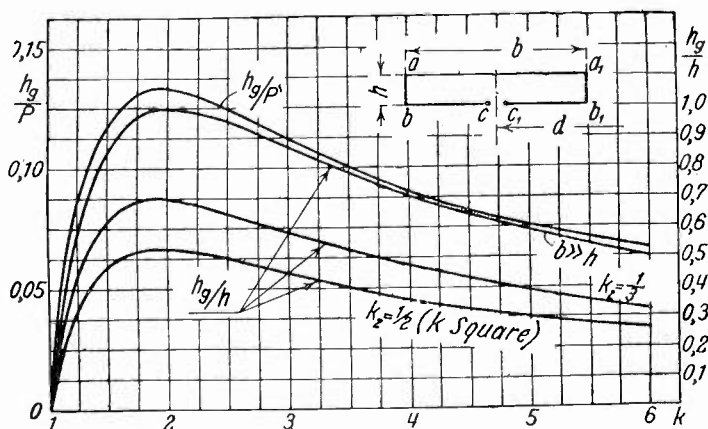

Fig. 21

We find that on increasing b/h the most useful value of k increases, changing from 1.89 to 2. This statement will not be shown here, but the discussion will be limited to an examination of the special case, when $b \gg h$. In this case, in view of the smallness of $k_2 = 2h/P$, making

$$\sin \frac{\pi k_2}{2k} = \frac{\pi k_2}{2k} \quad \text{and} \quad \sin \frac{\pi}{2k}(1 - k_2) = \sin \frac{\pi}{2k}$$

we can rewrite (37) thus:

$$h_{\text{eff}} = h \sin \frac{\pi}{k}. \quad (40)$$

It is not difficult to see that at $k = 2$ the effective height of a very thin ($b \gg h$) rectangle has a maximum equal to the geometrical height of the system ($h_{\text{eff}} = h$). This is a case when the geometrical height of a closed rectangular system is the same as that for the best utilization of the perimeter. Fig. 21 gives the values h_{eff}/h for $b \gg h$ as well as $b = h$ and $b = 2h$.

The above, taken with the following table, in which the maximum possible relations of the effective height to the perimeter and the geometrical height of the system, in the case of the three forms of antenna examined by us, are given, proves that out of the three configurations examined, the most useful appears to be the rectangle.

TABLE I

	$\frac{h_{eff}}{P}$	$\frac{h_{eff}}{h}$
Isosceles triangle	0.1180	0.732
Rhomb	0.1310	0.500
Rectangle	0.1325	1.000

However, the installation of a closed aerial, built in the form of a rectangle, requires no less than two masts; this makes a rectangular aerial considerably less convenient than a triangular, rhombic, or any

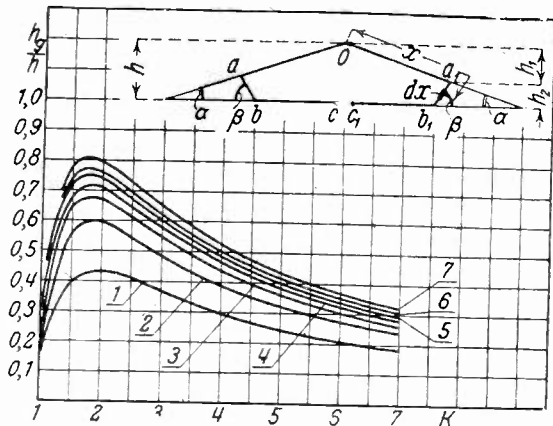

Fig. 22

other kind of closed aerial, a considerable number of which can be attached to one mast. This circumstance has to be especially considered in the case of station systems consisting of several closed aerials (a most frequent case in practice), these stations being of a portable type. The problem of building a closed aerial in such a way as to enable one to install a considerable number of aerials on one mast and to get the most use out of it, leads to the adoption of a pentagonal aerial.

(4) *Pentagon, Symmetrical in Respect to the Vertical Axis.* In general a pentagonal aerial is a kind of combination of a triangular and a rectangular one; the upper half (wires ao and a_1o ; see Fig. 22) forms a triangular aerial oaa_1 with the geometrical height h_1 . The lower half on the other hand, having the geometrical height h_2 (wires ab and a_1b_1) as to its contour in most cases resembles very much a rectangle.

The effective height of the pentagon $oabb_1a_1$, evidently, is the sum of the effective heights of its upper half oaa_1 , and the lower abb_1a_1 :

$$h_{\text{eff}} = h_{\text{eff}_1} + h_{\text{eff}_2} \tag{41}$$

where h_{eff_1} is the effective height of the triangle oaa_1 and h_{eff_2} the effective height of trapezium aba_1b_1 .

The value h can easily be determined as the effective height of a triangle, the perimeter of which is $P_1 = oa + aa_1 + oa_1$ and the geometrical height h_1 . Having defined P_1 and fixed $k_1 = \lambda/P_1$ we shall find:

$$h_{\text{eff}_1} = h_1 [\phi(k_1)] - [\phi(k_{11})] \tag{42}$$

where $k_{11} = k_1(P_1/2h_1)^2$ and both values of the function ϕ are determined from the graph on Fig. 11.

When calculating the effective height h_{eff_2} of the lower part of the perimeter, taking into consideration the figures on Fig. 22 and putting $oa = oa_1 = x_1$ and $oa + ab = oa_1 + a_1b_1 = x$ and adopting the usual method, we find:

$$dE = \frac{240\pi I}{\lambda\alpha} \sin \beta \cos F \cos \frac{2\pi x}{\lambda} \sin \frac{2\pi}{\lambda} [x_1(\cos \alpha + \cos \beta) - x \cos \beta] dx$$

from which,

$$E = \int_{x_1}^{x_2} dE$$

and,

$$h_{\text{eff}_2} = \frac{\lambda}{120\pi I} \int_{x_1}^{x_2} dE = h_2 \left\{ \frac{\sin \left[\frac{\pi}{\lambda} (x_2 - x_1) (1 - \cos \beta) \right]}{\frac{\pi}{\lambda} (x_2 - x_1) (1 - \cos \beta)} \right. \\ \left. \frac{\sin \left[\frac{\pi}{\lambda} 2x_1 (\cos \alpha + \cos \beta) + (x_1 + x_2) (1 - \cos \beta) \right]}{\frac{\pi}{\lambda} (x_2 - x_1) (1 + \cos \beta)} \sin \left[\frac{\pi}{\lambda} 2x_1 (\cos \alpha + \cos \beta) \right] \right. \\ \left. - (x_1 + x_2) (1 + \cos \beta) \right\} \tag{43}$$

Very often it is possible with sufficient precision to consider:

$$\frac{\sin \left[\frac{\pi}{\lambda}(x_2 - x_1)(1 - \cos \beta) \right]}{\frac{\pi}{\lambda}(x_2 - x_1)(1 - \cos \beta)} = 1$$

$$\frac{\sin \left[\frac{\pi}{\lambda}(x_2 - x_1)(1 + \cos \beta) \right]}{\frac{\pi}{\lambda}(x_2 - x_1)(1 + \cos \beta)} = 1.$$

In this case (43) presents itself in the following rather simple form:

$$h_{\text{eff}} = h_2 2 \cos \left[\frac{\pi}{\lambda}(x_1 + x_2) \right] \sin \frac{\pi A}{\lambda} \tag{44}$$

where A is the middle line of trapezium aa_1b_1b .

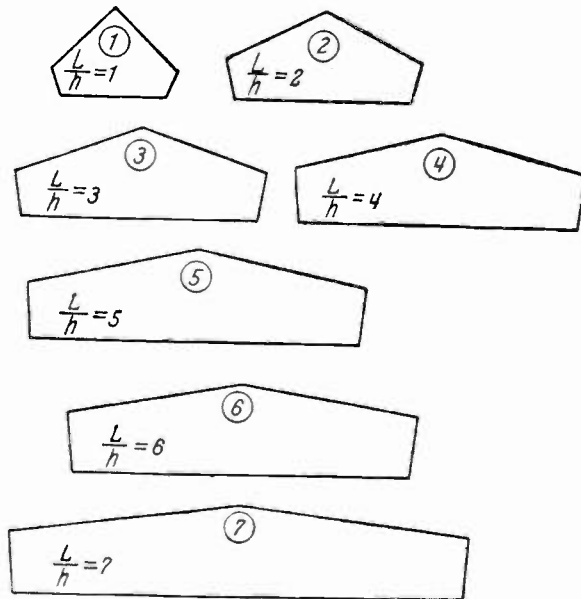

Fig. 23

In Fig. 22 are given the results of the adaption of (41) and (43) to the configurations of closed aerials from the group of pentagons with the most useful n (see Fig. 4). The drawing gives the dependence of value h_{eff}/h on k for the pentagons with different L/h shown in Fig. 23 (see Fig. 4), and the most useful value n at a given L/h .

AUTOMATIC TIME-DELAY RELAY*

BY

C. HUFF

(Department of Terrestrial Magnetism, Carnegie Institution, Washington, D.C.)

Summary—The design of an automatic time-delay relay is described. For certain types of mercury-rectifier tubes no plate voltage should be applied for at least one-half minute after the filament current is turned on if the peak inverse potential exceeds 2100 volts. During a six-months' test of this relay on a special radio transmitter it has not failed to function at any time.

THE problem of conveniently supplying a constant high voltage for the plate circuits of transmitting sets, and other types of apparatus requiring potentials of a similar character, has been met by the development of the hot-cathode, mercury-rectifier tubes of the 866, 872, 869, and 857 types.

In using the type-866 mercury-rectifier tubes it is important that no plate voltage be applied for at least one-half minute after the filament current is turned on if the peak inverse potential exceeds 2100 volts. In a transmitter constructed at the Department of Terrestrial Magnetism of the Carnegie Institution of Washington, which employs four of these tubes in two rectifier banks, the keying is accomplished by breaking the primary circuit of the transformer supplying the plate current for the amplifiers. The plate potentials for the oscillator and *C*-bias are furnished by a separate transformer. Secondaries of both of these transformers are fed into type 866 tubes in the conventional manner.

The necessary time-delay control and operation of these circuits are brought about by employing a combination of relays and a Telechron clock motor as shown in Fig. 1 and the schematic diagram of Fig. 2.

This consists of a No. 410 "Dunco" standard relay, a No. 466 "Dunco" relay with an auxiliary contact which closes when the main contacts open, and a Telechron clock with bakelite cams attached to the one-minute shaft.

The schematic diagram as drawn shows a condition of operation where the main switch has just been closed and the sequence of operation may be started by pressing the "on" button. Now if we close the "on" button momentarily the main relay will close, the circuit being through 2, 16, 15, 10, 9, 8, 7, magnet coil, 6, resistor, 4, 3, 1. The closing of this relay, however, does not close the primary circuits of either

* Decimal classification: 621. 383. 21. Original manuscript received by the Institute, March 20, 1931.

transformer, as one side of the main circuit is still open through the heavy silver contacts 17 and 18 of the Telechron relay. It will be noted here that these silver contacts only make the circuit, and never break

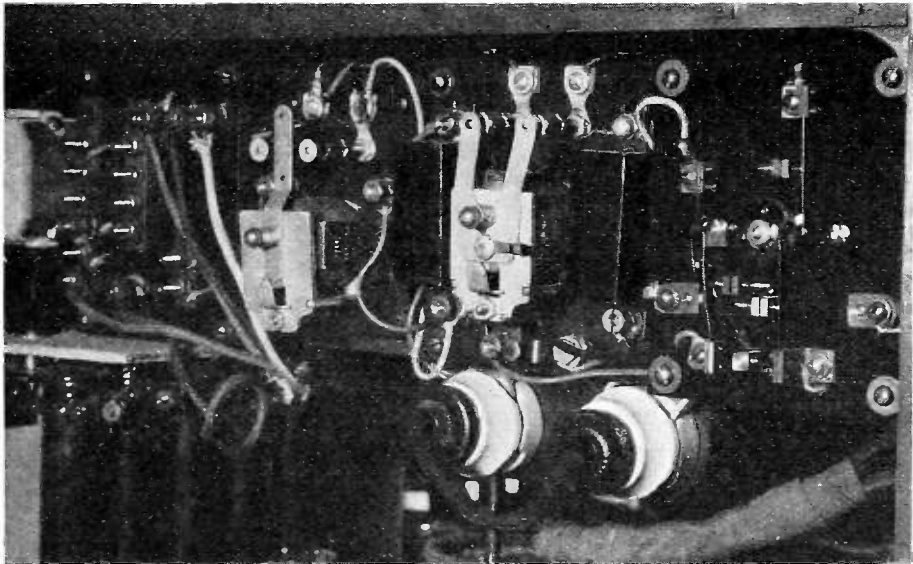

Fig. 1—Time-delay relay as installed in radio transmitter.

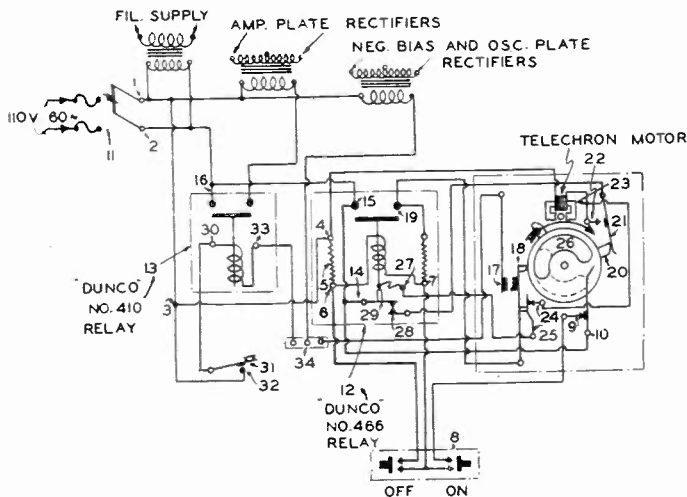

Fig. 2—Schematic diagram of connections for time-delay relay.

it, the break always occurring at the contacts 15 and 19 on the main relay.

When the main relay closes, the Telechron motor starts by way of the circuit, 1, 3, 4, motor, 23, 24, 25, 27, 15, 16, 2. It will continue to run for one-half minute until the cam lobe 20 closes the silver contacts 17 and 18 and opens the Telechron circuit at 24. The contact spring 18

is insulated from the contact spring 25; both, however, move together. As the cam lobe 20 moves forward, contact 21 closes, but as the main relay is now closed this circuit is broken at 28 and 29. The function of these contacts is to advance the cam to the starting position automatically when the current is restored after having been cut off either accidentally or through the operation of the "off" button at any point between positions 18 and 20 of the cam lobe. The circuit is 1, 3, 4, motor, 21, 28, 29, 15, 16, 2.

Cam lobe 26 prevents the closing of the main relay at any point between the starting point 20 and circuit closing point 18 by opening the "on" control circuit at 9 and 10. However, if the current is cut off at any position between these two points either by opening the main switch or pressing the "off" button, on restoration of the current, as explained in the previous paragraph, the cam will automatically return to the starting position.

The main circuit then is closed through 18 and 17, bus 34, where it divides, going through the primary of the oscillator and *C*-supply transformer and to the keying relay, 13.

Should the main current be interrupted before the cam lobe 20 has completed its half-minute movement, and remain off for any length of time, it will not be possible to close the main relay 12 on cold filaments by means of the "on" button because the "on" control circuit has been opened between 9 and 10 by the cam lobe 26.

However, the cam will rotate because the Telechron circuit is now completed through 1, 3, 4, motor, 22, 21, 28, 29, 14, 15, 16, 2. The main circuit will still remain open even though contacts 17 and 18 will close for a few seconds while the cam lobe 20 is passing them because it is still not possible to close the "on" control-circuit on account of the arrangement of cam lobe 26. Under these circumstances, as soon as contacts 17 and 18 are open and 24 and 25 are closed, it will be possible to close the main relay 12 because the "on" control circuit is again complete at 9 and 10. If then the "on" button is pressed at this time, the cam will continue to rotate without further interruption until the main contacts 17 and 18 close.

The "off" button operates directly on the main relay by shorting out the holding coil at points 5 and 7.

This device has been in daily use for about six months, has been used repeatedly during tests of the transmitter, and has not failed at any time. No special thought is required on the part of the operator in using this device, the "off" button or main switch being used at will in shutting down the transmitter.

NOTE ON THE PIEZO-ELECTRIC QUARTZ OSCILLATING CRYSTAL REGARDED FROM THE PRINCIPLE OF SIMILITUDE*

BY

ISSAC KOGA

(Assistant Professor, Tokyo University of Engineering, Tokyo, Japan).

Summary—It is pointed out that the principle of similitude in the vibrating periods of an *æolotropic* elastic body has several useful applications. As an example the case of *X*-waves in *X*-cut quartz plates, is discussed.

A NUMBER of valuable papers on the piezo-electric quartz oscillating crystal have already been published, and yet the present writer believes that it will not be useless to give some suggestions in connection with its practical problems.

Everyone knows that the principle of similitude offers sometimes a very convenient means for the treatment of dynamical problems, but the following rather simple theorem has not yet been recognized distinctly or at least taken advantage of in the problem of the piezo-electric quartz oscillating crystal.

The theorem: "If the configurations of the two homogeneous *æolotropic* elastic bodies of a certain substance be geometrically similar when their crystallographic axes are faced in the same orientations, the ratio of the vibrating periods of the two bodies for a certain mode of vibration is equal to the ratio of their linear dimensions."

This theorem may be expressed in a much more general form, but the writer thinks it superfluous for the present purpose.

To illustrate it more concretely in a practical example, it can be stated that, if two *X*-cut quartz oscillating crystals are similar in their geometrical configurations, the periods of *X*-vibrations, *Y*-vibrations and *Z*-vibrations are all proportional to their linear dimensions.

This theorem can be proved easily by reasoning similar to that given by Lord Rayleigh,¹ though he did not mention it explicitly.

To show the usefulness of this theorem, a few examples of its application are given below.

(1) If, after some experimental trial, a special quartz oscillating crystal, of very small temperature coefficient^{2,3} or of single period⁴ be

* Decimal classification: 537.65 Original manuscript received by the Institute, March 13, 1931.

¹ Lord Rayleigh, *The Theory of Sound*, 1926, Macmillan, London, Vol. 2, Chap. 22, *Vibrations of Solid Bodies*, §381; p. 429, *Principle of Dynamical Similarity*.

² I. Koga, "Influence of temperature upon the frequency of quartz oscillat-

obtained, another crystal of the same kind, with any desired period, may be manufactured easily.

(2) The dependence of frequency upon geometrical form, with given orientations of the crystallographic axes, can be expressed in concise manner. Fig. 1 shows the dependence of the period of X -waves upon the thickness of X -cut crystal plates, reduced to the relation for plates of unit diameter. This result was collected from experiments on a large number of X -cut circular crystal plates of different diameters. The writer believes that all the similar diagrams published hitherto should have been given in the same way. The dependence of the so-called wave

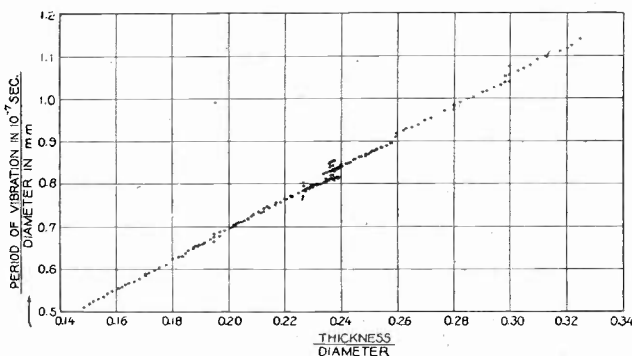

Fig. 1

constant upon the dimensions can also be expressed in a convenient form if all things be reduced to the relation for plates of unit thickness. Typical diagrams thus prepared will give instantly the accurate dimensions of new plates for any given oscillating period and shape.

(3) Irregularities in the orientations of crystal plates, referred to the crystallographic axes, as supplied by any dealer, can be checked easily by preparing curves as shown in Fig. 1 plotted with data furnished by that maker.

In closing the present paper, the writer wishes to acknowledge his indebtedness to Mr. S. Matsumura of the Electrotechnical Laboratory of the Ministry of Communications in preparing the figure.

ing crystal" Supplementary Issue, *Jour. I. E. E.* (Japan), pp. 1-3, April, 1929.

³ W. A. Marrison, "High precision standard of frequency," *Proc. I. R. E.*, 17, 1105-1122, July, 1929; *Bell Sys. Tech. Jour.* 8, 493-514; July, 1929.

⁴ I. Koga, "Piezo-electric quartz Oscillating crystal with single frequency," presented by Dr. H. Nagaoka at the meeting of the U. R. S. I., 1928 in Brussels.



THE MULTIPLE REFRACTION AND REFLECTION OF SHORT WAVES*

BY N. H. EDES

(Captain, Royal Signals, Catterick Camp, Yorkshire, England)

Summary—This paper discusses the theory that normal long-distance short-wave communication is brought about by a series of refractions and reflections. It shows how, if we know the "range/best wavelength" characteristic for ranges which entail only one "hop" of the rays, we can predict the best wavelength for any larger range necessitating a number of hops, it being assumed that propagation conditions, such as ionic distribution, remain the same throughout all those ranges.

Single-hop characteristics given by the author in a previous paper¹ are used in this way to derive the characteristic for longer ranges in daylight. The result is in close accord with a curve given by Lloyd Espenschied² which shows the result of actual experiment over long ranges. For conditions of darkness the present theory cannot be fully tested owing to incompleteness of the data over short ranges, but general agreement is indicated. It is shown that the theory helps to account for the phenomenon of "fading," and for dissimilarities in reception at stations situated a few miles apart, but both receiving from the same sending station. Suggestions are made as to future research.

It is thought that multiple refraction and reflection is the most satisfactory explanation of the effects met with in the course of ordinary short-wave communication at long ranges.

THEORIES TO ACCOUNT FOR SIGNALS AT LONG RANGES

THE theories hitherto propounded to account for the long-distance communication obtainable by means of short waves are three in number. The first supposes that the waves are refracted or reflected by some agency outside the earth's atmosphere. The second pictures the waves as entering the Kennelly-Heaviside layer, traveling along in it for a considerable distance, reëmerging and striking the earth. The third supposes that the waves are successively refracted or reflected by the layer, reflected at the earth's surface, turned back by the layer again, and so on, thus proceeding round the curvature of the globe in a series of "hops."³

* Decimal classification: R113.6. Original manuscript received by the Institute November 29, 1930.

¹ N. H. Edes, "Some experiences with short-wave wireless telegraphy," Proc. I.R.E., 18, 2011-2032; December, 1930.

² Lloyd Espenschied, "Technical considerations involved in the allocation of short waves; frequencies between 1.5 and 30 megacycles," Proc. I.R.E., 16, 773-777; June, 1928.

³ See, for instance, A. Hoyt Taylor, "Relation between the height of the Kennelly-Heaviside layer and high-frequency radio transmission phenomena," Proc. I.R.E., 14, 521-540; August, 1926; and many other writers, notably T. L. Eckersley.

In this paper it is proposed to discuss to what extent the principle enunciated in the third theory is able to account for the observed phenomena.

METHOD OF INVESTIGATION

Short-wave signaling is, *par excellence*, a method giving a high value of the ratio of range obtainable to power input. Consequently it is chiefly employed over very long ranges, and most of the available data have been accumulated on channels working over some thousands of miles. According to the theory under discussion the waves might make a number of hops in such journeys.

The method pursued in this paper is to assume that we know the propagation characteristics over the ranges necessitating only one hop, and from them to derive the characteristics for the longer ranges.

THE GENERAL CASE

Suppose for simplicity that the propagation conditions (e.g., distribution of ionic density, atmospheric pressure, temperature etc.) are uniform throughout spherical surfaces concentric with the earth in the region between the sending and receiving stations. And suppose that the (purely hypothetical) curve in Fig. 1 represents the "range/best wavelength" characteristic for that region under the given conditions, for one hop.

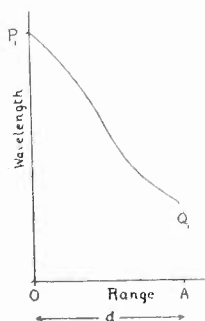

Fig. 1

It is assumed that the right-hand extremity of the curve represents the greatest range d obtainable with only one hop. For the present we shall simply assume that we know where the curve ends.

For a range x lying between d and $2d$ we are dependent on at least two hops. And rays that have hopped twice will give better signals than rays that have hopped three or more times; for they have followed a shorter path, and each hop entails absorption and scattering at the processes of reflection or refraction by the layer and reflection by the earth. The best wavelength for the range x will therefore be

given by that ordinate on the curve of Fig. 1 which corresponds to an abscissa $1/2 x$.

Similarly, for values of x between $2d$ and $3d$ at least three hops are required, and the best wavelength will be given by the ordinate corresponding to an abscissa of $2x/3$. For values of x between $(n-1)d$ and nd the corresponding abscissa will be $(n-1/n) \cdot d$.

It will be seen, therefore, that the complete range best wavelength characteristic for any range will be as shown in Fig. 2.

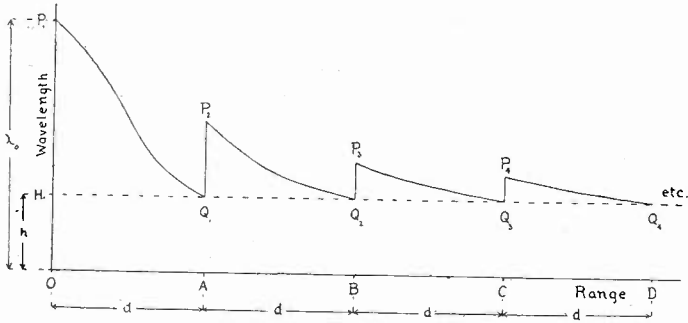

Fig. 2

For ranges between $(n-1)d$ and nd (i.e., for n hops) the curve is one n th, measured along AO , of the single-hop curve, but with the horizontal scale increased n -fold. At long ranges the curve approaches the horizontal line drawn through the point which represents the wavelength for the maximum range of one hop; and to derive an accurate curve for the longer ranges we must know accurately the right-hand portion of the curve for a single hop.

SPECIAL CASE OF LINEAR CHARACTERISTIC

Should the range/best wavelength curve for a single hop happen to be a straight line, the curve for any range can be obtained by a simple geometrical construction.

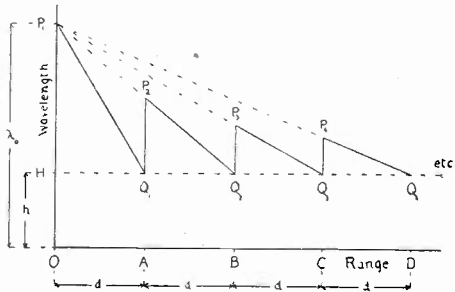

Fig. 3

In Fig. 3 let P_1Q_1 be the curve for a single hop. Through Q_1 draw a horizontal straight line and mark off on it distances HQ_1 , Q_1Q_2 , Q_2Q_3

... etc., each representing d the limiting range for one hop. Join $P_1Q_2, P_1Q_3, P_1Q_4 \dots$ etc., to meet the ordinates through $Q_1, Q_2, Q_3 \dots$ etc., in $P_2, P_3, P_4 \dots$ etc., Then $P_1Q_1P_2Q_2P_3Q_3P_4Q_4 \dots$ etc., is the best wavelength characteristic for any range. (The proof follows easily from considerations of similar triangles.)

If we take a range between $(n-1)d$ and nd , at least n hops are required, as we have seen; but communication may also be possible by means of a greater number of hops. This will apply particularly at the longer ranges. Therefore, in the case of a falling characteristic such as we have assumed, communication will be possible (but not so good) with wavelengths higher than those given by Fig. 3.; it is, in fact, known that communication at the longer ranges normally takes place by virtue of rays of several different orders.⁴ But, owing to "skip" effect, signal strength will fall off rapidly as we lower the wavelength below that given by the figure. The ranges most difficult to provide for will be those of which the representations fall near the discontinuities Q_1, Q_2, Q_3, \dots etc. Thus, although the figure indicates the best wavelength for any range, the curve giving the lowest useful wavelength lies only just beneath it. If we wish to draw a smooth approximate best wavelength curve for the longer ranges we must therefore draw it through the points P .

If $OP_1 = \lambda_0$ and $OH = h$, the coördinates of P_n are:

$$x = (n-1)d, \quad y = h + \frac{\lambda_0 - h}{n}.$$

By elimination of n we get as the equation of the curve:

$$x(y-h) + dy = d\lambda_0,$$

a rectangular hyperbola having as asymptotes the line HQ and the line $x+d=0$. Transferred to the center $(-d, h)$ as origin, the equation becomes:

$$xy = d(\lambda_0 - h)$$

$$\text{i.e., } xy = d \cdot HP_1.$$

It is possible that the single-hop characteristic P_1Q_1 may continue till it meets the range-axis; in other words it may be such that Q_1 lies on the range-axis, and that greatest range in a single hop is to be obtained by making the wavelength vanishingly small. In such a case h becomes zero, and further simplification results.

⁴ T. L. Eckersley, "Multiple signals in short-wave transmission," Proc. I.R.E., 18, 121; January, 1930.

QUANTITATIVE APPLICATION OF THE THEORY

In the PROCEEDINGS for December, 1930, the present author gave some range/best wavelength diagrams* for the zone of latitude 30 degrees to 40 degrees North, for ranges up to about eight hundred miles. The most reliable diagrams were those for summer daylight and winter daylight, which proved to be approximately straight lines. From the nature of the daylight curves and their freedom from discontinuities it seems clear that they represent the characteristics for one hop. Unfortunately, partly owing to the lower wavelength limit of the sets in use, it had not been possible to carry the investigation far enough to find the maximum range obtainable with a single hop. If, in the absence of direct evidence to the contrary, we assume that reducing the wavelength to the vanishing point would have given a continuous increase in range we get, by extrapolation, values of d for summer daylight and winter daylight of approximately 1105 and 1210 miles respectively. The corresponding values of λ_0 are 51.7 and 52.0 meters. Fig. 4 shows the points $P_2P_3 \dots P_5$ obtained by the method of the preceding paragraph, h being taken to be zero.

In the PROCEEDINGS for June, 1928, Lloyd Espenschied gave curves showing the limits within which the transmitting frequency must lie in order to provide communication over ranges varying from 1000 to 7000 miles by day and by night. His curve for upper limiting frequencies for daylight has been converted into one for lower limiting wavelengths and plotted in Fig. 4.

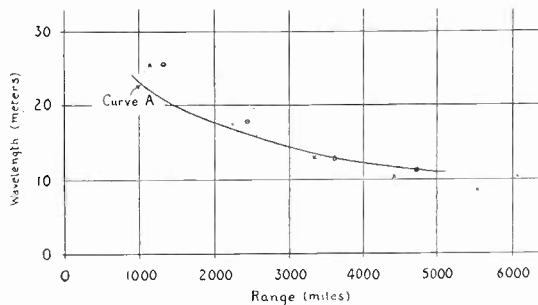

Fig. 4—Daylight

Points for summer, by author's method, shown by \times

Points for winter, by author's method, shown by \circ

Lower limiting curve, derived from Espenschied's paper, shown as Curve A.

It will be seen that the results given by the present theory are in close general accord with those of Espenschied. It is true that the assumptions we have made as to the value of h and in the act of extrap-

* NOTE: These diagrams appear at the end of this paper, and show shaded areas which were not included in the original reproduction.

olating are not fully warranted. Nevertheless, even if the daylight curve for one hop does not continue quite as assumed, the general form of the curve for the long ranges will still be very much as shown in Fig. 4, and it is thought that the agreement with Espenschied's curve is more than mere coincidence.

The curves obtained by the author for summer darkness and winter darkness⁵ are not so amenable to this treatment. The summer dark-

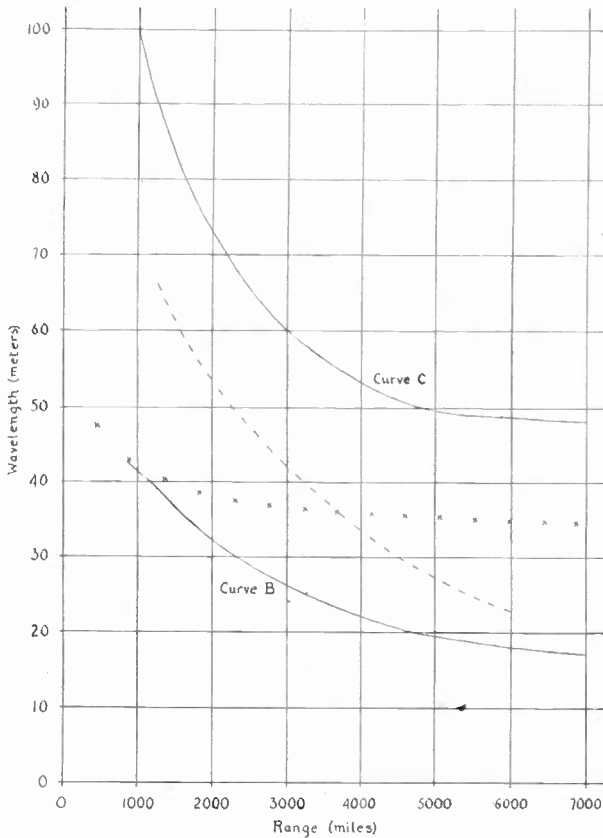

Fig. 5—Darkness

Points for summer, by author's method, shown by ×

Suggested form of curve for winter, shown by — — — — —

Lower limiting curve, derived from Espenschied's paper, shown as Curve B.

Upper limiting curve, derived from Espenschied's paper, shown as Curve C.

ness curve, because it has a turning point at a range of about 460 miles, hints at a value of about 460 for d , but the shape of the curve between 460 and 800 miles does not seem to bear this out. But from the experiences over links of several thousand miles described in the same paper⁵ we know that the curve descends again at longer ranges. It possesses, therefore, something of the undulating nature predicted by the present theory.

⁵ Edes, *loc. cit.*

In the diagram for winter darkness⁶ no best wavelength curve was ascertained.

In Fig. 5 Espenschied's limiting curves for darkness are plotted in terms of range and wavelength. Points are also plotted, by the method already described, to show the "smoothed" best wavelength curve obtained from the author's curve for summer darkness,⁵ taking the curve's suggestion of $\lambda_0 = 62.5$, $d = 460$, $h = 32.7$. The curve so obtained seems to be nearly tangential to the lower limiting curve *B*. Possibly the curve for winter darkness, if ascertained, would go somewhat as shown by the dotted line. The curve for darkness would thus swing in the space between curves *B* and *C* as the seasons changed. But it would not meet curve *C* since this is the *upper* limiting curve. It should be added that Espenschied's curves are only intended to be approximate boundaries applicable, for instance, to the allocation of different wave bands to different services. Similarly in the theory given here the smoothed curves are simply an approximate guide applicable to the longer ranges. The accurate best wavelength curve would exhibit discontinuities such as those described in the previous paragraphs.

COROLLARIES TO THE THEORY

If the principle of the theory outlined above be accepted it leads to several further considerations.

In the first place, the propagation conditions are never likely to be uniform everywhere between a given pair of sending and receiving stations (indeed over long ranges they cannot be, owing to difference of latitude or difference in local time of day, or both), nor will they remain constant from instant to instant. Thus the best wavelength characteristic will not be so geometrically perfect as we have assumed, and, moreover, the positions of the discontinuities Q_1 , Q_2 , \dots etc., will be perpetually varying even in the space of a few seconds. This will not matter much if the variation is not too great, and if the range does not approximate to any one of the distances represented by OA , OB , \dots etc., (Fig. 2). But should the range approximate to one of these values the effects will be serious: for even if the sending wavelength is suitable for one instant it will not be so for the next, because of the shift of the discontinuity in the neighbourhood of that particular range. This would account for the phenomenon of "fading";⁶ and it would also account for the nonsimultaneous fading of a sending station at two receiving stations situated a few miles apart, or for reception at the first receiving station being much worse than at the second on one

⁶ See also J. K. Clapp, "Some experiments in short distance short-wave radio transmission," *Proc. I.R.E.*, 17, 484; March, 1929.

wavelength but much better on another.⁷ From the theory, it would seem that, for a given set of propagation conditions, there is a series of "unfortunate" ranges—unfortunate for the reasons already given. And it would seem that an important long-distance short-wave service which is required to furnish continuous communication should possess at least two receiving stations at either terminal, far enough apart to ensure that if on any day a discontinuity is, so to speak, sweeping backwards and forwards past one of them, the other is unmolested in this respect. The two receiving stations should, of course, be situated roughly along the great circle direction to the distant terminal.

It must be remembered, however, that these effects will be masked to some extent (a) by the wavelength tolerance in the characteristics for one hop, i.e., the width measured parallel to the λ -axis of the shaded strips in the author's diagrams here quoted,⁸ and (b) by the superimposing of signals from rays that have hopped a larger number of times than the minimum. The tolerance mentioned in (a) is greater in darkness than in daylight, and the masking effect (b) will be greater at the longer than at the shorter ranges.

Furthermore, evidence is required as to how short a wavelength is effective for a single hop, and as to whether waves of this length suffer serious absorption at successive refractions and reflexions. There is some evidence that wavelengths below about 8 to 10 meters by day and 20 meters on winter nights are not of much value for long-distance work.⁹

SUGGESTIONS AS TO FURTHER RESEARCH

It seems that a fruitful field for research would be the exploration of the ranges (a) from, say, 800 to 2500 miles in daylight, particular attention being paid to the shorter wavelengths, and to the existence and position of any discontinuity in the characteristic, and (b) from, say, 0 to 2500 miles in darkness at all seasons, particularly with a view to finding the curves for best wavelength and upper limit of wavelength.

The results, especially of (b), may be expected to depend on the zone of latitude in which the experiments are carried out.

Measurements of this kind should throw further light on the physical structure of the upper atmosphere.

⁷ See, for instance, the example quoted by L. B. Turner, "A review of progress in radio-telegraphy and radio-telephony," *Proc. Wireless Section I.E.E.* (London), 2, 43; March, 1927.

⁸ Edes, *loc. cit.*

⁹ Eckersley, *loc. cit.*, pp. 116 and 122.

CONCLUSION

This paper is admittedly somewhat conjectural. But it is thought that evidence has been advanced to show that the theory of multiple refraction and reflection fully accounts for the main phenomena of long-distance propagation. That is not to say that other theories are altogether incorrect. As has been shown by several writers, these other theories appear necessary in order to explain such phenomena as long delay echoes; but the author thinks that they are less likely to be applicable to the more ordinary results met with in the course of everyday short-wave signaling.¹⁰ Equally he thinks that the theory here advanced to account for fading is not necessarily at variance with other theories (such as that of the rotation of the plane of polarization). Many causes are probably at work simultaneously, now one preponderating, now another.

¹⁰ Cf. Eckersley, *loc. cit.*, pp. 118 and 122.



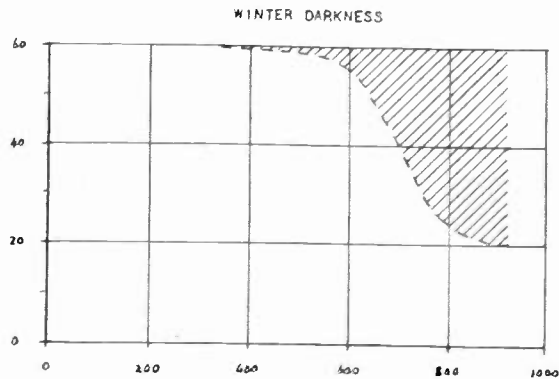
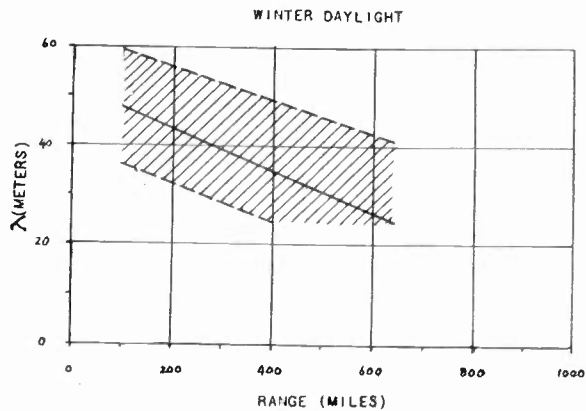

↑
UPPER WAVELENGTH LIMIT
OF SETS IN USE

N.B. CURVE OF BEST WAVELENGTH
WAS NOT DETERMINED

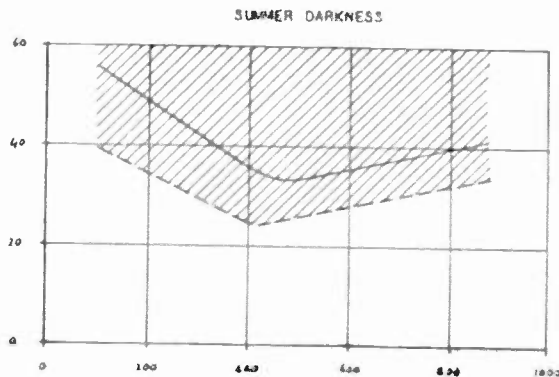
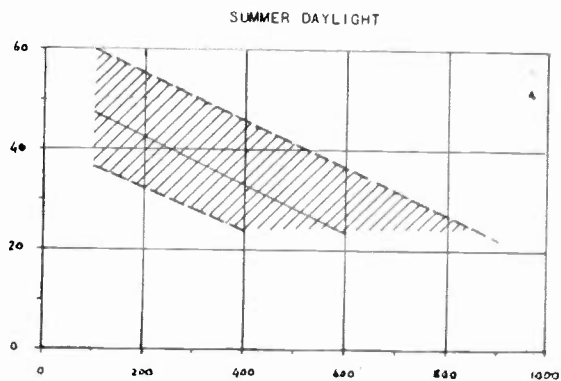

↑
UPPER WAVELENGTH LIMIT
OF SETS IN USE

↘ THESE CURVES MUST
DESCEND AGAIN AT LONGER RANGES

Fig 7

BIBLIOGRAPHY ON RADIO WAVE PHENOMENA AND MEASUREMENT OF RADIO FIELD INTENSITY*

PREPARED BY THE BUREAU OF STANDARDS¹

These references are divided approximately among the following subjects indicated by the section headings:

Radiation
Radio Wave Phenomena
Fading
Daily Variations, Seasonal Variations
Direction Variations
Meteorological, Geophysical, and Cosmical Effects
Eclipses
Reflection, Refraction, Diffraction, Absorption, Polarization
Kennelly-Heaviside Layer
Wave Front Angle
Transmission Formulas
Atmospheric Disturbances, Strays
Directional Properties
Intensity (Field Intensity, Signal Intensity, Noise, etc.)

The number at the left of each section heading classifies the subject in accordance with the subject classification system given in Bureau of Standards Circular No. 385, "Classification of radio subjects; an extension of the Dewey decimal system," which appeared in full on pages 1433-1456 of the August, 1930, issue of the PROCEEDINGS of the Institute of Radio Engineers.

ABBREVIATIONS USED

A.I.E.E., J.—Journal of the American Institute of Electrical Engineers.

Ann. de Physique—Annales de Physique.

Ann. d. Physik—Annalen der Physik.

Annales des P.T.T.—Annales des Postes, Télégraphes et Téléphones.

Arch. f. Elektrot.—Archiv für Elektrotechnik.

Bureau of Standards Tech. Papers—Bureau of Standards Technical Papers.

Bureau of Standards Sci. Papers—Bureau of Standards Scientific Papers.

Bureau of Standards Jnl. of Research—Bureau of Standards Journal of Research.

Bell System Techn. J.—Bell System Technical Journal.

* Decimal classification: R055×R113. Original manuscript received by the Institute, January 6, 1931.

¹ This compilation was made largely by T. Parkinson, S. S. Kirby, P. N. Arnold, and Miss E. M. Zandonini. Publication approved by Director, Bureau of Standards, U. S. Department of Commerce.

- Bull. Bureau of Standards*—Bulletin of the Bureau of Standards.
Bull. Nat. Research Council—Bulletin of the National Research Council.
Cambridge Phil. Soc., Proc.—Proceedings of the Cambridge Philosophical Society.
Comptes Rendus—Comptes Rendus Hebdomadaires des Séances de l'Académie des Sciences.
Deutsch. Phys. Gesell. Verh.—Deutsche Physikalische Gesellschaft Verhandlung.
Electrot. Laborat. Tokyo, Japan, Researches—Researches of the Electrotechnical Laboratory, Electrotechnical Laboratory, Ministry of Communications, Tokyo, Japan.
El. Rev.—The Electrical Review.
El. Rev. & W.E. News—Electrical Review & Western Electric News.
El. World—Electrical World.
E.N.T.—Elektrische Nachrichten-Technik.
E.T.Z.—Elektrotechnische Zeitschrift.
E.u.M.—Elektrotechnik und Maschinenbau.
Experimental Wireless—Experimental Wireless and the Wireless Engineer.
Elec. Wld. & Engineer—Electrical World and Engineer.
Frank. Inst., J.—Journal of the Franklin Institute.
Gen. El. Rev.—General Electric Review.
I.E.E., J.—Journal of the Institution of Electrical Engineers.
I.E.E., J. (Japan)—Journal of the Institute of Electrical Engineers (Japan).
Jahrb. d. drahtl. Tel.—Jahrbuch der drahtlosen Telegraphie.
Journ. Sci. Instruments—Journal of Scientific Instruments.
Journ. Telegraph.—Journal Télégraphique.
La T.S.F. Moderne—La Télégraphie Sans Fils Moderne.
Lumière Elec.—Lumière Électrique.
Marconi Rev.—Marconi Review.
Monthly Weather Rev.—Monthly Weather Review.
Nat. Acad. Sci., Proc.—Proceedings of the National Academy of Sciences.
Natl. Research Council Bull.—Bulletin of the National Research Council.
Onde Élec.—L'Onde Électrique.
Phil. Mag.—The London, Edinburgh and Dublin Philosophical Magazine and Journal of Science.
Phil. Trans.—Philosophical Transactions.
Phys. Rev.—The Physical Review.
Phys. Soc., Proc.—Proceedings of the Physical Society of London.
Phys. Zeits.—Physikalische Zeitschrift.
P.O.E.E., J.—The Post Office Electrical Engineers' Journal.
Proc. American Philosophical Soc.—Proceedings of the American Philosophical Society.
Proc. I.R.E.—Proceedings of the Institute of Radio Engineers.
Proc. Third Pan-Pacific Science Congress, Tokyo—Proceedings of the Third Pan-Pacific Science Congress, Tokyo.

Q.S.T. Français—*Q.S.T. Français et Radioélectricité.*

Radio Rev.—Radio Review.

R.G.E.—Revue Générale de l'Électricité.

Roy. Meteorolog. Soc., J.—Quarterly Journal of the Royal Meteorological Society.

Roy. Soc., Proc.—Proceedings of the Royal Society of London.

Sci. Amer.—Scientific American.

Sci. Papers Inst. Phys. & Chem. Research, Tokyo (Japan)—Scientific Papers of the Institute of Physical and Chemical Research, Tokyo (Japan).

Soc. Franç. Élect. Bull.—Bulletin de la Société Française des Électriciens.

Terr. Mag.—Terrestrial Magnetism and Atmospheric Electricity.

T.F.T.—Telegraphen und Fernsprech Technik.

Washington Acad. Sci., J.—Journal of the Washington Academy of Sciences.

Wireless World and Radio Rev.—Wireless World and Radio Review.

Zeits. f. Hochfrequenztechn.—Jahrbuch der drahtlosen Telegraphie und Telephonie. Zeitschrift für Hochfrequenztechnik.

Zeits. f. techn. Physik—Zeitschrift für technische Physik.

R112.1—Radiation

1. Optimum wave length in radio telegraphy. A. H. Taylor. *Phys. Rev.*, 1, 321-325; April, 1913.

2. Radiated and received energy in radio telegraphy. L. W. Austin. *Proc. American Philosophical Soc.*, 52, 407-419; April 19, 1913.

3. The nature of electromagnetic radiation employed in radio telegraphy and mode of propagation. G. W. O. Howe. *Electrician*, 71, 965-969; September 19, 1913. In German in *Jahrb. d. drahtl. Tel.*, 8, 221-235, 1914.

4. The mechanism of radiation and propagation in radio communication. F. Lowenstein. *Proc. I.R.E.*, 4, 271-281; June, 1916.

5. On the wave length and radiation of loaded antennae. B. van der Pol, Jr. *Phys. Soc., Proc.*, 29, 269-289, 1916.

6. Verification expérimentale d'une formule de la théorie des radiocommunications. (Experimental verification of a formula on the theory of radio communication.) L. Bouthillon. *Annales des P.T.T.*, 5, 443-447, 1916.

7. On the interpretation of early transmission experiments by Commandant Tissot and their application to the verification of a fundamental formula in radio transmission. L. Bouthillon. *Proc. I.R.E.*, 6, 221-224; August, 1918.

8. Principles of radio transmission and reception with antenna and coil aerials. J. H. Dellinger. Bureau of Standards Sci. Papers No. 354, 1919.

9. Measurements of the radiation from aerials and their effective heights. G. Vallauri. *Radio Rev.*, 2, 77-85, 138-143, 179-187, 1921. In Italian in *Elettrotecnica*, 8, 213-218, 233-237; April, 1921.

10. Drahtlose Energieübertragung. (Wireless transfer of energy.) F. von Vogel. *Jahrb. d. drahtl. Tel.*, 19, 197-205; March, 1922.

11. Notes on wireless matters. The radiation of wireless waves. G. W. O. Howe. *Electrician*, 90, 386; April 13, 1923. (A nontechnical discussion of what happens a quarter wave length from the transmitting aerial, the field being separated into oscillation and radiation components.)

12. On the optimum transmitting wave length for a vertical antenna over perfect earth. S. Ballantine. *Proc. I.R.E.*, 12, 833-839; December, 1924.

13. Mesures de rayonnement des stations radiotelegraphiques. (Measurement of radiation from radio transmitting stations.) R. Mesny. *Soc. Franç. Élect. Bull.*, 5, 143-156, 1925.

14. Die Berechnung der Strahlungsvorgänge. (Electromagnetic radiation.) F. Kiebitz. *T.F.T.*, 15, 7-10, 1926.

15. High angle radiation of short electric waves. S. Uda. *Proc. I.R.E.*, 15, 377-385; May, 1927.

16. Strahlungsdichte und Empfangsfläche. (Radiation density and receiving surface.) M. Dieckmann. *Zeits. f. Hochfrequenztechn.*, 31, 8-15; January, 1928.

17. Über das Verhalten der radiotelegraphischen Wellen in der Umgebung des Gegenpunktes der Antenne und über die Analogie zu den Poissonschen Beugungserscheinungen. (On the behavior of radio waves in the vicinity of the image point of the antenna and on the analogy to refraction phenomena due to Poisson.) J. Gratsialos. *Ann. d. Physik*, 86, 1041-1061; August, 1928. (The electric potential at the image point of a transmitting set and in the vicinity is derived, based on the theory of Watson. This gives expressions for the electric and magnetic field.)

18. Das Verhalten kurzer Wellen in unmittelbarer Nähe des Senders. (Behavior of short waves in the immediate neighborhood of the transmitter.) J. Fuchs. *Zeits. f. Hochfrequenztechn.*, 32, 170-171, 1928. Comment by Pedersen, 33, 66, 1928. (Systematic observations carried out on a number of short wave transmitters show that certainly at distances up to 7 km from the transmitter, and probably still farther, there is a definite dependence of the measured field strength on the illuminating power of the sun's rays.)

19. Strahlung von Antennen unter dem Einfluss der Erdbodeneigenschaften; (a) elektrische Antennen, (b) magnetische Antennen, (c) Rechnung in zweiter Näherung. (Radiation from antennas and effects of the earth's influence.) M. J. O. Strutt. *Ann. d. Physik*, 1, 721-722, 1929. Abstracted in *Experimental Wireless*, 6, 351-352; July, 1929. (A thorough discussion of the radiation characteristics of both horizontal and vertical antennas, especially of the doublet type.)

20. The wave band—theory of wireless transmission. J. A. Fleming. *Nature* (London), 125, 92; January 18, 1930. (The concept of the radiation of a modulated carrier wave as the radiation of waves of frequencies distributed over a band is questioned.)

21. The physical reality of side-bands. F. M. Colebrook. *Nature* (London), 125, 726-727; May 10, 1930. (Experimental evidence is presented of the physical reality of the added radio frequencies attributed to the modulation of a carrier wave. Resonance curves are presented showing peaks at the carrier frequency and other peaks at frequencies corresponding to the carrier frequency plus and minus the modulating frequency. The method used in obtaining the curves is outlined.)

R113.—Radio Wave Phenomena

22. Electric waves. Hertz. (Book.) Translated by D. E. Jones. McMillan Co., 1900.

23. On some phenomena affecting the transmission of electric waves over the surface of the sea and earth. H. B. Jackson. *Roy. Soc., Proc.*, 70, 254-272, 1902.

24. Über die Fortpflanzung ebener elektromagnetischer Wellen längs einer ebener Leiterfläche und ihre Beziehung zur drahtlosen Telegraphie. (Propagation of plane electromagnetic waves along a plane conducting surface and its bearing on the theory of transmission in radiotelegraphy.) J. Zenneck. *Ann. d. Physik*, 23, 846-866, 1907.
25. A study of the propagation and interception of energy in wireless telegraphy. C. A. Culver. *Phys. Rev.*, 25, 200-223, 1907; 3, 282-286, 1914.
26. Die Ausbreitung ebener elektromagnetischer Wellen längs eines geschichteten Leiters besonders in den Fällen der drahtlosen Telegraphie. (Propagation of plane electromagnetic waves along a stratified conductor with special reference to the conditions of radio telegraphy.) F. Hack. *Ann. d. Physik*, 27, 43-63, 1908.
27. Störende und fördernde einflüss bei der übertragung elektrischer Wellen. (Hindering and assisting influences in wireless transmission.) P. Schwartzhaupt. *E.T.Z.*, 31, 113-114; February 3, 1910. *Electrical Engineering*, 45, 239; February 25, 1910.
28. Some quantitative experiments with coupled high-frequency circuit. L. W. Austin. *Bull. Bureau of Standards*, 7, No. 3, 1911. Reprint No. 158. In German in *Jahrb. d. drahtl. Tel.*, 5, 75-106, 1911; 12, 185-192, 1917.
29. Telegraphie sans fil a grandes longueurs d'ondes. (Wireless telegraphy on long wave lengths.) *Annales des P.T.T.*, 3, 380; December, 1912. *Lumière Élec.*, 22, 45-46; April 12, 1913. In German in *T.F.T.*, 2, 11-12; April 10, 1913.
30. Quantitative results of recent radio telegraphic tests between Arlington, Va., and U.S.S. Salem. J. V. L. Hogan. *El. World*, 61, 1361-1366; June 21, 1913 *Electrician*, 71, 720-723, 1913.
31. Über die Ausbreitung der Wellen in der drahtlosen Telegraphie auf der Erdkugel. (On the propagation of waves in wireless telegraphy on the earth's surface.) W. V. Rybczynski. *Ann. d. Physik*, 41, 191-208, 1913.
32. Quantitative experiments on radio telegraphic transmission. L. W. Austin. Reprint 226 from *Bull. of Bureau of Standards*, 11, 69-86, 1914. Abstracted in German in *Jahrb. d. drahtl. Tel.*, 8, 575-594; August, 1914.
33. Aus dem Gebiete der drahtlosen Messtechnik. (Measurements in wireless telegraphy.) C. J. DeGroot. *Jahrb. d. drahtl. Tel.*, 8, 109-132, 1914.
34. Propagation of waves. E. Thomson. *Gen. El. Rev.*, 18, 316-327; May, 1915.
35. Long distance transmission. L. Cohen. *Electrician*, 76, 743-744; February, 1916.
36. Sustained wave receiving data. L. F. Fuller. *Proc. I.R.E.*, 4, 305-306; June, 1916.
37. Explorations Hertzienne entre Toulon et Tahiti. (Hertzian explorations between Toulon and Tahiti.) M. Guierre. *Soc. Franc. Elect. Bull.*, 10, 247-268, 1920.
38. La theorie et la pratique des radiocommunications. Vol. II—La propagation des ondes electromagnetiques à la surface de la terre. (Book.) (The propagation of electromagnetic waves on the earth's surface.) L. Bouthillon. Delagrave—Paris, 1921.
39. Discussion on long distance wireless transmission. Jackson, Round, T. L. Eckersley, and others. *I.E.E., J.*, 59, 677-692, 1921.
40. Mesures de rayonnement. (Radiation measurements in wireless telegraphy.) R. Mesny. *Onde Elec.*, 1, 54-61; January, 1922.

41. Abaque pour le calcul de la portée, du champ electromagnetique, des caracteristiques de l'emission, de la longueur d'onde favorable au moyen de la formule d'Austin-Cohen. (Table for the calculation of distance of the electromagnetic field, and characteristics of the transmission of a suitable wave length using the Austin-Cohen formula.) L. Bouthillon. *Radioélectricité*, 3, 153-162; April, 1922. *Journ. Telegraph.*, 47, 137-142, 157-159, 1923.
42. La propagation des ondes electromagnetiques a la surface de la terre. (The propagation of electromagnetic waves on the earth's surface.) L. Bouthillon. *Radioélectricité*, 3, 289-294; July, 1922. *Journ. Telegraph.*, 47, 49-54, 1923.
43. Application to radio of wire transmission engineering. L. Espenschied. *Proc. I.R.E.*, 10, 344-372; October, 1922. *Bell System Techn. J.*, 1, 117-141; November, 1922.
44. Sur la determination de la longueur d'onde optimum pour une radio-communication donnée. (On the determination of the optimum wave length for a given transmission.) Association française pour l'avancement des sciences, Congres de Montpellier, 1922. L. Bouthillon. *R.G.E.*, 12, 585-587; October 21, 1922.
45. La transmission a longue distance par telegraphie sans fil. (Long distance radio telegraphic transmission.) G. Malgorn. *R.G.E.*, 11, 483-490, 1922.
46. Receiving measurements and atmospheric disturbances at the Naval Radio Research Laboratory, Bureau of Standards, Washington, March and April, 1922. L. W. Austin. *Proc. I.R.E.*, 10, 239-243, 1922.
47. Exposé critique des théories de la propagation. (Treatise on the theories of wave propagation.) L. Bouthillon. *Onde Elec.*, 2, 275-289; May, 1923; 345-357; June, 1923. Discussion by R. Mesny, 358-359; June, 1923.
48. Über Ausbreitungsvorgänge und Empfangsstörungen in der Funkentelegraphie. (On propagation phenomena and disturbances of reception in radio telegraphy.) F. Kiebitz. *Jahrb. d. drahtl. Tel.*, 22, 196-203, 1923. *Proc. I.R.E.*, 12, 233-241; June, 1924.
49. Distribution of radio waves from broadcasting stations over city districts. R. Bown and G. D. Gillett. *Electrician*, 92, 694-696; June 6, 1924. *Proc. I.R.E.*, 12, 395-409; August, 1924.
50. The effect of the earth in the transmission of electromagnetic waves in radiotelegraphy. G. W. O. Howe. *Electrician*, 93, 148-149; August 8, 1924.
51. Neue Untersuchungen über die Ausbreitung elektromagnetischen Wellen. (Recent investigations on the propagation of electromagnetic waves.) M. Bäumlér. *E.N.T.*, 1, 50-64; August, 1924. *Proc. I.R.E.*, 13, 5-27; February, 1925.
52. Étude sur les irregularités de propagation des ondes courtes. (Study of irregularities of short wave transmission.) P. Lardry. *Onde Elec.*, 3, 449-466; September; 502-510; October, 1924. Abstracted in German in *Jahrb. d. drahtl. Tel.*, 25, 138, 1925.
53. Wellentelegraphie und Vorgänge in der Atmosphäre. (Process of radio waves in the atmosphere.) K. Stoye. *Jahrb. d. drahtl. Tel.*, 23, 87-88, 1924.
54. Essais entre Paris et Alger sur ondes 180, 90 et 50 metres. (Tests between Paris and Algiers on waves of 180, 90 and 50 meters.) A. Colmant. *Onde Elec.*, 4, 5-13; January, 1925.
55. Die Ausbreitung der elektromagnetischen Wellen in der Grosstadt. (Propagation of electromagnetic waves in a large city.) M. Bäumlér. *E.T.Z.*, 46, 973-974; June 25, 1925.

56. Die Ausbreitung der Wellen in der drahtlosen Telegraphie. (Propagation of waves in wireless telegraphy.) J. Zenneck. *E.u.M.*, 43, 593-598, 612-616; August, 1925.
57. On recent advances in wireless propagation both in theory and in practice. A. S. Eve. *Frank. Inst., J.*, 200, 327-333; September, 1925.
58. Wave propagation at high frequencies. A. H. Taylor and E. O. Hulburt. *QST*, 9, 12-21; October, 1925.
59. An investigation of transmission on the higher radio frequencies. A. H. Taylor. *Proc. I.R.E.*, 13, 677-683; December, 1925.
60. A statistical study of conditions affecting the distance range of radio telephone broadcasting stations. C. M. Jansky, Jr. *B. S. Tech. Papers No. 297*, 1925.
61. Sur la propagation des ondes courtes. (On the propagation of short waves.) Delcambre and R. Bureau. *Comptes Rendus*, 180, 2028-2030, 1925.
62. Nouvelle contribution à l'étude de la propagation des ondes. (New contribution to the study of wave propagation.) P. Lardry. *Onde Elec.*, 4, 355-370, 401-418, 1925.
63. Distribution of wireless waves (how blind spots in broadcast transmission are produced.) R. L. Smith-Rose. *Wireless World and Radio Rev.*, 18, 401-405; March 17, 1926.
64. The propagation of radio waves. J. Hollingworth. *I.E.E., J.*, 64, 579-595; May, 1926. Abstracted in *Experimental Wireless*, 3, 178, 1926. (Long wave intensity measurements are made simultaneously at four points. Data show lack of consistence, not agreeing with Austin-Cohen formula. Interference and multiple reflection effects are noted.)
65. Transmission en ondes courtes. (Short wave transmission.) H. Chireix. *Onde Elec.*, 5, 237-262; June, 1926.
66. The correlation of some recent advances in radio. B. van der Pol. *Experimental Wireless*, 3, 338-343; June, 1926.
67. Wireless transmission. Chas. E. Snell. *El. Rev.*, 99, 138-140, July 23; 207-209, August 6, 1926. (A survey of what is known about the daylight effect and the causes of atmospherics.)
68. Die Ausbreitung der elektromagnetischen Wellen längs der Erdoberfläche. (Propagation of electromagnetic waves along the earth's surface.) M. Bäumlner. *E.T.Z.*, 47, 955-959; August 19, 1926.
69. Reduction of interference in broadcast reception. A. N. Goldsmith. *Proc. I.R.E.*, 14, 575-603; October, 1926.
70. Die Ausbreitung der elektrischen Wellen insbesondere die gerichtete Ausbreitung. (The propagation of electric waves, especially directed ones.) F. Kiebitz. *E.N.T.*, 3, 376-382; October, 1926.
71. Some measurements of short wave transmission. R. A. Heising, J. C. Schelleng, and G. C. Southworth. *Proc. I.R.E.*, 14, 613-647; October, 1926. *Wireless World and Radio Rev.*, 19, 854-859; December 29, 1926. (Quantitative data on field intensity and telephonic intelligibility are given for frequencies of 2.7 to 18 megacycles and for distances up to 1000 miles, with some data at 3400 miles. Data presented as curves and surfaces. Comparisons made over land and water, between night and day, vertical and horizontal antenna transmissions. Fading, speech quality, and noise discussed.)
72. Neues über die Ausbreitung von kurzen Wellen. (Recent developments on the propagation of short waves.) E. Quäck. *Jahrb. d. drahtl. Tel.*, 28, 177-178;

December, 1926. Translated into English by S. Ballantine, *Proc. I.R.E.*, 15, 341-345; April, 1927. (Report of disturbances in the autographic records of signals received in Germany from the American short wave station 2XT (wave length 16.18 m.) apparently due to waves which have encircled the earth in the other direction. Also a presentation of oscillograms showing a direct signal from AGA (wave length, 15 m.) and that which had travelled completely around the earth and of a calculation based on a normal light velocity giving the path of the latter as a great circle girdling the earth at a height of 182 km.)

73. Über Raumstrahlung. (Space wave.) A. Meissner. *Jahrb. d. drahtl. Tel.*, 28, 78-82, 1926.

74. Propagation des ondes courtes. (Short wave propagation.) R. Mesny. *Onde Elec.*, 5, 434-459, 1926.

75. Über die Ausbreitung elektrischer Wellen an der Erdoberfläche. (Propagation of electric waves on the earth's surface.) F. Kiebitz. *T.F.T.*, 15, 207-214, 1926.

76. Radio broadcast coverage of city areas. L. Espenschied. *Bell System Techn. J.*, 6, 117-141; January, 1927. Abridgement in *A.I.E.E.*, J., 46, 25-32; January, 1927.

77. Note sur certaines anomalies dans la propagation des ondes courtes. (Note on certain anomalies in propagation of short waves.) R. Bureau. *Onde Elec.*, 6, 52-55; January, 1927. *Comptes Rendus*, 184, 1078-1080, 1927.

78. Über die Bestimmung des Neigungswinkels elektrischer Wellen und die Ausschaltung geneigt einfallender Wellen am Empfänger. (On the determination of the angle of inclination of electric waves and the cutting out of bending waves occurring in the receiver.) A. Esau. *Jahrb. d. drahtl. Tel.*, 29, 4-10; January, 1927. Abstracted in *Experimental Wireless*, p. 305; May, 1927.

79. Die Ausbreitung der Elektromagnetischen Wellen. (The propagation of electromagnetic waves.) A. Sacklowski. *E.N.T.*, 4, 31-74; January, 1927. Abstracted in *Experimental Wireless*, 4, 242; April, 1927. Noted in *Experimental Wireless*, 6, 83; February, 1929. Book—published by Weidmannsche Buchhandlung, Berlin, 1929.

80. Experiences sur la propagation des ondes courtes. (Experiments on short wave propagation.) A. Colmant. *Onde Elec.*, 6, 82-91; February, 1927.

81. Some possibilities and limitations in common frequency broadcasting. D. Martin, Gillett and Bemis. *Proc. I.R.E.*, 15, 213-223; March, 1927.

82. Sur la propagation des ondes electromagnetiques autour de la terre. (On the propagation of electromagnetic waves around the earth.) H. Gutton and J. Clement. *Comptes Rendus*, 184, 676-678; March, 1927. Abstracted in *Experimental Wireless*, 368; June, 1927.

83. Experiences sur la propagation des ondes radiotelegraphiques en altitude. (Experiments on the propagation of radio waves at an altitude.) P. Idrac and R. Bureau. *Comptes Rendus*, 184, 691-692; March, 1927. Also in *Onde Elec.*, 6, 266-267; June, 1927. Abstracted in *Experimental Wireless*, p. 368; June, 1927.

84. Radio phenomena recorded by the University of Michigan Greenland Expedition—1926. P. C. Oscanyan, Jr. *Proc. I.R.E.*, 15, 425; May, 1927. (Report on short wave radio communication on Greenland expedition. Notes on screening by hills and on Arctic static.)

85. Some practical aspects of short wave operation at high power. H. E. Hallborg. *Proc. I.R.E.*, 15, 501-517; June, 1927. (Presentation of propagation data over the frequency range of 3000 to 30,000 kc, with discussion (1) of the

effect of ionization on the angle of projection of the wave front; (2) of the probable values of attenuation constants; (3) of the importance of frequency stabilization; (4) of antenna feed systems; and (5) of the relative importance of static at short wave lengths.)

86. Short wave radio transmission and its practical uses. C. W. Rice. *QST*, 11, 8-14; July; 36-42; August, 1927.

87. Weitere Mitteilungen über die Ausbreitung von Kurzwellen. (Further communications on the propagation of short waves.) E. Quäck. *Jahrb. d. drahtl. Tel.*, 30, 41-42; August, 1927. Translated into English by S. Ballantine. *Proc. I.R.E.*, 15, 1065-1068; December, 1927.

88. Suite d'une étude sur la propagation des ondes courtes. (Continuation of investigation on propagation of short waves.) P. Lardry. *Onde Elec.*, 6, 465-481; October, 1927. Abstracted in *Experimental Wireless*, 31; January, 1928. (Anomalies of propagation on 51 and 31 meters.)

89. The propagation of radio waves along the surface of the earth and in the atmosphere. P. O. Pedersen. Danmarks Naturvidenskabelige Samfund, 1927. Pamphlet and supplement published in English and sold in Denmark for 15 kronen.

90. Über den Einfluss des Erdmagnetfeldes auf die Fortpflanzung der elektrischen Wellen der drahtlosen Telegraphie in der Atmosphäre. (On the influence of the earth's magnetic field on the propagation of radiotelegraph waves in the atmosphere.) Hans Lassen. *E.N.T.*, 4, 324-334, 1927.

91. A comparison of the variation of intensity and direction of radio signals. H. Reich. *Frank. Inst., J.*, 203, 537-548, 1927.

92. The short wave echo effect. G. W. O. Howe. *Experimental Wireless*, 4, 257-258, 1927.

93. Influence des surfaces de discontinuités atmospheriques sur la propagation des ondes courtes. (Influence of the atmospheric surfaces of discontinuity on the propagation of short waves.) G. H. Huber. *Comptes Rendus*, 185, 934-936, 1927.

94. Observations et travaux recents sur la propagation des ondes electromagnetiques. (Recent work on the propagation of electromagnetic waves.) R. Mesny. *Annales des P.T.T.*, 16, 889-914, 1927. *Onde Elec.*, 7, 129-155, 1928. (After outlining the principal facts observed in wave propagation round the earth the author discusses the principal theories advanced. The facts are compared with the theory and it is concluded that no theory put forward up to the present is altogether satisfactory.)

95. Considerazioni sulla propagazione delle onde elettromagnetiche. (Propagation of electromagnetic waves.) G. Pession. *Elettrotecnica*, 14, 666-682, 1927. (This paper deals in detail with the following sections of the question; propagation at short distances, transmission at great distances, short waves, zones of silence.)

96. Phase and group velocities in an ionized medium. G. W. O. Howe. *Experimental Wireless*, 4, 259-260, 1927. (In Quäck's experiments to determine the time taken by a high frequency signal to encircle the globe, the length of the path and thus the height of the path above the earth, was deduced by multiplying the time interval by the velocity of light. Consideration shows that instead of the velocity of light the group velocity should have been employed. Further, it is shown that the group velocity is less than that of light, the phase velocity

being greater. These considerations lead to an estimated height of path considerably less than that given by Quäck.

97. Short wave wireless telegraphy. T. L. Eckersley. *I.E.E., J.*, 65, 600-644, 1927. Abstracted in *Experimental Wireless*, 4, 213-222, 1927, and *El. Rev.*, 100, 995-997, 1927. (This paper is chiefly concerned with experiments both in transmission and reception at high frequencies which throw light on the nature of the transmission as well as upon the design of suitable aerials for high frequency working.)

98. Les ondes électriques courtes. (Short waves.) (Book.) R. Mesny. Recueil des Conférences. *Rapports de Documentation sur la Physique*, 12, 2d series, 1927. Les presses Universitaires de France, Paris, prix 30 fr.

99. A radio field strength survey of Philadelphia. K. McIlwain and W. S. Thompson. *Proc. I.R.E.*, 16, 181-192; February, 1928.

100. Report of the chairman of the commission on radio wave propagation, U.R.S.I. L. W. Austin. *Proc. I.R.E.*, 16, 348-358; March, 1928.

101. The polarization and fading of short wireless waves. T. L. Eckersley. Letter to *Nature* (London), 121, 707; May 5, 1928. Abstracted in *Experimental Wireless*, 5, 397; July, 1928. (The author working in the ultra short range finds that at great distances the waves are in general plane polarized due to the union of the two oppositely circularly-polarized rays into which the original ray has been split by double refraction in the Kennelly-Heaviside layer. The plane of polarization often revolves slowly in periods of a few seconds producing fading on either a vertical or horizontal antenna. By using a combination of the two, the fading would be much reduced.)

102. Technical considerations involved in the allocation of short waves; frequencies between 1.5 and 30 megacycles. L. Espenschied. *Proc. I.R.E.*, 16, 773-777; June, 1928. (Chart given which shows approximate relation of optimum frequency to distance in short wave radio transmission and the number of available channels based on present practice.)

103. Some studies of radio broadcast coverage in the Middle West. C. M. Jansky, Jr. *Proc. I.R.E.*, 16, 1356-1367; October, 1928.

104. On the difference of east to west and west to east transmission phenomena at sunrise and sunset. T. Nakai. *Electrot. Laborat.* Tokyo, Japan, *Researches*, No. 241, November, 1928. Original in Japanese. Abstract from author's abstract in *Experimental Wireless*, 6, 323; June, 1929. (From theoretical considerations based on ultra-violet radiation from sun, it was concluded that the ionized layer goes down much more rapidly after sunrise than it rises after sunset. Therefore, little difference between sunrise and sunset effects should be found in east-west radio transmissions, while sunrise effects should be much larger than sunset effects for west-east transmission. Data is cited in confirmation of this reasoning.)

105. Sur un echo d'ondes électromagnétiques courtes arrivant plusieurs seconds après le signal émis et son explication d'après la théorie des Aurores Borealis. (On an echo of short electromagnetic waves arriving several seconds after the main signal and explanation by means of the theory of the aurora borealis.) C. Störmer. *Onde Elec.*, 7, 531-533; December, 1928. Same work reported in abstract in *Comptes Rendus*, 187, 811-813; November 5, 1928, and in *Nature* (London), 122, 681; November 3, 1928.

106. Essai d'explication de l'écho Störmer-Hals sur les ondes de 31.4 metres de PCJJ. (Analysis of the explanation of the echo of Störmer-Hals on waves of

- 31.4 meters from PCJJ.) H. S. Jelstrup. *Onde Elec.*, 7, 538-540; December, 1928. (Attributes the long interval echoes to many reflections between the Kennelly-Heaviside layer and the earth, and calculates the time lapse between the original signal and the echo by means of Howe's equivalent transmission line formula for the Kennelly-Heaviside layer.)
107. Über die Wellen Ausbreitung in einem dispergierenden Medium. (Wave propagation in a dispersive medium.) K. Sreenivasan. *Jahrb. d. drahtl. Tel.*, 32, 121-124, 1928. (The velocity of propagation of an electromagnetic wave in an electron containing atmosphere shows evidence of dispersion, and that the group velocity becomes smaller the higher the wave frequency. The effect of this dispersion is that the component oscillations of a modulated wave arrive at different times and hence cause distortion.)
108. Über Telegraphie mit kurzen Wellen. (Short wave telegraphy.) H. Rukop. *E.T.Z.*, 49, 1815, 1928.
109. Zur Theorie der Ausbreitung elektromagnetischer Wellen längs der Erdoberfläche. (The propagation of electromagnetic waves on the earth's surface.) R. Weyrich. *Ann. d. Physik*, 85, 552-580, 1928.
110. Über die Fortpflanzung elektromagnetische Wellen. (On the propagation of electromagnetic waves.) H. Benndorf and A. Szekely. *Zeits. f. Hochfrequenztechn.*, 31, 43-45, 1928.
111. Untersuchungen über die Ausbreitungsvorgänge ultra-kurzer Wellen. (Experiments on the radiation of ultra-short waves.) F. Gerth and W. Scheppman. *Zeits. f. Hochfrequenztechn.*, 33, 23-27; January, 1929. (An investigation of radiation for frequencies higher than 28 megacycles. It is shown that the waves spread out like light and that objects larger than a wave length produce shadow effects. It is assumed that only direct waves play a part and calculations are given for the distance range.)
112. Abhängigkeit der Reichweite sehr kurzer Wellen von der Höhe des Senders über der Erde. (Dependence of the range of very short waves on the height of the transmitter above the earth.) H. Fassbender and G. Kurlbaum. *Zeits. f. Hochfrequenztechn.*, 33, 52-55; February, 1929. (Experiments on range of transmission on wave length of 3.7 m. This work was carried out on an air-plane, the transmitter being on the plane and the receiver on the ground.)
113. Reception experiments in Mount Royal tunnel. A. S. Eve, W. A. Steel, G. W. Olive, A. R. McEwan, and J. H. Thompson. *Proc. I.R.E.*, 17, 347-376; February, 1929. (Experiments are presented which were carried out in the Mt. Royal tunnel of Canadian National Railways at Montreal, in order to determine how radio waves reach the receiving set.)
114. Étude experimental des zones de silence dans la propagation des ondes courtes. (Experimental study of silence zones in propagation of short waves.) R. Bureau. *Comptes Rendus*, 188, 455-457; February 4, 1929. (A brief summary of simultaneous observations of silent zones and zones of strong signals by European listeners, with suggestions of correlation with atmospheric conditions.)
115. Some experiments in short distance short wave radio transmission. J. K. Clapp. *Proc. I.R.E.*, 17, 479-493; March, 1929. (Some experiments in short wave radio transmission over a distance of 55 miles are described.)
116. Über die Ausbreitung der kurzen Wellen bei kleiner Leistung im 1000-kilometer-Bereich. (The propagation of low power short waves in the 1000-kilometer range.) K. Krüger and H. Plendl. *Zeits. f. Hochfrequenztechn.*, 33, 85-92; March, 1929. Translated in *Proc. I.R.E.*, 17, 1296-1312; August, 1929.

(A description is given of experiments carried out between the two ground stations and between an airplane and a ground station to determine possibility of obtaining reliable short wave (25-55 m.) communication over a distance of 500 km or more with relatively low power (CW 2 watts). An airplane installation operating into a fixed dipole antenna is described, and results of a large number of observations at ground receiving stations of the signals received from the airplane in flight are presented.)

117. Beitrag zur Beschreibung des Interferenzgebietes in der Nähe von Empfangs-Antennen. (Discussion on interference regions in the neighborhood of receiving antennas.) M. Dieckmann. *Zeits. f. Hochfrequenztechn.*, 33, 161-166; May, 1929. (By making simplified assumptions the interference regions in the vicinity of receiving antennas are discussed, and pictured by models and drawings. Instantaneous as well as average values of field intensity are given.)

118. East-West and North-South attenuations of long radio waves on the Pacific. E. Yokoyama and T. Nakai. *Proc. I.R.E.*, 17, 1240-1247; July, 1929. (A comparative study of the observed values of field intensity of low-frequency high-power stations in the Pacific region seems to show a much greater east-west than north-south attenuation during daylight hours in fairly high latitudes. A comparison of observed values with values calculated by various transmission formulas indicate the need for the inclusion in the formulas of a factor depending on direction and latitude.)

119. Über die Ausbreitung elektrischer Wellen um eine leitende Kugel. (The propagation of electric waves around a conducting sphere.) F. Breisig. *E.N.T.* 6, 268-271; July, 1929. (The derivation of a formula for finding the field intensity of an electromagnetic radiation at any point on the surface of a conducting sphere is given.)

120. An investigation of short waves. T. L. Eckersley. *I.E.E., J.*, 67, 992-1032; August, 1929. Abstracted in *Experimental Wireless*, 6, 255-260; May, 1929, and *Electrician*, 102, 468; April 19, 1929. (An account is given of investigation made during the past two years of the following short wave transmission phenomena; (1) scattering, (2) multiple signals, and (3) signal mutilation. The results of a nine month's direction finding interception of short wave commercial stations are presented with a discussion of the problems of short wave transmissions and such cognate subjects as the Kennelly-Heaviside layer, fading, and polarization effects. Certain revisions of results presented in previous papers are offered.)

121. Versuche mit ultrakurzen Wellen im Flugzeugverkehr. (Experiments with ultra-short waves in aircraft work.) H. Fassbender. *E.N.T.*, 6, 358-365; September, 1929. (Description of communication tests from ground to plane and from plane to ground on 3.7 meters up to distances of 137 kilometers. A short treatise is given on the possible application of ultra-short waves to aircraft communication channels and beacons.)

122. Die Bedeutung der ultrakurzen Wellen für die elektrische Nachrichtentechnik, insbesondere die der Wellenlängen von 1 m. abwärts. (The importance of ultra-short waves for electric communication technique, especially those of about 1 meter wave length.) W. Hahnemann. *E.N.T.*, 6, 365-370; September, 1929. Discussion, 370-374; September, 1929. (A general discussion of the properties of short waves from 100 to 1 meter (300 to 30,000 kc) and description of experiments carried out with 50-cm waves employing parabolic reflectors made up of sheet copper.)

123. The use of short waves for long distance communication. *Marconi Rev.*, 18-21; September, 1929. (A compressed recapitulation of some of the most salient features of long distance communication at high frequencies.)
124. Experimentelle Untersuchungen an Wasserwellen zwecks Herstellung von Analogien zu elektromagnetischen Strahlungsvorgängen. (Experimental investigation of wave motion in water with the purpose of developing analogies to the propagation of electromagnetic waves.) L. Heck. *Zeits. f. Hochfrequenz-techn.*, 34, 121-131; October, 1929. (A description (well illustrated) of experiments carried out with water waves and a theoretical discussion of the analogies between water waves and electromagnetic waves.)
125. Propagation of electromagnetic waves in a stratified medium. D. R. Hartree. *Cambridge Phil. Soc., Proc.*, 25, 97-120, 1929.
126. The reflection and transmission of electric waves at the interface between two media. H. M. MacDonald. *Roy. Soc. Proc.*, 123A, 1-27 and 391-400, 1929.
127. Two energy types in wave motion and their relation to group and wave velocity. L. Tonks. *Phys. Rev.*, 33, 239-242, 1929.
128. Wellen induktion in der drahtlosen Telegraphie. (Wave induction in wireless telegraphy.) K. Uller. *Zeits. f. Hochfrequenz-techn.*, 33, 15-22, 1929.
129. La penetration des déplacements electriques ou magnetiques ainsi que des ondes electromagnetiques a la surface de separation de deux milieux. (The penetration of electromagnetic waves at the surface of separation of two media.) A. K. Kotelnikoff. *R.G.E.*, 26, 53-59, 1929.
130. Reichweitenversuche mit Zentimeterwellen. (Transmission ranges of ultra short waves.) W. Ludenia. *E.N.T.*, 248-249, 1929. (A preliminary report on experiments dealing with ranges obtainable with wave lengths of the order of 10 cm. With directional radiation and reception, ranges of 10 km, with 35 watts input, were obtained with wave lengths of 40 cm.)
131. Report on experiments with electric waves of about 3 meters, their propagation and use. A. Esau and W. H. Hahnemann. *Proc. I.R.E.*, 18, 471-489; March, 1930. (Experiments upon the maximum range obtainable with wave lengths of about 3 meters are reported and brief explanations are given concerning the apparatus and methods used. Directive devices, in the form of parabolic reflectors, were used successfully. The results clarify the phenomena of propagation of these wave lengths and indicate the possibility of their practical application to short range signalling and possibly to television.)
132. Transmission characteristics of a short-wave telephone circuit. R. K. Potter. *Proc. I.R.E.*, 18, 581-648; April, 1930. (A method of observing and recording the audio-frequency transmission characteristics of a short-wave radio-phone channel is described. The characteristics are found to undergo rapid changes, apparently the result of wave interference and progressive changes in the angle of rotation of the polarization plane with the frequency over the signal band. It is indicated that changes in the transmission path are progressive rather than erratic. Various types of distortion and fading are discussed at length, and seasonal effects are noted. Many specimen records of double and single side-band transmissions are given.)
133. Summary of progress in the study of radio wave propagation phenomena. G. W. Kenrick and G. W. Pickard. *Proc. I.R.E.*, 18, 649-668; April, 1930. (Recent progress in the study of radio wave propagation phenomena is reviewed in the light of the history of the art. The development of the art

through 1927 is outlined. The discussion of recent advances concerns publications on the Störmer-van der Pol echoes and their interpretations, progress in Kennelly-Heaviside layer height determinations, and experimental studies in transmission and magnetic and solar correlations. The need of further consistent observations and other means of investigation is pointed out. A bibliography is included.)

134. Recherches sur les propriétés dielectriques des gaz ionisés et la décharge en haute fréquence. (Researches on the dielectric properties of ionized gases, and high frequency discharge.) H. Gutton. *Ann. de Physique*, 13, 62-129, 1930 (This paper deals very fully with the writer's theory of quasi-elastic forces causing natural periods of oscillations of the ions, and leading to resonance phenomena in an ionized gas. The theory is applied to the phenomena of radio propagation for low, medium, and high frequencies.)

R113.1—Fading

135. A study of radio signal fading. J. H. Dellinger, L. E. Whittmore and S. Kruse. Preliminary publication in *QST*, 4, 11-14, September, 3-12, November, 13-19, December, 1920. *Washington Acad. Sci., J.*, 11, 245-259; June 4, 1921. *QST*, 7, 29-34, August, 23-26, September, 1923. Abstract in German in *Jahrb. d. drahtl. Tel.*, 24, 66-70; 144-148, 1924.

136. Some experiments on the fading of signals. J. A. Cash. *Experimental Wireless*, 1, 132-135, 1923.

137. Short period variations in radio reception. G. W. Pickard. *Proc. I.R.E.*, 12, 119-158; April, 1924. Abstract in German in *Jahrb. d. drahtl. Tel.*, 23, 90-91, 1924.

138. Étude de l'évanouissement sur les ondes courtes. (Study on the fading of short waves.) P. Lardry. *Onde Elec.*, 3, 254-263, 1924.

139. Some recent observations on periodic fading and the night effect. P. D. Tyers. *Experimental Wireless*, 2, 650-654; July, 1925.

140. Investigation on fading of signals. S. R. Chapman. *Experimental Wireless*, 2, 775-779; September, 1925.

141. The nature, cause and reduction of fading. G. W. Pickard. *Radio News*, 7, 772-773; December, 1925. *Modern Wireless* (London), 5, 349-354; December, 1925.

142. Wireless signal variations. E. V. Appleton and M. A. F. Barnett. *Electrician*, 95, 678-679; December 11, 1925.

143. Fading measurements. E. A. Anson. *Experimental Wireless*, 2, 645-649, 1925.

144. Some studies in radio broadcast transmission. R. Bown, DeL. K. Martin, and R. K. Potter. *Bell System Techn. J.*, 5, 143-213; January, 1926. *Proc. I.R.E.*, 14, 57-131; February, 1926. Abstracted in *Electrician*, 96, 168-171; February 12, 1926.

145. The mystery of fading (some notes of observations taken on broadcast stations.) O. Hall. *Experimental Wireless*, 3, 211-214; April, 1926.

146. Cooperative measurements of radio fading in 1925. J. H. Dellinger, C. B. Jolliffe, and T. Parkinson. *Radio News*, 8, 146; August, 1926. *Bureau of Standards Sci. Papers* No. 561. Abstracted in *Q.S.T. Français*, 9, 16-17; February, 1928.

147. The observation of fading effects.—Measurement of signal strength

- with simple apparatus. E. V. Appleton. *Wireless World and Radio Rev.*, 18, 581-582, 1926.
148. An automatic fading recorder. T. A. Smith and G. Rodwin. *Proc. I.R.E.*, 15, 41-47; January, 1927.
149. Signal fading measurements—(practical details for constructing and calibrating the necessary apparatus.) R. L. Smith-Rose. *Wireless World and Radio Rev.*, 20, 32-37; January 12, 1927.
150. Dispositif atténuant les effets du fading. Applications et conséquences. (Arrangement for attenuating the effects of fading—application and results.) H. de Bellecize. *Onde Elec.*, 6, 110-119; March, 1927.
151. A suggestion of a connection between radio fading and small fluctuations in the earth's magnetic field. G. Breit. *Bull. Nat. Research Council*, No. 61, 150-158; July, 1927. *Proc. I.R.E.*, 15, 709-723; August, 1927.
152. Fishing for radio waves (some radio fading experiments on long and short waves.) E. W. Thatcher. *Radio* (San Francisco), 9, 18-20; November, 1927.
153. De l'onde hertzienne et de sa propagation. (Hertzian wave and its propagation.) L. Garrigue. *Q.S.T. Français*, 8, 53-56; December, 1927. (Discussion of superiority of short over long waves and comparison of fading on these waves.)
154. The study of signal fading. E. V. Appleton. *I.E.E., J.*, 66, 872-885; August, 1928. Abstracted in *Experimental Wireless*, 5, 267-272; May, 1928. (Methods of investigating fading of downcoming waves, including a frequency variation method. Results of some observations, in particular, during an eclipse.)
155. Fading on short waves at long distance. E. Gherzi. *QST*, 12, 31-32; June, 1928.
156. Fading curves along a meridian. R. C. Colwell. *Proc. I.R.E.*, 16, 1570-1573; November, 1928. (Fluctuations in signal strength of KDKA, Pittsburgh, Pa., were observed through the sunset period of Morgantown, W. Va. Observations made covered 21 days. On bright, clear days, the curve fluctuated considerably, while on cloudy days, the curve was fairly steady.)
157. A visual method of observing the influence of atmospheric conditions on radio reception. E. Merritt and W. E. Bostwick. *Nat. Acad. Sci., Proc.*, 14, 884-888; November, 1928. (A method is described which utilizes the crossed-coil system and a cathode-ray oscillograph. It was possible to notice visually several successive rotations of the plane of polarization of the down-coming wave during sunset periods.)
158. Über Beobachtung der Regelmässiger Schwunderscheinungen im Zusammenhang mit Schwankungen der Sende-frequenz bei kurzen Wellen. (Observations of regular fading effects connected with variations in transmitted frequency in short wave transmission.) Eppen, Schiebe and Weight. *Zeits. f. Hochfrequenz-techn.*, 31, 151-152, 1928.
159. Fading curves and weather conditions. R. C. Colwell. *Proc. I.R.E.*, 17, 143-148; January, 1929. (Sunset fading curves from KDKA made at Morgantown, W. Va., with a Shaw recorder during April and May 1927 showed that the signal strength from KDKA during the night was sometimes below and sometimes above daylight strength. Apparent correlation with weather.)
160. Some observations of short-period radio fading. T. Parkinson. *Bureau of Standards Jnl. of Research*, 2, 1037-1075; June, 1929. RP 70. *Proc. I.R.E.*, 17, 1042-1061; June, 1929. (Causes of fading are investigated by means of

graphic fading records made simultaneously with different types of receiving antennas. Evidences found of fading due to interference, to direction shifts, to rotation of plane of polarization, to varying intensity of indirect rays, and to multiple rays.)

161. Messungen über die Ausbreitung elektromagnetischer Wellen auf der Erde. (Measurements on the propagation of electromagnetic waves over the earth.) M. J. O. Strutt. *Naturwissenschaften*, 17, 919-920, 1929. (Experiments made at very high frequencies to test propagation theories. The author gets definite proof of the existence of Sommerfeld's cylindrical waves. The effect on the signal strength of raising the receiving aerial above the earth was investigated.)

R113.2—Daily Variations, Seasonal Variations

162. A note on the effect of daylight on the propagation of electromagnetic impulses over long distances. G. Marconi. *Roy. Soc., Proc.*, 70, 344-347, 1902.

163. Störungen in einem geerdeten Empfangssystem für drahtlose Telegraphie mit doppelter täglicher Periode. (Diurnal disturbances in earthed wireless telegraph systems.) K. E. F. Schmidt. *Phys. Zeits.*, 8, 133-136, 1907. Abstracted in English in *Electrician*, 59, 19; April 19, 1907.

164. On the diurnal variations of the electric waves occurring in nature and on the propagation of electric waves around the bend of the earth. W. H. Eccles. *Roy. Soc., Proc.*, 87, 79-99; August 13, 1912. In German in *Jahrb. d. drahtl. Tel.*, 8, 253-281, 1914. Abstract in *Electrician*, 969-970; September, 1913.

165. Difference in strength of day and night signals in radio telegraphy. L. W. Austin. *Washington Acad. Sci., J.*, 3, 326-328; June 4, 1913. Abstract in *Electrical Review and Western Electric News*, 62, 1332; June 21, 1913.

166. The daylight effect in radiotelegraphy. A. E. Kennelly. *Proc. I.R.E.*, 1, 39-74; July, 1913.

167. Intensitätsmessungen radiotelegraphischer Zeichen zu verschiedener Jahres- und Tageszeiten. (Intensity measurement of radiotelegraphic signals at different times of year and day.) H. Mösler. *E.T.Z.*, 34, 996-998; August 28, 1913. In German in *Jahrb. d. drahtl. Tel.*, 8, 360-366, 1914. Abstract in English in *Electrician*, 72, 529; January 2, 1914.

168. Diurnal and annual variations in overland radio transmission. A. H. Taylor. *Phys. Rev.*, 4, 435-439; November, 1914.

169. Conditions affecting the variations in strength of wireless signals. E. W. Marchant. *Electrician*, 74, 621-624; February 12, 1915. *Engineering*, 99, 232-236; February 19, 1915. *I.E.E., J.*, 53, 329-348; March 1, 1915.

170. Seasonal variations in strength of radiotelegraphic signals. L. W. Austin. *Proc. I.R.E.*, 3, 103-105; June, 1915.

171. Variations in nocturnal transmission. A. H. Taylor and A. S. Blatterman. *Proc. I.R.E.*, 4, 131-148; April, 1916. In German in *Jahrb. d. drahtl. Tel.*, 12, 72-75, 1918.

172. Experiments at the U. S. Naval Radio Station at Darien, Canal Zone. L. W. Austin. *Proc. I.R.E.*, 4, 251-269, 1916. In German in *Jahrb. d. drahtl. Tel.*, 11, 125-132, 1916.

173. Quantitative measurements at Washington of the signals from the German radio stations at Nauen and Eilvese. L. W. Austin. *Frank. Inst., J.*, 182, 605-611, 1916. *Electrician*, 78, 465-466; January 12, 1917.

174. Misura del campo elettromagnetico di onde radio telegrafiche trans-

- oceaniche. (Measurement of the electromagnetic field of waves received during transoceanic radio transmissions.) G. Vallauri. *Elettrotecnica*, 7, 298-300, 1920. Translated in Proc. I.R.E., 8, 286-298, 1920. Comments by G. W. O. Howe in *Radio Rev.*, 1, 652-655, 1920. Abstracted in *Electrician*, 86, 249-250, 1921.
175. Measurement of the signals received in Washington from the Lafayette station. L. W. Austin. *Radio Rev.*, 2, 301-303; June, 1921.
176. Über das gleichzeitige auftreten atmosphärischer Störungen. (On the simultaneous appearance of atmospheric disturbances.) M. Bäumlcr. *Jahrb. d. drahtl. Tel.*, 19, 102-109; February, 1922.
177. Reception measurements at Naval Radio Research Laboratory, Washington. L. W. Austin. Proc. I.R.E., 10, 158-160; June, 1922.
178. The monthly averages of signal strength of Nauen in Washington 1915-1921 and the monthly averages of atmospheric disturbances in Washington 1918-1921. L. W. Austin. Proc. I.R.E., 10, 153-157; June, 1922. Abstract in German in *Jahrb. d. drahtl. Tel.*, 21, 189-192, 1923.
179. Receiving measurements and atmospheric disturbances at the Bureau of Standards, March and April, 1922. L. W. Austin. Proc. I.R.E., 10, 239-243, 1922. May and June, 1922; 10, 315-319, 1922. July and August, 1922; 10, 421-425, 1922. September and October, 1922; 11, 3-8, 1923; November and December, 1922; 11, 83-88, 1923. January and February, 1923; 11, 187-191, 1923. March and April, 1923; 11, 333-338, 1923. May and June, 1923; 11, 579-585, 1923. July and August, 1923; 12, 3-8, 1924. September and October, 1923; 12, 113-118, 1924. November and December, 1923; 12, 227-232, 1924.
180. Observations on Lafayette and Nauen stations in Washington March 1, 1922 to February 28, 1923. L. W. Austin. Proc. I.R.E., 11, 459-465; October, 1923.
181. Diagrammes des forces électromotrices mesurées à Meudon pour les émissions de Bordeaux, Nantes et Rome. (Electromotive force measured at Meudon for signals from Bordeaux, Nantes, and Rome.) R. Mesny. *Onde Elec.*, 2, 296-299, May; 599-601; October, 1923; 3, 43-46; January 1, 374-375; July, 1924.
182. Long distance radio receiving measurements at the Bureau of Standards in 1923. L. W. Austin. Proc. I.R.E., 12, 389-394; August, 1924.
183. Field intensity measurements in Washington on the Radio Corporation stations at New Brunswick and Tuckerton, N. J. L. W. Austin. Proc. I.R.E., 12, 681-692; December, 1924. Abstracted in German in *Jahrb. d. drahtl. Tel.*, 25, 144, 1925.
184. Diagramme des forces electromotrices mesurées à Meudon pour les émissions de Bordeaux et Nantes pendant la première, et Bordeaux, Nantes et Rocky Point pendant la deuxième trimestre, 1924. (Diagram of electromotive forces measured at Meudon on the transmissions from Bordeaux and Nantes during the first, and on Bordeaux, Nantes and Rocky Point during the second trimester of 1924.) R. Mesny. *Onde Elec.*, 3, 374-375; 551-553, 1924.
185. Diagramme des champs électriques mesurées à Meudon. (Diagram of electric fields measured at Meudon.) R. Mesny. *Onde Elec.*, 3, 599-601, 1924; 4, 252-254, 350-352, 555-557, 1925; 5, 186-187, 223-226, 1926.
186. Some trans-pacific radio field intensity measurements. L. W. Austin. Proc. I.R.E., 13, 151-157; April, 1925. *Washington Acad. Sci.*, J., 15, 139-143; April 4, 1925.
187. Signal strength measurements. A report on some experiments made

over great distances during 1922 and 1923 by an expedition sent to Australia. H. J. Round, T. L. Eckersley, K. Tremellen, and F. C. Lunnon. *I.E.E., J.*, 63, 933-1011, 1925. Abstracted in *Electrician*, 94, 538-539; May 8, 1925.

188. Long distance radio receiving measurements in 1924. L. W. Austin. *Proc. I.R.E.*, 13, 283-290; June, 1925. *Washington Acad. Sci., J.*, 15, 227-234; June 4, 1925.

189. Transatlantic radio telephone transmission. Espenschied, Anderson, and Bailey. *Bell System Techn. J.*, 4, 459-507, 1925. *Proc. I.R.E.*, 14, 7-56; February, 1926.

190. Sur la propagation des ondes courtes émises à bord du "Jacques Cartier." (On the propagation of short waves transmitted on board the "Jacques Cartier.") Delcambre and Bureau. *Onde Elec.*, 5, 53-71; February, 1926.

191. On the diurnal variation of ultra-short wave wireless transmission. E. V. Appleton. *Cambridge Phil. Soc. Proc.*, 23, 155-161; April, 1926.

192. Difference of attenuation of radio waves along and across the meridian of the earth in the Pacific region. S. Inada. *Proc. Third Pan-Pacific Science Congress*, Tokyo, 2, 1245-1248, 1926. (It is stated that the best times for transmission are midnight and noon of the middle point between sending and receiving stations. A single graph is given showing this relationship. Graphs are given showing times of day for best transmission on 16, 25, 26 and 42 meters between Nauen, Germany, and Twatsuki, Japan.)

193. Communication test on short wave across the Pacific. T. Nakagami and T. Kawahara. *Proc. Third Pan-Pacific Science Congress*, Tokyo, 2, 1272-1281, 1926. *I.E.E., Japan*, 46, 1251-1264; November, 1926. (Excellent communication was obtained during tests made with ships sailing from Japan to San Francisco. Curves are given showing best wave lengths to use for given distances. For trans-pacific communication a 30-meter wave length was found best at night while 15 meters was correct for daytime transmission during the winter.)

194. Variation in high-frequency ground wave ranges. A. H. Taylor. *Proc. I.R.E.*, 15, 707-708; August, 1927.

195. Diagramme des champs électriques mesurées à Meudon pendant le début de l'année 1926. (Graphs of electric fields measured at Meudon during the first part of 1926.) *Onde Elec.*, 6, 509-511; October, 1927. Abstracted in *Experimental Wireless*, 5, 31; January, 1928.

196. The relation of radio reception to sun-spot position and area. G. W. Pickard. *Proc. I.R.E.*, 15, 1004-1012; December, 1927. (Correlation of fading measurements with sun-spot variations.)

197. The effect of weather conditions on long distance reception. S. K. Lewer. *Experimental Wireless*, 5, 152-161; March, 1928. (Correlation of reception with atmospheric pressure distribution over transmission path.)

198. Long wave radio receiving measurements at the Bureau of Standards in 1927. L. W. Austin. *Proc. I.R.E.*, 16, 1252-1257; September, 1928. (Curves and tables give daylight signal intensities of a number of stations and strength of atmospheric disturbances.)

199. Variations in signal strength from Australia. R. G. De Wardt. *P.O.E.E., J.*, 22, 52-58; April, 1929. (Data from systematic records of 11,660-kc transmissions from Australia as received in England are presented in graphic form. Average diurnal and seasonal variations of signal strength are shown for the twelve months of the year. Daylight-darkness effects on different portions of two transmission paths are noted.)

200. Long wave radio receiving measurements at the Bureau of Standards in 1928. L. W. Austin. *Proc. I.R.E.*, **18**, 101-105; January, 1930. (Monthly averages of daylight signal intensity at Washington for 1928 from a number of European and American low-frequency stations are given. The annual field intensity averages of both European and nearby American stations were found to be slightly lower than those of 1927, while atmospheric disturbances varied little from the earlier year.)

R113.3—Direction Variations

201. Variation in direction of propagation of long electromagnetic waves. A. H. Taylor. *Bureau of Standards Sci. Papers*, No. 353, 1919.

202. Radio direction changes and variations in audibility. C. Kinsley and A. Sobey. *Proc. I.R.E.*, **8**, 299-325; August, 1920.

203. Effect of the Heaviside layer upon the errors of direction finders. T. L. Eckersley. *Radio Rev.*, **2**, 60-65, February; 231-248; May, 1921. In German in *Jahrb. d. drahtl. Tel.*, **21**, 162-188, 1923.

204. Directional measurement with the Royal Air Force System. J. Hollingworth. *Radio Rev.*, **2**, 282-301; June, 1921.

205. The direction and intensity of waves from European radiotelegraphic stations. G. W. Pickard. *Proc. I.R.E.*, **10**, 161-175; June, 1922.

206. Variation en direction et en intensité du champ électromagnétique d'une émission. (Variation in direction and intensity of the electromagnetic field of transmission.) R. Mesny. *Onde Elec.*, **1**, 501-517; September, 1922; 577-587; October, 1922.

207. A suggestion for experiments on apparent radio direction variations. L. W. Austin. *Proc. I.R.E.*, **13**, 3; February, 1925. In German in *Jahrb. d. drahtl. Tel.*, **26**, 89, 1925.

208. A new phenomenon in sunset radio direction variations. L. W. Austin. *Proc. I.R.E.*, **13**, 409-412; August, 1925. Discussion, 781-783; December, 1925. *Washington Acad. Sci., J.*, **15**, 317-319; August 19, 1925.

209. Direction and intensity changes of radio waves. C. C. Bidwell. *Frank. Inst., J.*, **201**, 107-112; January, 1926.

210. The cause and elimination of night errors in radio direction finding. R. L. Smith-Rose and R. H. Barfield. *I.E.E., J.*, **64**, 831-843; August, 1926. Abstracted in *Experimental Wireless*, **3**, 367-369; June, 1926.

211. On the nature of wireless signal variations. Part I and II. E. V. Appleton and J. A. Ratcliffe. *Roy. Soc., Proc.*, **115**, 291-317; July 1, 1927. Abstracted in *Experimental Wireless*, **4**, 571; September, 1927. In German in *Zeits. f. Hochfrequenztechn.*, **31**, 157-161; May, 1928. (Part I describes the wave length change and the angle-of-incidence methods of determining height of the ionized layer, and presents results showing regular variations in height during the daylight period. Rapid fluctuations in height also noted at times. Part II presents fading data secured by simultaneous recording with different types of receiving antenna and discusses following causes of night-time fading: (a) changes in angle of incidence; (b) intensity changes in indirect ray; (c) phase difference (interference) between ground and indirect rays; (d) polarization of indirect ray. Indications of (a) and (d) were lacking; (c) proved to be a minor, and (b) the major cause.)

212. A study of radio direction finding. R. L. Smith-Rose. *Radio Research Report No. 5*, Dept. Scientific & Industrial Research, 1927. (Summary of the progress in the investigations on radio direction finding and particularly "night

effects" carried out under auspices of the Directional Wireless Committee of the British Radio Research Board during past five years. Includes results of investigations previously reported in separate papers dealing with direction finding systems, instrumental, local, and coastal errors, and night effects. Includes a bibliography.)

213. Oscillographic observations on the direction of propagation and fading of short waves. H. T. Friis. *Proc. I.R.E.*, **16**, 659-665; May, 1928. (Observations made on the 16-meter transatlantic signals to determine variation of direction of propagation and amount of fading.)

214. Apparent night variations with crossed-coil radio beacons. H. Pratt. *Proc. I.R.E.*, **16**, 652-657; May, 1928. (Describes night direction shifts and fading of signals from directive type of radio beacon as received on airplane in flight.)

215. Vagaries of the ether. W. Kelk. *Radio* (San Francisco), **10**, 16; June, 1928. (Results are given of the stability of 800-meter signals traveling over water as compared with those traveling over land at night.)

216. Elektrische Schwingungen und ihre Grenzgebiete drahtlose Telegraphie—Über Fehlweisung der Funkpeilung in Abhängigkeit von der Wetterlage. (Electric waves and their limited transmission: On Direction shifts due to weather.) P. Duckert. *Zeits. f. techn. Physik*, **9**, 466-469, 1928. *E.N.T.*, **5**, 438-441, 1928. (Experiments carried on during several years (day measurements) show that the power received from a transmitter passes over a curved instead of a straight horizontal path so that the direction finder may be in error by several degrees. This is true when certain weather conditions exist, so-called atmospheric border layers. During the night the direction deviations are also accompanied by fading.)

217. Some experiments on night errors for long waves. I. Tanimura. *Proc. I.R.E.*, **18**, 718-722; April, 1930. (The results of experiments on night errors observed for a 19.7-kc station located at a distance of 148 km are described. They are compared with the results of a theoretical analysis following methods used by Eckersley, and good agreement is found. Cyclic variations of bearings are noticed at sunset and sunrise, the maximum shifts being about 30 degrees. At the moments of maximum shift the bearings are distinct while they are broad at other moments.)

R113.5—Meteorological, Geophysical, and Cosmical Effects

218. Funkentelegraphische Versuche beim Durchgang des Halleyschen Kometen. (Radiotelegraphic experiments made during the transit of Halley's comet.) *Deutsche Verkehrs-Zeitung*, **34**, 256, 1910. *E.T.Z.*, **31**, 644; June 23, 1910.

219. Effects of sunlight on transmission of wireless signals. B. L. Dolbear and J. A. Proctor. *El. World*, **58**, 321-323; August 5, 1911.

220. Sonnenlicht Gebirge und Wellen Telegraphie. (Effects of sunlight and mountains on radio telegraphy.) P. Schwartzhaupt. *E.T.Z.*, **32**, 1313-1314; December 28, 1911.

221. Sur l'influence possible des radiations solaires sur la propagation des ondes Hertiennes. (Influence of the sun's rays on the propagation of Hertzian waves.) E. Rothe. *Comptes Rendus*, **154**, 1454-1456; May 28, 1912.

222. Über den Einfluss der Atmosphäre auf Funkentelegraphische Sender und Empfänger. (Influence of atmospheric conditions on transmission and reception.) A. Esau. *Phys. Zeits.*, 13, 721-729, 1912.
223. Effect of the moon on wireless signals. A. M. Curtis. *Electrician*, 70, 1104-1105; March 21, 1913; 71, 143-144; May 2, 1913.
224. Radio transmission and weather. (Correlation of cloud areas shown on weather maps with good transmission.) A. H. Taylor. *El. World*, 62, 425-427; August 30, 1913. *Phys. Rev.*, 3, 346-352; May, 1914.
225. Influence de l'état de l'atmosphère sur la propagation et la réception des ondes Hertiennes. (Influence of the state of atmosphere on transmission and reception of Hertzian waves.) E. Rothe and R. Clarte. *Comptes Rendus*, 158, 699-702; March 9, 1914.
226. The effect of water vapour in the atmosphere on the propagation of electromagnetic waves. F. Schwers. *Phys. Soc. Proc.*, 29, 150-158; January 26, 1917. Abstracted in German in *Jahrb. d. drahtl. Tel.*, 12, 184, 1917.
227. Der Einfluss geophysikalischer und meteorologischer Faktoren auf die drahtlose Telegraphie. (The influence of geophysical and meteorological factors in wireless telegraphy.) Paul Ludewig. *Jahrb. d. drahtl. Tel.*, 12, 122-155; August, 1917.
228. Forecasting thunderstorms by means of static electricity. F. W. Reichelderfer. *Monthly Weather Rev.*, 49, 152-153; March, 1921.
229. Über die Beziehungen zwischen der Ausbreitung elektromagnetischer Wellen und den Vorgängen in der Atmosphäre. (Atmospheric conditions and radio telegraphy.) S. Wiedenhoff. *Jahrb. d. drahtl. Tel.*, 18, 242-260, 1921.
230. Der Einfluss von atmosphärischen Vorgängen auf elektrische Wellen. (Atmospheric conditions and electric waves.) K. Stoye. *Jahrb. d. drahtl. Tel.*, 19, 58-72; January, 1922.
231. Effects of aurora on telegraphs, telephones, and wireless. A. Gibbs. *P.O.E.E., J.*, 15, 39-42; April, 1922. *Telegraph and Telephone Age*, 40, 248-249; June, 1922.
232. Perturbations solaires et ondes électromagnétiques. (Solar disturbances and electromagnetic waves.) L. Bouthillon. *Annales des P.T.T.*, 12, 1432-1435, 1923.
233. Der Einfluss meteorologischer Faktoren auf die drahtlose Telegraphie. (Influence of meteorological factors on wireless telegraphy.) P. Ludewig. *E.u.M.*, 32, 181-187; March 1; 209-214; March 8, 1924.
234. Rôle de l'atmosphère dans la propagation des ondes Hertiennes. (Role of the atmosphere in the propagation of Hertzian waves.) J. Guinchant. *Comptes Rendus*, 179, 327-330; August, 1924.
235. Portée des ondes; action de l'atmosphère. (Range of waves; action of the atmosphere.) J. Guinchant. *Onde Elec.*, 3, 445-448; September, 1924.
236. The electric field of a thundercloud and some of its effects. C. T. R. Wilson. *Phys. Soc., Proc.*, 37 (part 2), 32D-37D; February 15, 1925.
237. Geophysical influences on the transmission of wireless waves. E. V. Appleton. *Phys. Soc., Proc.*, 37, 16D-22D; February 15, 1925.
238. Do weather conditions influence radio? E. Van Cleef. *Radio Broadcast*, 7, 90-94; May, 1925.
239. Über den Stand unserer Kenntnis über die Heavisideschicht. (On the present knowledge of the Heaviside layer.) G. J. Elias. *E.N.T.*, 2, 351-358; October, 1925.

240. Can we forecast radio reception by the weather? J. C. Jensen. *Radio Broadcast*, 8, 558-562; March, 1926.
241. A new theory; the effect of the moon on radio reception. D. Shannon. *Experimental Wireless*, 3, 429-433; July, 1926. *Popular Radio*, 12, 211-213; October, 1927.
242. Aurora and its effect upon radio signals. W. M. Sutton. *QST*, 10, 23-24; October, 1926.
243. Radio signal strength and temperature. L. W. Austin and I. J. Wy-more. *Proc. I.R.E.*, 14, 781-784; December, 1926.
244. Wireless communication and terrestrial magnetism (letter to Editor). C. Chree. *Nature* (London), 119, 82-83; January 15, 1927.
245. The correlation of radio reception with solar activity and terrestrial magnetism. G. W. Pickard. *Proc. I.R.E.*, 15, 83-97; February, 1927; 749-766; September, 1927. Discussion by Dellinger in *Proc. I.R.E.*, 15, 326-329; April, 1927. *Natl. Research Council Bull.*, No. 61, 133-145; July, 1927. Abstracted in German in *Zeits. f. Hochfrequenztechn.*, 30, 130-131; October, 1927.
246. Propagation solaire et activité des ondes. (Solar propagation and activity of waves.) G. W. Pickard. *Onde Elec.*, 6, 91-96; February, 1927.
247. Au sujet de l'aurore du 15 octobre observée en Norvege. (About the aurora of the 15th of October observed in Norway.) H. Jelstrup. *Onde Elec.*, 6, 132-134; March, 1927.
248. The intensity of the radiation from a source of electric waves when the electric constants of the medium in the neighborhood of the source are different from the electric constants at a distance from it. H. MacDonald. *Roy. Soc., Proc.*, 114, 367-375; April, 1927. Abstracted in *Experimental Wireless*, 4, 369; June, 1927.
249. Summary of symposium on correlations of various radio phenomena with solar and terrestrial magnetic and electric activities. J. H. Dellinger. *Natl. Research Council Bull.*, No. 61, 192-197; July, 1927.
250. The aurora and fading (report of observations on relation between radio signals and the aurora made during the last MacMillan Arctic Expedition to Greenland and Labrador). A. G. Cooley. *Radio Broadcast*, 11, 135-137; July, 1927.
251. Symposium on correlations of various radio phenomena with solar and terrestrial magnetic and electric activities. N. H. Heck. *Natl. Research Council Bull.*, No. 61, 127-128; July, 1927.
252. Long wave radio measurements at the Bureau of Standards in 1926, with some comparisons of solar activity and radio phenomena. L. W. Austin. *Proc. I.R.E.*, 15, 825-836; October, 1927.
253. Influence de la nature du sol sur l'émission et la réception radio-électriques. (Influence of ground on radio transmission and reception.) L. Bouthillon. *Onde Elec.*, 6, 533-553; November, 1927. Abstracted in *Experimental Wireless*, 4, 162; March, 1928. (Theoretical discussion of transmission phenomena and antenna systems giving method of measuring electromagnetic fields.)
254. Wireless and meteorology (atmospherics used to trace progress of hurricanes). *Wireless World and Radio Rev.*, 21, 813-816; December 21, 1927. (Work of USS Kittery recording atmospherics by means of direction finder and correlation with meteorological disturbances.)
255. Wave propagation and the weather. F. Charman. *Experimental Wire-*

less, 4, 735-742; December, 1927. (Tests conducted on 30-45 meters two hours after sunrise in England and correlation with meteorological phenomena.)

256. Magnetic storms and wireless telegraphy. E. V. Appleton. *Electrician*, 98, 256-257, 1927. (The author shows how the two discrepancies between the evidence from terrestrial magnetism and from wireless telegraphy regarding the existence of an ionized upper layer is removed by recent experimental results.)

257. On the influence of solar activity on radio transmission. L. W. Austin and I. J. Wymore. *Proc. I.R.E.*, 16, 166-173; February, 1928. (Short period observations of daylight long wave signal measurements of Bureau of Standards and curves showing correlations with solar activity.)

258. A theory of the upper atmosphere and meteors. H. B. Maris. *Proc. I.R.E.*, 16, 177-180; February, 1928. (Radio experiments needed to determine conclusions concerning diurnal and seasonal changes in temperature and composition of atmosphere at heights greater than 50 km.)

259. Correlation of long wave transatlantic radio transmission with other factors affected by solar activity. C. N. Anderson. *Proc. I.R.E.*, 16, 297-347; March, 1928. (Correlation of radio data with data on occurrence of sunspots, solar activity, earth currents, etc.)

260. Relations entre la propagation des ondes electromagnetiques, l'activite solaire et l'etat atmospherique. (Relations between the propagation of electromagnetic waves, solar activity, and amount of atmospherics.) A. Nodon. *Onde Elec.*, 7, 156-161; April, 1928.

261. Some correlations of radio reception with atmospheric temperature and pressure. G. W. Pickard. *Proc. I.R.E.*, 16, 765-772; June, 1928. (Night reception and temperature at receiving station found to be directly related, maximum reception being associated with maximum temperatures. Temperature effect is local to the receiver. Correlation between night reception and pressure found.)

262. The relation of radio propagation to disturbances in terrestrial magnetism. I. J. Wymore. *Bureau of Standards Jnl. of Research*, July, 1928. RP76. *Proc. I.R.E.*, 17, 1206-1213; July, 1929. (The results of a study of the relationship between radio reception and the changes in the earth's magnetism show that for daylight reception over great distances there is an increase in the intensity of received signal which reaches its maximum in from one to two days and disappears in from four to five days after a magnetic storm.)

263. Concerning lunar effects on electromagnetic waves. G. W. Pickard. *QST*, 12, 20; August, 1928. (Observations taken on General Electric Station 2XAF (high frequency) showing lunar effects on these high frequency signals.)

264. Sur l'orage magnetique du 7 au 8 juillet 1928 et les phenomenes connexes. (On the magnetic storm of the 7-8th of July, 1928, and connected phenomenon.) Ch. Maurain. *Onde Elec.*, 7, 363-364; August, 1928; 8, 170-172; April, 1929. (Reports concerning sun spots, radio transmission, and aurora displays attending the magnetic storm of July 7 to 8, 1928, are summarized.)

265. The influence of the earth's magnetic field on electric transmission in the upper atmosphere. S. Goldstein. *Roy. Soc., Proc.*, 121A, 260-285; November, 1928. (Based on lectures by Prof. J. Larmor. The theory of the effect of the magnetic field of the earth on the propagation of electromagnetic waves in the Heaviside layer is given in much detail.)

266. Short wave echoes and the aurora borealis. Balth. van der Pol. Also E. V. Appleton. *Nature* (London), 122, 878-879; December 8, 1928.

267. Les echos des ondes courtes et les Auroras Borealis. (Short wave echoes and the aurora borealis.) B. van der Pol. *Onde Elec.*, 7, 534-537; December, 1928. (Does not agree with Störmer's explanation since rays will never pass through the upper region of the Kennelly-Heaviside layer, but where short waves pass into the layer at a large angle they may go into electron densities where the phase velocity becomes almost infinity, that is, the group velocity almost zero. The reflected wave can then come back to earth after a considerable time has elapsed.)

268. Radio communication and magnetic disturbances. C. S. Wright. *Nature* (London), 122, 971; December 22, 1928. (Note on the effect of magnetic disturbances on radio reception for frequencies greater than 150 kc. A close relation between bad radio communication and magnetic disturbances. The polar regions contain the auroral belts which are highly disturbed magnetically and world-wide communication along great circle paths will often cross these belts.)

269. Der Einfluss der Erdatmosphäre auf die Ausbreitung kurzer Wellen. (Influence of the earth's atmosphere on the propagation of short waves.) J. Fuchs. *Zeits. f. Hochfrequenztechn.*, 32, 125-129, 1928. (Changes in audibility of high frequency signals over the sea are shown to be closely connected with changes in the distribution of air pressure over the intermediate distance.)

270. Wireless telegraphy and magnetic storms. H. B. Maris and E. O. Hulburt. *Proc. I.R.E.*, 17, 494-500; March, 1929. (A recent theory of auroras and magnetic storms attributes these phenomena to the action of a flash of ultra-violet light from the sun; this flash causing an unusual ionization in the Kennelly-Heaviside layer. This theory is found to be borne out in a detailed discussion of data of high frequency (7500 to 20,000 kc) circuits of the U. S. Navy during the magnetic storms of May 28, July 7, October 18, and October 24, 1928.)

271. Activité solaire et propagation. (Solar activity and propagation.) R. Mesny. *Onde Elec.*, 8, 103-110; March, 1929. (Summary of results of several investigators attempting to correlate variations in reception with periods of increased solar activity. Results of Espenschied, Anderson and Bailey, of Pickard and of Austin, are considered.)

272. Radio frequency phenomena associated with the aurora borealis. F. Dearlove. *Experimental Wireless*, 6, 193-195; April, 1929. (Observations made in Labrador and Newfoundland on the effect of aurora borealis on reception at high frequencies. Two types of aurora appear. Type A, a faint glow generally seen in northern sky extending faint streaks of greenish light in all directions and appearing at a great altitude, generally moving slowly but sometimes stationary. Type B appears suddenly, and consists of undulating patches of vivid greenish light. Type A, and to a less extent type B, produce very abnormal types of reception for frequencies of 7500, 3750, and 1775 kc even during daylight.)

273. Sur l'origine de certain parasites. (On the origin of certain atmospheric.) R. Bureau. *Onde Elec.*, 8, 135-142; April, 1929. (Arguments in favor of a meteorological origin of night atmospheric are summarized. The theory is offered that atmospheric of the afternoon are the effect of a strong meteorological situation and not of the storm itself.)

274. On the ultra-violet light theory of aurorae and magnetic storms. E. O. Hulburt. *Phys. Rev.*, 34, 344-351; July 15, 1929. (Certain details of the ultra-violet light theory of aurorae and magnetic storms are developed and experimental facts which are in accord with the theory are cited.)

275. The penetration of rock by electromagnetic waves and audio frequencies. A. S. Eve, D. A. Keys, and F. W. Lee. *Nature* (London), **124**, 178-179; August 3, 1929. *Proc. I.R.E.*, **17**, 2072-2074; November, 1929. (Experiments performed at Mammoth Cave, Ky., are described. Radio signals from distant stations as well as signals of radio and audio frequencies transmitted from directly above were received at various depths in the cave at points remote from the entrance. Since no conductors led from the cave it was concluded that the waves were passing through the solid rock.)

276. Die Sends—und Empfangsverhältnisse im Hochgebirge mit besonderer Berücksichtigung der atmosphärischen Störungen. (Transmitting and receiving conditions in high mountains with special reference to atmospheric disturbances.) J. Fuchs. *Zeits. f. Hochfrequenztechn.*, **34**, 96-101; September, 1929. (Observations of radio transmission and reception made in August and September, 1928, at the meteorological observatory at Sonnblick, Austria, at an altitude of 3106 meters, gave results similar to those at lower levels, but atmospheric noises such as clicks, grinders and whistles which differed qualitatively or quantitatively from the usual diurnal trends appeared related to definite weather conditions in the environment.)

277. Notes on the effect of solar disturbances on transatlantic radio transmission. C. N. Anderson. *Proc. I.R.E.*, **17**, 1528-1535; September, 1929. (The effects of magnetic storms on 60-kc transatlantic radio transmission and also on short wave radio transmission are shown. In general, individual storms tend to increase 60-kc daylight signal intensities and to decrease high frequency signal field intensities.)

278. A propos de la relation entre les orages et les parasites. (Concerning the relation between storms and atmospherics.) R. de Montessus de Ballore. *Onde Elec.*, **8**, 463-464; October, 1929. (Statistics giving monthly calculated and observed values of the frequency of storms and of temperature (at Paris) are tabulated to aid in the study of the influence of storms on atmospherics.)

279. On the relation between long wave reception and certain terrestrial and solar phenomena. K. Sreenivasan. *Proc. I.R.E.*, **17**, 1793-1814; October, 1929. (Signal intensity measurements of Madras (Fort) radio working on 75 kc made at the Radio Laboratory of the Indian Institute of Science, Bangalore, between March, 1926 and August, 1927, are reported. Certain correlations are found between the reception, temperature, atmospheric ozone, sun spots, and terrestrial magnetism.)

280. Weather forecasting by signal radio intensity. Part I. R. C. Colwell. *Proc. I.R.E.*, **18**, 533-536; March, 1930. (At Morgantown, W. Va., 60 miles from Pittsburgh, the night intensity of KDKA sometimes rises above the day signal and sometimes falls below it. Observations during 1927 and 1928 have shown that this phenomenon foreshadows weather conditions from twelve to twenty-four hours ahead. A rising curve after nightfall indicates an approaching storm while a falling curve is followed by fair weather. Typical curves are shown.)

281. The effect of rain and fog on the propagation of very short radio waves. J. A. Stratton. *Proc. I.R.E.*, **18**, 1064-1074; June, 1930. (The effect of rain, fog or clouds on the propagation of short radio waves is investigated theoretically. The theory of the propagation of electromagnetic waves in a medium in which are suspended particles of an arbitrary material is first reviewed. The available physical data on fog and rain is then referred to. The conclusion is

arrived at that for waves greater than 5 cm in length, the effect of ordinary rain or fog on the absorption is negligible.)

282. Meteorological influences on long-distance long-wave reception. E. Yokoyama and T. Nakai. *Proc. I.R.E.*, 18, 1075-1083; June, 1930. (The results of an analytic study of a series of measurements of the field intensity of several distant long wave stations are given. The field intensities of both daylight and night reception were found to vary inversely with changes of atmospheric temperature and absolute humidity at the receiver end of the transmission path. The intensity-pressure relation and the influences of weather were found to be more complex and less clear.)

283. Comparison between sun spot numbers, intensity of the earth's magnetic field, and strength of radiotelegraphic signals. L. W. Austin. *Washington Acad. Sci., J.*, 20, 73-74, 1930.

284. The critical frequency in an ionized medium. Steady magnetic force present. T. L. Eckersley. *Phil. Mag.*, 9, 225-232, 1930. (This note investigates the effect of the presence of a steady magnetic field on the critical frequency. In this case the critical frequency is altered. The purpose of the note is to show that the momentum balance is the same as in the absence of the magnetic field and that the waves are brought to a standstill for the same reason, i.e., the transference of the wave momentum to the ions.)

R113.55—Eclipses

285. Influence de l'éclipse du soleil du 17 avril 1912 sur la propagation des ondes électriques. (Influence of the eclipse of the sun, April 17, 1912, on the propagation of electric waves.) M. A. Turpain. *Comptes Rendus*, 154, 1457-1461; May 28, 1912.

286. Réception à l'observatoire de Lyon des signaux radiotelegraphiques de la Tour Eiffel, pendant l'éclipse de soleil du 17 avril. (Reception of radiotelegraphic signals from the Eiffel Tower during the solar eclipse.) M. Flajolet. *Comptes Rendus*, 154, 1488-1491; June 3, 1912.

287. Influence de l'éclipse de soleil du 17 avril 1912 sur la propagation des oscillations électriques. (Influence of solar eclipse of April 17, 1912 on propagation of electric waves.) A. Boutaric and G. Meslin. *Comptes Rendus*, 154, 1746-1747; June 17, 1912.

288. Funkentelegraphische Beobachtungen während der Sonnenfinsternis am 17 April 1912. (Wireless telegraphy and the eclipse of the sun April 17, 1912.) F. Kiebitz. *Phys. Zeits.*, 13, 890-892; September 15, 1912. *Jahrb. d. drahtl. Tel.*, 6, 151-153, 1912.

289. Messung der während der Sonnenfinsternis am 17 April 1912 von Paris ausgesandten Hertzschen Wellen zu Marburg i. H. und zu Graz. (Wireless telegraphy measurements at Marburg and Graz during the recent eclipse of the sun.) E. Take and M. Vos. *Deutsch. Phys. Gesell. Verh.*, 14, 837-843; September 30, 1912. *Jahrb. d. drahtl. Tel.*, 5, 151-153, 1912.

290. Effect of the eclipse on wireless telegraphic signals. W. H. Eccles. *Nature*, 89, 191-192, 1912. Abstract in *Electrician*, 69, 109; April 26, 1912.

291. Proposed investigation of the effect on the propagation of electric waves of the total eclipse of the sun 21st August, 1914. *Phys. Rev.*, 3, 479-480; June, 1914.

292. Wireless telegraphy and solar eclipse. J. A. Fleming. *Nature* (London), 102, 405; January 23, 1919.

293. Radiotelegraphic investigations in connection with the solar eclipse of 29th May, 1919. British Association Committee, Sir Oliver Lodge, Chairman. *Electrician*, 82, 550-551; May 9, 1919.

294. Über radioelektrische Versuche während der Sonnenfinsternis am 29 Mai 1919. (Wireless investigations during the eclipse of May 29, 1919.) E. Lübecke. *Jahrb. d. drahtl. Tel.*, 14, 298-300; August, 1919.

295. Radiotelegraphy during the solar eclipse of May 29, 1919. *Radio Rev.*, 1, 24-26; October, 1919. *Nature* (London), 104, 323-324; November 20, 1919.

296. Eclipse of the sun April 8, 1921—effects produced at wireless stations. F. Addey. *Radio Rev.*, 2, 226-227; May, 1921.

297. Messungen der Empfangsintensität der atmosphärischen Ionisation und anderer meteorologischer Elemente während der Sonnenfinsternis am 8 April 1921. (Measurements of receiving intensity of atmospheric ionization and other meteorological phenomena during the solar eclipse of April 8, 1921.) B. Illin. *Jahrb. d. drahtl. Tel.*, 22, 128-132; September, 1923.

298. Atmospheric electric observations during the total solar eclipse of Sept. 10, 1923. H. F. Johnston. *Terr. Mag.*, 29, 13-22; March, 1924.

299. Observations radiotelegraphiques pendant l'éclipse du soleil du 10 septembre 1923. (Radio observations during the eclipse of the sun on the 10th of September 1923). L. W. Austin. *Onde Elec.*, 3, 591-594; December, 1924. Abstract in German in *Jahrb. d. drahtl. Tel.*, 25, 139, 1925.

300. Wireless and the eclipse—results of signal measurements between England and the U. S. *Electrician*, 94, 152-153; February 6, 1925.

301. The solar eclipse and the wireless signals. (Correspondence). W. H. Eccles. *Electrician*, 94, 208; February 20, 1925.

302. The effects of the eclipse on radio. A. P. Lane and F. X. Walsh. *Sci. Amer.*, 132, 224-226; April, 1925.

303. Changes observed in the direction of radio signals at the time of the eclipse of January 24, 1925. E. Merritt, C. C. Bidwell, and H. J. Reich. *Frank. Inst., J.*, 199, 485-492; April, 1925.

304. La T. S. F. et l'éclipse du soleil du 24 janvier 1925. (Wireless and the eclipse of the sun the 24th of January, 1925.) A. Morizot. *La T.S.F. Moderne*, 6, 344-348; June, 1925.

305. A note on wireless signal strength measurements made during the solar eclipse of January 24, 1925. E. V. Appleton and M. A. F. Barnett. *Cambridge Phil. Soc., Proc.*, 22, 672-675; July 20, 1925.

306. The effect of the solar eclipse of January 24, 1925 on radio reception. G. W. Pickard. *Proc. I.R.E.*, 13, 539-569; October, 1925.

307. Einfluss der Sonnenfinsternis vom 14 Januar 1926 auf die Fortpflanzung der drahtlosen Wellen. (Influence of the eclipse of the sun on January 14, 1926, on the propagation of radio waves.) *Jahrb. d. drahtl. Tel.*, 28, 189-190; December, 1926.

308. Report concerning the observation of the influence on the propagation of radio waves of the sun eclipse of the 14th of January, 1925, in the Dutch East Indies. E. C. Holtzappel. *Proc. I.R.E.*, 15, 61-62; January, 1927.

309. The solar eclipse and its effect on radio (some suggestions for research during this year's total eclipse of the sun.) H. de A. Donisthorpe. *Experimental Wireless*, 4, 293-300; May, 1927.

310. Wireless and the eclipse (tests on June 29, 1927). E. V. Appleton. *Wireless World and Radio Rev.*, 20, 709-711; June, 1927.

311. Ditton Park research station. Apparatus that will be used during the eclipse for studying the propagation of waves and atmospherics. J. F. Herd. *Wireless World and Radio Rev.*, 20, 740-742; June 15, 1927.

312. Two contrasting examples wherein radio reception was affected by a meteorological condition. E. H. Kincaid. *Proc. I.R.E.*, 15, 843-868; October, 1927.

313. Propagation of short waves during a solar eclipse. E. J. Alway. *Proc. I.R.E.*, 15, 998-1001; December, 1927. (Observations on 30-45 meter waves during solar eclipse of June 29, 1927.)

314. Der Einfluss der Sonnenfinsternis am 29 Juni 1927 auf die Ausbreitung drahtlosen Wellen. (The influence of solar eclipse of June 29 on the propagation of radio waves.) M. Bäumlér. *E.N.T.*, 4, 343-349, 1927.

315. Comptes rendus des observations faites pendant l'eclipse de soleil du 29 juin 1927. (Report of the observations made during the sun's eclipse, June 29, 1927.) H. S. Jelstrup. *Onde Elec.*, 6, 445-460, 1927. Abstracted in *Experimental Wireless*, 5, 162; March, 1928. (Observations made at East Norway on wave length of 566 meters.)

316. Observations sur la propagation des ondes electriques courtes pendant l'eclipse solaire du 12 novembre 1928. (Observations on the propagation of short electric waves during the solar eclipse of November 12, 1928.) M. A. Stehoukin. *Onde Elec.*, 8, 411-419; September, 1929. (Records obtained at Leningrad of the transmission of RRP (Nijnii-Novgorod, wave length = 15 meters) before, during, and after the solar eclipse of November 12, 1928, are reproduced and explained.)

317. Recherches relative a la propagation des ondes radioelectriques effectuées à l'occasion de l'eclipse du 9 mai, 1929. (Researches on the propagation of radio waves on the occasion of the eclipse of May 9, 1929.) J. B. Galle and G. Talon. *Comptes Rendus*, 190, 48-52, 1930. Discussion by Störmer, 106-107. (Report of the results obtained by the Indo-China Expedition.)

R113.6—Reflection, Refraction, Diffraction, Absorption, Polarization

318. The bending of electric waves round a conducting obstacle (diffraction). H. M. MacDonald. *Roy. Soc., Proc.*, 71a, 251-258, 1903; 72A, 59-68, 1903; 90, 50-61, 1914; 92, 493-500, 1916; 108A, 52-76, 1925. In German in *Jahrb. d. drahtl. Tel.*, 12, 45-55, 1918; 26, 109-110, 1925.

319. Atmospheric absorption of wireless signals. R. A. Fessenden. *Nature* (London), 76, 444, 1907.

320. Bending of waves. Poincaré. *Comptes Rendus*, 149, 621-622, 1909. In German in *Jahrb. d. drahtl. Tel.*, 3, 445-487, 1909-1910. Schaeffer. In German in *Jahrb. d. drahtl. Tel.*, 3, 183-188, 1909-1910. Nicholson. *Phil. Mag.*, 19, 276-278; 516-537; February, 1910; 20, 157-172, 1910; 21, 62-68; 281-295, 1911. MacDonald—*Phil. Trans.*, A210, 113-144, 1910. Sommerfeld. *Ann. d. Physik*, 28, 665-736, 1909.

321. On certain phenomena accompanying the propagation of electric waves over the surface of the globe. W. H. Eccles. *Electrician*, 69, 1015-1018; September 27, 1912; 71, 969-970, 1913. In German in *Jahrb. d. drahtl. Tel.*, 7, 191-210 1913.

322. Absorption of undamped waves. L. de Forest. *Electrician*, 69, 369-370, 1912.

323. Transmission of electromagnetic waves through and around the earth. G. W. O. Howe. *Electrician*, 72, 484-486; December 26, 1913.

324. Über die Brechung der elektrischen Wellen in der Atmosphäre. (Refraction of radio waves in the atmosphere). F. Kiebitz. *Jahrb. d. drahtl. Tel.*, 7, 154-157, 1913.
325. On atmospheric refraction and its bearing on the transmission of electromagnetic waves. J. A. Fleming. *Phys. Soc. Proc.*, 26, 318-333, 1914. Abstracted in *Electrician*, 74, 152-154, 1914.
326. Die Überwindung der Erdkrümmung durch die Wellen der drahtlosen Telegraphie. (Effect of the earth's curvature on wireless telegraphy.) A. Sommerfeld. *Jahrb. d. drahtl. Tel.*, 12, 2-15; June, 1917.
327. Diffraction of electric waves by the earth. G. N. Watson. *Roy. Soc. Proc.*, 95, 83-99, October 7, 1918; 95A, 546, 1919. *Nature* (London), 102, 80, 517, 1919.
328. Experimentelle Untersuchungen über die Beugung elektromagnetischer Wellen an einem Schirm mit geradlinigem Rande. (Investigations on the diffraction of electromagnetic waves in a screen with rectilinear border.) M. Sjöstrom. *Jahrb. d. drahtl. Tel.*, 14, 171-180; July, 1919.
329. Refraction of electric waves. T. L. Eckersley. *Radio Rev.*, 1, 421-428; June, 1920. In German in *Jahrb. d. drahtl. Tel.*, 18, 369-378; November, 1921.
330. Local errors in radio direction finding. J. Hollingworth and B. Hoyle. *Radio Rev.*, 1, 644-649; October, 1920. (Experiences showing distortion of radio direction finder bearings by masses of metal, large conducting surfaces, tuned circuits, telegraph and telephone lines.)
331. Objects that distort radio waves. L. E. Whittemore. *Radio Broadcast*, 1, 101-106; June, 1922.
332. The effect of underground metalwork on radio direction finders. R. L. Smith-Rose. *Wireless World and Radio Rev.*, 11, 165-171; November 4, 1922. Discussion, 202-203, November 11, 1922.
333. The effect of local conditions on radio direction finding installations. R. L. Smith-Rose and R. H. Barfield. *I. E. E., J.*, 61, 179-196; January, 1923.
334. Sur l'absorption des ondes courtes. (On the absorption of short waves.) J. Granier. *Onde Elec.*, 3, 572-582; December, 1924.
335. Eigentümlichkeiten und Anwendungsmöglichkeiten kurzer elektrischer Wellen. (Peculiarities and possible applications of short waves.) A. Esau. *E. N. T.*, 2, 3-9; January, 1925.
336. Geophysical influences on the transmission of wireless waves. E. V. Appleton. *Phys. Soc., Proc.*, 37, 16D-22D; February 25, 1925.
337. The reflection of short waves. J. L. Reinartz. *QST*, 9, 9-12; April, 1925.
338. Optique et radioélectricité. (Optics and radio.) L. Bouthillon. *Onde Elec.*, 4, 287-296; July, 1925. 5, 577-592; November, 1926; 6, 97-109; March, 1927.
339. On some direct evidence for downward atmospheric reflection of electric rays. E. V. Appleton and M. A. F. Barnett. *Roy. Soc., Proc.*, 109, 621-641, 1925. *Wireless World and Radio Rev.*, 17, 885-887; December 23, 1925. Abstracted in German in *Jahrb. d. drahtl. Tel.*, 27, 123-124, 1926.
340. The polarization of radio waves. G. W. Pickard. *Proc. I.R.E.*, 14, 205-212; April, 1926. *Radio News*, 7, 1540-1541; May, 1926. Abstracted in German in *Jahrb. d. drahtl. Tel.*, 27, 161, 1926. Discussion by Alexanderson in *Proc. I.R.E.*, 14, 391-393; June, 1926.
341. Short wave reflection phenomena (short waves vs. long waves.) E. W.

Thatcher. *Radio* (San Francisco), 8, 21-24; April, 1926. (A very clear analysis and explanation of why short waves travel farther and skip farther than long waves.)

342. Changes in the polarization of radio waves. G. W. Pickard. *Radio News*, 7, 1540-1541; May, 1926.

343. On the attenuation of wireless signals in short distance overland transmission. J. A. Ratcliffe and M. A. F. Barnett. *Cambridge Phil. Soc., Proc.*, 23, 288-303; May, 1926. (Measuring apparatus is described. Measurements below 1000 kc (300 meters) give information on resistivity of ground, and measurements of frequencies above 2 megacycles (15 meters) give dielectric constant of the ground. Attenuation measurements on 187.5 kc (1600 meters) and 830 kc (360 meters) correlate closely with values calculated from Sommerfeld's theory for distances greater than 10 wave lengths but deviate for shorter distances. Distance attenuation curves are given.)

344. Bending of radio waves by storms (experiments on influence of weather conditions on fading, etc.) J. J. O'Neill. *Radio* (San Francisco), 8, 8-11; June, 1926.

345. Refraction of short radio waves in the upper atmosphere. W. G. Baker and C. W. Rice. *A. I. E. E., J.*, 45, 535-539; June, 1926. Abstracted in German in *Jahrb. d. drahtl. Tel.*, 28, 197; December, 1926. Abstracted in French in *Onde Elec.*, 6, 17A; March, 1927.

346. Eine Ursache der Änderung des Polarisationszustandes Kurzen Wellen (An investigation of the change of the condition of polarization in short waves.) N. von Korshenewsky. *Jahrb. d. drahtl. Tel.*, 28, 184-185; December, 1926.

347. An investigation of wireless waves arriving from the upper atmosphere. R. L. Smith-Rose and R. H. Barfield. *Roy. Soc., Proc.*, 110, 580-614, 1926. 116A, 682-683; November, 1927.

348. Die Ausbreitung kurzer Wellen rund um die Erde. (The propagation of short waves around the earth.) K. W. Wagner. *E. N. T.*, 4, 74-77; January, 1927. Abstracted in *Wireless World and Radio Rev.*, 22, 11-12; January 4, 1927. (2XT R. C. A. short-wave station experiments on 18 meters in Germany.)

349. Refraction of electromagnetic waves around the earth's surface. J. McPetrie and R. Wilmotte. *Nature* (London), 121, 317; February 26, 1927. Abstracted in *Experimental Wireless*, 4, 244; April, 1927.

350. Short wave echo effect. (Editorial). *Experimental Wireless*, 4, 257-258; May, 1927.

351. Distribution de l'énergie radioélectrique dans les agglomérations urbaines. (Distribution of radio energy in crowded cities.) Lloyd Espenschied. *Onde Elec.*, 6, 229-254; June, 1927.

352. La radiophonie et les phénomènes de propagation (reflection, refraction, diffraction). (Radiotelephony and propagation phenomena) G. Cartier. *QST Français*, 8, 3-9; December, 1927.

353. The absorption of radio waves in upper atmosphere. E. O. Hulburt. *Phys. Rev.*, 29, 706-716, 1927.

354. On the refraction of electromagnetic waves in a spherically stratified medium. T. Y. Baker. *Phil. Mag.*, 4, 955-980, 1927.

355. Deviation of wireless waves at a coastal boundary. R. L. Smith-Rose. *Nature* (London), 122, 35; January 7, 1928. Abstracted in *Experimental Wireless*, 5, 162; March, 1928.

356. The attenuation of wireless waves over land. R. H. Barfield. *I. E. E.*,

- J.*, 66, 204-218; February, 1928. Abstracted in *Experimental Wireless*, 5, 25-30; January, 1928. *Wireless World and Radio Rev.*, 22, 2-6; January 4, 1928. Discussion, *I. E. E., J.*, 7, 931; July, 1929. (Intensity measurements on transmission of 2LO (London) giving results of investigation which showed greater attenuation than that expected from the Sommerfeld theory.)
357. On a method of determining the state of polarization of downcoming wireless waves. E. V. Appleton and J. A. Ratcliffe. *Roy. Soc., Proc.*, 117A, 576-588; February 1, 1928.
358. Polarisation of radio waves. J. Hollingworth and R. Naismuth. *Nature* (London), 122, 171; February 4, 1928. Abstracted in *Experimental Wireless*, 163; March, 1928.
359. On round-the-world signals. E. O. Hulburt. *Proc. I.R.E.*, 16, 287-289; March, 1928.
360. The reflecting layer of the upper atmosphere. G. H. Munro. *Experimental Wireless*, 5, 242-244; May, 1928. (Experiments carried on in New Zealand during December, 1925 for estimation of height of reflecting layer for waves of 500 kc.)
361. A study of short-time multiple signals. J. B. Hoag and V. J. Andrew. *Proc. I.R.E.*, 16, 1368-1374; October, 1928. (An investigation of signals which may have travelled one or more times around the earth. Shows reflections of signals from regions other than Kennelly-Heaviside layer.)
362. On the anomalous dispersion and absorption of electric waves. S. Mizushima. *Sci. Papers Inst. Phys. & Chem. Research*, Tokyo (Japan), 5, 201-248, 1927 or 1928. Abstracted in *Experimental Wireless*, 5, 164; March, 1928.
363. The attenuation of wireless waves over towns. R. H. Barfield and G. H. Munro. *I. E. E., J.*, 67, 253-270; February, 1929. Abstracted in *Experimental Wireless*, 6, 31-37; January, 1929. (Shows that the rate of change of attenuation with wave length of the radiated field over towns is rather great. A theoretical discussion is given by means of Sommerfeld's numerical distance, and the same applied to the absorbing effect of vertically grounded conductors which exist in the towns in many forms. Also a theoretical discussion on selective absorption due to tuned antennas and to their reradiation. Sommerfeld's theory seems to confirm the high rate of attenuation over towns.)
364. Note on earth reflection of ultra short radio waves. E. H. Lange. *Proc. I.R.E.*, 17, 745-751; April, 1929. (Computations and curves are given for the reflection coefficients and phase angles for various surface conditions in conjunction with a horizontal ultra-short antenna. Theoretical polar diagrams were computed for various heights of horizontal antenna above the surface.)
365. Wireless echoes of long delay. P. O. Pedersen. *Nature* (London), 124, 164; July 27, 1929. *Proc. I.R.E.*, 17, 1750-1785; October, 1929. (Shows mathematically that radio echoes occurring after ten seconds cannot be due to propagation of waves within the earth's atmosphere, that echoes occurring after intervals up to 30 seconds are due to propagation along or reflection from Störmer bands as explained in *Nature* (122, 681, 1928); that echoes after several minutes must be from outside the space in which the earth's magnetic field exerts appreciable effect. Transmissions at various wave lengths are also treated.) Also appeared in *Det. Kgl. Danske Videnskabernes Selskab* (Mathematical and Physics Number), 9, 1929.
366. Kurzwellenechos, die mehrere Sekunden nach dem Hauptsignal eintreffen, und wie sie sich aus der Theorie des Polarlichtes erklären lassen. (Short

wave echoes that occur several seconds after the main signal and their explanation in the light of the theory of the aurora borealis. Theoretical discussion). C. Störmer. *Die Naturwissenschaften*, 17, 643-651; August 16, 1929.

367. Group velocity and long retardations of radio echoes. G. Breit. *Proc. I.R.E.* 17, 1508-1512; September, 1929. (Van der Pol's hypothesis that group velocity may account for the retardation (up to 15 seconds) of echoes observed by Störmer is analyzed. It is shown that only under special circumstances can the electron distribution in the Kennelly-Heaviside layer be proper. A favorable condition is obtained if the refractive index decreases exponentially with the height.)

368. Studies of echo signals. A. H. Taylor and L. C. Young. *Proc. I.R.E.* 17, 1491-1507; September, 1929. (Work reported in the *Proc. I.R.E.* for May, 1928, by the same authors has been continued as a more extended study of echo signals with particular reference to directional characteristics and to diurnal variations. Attention has been given to the relations between echo signals, frequency and the effective height of the Kennelly-Heaviside layer.)

369. The significance of observations of the phase of radio echoes. G. Breit. *Proc. I.R.E.*, 17, 1815-1821; October, 1929. (An interferometer method of observing the phase of radio echoes has been developed by Tuve and Hafstad. It is shown that by measurement on reflections with low retardation the ratio between the changes in the equivalent height found through the interferometer method and in the effective height found by measurement of the echo retardation is a measure of how much of the change is due to the layer moving as a whole and how much is due to a redistribution of electron densities through the layer.)

370. An echo interference method for the study of radio wave paths. L. R. Hafstad and M. A. Tuve. *Proc. I.R.E.*, 17, 1786-1792; October, 1929. (The rate of change of the radio frequency phase of separate downcoming echoes has been experimentally determined by an interferometer method. Oscillograms show the echoes to alternately add to and subtract from a constant pickup in the radio receiver from the crystal-controlled oscillator of the nearby pulse transmitter. Changes are regular but the time of a 360-degree phase change on 4435 kc varies from 1 to 60 seconds and at times changes between these limits in as short a time as 15 minutes.)

371. L'absorption des ondes electromagnetiques au dessus des forêts. (The absorption of electromagnetic waves over forests.) A. Nodon. *Onde Elec.*, 8, 85-86, 1929.

372. Polarization of very short waves. E. A. Paulin. *Phys. Rev.*, 33, 432-443, 1929. (Transmissions on 5 to 7.5 meters showed that the polarization depended upon the orientation of the lineal oscillator. It was further found that up to a range of 100 meters the polarization showed no tendency to change.)

373. The refractive index of spaces with free electrons. A mechanical model. P. O. Pedersen. *Experimental Wireless*, 7, 16-21; January, 1930. (Elementary considerations of an electron in space subject to the electric field of a radio wave show that the dielectric constant of the space may be positive, zero, or negative, and that, in consequence, the refractive index may be reduced to values less than one and even to zero. A mechanical model is offered as an illustration of principles involved.)

374. Les ondes très courtes. (Very short waves.) R. Jouaust. *Onde Elec.*, 9, 5-17; January, 1930. (The transmission of waves of very high frequency ($\lambda = 10$ meters) is discussed. The treatment is historical, the theoretical and experimental

work of French scientists being specially noted. Transmission phenomena found in the application of the very high frequencies to telephone communication between France and Corsica are explained by the use of the theory of refraction.)

375. Reflecteur pour ondes hertziennes polarisées très courtes. (Reflector for short polarized Hertzian waves.) A. Della Riccia. *R. G. E.*, 14, 87-90; January, 1930. (The reflecting properties of surfaces are theoretically studied. The cases where the directrix of the surface is an hyperbola or a parabola are reviewed and the case where the directrix is an ellipse is treated in detail. Formulas are established for use in the design of the reflector that the rays emitted by the various paths (direct and reflected) may be in phase.)

376. Multiple signals in short wave transmission. T. L. Eckersley. *Proc. I.R.E.*, 18, 106-122; January, 1930. (The facsimile records obtained in transmissions between New York and Somerton, England, give measurements of the time intervals between the various signals which produce distortion in the received record. From an analysis of these measurements information is secured (1) as to the angle within which the useful radiation is confined at the transmitter; (2) as to the distortion to be expected on different wave lengths; and (3) as to the electron density in the Kennelly-Heaviside layer.)

377. Reflexionsmessungem mit sehr kurzen elektrischen und mit akustischen Wellen. (Reflection measurements with very short electrical and acoustical waves.) M. J. O. Strutt. *E. N. T.*, 7, 65-71; February, 1930. (Field intensity measurements were made in a vertical plane of the radiation from a high-frequency electric oscillator and from an acoustic oscillator. The effects of the ground conditions and intervening objects between the transmitter and receiver were observed. A short explanation of the relationship between the direct and reflected waves according to the theory of Sommerfeld is included.)

378. Cartes de propagation d'ondes courtes. (Propagation maps of short waves. (R. Bureau. *Onde Elec.*, 9, 93-114; March, 1930. (Propagation maps are presented and discussed. The method of construction, similar to that used in making weather maps, is explained. The various maps show daytime zones of silence on intermediate waves, nighttime zones of audition within zones of silence on short waves, and the birth and development of a zone of silence.)

R113.61—Kennelly-Heaviside Layer

379. On the elevation of the electrically-conducting strata of the earth's atmosphere. A. E. Kennelly. *Elec. Wld. & Engineer*, 39, 473; March 15, 1902.

380. On the cause of ionization in the atmosphere. J. A. Fleming. *Roy. Inst., Proc.*, 17, 223, 1902. In German in *Jahrb. d. drahtl. Tel.*, 12, 175-183, 1918.

381. Effect of ionization of air on electrical oscillations and its bearing on long distance wireless telegraphy. E. H. Barton and W. B. Kelby. *Phil. Mag.*, 26, 567-578; October, 1913. Abstract in German in *Jahrb. d. drahtl. Tel.*, 8, 374-375, 1914.

382. Das Reflexionsvermögen eines ionisierten Gases für elektrische Wellen. (The reflection power of an ionized gas on electric waves.) J. Salpeter. *Phys. Zeits.*, 14, 201-203, 1913. *Jahrb. d. drahtl. Tel.*, 8, 247-253, 1914.

383. The influence of atmospheric ionization on the propagation of electromagnetic waves. H. M. Dowsett. *Wireless World*, 3, 386-390; September, 1915.

384. The propagation of electric waves at the surface of the earth and the ionized layer of the atmosphere. H. Nagaoka. *Electrician*, 76, 731; February 25,

1916. In German in *Jahrb. d. drahtl. Tel.*, 12, 35-38; June, 1917. (Explains sunset-sunrise and eclipse effects.)

385. The Heaviside layer. E. W. Marchant. *PROC. I.R.E.*, 4, 511-521, 1916. In German in *Jahrb. d. drahtl. Tel.*, 12, 56-67; June, 1917.

386. Sur la theorie du developpement de Heaviside. (On the theory of the development of Heaviside.) J. B. Pomey. *R. G. E.*, 4, 693-694; November 9, 1918.

387. Über die Ursache der Zunahme der Ionisation der Atmosphäre mit der Höhe. (On the cause of the increase of the ionization in the atmosphere with the height.) A. Cockel. *Phys. Zeits.*, 19, 114-115, 1918.

388. Electrical phenomena occurring in high levels in the atmosphere. S. Chapman. *I. E. E., J.*, 57, 209-222, 1919. *Sci. American Supplement*, 88, 100, 200, 201; September 27, 1919.

389. Über einen ionenbeldenen Effekt in den abersten Schichten der Atmosphäre. (An ion-producing effect in the upper atmosphere.) W. Hammer. *Phys. Zeits.*, 21, 218-219; April 15, 1920. *Radio Rev.*, 1, 563; August, 1920.

390. The effect of the Heaviside layer on the apparent direction of electromagnetic waves. T. L. Eckersley. *Radio Rev.*, 2, 60-65, 231-248, 1921.

391. Spannungsgefälle und vertikaler leitungsstrom in der freien Atmosphäre nach Messungen bei hochfahrten im Freiballon. (Potential differences and vertical currents in the atmosphere, from measurements taken during balloon ascensions.) E. Everling and A. Wiegand. *Ann. d. Physik*, 66, 261-282, 1921.

392. The Heaviside layer. (Editorial). G. W. O. Howe. *Electrician*, 89, 260-261; September 8, 1922.

393. The overworked Heaviside layer problem and a possible alternative. G. W. O. Howe. *Electrician*, 92, 720; June 13, 1924.

394. The Heaviside layer and how it may be produced. O. F. Brown. *Experimental Wireless*, 1, 595-597; July, 1924.

395. Atmospherics. R. A. Watson-Watt. *Phys. Soc., Proc.*, 37, 23D-31D; February 15, 1925.

396. Atmospheric ionisation and its variations. C. Chree. *Phys. Soc., Proc.*, 37, 5D-15D; February 15, 1925.

397. Ionisation der Atmosphäre und Ausbreitung elektrischer Wellen. (Ionization of the atmospheric propagation of electric waves.) A. Cockel. *Jahrb. d. drahtl. Tel.*, 25, 131-134, 1925.

398. Local reflections of wireless waves from the upper atmosphere. E. V. Appleton and M. A. F. Barnett. *Nature (London)*, 115, 333-334, 1925.

399. The Kennelly-Heaviside layer and radio wave propagation. E. O. Hulbert. *Frank. Inst., J.*, 201, 597-634; May, 1926.

400. Ionization of the upper atmosphere. S. Chapman. *Roy. Meteorolog. Soc., J.*, 52, 225-237; July, 1926. Abstract in French in *Onde Elec.*, 6, 18A; March, 1927.

401. A test of the existence of the conducting layer. G. Breit and M. A. Tuve. *Phys. Rev.*, 28, 554-575; September, 1926. Abstract in *Nature (London)*, 116, 357; September 5, 1925.

402. Atmosphärische einflüsse auf die Ausbreitung und Störung elektromagnetischer Wellen. (Atmospheric influence on the propagation and disturbance of electromagnetic waves.) P. Duckert. *E.N.T.*, 3, 440-441; November, 1926.

403. Relation between the height of the Kennelly-Heaviside layer and high

- frequency radio transmission phenomena. A. H. Taylor. *Proc. I.R.E.*, **14**, 521-540, 1926.
404. Anomalies in the transmission of radio waves. H. Nagaoka. *Proc. 3d Pan-Pacific Science Congress*, Tokyo, **2**, 1266-1270, 1926. (Theories are given for behavior of both long and short waves at the Kennelly-Heaviside layer.)
405. The Heaviside layer (experimental proof of its existence). E. V. Appleton. *Wireless World and Radio Rev.*, **20**, 2-4; January 5, 1927.
406. Die täglichen Schwankungen des Ionisationszustandes der Heaviside Schicht. (The daily variations of ionization in the Heaviside layer.) Hans Lassen. *E.N.T.*, **4**, 174-179; April, 1927.
407. Preliminary note on conclusions regarding the constitution of the upper atmosphere indicated by radio data. E. O. Hulburt. *Nat. Research Council Bull.* No. 61, 125-126; July, 1927.
408. Transmission of electric waves through the ionized medium. T. L. Eckersley. *Phil. Mag.*, **4**, 147-165; July 2, 1927. Abstracted in *Experimental Wireless*, **4**, 571; September, 1927.
409. Sur les propriétés diélectriques des gaz ionisés et la propagation des ondes électromagnétiques dans la haute atmosphère. (On the dielectric properties of ionized gases and the propagation of electromagnetic waves in the upper atmosphere.) H. Gutton and J. Clement. *Onde Elec.*, **6**, 137-151, 1927.
410. Experiments and observations concerning the ionized regions of the atmosphere. R. A. Heising. *Proc. I.R.E.*, **16**, 75-99; January, 1928. (Determination of the height and variation in ionized regions of atmosphere.)
411. Ionization in the upper atmosphere. E. O. Hulburt. *Proc. I.R.E.*, **16**, 174-176; February, 1928. Abstracted in *Washington Acad. Sci.*, **J.**, **18**, 227; April, 1928. (Radio experiments show that ultra-violet rays are one cause of ionization.)
412. Measurements of the effective heights of the conducting layer and the disturbances of August 19, 1927. O. Dahl and L. A. Gebhardt. *Proc. I.R.E.*, **16**, 290-296; March, 1928. (Uses reflection method of measuring effective heights of reflecting layer and gives values of height at various times of day from August 15 to 25, 1927. Shows abrupt change on August 19, 1927.)
413. A transmitter modulating device for the study of the Kennelly-Heaviside layer by the echo method. M. A. Tuve and O. Dahl. *Proc. I.R.E.*, **16**, 794-798; June, 1928. (A method of modulating a transmitter by sudden pulses of plate current which occur in an unbalanced multivibrator circuit is described.)
414. Les phénomènes de propagation des ondes radiotélégraphiques. (The propagation phenomena of radio waves.) R. Jouaust. *Comptes Rendus*, **187**, 208-209; July 23, 1928. (Calls attention to the fact that the propagation theory is based on a certain law for which the ionic density in the upper atmosphere is taken as a regular function of the altitude. The electrified particles given off from the sun are, however, a discontinuous emission similar to the Schottky effect in tubes.)
415. Effective heights of the Kennelly-Heaviside layer in December, 1927, and January, 1928. G. Breit, M. A. Tuve, O. Dahl. *Proc. I.R.E.*, **16**, 1236-1239; September, 1928. (Report on results of effective heights of Kennelly-Heaviside layer obtained December 19, 1927, to January 16, 1928, by the reflection method. Work done on a frequency of 4015 kc.)
416. Short wave echoes and the Aurora Borealis. C. Störmer. *Nature* (London), **122**, 681; November 3, 1928. (Report on signals and echoes received

at Bygdo, Oslo, from the short wave station at Eindhoven, Holland. The echoes arrived from 3 to 15 seconds later than the principal signal. The writer explains these belated echoes by the theory that radio waves penetrate the Kennelly-Heaviside layer passing then into empty pockets of large dimensions. The pockets are surrounded by walls of electrons from which the waves are reflected.)

417. Radio echoes and magnetic storms. *Nature* (London), 122, 768; November 17, 1928. (Two notes, one by S. Chapman and the other by T. L. Eckersley, with respect to above article by Störmer. Eckersley calls attention to his paper in the *Phil. Mag.*, June, 1925, where he explained the whistles of lowering pitch by means of dispersion and the group velocity along the path in the Kennelly-Heaviside layer. Chapman calls attention to the fact that positive ions are also present in addition to the electrons which were considered in Störmer's theory.)

418. Note on the determination of the ionization in the upper atmosphere. J. C. Schelleng. *Proc. I.R.E.*, 16, 1471-1476; November, 1928; 17, 1313-1315; August, 1929. (Describes a method of estimating distribution of ionization in upper atmosphere. This method based on measurements on several frequencies of effective height as determined by interference or echo experiments.)

419. Short wave signals which travel over a million miles and return. R. T. Beatty. *Wireless World and Radio Rev.*, 23, 722-723; November 28, 1928. (A picturization of electron vortices of extremely large dimensions and their possible effects on radio transmission explaining long time interval echoes.)

420. Echos von Hertzschen Wellen. (Echoes from electromagnetic waves.) K. W. Wagner. *E.N.T.*, 5, 488; December, 1928. (Gives the different suppositions which may explain the echo effects. One explanation (Lassen and Försterling) assumes that the rays travel along different paths in the ionized layer. The second explanation (Störmer) assumes reflections or refractions on the envelope of electron pockets of very great dimensions. The third explanation (B. van der Pol, Jr.) assumes that the group velocity of the waves through the ionized layer can be slowed down considerably for certain conditions in the layer. The fourth explanation has reference to echoes corresponding to 0.005 to 0.08 second intervals, such as observed by Taylor, Young and Hoag, and Andrew, Quäck and Mögel. They are due to reflections from a layer 1500 km above the earth or from the polar night light zone or from the sunset shadow wall.)

421. Étude sur la propagation des ondes courtes. (Study on the propagation of short waves.) Lieut. Guyot. *Onde Elec.*, 7, 509-530; December, 1928. (Review of the propagation of short waves assuming that the Kennelly-Heaviside layer is defined by the position of the earth's surface with respect to the sun. Based on this, the height of the layer depends on the time during 24 hours, the latitude of the station, and the declination of the sun. Experimental curves are given based on simplified formulas for the calculation of the height of the layer.)

422. Über die Ausbreitung kurzer elektromagnetischer Wellen in der Heavisideschicht. (On the propagation of short electromagnetic waves in the Heaviside layer.) K. Försterling. *E.N.T.*, 5, 530-542; December, 1928. (General discussion on the refraction and absorption of short waves (less than 60 meters). Assumes that the ionization is due to ultraviolet rays from the sun. The article also indicates that there can be three layers from which the atmospheric ray may descend.)

423. Some notes on wireless methods of investigating the electrical structure of the upper atmosphere. E. V. Appleton. *Phys. Soc., Proc.*, 41, 43-59; Decem-

- ber 15, 1928. (Comparison of the wave length change method, angle of incidence method, and the group retardation method for finding the effective height of the Kennelly-Heaviside layer. If the effect of the earth's magnetic field is neglected, the methods measure the same equivalent height which is greater than the maximum height reached by the atmospheric ray. A method for investigating the ionic concentration is given. This is partly based on an assumption by Pedersen for which the angle of incidence at the ground is greater than 30 degrees.)
424. Radio transmission and the upper atmosphere. G. W. O. Howe. *Experimental Wireless*, 5, 657-659, 1928.
425. Rôle possible de la diffusion par les electrons dans la propagation des ondes courtes. (Possible role of the diffusion by electrons in the propagation of short waves.) Ponte and Rocard. *Comptes Rendus*, 187, 942-943, 1928.
426. Studies of high frequency radio wave propagation. A. H. Taylor and L. C. Young. *Proc. I.R.E.*, 16, 561-578, 1928. (Preliminary report on the studies made of multiple signals on high frequencies with reference to round-the-world and nearby echoes.)
427. The equivalent heights of the atmospheric ionized regions in England and America. E. V. Appleton. *Nature* (London), 123, 445; March 23, 1929.
428. Measurements of the height of the Kennelly-Heaviside layer. G. W. Kenrick and C. K. Jen. *Proc. I.R.E.*, 17, 711-733; April, 1929. (Further contribution to the Kennelly-Heaviside layer problem is offered in the form of experimental data showing evidence of the diurnal cycle in layer, height and a mathematical discussion of methods for the interpretation of group time and phase retardation experiments with the view of determining the relationship between "virtual" and "true" heights.)
429. Sur la couche ionisée de la haute atmosphere. (On the ionized layer of the upper atmosphere.) M. Ponte and Y. Rocard. *Onde Elec.*, 8, 179-191; May, 1929. (In problems concerning the conductivity of the Kennelly-Heaviside layer the mean free path of the electrons is a relevant quantity. An analysis based on the kinetic theory in which the forces of interaction between the molecules and the electrons are considered shows the value of the mean free path to be from 40 to 160 times as small as the value obtained by the elementary theory.) *Onde Elec.*, 8, 306-314; July, 1929. (Transmission experiments have shown that below 5000 kc the zone of silence does not appear. This value is used as the critical value above which there is "dielectric reflection" and below which there is "metallic reflection." It is related to the frequency of collision of electrons in the upper atmosphere. Using this theory and the formulas of the physics of the atmosphere, the height of the Kennelly-Heaviside layer is calculated.)
430. A new method of determining height of the Kennelly-Heaviside layer. C. B. Mirick and E. R. Hentschel. *Proc. I.R.E.*, 17, 1034-1041; June, 1929. (Periodic variations of fairly constant frequency over a considerable time interval are shown in graphic records of radio signals transmitted from a high-frequency aircraft transmitter. From geometric considerations of this frequency, the ground speed of the plane, and the transmitting distance, the effective height of the layer is computed.)
431. Further studies of the Kennelly-Heaviside layer by the echo method. L. R. Hafstad and M. A. Tuve. *Proc. I.R.E.*, 17, 1513-1522; September, 1929. (Recent observations of the Kennelly-Heaviside layer by the echo method are reported. Two 24-hour series of observations showed a marked diurnal variation in the effective height of the layer and in the echo pattern received for each trans-

mitted "peak." The pattern was most complex at night. Observations during magnetic disturbances showed an unusually great effective height and a change in the echo pattern.)

432. Ionization in the atmosphere of Mars. E. O. Hulburt. *Proc. I.R.E.*, 17, 1523-1527; September, 1929. (The composition of the atmosphere of Mars to great heights is calculated on certain assumptions and the electron density in the atmosphere due to the ultraviolet light of the sun is theoretically found. Calculated skip distances indicate 47 meters as the shortest wave for reliable long distance wireless communication over the surface of Mars. The improbability of interplanetary radio communication is pointed out.)

433. Further observations of radio transmission and the heights of the Kennelly-Heaviside layer. G. W. Kenrick and C. K. Jen. *Proc. I.R.E.*, 17, 2034-2052; November, 1929. (Further observations on radio transmission phenomena associated with reflections of radio pulse and spark signals are described with a theoretical discussion of the form of the variation of index of refraction which seems best adapted to explain the observed phenomena. Results of long wave field strength observations are also presented.)

434. Short range echoes with short waves. E. Quäck and H. Mögel. *Proc. I.R.E.*, 17, 824-829, 1929. (The authors have made an examination of short range echoes by special signals transmitted from Nauen (21,430 to 11,528 kc) and recorded photographically at Geltow, Germany. The echoes are sometimes blurred and sometimes repeated at fairly regular intervals indicating multiple reflection between the earth and a reflecting layer the height of which is estimated to be about 1500 meters.)

435. Doppel- und mehrfachzeichlein bei kurzwellen. (Double and multiple echoes on short waves.) E. Quäck and H. Mögel. *E.N.T.*, 6, 45-79, 1929.

436. On some measurements of the equivalent height of the atmospheric ionized layer. E. V. Appleton. *Roy. Soc., Proc.*, 126A, 542-569; March 3, 1930. (The results of a series of early morning measurements of the equivalent height of the ionized layer for 400-meter waves are recorded and discussed. Measurements were made by the "frequency change" method, the theoretical basis of which is analyzed. Deviations from the normal type of nocturnal variation of equivalent height are noted, and a theory of regional distribution of ionization is presented as a possible explanation of the deviations.)

437. Recombination of electrons and positive ions in the upper atmosphere. T. L. Eckersley. *Nature* (London), 125, 669; May 3, 1930. (A method of obtaining the recombination coefficient of the electrons and ions in the upper atmosphere is outlined. The method consists in determining by radio transmission the value of the greatest angle at which rays are reflected to earth at various times of night after the ionizing agent, the sun's ultra-violet light, has been removed. The records of facsimile transmission between New York and England provide the necessary data for the evaluation of this angle. The physical significance of the value of the recombination coefficient obtained is discussed.)

R113.63—Wave Front Angle

438. Determination of wireless wave fronts. G. W. Pickard. *El. Rev. & W.E. News*, 53, 494-495; October 3, 1908.

439. The wave front angle in radio telegraphy. L. W. Austin. *Washington Acad. Sci., J.*, 11, 101-106; March 4, 1921. In German in *Jahrb. d. drahtl. Tel.*, 18, 45-71, 1921.

440. On the determination of the directions of the forces in wireless waves at the earth's surface. R. L. Smith-Rose and R. H. Barfield. *Roy. Soc., Proc.*, 107, 587-601; March, 1925.
441. Messungen über die Stern von Wanderwellen mittels angekoppelter Schwingungskreise. (Measuring traveling wave fronts by means of coupled oscillating circuits.) H. Müller. *Arch. f. Elektrot.*, 15, 97-120; September 21, 1925.
442. Some measurements on wireless wave-fronts. R. L. Smith-Rose and R. H. Barfield. *Experimental Wireless*, 2, 737-749; September, 1925.
443. Polarization of wireless waves (experiments in the transmission of vertically and horizontally polarized waves.) R. L. Smith-Rose. *Wireless World and Radio Rev.*, 17, 859-862; December 16, 1925.
444. Polarization of radio waves. E. F. W. Alexanderson. *A.I.E.E., J.*, 45, 636-640; July, 1926.
445. Further measurements on wireless wave fronts. R. L. Smith-Rose and R. H. Barfield. *Roy. Soc., Proc.*, 116A, 682-693, 1927. *Experimental Wireless*, 4, 130-139; March, 1927.
446. Experimental confirmation of the influence of a low resistivity layer subsoil on the forward inclination of radio waves. J. Cairns. *Washington Acad. Sci., J.*, 17, 264-269, 1927.

R113.7—Transmission Formulas

447. Über die Ausbreitung der Wellen in der drahtlosen Telegraphie. (On the propagation of waves in wireless telegraphy.) A. Sommerfeld. *Ann. d. Physik*, 28, 665-736; March, 1909; 62, 95, 1920; 81, 1135-1153, 1926. *Jahrb. d. drahtl. Tel.*, 4, 157-176, 1910.
448. Kraftliniendiagramme für die Ausbreitung der Wellen in der drahtlosen Telegraphie bei Berücksichtigung der Bodenbeschaffenheit. (The propagation of waves in wireless telegraphy taking into consideration the nature of the ground.) Epstein. *Jahrb. d. drahtl. Tel.*, 4, 176-187; December, 1910.
449. Atmospheric refraction in wireless telegraphy. W. H. Eccles. *Electrician*, 71, 969-970; September, 1913.
450. The propagation of electromagnetic waves in wireless telegraphy. G. R. Dean. *Electrician*, 73, 13-17; April 10; 896-898; September 11, 1914.
451. Transmission of electric waves around the earth's surface. H. M. MacDonald. *Roy. Soc., Proc.*, 90A, 50-61; April, 1914; 92, 493-500; August 1, 1916; 98, 216-222; December, 1920; 98, 409-411; March 3, 1921; 108, 52-76; May, 1925.
452. Die Ausbreitung der Elektromagnetischen Wellen in der drahtlose Telegraphie. (Propagation of electromagnetic waves in wireless telegraphy.) H. Barkhausen. *E.T.Z.*, 35, 448-449, 1914.
453. The signalling range in radio telegraphy. J. V. L. Hogan. *Electrical World*, 66, 1250-1251; December 4, 1915. *Electrician*, 76, 699-700; February 18, 1916.
454. Transmission of electric waves over the surface of the earth. A. E. H. Love. *Roy. Soc., Trans.*, 215A, 105-131, 1915.
455. Sur l'application de la formule d'Austin-Cohen a la resolution de quelques problemes importantes de la technique des radio communications. (On the application of the Austin-Cohen formula for the solving of some important technical radio problems.) L. Bouthillon. *R.G.E.*, 3, 419-424; March 23, 1918.

456. On the propagation of electromagnetic waves around the earth. B. van der Pol. *Phil. Mag.*, 38, 365-380; September, 1919; 40, 163, 1920. *Radio Rev.*, 1, 98; November, 1919; 725; November, 1920. *Wireless World*, 7, 502-504; December, 1919.
457. The transmission of electric waves around the earth. G. N. Watson. *Roy. Soc., Proc.*, 95, 546-563, 1919.
458. Über die Anwendung der Austin-Cohen Formel zur Lösung einiger wichtiger Probleme in der Technik des radiotelegraphischen Verkehrs. (On the application of the Austin-Cohen formula to the solution of an important problem in the art of wireless communication.) Franz Tank. *Jahrb. d. drahtl. Tel.*, 16, 114-125; August, 1920.
459. The transmission of electromagnetic waves about the earth. J. Erskine-Murray. *Wireless World*, 7, 651-664, 1920. Abstracted in *Radio Rev.*, 1, 237-239, 1920.
460. The power required for long distance transmission. G. W. O. Howe. *Radio Rev.*, 1, 598; September, 1920. *E.T.Z.*, 42, 313-315; March 31, 1921.
461. Discussion on long distance wireless transmission. H. J. Round and F. C. Lunn. *I.E.E., J.*, 59, 677-692, 1921.
462. Note sur le choix de la longueur d'onde la plus efficace selon la formule d'Austin. (Note on the choice of the most efficient wave length according to the Austin formula.) O. Zappuli. *Radioélectricité*, 3, 20-21; January, 1922.
463. Long distance radio communication. L. W. Austin. *Frank. Inst., J.*, 193, 437-460; April, 1922. In German in *Jahrb. d. drahtl. Tel.*, 20, 372-386; November, 1922.
464. Solution rapide de quelques problemes relatifs à l'onde optimum et à la portée de communication. (Rapid solution of some problems relative to the optimum wave length and the range of radio communication.) J. de la Baume. *Radioélectricité*, 3, 411-416, 1922.
465. État actuel des formules sur la propagation des ondes. (Actual state of formulas on propagation of waves.) L. W. Austin. *Onde Elec.*, 2, 504-507; September, 1923.
466. Notes on wireless matters— a new theory of long distance radio-communication. G. W. O. Howe. *Electrician*, 93, 282-283; September 12; 402-403; October 10, 1924.
467. Why wireless electric rays can bend round the earth. Joseph Larmor. *Phil. Mag.*, 48, 1025-1036; December, 1924. Discussion by G. W. de Tunzelman in *Electrician*, 94, 30-31; January 9, 1925.
468. Die Ausbreitung der elektrischen Wellen über die Erde. (Spreading of electric waves above the earth.) A. Meissner. *Jahrb. d. drahtl. Tel.*, 24, 85-92, 1924.
469. Wireless wave propagation. E. V. Appleton and M. A. F. Barnett. *Electrician*, 94, 398; April 3, 1925.
470. Propagation of electric waves over the earth. H. W. Nichols and J. O. Schelleng. *Bell System Tech. J.*, 4, 215-234; April, 1925. Abstracted in German in *Jahrb. d. drahtl. Tel.*, 26, 140-141, 1925.
471. Radio propagation. G. W. de Tunzelman. *Electrician*, 95, 56-57; July 17, 1925.
472. A new theory of wave transmission. E. F. W. Alexanderson. *Radio News*, 7, 410-411; October, 1925. *Popular Radio*, 9, 207-212; March, 1926. *Radio (Canada)*, 9, 17-18; August, 1926.

473. The propagation of radio waves over the earth. A. H. Taylor and E. O. Hulburt. *Phys. Rev.*, 27, 189-215; February, 1926.
474. À propos de la théorie de la propagation des ondes électriques et des récentes mesures U.R.S.I. (On the theory of the propagation of electric waves and recent U.R.S.I. measurements.) M. A. Turpain. *Onde Elec.*, 5, 181-185; April, 1926.
475. Versuche über die Ausbreitung der elektromagnetischen Wellen. (Investigation on the propagation of electromagnetic waves.) M. Bäumlér and J. Zenneck. *E.N.T.*, 3, 139-141; April, 1926.
476. Preliminary note on proposed changes in the constants of the Austin-Cohen transmission formula. L. W. Austin. *Proc. I.R.E.*, 14, 377-380; June, 1926. *Washington Acad. Sci.*, J, 16, 228-231, 1926.
477. The attenuation of wireless waves due to the resistance of the earth. R. L. Smith-Rose and R. H. Barfield. *I.E.E.*, J., 64, 766-770; July, 1926. In German in *Jahrb. d. drahtl. Tel.*, 28, 197-198, 1926.
478. Observations of freak ranges—curvature of the earth. The Heaviside layer. L. B. Turner. *Electrician*, 97, 42-43; July 9, 1926. (Brief explanation of transmission formulas.)
479. Hat des Erdfeld einen Einfluss auf die Wellenausbreitungs Vorgänge? (Has the earth's field an influence on the propagation of radio waves?) A. Meissner. *E.N.T.*, 3, 321-324; September, 1926.
480. Über die Ionisation der Atmosphäre und ihren Einfluss auf die Ausbreitung der kurzen elektrischen Wellen der drahtlosen Telegraphie. (On the ionization in the atmosphere and its influence on the propagation of short electric waves in wireless telegraphy.) H. Lassen. *Jahrb. d. drahtl. Tel.*, 28, 109-113; October; 139-147; November, 1926. In French in *Onde Elec.*, 6, 20A; March, 1927. Reviewed in *Q.S.T. Français*, 8, 43-47; May, 1927.
481. Horizontal wave experiments at 2AER (wave propagation). J. M. Hollywood. *QST*, 10, 32-33; November, 1926.
482. General Electric short wave test results. M. L. Prescott. *QST*, 10, 9-13; November, 1926. *Gen. El. Rev.*, 30, 113-116; February, 1927.
483. Über Relaxationsschwingungen. (On relaxation oscillations.) B. van der Pol. *Jahrb. d. drahtl. Tel.*, 28, 178-184; December, 1926.
484. Au sujet de la nouvelle formule de propagation de Kiebitz. (On Kiebitz' new propagation formula.) R. Mesny. *Onde Elec.*, 5, 650-656; December, 1926.
485. Über die Fortpflanzung elektromagnetischer Wellen. (On the propagation of electromagnetic waves.) G. J. Elias. *Jahrb. d. drahtl. Tel.*, 27, 66-73, 1926.
486. Zur Erforschung der Ausbreitung der elektromagnetischen Wellen über die Erde. (On the investigation of the propagation of electromagnetic waves over the earth.) K. W. Wagner. *E.N.T.*, 4, 30-31; January, 1927.
487. Inclinaison des ondes et systèmes dirigés. (Inclination of waves and directed systems.) L. Bouthillon. *Comptes Rendus*, 184, 190-192; January 24, 1927. Abstracted in *Experimental Wireless*, 4, 305; May, 1927.
488. Les limites de ma théorie de propagation. (The limits of my propagation theory.) F. Kiebitz. *Onde Elec.*, 6, 127-131; March, 1927.
489. Radio transmission formulae. G. W. Kenrick. *Phys. Rev.*, 31, 1040-1050; June, 1928. *Phil. Mag.*, 6, 289-304; August, 1928. (Derives a transmission formula for long-wave work taking the upper reflecting layer into account. The

results indicate that the inverse square root of the wavelength in the damping factor of the Austin-Cohen formula has considerable theoretical justification, but the inverse square root of the distance should be used instead of the inverse first power of the distance. A slight change in the numerical constant is needed.)

490. Die unmittelbare Messungen von Entfernungen durch elektrische Wellen. (Direct measurement of distances by means of electric waves.) W. Burstyn. *Zeits. f. Hochfrequenztechn.*, 33, 181-183; May, 1929. (Formulas and curves showing the relationship between intensity of reception and distance from the transmitting set are given with a discussion of their accuracy. This method of measuring distances is believed invaluable for ships in foggy weather.)

491. Some measurements in Cornwall of the signal strength from 5XX. J. H. Reyner. *I.E.E., J.*, 68, 181-184; January, 1930. (The results of an investigation carried out with the aid of portable equipment into the field strength in Cornwall of 5XX are given. Equisignal contours show what appears to be a radio shadow caused by the towers of a beam station at Bodmin. The general order of field strength is in accord with theory up to 300 km if due allowance is made for attenuation according to Sommerfeld's formula.)

492. Numerical discussion of Sommerfeld's attenuation formula. B. Rolf. *Ingeniors Vetensk. Akad.* (in English), Stockholm. *Handlering Nr. 96*, 1929. *Proc. I.R.E.*, 18, 391-402, 1930. (Graphs resulting from calculations of Prof. Sommerfeld's attenuation formula are presented. By using them predictions may be made of the field strength for all wavelengths over soil, the electrical constants of which are known. An abac is included and instructions are given for its use to obtain the inductivity and conductivity of the ground over which a series of field strength measurements have been made.)

R114—Atmospheric Disturbances, Strays

493. Notes on the electrical waves occurring in nature. W. H. Eccles and H. M. Airey. *Roy. Soc., Proc.*, 85, 145-150, 1911.

494. Wireless telegraph working in relation to interferences and perturbations. J. E. Taylor. *I.E.E., J.*, 47, 119-166, 1911. Abstracted in *Electrician*, 66, 1022-1024, 1911, and *Elec. Rev.*, 58, 752-755, 1911.

495. Zusammenhang der Störungen des atmosphärischen Potentialgefälles mit den luftelektrischen Empfangsstörungen der drahtlosen Telegraphie, nach Untersuchungen am Boden und im Freiballon. (Relationship of potential fall of atmospheric disturbance with the reception disturbances in wireless telegraphy according to investigations on the ground and in a balloon.) G. Lutz. *Phys. Zeits.*, 14, 1148-1151, 1913.

496. Radiotelegraphic investigations—analysis of records of strays. Report of Committee of British Association. *Electrician*, 75, 907-908; September 24, 1915.

497. Investigation of atmospheric electrical variations at sunrise and sunset. E. H. Nichols. *Roy. Soc., Proc.*, 92, 401-408; July 1, 1916.

498. Strays and their origin. *Wireless World*, 8, 346-347; August 7, 1920.

499. The relation between atmospheric disturbances and wave length in radio reception. L. W. Austin. *Proc. I.R.E.*, 9, 28-40; February, 1921. In German in *Jahrb. d. drahtl. Tel.*, 17, 402-409; June, 1921.

500. The reduction of atmospheric disturbances in wireless telegraphy. L. W. Austin. *Proc. I.R.E.*, 9, 41-55; February, 1921. In German in *Jahrb. d. drahtl. Tel.*, 17, 410-426; June, 1921.

501. Radiogonometrie et influences atmospheriques. (Radiogoniometry and atmospheric influences.) E. Rothe. *Comptes Rendus*, 172, 1345-1347; May 30, 1921.
502. Determination of the direction of atmospheric disturbances or static in wireless telegraphy. L. W. Austin. *Frank. Inst., J*, 191, 619-629; May, 1921. In German in *Jahrb. d. drahtl. Tel.*, 19, 115-126; February, 1922.
503. Optimum wave length and atmospherics. L. B. Turner. *Radio Rev.*, 2, 524-534; October, 1921. Abstract in French in *Onde Elec.*, 1, 257-258; April, 1922.
504. Sur la relation existant entre le direction des depressions et le direction des maximums de parasites atmospheriques. (On the relation existing between the minimum and maximum directions of atmospheric disturbances.) M. J. Lacoste. *Comptes Rendus*, 173, 843-845, 1921.
505. Static interference as a function of wave length. H. T. Friis and L. J. Sivian. *Wireless World and Radio Rev.*, 10, 285-288; June 3, 1922.
506. Nouvelles observations radiogoniometriques des parasites atmospheriques. (New goniometric observations of atmospheric disturbances.) M. J. Lacoste. *Comptes Rendus*, 175, 707-708; October 23, 1922.
507. The origin of atmospherics. R. A. Watson-Watt. *Nature* (London), 110, 680-681, 1922.
508. Les parasites; leur origine et leur elimination. (Atmospherics, their origin and elimination.) G. Malgorn and J. Brun. *Radioelectricité*, 3, 278-283, 341-347, 365-368, 416-423, 1922; 4, 36-40, 76-80, 1923.
509. Directional observations of atmospheric disturbances. 1920-21. R. A. Watson-Watt. *Roy. Soc., Proc.*, 102, 460-478, 1922. Abstracted in French in *Onde Elec.*, 2, 187-188; March, 1923.
510. Sur la radiogoniometrie des parasites atmospheriques et la prévision du temps. (On the radiogoniometry of atmospheric disturbances and the prediction of weather.) E. Rothe. *Ann. d. Phys.*, 17, 383-415, 1922. *Onde Elec.*, 2, 7-18, 1923.
511. Perturbations atmospheriques et communications part T. S. F. (Atmospheric disturbances and wireless communications). H. de Bellescize. *Radioelectricité*, 4, 32-36; January; 70-76, February; 113-120, March; 151-156, April, 1923. *Bulletin Technique*, 1-4, June 15; 17-21, July 15, 1923.
512. Directional observations of atmospherics (1916-1920). R. A. Watson-Watt. *Phil. Mag.*, 45, 1010-1026; May, 1923.
513. The nature of atmospherics. O. F. Brown. *Modern Wireless* (London), 1, 303-306; June, 1923.
514. Les perturbations atmospheriques. (Atmospheric disturbances.) R. Mesny. *Onde Elec.*, 2, 391-405; July, 1923.
515. Das gleichzeitige Auftreten atmosphärischer Störungen. (The simultaneous appearance of atmospheric disturbances.) Max Bäumlér. *Jahrb. d. drahtl. Tel.*, 22, 2-8; July, 1923.
516. Observations on atmospherics. R. A. Watson-Watt. *Wireless World and Radio Rev.*, 12, 601-612; August 1; 636-637, August 8, 1923.
517. On the nature of atmospherics. R. A. Watson-Watt and E. V. Appleton. *Roy. Soc., Proc.*, 103, 84-102; 1923.
518. Über die Richtung atmosphärischer Störungen. (The direction of atmospheric disturbances.) F. Schindelbauer. *Jahrb. d. drahtl. Tel.*, 22, 163-167, 1923.

519. Loop unidirectional receiving circuits for the determination of the direction of atmospheric disturbances. L. W. Austin. *Proc. I.R.E.*, 11, 395-397, 1923.
520. The energy of atmospherics. T. L. Eckersley. *Electrician*, 93, 150-151 and 155; August 8, 1924.
521. Recent experiments on atmospherics. E. V. Appleton. *Yearbook of Wireless Telegraphy*, 807-809, 1924.
522. Origine meteorologique de certaines perturbations des recepteurs de telegraphie sans fil. (The meteorological origin of certain disturbances in radio receivers.) R. Bureau. *Comptes Rendus*, 178, 556-558, 1924.
523. Our present knowledge concerning the atmospheric disturbances of radio telegraphy. L. W. Austin. *Nat. Research Council Bull.*, No. 41, 127-130, 1924.
524. Influence des discontinuités meteorologiques sur certaines perturbations atmospheriques en telegraphie sans fil. (Influence of meteorological discontinuities on certain atmospheric disturbances in radio telegraphy.) R. Bureau. *Comptes Rendus*, 178, 1623-1625, 1924.
525. Onze mois d'observations des atmospheriques (November, 1923 to October, 1924). (Eleven months of atmospheric observations.) R. Bureau. *Onde Elec.*, 4, 31-43; January, 1925.
526. Atmospherics. R. L. Smith-Rose. *World Power* (London), 3, 20-25; January, 1925.
527. The present status of radio atmospheric disturbances. L. W. Austin. *Proc. I.R.E.*, 14, 133-138; February, 1926.
528. A static recorder. H. T. Friis. *Bell System Techn. J.*, 5, 282-291; April, 1926.
529. The directional recording of atmospherics. R. A. Watson-Watt. *I. E. E., J.*, 64, 596-610; May, 1926. Abstracted in *Experimental Wireless*, 3, 234-238; April, 1926.
530. Direction determinations of atmospherics on the Isthmus of Panama. L. W. Austin. *Proc. I.R.E.*, 14, 373-376; June, 1926.
531. Les atmospheriques. (Atmospherics). R. Bureau. *Onde Elec.*, 5, 301-346; July, 1926. (Good bibliography and discussion.)
532. Perturbations atmospheriques et longueur d'ondes. (Atmospheric disturbances and wave lengths.) H. de Bellescize. *Onde Elec.*, 5, 347-358; July, 1926.
533. Relations entre les perturbations electromagnetiques et les troubles solaires. (Relations between electromagnetic disturbances and solar troubles.) A. Nodon. *Onde Elec.*, 5, 359-364; July, 1926.
534. The nature of atmospherics. I and II. E. V. Appleton, R. A. Watson-Watt and J. F. Herd. *Roy. Soc., Proc.*, 111, 615-677; July, 1926.
535. Long distance radio receiving measurements and atmospheric disturbances at the Bureau of Standards in 1925. L. W. Austin. *Proc. I.R.E.*, 14, 663-673; October, 1926. *Discussions*, 15, 155-157; February, 1927; 15, 1002-1003; December, 1927.
536. Les perturbations orageuses du champ electric et leur propagation à grande distance. (Magnetic disturbances of the electric field and their propagation to great distances.) P. Lejay. *Onde Elec.*, 5, 493-531; October; 557-576, November, 1926.
537. Simultaneous atmospheric disturbances in radiotelegraphy. M.

- Bäumler. Proc. I.R.E., 14, 765-771; December, 1926. *E. N. T.*, 3, 429-435; 1926. In German in *Jahrb. d. drahtl. Tel.*, 29, 52-56; February, 1927. (Graphic records of timing signals and static made simultaneously at Hawaiian Islands, California, and Berlin, show that a large number of disturbances occur simultaneously at distances of 3900 km apart, and occasional disturbances at distances of 10,000-12,000 km apart. Theory of their propagation by electromagnetic waves is propounded.)
538. Observations on the atmospheric disturbances. T. Nakagami and K. Kanoko. *I. E. E. J.*, (Japan), 1423-1436; December, 1926. Abstracted in *Experimental Wireless*, 4, 244; April, 1927.
539. Directional observations of atmospheric disturbances. T. Nakagami. Proc. Third Pan-Pacific Science Congress. Tokyo, 2, 1249-1257, 1926. (A study of static with regard to directional characteristics.)
540. Premiers observations relatifs aux parasites atmospheriques en Afrique occidentales. (Observations of atmospherics in western Africa.) H. Hubert. *Comptes Rendus*, 183, 368-370, 1926.
541. Un enregistreur de la fréquence des atmospheriques; son utilisation en meteorologie. (A recorder of the frequency of atmospherics and its use in meteorology.) R. Bureau, A. Viant, and A. Gret. *Comptes Rendus*, 184, 157-158; January 17, 1927. Abstracted in *Experimental Wireless*, 4, 244; April, 1927.
542. Radio atmospheric disturbances and solar activities. L. W. Austin. *Nat. Research Council Bull.* No. 61, 145-158; July, 1927. Proc. I.R.E., 15, 837-842; October, 1927.
543. Correlation of static with the atmosphere. E. H. Kincaid. *Nat. Research Council Bull.* No. 61, 158-179; July, 1927.
544. La resonance et les atmospheriques. (Resonance and atmospherics.) H. de Bellecize. *Onde Elec.*, 6, 333-356; August, 1927; 427-444; September, 1927.
545. The electric fields of South African thunderstorms. E. F. J. Shouland and J. Braib. *Roy. Soc., Proc.*, 114, pp. 229-243, 1927. Abstracted in German in *Zeits. f. Hochfrequenztechn.*, 30, p. 131; October, 1927.
546. Atmospherics and transatlantic telephony; new directional polar curve. C. L. Fortescue. *Experimental Wireless*, 4, 757-759; December, 1927. (Discussion of directional methods of minimizing effect of atmospherics.)
547. Atmospherics at Watheroo, Western Australia. J. E. J. Cairns. Proc. I.R.E., 15, 985-997; December, 1927. (Observations on wave form of atmospherics.)
548. Wireless Section—Chairman's address. A. G. Lee. *I. E. E. J.*, 66, 12-24; December, 1927. (Important radio events in England from technical viewpoint—atmospherics, receivers, directive reception with wave antenna and antenna arrays.)
549. Diagramme des champs électriques mesurés à Moudon pendant le premier semestre 1927. (Diagrams of electric fields measured at Meudon during the first months of 1927.) *Onde Elec.*, 6, 603-605; December, 1927. (Curves shown for field intensity of LY, WSS, IDO, and GBL.)
550. Über elektromagnetische Störungen. (On electromagnetic disturbances.) F. Schindelbauer. *E. N. T.*, 5, 442-449; November, 1928. (Study of the clicks and grinders by means of the direction finder due to Watson-Watt. The author concludes that since the direction of the maximal disturbance is either along or perpendicular to the earth magnetic axis, most of the atmos-

pherics are due to field changes above the surface of the earth. These field changes cause the electron to be drawn from the sun towards the earth and then produce the eddies of the Kennelly-Heaviside layer. The first causes the clicks, and the latter, the grinders.)

551. Present state of knowledge of atmospherics. R. A. Watson-Watt. *Experimental Wireless*, 5, 629-632; November, 1928. (Reviews work done on this subject by himself and others up to present date.)

552. Nuovo registratore di atmosferici e primi risultati con esso ottenuti. (A new method of registering atmospherics and first results obtained.) I. Ranzi. *Nuovo Cimento*, 5, 326-330, 1928. (An apparatus for registering atmospherics based on the employment of a neon lamp and of a photographic register is described. The results obtained from 2000 hours of actual registration carried out between March 1 and July 10, 1928, confirm the conclusions of Bureau concerning the classification and origin of atmospherics.)

553. The analysis of irregular motions with applications to the energy frequency spectrum of static and telegraph signals. G. W. Kenrick. *Phil. Mag.*, 7, 176-196; January, 1929. (The analysis shows that the energy contained within a frequency band of given width due to atmospheric disturbance produced by a random sequence of pulses varies directly with the square of the wave length. A numerical example shows that the energy due to pulses of the order of 10^{-3} second in duration and sharply rising exponential form can produce appreciable fields (since proportional to the square roots of the energies) on the longer wave lengths.)

554. A note on the directional observations on grinders in Japan. E. Yokoyama and T. Nakai. *Proc. I.R.E.*, 17, 377-379; February, 1929. (Direction of grinders in Japan during 1927 showed diurnal and seasonal changes in the direction of atmospherics.)

555. Sur l'origine de certains parasites. (On the origin of certain atmospherics). Ch. Maurain. *Onde Elec.*, 8, 131-134; April, 1929. (The value of making observations of the connection between radio disturbances, electromagnetic phenomena, and meteorological conditions as a study of the relations between the meteorological and electrical properties of the atmosphere is stressed.)

556. Compte rendue des observations radioatmosphériques faites pendant l'année 1927. (An account of radio atmospheric observations made in 1927.) D. B. Paoloni and G. P. Ilardi. *Onde Elec.*, 8, 222-226; May, 1929. (Atmospherics are classed according to the Paoloni radio atmospheric scale. Observations for each class were taken daily during 1927 by an aural system. Observations are summarized in curves and general statements.)

557. Elektromagnetische Störungen. (Electromagnetic disturbances.) F. Schindelhauer. *E. N. T.*, 6, 231-236; June, 1929. (A study of electromagnetic disturbances in the atmosphere and results of experiments carried on at the Meteorological-Magnetic Observatory at Potsdam, Germany.)

558. Correlation of directional observations of atmospherics with weather phenomena. S. W. Dean. *Proc. I.R.E.*, 17, 1185-1191; July, 1929. (Description of the results obtained with a cathode-ray direction finder used by the A. T. & T. Co., at Houlton, Maine. Direction of storms was determined with a considerable degree of accuracy.)

559. Some measurements on the directional distribution of static. A. E. Harper. *Proc. I.R.E.*, 17, 1214-1224; July, 1929. (The utility of directional data on static is shown, and two types of apparatus for directional investigation

are compared. A method which gives direction of individual crashes is found superior to the integrating methods. Distribution of thunder-storms over the world is discussed. Probable geographic locations are assigned to disturbances.)

560. Registrierung von atmosphärischen Störungen. (Recording of atmospheric disturbances.) H. Joscheck. *E. N. T.*, 6, 341-349; September, 1929. (Observations made at the University of Halle include the form, duration, intensity and audible impression of such disturbances as well as the relation between these characteristics.)

561. Sur la variation diurne des parasites atmospheriques. Moyennes mensuelles, variation annuelle, influences meteorologiques. (On the daily variation of atmospheric. Monthly averages, annual variation, and meteorological influences.) R. Bureau. *Comptes Rendus*, 189, 1293-1295, 1929.

562. Über das Strahlungsfeld des Blitzes. (On the radiation field of lightning). F. Ollendorff. *E. N. T.*, 7, 108-119; March, 1930. (Formulas are derived for computing the radiation due to a stroke of lightning and conclusions are drawn that such interference fields, while not disturbing to telegraphic traffic, may seriously interfere with radiotelephony.)

R115—Directional Properties

563. On the daylight transmission characteristics of horizontally and vertically polarized waves from airplanes. R. H. Drake and R. M. Wilmotte. *Proc. I.R.E.*, 17, 2242-2258; December, 1929. (Transmission characteristics of horizontally and vertically polarized waves as transmitted from an airplane are compared. The experiments were carried on at distances up to 600 miles and a frequency of about 6000 kc was used. A method is described by which it is possible to deduce the transmission characteristics for flight at any altitude when those at a given altitude are known. Experiments with a very low ground antenna are described.)

564. On the effect of the ground on downcoming plane space waves. E. T. Glas. *Experimental Wireless*, 6, 663-668; December, 1929. (A discussion on the deforming action of the ground on downcoming space radiation is presented. Mathematical analysis shows that the ground itself may be responsible for certain peculiar polarization phenomena observed in short wave work.)

R270—Intensity (Field Intensity, Signal Intensity, Noise, etc.)

565. Sur la mesure de l'effet des ondes electriques à distance au moyen du bolometre. (Quantitative measurements of electric waves at a distance by means of a bolometer.) C. Tissot. *Comptes Rendus*, 137, 846-848, 1903.

566. The measurement of electrical oscillations in the receiving antenna. L. W. Austin. *Bureau of Standards Sci. Papers* No. 157; *Bull. of the Bureau of Standards*, 7, 295, 1910.

567. Some quantitative experiments in long distance radio telegraphy. L. W. Austin. *Bureau of Standards Sci. Papers* No. 159; *Bull. of the Bureau of Standards*, 7, 315, 1911. *Washington Acad. Sci.*, J., 1, 82-84, 1911.

568. Theorie der gleichzeitigen Messungen vom Sende-und Empfangsstrom. (Theory of simultaneous measurements of sending and received currents.) H. Barkhausen. *Jahrb. d. drahtl. Tel.*, 5, 261-269; January, 1912.

569. The measurement of received radiotelegraphic signals. L. W. Austin. *Washington Acad. Sci.*, J., 3, 133-137; March 4, 1913.

570. Das Problem der Reichweite elektrischer Wellen. (The problem of

range with electromagnetic waves.) K. E. F. Schmidt. *Phys. Zeits.*, 15, 202-209; February 15, 1914.

571. Eine absolute Messung des vom Eiffelturm ausstrahlenden Feldes in Strassburg. (Absolute measurement in Strassburg of the field of the Eiffel Tower radiation.) F. Braun. *Jahrb. d. drahtl. Tel.*, 8, 132-139; February, 1914.

572. Lautstarkemessungen nach der Parallelohmethode und ihre quantitative Brauchbarkeit. (Measurement of strength of radio telegraph signals and their quantitative value). A. Klages and O. Demmler. *Jahrb. d. drahtl. Tel.*, 8, 212-220; March, 1914.

573. Was misst man mit unipolardetektor und Parallelohmethode? (Radio telegraphic measurements by the shunted telephone method.) F. Braun. *Jahrb. d. drahtl. Tel.*, 8, 203-212; March, 1914.

574. Uber einige Anwendungen des Einfadenelektrometers in der drahtlosen Telegraphie. (Employment of string electrometer in wireless telegraphy.) T. Wulf. *Phys. Zeits.*, 15, 611-616; June 15, 1914.

575. Methods of measuring the strength of wireless signals. E. W. Marchant. *Electrician*, 75, 267-270; May 28; 309-311, June 4, 1915.

576. On telephonic measurements in a radio receiver. J. Zenneck. *Proc. I.R.E.*, 4, 363-369; August, 1916.

577. Measurement of signal intensity. J. V. L. Hogan. *Yearbook of Wireless Telegraphy*, 662-670, 1916.

578. The measurement of radio telegraphic signals with the oscillating audion. L. W. Austin. *Proc. I.R.E.*, 5, 239-254; August, 1917. Note in *Proc. I.R.E.*, 5, 327-329, 1917. In German in *Jahrb. d. drahtl. Tel.*, 12, 296-304; October, 1917.

579. A note on the relation of audibility factor of a shunted telephone to the antenna current as used in the reception of wireless signals. B. van der Pol. *Phil. Mag.*, 34, 184-188; September, 1917.

580. Uber messungen an Wechselstromkurven mit der Braunschen Rohre. (Measurement of alternating waves with the Braun tube.) E. Lubke. *Arch. f. Elektrot.*, 5, 314-334; 1917, and 161-164, 1917. *Jahrb. d. drahtl. Tel.*, 13, 108-120, 1919. Abstracted in English in *Electrician*, 83, 270; September 12, 1919.

581. Relation of the audibility factor of a shunted telephone to the antenna current. G. W. O. Howe. *Phil. Mag.*, 35, 131-133; January, 1918.

582. On measurement of signal strength. W. H. Eccles. *Proc. I.R.E.*, 7, 267-280; June, 1919.

583. Uber die quantitative Bestimmung elektromagnetischer Strahlungsfelder in der drahtlosen Telegraphie. (On the quantitative determination of electromagnetic radiation fields in wireless telegraphy.) H. R. von Traubenberg. *Jahrb. d. drahtl. Tel.*, 14, 569-578; November, 1919.

584. Mesure et comparaison des intensites dans les recepteurs de telegraphie sans fil. (Measurement and comparison of intensity of radiotelegraphic signals.) H. de Bellescize. *R. G. E.*, 7, 325-328; March 7, 1920.

585. The measurement of received radio currents with the electrometer. E. O. Hulburt and G. Breit. *Phys. Rev.*, 15, 405-408; May, 1920.

586. System for measuring the amount of static interference. A. M. Curtis. *Proc. I.R.E.*, 9, 225-227; June, 1921.

587. The measurement of radiation (signal). A. G. Lee. *P. O. E. E., J.*, 15, 254-262; October, 1922.

588. Die Brauchbarkeit der Parallelohmethode für lautstärkemessungen in die Funktelegraphie. (On the usefulness of a parallel resistance method for signal strength measurements in wireless telegraphy.) M. Bäumler. *Jahrb. d. drahtl. Tel.*, 20, 268-277; October, 1922; 456-457; December, 1922.
589. Note on measurement of radio signals. C. R. Englund. *Proc. I.R.E.*, 11, 26-33; February, 1923.
590. Radio transmission measurements. R. Bown, C. R. Englund, and H. T. Friis. *Proc. I.R.E.*, 11, 115-152; April, 1923. Abstracted in *Electrician*, 90, 645-648; June 15, 1923.
591. Radio transmission measurements on long wave lengths. H. H. Beverage and H. O. Peterson. *Proc. I.R.E.*, 11, 661-673; December, 1923.
592. The measurement of the electric intensity of received radio signals. J. Hollingworth. *I. E. E., J.*, 61, 501-516, 1923.
593. Observations of the field strength of Horsea wireless station. E. B. Moullin. *I. E. E., J.*, 61, 67-74, 1923.
594. An instrument to compare signal strengths. A. Castellain. *Wireless World and Radio Rev.*, 14, 184-188; May 14, 1924.
595. A resume of modern methods of signal measurement. J. Hollingworth. *Wireless World and Radio Rev.*, 14, 485-487; July 23; 518-520; July 30; 548-549; August 6; 578-579; August 13, 1924.
596. A method of measuring radio field intensities and atmospheric disturbances. L. W. Austin and E. B. Judson. *Proc. I.R.E.*, 12, 521-532; October, 1924.
597. Empfangs und Störungsmessungen in drahtlosen Telegraphie und Telephonie (Receiving and disturbance measurements in wireless telegraphy and telephony.) Guido Anders. *Elektrot. Zeits.*, 45, 1439-1442; December 25, 1924.
598. Feldstärkeschwingungen und Wellenablenkung Empfangsmessungen Europaischer Grosstationen an der Funkstelle Strelitz. (Receiving measurements at "Strelitz" of large European stations.) S. Wiedenhoff. *E. N. T.*, 1, 64-67, 1924.
599. Quantitative Empfangsmessungen in der Funktelegraphie. (Quantitative measurements on reception in radio telegraphy.) G. Anders. *E. N. T.*, 2, 401-425; December, 1925. In English in *Proc. I.R.E.*, 15, 297-311; April, 1927.
600. Eine Anordnung zur Messung der absoluten empfangsenergie in der drahtlosen Telegraphie. (An arrangement for the measurement of absolute received energy in wireless telegraphy.) L. Bergmann. *Telefunken Zeitung Nr.*, 39, 22-29, 1925.
601. A radio field strength measuring system for frequencies up to 40 megacycles. H. T. Friis and E. Bruce. *Proc. I.R.E.*, 14, 507-519; August, 1926.
602. Portable receiving sets for measuring field strengths at broadcasting frequencies. A. G. Jensen. *Proc. I.R.E.*, 14, 333-344; June, 1926. Discussion by G. D. Gillett. *Proc. I.R.E.*, 14, 699-705; October, 1926.
603. Device for limiting signal and static intensity. S. Y. White. *QST*, 11, 36; June, 1927.
604. Geräte zur Messung von Empfangsfeldstärken in der drahtlosen Telegraphie und Telephone. (Instruments for measuring field strength in wireless telegraphy and telephony.) G. Anders. *Zeits. f. Techn. Physik*, 8, 464-471; November, 1927. (Description of apparatus for measuring small and large field strength.)

605. A radio signal intensity recorder. B. Saltmarsh. *Experimental Wireless*, 4, 743-745; December, 1927.

606. A new universal long-wave radio intensity measuring set. J. Hollingworth. *Journ. Sci. Instruments*, 5, 1-9; January, 1928. (New apparatus designed for observation of polarization of radio waves. Intensities of the two components of polarization and their phase relations relative to the ground wave can be measured in quick succession. Constructional details, theory and method of operation are given.)

607. A short survey of some methods of radio signal measurement. K. Sreenivasan. *Experimental Wireless*, 5, 205-210; April; 273-278, May, 1928. (Describes various methods now in use for signal intensity measuring apparatus.)

608. Signal strength measurements of 3L0, Melbourne, Australia. R. O. Cherry. Reprint from The Specialty Press, Pty., Ltd., 174 Little Collins Street, Melbourne, Australia. May, 1928. (Field intensity survey around 3L0, Melbourne, Australia, made by means of loop antenna and vacuum tube voltmeter. Discusses causes of uneven distribution of intensity and standards for satisfactory service.)

609. An automatic recorder for measuring the strength of radio signals and atmospheric disturbances. E. B. Judson. *Proc. I.R.E.*, 16, 666-670; May, 1928. (Apparatus described for automatically recording field intensity of low frequency stations and atmospheric disturbances. Curves shown of variations in signals and atmospheric disturbances.)

610. The polarization of radio waves. J. Hollingworth. *Roy. Soc., Proc.*, 119, 444-464; June, 1928. (General discussion on polarization of radio waves due to Kennelly-Heaviside layer. A modified method is given for studying the effect of frequencies less than 30 kc.)

611. The use of radio field intensities as a means of rating the outputs of radio transmitters. S. W. Edwards and J. E. Brown. *Proc. I.R.E.*, 16, 1173-1193; September, 1928. (Method described by which outputs of radio transmitters can be regulated by federal authority in terms of measured radio field intensities instead of watts in the transmitting set or antenna circuits. Field intensity contour maps given for several broadcasting stations.)

612. Die Physikalischen Grundlagen und die Technik der Feldstärke Messung in der drahtlosen Telegraphie. (The fundamental principles of field strength measurements.) M. Bäumlner. *T. F. T.*, 17, 193-199, 1928. (A discussion of the fundamental principles and procedure in methods used for field strength measurements in radio telegraphy.)

613. Feldstärkemessungen auf grosse Entfernungen in Rundfunkwellenbereich. (Field strength measurements at great distances for broadcast wave lengths.) M. Bäumlner. *E. N. T.*, 5, 473-477, 1928.

614. Ein Kurzwellenempfangsgerät zur Messung der Feldstärke. (A short wave receiving apparatus for the measurement of field strengths.) G. Leithäuser. Abstracted in *E. T. Z.*, 49, 1816, 1928.

615. A portable radio intensity measuring apparatus for high frequencies. J. Hollingworth and R. Naismith. *Experimental Wireless*, 6, 316-318; June, 1929. *I. E. E., J.*, 67, 1033-1034; August, 1929. (Circuit for apparatus to measure radio field intensities in the range 12,000 to 4547 kc (25-66 meters) is described. It includes a local oscillator, an attenuator in the form of a resistance voltage divider, and a heterodyne receiving set and a rectifying unit for measuring the output.)

616. Experiments in recording radio signal intensity. L. W. Austin. *Proc. I.R.E.*, 17, 1192-1205; July, 1929. (The method of recording intensity of long wave radio signals used at the Bureau of Standards and some of the results obtained are given. Variability of wave propagation in regard to field intensity and angle of incidence is shown in curves. An apparent connection between night signal variation and magnetic storms is shown. The downcoming waves seem to be reflected from rapidly changing masses of ionized gas.)
617. Die Wellenausbreitung des Deutschlandsenders. (Wave propagation of Deutschland transmitters.) F. Kiebitz. *E. N. T.*, 6, 303-306; August, 1929. *Zeits. f. Hochfrequenztechn.*, 6, 173-175; November, 1929. (Field intensity measurements made in the fall of 1928 at about one hundred places at distances of 50-100 km around the "Deutschland" radio transmitter at Zessen, indicate greater absorption at close range than at greater distances. A map is given illustrating the effect, and two possible explanations are suggested.)
618. The problems centering about the measurement of field intensity. S. W. Edwards and J. E. Brown. *Proc. I.R.E.*, 17, 1377-1384; August, 1929. (Surveys of the service areas of broadcasting stations as made with a Western Electric field intensity measuring set by the Radio Division of the Department of Commerce, are described. Field intensity contour maps are explained.)
619. Registrierungen der Feldstärke von Rundfunkwellen in Königsberg i. Pr. (The recording of field strength of broadcast waves in Königsberg in East Prussia.) W. Kaufmann. *E. N. T.*, 6, 349-354; September, 1929. (Field intensity measurements made at Königsberg on two transmitters; one at Oslo 800 km distant, the other at Landenberg 110 km distant. Field intensity graphs are presented showing short and long period variations which differ for the two transmitting stations.)
620. Field intensity measurements around some Australian broadcast stations. R. O. Cherry. *Phys. Soc., Proc.*, 42, 192-211, 1930.



INDEX TO AUTHORS

A

Addey, F. 296.
 Airey, H. M. 493.
 Alexanderson, E. F. W. 340, 444, 472.
 Always, E. J. 313.
 Anders, Guido 597, 599, 604.
 Anderson, C. N. 189, 259, 277.
 Andrew, V. J. 361.
 Anson, E. A. 143.
 Appleton, E. V. 142, 147, 154, 191, 211,
 237, 256, 266, 305, 310, 336, 339,
 357, 398, 405, 423, 427, 436, 469,
 517, 521, 534.
 Austin, L. W. 2, 28, 32, 46, 100, 165,
 170, 172, 173, 175, 177, 178, 179,
 180, 182, 183, 186, 188, 198, 200,
 207, 208, 243, 252, 257, 283, 299,
 439, 463, 465, 476, 499, 500, 502,
 519, 523, 527, 530, 535, 542, 566,
 567, 569, 578, 596, 616.

B

Bailey, 189.
 Baker, T. Y. 354.
 Baker, W. R. G. 345.
 Ballantine, S. 12, 72.
 Barfield, R. H. 210, 333, 347, 356, 363,
 440, 442, 445, 477.
 Barkhausen, H. 452, 568.
 Barnett, M. A. F. 142, 305, 339, 343,
 398, 469.
 Barton, E. H. 381.
 Bäumlcr, M. 51, 55, 68, 176, 314, 475,
 515, 537, 588, 612, 613.
 Beatty, R. T. 419.
 Bemis, E. W. 81.
 Benndorf, H. 110.
 Bergmann, L. 600.
 Beverage, H. H. 591.
 Bidwell, C. C. 209, 303.
 Blatterman, A. S. 171.
 Bostwick, W. E. 157.
 Boutraic, A. 287.
 Bouthillon, L. 6, 7, 38, 41, 43, 44, 47,
 232, 253, 338, 455, 487.
 Bown, R. 49, 144, 590.
 Braib, J. 545.

Braun, F. 571, 573.
 Breisig, F. 119.
 Breit, G. 151, 367, 369, 401, 415, 585.
 Brown, J. E. 611, 618.
 Brown, O. F. 394, 513.
 Bruce, E. 601.
 Brun, J. 508.
 Bureau, R. 61, 77, 83, 114, 190, 273,
 378, 522, 524, 525, 531, 541, 561.
 Burstyn, W. 490.

C

Cairns, J. 446, 547.
 Cartier, G. 352.
 Cash, J. A. 136.
 Castellain, A. 594.
 Chapman, S. R. 140, 388, 400, 417.
 Charman, F. 255.
 Cherry, R. O. 608, 620.
 Chireix, H. 65.
 Chree, C. 244, 396.
 Clapp, J. K. 115.
 Clarte, R. 225.
 Clement, J. 82, 409.
 Cockel, A. 387, 397.
 Cohen, L. 35.
 Colebrook, F. M. 21.
 Colmant, A. 54, 80.
 Colwell, R. C. 456, 159, 280.
 Cooley, A. G. 250.
 Culver, C. A. 25.
 Curtis, A. M. 223, 586.

D

Dahl, O. 412, 413, 415.
 Dean, G. R. 450.
 Dean, S. W. 558.
 Dearlove, F. 272.
 de Bellescize, H. 150, 511, 532, 544,
 584.
 de Forest, L. 322.
 De Groot, C. J. 33.
 de la Baume, J. 464.
 Delcambre, General 61, 190.
 Dellinger, J. H. 8, 135, 146, 245, 249.
 Demmler, O. 572.
 de Montessus de Ballore, R. 278.

- de Tunzelman, G. W. 471.
 De Wardt, R. G. 199.
 Dieckmann, M. 16, 117.
 Donisthorpe, H. de A. 309.
 Dolbear, B. L. 219.
 Dowsett, H. M. 383.
 Drake, F. H. 563.
 Duckert, P. 216, 402.
- E
- Eccles, W. H. 164, 290, 301, 321, 449, 493, 582.
 Eckersley, T. L. 39, 97, 101, 120, 187, 203, 284, 329, 376, 390, 408, 417, 437, 520.
 Edwards, S. W. 611, 618.
 Elias, G. J. 239, 485.
 Englund, C. R. 589, 590.
 Eppen 158.
 Epstein 448.
 Erskine-Murray, J. 459.
 Esau, A. 78, 131, 222, 335.
 Espenschied, L. 43, 76, 102, 189, 351.
 Eve, A. S. 57, 113, 275.
 Everling, E. 391.
- F
- Fassbender, H. 112, 121.
 Fessenden, R. A. 319.
 Flajolet, M. 286.
 Fleming, J. A. 20, 292, 325, 380.
 Försterling, K. 422.
 Fortescue, C. L. 546.
 Friis, H. T. 213, 505, 528, 590, 601.
 Fuchs, J. 18, 269, 276.
 Fuller, L. F. 36.
- G
- Galle, J. B. 317.
 Garrigue, L. 153.
 Gebhardt, L. A. 412.
 Gerth, F. 111.
 Gherzi, E. 155.
 Gibbs, A. 231.
 Gillett, G. D. 49, 81, 602.
 Glas, E. T. 564.
 Goldsmith, A. N. 69.
 Goldstein, S. 265.
 Granier, J. 334.
 Gratsialos, J. 17.
- Gret, A. 541.
 Guierre, M. 37.
 Guinchant, J. 234, 235.
 Gutton, H. 82, 134, 409.
 Guyot, Lieut. 421.
- H
- Hack, F. 26.
 Hahnemann, W. H. 122, 131.
 Hall, O. 145.
 Hallborg, H. E. 85.
 Hammer, W. 389.
 Hafstad, L. R. 370, 431.
 Harper, A. E. 559.
 Hartree, D. R. 125.
 Heck, L. 124.
 Heck, N. H. 251.
 Heising, R. A. 71, 410.
 Hentschel, E. R. 430.
 Herd, J. F. 311, 534.
 Hertz, H. 22.
 Hoag, J. B. 361.
 Hogan, John V. L. 30, 453, 577.
 Hollingworth, J. 64, 204, 330, 358, 592, 595, 606, 610, 615.
 Hollywood, J. N. 481.
 Holtzapple, E. C. 308.
 Howe, G. W. O. 3, 11, 50, 92, 96, 174, 323, 392, 393, 424, 460, 466, 581.
 Hoyle, B. 330.
 Huber, G. H. 93.
 Hubert, H. 540.
 Hulburt, E. O. 58, 270, 274, 353, 359, 399, 407, 411, 432, 473, 585.
- I
- Idrac, P. 83.
 Ilardi, G. P. 556.
 Illin, B. 297.
 Inada, S. 192.
- J
- Jackson, H. B. 23, 39.
 Jansky, C. M., Jr. 60, 103.
 Jelstrup, H. S. 106, 247, 315.
 Jen, C. K. 428, 433.
 Jensen, A. G. 602.
 Jensen, J. C. 240.
 Johnston, H. F. 298.
 Jolliffe, C. B. 146.
 Joscheck, H. 560.

Jouaust, R. 374, 415.
 Jones, D. E. 22.
 Judson, E. B. 596, 609.

K

Kaneko, K. 538.
 Kaufmann, W. 619.
 Kawahara, T. 193.
 Kelby, W. B. 379.
 Kelk, W. 215.
 Kennelly, A. E. 166, 379.
 Kenrick, G. W. 133, 428, 433, 489, 553.
 Keys, D. A. 275.
 Kiebitz, F. 14, 48, 70, 75, 288, 324, 488,
 617.
 Kincaid, E. H. 312, 543.
 Kinsley, C. 202.
 Klages, A. 572.
 Kotelnikoff, A. K. 129.
 Krüger, K. 116.
 Kruse, S. 135.
 Kurlbaum, G. 112.

L

Lacoste, M. J. 504, 506.
 Lane, A. P. 302.
 Lange, E. H. 364.
 Lardry, P. 52, 62, 88, 138.
 Larmor, Joseph 265, 467.
 Lassen, Hans 90, 406, 480.
 Lee, A. G. 548, 587.
 Lee, F. W. 275.
 Leithäuser, G. 614.
 Lejay, P. 536.
 Lewer, S. K. 197.
 Love, A. E. H. 454.
 Lowenstein, F. 4.
 Lübke, E. 294, 580.
 Ludenia, W. 130.
 Ludewig, Paul 227, 233.
 Lunnon, F. C. 187, 461.
 Lutz, G. 495.

M

MacDonald, H. M. 126, 248, 318, 320,
 451.
 Malgorn, G. 45, 508.
 Marchant, E. W. 169, 385, 575.
 Marconi, G. 162.
 Maris, H. B. 258, 270.

Martin, D. 81, 144.
 Maurain, Ch. 264, 555.
 McEwan, A. R. 113.
 McIlwain, K. 99.
 McPetrie, J. 349.
 Meissner, A. 73, 468, 479.
 Merritt, E. 157, 303.
 Meslin, G. 287.
 Mesny, R. 13, 40, 47, 74, 94, 98, 181,
 184, 185, 206, 271, 484, 514.
 Mizushima, S. 362.
 Mirick, C. B. 430.
 Mögel, H. 434, 435.
 Moullin, E. B. 593.
 Morizot, A. 304.
 Mösler, H. 167.
 Müller, H. 441.
 Munro, G. H. 360, 363.

N

Nagaoka, H. 384, 404.
 Naismith, R. 358, 615.
 Nakagami, T. 193, 538, 539.
 Nakai, T. 104, 118, 282, 554.
 Nichols, E. H. 497.
 Nichols, H. W. 470.
 Nicholson, 320.
 Nodon, A. 260, 371, 533.

O

Olive, G. W. 113.
 Ollendorf, F. 562.
 O'Neill, J. J. 344.
 Oscanyan, P. C., Jr. 84.

P

Paoloni, D. B. 556.
 Parkinson, T. 146, 160.
 Paulin, E. A. 372.
 Pederson, P. O. 89, 365, 373.
 Pession, G. 95.
 Peterson, H. O. 591.
 Pickard, G. W. 133, 137, 141, 196, 205,
 245, 246, 261, 263, 306, 340, 342,
 438.
 Plendl, H. 116.
 Poincare 320.
 Pomey, J. B. 386.
 Ponte, M. 425, 429.
 Potter, R. K. 132, 144.

Pratt, H. 214.
 Prescott, M. L. 482.
 Proctor, J. A. 219.

Q

Quäck, E. 72, 87, 434, 435.

R

Ranzi, I. 552.
 Ratcliffe, J. A. 211, 343, 357.
 Riccia, A. Della 375.
 Reich, H. 91, 303.
 Reichelderfer, F. W. 228.
 Reinartz, J. L. 337.
 Reyner, J. H. 491.
 Rice, C. W. 86, 345.
 Rocard, Y. 425, 429.
 Rodwin, G. 148.
 Rolf, B. 492.
 Rothe, E. 221, 225, 501, 510.
 Round, H. J. 39, 187, 461.
 Rukop, H. 108.
 Rybczynski, W. V. 31

S

Sacklowski, A. 79.
 Salpeter, J. 382.
 Saltmarsh, B. 605.
 Schaeffer 320.
 Schelleng, J. C. 71, 418, 470.
 Scheppman, W. 111.
 Schiebe 158.
 Schindelhauer, F. 518, 550, 557.
 Schmidt, K. E. F. 163, 570.
 Schwartzhaupt, P. 27, 220.
 Schwers, F. 226.
 Shannon, D. 241.
 Sivian, L. J. 505.
 Shouland, E. F. J. 545.
 Sjostrom, M. 328.
 Smith, T. A. 148.
 Smith-Rose, R. L. 63, 149, 210, 212,
 332, 333, 347, 355, 440, 442, 443,
 445, 477, 526.
 Snell, Chas. E. 67.
 Sobey, A. 202.
 Sommerfeld, A. 320, 326, 447.
 Southworth, G. C. 71.
 Sreenivasan, K. 107, 279, 607.
 Stchoukin, M. A. 316.
 Steel, W. A. 113.

Störmer, C. 105, 317, 366, 416.
 Stoye, K. 53, 230.
 Stratton, J. A. 281.
 Strutt, M. J. O. 19, 161, 377.
 Sutton, W. M. 242.
 Szekely, A. 110.

T

Take, E. 289.
 Talon, G. 317.
 Tanimura, I. 217.
 Tank, Franz 458.
 Taylor, J. E. 494.
 Taylor, A. H. 1, 58, 59, 168, 171, 194,
 201, 224, 368, 403, 426, 473.
 Thatcher, E. W. 152, 341.
 Thompson, J. H. 113.
 Thompson, W. S. 99.
 Thomson, E. 34.
 Tissot, C. 565.
 Tonks, L. 127.
 Tremellen, K. 187.
 Turner, L. B. 478, 502.
 Turpain, M. A. 285, 474.
 Tuve, M. A. 370, 401, 413, 415, 431.
 Tyers, P. D. 139.

U

Uda, S. 15.
 Uller, K. 128.

V

Vallauri, G. 9, 174.
 Van Cleef, E. 238.
 Van der Pol, B., Jr. 5, 66, 266, 267,
 456, 483, 579.
 Viant, A. 541.
 Von Korshenewsky, N. 346.
 von Traubenberg, H. R. 583.
 Von Vogel, F. 10.
 Vos, M. 289.

W

Wagner, K. W. 348, 420, 486.
 Walsh, F. X. 302.
 Watson, G. N. 327, 457.
 Watson-Watt, R. A. 395, 507, 509, 512,
 516, 517, 529, 534, 551.
 Weight 158.
 Weyrich, R. 109.
 White, S. Y. 603.

Whittemore, L. E. 135, 331.
Wiedenhoff, S. 229, 598.
Wiegand, A. 391.
Wilmotte, R. M. 349, 563.
Wilson, C. T. R. 236.
Wright, C. S. 268.
Wulf, T. 574.
Wymore, I. J. 243, 257, 262.

Y

Yokoyama, E. 118, 282, 554.
Young, L. C. 368, 426.

Z

Zappuli, O. 462.
Zenneck, J. 24, 56, 475, 576.



BOOKLETS, CATALOGS, AND PAMPHLETS RECEIVED

Copies of the publications listed on this page may be obtained gratis by addressing a request to the manufacturer or publisher.

A mimeographed data sheet, "Model 588 Modulation Meter," by W. N. Goodwin of the Weston Electric Instrument Corporation, Newark, N. J., describes a meter for determining the percentage modulation in radiotelephone transmitters using the constant current system of modulation. A Weston model 301 rectifier type milliammeter is used and is calibrated directly in percentages.

A three-page folder of the DeJur-Amsco Corporation, 95 Morton Street, New York, N. Y., is devoted to heavy duty rheostats and potentiometers.

"Davohms" and "The Super-Davohm" are the titles of two folders describing products of the Daven Company, 160 Summit Street, Newark, N. J. The former describes wire-wound heavy duty resistors; the latter describes wire-wound resistors for laboratory work or for use in instruments where an accurate resistor is required.

"Let 'Talkies' Tell Your Story" is the title of a folder describing portable sound picture equipment manufactured by the Pacent Reproducer Corporation, 91 Seventh Avenue, New York, N. Y.

Several mimeographed data sheets and folders describing dry metallic rectifiers, filters, and power packs are available from the B-L Manufacturing Company, 19th and Washington Avenue, St. Louis. Mo.



REFERENCES TO CURRENT RADIO LITERATURE

THIS is a monthly list of references prepared by the Bureau of Standards, and is intended to cover the more important papers of interest to the professional radio engineer which have recently appeared in periodicals, books, etc. The number at the left of each reference classifies the reference by subject, in accordance with the "Classification of radio subjects: An extension of the Dewey Decimal System," Bureau of Standards Circular No. 385, which appeared in full on pp. 1433-56 of the August, 1930, issue of the PROCEEDINGS of the Institute of Radio Engineers. The classification numbers are in some instances different from those used in the earlier version of this system used in the issues of the PROCEEDINGS of the Institute of Radio Engineers before the October, 1930, issue.

The articles listed are not obtainable from the Government or the Institute of Radio Engineers, except when publications thereof. The various periodicals can be secured from their publishers and can be consulted at large public libraries.

R100. RADIO PRINCIPLES

- R110 Twyman, F. Optics in radio transmission and other fresh fields. *Trans. Opt. Soc.*, 31, 113-130; 1929-1930.
The subject of electromagnetic radiation is treated from an optical viewpoint.
- R111 Jouaust, R. Some details relating to the propagation of very short waves. *PROC. I.R.E.*, 19, 479-488; March, 1931.
The laws governing propagation of very short waves are the same as those governing the propagation of luminous vibrations. However, because of the difference in frequencies, the absorption, due in large measure to diffusion by particles suspended in air, is less for very short waves than for light, which explains the very great distance traveled by these waves. Communications have been carried on by very short waves between points not in direct line of vision. The phenomena of atmospheric refraction may explain this result, and the hypothesis seems to be justified by certain observations.
- R113 Kantebet, S. R. Negative attenuation of wireless waves at broadcast frequencies. *Nature* (London), 127, 521; April, 1931.
A brief note dealing with a type of negative attenuation effect observed on a 357.1-meter wave at a great circle distance of 640 km.
- R113.2 Pickard, G. W. Note on the fifteen-month period in solar activity, terrestrial magnetism, and radio reception. *PROC. I.R.E.*, 19, 353-355; March, 1931.
A marked fifteen-month period has been found in sun spots, terrestrial magnetism, and radio reception. Early in 1929 this cycle abruptly changed phase by about 60 degrees, 210 degrees, and 160 degrees, respectively, for these elements, resulting in changed relations between solar activity and the two geophysical measures.
- R125.1 Martin, E. F. Radio antennas. *Radio Eng.*, 11, 39-41; April, 1931.
A description of several types of directive antenna arrangements is given.
- R125.1 Walmsley, T. Radio beams. *Post Office Elec. Eng. Jour.*, 24, 59-62; April, 1931.
A brief semitechnical discussion of the fundamental principles governing directive aeri-als.
- R131 Bittmann, H. Der Einfluss der Sekundäremission auf die Röhrenkennlinien. (The influence of secondary emission on the characteristics of vacuum tubes.) *Annalen der Physik*, 8, 737-776; No. 6, 1930.
The results of an exhaustive experimental study of dynatron characteristics are given.

- R131 Völker, J. Die Magnet-Charakteristiken eines Drei-Elektroden rohrtes. (The characteristics of triodes in a magnetic field.) *Zeits. für Hochfrequenz.*, 37, 89-98; March, 1931.
Experimentally determined characteristic curves for various types of magnetrons are given.
- R132 Herd, J. F. A saturated diode as an anode resistance. *Exp. Wireless and Wireless Engineer*, 8, 192-195; April, 1931.
A description of experiments in which a saturated diode was used in place of usual type of resistance in a resistance-battery coupled amplifier.
- R132 Thompson, B. J. Oscillation in tuned radio-frequency amplifier. *Proc. I.R.E.*, 19, 421-437; March, 1931.
The wide use of screen-grid tubes renders an understanding of the conditions for stability of tuned radio-frequency amplifiers important. In this paper the relation between feed-back capacity and the other circuit and tube parameters at the threshold of instability is computed for one, two, three, and four stages, and experimental verification of results is described.
- R133 Fox, G. W. Oscillations in the glow discharge of Argon. *Phys. Rev.*, 37, 815-820; April, 1931.
Report is made of radio-frequency oscillations observed in Argon glow discharges. The frequencies lie in the range of 10^4 to 10^5 cycles per second, in approximately harmonic relations. The peculiar action of a magnetic field on the oscillations is described.
- R133 Thomson, J. J. Oscillations in discharge tubes and allied phenomena. *Phil. Mag.*, 2, 697-735; March, 1931.
A theoretical investigation of the behavior of an ionized gas under conditions existing in a discharge tube, and a description of experiments made to investigate these effects.
- R134 Nelson, J. R. Grid circuit power rectification. *Proc. I.R.E.*, 19, 489-500; March, 1931.
Grid circuit power rectification is investigated by studying the ideal rectifier and applying the results obtained in the case of a tube rectifier. Characteristic curves are used in this study to obtain the optimum conditions for rectification and the order of the output voltage obtainable. Conditions for minimum loading of the circuit preceding the detector are discussed. Audio-frequency discriminations are also studied as a function of grid circuit impedances and experimentally determined curves showing the magnitude of the frequency distortion are also given.
- R139 Grammar, G. Impedance matching in oscillator circuits. *QST*, 15, 28-30; May, 1931.
Some comments on matching the output impedance of an oscillating tube for maximum efficiency.
- R140 Verman, L. C. Negative circuit constants. *Proc. I.R.E.*, 19, 676-681; April, 1931.
A brief review of literature on devices furnishing negative resistance is made and further possibilities of development indicated. New names are suggested for negative circuit constants. It is shown that for transient states the negative inductances and negative capacitances respond as would be expected of true negative circuit constants. External circuits are suggested to vary the negative resistance of a given vacuum tube system. A system of circuits is described by means of which it is possible to obtain impedances proportional to $\pm (j\omega)^n$, where n is any positive or negative integer.
- R145.3 Russell, L. H. and Abraham, G. B. Simplified inductance calculation. *Electronics*, 2, 598-99; April, 1931.
A set of curves is given from which it is possible to determine quickly the number of turns required for a given inductance. The curves are based on Nagaoka's formula.
- R145.3 Chao, R. F. H. Some formulas for the strength of the magnetic field of a cylindrical coil. *Jour. Math. and Phys.* (Massachusetts Institute of Technology), 10, 13-18; January, 1931.
A number of formulas for the strength of the magnetic field are derived, which cover a larger part of the field of a coil, and comparisons are made with published formulas.

- R148 Gunsolley, V. V. Modulation and its suppression. *Radio Eng.*, 11, 46-50; April, 1931.

While the solution of the tuned circuit either by the sideband method or by the direct method gives identical results, there are many who are not reconciled to this conclusion. The purpose of this article is to show the equivalence between the two methods and to show that the sideband theory while perfectly valid is nevertheless based on an imaginary conception having no part in the actual physical phenomena for broadcasting.

- R148
×R363 Harnish, A. Ein hochselektiver Hochfrequenzverstärker und der experimentelle Nachweis der Seitenbänder bei Modulation. (A very selective radio-frequency amplifier and experimental proof of the existence of side bands.) *Phys. Zeits.*, 32, 223; March, 1931.

A brief report of an experiment is given, in which a very selective radio-frequency amplifier was used to prove the physical existence of side bands.

- R191 Wheeler, L. P. An analysis of a piezo-electric oscillator circuit. *Proc. I.R.E.*, 19, 627-646; April, 1931.

A mathematical analysis of a piezo-oscillator circuit arrangement, based on the suppositions that the quartz plate may be replaced by an equivalent electrical network and that the oscillation characteristic of the tube may be represented by a three term non-linear expression.

R200. RADIO MEASUREMENTS AND STANDARDIZATION

- R241 Green, A. L. The high-frequency resistance of coils. *Exp. Wireless and Wireless Eng.*, 8, 183-191; April, 1931.

It is shown that there are methods of measuring the high-frequency resistance of coils which do not require the use of a thermojunction and calibrated resistances. These methods depend on the condition for oscillation in a triode assembly, and the simplest of them uses the dynatron oscillator. Experimental results show that the condition-for-oscillation procedure can be made to compare favorably with resistance-variation as regards accuracy, and, in the case of the dynatron, there is the advantage that numbers of measurements over a range of wave lengths can be made in a short time.

- R241 Iinuma, H. Resonant impedances and effective series resistance of high-frequency parallel resonant circuits. *Proc. I.R.E.*, 19, 467-478; March, 1931.

A new method of measuring impedance and radio-frequency resistance as applied to broadcast frequencies was presented by the author in a previous paper (*Proc. I.R.E.*, 18, 537; March, 1930). The method is here extended to apply to frequencies up to 26,300 kc.

- R241 Labus, J. W. Measurement of resistance and impedances at high frequencies. *Proc. I.R.E.*, 19, 452-460; March, 1931.

It is shown that the absolute value of an unknown impedance when put across the end of a transmission line is a simple function of the ratio of the currents measured at the beginning and the end of the transmission line, and that the real and imaginary components of the unknown impedance may be determined by combining a known capacity or resistance with the unknown impedance. The transmission line may be replaced by a lumped circuit at frequencies corresponding to a wave-length of 150 meters or more.

- R250 Pession, G. and Gorio, T. Measurement of power and efficiency of radio transmitting apparatus. *Proc. I.R.E.*, 19, 377-400; March, 1931.

This paper reports the various methods and results of the measurement of power and efficiency in radio transmitting apparatus. High-frequency power measurements are classified as wattmeter, ammeter, calorimeter, and indirect methods. The high-frequency wattmeter method and the methods based on the current and resistance measurements are briefly discussed. The direct and indirect calorimeter methods are upheld by the authors on account of their advantages, which are enumerated. The experimental results employing calorimeter methods for direct and indirect power measurement are quantitatively reported and the degree of precision obtainable in practical applications is shown.

- R261 Knouf, R. J. Adjusting the superheterodyne for maximum sensitivity. *Radio Eng.*, 11, 42-44; April, 1931.

A description of apparatus required, and the procedure in determining superheterodyne receiving set performance is given.

- R261.5 Llewellyn, F. B. A rapid method of estimating the signal-to-noise ratio of a high gain receiver. *PROC. I.R.E.*, 19, 416-420; March, 1931.
It is shown that a figure of merit for the signal-to-noise ratio in a receiving system is obtained directly by noting how much the total noise output increases when the input circuit is tuned through resonance, in the absence of signal. The effect of mismatching the antenna and input circuit impedances is discussed, and it is concluded that although a small improvement may be obtained in certain ideal cases by making the circuit impedance much higher than the antenna impedance, other considerations indicate that the matched impedance condition gives the best results in practice.
- R262.9 Sarbly, M. D. Measurement of vacuum in radio tubes. *Electronics*, 2, 594-595; April, 1931.
A method for determining the degree of vacuum in electron tubes by means of gas current measurements is described.
- R263 Reich, H. J. A new method of testing for distortion in audio-frequency amplifiers. *PROC. I.R.E.*, 19, 401-405; March, 1931.
A periodic voltage wave consisting of a series of straight lines is distorted into a series of curves when it passes through an amplifier which gives nonuniform amplification. As such distortion can very readily be detected visually with an oscillograph, it affords a means of testing for uniformity of amplification.
- R300. RADIO APPARATUS AND EQUIPMENT
- R334 Campbell, A. G. The new variable-mu vacuum tubes. *Radio Eng.*,
×R131 11, 21-24; April, 1931.
A study is made of the characteristics and performance of the new variable-mu tubes as compared with the present type screen-grid tubes.
- R334 Grammar, G. The variable-mu tetrode. *QST*, 15, 13-18; May, 1931.
×R131 This modified screen-grid receiving tube of improved performance, is described and its performance curves are analyzed.
- R335 French, B. V. K. Power pentodes for radio receivers. *Electronics*, 2,
×R132 576-577; April, 1931.
A discussion of design problems and technical possibilities of the power pentode.
- R355.4 Marconi short wave transmitter type S3. *Marconi Rev.*, 13-24; Janu-
ary-February, 1931.
A medium power general purpose short-wave radio transmitter recently developed by the Marconi Company is described.
- R355.5 McLennan, J. C. The heating effect of short radio waves. *Jour.*
Maryland Acad. Sci., 2, 14-24; January, 1931.
A study of the heating effects of short waves of the order of 25 meters, showing the possibility of directive or selective heating of different parts of the body.
- R255.5 Telephony on 18 centimeters. *Wireless World and Radio Rev.*, 28, 392-
394; April, 1931.
A description is given of the equipment used in recent ultra-high-frequency telephony tests across the English channel. Good quality, two-way communication was maintained with one-half watt of radiated power on a wave length of 18 centimeters.
- R355.5 Lewitsky, M. A. Die Wirkung des Magnetischen Feldes auf die lang-
wellige Strahlung des elektrischen Funkens. (The effect of a magnetic
field on the radiation from an electric spark.) *Phys. Zeits.*, 32, 252-
255; March, 1931.
A study of the effect of a magnetic field on the radiation from the author's special oscillator which generates frequencies corresponding to wave lengths of the order of a fraction of a millimeter.
- R355.5 Gresky, G. Über die Verwendung sichtbarer und unsichtbarer, ins-
×623.731 besondere ultraroter Strahlen für Nachrichtenübermittlung und

Verkehrssicherung. (The application of visible and invisible, especially infra-red radiation, to communication purposes.) *Phys. Zeits.*, 32, 193-212; March, 1931.

A comprehensive review of the developments and present status of light-telephony is given, with a supplementing extensive bibliography.

- R355.9 Bird, J. R. The design of radio-frequency signal generators. *Proc. I.R.E.*, 19, 438-451; March, 1931.

Certain factors involved in designing signal generators free from stray voltage errors are considered. The importance of accounting for all circuit details, particularly of wiring elements, is stressed. The impedances of certain connections, particularly of the output connections from generator to measured receiver, are shown to be important. Shielding is considered in some detail.

- R361.4 Kohn, H. Über die Pendelrückkoppelung. (On superregeneration.)
×R130 *Zeits. für Hochfrequenz.*, 37, 51-58; February, 1931; 37, 98-105; March, 1931.

A comprehensive theoretical and experimental investigation of superregenerative reception.

- R365.3 Parkinson, T. and Gilliland, T. R. A radio method for synchronizing recording apparatus. *Bureau of Standards Journal of Research*, 6, 195-198; February, 1931; *Proc. I.R.E.*, 19, 335-340; March, 1931. RP269.

A method is described, for keeping two recorders in synchronous operation when one is portable and is to be moved to various distances from the other. The recorder drums are driven by clock type synchronous motors and are controlled by a radio transmitter at the fixed station.

- R381 Godsey, F. W. Electrolytic condensers for radio use. *Electronics*, 2, 596-597; April, 1931.

A study of the characteristics of typical electrolytic condensers reveals their suitability for radio purposes.

- R382.1 Aughtie, F. and Cope, W. F. The resistance capacity coupled trans-
R142 former. *Exp. Wireless and Wireless Eng.*, 8, 177-182; April, 1931.

A mathematical analysis of recently developed amplifying transformers and their associated circuit arrangement.

- R383.1 Boyd, W. E. Variable high resistance grid leaks. *Nature* (London),
×535.38 127, 521; April, 1931.

A note on the use of suitable photoelectric cells as variable high-resistance grid leaks.

- R384 Guarnaschelli, F. and Vecchiacchi, F. Direct-reading frequency meter. *Proc. I.R.E.*, 19, 659-663; April, 1931.

The frequency meter described functions over the whole scale of acoustic frequencies from 20 to 10,000 cycles per second, and in addition constitutes a static equivalent of the vibrating reed apparatus used for precise comparisons of a capacity with a resistance and a time.

- R386 Craig, P. H. A system of suppressing hum by a new filter arrangement. *Proc. I.R.E.*, 19, 664-675; April, 1931.

A new system for filtering the output of rectifiers or the commutator ripple from generators is discussed, giving the mathematical design and showing the superiority in practical results as compared with standard systems. The system is based on the superposition of a current which has been shifted in phase by means of a wave filter with one not displaced in phase. The method is also applicable to frequency doubling.

- R387.1 Seiler, W. Experimentelle Untersuchungen über Blechschirme im
elektromagnetischen Strahlungsfeld. (An experimental investigation
of the effect of sheet metal shields placed in an electromagnetic, radiation field). *Zeits. für Hochfrequenz.*, 37, 79-89; March, 1931.

The effects of a metal sheet, a metal screen and of a dipole antenna when placed at varying points in a radiation field are measured and compared by the author. These measurements were carried out at points in the region between an ultra-high-frequency ($\lambda = 2$ meters) radio transmitter and receiver located fifteen wavelengths apart.

- R387.7 Mitchell, G. H. and Wills, H. H. The insulation of pyrex glass after heating in vacuo. *Phil. Mag.*, 2, 748-753; March, 1931.

An experimental investigation of the insulating properties of pyrex indicate that the increase in conductivity manifested by that substance, when subjected to the usual heat treatment given vacuum apparatus, is due to some chemical change in the outer layers of the glass.

- R389 Wolff, I. Alternating-current measuring instruments as discriminators against harmonics. *Proc. I.R.E.*, 19, 647-654; April, 1931.

Alternating-current measuring instruments are classified and a brief description of a method for obtaining each one of them is given. They are then discussed from the standpoint of the increase in reading which can be caused by harmonics added to the pure tones. It is shown that, under certain conditions, the linear detector may be superior to other forms of alternating-current instruments in that the increase due to harmonics is the smallest, whereas the full-wave square-law detector or energy measuring device has the unique superiority of having an increase which is independent of the phase relations between the fundamental and the harmonics and between the harmonics themselves.

R400. RADIO COMMUNICATION SYSTEMS

- R410 Beverage, H. H. and Peterson, H. O. Diversity receiving system of Radio Corporation of America Communications, Inc., for radiotelegraphy. *Proc. I.R.E.*, 19, 531-561; April, 1931.

A receiving system for materially reducing the effects of fading is described. The apparatus consists essentially of three spaced antennas connected to three separate receiving sets, whose outputs are each rectified and combined in a common resistor. The drop in the resistor is used to actuate means for controlling a locally generated tone which may be transferred to the receiving operator over a wire circuit. Further, an aperiodic form of directive receiving antenna is described and effects of echo and cosmic disturbances are briefly discussed.

- R412 Peterson, H. O., Beverage, H. H., and Moore, J. B. Diversity telephone receiving system of RCA Communications, Inc. *Proc. I.R.E.*, 19, 562-584; April, 1931.

The utilization of space diversity of fading and methods of applying this principle to the reception of telephone signals are discussed. The equipment of a diversity telephone receiving system is described in detail and over-all characteristics of selectivity, fidelity, sensitivity, etc., are given.

- R430 Dennhardt, A. Zur Frage der Beseitigung von Rundfunkstörungen durch Kondensatoren. (On the question of eliminating local interference with broadcast reception by means of condensers). *Elek. Zeits.*, 52, 347-48; March 12, 1931.

Certain precautions to be observed when using condensers to by-pass disturbing electrical machines, are mentioned.

- R450 Scarborough, W. H. The radio telephony terminal. *Post Office Elec. Eng. Jour.*, 24, 53-58; April, 1931.

A description is given of the London Telephony terminal where seven long distance, two-way radiophone channels are controlled and linked with telephone trunk lines to all parts of Europe.

R500. APPLICATIONS OF RADIO

- R520 Gross, G. C. European aviation radio. *Proc. I.R.E.*, 19, 341-352; March, 1931.

The author summarizes observations made on an inspection trip over the major European airways. The type of equipment used for receiving and transmitting on ground and on aircraft, together with the frequencies and power used, is described and the present system of direction finding is given in detail.

- R526.3 Diamond, H. and Dunmore, F. W. A radiobeacon and receiving system for blind landing of aircraft. *Bureau of Standards Journal of Research*, 5, 897-931; October, 1930; PROC. I.R.E., 19, 585-626; April, 1931. Research Paper No. 238.
Abstracted in January, 1931, issue of PROCEEDINGS of the Institute of Radio Engineers.
- R550
×R090 Horn, C. W. Ten years of broadcasting. PROC. I.R.E., 19, 356-376; March, 1931.
The salient points in the development of broadcasting during the last decade are reviewed. It is shown that further improvement may be expected with the more extensive introduction of higher powered transmitters.
- R583 Dinsdale, A. Television by cathode ray. *Wireless World and Radio Review*, 28, 286-288; March, 1931.
Details of the new Farnsworth cathode ray television system are explained.
- R583 Wright, H. R. Cathode rays in television. *Radio Eng.* 11, 29-30; April, 1931.
Advantages of the use of cathode ray tubes for television purposes are enumerated, and a description of a system of cathode ray operation of television receivers and transmitters is given.

R800. NONRADIO SUBJECTS

- 510 Willis, B. S. Mechanical aids in the construction of vector diagrams. *Gen. Elec. Rev.*, 4, 224-227; April, 1931.
A so-called "Vector Diagraph" is described, which consists of a drawing board with a rotatable central plate and a graduated T-square. With this device graphical solutions accurate to one-half of one per cent are possible. A graduated triangle permitting solutions accurate to two per cent is also described.
- 535.38 Asao, S. and Suzuki, M. Improvement of thin film caesium photo electric tubes. PROC. I.R.E., 19, 655-658; April, 1931.
A thin film of silver or gold when deposited on a sensitive caesium cathode surface increases the sensitivity of the latter. A sensitivity of forty eight microamperes per lumen were thus obtained.
- 537.1 Kennelly, A. E. The convention of equidimensional electric and magnetic units. *Proc. Nat. Acad. Sci.*, 17, 147-153; March, 1931.
A set of electromagnetic unit dimensions are presented, which are common to both electric and magnetic systems, and are based on the conventional hypothesis that the dimensions of the permittivity and permeability for free space are the same.
- 621.375.1 Baker, W. R. G., Fitzgerald, A. S. and Whitney, C. F. Electron tubes in industrial service. *Electronics*, 2, 467-469; January, 1931; *Electronics*, 2, 581-583; April, 1931.
Applications of several types of tubes, including the thyatron, are given. The action of the latter, a three-element gaseous tube, as a power control, phase-relation control, relay, and as an inverter is described.
- 621.375.1 Heil, H. G. Application of the Wynn-Williams bridge valve amplifier to microphotometry and absorption problems. *Phil. Mag.*, 2, 736-740; March, 1931.
The application of the bridge amplifier as a detector of photo-electric current is described and results of measurements made with this device are compared with those obtained with a Moll recording microphotometer.
- 621.385 Hangwitz, O. Über die Beeinflussung von Kopplungen in Fernsprechkabeln während der Herstellung. (Concerning methods of balancing mutual coupling in telephone cables during manufacture). *Elek. Nach. Tech.*, 8, 49-62; February, 1931.

A discussion of the possibilities of controlling the production of telephone cables in such a way that the coupling between lines and therefore cross-talk may be eliminated.

- 621.385 Doebke, W. Das Nebensprechen in Fernsprechkabeln. (Crosstalk in telephone cables). *Elek. Nach. Tech.*, 8, 63-76; February, 1931.

A mathematical analysis, in which the voltage and current distribution in a disturbed line is calculated for any condition of coupling.

- 621.385.95 West, W. Frequency characteristics of standard reference type condenser transmitters and moving coil receivers. *Post Office Elec. Eng. Jour.*, 24, 27-30; April, 1931.

The frequency characteristics are found to depend, both in shape and level on the acoustical conditions under which the calibrations are made. If these conditions are reasonably similar to those of the Standard Reference method of calibration, the results, based on the use of the Raleigh disc, are very similar to those obtained by the Thermophone. When, however, actual use conditions are imitated, differences of the order of 5:1 for the transmitters and 3:1 for the receivers are found at certain considerable portions of the frequency range.

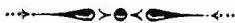

CONTRIBUTORS TO THIS ISSUE

Bashenoff, Valerian I.: Born January 9, 1890 at Kostroma, U.S.S.R. Received E.E. degree, Polytechnical High School, 1918; in charge of radio engineering, 1918-1920. Engineer in charge, State Radio Works, Moscow, 1920-1921. Docent in radio engineering, Moscow Technical High School, 1921; associate professor of radio engineering, Moscow Transport Engineers' Institute, 1924-1928. Charter member (1918) and secretary (1919 to date) of the Russian Society of Radio Engineers. Secretary of the All-Russian Radio Association, 1921-1925. Since 1921 chief engineer, radio department, State Electrical Research Institute. Technical editor, radio engineering section, *Technical Encyclopedia*, 1927 to date. Member, American Association for the Advancement of Science, Member, Institute of Radio Engineers, 1927.

Case, N. P.: Born July 17, 1904 at Canon City, Colorado. Received A. B. degree, Stanford University, 1924; E.E. degree, 1926. Physicist, Frank Rieber, Inc., 1926-1927; nontechnical work, 1927-1928; assistant physicist, Bureau of Standards, 1928-1929; research investigator, Department of Engineering Research, University of Michigan, 1929 to date. Member, Seismological Society of America. Associate member, Institute of Radio Engineers, 1926.

Edes, N. H.: Born October 22, 1898 in Bermuda. Royal Military Academy, 1916-1917; commissioned, Royal Engineers, 1918; Royal Corps of Signals, 1921. Received A. B. degree in Mathematics and Physics, Clare College, Cambridge, 1926. Instructor School of Signals, Catterick, 1929 to date. Associate member, I.E.E. Associate member, Institute of Radio Engineers, 1922.

Huff, Christian: Born September 19, 1878 at Portland, Maine, Machine design, Maryland Institute, 1896-1900; electrical and mechanical development work, 1900-1905; electrical construction, 1905-1915; Department of Terrestrial Magnetism of Carnegie Institution of Washington, 1915, to date, at present electrical engineer in charge of shop. Fellow, American Association for Advancement of Science; Member, Philosophical Society of Washington; Fellow, American Geographical Society, Nonmember, Institute of Radio Engineers.

Koga, Issac: Born December 5, 1899 at Kashii, near Fukuoka, Japan. Received E.E. degree, Tokyo Imperial University, 1923; University Hall student, Tokyo Imperial University, 1923-1925; lecturer, Tokyo Imperial University, 1925 to date; Electrical Research Institute, Tokyo Municipality, 1926-1929; assistant professor, Tokyo University of Engineering, 1929 to date. Nonmember, Institute of Radio Engineers.

Labus, J. W.: See Proceedings for March, 1931.

*** Pfitzer, Werner:** Born June 16, 1901 at Leipzig, Germany. Technical High School, Dresden, 1921-1926; received degree Doktor-Ingenieur, 1923. With firm Electroacoustic, Kiel, working on study of submarine acoustic sets, 1927-1929. With Reichpostzentramt, working on field strength and frequency measurements, 1929 to date. Nonmember, Institute of Radio Engineers.

* Paper published in May, 1931, PROCEEDINGS.

Polkinghorn, F. A.: Born July 23, 1897 at Holbrook, Massachusetts. Received B.S. degree in E.E., University of California, 1922. U. S. Naval Radio Laboratory at Mare Island Navy Yard, 1922-1924. A-P Radio Laboratories, San Francisco, 1924-1925. Engineer, Pacific Telephone and Telegraph Company, San Francisco, 1925-1927. Member, technical staff engaged in design of short-wave receiving apparatus, Bell Telephone Company, 1927 to date. Associate member, Institute of Radio Engineers, 1925.

Roetken, A. A.: Born October 15, 1902 at Covington, Kentucky. University of Cincinnati, 1922-1925; Ohio State University, 1925-1929. Received B.E.E. degree, Ohio State University, 1927; M.S. degree, 1929. Member, technical staff, Bell Telephone Laboratories, 1929 to date. Associate member, Institute of Radio Engineers, 1929.

Wenstrom, William H.: Born July 28, 1898 at Sala, Sweden. Graduate, United States Military Academy, 1918; postgraduate course, 1919, Cavalry School, 1920; Signal School, 1924. Regimental and brigade communications officer, 1921-1923, 1924-1926. Instructor, United States Military Academy, 1926-1930. Graduate student, Yale University, 1930-1931. First Lieutenant, Signal Corps, United States of America. Associate member, Institute of Radio Engineers, 1925.



METALLIZED has made *possible new Resistance Standards*

Old ideas of performance
have gone by the board
with the perfection of
Type "K" Filament

How do you judge resistor standards?

- Low voltage coefficient.
- Low noise level.
- Slight change in resistance under load.
- Ability to withstand overload.
- Imperviousness to moisture.
- Long shelf life—no ageing.
- Unchanged resistance value under all frequencies.

You will find that I R C Metallized Resistors, with the new Type "K" Filament, lead the field in these particulars. Rigid tests under extreme conditions, in both our own and customers' laboratories, confirm this. Curves and data showing the results of these tests will be mailed on request.

INTERNATIONAL RESISTANCE COMPANY
Philadelphia Toronto

Used wherever vacuum tubes are used.

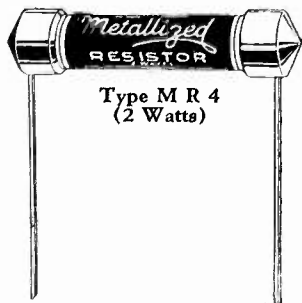

IRC
Metallized
RESISTORS

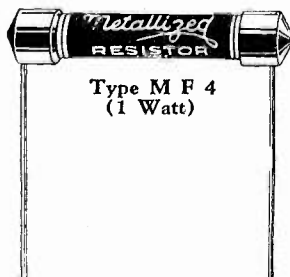

ALSO PRECISION WIRE WOUND RESISTORS.

When writing to advertisers mention of the PROCEEDINGS will be mutually helpful.

For these NEW TUBES

-for ALL TUBES-

FANSTEEL

Rare Metal

Wire

and Sheet

In your new 1931 tubes, don't try to work with uncertain metals and alloys. Standardize on Fansteel Molybdenum, Tungsten and Tantalum, elementary metals refined from ores and basic salts, finished to accurate dimensions, uniform, dependable. Alloys of these rare metals are available too, and close laboratory check on production makes certain that exact specifications are maintained.

Given such materials to work with, you can not only make better tubes, but also cut production costs through reduction of shrinkage, waste and spoilage. Reduction of costs isn't all, however. There's more at stake than that. The new tubes must be "right"—must win public favor through their performance be-

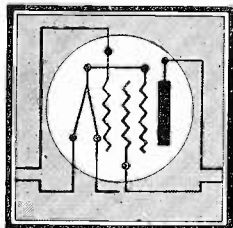

cause for *profits* you need the steady repeat business which only better than average tubes will provide. If the tubes are to be "standard equipment" on a well known set, importance of trouble-free performance can not be overestimated.

Obviously it's a poor time to take chances or cut corners. The very best of materials are only just barely good enough this year. To help manufacturers find the one best metal or alloy for their purposes, Fansteel offers the assistance of its scientific staff on development work.

Fansteel's ample stock assures prompt shipments. Special cooperation to users desiring small lots for experimental use.

Write for samples and prices

FANSTEEL PRODUCTS COMPANY, Inc.

North Chicago, Illinois

TANTALUM · TUNGSTEN · MOLYBDENUM · RARE METAL ALLOYS

When writing to advertisers mention of the PROCEEDINGS will be mutually helpful.

PRE-EMINENT

LEADERSHIP

Produces LOWER PRICES



DURING PAST TWO YEARS

101

RADIO MANUFACTURERS

in the United States used

Cornell

“CUB” CONDENSERS

and were pleased with their performance.

Such leadership and large production enable us to announce, as of May 1st, a new and lower price list with the same high standard of quality.

Cornell Electric Mfg. Co., Inc.

LONG ISLAND CITY, NEW YORK

Filter Condensers—By-Pass Condensers—Radio Interference Filters—Power Factor Correction Banks—Uniformly High Insulation Resistance—Paper Dielectric Condensers (All Types)—Resistors (All Types)

When writing to advertisers mention of the PROCEEDINGS will be mutually helpful.

THE UNSEEN COURIERS OF THE SPOKEN WORD

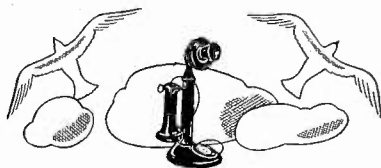

THE FAMILIAR TELEPHONE that stands upon your desk at the office or in your home is only a very small part of the great communication system that enables you to talk across the miles with such surprising ease.

Behind it are complicated exchanges, a carefully trained organization of more than four hundred thousand men and women and eighty million miles of wire. These are the forces that make efficient telephone service possible. These are the unseen couriers of the spoken word.

Tirelessly, day or night, without rest or sleep, the Bell System awaits but the lifting of the receiver to carry your voice to any one of thirty-two million other telephone users in this country and abroad, and on ships at sea. It is done so quickly and with so little trouble that few people stop to consider what goes on between the giving of the number and the completion of the call.

Some time every day—perhaps many times a day—you use some part of a telephone system that has taken fifty years and more than four thousand million dollars to build. The simple words “long distance,” which you speak so casually into your telephone, place millions of dollars of equipment at your disposal. Yet the cost of a call from New York to Chicago is only three dollars and but a fraction of that for lesser distances.

Equipment of comparable cost is also needed to connect your home with the thousands or hundreds of thousands of other telephones in your town or city. Yet the charge for local service is only a few cents a day.

In relation to service rendered, the cost of the telephone is one of the smallest items in the monthly business and family budget. Few things purchased are of such real, constant and increasing value.

★ AMERICAN TELEPHONE AND TELEGRAPH COMPANY ★



When writing to advertisers mention of the PROCEEDINGS will be mutually helpful.

AS OLD AS RADIO AS NEW AS TELEVISION

No other single organization offers as complete and diversified line of radio products as the DeForest Radio Company.

Today the DeForest name is to be found on—

- Receiving Tubes
- Transmitting Tubes
- Special Purpose Tubes
- Transmitters
- Carrier-Current Equipment
- Speech Amplifiers
- Centralized Receiving Systems
- Short-Wave Receivers
- Facsimile Apparatus
- Television Equipment from Home to Studio

DeForest does not rest on its laurels. Having contributed the

- Audion or practical radio tube
- Regenerative principle
- Oscillating tube circuit
- Audio amplifier
- Practical radio telephone
- Practical radio telegraph
- Broadcasting of entertainment
- Outstanding features of 1931 tubes

—the very foundations of our present radio industry, the DeForest organization looks ahead rather than behind in serving you.

See our unique DeForest exhibit, during R.M.A. Trade Show, by visiting Booths 92, 93, 96 and 97, facing main entrance, Hotel Stevens. Or if you prefer, write for our Silver Anniversary Souvenir.

DE FOREST
RADIO
CO
PASSAIC
NEW JERSEY

When writing to advertisers mention of the PROCEEDINGS will be mutually helpful.

NEW IDEAS

INDUSTRY, in the year 1931, is going to need (and get) a lot of constructive thinking. Old methods will be scrapped. New ideas will be welcomed, and money will be made by those who originate economies.

If your thinking is along the lines of reduced overhead, lower manufacturing costs, better appearance, value or performance, check your theories against the versatile properties and uses of NVF products.

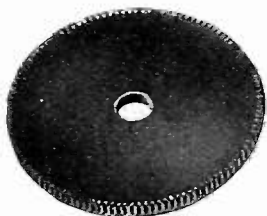

Phenolite gear for a household appliance.



Combination Phenolite and fibre high-tension fuse tube.

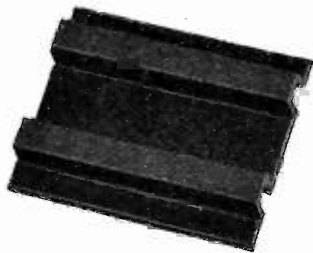

Phenolite double channel for refrigerated show case insulation and runner.

All NVF products—their uses, properties and workabilities are fully detailed in "Fact-Sheets of Industry." May we send you a copy?

N V F



"Let's see what National can do about it?"

"I think we're working in the right direction all right, but this trial-and-error business is costing us money. Why not tell National what we are trying to accomplish here and put it up to them to furnish us with the right material for the job. After all, that's their business."

TURNING the job over to us isn't shirking responsibility—it's simply a time saving, money saving move that many a manufacturer has suggested to his engineers with happy results.

Vulcanized Fibre and Phenolite (laminated brakelite) are versatile materials applicable to a thousand-and-one uses. But to make practical the improvement ideas of designers and engineers often requires an intimate knowledge of the properties and characteristics of these materials. And right there is where National, with 58 years in this specialized business, can render you valuable service. Tell us what you're after and let us work out the practical, economical solution. Our services on development are gratis.

NATIONAL VULCANIZED FIBRE CO.
Wilmington, Delaware Offices in principal cities

When writing to advertisers mention of the PROCEEDINGS will be mutually helpful.

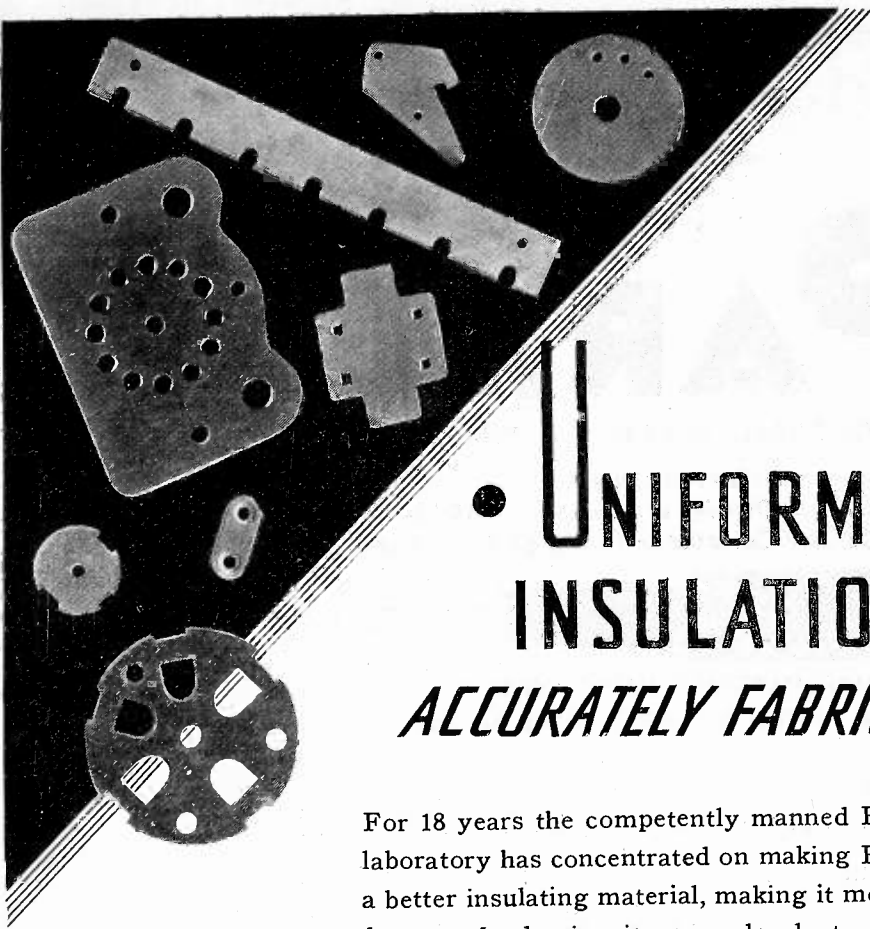

UNIFORM INSULATION *ACCURATELY FABRICATED*

For 18 years the competently manned Formica laboratory has concentrated on making Formica a better insulating material, making it more uniform, and adapting it more closely to the different requirements of different users.

The Formica factory has the most varied and complete fabricating equipment in the industry, operated by skilled men who work on one material only.

You can get good material properly machined for any insulating use from Formica. Send your blue prints for estimates.

THE FORMICA INSULATION COMPANY
4638 Spring Grove Avenue
Cincinnati, Ohio.

FORMICA
Made from Anhydrous Bakelite Resins
SHEETS TUBES RODS

When writing to advertisers mention of the PROCEEDINGS will be mutually helpful.



PARALAC

The Moisture Proof Hook-up Wire with the Slide Back Feature

CONSTRUCTION

Shown by Enlarged Drawing of a Sample of PARALAC Tinned Copper Conductor (Solid or Stranded)



The Paralac coating is applied between the copper conductor and the outer sleeve, insuring moisture protection and adding greatly to the voltage breakdown. In use, the Paralac coating and outer sleeve push back together without bunching.

The Engineer Needs a High Voltage Hook-up Wire with a High and Constant Insulation Resistance

To fulfill these requirements our engineers have designed PARALAC. Recent tests made at the Electrical Testing Laboratories, New York City, show conclusively that PARALAC meets all these requirements.

INSULATION RESISTANCE

Recent tests made by the Electrical Testing Laboratories of New York City show that Paralac maintains a high and constant insulation resistance even after immersion in water over an extended period of time.

Paralac is admirably adapted for Multi-Conductor Cables to your specifications.

VOLTAGE BREAKDOWN

E. T. Lab. Report No. 89885 Test. No.	VOLTS AT PUNCTURE Size 20 Solid	
	In Mercury	Twisted Pairs in Air
1	2600	4900
2	2850	5000
3	2950	5700
4	2250	5100
5	3200	
6	3400	
7	3700	
8	3100	
9	3700	
10	3450	
Average	3100	5200

We Shall Be Pleased to Send You Complete Copies of These Reports. Better Yet—Write for a Sample of Paralac and Verify these Results in Your Own Laboratory.

Paralac is made with both solid and stranded core in assorted colors from 12 to 24 gauge. Prices on request.

CORNISH WIRE CO., Inc. 30 Church Street, New York

"MADE BY ENGINEERS FOR ENGINEERS"



When writing to advertisers mention of the PROCEEDINGS will be mutually helpful.

ELECTRAD
FLEXIBLE WIRE RESISTOR

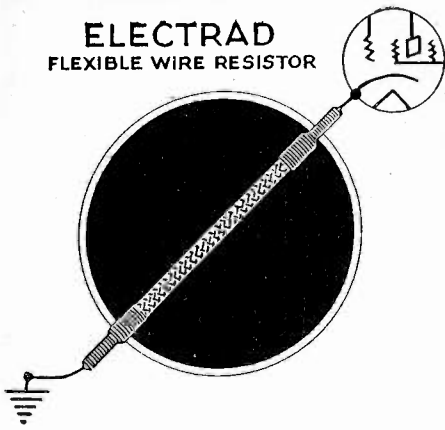

BETTER
from
every
angle

ASK yourself just four questions about a resistor. The answer will tell you if it is the quality of product you *must* consider.

How does it test?

Who makes it?

Who uses it?

What does it cost?

ELECTRAD Engineers are *Resistor Specialists*. They know your resistor needs and can supply them with the least delay and lost motion. Whenever you have a resistor, volume control or tone control problem, call **ELECTRAD**. Put **ELECTRAD** engineers on your pay roll —without pay.

Electrad Flexible Wire Resistors. Spiral winding over silk cord—original with Electrad. Impregnated fabric sleeving. Wire leads or soldering lugs. Flexible, easily adaptable. Low temperature coefficient. **ACCURATE.** Rating, one-half watt to inch. Value, from one to 1000 ohms per inch.



Metal Shell Royalty Resistors. Resistance element not exposed to air, dust or oxidation. Positive metallic contact without wear on resistance element, or change in resistance value. Quiet, smooth. Shaft and bushing grounded to contact arm. Made linear or any desired taper commonly used for tone or volume controls. With or without power switch. Standard or special-length shafts and bushings.

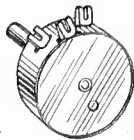

Enclosed Metal Shell Royalty Resistors (With Insulated Contact Arm.) Same specifications and characteristics as above, except enclosed in metal shell. Contact arm insulated from shaft, bushing and shell.

Electrad Super-Tonatrol. Distinctly new and superior adjustable high resistor. Resistance element permanently fused to a vitreous enameled steel plate. Uncanny smoothness and quietness and positive electrical contact through floating silver brush points. No tendency to deteriorate or change in resistance. Practically immune to moisture and temperature. Bakelite case. Insulated shaft and bushing. Made in single, dual, and triple units, in ranges up to 100,000 ohms. Uniform or tapered curves.



Electrad Engineers Will Gladly Cooperate in Designing Special Units. Ask them.

175 Varick St., New York, N.Y.

ELECTRAD
INC.

ELECTRAD, INC., 175 Varick St., New York
Please send general catalog of all products and special
data on
Name
Address
PE-6

When writing to advertisers mention of the PROCEEDINGS will be mutually helpful.

HIGH GAIN TRANSISTORS



The transitor is a shielded intermediate-frequency transformer with "Varitor" condenser tuning in primary and secondary circuits. One hundred and fifty to two hundred kc, with standard production windings or step-up ratios. Mechanically suited to upright or inverted mounting.

Manufactured in three standard values of gain and selectivity, meeting the requirements of any intermediate frequency amplifier.

DIALS

The DeJur-Amsco complete line of dials meets the manufacturer's predominant requirements of excellence, economy and standardization.

This new line of DeJur-Amsco Full Vision Dials combines the economical requirements of midget receiver design with the luxury and refinement of console types. In kc and metric scales.

Write for literature describing the complete line of DeJur-Amsco Radio Manufacturers' parts

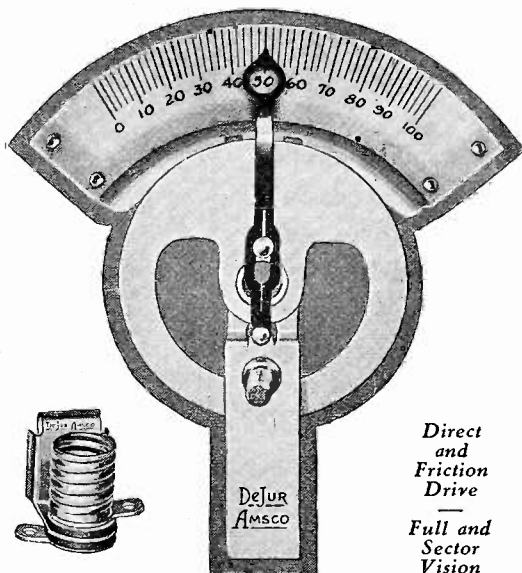

Direct and Friction Drive — Full and Sector Vision

DeJUR-AMSCO CORPORATION

Varitors—Variable Condensers—Power Rheostats—Dials—Pilot Lights—Escutcheons
95 MORTON ST., NEW YORK CITY

When writing to advertisers mention of the PROCEEDINGS will be mutually helpful.



No Other Condenser
Gives You All The Features
of The
ACRACON*
ELECTROLYTIC
CONDENSER

Exhaustive tests by many leading engineers have proved Acracon's superiority in electrical efficiency as well as in mechanical construction. And yet the Acracon Electrolytic costs no more than other makes of inferior quality.

The Acracon unit is now available in capacities up to 16 microfarads at either 440 or 475 volt peak in the single anode type.

If you are not already specifying Acracon, write today and learn first hand why this finest of all electrolytic condensers is fast becoming the choice of the industry.

**All Acracon Features Are Protected by Patents Pending*

Condenser Corporation of America
259-271 Cornelison Ave. Jersey City, N. J.

Factory Representatives in:

Chicago
Cincinnati

St. Louis
San Francisco

Los Angeles
Toronto

and other Principal Cities

When writing to advertisers mention of the PROCEEDINGS will be mutually helpful,

THORDARSON EXPERIENCE

keeps transformer cost down

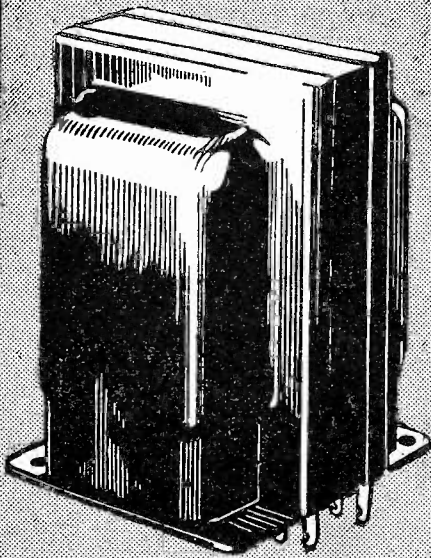

THORDARSON leadership in transformer manufacture . . . of nearly 40 years' duration . . . now brings to the builder of radio equipment, rare dependability and perfect reception, plus appreciably lowered production cost. Continuous research . . . enormous output . . . constantly improved methods and equipment . . . have resulted in a superior product at a price only made possible by vast purchasing, production, and distribution facilities. Thus Thordarson Transformers can help you keep the quality of your product up—yet keep your costs down. Let us show you. Thordarson Electric Manufacturing Company
500 West Huron Street, Chicago, Illinois

TO THINK OF TRANSFORMERS IS TO THINK OF THORDARSON

Visit our Exhibit—
Booth No. 23
Annual I.R.E. Convention
Sherman Hotel, Chicago
June 4, 5, 6

THORDARSON
Reg. U. S. Pat. Off.
TRANSFORMER
SPECIALISTS
SINCE 1895 . . .

When writing to advertisers mention of the PROCEEDINGS will be mutually helpful.

DUBILIER INVERTED TYPE HI-MIKE CON- DENSER

For sub-panel wiring jobs, the Dubilier engineers have developed the Dubilier Inverted Type Hi-Mike Condenser—a fitting companion for the standard type, with the same general characteristics:

1. Aluminum can $4\frac{1}{2}$ by $1\frac{3}{8}$ inches, interchangeable with other standard electrolytic units.
2. Standard capacity of 8 mfd., with highest percentage of effective capacity.
3. Working voltage conservatively rated at 400, peak of 430, and capable of withstanding 500 for short periods.
4. Fully self-healing, reforming faster than any other electrolytic condenser.
5. Lowest leakage at high voltages—approximately 0.2 milliamperes at 430 volts peak, after 100 hours.
6. Power factor less than 10%.
7. Life expectancy in excess of requirements of usual radio assembly.
8. Compact, clean, non-spillable, efficient, inexpensive, self-healing, reliable.

The original research and development work of Dubilier engineers in the electrolytic condenser field is now at your disposal. Do not hesitate to place your condenser problems before us. Details and samples of Dubilier Hi-Mike Condensers will be cheerfully submitted.

DUBILIER
CONDENSER CORPORATION
4377 BRONX BOULEVARD · · · NEW YORK CITY

When writing to advertisers mention of the PROCEEDINGS will be mutually helpful.

Continental Resistors

SEE OUR EXHIBIT I. R. E. SHOW—BOOTH NO. 45

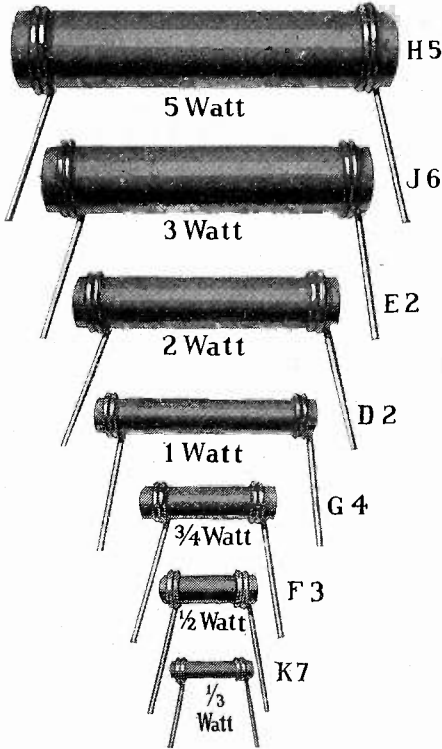

RESISTOR CHARACTERISTICS:

NOISELESS
RESISTANCE CONSTANT
SMALL TEMPERATURE
COEFFICIENT
RUGGED
FIRMLY SOLDERED TERMINALS
DEPENDABLE
COLOR CODED

UNITS SHOWN HALF SIZE

CONTINENTAL SUPPRESSORS

For Radio-Equipped Cars

Stop ignition noise in the automobile radio set when used with suitable by-pass condensers. The distributed capacity is extremely small. The resistors are enclosed in a tough ceramic tube of high crushing and tensile strength, of low coefficient of expansion and of high dielectric strength. They are hermetically sealed in the tube and this renders the suppressors moisture proof.

Suppressors shown full size

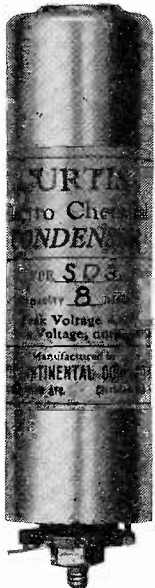

**Curtis
Electro
Chemical
Condenser**

*Essential
Characteristics*

Full capacity at all voltages

Uniform capacity at all frequencies

Low freezing point

Low internal resistance

Low leakage

No nipples, new breather principle

One hole mounting terminal at bottom

For Further Particulars Write to
Curtis Continental Corp.

13900 Lorain Ave.,
Cleveland, O.



SPARK PLUG SUPPRESSOR

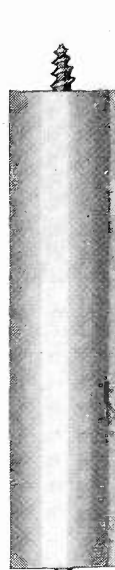

SCREW IN CABLE TYPE SUPPRESSOR



DISTRIBUTOR SUPPRESSOR

Write for Information and Prices
**CONTINENTAL CARBON
INC.**

13900 Lorain Ave.
WEST PARK, CLEVELAND, O.

When writing to advertisers mention of the PROCEEDINGS will be mutually helpful.

THE INVERTED TYPE (8 Mfd.)

ELKON NON-AQUEOUS HI-VOLT CONDENSER

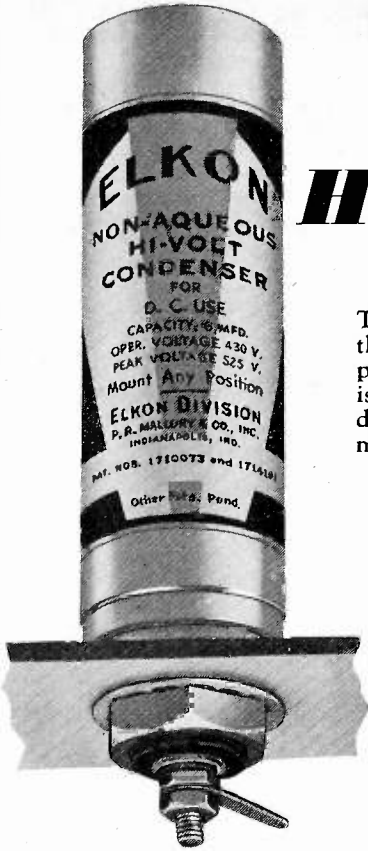

The new Inverted Type 8 mfd. Elkon condenser meets the standard requirements for a unit to be used on sub-panel wiring jobs. It has the same outstanding characteristics as the other Elkon Non-Aqueous Hi-Volt Condensers which have been adopted as standard equipment by many leading set and instrument manufacturers.

- 1 Highest Filtering Capacity of any electrolytic condenser.
- 2 Working Voltages—up to 450 v., d. c., to meet the varied requirements of present radio sets.
- 3 Absolutely Dry: A condenser from which all free water is eliminated.
- 4 Low Leakage: Normal rated leakage 0.1 mil per mfd., after operating short period.
- 5 Impervious to Low Temperatures: Operates efficiently from minus 40° F to 125° F.
- 6 Long Life: To reduce replacements and interrupted service periods to a minimum.
- 7 Self Healing: All surge voltage conditions encountered in properly designed sets have no detrimental effect on the Elkon condenser.
- 8 Compactness: Small cubical volume per microfarad.
- 9 Stability in Operation: To guard against mechanical and electrical variation that would affect action of the circuit.
- 10 Low Cost Per Microfarad Per Voltage Rating.

For Production Economy use the ELKON Condenser WITHOUT THE CAN!

Many manufacturers have substantially reduced their condenser costs by using Elkon condensers without the can. The illustration at the right shows how they can be mounted in the set.

The metal can is not necessary with Elkon condensers as each unit is enclosed in a sturdy, wax-dipped cardboard container providing ample protection for efficient operation.

Samples of Elkon condensers without the can in any capacity or combination of capacities will be sent to all recognized manufacturers.

Send for booklet giving complete technical data and general description.

ELKON DIVISION
P. R. Mallory & Company, Incorporated
Indianapolis, Indiana

When writing to advertisers mention of the PROCEEDINGS will be mutually helpful.

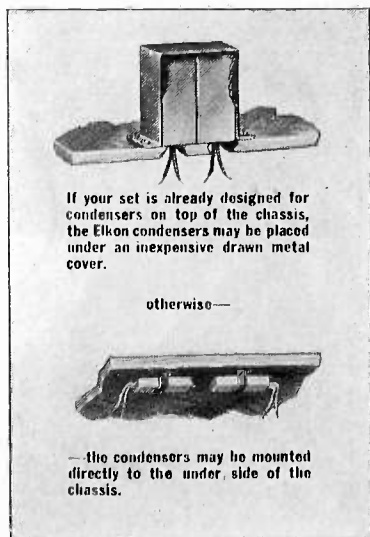

If your set is already designed for condensers on top of the chassis, the Elkon condensers may be placed under an inexpensive drawn metal cover.

otherwise—

— the condensers may be mounted directly to the under side of the chassis.

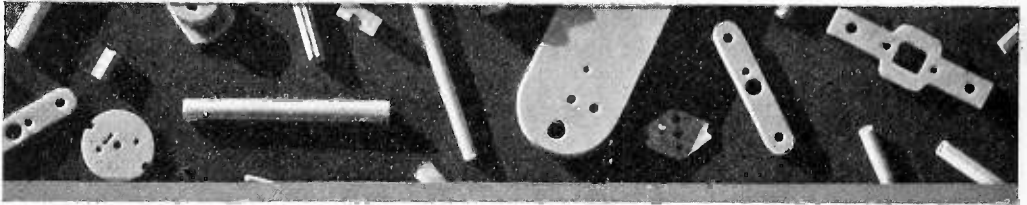

Isolantite *Insulators*

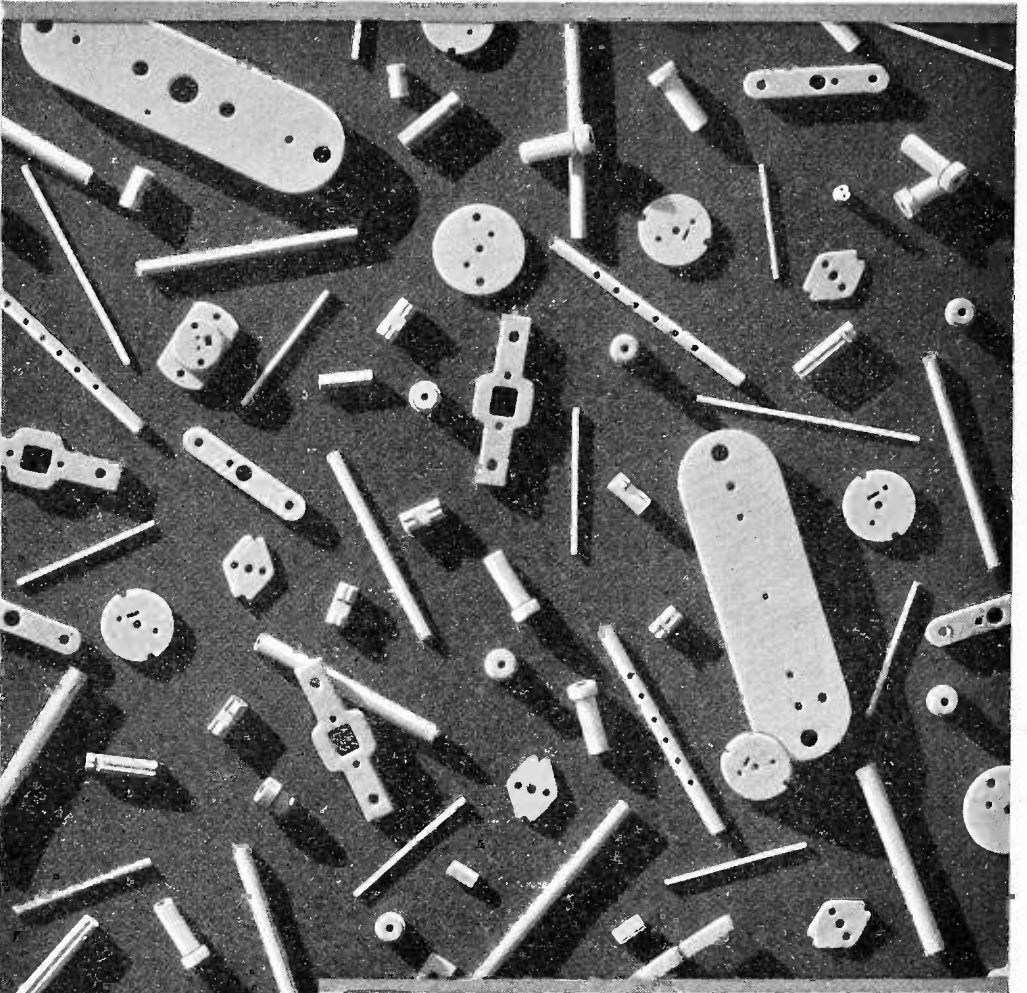

Isolantite Inc.



When writing to advertisers mention of the PROCEEDINGS will be mutually helpful.

When writing to advertisers mention of the PROCEEDINGS will be mutually helpful.

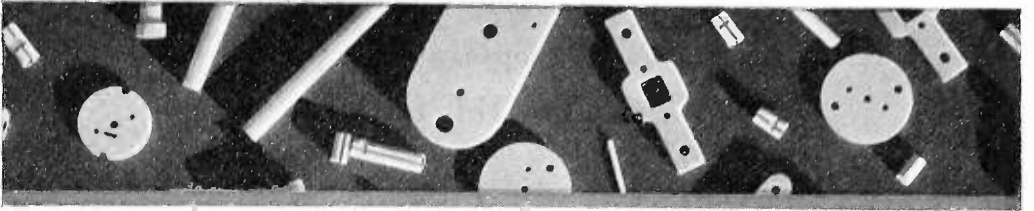

Belleville, New Jersey

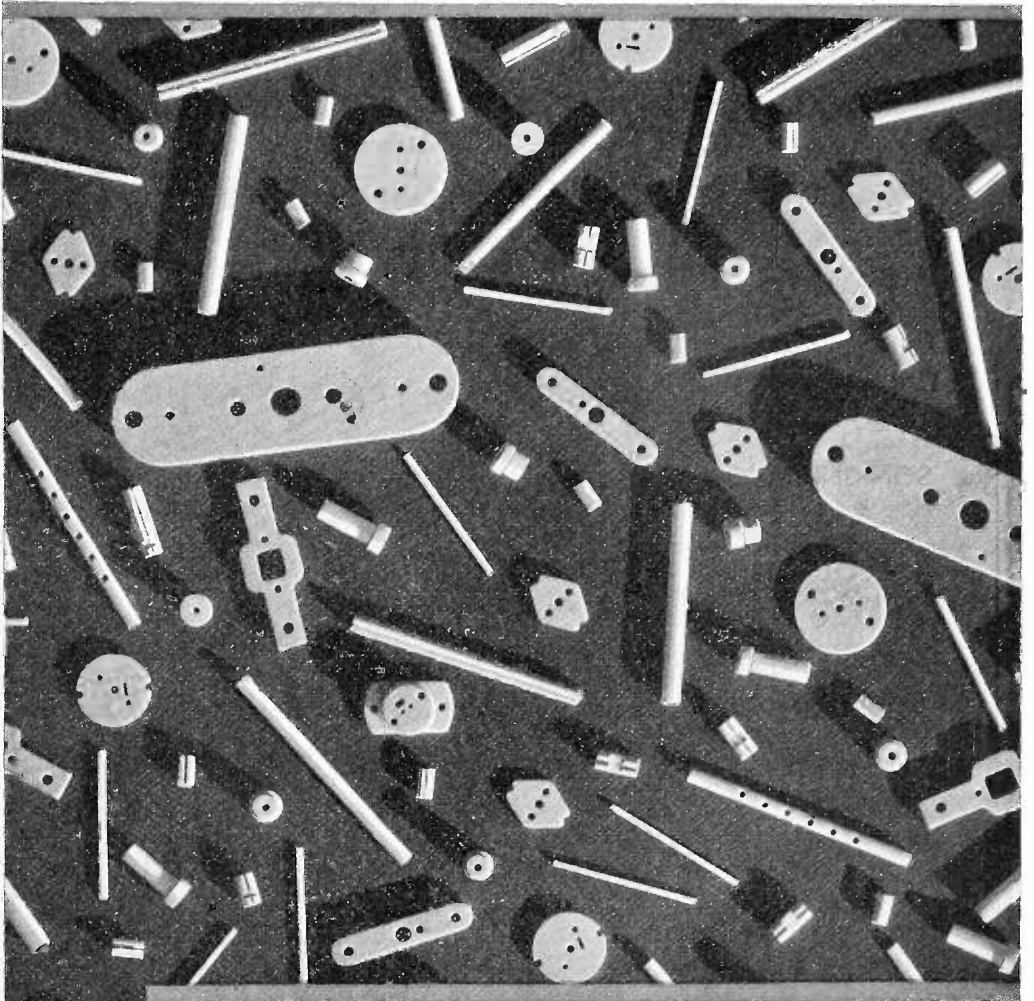

for Vacuum Tubes



\$ \$ \$ \$ \$ \$ \$ \$ \$

Down Go Costs

☛ In this price war, POLYMET PRODUCTS are helping radio's leaders to maintain:

- (1) A competitive position.
- (2) A good name.

☛ You dare sacrifice neither.

☛ Follow these leaders!

P O L Y M E T
M A N U F A C T U R I N G C O R P .

*World's Largest Manufacturer
of Radio Essentials*

829 E. 134th St. New York City

Canadian Representative
WHITE RADIO, Ltd.

41 West Avenue _____ North Hamilton, Canada

Representative for the British Isles
A. H. HUNT, Ltd.
Tunstal Road, Croydon, Surrey, England

PAPER, MICA
AND ELECTROLYTIC
CONDENSERS



TRANSFORMERS
AND CHOKES



RESISTORS



COIL WINDINGS



VOLUME CONTROLS



MAGNET WIRE



SOUND EQUIPMENT
AND COMPONENT
PARTS

When writing to advertisers mention of the PROCEEDINGS will be mutually helpful.

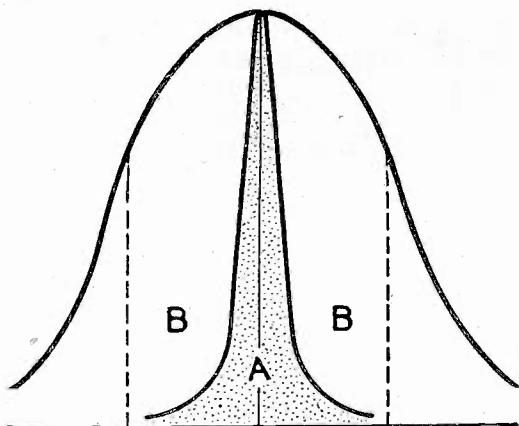

Inner curve shows Stenode's selectivity, outer curve that of ordinary receiver. Lines BB are 5 k. c. distant from Line A. All background noise, included in the light portion between A and BB is eliminated by the Stenode.

STENODE TUBES

Until the American Tube Manufacturers licensed by the Stenode Corporation of America are in sufficient production, we can supply the rapidly growing demand of laboratories and serious investigators for:

QUARTZ CRYSTALS

Suitably Mounted in Tube Form To Fit Standard Tube Sockets

These crystals are all approved by our own laboratory after actual tests in a standard Stenode developed under the patents of Dr. James A. Robinson, M.B.E., D.Sc., Ph.D., M.I.E.E., F.Inst.P., and former Chief of Wireless Research, British Royal Air Force, by the engineers of the Stenode Corporation of America.

All crystals are ground to respond to a frequency of 175 kilocycles, which is the frequency accepted as standard in all modern superheterodynes, and are mounted in vacuum tube form.

STENODE TUBES (Standard UX Socket Base) \$15

"If it isn't a STENODE it isn't a modern receiver."

STENODE CORP. of AMERICA

(Formerly American Radiostat Corp.)

Hempstead Gardens, Long Island, N. Y.

STENODE CORP. OF AMERICA
Hempstead Gardens, Long Island, N.Y.

Enclosed find Personal Check, P.O. or Express Money Order for which please forward me Stenode Tubes.
(state number)

Name

Street

City State

When writing to advertisers mention of the PROCEEDINGS will be mutually helpful.

**ARCTURUS
PZ
PENTODE**



SENSITIVE . . .

***4 times the sensitivity
of a '45 Power Tube***

Because of its high "power sensitivity" the Arcturus PZ Pentode is almost 4 times as sensitive as the '45 power tube—a feature of decided importance when considering output, detector overload and plate supply arrangements. Greater volume, increased efficiency, and compactness of set design are the natural results.



**ARCTURUS 551
VARIABLE-MU**

**DISTORTION IS
NEGLECTIBLE . . .**

***even at 20 times the
voltage of a '24 tube***

The input limit for the Arcturus 551 is 4 to 10 volts as compared to a typical '24 tube which is about 0.2 to 0.4 volts. The 551 tube operates without distortion at about 20 times the voltage permissible with the '24 tube.

This and other features of the Arcturus 551 eliminate the need for double pre-selectors, dual volume controls, and "local-long distance" switches. Maximum cross-talk is divided by 500; receiver hiss is reduced. Circuits using this new tube are simplified as well as more efficient.

*Send for Technical Bulletins giving complete performance data on the
Arcturus Type PZ Pentode and the Arcturus 551 Variable-Mu Tube.*

ARCTURUS RADIO TUBE CO., NEWARK, N. J.

ARCTURUS

The TUBE with the LIFE-LIKE TONE

When writing to advertisers mention of the PROCEEDINGS will be mutually helpful.

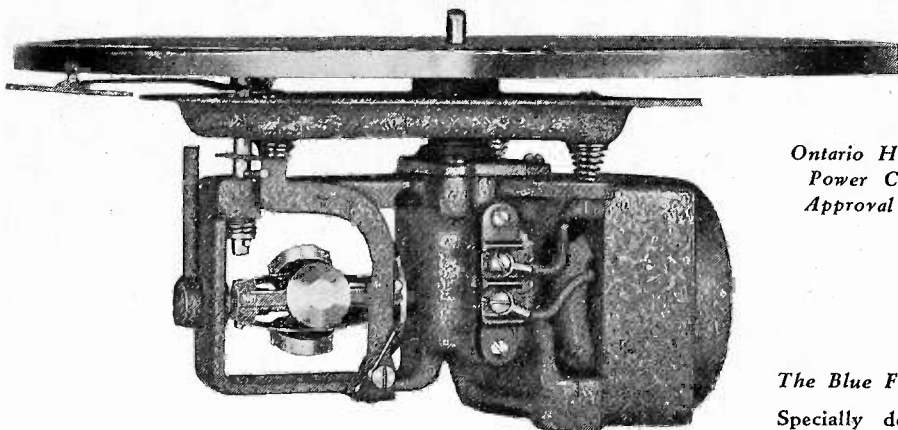

Ontario Hydro-Electric
Power Commission
Approval No. 2685

The Blue Flyer Unit

Specially designed for Radio-Phonographs. Compact, light, amply powerful for heaviest pick-ups on records with extreme drag. Open construction with complete ventilation—no overheating. Silent spiral-cut fiber gears and long oversize bearings. Operates on all voltages and frequencies. Furnished complete, with mounting plate, turn-table and speed regulator. Automatic stop is optional.

*Responsibly
Guaranteed*

Flyer Electrics

keep forging ahead
in popularity for
Radio-Phonographs

Designed and produced under unequalled advantages, Flyer Electric Motors invite the highest expectations. Their steady, year-by-year superior service answers for them with constantly more and more friends.



These simplest, soundest and most dependable motors will give you the same *balanced* excellence of service. Coming not alone from their exceptional co-ordinated simplicity and efficiency of design. Nor limited to that and superior manufacturing. Coming in equal measure from over 17 years of leadership in large-scale production of quality phonograph motors and more than a quarter century of like success in specialized electrical manufacturing.

The Green Flyer and the larger Blue Flyer. Self-starting induction type, giving abundant power under perfect control, without heat or hum.

The **GENERAL INDUSTRIES CO.**

3146 Taylor Street, Elyria, Ohio

*In ordering
samples give
voltage and fre-
quency.*

When writing to advertisers mention of the PROCEEDINGS will be mutually helpful.

STUPAKOFF MAGNESIA INSULATORS

*An Actual Size
Photograph*

**Write for samples
Stupakoff Laboratories, Inc.
6619 Hamilton Ave.
Pittsburgh (6) Pa.**

When writing to advertisers mention of the PROCEEDINGS will be mutually helpful.

The Institute of Radio Engineers

Incorporated

33 West 39th Street, New York, N. Y.

APPLICATION FOR ASSOCIATE MEMBERSHIP

(Application forms for other grades of membership are obtainable from the Institute)

To the Board of Direction
Gentlemen:

I hereby make application for Associate membership in the Institute.

I certify that the statements made in the record of my training and professional experience are correct, and agree if elected, that I will be governed by the constitution of the Institute as long as I continue a member. I furthermore agree to promote the objects of the Institute so far as shall be in my power, and if my membership shall be discontinued will return my membership badge.

Yours respectfully,

.....
(Sign with pen)

.....
(Address for mail)

.....
(Date)

.....
(City and State)

References:

(Signature of references not required here)

Mr. Mr.

Address Address

Mr. Mr.

Address Address

Mr.

Address

The following extracts from the Constitution govern applications for admission to the Institute in the Associate grade:

ARTICLE II—MEMBERSHIP

Sec. 1: The membership of the Institute shall consist of: * * * (d) Associates, who shall be entitled to all the rights and privileges of the Institute except the right to hold the office of President, Vice-president and Editor. * * *

Sec. 5: An Associate shall be not less than twenty-one years of age and shall be: (a) A radio engineer by profession; (b) A teacher of radio subjects; (c) A person who is interested in and connected with the study or application of radio science or the radio arts.

ARTICLE III—ADMISSION

Sec. 2: * * * Applicants shall give references to members of the Institute as follows: * * * for the grade of Associate, to five Fellows, Members, or Associates; * * * Each application for admission * * * shall embody a concise statement, with dates, of the candidate's training and experience.

The requirements of the foregoing paragraph may be waived in whole or in part where the application is for Associate grade. An applicant who is so situated as not to be personally known to the required number of members may supply the names of non-members who are personally familiar with his radio interest.

ESCO Motor-Generators

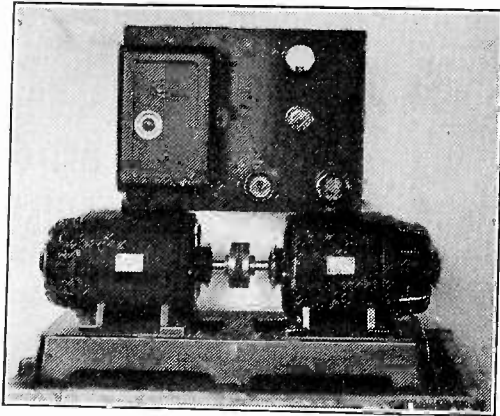

“Fit” the application

“Fit” the power supply

Motors—Generators—Dynamotors—Rotary Converters

Designed · Developed · Manufactured

Quick Delivery · Low Priced

“ESCO” is a company where “Special” does not mean “soak ‘em” or “Let ‘em wait.” Because for twenty years “ESCO” has specialized in the “Special.” “Special” voltages, frequency, speed, and mechanical design is the objective of our equipment and organization. **OUR EXPERIENCE IS BROAD.** Below is a list of some of the special applications of our motors and generators, manufactured during this last December.

Telegraph
Airplane dynamotors
Wind driven generators
Portable gasoline units
Radio beacons
Radio transmitters
Television
Talkies
Radio receivers
Automobile radio
Valve control
Water light doors
Planos
Electric indicators

Speed reducers
Ventilators
Telechron resetters
Automatic chucks
Recording instruments
Elevator door control
Elevators
Flexible shafts
Riveters
Gasoline pumps
Bottle washers
Phase shifters
Frequency changers
Hair dryers

Arc lamps
Anti-corrosion
Oil burners
Automatic whistle
Ore-vibrators
Organ generators
Hoists
Freight trucks
Temperature control
Polishers
Stock quotations
Sun lamps
Bookkeeping unit
Forced draft

Knitting mills
Printing press
Electro plating
Remote control
Movie cameras
Aerial cameras
Cloth cutting
Coin counters
Pneumatic valves
Valve grinders
Theater dimmers
Cup vending
Refrigerator
Automatic stoker
Weaving

Why not profit by our long experience? Up to date equipment and practical engineering talent. They are all at your disposal. Write us for bulletins or information.

ELECTRIC  **SPECIALTY**
COMPANY

300 South St.

Stamford, Conn.

Manufacturers of motors, generators, dynamotors and rotary converters.

When writing to advertisers mention of the PROCEEDINGS will be mutually helpful.

AMERTRAN

SOUND SYSTEM PANELS

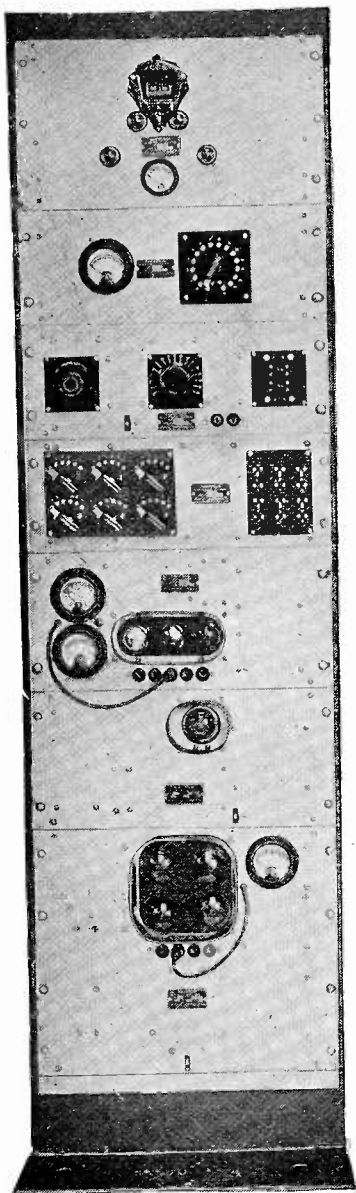

Suggested Panel Layout No. 2
(For Undistorted Outputs of 12.5 Watts)

Long recognized as typifying the "Standard of Excellence" in audio products, the Amertran line now includes a wide assortment of standard panels designed to fill every requirement for complete sound systems.

Amertran panels are so constructed that they may be assembled on racks in various combinations for every purpose. They are the best that engineering genius can produce with the finest of materials and workmanship.

Before placing these Sound Systems on the market, months of research were spent in perfecting them, and thousands of panels were built for special applications—tested for true fidelity and satisfactory service, both in the laboratory and in actual installations.

Bulletin 1200 gives complete information and illustrations of Standard Amertran Panels. Write for it on your business stationery, and send specifications of your particular problem. Our engineering staff is at your service.

AMERICAN TRANSFORMER COMPANY
179 Emmet Street, Newark, N. J.

Representatives in following cities

Boston · Chicago · Cleveland · Knoxville · Montreal
New York · Philadelphia · San Francisco · St. Louis



AMERTRAN

When writing to advertisers mention of the PROCEEDINGS will be mutually helpful.

Data, Parts List and Blue Prints

Complete Schematic Diagrams and Construction Details for building:

THE STENODE CIRCUIT

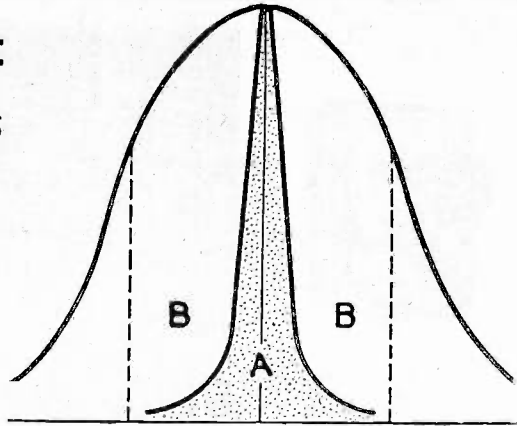

Inner curve shows Stenode's selectivity, outer curve that of ordinary receiver. Lines BB are 5 k. c. distant from Line A. All background noise included in the light portion between A and BB is eliminated by the Stenode.

Developed under the patents of James A. Robinson, M.B.E., D.Sc., Ph.D., M.I.E.E., F. Inst. P., and former Chief of Wireless Research, British Royal Air Force, by the engineers of the Stenode Corporation of America.

PRICE \$10.00

Several reliable American manufacturers are now making all parts meeting Dr. Robinson's specifications for the Stenode circuit. The special quartz crystals—in tube form for convenient handling and mounting—are obtainable from us until the American Tube Manufacturers licensed by us are in sufficient production to supply the demand.

The Stenode Corporation of America now throws open to serious investigators the study of this revolutionary circuit, which is the greatest single advance since Morse invented the telegraph.

"If it isn't a Stenode it isn't a modern receiver."

STENODE CORP. of AMERICA

(Formerly American Radiostat Corp.)

Hempstead Gardens, Long Island, N. Y.

STENODE CORP. OF AMERICA
Hempstead Gardens, Long Island, N. Y.

Enclosed find Personal Check, P. O. or Express Money Order for \$10.00 for which please send me complete diagrams, details and list of Parts for constructing the Stenode Circuit.

NAME

STREET

CITY STATE

When writing to advertisers mention of the PROCEEDINGS will be mutually helpful.

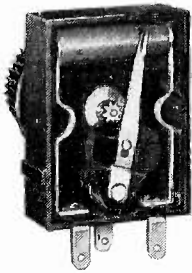

In the Bradleyometer approximately 50 solid resistance disks are interleaved between metal disks forming a resistance column of any desired value. No other resistor offers such flexibility or accuracy.

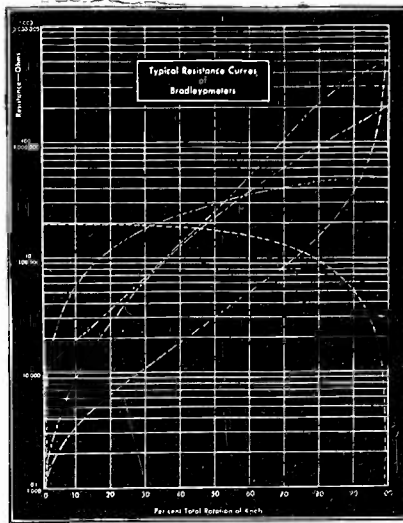

Type A, Single Bradleyometer



Type AA, Double Bradleyometer



Type AAA, Triple Bradleyometer

With Leads

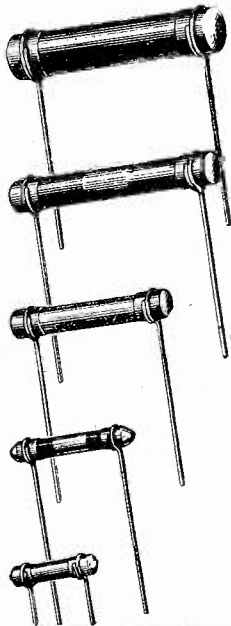

Radio Resistors

Fixed or Variable for any Electronic Circuit

Without Leads

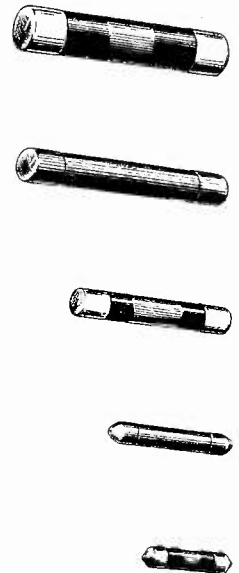

BRADLEYUNIT RESISTORS are made in five sizes, with or without leads. All Bradleyunits are color-coded to meet set manufacturers' specifications. These solid molded resistors are accurately calibrated and have great mechanical strength. They are used by the world's largest radio manufacturers for providing correct C-bias, plate voltage, screen grid voltage and for use as grid leaks.

The Bradleyometer is a stepped potentiometer of most amazing performance. It has astounded radio engineers who were skeptical of its advertised performance. Any type of resistance-rotation curve can be arranged to meet your requirements. Samples will be sent to established manufacturers of electronic apparatus, for test and trial.

Get an Allen-Bradley quotation on your next resistor order.

Allen-Bradley Co.

116 W. Greenfield Ave

Milwaukee, Wisconsin



ALLEN-BRADLEY RESISTORS

Produced by the makers of Allen-Bradley Control Apparatus

When writing to advertisers mention of the PROCEEDINGS will be mutually helpful.

THERE IS A DIFFERENCE

A little change here, a little cut there—the letter of your specifications may have been met—yet the finished job may not produce the expected results if the manufacturer has failed to interpret your intention. Then what? Who gets the headache?

Take, for example, CARDWELL manufactured-to-specification instruments and apparatus. Built with scrupulous exactness, no product of the CARDWELL factory has failed to meet the requirements of a most discriminating clientele, composed of the foremost engineering organizations in the country and various departments of the government. The headaches, if any, have been ours.

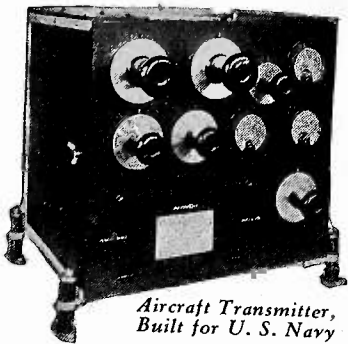

*Aircraft Transmitter,
Built for U. S. Navy*

CARDWELL condensers, too, insure that quality of performance desired and expected by the engineer or designer, and the great variety of types and sizes available in the CARDWELL line affords an opportunity to choose *exactly* the *right* condenser for the *right* place in any circuit.

May we serve you?

CARDWELL CONDENSERS
(Variable and Fixed)

AND

MANUFACTURING SERVICE

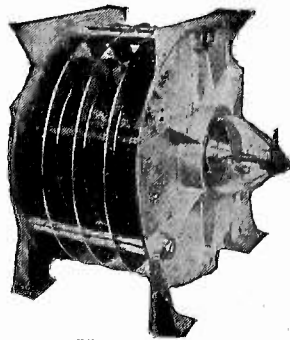

*High Voltage
Fixed Condenser*



**THE ALLEN D. CARDWELL MFG.
CORP'N**

93 Prospect Street, Brooklyn, N.Y.

“THE STANDARD OF COMPARISON”

When writing to advertisers mention of the PROCEEDINGS will be mutually helpful.

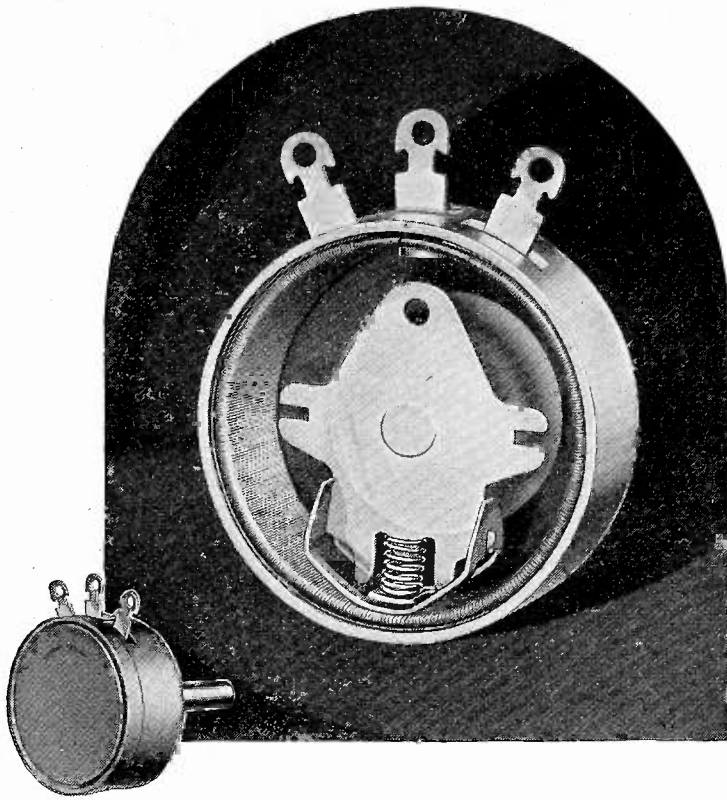

Here is an achievement!

The perfection by our engineers of our new No. 20 Series Wire-Wound Volume Controls to a degree that practically eliminates all noise in operation, is a distinct Frost-Radio achievement. Many months of research and ceaseless endeavor are back of this new type noiseless unit. Its construction embodies a new principle of design, the use of the finest materials available, and an extremely high standard of accuracy in manufacture, which had the courage to reject previous precision attainments and recognize that accuracy within limits of tenths of thousandths of an inch was not only possible, but well worthy of accomplishment . . . Unquestionably the year's highest achievement in the volume control field!

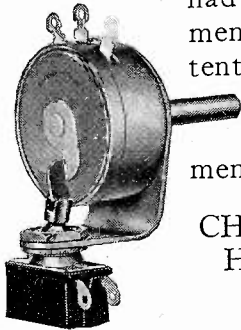

CHICAGO TELEPHONE SUPPLY CO.
 HERBERT H. FROST, *Inc.*, Sales Division
 GENERAL OFFICES AND PLANT
 ELKHART, INDIANA

FROST-RADIO

When writing to advertisers mention of the PROCEEDINGS will be mutually helpful.

One responsibility for coils

From copper bar to finished product, every operation in the manufacture of coils is performed in General Cable plants. Complete responsibility for fabrication of coils rests upon General Cable.

Interpret that responsibility as broadly as you will. It embraces the maintenance of quality manufacture and the capacity to supply your needs for coils of any kind, in any quantity—quickly and dependably. It includes the tireless search for better coils—better magnet wire, better

methods of application—greater economy in production.

To effect such results General Cable marshals coil experience, manufacturing facilities, research laboratories, and personnel of an unusual character. Dudlo, Rome and the other organizations now part of General Cable supplement and strengthen each other.

One responsibility covering all factors, converges upon a single purpose—the assurance of unequalled satisfaction in the purchase and use of General Cable Coils for your products.

GENERAL CABLE CORPORATION

420 LEXINGTON AVENUE, NEW YORK

• OFFICES IN PRINCIPAL CITIES



When writing to advertisers mention of the PROCEEDINGS will be mutually helpful.

Announcing the New TMV-18 Signal Generator

Designed to meet the demand for an accurate yet portable source of R.F. voltage covering a wide frequency range

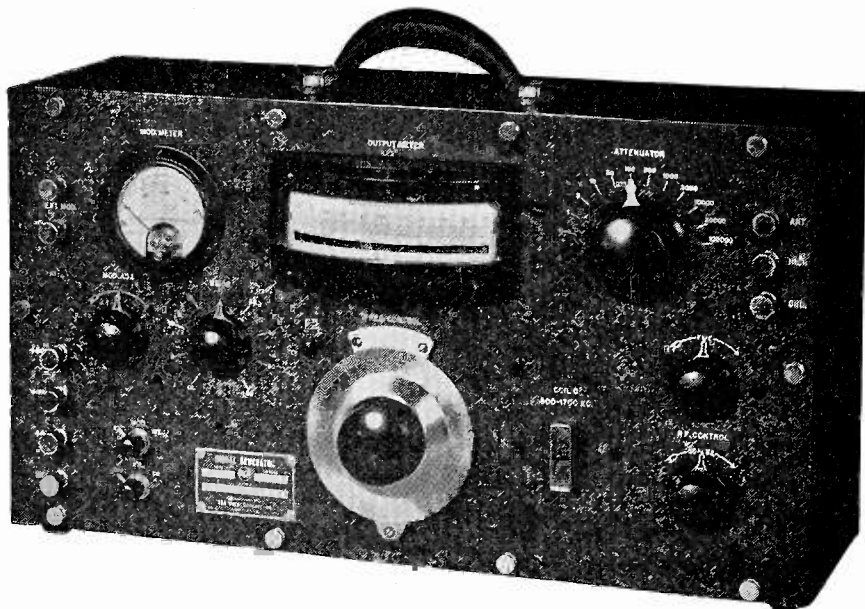

SUPPLIES known R.F. voltages from .25 microvolts to 2 volts. Frequency range 100 to 10,000 K. C. covered with 6 plug-in coils removable from the front of the panel. Can be obtained to cover the broadcast band only. Accuracy within 5% above 5 microvolts for frequencies below 1500 K. C. and 10% for frequencies above 1500 K. C.

Contains 400 cycle audio oscillator

capable of modulating the output up to 80% in 9 steps. Frequency modulation less than 200 cycles with 30% modulation below 1500 K. C. External variable frequency oscillator may be used for modulation if desired. Enclosed in heavy aluminum shielding case finished with black crackle lacquer. All internal parts carrying R. F. are enclosed in individual shields to further reduce leakage.

Representative test and laboratory instruments will be on display in Chicago during the I. R. E. Convention, June 4th to 6th, at the Hotel Sherman and during the R. M. A. Trade Show, June 8th to 12th, at the Hotel Stevens.

Prices and information on request

ENGINEERING PRODUCTS DIVISION
RCA Victor Company, Inc.
A Radio Corporation of America Subsidiary
CAMDEN, N. J.

100 W. Monroe St.—Chicago

235 Montgomery St. — San Francisco

When writing to advertisers mention of the PROCEEDINGS will be mutually helpful.

CHANGE IN MAILING ADDRESS OR BUSINESS TITLE

Members of the Institute are asked to use this form for notifying the Institute office of a change in their mailing address or any change in the listing of their company affiliation or title for the Year Book membership list.

The Secretary,
THE INSTITUTE OF RADIO ENGINEERS,
33 West 39th Street,
New York, N.Y.

Dear Sir:

Effective please note change in my address
(date)
for mail as follows:

FROM

.....
(Name)

.....
(Street Address)

.....
(City and State)

TO NEW ADDRESS

.....
(Street Address)

.....
(City and State)

Also for the membership list for next year's Year Book note change in my business address (or title) as follows, this ^{is} my mailing address: _{is not}

.....
(Title)

.....
(Company Name)

.....
(Address: Street, City and State)

PLEASE FILL IN, DETACH, AND POST TO THE
INSTITUTE PROMPTLY

Back Numbers of the Proceedings, Indexes, and Year Books Available

MEMBERS of the Institute will find that back issues of the Proceedings are becoming increasingly valuable, and scarce. For the benefit of those desiring to complete their file of back numbers there is printed below a list of all complete volumes (bound and unbound) and miscellaneous copies on hand for sale by the Institute.

The contents of each issue can be found in the 1914-1926 Index and in the 1929 Year Book (for the years 1927-28).

BOUND VOLUMES:

Vol. 10 (1922), \$8.75 per volume to members
Vols. 17 and 18 (1929-1930), \$9.50 to members

UNBOUND VOLUMES:

Vols. 6, 8, 9, 10, 11, and 14 (1918-1920-1921-1922-1923-1926), \$6.75 per volume (year) to members

MISCELLANEOUS COPIES:

Vol. 1 (1913) July and December
Vol. 2 (1914) June
Vol. 3 (1915) December
Vol. 4 (1916) June and August
Vol. 5 (1917) April, June, August, October and December
Vol. 7 (1919) February, April and December
Vol. 12 (1924) August, October and December
Vol. 13 (1925) April, June, August, October and December
Vol. 15 (1927) April, May, June, July, August, October, November and December
Vol. 16 (1928) January, February, March, April, May, June, July, August, September and November
Vol. 17 (1929) February, March, April, May, June, July, August, September, November and December
Vol. 18 (1930) April, May, June, July, August, September, October, November and December

These single copies are priced at \$1.13 each to members to the January 1927 issue. Subsequent to that number the price is \$0.75 each. Prior to January 1927 the Proceedings was published bimonthly, beginning with the February issue and ending with December. Since January 1927 it has been published monthly.

MEMBERS will also find that our index and Year Book supplies are becoming limited. The following are now available:

INDEX

The Proceedings Index for the years 1909-1930 inclusive is available to members at \$1.00 per copy. This index is extensively cross indexed.

YEAR BOOK

The 1931 Year Book is available to members at \$1.00 per copy. This Year Book includes the 1931 Report of the Committee on Standardization,—an "up to the minute" report on the most recent standardization information available.

Make remittances payable to the Institute of Radio Engineers and send orders to:

THE INSTITUTE OF RADIO ENGINEERS

33 West 39th Street
NEW YORK CITY, N. Y.

REL POWER TUBE SOCKETS

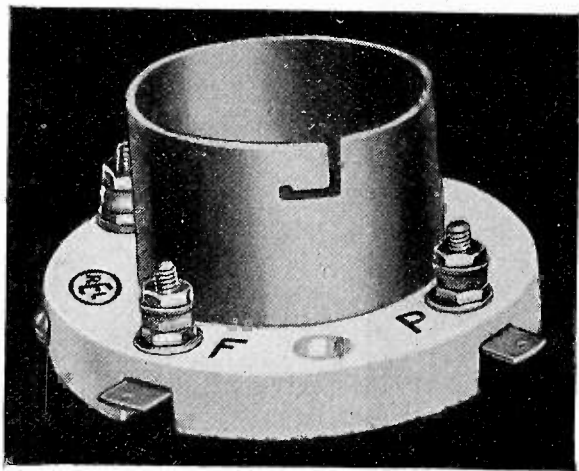

50 Watt Socket—Cat. 131A

FOR STANDARD 50 WATT
BASE TUBES
CAT. 131A

GLAZED ISOLANTITE
INSULATION

HEAVY PHOSPHOR BRONZE
SIDE AND BOTTOM WIPE
CONTACTS

FILAMENT CONTACTS
CARRY 12 AMPERES

List Price \$2.75 each

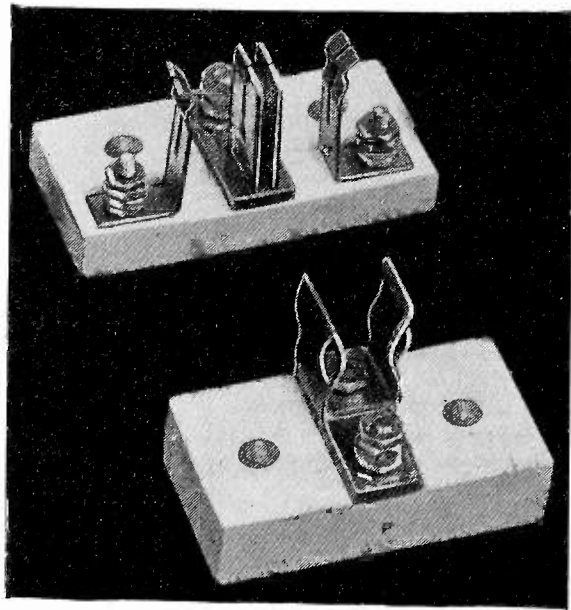

250 Watt Mountings—Cat. 128A

FOR STANDARD 250 WATT
BASE TUBES
CAT. 128A

GLAZED ISOLANTITE
INSULATION

HEAVY SPRING CONTACT
ONE PIECE GRID CONTACT

FILAMENT CONTACTS
CARRY 20 AMPERES

List Price \$4.75 pair

Your Dealer or Direct

Radio Engineering Laboratories, Inc.

100 Wilbur Ave.

Long Island City, N.Y., U.S.A.

When writing to advertisers mention of the PROCEEDINGS will be mutually helpful.

TO PERFECT THE FILTER CIRCUIT



Single hole mounting

One-piece anode

Vent-metal enclosed

Dull Nickel Can

1931 witnesses the definite triumph of the SPRAGUE INVERTED TYPE ELECTROLYTIC CONDENSER which is now specified by most of the leading radio manufacturers, producing the largest volume of radio receivers absorbed by the American public.

No other device can compare with the SPRAGUE CONDENSER for efficiency, economy and performance in the perfecting of the Filter Circuit. Produced with absolute uniformity, Sprague condensers are specified by those who seek maximum efficiency.

Write for illustrated booklet, diagrams, etc.
Department Number 3

SPRAGUE SPECIALTIES COMPANY
North Adams, Mass.

Small Space

High Capacity

High Voltage

Self-Healing

SPRAGUE
Electrolytic CONDENSERS

When writing to advertisers mention of the PROCEEDINGS will be mutually helpful.

The 700 Series Multi-Range Kilovolt- meters and Multipliers

for A. C. and D. C. measurements
up to 20,000 volts.

Resistance 1000 ohms per volt and
higher.

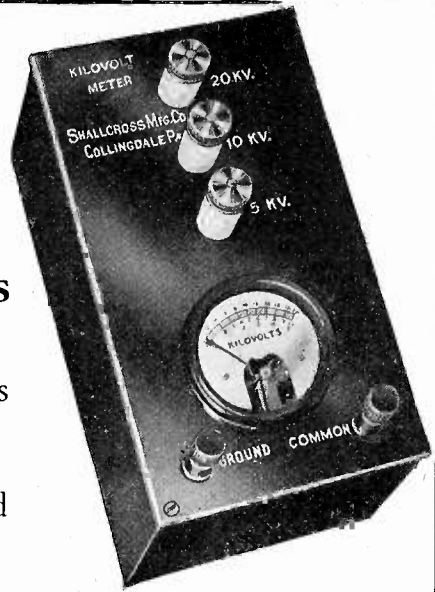

The 900 Series Megohm Decade Resistance Boxes



Incorporating the high-
est grade non-reactive,
wire-wound resistor
units and the most mod-
ern methods of insula-
tion to guarantee *Low
Leakage.*

- #935—Two Decade $10 \times (.01 + 0.1)$ Total 1.1 Megohms
- #945—Two Decade $10 \times (0.1 + 1.0)$ Total 11 Megohms
- #960—Two Decade $10 \times 1.0 + 5 \times 10$ Total 60 Megohms

*Prices and descriptions furnished upon request.
Write for Bulletin 900-W.*



Shallcross Mfg. Company

ELECTRICAL SPECIALTIES

700 PARKER AVENUE

Collingdale, Pa.

(NEAR PHILADELPHIA)



When writing to advertisers mention of the PROCEEDINGS will be mutually helpful,

When writing to advertisers mention of the Proceedings will be mutually helpful.

THE diagram at right gives the mechanical specifications and electrical characteristics of new Scovill 4-gang midget condenser with high shields.

This condenser can also be supplied with low shields, and as a 3-gang unit with either high or low shields.

For the heterodyne circuit these condensers can be furnished with a special section for tuning the oscillator.

Available in any quantity at moderate prices.

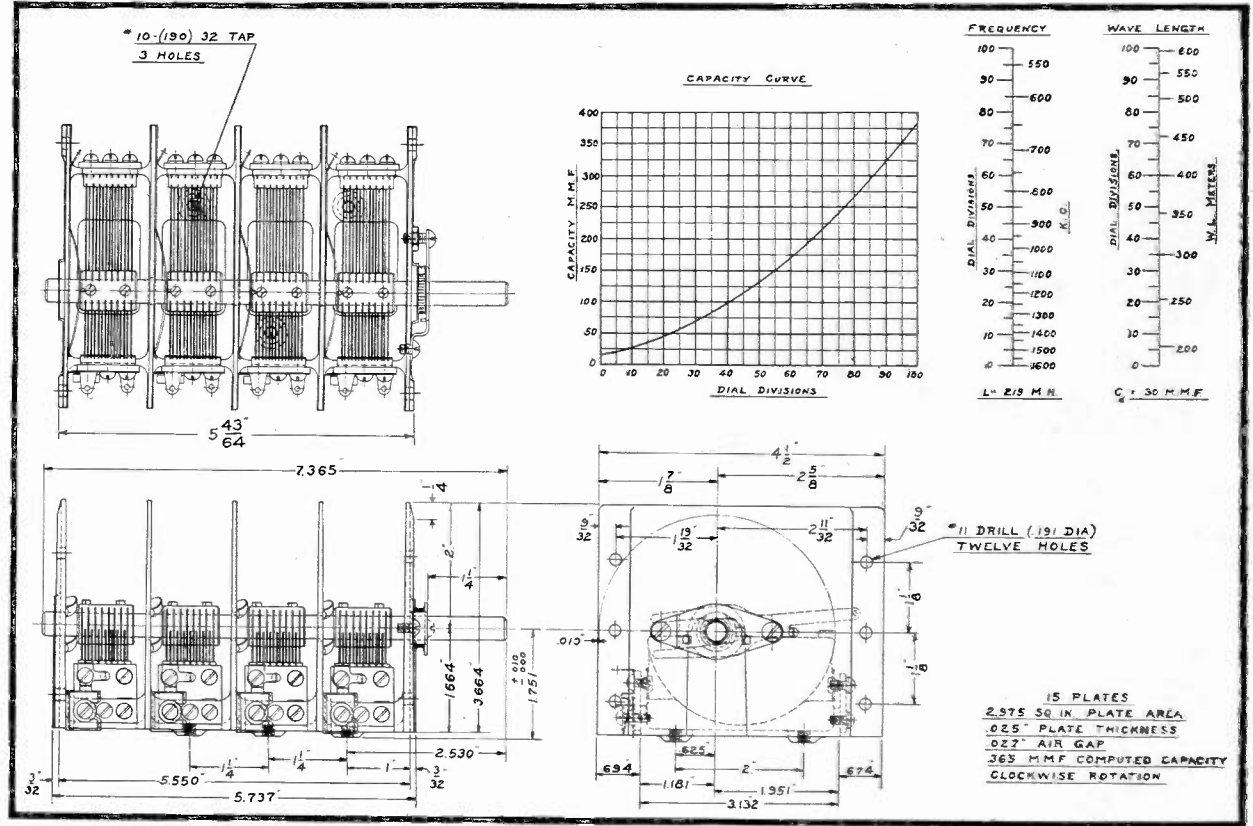

Scovill



SCOVILL MANUFACTURING COMPANY
WATERBURY CONNECTICUT

New York, Philadelphia, Boston, Providence, Chicago, Detroit, Akron, Cincinnati, Atlanta, San Francisco, Los Angeles. In Europe: The Hague, Holland.



The ability to adapt one's product to the ever changing trends of design is a real consideration

when the manufacturer in the radio industry is selecting his source of supply for coils.

Inca's position is unique. With the latest equipment in the industry; with an experience that only pioneers can acquire; with research and engineering facilities second to none . . . Inca is leading, not merely following the progress of the radio industry . . . particularly wherever a coil is involved.

Each change in radio design finds Inca prepared. Each change finds Inca's customers secure from the uncertainty of unauthoritative or obsolete coil design.

Inca enameled wire makes well designed coils still better . . . because no coil can be better than the wire in its windings.

INCA

MANUFACTURING DIVISION



Eastern Office: 233 Broadway, New York, N. Y.
Western Office: 1547 Venice Blvd., Los Angeles, Calif.

of NATIONAL ELECTRIC PRODUCTS CORPORATION
 FORT WAYNE, INDIANA

When writing to advertisers mention of the PROCEEDINGS will be mutually helpful.

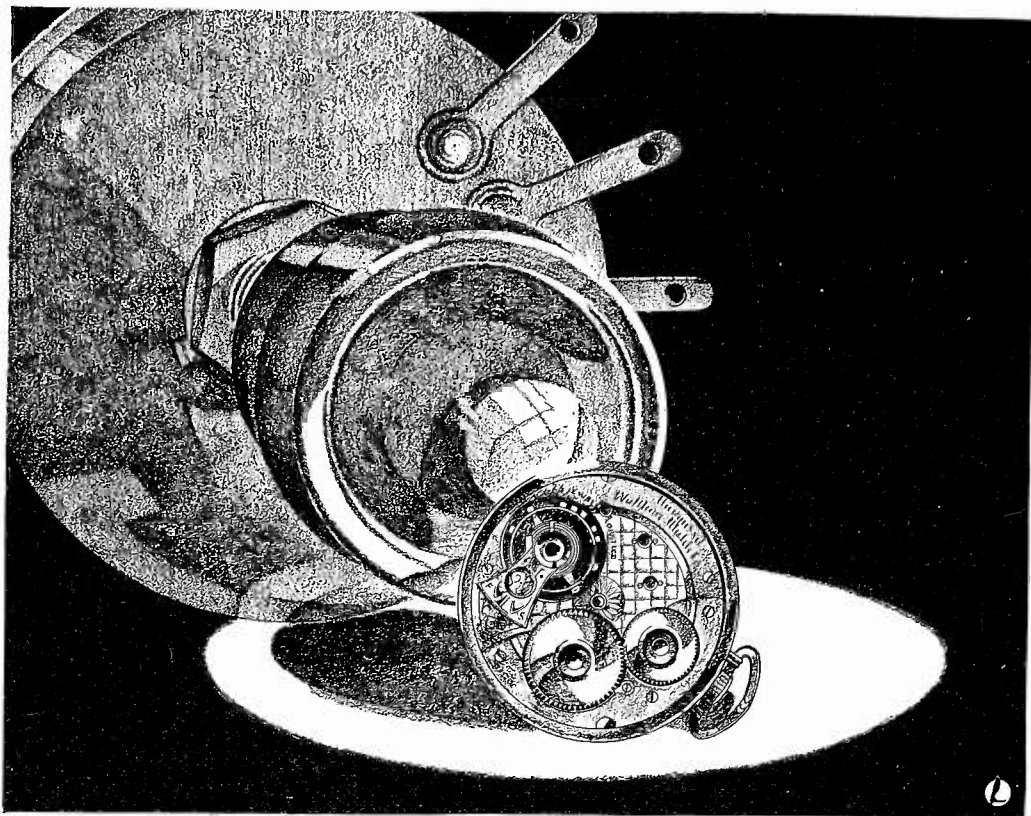

21 JEWEL DEPENDABILITY

Accuracy in construction makes for accuracy in performance. The watch-like precision so characteristic of the CENTRALAB Volume Control is reflected in its smooth, noiseless, ACCURATE performance. Just as satisfactory service in a watch is the result of the perfection of its many parts . . . radio performance is no less dependent upon the accuracy of its component units.

That more than twenty million radio receivers have been CENTRALAB equipped is a splendid testimonial to the watch-like precision with which it is built.

The New CENTRALAB

Volume Control with Off and On Switch

More convenient than when mounted separately. Saves space, saves assembly cost, saves in first cost. Engineers: send your volume control specifications for sample.

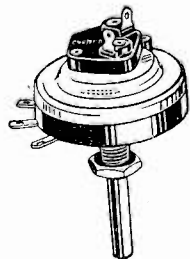

Centralab

Volume Controls

CENTRAL RADIO LABORATORIES—MILWAUKEE, WIS.

When writing to advertisers mention of the PROCEEDINGS will be mutually helpful.

EMPLOYMENT PAGE

Advertisements on this page are available to members of the Institute of Radio Engineers and to manufacturing concerns who wish to secure trained men for positions. For rates and further information address the Advertising Department, The Institute of Radio Engineers, 33 West 39th Street, New York City, New York.

MANUFACTURERS and others seeking radio engineers are invited to address replies to these advertisements at the Box Number indicated, care the Institute of Radio Engineers. All replies will be forwarded direct to the advertiser.

COLLEGE GRADUATE, having one year experience in planning and writing specifications for new telephone exchanges, and three years' experience in the design and operation of high power equipment for high frequency radio telegraph communication system, desires position with radio concern where an opportunity will be provided for doing design, manufacturing or technical sales work. Has operator's license. Single. Will travel. B.Sc. in E.E., 1927. Age 25. Box 61.

COLLEGE GRADUATE is interested in position offering opportunity to do design and construction on television or carrier current systems. Experience includes two and one-half years' sales work on fabricated steel, two years' radio sales and sales promotion, one year radio test work, two years' research and two years' work on theater sound equipment. C.E., 1922. Age 33. Box 62.

COLLEGE GRADUATE AVAILABLE, with experience in radio sales and service, design and construction of service equipment, and construction of public address and talking picture systems. B.A., 1928. Age 23. Box 63.

ENGINEER with six and one-half years' experience in responsible positions desires work preferably in audio frequency field. Has had two and one-half years as chief engineer in manufacturing superheterodyne receivers, two and one-half years as chief engineer and assistant manager of concern manufacturing small transformers and chokes, and one-half year in full charge of engineering and production of resistance and special alloy wires. Immediate position secondary in importance to opportunity. Prefer work in Chicago district but will travel. Salary to be based on opportunity and responsibilities. Married. B.S. in E.E., 1925. Age 34. Box 59.

COLLEGE GRADUATE, having several years' experience with design of public address and centralized radio systems and talking picture equipment desires position with opportunity for doing design, development and research in audio systems or on radio equipment. Now employed. Age 25. Box 54.

COLLEGE GRADUATE with one year of post graduate work in physics and mathematics desires position in the radio field where present education and experience can be most completely utilized. Studied electrical engineering at Johns Hopkins University graduating with degree of B.E. in E.E. in 1930. During past year has studied advanced mathematics and physics especially as applied to problems of radio communication at Hopkins. Immediately available. Age 23. Box 64.

YOUNG MAN, available for design of amplifiers and amplifier test equipment. Past ten years spent in design and test of radio frequency amplifiers and receivers. Education includes four year high school course and electrical theory during two summer sessions at university. Age 30. Box 65.

When writing to advertisers mention of the PROCEEDINGS will be mutually helpful.

YOUR NEW PROBLEM . . . *and* ITS SOLUTION!

WITH home recording promising to be an outstanding feature of next year's radio receivers, the problem of HUM is more serious than ever.

Even a slight hum not noticeable in radio reproduction will, when recorded and augmented through reproduction, make itself heard with sufficient volume to prove disagreeable. In this modern day of radio, hum is not to be tolerated in radio or phonograph reproduction.

For more than twenty years, Pacent engineers have concerned themselves exclusively with problems relating to sound amplification. That's why Pacent amplifiers are the best in the field today.

A standard two stage Pacent Amplifier, Cat. No. 2245M (without input transformer) employing one 227 and two 245's in push-pull has a hum level of 23 DB below its maximum output rating. This same amplifier will provide 4.3 watts undistorted power output and has a voltage gain at 1000 cycles of 31 DB with 3.8 volts input. These figures are not theoretical calculations. They are the result of actual measurements made with a stock amplifier.

A Pacent Amplifier, the 170 Recordovox and the 107 Hi-Output Phonovox make a remarkable combination for recording and reproducing. With this apparatus, it is possible to assure professional results.

The Recordovox and Phonovox are available in special manufacturers' types. Write for additional information.

PACENT ELECTRIC COMPANY, INC.
91 SEVENTH AVE., NEW YORK, N. Y.

Pioneers in Radio and Electric Reproduction for over 20 Years.
Licensee for Canada: White Radio, Ltd., Hamilton, Ont.

PACENT

When writing to advertisers mention of the PROCEEDINGS will be mutually helpful.

"I'm Smaller than other fellows----

But I do a MAN-SIZED JOB!"

"I'VE been through an awful lot in the past few months. I've been tested and rebuilt and tested again until I'm tired of looking at Elkon engineers. . . . Just as I began to think I was perfect, they sent me out to a lot of other places where I was put through my paces again and again . . . Rather rough going for a long while but I guess it was all for the best because I know now that I'm ready to start out on my own . . . Thank heavens that I won't have to go back to those Elkon engineers again,—they're the testingest bunch I've ever met."

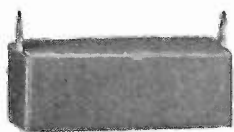

Small size and efficient operation are the outstanding characteristics of the Elkon Audio By-pass Condensers. They are covered with the same type of sturdy, wax-dipped cardboard carton which is being used so successfully on the standard Elkon Filter Condensers.

The following sizes can be supplied.

Capacity	Size	Voltage
1/4 mfd	1/2 x 1/2 x 2	450
1/2 mfd	1/2 x 1/2 x 2	450
1 mfd	3/4 x 3/4 x 2	450
2 mfd	1 x 1 x 2	450
1/2 mfd	1/2 x 1/2 x 2	up to 150
1 mfd	1/2 x 1/2 x 2	up to 150
2 mfd	3/4 x 3/4 x 2	up to 150
4 mfd	1 x 1 x 2	up to 150
8 mfd	1 x 1 x 2	up to 150



A special mounting band for fastening condensers to the chassis can be supplied if desired.



That's his story—and he sticks to it! For our part we're rather proud of the job. The Elkon Audio By-pass Condensers are small, compact, efficient and economical,—with a life-expectancy in excess of the usual set requirements. That's just about the full line-up for an ideal audio by-pass condenser!

Samples will be sent upon request to all recognized manufacturers.

ELKON DIVISION

P. R. Mallory & Co., Incorporated
Indianapolis, Ind.

ELKON BY-PASS AUDIO CONDENSERS

When writing to advertisers mention of the PROCEEDINGS will be mutually helpful.

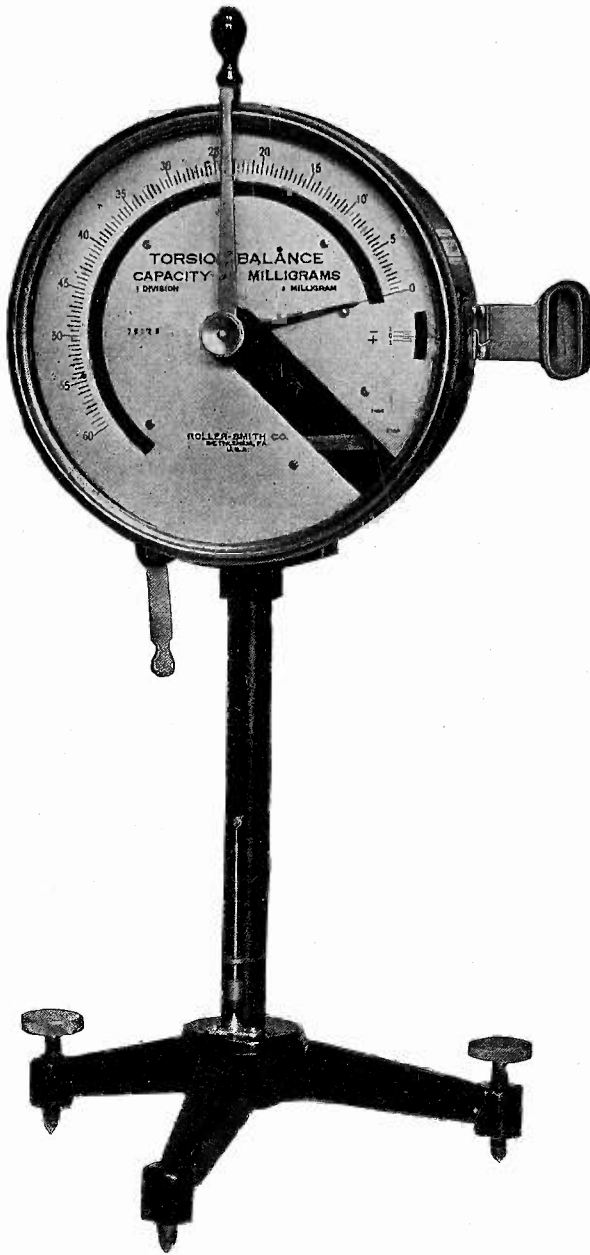

Gram and Milligram Balances

These balances are made in ranges from 0-3 milligrams to 0-50 grams. They are recommended for the weighing of lamp filaments and filament coatings and other masses within their range.

They are direct reading, have scales 10" long and are accurate within one-fifth of one per cent of full scale value at any point on the scale.

Suitable check weights and accessories are available.

Send for new Bulletin No. K-240, which gives all details.

Forty years' instrument experience is back of

ROLLER-SMITH COMPANY

Electrical Measuring and Protective Apparatus

Main Office:
2134 Woolworth Bldg.
NEW YORK



Works:
Bethlehem,
Pennsylvania

Offices in principal cities in U. S. A. and Canada

When writing to advertisers mention of the PROCEEDINGS will be mutually helpful.

OVER

4,000,000

IN USE



IF YOU would build radios forever free from condenser troubles, specify puncture-proof Mershons. For only Mershons embody twenty years' experience in electrolytic condenser development. Only Mershons have stood the test of ten years' service in radio—a far, far longer period than any other electrolytic condenser has been on the market. That is why the great majority of better radios built today are equipped with Mershon Electrolytic Condensers. *Mershons are a proven product, incorporating many exclusive features.* They are available in a wide range of capacities to suit the requirements of every make of radio.

Magnavox Company Ltd.

Executive and Sales Offices: 155 East Ohio St.,
Chicago, Ill.

Factories: Fort Wayne, Ind.
SUBSIDIARIES
The Magnavox Co.
Electro Formation,
Inc.

SUBSIDIARIES
Magnavox (Great
Britain) Ltd.
Magnavox (Australia)
Ltd.

M E R S H O N

ELECTROLYTIC CONDENSERS

SEE THE NEW MERSHONS, AND THE NEW MAGNAVOX SYMPHONIC SPEAKER, AT THE R. M. A. TRADE SHOW AND THE I. R. E. CONVENTION

When writing to advertisers mention of the PROCEEDINGS will be mutually helpful.

Piezo Electric Crystals

"Superior by Comparison"



When in the market for Accurately Ground Piezo Electric Crystals suitable for POWER USE, write us stating your requirements and our *seven years* of experience in this specialized field will be at your disposal.

Our prices for grinding these crystals are not the cheapest, but we believe our product to be *second to none* considering output and accuracy of frequency.



"A Trial Will Convince You"



Scientific Radio Service

"The Crystal Specialists"

P.O. Box 86

Mount Rainier, Maryland

PROFESSIONAL ENGINEERING DIRECTORY

For Consultants in Radio and Allied Engineering Fields

ELECTRICAL TESTING LABORATORIES

Tests of Inductances.
Condensers. Transform-
ers etc. Life and charac-
teristics of Radio Tubes

80th. Street and East End Ave.
• • NEW YORK, N. Y. • •

For EXPORT of Material Manufactured
by:

American Transformer Co.
Allen D. Cardwell Mfg. Co.
Corning Glass Works
Dubilier Condenser Corp.
P. R. Mallory
Radio Engineering Labs.
Universal Microphone Co., Ltd.
Ward Leonard Electric Co.
Weston Elec. Inst. Co.

Apply to

AD. AURIEMA, INCORPORATED
116 Broad St.
New York City, N. Y.

JENKINS & ADAIR, INC. *Engineers*

Designers and manufacturers of appa-
ratus essential to broadcasting, sound re-
cording and sound measurement work.

3333 Belmont Ave., Chicago, U.S.A.
Cable Address: *Jenkadair*
Telephones: Keystone 2130

The J. G. White Engineering Corporation

Engineers—Constructors

*Builders of New York Radio
Central*

43 Exchange Place New York

BEN J. CHROMY

Attorney at Law

Patents and Patent Causes

National Press Bldg.

WASHINGTON, D.C.

"Radio Patent Service"

Weekly

R. H. RANGER

Consulting Engineer

Radio and Allied Problems
Development of Special Processes
Using High Frequencies

574 Parker St. NEWARK, N. J.

I. R. E. Members

You will find that the 8,000 active, influential radio men who read the monthly PROCEEDINGS I.R.E. will help you increase your business—if you let them know of your services. For detailed yearly, quarterly, and single insertion rates on this Professional Engineering Directory, write to:

Advertising Department

Institute of Radio Engineers
33 West 39th St., New York, N. Y.

When writing to advertisers mention of the PROCEEDINGS will be mutually helpful.

Alphabetical Index to Advertisements

A

Aerovox Wireless Corp.....LIX
Allen-Bradley Co.XXXVIII
American Tel. & Tel. Co.XIV
American Transformer Co. ...XXXVI
Arcturus Radio Tube Co.XXX

C

Cardwell, Allen D. Mfg. Corp..XXXIX
Central Radio LaboratoriesL
Chicago Transformer Corp.
.....Inside Back Cover
Condenser Corp. of AmericaXXI
Continental Carbon, Inc.XXIV
Cornell Electric Mfg. Co.XIII
Cornish Wire Co., Inc.XVIII

D

DeForest Radio Co.XV
DeJur-Amsco Corp.XX
Dubilier Condenser Corp.XXIII

E

Electrad, Inc.XIX
Electric Specialty Co.XXXV
Employment PageLI

F

Fansteel Products Co., Inc.XII
Formica Insulation Co.XVII
Frost, H. H., Inc.XL

G

General Cable Corp.XLI
General Industries Co.XXXI
General Radio Co..Outside Back Cover
Gilby Wire Co.LX

H

Hammarlund Mfg. Co.....LXI

I

Inca Mfg. Co.XLIX
International Resistance Co.XI
I.R.E.XXXIII, XXXIV,
XLIII, XLIV
Isolantite Inc.XXVI, XXVII

M

Magnavox Co., Ltd.LV
Mallory, P. R. & Co. Inc. ..XXV, LIII

N

National Vulcanized Fibre Co. ..XVI

P

Pacent Electric Co., Inc.LII
Polymet Mfg. Co.XXVIII
Professional Eng. DirectoryLVII

R

RCA Victor Co., Inc.XLII
Radio Engineering Labs.XLV
Roller-Smith Co.LIV

S

Scientific Radio ServiceLVI
Scovill Mfg. Co.XLVIII
Shallcross Mfg. Co.XLVII
Sprague Specialties Co.XLVI
Stenode Corp.XXIX, XXXVII
Stupakoff Labs., Inc.XXXII

T

Thordarson Elec. Mfg. Co.XXII

W

Weston Elec. Instrument Corp. ..LXII

When writing to advertisers mention of the PROCEEDINGS will be mutually helpful.

AEROVOX

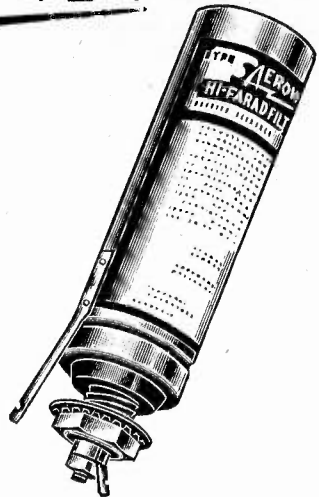
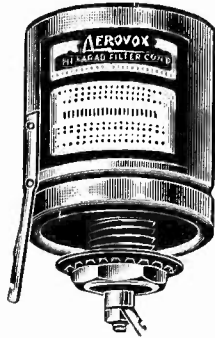
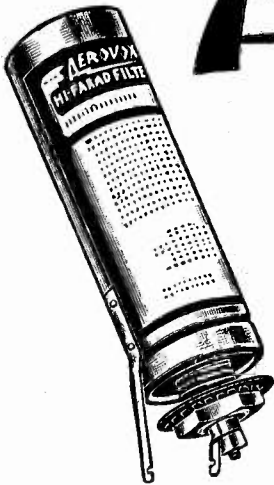

The Most Complete Line of Screw Mounting DRY Electrolytic Condensers in the Radio and Electrical Industries

Available in a wide variety of sizes, capacities, voltage characteristics and mounting features. These units are Dry, Low in Cost per Microfarad per Volt Rating, Low in Leakage, Compact, Light in Weight, Safe, Surge-Proof, Self-Healing, and provide Long Life, Stable Operation and High Filtering Efficiency. They may be mounted in any position—Upright, Inverted, Horizontal or at any other angle.

Compact, Efficient and Reliable Condensers for Many Purposes



Type 1465

A new extra small size mica condenser available in capacities up to .0005 mfd., rated at 500 d.c. volts retest voltage and 250 d.c. working voltage. Especially adapted for use in very small spaces.



Type 1120

A heat resisting, leakproof condenser especially adapted for use in automobile radios and other applications where high temperatures are encountered.



Type 280

A compact condenser made to meet manufacturers' requirements for an all-around efficient, high quality and low cost condenser. These units are hermetically sealed in special tubes and provided with wire leads.

Free!

A copy of a 32-page book, containing a wealth of information on all types of electrolytic condensers will be sent free of charge on request. Just mail the coupon below.

Write for our new 40-page 1931 Condenser and Resistor Manual and Catalog. Also, the AeroVox Research Worker sent free upon request.

AeroVox Wireless Corporation
80 Washington Street
Brooklyn, N. Y.

Please send me, without charge or obligation, a copy of your book, "The Hi-Farad DRY Electrolytic Condenser."

Name

Address

City..... State.....



70 WASHINGTON ST.
BROOKLYN, N. Y.



When writing to advertisers mention of the PROCEEDINGS will be mutually helpful.

GILBY — A DEPENDABLE SOURCE

FOR TUBE MATERIALS

AND ELECTRICAL RESISTANCE ALLOY PRODUCTS

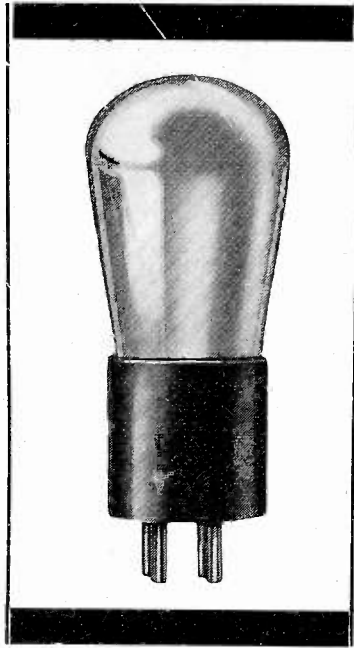

FILAMENT. Our Engineering & Production Departments in strict co-operation with developments and accomplishments, have won the confidence of the Radio Tube Industry for supply of Radio Tube Filaments. This was brought about by absolute control of material, by successfully meeting rigid specifications, and by duplicating laboratory developments in actual production.

GRID PLATE AND OTHER MATERIALS. GILBY WIRE COMPANY can supply pure nickel and various alloys for the correct working of these parts. GILGRID #40, which is a new grid wire, is the latest development for the improved grid.

MESH. GILBY SELVAGE MESH and plain mesh are long time standards.

CARBONIZED NICKEL. GILBY WIRE COMPANY has been a reliable source for uniform and improved carbonized nickel sheet

and mesh. We will cooperate with your Engineering Department in developing the proper carbonized material for your product.

RESISTANCE MATERIALS. As in Radio products, GILBY WIRE COMPANY'S Engineering & Production Departments have accomplished real things in the improve-

ment of resistance materials in nickel-chrome, copper-nickel and allied materials.

ENGINEERING DEPARTMENT. GILBY WIRE COMPANY'S Engineering Department is our contribution to the industry in that we are developing new products, improving processes continuously in order to meet requirements of the Radio and Electrical industries in these days of over night demand for new and better materials. Our methods conform to most rigid specifications, thereby cutting down shrinkage, so essential in the present business world. Specify GILBY products, and your production costs will be reduced.

GILBY WIRE COMPANY

Wilbur B. Driver, President

NEWARK, NEW JERSEY

MANUFACTURERS OF

Filament—Grid Materials—Plate Materials—Nickel Wire & Sheet
—Nickel Mesh—plain and selvage—Carbonized Nickel Sheet &
Mesh—Nickel Chrome Alloys—Nickel Copper Alloys—Manganin
These materials in wire and sheet form covered with cotton, silk
and enamel.

When writing to advertisers mention of the PROCEEDINGS will be mutually helpful.

3 ranges

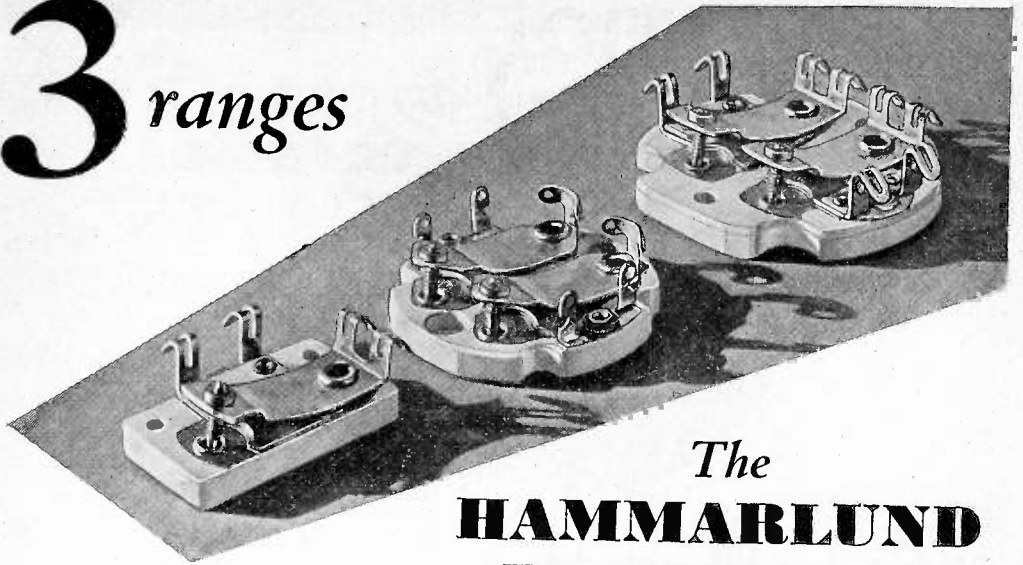

Proved!

The **HAMMARLUND** **INTERMEDIATE** **TUNING CONDENSER**

WHY experiment with the unknown when Hammarlund can supply you with Condensers of *proved* efficiency!

Here are the features which appeal to the many large manufacturers who are standardizing on this Hammarlund Condenser.

Constant capacity and power factor under all conditions of temperature and humidity. Not affected by vibration.

Specially conditioned Isolantite base will not absorb moisture. Selected mica of much higher quality than many manufacturers consider good enough. Practically straight-line capacity curve, affording minute adjustment. Cut thread adjusting screws, with tapered self-aligning heads. Solder-dipped heat dissipating terminals. All material and processes strictly controlled. Individually inspected for capacity, power and 300 V A.C. breakdown.

Three capacity ranges—10 to 70 mmf.—70 to 140 mmf.—140 to 220 mmf. Singles and duals for 2" and 2½" shields.

About 2,000,000 Condensers of this type are now in use. You too, should know more about them.

*Mail Coupon for
Samples and Prices*

For Better Radio
Hammarlund
PRECISION
PRODUCTS

HAMMARLUND MANUFACTURING CO.
424-438 W. 33rd St., New York
Please send us samples of your new Intermediate
Frequency Transformer Tuning Condensers
and quotations.
Name
Address

PE-6

When writing to advertisers mention of the PROCEEDINGS will be mutually helpful.

MODULATION METER

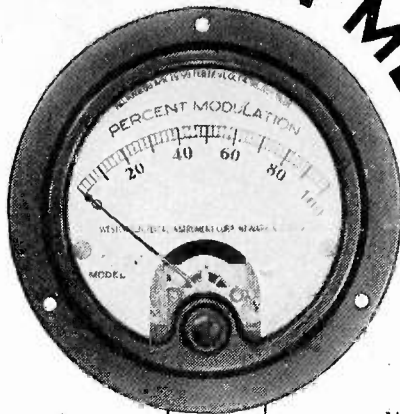

for direct reading in percent of full modulation

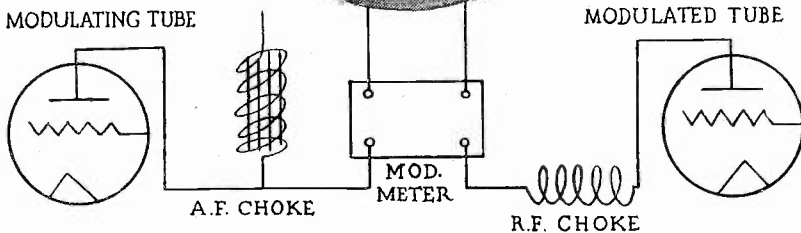

This new Modulation Meter, Weston Model 588, involving an improved advanced construction, gives a continuous indication of the percentage of modulation. This is extremely valuable to broadcasting stations and amateurs in transmission of speech and music, as it furnishes a simple means to indicate continuously the effectiveness of station output.

Model 588 is an instrument of the rectifier type. Its scale is calibrated in percent of full modulation of the transmitter. It consists of a meter and an external box with four binding

posts. Two of these binding posts are connected in the plate circuit of the modulated tube and the other two to the instrument which may be placed at any convenient location. The circuit of the external box is so arranged that no direct current passes through the meter.

When ordering, specify the amplitude of the carrier wave or, if this is not known and cannot be measured, specify the known D. C. plate current of the modulated tube in your transmitter. This value is necessary to accurately adjust the instrument to your operating condition.

WESTON ELECTRICAL INSTRUMENT CORPORATION
 589 Frelinghuysen Avenue, Newark, N. J.

WESTON ELECTRICAL INST. CORP.,
 589 Frelinghuysen Avenue,
 Newark, N. J.

Please send further details regarding the new Weston Modulation Meter, Model 588.

Name Station.....

Street

City State.....

When writing to advertisers mention of the PROCEEDINGS will be mutually helpful.

From Transformer Headquarters



Here are Facilities for Exceptional Service
Any Transformer • Any Quantity • Any Delivery

Cores

The C. T. C. range of core-sizes makes it easy to fill any special transformer order from our stock of standard laminations. The C. T. C. tool room makes dies for any special core. Immediate production on any transformer order is thereby assured.

Coils

Prompt service is a simple matter because the C. T. C. coil winding department is fully equipped with the latest high speed coil winding machinery. Any arrangement of taps, turns, shielding or insulation is handled without delay. Let us quote on your next order.

Mountings

Exceptional flexibility is a big feature of C. T. C. design. A wide assortment of mountings used interchangeably on C. T. C. cores provides transformers that meet special needs at standard prices. Every C. T. C. transformer part is made in our own plant for quick service.

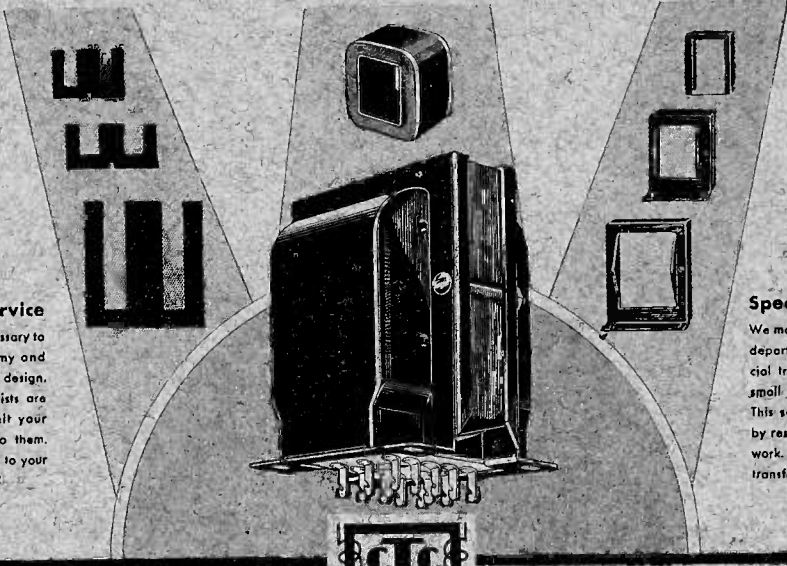

Engineering Service

Long experience is necessary to obtain highest economy and efficiency in transformer design. Our transformer specialists are at your service. Submit your transformer problems to them. A C. T. C. design, suited to your needs, will be submitted.

Special Transformers

We maintain a special assembly department to manufacture special transformers on orders too small for quantity production. This service is used extensively by research laboratories in their work. Do you need a special transformer? Let us quote you.



CHICAGO TRANSFORMERS

CHICAGO TRANSFORMER CORP., 2622 WASHINGTON BLVD., CHICAGO, U. S. A.

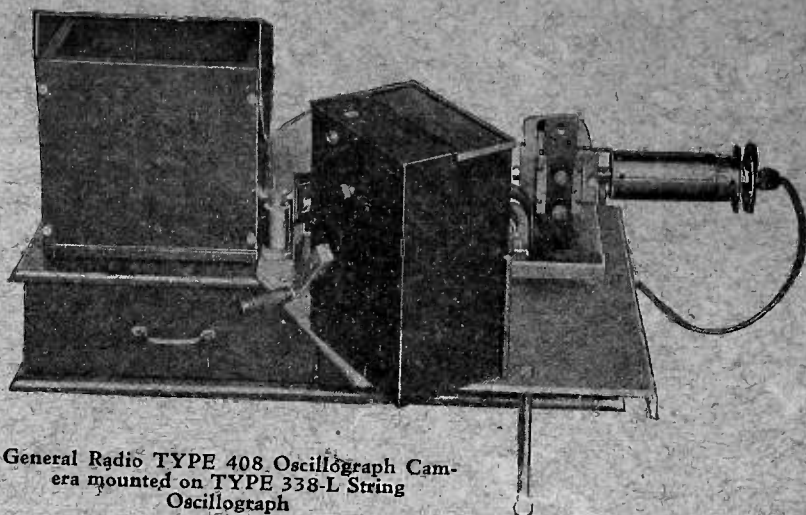

General Radio TYPE 408 Oscillograph Camera mounted on TYPE 338-L String Oscillograph

A STRING OSCILLOGRAPH AND RECORDING CAMERA

For a number of years we have been manufacturing a string-type oscillograph for viewing the shape of recurring wave patterns. We are pleased to announce that development has been completed on a continuous-film camera attachment by means of which transient phenomena may be recorded.

The camera uses standard 35-mm. motion-picture film or paper, which may be loaded in daylight. Film speeds up to 30 inches per second can be attained. A synchronous-motor-driven shutter operated from the 60-cps. line marks the film every $1/50$ th second.

The price of the camera attachment is \$269.25 complete.

Further details will be supplied on request.

Ask for Catalog F-R5.

GENERAL RADIO COMPANY
OFFICES :: LABORATORIES :: FACTORY
CAMBRIDGE A, MASSACHUSETTS