

Proceedings



of the I·R·E

A Journal of Communications and Electronic Engineering
(Including the WAVES AND ELECTRONS Section)

A.S.T.
April, 1948

Volume 36

Number 4

PROCEEDINGS OF THE I.R.E.

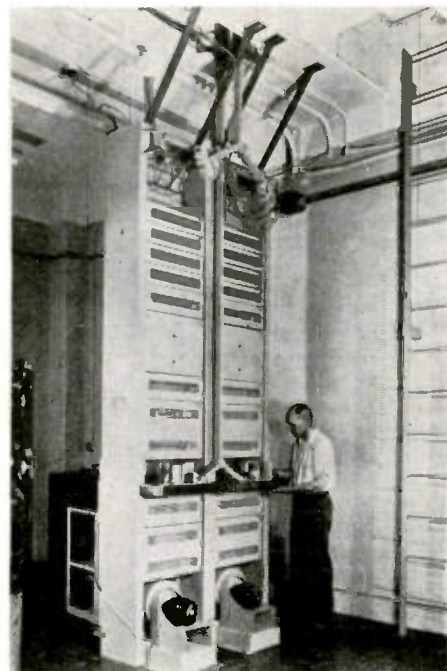
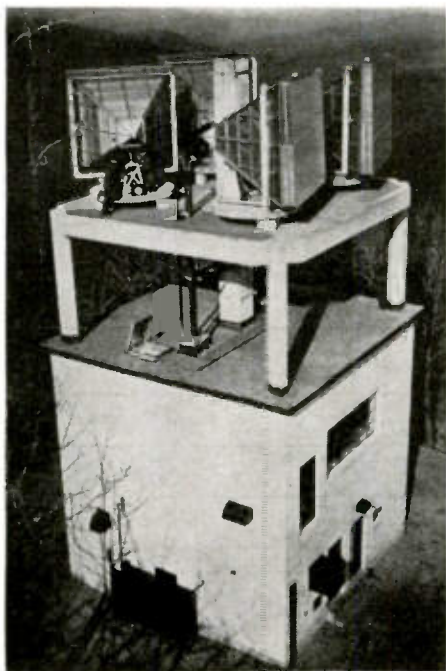

Bell Telephone Laboratories

MICROWAVE RADIO-RELAY STATION

The shielded-lens antennas at the Jackie Jones Mountain, N.Y., station on the New York-Boston radio-relay system, face the Long Lines Building in New York City; the other two antennas are directed toward the Birch Hill, N.Y. station, 35 miles away. The station equipment is shown in the right-hand illustration.

PROCEEDINGS OF THE I.R.E.

Noise-Suppression Characteristics of Pulse-Time Modulation

Magnetoionic Multiple Refraction at High Latitudes

Solar Noise Observations on 10.7 Cm.

Distortion Analysis by the Intermodulation Method

A.V.C. as a Feedback Problem

Flat-Response Single-Tuned I.F. Amplifier

Radiation Resistance of Antenna in Infinite Array or Waveguide

Coupled Antennas

Waves and Electrons Section

Engineering Responsibilities in Today's Economy

Industrial Standards

Radio Progress During 1947

The Duct Capacitor

Abstracts and References

TABLE OF CONTENTS FOLLOWS PAGE 32A

The Institute of Radio Engineers



COMMERCIAL GRADE COMPONENTS

A wide range of units for every application

U.T.C. Commercial Grade components employ rugged, drawn steel cases for units from 1" diameter to 300 VA rating . . . vertical mounting, permanent mold, aluminum castings for power components up to 15 KVA. Units are conservatively designed . . . vacuum impregnated . . . sealed with special sealing compound to insure dependability under continuous commercial service.

A few of the large number of standard C.G. units are described below. In addition to catalogued units, special C.G. units are supplied to customer's specifications.

CG VARIMATCH OUTPUTS FOR P. A.

Universal units designed to match any tubes within the rated output power, to line or voice coil. Output impedance 500, 200, 50, 16, 8, 5, 3, 1.5 ohms. Primary impedance 3000, 5000, 6000, 7000, 8000, 10,000, 14,000 ohms.

Type No.	Audio Watts	Typical Tubes	List Price
CVP-1	12	42, 43, 45, 47, 2A3, 6A6, 6F6, 25L6	\$ 9.00
CVP-2	30	42, 45, 2A3, 6L6, 6V6, 6X5	14.00
CVP-3	60	46's, 50's, 300A's, 6L6's, 801, 807	20.00
CVP-4	125	800's, 801's, 807's, 4-6L6's, 845's	29.00
CVP-5	300	211, 242A's, 203A's, 838's, 4-845's, ZB-120's	50.00

CG VARIMATCH LINE TO VOICE COIL TRANSFORMERS

The UTC VARIMATCH line to voice coil transformers will match any voice coil or group of voice coils to a 500 ohm line. More than 50 voice coil combinations can be obtained, as follows:

.2, .4, .5, .62, 1, 1.25, 1.5, 2, 2.5, 3, 3.3, 3.8, 4, 4.5, 5, 5.5, 6, 6.25, 6.6, 7, 7.5, 8, 9, 10, 11, 12, 14, 15, 16, 18, 20, 25, 28, 30, 31, 40, 47, 50, 63, 69, 75.

Type No.	Audio Watts	Primary Impedance	Secondary Impedance	List Price
CVL-1	15	500 ohms	.2 to 75 ohms	\$ 8.00
CVL-2	40	500 ohms	.2 to 75 ohms	11.50
CVL-3	75	500 ohms	.2 to 75 ohms	17.50

CG VARIMATCH MODULATION UNITS

Will match any modulator tubes to any RF load.
Primary impedances from 500 to 20,000 ohms
Secondary impedances from 30,000 to 300 ohms

Type No.	Max. Audio Watts	Max. Class C Input	Typical Modulator Tubes	List Price
CVM-0	12	25	30, 49, 79, 6A6, 53, 2A3, 6B5	\$ 8.50
CVM-1	30	60	6V6, 6B5, 2A3, 42, 46, 6L6, 210	14.00
CVM-2	60	125	801, 6L6, 809, 4-46, T-20, 1608	20.50
CVM-3	125	250	800, 807, 845, TZ-20, RK-30, 35-T	30.00
CVM-4	300	600	50-T, 203A, 805, 838, T-55, ZB-120	50.00
CVM-5	600	1200	805, HF-300, 204A, HK-354, 250TH	115.00

INPUT, INTERSTAGE, MIXING AND LOW LEVEL OUTPUT TRANSFORMERS

(200 ohm windings are balanced and can be used for 250 ohms)

CG Type No.	Application	Primary Impedance Ohms	Secondary Impedance Ohms	Ratio	List Price
131	1 plate to 1 grid	15,000	135,000	3:1 ratio	\$ 9.50
132	1 plate to 2 grids	15,000	135,000	reterapped 3:1 ratio overall	10.00
133	2 plates to 2 grids	30,000 P to P	80,000 overall	1.6:1 ratio overall	12.50
134	Line to 1 grid hum-bucking	50, 200, 500	80,000		12.50
135	Line to 2 grids hum-bucking	50, 200, 500	120,000 overall		13.50
235	Line to 1 or 2 grids, hum-bucking; multiple alloy shielded for low hum pickup	50, 200, 500 ohms	80,000 overall		17.50
136	Single plate and low impedance mike or line to 1 or 2 grids Hum-bucking	15,000, 50, 200	80,000 overall		13.50
233	PP 6C5, 56, similar triodes to AB 45's, 2A3's, 6L6's, etc.	30,000 P to P	25,000 overall	9:1 ratio overall	11.00
333	PP 6C5, 56, similar triodes to fixed bias 6L6's	30,000 P to P	7,500 overall	3:1 ratio overall	11.00
433	PP 45, 2A3, similar tubes to fixed bias 2 or 4 6L6's	5,000 P to P	1,250 overall	5:1 ratio overall	12.00
137	Mixing	50, 200, 500	50, 200, 500		10.00
140	Triode plate to line	15,000	50, 200, 500		12.00
141	PP triode plates to line	15,000	50, 200, 500		13.50

United Transformer Corp.
150 VARICK STREET NEW YORK 13, N. Y.

EXPORT DIVISION: 13 EAST 40th STREET, NEW YORK 16, N. Y., CABLES: "ARLAB"

For full details on this line, write for Catalog PS-408.

For Quality and Performance

BURNELL offers

High Q

TOROIDAL COILS

The solution of filter network problems, has been greatly simplified through the use of toroidal coils wound on molybdenum permalloy cores. Design engineers have learned to depend upon them since discovering that only these toroids possess all the necessary qualities of a good high "Q" coil.



The most available types now being supplied are

TYPE	IND. RANGE
TC-1	Any Ind. up to 7 HYS
TC-2	Any Ind. up to 20 HYS
TC-3	Any Ind. up to 350 MHYS

Be sure to state desired inductance.

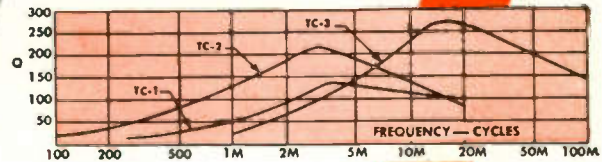

TOROIDAL COIL FILTERS



Our toroid filters have become a by-word in every phase of electronics where only the best results are acceptable. Toroidal coils wound on **MOLYBDENUM PERMALLOY DUST CORES** are the primary basis for our success in producing filters unexcelled in performance. We are producing toroidal coil filters which consistently demonstrate the value of toroidal coils. These filters cannot be matched in stability, accuracy and sharpness by filters made with the usual laminated type of coil.

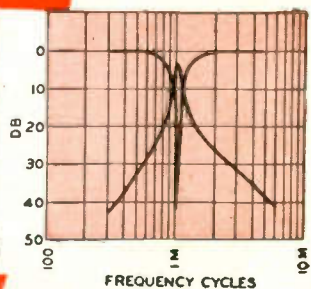
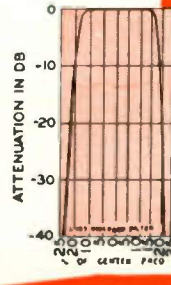
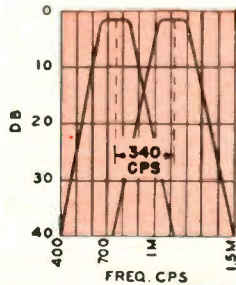

Burnell & Company

DESIGNERS AND MANUFACTURERS OF ELECTRONIC PRODUCTS

45 WARBURTON AVE., YONKERS 2, N. Y.

CABLE ADDRESS "BURNELL"

ALL INQUIRIES WILL BE PROMPTLY HANDLED
WRITE FOR OUR CATALOGUE

THIS IS THE REPRODUCER OF THE FIRST ORTHOPHONIC PHONOGRAPH

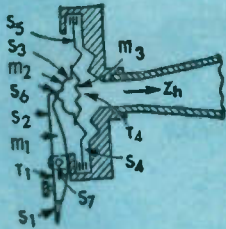

When the Orthophonic phonograph, developed in Bell Telephone Laboratories, was introduced in 1925, it represented an outstanding advance over previous acoustical types. Even more important to the progress in mechanical-acoustical and electro-acoustical systems, it represented the practical application of a basically new design tool—the equivalent circuit.

THIS IS THE SAME REPRODUCER WITH ITS MECHANICAL PARTS REPRESENTED BY ELECTRICAL COMPONENTS

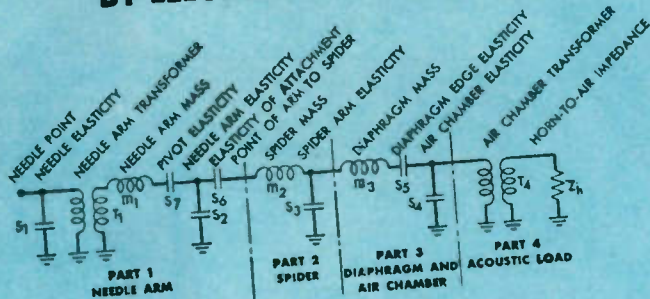

Instead of time-consuming cut-and-try methods—involving experiments with mechanical parts of different sizes and shapes—Bell engineers tackled the design of the Orthophonic phonograph by representing each of its mechanical parts by an electrical equivalent.

The effect of changing the mechanical specifications of any part of the phonograph could be predicted simply by changing the value of the corresponding electrical component, in accordance with the mathematics of electrical networks.

THIS IS THE CONCEPT OF THE "EQUIVALENT CIRCUIT"

An equivalent circuit is an electrical system in which each part is equivalent to a part in the corresponding mechanical system. The reaction of such an electrical system to electrical oscillations is identical to the reaction of the mechanical

system to mechanical vibrations. As a design tool, the equivalent circuit is particularly valuable in predicting performance of transducers, in which electrical energy is transformed into mechanical (and vice versa).

How

the equivalent circuit came into being

The close analogy between elements in electrical and vibrating mechanical systems has long been recognized. Inductance corresponds to mass; capacitance to elasticity; electrical resistance to mechanical resistance, etc.

But it remained for the engineers of Bell Telephone Laboratories to integrate these facts into a practical design tool—to recognize and utilize the equivalence, not merely between parts, but between systems.

Once the fundamental idea of the "equivalent circuit" was applied, it quickly proved its merits as a practical, effective tool of transducer design. Employed in the design of the revolutionary Orthophonic phonograph, the equivalent circuit technique later became a standard procedure in transducer design.

The concept of the equivalent circuit is one of the many advances originating in Bell Telephone Laboratories that have contributed materially to progress in communications equipment.



BELL TELEPHONE LABORATORIES

World's largest organization devoted exclusively to research and development in all phases of electrical communications.

Why

it means
better quality
in Western Electric
equipment

In designing Western Electric microphones, crystal filters and recording and reproducing equipment, Bell Laboratories applies its long experience and thorough knowledge in the use of equivalent circuits.

The results are twofold: *product designs* that mean greater dependability and improved performance, and *precise manufacturing information* that gives better control of quality during production.

The use of equivalent circuits is another example of the thorough research and careful manufacture which typify all Western Electric products—for radio broadcasting, radio communications, sound distribution and industrial uses.

— QUALITY COUNTS —

OTHER WESTERN ELECTRIC EQUIPMENT IN WHICH
THE EQUIVALENT CIRCUIT IS A USEFUL DESIGN TOOL



LOUDSPEAKERS

Finest in the Western Electric line is the dual-unit 757A—handling 30 watts, giving uniform response from 60 to 15,000 cycles, having a 90 degree coverage angle.

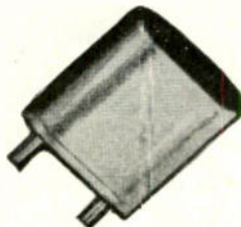

CRYSTALS

This new line of crystals for oscillator control ranges from 1.2 KC to 50 MC. All are engineered for improved accuracy and stability.

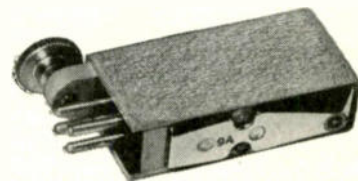

REPRODUCERS

The 9A, specially recommended for vertical cuts, and the 9B, used to best advantage on lateral cuts, have low distortion and provide maximum elimination of record noise.

THIS IS THE 639 MICROPHONE
IN EQUIVALENT CIRCUIT FORM

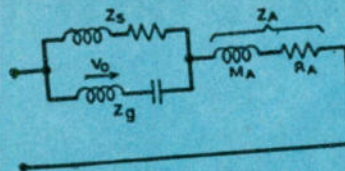

Electrical equivalent of ribbon type pressure gradient element

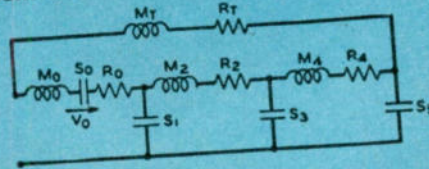

Electrical equivalent of diaphragm type pressure element

These circuits were the starting-point in the design of Western Electric's popular 639 Type Cardioid Microphone. By changing the values of the electrical components, they provided extensive information on expected performance before the first model was built.

THIS IS THE
MICROPHONE ITSELF

When the 639 was built, its outstanding performance—in quality and adaptability to various pick-up problems—bore out the predictions of the equivalent circuit.



Western Electric

Manufacturing unit of the Bell System and the
nation's largest producer of communications equipment.



DISTRIBUTORS: IN U. S. A.—Graybar Electric Company, IN CANADA AND NEW FOUNDLAND—Northern Electric Co., Ltd.

A MINIMUM OF OPERATIONS MADE THESE CONNECTORS

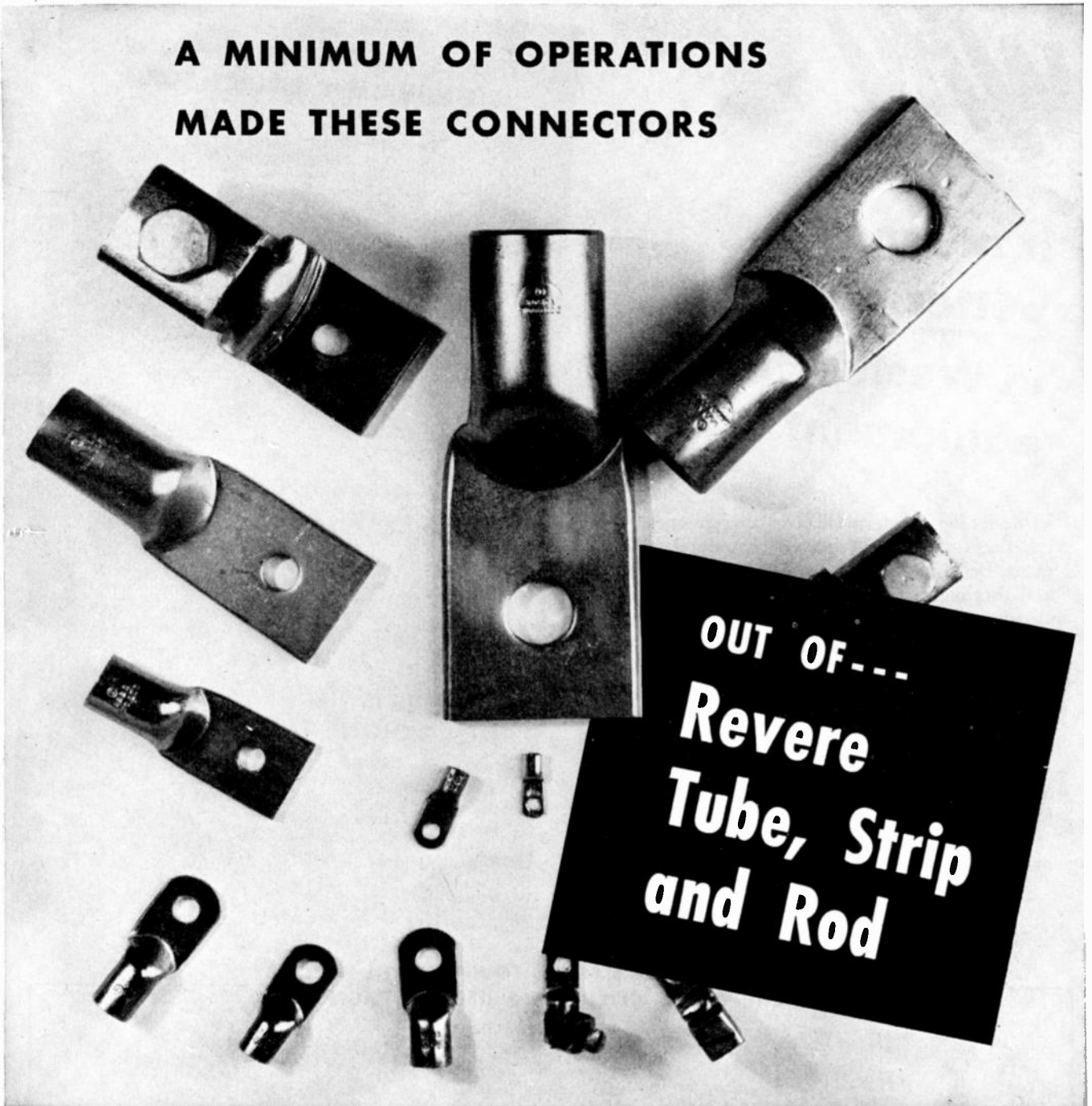

THESSE electrical connectors are but a few out of the hundreds of types being made today out of Revere copper and copper alloy tube, strip and rod.

Soldering lugs are made of Revere seamless tube, and are finished by simple stamping and punching. Solderless connectors are manufactured of tube, strip, bar and rod. The easy workability of the metal, plus the fact that it is supplied in forms requiring a minimum of operations, make Revere a favorite source of supply.

Other Revere products for electrical purposes include: Electrolytic and silver bearing copper commutator bar and segments; O.F.H.C., silver bearing, and electrolytic copper for armatures and rotors of micromotors and fractional h-p motors; Specially Prepared Switch Copper for switches, bus bars and similar applications; Extruded copper shapes for contacts, contact arms, solderless connectors, etc.,

Free Cutting Rod for parts machined to close tolerances; Tubular rivet wire.

The Revere Technical Advisory Service will gladly work with you in studying your requirements and determining the Revere mill products that lend themselves to the most economical manufacture and best service.

• • •

REVERE

COPPER AND BRASS INCORPORATED

Founded by Paul Revere in 1801

230 Park Avenue, New York 17, New York
Mills: Baltimore, Md.; Chicago, Ill.; Detroit, Mich.; New Bedford, Mass.;
Rome, N. Y.—Sales Offices in Principal Cities, Distributors Everywhere



WHEN YOU AIM AT...



Make

EL-Menco CAPACITORS
Your Selection

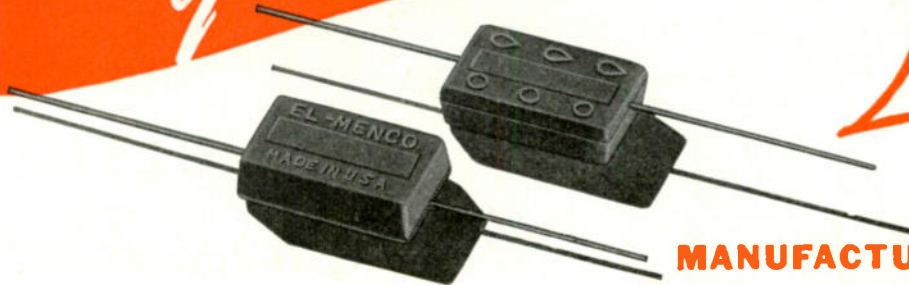

MANUFACTURERS

Facts are stubborn things . . . El-Menco Capacitors are backed by impressive facts . . . proven performance, dependable quality . . . earned as components in the world's finest radio and electronic equipment.

You can't discount the reputation of leadership El-Menco has built with the most renowned manufacturers. If you want your product to win preference through perfection . . . use El-Menco Capacitors . . . improve its performance.

THE ELECTRO MOTIVE MFG. CO., Inc.
Willimantic, Connecticut

Our silver mica department is now producing silvered mica films for all electronic applications. Send us your specifications.



Write on Firm Letterhead for Catalog and Samples.

Send for samples and complete specifications. Foreign Radio and Electronic Manufacturers communicate direct with our Export Department at Willimantic, Conn., for information.

JOBBERS AND DISTRIBUTORS

ARCO ELECTRONICS

135 Liberty St. New York, N. Y.
Is Sole Agent for El-Menco Products in United States and Canada.

MOLDED MICA **EL-Menco** **MICA TRIMMER**
CAPACITORS

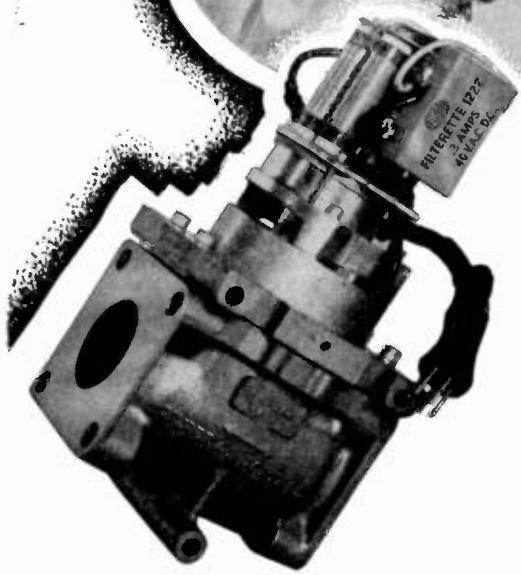

THE CLINIC *that Cures Radio Noise*

For every evil
under the sun,
There is a remedy
or there is none.
Old Eng. Prov.

For radio noise, the remedy is Filterizing by Tobe . . . a complete service that enables you to guarantee that your electrical products will not interfere with radio reception. Filterizing by Tobe covers these three important aspects of every radio noise problem:

R.F. Circuit Design — Engineers with many years experience, thoroly versed in measurement techniques, and using the latest instruments, determine the radio noise output and r-f characteristics of your product and specify the correct circuit elements to stop radio interference over the desired frequency range.

Electrical Design — The filterizing circuit is checked for effect upon performance of the apparatus being Filterized and all components are selected so that normal performance is obtained after Filterizing; voltage drop, temperature rise, phase relationships — all are held within required limits.

Mechanical Design — The arrangement of circuit elements is co-ordinated with existing space limitations so that radio noise is quelled without need for extensive re-design of the apparatus.

These three design factors, embodied in every Tobe Filterette, are based on exact, scientific knowledge and, when applied by Tobe engineers, enable you to guarantee radio silence for your electrical apparatus. This guarantee, shown by the FILTERIZED label, helps build sales for your product. Ask us for details.



TOBE DEUTSCHMANN CORPORATION • NORWOOD, MASSACHUSETTS

ORIGINATORS OF FILTERETTES . . . THE ACCEPTED CURE FOR RADIO NOISE

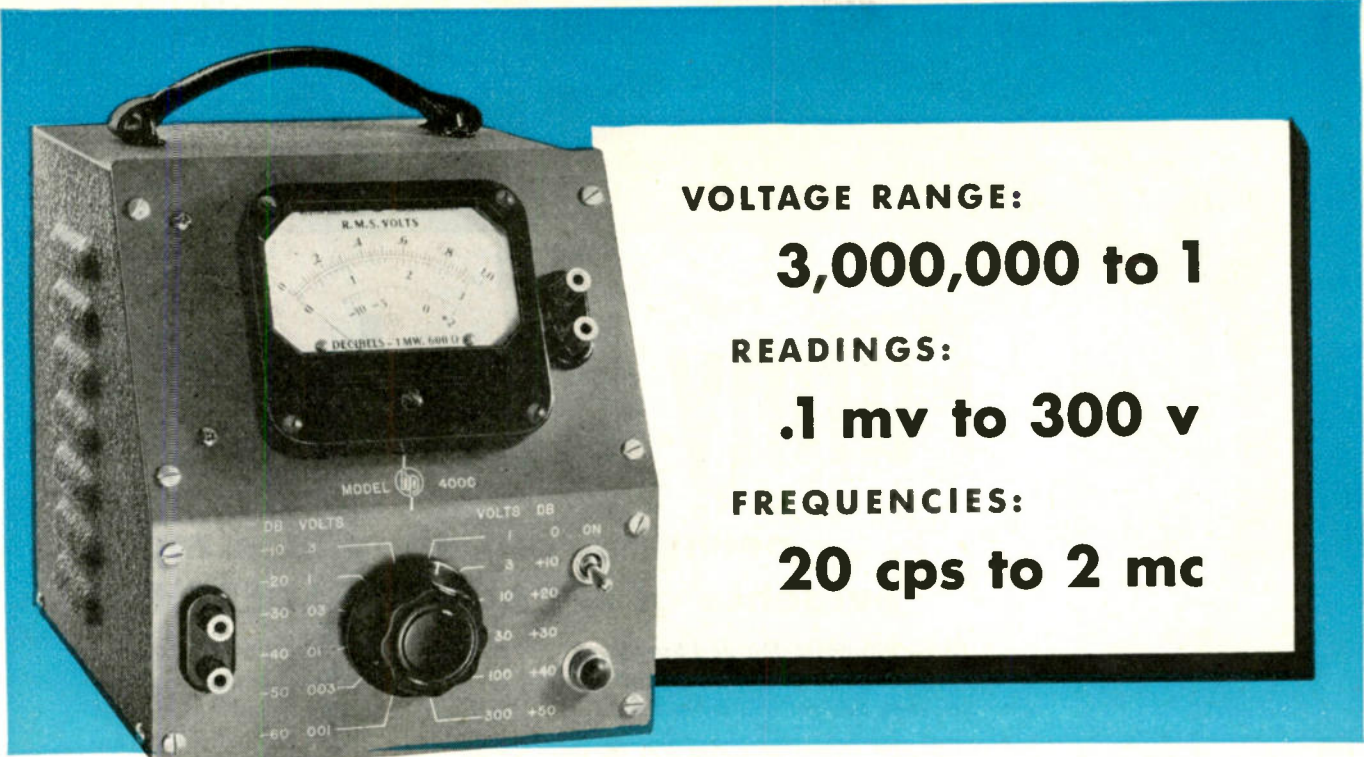

VOLTAGE RANGE:

3,000,000 to 1

READINGS:

.1 mv to 300 v

FREQUENCIES:

20 cps to 2 mc

THE NEW *-hp-* 400C VACUUM TUBE VOLTMETER

Increased sensitivity. Wider range. Easy-to-read linear scale. Space-saving, time-saving versatility! Those are but a few of the many advantages of the new *-hp-* 400C Vacuum Tube Voltmeter.

30 times more sensitive than the *-hp-* 400A voltmeter, the new *-hp-* 400C accurately determines voltages from .1 mv to 300 v. Its measuring range is broad and new—3,000,000 to 1. And with it you can make split-hair measurements all the way from 20 cps to 2 mc!

The big, clearly-calibrated linear scale reads directly in RMS volts or db based on 1 mw into 600 ohms. Generous overlap makes possible more readings at mid or maximum scale, where accuracy is highest. A new output terminal lets you use the *-hp-* 400C as a wide-band stabilized amplifier, for increasing gain of oscilloscopes, recorders and measuring devices. As a voltmeter, the new instrument has still wider applicability—for direct hum or noise readings, transmitter and receiver voltages, audio, carrier or supersonic voltages, power gain or network response.

Naturally the new *-hp-* 400C includes the familiar advantages of the *-hp-* 400A voltmeter. Range switch is calibrated in 10 db intervals providing direct readings from -70 dbm to +52 dbm. Overall accuracy

is $\pm 3\%$ full scale to 100 kc. High input impedance of 1 megohm means circuits under test are not disturbed. And the rugged meter movement is built to safely withstand occasional overloads 100 times normal.

In every respect, the convenient, durable *-hp-* 400C is the ideal new voltmeter for precision work in laboratory, plant or repair shop. Complete details are available at no obligation. Write today!

Hewlett-Packard Company

1556D Page Mill Road • Palo Alto, Calif.

CHECK THESE SPECIFICATIONS

VOLTAGE RANGES:

12 ranges. Full-scale readings.

.001 v	.100 v	10.0 v
.003 v	.300 v	30.0 v
.010 v	1.00 v	100. v
.030 v	3.00 v	300. v

FREQUENCY RANGE: 20 cps to 2 mc

ACCURACY:

$\pm 3\%$ full scale 20 cps to 100 kc
 $\pm 5\%$ full scale 100 kc to 2 mc

INPUT IMPEDANCE:

1 megohm shunted by 15 uuf, on .01 v to 300 v ranges.
 1 megohm shunted by 25 uuf, on .001 v to .003 v ranges.

METER SCALE:

3" linear. Voltage ranges related by 10 db steps. Db calibrated -12 to +2 db. Zero level 1 mw into 600 ohms.

OUTPUT CIRCUIT:

Maximum 0.5 v full scale. Internal impedance 1000 ohms.

POWER SUPPLY:

115 v, 50/60 cps, 45 watts.

CABINET SIZE:

8" high, 7 1/2" wide, 9" deep.



Power Supplies Frequency Standards Amplifiers Electronic Tachometers Frequency Meters
 UHF Signal Generators Square Wave Generators Audio Frequency Oscillators Attenuators
 Audio Signal Generators Noise and Distortion Analyzers Wave Analyzers Vacuum Tube Voltmeters

.022

.0047

.51

.033

.068

Funny Numbers?

... perhaps, but they are more evidence of **SPRAGUE LEADERSHIP!**

New Phenolic-Molded Sprague Tubular Capacitors Produced in Decade Ranges and Color-Coded!

With the recent introduction of its sensational new *molded* tubular capacitors, Sprague now announces standardized capacities, and color-coding for ready identification of these new units. For example, starting with the number 1, the next numbers in the 20% tolerance decade are 1.5, 2.2, 3.3, 4.7, 6.8 and on back to 10.

Established decade ranges and color-coding have proved their efficiency and acceptability in the resistor industry over a period of years.

Now, for the first time, this same practice will allow capacitor manufacturers the many advantages of standardized production—advantages which we feel will be cumulative through the years.

In the firm conviction that these steps toward standardization will prove mutually beneficial, Sprague Electric Company solicits your cooperation and invites your inquiries for information, samples and application data concerning the new **SPRAGUE MOLDED TUBULAR CAPACITORS**. WRITE FOR ENGINEERING BULLETIN NO. 210 A.

THE FIRST TRULY PRACTICAL PHENOLIC-MOLDED PAPER TUBULAR!

Highly heat- and moisture-resistant • Non-inflammable • Conservatively rated for —40°C. to 85°C. operation • Small in size • Completely insulated • Mechanically rugged • Moderately priced.



SPRAGUE MOLDED TUBULAR CAPACITOR COLOR CODE

		Black	Brown	Red	Orange	Yellow	Green	Blue	Violet	Gray	White	
1st BAND	Capacity in MFD	First Significant Number	0	1	2	3	4	5	6	7	8	9
2nd BAND		Second Significant Number	0	1	2	3	4	5	6	7	8	9
3rd BAND		Decimal Multiplier		10	100	1000	10,000	100,000				
4th BAND	TOLERANCE	±20%			±30%	±40%	±5%				±10%	
5th BAND	RESERVED FOR ARMED SERVICES											
6th BAND	Voltage in Hundreds (x 100)	First Significant Number	0	1	2	3	4	5	6	7	8	9
7th BAND		Second Significant Number	0	1	2	3	4	5	6	7	8	9

SPRAGUE ELECTRIC COMPANY North Adams, Mass.

CAPACITORS

SPRAGUE

*KOOLOHM
RESISTORS

*Trademark reg. U. S. Pat. Off.

PIONEERS OF ELECTRIC AND ELECTRONIC PROGRESS

WILCOX . . . First Choice
OF THE
TRANS WORLD
AIRLINE



TWA EQUIPS GROUND STATIONS WITH
NEW WILCOX VHF RECEIVERS AND TRANSMITTERS

*New Fixed Frequency Equipment Offers New
Performance Features in the 118-136 Mc. Band*

- Selectivity Permits 100 Kc. Adjacent Channel Operation
- Co-Axial Transmission Line Relay Allows Common Antenna
- .005% Frequency Stability Without Temperature Control
- New Noise Limiter Means Better Reception
- Design Simplicity Simplifies Service

364A
Transmitter

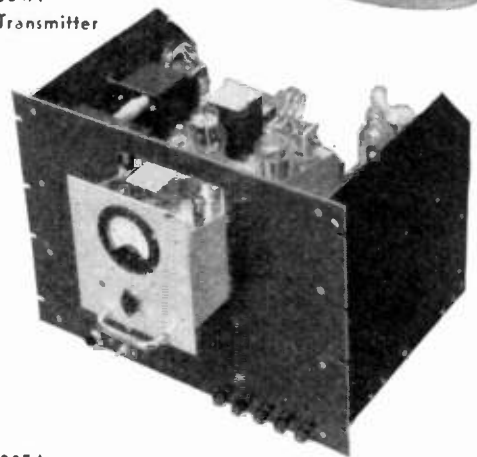

305A
Receiver

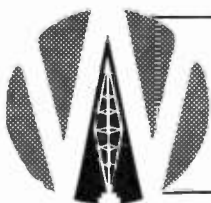

Write Today For Complete Information on the
WILCOX 305A Receiver and 364A Transmitter

WILCOX MEANS
Dependable Communication

WILCOX ELECTRIC COMPANY • Kansas City I, Missouri

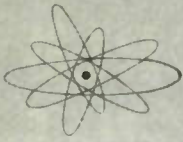

Designers

Television Transformers... tailored to your needs

1. Line supply voltage and frequency
2. High voltage d-c required
3. D-c milliamperes required
4. Filament volts and amperes
5. Sub-panel or above-panel mounting
6. Description of rectifier circuit
7. Winding insulation voltage required
8. Maximum ambient temperature

TELL US THESE ↗

WE SHIP THESE ↘

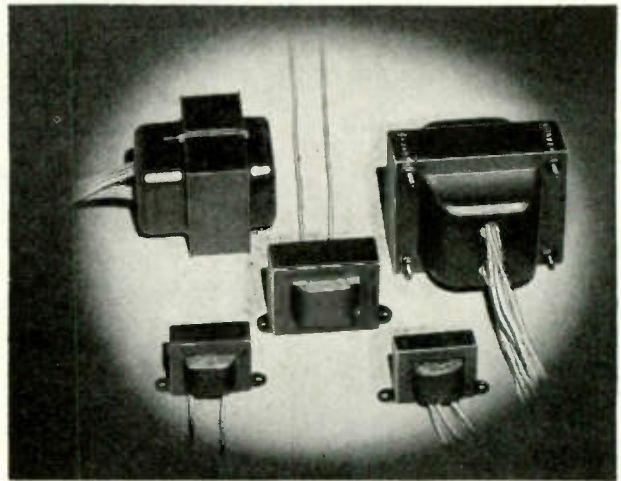

● Whatever your transformer needs—power units like these, or special designs for deflection yokes, horizontal or vertical sweeps, or oscillators—General Electric can supply them . . . and quickly. G.E. offers its facilities and engineering

“know-how” to television manufacturers in tailoring these transformers to their requirements. Just tell us your specifications and we will meet them to your complete satisfaction. Power-supply transformers are available now in core-

and-coil and enclosed-case styles as standard units designed for television applications. Units for other uses are tailor-made from standard parts. Ask your G-E representative for more information; you'll be pleased with the prices and shipments he will offer you.

**NEW PYRANOL CAPACITORS
SAVE SPACE, WEIGHT, MONEY**

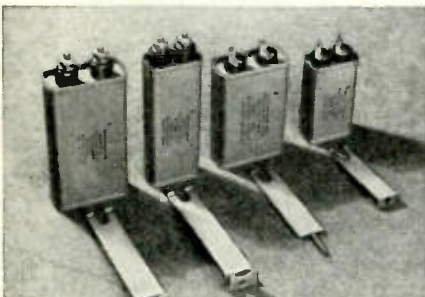

If you have been using 600-volt d-c capacitors on circuits rated 400 volts or less, you're in for a substantial saving in weight, size and cost by specifying General Elec-

tric's new 400-volt Pyranol units. Compared with 600-volt ratings, these new, standard, 400-volt capacitors will save you from 24 to 51 per cent in volume, 23 to 33 per cent in weight, and approximately 10 per cent in cost. They are available in 2-, 4-, 6-, 8- and 10-muf ratings with solder-lug or screw-thread terminals optional on the four larger sizes; the 2-muf size comes with solder-lug terminals only.

New developments, such as silicones and new paper, are continually improving the quality of G-E capacitors. They also permit our engineers to handle your new requirements to your complete satisfaction. Write for quotation on any

capacitor needs, or check Bulletin GEA-2621 for more information on the new d-c line described above.

**NEW,
SMALLER
SELENIUM
RECTIFIER**

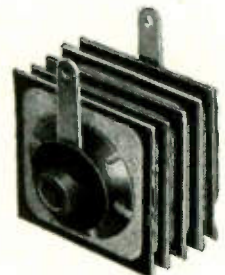

This new General Electric selenium rectifier, less than one inch long and one inch square, is available now for receiver and other elec-

Digest

TIMELY HIGHLIGHTS ON G-E COMPONENTS



tronic applications. It costs little and mounts in places where a rectifier tube and socket won't fit. Tests prove that this new selenium rectifier will outlast several 117-volt rectifier tubes. Installation is easier too—only two soldering operations and a minimum of mounting hardware are required.

These rectifiers have an exceptionally high inverse-peak rating, and the inverse current is extremely low even with peak voltages up to 350 volts. At rated current output, the forward drop is five volts or less. Ratings are based on ambients of 50 to 60 C. Check Bulletin 21-127 for more information on this and other General Electric radio rectifiers.

NEW MACHINABLE PLASTIC FOR UHF INSULATION

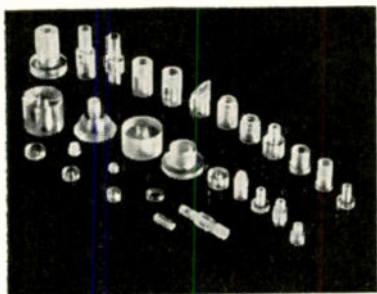

A new arrival in the plastics insulator field is G-E No. 1422, which offers characteristics of advantage in the manufacture of ultra-high-frequency equipment, television, FM, radar, and radio sets, and many other electronic applications. Possessing a dielectric constant of 2.5 to 2.6 with a power factor of .0006 to .0009 at 3000 mc, G-E No. 1422 exhibits unusual heat resistance and excellent machinability.

Indicative of its machinability is the industrial production of r-f con-

ductor beads from G-E No. 1422 on automatic and semi-automatic screw machines. As a low-loss dielectric in the hands of the electric-equipment designer, it affords an excellent low-cost means of producing experimental models and small production quantities through the use of standard machine shop tools. Check coupon for technical report.

HANDLES 12 CIRCUITS SIMULTANEOUSLY

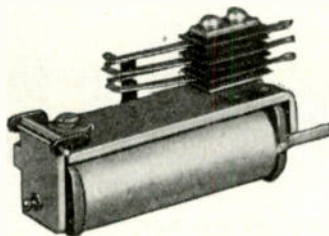

This new telephone-type relay is capable of handling as many as 12 circuits in a wide variety of contact combinations. Designed for multi-purpose use in industrial electronic apparatus, communications and signaling equipment, these devices have service lives measured in millions of operations. Working from five basic contact arrangements, combinations can be stacked to satisfy intricate circuit switching requirements. Silver, palladium, or tungsten contacts can be supplied; the choice depends on rating and life specifications.

More than 500 different coils are available, with ratings ranging

from 1 to 250 volts, and 0.1 to 26,000 ohms. This varied selection of coil ratings makes it possible to match closely the coil voltage and resistance with the rating of the energizing circuits. Check Bulletin GEA-4859 for full details.

TO MEASURE TUBE LIFE



Now available for immediate delivery, General Electric Type KT time meters are ideal for inclusion in transmitters and other electronic equipment where knowledge of tube "on time" is important. They can record operating time in hours, tenths of hours, or minutes, and are built in four forms: round or square for panel mounting, portable with attached base, or for conduit mounting. Those designed for panel mounting are housed in small Textolite cases that harmonize with other panel devices.

Telechron motor drive assures an accurate record of tube operation over a long period of time. They can also be used on electronic production tools, such as resistance welders, to keep an accurate record of machine operating time. Researchers use them for measuring time intervals, verifying circuit operation, and life testing. Bulletins GEA-3299 and GEA-1574 have full details.

GENERAL ELECTRIC COMPANY, Section H642-16
Apparatus Department, Schenectady 5, N. Y.

Please send me:

- | | | |
|-----------------------------------|----------------------|---|
| <input type="checkbox"/> GEA-2621 | 400-v D-c Capacitors | <input type="checkbox"/> 21-127 Selenium Rectifier |
| <input type="checkbox"/> GEA-3299 | Type KT Time Meter | <input type="checkbox"/> GEA-4859 Telephone-type Relay |
| <input type="checkbox"/> GEA-1574 | | <input type="checkbox"/> Report on G-E No. 1422 Plastic |

NOTE: More data available in Sweets' File for Product Designers.

Name.....

Company.....

Address.....

City.....State.....

PROGRESS REPORT ON P.E.C.*

How Beltone uses Centralab's
"Printed Electronic Circuit" to design
and manufacture the
"world's smallest hearing aid"

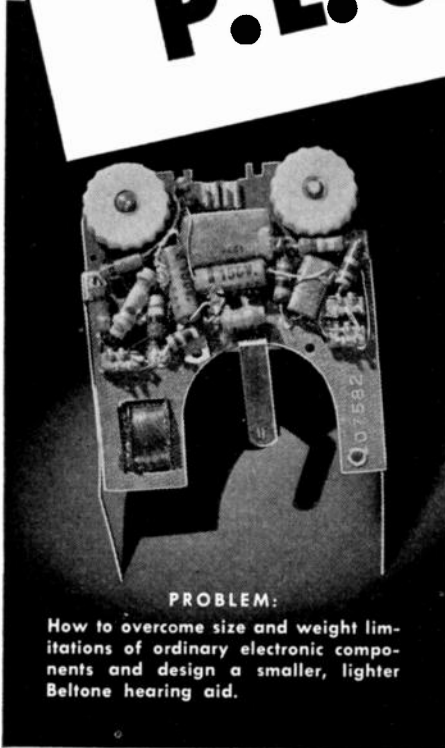

PROBLEM:

How to overcome size and weight limitations of ordinary electronic components and design a smaller, lighter Beltone hearing aid.

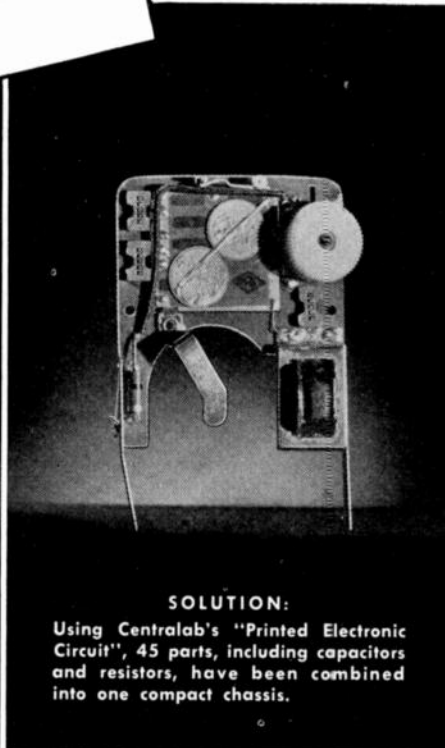

SOLUTION:

Using Centralab's "Printed Electronic Circuit", 45 parts, including capacitors and resistors, have been combined into one compact chassis.

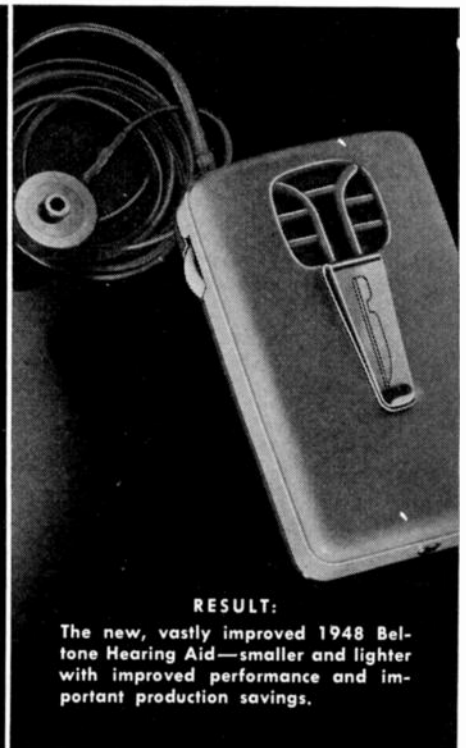

RESULT:

The new, vastly improved 1948 Beltone Hearing Aid—smaller and lighter with improved performance and important production savings.

Models courtesy of Beltone Hearing Aid Co., Chicago

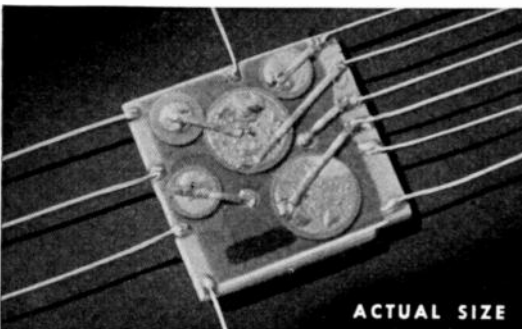

ACTUAL SIZE

REAR VIEW of Beltone PEC unit is shown above. Note ceramic disc capacitors, "printed" silver leads and resistors (black paths). See below for schematic diagram of entire Printed Electronic Circuit.

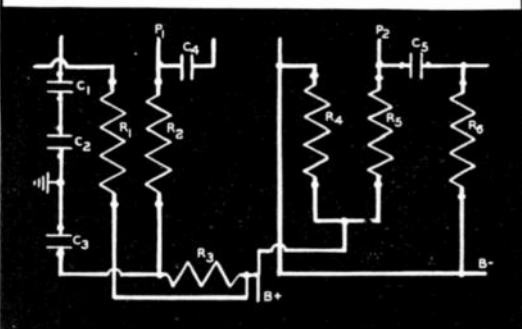

***Centralab's "Printed Electronic Circuit"
— Industry's newest method for
improving design and manufacturing efficiency!**

FOR USE where miniature size is of the utmost importance, nothing has ever been offered to manufacturers of electronic equipment which combines ruggedness, dependability and resistance to humidity and moisture in such a small unit package. That's what engineers of the Beltone Hearing Aid Co., Chicago, say about CRL's *Printed Electronic Circuit*, and that's what you will say when you have seen and tested this amazing new electronic development.

Integral ceramic construction: Each *Printed Electronic Circuit* is an integral assembly of "Hi-Kap" capacitors and resistors closely bonded to a steatite ceramic plate and mutually connected by means of metallic silver paths "printed" on the base plate. All leads are always the same length, each plate is an exact duplicate of the original or "master".

This outstanding new hearing aid development, illustrated above, was the product of close cooperation between Centralab and Beltone engineers. Working with your engineers, Centralab may be able to fit its *Printed Electronic Circuit* to your specific needs. Write for complete information, or get in touch with your nearest Centralab Representative.

LOOK TO **Centralab** IN 1948!

Division of GLOBE-UNION INC., Milwaukee

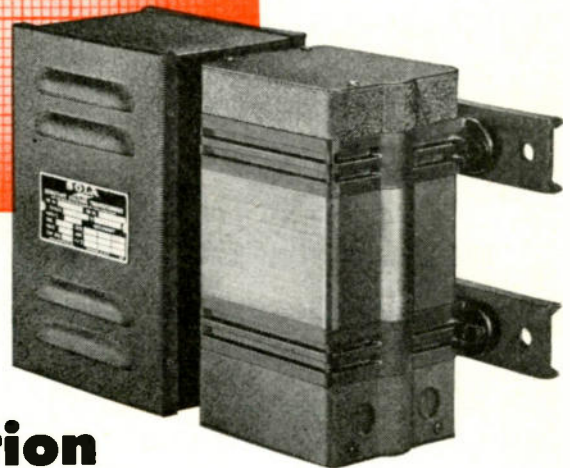
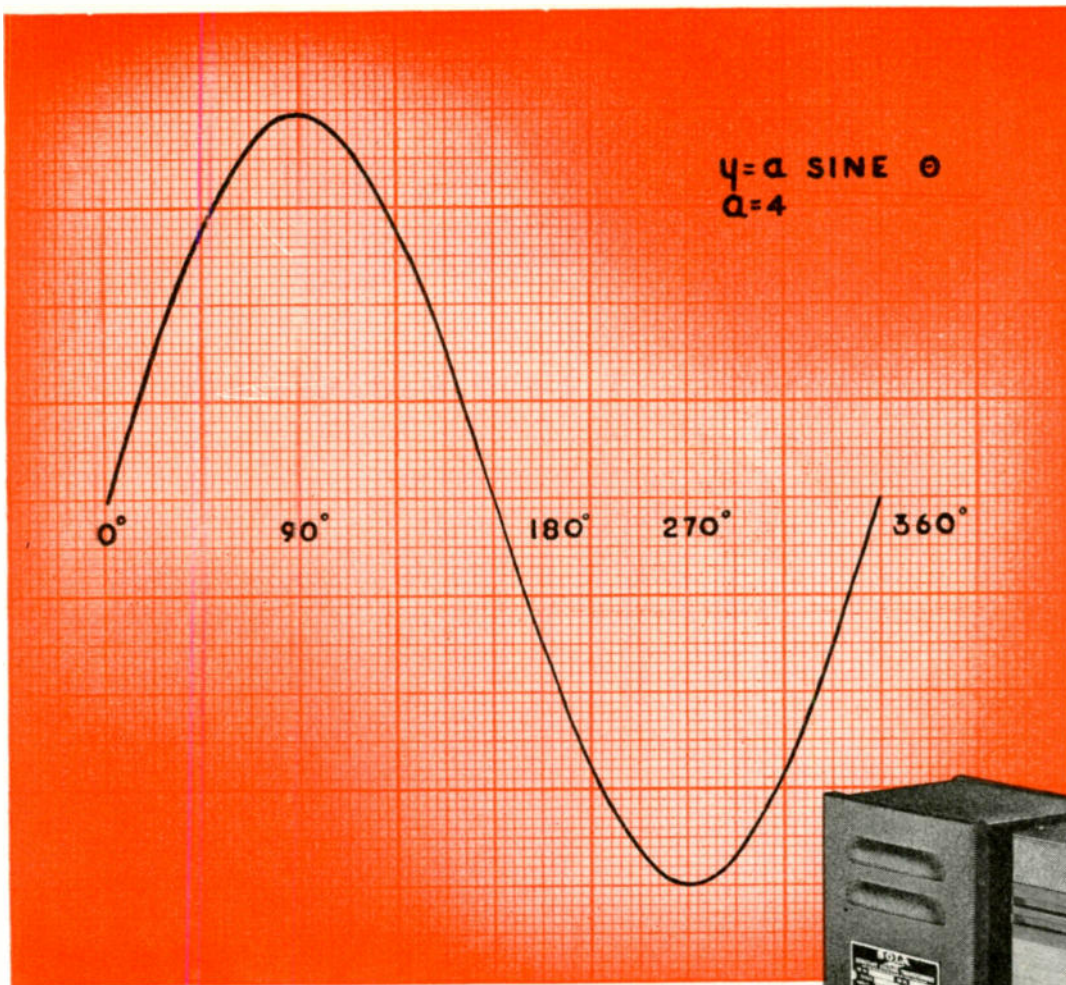

CONSTANT VOLTAGE with low harmonic distortion

TYPE CVH, an important newcomer in a famous line—a SOLA CONSTANT VOLTAGE Transformer designed for use with equipment that requires a source of undistorted voltage. These new transformers, available in 250, 500 and 1,000 VA capacities, provide all of the voltage stabilizing characteristics of the standard SOLA Constant Voltage Transformer, with less than 3% harmonic distortion of the output voltage wave.

Since the output voltage wave is essentially sinusoidal, these transformers may be used for the most exacting applications such as general laboratory work, instrument calibration, precision electronic equipment or other equipment having elements which are sensitive to

power frequencies harmonically related to the fundamental.

As in all SOLA Constant Voltage Transformers the regulation is automatic and instantaneous. There are no moving parts, no manual adjustments and every unit is self-protecting against short circuit.

Type CVH represents an outstanding advance in automatic voltage regulation and an important contribution to precise electronic equipment.

WRITE FOR THESE BULLETINS

XCVM-136—complete electrical and mechanical characteristics of the new Type CVH Constant Voltage Transformers.

CV-102—complete engineering handbook and catalog of standard Constant Voltage Transformers available for remedial or built-in applications.

SOLA

Constant Voltage
TRANSFORMERS

Transformers for: Constant Voltage • Cold Cathode Lighting • Airport Lighting • Series Lighting • Fluorescent Lighting • Luminous Tube Signs • Oil Burner Ignition • X-Ray • Power • Controls • Signal Systems • etc. SOLA ELECTRIC COMPANY, 4633 W. 16th Street, Chicago 50, Illinois

Manufactured under license by: ENDURANCE ELECTRIC CO., Concord West, N. S. W., Australia • ADVANCE COMPONENTS LTD., Walthamstow, E., England • UCOA RADIO S.A., Buenos Aires, Argentina • M. C. B. & VERITABLE ALTER, Courbevoie (Seine), France



**Impedance
unknown?**

...AT 2,600 MEGACYCLES?

**..AT 26,000
MEGACYCLES?**

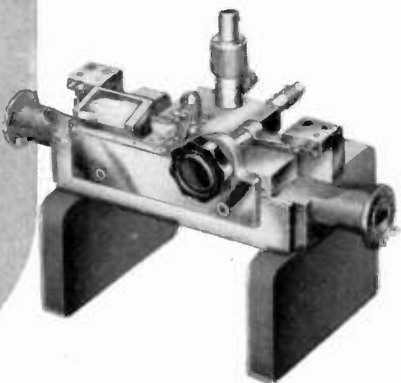

**PRD
SLOTTED
SECTIONS
AND
PROBES**

Features:

BALL BEARING
CARRIAGE SUPPORT
SHOCK-PROOF
FRICTION DRIVE
BROADBAND TUNING
CRYSTAL AND
BOLOMETER DETECTION
SLOPE ELIMINATED
BY ELECTRICAL LEVELLING
LOW REFLECTION
CONNECTORS
CALIBRATED PROBE
POSITION MEASURED
TO OUTPUT COUPLING

Each product is designed, manufactured, and tested with the precision necessary to meet the exacting requirements of the microwave research engineer. An illustrated catalog may be obtained by writing Dept. R4 on company letterhead.

PRD Slotted Sections and Probes are now available for determining with maximum precision the phase and magnitude of impedances at microwave frequencies. These units are precision fabricated devices for use in exploring the standing wave patterns of r-f fields in microwave transmission lines.

The instruments shown are only two of an extended series of coaxial and waveguide slotted sections specifically designed for precise impedance measurement over the microwave spectrum from 1,000 to 40,000 megacycles per second. PRD offers a full complement of microwave measurement and test equipment including Attenuators, Frequency Meters and Standards, Tuners, Matched Loads, Directional Couplers, Signal Generators and Standing Wave Amplifiers.

66 COURT ST., BROOKLYN 2, N. Y.



Polytechnic **RESEARCH
& DEVELOPMENT COMPANY, Inc.**

MECHANICAL ACCURACY

is *vital* to

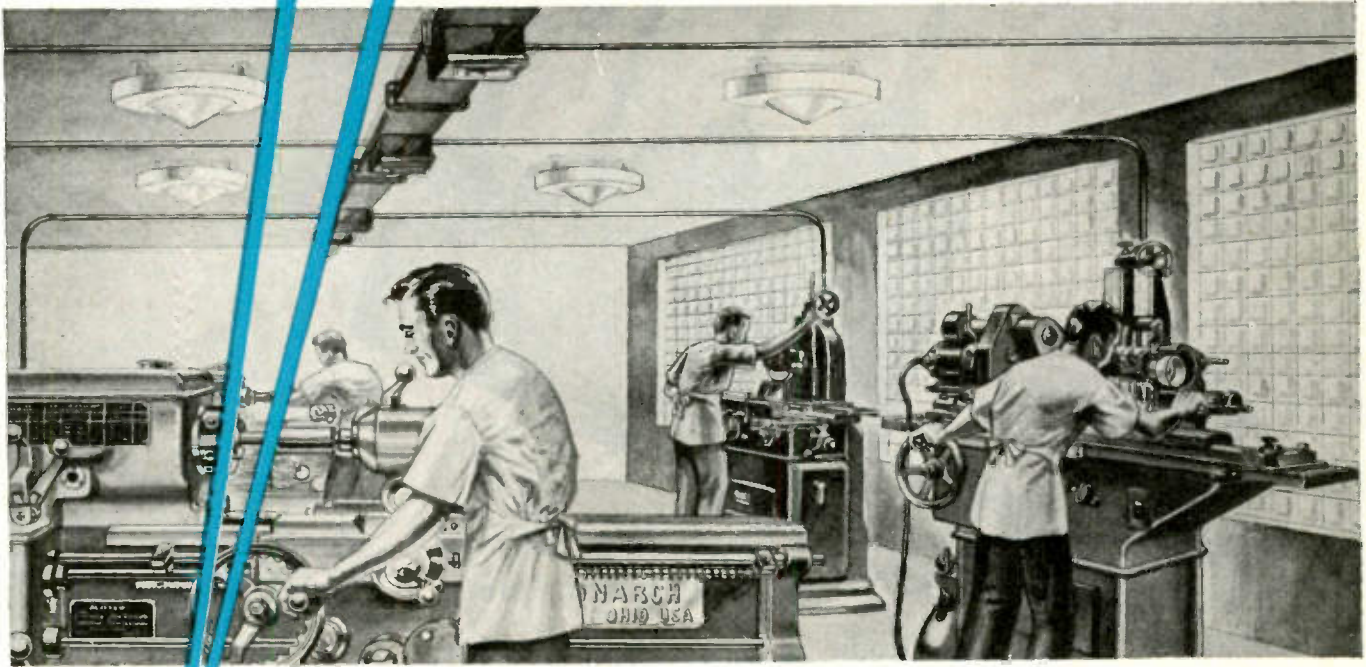

PRECISION ELECTRONICS

THE SHERRON
ELECTRO-MECHANICAL
LABORATORY SERVES IN THE
FABRICATION OF MECHANICAL
COMPONENTS FOR :

- *Mechanical Equipment for Electronoptics*
- *Special Precision Wave Guides*
- *Computers*
- *Vacuum Tube Structures*
- *Precision Tuning Units*
- *Precision Drive Mechanisms*
- *Servo Mechanisms*



Shown above is a view of the Sherron electro-mechanical laboratory. Here you will see the finest modern tools. Every machine, every piece of apparatus is a precision instrument. Lathes, jig bores, shapers, heat treating equipment, locators, millers — they're all here. Yes, and the entire gamut of standards, gauges, mechanical measuring instruments . . . We allow no margin for error in any detail of the electronic equipment we make. As a result, the Sherron electro-mechanical laboratory performs a vital function in our complete and coordinated service to manufacturers . . . Why not consult our electro-mechanical engineering group on your "precision electronics" problems?

SHERRON ELECTRONICS COMPANY
Division of Sherron Metallic Corporation

1201 FLUSHING AVE. • BROOKLYN 6, NEW YORK

there IS a difference.

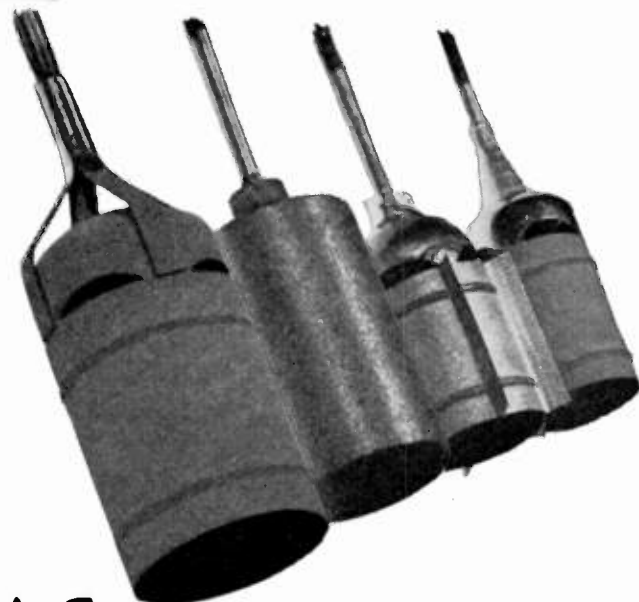

PYROVAC the new Eimac plate material makes a better vacuum tube anode . . . on all counts.

- 1** **LIFE** . . . Tubes with tantalum plates formerly giving 3000 hours of service, now, with Pyrovac plates operate in excess of 15,000 hours . . . a 400 percent increase.
- 2** **OVERLOADS** . . . With Pyrovac plate, 65 watt tubes have dissipated 900 watts—a 1280 percent momentary overload—without indication that the eventual life of the tubes or their characteristics were affected. In normal service these tubes are still going strong. Excessive plate dissipation due to tuning procedure and circuit failure normally won't mean the loss of your tube.
- 3** **MECHANICAL CHARACTERISTICS** . . . Pyrovac is easily welded, enabling rugged shock-resistant mounting. It is a "black body" radiator and possesses excellent characteristics as an electrical conductor.
- 4** **COSTS** . . . Pyrovac plates in Eimac tubes cost you no more, yet since they enable longer life you actually get more for your vacuum-tube-dollar.
- 5** **PROVEN IN SERVICE** . . . Pyrovac is the result of millions of hours of life tests. The universal acceptance of the 4-125A and the 4-250A in all fields of electronic endeavor can, in part, be attributed to Pyrovac for contributing overload resistance, life, and a general ability to "take it."

THESE ARE THE TUBES WITH PYROVAC PLATES

EIMAC TUBE TYPES	PLATE DISSIPATION watts
TETRODES	
4-65A	
4-125A	65
4-250A	125
4-100A	250
4-1000A	400
	1000
TRIODES	
25T	
3C24	25
35T	25
35TG	50
75TH	50
75TL	75
100TH	75
100TL	100
152TH	100
152TL	150
250TH	150
250TL	250
304TH	250
304TL	300
450TH	300
450TL	450
750TL	450
1000T	750
1500T	1000
2000T	1500
	2000

EITEL McCULLOUGH, Inc.
193 San Mateo Ave., San Bruno, California

Export Agents: Frazier & Hansen 301 Clay St., San Francisco, Calif.

Typical insulators produced by Alsimag
at very low cost



IN SOME INSTANCES

ALSIMAG

TRADE MARK REGISTERED U.S. PATENT OFFICE

INSULATORS ARE

lowest in cost

Some types of insulators can be produced by Alsimag at very low cost. Our files show many instances where Alsimag insulators are used simply because they are the lowest cost insulators that will do the job.

This comes as a surprise to many engineers and purchasing agents. They know that Alsimag materials are expensive, that Alsimag parts have dimensional accuracy and uniformity which facilitates assembly, that Alsimag has great mechanical strength, permanent rigidity, that it will not char or form electrical conduction paths and that it has a far greater dielectric efficiency than most insulating materials. Therefore it is natural that they would think that Alsimag components would be more expensive... However, in some instances, the greater cost of the Alsimag materials is more than offset

by production savings. Certain sizes and designs, usually small and relatively simple shapes, are produced in quantity on automatic production equipment at such low production cost that the final price is highly competitive. Many materials commonly regarded as "cheap" are actually more expensive in first cost because those cheap materials do not lend themselves to economical manufacturing processes.

This advertisement is not an announcement of "bargain" prices. The Alsimag price structure remains unchanged. It is simply a statement of fact and an invitation to submit your insulator problems to Alsimag for cost and design analysis. You may be surprised to find Alsimag production efficiency enables you to buy superior insulators at a price competitive with materials which you have always thought of as "cheap."

AMERICAN LAVA CORPORATION

46TH YEAR OF CERAMIC LEADERSHIP

CHATTANOOGA 5, TENNESSEE

SALES OFFICES: ST. LOUIS, MO., R. H. Geiser, Tel: Garfield 4959 • CAMBRIDGE, MASS., J. F. Morse, Tel: Kirkland 4498 • NEWARK, N. J., J. H. Mills, Tel: Mitchell 2-8159 • PHILADELPHIA, S. J. McDowell, Tel: Stevenson 4-2823 • CHICAGO, W. E. Glasby, Tel: Central 1721 • SAN FRANCISCO, F. S. Hurst, Tel: Douglas 2464 • LOS ANGELES, L. W. Thompson, Tel: Mutual 9076

Keep DISTORTION out of the picture



Photograph, courtesy of RCA Service Company, Inc., a Radio Corporation of America Subsidiary

PERMEABILITY CHANGE DUE TO TEMPERATURE

(For uncompensated toroid of
G. A. & F. Carbonyl Iron Powders)

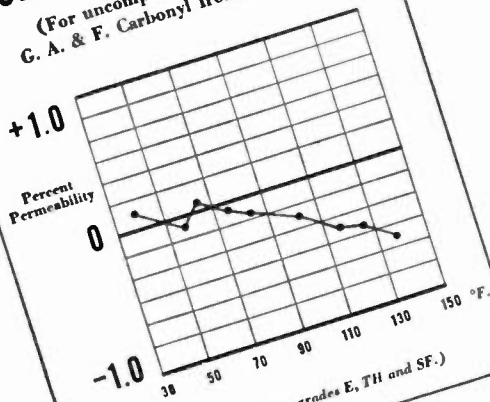

(NOTE: Applicable to grades E, TH and SF.)

Distortion of the television image can be reduced more effectively if your wave trap is cored with a G. A. & F. Carbonyl Iron Powder.

The inherent characteristics of G. A. & F. Carbonyl Iron Powders enable your core maker to produce cores with negligible temperature drift and excellent magnetic stability. Such cores in well designed coils give incomparable fidelity to your TV and RF circuits.

WHEN USED at radio frequency, G. A. & F. Carbonyl Iron Powders are superior in all important coefficients of stability (magnetic and temperature) and loss (eddy current and residual).

In comparison with air-cored coils, G. A. & F. Carbonyl Iron Powder-cored coils permit considerable savings in volume, weight and wire-length, along with great increases in inductance and Q value.

Ask your core manufacturer for information about G. A. & F. Carbonyl Iron Powders. Or write direct to: Antara Products, 444 Madison Avenue, New York 22, N. Y. Dept. 43

G. A. & F. CARBONYL IRON POWDERS

An Antara Product of General Aniline & Film Corporation*

*®

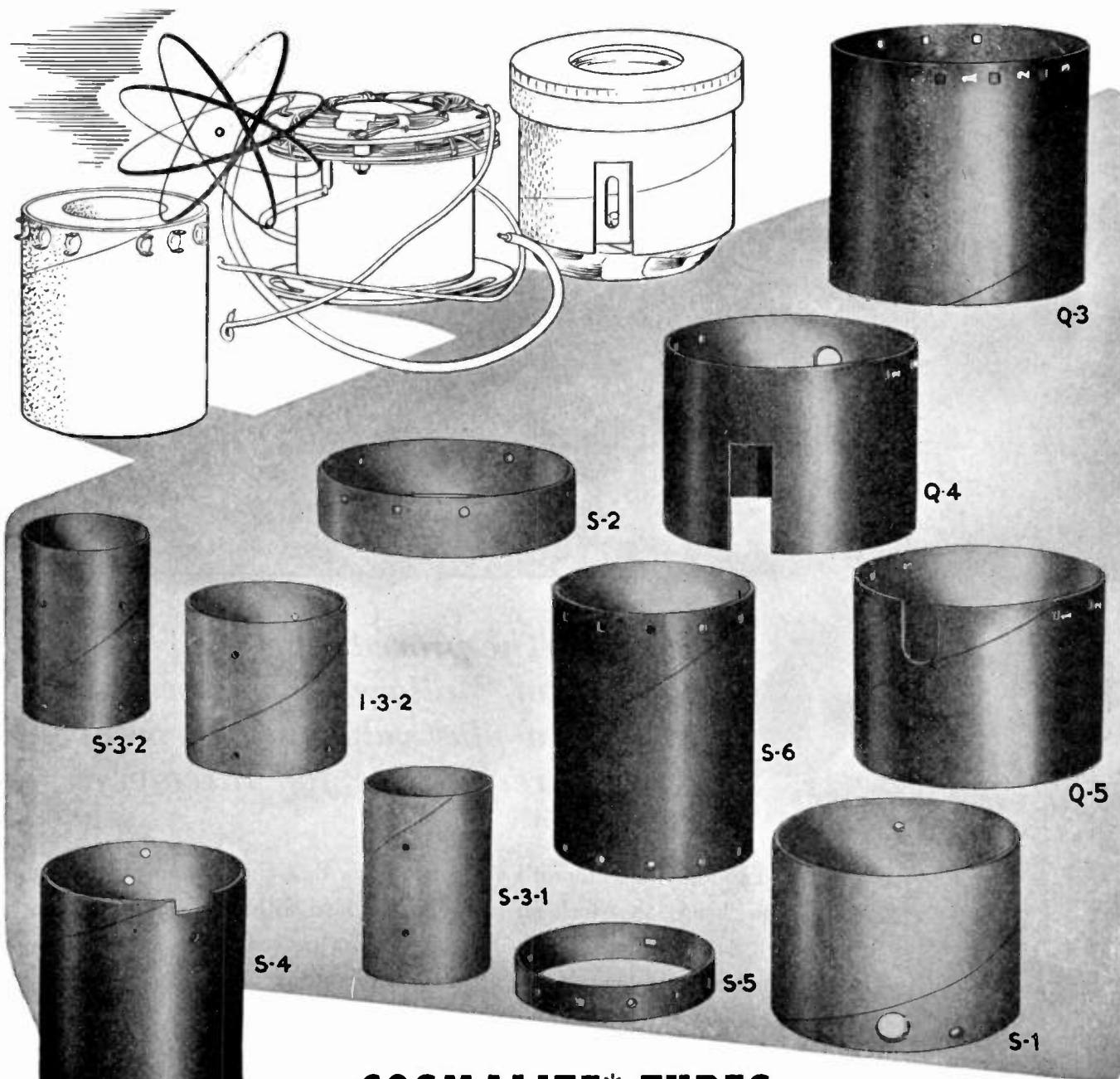

COSMALITE* TUBES for *Television* deflection yokes

- These spirally laminated paper base, Phenolic Tubes are obtainable in sizes and with punching and notching that meet each customer's individual needs. Quality performance at prices that appeal.

Other Cosmalite Types include . . .

#96 Cosmalite for coil forms in all standard broadcast receiving sets.

SLF Cosmalite for Permeability Tuners.

★ ★

Spirally wound kraft and fish paper Coil Forms and Condenser Tubes. Inquiries given specialized attention.

DEFLECTION YOKE SHELLS

	Inside Diameter	Length
S-1	3"	2 ⁵ / ₁₆ "
S-4	2 ³ / ₈ "	3 ⁷ / ₁₆ "
Q-3	3"	2 ³¹ / ₁₆ "
Q-4	3"	2 ¹¹ / ₃₂ "
Q-5	3"	2 ¹¹ / ₃₂ "
S-6	2 ³ / ₈ "	3 ⁷ / ₁₆ "

DEFLECTION YOKE CORES

S-3-1	1 ³ / ₄ "	2 ¹⁵ / ₃₂ "
S-3-2	1 ³ / ₄ "	2 ¹¹ / ₃₂ "
S-3-3	1 ³ / ₄ "	2 ¹⁹ / ₃₂ "
I-3-1	1 ¹⁷ / ₃₂ "	2 ³ / ₈ "
I-3-2	1 ⁷ / ₈ "	2"

DEFLECTION YOKE RINGS

S-2	3"	3 ¹ / ₂ "
S-5	2 ³ / ₈ "	1 ¹⁵ / ₃₂ "

The **CLEVELAND CONTAINER Co.**
6201 BARBERTON AVE. CLEVELAND 2, OHIO

- All-Fibre Cans • Combination Metal and Paper Cans
- Spirally Wound Tubes and Cares for all Purposes
- Plastic and Combination Paper and Plastic Items

PRODUCTION PLANTS also at Plymouth, Wis., Ogdensburg, N.Y., Chicago, Ill., Detroit, Mich., Jamesburg, N.J.
PLASTICS DIVISION at Plymouth, Wis. • ABRASIVE DIVISION at Cleveland, Ohio
SALES OFFICES: Room 5632, Grand Central Term. Bldg., New York 17, N.Y., also 647 Main St., Hartford, Conn.
CANADIAN PLANT: The Cleveland Container Canada, Ltd., Prescott, Ontario



* Trade Mark Registered

After Six Years on the Shelf —These Mallory Capacitors Met Every Specification!

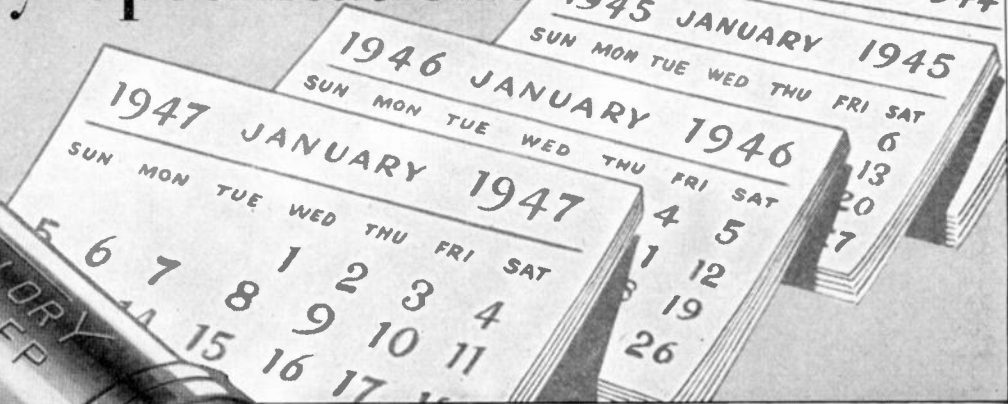

The proved long shelf life of Mallory Capacitors is a plus value to the man responsible for Inventory

When you buy capacitors it's a relief to know that, should your production program change, the stock on hand may be held without becoming useless through deterioration. Mallory Capacitors have proved on many occasions that they can take long periods of storage without loss of efficiency.

We recently tested capacitors for several customers* who had shelved them for up to six years. All proved ready to use without re-aging. None took more than seven minutes to reach the leakage limit of new units. All characteristics were within the limits of new-unit inspection.

Such quality is added protection for the man who specifies Mallory Capacitors. Such quality is invariably built into Mallory Approved Precision Products.

*Names on request.



Yours for the asking!

Everything you want to know about Mallory electrolytic capacitors—types, sizes, electrical characteristics—even data on test measurements and mounting hardware!

BUY MALLORY ASSURED QUALITY AT REGULAR PRICE LEVELS

P. R. MALLORY & CO. Inc.
MALLORY CAPACITORS
(ELECTROLYTIC, OIL and WAX)

P. R. MALLORY & CO., Inc., INDIANAPOLIS 6, INDIANA



Voice of America!...

... ON **audiodiscs***

The Voice of America gives to other nations a full and fair picture of American life, aims and policies, plus factual news of the world and the United States.

Broadcast in twenty-three languages, these programs blanket Europe, Latin America and the Far East, with a potential radio audience of more than 150,000,000 persons.

Of the thirty-two hours of daily broadcast, approximately one-fourth of the time is devoted to

news, one-half to additional comment and informational programs, and the remainder to music and entertainment.

A substantial part of these daily programs is recorded and, due to the excellent quality of these transcriptions, such recorded portions cannot be distinguished from the *live* transmissions.

Today, as from the beginning, the recorded parts of these broadcasts are on AUDIODISCS.

AUDIO DEVICES, INC., 444 Madison Avenue, New York 22, N.Y.

Export Department: Rocke International Corp., 13 E. 40th Street, New York 16, N. Y.

Audiodiscs are manufactured in the U.S.A. under exclusive license from PYRAL, S.A.R.L., Paris

REG. U. S. PAT. OFF.



they speak for themselves **audiodiscs**

★ You can
Reduce Costs

★ You can Improve
Performance with

ARNOLD

PERMANENT

MAGNETS



Where's the manufacturer these days who doesn't need all the competitive and cost advantages he can get? Maybe you have new electrical or mechanical equipment in mind—designs or re-designs that should employ permanent magnets for best results. Maybe you have existing applications that permanent magnets will do *better*—save you time and money in production, and step up the efficiency of your product.

In either case, let Arnold's engineering service help you to find the answers to your magnet problems. Arnold offers you a fully complete line of permanent magnet materials, produced under 100% quality-control in any size or shape you require, and supplied in any stage from rough shapes to finish-ground and tested units, ready for final assembly. Write direct, or to any Allegheny Ludlum branch office.

W&D 1295



THE ARNOLD ENGINEERING CO.

Subsidiary of ALLEGHENY LUDLUM STEEL CORPORATION

147 East Ontario Street, Chicago 11, Illinois

Specialists and Leaders in the Design, Engineering and Manufacture of PERMANENT MAGNETS

Self Control

Here's how
the CONTROLLER answers
typical regulation problems

Q. An AC requirement. Can you stabilize the output of a transformer?

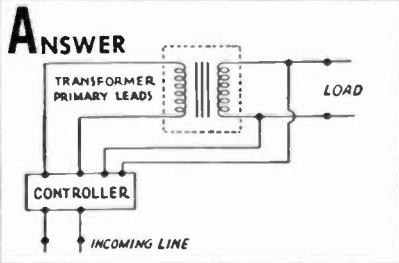

Q. Can you selectively regulate a number of DC voltages and currents?

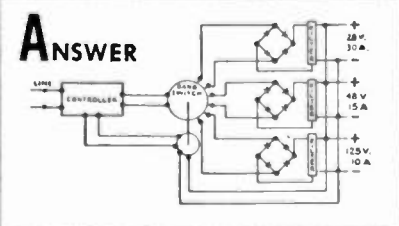

Q. Can the CONTROLLER stabilize a generator field to regulate its output?

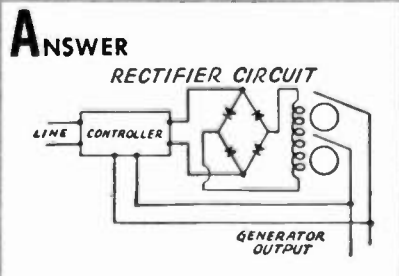

—of AC; DC or RF outputs in any one circuit, selectively stabilized over wide ranges of line and load with the new  SORENSEN ELECTRONIC CONTROLLER

The AC output of the CONTROLLER will swing between 85-145 VAC, AUTOMATICALLY adjusting the output of your unit against line and load variations. By referencing this output back to the CONTROLLER you get output regulation.



TECHNICAL SPECIFICATIONS

The controlled circuit must make available at least one watt of power to the CONTROLLER.

Input voltage range: 95-125 volts AC
(50 or 60 cycles)

Load range: 200 to 2000 VA

Regulation accuracy: 0.5% at the controlled point

write today for more information on the new CONTROLLER. Arrange to have a Sorensen Engineer analyze voltage regulation requirements in your plant. He can select a Sorensen unit or suggest a special design to fit your unusual application.

Represented in all principal domestic and foreign cities.



The FIRST line of standard ELECTRONIC Voltage Regulators

SORENSEN

& COMPANY, INC. • STAMFORD, CONNECTICUT

WHAT IT IS...

- Two separate, completely independent, electron guns.
- Individual circuits for intensity, focus, and X-, Y- and Z-axis modulations.
- Independent, identical linear time bases for each beam. Choice of driven or continuous sweeps, or combinations thereof.
- Provision for applying common linear time base signal to the horizontal plates of both guns.
- Automatic beam control.
- Balanced-output deflection amplifiers for each deflection system.
- Built-in voltage calibrator applicable to either Y-axis amplifier at any time.
- Position and sensitivity equalizing circuits for X-axis.
- Provision for use of an oscillograph-record camera such as Du Mont Types 271-A or 314.
- Operation at total acceleration potential of 4500 volts.
- Brilliant traces.

WHAT IT DOES...

Only the dual-beam oscillograph can simultaneously...

- ✓ Compare the complete signal and an expanded portion thereof.
- ✓ Enable observation of transient voltage and current (see accompanying oscillogram).
- ✓ Measure explosion time and rate of change of pressure.
- ✓ Show velocity and acceleration.
- ✓ Show velocity and pressure changes on engine valves.
- ✓ Compare speed and vibration.
- ✓ Compare voltages and currents in multi-phase circuits.
- ✓ Compare adjustment of push-pull and other symmetrical circuits.
- ✓ Compare electrocardiograms picked up from two different points.
- ✓ Compare input and output signals of amplifiers.
- ✓ Offer two channel recordings, with Type 314 Oscillograph-record Camera.
- ✓ Compare related periodic phenomena on different sweep frequencies.

SPECIFICATIONS...

Type 5SP. Cathode-ray Tube.

Sweep-frequency range: 2 to 30,000 saw-tooth cps.

Sweep recurrence: single or continuous.

Y-axis amplifier response: flat to dc., down 3db at 200 kc.

X-axis amplifier response: flat to dc., down 3db at 150 kc.

Deflection: for all amplifiers 1 v. dc./in. approx.

Power: 115/230 v., 50-60 cps., 300 watts, 3 amp. fuse.

Size: 17½" x 22½" x 22½"; wt. 125 lbs.

Housing: Cabinet or relay rack.

Two Completely Independent Oscillographs are combined in the *new* DUMONT Type 279

DUAL-BEAM CATHODE-RAY OSCILLOGRAPH

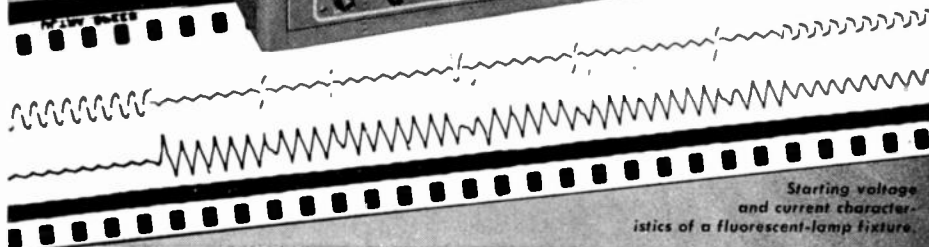
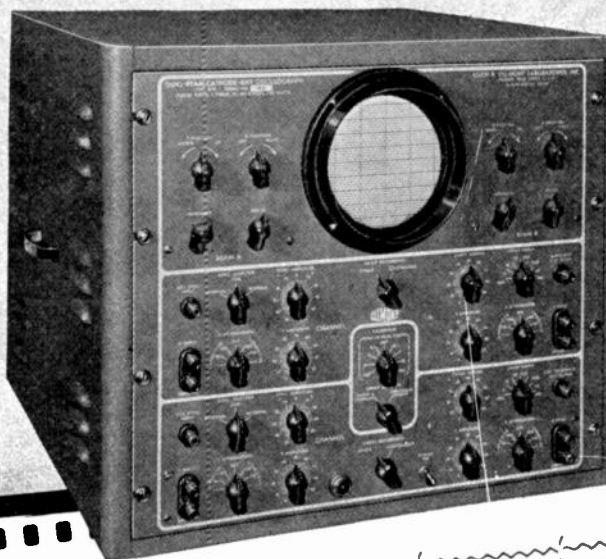

◆ The introduction of the Type 279 Dual-beam Cathode-ray Oscillograph makes available for the first time a really dual instrument with *separate and wholly independent* electron guns. The circuits associated with each gun are also distinct and separate. For the first time, separate time bases are provided for each beam with provision for applying one time base to both guns, if so desired. For the first time, an oscillograph is offered which alone can

perform the applications listed.

Now it is possible to superimpose two complete traces without a cumbersome and costly optical system or by the use of time-sharing devices. And with the P2 screen, the light output is more than sufficient for visual observation or for photographic recording of high-speed transients.

Other advanced features are the built-in calibrator and the ability to respond to direct-current signals.

◆ **Descriptive literature on request.**

© ALLEN B. DUMONT LABORATORIES, INC.

DUMONT

Precision Electronics & Television

ALLEN B. DUMONT LABORATORIES, INC., PASSAIC, NEW JERSEY • CABLE ADDRESS: ALBEEDU, PASSAIC, N. J., U. S. A.



Specify **Hi-Q** COMPONENTS for **DEPENDABILITY**

The dependability of **Hi-Q** components contained in your finished product will enhance your reputation as a manufacturer of *quality* equipment. The dependability of **Hi-Q** components is the result of meeting exacting specifications which insure their conformance to your requirements...temperature coefficients within recommended tolerances, insulation resistances to minimum standards, capacities as specified. **Hi-Q** dependability results from the use of highest quality materials and from constant surveillance throughout processing...your assurance of efficient, dependable service. Write for detailed information and engineering specifications.



STAND-OFF CONDENSERS

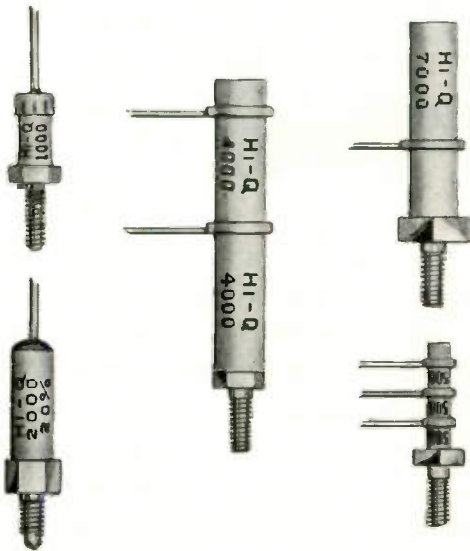

Hi-Q stand-off condensers insure the complete dependability of all your by-pass work. Stud hook-up provides exceptional rigidity and positive ground connection. These sturdy components permit easy access to tube terminals and are available in all capacities.

Hi-Q COMPONENTS BETTER 4 WAYS

- PRECISION** Tested step by step from raw material to finished product. Accuracy guaranteed to your specified tolerance.
- UNIFORMITY** Constancy of quality is maintained over entire production through continuous manufacturing controls.
- DEPENDABILITY** Interpret this factor in terms of your customers' satisfaction . . . Year after year of trouble-free performance. Our Hi-Q makes your product better.
- MINIATURIZATION** The smallest **BIG VALUE** components in the business make possible space saving factors which reduce your production costs . . . increase your profits.

Hi-Q

Electrical Reactance Corp.

FRANKLINVILLE, N. Y.

Plants: FRANKLINVILLE, N. Y. — JESSUP, PA.
Sales Offices: NEW YORK, PHILADELPHIA, DETROIT, CHICAGO, LOS ANGELES

EVERY DESIGN ENGINEER SHOULD HAVE A COPY



**SEND FOR
YOURS TODAY!**

THE WORD *Linde* IS A TRADE-MARK OF THE LINDE AIR PRODUCTS COMPANY

If you are concerned with material specifications, you'll find ideas on solving wear problems in this 28-page booklet—because LINDE Synthetic Sapphire is a material for key parts on which successful operation of a whole machine or instrument can depend.

This booklet describes the successful uses of this material, the colors, forms, and grades available; and gives a complete properties chart. It's full of pertinent illustrations—a picture-caption story of fabricating techniques, including LINDE's time-saving developments.

You'll want this new booklet — send for it on your business letter-head. Ask for Booklet 4-1. You will incur no obligation.

THE LINDE AIR PRODUCTS COMPANY
Unit of Union Carbide and Carbon Corporation
30 E. 42nd St., New York 17, N. Y. Offices in Other Principal Cities
In Canada: DOMINION OXYGEN COMPANY, LIMITED, Toronto

SELECT from the

Techniquality

GROUP



Bliley CRYSTALS

Many Bliley crystal units are first produced on a custom-built basis for special application. Quite often these designs contain outstanding features that are desirable in many applications and when this occurs the unit is included in our catalog listing. Our Bulletin 36 contains 22 standard crystal units, all widely used in commercial and governmental applications.

Bliley engineers are constantly utilizing

our many years of specialized experience to solve new frequency control problems. If you have a frequency control application, whether standard or specialized, we can probably come up with the right answer. Remember to specify Bliley TECHNICALITY crystals for greater accuracy, stability, quality, and advance design.

WRITE FOR YOUR COPY OF BULLETIN 36

BLILEY ELECTRIC COMPANY • UNION STATION BUILDING • ERIE, PENNSYLVANIA

See why Leaders in

TELEVISION

choose

MYCALEX 410

insulation

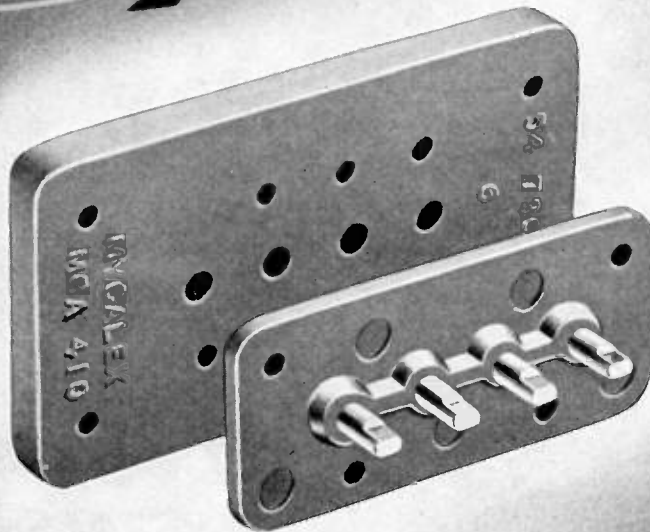

In television seeing is believing . . . and big name makers of television sets are demonstrating by superior performance that MYCALEX 410 molded insulation contributes importantly to faithful television reception.

Stability in a television circuit is an absolute essential. In the station selector switch used in receivers of a leading manufacturer, the MYCALEX 410 molded parts (shown here) are used instead of inferior insulation in order to avoid drift in the natural frequency of the tuned circuits. The extremely low losses of MYCALEX at television frequencies and the stability of its properties over extremes in temperature and humidity result in dependability of performance which would otherwise be unattainable.

Whether in television, FM or other high frequency circuits, the most difficult insulating problems are being solved by MYCALEX 410 molded insulation . . . exclusive formulation and product of MYCALEX CORPORATION OF AMERICA. Our engineering staff is at your service.

Specify MYCALEX 410 for:

1. Low dielectric loss
2. High dielectric strength
3. High arc resistance
4. Stability over wide humidity and temperature changes
5. Resistance to high temperatures
6. Mechanical precision
7. Mechanical strength
8. Metal inserts molded in place
9. Minimum service expense
10. Cooperation of MYCALEX engineering staff

MYCALEX CORP. OF AMERICA

"Owners of 'MYCALEX' Patents"

Plant and General Offices, CLIFTON, N. J.

Executive Offices, 30 ROCKEFELLER PLAZA, NEW YORK 20, N. Y.





**MODEL 260
VOLT-OHM-MILLIAMMETER**

20,000 Ohms per Volt D.C.
1,000 Ohms per Volt A.C.

Volts, A.C. and D.C.: 2.5, 10, 50, 250, 1000, 5000.

Milliamperes, D.C.: 10, 100, 500.

Microamperes, D.C.: 100.

Amperes, D.C.: 10.

Decibels (5 ranges): -10 to 52 D.B.

Ohms: 0-2000 (12 ohms center).

0-200,000 (1200 ohms center).

0-20 megohms (120,000 ohms center).

Model 260—Size 5 1/4" x 7" x 3 1/8"
\$38.95

Model 260 in Roll Top Safety Case
—Size 5 3/8" x 9" x 4 3/4" \$43.75

Both complete with test leads and
32-page Operator's Manual*

ASK YOUR JOBBER

**WORTH MORE...
...COSTS NO MORE!**

For what it buys in sensitivity, precision, and useful ranges, the price of Model 260 has always purchased value far beyond that of even remotely similar test instruments. Today this famous volt-ohm-milliammeter is a finer instrument than ever, with added ranges and with a new sub-assembly construction unmatched anywhere in strength and functional design.

The price is the same. That means, of course, that your investment today buys even more in utility and the *staying* accuracy that distinguish this most popular high-sensitivity set tester in the world.

*No other maker of test instruments provides anything to approach the completeness of the pocket-size 32-page Operator's Manual that accompanies Simpson Model 260. Illustrated with 12 circuit and schematic diagrams. Printed on tough map paper to withstand constant usage.

Simpson
INSTRUMENTS THAT STAY ACCURATE

SIMPSON ELECTRIC COMPANY • 5200-5218 W. Kinzie Street, Chicago 44, Ill.
In Canada, Bach-Simpson Ltd., London, Ont.

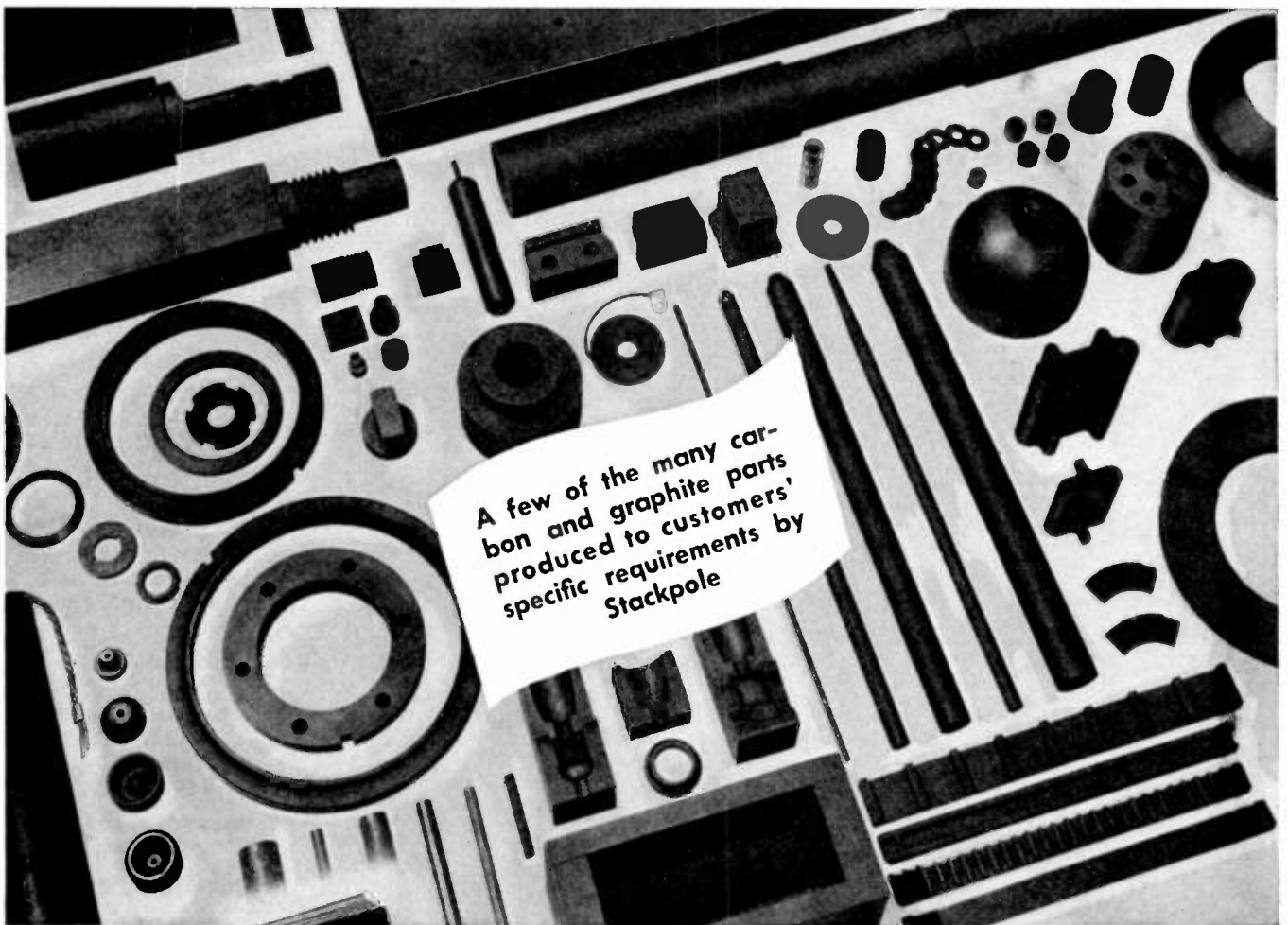

A few of the many carbon and graphite parts produced to customers' specific requirements by Stackpole

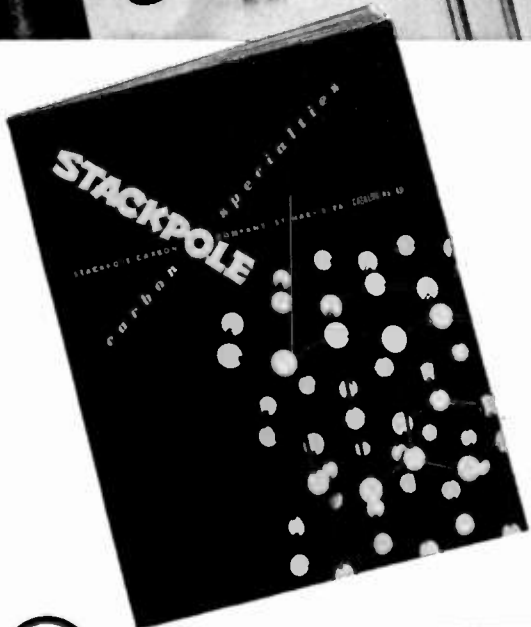

STACKPOLE

CARBON and GRAPHITE SPECIALTIES

Carbon and Graphite have been termed "the most flexible of Mother Nature's materials"... and for more than two decades, Stackpole has been proving the accuracy of this statement as applied to engineering problems involving friction, temperature, arcing, corrosion, shaft sealing and other related factors. Stackpole will be glad to work with you and your organization on any specific problem which carbon, graphite or powdered metal specialties might help solve.

STACKPOLE CARBON COMPANY • ST. MARYS, PA.



WRITE FOR THIS BIG CARBON-GRAPHITE BOOK

Far more than being a mere catalog, the Stackpole CARBON SPECIALTIES BOOK contains a wealth of detailed information that should prove invaluable in helping you evaluate the unique possibilities of carbon, graphite, and powdered metal materials in solving a wide range of engineering and production problems. Write for your copy today using your company letterhead. Ask for Booklet No. 40.

RELAYS • CONTACTORS • LIMIT SWITCHES

for ELECTRONIC APPLICATIONS

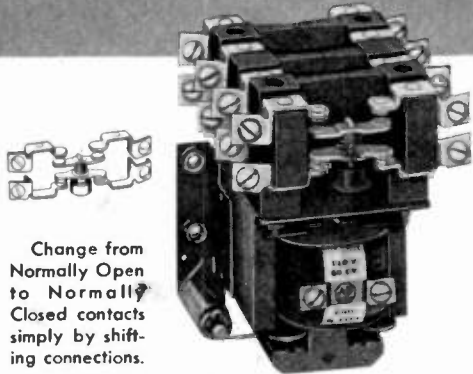

Change from Normally Open to Normally Closed contacts simply by shifting connections.

Dimensions 3 3/4 in. x 3 in. x 3 3/4 in.

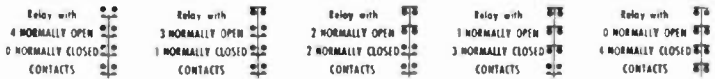

BULLETIN 700 UNIVERSAL RELAYS have two banks of contacts for quick changes from Normally Open to Normally Closed contacts . . . or vice versa. Available in 10-ampere rating with 2, 4, 6, and 8 poles; double break, silver alloy contacts need no maintenance. No pins, pivots, bearings, or hinges to bind or stick.

A-B TIMING RELAYS



BULLETIN 848 TIMING RELAYS are ideal for any service requiring an adjustable, delayed action relay. Have Normally Open or Normally Closed contacts.

Magnetic solenoid core is restrained from rising by the piston in fluid dashpot. Adjustable valve in piston regulates time required to pull piston through fluid seal and trip the contacts, which open or close with quick, snap action. Ideal for transmitter plate voltage control.



A-B HEAVY DUTY CONTACTORS

BULLETIN 702 SOLENOID CONTACTORS for heavy duty ratings up to 300 amperes. Arranged for 2- or 3-wire remote control with push buttons or automatic pilot devices.

Enclosing cabinets for all service conditions. Double break, silver alloy contacts require no maintenance. Solenoid mechanism is simple and trouble free. These Allen-Bradley solenoid contactors can be furnished in a variety of enclosures to meet any service requirement. Write for Bulletin 702, today.

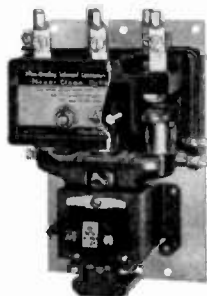

A-B LIMIT SWITCHES

for Radio Transmitter Cabinet Doors

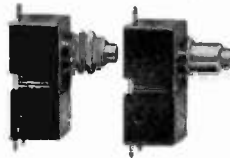

Precision Limit Switches with solder lugs or screw terminals.



Push Type. Slow action. N. O. or N. C. contacts.



Spring return roller type limit switch. Setting is adjustable.

Limit switches serve many electronic applications. Those shown above may be used for safety interlocks on transmitter cabinets. They serve as pilot controls for actuating Allen-Bradley 702 Heavy Duty Contactors which will disconnect all electrical apparatus in the cabinet if the doors are opened.

Limit switches are also used for electrical sequence switching; restricting machine motions; starting, stopping, and reversing motors, etc. The Allen-Bradley line of limit switches fills a 70-page catalog. Let us send you a copy.

Allen-Bradley Company
114 W. Greenfield Ave., Milwaukee 4, Wis.



ALLEN-BRADLEY

RESISTORS RELAYS





Representative RCA types standardized for future equipment designs

Tubes for today and tomorrow

HERE ARE power tubes, phototubes, and c-r tubes to serve the major requirements of equipment manufacturers for a long time to come. The tubes listed are those you can depend on now, and for your future designs.

These RCA types are especially recommended because their wide-spread application permits production to be concentrated on fewer types. Such longer manufacturing runs reduce costs—lead to improved quality and greater uniformity. Resultant benefits are shared alike by the equipment manufacturer and his customers.

RCA Application Engineers are ready to suggest suitable tube types for your design requirements. For further information write RCA, Commercial Engineering, Section DR-42, Harrison, N. J.

THE FOUNTAINHEAD OF MODERN TUBE DEVELOPMENT IS RCA



TUBE DEPARTMENT

RADIO CORPORATION of AMERICA

HARRISON, N. J.

Preferred List of RCA Non-Receiving Types

CATHODE-RAY TUBES AND CAMERA TUBES

Kinescopes (Projection)	Camera Types	Oscillograph Types	Monoscope
5TP4	5527 2P23 5655 1850-A	2BP1 3KP1 5UP1	2F21
(Directly Viewed)			
7DP4 7JP4 10BP4			

PHOTOTUBES

Gas Types	1P41	921	927	930
Vacuum Types	922	929		
Multiplier	931-A			

GAS TUBES

Thyratrons	2D21	3D22	884	2050		
Ignitrons	5550	5551	5552	5553	5563	
Rectifiers	3B25	673	816	857-B	866-A	869-B
	8008					
Voltage Regulators	0A2	0C3/VR105			0D3/VR150	

POWER AMPLIFIERS AND OSCILLATORS

TETRODES		TRIODES		PENTODES	
(Air-Cooled)	(Water-Cooled)	(Forced-Air-Cooled)	(Forced-Air-Cooled)	(Air-Cooled)	(Water-Cooled)
4-125A/4D21	8D21	6C24	7C24	2E24	9C21
		807	9C22	2E26	9C27
		813	9C25	807	889-A
		815	889R-A	813	892
		829-B	892-R	815	
		832-A	5588	829-B	
			5592	832-A	

The world's most modern tube plant . . .

RCA, Lancaster, Pa.



BOARD OF DIRECTORS, 1948
Benjamin E. Shackelford
President

R. L. Smith-Rose
Vice-President

S. L. Bailey
Treasurer

Haraden Pratt
Secretary

Alfred N. Goldsmith
Editor

Frederick B. Llewellyn
Senior Past President

W. R. G. Baker
Junior Past President

1948-1949

J. B. Coleman
Murray G. Crosby
Raymond A. Heising

T. A. Hunter
H. J. Reich
F. E. Terman

1948-1950

J. E. Shepherd
J. A. Stratton

1948

A. E. Cullum, Jr.
Virgil M. Graham
Raymond F. Guy

Keith Henney
J. V. L. Hogan

F. S. Howes
J. A. Hutcheson

I. J. Kaar

D. B. Sinclair

Harold R. Zeamans
General Counsel

George W. Bailey
Executive Secretary

Laurence G. Cumming
Technical Secretary

E. K. Gannett
Assistant Secretary

BOARD OF EDITORS

Alfred N. Goldsmith
Chairman

PAPERS REVIEW COMMITTEE

Murray G. Crosby
Chairman

PAPERS PROCUREMENT COMMITTEE

John D. Reid
General Chairman

PROCEEDINGS OF THE I.R.E.

(Including the WAVES AND ELECTRONS Section)

Published Monthly by

The Institute of Radio Engineers, Inc.

VOLUME 36

April, 1948

NUMBER 4

PROCEEDINGS OF THE I.R.E.

Julius A. Stratton, Director, 1948-1950.....	442
Hammond Vinton Hayes.....	443
3033. Noise-Suppression Characteristics of Pulse-Time Modulation....	
.....Sidney Moskowitz and Donald D. Grieg	446
3034. Magnetoionic Multiple Refraction at High Latitudes. S. L. Seaton	450
3035. Solar Noise Observations on 10.7 Centimeters... A. E. Covington	454
3036. An Analysis of the Intermodulation Method of Distortion Measurement.....	
.....W. J. Warren and W. R. Hewlett	457
3037. Automatic Volume Control as a Feedback Problem. B. M. Oliver	466
3038. A Flat-Response Single-Tuned I. F. Amplifier.....	
.....E. H. B. Bartelink, J. Kahnke, and R. L. Watters	474
3039. The Radiation Resistance of an Antenna in an Infinite Array or Waveguide.....	
.....Harold A. Wheeler	478
3040. Coupled Antennas.....	
.....C. T. Tai	487
Correspondence:	
3041. "Continuous Tropospheric Soundings by Radar".....	
.....A. W. Friend	501
Contributors to PROCEEDINGS OF THE I.R.E.....	503

INSTITUTE NEWS AND RADIO NOTES SECTION

Canadian I.R.E. Convention.....	506
Industrial Engineering Notes.....	507
Sections.....	510
Books:	
3042. "Radio Engineering," Third Edition, by Frederick Emmons Terman.....	
.....Reviewed by F. B. Llewellyn	511
3043. "Theory and Application of Microwaves," by A. B. Bronwell and R. E. Beam.....	
.....Reviewed by Simon Ramo	512
3044. "FM Simplified," by Milton S. Kiver.....	
.....Reviewed by C. M. Jansky, Jr.	512
I.R.E. People.....	513

WAVES AND ELECTRONS SECTION

Karl Kramer, Chairman, Chicago Section, 1947-1948.....	515
A Modern Telecommunications Laboratory.....	516
3045. Engineering Responsibilities in Today's Economy. E. Finley Carter	517
3046. Industrial Standards.....	
.....C. H. Crawford	519
3047. Radio Progress During 1947.....	522
3048. The Duct Capacitor.....	
.....Alan Watton, Jr.	550
Contributors to Waves and Electrons Section.....	554
3049. Abstracts and References.....	555
News—New Products.....	57A
Student Branches.....	38A
Section Meetings.....	34A
Positions Open.....	50A
Membership.....	40A
Positions Wanted.....	54A
Advertising Index.....	70A

EDITORIAL DEPARTMENT

Alfred N. Goldsmith
Editor

Clinton B. DeSoto
Technical Editor

Mary L. Potter
Assistant Editor

William C. Copp
Advertising Manager

Lillian Petranek
Assistant Advertising Manager

Responsibility for the contents of papers published in the PROCEEDINGS OF THE I.R.E. rests upon the authors. Statements made in papers are not binding on the Institute or its members.

Changes of address (with advance notice of fifteen days) and communications regarding subscriptions and payments should be mailed to the Secretary of the Institute, at 450 Ahnaip St., Menasha, Wisconsin, or 1 East 79 Street, New York 21, N. Y. All rights of republication, including translation into foreign languages, are reserved by the Institute. Abstracts of papers, with mention of their source, may be printed. Requests for republication privileges should be addressed to The Institute of Radio Engineers.





Julius A. Stratton

Director, 1948-1950

Julius A. Stratton was born in Seattle, Washington, on May 18, 1901. He attended the University of Washington from 1919 to 1920, when he came east and enrolled at the Massachusetts Institute of Technology. There he received the B.S. degree in electrical engineering in 1923. That same year he left for Europe, where he studied at the Universities of Grenoble and Toulouse. In 1925 he received the S.M. degree in electrical engineering from the Massachusetts Institute of Technology.

Returning to Europe, he obtained the degree of Sc.D in mathematical physics at the Technische Hochschule in Zurich, Switzerland, in 1927. In 1928 he did post-graduate work at the University of Munich.

On his return home once again, Dr. Stratton became assistant professor of electrical engineering at M.I.T. He was later made associate professor, and in 1940 became professor of physics at that institution, in which capacity he has remained to date.

From 1940 to 1945 he was a staff member of the M.I.T. Radiation Laboratory of the National Defense Research Council, and in 1945 he became director of the Research Laboratory of Electronics at the Massa-

chusetts Institute of Technology. During World War II he was associated with the Office of the Secretary of War as expert consultant. Since 1946 he has served on the Research Development Board as chairman of the Committee on Electronics.

Dr. Stratton is a Fellow of the American Academy of Arts and Sciences and of the American Physical Society, and is a director of the Armed Forces Communication Association. He became a member of the Institute of Radio Engineers in 1942, a Senior Member in 1943, and a Fellow of the Institute in 1945, "in recognition of his contribution as a teacher and author, adept in the field of fundamental research, who has applied his knowledge to improve radio communications." His contribution to the affairs of The Institute of Radio Engineers has always been one of active service. He was on the Annual Review Committee in 1945 and 1946, on the Education Committee in 1945, on the Radio Wave Propagation and Utilization Committee in 1945, 1946, and 1947, on the Standards Committee in 1945 and 1946, on the Board of Editors in 1946 and 1947, and on the Membership Committee in 1947.

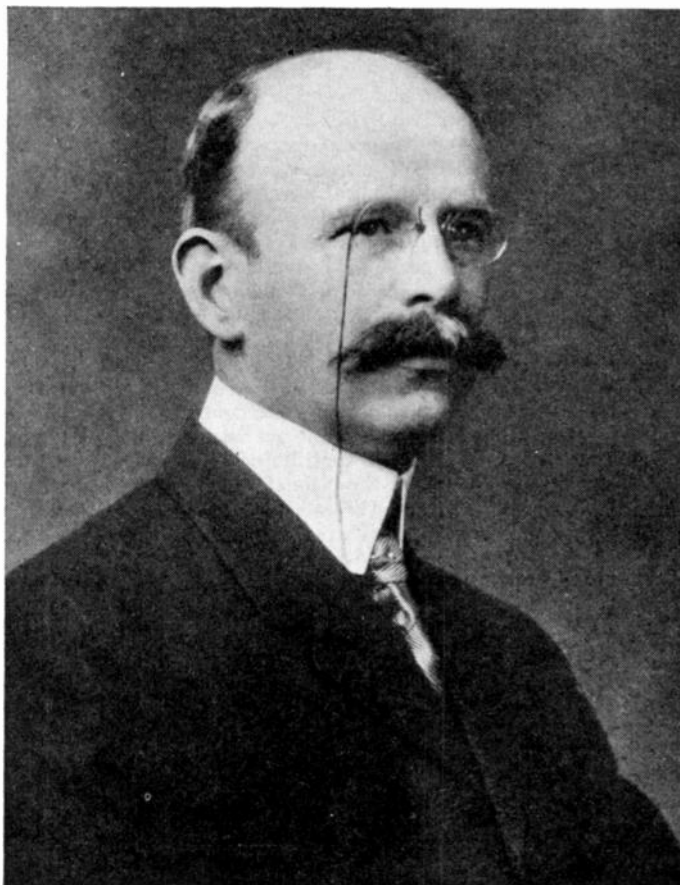

Hammond Vinton Hayes
August 28, 1860—March 22, 1947
 Scientist, Pioneer, and Benefactor

Edward L. Bowles

On the 21st of August, 1947, in routine formality, the will of Hammond Vinton Hayes was allowed for probate in Boston. It named Harvard University and the Massachusetts Institute of Technology co-equally as residuary legatees. The wish of the benefactor was that the income from the funds be used to encourage young scholars in advanced work in the fields of electrical communications and electronics.

Hayes died on March 22, 1947, at his home, 48 Beacon Street, Boston, the city

in which he had lived most of his life. So selfless was he, so inconspicuously did he go about his work, that few of the present generation knew of his existence. Even fewer were aware of his varied scientific achievements and his profound influence on the early technological development of the telephone art. This influence alone is of such historical significance that notice of the Hayes contribution is of importance. A glimpse of the telephone scene at the time of his entrance upon it is material to an

understanding of this contribution. The Bell System, whose annual gross income today is nearly two billion dollars, was embryonic at this time.

It was on December 7, 1885, that Hayes joined the American Bell Telephone Company as head of the Mechanical Department. He had been graduated by Harvard University in 1883. Subsequently he had studied electrical engineering at the Massachusetts Institute of Technology and science at Harvard, where he was granted a Master's

degree and the second Doctor's degree in Physics to be awarded by the University. His entry into the employ of the Bell Company was auspicious, not only because of his inheritance and unusual training, but because of the formative state of the electrical communication art.

At the time Hayes joined the organization it had been ten years since Bell electrically transmitted and reproduced the "twanging" of a spring. Within a year he had followed the discovery with the transmission of articulate speech. Gardiner G. Hubbard and Thomas Saunders, visionary entrepreneurs, had given initial financial and management impetus to the Bell idea of telephony. The concept of the microphone, as demonstrated by Professor David E. Hughes and discovered independently by Thomas A. Edison and Emile Berliner, had been adapted in carbon form by Henry Hunnings, Francis Blake, Jr., and others. Hughes had demonstrated the phenomenon of amplification by this means—the modulation of a local (battery) energy source—and thus opened up vast possibilities in communication. The Western Union organization in the fall of 1876 had turned down the proffer of Bell's telephone invention, later to realize its shortsightedness and entreat Edison to help with the development of a competitive patent position in the field. Only six years before Hayes joined the Bell interests they had overcome the Western Union threat by an adroit settlement in which Western Union was paid handsome tribute to keep out of the telephone business for seventeen years. Other inventors, including Stephen Gray, Daniel Drawbaugh, and Amos Dolbear, were asserting their interests. Crucial and protracted patent litigation was in process, and James J. Storrow had begun his distinguished legal work which later was to characterize him as savior of the Bell interests, when in March, 1888, the U. S. Supreme Court handed down its dramatic (4 to 3) decision sustaining the Bell interests.

Five years before Hayes' employment, an iron wire line between Boston and Providence was put into operation. The preceding year, a hard-drawn copper wire line between Boston and New York had been opened. Authorizations had been effected to extend long-distance facilities to Philadelphia and Washington and from New York to Albany. Hubbard had determined on the idea of leasing telephone instruments, and the concept of a federation of operating companies was in the making by the precedential incorporation of a New England Telephone Company. The concept of a parent company controlling links interconnecting local operating companies was generating, as evidenced by the establishment of the American Telephone and Telegraph Company in February, 1885, for the purpose of installing and operating long-distance lines.

In this first decade of Bell history the vicissitudes of finance and management, the uncertainties of competition and patent position had already conjured up some seven patterns of organization and reorganizations. There had been a wealth of empirical experimentation and invention and negligible scientific analysis. The telephone was as yet a local-battery magneto ringing device. Had this initial Bell management been fully aware of the technical obstacles ahead, it would have been far less courageous. As matters stood upon Hayes' entry, the Bell operations were approaching a stage where real technical obstacles were beginning to assert themselves and seriously threaten company survival. Because of the growing complexity of the scientific and technological problems, considering Bell's characteristics, perhaps the greatest contribution he made to the telephone art was to have retired as an active contributor some years before. Fortunate it was for the organization that a man of Hayes' background and qualities was available to formulate and help to solve the manifold problems, which by his scientific acumen he was well prepared to comprehend.

Hayes was faced with two principal tasks, one the acute job of improving the immediate apparatus and techniques, and the other the responsibility for planning ahead to anticipate the difficulties of the future, difficulties sure to come with the growing demand for better local service and greater long-distance capabilities. Dovetailed into these complementary challenges was the ever-recurring job of working with Storrow, Professor Charles R. Cross, and others on pressing and vital patent litigation constantly threatening the companies' position.

One of the first problems confronting Hayes was the complex development of better transmitters. By the early nineties, progress had been made through the development of the solid-back granular-carbon device by Anthony C. White. Impressed by the difficulties and limitations of the local-battery subscriber set, Hayes gave much of his attention directly to the amelioration of this problem. Current practice was to utilize Fuller cells for the long-distance transmitters. In Hayes' words, wagons used in the replacement of these batteries became so weakened by the corrosive effect of the bichromate electrolyte that often they fell apart in the streets, leaving a somewhat colored impress and distressing corruption upon the byways of Boston. By 1888 Hayes was ready to make an experimental installation of a central-office battery system in the offices of the American Bell Telephone Company in Boston. The next step was a common-battery switchboard in Lexington, Massachusetts, in 1892. Based on a study of the detail difficulties brought out in these installations, victory over the opposition was finally won after the installation of a com-

plete common-battery system in Philadelphia in 1895. The Hayes patent No. 474,323, issued in May, 1892, is eloquent evidence of his grasp of the problem. The two-winding "induction coil" shown therein is to be found in modern embodiment as the "repeating coil" in every central-office cord circuit.

One of the most vexing problems was that of protecting telephone apparatus from destructive outside disturbances, such as lightning, and crosses with other electric power circuits now coming into practice. Not only was a sure-fire method an imperative need, but there must be a standard practice in the operating organizations. By 1891 Hayes and his assistants had developed the protective combination of special tubular fuse, carbon gap, and heat coil, an effective ensemble today. The heat coil to short the control-office terminal of a line, thus obviating the passage of damaging "sneak currents" through the delicate apparatus, was a direct contribution by Hayes. His analysis and direction of this problem was further evidence of his comprehension of the importance of systems engineering and standard practices.

The technical difficulties of long-distance transmission asserted themselves early. The introduction of hard-drawn copper wire made it possible to reach as far west as Chicago in 1894. Denver proved too much. The sheer weight of copper, cross talk from unbalance, and the variability of open-wire transmission presented discouraging problems. Underlying the application of cables and long open-wire lines was the problem of complex attenuation which affected not only the amplitude of a signal but independently its intelligibility. With overhead plant forced under ground by public reaction, and in the interest of safety, recourse to cables was essential, yet here the problem of transmission was acute. Hayes, conscious of the need for fundamental study of the theoretical limitations and potentialities of transmission, put George A. Campbell to work on this problem.

I quote from the Annual Report, Mechanical Department, dated December 31, 1898, by Hayes: "With Mr. Campbell's assistance I confidently expect during the coming year to be able to report progress in the design of Long Distance cables . . ."

The result was a brilliant achievement—the specific way in which to load cables and open-wire lines so as to give relatively uniform transmission over a band of the voice-frequency spectrum sufficiently broad for good articulation. Although in the ensuing patent interference Pupin was adjudged the inventor, this legal technicality does not alter the stature of Campbell's superb intellectual and practical achievement. Unfortunately, in the subsequent confusion between legal and intellectual credit, coupled with other factors, it appears to have been

well-nigh mandatory that henceforth Hayes and others give general credit to Pupin. This dichotomy between intellectual recognition and legal credit was a tragedy. Hayes and Campbell both must have suffered severely from the blow. It is to their great credit that it did not affect their enthusiasm for the telephone art.

This outline of Hayes' contribution to telephony would not be complete without reference to the work carried out on repeaters. The early application by Edison of the microphone as a relay was developed by several men under Hayes' direction. The most notable detail work on the mechanical repeater was done by Shreve. These mechanical devices were first applied to a long-distance circuit in 1904 between New York and Chicago, and in 1907 between Boston and Chicago. Although the line from the East to Denver, 1911, and Salt Lake City, 1913, made use of loading and not repeaters, the coast-to-coast circuit of 1915 was tested interchangeably with mechanical and audion amplifiers. By this time the pioneer work of the Hayes group on repeaters, including the classical analysis by Campbell of gain limitation in repeater circuits, was ripe for substitution of the improved DeForest amplifier tube in place of the carbon-button cartridge. The introduction of this repeater technique was to open a golden era of long-distance potentialities.

These systematic developments, punctuated by the studies of J. S. Stone and the experiments of G. W. Pickard in 1902 in the field of radio telephony, eloquently bespeak Hayes' spirit of exploration. This philosophy is so well expressed in a paper read by him shortly after the turn of the century, from which I quote: ". . . until we are able to offer commercially telephone service across the continent, from the Atlantic to the Pacific Coasts, we, the engineers, will not feel that the problem has been solved. In fact, I think it not unlikely that when this range of long-distance transmission has been reached we will still feel it incumbent upon us to find some way of communicating telephonically across the Atlantic Ocean." Little did he know he was presaging the Arlington-Paris-Honolulu tests of 1915.

Hayes became chief engineer of the American Telephone and Telegraph Company in January 1905. This organization in 1899 had taken over all assets of the American Bell Telephone Company and was at that time made the central organization of the Bell System. Early in 1907 Theodore N. Vail was brought back once more to head this parent company. Vail, conditioned by some business failures as well as success in the intervening period, attributed the failures to poor advice by engineers. He had doubt that engineers could be of any real help to the Bell System. Impressed with J. J. Carty, Vail had predetermined to have him as his chief engineer. Vail informed

Hayes he was not satisfied with the condition of the engineering work, it was costing far too much. The company, Vail observed, was burdened with debt in a very bad way. Summarily Vail announced to Hayes that forthwith he was turning over to Carty the duties of chief engineer (Hayes diary).

Hayes was offered a pitifully small retainer, and there was humiliation in the bargain. This all happened in the late spring and summer of 1907. To Hayes, an aristocratic gentleman and a scholar, this episode was never condoned. To him there was an impersonal brutality to the act he could not forget. His interest in telephony, however, never wavered despite the shock. His spirit is summed up in a sentence from a letter from Campbell: "In August, 1907, you could not have been more enthusiastic about the future of the Bell System had you had the vacuum-tube amplifier up your sleeve."

In his twenty-two years Hayes had seen the Bell System through a most trying period. He had brought it technical vigor and had set a high standard in research and engineering. His influence on the future of telephony was to be felt through such disciples as O. B. Blackwell, G. A. Campbell, F. J. Chesterman, E. H. Colpitts, F. B. Jewett, E. C. Molina, W. L. Richards, G. K. Thompson, H. S. Warren, and many more of his staff of some two hundred and fifty. The modest group gathered under his scholarly leadership and inspired by his high principles was to continue on and, in the course of evolution, become the Bell Telephone Laboratories of today, an organization which may look with pride on its Boston inheritance. Walter O. Pennell's statement to Hayes at this juncture was therefore significantly prophetic: "Your name will always be associated with the modern telephone system."

In the period 1907 to 1924 Hayes practiced as a consulting engineer. One of his larger clients was the National Telephone Company of Great Britain, for which he appeared as an expert in the evaluation of plant assets. The issue was the price the government should pay for the property in the course of the nationalization of communications. Based on his evaluation experience he published two volumes: *Public Utilities, Their Cost New and Depreciation*, 1913; and *Public Utilities, Their Fair Present Value and Return*, 1915.

Another client was the Submarine Signal Company, of which he became chief engineer in 1922 and president in 1925. Here he was active in the development of much classified underwater sound equipment for the U. S. Navy, and the Fathometer, which has come to take an indispensable place in modern navigation.

Upon his retirement from the Submarine Signal Company in 1930 Hayes established his own laboratory where, up to his death, he continued his scientific work. Early in his

career he had become interested in Bell's photophone experiments. In 1900 in collaboration with Ernest R. Cram he developed a system of "radiophony" comprising a modulated-arc transmitter in combination with a radiant-energy receiver. His discovery of the speaking arc was basic. One of the detectors in this system was derived from a device originally used by Bell—charred cork particles confined in a vessel coupled stethoscope-like to the ear upon which the modulated radiant energy impinged. Upon his retirement Hayes went back to this idea, refining and developing it as a modern sensitive detector of radiant energy. His principal application of it was to the transmission of radiant energy through fog. His "baby," as he termed his carbonized-fluff detector, and his work on transmission through fog are described in the *Review of Scientific Instruments*, *Journal of Applied Physics*, and the *Journal of The Optical Society of America*.

The following impression of him may be of some interest:

"I saw Mr. Hayes only once, when he was an old gentleman of eighty-five. But I had read several letters of his, in his beautifully clear and precise handwriting, and he was very like the picture I had formed of him.

He was tall and spare and very fastidious. His clothes, his collar and his boots, not shoes, obviously made to measure, and a little old-fashioned in style. His eyes were still a clear and tranquil blue, his white moustache a little too long, his hands long, thin and precise.

He had a charming, grave courtesy, formal, dignified, and yet very friendly. His eyes had a quiet twinkle in them. But he gave the very definite impression of being a lonely man in his old age, and he admitted as much.

He could have lived in just one place, on Beacon Street, facing the Common. He looked down on its crowds through lavender-paned windows, the rooms behind him filled with the lovely furniture which had been in his family for generations.

He lived, in his old age, in the years long behind him; because for him they had been comfortable and happy years of busy accomplishment, and their standards were right and so much finer than those of 1945."

His devotion to science, his meticulousness as a worker, and his quiet aristocratic manner are worthy bases for emulation. With his ideals it is natural that he should have held steadfastly to the principle that higher education is one of our great national assets. That he should have dedicated his modest fortune to this end, when government subsidy to educational institutions is of a magnitude greatly to overshadow private grants, is further testimonial to his faith in the principle that the security of higher education rests in control and support by the individual.

Noise-Suppression Characteristics of Pulse-Time Modulation*

SIDNEY MOSKOWITZ†, MEMBER, I.R.E., AND DONALD D. GRIEG†, SENIOR MEMBER, I.R.E.

Summary—An experimental investigation of the noise-suppression characteristics of pulse-time modulation is outlined. Impulse noise and thermal-agitation or fluctuation noise are treated. The effects of these types of noise and the improvements obtained through the use of limiters, differentiators, and multivibrators are presented graphically.

INTRODUCTION

COMMUNICATION SYSTEMS utilizing pulse-time modulation and the general properties of this type of modulation have been described in the technical literature.¹⁻⁵ Briefly, in this method, instantaneous samples of the modulating wave vary the time of occurrence of a pulse subcarrier. Thus, a particular value or sample of the modulating signal is represented by the displacement of the pulse in time with respect to a synchronizing pulse or time reference, and the frequency of the modulating signal is given by the rate of change of pulse displacement.

One of the important characteristics of pulse-time modulation is its noise-reducing properties. The noise can be of two distinct types: impulse noise, and thermal-agitation or fluctuation noise. The first may be short impulses caused by electrical disturbances or they may originate in neighboring systems. Thermal-agitation and other noises that have a similar spectral distribution such as "shot" noise are usually contributed by the first few stages of the receiving equipment and, to a lesser degree, by the transmitter if "jitter" exists.^{6,7} In general, thermal-noise effects are most important because they determine the lower limit of sensitivity and, hence, such transmission parameters as bandwidth and power.

In a pulse-time system in which the transmitted intelligence is derived from the timing of a pulse edge, noise may displace the pulse edge from the value corresponding to the modulating signal. Noise impulses also may modulate other characteristics of the signal pulses such as amplitude, width, and slope of the pulse edges, but are ultimately translated into pulse-time displacement. The optimum signal-to-noise ratio is realized when all effects of noise, other than time displacement, are eliminated by suppression devices in the receiver.

The method by which noise distorts the signal pulses and causes a distortion of the pulse edge timing is shown in Fig. 1. It should be noted that only d.c. or "video" pulses are treated; they are considered independently of the method of transmission. Where amplitude modulation of an r.f. carrier is utilized, noise-reduction properties are the same as at video frequencies. Where frequency modulation of the carrier is by means of time-modulated pulses (frequency-shift keying), the video-frequency relationships with respect to noise are likewise similar, but reduced by the ratio of the improvement factor attributable to f.m. transmission.

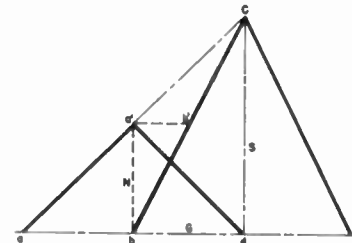

Fig. 1— S and N are signal and noise impulses. Output noise $= a'b'$. (S/N) output $= D/a'b'$, where D = modulation displacement. $ab = bd = G$. $a'b'/ab = a'b'/G = (N/S)$ input. (S/N) output $= (S/N)$ input D/G .

A gate limiter will remove noise amplitude modulation as well as noise occurring between pulses. The following discussion assumes an idealized pulse that builds up to maximum amplitude and decays in a time determined by the transmission bandwidth. Under these conditions, both the noise and signal pulses can be represented approximately by triangular shapes.

The time displacement of the pulse edge caused by a noise impulse is shown in Fig. 1 as $a'b'$. A narrow gate limiter is set at the pulse amplitude corresponding to the peak of the noise. Hence, as shown, the signal-to-noise ratio at the threshold level represented by time modulation is improved over that obtained at the receiver input by the factor D/G , where D is the modulation displacement and G is the build-up time. It is well

* Decimal classification: R148.6. Original manuscript received by the Institute, April 30, 1947; revised manuscript received, September 15, 1947. Presented, 1947 I.R.E. National Convention, March 6, 1947, New York, N. Y.

† Federal Telecommunication Laboratories, Inc., New York, N. Y.

¹ E. M. Deloraine and E. Labin, "Pulse-time modulation," *Elec. Commun.*, vol. 22, no. 2, pp. 91-98; 1944.

² D. D. Grieg and A. M. Levine, "Pulse-time-modulated multiplex radio relay system—Terminal equipment," *Elec. Commun.*, vol. 23, pp. 159-178; June, 1946.

³ F. F. Roberts and J. C. Simmonds, "Multichannel communication system," *Wireless Eng.*, vol. 22, p. 538; November, 1945.

⁴ R. E. Lacey, "Two multichannel microwave relay equipments for the United States Army communication network," *Proc. I.R.E.*, vol. 35, pp. 65-70; January, 1947.

⁵ B. Trevor, O. E. Dow, and W. D. Houghton, "Pulse-time division radio relay," *RCA Rev.*, vol. 7, pp. 561-575; December, 1946.

⁶ H. T. Friis, "Noise figures of radio receivers," *Proc. I.R.E.*, vol. 32, pp. 419-422; July, 1944.

⁷ C. W. Hansell, "Radio-relay-systems development by the Radio Corporation of America," *Proc. I.R.E.*, vol. 33, pp. 156-168; March, 1945.

known that the frequency band necessary to support a pulse build-up time G is inversely proportional to G . Therefore, the signal-to-noise improvement ratio is directly proportional to the frequency bandwidth of the receiver, provided the transmitted bandwidth is equal to or greater than the receiver bandwidth.

It should be pointed out that it is not possible to derive in a simple manner the exact constants of proportionality. In practice, purely triangular pulses are not common, nor is the pulse edge truly linear. Furthermore, it is necessary to know the relation between the equivalent noise peak (N) and the r.m.s. noise voltage.

It is interesting to note that the input signal-to-noise ratio in a time-modulation system in which the frequency band is optimum for a given pulse width is constant with respect to the frequency band, and depends only on the average power. Corresponding to the increase in noise amplitude with increasing bandwidth, the pulse amplitude will be increased in the same proportion, because the narrower pulse for the same average power will represent greater peak power. Thus, for a given average power, the improvement in signal-to-noise ratio that can be realized with time-modulated pulses is proportional to the frequency band, as is the case with frequency modulation, but, unlike frequency modulation, the improvement ratio continues to increase with increasing bandwidth.

This analysis of pulse-time modulation is based on a demodulation system in which the pulse edge defines the pulse timing. It is possible for the leading and trailing edges of the pulse to be distorted in opposite directions by noise pulses. A further gain of approximately 3 db in signal-to-noise ratio may be obtained by utilizing the center of the pulse for demodulation. This gain is realized, however, at the expense of system complication. For example, a system may be visualized whereby both pulse edges are demodulated and the outputs added to reinforce the modulating signal, but partially cancel noise.

Many types of noise pulses, which run the gamut of all shapes and variations in time consistent with the bandwidth of the receiver, might be imagined. As far as their interfering effects are concerned, only those edges of noise pulses that actually coincide in time with the signal pulse edge will cause an a.f. noise output.

I. NOISE TESTS

The types of noise suppressors described in this paper that have been used in pulse-time-modulation receivers are gate limiters, differentiators, and multivibrators. Tests were conducted wherein a train of time-modulated pulses was transmitted to a pulse-time demodulator over a wire link in which the noise-suppression circuit under test was inserted.

A block diagram of the apparatus is shown in Fig. 2. The wide-band fluctuation noise contained frequency components from 30 c.p.s. to 1.5 Mc. The noise generated in a resistor was amplified by an 11-Mc. i.f. am-

plifier having a bandpass characteristic of ± 2.5 Mc. The band of noise at the intermediate frequency was

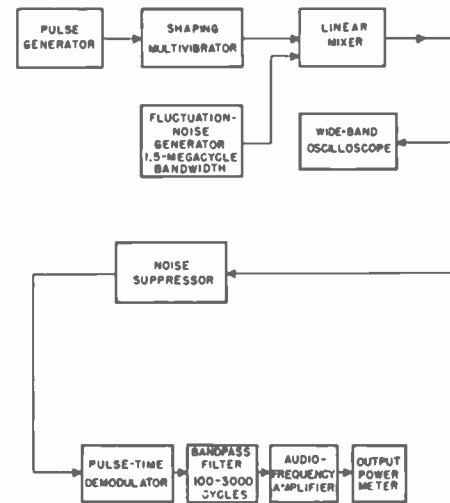

Fig. 2—Block diagram of pulse-time-modulation noise-test setup.

transposed to video frequency and the bandwidth limited to 1.5 Mc. by an adjustable output filter.

In carrying out the noise tests, provision was made for substituting a pulse-interfering source for the fluctuation-noise generator. The pulse-interference source consisted of a combination multivibrator, differentiator, and shaper circuit. This device generated pulses of a constant width and with a repetition rate continuously variable from 250 to 1000 pulses per second. The amplitude of this interfering signal was continuously adjustable without destroying the pulse shape.

The double-gate limiter, shown in Fig. 3, consisted of two pentodes having individually adjustable grid-bias controls to determine the position of the upper and lower levels of limiting.

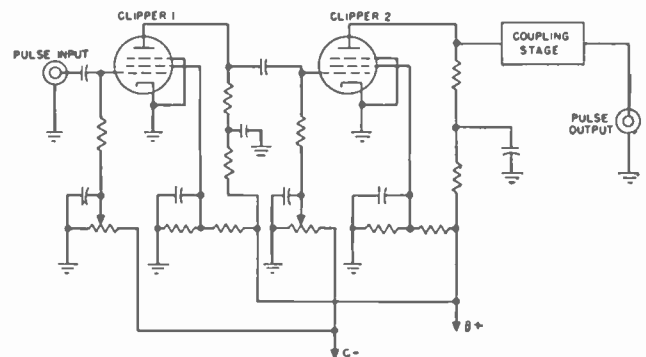

Fig. 3—Double-gate limiter used as protection against interference.

A resistance-capacitance type of differentiator was used in conjunction with a limiter, so that the leading edge of the signal pulse could be selected and demodulated. The multivibrator was of conventional type, as may be seen from Fig. 4. Input and output coupling stages isolate the multivibrator from external effects. In addition to variable time constants, an input attenuator was provided to control the amplitude of the synchronizing signal supplied to the multivibrator. This input at-

tenuator was constructed so that neither the input pulse shape, output pulse shape, nor the multivibrator time constant was affected during manipulation.

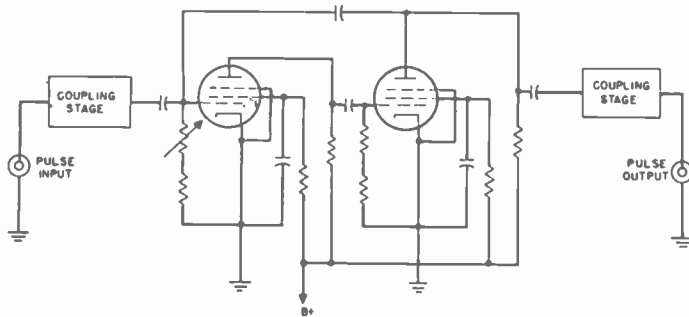

Fig. 4—Multivibrator used as protection against interference.

The characteristics of the pulse-time transmission system were as follows:

Pulse repetition rate (p.p.s.)	12,000
Pulse period (μ s.)	83
Modulation displacement (μ s.)	± 8
Pulse build-up time (μ s.)	0.75
Pulse decay time (μ s.)	1.5
Pulse width at base (μ s.)	2.5
Audio modulation frequency (c.p.s.)	400
Demodulator audio-frequency pass band (c.p.s.)	100 to 3000

Oscillographic comparison was made of the input pulse signals and interfering noise. For this measurement the horizontal sweep voltage usually was removed from the deflecting plates, and the magnitude of the vertical traces compared.

Peak values of noise were measured in this manner for convenience. A comparison measurement by means of a thermocouple was made to determine the ratio of the peak value of noise as measured by the oscilloscope to the r.m.s. value, and this ratio was found to be 3.5.

II. FLUCTUATION NOISE

In the first test on fluctuation noise, the output signal-to-noise ratio was compared to that at the demodulator input without noise-suppression devices. The results are shown graphically in curve A of Fig. 5. The input signal-to-noise ratio is given in terms of peak amplitude, because of the oscillographic method of measurement. Thus, 6 db here corresponds to a noise peak equal to one-half the modulation pulse peak.

The output signal-to-noise ratio is shown to be proportional to the input ratio with no improvement. Under these conditions, the output signal contains noise for two main reasons. First, noise is introduced directly as amplitude modulation in the demodulator. Secondly, some noise is introduced as time modulation because of the inherent nonlinearity of the demodulator. It is obvious that, in a multichannel system, where only selected groups of pulses are applied to the demodulator, some improvement would be obtained because a large portion of the pulse-repetition period would be blanked out. Thus, only noise appearing within the time allotted to one channel would affect the output signal. The sys-

tem used here may be compared to a multiplexed system by extrapolating the results obtained. The output signal is proportional to the modulation displacement, so that, for a maximum modulation displacement of $\pm 40 \mu$ s., an output signal-to-noise ratio 5 times greater would be obtained. In the multichannel pulse system, the same signal-to-noise conditions for maximum individual channel displacement would be obtained, since the noise power is less per channel by the ratio of channel time to base pulse period. (This example holds, of course, only for the same pulse peak power for both systems.)

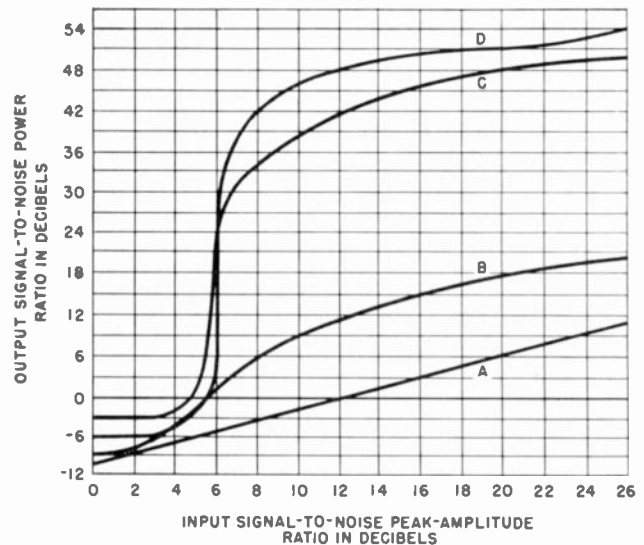

Fig. 5—Output signal-to-noise power ratio plotted against input signal-to-noise peak-amplitude ratio for fluctuation noise and a pass band of 1.5 Mc. Curve A is with no protection. Curve B is for a double-gate limiter. Curve C is for two double-gate limiters separated by a differentiator. Curve D is for three double-gate limiters and two differentiators alternately connected.

Curve B of Fig. 5 illustrates the results of using a double-gate limiter to remove a.m. noise. It can be seen that no critical threshold occurs, although the output signal-to-noise ratio begins to increase more rapidly when a 2:1 ratio is obtained at the input. There is a gain of about 12 db over the ratio obtained in the preceding test. The slight effect of the limiter is accounted for by the presence of width-modulation noise, which may be removed by a differentiator and second double-gate limiter. The action of such devices is shown by curve C of Fig. 5. A definite threshold level is obtained, above which noise suppression is considerable. By further differentiation and limiting, the improvement above the threshold is further increased as illustrated by curve D.

The function of successive stages of differentiation may be accomplished by a multivibrator that is synchronized by the signal pulses. The multivibrator furnishes a pulse whose leading edge corresponds in time to the leading edge of the synchronizing pulse, and whose trailing edge is a function only of the multivibrator time constants. Only the leading edge is selected for demodulation. In addition, the limiting effect is obtained by the triggering action of the multivibrator. The results obtained with this device are shown in Fig. 6,

whence it can be seen that superior improvement is obtained at and above the threshold level.

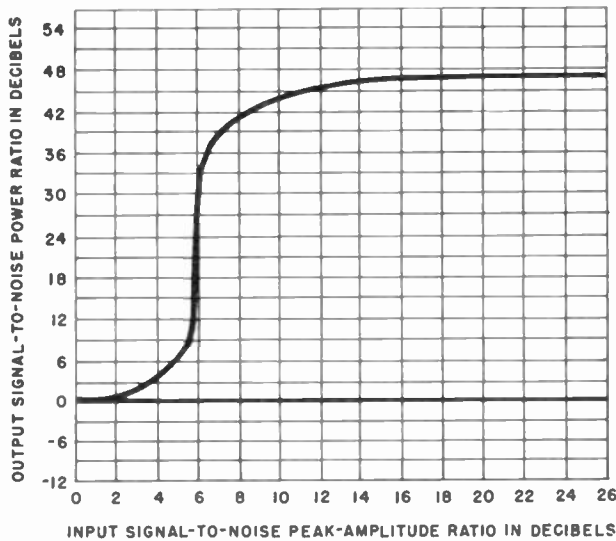

Fig. 6—Conditions similar to Fig. 5, but with a double-gate limiter and multivibrator.

Further tests were made in which a stage of differentiation was added to the multivibrator. No significant further improvement was noted, showing that the multivibrator entirely removed the width-modulation noise.

It can be concluded from the foregoing tests that the maximum signal-to-noise ratio improvement can be obtained from a pulse-time-modulation system either by including successive stages of limiting and differentiation, or by incorporating these functions in a multivibrator. In this manner, the reduction of output noise by the elimination of all noise modulations, except that of edge timing, is accomplished.

To determine the noise improvement of pulse-time modulation as a function of the bandwidth utilized, a test was made wherein the video-frequency and noise bandwidths were simultaneously varied, and the output signal-to-noise ratios at the threshold were measured. The resulting curve, Fig. 7, shows that the threshold

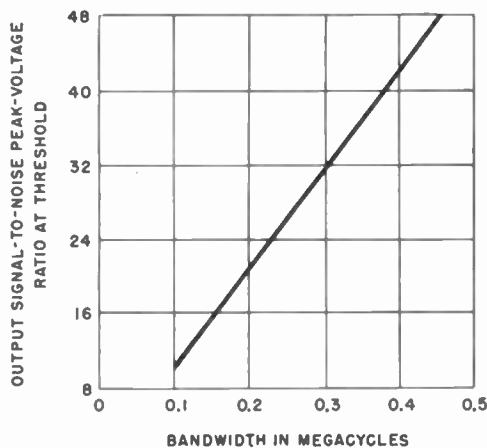

Fig. 7—Signal-to-noise ratio plotted against bandwidth for thermal agitation noise and signal-pulse displacement of $\pm 8 \mu\text{s}$.

signal-to-noise ratio is proportional to the bandwidth utilized. From this curve, the empirical constant of pro-

portionality between input and output signal-to-noise ratio may be obtained, since

$$\text{output peak } S/N = \text{input peak } S/N (KDF_v)$$

where K is a constant, D is the modulation displacement, and F_v is the video-frequency bandwidth. The value of K can be determined from Fig. 7 to be equal to 7.5.

Since the optimum a.f. bandwidth, equal to 0.5 the pulse-repetition rate, was not used in these tests, the above equation may be corrected by a factor of $1/\sqrt{2}$. Thus, for the optimum system, we have

$$\text{output peak } S/N = \text{input peak } S/N 5.3 DF_v.$$

Furthermore, the maximum modulation displacement is equal to $1/2f_p$, where f_p is the pulse-repetition rate, and since f_p may equal twice the highest modulation frequency f_a , we may then conclude that

$$\text{output peak } S/N = \text{input peak } S/N 1.3 \frac{F_v}{f_a}.$$

This equation defines the signal-to-noise improvement for the optimum pulse-time-modulation system. The result may be applied to a multiplexed system by assuming the highest modulation frequency to be the value for one channel multiplied by the number of channels in the system.

III. IMPULSE NOISE

Under some conditions, the suppression of impulse noise may be of interest. A study, similar to the foregoing for fluctuation noise, has been made in which the impulse-noise-suppression characteristics of pulse-time modulation have been measured. The noise source for the previous tests was replaced by a generator of pulses whose repetition rate was variable. Fig. 8 illustrates the results obtained without any suppression devices. The output interference varies almost directly with input interference. However, the lower-repetition-frequency

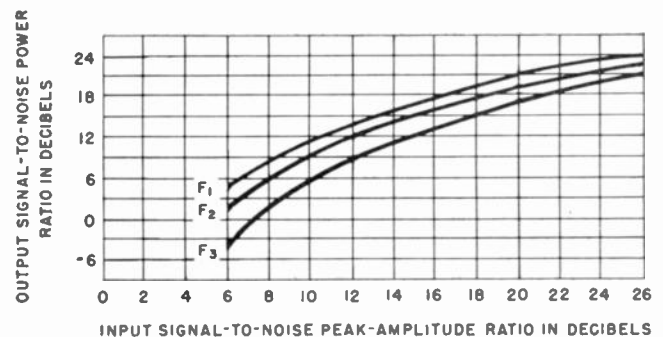

Fig. 8—Output signal-to-noise power ratio plotted against input signal-to-noise peak-amplitude ratio for 3- μs . noise pulse having repetition frequencies of $F_1=250$, $F_2=500$, and $F_3=1000$. No protection.

pulses cause less interference than those at higher rates. The pulses being of constant width, doubling the pulse frequency increases the noise power by 3 db, accounting for the variation shown on the curves. All pulses react

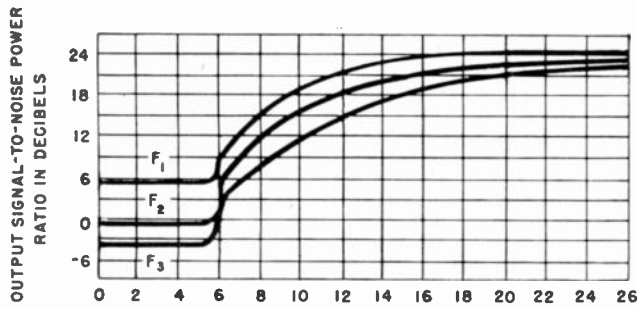

Fig. 9—Conditions similar to Fig. 8, but with double-gate limiter.

on the demodulator, and their fundamental and some higher harmonics are within the pass band of the a.f. system. As a result, there is very little, if any, improvement in this unprotected system.

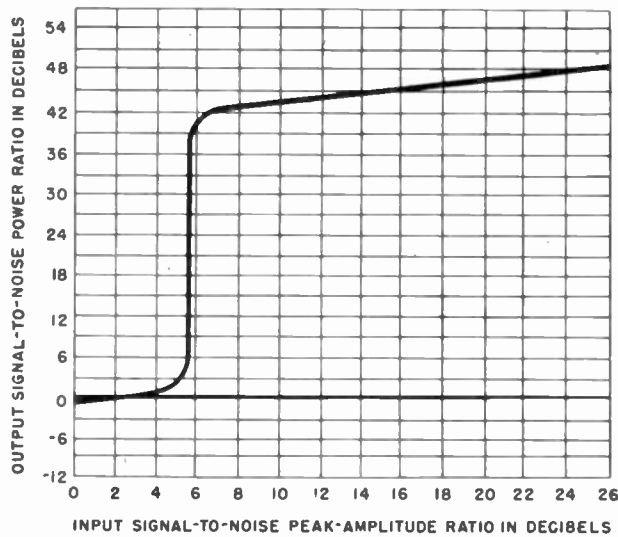

Fig. 10—Conditions similar to Fig. 8, but with two double-gate limiters separated by a differentiator. Noise pulses are at a rate of 500 p.p.s.

By incorporating a double-gate limiter, a 6-db improvement is obtained as shown in Fig. 9. When the signal-to-interfering-pulse ratio is above the 2:1 threshold, only those pulses that occur at the same time as the signal pulses can cause interference. This effect takes place at the beat frequency of the two sets of pulses, causing a distortion of the signal in the same manner as the fluctuation noise, but with a more limited frequency spectrum. Below the threshold, the signal and interfering pulses are limited to the same amplitude, so that the output signal-to-noise ratio is constant.

By adding a differentiating circuit and a second stage of limiting, a sharply defined threshold is obtained. The results of a test using this suppression device are shown in Fig. 10. The steep threshold indicates that the suppression is more complete than that obtained with fluctuation noise.

IV. CONCLUSION

The described tests and results have illustrated the signal-noise capabilities of a pulse-time-modulation system. In addition, the effectiveness of limiters, differentiators, and multivibrators in realizing optimum noise improvement for both thermal and agitation noise and impulse interference has been demonstrated. In addition to normal pulse displacement, noise may result from variations in pulse amplitude, width, and edge slope.

The various devices tested have proved effective in reducing such noise. The uses of these devices are, therefore, indicated to take maximum advantage of the bandwidths utilized for the system. A communication system operating in this manner may then be designed for minimum transmitter power necessary to produce a conservative output signal-to-noise ratio.

Magnetoionic Multiple Refraction at High Latitudes*

S. L. SEATON†, SENIOR MEMBER, I.R.E.

Summary—Experimental ionospheric soundings examined by Scott and Davies are cited, with a short discussion of the interpretation these authors offer for multiple refraction at high latitudes. The theory of magnetoionic multiple refraction of Appleton and Builder is discussed with especial regard to effects to be expected in high geomagnetic latitudes. Experimental evidence is offered to show that the "Z" component of Scott and Davies is probably the longitudinal ordinary ray predicted by Appleton and Builder and by Taylor when collisional friction is appreciable. On the basis of certain assumptions, the collisional frequency near Fairbanks, Alaska, is calculated as about $4(10)^4$ at 300 km. height.

* Decimal classification R113.613. Original manuscript received by the Institute, July 21, 1947.

† The Geophysical Observatory, University of Alaska, College, Alaska.

RECENTLY Scott and Davies¹ have discussed the fine structure of the ionosphere in high northern latitudes and have shown that three wave components, corresponding to ordinary ray, extraordinary ray, and a third which they designate the Z component, are frequently returned at vertical incidence from the ionosphere. Determinations were made by means of ionospheric soundings, and the three components were interpreted as resulting from magnetoionic

¹ Joint Meeting, The International Scientific Radio Union, and American Section, The Institute of Radio Engineers, paper No. 25, Washington, D. C., May 6, 1947.

multiple refraction. The theories of Appleton² and of Appleton and Builder³ were applied to explain the occurrence of multiple refraction. Scott and Davies are, however, uncertain concerning their Z component, but believe it to be the longitudinal ordinary ray described by Appleton and Builder. Discussion of the corresponding longitudinal extraordinary ray was neglected.

It is the purpose of this note first to examine the theories of Appleton and Builder with especial regard to high geomagnetic latitudes; secondly, to compare the theoretical and experimental results; and finally, to discuss these comparisons.

Appleton and Builder have shown that the relation between wave components of electromagnetic waves returned at vertical incidence from the ionosphere depends principally upon:

(a) The natural frequency of gyration of free electrons in the earth's magnetic field

$$f_H = \frac{He}{2\pi mc} \quad (1)$$

where

H = the magnetic field strength in gauss

e = the charge of the electron in e.s.u.

m = the electron mass in grams

c = the velocity of light in vacuo.

(b) Upon a critical ratio

$$2P_L\nu/P_T^2 \quad (2)$$

where

P_L = the natural angular frequency of gyration of free electrons about the longitudinal component of the magnetic field

P_T = the natural angular frequency of gyration of free electrons about the transverse component of the magnetic field

ν = the frequency of collision of free electrons with neutral air particles.

(N.B. Direction is taken for P_L and P_T with respect to the vertical for normal-incidence ionospheric soundings.)

It has been shown by Appleton and Builder that for the ionosphere the condition that the square of the refractive index equals zero, and reflection takes place, is reached when, approximately,

$$N = 3/2 \frac{\pi m}{e^2} f^2 \quad (3)$$

or when

$$N = 3/2 \frac{\pi m}{e^2} (f^2 \pm ff_H) \quad (4)$$

² E. V. Appleton, "Wireless studies of the ionosphere," *Inst. Elec. Eng.*, vol. 71, pp. 642-650; October, 1932.

³ E. V. Appleton and Geoffrey Builder, "The ionosphere as a doubly refracting medium," *Proc. Phys. Soc.*, vol. 45, pp. 208-220; March 1, 1933.

where

f = the exploring wave frequency

N = the free electron concentration.

If f is a penetration frequency, then N represents a maximum of electron concentration.

For propagation at any angle with respect to the earth's magnetic field, if the ratio

$$2P_L\nu/P_T^2 \gg 1,$$

then propagation is of the longitudinal type, and

$$N = 3/2 \frac{\pi m}{e^2} (f^2 + ff_H) \quad (5)$$

for the ordinary ray, and

$$N = 3/2 \frac{\pi m}{e^2} (f^2 - ff_H) \quad (6)$$

for the extraordinary ray.

This condition also exists for propagation along the direction of the earth's magnetic field for values of the ratio

$$2P_L\nu/P_T^2 \ll 1.$$

However, for propagation at any angle with respect to the earth's magnetic field, if

$$2P_L\nu/p_T^2 \ll 1,$$

then propagation is of the transverse type, and

$$N = 3/2 \frac{\pi m}{e^2} f^2 \quad (7)$$

for the ordinary ray, and

$$N = 3/2 \frac{\pi m}{e^2} (f^2 - ff_H) \quad (8)$$

for the extraordinary ray.

It has been tacitly assumed up to this point that ν is small, and consequently that friction is negligible. If, however, ν is appreciable, (8) takes the form

$$N = 3/2 \frac{\pi m}{e^2} (f \pm ff_H). \quad (9)$$

Thus, for propagation at any angle to the earth's magnetic field, three wave components should be returned from the ionosphere when appreciable friction exists. However, from many temperate-latitude ionospheric soundings, only two components are found. These correspond to those of (7) and (8).

It is to be noted that (6), extraordinary-ray longitudinal transmission, is identical with (8), transverse extra-ordinary ray. It is also to be noted that (5), longitudinal ordinary ray, is identical with (9) with the upper sign, i.e., second extraordinary ray, transverse propagation. The wave component of (7), transverse ordinary ray, is thus unique in that it represents only one possibility.

Appleton and Builder, in discussing polarization of the returned wave components, point out that for true longitudinal propagation the wave components are circularly polarized; the component of (5) being of the left-handed sense of rotation, while that of (6) is of the right-handed sense of rotation, all for the northern hemisphere. In the case of the transverse type of propagation the component of (7) is, in general, elliptically polarized with the left-handed sense of rotation, while the rays of (8), and (9) with upper sign, which are the extraordinary rays, are elliptically polarized with right-handed sense of rotation, all again for the northern hemisphere. Now, in the usual manner of ionospheric sounding in temperate latitudes, as noted above, only two wave components are found to be returned from the ionosphere. They have been identified by polarization measurements to be the ordinary ray and first extraordinary ray of the transverse mode of propagation.

If a constant value of N is supposed to exist, as is the case generally, then the frequency separation between these two components may be found by equating (7) and (8) thus:

$$(f_3 - f_2) = \frac{f_3 f_H}{(f_3 + f_2)} \quad (10)$$

where

- f_3 = the penetration frequency of the extraordinary ray
- f_2 = the penetration frequency of the ordinary ray
- f_H = the gyrofrequency.

Experimentally, the relationship of (10) has been verified to a rough approximation. It has been assumed that friction is negligible.

In longitudinal propagation it can be predicted by equating (5) and (6) that the frequency separation of the refracted wave components will be

$$(f_4 - f_1) = f_H \quad (11)$$

where

- f_4 = the penetration frequency of the extraordinary ray
- f_1 = the penetration frequency of the ordinary ray.

A similar separation, i.e., f_H , will occur for transverse propagation, with large values of friction, between the first and second extraordinary rays.

Now Scott and Davies find in high geomagnetic latitudes three components returned from the ionosphere. In view of the ambiguities noted above, the question clearly arises as to what are these three components.

With very small, or at least with negligible, friction, the change-over from the transverse to the longitudinal mode of propagation as the direction of wave travel approaches the direction of the earth's magnetic field

has been shown by Taylor⁴ to be discontinuous. Under these conditions, one would never expect to see three components simultaneously returned from the ionosphere. This does not agree with the experimental results.

However, it has been shown by Appleton, Appleton and Builder, Taylor, and others, that the extraordinary ray is more highly absorbed than is the ordinary ray. This conclusion is confirmed by ionospheric measurements. Furthermore, the second extraordinary ray in transverse propagation, to be expected under conditions of appreciable friction, is not only highly absorbed but encounters a barrier, so that even under conditions in which friction is not negligible this second extraordinary ray might fail to appear.

Since Scott and Davies observe three components at a location where vertical incidence soundings do not exactly coincide with vertical direction of the earth's magnetic field, the work of Taylor may be drawn upon, wherein it is shown that, when friction is appreciable, the transition from transverse to longitudinal propagation is a continuous function. Thus there is reason to believe that collisional friction is not negligible.

Under these conditions the three components observed by Scott and Davies may be explained as follows:

(a) The highest penetration frequency observed in the experimental soundings is the transverse extraordinary ray, the longitudinal extraordinary ray, or both.

(b) The next lower penetration frequency is unique and can only be the transverse ordinary ray.

(c) The lowest penetration frequency is very apt to be the longitudinal ordinary ray, but could be the second transverse extraordinary ray.

There appears to be no difficulty with the two higher penetration frequencies, and little doubt about the lowest penetration frequency. If polarization measurements were made on this lowest penetration frequency, the ambiguity could be resolved at once. However, polarization measurements are somewhat difficult to make.

There is, fortunately, another way in which a decision can be reached. The dispersion equations, as interpreted by Booker and Berkner⁵ and by Martyn and Munroe⁶ in examination of the Lorentz polarization correction in the ionosphere, show that at the gyrofrequency the extraordinary ray alone is retarded. One should, therefore, if the foregoing conclusions are correct, expect that at night, when the electron concentration is small and hence the penetration frequencies low,

⁴ M. Taylor, "The Appleton-Hartree formula and dispersion curves for the propagation of electromagnetic waves through an ionized medium in the presence of an external magnetic field," *Proc. Phys. Soc.*, vol. 45, p. 245, 1933; and vol. 46, p. 408, 1934.

⁵ H. G. Booker and L. V. Berkner, "An ionospheric investigation concerning the Lorentz polarization correction," *Terr. Mag.*, vol. 43, pp. 427-450; December, 1938.

⁶ D. F. Martyn and G. H. Munro, "The Lorentz polarization correction in the ionosphere," *Terr. Mag.*, vol. 44, pp. 1-6; March, 1939.

an experimental condition might exist such that the lowest penetration frequency will fall near the gyrofrequency. No unusual retardation would be expected for this third component as it crosses over the gyrofrequency if it is the longitudinal ordinary ray, but one would expect to find a retardation if it is the second extraordinary ray of the transverse mode of propagation.

Through the courtesy of the College Geophysical Observatory, University of Alaska, 64° north latitude (near Fairbanks, Alaska), Fig. 1 is presented showing

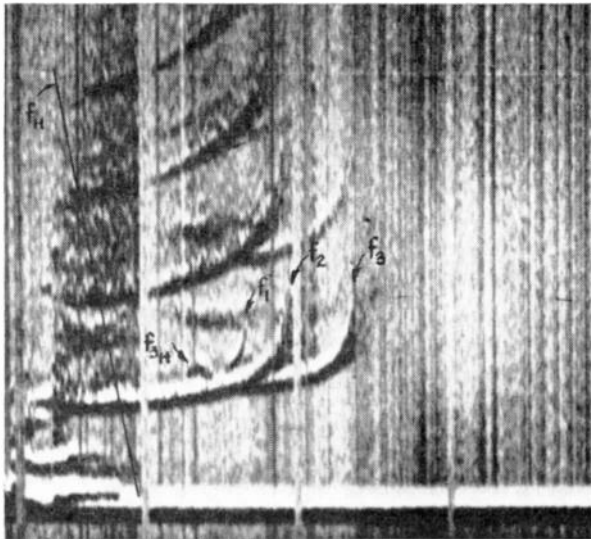

Fig. 1—Experimental evidence of magnetoionic multiple refraction.

three wave components simultaneously returned from the ionosphere at the above-noted location. The slanting line to the left in the figure is the calculated gyrofrequency versus height based upon the inverse cube rate of decrease of the earth's magnetic field; it is noted as f_H in the figure. Abscissae are in terms of frequency, increasing to the right. Ordinates are height increasing upwards. The penetration frequency for the F layer at the extreme right, marked f_3 , is that of the longitudinal extraordinary ray, the transverse extraordinary ray, or both. The center penetration frequency, marked f_2 , is that of the transverse ordinary ray. There can be little doubt from close examination of the figure that the retardation marked f_{3H} carries through across the instrumental recovery time and joins the penetration frequency f_3 , and that the penetration frequency f_1 joins the main bulk of the echo pattern. Thus, f_1 must be the longitudinal ordinary component and f_{3H} the extraordinary ray retardation as the gyrofrequency is approached.

Fig. 2 is a line drawing of the situation developed after study of several of the best examples available experimentally. It is to be noted that, while multiple refraction of the wave into three components is quite common near Fairbanks, Alaska, it is only under almost perfect experimental conditions that clear-cut examples

useful for this type of discussion present themselves.

It is worth while to point out, in connection with the Appleton and Builder critical ratio

$$2P_L\nu/P_T^2, \tag{12}$$

that as the magnetic poles are approached P_L becomes large while P_T decreases, becoming zero just at the pole.

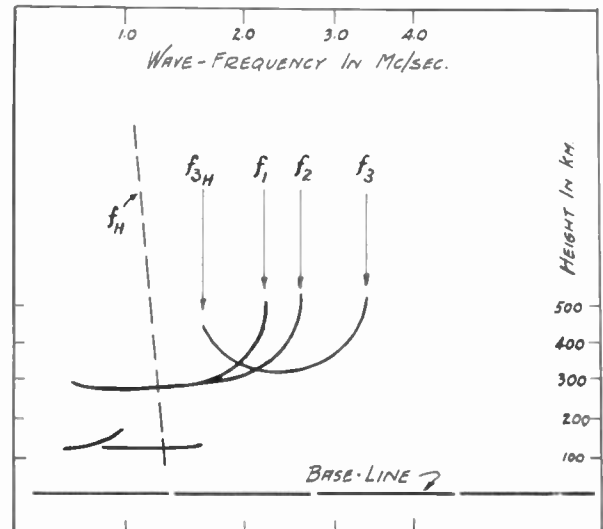

Fig. 2—Interpretation of situation shown in Fig. 1.

Thus the critical values of ν becomes smaller as the magnetic poles are approached. There seems little doubt that somewhere in high geomagnetic latitudes the critical value of ν coincides with the actual value of ν for the atmosphere.

If (12) is set equal to unity, then the critical value of collisional frequency may be expressed as

$$\nu_c = \frac{P_T^2}{2P_L}. \tag{13}$$

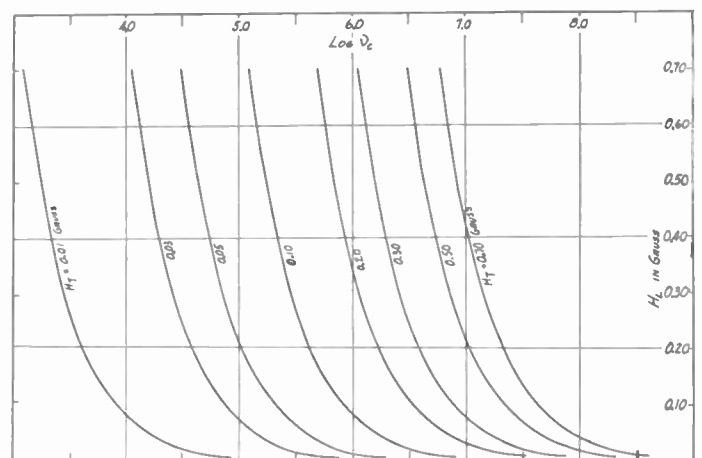

Fig. 3—Critical collisional frequency for various values of magnetic field.

At Fairbanks, Alaska, from experimental values of the earth's magnetic field,⁷

⁷ Annual Report of the Director, Dept. Terr. Mag., Carnegie Institution of Washington Year Book, p. 49, December 14, 1945.

$$\nu_c = 4.42(10)^4 \text{ at sea level}$$

and

$$\nu_c = 3.54(10)^4 \text{ at 300 km.}$$

The change in ν_c with height is, of course, a function of the change in the earth's magnetic field strength with altitude. Inclination of the magnetic field at Fairbanks, Alaska, is a little greater than 77° with respect to the horizontal.

For convenience in other calculations of this sort, values of ν_c for various values of longitudinal field strength H_L and transverse field strength H_T have been arranged in Fig. 3.

George,⁸ on the basis of certain assumptions concerning composition, dissociation, and temperature distribution in the atmosphere, has calculated the collisional frequency of electrons. He finds among other values that:

$$\begin{aligned} \nu &= 1.08(10)^7 \text{ at 80-km. height} \\ \nu &= 1.38(10)^8 \text{ at 100-km. height} \\ \nu &= 2.71(10)^8 \text{ at 200-km. height} \\ \nu &= 1.02(10)^9 \text{ at 300-km. height.} \end{aligned}$$

It appears, therefore, that $\nu > \nu_c$ below about 160 km. on the basis of George's calculations. With other tem-

⁸ E. F. George, "Electronic collisional frequency in the upper atmosphere," *Proc. I.R.E.*, vol. 35, pp. 249-252; March, 1947.

perature distributions⁹ and somewhat different values of dissociation, $\nu \geq \nu_c$ in the neighborhood of 300 km. for the geomagnetic latitude of Fairbanks, Alaska, can easily be found.

In fact, since it is at about this geographical location that the longitudinal mode of propagation first appears, it could be argued on the basis of the calculated value of ν_c that the collisional frequency of electrons with neutral air particles at the 300-km. level must be near $4(10)^4$.

It is curious to note that locations on the earth where the collisional frequency first approaches critical values for wave propagation are also those regions where great magnetic disturbances occur, where the aurora polaris is seen with greatest frequency and intensity, and where exceptionally great absorption of radio wave energy takes place.

ACKNOWLEDGMENT

It is a pleasure to acknowledge both the helpful criticism of N. C. Gerson during the preparation of the manuscript and the courtesy of the University of Alaska in furnishing the excellent material used in the discussion.

⁹ S. L. Seaton, "Temperature of the upper atmosphere," *Phys. Rev.*, vol. 71, sec. ser., p. 557; April 15, 1947.

Solar Noise Observations on 10.7 Centimeters*

A. E. COVINGTON†

Summary—Daily observations of the 10.7-cm. solar radiation show a 27-day recurrent peak which has a strong correlation with the appearance of sunspots. In the absence of large spots the equivalent temperature of the sun is 7.9×10^4 K. Sudden bursts of solar noise show a sharp rise lasting one or two minutes and a gradual decline to pre-storm value or to a somewhat higher value. Average burst duration is ten minutes.

IN THE PAST five years the emission of radio-frequency energy, or "noise," from the sun has been detected and studied by many observers. The early experiments of Southworth¹ on three wavelengths in the microwave region showed that the magnitude of the solar radiation at a wavelength of 10 cm. is 2.9 times greater than the thermal radiation expected from the

sun at a temperature of 6000° K., the observed optical temperature. Later observations by Appleton and Hey² on the solar noise spectrum revealed that the emission reaches a peak many thousands of times the sun's optical temperature at a wavelength of 4.7 meters. In this region the radio noise varies gradually with the solar rotation due to the appearance and disappearance of sunspots, and impulsively with the appearance of bright chromospheric eruptions. For a further discussion of the many recent papers, reference should be made to a review by Reber and Greenstein.³

Similar intense bursts of radio noise occurring during radio fadeouts were also noticed during the years of the last sunspot maximum.⁴ Appleton⁵ has remarked that

* Decimal classification: R113.411. Original manuscript received by the Institute, August 18, 1947. Presented, Joint Meetings of the International Scientific Radio Union, American Section, and The Institute of Radio Engineers, Washington, D. C., May, 1947, (Paper No. 45), and October, 1947, (Paper No. 10).

† National Research Council of Canada, Ottawa, Canada.

¹ G. C. Southworth, "Microwave radiation from the sun," *Jour. Frank. Inst.*, vol. 239, pp. 285-97; April, 1945. Errata, 241, March, 1946.

² E. V. Appleton and J. S. Hey, "Solar radio noise," *Phil. Mag.*, vol. 37, p. 73; February, 1946.

³ G. Reber and J. L. Greenstein, "Radio frequency investigations of astronomical interest," *Observatory*, vol. 67, pp. 15-26; February, 1947.

⁴ O. P. Ferrell, "Noise during radio fade-outs," *Terr. Magn. Atmos. Elect.*, vol. 51, p. 449; 1946.

⁵ E. V. Appleton, "Departure of long wave solar radiation from black body intensity," *Nature*, vol. 156, November 3, 1945.

these are associated with the solar emission of a radiation in excess of the optical black-body temperature of 6000°K.

The solar noise observations at the National Research Council of Canada at Ottawa have been limited to the average value of the radiation at 10.6 and 10.8 cm., contained in bandwidths of 4.5 Mc. Since microwave receivers have a large noise factor, a modulation method similar to that developed by Dicke⁶ for use in the 1-cm. region has been used to increase the sensitivity. In this system, a superheterodyne receiver is alternatively connected to the antenna and to an equivalent resistance kept at a fixed temperature; thus, the received energy is modulated to an extent determined by the temperature difference between the radiation resistance of the antenna and the reference resistance. The modulated noise voltage is converted to an intermediate frequency of 30 Mc., amplified, and then demodulated by a diode rectifier. The modulation frequency is again amplified, and finally synchronously converted to d.c. for registration by a pen recorder. The response time, about 7 seconds, is determined by a low-pass filter in the meter circuit. Since thermal radiation can be detected readily, the receiver is termed a radiometer. A calibration is made by measuring the thermal emission from a resistance which is substituted for the antenna and is heated to a temperature about 200°C. higher than the fixed reference resistance.

The antenna, a 4-foot parabolic reflector with a dipole placed at the focus, is mounted and motor-driven so that the sun can be followed. The dipole axis is parallel to the solar axis of rotation. However, a few observations have shown that there is little temperature variation as the dipole is rotated through 180°.

Since the cone of acceptance of the antenna is about 6° to the half-power points, all of the energy from the sun as well as from some of the surrounding space will be received. Calculation of the temperature of the radiation resistance is made by means of the equation:

$$T_{\text{ant}} = \frac{1}{4\pi} \int T(\theta, \phi) G(\theta, \phi) d\Omega \quad (1)$$

where

T_{ant} = the temperature of the antenna radiation resistance

$T(\theta, \phi)$ = the temperature in direction θ, ϕ

$G(\theta, \phi)$ = the gain in direction θ, ϕ .

When the antenna gain is low, the integration can be taken over two regions, one containing the sun and one the background. Both of these quantities have been studied.

The present method of observations partially eliminates the background temperature by measuring the temperature difference between the sun plus back-

ground and the zenith background. This quantity is the abscissa in the accompanying graphs of solar noise. If one neglects the absorption in the earth's atmosphere and assumes that the source of radiation is small in comparison with the antenna beamwidth and at a uniform temperature, then the temperature of the radiation resistance, as given by an integration over the sun's disk, can be written:

$$T_{\text{ant}} = \frac{T_{\text{sun}} G_0 \Omega_s}{4\pi} \quad (2)$$

where

T_{sun} = the equivalent temperature of the sun

$G_0 = 700 \pm 5$ per cent, the maximum antenna gain

$\Omega_s = 6.8 \times 10^{-5}$ rad², the solid angle of the sun.

Preliminary observations of the radiation from the sky show that the equivalent temperature of the zenith is about 50°K., and at times fluctuations in sky noise have been observed. Some have been correlated with geomagnetic disturbances.⁷ In a study of solar noise with a low-gain antenna, it will be necessary to record the background temperature in order to distinguish between variations of solar noise and variations of sky noise. Recently, for most of the observations, two radiometers have been in operation, one continuously pointing towards the sun and one pointing towards the zenith. Although this method does not allow the same background to be watched, a similar disturbance has been recorded on both radiometers, thus showing the nonsolar origin of a particular type of noise. Disturbances recorded only on the set which is following the sun are regarded as fluctuations of solar noise. Appleton and Hey² and Reber⁸ have on single occasions observed other radio noise which appears to be of non-solar origin.

Measurements of the solar radio temperature were started on July 26, 1946, one day after the appearance of the flare in the large sunspot which was then centrally located. With the disappearance of this group eight days later, the antenna temperature difference between sun and background decreased from 500°K. to 250°K. (absolute value uncertain). This is recorded, since many observations were made on the sunspot group.⁹⁻¹² During the early part of 1947, more extensive and continuous measurements show that, in addition to a component showing daily variations, there are sudden bursts of solar noise.

⁷ A. E. Covington, "Microwave sky noise," *Terr. Magn. Atmos. Elect.*, vol. 52, pp. 339-341; September, 1947.

⁸ G. Reber, "Solar radiation at 480 mc/sec.," *Nature*, vol. 158, p. 945, December 28, 1946.

⁹ A. C. B. Lovell and C. J. Banwell, "Abnormal solar radiation on 72 megacycles," *Nature*, vol. 158, pp. 517-518; October 12, 1946.

¹⁰ D. F. Martyn, "Polarization of solar radio frequency emissions," *Nature*, vol. 158, p. 308; August 31, 1946.

¹¹ E. V. Appleton and J. S. Hey, "Circular polarization of solar radio noise," *Nature*, vol. 158, p. 339; September 7, 1946.

¹² M. Ryle and D. D. Vonberg, "Solar radiation at 175 mc/s.," *Nature*, vol. 158, pp. 339-340; September 7, 1946.

⁶ R. H. Dicke, "The measurement of thermal radiation at microwave frequencies," *Rev. Sci. Instr.*, vol. 17, pp. 268-275; July, 1946.

In Fig. 1, the daily intensity of solar radiation, an average value of a few hours of observations obtained about noon is plotted as curve A. The American relative sunspot number¹³ is plotted as curve B and will serve as one measure of the solar activity. Although the amplitudes of the two curves are different, both show the effect of the 27-day period of solar rotation. In the

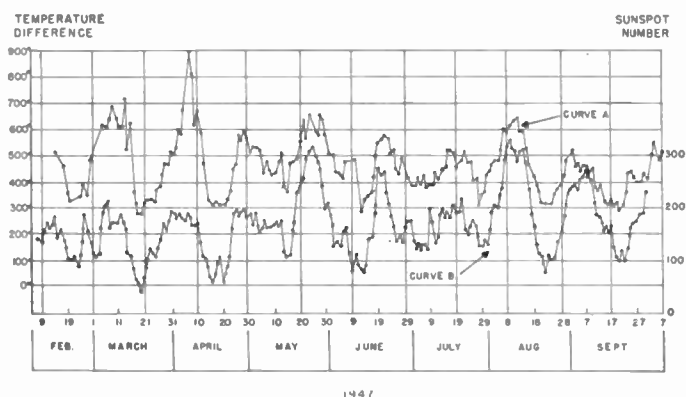

Fig. 1—Curve A: Daily variations of solar noise.
Curve B: American relative sunspot numbers.

absence of large sunspots, the lowest measured antenna temperature is about 300°K . Using (2), the equivalent black body temperature for the visible solar disk is $7.9 \times 10^4^{\circ}\text{K}$. Although the temperature measurements of the radiometer can be made to an accuracy of ± 1 per cent, occasional operational errors could introduce another error of the order of ± 5 per cent. In addition, any error in the measurements of the antenna gain will show in the absolute level of solar noise.

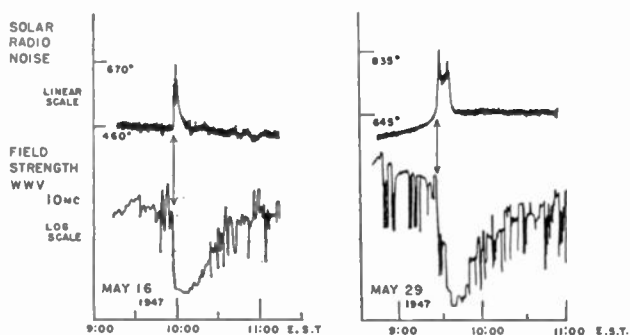

Fig. 2—Solar noise bursts and sudden ionospheric disturbances.

In Fig. 2, examples of sudden bursts of solar noise are plotted together with the 10-Mc. field-strength recording of WWV taken at Ottawa. These records show the close association of the sharp leading edges of a burst of solar noise and of a sudden ionospheric disturbance, the two events occurring within an interval of ± 2

minutes. This discrepancy arises from a combination of observational errors and of uncertainty in estimating the beginning of the storm. The solar noise increases to a maximum within 1 or 2 minutes and gradually returns to pre-storm value before the recovery of the ionosphere. Some exceptions have been observed where the solar noise after the storm has remained at a higher value than before. This may be one indication of the manner in which the value of the daily solar noise can change.

Some exceptional storms have been recorded. On April 15, 1947, the radiometer was focused on the sun at $14^{\text{h}}57^{\text{m}}$ G.M.T. A small 7-minute burst of 120°K . amplitude appeared at $15^{\text{h}}18^{\text{m}}$ G.M.T., and was succeeded by a second large 9-minute burst at $16^{\text{h}}18^{\text{m}}$ and a third at $17^{\text{h}}26^{\text{m}}$. During this last burst the antenna was directed towards the sun through a process of maximizing on the solar noise. The measured temperature of the radiation resistance was about $12,000^{\circ}\text{K}$., the highest that has been observed. When the radiometer was closed down at $21^{\text{h}}20^{\text{m}}$ G.M.T., the activity was still present. On this day, a solar limb flare and associated radio fade-out were reported.¹⁴ On May 21, two bursts of noise were recorded on the radiometer following the sun; the first one of 40°K . amplitude occurred at $15^{\text{h}}29^{\text{m}}$ G.M.T., and the second one of 650°K . at $18^{\text{h}}20^{\text{m}}$. On the radiometer pointing towards the zenith, only one burst of 125°K . amplitude was received at $15^{\text{h}}29^{\text{m}}$ G.M.T. These observations indicate that the first burst of noise occurred over a wide expanse of the sky and was probably associated with an ionospheric storm of a type different from those associated with solar flares. On May 30, a 1-minute burst of solar noise of 57°K . amplitude was associated with a sudden ionospheric disturbance. This is the shortest storm observed.

In the 250 hours of observations taken during the three-month period of March, April, and May, 1947, twenty bursts of solar noise and twenty sudden ionospheric disturbances¹³ were recorded. During these disturbances, the radiations from the zenith remained constant. The results of comparing the times of commencement of the two types of storms are shown in Table I. A correlation is obtained if the leading edges of the storms occur within a 4-minute period. A

TABLE I

(S.N.B. = solar noise bursts; S.I.D. = sudden ionospheric disturbances)

Number of associated S.N.B. and S.I.D.	14
Number of doubtfully associated S.N.B. and S.I.D.	4
Number of separate S.N.B.	2
Number of separate S.I.D.	2
Number of background disturbances	2

few solar noise disturbances showed a gradual rise and decline in intensity, and consequently could not be associated exactly with the ionospheric disturbances.

¹³ "Ionospheric Data," Central Radio Propagation Laboratory, Washington, D. C.

¹⁴ E. T. Pierce, "Solar limb flare and associated radio fade-out," April 15, 1947," *Nature*, vol. 160, p. 59; July 12, 1947.

With the exception of the long storm of April 15, the average solar storm has a duration of 10 minutes and an amplitude of 120°K .

With the present low-gain antenna, a detailed account cannot be made of the sources of the solar radiations. However, some idea of a distribution was obtained from measurements taken during a partial eclipse of the sun on November 23, 1946.¹⁵ On this day the measured temperature of the radiation resistance was 460°K . A sudden 9 per cent decrease of the solar noise occurred three minutes before the first contact. The spectroheliograms taken on November 24 and 25 by the Mount

¹⁵ A. E. Covington, "Microwave solar noise observations during the partial eclipse of November 23, 1946," *Nature*, vol. 159, pp. 405-406; March 22, 1947.

Wilson Observatory show an extensive band of prominences on the northern hemisphere, extending off the western limb just at the point of contact. It seems likely that a prominence existed on the day of the eclipse, so that the initial reduction of noise occurred when it was being obscured. The associated equivalent temperature of the prominence is of the order of $2 \times 10^7^{\circ}\text{K}$. A further 25 per cent reduction was associated with the passage of the moon across a central region (2.2 per cent of the sun's projected surface) which contained a large sunspot. From the data obtained, an equivalent temperature of $1.5 \times 10^6^{\circ}\text{K}$. was calculated for this area. A sharp fall and rise in the noise occurred with the covering and uncovering of the penumbra of the well-formed leading spot of the group.

An Analysis of the Intermodulation Method of Distortion Measurement*

W. J. WARREN†, SENIOR MEMBER, I.R.E., AND W. R. HEWLETT†, FELLOW, I.R.E.

Summary—Part A of this paper is an analysis of the intermodulation method of distortion measurement. Results obtained by its use are compared with those obtained by the harmonic-measurement method. Predicted values for the intermodulation distortion and harmonic distortion are given for several typical transfer characteristics. For single-ended and push-pull characteristics, which are representable by simple power series, general equations are derived for intermodulation and harmonic distortion. With the aid of equations for the former, the effects of the ratio of signal amplitudes used in intermodulation testing are studied. These equations also permit derivation of relatively fixed ratios of per cent intermodulation distortion to per cent harmonic distortion for an intermodulation test method, which is described. Predicted values for distortion and their

ratios are supported by test results. Curves expressing the actual distortion ratios, plotted against harmonic distortion, summarize the results of this analysis. These curves are useful for correlating the results of the two methods of test. Possible meter types, usable for metering the carrier- and intermodulation-frequency components in the intermodulation test method, are reviewed. The choice of meter type is found to affect the readings obtained for these components, and hence will affect the per cent intermodulation distortion. In Part B, simple equations are given for approximate predetermination of per cent intermodulation distortion from three or five points on the transfer characteristic. For more accurate prediction, tables are given for calculation of the prominent intermodulation components from eleven points on the transfer characteristics.

INTRODUCTION

THE INTERMODULATION METHOD of distortion measurement¹⁻³ has been receiving increasing attention in the last few years. Instruments have been developed for application of this method. The question: "How will results obtained by the intermodulation method compare with those of harmonic measurement?" has been asked frequently. To provide an answer to this question, the intermodulation method is analyzed in this paper, and results are pre-

sented comparing the two methods. The comparisons will hold for test conditions for which both methods are applicable.

The analysis is based on the fact that the same non-linearity of the transfer characteristic of a network that causes harmonic distortion also causes intermodulation distortion. The extent to which the transfer characteristic is nonlinear may vary with frequency, as in disk reproduction. This paper assumes that the transfer characteristic is substantially independent of frequency. Then, the sameness of the underlying factors causing distortion leads to the development of relatively fixed ratios for per cent intermodulation to per cent harmonic distortion. For the intermodulation test method described below, this ratio is about 3.2 to 1 for a single-ended amplifier and about 3.8 to 1 for a balanced push-pull amplifier.

Several methods have been proposed for intermodulation testing, and, to differing extents, most of these

* Decimal classification: R225.12×R148.18. Original manuscript received by the Institute, June 10, 1947; revised manuscript received October 8, 1947. Presented, National Electronics Conference, November, 1947, Chicago, Ill.

† Hewlett-Packard Co., Palo Alto, Calif.

¹ D. C. Espley, "Harmonic production and cross modulation in thermionic valves with resistive loads," *Proc. I.R.E.*, vol. 22, pp. 781-791; June, 1934.

² John K. Hilliard, "Distortion measurements by the intermodulation method," *Proc. I.R.E.*, vol. 29, pp. 614-620; December, 1941.

³ H. H. Scott, "Audible audio distortion," *Electronics*, vol. 18, p. 126; January, 1945.

are in use.¹⁻⁶ This paper will confine itself to an analysis of one of the generally accepted methods.⁵ Similar analyses can be made for each method; giving rise to specific numeric relations, as illustrated above, for each method. A block diagram of the intermodulation test method being treated is shown in Fig. 1, and the principle of operation is described below.

For brevity, harmonic distortion will hereafter be written *HD* and intermodulation distortion will be written *IM*.

The signal frequencies used in *IM* testing are chosen so f_b (Fig. 1) is higher than f_a , and their actual values are selected with regard to the frequencies at which performance of the test unit is to be examined, and with regard to the frequency characteristics of the filters used. Typical values for the *IM* method being treated are 40, 60, and 100 cycles for f_a , and 1000, 7000, and 12,000 cycles for f_b . Present practice makes the high-frequency signal (V_b) 12 db lower than the low-frequency signal V_a . The effect of this voltage ratio upon the quantitative results obtained is discussed in a subsequent section.

The *IM* apparatus is calibrated by introducing two signals at $X-X'$, or $Y-Y'$, in Fig. 1; one of frequency f_a' and of magnitude V_a' , and the other of frequency f_b' and magnitude V_b' . These voltages and frequencies are so selected that $V_a' = 10V_b'$, $f_b' - f_a'$ is in the pass band of the low-pass filter, while both f_a' and f_b' are greater than the cutoff frequency of the high-pass filter. The envelope of the composite signal, $V_a' + V_b'$, will be nearly sinusoidal and of amplitude B_b' with apparent carrier level nearly equal to V_a' .⁶ The results of detection and metering will give a reading on the output meter M' proportional to V_b' , and a reading on the carrier meter M_c proportional to V_a' . Since the amplitude ratio B_b' to V_a' is 0.1, the ratio of output-meter to carrier-meter readings is, by definition, 10 per cent intermodulation. In actual practice, an amplifier with adjustable gain is used ahead of the carrier meter M_c to set this meter to a 100 per cent mark. This permits calibration of the output meter M' directly in per cent *IM*.

PART A—ANALYSIS OF INTERMODULATION METHOD AND COMPARISON WITH HARMONIC-DISTORTION METHOD

Scope of Analysis

For quantitative comparison of the *IM* and *HD* techniques and to evaluate the effects of metering practice in the former, the following cases have been treated:

I. Transfer characteristic readily representable by a power series.

II. Transfer characteristic having an abrupt slope

¹ N. C. Pickering, "Measuring audio intermodulation," *Electronic Ind.*, vol. 5, pp. 55-58; June, 1946.

⁵ John K. Hilliard, "The use of intermodulation tests in designing and selecting high quality audio channels," Altec-Lansing Corp., Hollywood, Calif., issue no. 2, May, 1946.

⁶ F. E. Terman, "Radio Engineer's Handbook," McGraw-Hill Publishing Co., New York, N. Y., 1943; p. 567.

change, for which case the power series becomes too lengthy for convenient treatment.

III. Transfer characteristic representable by a portion of a sine wave.

The analysis and comparisons assume that:

1. The transfer characteristic is independent of frequency. Many applications of the test methods considered will satisfy this assumption wholly or reasonably well. An exception, disk reproduction, was previously cited.

2. The same total peak driving voltage is used for both methods of test. The device under test will thereby be working between the same limits of input voltage and output current. If the same total output power is used as a basis of comparison, the peak driving voltage, with a signal of two or more frequencies, would be larger than the peak single-frequency voltage by an amount depending upon the ratio of signal-voltage amplitudes.

In their respective cases, per cent harmonic distortion and per cent intermodulation distortion are respectively evaluated according to the definitions:

per cent r.m.s. *HD*

$$= \frac{\sqrt{\sum (\text{harmonic output voltages, or currents})^2}}{\text{fundamental output voltage, or current}} \times 100 \quad (1)$$

and

per cent r.m.s. *IM*

$$= \frac{\sqrt{\sum (\text{sum and difference frequency voltages in output})^2}}{\text{fundamental output voltage of one of the signals}} \times 100. \quad (2)$$

In (1) a sine-wave signal voltage is assumed, and in (2) the two signals are both assumed sinusoidal. Unless specifically noted otherwise, in this paper per cent *HD* and per cent *IM* will denote the r.m.s. values.

Case (I-a). Power Series for Single-Ended Transfer Characteristic: The transfer characteristic of a nonlinear network or amplifier may be represented by a power series in which the output current may be expressed as a function of increasing powers of input voltage. Thus

$$i = a_0 + a_1e + a_2e^2 + a_3e^3 + \dots + a_n e^n \quad (3)$$

and

$$e = A_0 + A \sin a \pm B \sin b; \quad (4)$$

then, considering only terms up to and including the 5th-power term,

$$\begin{aligned} i = & \text{d.c. component} + A \left\{ a_1 + 2a_2A_0 + 3a_3(A_0^2 + \frac{1}{2}A^2 + \frac{1}{2}B^2) \right. \\ & + 4a_4(A_0^3 + \frac{3}{2}A_0A^2 + \frac{3}{2}A_0B^2) + 5a_5(A_0^4 + \frac{3}{2}A_0^2A^2 \\ & \left. + 3A_0^2B^2 + \frac{3}{2}A^2B^2 + \frac{3}{8}B^4 + \frac{1}{8}A^4) \right\} \sin a \\ & - A^2 \left\{ \frac{a_2}{2} + \frac{3a_3}{2}A_0 + a_4(3A_0^2 + \frac{1}{2}A^2 + \frac{3}{2}B^2) \right. \end{aligned}$$

$$\begin{aligned}
 &+ 5a_5(A_0^3 + \frac{1}{2}A_0A^2 + \frac{3}{8}A_0B^2) \} \cos 2a \\
 &- A^3 \{ \frac{1}{4}a_3 + a_4A_0 + 5a_5(\frac{1}{2}A_0^2 + \frac{1}{4}B^2 + \frac{1}{8}A^2) \} \sin 3a \\
 &+ \frac{1}{8}A^4 \{ a_4 + 5a_5A_0 \} \cos 4a + \frac{1}{8}a_5A^5 \sin 5a \\
 &\pm B \{ a_1 + 2a_2A_0 + 3a_3(A_0^2 + \frac{1}{4}B^2 + \frac{1}{2}A^2) \\
 &+ 4a_4(A_0^3 + \frac{3}{4}A_0B^2 + \frac{3}{8}A_0A^2) + 5a_5(A_0^4 + \frac{3}{8}A_0^2B^2 \\
 &+ 3A_0^2A^2 + \frac{3}{4}A^2B^2 + \frac{3}{8}A^4 + \frac{1}{8}B^4) \} \sin b \\
 &\pm AB \{ a_2 + 3a_3A_0 + 3a_4(2A_0^2 + \frac{1}{2}A^2 + \frac{1}{2}B^2) \\
 &+ 5a_5(2A_0^3 + \frac{3}{8}A_0A^2 + \frac{3}{8}A_0B^2) \} [\cos(b-a) - \cos(b+a)] \\
 &\mp A^2B \{ \frac{3}{4}a_3 + 3a_4A_0 + 5a_5(\frac{3}{8}A_0^2 + \frac{3}{4}A^2 \\
 &+ \frac{3}{8}B^2) \} [\sin(b-2a) + \sin(b+2a)] \\
 &\mp A^3B \{ \frac{1}{2}a_4 + \frac{5}{8}a_5A_0 \} [\cos(b-3a) - \cos(b+3a)] \\
 &\pm \frac{5}{16}a_5A^4B [\sin(b-4a) + \sin(b+4a)] \\
 &- B^2 \{ \frac{a_2}{2} + \frac{3}{8}a_3A_0 + a_4(3A_0^2 + \frac{1}{2}B^2 + \frac{3}{8}A^2) \\
 &+ 5a_5(A_0^3 + \frac{1}{2}A_0B^2 + \frac{3}{8}A_0A^2) \} \cos 2b \\
 &+ AB^2 \{ \frac{3}{4}a_3 + 3a_4A_0 + 5a_5(\frac{3}{8}A_0^2 + \frac{3}{8}A^2 \\
 &+ \frac{3}{4}B^2) \} [\sin(2b-a) - \sin(2b+a)] \\
 &+ A^2B^2(\frac{3}{4}a_4 + \frac{1}{4}a_5A_0) [\cos(2b-2a) + \cos(2b+2a)] \\
 &- \frac{5}{8}a_5A^3B^2 [\sin(2b-3a) - \sin(2b+3a)] \\
 &\pm B^3 \{ \frac{a_3}{4} + a_4A_0 + 5a_5(\frac{1}{2}A_0^2 + \frac{1}{4}A^2 + \frac{1}{8}B^2) \} \sin 3b \\
 &\mp AB^3 \{ \frac{a_4}{2} + \frac{5}{8}a_5A_0 \} [\cos(3b-a) - \cos(3b+a)] \\
 &\pm \frac{5}{8}a_5A^2B^3 [\sin(3b-2a) + \sin(3b+2a)] \\
 &+ \frac{1}{8}B^4(a_4 + 5a_5A_0) \cos 4b \\
 &- \frac{5}{16}a_5AB^4 [\sin(4b-a) - \sin(4b+a)] \\
 &\pm \frac{1}{16}a_5B^5 \sin 5b. \tag{5}
 \end{aligned}$$

Equation (5) reduces to the output current for *IHD* measurement upon setting $B = 0$.

Terms involving f_b and its harmonics are grouped with corresponding sideband terms in (5). The high-pass filter (Fig. 1) removes all low-frequency terms, so

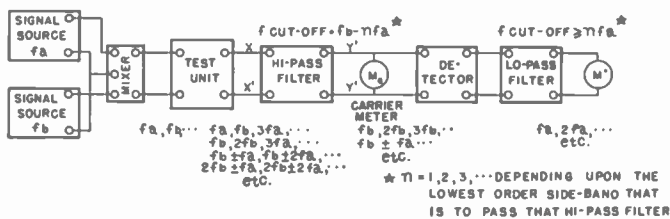

Fig. 1—Block diagram for intermodulation test method treated in this paper for calibration, f_a, f_b are connected into $X-X'$ or $Y-Y'$.

that, if $f_b > 9f_a$, then all of the sidebands and carrier components will appear at the detector input, and all har-

monics of f_a will be suppressed. The term of frequency f_b will predominate and the carrier-level meter, M_c , which is an average-reading meter, will indicate substantially only the amplitude of this term.

Carrier and sideband term magnitudes in (5) are seen to depend upon the signal amplitudes A and B . For an assigned peak driving voltage and given quiescent status of an amplifier, the per cent *IM* will hence depend upon the ratio A/B . The exact nature of this dependence is partially discernible for the case of a transfer characteristic given by

$$i = a_1e + a_2e^2 + a_3e^3 + a_4e^4. \tag{6}$$

With the origin for the characteristic taken at the operating point, i.e., $a_0 = 0$ and $A_0 = 0$, the signal for *IM* testing will be $e = A \sin a \pm B \sin b$, and for *HD* testing it will be $e = A' \sin a$. Applying the defining equations (1) and (2), there follows:

$$\begin{aligned}
 &\text{per cent } IM \\
 &\cong 2A \frac{\{ [a_2 + \frac{3}{8}a_4(A^2 + B^2)] + \frac{9}{16}a_3^2A^2 + \frac{1}{4}a_4^2A^4 \}^{1/2}}{a_1 + \frac{3}{4}a_3(2A^2 + B^2)} \times 100, \tag{7a}
 \end{aligned}$$

and

$$\begin{aligned}
 &\text{per cent } HD \\
 &\cong \frac{A'}{2} \frac{\{ [a_2 + a_4(A')^2] + \frac{1}{4}a_3^2(A')^2 + \frac{1}{16}a_4^2(A')^4 \}^{1/2}}{a_1 + \frac{3}{4}a_3(A')^2} \times 100. \tag{8a}
 \end{aligned}$$

If $A + B = A'$ for the same total peak driving voltage, $A/B = 4$, and the usual insignificance of the squared values of a_3 and a_4 as compared to a_1^2 and a_2^2 is acknowledged, then

$$\text{per cent } IM \cong \frac{8}{5} \frac{A'(a_2 + a_4(A')^2)}{a_1 + a_3(A')^2} \times 100 \tag{7b}$$

$$\text{per cent } HD \cong \frac{1}{2} \frac{A'(a_2 + a_4(A')^2)}{a_1 + \frac{3}{4}a_3(A')^2} \times 100. \tag{8b}$$

When a_3 and a_4 are set equal to zero, (7b) and (8b) check those developed by Frayne and Scoville.⁷ Equation (7a) indicates that, to a first approximation, the per cent *IM* will vary directly with the larger signal amplitude A . Maintaining the peak drive $A + B$ constant, it follows that, as A/B is increased, the per cent *IM* will approach a maximum. Comparison of (7b) and (8b) shows that, for the conditions imposed, i.e., $A/B = 4$, the theoretical ratio of per cent *IM* to per cent *HD* is practically constant at 3.2. A summary of the values of this ratio for several types of transfer characteristics is given in Fig. 15.

To check the above theory, a triode-connected 6V6 amplifier working into a 7500-ohm resistive load was tested. The dynamic characteristic for the chosen operating conditions was:

⁷ J. G. Frayne and R. R. Scoville, "Analysis and measurements of distortion in variable-density recording," *Jour. Soc. Mot. Pic. Eng.*, vol. 32, p. 648; June, 1939.

$$i = 60 + 1.2423e + 0.0102e^2 + 0.972 \times 10^{-4}e^3$$

$$= 60(1 + 0.5383x + 0.1149x^2 + 0.0285x^3) \quad (9)$$

where i is in milliamperes, and $x = e/26$; *i.e.*, x is the fraction of the maximum peak drive of 26 volts. The coefficients in the equation, of the form of (3), were reduced from experimental data.

The effect of the ratio A/B of signal voltages upon the per cent *IM* and correlation between theoretical and experimental values is shown in Fig. 2. For a fixed

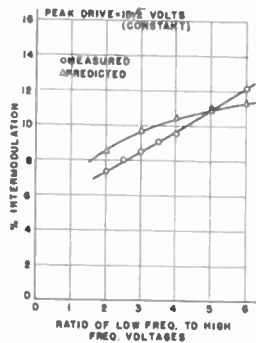

Fig. 2—Per cent intermodulation as a function of the ratio of signal amplitudes. Single-ended 6V6 amplifier; 7500-ohm load; bias voltage, 26 volts; plate-supply voltage, 610 volts.

ratio $A/B=4$, the predicted and measured values for per cent *IID* and per cent *IM* agree well, as shown in Fig. 3. The agreement between per cent *IM* values obtained with an average-reading meter used for the output meter M' (Fig. 1) and those computed from data obtained with a harmonic analyzer at the output-meter position justifies the use of the former for measurement of the r.m.s. value of the complex output voltage.

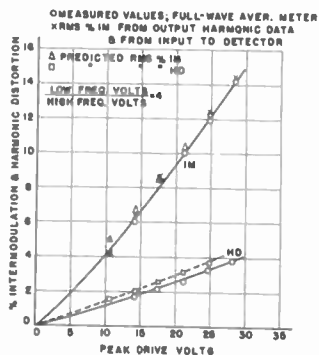

Fig. 3—Per cent intermodulation and harmonic distortion of the single-ended 6V6 amplifier of Fig. 2 as a function of signal voltage.

If the output meter M' is a full-wave, peak-reading meter, then the per cent *IM*, for the same conditions applying to (7a), will become:

per cent peak *IM*

$$= 2A \frac{[a_2 + \frac{3}{4}a_3A + \frac{1}{2}a_4(4A^2 + B^2)]}{a_1 + \frac{3}{4}a_3(2A^2 + B^2)} \times 100. \quad (10a)$$

The arithmetic summation of the sideband components is correct because of their relative phase relationships,

as shown in Fig. 12. Relative magnitudes of the several components are such that, for all practical cases, the resultant peak is time-coincident with the peak of the fundamental. For $A+B=A'$, *i.e.*, the same peak driving voltage for *IM* and *IID* testing, and $A/B=4$, (10a) becomes

per cent peak *IM*

$$= \frac{8}{5} A' \frac{[a_2 + \frac{3}{8}a_3A' + \frac{5}{4}a_4(A')^2]}{a_1 + \frac{9}{100}a_3(A')^2} \times 100. \quad (10b)$$

In like manner, measurement of harmonic distortion by a full-wave peak-reading meter will give

per cent peak *HD*

$$= \frac{A'}{2} \frac{[a_2 + \frac{1}{2}a_3A' + \frac{5}{4}a_4(A')^2]}{a_1 + \frac{3}{4}a_3(A')^2} \times 100. \quad (11)$$

Comparison of (10b) and (11) reveals that the ratio of peak per cent *IM* to peak per cent *IID* will again remain practically constant at 3.2.

Case (I-b). Power Series for Push-Pull Transfer Characteristic: All terms involving $a_0, A_0, a_2,$ and a_4 in (5) vanish for the perfectly balanced push-pull amplifier. The effect of signal voltage ratio A/B upon per cent *IM* and per cent *HD* is partially discernible upon applying the defining equations (1) and (2) to the applicable form of (5). There results:

per cent *IM*

$$\cong \frac{3A^2}{2} \frac{\{[a_3 + \frac{5}{8}a_5(2A^2 + B^2)]^2 + (\frac{5}{12}a_5A^2)^2\}^{1/2}}{a_1 + \frac{3}{4}a_3(2A^2 + B^2) + \frac{15}{8}a_5(2A^2B^2 + 3B^4 + A^4)} \times 100 \quad (12a)$$

and

per cent *HD*

$$\cong \frac{(A')^2}{4} \frac{\{[a_3 + \frac{5}{4}a_5(A')^2]^2 + (\frac{1}{4}a_5(A')^2)^2\}^{1/2}}{a_1 + \frac{3}{4}a_3(A')^2 + \frac{5}{8}a_5(A')^4} \times 100. \quad (13a)$$

For given operating conditions and constant peak signal voltage, (12a) indicates that per cent *IM* will vary roughly as the square of the larger signal amplitude A . Typical push-pull characteristics will often have a negative value for the coefficient a_3 . This tends to make the variation of per cent *IM* with signal ratio to be somewhat more rapid than as A^2 . For $A/B=4$ and $A+B=A'$, and neglecting the usually small terms, (12a) and (13a) become

per cent *IM* $\cong \frac{24}{25} (A')^2 \frac{[a_3 + \frac{3}{8}a_5(A')^2]}{a_1 + a_3(A')^2} \times 100 \quad (12b)$

and

per cent *HD* $\cong \frac{1}{4} (A')^2 \frac{[a_3 + \frac{5}{4}a_5(A')^2]}{a_1 + \frac{3}{4}a_3(A')^2} \times 100, \quad (13b)$

resulting in a ratio of *IM* to *HD* which is practically

3.84. The effect of a negative a_3 is to make this ratio increase with peak-signal level A' . If the terms involving a_5 in the numerator and a_3 in the denominator are neglected, then (12b) and (13b) agree with those given by Frayne and Scoville⁷ for the cubic characteristic.

If the output meters M' and M_c are full-wave peak-reading meters, then the per cent IM and IHD become, respectively, by the method of analysis used with (10) and (11),

per cent peak IM

$$\approx \frac{24}{25} (A')^2 \frac{[a_3 + \frac{1}{80} a_5 (A')^2]}{a_1 + \frac{3}{100} a_3 (A')^2 + \frac{87}{1000} a_5 (A')^4} \times 100 \quad (14)$$

and

per cent peak IHD

$$\approx \frac{1}{4} (A')^2 \frac{[a_3 + \frac{3}{8} a_5 (A')^2]}{a_1 + \frac{3}{4} a_3 (A')^2 + \frac{5}{8} a_5 (A')^4} \times 100. \quad (15)$$

It is seen that the ratio of per cent peak IM to per cent peak IHD will be nearly constant at 3.84.

The absence of even-harmonic carrier-frequency terms eliminates the detector turnover effect discussed in connection with Fig. 13. Even-order harmonics of the principal output low frequency $2f_a$ may, however, prevail at the meter M' .

For experimental verification, a push-pull 6L6 amplifier was tested. The dynamic characteristic for the 8000-ohm plate-to-plate load was representable by

$$\begin{aligned} i &= 2.567e - 0.1207 \times 10^{-3}e^3 - 0.66 \times 10^{-7}e^5 \\ &= 97.546(1 - 0.0679x^3 - 0.0332x^5), \end{aligned} \quad (16)$$

where i is in ma. and $x = e/38$; i.e., x is the fraction of the maximum peak driving volts. The predicted per cent IM variation with signal ratio A/B and the measured

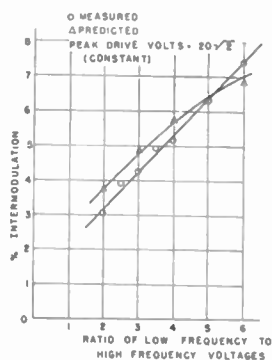

Fig. 4—Per cent intermodulation as a function of the ratio of signal amplitudes. Push-pull 6L6 amplifier; 8000-ohm plate-to-plate load; plate-supply voltage, 400 volts; bias voltage, 37 volts.

results are shown in Fig. 4. For the signal ratio $A/B = 4$, the measured and predicted per cent IM and per cent IHD values, as a function of drive, are shown in Fig. 5. The measured results were independent of the direction of connection of the half-wave peak detector used. Though not shown, the results for per cent IM , obtained with a peak-reading output meter M' , depended

upon the direction of its connection because of the even-harmonic content of the low-frequency output.

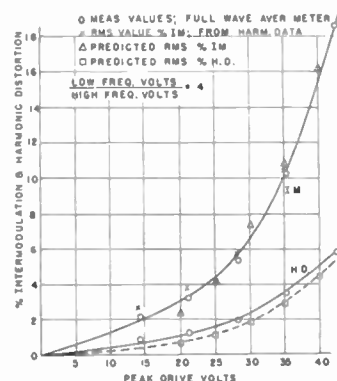

Fig. 5—Per cent intermodulation and harmonic distortion of the push-pull 6L6 amplifier of Fig. 4 as a function of signal voltage.

Case (II-a). Single-Ended, Sharp-Cutoff Characteristic:

To simulate certain types of amplifier characteristics, such as that of an amplifier overdriven from a high-impedance source, or an amplifier having negative feedback that is driven beyond cutoff, the $e-i$ characteristic shown in Fig. 6 was investigated. Insomuch as adequate

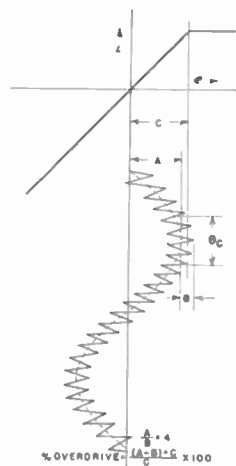

Fig. 6—Single-ended, sharp-cutoff characteristic with a two-frequency input signal.

representation by a power series requires too many terms, a different method of analysis was used. The steps in the approximate analysis were as follows:

1. For an arbitrary ratio f_a/f_b and signal ratio $A/B = 4$, the number of peaks "clipped" and the amplitude of each was determined for an assigned amount of overdrive. (See Fig. 6 for definition of overdrive.)
2. The total area under the clipped peaks was evaluated from their relative amplitudes and time-axis spans. (See Fig. 7(b).)
3. The half sine wave of Fig. 7(c) was so proportioned that its duration θ_c was equal to that clipped from the composite envelope, and its height so selected that the area under it was equal to that of the clipped peaks.
4. The reading of a full-wave average-reading meter, on which the wave of paragraph 3 is impressed, was

evaluated. This meter reading, compared to that of the same meter with only the carrier impressed, is the intermodulation distortion.

5. In actual testing, the carrier-level meter M_c has the wave of Fig. 7(a) impressed upon it. The reading

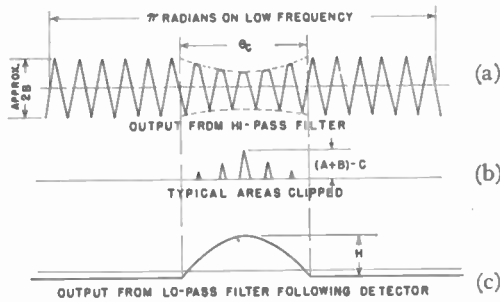

Fig. 7—Wave shapes applying to the analysis of the output current of the characteristic of Fig. 6.

of M_c will be less than if the carrier alone were impressed. For an average-reading meter, as used in the test arrangement for checking this analysis, the reading of M_c will be less, substantially, by the amount of the total areas clipped; i.e., by the amount corresponding to the area calculated in 2. The intermodulation distortion of paragraph 4 was corrected for this "carrier loss" to permit ready comparison with measured values.

6. For calculating the per cent HD , the procedure of steps 2 and 3 was repeated for the area clipped from the single signal wave. The fundamental frequency component of this wave was calculated and subtracted. The reading of an average-type meter, having the remaining wave impressed upon it, was determined and compared with the reading of the meter with the "unclipped" signal applied.

For a specific value of overdrive, the clipped areas of Fig. 7(b) were resolved by Fourier analysis and the re-

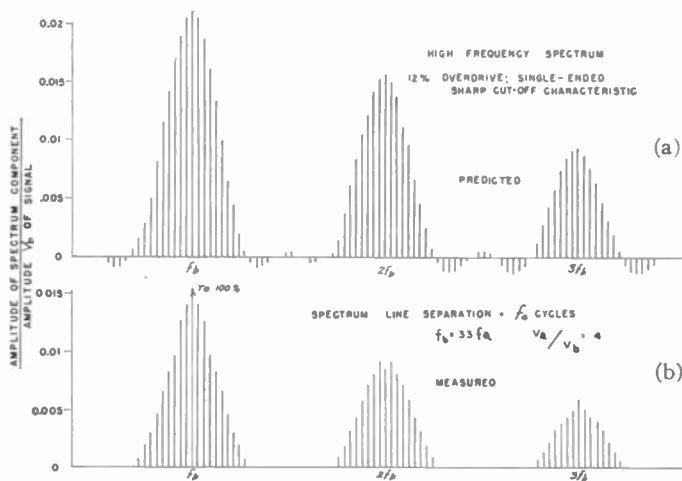

Fig. 8—Spectrum of h.f. components as found from Fourier analysis of the intermodulation products in the output of the characteristic of Fig. 6.

sults of the above approximate analysis were checked. The Fourier analysis gave rise to carrier and sideband terms as shown in the spectrum of Fig. 8(a). This spec-

trum was experimentally checked with the results as shown in Fig. 8(b). It is seen that careful consideration must be given to the frequency response of the IM test apparatus to properly include all prominent distortion components.

Fig. 9 shows the calculated and the measured values for IM and HD of the single-ended, sharp-cutoff characteristic. An average-type detector and an average-reading output meter were used, in keeping with the method of analysis. The predicted IM values are shown only with correction for carrier loss. The agreement with measured values is good. If the rectification characteristics of the detector and output meter are of the peak type, the IM results will depend upon carrier harmonic content and upon harmonics in the output voltage, as discussed below.

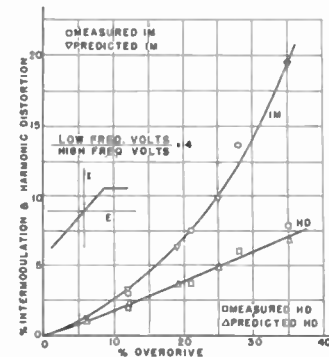

Fig. 9—Per cent intermodulation and harmonic distortion for a single-ended, sharp-cutoff characteristic as a function of overdrive.

Case (II-b). Double-Ended, Sharp-Cutoff Characteristic: Examination of the relative phase relationships of sideband components in the deficiency spectrum of Fig. 8(a) reveals that, for the push-pull, sharp-cutoff char-

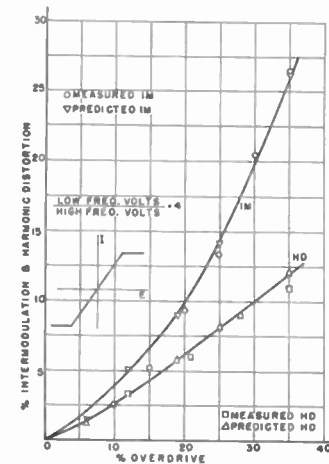

Fig. 10—Per cent intermodulation and harmonic distortion for a push-pull, sharp-cutoff characteristic as a function of overdrive.

acteristic, certain carrier and sideband terms will cancel, while others will add. Taking these effects into account, it was possible to predict per cent IM values from

TABLE I
4-TO-1 SIGNAL RATIO CASE; MULTIPLYING COEFFICIENTS FOR EVALUATING INTERMODULATION PRODUCTS FROM ELEVEN EQUIDISTANT ORDINATES ON RESISTIVE LOAD LINE

Frequency	Common Multiplier	Intermodulation Products					Signal Ratio, $V_a/V_b=4$					
		i_{+4}	i_{+3}	i_{+2}	i_{+1}	i_0	i_{-1}	i_{-2}	i_{-3}	i_{-4}	i_{-5}	
f_b	1/3780	207	528	-585	480	-462	0	462	-480	585	-528	-207
$2f_b$	1/7560	207	114	-1227	2292	-3234	3696	-3234	2292	-1227	114	207
Coefficients found for following sum- and difference-frequency terms will be amplitudes of each sideband												
$f_b \pm f_a$	1/420	23	44	-44	-16	21	-56	21	-16	-44	44	23
$f_b \pm 2f_a$	1/5040	243	352	-915	320	-518	0	518	-320	915	-352	-243
$f_b \pm 3f_a$	1/24	1	0	-3	0	2	0	2	0	-3	0	1
$f_b \pm 4f_a$	1/720	23	-32	-51	64	38	0	-38	-64	51	32	-23
$f_b \pm 5f_a$	1/45	1	-3	1	4	-2	-2	-2	4	1	-3	1

the area and deficiency spectrum data of the single-ended case. The effects of "carrier loss" were similarly taken into account. Predicted and measured results for *IM* and *IID* agreed, as shown in Fig. 10. An average-type detector was used, and the output meter *M'* was a full-wave average-reading meter. A supplementary experimental check showed that a peak-type detector was not subject to turnover effect, but that a half-wave peak-type output meter was so subject. These effects are in agreement with the analysis presented under the section on Metering Practice below.

Case (III). Push-Pull Sine-Form Characteristic: This case, seemingly of no more than academic interest, is presented here in summary form. The results of this analysis were found useful for correlation and a check of other analyses, as described in the next paragraph.

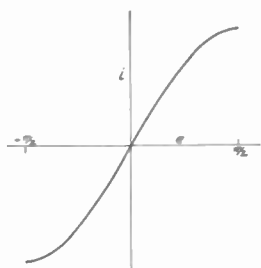

Fig. 11—Push-pull sine-form transfer characteristic.

If the transfer characteristic can be represented by a portion of a sine wave, as shown in Fig. 11, the analysis shows that, considering only the prominent sideband and harmonic terms,

$$\text{per cent } IM \cong \frac{2J_2(A)}{J_0(A)} \times 100, \tag{17}$$

and

$$\text{per cent } HD \cong \frac{J_3(A')}{J_1(A')} \times 100 \tag{18}$$

where J_0, J_1, \dots , are Bessel functions of the first kind on the respective arguments, and A and A' have the same meaning as in Case (I). The theoretical ratio of *IM* to *IID* values is practically 4 for $A/B=4$ and for peak-signal levels not exceeding $e=\pi/2$. No experimental

data were obtained for this case. The results serve to check those for the push-pull Case (I-b) when these results are expressed as the ratio of per cent *IM* to per cent *IID* as done in Fig. 15. *IM* values computed for the push-pull sine-form characteristic, using the coefficients listed in Tables I and II, were identical with those obtained from a more exact form of (17). This serves to check the method using these coefficients.

Effects of Metering Practice

In the intermodulation test arrangement, Fig. 1, the carrier-level meter M_c and output meter M' are generally d.c. meters used with a suitable rectifier. Each such meter-rectifier arrangement may be of the full-wave or half-wave average type, or of full-wave or half-wave peak-reading type. In general, the voltages impressed on the meter-rectifier arrangement are of complex wave form, and the readings obtained for the respective quantities will be affected by the behavior of the metering arrangement with such voltages impressed. This section summarizes analytical and experimental observations pertinent to this problem. The behavior of the full-wave and half-wave average types is the same; hence, these are referred to only as a single type in what follows.

TABLE II
1-TO-1 SIGNAL-RATIO CASE; MULTIPLYING COEFFICIENTS FOR EVALUATING INTERMODULATION PRODUCTS FROM ELEVEN EQUIDISTANT ORDINATES ON RESISTIVE LOAD LINE

Frequency	Common Multiplier	Intermodulation Products					Signal Ratio, $V_a/V_b=2/2=1$			
		i_{+4}	i_{+3}	i_{+2}	i_{+1}	i_0	i_{-1}	i_{-2}	i_{-3}	i_{-4}
f_b	1/18	1	3	2	1	0	-1	-2	-3	-1
$2f_b$	1/24	1	2	-2	-2	2	-2	-2	2	1
$3f_b$	1/36	1	0	-4	4	0	-4	4	0	-1
Coefficients found for following sum- and difference-frequency terms will be amplitudes of each sideband										
$f_b \pm f_a$	1/18	1	2	1	-2	-4	-2	1	2	1
$f_b \pm 2f_a$	1/24	1	1	-2	-3	0	3	2	-1	-1
$f_b \pm 3f_a$	1/36	1	-1	-2	1	2	1	-2	-1	1
$f_b \pm 4f_a$	1/72	1	-3	2	1	0	-1	-2	3	-1

The relative phase relationships of the carrier components of voltage input to the detector in Fig. 1 are correctly given by (5). Expressed graphically, they are

as shown in Fig. 12. Certain of the harmonic components may have reversed phase if any of the coefficients

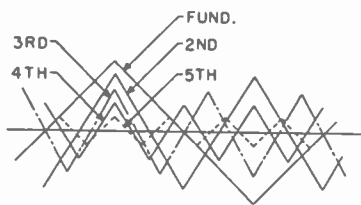

Fig. 12—Relative phase relationships of the carrier frequency and its harmonic terms from interpretation of (5). These same phase relationships apply to the l.f. components in the modulation envelopes.

a_2, a_3 , etc., in (3) are negative. In general, however, the following observations pertinent to detector and metering practice in *IM* testing apply:

(a) The reading of the carrier-level meter M_c in the presence of a modulated carrier will depend upon its rectification characteristic. Thus, if the rectifier is (1) of the average type, the meter reading is unaffected by the presence of modulation and is substantially independent of the harmonic content of the signal. The area under a half cycle of a composite wave containing fundamental and 20 per cent second harmonic, with relative phase relationship as shown in Fig. 12, is hardly 2 per cent greater than the area under the fundamental alone. No turnover effect will be obtained; i.e., reversing the connections to the terminals of the meter-rectifier arrangement will not change the reading of the meter.

If the rectifier is (2) of the half-wave peak type, the meter reading will be affected by modulation and by harmonic content (magnitudes and phase relations) of the carrier. This is illustrated in Fig. 13(c), which

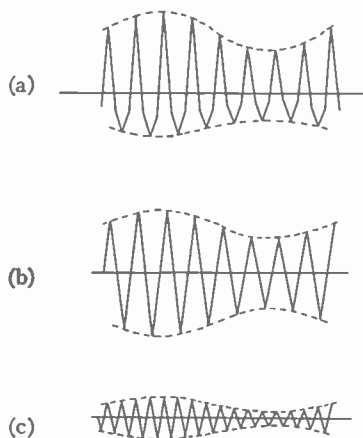

Fig. 13—Composite envelope (a), of the fundamental carrier (b) and its second harmonic (c), each of the later amplitude-modulated with the fundamental low-frequency signal.

shows the composite wave resulting from fundamental and second-harmonic carrier terms each with sideband terms corresponding to modulation at the low frequency of the test signal. This figure also indicates that turnover effect will prevail.

If the rectifier is (3) of the full-wave peak type, the meter reading will be affected by modulation and by harmonics of the carrier. There will be no turnover effect.

(b) The output of the detector will depend upon its rectification characteristic in the following ways. If the detector is (1) of the average, or "area," type, the presence of harmonics of the carrier frequency will have practically no effect on its l.f. output components. The r.m.s. summation of the sum and difference components, having frequencies $f_b \pm f_a$ and $2f_b \pm f_a$ in this instance, for a case such as developed in Fig. 13 will be almost correctly represented by the l.f. output of the average-type detector.

If the rectifier is (2) of the half-wave peak type, the output will be markedly affected by the direction of connection of the detector when harmonics of the carrier frequency combine as illustrated in Fig. 13(c) to make for different modulation-envelope amplitudes on opposite half cycles of the composite voltage.

If the rectifier is (3) of the full-wave peak type, the output will be affected by harmonics of the carrier frequency, but it will not be subject to turnover effect.

(c) The reading of the output meter M' will also be directly affected by its rectification characteristics. If the rectifier is (1) of the average type, the reading of M' will be unaffected by the direction of connection of the rectifier, and the reading will represent the r.m.s. sum of the l.f. components of a complex output voltage with good accuracy.

If the rectifier is (2) of the half-wave peak type, the reading of M' will be subject to turnover and it will be affected by the harmonic content (magnitudes and phase relations) of the output.

If the rectifier is (3) of the full-wave peak type, the reading of M' will be affected by the harmonic content (magnitudes and phase relations) of the output but will not be subject to turnover.

In summary, it follows that, depending upon their respective rectification characteristics:

(a) The carrier-meter reading may be affected by harmonics of the carrier and by the presence of modulation; (b) the detector output may be affected by harmonics of the carrier; and (c) the output-meter reading may be affected by harmonics of the l.f. (modulating) signal.

Fig. 14 shows results revealing the effect of detector and output-meter M' turnover on the per cent *IM*. These results are for the 6V6 amplifier previously treated. The tube was operated under conditions that give rise to a more prominent cubic term than indicated by (6). The solid-line curves of Fig. 14 are all for the same test-circuit conditions excepting for the output meter M' which is connected to read the average value, or positive or negative peaks. The prominent second harmonic present in the voltage being measured by the peak-type meter M' gives rise to the markedly different results for positive and negative peaks. The agreement

between per cent *IM*, calculated from low-frequency component voltages as measured with a harmonic analyzer, and from the full-wave average-reading meter, follows from the relative freedom of the latter from wave-form errors.

Comparison of the two center curves in Fig. 14 reveals the effect of relative phase relationship of the fundamental and second harmonic of the carrier fre-

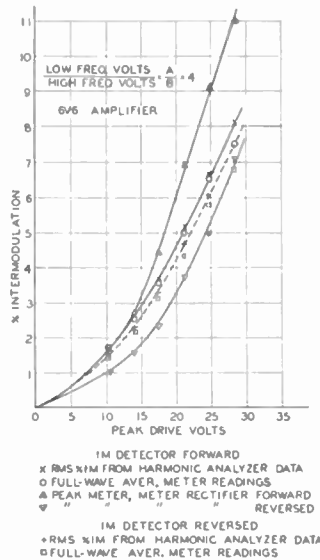

Fig. 14—Per cent intermodulation as a function of signal voltage, showing how the results are affected by direction of connection of the detector and by direction of connection and type of output meter used.

quency with respective first-order sidebands, as illustrated in Fig. 13. Using a half-wave peak detector to rectify the composite wave of Fig. 13(c) gives rise to a larger low-frequency component for one direction of connection of the detector than for the other. The carrier-level reading was made ahead of the detector, and a full-wave average-type meter was used. The carrier-level reading then will be independent of the direction of connection of the detector. This serves to illustrate the effect of the type and manner of connection of the detector upon per cent *IM* in the test arrangement considered. The effect of the detector was checked by noting that the magnitude of the f_a term, as measured with the harmonic analyzer, changed with the change in detector connection.

PART B—PREDICTION OF INTERMODULATION DISTORTION

I. Approximate Prediction Equations

For amplifiers working into a resistance load, the intermodulation distortion can be predicted with the aid of equations essentially similar to those expressing harmonic distortion in terms of selected ordinates on the tube load line. Both predictions are subject to the same reservations with regard to accuracy. Using Terman's⁸ method for prediction of harmonic distortion, together

⁸ See p. 380 of footnote reference 7.

with the previously derived theoretical ratios of *IM* to *HD* for the signal ratio $A/B=4$, there follows:

For the single-ended amplifier, assuming only second-harmonic distortion:

$$\text{per cent } IM = 1.6 \frac{I_{max} + I_{min} - 2I_b}{I_{max} - I_{min}} \times 100. \quad (19)$$

For the push-pull amplifier, assuming only third-harmonic distortion:

$$\text{per cent } IM = 3.84 \frac{I_{max} - I_{min} - \sqrt{2} (I_2 - I_3)}{I_{max} - I_{min} + \sqrt{2} (I_2 - I_3)} \times 100 \quad (20)$$

where the tube plate-current values are

- I_{max} at positive peak of total signal voltage
- I_{min} at negative peak of total signal voltage
- I_2 at 0.707 times positive peak of total signal voltage
- I_3 at 0.707 times negative peak of total signal voltage
- I_b at zero signal.

II. Coefficients for Prediction from Eleven Points on Transfer Characteristic

Bloch⁹ has prepared a table of multiplying factors for calculation of the amplitudes of the sideband terms from the current values on the tube load line. The tabulation is limited to a signal ratio amplitude (A/B) not greater than 3. Use of this method yields the actual current amplitudes of the sideband terms. Extension of the work of Espley¹⁰ to enable calculation of harmonics up to the 8th from nine equally spaced ordinates made it possible to extend the tables of Bloch to the case of signal ratio=4. The fundamental and second-harmonic carrier terms and all prominent sideband terms can be calculated by use of Table I. The eleven current values, designated as $i_{+5}, i_{+4} \dots i_0 \dots i_{-4}, i_{-5}$, are taken from the load line for corresponding, equal intervals of the total peak-signal voltage. Each current value is multiplied by the factor listed, and the sum of such products, with due regard to sign, is formed and multiplied by the common multiplier. The result will be the amplitude, in current units, of the corresponding carrier or sideband term. As an example, the following are the results for the triode-connected 6V6 of Case I-a; signal ratio $A/B=4$, 20 volts peak drive, and 26 volts bias:

Instantaneous grid voltage	Plate-current (ma.)
-6	53.0
-10	48.7
-14	44.6
-18	40.7
-22	36.9
-26	33.2
-30	29.5
-34	25.9
-38	22.4
-42	18.9
-46	15.5

⁹ A. Bloch, "Modulation products; calculation from equidistant ordinates," *Wireless Eng.*, vol. 23, pp. 227-230; August, 1946.

¹⁰ D. C. Espley, "The calculation of harmonic production in thermionic valves with resistive loads," *Proc. I.R.E.*, vol. 21, pp. 1439-1446; October, 1933.

Use of the tabulated multipliers yields:

Current of frequency $f_b = 3.755$ ma.

Current of frequencies $f_b \pm f_a = 0.170$ ma.

Current of frequencies $f_b \pm 2f_a = 0.021$ ma.

Current of frequency $2f_b = 0.039$ ma.

Per cent $IM \cong (2 \times 0.170 / 3.755) \times 100 = 9.1$ per cent.

When testing the performance of amplifiers at the higher frequencies, it is sometimes found desirable to use a signal ratio of 1. Table II gives the multipliers for predetermining the carrier frequency and sideband terms for this signal ratio.

CONCLUSIONS

I. If the transfer characteristic of a network is substantially independent of frequency, it is possible to evaluate the intermodulation and harmonic distortion

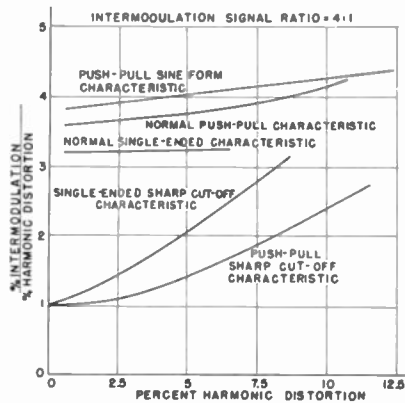

Fig. 15—Ratio of intermodulation to harmonic distortion as a function of the latter for some typical transfer characteristics. The intermodulation test method for which these results apply is described in the text of this paper.

due to the nonlinearity of the characteristic. Relatively simple equations are derived for per cent IM and per

cent HD for transfer characteristics expressible in simple analytic form.

For a given intermodulation test method, therefore, the specified operating conditions can be introduced to uniquely evaluate this distortion. It becomes possible, then, to express the ratio of the two distortion percentages. This has been done for certain typical transfer characteristics and for an intermodulation test method as described, and the ratios have been found to be relatively constant. Fig. 15 summarizes these ratios for the cases covered by this study.

II. The presently accepted value of 4:1 for ratio of signal amplitudes in intermodulation testing is a good compromise, making for operating conditions that give a high IM percentage and still have reasonable values of carrier and sideband voltages for detection and measurement.

III. The type of carrier-level meter, detector, and output meter used in the intermodulation testing apparatus will each, and in combination, affect the results obtained.

The analysis above indicates that the intermodulation-measurement technique will best satisfy the defining equation if an average-type detector is used and if the carrier-level and output meters are of the average-reading type. This practice will also help eliminate differences that may appear in IM results obtained with apparatus of different manufacture in which different amounts of phase shift are introduced between the fundamental and harmonics. Such phase shift differences will have a direct bearing upon the output of a peak-type detector as well as upon the readings of peak-type meters.

IV. Intermodulation-distortion percentage values are readily predictable from transfer characteristic or load-line data by the use of tabulated multiplying coefficients that can be used to calculate the magnitudes of the usually prominent intermodulation terms.

Automatic Volume Control as a Feedback Problem*

B. M. OLIVER†, MEMBER, I.R.E.

Summary.—Feedback amplifier theory is shown to be applicable to the usual a.v.c. system. Expressions are derived for the loop gain in terms of the design requirements and the gain-control characteristic of the controlled amplifier. Using these expressions, the design of an a.v.c. system is quite straightforward, and its characteristics, such as regulation and effect on desired modulation, are readily predictable.

* Decimal classification: R361.201×R139.2. Original manuscript received by the Institute, July 8, 1946; revised manuscript received, October 8, 1947.

† Bell Telephone Laboratories, Inc., New York, N. Y.

I. INTRODUCTION

A SIMPLE FEEDBACK amplifier has these essential features:

- (1) There is an input.
- (2) There is an output.
- (3) There is a transmission path (called the β circuit) which develops a measure of the output.
- (4) There is a means for comparing this measure of the output with the input, i.e., means for developing a "net" or "error" signal which is the algebraic sum of the input and the measure of the output.

(5) There is an amplifier (called the μ circuit) which develops the output from this "net" or "error" signal. Whenever all of these features are present in any linear system,¹ be it a thermostat, or a regulated power supply, or an automatic-tracking radar, we may properly call that system an analog of a feedback amplifier, and profit by the analogy. The following analysis of an automatic-volume-control (a.v.c.) system is presented, not only for its own sake, but also with the hope of stimulating this point of view in the reader.

II. FEEDBACK NATURE OF A TYPICAL A.V.C. SYSTEM

In Fig. 1 are shown in block schematic form an r.f. amplifier whose gain depends on the potential V of a control lead, an envelope detector to monitor the output amplitude of this amplifier, a low-pass filter in the output of the detector, and a d.c. amplifier which develops the control voltage V proportional to the amount by which the output of the low-pass filter exceeds a "threshold" voltage E . Together, these units comprise a typical a.v.c. circuit.

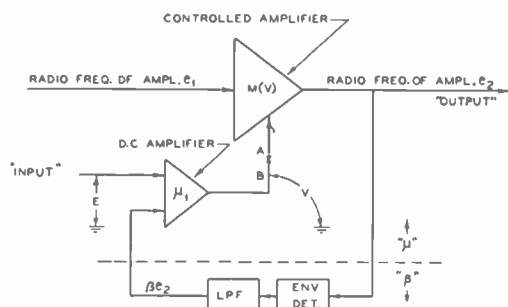

Fig. 1—A typical a.v.c. system.

But now let us replace the constant threshold or reference voltage E by an audio-frequency input, and let us call the variable-gain amplifier a modulator. The circuit might now be called "a block schematic of a radio transmitter with envelope feedback." There is an input (the voltage E), there is an output (the radio frequency of amplitude e_2), there is a transmission path (the envelope detector and low-pass filter) which develops a measure of the output (βe_2), there is a means for developing the algebraic sum of E and βe_2 (this is the net input to the d.c. amplifier), and finally, there is an amplifier (the d.c. amplifier and the r.f. modulator) for producing an output proportional to this net input. All of the circuit between the comparison point and the output is called, in feedback amplifier terminology, the " μ " circuit, while the transmission path which develops at the comparison point a measure of the output is called the " β " circuit.² Considering envelope quantities

¹ Even a large class of nonlinear systems may be treated as linear systems, provided only that all characteristics are continuous around the operating point. An a.v.c. system is an example of this.

² In many a.v.c. circuits the output of the envelope detector is taken as the useful output of the system. The envelope detector then properly is part of the " μ " circuit.

only in the r.f. portion of the circuit, and denoting the transmission of the " μ " circuit by μ , and the transmission of the " β " circuit by β , it is evident that

$$e_2 = \mu(E + \beta e_2) \quad (1)$$

$$e_2 = \frac{\mu}{1 - \mu\beta} E. \quad (2)$$

So long as $|\mu\beta| \gg 1$,

$$e_2 \cong -\frac{1}{\beta} E, \quad (3)$$

and the output is independent of μ , so that disturbances in the μ circuit are suppressed. The degree of this suppression may be obtained by differentiating (2) with respect to μ and dividing the result by (2) itself. Thus

$$de_2 = \frac{d\mu}{(1 - \mu\beta)^2} E$$

$$\frac{de_2}{e_2} = \frac{1}{1 - \mu\beta} \frac{d\mu}{\mu}, \quad (4)$$

and any variations in the μ circuit are suppressed by the factor $1/1 - \mu\beta$.

In a radio transmitter the principal μ -circuit variations might be the nonlinearity of the modulator, and $|\mu\beta|$ would be made much larger than unity over the entire modulation-frequency spectrum. In the a.v.c. case the principal μ -circuit variation is fluctuations in the received r.f. signal strength; i.e., variations in the amplitude of e_1 . So long as $|\mu\beta| \gg 1$ these variations will be suppressed, and an output amplitude e_2 equal to $(1/\beta)E$ (and therefore constant) will be developed. Obviously, $|\mu\beta|$ must be less than unity over the range of desired modulation frequencies in e_1 , or these modulations also would be suppressed in the output.

The importance of the input or reference voltage is apparent, since, if E were zero, any output which might appear would be due to the failure of the circuit to regulate completely. In many a.v.c. systems (called "undelayed" systems)³ the input voltage E is zero. That this type of system performs satisfactorily in many applications arises from the fact that the loop gain is low for small received-signal amplitudes, as will be shown later. The "failure to regulate" is thus quite large for low signal inputs, and the regulation does not become good until an appreciable (and usable) output has developed.

From the feedback viewpoint, then, an a.v.c. circuit is a d.c. amplifier-modulator with negative-envelope feedback, whose input is a constant voltage and whose average output amplitude therefore is constant so long as the loop gain is high.

³ A.v.c. systems incorporating a reference input or threshold often are called "delayed" systems. The term is perhaps an unfortunate one, since it connotes a time delay rather than an amplitude threshold.

III. LOOP GAIN

Let the control lead in Fig. 1 be broken at the point marked "X," and let each side of the break be terminated in the impedance normally presented by the other side. An incremental voltage $\Delta V_a(\omega)$ applied to point A will cause a return voltage at B, $\Delta V_b(\omega)$. Let the loop transmission⁴ $\mu\beta$ be defined as

$$\mu\beta(\omega) = \lim_{\Delta V_a \rightarrow 0} \frac{\Delta V_b(\omega)}{\Delta V_a(\omega)}. \quad (5)$$

e_1 is assumed constant at the value \bar{e}_1 . Except for the restriction to infinitesimally small inputs, this is the usual definition of loop transmission. Since the a.v.c. loop transmits d.c., it is convenient first to evaluate the loop transmission at d.c., by considering ΔV_a to be a d.c. increment in the control voltage. Thus,

$$\mu\beta(0) = \lim_{\Delta V_a \rightarrow 0} \frac{\Delta V_b}{\Delta V_a},$$

and

$$\mu\beta(\omega) = \mu\beta(0)Y(\omega) \quad (6)$$

where $Y(\omega)$ is the transmission versus frequency characteristic around the loop normalized to unity at d.c., i.e., $Y(0) = 1$. ($Y(\omega)$ will ordinarily be simply the transmission characteristic of the low-pass filter in the β circuit, but may in some cases contain contributions from other sources, such as band limitation in the d.c. and r.f. amplifiers.)

If e_1 is constant at the value \bar{e}_1 and V is constant, the output will be a constant value \bar{e}_2 . $M(V)$ is defined as the envelope transmission of the amplifier under these conditions; that is,

$$\bar{e}_2 = M(V)\bar{e}_1. \quad (7)$$

Suppose now V is increased from \bar{V} to $\bar{V} + \Delta V_a$. The output amplitude \bar{e}_2 will increase by an amount

$$\Delta \bar{e}_2 = \bar{e}_1 [M(\bar{V} + \Delta V_a) - M(\bar{V})].$$

Dividing both sides by ΔV_a and taking the limit as $\Delta V_a \rightarrow 0$,

$$\lim_{\Delta V_a \rightarrow 0} \frac{\Delta \bar{e}_2}{\Delta V_a} = \bar{e}_1 \left[\frac{dM}{dV} \right]_{V=\bar{V}}. \quad (8)$$

But, by definition of μ_1 and β ,

$$\Delta V_b = \mu_1(0)\beta(0)\Delta \bar{e}_2. \quad (9)$$

Combining (8) and (9),

$$\mu\beta(0) = \mu_1(0)\beta(0)\bar{e}_1 \frac{dM}{dV}. \quad (10)$$

Obviously, the loop transmission depends upon the received r.f. signal amplitude \bar{e}_1 , and is zero in the absence

⁴ The term "gain," in its present usage, is the transmission ratio expressed in logarithmic units. Thus the "loop gain" in db may be taken as $20 \log_{10} |\mu\beta|$.

of any received signal. While this fact is of importance in the design of an a.v.c. system, it is not peculiar to this type of circuit. The loop transmission in a radio transmitter with negative-envelope feedback vanishes if the carrier input to the modulator is removed. The loop transmission in a feedback amplifier is zero if the plate supply fails. From the feedback viewpoint, the received signal in an a.v.c. system is simply a power source in the μ circuit.

Remembering that $\bar{e}_1 = \bar{e}_2/M(V)$, (10) may be rewritten:

$$\mu\beta(0) = \mu_1(0)\beta(0)\bar{e}_2 \left(\frac{1}{M} \frac{dM}{dV} \right). \quad (11)$$

The quantity $\mu_1(0)\beta(0)$ may now be expressed in terms of the static regulation requirements of the a.v.c. system. The following action will ordinarily be expected:

1. If the received signal amplitude is so weak that with the maximum gain of the r.f. amplifier the output is less than a desired minimum value, no gain reduction should be produced by the a.v.c.

2. If the received signal has the maximum expected amplitude, the output amplitude should not exceed a certain permissible value, and with this value of output the a.v.c. circuit must produce the required gain reduction in the r.f. amplifier.

Let

e_{\min} = minimum desired value of \bar{e}_2

e_{\max} = maximum permissible value of \bar{e}_2

V_{\max} = control voltage required to produce maximum required gain reduction in r.f. amplifier.

Condition (1) requires⁵ that, for $\bar{e}_1 = e_{\min}$, $V = 0$. Now,

$$V = \mu_1(0)[\beta(0)\bar{e}_2 \pm E]. \quad (12)$$

(The + sign is chosen if the two inputs to the d.c. amplifier are added; the - sign if they are subtracted, as in a differential amplifier.) Therefore, by condition (1),

$$E = \mp \beta(0)e_{\min}. \quad (13)$$

Substituting this in (12),

$$V = \mu_1(0)\beta(0)[\bar{e}_2 - e_{\min}]. \quad (14)$$

$$\mu_1(0)\beta(0) = \frac{V_{\max}}{e_{\max} - e_{\min}}. \quad (15)$$

Equation (15) gives the amplification necessary in the a.v.c. path in order to meet the static regulation requirements, while (13) gives the input or reference voltage required. If these conditions are met, the loop transmission may be found by substituting (14) and then (15) into (11). Thus,

⁵ Obviously, if the potential required on the control lead to produce maximum gain is not zero, but has some value, V_0 , then V in all the following equations may be replaced by $V - V_0$. V is taken to be the change in control-lead potential from the maximum-gain condition.

$$\mu\beta(0) = [V + \mu_1(0)\beta(0)e_{min}] \frac{1}{M} \frac{dM}{dV}$$

$$\mu\beta(0) = \left[V + \frac{V_{max}}{\frac{e_{max}}{e_{min}} - 1} \right] \frac{1}{M} \frac{dM}{dV} \quad (16)$$

Or, at any frequency,

$$\mu\beta = \left[V + \frac{V_{max}}{\frac{e_{max}}{e_{min}} - 1} \right] \frac{1}{M} \frac{dM}{dV} Y(\omega) \quad (17)$$

The foregoing implies that $M(V)$ is a continuous, monotonic function, i.e., that dM/dV is never infinite and does not reverse in sign over the operating range. Not only is this usually true, but often

$$\left| \frac{1}{M} \frac{dM}{dV} \right|$$

increase as $|V|$ increases. In this case, the maximum loop transmission occurs when $V = V_{max}$, and is given by

$$\mu\beta_{max} = \left[\frac{1}{1 - \frac{e_{min}}{e_{max}}} \frac{V}{M} \frac{dM}{dV} \right]_{V=V_{max}} Y(\omega) \quad (18)$$

The less the permissible db variation in \bar{e}_2 , and hence the more closely e_{max}/e_{min} is required to approach unity, the greater will be the required loop gain. For an "undelayed" system, $e_{min} = 0$, and (17) reduces to

$$\mu\beta = \frac{V}{M} \frac{dM}{dV} Y(\omega) \quad (19)$$

Hence, the loop gain in an "undelayed" system depends entirely on the control characteristic of the r.f. amplifier and the operating control voltage, and is independent of the amplification in the a.v.c. circuit. More about this later.

It is useful to note in connection with the expressions for loop transmission that

$$\frac{1}{M} \frac{dM}{dV} = \frac{d}{dV} \log_e M.$$

If $G = 20 \log_{10} M$

= r.f. amplifier gain in db,

then

$$\frac{1}{M} \frac{dM}{dV} = \frac{\log_e 10}{20} \frac{dG}{dV}$$

$$= 0.11514 \frac{dG}{dV} \quad (20)$$

dG/dV is readily found by measuring the slope of the gain-control characteristic. For example, suppose the amplifier whose gain-control characteristic is shown in

Fig. 6 were used. Suppose further that it is never necessary to reduce the gain of the amplifier below 0 db, and that the output should be held between 10 and 12 volts. Then

$$e_{min} = 10 \text{ volts}$$

$$e_{max} = 12 \text{ volts}$$

$$V_{max} = -6.1 \text{ volts.}$$

dG/dV increases as $|V|$ increases, and at $V = V_{max}$, $dG/dV = 33$ db/volt. So

$$\frac{1}{M} \frac{dM}{dV} = 3.8,$$

and, from (18),

$$\mu\beta_{max}(0) = \frac{1}{1 - \frac{10}{12}} (-6.1)(3.8) = -139$$

$$= 42.8 \text{ db.}$$

It should be noted that the loop gain is by no means nearly equal to the r.f.-amplifier gain reduction. Both of these quantities increase with increasing r.f. inputs, but it is not unusual to have a gain reduction of over 80 db with less than 40-db loop gain.

IV. EFFECT OF A.V.C. ON MODULATION

The a.v.c. circuit is expected to suppress certain modulations in the received-signal amplitude without affecting others. To be able to design such a system intelligently, we need to know quantitatively what its effect will be on any received modulation.

By definition of $M(V)$,

$$\bar{e}_1 = \frac{\bar{e}_2}{M(V)}.$$

Differentiating,

$$\frac{d\bar{e}_1}{d\bar{e}_2} = \frac{M - \bar{e}_2 \frac{dM}{d\bar{e}_2}}{M^2} = \frac{1 - \bar{e}_1 \frac{dM}{d\bar{e}_2}}{M}$$

But

$$\frac{dM}{d\bar{e}_2} = \frac{dM}{dV} \frac{dV}{d\bar{e}_2} = \mu_1(0)\beta(0) \frac{dM}{dV}.$$

So

$$\frac{d\bar{e}_1}{d\bar{e}_2} = \frac{1 - \mu_1(0)\beta(0)\bar{e}_1 \frac{dM}{dV}}{M}.$$

But, from (10),

$$\mu_1(0)\beta(0)\bar{e}_1 \frac{dM}{dV} = \mu\beta(0).$$

Substituting,

$$\begin{aligned} \frac{d\bar{e}_1}{d\bar{e}_2} &= \frac{1 - \mu\beta(0)}{M} \\ d\bar{e}_2 &= \frac{M}{1 - \mu\beta(0)} d\bar{e}_1 \\ \frac{d\bar{e}_2}{\bar{e}_2} &= \frac{1}{1 - \mu\beta(0)} \frac{d\bar{e}_1}{\bar{e}_1}. \end{aligned} \quad (21)$$

Thus an incremental change in the d.c. amplitude of the received signal is suppressed in the output by the factor $1/1 - \mu\beta(0)$. This is entirely in accord with feedback theory, and could have been predicted from (4) since μ is proportional to \bar{e}_1 .

If the input modulation is an incremental voltage $\Delta e_1(\omega)$, a similar analysis shows that

$$m_2(\omega) = \frac{Y_a(\omega)}{1 - \mu\beta(\omega)} m_1(\omega)$$

where

$$m_1 = \Delta e_1(\omega) / \bar{e}_1 = \text{input modulation index}$$

$$m_2 = \Delta e_2(\omega) / \bar{e}_2 = \text{output modulation index}$$

$Y_a(\omega)$ = normal modulation versus frequency characteristic of the r.f. amplifier.

Letting

$$Y_m(\omega) = m_2 / m_1 = \text{modulation versus frequency characteristic with a.v.c.,}$$

we may write

$$Y_m(\omega) = \frac{Y_a(\omega)}{1 - \mu\beta(\omega)}. \quad (22)$$

These equations hold in their linear form provided the input modulation index is so small or the frequency so high that only a small variation in the r.f. amplifier gain occurs during the cycle. Otherwise, harmonic distortion of the received modulation is produced.

$Y_a(\omega)$ is simply the selectivity characteristic of the r.f. amplifier centered about d.c. rather than the carrier frequency, and normalized to unity at d.c., i.e., $Y_a(0) = 1$. Without a.v.c., the modulation transmission characteristic is that of a simple low-pass filter having flat transmission in the low-frequency region. The situation is very different with a.v.c. At high frequencies $\mu\beta \ll 1$ and $Y_m(\omega) \cong Y_a(\omega)$, so that the high-frequency-modulation transmission is unaffected. At d.c. and very low frequencies, however, $\mu\beta \gg 1$ and $Y_m(\omega) \ll Y_a(\omega)$. The transmission of low-frequency modulation is therefore reduced by the a.v.c. (the reduction at d.c. is the desired regulation) and a low-frequency cutoff is introduced. This cutoff is near the frequency of gain crossover⁶ of the a.v.c. loop and therefore at a much higher frequency than the nominal cutoff of the low-pass filter in the a.v.c. circuit.

⁶ This is the frequency for which $|\mu\beta| = 1$.

Two typical loop-gain characteristics and the resulting low-frequency suppression are shown in Fig. 2. A loop gain of 40 db at d.c. has been assumed. The curves marked (1) are for the case of a simple low-pass filter in the β circuit, such as might be obtained with a single series-resistance, shunt-capacitance structure. The curves marked (2) are for a somewhat sharper filter characteristic.⁷

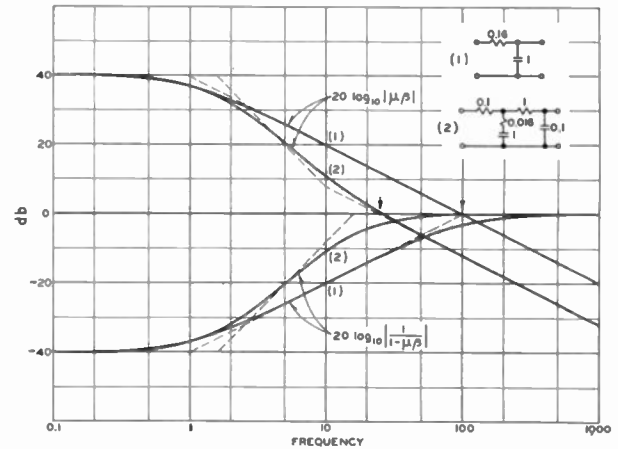

Fig. 2—Low-frequency suppression caused by a.v.c. action.

The loop gain in both cases is roughly the same up to about 2 c.p.s., and therefore both circuits provide equal suppression of modulation below this frequency. (Likewise, the recovery times of the two circuits for large input-signal changes will be nearly equal.) However, the gain crossover in case 1 is at 100 c.p.s., while that in case 2 is at 25 c.p.s. In each case the modulation transmission is down 3 db at the frequency of gain crossover. Thus the sharper cutoff extends the low-frequency-modulation transmission from 100 c.p.s. down to 25 c.p.s. Alternatively, the sharper cutoff characteristic could be raised in frequency to provide faster a.v.c. action for roughly the same low-frequency degradation as in case 1.

Obviously, the sharper the filter cutoff, the more closely the gain crossover frequency approaches the filter cutoff frequency; i.e., a smaller frequency interval is consumed in dropping the a.v.c. loop gain. However, stability requirements and the permissible low-frequency gain enhancement definitely limit the sharpness of cutoff which can be used. This will be discussed later.

Since $Y_m(\omega)$ as given by (22) is an admittance characteristic in complex form, the expression can be used to determine the transient response $A(t)$ of the system to an incremental step in received-signal amplitude. If, as is usually the case, the bandwidth of the amplifier is much wider than that of the a.v.c. system, the terms in $A(t)$ contributed by $Y_a(\omega)$ will affect only the initial part of the total transient. In studying the effect of

⁷ The broken lines in the figure represent the asymptotic slopes of the sections between the critical frequencies determined by the poles and zeros.

a.v.c. upon the system response, therefore, it is usually permissible to replace $Y_a(\omega)$ by unity.

Assuming that $\mu\beta(\infty) = 0$, it follows that

$$A(0) = 1$$

$$A(\infty) = \frac{1}{1 - \mu\beta(0)}$$

Thus a step-function increase of, say, 1 per cent in the received amplitude would produce an initial 1 per cent increase in the output amplitude, but this increase in output would ultimately decrease to $1/1 - \mu\beta(0)$ per cent.⁸

The form of the transient between initial and final values is, of course, determined by the particular form of $\mu\beta(\omega)$. In general, the time of recovery for a small step is closely associated with the frequency of gain crossover.

If a large step in received signal amplitude occurs, the loop may be broken momentarily either by amplifier overload or failure of the output to exceed e_{\min} , depending on the direction of the step. During this time the control voltage will change the new value in a manner which is given by the transient response of the a.v.c. path to a fixed step input.

V. STABILITY CONSIDERATIONS

Equation (22) contains the factor $1 - \mu\beta$ in the denominator. For the system to be stable, all the roots of the equation $1 - \mu\beta = 0$ must have negative real parts, for otherwise the transmission by the system of a modulation in the form of some exponentially increasing sinusoid would be infinite. Even with an unmodulated received signal, such a modulation would appear in the output and grow until limited by system nonlinearity.

Nyquist⁹ has shown that, if a polar plot is made of the magnitude and phase of $\mu\beta$ as a function of (real) frequency (from $\omega = -\infty$ to $\omega = +\infty$), and the resulting curve does not enclose the point $1|0$, then $1 - \mu\beta = 0$ has no roots with positive real parts, and the system is stable. This is known as Nyquist's criterion, and the figure used is called a Nyquist diagram.

Fig. 3 is a Nyquist diagram of a stable a.v.c. loop. The polar plot of $\mu\beta$ is shown for three conditions of gain as might be caused by different input-signal strengths.¹⁰ As the loop gain changes, the diagram simply expands or contracts radially. The magnitude of $\mu\beta$ changes, but the phase does not. Clearly, to be stable under all conditions, the diagram cannot have any convolutions which, under the maximum loop-gain condition, cross the real axis beyond the point $1|0$, for at certain values of reduced gain these convolutions would enclose the point $1|0$, and the system would become unstable.

⁸ Since $\mu\beta(0)$ is negative, $1 - \mu\beta(0) > 1$.

⁹ H. Nyquist, "Regeneration theory," *Bell Sys. Tech. Jour.*, vol. 11, p. 126; January, 1932.

¹⁰ $\mu\beta$ is shown here for positive frequencies only. The locus for negative frequencies is the image about the real axis.

At zero frequency the phase of $\mu\beta$ is 180° . The phase of $Y(\omega)$ reduces the total phase of $\mu\beta$, and must therefore never be greater (in absolute value) than 180° at any frequency for which $|\mu\beta| > 1$ (or, in other words, up to the maximum expected frequency of gain crossover). Mathematically, the system would be stable if the phase of $\mu\beta$ at gain crossover were greater than zero

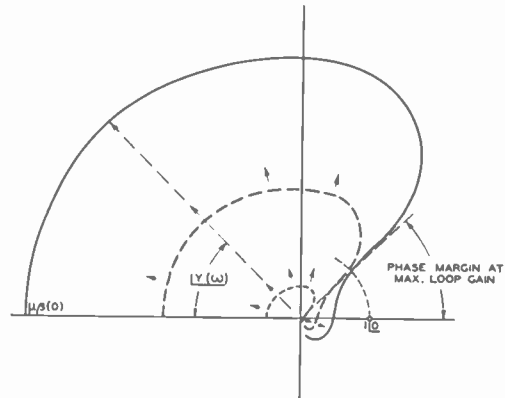

Fig. 3—Nyquist diagram of a stable a.v.c. system.

by an arbitrarily small amount. If, however, this phase margin is very small, then at the frequency of gain crossover the quantity $1 - \mu\beta$ is also very small, and serious enhancement of modulation frequencies in this region occurs. This is equivalent to saying that the system transient response becomes highly oscillatory. Practically, then, it is desirable to maintain a phase margin of 45° to 60° .

In order that unexpected increases in loop gain do not destroy the phase margin (at the new gain crossover), it is further desirable that the loop gain be some -10 or -20 db (under design conditions) at the frequency at which the phase shift becomes 180° ("phase crossover"). This is known as gain margin.

The problem of shaping the cutoff characteristic of a feedback system has been extensively treated in the literature^{11,12} and will not be discussed in detail here. Briefly, however, the situation is this: In any physical network there is an irreducible minimum amount of phase shift associated with a given amplitude versus frequency characteristic. The phase shift at any frequency is a weighted average of the slope of the gain versus log frequency characteristic about the given frequency. Thus the requirement that the phase shift be appreciably less than 180° limits the rate at which the loop gain may be reduced with frequency (over long intervals), usually to about 9 db per octave.

In certain applications the a.v.c. loop may not be closed continuously, but only periodically for small time intervals. This alters somewhat the conditions for stability. Appendix I contains a brief discussion of this case.

¹¹ H. W. Bode, "Relations between attenuation and phase in feedback amplifier design," *Bell Sys. Tech. Jour.*, vol. 19, p. 421; July, 1940.

¹² H. W. Bode, "Network Analysis and Feedback Amplifier Design," D. Van Nostrand & Co., New York, N. Y., 1945.

VI. CONDITIONS FOR ZERO GAIN ENHANCEMENT

In order that the a.v.c. action may never increase the modulation transmission at any frequency, $|1 - \mu\beta|$ must be greater or equal to unity at all frequencies. On a Nyquist diagram, then, $\mu\beta$ must stay outside a unit circle drawn around the point $1|0$. (See Fig. 4.) If α is the phase margin, this requires that

$$\alpha \geq \cos^{-1} \frac{|\mu\beta|}{2} \tag{23}$$

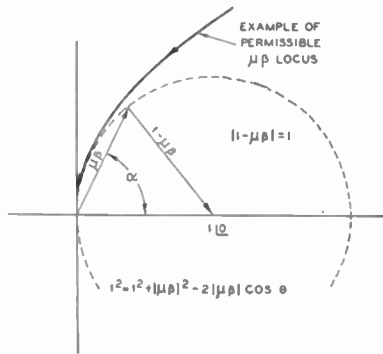

Fig. 4—Condition for zero gain enhancement.

In particular, as $|\mu\beta| \rightarrow 0$ at high frequencies, $\alpha \rightarrow 90^\circ$. This is the phase margin associated with a 6-dB/octave gain slope. Thus, for zero gain enhancement, the loop gain must not fall faster than 6 dB/octave at high frequencies. This may seem strange, but it is an annoying fact encountered in long transmission circuits having many a.v.c. circuits in tandem.

VII. VARIATION IN MODULATION TRANSMISSION WITH VARIATION IN A.V.C. LOOP GAIN

Remembering that $\mu\beta$ can vary anywhere from zero to a design maximum value, depending on received signal strength, it is clear from (22) that, to avoid variations in the transmission of modulation, $(\mu\beta)_{\max}$ must be much less than unity over the range of modulation frequencies for which distortionless transmission is desired.

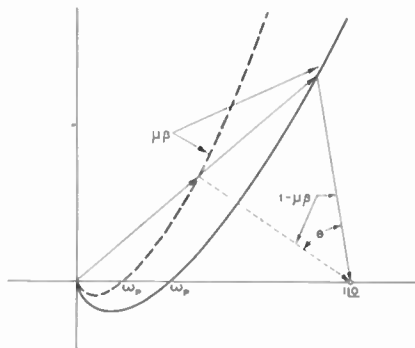

Fig. 5—Phase shift of $1 - \mu\beta$.

Although the phase of $\mu\beta$ does not change as the loop gain varies, the phase of the quantity $1 - \mu\beta$ may change a great deal. Fig. 5 shows a portion of a typical loop-gain characteristic under two conditions of gain dif-

fering by 6 db. The phase of $\mu\beta$ at any frequency is the same in the two cases, but the phase of the vector $1 - \mu\beta$ is different by an angle θ .

There is one frequency, ω_p , for which the phase of $1 - \mu\beta$ does not change with changes in $|\mu\beta|$. This is the frequency of phase crossover.¹³ As $|\mu\beta|$ varies, this point on the characteristic merely slides along the real axis, and the quantity $1 - \mu\beta$ has zero phase and changes in magnitude only. This fact may be used to advantage in certain cases where a severe requirement exists on the permissible variation in phase shift at a particular modulation frequency.

VIII. REGULATION CURVES

The static performance of an a.v.c. system is often shown as the regulation curve of steady-state output-signal amplitude against received-signal amplitude. These curves may easily be drawn if the control characteristic of the amplifier, and the d.c. transmission of

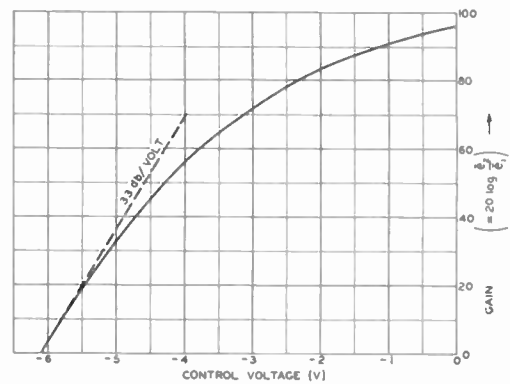

Fig. 6—Typical amplifier control characteristic.

the a.v.c. circuit $\mu_1(0)\beta(0)$, are known. For each output amplitude \bar{e}_2 , one may compute the control voltage produced. From the control characteristic, the corresponding amplifier gain is found. The received amplitude \bar{e}_1 is

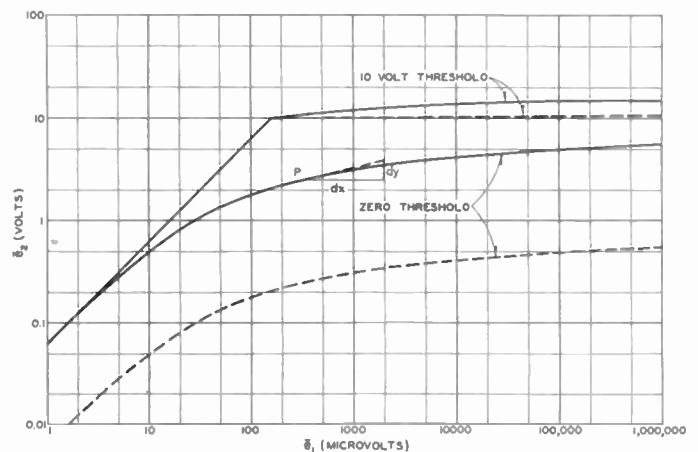

Fig. 7—A.v.c. regulation characteristics.

¹³ The same effect occurs at any frequency for which the phase of $\mu\beta$ is $n\pi$ radians ($n = 0, 1, 2, 3, \dots$).

then the assumed output divided by the existing amplification.

Fig. 6 shows a typical amplifier control characteristic. Assuming $\mu_1(0)\beta(0) = 1$, the two solid regulation curves of Fig. 7 were drawn, one for $e_{\min} = 0$ (zero threshold) and the other for $e_{\min} = 10$ volts.

The effect of adding amplification in the a.v.c. path is shown by the dotted curves for $\mu_1(0)\beta(0) = 10$. In the zero-threshold case, the entire output is simply reduced by a factor of 10, and the regulation (in db) is unimproved. For the 10-volt-threshold case, only the amount by which the output amplitude exceeds the threshold is reduced by a factor of 10, and the regulation is greatly improved.

There is a unique relation between these regulation curves and the d.c. loop gain. From (19),

$$\frac{\frac{d\bar{e}_2}{\bar{e}_2}}{\frac{d\bar{e}_1}{\bar{e}_1}} = \frac{1}{1 - \mu\beta(0)}.$$

If $y = \log \bar{e}_2$

$x = \log \bar{e}_1$

then $dy = d\bar{e}_2/\bar{e}_2$ and $dx = d\bar{e}_1/\bar{e}_1$. When the regulation curve is drawn, as shown, on log paper, then the slope S at any point P is given by

$$S = \frac{dy}{dx} = \frac{1}{1 - \mu\beta(0)}.$$

From which it follows that

$$\mu\beta(0) = 1 - \frac{1}{S}. \quad (24)$$

If the slope is unity, $\mu\beta(0) = 0$, as in the 10-volt-threshold case below 10 volts output amplitude. If the slope is very small, then $\mu\beta(0)$ is large and negative.

In the zero-threshold case, the slope of the regulation curve was nowhere affected by increasing $\mu_1(0)\beta(0)$ from 1 to 10. Thus the loop gain was unchanged, as predicted by (19).

APPENDIX I

Sometimes, when the signal being transmitted by the r.f. amplifier is of a periodic nature (or contains a certain component which recurs periodically), it is desirable to employ signal selection or "gating" means in the β circuit. The action is then to hold the amplitude of this selected signal constant in the output, regardless of the amplitude of signals which occur during other parts of the cycle. If this selected component is known to contain no desired modulation, as, for example, the line-frequency synchronizing pulse in a television signal, then the bandwidth of the a.v.c. system can be made quite wide to give very fast action, but without sup-

pressing the desired modulation between the pulses.¹⁴

The gating action is equivalent to a switch in the β circuit (prior to the low-pass filter) which is closed only for the selected interval in each cycle. If

f_p = repetition frequency of sampling

$\omega_p = 2\pi f_p$

$T_p = 1/f_p$ = repetition period

T_s = duration of selected interval

$\delta = T_s/T_p$ = "duty cycle,"

then the d.c. transmission of the β circuit will be decreased by the factor δ over what it would be with continuous closure. To make up for this, increased amplification could be used, but as $\delta \rightarrow 0$ this becomes increasingly difficult. What is often done is to sample the output amplitude during the selected interval and then to store or hold this amplitude until the next sample. Each sample is thus stretched into a rectangle of duration T_p . If $\delta \ll 1$, this is equivalent to passing the samples through a filter¹⁵ whose transmission is

$$\frac{1}{\delta} \frac{\sin \frac{\omega T_p}{2}}{\frac{\omega T_p}{2}} e^{-i(\omega T_p/2)}.$$

The d.c. transmission is thus restored, but the loop characteristic $Y(\omega)$ now contains the factor

$$\frac{\sin \frac{\omega T_p}{2}}{\frac{\omega T_p}{2}} e^{-i(\omega T_p/2)}.$$

Regardless of how the d.c. transmission of the loop is achieved, (16) will still be valid.

The stability considerations for the loop are different with intermittent closure. If $\delta \ll 1$, it can be shown that the loop will be stable if $\mu\beta(0)Y_p(\omega)$ satisfies Nyquist's criterion, where

$$Y_p(\omega) = \sum_{k=-\infty}^{k=\infty} Y(\omega - k\omega_p).$$

Since $Y_p(\omega)$ is periodic, it suffices to examine the stability over the interval $-(\omega_p/2) < \omega < (\omega_p/2)$. This is usually a lot of work and is unjustified unless extremely fast operation is required, for in general the loop will be stable if gain crossover occurs well below the frequency $f_p/2$. (At $f_p/2$, the pulse stretcher alone will introduce a phase shift of -90° .)

¹⁴ In television, for example, the received signal between synchronizing pulses contains a "d.c." component which depends on average picture brightness. If gating were not employed in the a.v.c. circuit this information would be suppressed, and furthermore the amplitude of the synchronizing pulses in the output would then vary instead.

¹⁵ The response of such a filter to an impulse of duration δT_p is a rectangle of the same height but of duration T_p after the impulse.

A Flat-Response Single-Tuned I. F. Amplifier*

E. H. B. BARTELINK†, SENIOR MEMBER, I.R.E., J. KAHNKE‡, ASSOCIATE, I.R.E., AND R. L. WATTERS§, ASSOCIATE, I.R.E.

Summary—An intermediate-frequency amplifier, providing double-tuned response using single-tuned circuits with negative feedback, is described. Particular attention is centered on the problems arising in the case where relatively narrow pass bands are wanted.

GENERAL

IN THE COURSE of some special work on radar systems, the authors found it desirable to have "flat-topped" intermediate-frequency amplifiers, mainly because they will allow some deviation in transmitter and local-oscillator frequencies without affecting the amplifier gain. Such amplifiers should be useful in many other applications.

At the time work on this project was started, there were no amplifiers readily available which combined the desired "flat-top" response with the compactness required. During a visit to the Radiation Laboratory at the Massachusetts Institute of Technology, the authors learned from L. A. Turner about the use of negative feedback¹ to obtain such a response from single-tuned circuits. The application at the Radiation Laboratory had been for rather wide pass bands, 10 Mc. and higher, while in the case under discussion a much narrower pass-band was needed.

The idea of using negative feedback to control the response curve has been known for some time. Wheeler¹ pointed out the effects of negative feedback on response. Feedback methods for the wide-band case were used by H. N. Beveridge and A. J. Ferguson and their co-workers in the National Research Council of Canada, and by E. Feenberg and W. W. Hansen in this country. These feedback applications contemplated "chain" feedback in which every stage was so equipped. In such cases, appreciable care has to be taken in the termination of the amplifier because reflected waves, similar to those in transmission lines and filters, can occur. Additional problems arise if gain control is desired, as is the case in most applications.

H. J. Lipkin, of the Radiation Laboratory, had proposed and used a different type of single-tuned feedback amplifier for the same wide pass bands (10 Mc. or more). In this amplifier, every stage of "feedback" amplification is separated from the next by a stage of "normal" amplification. This makes the amplifier unidirectional and eliminates all reflected-wave problems. In addition, gain control can easily be applied to the "normal"

stages. This type of feedback amplifier, which is by far the more desirable for a number of applications, is discussed in this paper.

It was found that, if the same techniques are used for narrow-band amplifiers (4 Mc. or less) as for wide-band amplifiers (10 Mc. or more), some particular problems arise. Initially, a direct plate-to-plate feedback resistor was mounted in an existing intermediate-frequency amplifier as shown in Fig. 1. A very large amount of spurious feedback was encountered. While it proved possible

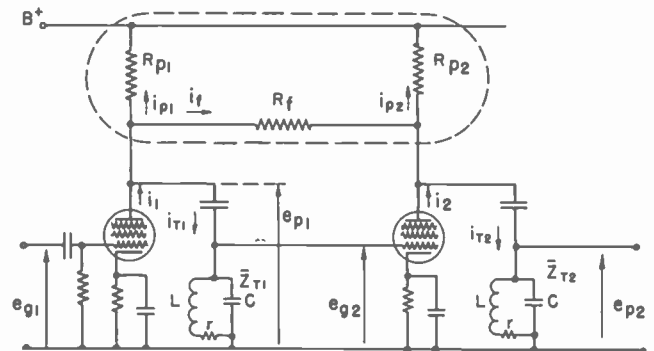

Fig. 1—Circuit diagram of the i.f. amplifier with high-impedance feedback.

to neutralize this spurious feedback and obtain the desired response curves, the resulting amplifier was highly unstable so far as the shape of the response curve was concerned. Part of this trouble was traced to the fact that decouplings, chiefly in screens and filaments, which are sufficient for the original purpose, are inadequate to produce stable response curves in the feedback amplifier. Even after these troubles were eliminated in a specially designed amplifier, it was observed that the direct plate-to-plate feedback method still resulted in excessive instability in the response curves.

To overcome this, a new method of applying the feedback was used which permits the use of low-impedance elements in the feedback circuit. The response curves of this arrangement proved to be highly stable. A new amplifier, designed to have the same physical dimensions as the existing single-tuned unit and in which particular care was given to decoupling and shielding, resulted in a very stable unit. The gain can be controlled by varying screen or control-grid voltages of the "straight" amplifier stages.

The following contains an analysis of the basic circuit showing the analogy of its response with that of the double-tuned intermediate-frequency stage, the analysis of the low-impedance feedback circuit, and a report on the development and behavior of the final unit.

* Decimal classification: R363.13. Original manuscript received by the Institute, December 24, 1946; revised manuscript received, September 18, 1947.

† General Telephone Service Corporation, New York 4, N. Y.

‡ Engineering Research Associates, Inc., St. Paul 4, Minn.

§ Research Laboratory, General Electric Company, Schenectady, N. Y.

¹ H. A. Wheeler, "Wide-band amplifiers for television," *Proc. I.R.E.*, vol. 27, pp. 429-438; July, 1939.

ANALYSIS OF THE BASIC CIRCUIT

The basic circuit is shown in Fig. 1. Simple reasoning shows that flat-topped and double-humped response curves may be expected from this circuit. The first approach is as follows: It is well known that any two coupled tuned circuits will produce "flat" and "double-humped" responses under suitable coupling conditions. The only exception is the case where the coupling is a pure unidirectional network like a tube. This case will have a response equal to the product of the single-tuned circuit responses. By inserting the feedback resistor R_F in Fig. 1, the bidirectional coupling and thus the ability to produce flat and double-humped responses has been restored.

The other way of reasoning is this: For large values of $\mu\beta$ the standard negative feedback equation

$$e_p = \frac{\mu\beta}{1 - \mu\beta} \frac{e_g}{\beta}$$

approaches $e_p = (1/\beta)e_g$. For a purely resistive feedback system this will give a gain which is independent of frequency. In the actual circuit of Fig. 1, however, the transfer constant of the feedback voltage is a maximum at the resonance frequency of the first plate circuit, i.e., more feedback exists at this frequency, and a dip in the response curve may be expected at this point.

Using the symbols appearing in Fig. 1, the following equations can be obtained:

$$i_1 = i_{p1} + i_{T1} + i_F \quad (1)$$

$$i_2 = i_{p2} + i_{T2} - i_F \quad (2)$$

$$i_1 = g_{m1}e_{g1} \quad (3)$$

$$i_2 = g_{m2}e_{g2} \quad (4)$$

$$i_{p1}R_{p1} = i_{T1}Z_{T1} \quad (5)$$

$$i_{p2}R_{p2} = i_{T2}Z_{T2} \quad (6)$$

$$i_{p1}R_{p1} - i_{p2}R_{p2} = i_F R_F \quad (7)$$

$$e_{g2} = -i_{p1}R_{p1} \quad (8)$$

These must be solved for the eight unknowns:

$$i_1, i_{p1}, i_{T1}, i_2, i_{p2}, i_{T2}, i_F, e_{g2}.$$

After some manipulation, (1) to (8) yield

$$g_{m1}e_{g1} = A_1 i_{p1} - B_{21} i_{p2} \quad (9)$$

$$0 = A_2 i_{p2} - B_{12} i_{p1} \quad (10)$$

where

$$A_1 = \left(1 + \frac{R_{p1}}{Z_{T1}} + \frac{R_{p1}}{R_F}\right) \quad (11)$$

$$A_2 = \left(1 + \frac{R_{p2}}{Z_{T2}} + \frac{R_{p2}}{R_F}\right) \quad (12)$$

$$B_{21} = \frac{R_{p2}}{R_F} \quad (13)$$

$$B_{12} = \frac{R_{p1}}{R_F} (1 - g_{m2}R_F). \quad (14)$$

Combining the preceding with

$$e_{p2} = i_{p2}R_{p2}, \quad (15)$$

the gain G becomes

$$G = -g_{m1}R_{p2} \frac{B_{12}}{A_1 A_2 - B_{12} B_{21}} = -g_{m1}R_{p2} \frac{B_{12}}{N} \quad (16)$$

where

$$N = A_1 A_2 - B_{12} B_{21}. \quad (16a)$$

All the frequency-dependent terms are concentrated in N . Substitution of (11), (12), (13), and (14) in (16a) gives

$$N = \left(1 + \frac{R_{p1}}{R_F} + \frac{R_{p1}}{Z_{T1}}\right) \left(1 + \frac{R_{p2}}{R_F} + \frac{R_{p2}}{Z_{T2}}\right) + (G_{m2}R_F - 1) \frac{R_{p1}R_{p2}}{R_F^2}. \quad (17)$$

Introducing

$$\left\{ \begin{aligned} Z_T &= \frac{(r + j\omega L) \frac{1}{i\omega C}}{r + j\left(\omega L - \frac{1}{\omega C}\right)} \\ \omega_c^2 &= \frac{1}{LC} \\ \omega &= (1 + \delta)\omega_0 \\ Q_T &= \frac{\omega_0 L}{r} = \frac{X_0}{r} \end{aligned} \right. \quad (18)$$

and assuming $\omega_{c1} = \omega_{c2} = \omega_c$, then

$$Z_T = \frac{X_0^2}{r} \frac{1 - j \frac{1}{Q_T(1 + \delta)}}{1 + 2j\delta Q_T \frac{1 + \delta/2}{1 + \delta}}. \quad (19)$$

Equation (19) is exact and not restricted to the case where the pass band is a small fraction of the carrier. If Q_T is large, the complex term in the numerator can be neglected. For the subsequent calculations a new variable ϵ is introduced, defined by

$$\epsilon = \delta \frac{1 + \delta/2}{1 + \delta} = \frac{1}{2} \left(\frac{\omega}{\omega_0} - \frac{\omega_0}{\omega} \right). \quad (20)$$

For small frequency deviations, ϵ approaches δ . Substitution of (20) in (19) under the assumption $Q_T \ll 1$ results in

$$\frac{1}{Z_T} = \frac{1 + 2j\epsilon Q_T}{X_0 Q_T}. \quad (21)$$

Neglecting the complex term in the numerator of (19) results in a small shift in the resonance frequency as compared to the value $\omega_0 = 1/\sqrt{LC}$. Assuming $Q_{T1} = Q_{T2}$

$= Q_T$, resonance will be obtained at a deviation $\delta^1 = 1/2Q_T r^2$ instead of $\delta = 0$. This effect shifts the response curve but does not affect its shape.

Introducing the symbols

$$\left\{ \begin{array}{l} \frac{X_{01}}{R_{p1}} = Q_{p1} \\ \frac{R_{p1}}{R_F} = \alpha_1 \\ (1 + \alpha_1)Q_{p1} + \frac{1}{Q_{T1}} = p_1 \end{array} \right. \left\{ \begin{array}{l} \frac{X_{02}}{R_{p2}} = Q_{p2} \\ \frac{R_{p2}}{R_F} = \alpha_2 \\ (1 + \alpha_2)Q_{p2} + \frac{1}{Q_{T2}} = p_2 \end{array} \right. \left\{ \begin{array}{l} G_F = g_{m2}R_F \\ Q_F^2 = \frac{X_{01}X_{02}}{R_F^2} \\ K^2 = (G_F - 1)Q_F^2 \end{array} \right. \quad (22)$$

equation (17) simplifies to

$$N = \frac{1}{Q_{p1}Q_{p2}} ((p_1 + 2j\epsilon)(p_2 + 2j\epsilon) + K^2). \quad (23)$$

This form is identical to the one for the double-tuned intermediate-frequency-transformer response. Thus the well-known criteria for critical coupling, attenuation, bandwidth, etc., can be applied directly to this case. Notably, "critical coupling" is obtained when

$$K^2 = K_0^2 = \frac{p_1^2 + p_2^2}{2}. \quad (24)$$

The bandwidth at the 1/2-power point is given by

$$\epsilon_{0.707} = 1/2\sqrt{p_1p_2 + K^2\sqrt{g + \sqrt{1 + g^2}}} \quad (24a)$$

where

$$g = \frac{K^2 - K_0^2}{p_1p_2 + K^2}.$$

If $p_1 = p_2 = p$, (24) reduces to $K_0 = p$, and (24a) to

$$\epsilon_{0.707} = 1/2\sqrt{(K^2 - K_0^2) + \sqrt{2(K^4 + K_0^4)}}. \quad (24b)$$

For $K \approx K_0$,

$$\begin{aligned} \epsilon_{0.707} &= 0.707K_0 = 0.707p \\ &= 0.707 \left\{ \left(1 + \frac{R_p}{R_F} \right) \frac{X_0}{R_p} + \frac{r}{X_0} \right\}, \end{aligned} \quad (24c)$$

and this same value holds in the region near critical coupling.

Equation (23) also determines the location ϵ_m of the peaks which occur at

$$\epsilon_m = 1/2\sqrt{K^2 - K_0^2}. \quad (24d)$$

Introducing (23) in (16), the gain becomes:

$$G = \frac{g_{m1}R_{p1} \cdot g_{m2}R_{p2} \left(1 - \frac{\alpha_1}{g_{m2}R_{p1}} \right)}{\frac{1}{Q_{p1}Q_{p2}} [(p_1 + 2j\epsilon)(p_2 + 2j\epsilon) + K^2]} \quad (25)$$

For the bandwidth in the particular region used, R_p is approximately 7000 ohms; R_F is approximately 15,000 ohms, resulting in $\alpha_1 \approx 7/15$; $g_m R_p \approx 70$, which will give $\alpha_1/g_{m2} R_{p1} \approx 1/150$. It is clear that this term may be neglected. The gain at resonance is

$$G_0 = \frac{g_{m1}R_{p1}g_{m2}R_{p2}}{1 + (\alpha_1 + \alpha_2) + (G_F - 1)\alpha_1\alpha_2}. \quad (26)$$

In this case, where G_F is in the order of 150, (26) may be rewritten:

$$G_0 = \frac{g_{m1}R_{p1}g_{m2}R_{p2}}{1 + \frac{R_{p1} + R_{p2}}{R_F} + g_{m2}R_F \frac{R_{p1}R_{p2}}{R_F^2}}. \quad (27)$$

LOW-IMPEDANCE FEEDBACK CIRCUIT

Experiments on the direct plate-to-plate feedback circuit, applied to the existing intermediate-frequency amplifier, showed that the values of R_F necessary to obtain the required bandpass, i.e., 1 to 5 Mc., were of the same order of magnitude as the impedance of the path through the stray capacitance in and around the feedback network. In particular, the original modification of this unit, constructed for 2.5-Mc. bandwidth, had a feedback resistor of 15,000 ohms. The capacitance across the resistor alone was of the order of $\frac{1}{2}$ micromicrofarad or approximately 10,000 ohms at about 30 Mc., where the amplifier was operated.

The effects of the spurious capacitances in the feedback network were eliminated by converting from a high-voltage, low-current to a low-voltage, high-current system. This is done by inserting the feedback at points of lower potential, as shown in Fig. 2. The feedback resistor was reduced to 3000 ohms and the tap was located approximately in the middle of the plate load resistor. The bandwidth of 2.5 Mc. remained the same, while the gain increased by a factor of 1.6 over the gain of a similar single-tuned amplifier having the same bandwidth.

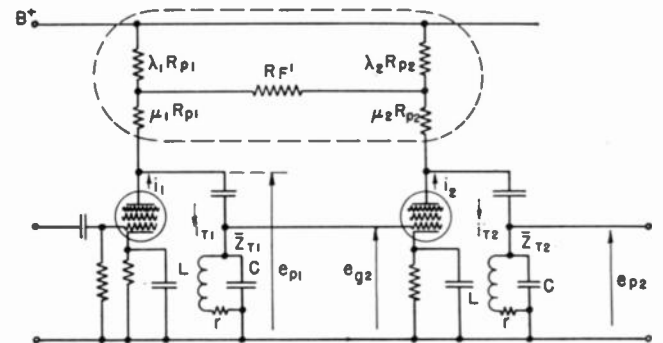

Fig. 2—Circuit diagram of the i.f. amplifier with low-impedance feedback.

ANALYSES OF THE NEW CIRCUIT

As can be seen from comparison of Figs. 1 and 2, the two circuits are identical except for the part circled by the dotted line. This part forms a four-terminal network and can, therefore, be changed by pi-tee equivalent

transformations. As the components are pure resistors, this equivalence is independent of frequency.

Fig. 3(a) to (c) shows the steps which will transform the new circuit into the old one.

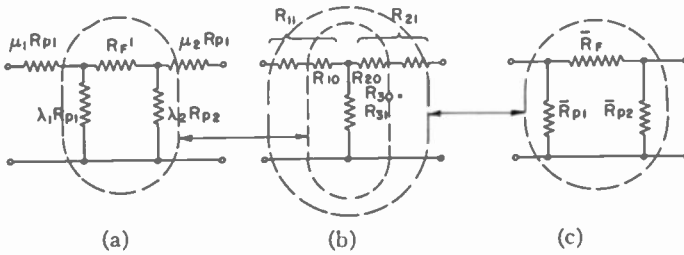

Fig. 3—Transformations to equivalent feedback network.

These transformations result in

$$\begin{aligned} \bar{R}_{p1} &= \frac{1}{(R_L + R_{F'})} \cdot \frac{P}{R_{p2}(\mu_2 R_L + R_{F'})} \\ \bar{R}_{p2} &= \frac{1}{R_L + R_{F'}} \cdot \frac{P}{R_{p1}(\mu_1 R_1 + R_{F'})}; \\ \bar{R}_F &= \frac{1}{R_L + R_{F'}} \cdot \frac{P}{R_m^2} \end{aligned} \quad (28)$$

where

$$\begin{aligned} R_L &= \lambda_1 R_{p1} + \lambda_2 R_{p2} \\ R_m^2 &= \lambda_1 R_{p1} \cdot \lambda_2 R_{p2} \\ P &= (R_{p1} R_{p2} (\mu_1 R_L + R_{F'})) (\mu_2 R_L + R_{F'}) \\ &\quad + R_{p1} (\mu_1 R_L + R_{F'}) R_m^2 \\ &\quad + R_{p2} (\mu_2 R_L + R_{F'}) R_m^2. \end{aligned} \quad (29)$$

Considerable simplification results if plate load resistors and tapping ratios are equal. In practice, this case will be the most common.

Introducing

$$\begin{aligned} \lambda_1 &= \lambda_2 = \lambda \\ \mu_1 &= \mu_2 = \mu \\ 1 - \lambda &= \mu \\ \alpha &= \frac{R_p}{R_{F'}} \end{aligned} \quad (29a)$$

then (29) simplifies to

$$\begin{aligned} \bar{R}_p &= R_p \frac{1 + 2\alpha\mu\lambda + 2\alpha\lambda^2}{(1 + 2\alpha\lambda)} \\ \bar{R}_F &= R_F \frac{(1 + 2\alpha\mu\lambda)^2 \left(1 + \frac{2\alpha\lambda^2}{1 + 2\alpha\mu\lambda}\right)}{\lambda^2(1 + 2\lambda\alpha)}. \end{aligned} \quad (30)$$

Under all conditions, $\mu\lambda < 1/4$, while usually $\alpha < 1/2$. In order to get appreciable reduction of the effect of spurious capacitances, it is necessary that $\lambda \leq 1/2$.

Under these conditions, $\begin{cases} 2\alpha\lambda < 1/2 \\ 2\alpha\mu\lambda < 1/4. \end{cases}$

In an actual example, the following values were used:

$$\begin{aligned} R_p &= 1750 \\ \lambda R_p &= 750 \\ R_{F'} &= 3000. \end{aligned}$$

Introducing these values,

$$\begin{aligned} \bar{R}_p &= R_p \\ \bar{R}_F &= 7R_{F'}. \end{aligned} \quad (30a)$$

Thus the plate load has not been changed, but the effect of the feedback resistor equals that of one 7 times larger in the original scheme.

Tests of the amplifier with the low-impedance feedback circuit showed that the high-frequency side of the response curve peaked up considerably over the low-frequency side. The feedback network is an H type of structure. Each of the components in the structure has resistance plus a small inherent capacitance of its own, and if the RC products are not balanced around the circuit, the network will be frequency-dependent. Addition of a balancing capacitance from plate to plate would cure this, but it may introduce appreciable lead capacitances which are hard to control. Inspection of the circuit will show that the same result may be obtained by a capacitance inserted between the grid and the plate of the last tube of the pair. To balance capacitances all around the loop stably, a small variable capacitor of about 1.2-micromicrofarad maximum capacitance was added at this point. By adjusting this capacitor, it was possible to produce a double-humped response curve having equal

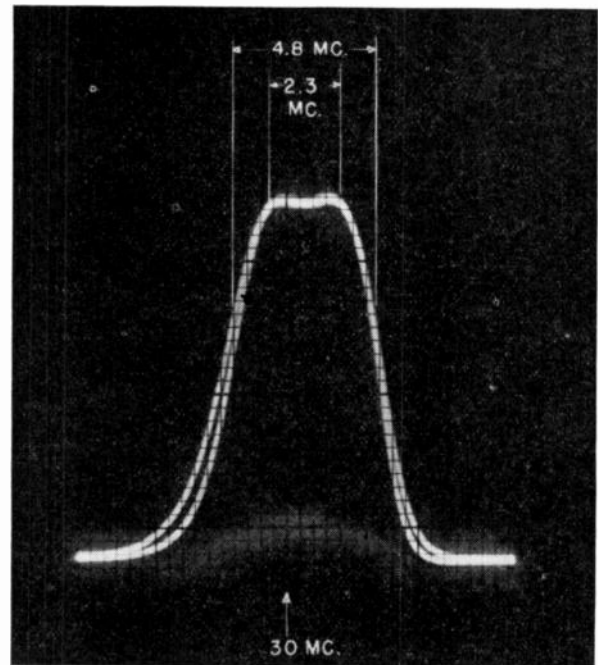

Fig. 4—Band-pass characteristics of the i.f. amplifier.

peaks. Reduction of the capacitance brought up the high-frequency side, while too much capacitance brought

up the low-frequency side. Further increase of the response toward the low-frequency side produced oscillation. When the size of the capacitance is adjusted properly, it is possible to line the amplifier up at any frequency over the range of the tuning coils and preserve the double-hump response curve.

A typical response curve of one of the amplifiers is shown in Fig. 4. The bandwidth between the tops of the two slight peaks is 2.3 Mc. The bandwidth at 0.707 down is 4.8 Mc. The measured voltage gain to and including a diode detector (from r.m.s. to d.c.) was 20,000 for two feedback pairs. The gain of a pair of stages was approximately 200.

ADJUSTMENT PROCEDURE

As can be seen (for instance, from (24b) and (22)), the bandwidth increases and decreases with the factor $K^2 = Q_F^2(G_{m2}R_F - 1)$. One can, therefore, reduce the bandwidth by reducing the gain of the second tube to where a sharp response is obtained. In this condition it is very easy to tune the different stages of the amplifier to the same frequency.

If the particular shape of the response curve is not important, this provides a means for changing the bandwidth of an amplifier by a d.c. control.

If it is desired to keep a flat response curve, the pass band of the amplifier can be changed over smaller ranges merely by changing the feedback resistors and readjust-

ing the second-stage gain to critical coupling. Larger changes in bandwidth will, in general, call for a new set of loading resistors.

It will be seen that the degree of coupling between the stages can be reduced to zero. This occurs if $K=0$ or $G_{m2}R_F=1$. This condition corresponds to a balance between forward and reverse transmission through the system, i.e., no over-all gain at all; it occurs at a gain setting for which $G_{m2}=1/R_F$.

This opens the possibility of using the amplifier as a disconnect switch by making $G_{m2}=1/R_F$ at such times as suppression of the output voltage is desired.

Another interesting effect results from these conditions. As the mutual conductance of the second tube is further reduced, the phase or "polarity" of the gain reverses, and the output amplitude begins to increase again. (The influence of small values of K on the term N in (23) may be neglected.) For the extreme case, $G_{m2}=0$, the arrangement presents two tuned circuits in the plate of tube No. 1 coupled by resistor R_F and having an over-all gain at resonance of $g_{m1}R_{p1}(R_{p2}/R_F)$. If two of such pairs are used, fed by voltages 90° apart, and if their outputs are fed into a common circuit (for instance, through two cathode followers), it is possible, by proper control of the two second screen voltages, to obtain a voltage which can be phase-shifted by any desired amount with respect to the phase of the input voltage.

The Radiation Resistance of an Antenna in an Infinite Array or Waveguide*

HAROLD A. WHEELER†, FELLOW, I.R.E.

Summary—The electromagnetic field in front of an infinite flat array of antennas can be subdivided into wave channels, each including one of the antennas. Each channel behaves like a hypothetical waveguide similar to a transmission line made of two conductors in the form of parallel strips. A simple derivation then leads to the radiation resistance of each antenna and to some limitations on the antenna spacing. In the usual flat array of half-wave dipoles, each allotted a half-wave-square area, and backed by a plane reflector at a quarter-wave distance, the radiation resistance of each dipole is $480/\pi = 153$ ohms. In a finite array, this derivation is a fair approximation for all antennas except those too close to the edge. This derivation also verifies the known formula for the directive gain of a large flat array in terms of its area. The same viewpoint leads to the radiation resistance of an antenna in a rectangular waveguide, which has previously been derived by more complicated methods.

I. INTRODUCTION

IN THE SCIENCE of radio antennas, one of the most fundamental and useful concepts is the radiation resistance of a thin conductor of a certain

length and configuration. The classic example is the half-wave dipole in free space, whose radiation resistance is 73.13 ohms. Its exact value was difficult of computation because it involved the spherical electromagnetic wave with all its complexities.

In combining several elementary antennas into a directive array, it has been customary to compute the self and mutual impedances associated with radiation, and to obtain therefrom the radiation resistance of each antenna with respect to its own current. With a greater number of antennas in an array, this procedure involves a number of components proportional to the square of the number of antennas. However, the interactions of the more distant elements usually becomes negligible for practical approximations.

This circumstance suggests the possibility of attacking the problem by assuming an array of infinite dimensions as an approximation to a finite array of a large number of elements. It devolves that many cases of the infinite array yield extremely simple solutions for the radiation resistance of the component antennas, and

* Decimal classification: R144×R125.1. Original manuscript received by the Institute, May 16, 1947. Presented, 1948 I.R.E. National Convention, New York, N. Y., March 24, 1948.

† Consulting Radio Physicist, Great Neck, L. I., N. Y.

values which are known to be nearly correct in practical cases of finite arrays.

The simplicity of the solution for the infinite flat array resides in its radiation of a plane wave, the most simple case of a wave in space. This condition is closely approximated in the vicinity of a finite flat array, so it determines approximately the radiation resistance of all antennas except those too close to the edges. It leads to simple formulas of practical value, as well as some theorems of general interest and significance.

The infinite flat array is solved by comparison with a hypothetical case of the ordinary transmission line, which also transmits a plane wave. An antenna in the array is compared with the same antenna radiating into this transmission line. The entire array is compared with many such antennas radiating into contiguous channels in space.

The same method is applicable to a reflector made of a plane conductor or another flat array.

An application of special interest, which has appeared in the literature, is the computation of the resistance of an antenna radiating in a rectangular waveguide. This is the simplest practical example of radiation of plane waves in a confined channel of space. It is compared with the oblique radiation from a particular kind of flat array.

If the antenna elements in a certain pattern are spaced beyond certain limits, the array (or the corresponding waveguide) radiates beams in several directions (or modes), so the resistance of each antenna has a corresponding number of components. The present treatment is limited to the cases of only one component of radiation resistance, and to the requisites for these cases.

These concepts offer a simple proof of the directive gain of a flat array in terms of its area, regardless of its shape and of the details of the component antennas.

II. SYMBOLS

Rationalized m.k.s. units.

- $A = nab =$ area of flat array (meters²)
- $a =$ width of rectangular cross section (meters)
- $a' = a\lambda/\lambda' =$ effective width of rectangular waveguide (meters)
- $b =$ height of rectangular cross section (meters)
- $h =$ effective height of antenna (meters)
- $l = \lambda/2\pi =$ radianlength in free space (meters)
- $\lambda = 2\pi l =$ wavelength in free space (meters)
- $\lambda' =$ effective wavelength along waveguide (meters)
- $\lambda_c =$ cutoff wavelength of waveguide (meters)
- $\epsilon =$ electric permittivity (farads/meter)
- $\mu =$ magnetic permeability (henries/meter)
- $R =$ radiation resistance (ohms)
- $R_i =$ radiation resistance of isotropic antenna (ohms)
- $R_n =$ total radiation resistance of array (ohms)

$R_i = 377 =$ wave resistance of square cross section in free space (ohms)

$p =$ power ratio of directive gain of array

$p_1 =$ power ratio of directive gain of one dipole

$n =$ integral number

$n =$ large number of dipoles in array.

III. AN ELEMENTARY ANTENNA IN A HYPOTHETICAL RECTANGULAR TRANSMISSION LINE OR WAVEGUIDE

The simplest example of the propagation of electromagnetic waves is the case of plane waves along a transmission line comprising a pair of parallel conductive strips separated by a dielectric of rectangular cross section.¹ Fig. 1(a) shows one end of such a line. The simplest configuration of a plane wave is approximated between the strips if their separation is much less than their width.

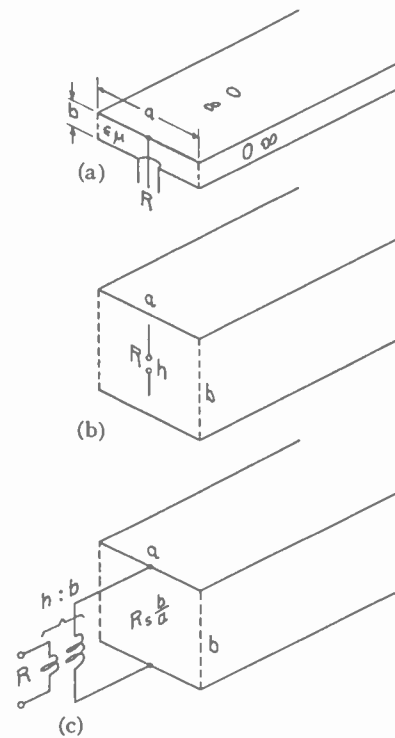

Fig. 1—A hypothetical rectangular waveguide supporting the *TEM* mode. (a) Waveguide of small height and antenna of equal height. (b) Waveguide of substantial height and antenna of lesser effective height. (c) Equivalent transformer coupling the antenna with the waveguide.

The idealized boundaries of the rectangular line cannot be realized, but are defined for theoretical purposes. The upper and lower surfaces have infinite electric permittivity and zero magnetic permeability, which are approximated by a conductor at frequencies so high that the skin effect precludes penetration of the magnetic flux to an appreciable depth in the conductor. The side surfaces have zero permittivity and infinite permeability, which cannot be approximated by known materials. The intervening space has nominal values of

¹ See Bibliography, references 4, pp. 93–100, 182, and 5, p. 243.

permittivity ϵ and permeability μ , of either free space or a wave-propagation material.

These conditions define a hypothetical waveguide capable of propagating simple plane waves of the transverse electromagnetic mode (TEM or TE_{00} or TM_{00}). There is no cutoff wavelength, all wavelengths being propagated at the same velocity to the extent that all materials are assumed to have uniform properties non-selective as to wavelengths.

The wave impedance of such a line is the pure resistance

$$R = R_0 b/a. \quad (1)$$

The transverse dimensions of the line are the width a and the height b . The plane-wave impedance of the wave medium for a channel of square cross section is

$$R_0 = \sqrt{\mu/\epsilon} \quad (2)$$

which, in free space, has approximately the value 120π (or, more closely, 376.7) ohms. The present treatment is limited to free space henceforward.

If the transverse dimensions of the rectangular line of Fig. 1(a) are much smaller than the radianlength of the waves, its wave impedance may be realized as a terminal impedance. For example, it may be connected with a coaxial line as shown. If $a/b=10$, it matches a line of 37.7 ohms wave impedance.

The vertical center wire of the coaxial line in Fig. 1(a) may be regarded as a vertical antenna radiating into a waveguide. Since the antenna is much shorter than the radianlength, it has uniform current over its length. Therefore, its effective length or height is equal to its actual length b . Its radiation resistance is R , the wave impedance of the rectangular line.²

If any configuration of antenna is located in the end plane of the rectangular line, its coupling with the line is proportional to its effective length h in the direction of the electric field (vertical). This is understood if a plane wave is being received from the line by the antenna; the induced voltage is proportional to the effective height. In fact, that is really the basis for the definition of effective height. By the law of reciprocity, the same rule applies to the coupling of transmission from the antenna to the line.

Fig. 1(b) shows a vertical dipole antenna in the end plane of the hypothetical line. It has a certain effective length h . It is assumed that the wave medium exists only within the line and not beyond the end, so the antenna radiates only into the line.

The power radiated from the antenna through the

line determines the radiation resistance of the antenna, by definition of the latter:

$$R = R_0 \frac{b}{a} \left(\frac{h}{b} \right)^2 = R_0 h^2/ab = 377 h^2/ab \quad \text{ohms.} \quad (3)$$

This represents only the power radiated in the simple plane wave (TEM), which is the only mode of vertical polarization if both of the transverse dimensions are less than one wavelength, as will be shown.

A series-resonant antenna in the end plane of the rectangular line has an impedance equal to its radiation resistance, free of reactance. At its wavelength of resonance, it may be regarded as an ideal transformer coupling the antenna terminals to the line. This is illustrated in Fig. 1(c), the voltage ratio of the transformer being $h:b$.

The simplicity of this treatment is emphasized by a comparison with the simplest other formula for radiation resistance, namely, that of a small dipole (shorter than the radianlength) in free space:³

$$R = \frac{2}{3} \frac{1}{4\pi} R_0 \left(\frac{h}{l} \right)^2 = 20(h/l)^2 \quad \text{ohms.} \quad (4)$$

The essential dimensions here are the effective length h and the radianlength l . The denominator 4π is the area of a sphere of unit radius, as usually appears in spherical problems. The factor $2/3$ is the fraction of the spherical area filled by the doughnut pattern of radiation. No simple and exact formula exists for a larger antenna in free space, even if its effective length is known.

IV. THE SAME CONCEPT APPLIED TO AN INFINITE FLAT ARRAY

While not all of the boundary conditions of the rectangular waveguide of Fig. 1 can be realized by physical boundaries, they can all be approximated by locating an array of like antennas in the positions of the images of the given antenna reflected in the hypothetical boundaries. The images in the four boundary planes form a flat array which has infinite width and height.

Fig. 2 shows the plan and rear elevation views, (a) and (b), of an area of this infinite flat array. Only the space in front of the array is considered here, to correspond with the waveguide of Fig. 1 extending in only one direction from the antenna. While this leaves a non-physical boundary (of zero permittivity and infinite permeability) behind the array, it is the next step in the logical development of the subject.

The array is made of many elements like Fig. 1(b), similarly oriented and displaced in two dimensions. The horizontal and vertical displacements are equal to the width a and the height b of the hypothetical rectangular waveguide in front of each element. If the antenna in Fig. 1(b) were asymmetrical about either or both of the transverse centerlines of the end of the waveguide, the

² The terms "effective height" or "effective length" are here used synonymously with their classic meaning. In the strict sense, they are applicable only to an antenna whose current distribution is determined by its localized reactance, independent of resistance and of mutual impedance with surrounding objects. This is true of a thin wire, whether resonant or not, and approximately true of moderately thick conductors. These terms require specification of the direction to which the effective length is referred and of the reference direction of wave transmission or reception.

³ See Bibliography, references 3 and 5, pp. 133-134.

adjacent antennas in the array would be mirror images of each other.

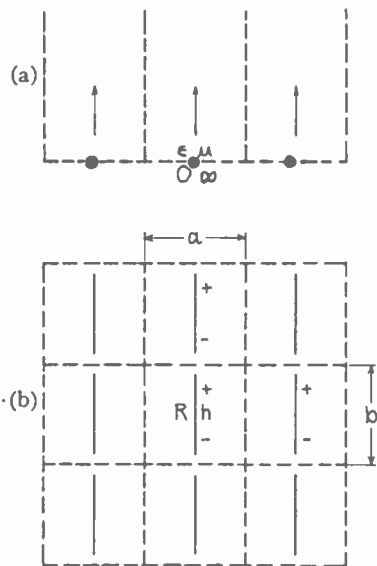

Fig. 2—An infinite flat array at the boundary of half-infinite space. (a) Plan. (b) Elevation.

Since an infinite array as described meets all the boundary conditions of the hypothetical waveguide, the derived radiation resistance of an antenna in the end plane of the waveguide is equal to that of the same antenna in the plane of the array.

In a practical flat array of a finite number of antennas in each dimension, those antennas which are separated from the edges of the array by several intervening antennas usually have approximately the radiation resistance computed for an infinite array. It is a fact of theory and experience that the radiation impedance of an antenna in an array is influenced mainly by the nearby other antennas. The only exceptions to this rule occur in the cases of critical spacing on the borderline of another mode of radiation, as will be described.

The propagation of a plane wave directly forward from the infinite flat array of Fig. 2 requires that the radiation from every antenna be in phase with that of every other in the wave front. This is inherent in a wave front parallel to the array, which is the transverse electromagnetic (*TEM*) mode of propagation (also termed *TE₀₀* or *TM₀₀*). Other modes are possible, as in the usual waveguides, if the displacement of adjacent columns or rows is sufficiently great. The present treatment is simplified by ruling out the other modes, so it is merely necessary to establish the conditions under which they are not radiated.

The simplest case is an antenna which radiates only with vertical polarization. The hypothetical image planes are so defined in Fig. 1 that all images are similarly oriented and therefore radiate with the same polarity. In this case, other wave fronts are possible only in directions such that the path difference of adjacent columns or rows is an integral multiple of one wave-

length. Only the one mode of radiation is possible if the area allotted to each antenna is less than one wavelength in width and in height.

The general case is any shape of antenna located in the plane of its allotted rectangular area. It may radiate with a component of horizontal polarization. The specified image planes have the property of reversing the polarity of this component. Oblique wave fronts are therefore possible in such directions that the path difference of adjacent columns or rows is an odd-integral multiple of one-half wavelength. Even in this general case, only the wave front parallel to the array is possible if the area allotted to each antenna is less than one-half wavelength in width and in height.

In the simplest practical case, a flat array radiates equally forward and backward, as shown in Fig. 3(a) which is the same as connecting two transmission lines like Fig. 1 in parallel. Therefore, the radiation resistance is one-half as great, because the same voltage radiates twice the power. From another point of view, the two lines require current to flow in the space on both sides of the antenna, instead of only one side, so twice the current radiates twice the power. Either derivation leads to a radiation resistance one-half as great. Separate formulas will not be given, because this case with forward and backward radiation is not the usual case.

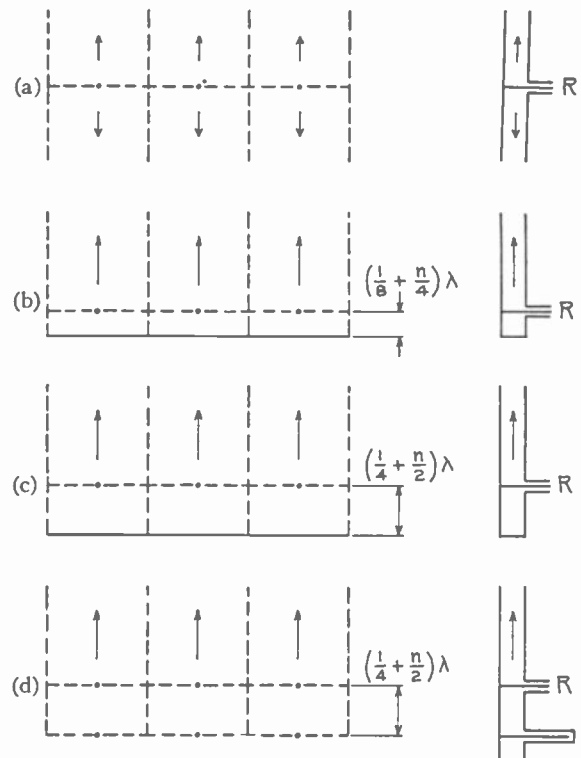

Fig. 3—The flat array with front and back radiation or reflection, and the equivalent transmission lines. (a) Front and back radiation. (b) Plane reflector for same resistance. (c) Plane reflector for double resistance. (d) Array reflector.

A special case of Fig. 3(a) is of particular interest. It is an array of vertical dipoles, each allotted a half-wave-square area as is customary in flat arrays. From (3), ra-

diation resistance of each dipole is expressed for this case:

$$\begin{aligned} a &= b = \lambda/2: \\ R &= \frac{1}{2} R_s \left(\frac{2h}{\lambda} \right)^2 = \frac{1}{2\pi^2} R_s \left(\frac{h}{l} \right)^2 \\ &= \frac{60}{\pi} \left(\frac{h}{l} \right)^2 = 19.1(h/l)^2 \quad \text{ohms.} \quad (5) \end{aligned}$$

Comparing with (4) for a small dipole in free space, the only difference is between the coefficients 19.1 and 20.

If half-wave dipoles are used in this special case, their effective length is $2/\pi$ of their actual length or two radianlengths, leading to the following value of radiation resistance in the array:

$$a = b = \lambda/2; h = \lambda/\pi = 2l: R = 240/\pi = 76.4 \text{ ohms.} \quad (6)$$

This is very close to the value of 73.13 ohms for the same dipole in free space.

In practice, a flat array is provided with a reflector to concentrate all the radiation in the forward direction. Fig. 3(b) shows a type of reflector which is sometimes used, and which has the peculiar property of leaving the radiation resistance of the individual antennas the same as if no reflector were used. This type of reflector is a plane conductor (or equivalent grid of parallel vertical wires) located behind the array at a distance of $\frac{1}{2}$ wavelength, as shown in Fig. 3(b). Since the reflected wave has a total path difference of $\frac{1}{2}$ wavelength, it adds to the direct wave in quadrature, radiating twice the power forward and none backward. Therefore the radiation resistance is the same as in Fig. 3(a), or $\frac{1}{2}$ as great as in Figs. 1 and 2.

The same result may be derived from the circuit viewpoint. The transmission line of Fig. 1(a) has its terminals shunted by another line of $\frac{1}{2}$ wavelength, on short circuit, corresponding to the space between the antenna and the reflector. This is known to have a shunt reactance equal to the wave resistance of the line. Reducing these equal parallel components of impedance to equal series components, the reactance and resistance are both multiplied by $\frac{1}{2}$. Therefore this reflector leaves the radiation resistance the same as if there were no reflector, but adds an equal value of reactance (which may be tuned out). The reactance is inductive if the reflector is at a distance of $\frac{1}{2} + n/4$ wavelengths, or capacitive if $\frac{3}{2} + n/2$ wavelengths, n being any integral number.

The reflector $\frac{1}{2}$ wavelength behind the array has some advantages and disadvantages relative to the usual reflector $\frac{1}{4}$ wavelength behind, yet to be analyzed. The $\frac{1}{2}$ type minimizes interaction between adjacent antennas, as indicated by their radiation resistance being approximately the same as when isolated in free space. Therefore the distance between adjacent antennas is not critical, and antennas near the edge of the array behave nearly like those near the center. On the other hand, the distance between each antenna and the re-

flector is critical as affecting both resistance and reactance of each antenna. The reduction of the radiation resistance narrows the bandwidth of resonance of a dipole, which is not itself desirable but in some cases may facilitate the connection with the associated lines.

A plane conductor used as a reflector at a distance of $\frac{1}{4}$ wavelength behind the array is shown in Fig. 3(c), with its equivalent transmission line. This reflector effectively "tunes out" the space behind the array, leaving only the forward radiation as in Fig. 2. Therefore each antenna has the same radiation resistance as in Figs. 1 and 2. This is the simplest reflector; it gives each antenna the greatest possible value of radiation resistance, and thus makes available the greatest bandwidth of resonance.

In the arrangement of Fig. 3(c), a half-wave dipole, allotted a half-wave square area, has a radiation resistance, computed by (3),

$$R = 480/\pi = 152.8 \quad \text{ohms.} \quad (7)$$

The relations inherent in the infinite flat array make it possible to obtain complete reflection from such an array. This contrasts with the simple case of an isolated single dipole antenna and a near-by resonant dipole reflector giving only partial reflection. Fig. 3(d) shows a radiating array backed by a reflecting array of resonant dipoles, which will be explained after a digression on the theory.

A pair of resonant antennas, displaced along a transmission line like Fig. 1, is shown in Fig. 4. The boundary conditions permit radiation from each antenna in both directions along the line but preclude any other radiation. Dissipation in the antenna conductors is neglected in this discussion, and also can be in many practical applications. From the circuit viewpoint shown in Fig. 1, it is possible for a resonant circuit across the line to present effectively a short circuit, and thereby to cause complete reflection. This is based on the concept that the circuit itself has no dissipation, although associated with the radiation resistance presented by the line.

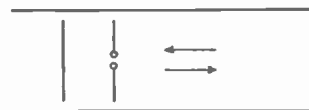

Fig. 4—The coupling between two antennas along the hypothetical waveguide.

A resonant antenna in a line, as the reflector in Fig. 4, has the same properties in a more general sense.

In Fig. 1, it is also possible for a resonant antenna to be matched to a load resistor and thereby to absorb all the power in a wave traveling along the line toward the antenna end. In this case, the radiation resistance is effectively equal to the generator resistance presented by the line and transformed by the antenna. If the radiation resistance of the antenna is matched to the load resistance, the maximum power is transferred from the

wave to the load, and that is all the power of the wave. This is complete absorption.

If a single antenna is located in a uniform line extending in both directions, the antenna cannot absorb all the power of a wave traveling along the line. From the circuit viewpoint this is apparent, because the incoming line is already matched to the outgoing line and the interposition of a load can only destroy the match. At best, the load can be matched to $\frac{1}{2}$ the line resistance (both directions in parallel) and then receives only $\frac{1}{2}$ the available power of the wave, reflecting $\frac{1}{4}$ back to the source and permitting the other $\frac{1}{4}$ to proceed along the line.

It is concluded that a reflector is necessary if an antenna array is to receive all the available power of an incident wave in space, as exemplified by the line in Fig. 4. The reflector may be an array of resonant antennas reasonably free of conductor dissipation. The receiving antenna can then abstract all of the available power by coupling to the standing wave in front of the reflector array in such a way as to match the resulting radiation resistance of the antenna to the load resistance. By reciprocity, a transmitting antenna array can likewise radiate all the transmitter power in one direction in space.

Returning to Fig. 3(d), each antenna in the reflecting array behaves as a resonant trap which blocks the area allotted to it, as indicated by the equivalent circuit in this figure. The reflecting array is shown $\frac{1}{4}$ wavelength behind the radiating array, in which case it behaves like Fig. 3(c) for the wavelength of resonance. For other wavelengths, the reflection becomes incomplete in a degree proportional to the departure from the wavelength of resonance.

In either the radiating array or the reflecting array, if made of a number of antennas of given size and shape, wideband operation is promoted by closer spacing which increases the radiation resistance of each antenna, and thereby proportionately increases its bandwidth of resonance.

V. EXAMPLES OF THE FLAT ARRAY

The preceding theory is directed to arrays of antennas in image relationship with respect to hypothetical perpendicular boundary planes. The resulting formulas for the radiation resistance are more generally applicable, since they are based on the concept of the power in a plane wave, and how much of that power need be supplied by each antenna.

Equation (3) is valid in the more general sense if each antenna is allotted an area ab of any shape, subject to some restrictions on the pattern of the array. It is required that the shape and environment of each antenna be like that of every other, or a mirror image thereof, to insure that every antenna contributes its share of the wave power, namely, the power through its allotted area. It is also required that the spacing of the antennas be within the limits outlined above, to insure radiation

in only the one mode. These limits may be $\frac{1}{2}$ wavelength between centers of adjacent columns or rows, or in special cases may be 1 wavelength.

With reference to Figs. 5 and 6, some examples are to be described which illustrate image and nonimage relationships, as well as the permissible spacing. The normal spacing is chosen arbitrarily as the least which is likely to be used, while the maximum spacing is that beyond which another mode of radiation occurs. Each antenna

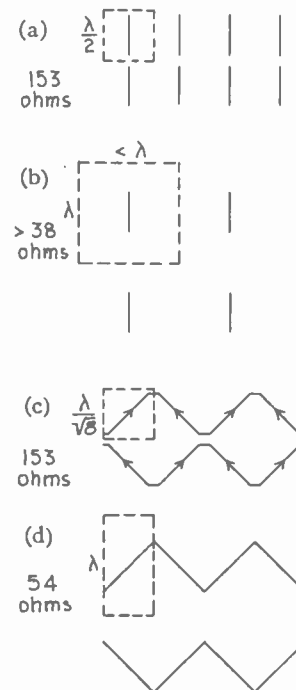

Fig. 5—Arrays of half-wave dipoles in image relations, with reflector. (a) Vertical antennas, normal spacing. (b) Same, maximum spacing. (c) Diagonal antennas, normal spacing. (d) Same, maximum spacing.

is a simple half-wave dipole, whose effective length is 2 radianlengths if vertical or $\sqrt{2}$ radianlengths if tilted by $\frac{1}{2}$ right angle (45 degrees). In all cases, the antennas are so oriented and excited that the radiated wave has vertical polarization. The radiation resistance of each antenna is noted in Fig. 5 and is the same in Fig. 6. Each array is backed by a plane reflector at a distance of $\frac{1}{4}$ wavelength for maximum radiation resistance.

Fig. 5 shows examples in which the component antennas of each array are in image relation. The ordinary case, Fig. 5(a), has vertical half-wave dipoles in half-wave-square areas.

The same pattern with maximum spacing, Fig. 5(b), has one-wave-square areas. The inequality signs ($<$ or $>$) denote noninclusive limits. In this case, $a < \lambda$, because the next mode in the side directions is radiated (strongly) at $a \times \lambda$. However, $b \times \lambda$ is permissible because the lack of vertical radiation from the dipoles prevents the next mode in the vertical direction; it occurs, tilted toward the front, if $b > \lambda$.

Another type of radiator is the zigzag wire, made of diagonal half-wave dipoles connected at adjacent ends. The effective height of each dipole is reduced in the

ratio $1/\sqrt{2}$. The horizontal effective lengths cancel out by reason of opposite directions of currents in the horizontal components of length.

With the normal spacing in Fig. 5(c), the square allotted to each antenna is also reduced in the ratio $1/\sqrt{2}$ from Fig. 5(a). Therefore the radiation resistance is the same as Fig. 5(a). In this type of radiator, retaining the zigzag connection, the spacing in Fig. 5(d) is increased to one wavelength in only the vertical direction, reducing the radiation resistance in the ratio $1/\sqrt{8}$ from Fig. 5(c).

The patterns shown in Fig. 6 correspond in some degree to those of Fig. 5, but depart from the image relation among the component antennas. They still meet the requirements of the present theory, and offer additional freedom of design.

The vertical dipoles of Fig. 6(a) in normal spacing have the same radiation resistance as Fig. 5(a), but each is allotted a diamond-shaped area. This pattern has the advantage of separating the ends of the dipoles, if center feed is used. The maximum spacing in Fig. 6(b) allots a diagonal one-wave-square area to each dipole, giving the same radiation resistance as Fig. 5(b).

Fig. 6(c) and (d) correspond to Fig. 5(c) and (d) in all respects except a shift in alternate rows, giving the same radiation resistance but more separation in the nearest points of adjacent rows.

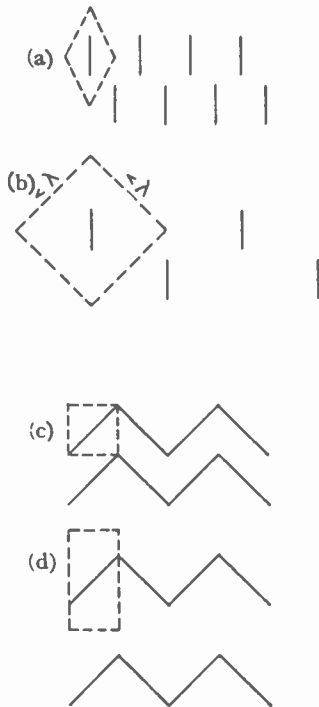

Fig. 6—Arrays of half-wave dipoles in nonimage relations, with reflector. (a) Vertical antennas, normal spacing. (b) Same, maximum spacing. (c) Diagonal antennas, normal spacing. (d) Same, maximum spacing.

A remarkable effect is observed in Figs. 5(b) and 6(b), as examples of vertical dipoles with maximum spacing. In spite of the reflector, each dipole has about $\frac{1}{2}$ as much resistance as if isolated in space ($\frac{1}{4}$ as much if the reflector were removed). This means that the total

interaction of each dipole with all the rest causes a great decrease of its resistance as the spacing is widened, up to the point where the next mode causes an abrupt increase. In the case of vertical dipoles, an approach to the critical spacing of columns causes a large change of the radiation reactance of each dipole, anticipating the abrupt increase of radiation resistance (to an infinite value) at the critical displacement. For these reasons, and for wideband operation, the normal spacing is usually used in preference to greater spacing.

VI. THE DIRECTIVE GAIN OF A FLAT ARRAY

The present derivation of radiation resistance yields directly a simple expression for the directive gain of a flat array made of many antennas. All of the antennas are alike in structure and environment, and carry the same current. The array is so large that its least lateral dimension is many wavelengths, but otherwise there is no restriction on the shape. There is a reflector behind the array, which is assumed at a distance of $\frac{1}{4}$ wavelength, but other distances would yield the same result.

The directive gain is expressed relative to a hypothetical isotropic antenna, that is, one which radiates equal power in all directions over the sphere.⁴ The radiation resistance of an isotropic antenna of effective length h is⁵

$$R_i = \frac{1}{4\pi} R_e \left(\frac{h}{l} \right)^2 = 30(h/l)^2 \text{ ohms.} \quad (8)$$

The large number (n) of antennas have a total radiation resistance, based on (3),

$$R_n = nR_e h^2 / ab. \quad (9)$$

The total effective length of the antennas in the array is $2nh$, which is that of one antenna multiplied by the total number of antennas and their images in the reflector. Unit current in the array develops by radiation in the center of its beam a certain value of field intensity at a certain distance which is sufficiently great that any two antennas in the array have less than one radianlength path difference.

The same value of field intensity at the same distance would be developed by an isotropic antenna carrying $2n$ units of current. The power radiated thereby is the apparent power of the array in the direction of its beam.

The power ratio of the directive gain of the array is the ratio of the apparent power to the actual power:

$$p = \frac{(2n)^2 R_i}{R_n} = \frac{4n^2 h^2 / l^2}{4\pi n h^2 / ab} = \frac{A}{\pi l^2}, \quad (10)$$

in which the total area of the array is $A = nab$. The denominator πl^2 is the area of a circle whose radius is one radianlength. Therefore the power ratio of directive

⁴ See Bibliography, references 4, pp. 215-216, 243-245; 5, pp. 335-336; and 7.

⁵ See Bibliography, reference 3.

gain is the ratio of the area of the array to that of the radian circle.⁶

The result is what would be expected from knowledge of the effective area of antennas in the interception of power from a plane wave. An antenna delivers to a matched load the amount of power which would otherwise flow through its effective area. The effective area of an isotropic antenna is the area of a radian circle, while that of a large array with its reflector is its actual area. Therefore the directive gain is the ratio of these two areas.

A special case of interest is the usual array made of half-wave dipoles, each allotted a half-wave-square area. The gain of each dipole is

$$p_1 = 120/73 = 1.64. \quad (11)$$

The area and relative gain of the array are

$$A = n(\lambda/2)^2 = n\pi^2 l^2; \quad p/p_1 = n\pi/1.64 = 1.91n. \quad (12)$$

If small dipoles were assumed instead of half-wave dipoles, the corresponding ratios would be

$$p_1 = 3/2; \quad p/p_1 = 2n\pi/3 = 2.10n. \quad (13)$$

These results confirm the simple rule that the power ratio of an ordinary array over a single dipole is approximately equal to twice the number of dipoles, which is the total number of the dipoles and their images in the reflector.

VII. THE OBLIQUE FLAT ARRAY AND THE RECTANGULAR WAVEGUIDE

The real rectangular waveguide, unlike the hypothetical one of Fig. 1, is bounded by conductors on all four sides so it cannot transmit the simple plane wave (*TEM* mode). The theory of the real waveguide is here included in its relation to the flat array, but more briefly because it has received more attention in the literature. Slater has clearly taught the array of images presented by an antenna in a rectangular waveguide, and the radiation resistance of a small dipole antenna therein.⁷

Fig. 7 is a plan view of one row of images of a vertical dipole in a rectangular waveguide of the shape of Fig. 1, but having conductive walls on all sides and extending in both directions. The conductive walls cause alternating polarity of the image dipoles in each row so there is no radiation with a wave front parallel to the array (*TEM* mode). The possible modes of radiation require a path difference between adjacent dipoles equal to an odd-integral multiple of $\frac{1}{2}$ wavelength for combination in the same phase. Any resulting wave fronts form an oblique angle with the array, as shown. Only the dominant (*TE*₁₀) mode is here considered, with $\frac{1}{2}$ wavelength path difference.

In the plane of the array of images, the area allotted to each dipole is the area ab of the waveguide cross section. In the plane of the wave front, the effective smaller area $a'b'$ is the projection of the waveguide area.

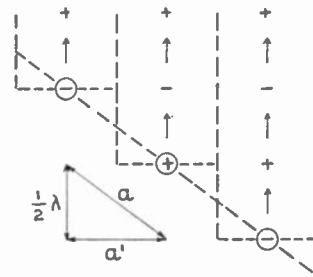

Fig. 7—Oblique array.

While the images in each row have alternating polarity, those in each column have the same polarity. Therefore each wave front is vertical and forms with the array an oblique horizontal angle. In this situation, each mode of radiation causes a pair of wave fronts, because the alternating polarity in each row causes the same amount of radiation toward either end of the row.

The effective area and the pair of wave fronts are the two factors which modify the radiation resistance in the oblique (*TE*₁₀) mode as compared with that of Fig. 1 (*TEM*).

Only the one most interesting and useful case will be treated in detail. It is a vertical dipole in the rectangular waveguide, backed by an end reflector at such a distance as to radiate maximum power forward in the guide. The plan view of the image pattern in this case is shown in Fig. 8. The geometry of the waveguide, the reflector, and the dipole location are so proportioned to the wavelength that the array of images behind the reflector radiate in the same phase as the array in front, in contributing to both of the oblique wave fronts. The

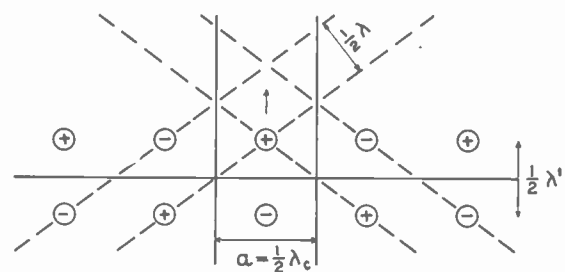

Fig. 8—Double array formed by images in end of rectangular waveguide.

dimensions involved are the wavelength in free space (λ), the cutoff wavelength (λ_c) which is twice the width a of the waveguide, and the wavelength (λ') along the waveguide. A distance of $\frac{1}{4}$ this last wavelength separates the dipole from the end reflector, a conductive plane like the walls of the waveguide.

Fig. 9 shows two right triangles, either of which gives the relation among the three wavelengths defined, as determined in Figs. 7 and 8.

⁶ See Bibliography, references 4, pp. 215–216, 260–264; and 5, pp. 360, 365.

⁷ See Bibliography, references 4, pp. 280–304; and 5, pp. 494–496.

By a modification of (3), the radiation resistance of the dipole in the waveguide of Fig. 8 is⁸

$$R = 2R_0 \frac{h^2}{a'b} = 240\pi \frac{h^2}{ab} \frac{\lambda'}{\lambda}$$

$$= \frac{754}{\sqrt{1 - (\lambda/\lambda_c)^2}} \frac{h^2}{ab} \text{ ohms.} \quad (14)$$

The modifications comprise the factor 2 (for the pair of wave fronts) and the effective area $a'b$.

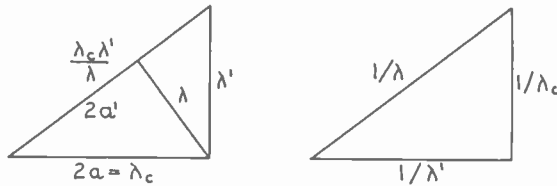

Fig. 9—Right triangles relating the wavelengths associated with a rectangular waveguide, TE_{10} mode.

It is also possible to derive the same value of radiation resistance by comparing the hypothetical waveguide of Fig. 1 with the real waveguide whose end cross section is shown in Fig. 10.⁹ In the TE_{10} mode under consideration, the average density of electric energy over the cross section is one-half that in the center and varies from a maximum in the center to zero at both sides. Therefore the effective width, based on a uniform electric field (like Fig. 1) equal to the maximum value, is only $\frac{1}{2}$ the actual width as shown by the dotted lines. Also, the longitudinal phase velocity of

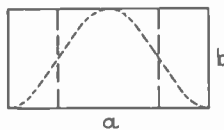

Fig. 10—Effective cross section of a rectangular waveguide, TE_{10} mode.

propagation of energy in the real waveguide is greater in the ratio λ'/λ . These two factors applied to (3) give the same formula (14) for a dipole in a waveguide.

The simplest antenna in a waveguide is a quarter-wave dipole connected with a coaxial line. Fig. 11 shows examples of such an antenna in rectangular waveguides of various relative sizes and shapes. In each case, only one mode (TE_{10}) is possible. The dipole is backed by a reflector at a distance of $\frac{1}{4}$ the wavelength along the waveguide. Its effective length h is $2/\pi$ of its actual length, or one radianlength l .

A quarter-wave dipole, located in a waveguide as described, has the radiation resistance

$$R = \frac{60}{\pi} \frac{\lambda^2}{ab} \frac{\lambda'}{\lambda} = 19.1 \frac{\lambda\lambda'}{ab} \text{ ohms} \quad (15)$$

in which

$$\lambda/\lambda' = \sqrt{1 - (\lambda/\lambda_c)^2} \quad (16)$$

In terms of the cutoff wavelength λ_c ,

⁸ See Bibliography, reference 4, pp. 296–298.

⁹ See Bibliography, reference 5, p. 319.

$$R = \frac{120}{\pi} \frac{\lambda\lambda'}{b\lambda_c} = 38.2 \frac{\lambda}{b} \frac{\lambda/\lambda_c}{\sqrt{1 - (\lambda/\lambda_c)^2}} \text{ ohms.} \quad (17)$$

In practice, it is customary to choose λ/λ_c between $\frac{1}{2}$ and 1 (not too close to either) and b/λ less than $\frac{1}{2}$ (not too close). The latter may also be between $\frac{1}{2}$ and 1 (not too close to either).

The diagrams of Fig. 11 have dimensions noted in wavelengths, and below each the radiation resistance in ohms. The examples of each column have the same width and cutoff frequency, but differ in height.

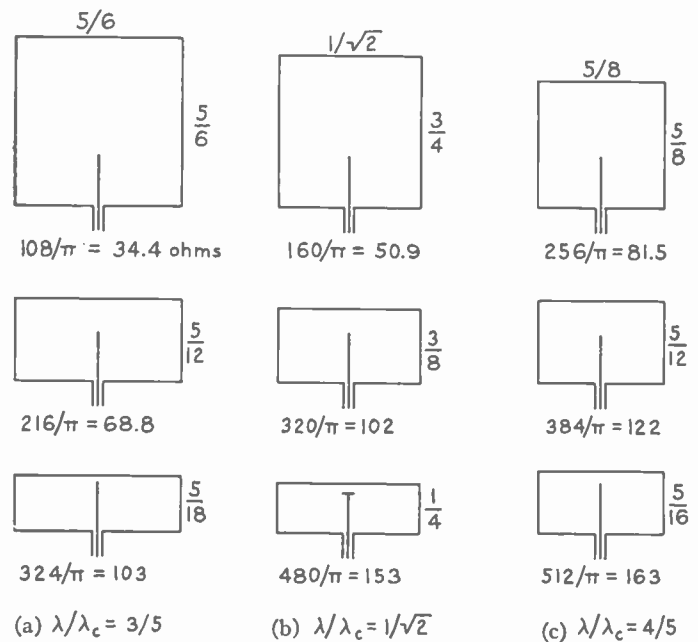

Fig. 11—Examples of a quarter-wave antenna in the reflector end of a rectangular waveguide TE_{10} mode.

The largest square example is the only one in which the dipole has about the same resistance as it has in free space over a plane (35.56 ohms). In all other cases it has greater resistance, up to more than 4 times as great, caused by the reflector and walls of the waveguide.

The resistance of the dipole may be decreased to match the coaxial line by decreasing its height and restoring resonance by capacitive loading at the open end. This loading may be provided by a disk or a cross wire (T shape).

VIII. CONCLUSION

The rectangular transmission line or hypothetical waveguide transmitting the transverse electromagnetic (TEM) mode is a concept which leads to a simple and exact solution for the radiation resistance of an antenna in an infinite flat array. It is a fair approximation in a large finite flat array. It also provides a derivation for the directive gain of such arrays.

The same concept leads to the radiation resistance of an antenna in a rectangular waveguide with closed conductive boundaries, which has previously been derived by other methods consistent with the viewpoint presented herein.

BIBLIOGRAPHY

- (1) C. R. Burrows, "Radio propagation over plane earth," *Bell. Sys. Tech. Jour.*, vol. 16, pp. 45-75, January, 1937. (Available power from a receiving antenna, p. 48.)
- (2) H. A. Wheeler, "Radio Wave Propagation Formulas," Hazeltine Report 1301W, May, 1942. (The isotropic antenna with effective area of one radian circle.)
- (3) H. A. Wheeler, "Radiation Resistance," Hazeltine Report 1491W, May, 1942. (Radiation resistance in terms of directive gain relative to isotropic antenna.)
- (4) J. C. Slater, "Microwave Transmission," McGraw-Hill Book Co., New York, N. Y., 1942. (Wave impedance of space and of parallel-strip transmission line, pp. 93-100, 182.) (Wave impedance of rectangular waveguide, pp. 184-185; formulas lacking a factor 2.) (Directive gain defined relative to mean spherical radiation, pp. 215-216.) (Effective area of mean spherical radiation, equal to one radian circle, pp. 243-245.) (Directive gain in terms of the area relative to one radian circle, pp. 260-264.) (Rectangular waveguide equivalent to an infinite lattice or flat array of images, pp. 284-285.) (Radiation resistance of small di-
- (5) pole in rectangular waveguide, pp. 288-289; with end reflector, pp. 296-298.) (Coupling of a dipole in a waveguide, pp. 291-296.) S. A. Schelkunoff "Electromagnetic Waves," D. Van Nostrand Co., New York, N. Y., 1943. (Radiation resistance of a small dipole, pp. 133-134.) (Available power from a receiving antenna, pp. 136, 512.) (Radiation resistance of half-wave dipole, pp. 144-340.) (Wave impedance of parallel-strip line, p. 243.) (Wave impedance of rectangular waveguide, pp. 316-319.) (Directive gain defined relative to isotropic antenna, pp. 335-336; of a small dipole, p. 337.) (Directive gain in terms of the area relative to one radian circle, pp. 360, 365.) (Radiation resistance of an antenna in a waveguide, pp. 494-496.)
- (6) F. E. Terman, "Radio Engineers' Handbook," McGraw-Hill Book Co., New York, N. Y., 1943. (Mutual impedance of antennas, pp. 776-782.) (Flat array of diagonal antennas, p. 852.)
- (7) H. T. Friis, "A note on a simple transmission formula," *Proc. I.R.E.*, vol. 34, pp. 254-256, May, 1946. (Available power from an antenna in terms of its effective area. Isotropic antenna having an area of one radian circle.)
- (8) Simon Ramo, "Introduction to Microwaves," John Wiley and Sons, New York, N. Y., 1946 (Parallel-strip transmission line, pp. 101-103, 113-114.)

Coupled Antennas*

C. T. TAI†, STUDENT, I.R.E.

Summary—The integral equation governing the current distribution on two coupled antennas has been solved. The method used is an improvement on the work originally formulated by King and Harrison. As a result of this improvement, the general solution pertaining to the antenna problem reduces to the conventional one obtained from transmission-line theory, when the two antisymmetrically driven antennas are closely coupled to each other. Numerical values of the self- and mutual impedances based upon the present work have been computed. The result is compared with those obtained by Carter based upon the so-called e.m.f. method, assuming a sinusoidal distribution of the currents.

INTRODUCTION

THE PROBLEM of finding the current distribution and impedance characteristic of a center-driven antenna is, in general, a problem of how to find a solution of the three-dimensional vector wave equation that satisfies the specified boundary conditions. Unless the body of the antenna as a whole can be well defined by one appropriate co-ordinate in some co-ordinate system—as, for example, a prolate spheroid¹—no general method² is so far available in the sense that the solution would satisfy the boundary condition at every part of the body, including, for instance, the end surfaces of a cylindrical antenna or those of a biconical antenna.

Hallén's vector potential method³ in dealing with the cylindrical antenna is a very satisfactory one because

* Decimal classification: R125.1. Original manuscript received by the Institute, May 21, 1947. The research reported in this document was made possible through support extended Cruft Laboratory, Harvard University, jointly by the United States Navy, Office of Naval Research, and the United States Army Signal Corps, under ONR Contract N5ori-76, T.O.I.

† Cruft Laboratory, Harvard University, Cambridge, Mass.

¹ J. A. Stratton and L. J. Chu, "Steady-state solutions of electromagnetic field problems," *Jour. Appl. Phys.*, vol. 12, p. 230; March, 1941.

² J. Aharoni, "Antennae," Oxford University Press, Oxford England, 1946.

³ E. Hallén, "Theoretical investigations into the transmitting and receiving qualities of antennae," *Nova Acta Uppsala*, vol. 77, pp. 1-44; November, 1938.

the end effect in such a formulation is negligible,⁴ while mathematically it permits reduction of the analysis into a one-dimensional form. Moreover, this method is especially appropriate for handling the problem of coupled antennas.

The present work is an improvement on the method originally formulated by King and Harrison.⁵ The improvement is twofold. In the first place, a proper distribution function has been chosen in expanding the integral equation as was done in the case of a single antenna,⁶ and secondly, the term corresponding to the contribution of the vector potential by the second antenna is treated as part of the main integral instead of as a correction term. Results derived from the present method show that, in the case of two coupled antennas driven antisymmetrically, the solution reduces exactly to the conventional one obtained from transmission-line theory, when the two antennas are sufficiently close to satisfy the conditions of line theory.

GENERAL EQUATIONS

The general formulation of the problem has been discussed in detail.⁵ Two coupled antennas of identical size are considered in this paper. To simplify the discussion, the internal or surface impedance of the antennas is also assumed to be negligible. With the arrangement shown in Fig. 1, the z component of the vector potential at the surface of each of the two antennas (viz., A_{1z} and A_{2z}) satisfy the following differential equations:

$$\frac{\partial^2 A_{1z}}{\partial z^2} + \beta^2 A_{1z} = 0 \quad (1)$$

⁴ L. Brillouin, "The antenna problem," *Quart. Appl. Math.*, vol. 1, pp. 201-204; October, 1943.

⁵ R. King and Charles W. Harrison, Jr., "Mutual and self-impedance for coupled antennas," *Jour. Appl. Phys.*, vol. 15, pp. 481-495; June, 1944.

⁶ R. King and D. Middleton, "The cylindrical antenna; current and impedance," *Quart. Appl. Math.*, vol. 3, pp. 302-335; January, 1946.

$$\frac{\partial^2 A_{2z}}{\partial z^2} + \beta^2 A_{2z} = 0 \tag{2}$$

with

$$A_{1z} = \frac{\mu_0}{4\pi} \int_{-h}^h I_{1z'} \frac{e^{-j\beta r_{11}}}{r_{11}} dz' + \frac{\mu_0}{4\pi} \int_{-h}^h I_{2z'} \frac{e^{-j\beta r_{12}}}{r_{12}} dz' \tag{3}$$

$$A_{2z} = \frac{\mu_0}{4\pi} \int_{-h}^h I_{2z'} \frac{e^{-j\beta r_{22}}}{r_{22}} dz' + \frac{\mu_0}{4\pi} \int_{-h}^h I_{1z'} \frac{e^{-j\beta r_{21}}}{r_{21}} dz' \tag{4}$$

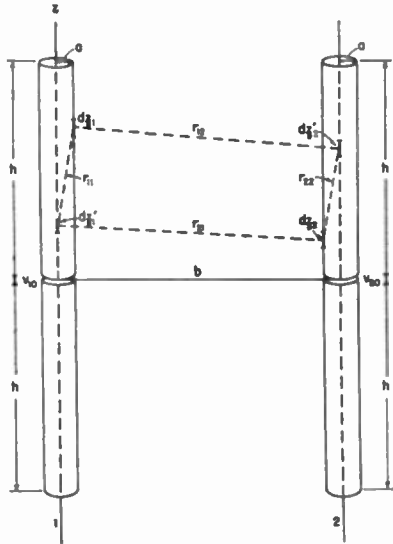

Fig. 1—Two coupled antennas.

The following notation is used:

$$\mu_0 = 4\pi \times 10^{-7} \text{ henry/meter}$$

$$\beta = \frac{\omega}{c}$$

$$r_{11} = \sqrt{(z_1' - z_1)^2 + a^2}$$

$$r_{12} = \sqrt{(z_2' - z_1)^2 + b^2}$$

$$r_{22} = \sqrt{(z_2' - z_2)^2 + a^2}$$

$$r_{21} = \sqrt{(z_1' - z_2)^2 + b^2}$$

where a is the radius, and h is the half length of each antenna.

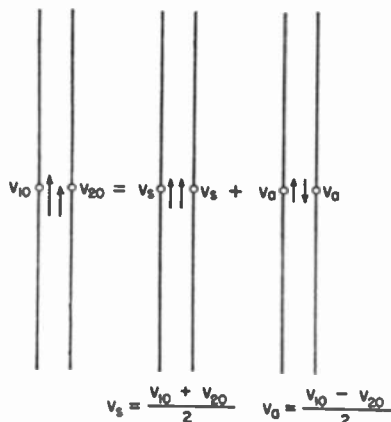

Fig. 2—Schematic diagram to illustrate the theorem of superposition as applied to two coupled antennas.

By means of the superposition theorem, the solution for two antennas driven by two given voltages V_{10} and V_{20} always can be obtained from the solutions for symmetrically and antisymmetrically driven pairs by writing $V_{10} = (V_s + V_a)$, $V_{20} = (V_s - V_a)$. Therefore, (1), (2), (3), and (4) may be specialized to these two cases without loss in generality. The superposition theorem and the notation are illustrated graphically in Fig. 2.

SYMMETRICALLY DRIVEN IDENTICAL ANTENNAS

For two identical antennas driven symmetrically, one has

$$I_{1z} = I_{2z}; \quad A_{1z} = A_{2z} \tag{6}$$

With (6), (1) and (3) or (2) and (4) reduce to the following form:

$$\frac{\partial^2 A_z}{\partial z^2} + \beta^2 A_z = 0 \tag{7}$$

$$A_z = \frac{\mu_0}{4\pi} \int_{-h}^h I_{z'} \frac{e^{-j\beta r_{11}}}{r_{11}} dz' + \frac{\mu_0}{4\pi} \int_{-h}^h I_{z'} \frac{e^{-j\beta r_{12}}}{r_{12}} dz' \tag{8}$$

The solution of (7) is

$$A_z = \frac{-j}{c} (C_1 \cos \beta z + \frac{1}{2} V_s \sin \beta |z|) \tag{9}$$

where one of the two arbitrary constants of the general solution has been determined to satisfy the discontinuity of the scalar potential V_s at the driving point of each antenna. The second constant C_1 is to be determined later when the boundary condition that the current must vanish at the ends of the antenna is imposed. Equating (8) and (9), one obtains the integral equation of I_z :

$$\int_{-h}^h I_{z'} \left(\frac{e^{-j\beta r_{11}}}{r_{11}} + \frac{e^{-j\beta r_{12}}}{r_{12}} \right) dz' = \frac{-j4\pi}{R_c} (C_1 \cos \beta z + \frac{1}{2} V_s \sin \beta |z|) \tag{10}$$

where

$$R_c = \sqrt{\frac{\mu_0}{\epsilon_0}} = 120\pi \text{ ohms.}$$

The two integrals in (8) have been combined to form one integral in (10) in order to emphasize the fact that the kernel of the integral equation is

$$\frac{e^{-j\beta r_{11}}}{r_{11}} + \frac{e^{-j\beta r_{12}}}{r_{12}} \tag{11}$$

It is at this point where the new method diverges from the old one, in which the integral due to the distant action of the second antenna was treated as a correction term, while the function $e^{-j\beta r_{11}}/r_{11}$ alone was regarded as the kernel of the integral equation. Equation (10) has the same form as that encountered in the problem of a single antenna except that the kernel of the integral equation involves two terms. A method of solving an

equation of this type has been discussed in detail,⁶ and will not be repeated here. The final expression of the first-order solution for I_{za} is

$$I_{za} = \frac{j2\pi V_a}{R_c \Psi_{ab}} \left[\frac{\sin \beta(h - |z|) + \frac{1}{\Psi_{ab}} \{G_0(h)[F_{1z} + P_{1z}] + F_{0z}[G_1(h) + Q_1(h)] - F_0(h)[G_{1z} + Q_{1z}] - G_{0z}[F_1(h) + P_1(h)]\}}{F_0(h) + \frac{1}{\Psi_{ab}} [F_1(h) + P_1(h)]} \right] \quad (12)$$

where the constant Ψ_{ab} and various functions are defined as follows:

$$\left. \begin{aligned} F_0(z) &= \cos \beta z; & G_0(z) &= \sin \beta |z| \\ F_{0z} &= F_0(z) - F_0(h); & G_{0z} &= G_0(z) - G_0(h) \\ F_{1z} &= \Psi_{ab} F_{0z} - \int_{-h}^h F_{0z'} \frac{e^{-i\beta r_{11}}}{r_{11}} dz' \\ &= \Psi_{ab} (\cos \beta z - \cos \beta h) - C_a(z) + E_a(z) \cos \beta h \\ G_{1z} &= \Psi_{ab} G_{0z} - \int_{-h}^h G_{0z'} \frac{e^{-i\beta r_{11}}}{r_{11}} dz' \\ &= \Psi_{ab} (\sin \beta |z| - \sin \beta h) - S_a(z) + E_a(z) \sin \beta h \\ F_{1z} &= F_1(z) - F_1(h); & G_{1z} &= G_1(z) - G_1(h) \\ P_1(z) &= - \int_{-h}^h F_{0z'} \frac{e^{-i\beta r_{12}}}{r_{12}} dz' = -C_b(z) + E_b(z) \cos \beta h \\ Q_1(z) &= - \int_{-h}^h G_{0z'} \frac{e^{-i\beta r_{12}}}{r_{12}} dz' = -S_b(z) + E_b(z) \sin \beta h \\ P_{1z} &= P_1(z) - P_1(h); & Q_{1z} &= Q_1(z) - Q_1(h) \end{aligned} \right\} \quad (13)$$

$$\Psi_{ab}(z) = \frac{[C_a(z) + C_b(z)] \sin \beta h - [S_a(z) + S_b(z)] \cos \beta h}{\sin \beta(h - |z|)} \quad (14)$$

$$\Psi_{ab} \begin{cases} |\Psi_{ab}(0)| & \text{for } \beta h \leq \frac{\pi}{2} \\ \left| \Psi_{ab}\left(h - \frac{\lambda}{4}\right) \right| & \text{for } \beta h \geq \frac{\pi}{2} \end{cases} \quad (15)$$

The functions $C_a(z)$, $C_b(z)$, $S_a(z)$, $S_b(z)$, $E_a(z)$, and $E_b(z)$ are defined by the following definite integrals:

$$C_a(z) = \int_{-h}^h \cos \beta z' \frac{e^{-i\beta r_{11}}}{r_{11}} dz';$$

$$I_{za} = \frac{j2\pi V_a}{R_c \Psi_{ab}'} \left[\frac{\sin \beta(h - |z|) + \frac{1}{\Psi_{ab}'} \{G_0(h)[F_{1z}' - P_{1z}'] + F_{0z}[G_1'(h) - Q_1(h)] - F_0(h)[G_{1z}' - Q_{1z}'] - G_{0z}[F_1'(h) - P_1(h)]\}}{F_0(h) + \frac{1}{\Psi_{ab}'} [F_1'(h) - P_1(h)]} \right] \quad (21)$$

$$\int_{-h}^h C_b(z) = \int_{-h}^h \cos \beta z' \frac{e^{-i\beta r_{12}}}{r_{12}} dz' \quad (16)$$

$$S_a(z) = \int_{-h}^h \sin \beta |z'| \frac{e^{-i\beta r_{11}}}{r_{11}} dz';$$

$$S_b(z) = \int_{-h}^h \sin \beta |z'| \frac{e^{-i\beta r_{12}}}{r_{12}} dz' \quad (17)$$

$$\begin{aligned} E_a(z) &= \int_{-h}^h \frac{e^{-i\beta r_{11}}}{r_{11}} dz'; \\ E_b(z) &= \int_{-h}^h \frac{e^{-i\beta r_{12}}}{r_{12}} dz' \end{aligned} \quad (18)$$

with

$$r_{11} = \sqrt{(z' - z)^2 + a^2}; \quad r_{12} = \sqrt{(z' - z)^2 + b^2}.$$

It is to be noted that the functions $F_0(z)$, $G_0(z)$, $P_1(z)$ and $Q_1(z)$ are the same as previously defined,^{5,6} while the functions $F_1(z)$ and $G_1(z)$ can also be expressed in terms of similar functions elsewhere defined.⁵ Consequently, (12) can be rearranged to contain these old functions in order to facilitate the numerical evaluation of (12). This modified form of (12) is given in the appendix, where the relations between the new functions and the old ones are outlined.

ANTISYMMETRICALLY DRIVEN IDENTICAL ANTENNAS

For two identical antennas driven antisymmetrically, one has

$$I_{1z} = -I_{2z}, \quad A_{1z} = -A_{2z}. \quad (19)$$

The integral equation in I_z becomes

$$\int_{-h}^h I_z' \left(\frac{e^{-i\beta r_{11}}}{r_{11}} - \frac{e^{-i\beta r_{12}}}{r_{12}} \right) dz' = \frac{-j4\pi}{R_c} (C_1 \cos \beta z + \frac{1}{2} V_a \sin \beta |z|). \quad (20)$$

As a result of the change of sign in the kernel, every function involving b reverses its sign, whereas those involving a do not. The final expression of the first-order solution for I_{za} follows:

The functions $F_0(z)$, $G_0(z)$, $P_1(z)$, and $Q_1(z)$ remain the same as before. The functions $F_1'(z)$ and $G_1'(z)$, however, appear in place of $F_1(z)$ and $G_1(z)$, since Ψ_{ab} is replaced by Ψ_{ab}' , which is given by

$$\Psi_{ab}'(z) = \frac{[C_a(z) - C_b(z)] \sin \beta h - [S_a(z) - S_b(z)] \cos \beta h}{\sin \beta(h - |z|)} \quad (22)$$

$$\Psi_{ab}' = \begin{cases} |\Psi_{ab}'(0)| & \text{for } \beta h \leq \frac{\pi}{2} \\ \left| \Psi_{ab}'\left(h - \frac{\lambda}{4}\right) \right| & \text{for } \beta h \geq \frac{\pi}{2} \end{cases} \quad (23)$$

The symmetrical and antisymmetrical impedances are obtained by setting $z=0$ in (12) and (21), and finding the ratio V_s/I_{0s} and V_a/I_{0a} , respectively. This gives

$$Z_s = \frac{-jR_c\Psi_{ab}}{2\pi} \left[\frac{\cos \beta h + \frac{1}{\Psi_{ab}} [F_1(h) + P_1(h)]}{\sin \beta h + \frac{1}{\Psi_{ab}} \{ [F_1(0) + P_1(0)] \sin \beta h - [G_1(0) + Q_1(0)] \cos \beta h + [G_1(h) + Q_1(h)] \}} \right] \quad (24)$$

$$Z_a = \frac{-jR_c\Psi_{ab}'}{2\pi} \left[\frac{\cos \beta h + \frac{1}{\Psi_{ab}'} [F_1'(h) - P_1(h)]}{\sin \beta h + \frac{1}{\Psi_{ab}'} \{ [F_1'(0) - P_1(0)] \sin \beta h - [G_1'(0) - Q_1(0)] \cos \beta h + [G_1'(h) - Q_1(h)] \}} \right] \quad (25)$$

substituting in (30) and (31). The resultant current on antenna 2 is the difference ($I_{2s} - I_{2a}$) obtained from (12) and (21).

CLOSELY COUPLED ANTENNAS

Two antennas are said to be closely coupled if the separation b between the two satisfies the following condition:

$$b^2 \ll h^2. \quad (32)$$

For two identical antennas driven by two arbitrary voltages V_{10} and V_{20} , the relation between the input currents and the exciting voltages are

$$V_{10} = I_{10}Z_{11} + I_{20}Z_{12} \quad (26)$$

$$V_{20} = I_{20}Z_{11} + I_{10}Z_{12} \quad (27)$$

where the self-impedance, Z_{11} and the mutual impedance Z_{12} are defined by (26) and (27) and are related to Z_s and Z_a according to the following equations:

$$Z_{11} = \frac{Z_s + Z_a}{2}; \quad Z_{12} = \frac{Z_s - Z_a}{2} \quad (28)$$

If the second antenna is a parasitic antenna loaded at center with an impedance Z_L , one replaces V_{20} by $-Z_L I_{20}$. The input impedance for V_{10} is then

$$Z_{in} = Z_{11} - \frac{Z_{12}^2}{Z_L + Z_{11}} = \frac{2Z_s Z_a + (Z_s + Z_a)Z_L}{2Z_L + Z_s + Z_a} \quad (29)$$

The values of V_s and V_a in terms of Z_s , Z_a , Z_L , and V_{10} are given below,

$$V_s = \left[\frac{Z_s(Z_s + Z_L)}{2Z_s Z_a + (Z_s + Z_a)Z_L} \right] V_{10} \quad (30)$$

$$V_a = \left[\frac{Z_a(Z_s + Z_L)}{2Z_s Z_a + (Z_s + Z_a)Z_L} \right] V_{10} \quad (31)$$

The resultant current in antenna 1 is then the sum ($I_{1s} + I_{1a}$) obtained from (12) and (21) with V_s and V_a

Without loss of generality, the discussion will again be carried on in two separate cases; namely, the symmetrical and the antisymmetrical.

Case 1. Symmetrically Driven Antennas

If one defines $\Psi_a(z)$ and $\Psi_b(z)$ according to the following equations,

$$\Psi_a(z) = \frac{C_a(z) \sin \beta h - S_a(z) \cos \beta h}{\sin \beta(h - |z|)} \quad (33)$$

$$\Psi_b(z) = \frac{C_b(z) \sin \beta h - S_b(z) \cos \beta h}{\sin \beta(h - |z|)}, \quad (34)$$

then (14) can be written into

$$\Psi_{ab}(z) = \Psi_a(z) + \Psi_b(z). \quad (35)$$

For a^2 and $b^2 \ll h^2$, the formulas of $C_a(z)$, $C_b(z)$, $S_a(z)$, and $S_b(z)$ tabulated in Appendix II can be used in (33) and (34). It can easily be verified that

$$\Psi_{ab} = \begin{cases} |2\Psi_a(0) - \Omega_a + \Omega_b| = |2\Psi_b(0) + \Omega_a - \Omega_b| & \text{for } \beta h \leq \frac{\pi}{2} \\ \left| 2\Psi_a\left(h - \frac{\lambda}{4}\right) - \Omega_a + \Omega_b \right| = 2\Psi_b\left(h - \frac{\lambda}{4}\right) + \Omega_a - \Omega_b & \text{for } \beta h \geq \frac{\pi}{2} \end{cases} \quad (36)$$

with

$$\Omega_a = 2 \ln \frac{2h}{a}; \quad \Omega_b = 2 \ln \frac{2h}{b} \quad (37)$$

The parameter Ω_a was first introduced by Hallén in his study of the integral equation for a single antenna. The function Ψ_a was introduced by King and Middleton in

their recent work on the same problem. Equation (36) is very useful to determine the numerical values of Ψ_{ab} , as it is possible to make use of data already computed by the authors mentioned above.

Case 2. Antisymmetrically Driven Antennas

Two closely coupled antennas driven antisymmetrically are equivalent to two open-end sections of two-wire line in series with each other and two generators V_a . Using the same formulas for $C_a(z)$, $C_b(z)$, etc., (23) in this case reduces simply to

$$\Psi_{ab'} = \Omega_a - \Omega_b = 2 \ln \frac{b}{a} \tag{38}$$

The solution of I_{za} then reduces ultimately to

$$\begin{aligned} I_z &= \frac{j2\pi V_a}{R_c \Psi_{ab'}} \frac{\sin \beta(h - |z|)}{\cos \beta h} \\ &= \frac{jV_a}{R_{line}} \frac{\sin \beta(h - |z|)}{\cos \beta h} \end{aligned} \tag{39}$$

with

$$R_{line} = 120 \ln \frac{b}{a}$$

Terms corresponding to higher orders than the first are identically vanishing. It is recalled that the term R_{line} is precisely the characteristic impedance of the parallel-wire line subjected to the condition that $b^2 \gg a^2$. Equation (39) therefore coincides with the solution derived from the line theory.⁷ The proximity effect is, of course, neglected at the very beginning, where the rotational symmetry of the current distribution was assumed in deriving the formula of A for the vector potential on the surface of the conductors. This effect can be taken into consideration by substituting the effective spacing

$$\frac{b}{2} \left(1 + \sqrt{1 - \left(\frac{2a}{b} \right)^2} \right)$$

for b in the original equations for the antisymmetrical case.⁸

EXTENSION TO n -COUPLED ANTENNAS

The method of analysis of two coupled antennas can be extended to n -coupled antennas provided that the simultaneous integral equations can be reduced to the same type described above. This sets up a limit to the geometrical configuration of the antennas as well as the way of excitation. For three identical coupled antennas arranged at the corners of an equilateral triangle, the problem can be solved completely no matter how the antennas are excited. By the method of symmetrical

components, three voltages of arbitrary magnitudes and phases can be decomposed into three sequences of voltages as shown schematically in Fig. 3. Each sequence is

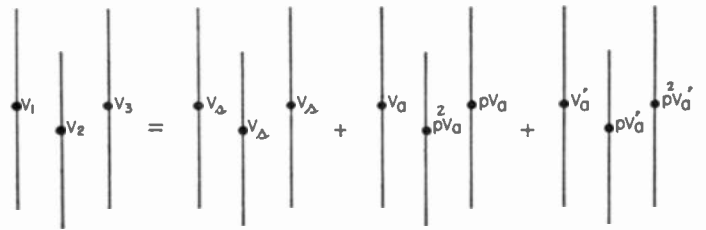

Fig. 3—Three different types of excitation occurring in the problem of three coupled antennas.

then analogous to the symmetrical or antisymmetrical component treated previously. For the zero sequence, the integral equation corresponding to (10) is

$$\begin{aligned} \int_{-h}^h I_z' \left(\frac{e^{-i\beta r_{11}}}{r_{11}} + 2 \frac{e^{-i\beta r_{12}}}{r_{12}} \right) dz' \\ = \frac{-j4\pi}{R_c} (C_1 \cos \beta z + \frac{1}{2} V_a \sin \beta |z|) \end{aligned} \tag{40}$$

The integral equation corresponding to the positive or negative sequence is

$$\begin{aligned} \int_{-h}^h I_z' \left(\frac{e^{-i\beta r_{11}}}{r_{11}} + p \frac{e^{-i\beta r_{12}}}{r_{12}} + p^2 \frac{e^{-i\beta r_{13}}}{r_{13}} \right) dz' \\ = \frac{-j4\pi}{R_c} (C_1 \cos \beta z + \frac{1}{2} V_a \sin \beta |z|) \end{aligned} \tag{41}$$

where p is the phase factor $e^{j(2\pi/3)}$ which satisfies the equation

$$1 + p + p^2 = 0. \tag{42}$$

By means of (42) and the relation $r_{12} = r_{13}$, (41) can be reduced to

$$\begin{aligned} \int_{-h}^h I_z' \left(\frac{e^{-i\beta r_{11}}}{r_{11}} - \frac{e^{-i\beta r_{12}}}{r_{12}} \right) dz' \\ = \frac{-j4\pi}{R_c} (C_1 \cos \beta z + \frac{1}{2} V_a \sin \beta |z|) \dots \end{aligned} \tag{43}$$

which is identical with (20). The method of evaluating (40) and (43) is the same as described before, and will not be repeated.

When the three antennas are closely coupled and excited by a sequence of voltages of equal amplitude but of a phase difference of $e^{j(2\pi/3)}$ (that is, by a positive sequence or a negative sequence), the system forms a three-phase transmission line. Accordingly, we may expect that a certain type of transmission-line equation can be derived from the equations of the potentials. The derivation of these line equations and a detailed analysis of them will be treated in a separate paper to be published later, where the general problem of n -phase transmission line and of two-phase multiple-wire transmission line will be discussed.

⁷ R. King, "Transmission-line theory and its application," *Jour. Appl. Phys.*, vol. 14, p. 577; November, 1943.

⁸ R. King, "Electromagnetic Engineering," McGraw-Hill Book Co., New York, N. Y., vol. 1, p. 468; 1945.

Numerical Computations

In order to give a quantitative discussion concerning the impedances, or, more essentially, the current distribution of two coupled antennas, it is necessary to know the nature of several functions that occur in the expressions for current and impedances. To illustrate the characteristic of these functions, two sets of curves have been

computed corresponding to two distinct values of antenna length, namely, $h = \lambda/4$ and $h = \lambda/2$.

For $h = \lambda/4$, it can be shown, by substituting (13), (14), and (15) into (12), that the expression of I_z can be reduced to the following form:

$$I_{zs} = \frac{j2\pi V_s}{R_c \Psi_s} \frac{[K_1 \cos \beta z + K_2 \sin \beta |z| - C_a(z) - C_b(z)]}{[F_1(h) - P_1(h)]} \quad (44)$$

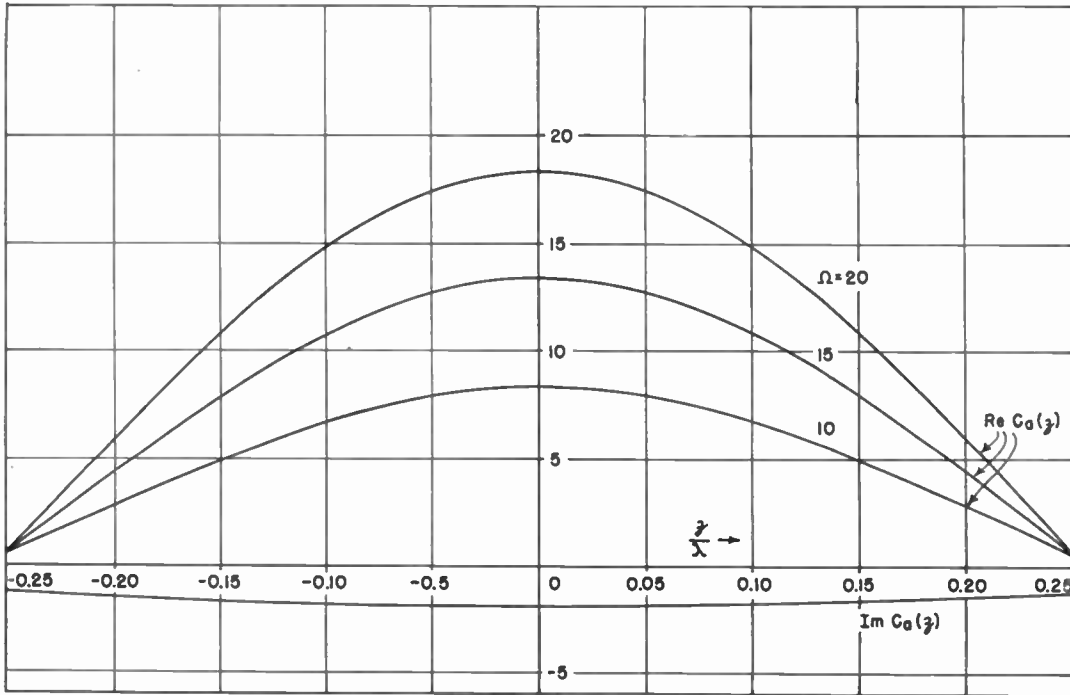

Fig. 4—The $C_a(z)$ function, $h = \lambda/4$.

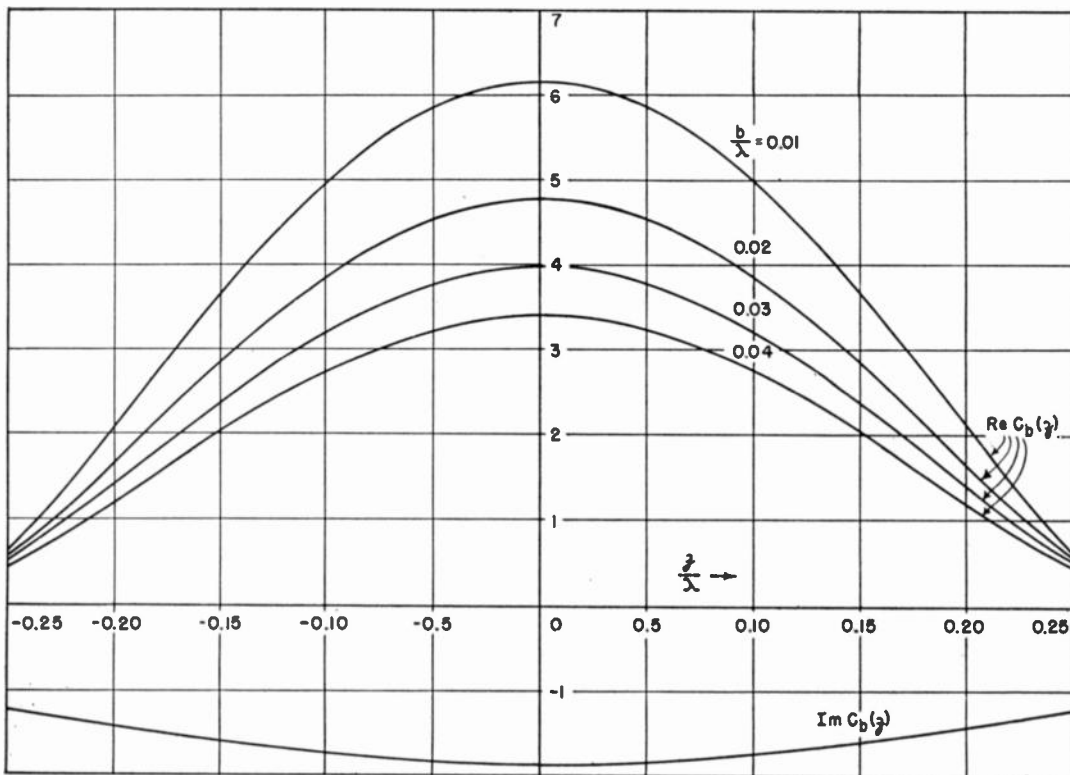

Fig. 5—The $C_b(z)$ function, $h = \lambda/4$.

where K_1 and K_2 are two complex constants defined as follows:

$$K_1 = 2\Psi_a + E_a(h) + E_b(h) - S_a(h) - S_b(h) \quad (45)$$

$$K_2 = C_a(h) + C_b(h). \quad (46)$$

It is obvious that the first-order solution for the currents on antennas may be considered as a superposition of two sinusoidal functions and two nonsinusoidal func-

tions, $C_a(z)$ and $C_b(z)$. The latter can be computed in terms of some sine integrals and cosine integrals. The formulas are given in Appendixes I and II. Figs. 4 and 5 show two typical sets of curves for different values of a and b . The value of the imaginary part of $C_a(z)$ or $C_b(z)$ is practically independent of a or b . There is an over-all change of about 1 per cent when a/h changes from 10^{-4} to 10^{-1} .

Fig. 6—The $S_a(z)$ function, $h = \lambda/2$.

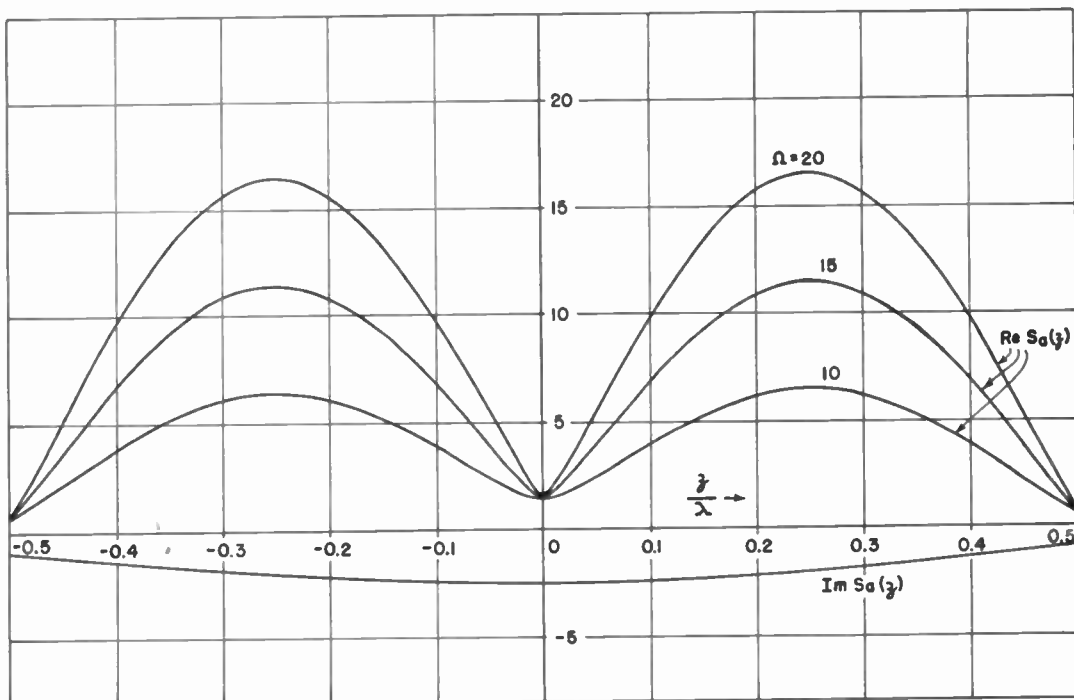
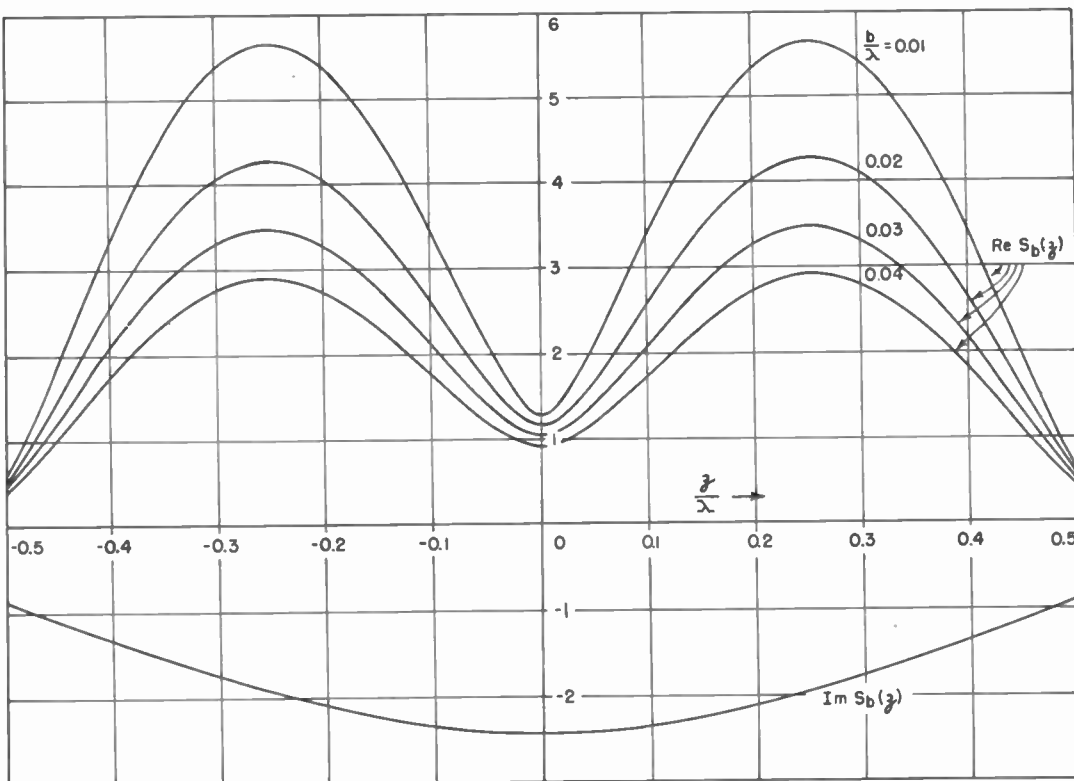

Fig. 7—The $S_b(z)$ function, $h = \lambda/2$.



For $h = \lambda/2$, (12) reduces to

$$I_{zs} = \frac{j2\pi V_s}{R_s \Psi_s} \left[\frac{K_1' \sin \beta |z| - K_2' \cos \beta z - S_a(z) - S_b(z)}{-\Psi_s + F_1(h) + P_1(h)} \right] \quad (47)$$

where K_1' and K_2' are two constants defined as follows:

$$K_1' = 2\Psi_s + E_a(h) + E_b(h) + C_a(h) + C_b(h) \quad (48)$$

$$K_2' = S_a(h) + S_b(h). \quad (49)$$

The fractions $S_a(z)$ and $S_b(z)$ for $h = \lambda/2$ are shown in Figs. 6 and 7. The parameters Ψ_s and Ψ_a for different values of a and b are plotted in Figs. 8 and 9.

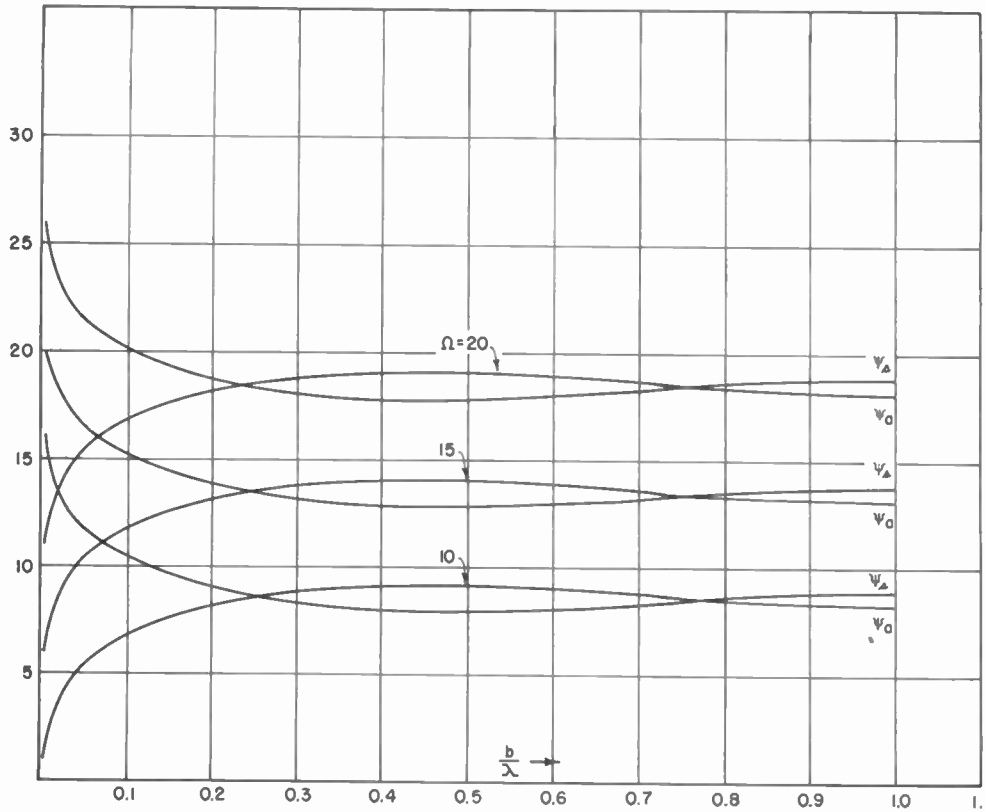

Fig. 8—The parameters Ψ_s and Ψ_a , $h = \lambda/4$.

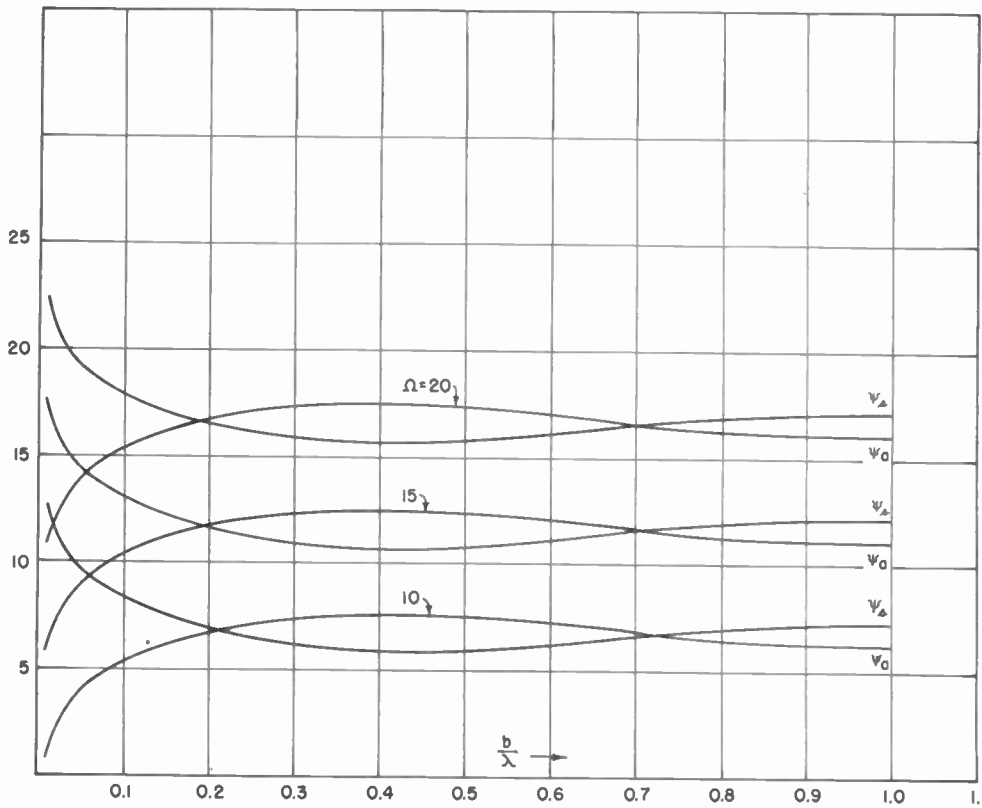

Fig. 9—The parameters Ψ_s and Ψ_a , $h = \lambda/2$.

To describe the current distribution on two coupled antennas, it is convenient to treat the symmetrical and antisymmetrical cases separately. In fact, these two cases may be regarded as two extreme conditions with

Fig. 10—First-order current distribution for $h = \lambda/4$.

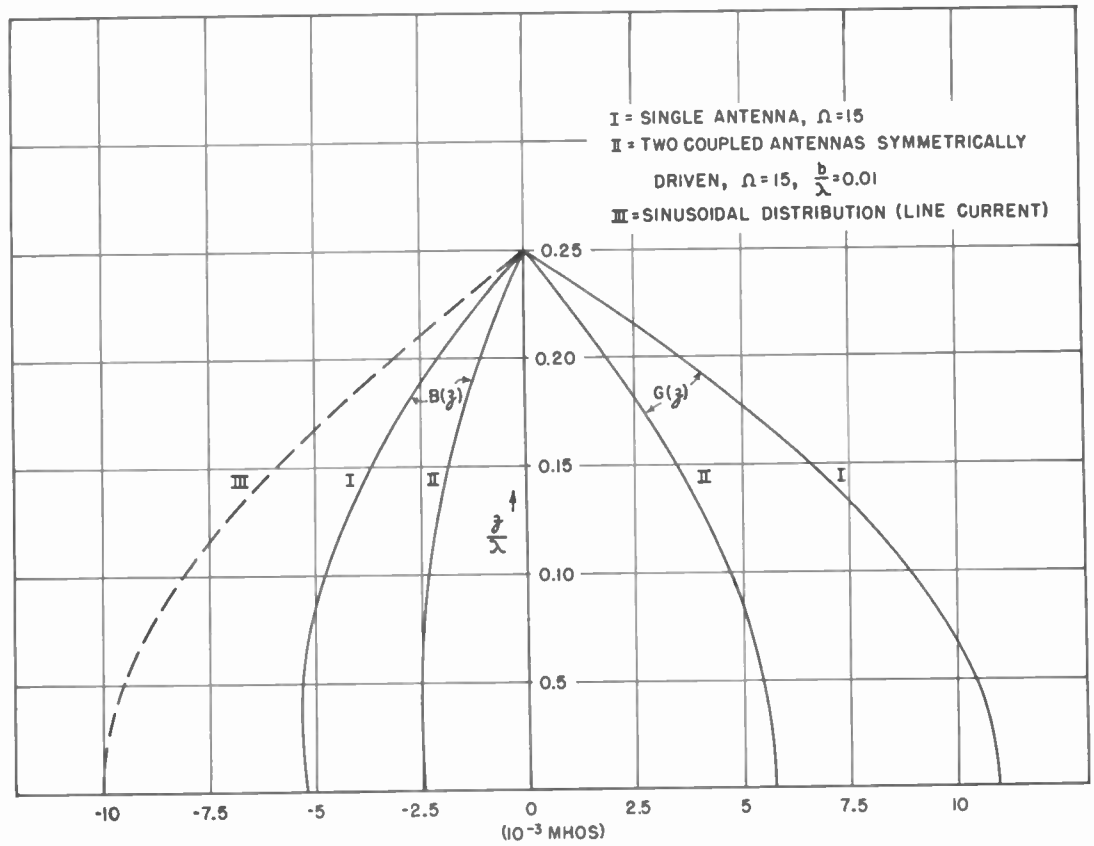
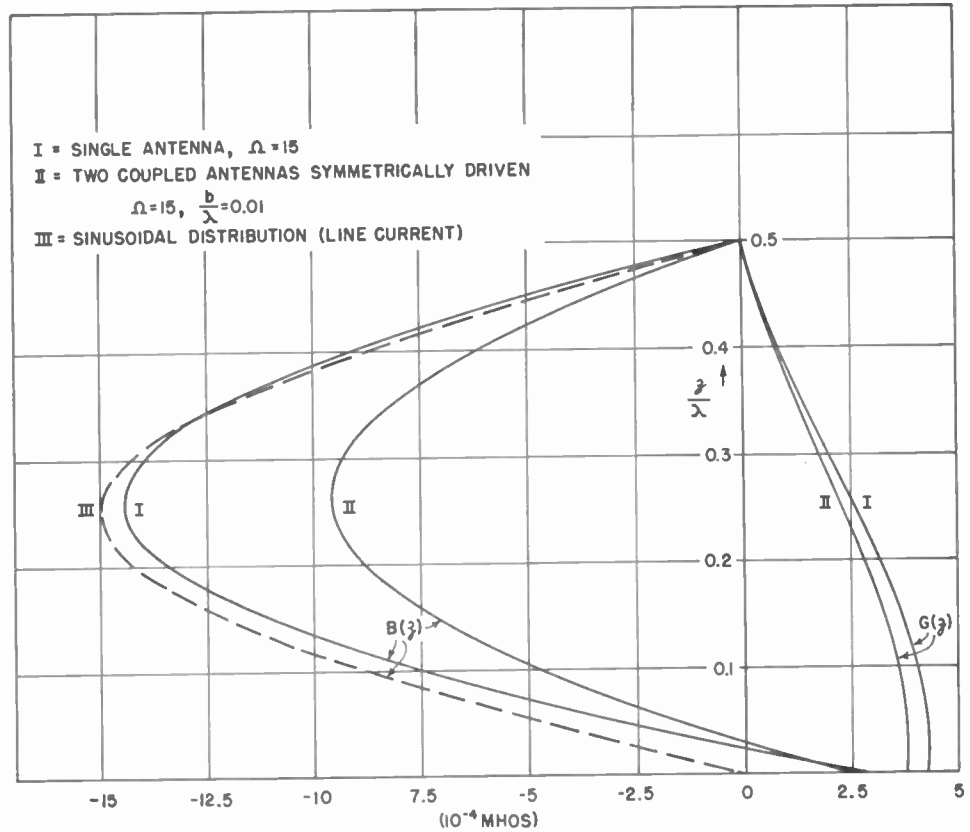

Fig. 11—First-order current distribution for $h = \lambda/2$.



the characteristics of an isolated antenna lying between them; thus, suppose one starts with two closely coupled antennas, driven antisymmetrically by two equal and opposite voltages. The system is then equivalent to a two-wire line. The current is known to be sinusoidal, or very close to sinusoidal, if the attenuation along the line is small. By separating these two lines, the currents gradually depart from the sinusoidal distribution. As the wires are further separated so that their separation is infinite, the distribution approaches that of an isolated antenna. Suppose that one of the exciting voltages now has its polarity reversed, and that the two antennas are then brought close together. The current distribution would then change from that of an isolated antenna to what would appear on two symmetrically driven antennas. The whole cycle therefore represents a complete picture involved in the problem of two coupled antennas.

The above reasoning suggests that, to study the current distribution on two coupled antennas, the simplest way is to compare three types of distribution corresponding to (a) two closely coupled antisymmetrically driven antennas (line current), (b) isolated antenna, and (c) two closely coupled symmetrically driven antennas.

The curves representing these three cases are shown in Figs. 10 and 11, where $G(z)$ and $B(z)$ are two real functions defined according to the following equation:

$$I_s = V[G(z) + jB(z)]. \tag{50}$$

In drawing the line current, it has been assumed that the attenuation is small but not identically zero. For two copper wires with $\Omega = 15$ and $b/\lambda = 0.01$, the magnitude of $B(0)$, i.e., the amplitude of the cosine function in Fig. 10, will be equal to about 0.78, or 78 times as great as the one drawn there.

Because of the importance of the knowledge about impedance in the design of an antenna system, the symmetrical and antisymmetrical impedances of two coupled antennas have been computed for the case $h = \lambda/4$ and $h = \lambda/2$. The self and mutual impedances as defined by (28) have also been evaluated. These curves are shown in Figs. 12, 13, 14, 15, 16, 17, and 18. It is interesting to compare the numerical result obtained here for the mutual impedance between the half-wave dipoles

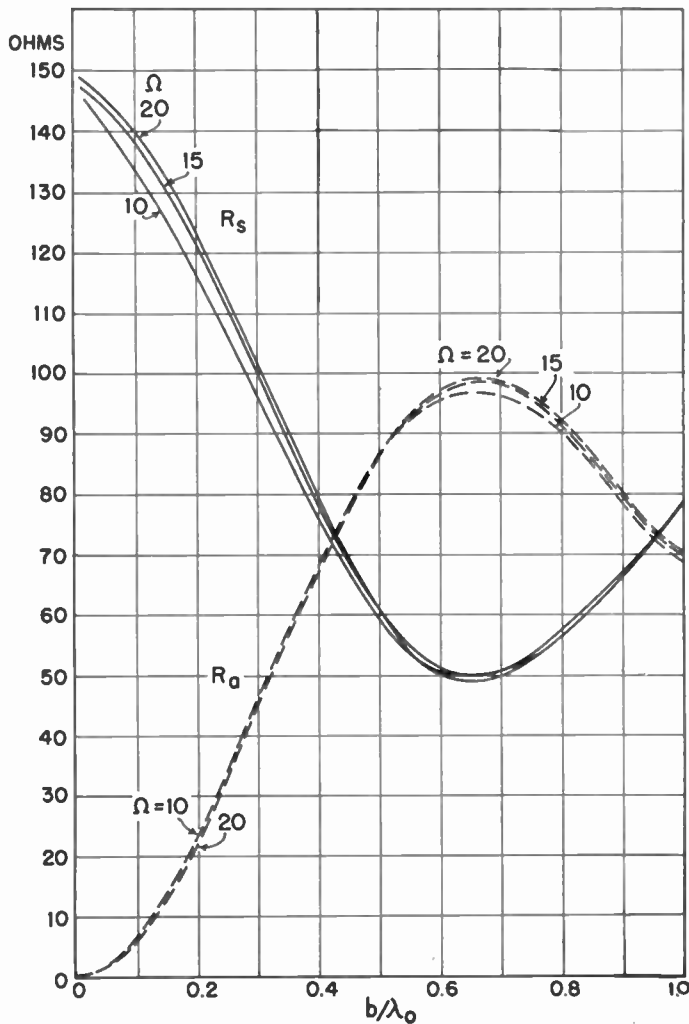

Fig. 12—Symmetrical and antisymmetrical resistances. $\beta_0 h = \pi/2$.

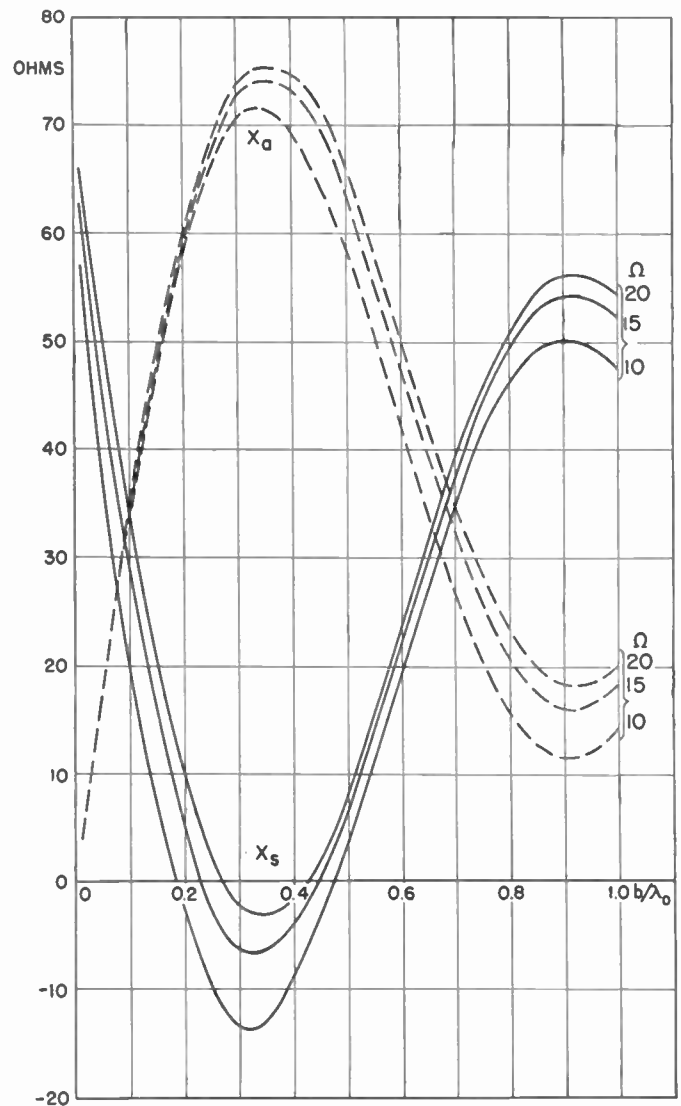

Fig. 13—Symmetrical and antisymmetrical reactances. $\beta_0 h = \pi/2$.

with that of Carter⁹ and Brown,¹⁰ who computed this coefficient by assuming a sinusoidal distribution of current on the two dipoles and obtained the result from a quite different approach. The curves are shown in Fig. 19. It is significant that the curve computed based upon the present theory oscillates up and down around that of Carter's.

CONCLUSION

The difference between the newly proposed method of solving the problem of coupled antennas and the older method lies in an improved mathematical approach to the solution of the integral equation. The verification by the present method of results obtained from line theory for closely spaced antisymmetrically driven wires is a significant confirmation of the validity of the new method. An extension of this method leads us to a rigor-

ous formulation of the problem of the n -phase transmission line and that of the single-phase multiwire transmission line. The analysis is useful to compute the input impedance of many antenna systems, including the folded dipole, triple-folded dipole, H antenna, and the corner-reflector antenna.

ACKNOWLEDGMENT

The writer wishes to acknowledge his indebtedness to Ronold King for suggesting this problem and supervising this work.

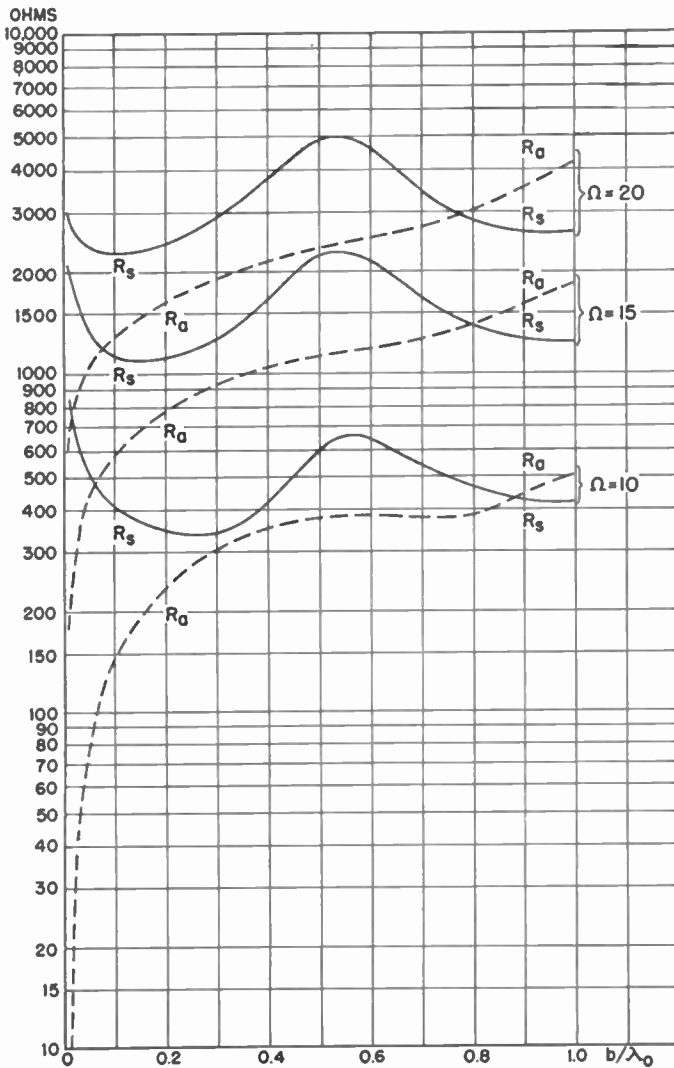

Fig. 14—Symmetrical and antisymmetrical resistances. β₀h = π.

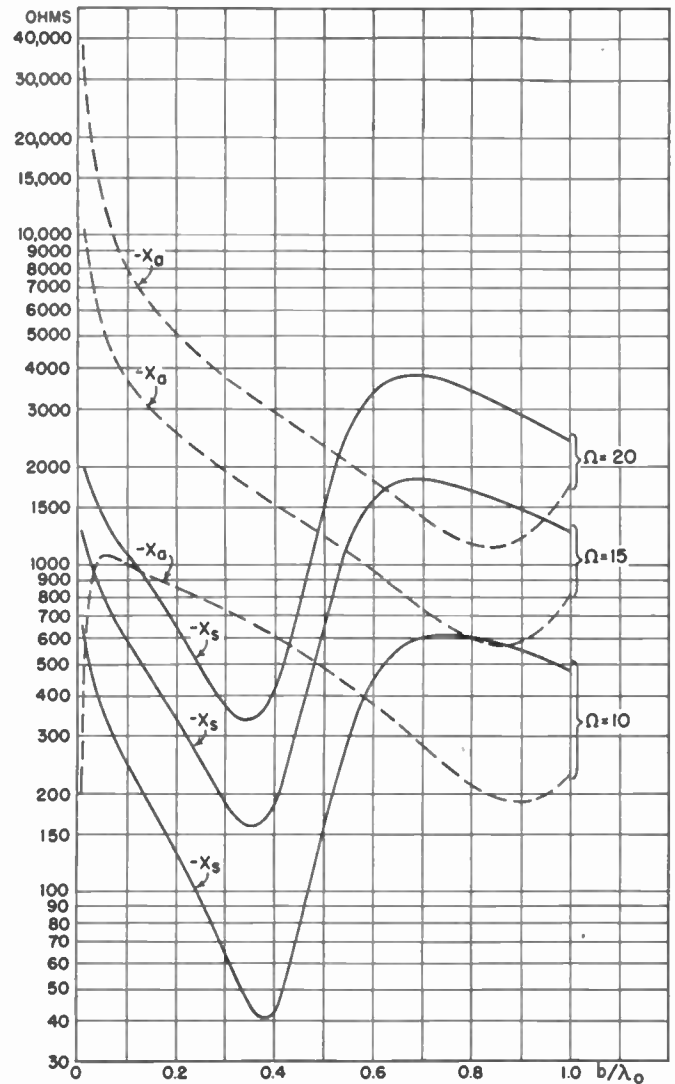

Fig. 15—Symmetrical and antisymmetrical reactances. β₀h = π.

APPENDIX I

General Formulas for C_a(z), S_a(z) and E_a(z)

The following notations are used in these formulas:

$$\left. \begin{aligned} \mu_2 &= h+z; & \mu_1 &= h-z \\ R_2 &= \sqrt{\mu_2^2+a^2}; & R_1 &= \sqrt{\mu_1^2+a^2}; & R_0 &= \sqrt{z^2+a^2} \\ C_i X &= \int_{\infty}^x \frac{\cos \mu}{\mu} d\mu; & S_i X &= \int_0^x \frac{\sin \mu}{\mu} d\mu \end{aligned} \right\} \quad (51)$$

⁹ P. S. Carter, "Circuit relations in radiating systems and applications to antenna problems," PROC. I.R.E., vol. 20, pp. 1004-1042; June, 1932.

¹⁰ G. H. Brown, "Directional antennas," PROC. I.R.E., vol. 25, pp. 78-145; January, 1937.

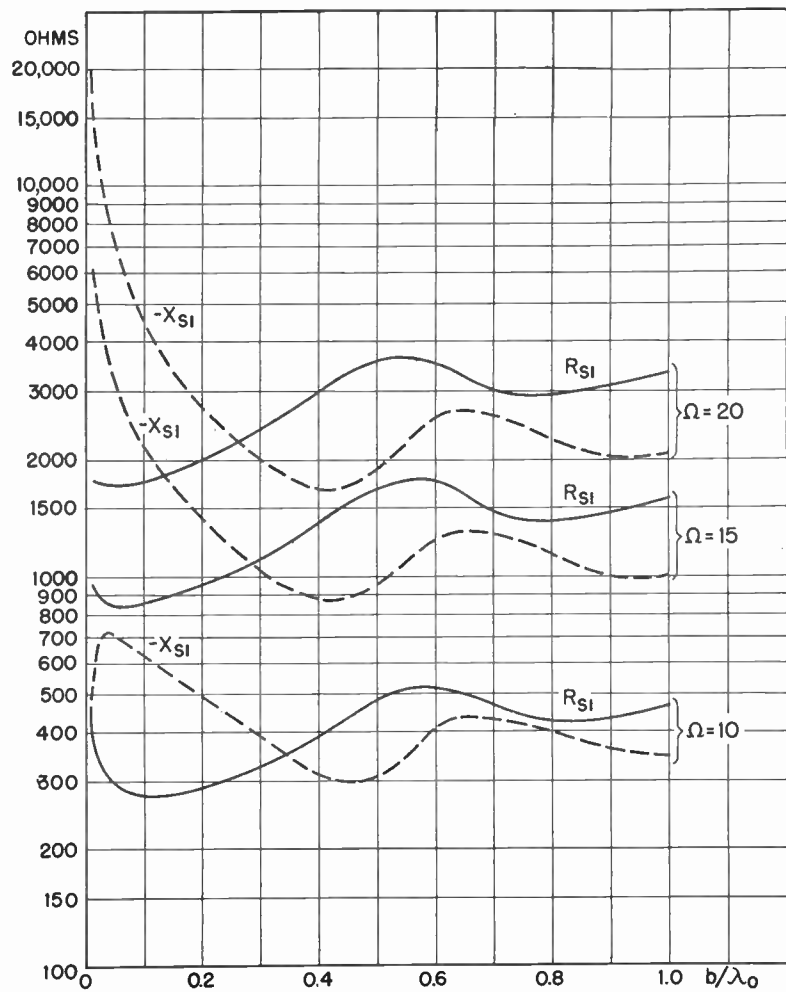

Fig. 17—Self-impedance, $\beta_0 h = \pi$.

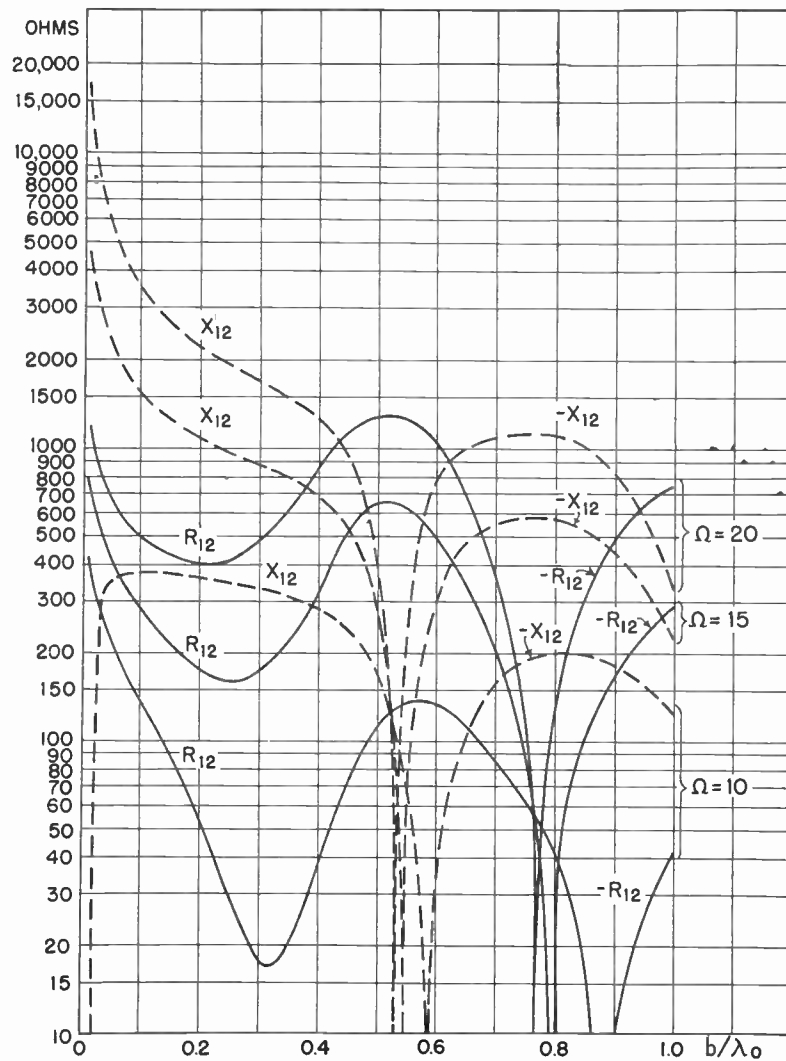

Fig. 18—Mutual impedance, $\beta_0 h = \pi$.

$$\begin{aligned}
C_a(z) = & \frac{1}{2} \cos \beta z [C i \beta (R_2 + \mu_2) + C i \beta (R_1 + \mu_1) \\
& - C i \beta (R_2 - \mu_2) - C i \beta (R_1 - \mu_1) - j S i \beta (R_2 + \mu_2) \\
& - j S i \beta (R_1 + \mu_1) + j S i \beta (R_2 - \mu_2) + j S i \beta (R_1 - \mu_1)] \quad (52) \\
& + \frac{1}{2} \sin \beta z [S i \beta (R_2 + \mu_2) - S i \beta (R_1 + \mu_1) \\
& + S i \beta (R_2 - \mu_2) - S i \beta (R_1 - \mu_1) + j C i \beta (R_2 + \mu_2) \\
& - j C i \beta (R_1 + \mu_1) + j C i \beta (R_2 - \mu_2) - j C i \beta (R_1 - \mu_1)]
\end{aligned}$$

$$\text{Cuv } X = \int_0^x (u^2 + v^2)^{-1/2} \cos (u^2 + v^2)^{1/2} du; \quad v = \beta a \quad (55)$$

$$\text{Suv } X = \int_0^x (u^2 + v^2)^{-1/2} \sin (u^2 + v^2)^{1/2} du; \quad v = \beta a. \quad (56)$$

The formulas for $C_b(z)$, $S_b(z)$, $E_b(z)$ will be the same as (52), (53), and (54), except that b is substituted for a .

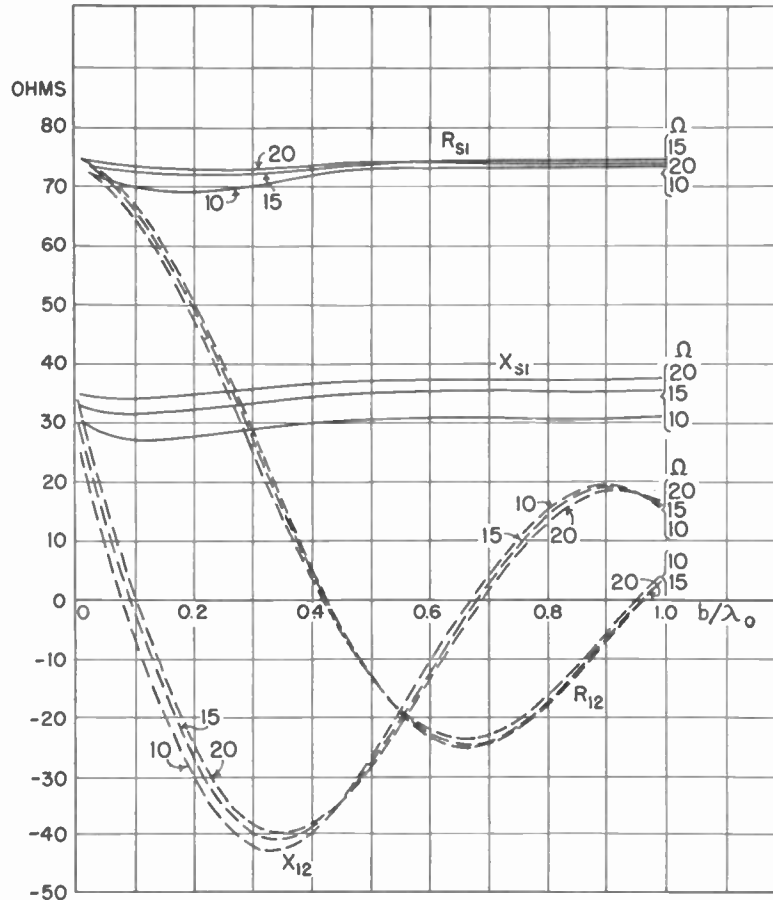

Fig. 16—Self and mutual impedance. $\beta_0 h = \pi/2$.

$$\begin{aligned}
S_a(z) = & \frac{1}{2} \cos \beta z [S i \beta (R_2 + \mu_2) + S i \beta (R_1 + \mu_1) \\
& + S i \beta (R_2 - \mu_2) + S i \beta (R_1 - \mu_1) - 2 S i \beta (R_0 + z) \\
& - 2 S i \beta (R_0 - z) + j C i \beta (R_2 + \mu_2) + j C i \beta (R_1 + \mu_1) \\
& + j C i \beta (R_2 - \mu_2) + j C i \beta (R_1 - \mu_1) \\
& - j 2 C i \beta (R_0 + z) - j 2 C i \beta (R_0 - z)] \quad (53) \\
& - \frac{1}{2} \sin \beta z [C i \beta (R_2 + \mu_2) - C i \beta (R_1 + \mu_1) \\
& - C i \beta (R_2 - \mu_2) + C i \beta (R_1 - \mu_1) - 2 C i \beta (R_0 + z) \\
& + 2 C i \beta (R_0 - z) - j S i \beta (R_2 + \mu_2) + j S i \beta (R_1 + \mu_1) \\
& + j S i \beta (R_2 - \mu_2) - j S i \beta (R_1 - \mu_1) \\
& + j 2 S i \beta (R_0 + z) - j 2 S i \beta (R_0 - z)]
\end{aligned}$$

APPENDIX II

Approximate formulas of $C_a(z)$, $S_a(z)$, and $E_a(z)$ subjected to the condition $a^2 \ll h^2$:

$$\begin{aligned}
C_a(z) \doteq & -\frac{1}{2} \cos \beta z [\bar{C} i 2 \beta (h+z) + \bar{C} i 2 \beta (h-z) \\
& + j S i 2 \beta (h+z) + j S i 2 \beta (h-z)] \\
& + \frac{1}{2} \sin \beta z [S i 2 \beta (h+z) - S i 2 \beta (h-z) \\
& - j \bar{C} i 2 \beta (h+z) + j \bar{C} i 2 \beta (h-z)] \quad (57)
\end{aligned}$$

$$\begin{aligned}
S_a(z) \doteq & \frac{1}{2} \cos \beta z [S i 2 \beta (h+z) + S i \beta (h-z) - 2 S i 2 \beta z \\
& - j \bar{C} i 2 \beta (h+z) - j \bar{C} i 2 \beta (h-z) + 2 j \bar{C} i 2 \beta z] \\
& + \frac{1}{2} \sin \beta z [\bar{C} i 2 \beta (h+z) - \bar{C} i 2 \beta (h-z) - 2 \bar{C} i 2 \beta z \\
& + j S i 2 \beta (h+z) - j S i 2 \beta (h-z) - 2 j S i 2 \beta z] \quad (58)
\end{aligned}$$

$E_a(z) = \text{Cuv } \beta \mu_2 + \text{Cuv } \beta \mu_1 - j \text{Suv } \beta \mu_2 - j \text{Suv } \beta \mu_1$ (54)
where the integrals $\text{Cuv } X$ and $\text{Suv } X$ are defined as follows:

$$-\sin \beta z \left[\sinh^{-1} \frac{h+z}{a} - \sinh^{-1} \frac{h-z}{a} - 2 \sinh^{-1} \frac{z}{a} \right]$$

$$E_a(z) \doteq -\overline{C_i} \beta (h+z) - \overline{C_i} \beta (h-z) - jS_i \beta (h+z) - jS_i \beta (h-z) + \sinh^{-1} \frac{h+z}{a} + \sinh^{-1} \frac{h-z}{a} \quad (59)$$

reference 6, are related to the functions $F_1(z)$ and $G_1(z)$ defined in this paper by the following equations:

$$F_1(z) = (\Psi_{ab} - \Omega_a) F_{0z} + F_{1H}(z) \quad (60)$$

$$G_1(z) = (\Psi_{ab} - \Omega_a) G_{0z} + G_{1H}(z). \quad (61)$$

It is to be noted that $F_1(h) = F_{1H}(h)$, $G_1(h) = G_{1H}(h)$ as F_{0z} and G_{0z} are equal to zero when $z = h$. By substituting (60) and (61) into (12), one obtains the following equation for I_{zs} , where only the first-order terms are retained:

$$I_{zs} = \frac{j2\pi}{R_c \Psi_{ab}} \left\{ \frac{\left(2 - \frac{\Omega_a}{\Psi_{ab}} \right) \sin \beta (h - |z|) h - |z| + \frac{1}{\Psi_{ab}} \{ G_{0z}(h) [F_{1H}(h) + P_1(z)] + F_{0z} [G_{1H}(h) + Q_1(z)] - F_{0z}(h) [G_{1H}(z) + G_{1z}] - G_{0z} [F_{1H}(h) + P_1(z)] \}}{F_{0z}(h) + \frac{1}{\Psi_{ab}} [F_{1H}(h) + P_1(h)]} \right\} \quad (62)$$

For Z_s , one obtains the following expression:

$$Z_s = \frac{-jR_c \Psi_{ab}}{2\pi} \left[\frac{\cos \beta h + \frac{1}{\Psi_{ab}} [F_{1H}(h) + P_1(h)]}{\left[2 - \frac{\Omega_a}{\Psi_{ab}} \right] \sin \beta h + \frac{1}{\Psi_{ab}} \{ [F_{1H}(0) + P_1(0)] \sin \beta h - [G_{1H}(0) + Q_1(0)] \cos \beta h + G_{1H}(h) + Q_1(h) \}} \right] \quad (63)$$

where $\overline{C_i} X$ is defined as

$$\int_0^x \left(\frac{1 - \cos u}{u} \right) du.$$

APPENDIX III

I_{zs} and Z_s , in (12) and (24), are expressed in terms of functions previously defined.

The functions $F_{1H}(z)$ and $G_{1H}(z)$, defined in footnote

where the following notations were used in the previous papers:

$$\left. \begin{aligned} F_{1H}(h) &= \alpha_1^I + j\alpha_2^{II} \\ P_1(h) &= C_1^I + jC_1^{II} \\ F_{1H}(0) \sin \beta h - G_{1H}(0) \cos \beta h + G_{1H}(h) &= \beta_1^I + j\beta_1^{II} \\ P_1(0) \sin \beta h - Q_1(0) \cos \beta h + Q_1(h) &= D_1^I + jD_1^{II} \end{aligned} \right\} \quad (64)$$

In case of antisymmetrically driven antennas, one changes Ψ_{ab} into Ψ'_{ab} and reverses all the signs of P and Q functions in (62) and (63).

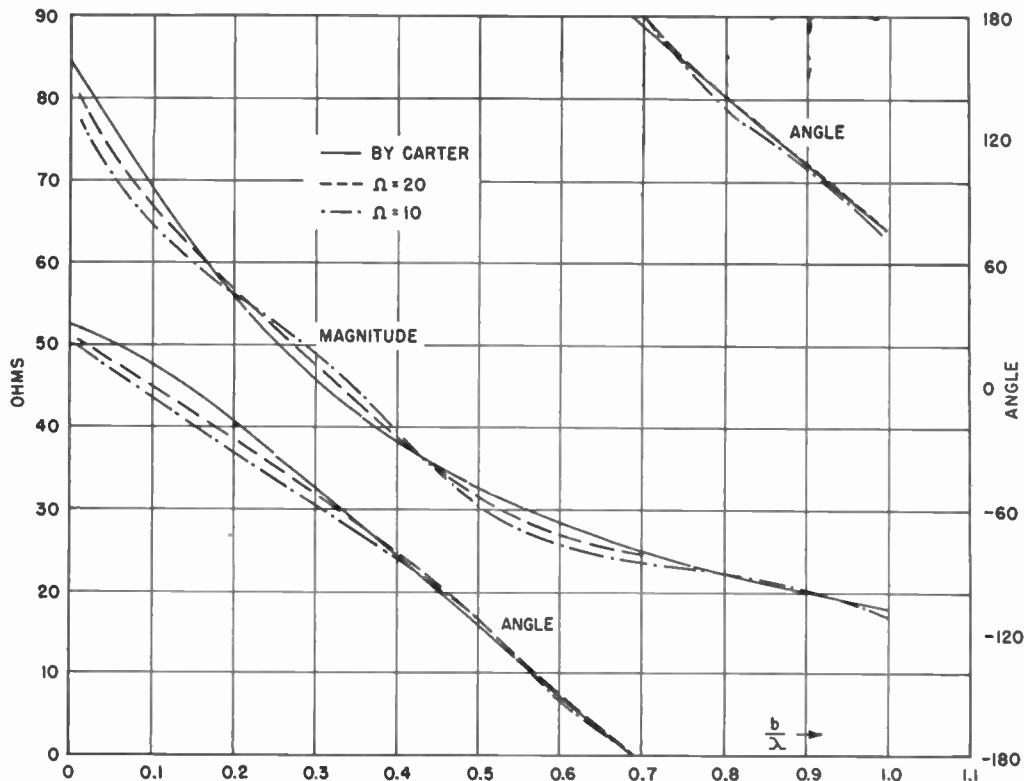

Fig. 19—Mutual impedance of two half-wave dipoles (comparison with Carter's computation).

Correspondence

Continuous Tropospheric Soundings by Radar*

The original tropospheric sounding experiments, which were conducted on medium frequencies (1.6 to 17.3 Mc.),¹⁻⁴ from 1935 to 1940 produced positive results, some of which were difficult to interpret in terms of simple theory. Additional tests were made on 2.398 Mc., during 1942, under more nearly idealized conditions.

During 1946 and 1947, experiments were conducted on 2800 Mc. (10.7-cm. wavelength). The scattering of microwaves by raindrops, snowflakes, and ice particles produced the well-known precipitate echoes. In addition, when a sufficient concentration of energy was employed, it was found possible to monitor continuously the boundaries between air masses of differing dielectric properties. A modified microwave early-warning (MEW) radar system of the AN/CPS-1 type was operated with a 2.0-microsecond pulse, 6×10^4 watts peak pulse power output and a vertically beamed transmitting and receiving antenna, which provided a power gain ($G_t = G_r$) of 15,300 times with respect to an isotropic radiator.

On many occasions the low-frequency waves produced detectable reflections from a complete boundary layer between air masses. The microwave system, in contrast, appeared to yield detectable reflections in most cases from smaller mixing region boundaries.

Theoretical treatments, which involve solutions of wave equations with variable coefficients and of specialized integral equations, indicate the orders of magnitude of detectable meteorological phenomena. Particular attention has been given to the frequencies 2.398, 110, and 2800 Mc.

The theory indicates that on 2.398 Mc. most of the observed low-level echoes are produced by normal and abnormal dielectric-gradient effects. Like the observed echo patterns, the mathematical analysis yields wave-interference patterns which have total time durations corresponding to a continuous range of echoes from the minimum observable range up to perhaps two to eight kilometers. Theory and experiment also indicate the detectability of echoes from discrete boundaries wherein the dielectric constant changes by a sufficient amount within a transition layer, which is usually less than one wavelength thick. In order to comply with the theory, the boundary layer

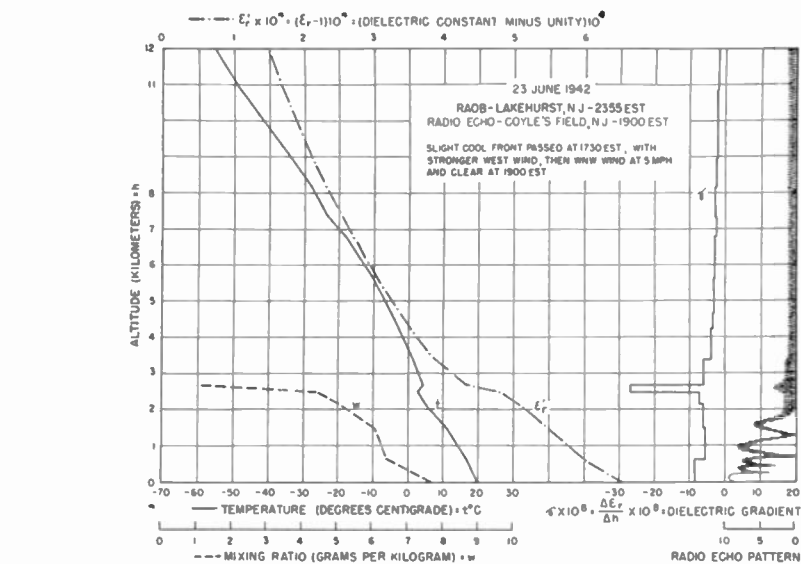

Fig. 1—RAOB and radio echo plots (June 23, 1942).

thicknesses must be less than those usually measured by the present radiosonde equipment, as reported via the coded teletype RAOB transmissions. The coarseness of the RAOB data and the present methods of measurement and recording should probably produce an effect of this nature.

Fig. 1 illustrates a comparison between RAOB and radio echo data on 2.398 Mc., on June 23, 1942. The Coyle's Field, N. J., location was chosen for its absolute freedom from medium-frequency "ground-clutter" effects, and for its proximity (14 miles) to the Lakehurst radiosonde site. The reflection pattern below 2.0 km. is an excellent example of the confused effect produced by the interference of the echo waves reflected from the almost continuous dielectric gradient (γ) produced by the steep lapse rate of the dielectric constant (ϵ'). The top of the lower layer of moist air is denoted by the peak of dielectric gradient (γ), computed from the RAOB data, and likewise by the radio echo, from about 2.5 km.

The work on continuous sounding with 2800 Mc. radar equipment began with explorations of the usefulness of the SCR-584 system. It was found that, by modification and careful adjustment, all echoes via the antenna side-lobe radiation could be suppressed, when the antenna was beamed within several degrees of the vertical direction.

A recording camera of the type used for ionosphere recording was fitted to the plan-position-indicator (PPI) system. A representative record of precipitate echoes is shown in Fig. 2. A variable gain-sweep attachment was used to operate the receiver at a high gain level for 15 seconds, and with exponentially decreasing gain for alternate 15-second intervals. This allowed the possibility of distinguishing between echoes of differing signal strength. The freezing isotherm was approximately traced by the top of the dark line at about 12,000 feet. A very faint echo from 25,000 to 30,000 feet was traced as it extended from the top of the shower clouds. These clouds were only faintly visible to the eye by the grazing-incidence reflection of the light of the setting sun. The moisture which remained in the air at a low altitude

after the rainfall had ceased was recorded as a dark band up to 8000 feet. Another faint dark band, between 8000 and 16,000 feet, appeared at about 1848 E.S.T. Clouds appeared within this altitude range about forty minutes later.

Upon certain occasions when the sky was completely clear, numerous momentary echoes were observed by means of the same SCR-584 radar system. The AN/CPS-1 (or MEW) system employed by the Air Forces Watson Laboratory, Cambridge Field Station, group at the Bedford, Mass., airfield was found to show very large numbers of spot or "dot" echoes apparently moving in streamline fashion (with the wind) upon the PPI indicator. These echoes seemed to appear in most instances on clear, warm days. As many as perhaps 200,000 of these echoes were sometimes noted within a 20-mile radius, according to Lawrence Mansur of Watson Laboratories.

It seemed evident that these echoes were the same as those observed at vertical incidence with the SCR-584. A special vertically beamed antenna was erected for use with the modified AN/CPS-1 system. No attempt was made to eliminate the side-lobe echoes (from fixed objects) during these exploratory tests. Initial results indicate that many quite interesting and useful records may be derived from this radar when it is used as a vertical-beam sounding system.

A record made on September 9, 1947, with unlimited visibility and ceiling, and no visible clouds, indicates a stratum of profuse dot echoes at about 4.755 km. (15,600 feet), above the trace produced by a side-lobe echo (from a near-by hill), as shown in Fig. 3. When the receiver gain was reduced, it was apparent that most of the medium-strength echoes were from a relatively limited range of altitude. Most of the echoes of greater strength appeared to be from either slightly higher or slightly lower levels. There were also broken traces at 4.00 km. (13,120 feet), 3.27 km. (10,730 feet), and 1.10 km. (3,609 feet). More diffuse and continuous traces were recorded during the maximum-gain period at levels of 6.08 km. (19,950 feet), 9.09 km. (29,820 feet), and 9.40 km. (30,840 feet).

* Received by the Institute, November 14, 1947. An abbreviated version, "Meteorological soundings by radar," was presented, joint meeting of the American Geophysical Union and the American Meteorological Society, Cambridge, Mass., September 19, 1947. The research reported in this document was made possible, in large part, through support extended Cruft Laboratory, Harvard University, jointly by the Navy Department, Office of Naval Research, and the Signal Corps, U. S. Army, under ONR Contract N50ri-76.T.O.1.

¹ R. C. Colwell and A. W. Friend, "The D-region of the ionosphere," *Nature*, vol. 137, p. 782; May 9, 1936.

² A. W. Friend and R. C. Colwell, "The heights of the reflecting regions in the troposphere," *Proc. I.R.E.*, vol. 27, pp. 626-634; October, 1939.

³ A. W. Friend, "Developments in meteorological sounding by radio wave echoes," *Jour. Aeron. Sci.*, vol. 7, pp. 347-352; June, 1940.

⁴ A. W. Friend, "Further comparisons of meteorological sounding by radio waves with radiosonde data," *Bull. Amer. Met. Soc.*, vol. 22, pp. 59-61; February, 1941.

Comparison with the radiosonde data of Fig. 4 indicates that the main line of recorded dot echoes corresponded with the top of a moist stratum of air. It may be possible that the strongest dot echoes represent major excursions of air across the boundary interface to higher or lower levels. The main line of dots may be produced by reflections from portions of the more usual mixing surface between the two masses of air. The lower-level reflections are apparently from lower-level mixing regions or from very thin strata of dust or moisture particles, or mixtures thereof. The three higher, continuous and slightly more diffuse, reflection regions at 6.08, 9.08, and 9.40 km. (19,950, 29,820, and 30,840 feet) appear to be from other thin strata of scattering particles.

An earlier recording made on August 20, 1947, is shown in Fig. 5. Dot echoes from an air-mass boundary are shown in contrast with scattering echoes from stratus, altostratus, and cirrus clouds.

Other records have indicated thunderhead echoes from as high as 14.4 km. (47,250 feet). High, thin broken clouds at 7 to 10 km. (22,970 to 32,810 feet) may produce quite dense traces upon the record. Clouds which are invisible, except for causing a slightly hazy sky, may produce weak, solid, detectable echo traces. As many as six separate layers of apparent alto-stratus have been recorded on a clear day when no distinct clouds were visible to the eye. The sky seemed to be slightly hazy.

It appears that thin, hazy, solid traces denote strata of scattering particles of dust or precipitate and that the dot echoes are produced by correctly oriented surfaces of dielectric transition, which may occur at random within air-mass-boundary transition layers. These two types of echoes are very easily distinguished.

When precipitate falls through the freezing-isotherm surface, the water produced upon the melting surfaces of the large frozen particles appears to produce a stronger reflection which causes a stronger trace to be indicated just below that surface. Precipitate, of particle sizes which approximate those which normally fall toward the ground, usually produces echoes which are very much stronger than those from thin clouds at high levels. A gain-sweep attachment has been used to produce a record which contains plots of echo amplitude versus height.

It is believed that the so-called dot echoes add new and important information to that already available from ordinary radar systems. A very high concentration of energy in a vertical beam allows many important tropospheric strata to be recorded as functions of time. The vertical beam improves the contrast, and the photographic recording process may decrease the minimum detectable signal level by more than 10 decibels. Theory indicates that the modified AN/CPS-1 radar may be used with an A-type indicator to detect a normally oriented dielectric transition boundary layer of 1-inch thickness at 9.8-km. range, when the temperature changes by 0.3°C., and the water vapor mixing ratio changes by 0.2 grams per kilogram, at 500 millibars total pressure. If the layer intercepts a fraction of the entire beam of radiation ($0.8^\circ \times 3.0^\circ$ for the AN/CPS-1), the range becomes less. Photographic recording from an intensity-modulated cathode-ray indicator, which

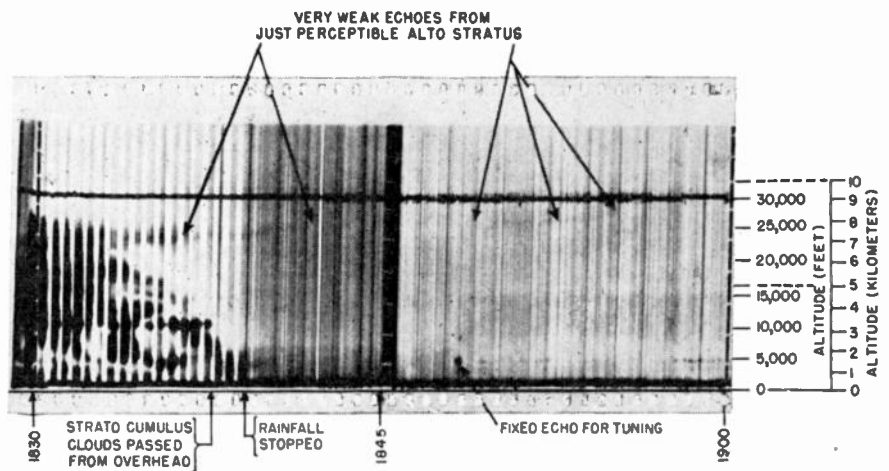

Fig. 2—Light frontal shower with large raindrops, vertical beam radar sounding on $\lambda = 10$ cm. with variable gain sweep, modified SCR-584 radar. East Lexington, Mass. July 31, 1947, Eastern Standard Time.

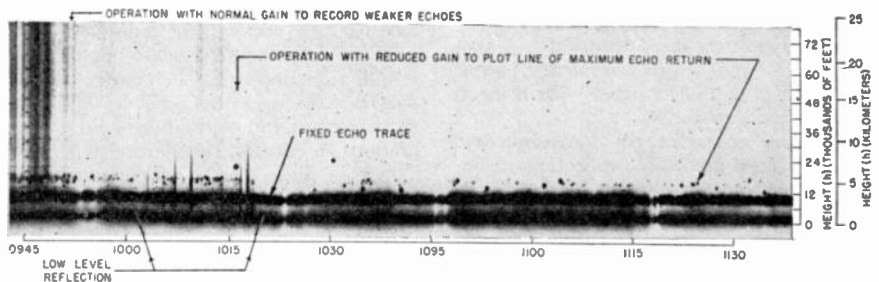

Fig. 3—Vertical beam radar sounding on 2800 Mc. on a perfectly clear day, modified AN/CPS-1 radar, Bedford Airfield, Mass., September 9, 1947, Eastern Standard Time. Weather, cloudless, visibility and ceiling unlimited; surface wind, S.E. 5 m.p.h.

may have a long-time-constant screen, may increase the detectability by at least one order of magnitude.

It is possible that tracking of dot echo patterns or the timing of their movement and observation of their directions of movement may lead to new data concerning winds aloft. The recording procedures yield an immediately available method for the continuous plotting of air-mass boundaries and the heights and magnitudes of various strata and clouds aloft, during all types of weather conditions. It is believed that these data should prove to be of considerable value to aerologists, meteorologist, and aircraft pilots. A more detailed account of these theories and experiments is now being prepared for publication.

These results stem from original experiments begun at West Virginia University in 1935 and continued at Harvard University intermittently since 1939.

The experiments of 1942 were arranged with J. A. Stratton under a Radiation Laboratory contract at the Massachusetts Institute of Technology in co-operation with Harvard University. The more recent work with microwaves has been done under a contract by the Office of Naval Research with Harvard University and with the co-operation of the

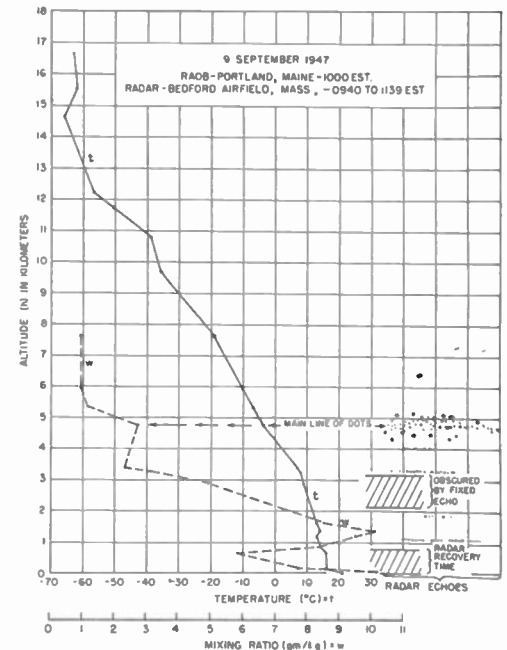

Fig. 4—RAOB and 2800-Mc. radar echo plots

Cambridge Field Station of the Watson Laboratory of the Air Force. The author was also aided by support provided by the Radio Corporation of America. Attention is called to the independent experiments conducted on 9000 Mc. at very

short vertical ranges by H. T. Friis and other staff members of the Bell Telephone Laboratories, as reported in an earlier issue of THE PROCEEDINGS OF THE I.R.E.⁵

It is regretted that these results could not have been provided during the recent war emergency. Numerous efforts were made to continue the work, but the general idea that these results were theoretically impossi-

⁵ H. T. Friis, "Radar reflections from the tower atmosphere," Proc. I.R.E., vol. 35, pp. 494-495; May, 1947.

ble of attainment was predominant at that time. It is sincerely hoped that it may be possible to apply these developments in the public interest in the very near future.

It was most gratifying to learn⁶ after this letter had been prepared, that personnel of the Evans Signal Laboratories, Belmar, N. J., have been observing the same type of echo on frequencies nearly the same as those

⁶ William B. Gould, "Radar reflections from the lower atmosphere," Proc. I.R.E., vol. 35, p. 1105; October, 1947.

used by the Bell Telephone Laboratories, because a considerable effort has been expended since 1941 in attempting to interest the Signal Corps in performing vertical-beam tropospheric-sounding experiments. It is hoped that, with the return to peacetime conditions and the expansion of research in the services, this work may be extended to the applicational phase.

ALBERT W. FRIEND
Radio Corporation of America
RCA Laboratories Division
Princeton, N. J.

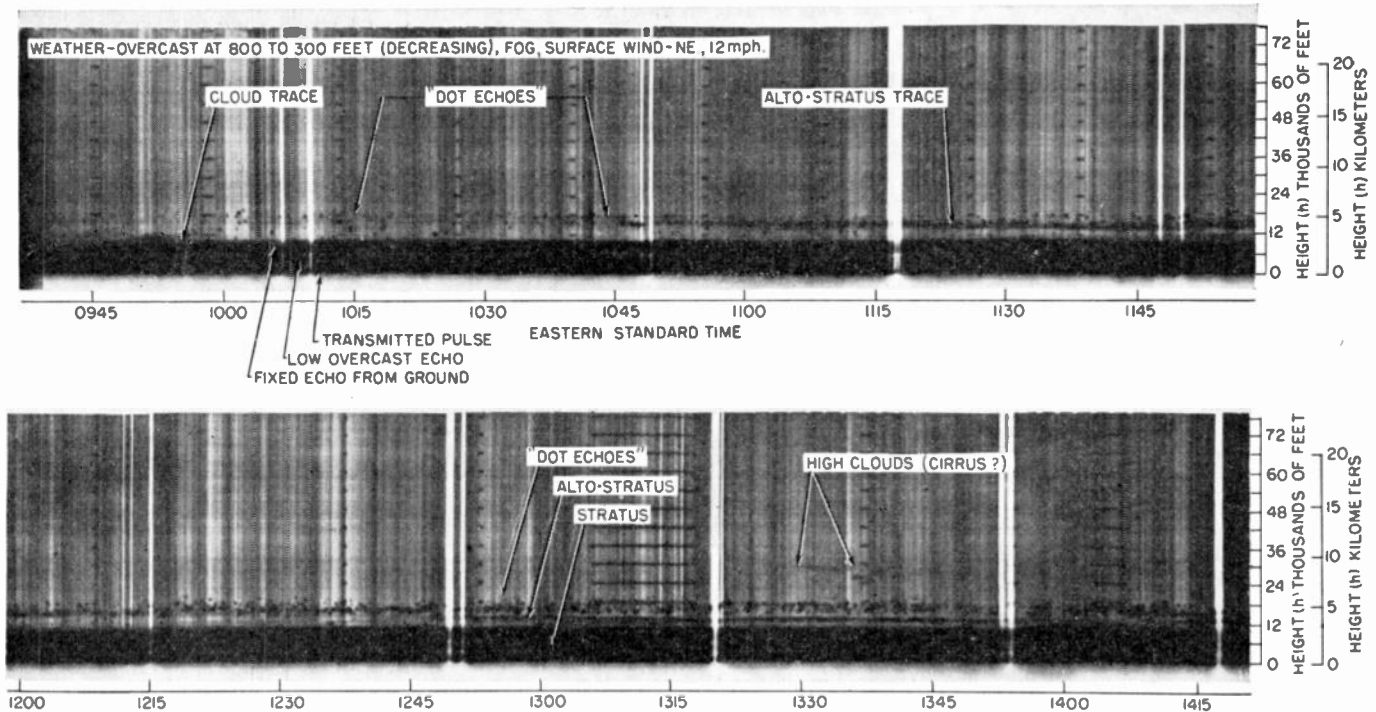

Fig. 5—Vertical beam recording with modified AN/CPS-1 (MEW) radar (2800 Mc.) showing many "dot echoes," and traces from alto-stratus and cirrus, Bedford Airfield, Mass., August 20, 1947, Eastern Standard Time.

Contributors to Proceedings of the I.R.E.



E. H. B. BARTELINK

E. H. B. Bartelink (A'29-M'37-SM'43) was born at Zutphen, Netherlands, on June 13, 1904. He received the M.S. degree in communications at Delft in 1928, and the Ph.D. degree in physics at Munich in 1936. He joined the Netherlands telephone system in 1929, where he organized the wire trans-

mission laboratory, and was active in the development of equipment for high-speed d.c. and carrier telegraph transmission, and several telephone developments. Later he was in charge of the technical equipment in the Amsterdam toll office.

In 1937 Dr. Bartelink joined the General Electric Company, where he was engaged in television, sonar, and radar developments. From 1943 until 1946 he was a staff member at the M.I.T. Radiation Laboratory, where he worked on analysis of radar bombing systems, and later on fire-control systems.

Since 1946, Dr. Bartelink has been associated with the General Telephone System, where he is in charge of the radio department and active in the application of radio techniques to the telephone field.



For a photograph and biography of DONALD D. GRIEG, see the November, 1947, issue of the PROCEEDINGS OF THE I.R.E.



A. E. Covington was born in Regina, Canada, in 1913. He received the B.A. degree in physics and mathematics in 1938



A. E. COVINGTON

and the M.A. degree in 1940 from the University of British Columbia. Postgraduate studies were taken at the University of California at Berkeley from 1940 to 1942. Since then he has been with the National Research Council of Canada at Ottawa. He is a member of the American Physical Society.

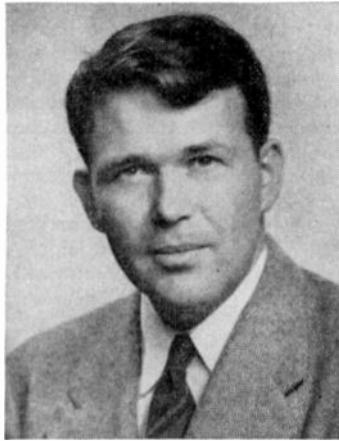

WILLIAM R. HEWLETT

William R. Hewlett (S'35-A'38-SM'47-F'48) was born in 1913 at Ann Arbor, Mich. He received the A.B. degree from Stanford University in 1934 and the M.S. degree from the Massachusetts Institute of Technology in 1936. In 1939 he received the E.E. degree from Stanford. He was engaged in electromedical research in Palo Alto, Calif., from 1936 to 1938. In 1939, he, together with David Packard, started the Hewlett-Packard Company in Palo Alto. He is a member of Sigma Xi and the A.I.E.E.



For a photograph and biography of SIDNEY MOSKOWITZ, see the November, 1947, issue of the PROCEEDINGS OF THE I.R.E.



Bernard M. Oliver (S'40-A'40-M'46) was born on May 27, 1916, at Santa Cruz Calif. He received the B.A. degree in electrical engineering from Stanford University in 1935, and the M.S. degree from the California Institute of Technology in 1936. Following a year of study in Germany in 1936-37 under an exchange scholarship, he returned to the California Institute of Technology and in 1940 received the Ph.D. degree. Since that time he has been employed as a research engineer with the Bell Telephone Laboratories. During the war he was active in the development of Army and Navy automatic tracking radar equipment.



BERNARD M. OLIVER

For a photograph and biography of J. KAHNKE, see the October, 1947, issue of the PROCEEDINGS OF THE I.R.E.



For a photograph and biography of R. L. WATERS, see the October, 1947, issue of the PROCEEDINGS OF THE I.R.E.



For biography and photograph of H. A. WHEELER, see the December, 1947, issue of the PROCEEDINGS OF THE I.R.E.



S. L. SEATON

S. L. Seaton (A'41-M'43-SM'43) was born in 1906 at Kirkwood, Mo. He attended the University of Maryland, the George Washington University, and received the B.S. degree from the University of Alaska in 1942. In 1929 until 1946 he was associated with the Carnegie Institution of Washington as a staff member, serving on the research yacht *Carnegie* in 1929; at the Huancayo, Peru, Observatory from 1930 to 1932; at the Watheroo, Western Australia, Observatory from 1934 until 1938; and at the College Alaska, Observatory from 1941 until 1946.

In 1946 Mr. Seaton joined the Staff of Watson Laboratories, United States Air Force, and became scientific advisor to the Chief of the Atmospheric Laboratory. During the war he participated in arctic propagation studies for the Office of Scientific Research and Development, and served as consultant to the Office of Strategic Services in the Aleutian Area. He is the author of some sixty monographs and two books. Mr. Seaton has recently been appointed Director of the Geophysical Observatory, at the University of Alaska.

Mr. Seaton is a member of the American Physical Society, the American Association for the Advancement of Science, the American Geophysical Union, and is an associate of the Institute of Physics (London). He is the recipient of Letters of Appreciation from the Office of Scientific Research and Development, of the Naval Ordnance Development Award, and of the Award for Exceptional Service to Naval Ordnance Development.



C. T. TAI

C. T. Tai (S'44) was born on December 30, 1915, at Soochow, China. He received the B.Sc. degree in physics from Tsing Hua University, Peiping, China, in 1937, and the D.Sc. degree in communication engineering from Harvard University in 1947. He was an instructor in communication engineering at Tsing Hua University from 1938 to 1943. During 1945, he was research associate at Cruft Laboratory, and then a teaching fellow in the Department of Engineering Sciences and Applied Physics, Harvard University. At present he is engaged in work on antennas as a research associate at Harvard University. Dr. Tai is a member of Sigma Xi.



W. J. Warren (SM'46) was born in 1910 at Eureka, Calif. He received the B.S. degree in electrical engineering in 1931 from Santa Clara University, and the Ph.D. degree in 1936 from the University of Illinois, where he taught from 1934 to 1937 and from 1938 to 1941. He was employed from 1937 to 1938 by the General Electric Company at Schenectady as a test engineer.

From 1941 to 1944 Mr. Warren taught engineering at Santa Clara University, and from 1944 to date he has been employed as an engineer at the Hewlett-Packard Company in Palo Alto, Calif. He is a member of Sigma Xi, Tau Beta Pi, Eta Kappa Nu, Phi Kappa Phi, and the A.I.E.E.



W. J. WARREN

Institute News and Radio Notes

Board of Directors

January 7, 1948

Distribution of Standards. S. L. Bailey moved that all Standards published henceforth by the I.R.E. be distributed without charge to all members of Member Grade, or higher, as of the date of issuance of the particular Standard. (Unanimously approved.)

Institute Policies. President Shackelford discussed the following items: The Planning Committee, under the chairmanship of R. A. Heising, has recently been at work developing the idea of Professional Groups in the Institute. These are similar to what is known in some societies as "Divisions." These Groups will enable the Institute to have semi-autonomous groups, each having its own meeting in order to get to know each other better. The Rochester Fall Meeting, the Broadcast Conference at Ohio State, the Electron Tube Conference, and the Television Conference illustrate some of these Groups. There is no intention on the part of the Board that these plans be formulated, but the plans in general are approved, so that there will be a place for Groups to form and accomplish their aims, as a part of the Institute. Accordingly, the Board at a recent meeting set up a Committee called the "Committee on Professional Groups," under the chairmanship of W. L. Everitt, to study this situation and bring in recommendations to the Board.

Another activity in which there is much interest is the rejuvenation of the Public Relations Committee, to cover not only publicity, but public relations, so that the Institute will become better known throughout the industry and throughout the country. During the campaign on the I.R.E. Building Fund, it was found there were high executives and officials of companies which had members of the Institute on their staff, who were not familiar with the Institute. This matter has been brought to the Board's attention from time to time, and it is expected that effective work in public relations will be accomplished under the chairmanship of Virgil M. Graham.

Bylaw Sections 6 and 7. Dr. Terman moved that the Board revise Bylaw Sections 6 and 7 to read as follows:

SEC. 6—The expression, "School of recognized standing," includes only accredited schools of college grade, as listed in the Educational Directory, Colleges and Universities, Federal Security Agency, Office of Education, providing an engineering or scientific curriculum of not less than four years and granting degrees, and such other schools as may be so designated by the Board of Directors.

SEC. 7—Graduation from a radio or allied curriculum in an accredited professional school shall be accepted as equivalent to two years' experience in radio or allied fields.

Graduation from a radio, arts and sciences, or equivalent curriculum in an accredited nonprofessional school shall be ac-

cepted as equivalent to two years' experience in radio or allied fields.

Graduation from an unaccredited radio or allied curriculum in a professional accredited school may be accepted as equivalent to one year's experience in radio or allied fields.

Full-time graduate work, or part-time graduate work with teaching, in a radio or allied course in a school of recognized standing may be accepted as equivalent to professional experience. (Unanimously approved.)

Executive Committee

January 6, 1948

Bylaw Section 80. Dr. Goldsmith moved that the Constitution and Laws Committee be instructed to prepare a Bylaw amending Bylaw Section 80 to include the new Technical Committee on "Electronic Computers." (Unanimously approved.)

Chairman, Technical Committee on Electronic Computers. Dr. Goldsmith moved that the Executive Committee approve the appointment of J. R. Weiner as Chairman of the Technical Committee on Electronic Computers. (Unanimously approved.)

Chairman, Section Committee. Mr. S. L. Bailey reported that Alois W. Graf had accepted the appointment as Chairman of the Section Committee, but no recommendations for the Committee personnel had as yet been received.

February 3, 1948

Admissions Committee Appointment. Dr. Sinclair moved that the appointment of C. E. Dean as a member of the Admissions Committee be approved. (Unanimously approved.)

Citation for George T. Royden and Members of the Admissions Committee. It is suggested by the Executive Committee to the Membership Relations Co-ordinator that a citation be prepared expressive of the appreciation of the Institute for the work done by George T. Royden, as Chairman, and his fellow members on the Admissions Committee, the citation to be given at the annual meeting of the Institute on March 22, 1948.

Student Branches. Mr. Graham moved that the petition for the formation of Student Branches at the following schools be approved:

Michigan State College (I.R.E.-AIEE Branch)

University of South Carolina (I.R.E.-AIEE Branch)

Manhattan College (I.R.E. Branch)

Alabama Polytechnic Institute (I.R.E. Branch)

(Unanimously approved.)

N.E.C. Representative. Mr. Graham moved that W. C. White be appointed the I.R.E. representative on the Board of Directors of the National Electronic Conference. (Unanimously approved.)

EXPANDED I.R.E. AUDIO GROUP

Because of the increasing emphasis on the quality of acoustics, audio, and video equipment and techniques in a maturing radio industry, there has developed a need for interchange of information among engineers specifically concerned with these matters. This need is not satisfied in all respects by existing media and organizations. Since one of the proposed Professional Groups of the I.R.E. could be of considerable assistance in meeting this need, and since this particular segment of the radio engineering profession is actively interested in an immediate solution to its problems, the Board of Directors has changed the name of the Audio Group in the Committee on Professional Groups to the Audio, Video, and Acoustic Group, and has expanded the membership of the Committee on Professional Groups to include representatives interested in all phases, as follows: H. A. Chinn, O. L. Angevine, Jr., A. A. Pulley, J. L. Hathaway, and J. E. Keister.

NEW A.S.A. COMMITTEE

On February 4, 1948, W. R. G. Baker of the General Electric Company, who is representing the Radio Manufacturers Association, was elected vice-chairman of the Electrical Standards Committee of the American Standards Association. The object of this committee is to give the electronics and radio industry greater representation in the national standardization work. L. G. Cumming, Technical Secretary of The Institute of Radio Engineers, was elected a member of the Executive Committee of the Electrical Standards Committee of the American Standards Association.

Calendar of COMING EVENTS

Chicago I.R.E. Conference
April 17, 1948

Cincinnati Spring Meeting
April 24, 1948

Syracuse I.R.E.-RMA Spring Meeting
April 26-28, 1948

Canadian I.R.E. Convention
April 30 and May 1, 1948

I.R.E.-URSI Meeting
May 3-5, 1948

New England Radio Engineering Meeting
May 22, 1948

I.R.E. Electron-Tube Conference
June 28 and 29

1948 I.R.E. West Coast Convention
September 30-October 2, 1948

Canadian I.R.E. Convention

Toronto, April 30-May 1

The Canadian I.R.E. convention and exhibition to be held in Toronto on April 30 and May 1, 1948, is expected to draw radio engineers and technicians from all parts of Canada as well as from the United States.

"Know the Canadian Radio Industry" is the official slogan of the convention, which is being planned to enable members of The Institute of Radio Engineers and guests to learn of the new developments in the radio art, with particular reference to the Canadian industry.

The convention will be staged in the Roof Garden of the Royal York Hotel, and will include technical sessions and a comprehensive exhibition of component parts, test apparatus, and allied products. There will also be a luncheon on each day of the convention and a dinner on Friday night at which B. E. Shackelford, noted engineer and president of the I.R.E., will be the guest speaker.

The Convention is a national event with all Canadian Sections of the Institute participating. Arrangements for the convention are in the hands of the Convention Committee, as follows: Gordon J. Irwin, Convention Chairman; Harry S. Dawson, Vice-Chairman; L. Claude Simmonds, Secretary; Frank H. R. Pounsett, Treasurer; J. R. Longstaffe, Hotel Liaison; Walter G. Ward, Speakers & Papers; W. Choat, Exhibits & Exhibitors; R. C. Poulter, Publicity & Advertising; E. O. Swan, Registration; H. Goldin, Sight & Sound; R. R. Desaulniers, representing the Montreal Section; F. R. Park, representing the Ottawa Section; B. Graham, representing the London Section; C. E. Trembley, representing the Winnipeg Sub-Section; and F. A. O. Banks, representing the Hamilton Sub-Section.

It is expected that twelve papers will be presented during the technical sessions, which will be held each morning and afternoon. The papers will cover a wide range of subjects of interest to all radio engineers attending the meetings.

An important feature of the convention will be the exhibition of component parts, test equipment, and allied products, much of which will represent postwar developments. There will be twenty-nine exhibits. This will be the first time that manufacturers and representatives will have an opportunity to display their products to members of the Institute in Canada, and it is expected that there will be tremendous interest in this portion of the proceedings.

DALLAS-FORT WORTH SECTION CORRECTION

The names of the Chairman and Vice-Chairman of the Dallas-Fort Worth Section, who appeared in the December, 1947, issue as a frontispiece for the Waves and Electronics section, should have been: Robert A. Broding, Chairman, and J. G. Rountree, Vice-Chairman.

ATTENTION, AUTHORS

There has been a diminution of the backlog of unpublished papers for the PROCEEDINGS OF THE I.R.E. Accordingly, if three copies of the manuscript of a paper are received from the author for the concurrent use of the first group of editorial readers, and if the paper is found fully acceptable and ready for publication, without revision, by the readers and the Editorial Department, it will be generally possible to publish the paper within five to six months after its date of receipt. (Receipt of a lesser number of copies of the paper, or the necessity for any revision of the manuscript prior to publication, will of necessity lengthen the foregoing period.)

The Editor

CHANGES IN STANDARD FREQUENCY BROADCASTS

Effective January 30, 1948, the technical broadcast services from radio station WWV of the National Bureau of Standards were somewhat modified and improved, according to an announcement by E. U. Condon, director of the Bureau.

Each of the eight radio carrier frequencies 2.5, 5, 10, 15, 20, 25, 30, and 35 Mc. are being broadcast continuously day and night. Standard audio frequencies of 440 and 4000 cycles per second are transmitted on the 10, 15, 20, and 25 Mc. carriers. The 440-cycle frequency, which is the standard of musical pitch (A above middle C), is also being broadcast on 2.5 and 5 Mc. The accuracy of each of the transmitted radio and audio frequencies is better than 1 part in 50 million.

The attention of all users of the National Bureau of Standards time announcements is particularly called to the following change: Time announcements in International Morse Code, accurately synchronized with basic U. S. Naval Observatory time, are now advanced 1 minute with respect to the old announcement scheme. With the new system the audio frequencies are interrupted at precisely 1 minute *before* each hour and at each succeeding five-minute period. They are resumed precisely on the hour and each five minutes thereafter.

Under the old system, the time signals were interrupted for a minute on the hour and on each succeeding five minutes, while under the new scheme interruption occurs for a minute precisely on the 59th minute, on 4 minutes past the hour, 9 minutes past the hour, etc., and resumed precisely on the hour and each five minutes thereafter. The exact moment to which the time refers is the moment of interruption of the audio frequencies of 440 and 4000 cycles per second. The audio frequencies still continue to be interrupted for one minute to allow for the time announcement, for station identification by voice at the hour and half hour, and to afford an interval for checking radio-frequency measurements free from the presence of audio transmissions.

I.R.E.-RMA SPRING MEETING

The Board of Directors of The Institute of Radio Engineers at its December 10, 1947, meeting approved participation in the I.R.E.-RMA Spring Meeting on transmitters to be held at the Syracuse Hotel, Syracuse, N. Y., on April 26, 27, and 28.

The Spring Meeting Committee consists of the following: V. M. Graham, Sylvania Electric Products Inc., member of the Board of Directors of I.R.E. and associate director of engineering of RMA, Chairman of the I.R.E.-RMA Spring Meeting Committee; E. A. LaPort, RCA International Division, acting as I.R.E. Representative; J. J. Farrell, General Electric Company, who will handle arrangements for the technical program, and Mrs. M. E. Kinzie, General Electric Company, who will be Chairman of the Ladies' Program. L. C. F. Horle, chief engineer of RMA, and L. G. Cumming, Technical Secretary of I.R.E., will arrange technical committee sessions for both groups during the gathering.

Tentative program arrangements include technical sessions for each morning of the three days. On Monday and Wednesday afternoons, April 26 and 28, I.R.E. and RMA committee meetings will be held. For Tuesday afternoon, April 27, an inspection trip to Electronics Park is planned. A buffet supper is planned for Monday evening, and the Spring Meeting Dinner will be held on Tuesday evening.

F.m. transmitters and antenna developments, new radio communications equipment, the New York-Boston microwave relay system, and radar aids to airline navigation are among the subjects to be discussed during the three-day conference.

CHICAGO CONFERENCE

The annual Chicago I.R.E. Conference will be held on April 17 at the Illinois Institute of Technology in its new buildings. It is to be an all-day affair featuring exhibits of new commercial products, together with up-to-date technical papers which should be of interest to all radio and electronic engineers within a 500-mile radius of Chicago.

In a recent survey in this area, practical engineers have voiced the opinion that technical advertising and sales promotion are of as much value to the prospective user as to the seller. Using this as a guide, approximately fifty per cent of the conference program will be devoted to short presentations extemporizing the manufacturer's product. The remainder of the time will be spent on the more formal technical papers relating to quality control, management-research engineering, and magnetic recording.

The regular registration fee for the conference is \$1.50. Tickets are available from Lloyd Hershey of the Hallicrafters Company, 4401 West 5th, Chicago, Ill.

URSI, AMERICAN SECTION

The next General Assembly of the URSI will be held in Stockholm, Sweden, during the latter half of July, 1948, according to an announcement made by J. H. Dellinger, chairman of the American Section of URSI.

Industrial Engineering Notes¹

GERMAN ELECTRONIC DEVELOPMENTS

An acoustic strain gage, timber and wheat moisture indicators, and other electronic measuring equipment are described in a report on German industrial measuring equipment released in January by the Office of Technical Services. The report also describes other electronic measuring devices, including a cable-fault locator, a field-strength measuring set for a.m. and f.m. which gives readings directly in microvolts, and an inductance meter, harmonic analyzer, and sweep oscillator and indicator. Mimeographed copies of the report (PB-32572), priced at 75 cents, may be obtained from the Office of Technical Services, Department of Commerce, Washington 25, D.C. Check or money order should be made payable to the Treasurer of the United States.

GERMAN AMPLIFIER DEVICE

A d.c.-amplifier control device which is said to operate reliably under severe mechanical conditions is described in detail in a report on German developments. It is stated that the apparatus has an over-all sensitivity of some 10 to 17 watts and can deliver a substantially larger amount of power to various control devices than a suspended-coil galvanometer. Mimeographed copies of the report may be obtained from the Office of Technical Services, Department of Commerce, Washington 25, D.C. Price, \$2.25.

NEW OTS LIST

A classified list of 1800 reports on German, Japanese, and American wartime technology, available in printed form, is now available. Seventy-three of these reports concern electrical equipment. Copies of the listing (PB-81500) may be obtained from the Office of Technical Services, Department of Commerce, Washington 25, D. C., at 75 cents each.

LIST OF FEDERAL PATENTS AVAILABLE

Copies of a pamphlet listing 811 U.S. Government-owned patents, most of which are available for use by American firms and individuals on a royalty-free nonexclusive licensing basis, may be had without charge from the Commissioner of Patents, Department of Commerce, Washington 25, D.C.

PROXIMITY-INDICATOR LICENSES

Early in January the F.C.C. announced that it will issue temporary licenses for terrain proximity indicators to be used in the 420-460-Mc. band until such time as suitable equipment is available for operation in the 4200-4400-Mc. band. The F.C.C. said that "Authorizations for terrain proximity indicators are a temporary expedient to enable air carriers to use existing war surplus equipment, which operates in this band, during the period when manufacturers and

users are developing and procuring equipment designed to operate in the band permanently allocated for this purpose, at which time, but not later than February 15, 1950, the aeronautical service will vacate the 420-460-megacycle band."

ACTING F.C.C. CHIEF ENGINEER

Early in the year John A. Willoughby was designated acting chief engineer to fill the vacancy caused by the advancement of George E. Sterling to a commission membership.

RADIO AUTHORIZATIONS AND OPERATORS

According to an F.C.C. release early in January, 608,340 radio stations, radio operator licenses, and other radio authorizations were outstanding at the start of 1948. Here is a breakdown of the principal radio categories as of December 31, 1947:

Broadcast Stations:	
A.M.	1962
F.M.	1010
Television	73
Educational	40
International	37
Television, (experimental)	91
Remote Pickup	590
Other	31
Total	3834
Nonbroadcast Stations:	
Aeronautical	20,818
Marine	14,254
Public Safety	4653
Land Transportation	2447
Industrial	2028
Miscellaneous	1307
Amateur (estimated)	75,000
Total	120,507
Radio Operators:	
Commercial (estimated)	341,000
Amateur	81,000
Special Aircraft Authorizations	61,999
Total	483,999

This is an increase of some 8600 stations and 54,000 operators since June 30, 1947. Slightly more than 60 per cent of the non-broadcast stations were amateur.

REVISED RULES ON LOW-POWER DEVICES

The F.C.C.'s revision of rules on low-power devices runs the gamut from phonoscissors to "wired-wireless" or carrier-current equipment used for broadcast purposes. The F.C.C. said that the extensive changes which will probably be required in order to prevent interference to authorized radio services may have the result of altering very substantially the conditions under which "low-power" equipment may continue to be operated.

F.C.C. ENDS TEMPORARY AUTHORIZATIONS

Effective April 15, 1948, the F.C.C. will change its rules so as to abolish special temporary authorizations for standard broadcast stations. The F.C.C. said that "the growing number of authorizations for operation in off hours is having a detrimental effect on regular night time broadcast service in many areas." It was pointed out that some requests for special authority "are so recurring as to constitute a series of broadcasts beyond the hours for which the stations are licensed." The F.C.C. added

that it saw no further need for such special temporary authority "in view of the opportunities for full-time frequency modulation operation, especially since many of the a.m. stations concerned have frequency modulation authorizations. Diligent efforts towards the early establishment of frequency modulation service will more than adequately satisfy public needs in this respect."

AMATEUR RULE CHANGE

At the beginning of February the Federal Communications Commission adopted a rule prohibiting the transmission of messages in codes or ciphers in domestic and international communications to or between amateur stations. This is the first application of this prohibition to domestic transmissions.

ELECTRONIC EQUIPMENT ON FEDERAL BUDGET

Provisions for the purchase of radio and electronic equipment and supplies were included in the Federal Government budget request for the 1949 fiscal year, which begins July 1, 1948. This was presented to Congress by the President on January 12. The Signal Corps included a request for approximately \$38 million for equipment and supplies, as against \$20 million allocated for this purpose in the current fiscal year. The Bureau of Ships, United States Navy, requested approximately \$47 million for electronics "maintenance and procurement." In 1946 it received \$64 million for this purpose. The Civil Aeronautics Administration requested \$155,570,000, of which \$23,009,000 would be expended for establishment of air navigation facilities. The latter figure compares with over \$36 million and a grant of \$11,149,066 in the current fiscal year. The CAA also asked \$2,000,000 for technical development, compared with a current appropriation of \$1,600,000.

The President's budget also included a request for \$1,000,000 for a building for the Radio Propagation Section of the Bureau of Standards.

ARRL ON TELEVISION INTERFERENCE

The American Radio Relay League issued a lengthy press statement toward the end of January in defense of amateur radio operators, or "hams." Amateurs are not fundamentally at fault for the interference of which owners of television receivers have been complaining, the ARRL said. Three points were brought out:

First, inadequate design and construction of the television receivers is responsible in 50 per cent of the cases. Second, although in the remaining cases the amateurs are often at fault, there are a number of other sources much more prevalent. Third, the interference in both cases could be materially reduced by a comparatively simple rearrangement of frequencies by the F.C.C.

The "ham" operators association said that there can be no satisfactory television reception in metropolitan areas until the F.C.C. revises its frequency assignments and manufacturers adequately design and construct their television sets. "The public must demand of television receiver manufacturers

¹ The data on which these NOTES are based were selected, by permission, from "Industry Reports," issues of January 9, 16, 23, and 30, and February 6, 1948, published by the Radio Manufacturers' Association, whose helpful attitude in this matter is here gladly acknowledged.

a product which is adequately designed and constructed so that it may hold its own in the complex technical structure of modern radio communication. Today, the manufacturer's trend is precisely in the opposite direction," the league stated.

NEW FREQUENCIES ALLOCATED

Effective March 16, 1948, the F.C.C.'s rules and regulations allocating frequency bands to the industrial, scientific, and medical services were amended in accordance with the recent Atlantic City Conference. Mimeographed public notices Nos. 8659 and 16868 are available. The following is excerpted from the Federal Communications Commission press statement announcing the change:

"Although the Commission did not adopt that portion of the proposed rules specifically mentioning the frequencies heretofore allocated by the Commission for industrial, scientific, and medical services, use of such frequencies may be continued until June 30, 1952, provided that no interference is caused to authorized radio services. However, the attention of manufacturers and users is invited to the fact that where propagation characteristics of these frequencies are such that interference resulting from use of equipment operating on these frequencies is likely to occur to authorized services, including those located outside the borders of the United States. In the event interference is caused to radio services operating on frequencies assigned in accordance with the Atlantic City Radio Regulations, the Commission's Regulations require the elimination of such interference. In some cases such elimination of interference may require adjustment of the equipment.

"All diathermy equipment for which certificates of type approval have been issued should be capable of satisfactory operation in the new frequency bands with but little or no modification, other than the installation of crystals or an adjustment of frequencies in the case of the self-excited oscillators. It is strongly urged that manufacturers who have sold type-approved equipment make every effort to assist purchasers in converting such equipment for operation on such new frequencies at the earliest possible date, and in that manner preclude the possibility of interference to authorized services. It is further suggested that equipment submitted to the Commission's Laboratory at Laurel, Md., for type approval, be adjusted to operate on the new frequencies."

"The frequencies available for industrial, scientific, and medical use are summarized as follows:

Assigned Band	Center Frequency of Channel	Tolerance from center Frequency
13,553.22-13,566.78 kc.	13,560 kc.	- 6.78 kc.
26,960.00-27,280.00 kc.	27,120 kc.	-160.00 kc.
40,660.00-40,700.00 kc.	40,680 kc.	- 20.00 kc.
890.00- 940.00 Mc.	915 Mc.	- 25.00 Mc.
2400.00- 2500.00 Mc.	2450 Mc.	- 50.00 Mc.
5775.00- 5925.00 Mc.	5850 Mc.	- 75.00 Mc.
10,500.00-10,700.00 Mc.	10,600 Mc.	-100.00 Mc.
17,850.00-18,150.00 Mc.	18,000 Mc.	-150.00 Mc.

"In addition to the frequencies specified above, an unspecified frequency in the vicinity of 6 megacycles for industrial, scientific and medical purposes is expected to be made available pursuant to the action taken by the Provisional Frequency Board of the International Telecommunications Union when the first International Frequency List is completed."

A.M. ENGINEERING STANDARDS

The "Standards of Good Engineering Practice Concerning Standard Broadcast Stations (550-1600 kc.)," revised to October 30, 1947, price, \$1.00, and Part 2, "General Rules and Regulations," revised June 1, 1946, price, 10 cents, are both on sale by the Superintendent of Documents, Government Printing Office, Washington 25, D. C.

RADIO-FREQUENCY STANDARDS

The February issue of *The Technical News Bulletin*, monthly publication of the National Bureau of Standards, carries a detailed description of the Bureau's work on radio-frequency standards. Copies of the publication may be obtained from the Superintendent of Documents, Government Printing Office, Washington 25, D. C.

MEGACYCLE MARKINGS ACCEPTED

F.m. broadcasters, as represented by the FMA Liaison Committee in conjunction with RMA, have agreed to accept the megacycle dial markings on f.m. receivers as standard instead of channel numbers. This agreement was reached amicably early in January.

Thomas F. McNulty, FMA treasurer and chairman of the RMA Liaison Committee, after hearing the manufacturers' reasons for preferring the megacycle markings, said that all FMA members would be advised to use these in advertising and promotion henceforth. Radio set manufacturers also were asked to include the f.m. channels in all television receivers, thereby giving the buyers the benefit of both services. FMA President Everett L. Dillard expressed the opinion that some "superregenerative" f.m. receivers have proved a disappointment to f.m. broadcasters, and that inferior f.m. sets are hurting the development of f.m. broadcasting. He agreed with set manufacturers that the growth of f.m. network broadcasting is "the solution to many f.m. problems."

Present for RMA were President Max F. Balcom, Paul V. Galvin, Director Joseph Gerl, Russ David (alternate for W.R.G. Baker), John Howland (for H. C. Bonfig), John West (for Frank Folsom), S. P. Taylor, C. R. Cummings (for E. A. Nicholas), Bond Geddes, and James D. Secrest. FMA was represented by President Dillard, Executive Director Bailey, T. F. McNulty, Stuart L. Bailey, Sol Chain, Elias Godofsky, E. C. Wood, Jr., Ross Beville, Matthew H. Bonebrake, and Leonard Marks, FMA general counsel.

STANDARD FREQUENCY BROADCAST CHANGES

Each of the eight carrier frequencies from radio station WWV of the Bureau of Standards is being broadcast continuously day and night since January 30, 1948. Time announcements by the Bureau in International Morse Code have been advanced one minute in relation to the previous schedule. With the new system the audio frequencies are interrupted at precisely one minute before each hour and at each succeeding five-minute period. A detailed announcement of WWV broadcast services, LC886, will be provided upon request from the National Bureau of Standards, Washington 25, D. C.

PARTS PRODUCTION RISES IN DECEMBER

A preliminary tabulation of the monthly summary of RMA Radio Parts Production Statistics for December indicate a slight rise in sales of radio components both to manufacturers and to jobbers.

F.M. AND TELEVISION STATION GRANTS

Construction permits for fifteen new commercial television stations were issued recently by the F.C.C. Two will be located at Atlanta, Ga., and the others at San Diego, Calif., New Orleans, La., Cincinnati, Ohio, Binghamton, N. Y., Birmingham, Ala., Dayton, Ohio, Indianapolis, Ind., Charlotte, N. C., Kansas City, Mo., Omaha, Neb., Houston, Tex., and New Orleans, La. The reinstatement of an application for another television station at Lancaster, Pa., was authorized. At the same time, the Commission issued two conditional grants for new f.m. stations at Charlotte, N. C., and Providence, R. I., and three construction permits for noncommercial f.m. educational broadcast stations at Chilton and Wausau, Wis., and San Diego, Calif.

Early this year the F.C.C. records showed 393 f.m. broadcast stations in operation, with new stations having come on the air at the following places: two at Baltimore, Md. (WCAO-FM) and (WMAR-FM), and one each at Garden City, Kan. (KGAR-FM), Kingsport, Tenn. (WKPT-FM), Mankato, Minn. (KYSM-FM), St. Paul, Minn. (WMIN-FM), Houston, Tex. (KXYZ-FM), Lincoln, Neb. (KFOR-FM), and Philadelphia, Pa. (WIBG-FM).

1947 RADIO AND TELEVISION SET PRODUCTION BREAKS RECORD

Production of television and radio receivers, including f.m., broke all industry records in 1947, according to RMA member-company reports. Sets produced by these companies in 1947 gave a total of 17,695,677. The previous industry record was 15,000,000 in 1946. Television sets produced during the year numbered 178,571 against 6476 manufactured in 1946 by RMA manufacturers. A total of 1,175,104 f.m.-a.m. receivers were produced in 1947, compared with 181,485 in 1946. Production of both automobile and portable radios in 1947 was more than double that of 1946 and helped swell the total set output for last year. Auto radios numbered 3,029,637 in 1947 as compared with 1,153,458

in 1946, while portables last year totalled 2,153,095 against 1,022,689 the previous year.

For December, total production of all types of receivers was 1,705,918. F.m.-a.m. receivers showed a total of 191,974, and 29,345 television sets were made. These figures represent increases over the monthly averages of the year of 96 and 97 per cent, respectively.

TRANSMITTER EQUIPMENT SALES

According to Haskins & Sells reports, sales billed on transmitter equipment manufactured by RMA member-companies in the first half of 1947 amounted to \$97,618,111, of which \$78,347,341 represented U. S. Government business.

Total of domestic sales billed by RMA member-companies of the Marine Section of the Transmitter Division, for nine months of 1947, was \$1,559,473, and export sales were in the amount of \$604,360. For the January to September, 1947, period, sales billed for broadcast transmitting equipment totalled \$15,150,646, and \$1,474,153 was the export total. This three-quarter 1947 period netted a total of \$2,174,968 of general communications equipment billed in the domestic market, and \$3,594,468 as an export total. Aviation equipment statistics for the same period give the following figures: airborne, domestic sales billed, \$3,423,270; export, \$1,256,855. The ground equipment domestic total was \$113,087; export, \$436,020. Domestic and export sales billed of piezoelectric quartz crystals for nine months of 1947 were \$607,645.

Total sales billed to the United States Government by RMA transmitting equipment manufacturers in three quarters of 1947 were as follows:

	<i>Sales Billed</i>
1. Communications:	
a. Transmitters	\$22,417,478
b. Receivers	3,719,563
c. Transceivers	5,703,615
Total	\$31,840,656
2. Radio Navigational Aids:	2,691,364
3. Radar:	
a. Research and navigational	30,221,901
b. Fire control	19,514,254
Total	\$49,736,155
4. Sonar	2,528,900
5. Laboratory and Test Equipment	4,134,691
6. Piezoelectric Quartz Crystals	687,240
Total	\$91,619,006

1947 RECEIVING-TUBE SALES

The cumulative radio receiving-tube sales by RMA member-companies were 199,533,827 for the year ending December 31, 1947. This was slightly below the 1946 figure of 205,217,174. December sales were 11,693,183.

ALL-TIME RECORD IN 1947 EXCISE TAXES

An RMA tabulation of monthly reports of the Bureau of Internal Revenue gives the following figures:

Collections of the 10 per cent radio excise tax on radio sets, certain components, and phonographs, for 1947, totalled \$71,087,582.39, as compared with \$38,087,396.91 in 1946. Tax payments for December

amounted to \$8,504,172.05, establishing a monthly high for the year. The December, 1946, figure was \$5,710,994.40.

S.E.C. RELEASES SALES DATA

Early this year the Securities and Exchange Commission announced that thirteen radio and television manufacturing concerns had net sales of \$217,424,000, and eight parts manufacturers had net sales totalling \$12,631,000 during the third quarter of 1947.

CANADIAN RADIO SALES

Radio receiving sets sold by Canadian manufacturers during the first ten months of 1947 totalled 632,203 and were valued at \$42,747,349, compared with 422,293 sets valued at \$20,208,497 sold during the corresponding period of 1946, according to the Office of International Trade, United States Department of Commerce.

During the first ten months of last year, a total of 95,380 receivers, valued at \$3,323,577, were imported, of which 39,319 valued at \$1,409,619 were designated as "sets imported under special conditions." Exports of radios during the ten months of 1947 totalled 46,879, valued at \$1,387,205. Canadian imports of radio receiving tubes during the first ten months of 1947 totalled 3,363,636 valued at \$1,546,675, compared with 1,163,642 valued at \$1,002,762 during the corresponding period of 1946. Imports of radio tube parts continued to decline in the ten months period of 1947, the OIT said.

GROWTH OF RADIO SERVICING

On January 11, in a talk opening the experimental Town Meeting for Radio Technicians in Philadelphia, RMA President Max F. Balcom predicted continued growth in the business of radio servicing as f.m. and television broadcasting increased, but he warned radio technicians that they must rid their trade of abuses. Technical sessions on f.m. and television set servicing continued through January 12 and 13, sponsored by the Radio Parts Industry Co-ordinating Committee and Philadelphia radio distributors, with the co-operation of local servicemen's organizations. Harry A. Ehle, of the International Resistance Company, was chairman of the subcommittee directing the experiment for the manufacturers. Sponsors were enthusiastic over its success and reported good attendance and considerable discussion and questions from the audience. Registration was 1200.

* * *

At the three-day RMA mid-winter conference, January 20-22, in Chicago, the RMA board approved recommendations of the Service Committee to set up a joint industry plan, with combined participation of manufacturers, jobbers, dealers, and servicemen, in a move to eliminate or minimize abuses and to improve radio service for the public. All efforts are being made to advise the public to patronize "authorized" franchised dealers when radios are in need of repair. Opposition to municipal licensing, as ineffective for the public, was reaffirmed. The board also approved motion to obtain

copyright of the name "Town Meeting of Radio Technicians," as well as the recommendation of Harry A. Ehle to the RMA Parts Division that similar clinics for radio servicemen be held in five major cities annually within a period of twelve months from the time the proposal is approved by member organizations of the committee. The Radio Parts Industry Co-ordinating Committee accepted Mr. Ehle's recommendation on January 29.

RMA CONVENTION TO MERGE WITH PARTS SHOW

Upon recommendation of the RMA Parts Division Executive Committee and Section Chairmen, the RMA Board approved a proposal of Chairman J. J. Kahn to merge the annual RMA convention with the annual Radio Parts Trade Show. The 1948 convention will mark the twenty-fifth anniversary of the Association, and an elaborate program and industry banquet are planned.

DRAFTING OF STANDARD MUNICIPAL CODES ON WIRING

W. R. G. Baker will direct the RMA Engineering Department in the investigation of possibilities of drafting standard municipal codes on electrical wiring in the installation of amplifier and sound equipment and of establishing test-equipment laboratory service for RMA manufacturers of amplifying and sound equipment. President Max F. Balcom was authorized to appoint a special committee to draft, in co-operation with the armed services, an industrial mobilization plan for the radio and electronic industry.

RMA MEETINGS

The following RMA engineering meetings were held:

- January 13—Committee on Cathode-Ray Tubes
- January 13-14—Subcommittee on Systems Standards of Good English Practice
- January 15—Committee on Television Transmitters
- January 15—Committee on Audio Facilities
- January 16—Transmitter Section Executive Committee
- January 21—Committee on Thermoplastic Hookup Wire
- January 23—Subcommittee on Gas-Filled Microwave Transmission Lines
- February 5—Committee on Sampling Procedure
- February 10—Committee on Dry-Disk Rectifiers
- February 13—Committee on Sampling Procedure
- February 17—Committee on Amplifiers
- February 17—Committee on Speakers
- February 17—Executive Committee
- February 18—Committee on Systems
- February 18—Committee on Microphones
- February 18—Committee on Audio Facilities
- February 18—Receiver Executive Committee

Sections

Chairman		Secretary	Chairman		Secretary
P. H. Herndon c/o Dept. in charge of Federal Communication 411 Federal Annex Atlanta, Ga.	ATLANTA April 16	M. S. Alexander 2289 Memorial Dr., S.E. Atlanta, Ga.	E. T. Sherwood Globe-Union Inc. Milwaukee 1, Wis.	MILWAUKEE	J. J. Kircher 2450 S. 35th St. Milwaukee 7, Wis.
F. W. Fischer 714 Beechfield Ave. Baltimore 29, Md.	BALTIMORE	E. W. Chapin 2805 Shirley Ave. Baltimore 14, Md.	R. R. Desaulniers Canadian Marconi Co. 211 St. Sacrement St. Montreal, P.Q., Canada	MONTREAL, QUEBEC April 28	R. P. Matthews Federal Electric Mfg. Co. 9600 St. Lawrence Blvd. Montreal 14, P.Q., Canada
John Petkovsek 565 Walnut Beaumont, Texas	Beaumont— Port Arthur	C. E. Laughlin 1292 Liberty Beaumont, Texas	J. E. Shepherd 111 Courtenay Rd. Hempstead, L. I., N. Y.	NEW YORK May 5	I. G. Easton General Radio Co. 90 West Street New York 6, N. Y.
W. H. Radford Massachusetts Institute of Technology Cambridge, Mass.	BOSTON	A. G. Bousquet General Radio Co. 275 Massachusetts Ave. Cambridge 39, Mass.	C. G. Brennecke Dept. of Electrical Eng. North Carolina State Col- lege Raleigh, N. C.	NORTH CAROLINA- VIRGINIA	C. M. Smith Radio Station WMIT Winston-Salem, N. C.
A. T. Consentino San Martin 379 Buenos Aires, Argentina	BUENOS AIRES	N. C. Cutler San Martin 379 Buenos Aires, Argentina	K. A. Mackinnon Box 542 Ottawa, Ont. Canada	OTTAWA, ONTARIO April 1	D. A. G. Waldock National Defense Headquarters New Army Building Ottawa, Ont., Canada
R. G. Rowe 8237 Witkop Avenue Niagara Falls, N. Y.	BUFFALO-NIAGARA April 21	R. F. Blinzler 558 Crescent Ave. Buffalo 14, N. Y.	P. M. Craig 342 Hewitt Rd. Wyncote, Pa.	PHILADELPHIA May 6	J. T. Brothers Philco Radio and Tele- vision Tioga and C Sts. Philadelphia 34, Pa.
G. P. Hixenbaugh Radio Station WMT Cedar Rapids, Iowa	CEDAR RAPIDS	W. W. Farley Collins Radio Co. Cedar Rapids, Iowa	E. M. Williams Electrical Engineering Dept. Carnegie Institute of Tech. Pittsburgh 13, Pa.	PITTSBURGH May 10	E. W. Marlowe 560 S. Trenton Ave. Wilkinburgh PO Pittsburgh 21, Pa.
Karl Kramer Jensen Radio Mfg. Co. 6601 S. Laramie St. Chicago 38, Ill.	CHICAGO April 16	D. G. Haines Hytron Radio and Elec- tronics Corp. 4000 W. North Ave. Chicago 39, Ill.	O. A. Steele 1506 S.W. Montgomery St. Portland 1, Ore.	PORTLAND	F. E. Miller 3122 S.E. 73 Ave. Portland 6, Ore.
J. F. Jordan Baldwin Piano Co. 1801 Gilbert Ave. Cincinnati, Ohio	CINCINNATI April 19	F. Wissel Crosley Corporation 1329 Arlington St. Cincinnati, Ohio	N. W. Mather Dept. of Elec. Engineering Princeton University Princeton, N. J.	PRINCETON	A. E. Harrison Dept. of Elec. Engineering Princeton University Princeton, N. J.
W. G. Hutton R.R. 3 Brecksville, Ohio	CLEVELAND April 22	H. D. Seielstad 1678 Chesterland Ave. Lakewood 7, Ohio	A. E. Newlon Stromberg-Carlson Co. Rochester 3, N. Y.	ROCHESTER April 15	J. A. Rodgers Huntington Hills Rochester, N. Y.
C. J. Emmons 158 E. Como Ave. Columbus 2, Ohio	COLUMBUS May 14	L. B. Lamp 846 Berkeley Rd. Columbus 5, Ohio	E. S. Naschke 1073-57 St. Sacramento 16, Calif.	SACRAMENTO	G. M. Cummings 7200 Delta Ave. Richmond Height 17, Mo.
L. A. Reilly 989 Roosevelt Ave. Springfield, Mass.	CONNECTICUT VALLEY April 15	H. L. Krauss Dunham Laboratory Yale University New Haven, Conn.	C. N. Tirrell U. S. Navy Electronics Lab. San Diego 52, Calif.	SAN DIEGO May 4	S. H. Sessions U. S. Navy Electronics Lab. San Diego 52, Calif.
J. G. Rountree 4333 South Western Blvd. Dallas 5, Texas	DALLAS-FT. WORTH	J. H. Homsy Box 5238 Dallas, Texas	L. E. Reukema Elec. Eng. Department University of California Berkeley, Calif.	SAN FRANCISCO	W. R. Hewlett 395 Page Mill Rd. Palo Alto, Calif.
E. L. Adams Miami Valley Broadcast- ing Corp. Dayton 1, Ohio	DAYTON April 15	George Rappaport 132 E. Court Harshman Homes Dayton 3, Ohio	W. R. Hill University of Washington Seattle 5, Wash.	SEATTLE May 13	W. R. Triplett 3840-44 Ave. S.W. Seattle 6, Wash.
C. F. Quentin Radio Station KRNT Des Moines 4, Iowa	DES MOINES- AMES	F. E. Bartlett Radio Station KSO Old Colony Bldg. Des Moines 9, Iowa	C. A. Priest 314 Hurlburt Rd. Syracuse, N. Y.	SYRACUSE	R. E. Moe General Electric Co. Syracuse, N. Y.
A. Friedenthal 5396 Oregon Detroit 4, Mich.	DETROIT April 16	N. C. Fisk 3005 W. Chicago Ave. Detroit 6, Mich.	C. A. Norris J. R. Longstaffe Ltd. 11 King St., W. Toronto, Ont., Canada	TORONTO, ONTARIO	C. G. Lloyd 212 King St., W. Toronto, Ont., Canada
N. J. Reitz Sylvania Electric Prod- ucts, Inc. Emporium, Pa.	EMPORIUM	A. W. Peterson Sylvania Electric Prod- ucts, Inc. Emporium, Pa.	O. H. Schuck 4711 Dupont Ave. S. Minneapolis 9, Minn.	TWIN CITIES	B. E. Montgomery Engineering Department Northwest Airlines Saint Paul, Minn.
F. M. Austin 3103 Amherst St. Houston, Texas	HOUSTON	C. V. Clarke, Jr. Box 907 Pasadena, Texas	G. P. Adalr 1833 "M" St. N.W. Washington, D. C.	WASHINGTON May 10	H. W. Wells Dept. of Terrestrial Mag- netism Carnegie Inst. of Wash- ington Washington, D. C.
R. E. McCormick 3466 Carrollton Ave. Indianapolis, Ind.	INDIANAPOLIS	Eugene Pulliam 931 N. Parker Ave. Indianapolis, Ind.	J. C. Starks Box 307 Sunbury, Pa.	WILLIAMSPORT May 5	R. G. Petts Sylvania Electric Prod- ucts, Inc. 1004 Cherry St. Montoursville, Pa.
C. L. Omer Midwest Eng. Devel. Co. Inc. 3543 Broadway Kansas City 2, Mo.	KANSAS CITY	Mrs. G. L. Curtis 6003 El Monte Mission, Kansas			
R. C. Dearie Dept. of Physics University of Western Ontario London, Ont., Canada	LONDON, ONTARIO	E. H. Tull 14 Erie Ave. London, Ont., Canada			
Walter Kenworth 1427 Lafayette St. San Gabriel, Calif.	LOS ANGELES April 20	R. A. Monfort L. A. Times 202 W. First St. Los Angeles 12, Calif.			
O. W. Towner Radio Station WHAS Third & Liberty Louisville, Ky.	LOUISVILLE	D. C. Summerford Radio Station WHAS Third & Liberty Louisville, Ky.			

SUBSECTIONS

Chairman		Secretary		Chairman		Secretary	
P. C. Smith 179 Ido Avenue Akron, Ohio	Akron (Cleveland Sub- section)	J. S. Hill 51 W. State St. Akron, Ohio		J. B. Minter Box 1 Boonton, N. J.	NORTHERN N. J. (New York Subsection)	A. W. Parkes, Jr. 47 Cobb Rd. Mountain Lakes, N. J.	
J. D. Schantz Farnsworth Television and Radio Company 3700 E. Pontiac St. Fort Wayne, Ind.	FORT WAYNE (Chicago Subsection)	S. J. Harris Farnsworth Television and Radio Co. 3702 E. Pontiac Fort Wayne 1, Ind.		A. R. Kahn Electro-Voice, Inc. Buchanan, Mich.	SOUTH BEND (Chicago Subsection) February 19	A. M. Wiggins Electro-Voice, Inc. Buchanan, Mich.	
F. A. O. Banks 81 Troy St. Kitchener, Ont., Canada	HAMILTON (Toronto Subsection)	E. Ruse 195 Ferguson Ave., S. Hamilton, Ont., Canada		W. M. Stringfellow Radio Station WSPD 136 Huron Street Toledo 4, Ohio	TOLEDO (Detroit Subsection)	M. W. Keck 2231 Oak Grove Place Toledo 12, Ohio	
A. M. Glover RCA Victor Div. Lancaster, Pa.	LANCASTER (Philadelphia Subsection)	C. E. Burnett RCA Victor Div. Lancaster, Pa.		R. M. Wainwright Elec. Eng. Department University of Illinois Urbana, Illinois	URBANA (Chicago Subsection)	M. H. Crothers Elec. Eng. Department University of Illinois Urbana, Illinois	
E. J. Isbister 115 Lee Rd. Garden City, L. I., N. Y.	LONG ISLAND (New York Subsection)	F. Q. Gemmill Sperry Gyroscope Great Neck, L. I., N. Y.		W. A. Cole 323 Broadway Ave. Winnipeg, Manit., Can- ada	WINNIPEG (Toronto Subsection)	C. E. Trembley Canadian Marconi Co. Main Street Winnipeg, Manit., Can- ada	
A. D. Emurian HDQRS. Signal Corps Engineering Lab. Bradley Beach, N. J.	MONMOUTH (New York Subsection)	Ralph Cole Watson Laboratories Red Bank, N. J.					

Books

"Radio Engineering," Third Edition, by Frederick Emmons Terman

Published (1947) by McGraw-Hill Book Company, Inc., New York and London, 969 pages plus xiv pages, 609 illustrations. 6×9 inches. Price, \$7.00.

The co-ordination and combination with older material of the developments that have taken place in radio engineering in the ten years since the appearance of the second edition of this well-known book is a task that might have daunted the most intrepid. The fact that Professor Terman has accomplished this in such a way that the whole is incorporated within the covers of a single volume suitable for classroom use of engineering seniors is an additional tribute to his ability as one of the foremost masters of technical exposition. This third edition contains an entirely new chapter on circuits with distributed constants and an expanded treatment of vacuum tubes that covers the newer microwave devices, even to the extent of a brief description of the traveling-wave amplifier.

The third edition contains 969 pages, in contrast with the 813 of the second edition. The inclusion of the new material without an even greater increase in size has necessitated an increased concentration upon fundamental principles throughout at the expense of some of the details of current engineering practice. In the opinion of the present reviewer, this is a distinct improvement in a book intended for classroom work of collegiate grade. The number of tuning knobs on the front panels of a type so-and-so radio transmitter is something the teacher may wish to introduce into the classroom discussion for purposes of arousing interest in certain types of student minds, but to put these details into the pages of a text intended to endure as a reference for the student in his coming years of practice is to

waste good paper that might better be employed for those more permanent things that do not change with the fashions of the times.

In one or two places it could be wished that the concentration on fundamentals had been carried to an even greater extent. Chapter 1, for example, is entitled "Elements of a System of Radio Communication" and would be expected to be quite thorough. In this chapter the section entitled "Radiation of Electrical Energy" contains but twenty lines, while in a later part of the book the treatment of magnetrons occupies thirteen pages. It is also a little disappointing to find the statement carried over from both of the earlier editions that "the strength of the wave . . . is exactly the same voltage that the magnetic flux of the wave induces in a conductor 1 meter long when sweeping across this conductor with the velocity of light." Convenient as this concept may be for certain quick calculations, it can hardly be said to be fundamental and, in fact, requires an intuitive extension of Maxwell's equations that has not been proved to be generally true. With students, in particular, one can hardly be too meticulous in expressing the nice points of such fundamentals with careful exactness.

In a similar vein (perhaps supercritical), but dealing with rather specific technicalities the following points may be cited for possible future consideration: The list of noise sources in amplifiers given in Chapter 12 would be more complete if mention were made of that from current flowing in carbon and thin-film resistors. The treatment of complex impedances in nonlinear circuits beginning on page 278 can lead to possible misunderstanding, if not error. On page 627 it is stated that an alternating electric field causes a free electron to vibrate, whereas an important part of the motion in other connections is a mean velocity superposed on the vibrations. On page 747 it is stated that the problem of key clicks is the same with frequency-shift and with on-off keying,

whereas it is really much simpler in the frequency-shift case. On page 764 the effect of bandwidth in connection with the use of limiters for reducing impulse noise in amplitude-modulated systems is not mentioned. The mechanism by which frequency modulation affects signal-to-noise ratio is explained on page 774 in such a condensed fashion that the student may have difficulty in grasping the real significance of this important property. Also, the impression is given that the extra-channel space available in the microwave region is proportional to the frequency, whereas many proposals for the use of these waves involve wider bands per channel.

In general, the book is relatively free from typographical errors and slips of expression. In a "straight-through" reading, only four hanging particples were found and two of these were in Chapter 13. This is something of a record in a technical writing of this length. Differing from previous editions, the present volume contains very few references to individuals and to original sources. In some respects this is a practice to be commended, but in others it does not seem to be wholly desirable. Thus, for a student never to hear of "Richardson's equation" or of "Child's equation" by those names in connection with vacuum tubes seems to omit something that comes like second nature to us oldsters. With regard to original sources, however, we must recognize that radio is growing up rapidly and it is no longer possible to carry forward the lengthening list of sources. In some cases, references are given to other books where more detailed treatment of special subjects is given, and this would seem to be a good way of dealing with the situation in those cases where such treatments are available.

The present edition incorporates certain portions of the appendices of the earlier editions into the main text and omits the remainder. This is a distinct improvement and results in a much neater arrangement. Finally, a conversion table of decibels,

power ratios, and voltage ratios appears on the inside of the back cover, for which the student will often have occasion to be thankful.

F. B. LLEWELLYN
Bell Telephone Laboratories
New York, N. Y.

Theory and Application of Microwaves, by A. B. Bronwell and R. E. Beam

Published (1947) by McGraw-Hill Book Company, Inc., 330 W. 42 Street, New York 18, N. Y. 464 pages+6-page index+ xv pages. 253 figures. 6×9 inches. Price, \$6.00.

Most books have features that make them especially useful, and this book is no exception. Its twenty-one chapters are attractively arranged and may be said to offer some discussion of virtually every phase of microwave application. Much of the discussion is compact and well presented, particularly the material on conventional transmission lines, their equations, graphical solutions, and networks. Problems are included, though probably not nearly enough for teaching purposes. Many of the chapters have good summaries of the important relations developed in the chapter. Good diagrams and curves are used liberally, as are also photographs of actual tubes and apparatus. A good job is done in going just so far along highly mathematical lines.

It is to be hoped that in future editions the material on the low-frequency criteria of oscillation and the usual (zero transit time) class-C operation, which two topics use up so much of the too-short chapter on grid-controlled tubes, will be replaced by the very important grid-return aspect of grid-controlled tube application at microwaves. Similarly, a good discussion of noise, in view of its importance at these frequencies, could well have enhanced the several pages on microwave receivers if it were present in place of the routine discussions of conversion, low-frequency a.m. detection, i.f. amplifiers, and f.m. limiters and discriminators. The few pages on transmitters are also made less interesting to a reader pursuing the microwave art when he finds little on the problems peculiar to microwave modulation, but space nevertheless is allotted to the usual amplitude, frequency, and phase modulation sideband theory.

Considering the large amount of topics covered and the consequent necessity for condensing discussions, the authors have done well in avoiding the creation of incorrect impressions by unfortunate wording. A number of such passages do appear, however, in connection with important points. As examples, amplifiers are said to be limited in application at microwaves because microwave circuits inherently have so wide a band that the signal-to-noise ratio is consequently poor. The true meaning, doubtless, is that present tubes produce more noise per unit of bandwidth at microwave frequencies than at lower frequencies; the actual bandwidth can be controlled later in the receiver, of course. The coaxial line is well covered from the conventional point of view, but in the field theory section of the text the possible order waves are discussed with an erroneous

general conclusion resulting from the apparent overlooking of the most important higher-order wave of all, the circumferential one (lowest-order *TE* wave) which, having the lowest cutoff frequency, gives the most trouble at microwave frequencies. A popular misconception is almost certain to be planted or continued in the reader's mind by the discussion of page 299, in which it is stated that the solution of the wave equation shows up possible modes but does not tell the specific field that will exist. But this is only true if all the boundary conditions have not yet been applied. It is further stated that if these specific fields are desired, the integral expressions for vector and scalar potentials must be set up and solved. Actually, the differential-equation and the integral-equation approach are alternative methods, each of which can give the complete result if all the boundary conditions are used. After all, the specific fields in a transmission line or guide are most often obtained by matching the possible wave series to the excitation or source boundaries.

SIMON RAMO
Hughes Aircraft Company
Culver City, Calif.

FM Simplified, by Milton S. Kiver

Published (1947) by D. Van Nostrand Company, Inc., 250 Fourth Avenue, New York, N. Y. 342 pages+5-page index+vii. 243 figures. 5½×8 inches. Price, \$6.00.

The title "FM Simplified" is a rather good description of the subject matter and manner of treatment utilized in this book. The author has attempted to describe in a very complete but not exhaustive manner the general subject of frequency modulation and a comparison of frequency modulation with amplitude modulation. The treatment is "complete" in the sense that all phases of the subject are treated, and is "not exhaustive" in the sense that merely a qualitative description of the various phases is given without detailed mathematical proofs.

It appears that the intention of the author was to introduce the subject of frequency modulation to a reader having a general radio background, in a simple manner which would provide a qualitative understanding of the principles involved. In an effort to do this, the author apparently has attempted to digest his own experiences and available information on the subject of frequency modulation and then to present the subject to a reader in a matter-of-fact manner treating each step in his description only to the extent necessary to provide the reader with a practical understanding of the subject matter. In this qualitative treatment of the subject, the author has devised numerous short cuts to facilitate his task. By making comparisons with a.m. practice he has simplified his descriptions of f.m. practices in several cases. He has made much use of description by example and by reference. In those cases in which a complete description of a particularly important subject is necessary for a practical understanding of the fundamentals involved, the author digresses for a time from the general trend of thought to acquaint the reader with the subject as for

the first time. In these descriptions of important points, the author takes full advantage of the use of simplified explanations in terms of diagrams and similes. Similarly, in lieu of detailed proofs of complex subjects the author short-cuts his explanation by statements of fact with merely general discussions of the reason behind the proofs.

In his attempt towards a complete, yet easy-reading qualitative treatment of the subject, the author has apparently imposed upon himself certain limitations with respect to the amount of detail into which he would delve and the extent of mathematical analysis which he would use. As a result, there are certain phases of his treatment in which he has found it necessary to compromise between a mere mention of a subject and complete discussion. In this respect, some question may be raised as to the merit of the lengthy description which is given of the differences between phase and frequency modulation. This subject is actually an excessively difficult one to treat in the descriptive terms to which the author is limited. In this case, as well as in certain others, the author has apparently found himself in conflict between a desire to cover the subject completely and his desire to restrict his discussions to general descriptions.

In general, the author has succeeded in his attempt to describe the broad aspects of frequency modulation in such a simple form that it can be easily understood with a minimum need for detailed analysis or knowledge of complex mathematics on the part of the reader. The contents are fairly well organized and, since the book is very easy and rapid reading, it is particularly useful for someone who prefers light reading but desires at the same time to become acquainted in a general way with the circuits experienced in f.m. The scope of the coverage is quite complete and up-to-date. Rather good discussion is included of common pitfalls, F.C.C. restrictions, and accepted opinions and conclusions of those experienced with the subject. There appears to be no repetition of subject matter. In fact, the author seems to go out of his way in referring to former sections which are applicable in particular cases.

In view of the broad scope of the book and the limitations which the author has imposed upon himself with respect to detail and mathematical proofs, it would be well if the reader were cautioned with respect to the need for a more exhaustive treatment of any particular phase of the subject before attaining a feeling of complete confidence in his knowledge of the subject. This is particularly pertinent with respect to the chapter on servicing f.m. receivers. Because of the complexities involved in radio servicing and the many dodges and angles which are attributable to this art, it is important that the reader recognize the incompleteness of the treatment of this subject and the need for a more complete study.

Considering the purpose for which the book is written and the type of reader attracted, a fairly acceptable work has been accomplished.

C. M. JANSKY, JR.
Consulting Radio Engineer
National Press Building
Washington 4, D. C.

I.R.E. People



ROBERT L. COE

ROBERT L. COE

Robert L. Coe (A'45-M'45-SM'47) has been named station manager of the new New York *Daily News* television station, called WPIX.

Mr. Coe was born in Missouri in 1902 and was a licensed radio amateur from 1914 to 1917, interrupting his activities to serve in the Army Air Force. He entered the broadcasting field in 1922 and in 1924 he joined the *St. Louis Post-Dispatch*. He became chief engineer of the radio department in 1933. In 1941 he interrupted his career once more and from 1942 to 1943 served as deputy chief of staff, I Troop Carrier Command. As a lieutenant colonel in 1944 he was in charge of Army Air Forces radio communications for the China-Burma-India theater. Retired from the Army in 1945 with the rank of lieutenant colonel, Mr. Coe, before taking up his new duties on January 1, 1948, was chief engineer of KSD, St. Louis, Mo. On his acceptance of the new post Mr. Coe said, "I am sure we can make the *News* station outstanding in the country."



JAMES F. WILLENBECHER

JAMES F. WILLENBECHER

James F. Willenbecher (SM'44), manager of the Production Division of the Hazeltine Electronics Corporation, Little Neck, L. I., was awarded a Certificate of Commendation by the United States Navy for his achievements during World War II. The citation read in part: "This award is made for your outstanding assistance in producing vast quantities of vital Naval electronics equipment. Your success in training of inexperienced factory help to produce some of the most complicated and involved electronics apparatus used during the war resulted in an appreciable savings in cost of equipment to the U. S. Navy."



FREDERICK R. LACK

Frederick R. Lack (A'20-F'37) a director of Western Electric and vice-president in charge of the Radio Division, received the Presidential Certificate of Merit "for outstanding fidelity and meritorious conduct in aid of the war effort against the common



FREDERICK R. LACK

enemies of the United States and its Allies in World War II," on November 19, 1947.

Starting his career as assembler with Western Electric in 1911, Mr. Lack remained in this position until World War I. On his return from France in 1919, he was assigned to development work on radiotelephony, and supervised the installation of a radiotelephone link between Peking and Tientsin. In 1923 he entered Harvard as a special student and obtained the B.S. degree with high honors. He re-entered the Bell System as a member of Bell Telephone Laboratories and engaged in a research program on the use of piezoelectric crystals in radio-frequency generators. Mr. Lack has been associated with the Western Electric Company and Bell Telephone Laboratories, for 36 years, and was elected vice-president in 1942. He is a member of the RMA, the American Standards Association, the American Institute of Electrical Engineers, the American Physical Society, and the Harvard Engineering Society.

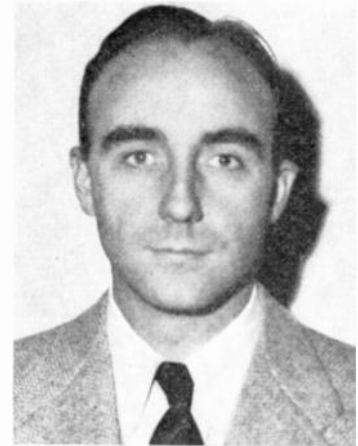

BENJAMIN F. TYSON

BENJAMIN F. TYSON

Benjamin F. Tyson (S'36-A'39-VA'39), senior development engineer of the Hazeltine Electronics Corporation, Little Neck, L. I., was awarded a Certificate of Commendation by the U. S. Navy for his achievements during World War II. The citation read in part: "This award is made for your outstanding ability and great personal effort, as a Senior Engineer of the Hazeltine Corporation, in designing airborne radar identification transpondors which were of vital importance to the operations of the Air Arm of the U. S. Navy."

ROBERT B. J. BRUNN

Robert B. J. Brunn (A'36-VA'39), senior radio engineer of the Hazeltine Electronics Corporation, Little Neck, L. I., was awarded a Certificate of Commendation by the United States Navy for his achievements during World War II. The citation read in part: "This award is made for your outstanding ability and great personal effort . . . in the design, development and continued improvement of land navigation beacons, airborne identification equipments, and radar beacons for vital use of the U. S. Navy."



ROBERT B. J. BRUNN



CHARLES J. HIRSCH

CHARLES J. HIRSCH

Charles J. Hirsch (M'39-SM'43), chief engineer, Commercial Products and Radio Aids to Navigation Division, Hazeltine Electronics Corporation, Little Neck, L.I., was awarded a Certificate of Commendation by the United States Navy for his achievements during World War II. The certificate was accompanied by a citation reading in part: "This award is made for your outstanding performance in achieving the first successful co-ordination of operations of complex surface radar equipments with multi-function radar identification equipment. Your participation in the development of a generic design of such surface radar identification equipment aided materially in standardizing the design and use of this equipment among the Allied Services."



ARTHUR W. MELLOCH

Arthur W. Melloch (A'33-SM'45) was recently appointed vice-director of the Texas Engineering Experiment Station at the Agricultural and Mechanical College, Texas.

Dr. Melloch was born at Wrenshall, Minnesota, on December 8, 1907. From the University of Minnesota he received the B.E.E. degree in 1932, the M.S. degree in electrical engineering in 1937, and the Ph.D. degree in 1940. He was also an instructor in electrical engineering from 1937 to 1940. From 1940 to 1942 he was connected with the Associated Electric Laboratories in Chicago, and from 1942 to 1945 he was with the Division of War Research at the Navy Radio and Sound Laboratory, University of California, San Diego, Calif. After leaving California he was for a time in the Research Department of the Stromberg-Carlson Company, Rochester, N. Y. He is a member of Sigma Xi and an associate member of the American Institute of Electrical Engineers.



GEORGE P. ADAIR

George P. Adair (A'42-SM'44-F'47) resigned from the position of chief engineer of the Federal Communications Commission in 1947. He had joined the Commission in 1934,

and from 1936 to 1939 was acting assistant chief of its Broadcast Division. In 1939 he was made assistant chief of the Division and assistant chief engineer in 1941. He was appointed chief engineer in 1944.

Mr. Adair was born in Rancho, Texas, December, 1903. He received his B.S. in electrical engineering from Texas A & M in 1926, and for the following three years was connected with the General Electric Company. His work with the F.C.C. encompassed practically all present-day broadcasting rules, including Standards of Good Engineering Practice. During the war he worked closely with the OWI in setting up the International Broadcast Service and was active in the Board of War Communications. He received highest civilian honors from the United States War Department for outstanding achievement in the development of radar and specifically for "outstanding assistance in development, research and production of radio set SCR-598." This set was part of a gun-laying radar equipment which made possible accurate and speedy aiming of large guns in sea warfare and harbor defense. One of its civilian applications is for precise harbor traffic control.



GEORGE P. ADAIR

In 1945 Mr. Adair was a United States delegate to the London Conference, and technical adviser to the NARBA Conference. He also served as the Commission's observer on RTPB. He is a consulting engineer in Washington, D.C., and Vice-Chairman of the Washington Section of The Institute of Radio Engineers.



ARTHUR V. LOUGHREN

Arthur V. Loughren (A'24-M'29-SM'43-F'44), director of engineering of the Hazeltine Electronics Corporation, Little Neck, L. I., was awarded a Certificate of Commendation by the United States Navy for his achievements during World War II. The certificate was accompanied by a citation reading: "This award is made for your outstanding assistance in planning and executing the design of radar beacons and complete systems of radar identification equipments. Through your unremitting



ARTHUR V. LOUGHREN

effort the principles involved were successfully applied in the design and production of the first series of identification radars, which became standard for all services, thus setting a pattern for the high degree of development attained in these equipments."



HAROLD A. WHEELER

Harold A. Wheeler (A'27-M'28-F'35) of the Wheeler Laboratories, Inc., Great Neck, L. I., formerly chief consulting engineer of the Hazeltine Electronics Corporation, Little Neck, L. I., was awarded a Certificate of Commendation by the United States Navy for his achievements during World War II. The certificate was accompanied by a citation reading: "This award is made for your unremitting effort, ability and leadership in the basic research and laboratory development of radar identification and beacon equipment, and for your contribution to the design for rapid production by a number of manufacturers of identical equipment which was used interchangeably by the various Allied Services. In addition your participation in the development of the 'steering wheel' antenna was of vital importance to the Naval electronics program."



WILLIAM H. GRIMDITCH

William H. Grimditch (M'36-SM'43), executive vice-president of the Hazeltine Electronics Corporation, New York, N. Y., was awarded a Certificate of Commendation by the United States Navy for his achievements during World War II. The certificate was accompanied by a citation reading: "This award is made for your outstanding ability and assistance in producing radar identification equipment. Your excellent co-ordination of subcontractors' production of a large quantity of these equipments, your expert appraisal and selection of manufacturing companies in relation to specified projects, together with your establishment of flow rates, delivery dates and other factors, constituted an important contribution to the Naval electronics program."



Karl Kramer

CHAIRMAN, CHICAGO SECTION, 1947-1948

Karl Kramer was born on August 28, 1909, in Columbus, Ohio. In early high-school days he became interested and active in radio as an amateur, and it was this interest that led him to study electrical engineering at Ohio State University. Here he majored in communications and was graduated with honors, receiving the B.E.E. degree in 1931. Graduate work was carried on at the same institution with particular attention to mathematics and physics, and in 1933 he received the degree of M.Sc. in E.E. During the years prior to World War II, he continued his academic studies through evening courses at the University of Chicago and the Illinois Institute of Technology.

In 1935 Mr. Kramer joined the Jensen Manufacturing Company in Chicago. He served as project engineer in connection with the design and development of loudspeaker equipment, and in 1937 he was named senior project engineer. During World War II, Jensen engineering and production facilities were devoted entirely to wartime purposes, particularly the design and manufacture of loudspeakers for use on capital ships, and his work was associated with the design and testing of these devices. After peacetime conversion he engaged in sales

activities through applications and customer service engineering, so that in 1946 he was appointed technical service engineer, becoming a member of the sales division. In this connection he now serves as technical consultant to this division in matters pertaining to product planning and customer relations. He is responsible for all technical matter released and his activities encompass special product design, particularly with respect to application engineering activities.

Mr. Kramer joined The Institute of Radio Engineers in 1941 as an Associate Member, becoming a Senior Member in 1945. He has been active in Chicago Section affairs for several years, having served on its Executive Committee since 1945. He is currently serving as a director of the Illinois Engineering Council and of the National Electronics Conference in behalf of the Section. He has served as Secretary of Central Region No. 5 Committee, and he has recently been appointed to the Committee on Professional Groups. Mr. Kramer is also a member of the Radio Engineers Club of Chicago and of the Acoustical Society of America, and an active member of the Society of Motion Picture Engineers. He is a registered professional engineer in the State of Illinois.

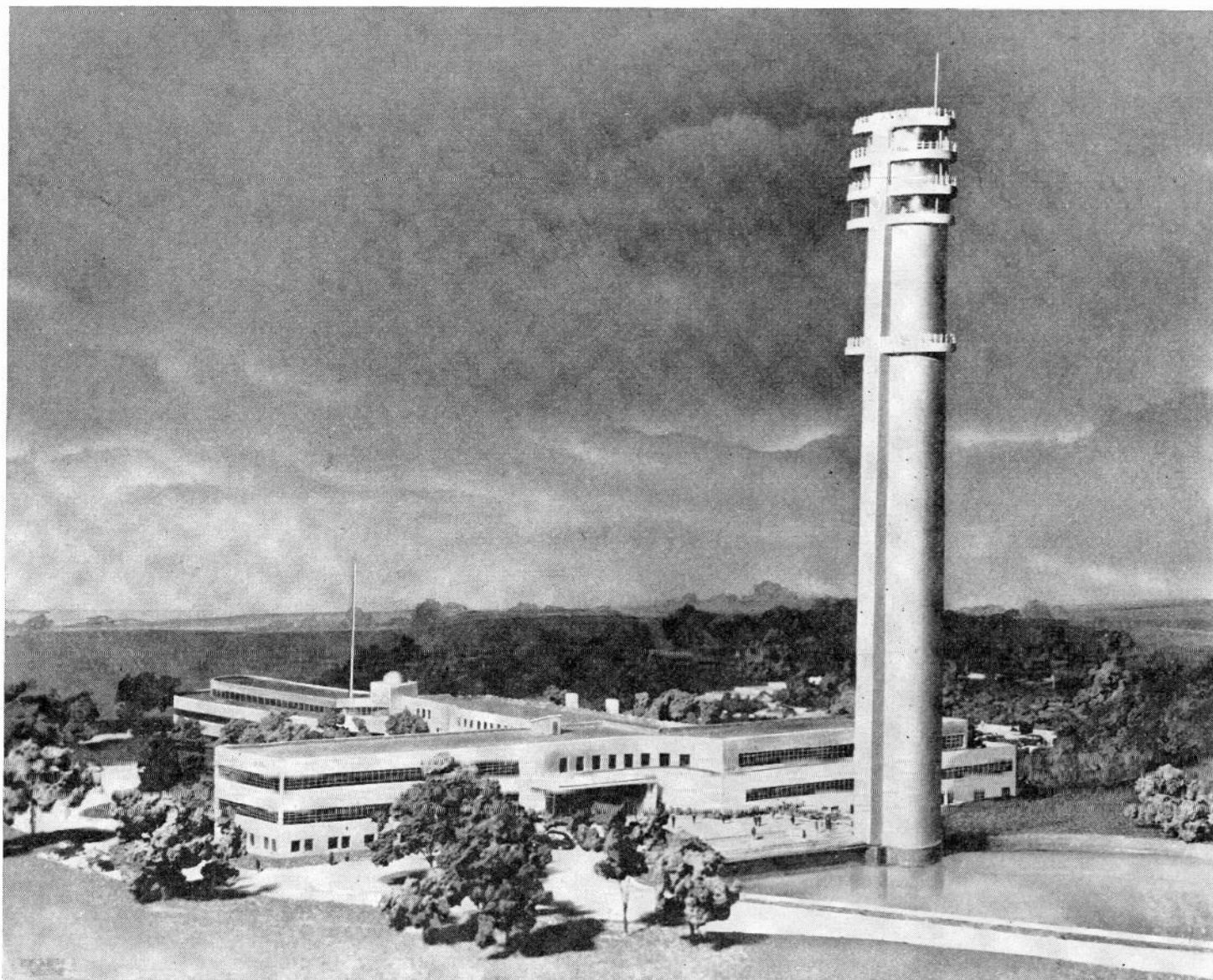

A MODERN TELECOMMUNICATIONS LABORATORY

Architect's model of the Federal Telecommunication Laboratories, Nutley, N. J., scientific associate of Federal Telephone and Radio Corporation and International Telephone and Telegraph Corporation. The Laboratories, now nearing completion, consist of four interconnected buildings enclosing more than 100,000 square feet of floor space.

The 300-foot "Microwave Tower" will be used for experiments in f.m. broadcasting, television, pulse-multiplex systems, police radio networks, aerial navigation, radar applications, and communication with automobiles and trains.

Engineering Responsibilities in Today's Economy*

E. FINLEY CARTER†, FELLOW, I.R.E.

THE TREMENDOUS MAGNITUDE and vital importance of engineering achievement within the past generation has placed the engineer, as an individual and as the member of a group, on the threshold of entirely new responsibilities. These are his new responsibilities to society as well as to the engineering profession. No longer can the engineer feel fully satisfied as the author of merely a good engineering job. He must learn to become fully aware of his social and economic responsibility in terms of his creative engineering effort.

Prior to this period, society had already experienced some difficulty in adjusting itself to engineering progress, though the benefits of the engineer's work were, in the light of recent developments, more aptly described as evolutionary rather than revolutionary.

Under the stimulus of a struggle for the survival for a way of life, engineers were suddenly called upon to create at a tremendously accelerated pace. In effect, years were compressed into months, and decades into years. Developments passed quickly from applied research to production and on to the battle fields. Radar beat the toughest air and submarine fleets. The proximity fuze put an electronic brain into ammunition. The atomic bomb ended the war and posed a vast new social problem as yet unsolved.

Thus the increased rate of engineering achievements has reached far beyond the people's ability to adjust, understand, acclimate, or cope with engineering progress. In consequence, engineers have created many necessary and beneficial things which may tend to produce alarming social and economic unrest should we fail to develop a new sense of social and economic responsibility. Indeed, we may, in some respects, be going through a period not unlike those during the Middle Ages and just before the Renaissance, when inability to understand progress created fear and chaos among great numbers of people.

Recognition of the creative work of physicists and engineers as an essential part of modern society and national security now extends beyond the engineering and research fraternities. Government research during the war was an investment of 600 million dollars in electronics alone. The development of the science and application of nuclear, during the same period, cost over 2 billion dollars, paid out of public funds. Both of these tremendous expenditures for war will pay rich dividends for peace—if physicists and engineers, who control their destinies, develop themselves as socially minded thinkers.

Today research is being carried on at the rate of 1 billion 100 million dollars annually, exclusive of the budget of the Atomic Energy Commission, to which the government has allotted about 100 million dol-

lars. These figures show that investment in engineering research by the government, industry, and universities has increased at least four times since the last prewar year, when expenditures were about ten times those of 1915.

These trends indicate the increased magnitude of the importance of engineering in daily life and the fact that, today, the federal government is spending about one-third as much for study and control of atomic energy as was spent for all types of engineering research before the war. Looking at it with a larger view, we can only see the increasing importance of the social and economic aspect of engineering.

No longer are physicists and engineers isolated in the chosen channels of their profession. They have become a vital part of national and international society. Today they must mingle with and be compatible with the politician, the layman, the businessman, and others in all walks of life. These are the people who look to them for understanding, interpretation, and control of the release of vast forces of nature created by engineering research.

And, just as the public looks to the engineer, the engineer must look to society and realize new social responsibilities. This calls for a new measure of fitness. One of the personal qualities which surely must be taken into consideration is adaptability. He who resists social progress might as well endeavor to hold back the tide or to stop time.

Now let us become more subjective in our thinking. I say "our thinking" because the problem of adjustment and readjustment is important to all of us. We must make adjustments within ourselves, and we must make readjustments through our efforts toward influence on others. This is a large order today. It means that we can no longer remain aloof from our sales departments, our production departments, and our subordinates. For these people are, in many instances, closer to the public than we are, and our new responsibility is essentially social and economic. Such a responsibility cannot be stratified. It is vertical and boundless. Pride, prejudice, petty jealousy, and cold rationalization of associates and neighbors as irrelevant or unimportant people is a part of our problem.

The time has come, and it has come quickly, when we must constructively analyze our own weaknesses and be tolerant of others whose weaknesses may have many points in common with our own. We must learn to keep uppermost in our minds the axiom that all members of society are becoming utterly interdependent. Engineers are no exception, and doubtless have begun to learn that lesson during the last few years. But, if they have learned only that engineers are interdependent, they have learned only half of a large and costly lesson. They have overlooked, or recognized but slightly, the interdependence of physicists, engineers, all people in general, and economics.

Do not be misled or discouraged by widespread disturbances current today throughout the world. They are merely manifestation of the great change in civilization that is taking place. Our problem is part of the greater problem. Scientists and engineers, in particular, have created new bricks to build the edifice of civilization's future. They are the new type of raw material. Our dilemma of the moment is not the new material, but how to use it. We need to know how to put the new house together and we need a new kind of binder or mortar for those bricks. Our bricklayers may be the common man, society itself. Our job is to show society how to use the new material to build a better structure. In many ways we are now too close to this material to see it clearly, let alone help put it to work.

The old adage, "A house divided against itself cannot stand," might well be amended to say, "A house cannot be erected by builders who stand against themselves." Scientists and engineers, more than any other group, have, wittingly or unwittingly, brought this about. They have advanced new materials for civilization at such a rapid rate that society is fearful, unable to trust or work at ease with the new building material. Some people definitely feel that if the new edifice is erected it will fall down. A new mortar or binder must be supplied for the new building blocks.

This mortar is not a physical material. It is a new spiritual concept of the engineer's social and economic responsibility. This spiritual concept must be put to work on the builders, as well as the building material.

A man from India awhile ago said, in speaking of our many inventions, "Yes, you can fly like birds and you can go through the sea like fish, but to walk together upon earth, that you have not learned." We know how to invent great machines, but we do not know how to live together as human beings. We can send radar pulses to the moon, but not goodwill across a narrow sea. Is there a greater economic problem today than the need for better human relations? Engineering has all but mastered the art of putting inanimate things together or separating them to suit his fancy, but what will this avail us if it results in driving us underground instead of giving us the abundance of all that is fine and beautiful? Is it not time to apply some of the cold, analytical logic used so effectively in solving our physical problems to the recognition of basic laws of human relations, laws of justice and fair dealing, mercy and unselfishness, faith and compassion, which are susceptible to the scrutiny of the cold logic of the mind, but can be fully understood and successfully applied only through the warm emotions of the heart?

We might be helped in such experiments by analogies in the field of natural science. For example, when two chemicals mixed together result in a violent reaction, does the chemist take sides with the one and damn the other, or does he seek to determine the

* Decimal classification: R071. Original manuscript received by the Institute, November 26, 1947. Presented, Rochester Fall Meeting, November 17, 1947, Rochester, N. Y.

† Sylvania Electric Products Inc., Flushing, L. I., N. Y.

cause and understand the reaction and either put it to a good use or avoid the possibility of such a combination in the future? You know the answer. We should be equally as diligent in learning to evaluate the causes for violent reaction between labor and management. Too often, instead of using our minds for a cool analysis of the situation and our emotions in a warm human application of our findings, we let our emotions reach a fever pitch and completely evaporate any semblance of cool thinking. Believe me, it is imperative that we learn to understand and harness the great forces of human relations before we look with any pride on the way we have met our responsibilities in today's economy.

I do not intend to oversimplify the social problems that face us today, but I am afraid there are many who could make real contributions to the crying need who are not doing so, merely because they feel the problem is too complex or far beyond their control.

In this respect, we are far fainter-hearted than many people of lesser capabilities and accomplishments, who, fortunately or unfortunately, have hitherto controlled the gain or loss of social progress in many cities, towns, states, and nations, by close work with the public. These people, and history is full of them, have appealed to the social and economic needs of the large masses of people.

Engineers and scientists will have to develop a sense of social appeal along the same basic principles in an age when science and engineering are vital to all citizens. They will have to pattern themselves as understandable universalists to the mass of people who are essentially provincial in their scope and thinking. This may mean, for some of us, that we must become more democratic, learn to humanize ourselves and our work in our contacts with society. This need not mean that we need sacrifice, but it does mean that we must strive to modify the thinking of those who may now call us "long hairs."

Perhaps an important part in our evolution as servants of society, as well as servants of science and industry, will come easier if we take care to reappraise our part in science and industry as well as in society. Engineers as specialists have played a vital role in the conception and delivery of many brain children of the modern world. They have nursed practical radar out of almost pure physics. They have given birth to the first uses of atomic energy. They have made radio the instrument of instantaneous world-wide communication and of enjoyment in the majority of homes, and have done a pretty good job of putting television and f.m. on a well-tolerated diet for further public enjoyment. These are but fragments of engineering achievements, the well-conceived ideas delivered by our engineering minds.

And I think it is fair to say that engineers have done a good mother-and-father job of it. But, once their lusty brain children begin to grow in industrial, social, and economic importance, they are taken away. This is a good thing. It prevents our becoming dotting parents who spoil their children.

There is, I think, a similarity between the way children were reared a hundred years ago, and today, and the way engineering brain children were brought up a few years

ago, and the way they are brought up today.

A century ago the child was not penalized in later life if his mother and father taught him his three R's and the basic principles of a good life. His obligations to a simpler society required only that he educate himself beyond these primary stages. But today the child would be ill-equipped indeed with only a homespun education. And it is just possible that he might soon evolve into a drag on society or even a criminal type like the late John Dillinger.

So today not only is professional schooling essential for children, from the kindergarten to the university, but a good part of it is required by law. Without much more education, today, the child cannot hope to cope with complex modern society.

Science and engineering also have reached a stage of complex development so that their brain children require far more than the fireside tutor or the Little Red Schoolhouse. They, too, must be turned over to professionals for training at a tender age. Otherwise, they may suffer frustration and be unable to make their best contribution to society.

This is particularly fortunate since scientists and engineers have become the parents of increasingly large families. Sending their older brain children off to school permits more attention to the little ones and assures greater attention to the intimate, formative stages of their lives. This stage is the primary responsibility of the engineer. It is the time he develops and directs the best uses of his brain children in later life.

Perhaps the engineer's secondary social responsibility might be said to begin when he turns his brain children over to the professional educators, the business men, and public servants. At this time he should take an active interest in what corresponds to the Parent-Teachers Association, the channel in which he can influence the school system for good and discourage corruption.

In both of these responsibilities his interest must be social. He must see ahead for the new creation, guide it patiently to an early stage of development, and then do a good public relations job with business men and politicians.

Now I know that some of you will wince slightly when I emphasize the importance of scientists and engineers getting along with their managements and the Government bureaus regulating their activities. But we should not forget that there is ample experience now behind us to show that this new social thinking is of paramount importance today.

The fact that we pyramided achievement on achievement during the war, when we had to get around, be social, and assume a liberal point of view for group achievement, should not be forgotten. It should be a sustaining reason against a cynical point of view about the future of engineering. Nor should the wartime development of our art and science make us feel that what we do will not be overwhelmingly for the good.

There are hundreds of other specific reasons for optimism. A case in point is the electric light bulb. Even in today's inflation cycle it sells for 10 per cent less than it did prewar. This represents a definite contribution, by engineering and production to the

national economy, since hundreds of millions of light bulbs are purchased for home and public service every year. But the few cents saved are small indeed compared to the better social value of the lamp. And by better social value I mean more useful light, less eyestrain; in a word, the saving of human life. Yet the light bulb is but one of a multiplicity of products to which engineers have made a large contribution to society and to national economy.

The fact that a few engineers have been vocal about bringing these contributions out from under the laboratory bushel and the recently accelerated growth of engineering has created new opportunity for engineers at the executive level. This is an increasing trend in the radio field due to the rapid expansion of technological improvements and the fact that the radio industry is still a robust infant.

At the executive level the engineer must have capacity for social thinking, essential to the co-ordination of many different kinds of people, many different kinds of talent, and a variety of markets for his product. His thinking also must not overlook the economy of the operation he directs, with respect to the industry, the nation, and his subordinates. He must learn to look broadly on the problem of maintaining a high standard of living within and outside his company through lower prices and higher wages.

Looking forward, we have several schools of thought about the immediate outlook for the engineering profession. One group says, "We can't afford large expenditures for engineering because we're going to have a depression and should prepare with thrift." A second group says, "Now is the time for increased engineering activity so that we can be prepared to lick a depression if it comes." Still another group thinks that you can always cut engineering activity when a depression comes, and then pick up where you left off when business gets better.

Of these three opinions I support the second, because it recognizes that engineering is a continuing need and is vital to social and economic progress. The third opinion completely overlooks this fact. It assumes that you can turn engineering on and turn off at will and the world will wait. It overlooks the fact that engineering is always ahead of the calendar and the industrial production index, if it is going to be of real service.

The first opinion, and a very common one, is held largely by people who have but a limited concept of the importance of engineering in their business and in the economy of the nation. They betray the crying need for active social and economic thinking by engineers within their own organizations. Their opinions are a rather grim reminder that public relations for the engineer, in many instances, may well begin at home.

It means that engineers should strive to enlist interest and confidence in their work by participating to an increasing degree in company and community activities to make themselves and their work of wide human interest. From this base they should spread their interest and activity in their association affiliations, in which there is often a dire need for increased thinking along social and economic lines with respect to engineering.

I think we are on the threshold of a great new era of opportunities for all members of the engineering profession, provided engineers will learn to realize their full re-

sponsibility and be alert to interests beyond the laboratory and their section of specific creative work. As I have just said, their public relations may well begin at home.

This means a greater interest in other people in all walks of life and at all levels within their own organization, from the top to the very bottom.

Industrial Standards*

C. H. CRAWFORD†, ASSOCIATE, I.R.E.

I. INTRODUCTION

THE GROWTH OF industry in the United States has been closely related to standardization, that kind of standardization which has as its objective the benefit of both the consumer and the manufacturer. Early standardization efforts were directed to the production of identical and interchangeable parts.

About 1800 the use of interchangeable parts was started in clock manufacture. By 1840 the American market was nearing saturation, and shipments were started to England where American clocks sold at about $\frac{1}{2}$ the price of English-made clocks.

In the meantime, the same effort to use interchangeable parts was being made in the field of firearms. Eli Whitney, of cotton-gin fame, took a government order for 10,000 muskets. To quiet criticisms arising from slowness in getting into production, he took parts for 10 muskets to Washington and there assembled 10 muskets from parts selected at random. Since in the past it had been necessary to have replacement parts fitted by a gunsmith, the military advantage of interchangeable parts was immediately apparent.

Standardization based on interchangeable parts is now an old story to us. However, there are other kinds of standardization applicable to industry.

II. STANDARDS

It might be well at this point to consider what we mean by a "standard." Let us review the term and see what we can develop. A dictionary definition¹ indicates that the word may have several meanings or shades of meaning. For instance, we find it defined as, "A flag, emblematic figure, or other object raised on a pole to indicate the rallying point of an army, fleet, etc." With this definition we are not at the moment interested. A further definition lists it as "the authorized exemplar of a unit of weight or measure; anything taken by general consent as a basis of comparison, or established as a criterion." Looking further we find the following: "the legal rate of intrinsic value for coins; the prescribed degree of fineness for gold or silver," and "a grade or level of excellence or advancement generally regarded as right or fitting (as, the standard of living in a community; standards of comfort); and the like.

We see that some of these standards are quite permanently fixed, while others vary with the times.

In order to discuss these various classes of standards we will divide them for con-

venience into, (1) fixed standards, and (2) variable standards.

To establish a reference level for the present discussion, we will say that fixed standards are those which we in industry cannot control, while variable standards are those we are free to change as conditions warrant.

A. Fixed Standards

Under fixed standards will be classified those standards which are legally defined or based upon physical laws. We have to use these standards whether we agree with them or not. Our system of weight and measures is a standard set by law. Standard time is another.

The rules and regulations set up by the Federal Communications Commission are fixed standards to us because they are backed by legal power. These rules and regulations set up system limits on such things as system noise, distortion, frequency response, etc. We in industry have to determine how to divide up the total allowable limits between the various parts of our system, so we create standards to do this.

B. Variable Standards

Referring back to our definitions of a standard, we find that many things which affect industry are those related to varying standards. Some of these standards are in a continual state of flux. These are the sort of standards which are described above as "standard of living," "standard of comfort," and by similar terms. We are all well aware of the fact that this type of standard changes continuously. We can very well remember that the standards of living and standards of comfort were quite different during the war years than they are now. They are different now than they were before the war. Our industrial standard may be considered as a special case of the variable standard.

III. INDUSTRIAL STANDARDS

The term "industrial standard"² is used to cover standardization done by industry. Our industrial standard may become quite a complicated document. In many cases it will refer to other standards. Included may be both fixed and variable standards. That this same situation exists in other fields is apparent from a further reference to Standard Time.

Standard Time as defined by law is a combination of a fixed standard determined by nature and a variable standard determined by man. The day consists of twenty-four hours. Now the divisions of time into hours, minutes, and seconds is a man-made

division. It could conceivably be changed into other divisions. However, there is nothing we can do about the rotational speed of the earth, which determines the length of the day.

The use of an industrial standard is voluntary. Such a standard must be a living, growing standard which changes with the conditions influencing it. It must keep step with the changing standards of living and with the new developments of the art. A very good example of this sort of a standard is one which affects the well-being of all of us. This is the National Electric Code. We are all affected by this code since it governs the installation of electrical wiring, switches, and similar devices in practically all industrial and business buildings in the country. The important point in connection with this code is the fact that it is in a continual process of revision. At intervals approved changes are incorporated in a new revision of the code. In this way all satisfactory and proven new devices, methods, and materials are brought into use as soon as they have justified themselves. Thus, it is recognized that an industrial standard cannot be written up and then neglected. It must be reviewed and kept up-to-date as the art progresses. If the National Electric Code had been made up as a fixed standard, or if no provisions were made to revise or modify it, the entire electrical industry would have broken down during the war when rubber for insulation became practically unobtainable. However, the standard was not held rigidly, but rather was allowed flexibility by the issuance of emergency requirements. Some of these have proved themselves to the point where they show advantage over previous requirements, and can be included in revised issues of the code.

A. Structure of the Industrial Standard

Our industrial standard like many other standards will have both fixed and variable parts. For instance, once we have set certain standard physical sizes for a given item, it is very desirable that these not be changed without considerable serious thought. At the same time we may give ratings to each of these various physical sizes. Yet we know that tomorrow someone is going to come along with new developments which will allow these same ratings to be put into smaller physical sizes; or, on the other hand, that any physical size we now have can be used or greater ratings than are presently covered by our standard.

Here is the place where the variable feature enters. After a time, when conditions have changed, we may decide that the limitations of ratings presently in effect on these physical sizes are now too stringent, and that the standard should be revised to

* Decimal classification: R020. Original manuscript received, November 5, 1947.

† General Electric Company, Syracuse, N. Y.

¹ The New Century Dictionary, D. Appleton Century Co., New York, N. Y.

² See "Industrial Standardization, Studies in Business Policy #22," National Industrial Conference Board, Inc., New York 17, N. Y.

change them. As an alternative, we may decide that the present standard is no longer useful and should be discarded. You will note that we have not changed physical dimensions or sizes in the above discussion nor is it anticipated that existing ratings will be discarded.

As an example, consider a standard covering molded-mica capacitors. This will delineate case sizes and also will give ratings which can be put in the various case sizes. Once we have set up case sizes and industry is tooled for them, both the user and the vendor are going to be very reluctant to change them. However, if developments are made which will allow a higher rating in a given case size, we can change our standard to include this higher rating. This increased rating may make certain sizes or even complete lines of ratings in other cases uneconomical. These will be eliminated in due time by natural economic laws.

B. When to Standardize

It is important to consider when we should standardize. Rapid changes are being made in the field of electronics, and a great many more changes will be made before this field becomes stabilized to the point which we find in many older activities. In view of this, it is desirable that our industrial standards be made available to the industry as rapidly as possible, even though, in some cases, they may not have reached the ultimate refinement.

Many times standardization is attempted only after a number of similar products are on the market. Standardization is then started as a sort of afterthought, possibly in an attempt to correct now-apparent errors and to bring various products into one standard. Thus standardization becomes only a procedure to correct past errors. It is rather obvious that such standardization is very difficult and creates many dissatisfied participants. No one desires to change molds or tools which he has currently in use, nor in many cases can he stand the economic loss which would occur if he did so. Such standardization, then, can be obtained only with extreme difficulty and at the expense of long delay. To avoid such conditions it is evident that standardization must be started early in the development of a new product or line of equipment.

C. Who Should Standardize

Standards must be created by individuals who have a definite interest in the subject at hand, and who have shown that they are competent and have the ability to be honest and impartial in setting up the requirements for the standard. Such individuals are available in all of our respective companies. It is only necessary to select the proper person to work on the standard in question.

In some cases considerable work has already been done on the item being standardized. The individuals on the committee will know of such work and should take advantage of it as far as it is satisfactory. For instance, on current RMA component standards much work done on JAN Specifications can be used, particularly the sizes and ratings. Many other parts of JAN Specifications are not suitable for commercial standards. One can see that all such material

must be carefully reviewed by the committee before being used. Where it is not suitable, new material must be developed.

D. Acceptability of Standards

In writing standards we must consider that, by necessity, they have to be acceptable to a great many different people. This in itself creates a very difficult task, since we must be prepared logically to show how our standards can be of value to the various persons who will be affected by them.

E. Advantages of Industrial Standards

Let us consider briefly some of the reasons why the standardization of things commonly used is an advantage to us. During the postwar scarcities of materials, we find that very much of our engineering effort is expended in checking substitutions and replacements of parts which are similar but on which there are no uniform requirements to indicate the comparative merits or characteristics of the alternate item. If such items had been made up to a uniform standard, we could save considerable of our engineering time in checking to determine if the alternate item would meet the requirements of the item for which a substitute is desired. Thus, from the standpoint of the user, a standardized item is desirable. It can be obtained from more than one source and applied without the further engineering effort necessary to test and determine if it is satisfactory and interchangeable. The engineering time so saved can be used to do creative engineering work looking towards new and improved products.

From the standpoint of the supplier, similar advantages accrue. Having once set up to produce a standardized item, the vendor will have the advantage of one product instead of many similar products, thereby allowing greater production of one item. His field of possible sales for this product will also be broadened, since the use of many nonstandard items will be minimized in favor of a standard item. Here, again, routine production engineering is reduced, with the result that the vendors' engineers can spend more time in creative engineering looking towards the development of new and improved products. The net result of this is that we will all be making more and better products, at less cost, for more people.

However, we will not obtain these advantages unless we have the standards to use. Since our standards are accepted voluntarily, we have many conflicting ideas to reconcile when writing a standard. Having a committee of competent people write the standard gives us a basis on which to make progress. Personal experience shows that these committees have to resolve many differences of opinion. In some cases no compromise seems possible, so the subject in question must be passed over until later. Realizing that there may be certain subjects upon which agreement cannot be immediately reached, we should first include all of that area of the problem upon which real agreement can be obtained. Then we can consider the advisability of issuing a standard, including the above "area of agreement" together with a complete outline covering all phases of the problem.

This will allow the issuance of a standard

which takes cognizance of all of the ramifications and requirements for the subject in question, even though certain sections may have to be determined later. Such a standard should save considerable time and engineering effort for the various member companies, since it outlines the points which must be covered in specifying a product. It is only necessary then for the user to fill in his requirements for the missing section, at which time he has a complete specification for his own use. At first glance this may appear to be additional work for the person using the standard. It may be said that he might just as well make up a complete standard. However, the following advantages seem apparent.

By having a uniform outline for the standard even though it is not complete, time is saved for the purchaser since he only has to add certain points to be otherwise complete standard. The possibility of omitting important requirements is minimized. We are also simplifying the problem of the vendor, since he will be acquainted with the standard and will only have to check the variables to meet the customer's requirements.

Another advantage of having an accepted outline for the standard, with a number of important points covered, is that we make a very definite gain towards obtaining a complete standard. It channels everybody's thinking along these particular lines. We can then forget about the general subject and commence working on the missing parts.

IV. STANDARDIZATION IN THE ELECTRONICS INDUSTRY

In the electronics industry, standardization efforts have been divided between I.R.E. and RMA. This division, as recently worked out by the RMA-I.R.E. Co-ordination Committee, is as follows:

"Institute of Radio Engineers: (1) Fundamental Terms, Definitions, and Symbols, and (2) Fundamental Methods of Testing Materials and Apparatus in order to determine their important characteristics."

"Radio Manufacturers Association: (1) Standardization of size and characteristics of apparatus to promote interchangeability, and (2) setting of standard ratings for the properties or performance of material or apparatus, including specific definitions and methods of testing as are necessary therefor."

Here we see that a division has been made such that, in general, I.R.E. has the fixed standards, while RMA has the variable standards. From previous comments it can be seen that such a division is never absolute. There are always exceptions.

Since we are here principally interested in the variable or industrial standard, let us consider the RMA program.

V. RMA STANDARDIZATION PROGRAM

Those who have recently read the preamble to the constitution of RMA, will remember the objects set for the Association. Quoting partially, these objects are: "To foster, encourage and promote laws, rules, regula-

tions, customs and practices which will be for the best interest of the public and the radio industry."

Current rules covering standardization are given in Section V of the Organization and Working Rules. Since this section has recently appeared with each Standards Proposal, it will not be quoted here.

1. Definitions

The following definitions indicate the various sorts of technical information which RMA may issue. These definitions are substantially copied from previous issues of the Organization and Working Rules.

a. RMA Standard

Definite RMA Standards may include: Definitions, Nomenclature, Symbols; Testing Methods and Apparatus; Performance Ratings, Capacities and Limits; Manufacturing Dimensions and Tolerances; Safety Provision.

b. RMA Recommended Practice

Any suggestion or practice which at the time of consideration may be thought unsuitable for adoption as an RMA Standard, but which is desirable to recommend as uniform practice, may be approved as an RMA Recommended Practice.

c. RMA Engineering Information

Any technical information of sufficient value to warrant publication, but which is not a subject for standardization, may be included in the section entitled "Engineering Information."

Thus we have several classes or grades under which we may issue technical information.

A number of "Standards," "Recommended Practices," and "Engineering Information" releases have already been made.

2. Subjects Covered by Industrial Standards

Now let us consider briefly what we should have in an industrial standard.

As a minimum, the following subjects should be included as applicable: (a) definitions; (b) dimensions and tolerances; (c) ratings; and (d) test procedures.

Definitions should clearly compass the subject being defined. It is suggested that the form of definitions be similar to definitions given in "American Standard Definitions of Electrical Terms."¹ Applicable terms listed in that publication or otherwise well defined and understood should not be redefined with a new or restricted meaning.

Dimensions and tolerances are of particular importance for components, and probably of no importance on a broadcast transmitter. Considerable time is now being spent in Component committees in trying to rationalize sizes. This emphasizes the need of standardizing early in the development of an item.

Ratings must be determined based on current knowledge. The rating for such items as transmitters may be affected by F. C. C. requirements, while ratings of components may have to be a compromise based on agreement between the various suppliers and users.

Test procedures must be adequate, but

not oppressively severe nor lengthy. They must be adequate to determine compliance with F. C. C. requirements as applicable. For other items they must be adequate to determine that the level of quality is equal to that set by the standard.

3. Form of Standards

In our current setup, the main committee for a general subject acts as a steering committee for the various subcommittees. This committee establishes the general policy in writing up standards and answers such questions as the subcommittee may have from time to time on the subject in question or on general matters of procedure.

Another matter which this main committee might well do would be to set up an outline of a standard for the type of subject which is being standardized in the subcommittees. This would cover all of the major points which must be considered for the particular subject in question. The advantage apparent from this is that the various standards written would then all follow the same general outline. This makes it simple for a person to check from one to another, to find a particular type of information. In other words, all information on physical dimensions would be in one section of all standards, and so on. Thus such subjects would be easier to find and compare. On the other hand, if a certain section of the outline were not applicable, it could be deleted. In general, the members of these subcommittees are more interested in the technical features of the standard than in its layout or how it is put together. This is understandable, since the persons working on the standards are those who are closely interested in the subject in question and not in general procedure. An outline should save them time.

This procedure would also have advantages in such cases as components, where a type number is usually developed. At the present time there is no generally accepted rule for composing a type number. As a result, it is likely that a number of dissimilar sorts of type number will appear. It also might conceivably happen that two different groups would arrive at the same type number for entirely different items.

At the present time there are two general forms of standard proposed in the Transmitter Section of RMA. One of these is exemplified by the "Electrical Performance Standards for Standard Broadcast Transmitters." The various points to be standardized are listed as major headings, and under each heading are the subheadings: (a) Definition; (b) Standard; and (c) Method of Measurement. The other form is the type exemplified by the "Standard for Dry Type Power Transformers for Radio Transmitters." Here all definitions are under one heading, performance standards under another heading, etc. Either form has certain advantages. For components the latter form is probably best, while for equipment the former may be handier.

4. Summary

Now let us summarize some of these points as a suggested procedure to be followed in RMA.

(a) First, let the main committee provide a general outline for the subject in question.

As previously mentioned, the subcommittee members are experts on the subject they are standardizing. They are not interested in the form of the standard, and will, no doubt, be glad to get on with the business of providing the technical part of the standard without bothering with details of its form. The use of a uniform outline for the standard will also make it more convenient to use the standard. Certain information will always appear in the same relative place in different standards.

(b) The second point is this: Write the standard as completely as possible covering the area of actual agreement. If standards for certain points cannot be agreed to, it is possible that agreement may be obtained for statements as "Recommended Practice," or even as "Engineering Information." In a few instances it may even be necessary to leave items with the comment, "To be determined later."

This procedure will get the problem before the RMA membership at the earliest possible date. Experience with the actual use of the standard will then allow corrections, changes, additions, or deletions to be made as the need becomes apparent.

(c) The third point is that we must continuously monitor the standard for changes. It is suggested that the committee which originates a standard should meet all regular intervals to consider how the standard is working, as well as to receive comments of the membership on its use. As necessary, revisions should be initiated based on current requirements. For a time after a standard is issued such meetings may be necessary at quite frequent intervals. However, as the initial faults of the standard are found and corrected, the need for such meetings should become less and less, until very infrequent meetings are required.

(d) Fourth, we should decide when we can have the Standard available. In other words, let us set a delivery promise. When building a transmitter we make schedules for the various related activities. We know that we must stop development at some point and build sets; otherwise we would not long remain in business. Improvements are then made in a new design for future production. We could well use this same principle in writing standards.

(e) The fifth point concerns early standardization. Let us get our standards set up early on new subjects so that they will not be afterthoughts and corrections, but rather lead the field in a direct and suitable path to its ultimate goal. If you have a subject on which you believe standardization is desirable, submit it to the RMA Engineering Department.

(f) A program such as we propose will require that we all exercise tolerance. When we are asked to review a standard proposal, let us look at it from the standpoint not only of its present adequacy but also from the standpoint of into what it can be developed. It may not have all of our personal ideas embodied in it. The important point is that we can use it until experience shows that changes are desirable and necessary from the standpoint of all users. If it is the best compromise currently possible, let us accept it, and then work towards further improvements.

¹"American Standard Definitions of Electrical Terms," American Institute of Electrical Engineers, New York, N. Y.

Radio Progress During 1947*

Introduction

DURING 1947 the fruits of wartime research and development were being rapidly integrated into the equipment and processes in every day use. This trend was clearly evident in many radio fields. For example, new radio navigational aids were applied on a wide scale, for the first time, to commercial flying. Instrument approach systems, runway localizers, GCA (ground-controlled approach), and other aids were put into service. Airborne and shipboard radar were placed in commercial operation during 1947.

In the industrial field, electronic methods and techniques were applied on a scale never equalled before. Digital computers, radio-frequency heating apparatus, photoelectric controls, electronic servo systems, and the like, came in for considerable application and were the subject of further development.

Antenna developments recorded during 1947 were mainly in the microwave and very-high-frequency ranges. This was to be expected in view of the preponderance of effort expended in these fields during the war.

The development of power-output tubes during the period December, 1946, to November, 1947, proceeded in the United States mainly along the line of design and improvements of tubes for frequencies from 100 to 1000 Mc. having in view their application to f.m. and television broadcasting. Another line of development was the design and improvement of tubes for operation on frequencies from 20 to 100 Mc. for dielectric heating in industrial applications. Several large tube manufacturing concerns put considerable effort into improvement of forced-air cooling of medium- and large-size tubes. Special efforts were made in some other countries to make use of microwave generators for television and f.m. transmission.

During 1947, television receiving-set production lines got under way on a large-enough scale to meet the existing demand. For the first time, television receiver supply was adequate to insure prompt delivery to the purchaser. In the f.m. home receiver field a number of new circuits were developed with the view of simplifying f.m. set manufacture without loss in performance. Many of these developments found their way into current production. In addition, f.m. converters made their appearance in considerable number.

In the audio-frequency field, the year saw the introduction into commercial production of several loudspeakers having superior performance characteristics.

In general, dual driving units, capable of covering almost the entire audio-frequency spectrum, were used. Some of these loudspeakers were characterized by their excellent, nondirectional radiation patterns. Furthermore, considerable interest was aroused by current studies into listener tonal-range preferences.

The broadcasting industry in the United States experienced a large expansion in number of stations during 1947.

TABLE I
RADIO BROADCAST STATIONS FOR WHICH LICENSES AND CONSTRUCTION PERMITS ISSUED BY THE FEDERAL COMMUNICATIONS COMMISSION WERE OUTSTANDING ON DECEMBER 31, 1947

Class of Broadcast Station	Number of Licenses and Construction Permits
Standard	1962
Commercial high-frequency (frequency-modulation)	787
Conditional grants	223
Commercial television	73
Experimental television	91
International	37
Facsimile	2
Noncommercial educational	40
Developmental	23
Studio-transmitter	6

The International Radio Conference, which met in Atlantic City from May 15 to October 2, 1947, drew up a revised table of allocation of frequency bands to radio services, to supersede the table adopted at the Cairo Conference in 1938. The Conference also adopted revised technical standards and definitions relating to frequency tolerance and bandwidth. One of its committees prepared extensive summaries of radio propagation data and of other technical factors applicable to the proper separation between radio frequency assignments. An international engineering group, called the Provisional Frequency Board (PFB), is to prepare a new list of the operating frequencies to be used by all international radio communication stations for which requirements are submitted by the countries of the world, this list being subject to review at a special international radio conference. Thereafter, an International Frequency Registration Board (I.F.R.B.) is to review all new international radio frequency assignments from the standpoint of radio interference. The I.F.R.B. is also authorized to recommend changes in frequency assignments where this will result in more efficient use of the radio frequency spectrum. The International Radio Consultative Committee (C.C.I.R.) is to have a full-time director and a vice-director, with continuing study groups to formulate recommendations on technical and operating questions relating to international radio communication.

* Decimal classification: R090.1. Original manuscript received by the Institute, January 21, 1948. This report is based on material from the 1947 Annual Review Committee of The Institute of Radio Engineers, as co-ordinated and edited by the Chairman.

- (1) Final Acts of the International Telecommunications and Radio Conferences at Atlantic City, N. J., 1947. Copies available from the American Radio Relay League, West Hartford, Conn.; price \$1.50. Copies are also available from the Secretary-General of the International Telecommunications Union, Geneva, Switzerland.

Modulation Systems and Radio Transmitters

Transmitter development was vigorously pursued throughout the world in response to the needs of point-to-point, marine, and aviation communication, and of broadcasting services. Much of the material that was published pertained to microwave techniques, radio relaying, frequency-modulated transmitters, and pulse-modulated transmitters and systems.

Pulse Modulation

Considerable general progress was reported during 1947, especially in the evaluation of the theoretical and practical advantages and disadvantages of pulse systems. As a means of expediting the application of pulse technique to pulse-modulation systems, many improved circuits and special components were developed.

- (2) A. S. Gladwin, "Pulse modulation," *Wireless Eng.*, (Letter to the editor), vol. 23, pp. 288-289; October, 1946.
- (3) V. A. Altovsky, "The principal factors underlying multi-channel radio telephone systems at ultra high frequencies," *l'Onde Elec.*, vol. 26, pp. 401-417; November, 1946.
- (4) J. C. Lozier, "Spectrum analysis of pulse modulated waves," *Bell Sys. Tech. Jour.*, vol. 26, pp. 360-387; April, 1947.
- (5) E. R. Kretzmer, "Distortion in pulse-duration modulation," *PROC. I.R.E.*, vol. 35, pp. 1230-1235; November, 1947.
- (6) L. L. Rauch, "Fluctuation noise in pulse-height multiplex radio links," *PROC. I.R.E.*, vol. 35, pp. 1192-1197; November, 1947.
- (7) H. R. L. Lamont, R. G. Robertshaw, and T. G. Hammerton, "Microwave communication link," *Wireless Eng.*, vol. 24, pp. 323-332; November, 1947.
- (8) M. M. Levy, "Some notes on pulse technique," *Jour. British I.R.E.*, vol. 7, pp. 99-116; May-June, 1947.
- (9) C. Potier, "Methods and devices used in multi-channel pulse transmission," *l'Onde Elec.*, vol. 27, pp. 215-230; June, 1947; pp. 284-291; July, 1947.
- (10) D. D. Grieg, J. J. Glauber, and S. Moskowitz, "The Cyclophon: A multi-purpose electronic commutator tube," *PROC. I.R.E.*, vol. 35, pp. 1251-1257; November, 1947.
- (11) D. G. Tucker, "Pulse distortion: The probability distribution of distortion magnitudes due to inter-channel interference in multi-channel pulse-transmission systems," *Jour. I.E.E.*, vol. 93, part III, pp. 323-334; September, 1946.

Early in 1947, additional information was published describing the circuits and transmission performance of pulse-modulation systems developed for the Army. These systems afforded extensive and reliable communication networks over distances of several hundred miles. A new 24-channel pulse-time-modulation system was announced. Three microwave radio systems, two 8-channel systems and one 16-channel system, each employing pulse-position modulation, were placed in commercial telephone service. Other pulse-modulation systems were utilized for a variety of purposes. An outstanding example was the application of pulse modulation to telemetering, thereby permitting a more useful system and simpler equipment.

- (12) H. S. Black, J. W. Beyer, T. J. Grieser, and F. A. Polkinghorn, "A multichannel microwave radio relay system," *Trans. A.I.E.E. (Elec. Eng.)*, December, 1946), vol. 65, pp. 798-806; December, 1946.
- (13) B. Trevor, O. E. Dow, and W. D. Houghton, "Pulse time division radio relay," *RCA Rev.*, vol. 7, pp. 561-575; December, 1946.
- (14) R. E. Lacy, "Two multichannel microwave relay equipments for the United States Army communication network," *Proc. I.R.E.*, vol. 35, pp. 65-70; January, 1947.
- (15) F. Altman and J. H. Dyer, "Multiplex broadcasting," *Elec. Eng.*, vol. 66, pp. 372-380; April, 1947.
- (16) D. D. Grieg and H. Gallay, "Pulse-time-modulated multiplex radio relay system—radio frequency equipment," *Elec. Commun.* (London), vol. 24, pp. 141-158; June, 1947.
- (17) E. Labin, "Microwave radio relay systems," *Elec. Commun.* (London), vol. 24, pp. 131-140; June, 1947.
- (18) V. L. Herren, C. H. Hoepfner, J. R. Kauke, S. W. Lichtman, and P. R. Shifflett, "Telemetering from V-2 rockets," *Electronics*, vol. 20, pp. 100-105; March, 1947.
- (19) L. L. Rauch, "Electronic commutation for telemetering," *Electronics*, vol. 20, pp. 114-120; February, 1947.
- (20) A. Van Weel, "48-channel FM phone transmitter," *FM and Telev.*, vol. 7, pp. 28-30, 54, 58, 61; March, 1947.

A new pulse communications technique, known as p.c.m. (pulse-code modulation or pulse-count modulation), was announced. In this system each original message wave is sampled periodically at a rate somewhat in excess of twice the highest message frequency. These samples are quantized into discrete steps. In addition, each quantized sample is assigned a particular pulse code, the code assigned being uniquely related to the magnitude of the quantized sample. This gives rise to various patterns of coded pulses (for example, on-or-off pulses) which are then transmitted over the medium. At the receiving end, each code pattern is identified, decoded, and caused to produce a voltage proportional to the original quantized sample. From a succession of such samples, the original wave can be approximated. By making each quantum step sufficiently small, the original wave can be approximated as closely as desired.

Pulse-code modulation affords marked freedom from noise and interference. It also allows the use of regenerative repeaters, thereby permitting the repeating of signals again and again without distortion. To illustrate the clear transmission which this new type of system affords, both speech and music were sent over a p.c.m. system and reproduced through loudspeakers. A vacuum tube which electronically converts the human voice into coded patterns was also displayed. It was reported that, in a 96-channel model now under development, such tubes will handle code signals at a speed of 5,376,000 pulses per second. Pulse-code modulation can be used also to transmit radio programs, pictures, and teletypewriter signals.

- (21) L. A. Meacham, "An experimental pulse code modulation system for ninety-six channels." Presented, New York Section, I.R.E., October 1, 1947.
- (22) H. S. Black, "Pulse code modulations," *Bell Lab. Rec.*, vol. 25, pp. 265-269; July, 1947.
- (23) W. M. Goodall, "Telephony by pulse code modulation," *Bell Sys. Tech. Jour.*, vol. 26, pp. 395-409; July, 1947.
- (24) H. S. Black and J. O. Edson, "PCM equipment," *Elec. Eng.*, vol. 66, pp. 1123-1125; November, 1947.
- (25) D. D. Grieg, "Pulse count modulation system," *Tele-Tech.*, vol. 6, pp. 48-52, 98; September, 1947.
- (26) A. C. Clavier, P. F. Panter, and D. D. Grieg, "PCM distortion analysis," *Elec. Eng.*, vol. 66, pp. 1110-1122; November, 1947.
- (27) R. R. Batcher, "Pulse code modulation method for multi-channel telephony," *Tele-Tech.*, vol. 6, pp. 28-33; July, 1947.

A symposium was presented dealing with an extension of the theory of the relation between the bandwidth used by a communication system and its capacity to transmit information. The additional element discussed was the signal-to-noise ratio. It was brought out that, depending on the method of modulation, the greater the signal power, the narrower the bandwidth required for the transmission of a given amount of intelligence. The methods of modulation referred to included amplitude modulation, frequency modulation, pulse-time modulation, and pulse-code modulation.

- (28) "Bandwidth vs. noise in communication systems." A review of a symposium before the New York Section of the I.R.E., November 12, 1947, on recent advances in the theory of communication participated in by A. G. Clavier, B. D. Loughlin, J. R. Pierce, and C. E. Shannon. *Electronics*, vol. 21, pp. 72-75; January, 1948.

Radio Transmitters

While very little work relating to radio transmitters of a fundamentally novel nature was reported during 1947, some descriptive papers were published.

- (29) E. Meili, "Modern 1 kw transmitters," *Brown-Boveri Rev.*, vol. 33, pp. 172-174; August, 1946.
 (30) M. G. Favre and E. Guyer, "A new 10 kw radiotelegraph transmitter," *Brown-Boveri Rev.*, vol. 33, pp. 175-178; August, 1946.
 (31) M. Toussaint and A. Sev, "The problem of synchronization in radio broadcasting networks," *Ann. de Radioelec.*, vol. 2, pp. 253-269; July, 1947.
 (32) W. H. Doherty, "Notes on modulation of AM transmitters," *W. E. Oscillator*, No. 5, pp. 22-23, 38; October, 1946.
 (33) L. C. Killian and F. Hilton, "Engineering a 250 watt BC transmitter for FM," *Tele-Tech.*, vol. 6, pp. 68-70; January, 1947.
 (34) R. L. Norton, B. O. Ballou, and R. H. Chamberlin, "KSBK's 50 kw FM transmitter," *Electronics*, vol. 20, pp. 80-84; October, 1947.
 (35) W. C. Hollis, "Transmitter for the Citizens Radio Service," *Electronics*, vol. 20, pp. 84-89; November, 1947.
 (36) W. L. Lyndon, "A new 50 kw AM transmitter," *Broadcast News*, No. 45, pp. 8-17; June, 1947.
 (37) D. H. Hughes, "Amplitude-modulated communication in the V.H.F. band," *Electronic Eng.* (London), vol. 19, pp. 143-146, 151; May, 1947.
 (38) P. A. T. Bevan, "High power television transmitters—some aspects of their design," *Electronic Eng.* (London), vol. 19, pp. 138-142; May, 1947 and pp. 181-184, 204; June, 1947.
 (39) N. H. Young, "Color-television transmitter for 490 megacycles," *Elec. Commun.*, vol. 23, pp. 406-414; December, 1946.
 (40) W. J. Gillule, "Single-unit radio equipment for passenger and cargo vessels," *Elec. Commun.*, vol. 23, pp. 468-470; December, 1946.

Occasional papers appeared on the development of transmitter components and circuit elements.

- (41) T. A. Hunter, "Precision master oscillators," *Tele-Tech.*, vol. 6, pp. 71-73, 125-126; February, 1947.
 (42) M. Marks, "Cascade phase-shift modulator," *Electronics*, vol. 19, pp. 104-109; December, 1946.

Miniature transmitter developments using printed circuits were also described.

- (43) C. Brunetti and R. W. Curtis, "Printed circuit techniques," National Bureau of Standards Circular No. 468; November 14, 1947.

Additional papers were published during 1947 relating to work done during the war on the subjects of radar and microwave techniques.

- (44) O. L. Ratsey, "Radar transmitters: a survey of developments," *Jour. I.E.E.*, vol. 93, part IIIA, No. 1, pp. 245-261; 1946.
 (45) R. V. Whelpton, "Mobile metre-wave ground radar transmitters for warning and location of aircraft," *Jour. I.E.E.*, vol. 93, part IIIA, No. 6, pp. 1027-1042; 1946.

- (46) T. S. England, "The development of decimeter-wave radar transmitters for the Royal Air Force," *Jour. I.E.E.*, vol. 93, part IIIA, No. 6, pp. 1016-1026; 1946.
 (47) K. J. R. Wilkinson, "Some developments in high-power modulators for radar," *Jour. I.E.E.*, vol. 93, part IIIA, No. 6, pp. 1090-1112; 1946.
 (48) D. F. Gibbs and B. W. Lythall, "High-power pulsed transmitters for the region of 3000 mc/s," *Jour. I.E.E.*, vol. 93, part IIIA, No. 1, pp. 266-267; 1946.
 (49) H. de B. Knight and L. Herbert, "An enclosed spark-gap for overvoltage protection," *Jour. I.E.E.*, vol. 93, part IIIA, No. 6, pp. 1058-1062; 1946.
 (50) W. S. Melville, "Theory and design of high-power pulse transformers," *Jour. I.E.E.*, vol. 93, part IIIA, No. 6, pp. 1063-1080; 1946.
 (51) J. M. Dodds and J. H. Ludlow, "The C.H. radiolocation transmitters," *Jour. I.E.E.*, vol. 93, part IIIA, No. 6, pp. 1007-1015; 1946.
 (52) B. W. Lythall, "Frequency instability of pulsed transmitters with long wave guides," *Jour. I.E.E.*, vol. 93, part IIIA, No. 6, pp. 1081-1089; 1946.
 (53) H. Wood, "A technique for the production testing of radar responders," *Jour. I.E.E.*, vol. 93, part IIIA, No. 6, pp. 1113-1114; 1946.
 (54) D. M. Mackay, "A multiple-pulse generator for synchronized transmitter systems," *Jour. I.E.E.*, vol. 93, part IIIA, No. 7, pp. 1199-1206; 1946.
 (55) J. P. Kinzer and I. G. Wilson, "Some results on cylindrical cavity resonators," *Bell Sys. Tech. Jour.*, vol. 26, pp. 410-445; July, 1947.
 (56) J. R. Pierce and W. G. Shepherd, "Reflex oscillators," *Bell Sys. Tech. Jour.*, vol. 26, pp. 460-681; July, 1947.
 (57) F. S. Goucher, J. R. Haynes, W. A. Depp and E. J. Ryder, "Spark gap switches for radar," *Bell Sys. Tech. Jour.*, vol. 26, pp. 463-620; October, 1946.
 (58) E. Peterson, "Coil pulsers for radar," *Bell Sys. Tech. Jour.*, vol. 26, pp. 603-615; October, 1946.
 (59) W. S. Hinman, Jr. and C. Brunetti, "Radio proximity-fuse development," *Proc. I.R.E.*, vol. 34, pp. 976-986; December, 1946.

F.m. and television broadcasting services continued their expansion, especially in the United States. Public telephone services to mobile stations (busses, taxicabs, trucks, and private cars) were extensively used and were being expanded. Point-to-point radiotelegraph services began conversion to teleprinter operation, and the use of frequency-shift keying and two-tone voice-frequency carrier on single-sideband increased. V.h.f. and microwave relaying began to take a place in long-distance overland communication, as experimental projects approached commercialization. The Western Union relay system from New York City to Philadelphia continued in use throughout the year, and construction of the Western Union radio relay system from New York City to Washington to Pittsburgh to New York City actively advanced. The American Telephone and Telegraph Company experimental radio relay system from New York City to Boston reached the stage of successfully transmitting television programs and telephone conversations. Many British and European organizations concerned with communication devoted activity to radio relaying. There was an increasing use of automatic conversion from Morse to teleprinter codes and vice versa, as a means of improving the efficiency of traffic handling between the two systems.

- (60) E. Hance, "Radio beam link for pumping plant," *Brown-Boveri Rev.*, vol. 33, pp. 114-115; April-May, 1946.
 (61) E. Huber, "The present state of development of Brown-Boveri multi-channel beam equipment," *Brown-Boveri Rev.*, vol. 33, pp. 182-185; August, 1946.
 (62) L. E. Thompson, "A microwave relay system," *Proc. I.R.E.*, vol. 34, pp. 936-942; December, 1946.

- (63) S. Sparks and R. G. Kreer, "Tape relay system for radio-telegraph operation," *RCA Rev.*, vol. 8, pp. 393-426; September, 1947.
- (64) A. G. Clavier and G. Phelizon, "Paris-Montmorency 3000-megacycle frequency-modulation radio link," *Elec. Commun.*, vol. 24, pp. 159-169; June, 1947.
- (65) G. N. Thayer, "New York-Boston radio-relay system," presented, New York Section of the I.R.E., December 3, 1947.

Mobile-portable television microwave program links were extensively used in service and in demonstrations in the U. S. A. and in Italy. During the annual convention of the National Association of Broadcasters at Atlantic City in September, 1947, television programs were relayed by radio from New York City and Jamaica, N. Y., to Atlantic City via Philadelphia and successfully reproduced on ordinary and on large-screen receivers, and shown to large audiences. This demonstration was witnessed by many of the delegates to the International Telecommunications Conference in session at Atlantic City. At times there were six radio relays used in this demonstration.

- (66) W. J. Poch and J. P. Taylor, "Microwave equipment for television relay service," *Broadcast News*, No. 44, pp. 20-27; October, 1946.

Several treatises have appeared in various European technical publications in Italian, Spanish, and French on the general theory and present status of f.m. transmission. These were digests of modern technology on the subject intended for instructional purposes.

- (67) Of particular merit was a series of articles on "Frequency Modulation," by P. Besson, in *L'Onde Électrique*, vol. 26, pp. 7-25, January; pp. 74-91, February; pp. 107-130, March; pp. 155-172, April; pp. 204-214, May; pp. 239-256, June, 1946.

Navigation Aids

Activity in the field of radio aids to navigation during 1947 was directed toward the civil application of systems and equipment developed for war use.

Radar

Several commercial forms of radar were introduced for merchant-ship service, and loran was also widely used in the merchant marine. Shoran, a transponder beacon system, was used for exploration and precise mapping of islands and coastlines. In aviation, radar continued to be used primarily as a ground aid, although the APS-10 airborne radar was used to a limited extent, and the APS-42 was developed specifically for airline use. Over 1000 transoceanic flights per month were scheduled with loran navigation service. Development of the low-frequency loran service was interrupted to some extent by the reallocation of frequencies proposed at the Telecommunications Conference at Atlantic City which reassigned the l.f. loran service from a band near 180 kc. to one centered at 100 kc., at which frequency development work is now being continued. The postwar interval necessary for their preparation having been completed, several comprehensive books on radar systems and equipment made their appearance.

The following bibliography lists the publications, besides those listed under other headings, which relate to

navigation aids and which have appeared since the 1946 review:

Books on Radar

- (68) "Very High Frequency Techniques," 2 volumes, by the Staff of the Radio Research Laboratory, Harvard University, McGraw-Hill Book Co., Inc., New York, N. Y., 1947.
- (69) "Ultra- and Extreme-Short Wave Reception," by M. J. O. Strutt, D. Van Nostrand Co., Inc., New York, N. Y., 1947.
- (70) "Radar System Engineering," edited by Louis N. Ridenour, McGraw-Hill Book Co., Inc., New York, N. Y., 1947.
- (71) "Radar Aids to Navigation," edited by John S. Hall, McGraw-Hill Book Co., Inc., New York, N. Y., 1947.
- (72) "Radar Engineering," by Donald G. Fink, McGraw-Hill Book Co., Inc., New York, N. Y., 1947.
- (73) "Radar Beacons," edited by Arthur Roberts, McGraw-Hill Book Co., Inc., New York, N. Y., 1947.
- (74) "Technique of Microwave Measurements," edited by C. G. Montgomery, McGraw-Hill Book Co., Inc., New York, N. Y., 1947.
- (75) "Radar—What It Is," J. F. Rider and G. C. B. Rowe, J. F. Rider Publisher, New York, N. Y., 1946.
- (76) "Principles of Radar," Staff of the Radar School, Massachusetts Institute of Technology, McGraw-Hill Book Co., Inc., New York, N. Y., 1946.
- (77) "Introduzione alla Radiotelemetria Radar," U. Tiberio, Editore Rivista Marittima, Rome, Italy, 1946. 277 pp. 300 lire.

General Information on Radar

- (78) R. W. Hallows, "Great Britain's part in the creation of radar," *Toute la Radio*, vol. 13, pp. 201-203, September, 1946.
- (79) R. A. Watson-Watt, "The evolution of radiolocation," *Jour. I.E.E.* (London), vol. 93, part I, pp. 374-382; September, 1946.
- (80) M. Ponte, "French contributions to radar technique," *Toute la Radio*, vol. 13, pp. 204-207; September, 1946.
- (81) M. Ponte, "French contributions to radar," *Bull. Soc. Franc. Elec.*, vol. 6, pp. 579-588; November, 1946.
- (82) G. M. Bennett, "Radio v. U-Boat," *Wireless World*, vol. 52, pp. 408-411; December, 1946.
- (83) R. I. Wilkinson, "Short survey of Japanese radar," *Elec. Eng.*, vol. 65, pp. 370-377; August-September; pp. 455-463; October, 1946.
- (84) F. H. Sanders, "Radar development in Canada," *Proc. I.R.E.*, vol. 35, pp. 195-200; February, 1947.
- (85) R. A. Smith, "A survey of the development of radar," *Jour. I.E.E.* (London), Part I, vol. 94, pp. 172-178; April, 1947.
- (86) R. D. Hultgren and L. B. Hallman, "The theory and application of the radar beacon," *Proc. I.R.E.*, vol. 35, pp. 716-730; July, 1947.
- (87) J. O. McNally and W. G. Shepherd, "Reflex oscillators for radar systems," *Proc. I.R.E.*, vol. 35, pp. 1424-1435; December, 1947.
- (88) J. F. Coales, H. C. Calpine and D. S. Watson, "Naval fire-control radar," *Jour. I.E.E.*, vol. 93, part IIIA, no. 2, pp. 349-379; 1946.
- (89) H. W. Pout, "Precision ranging systems for close-range weapons," *Jour. I.E.E.*, vol. 93, part IIIA, no. 2, pp. 380-394; 1946.
- (90) H. A. Prime, "The application and design of medium-precision ranging equipment," *Jour. I.E.E.*, vol. 93, part IIIA, no. 2, pp. 395-410; 1946.
- (91) T. C. Finemore and W. D. Mallison, "Engineering design of ship-borne gunnery radar panels," *Jour. I.E.E.*, vol. 93, part IIIA, no. 2, pp. 441-447; 1946.
- (92) G. H. Beeching, "Checking the angular accuracy of precision fire-control radar," *Jour. I.E.E.*, vol. 93, part IIIA, no. 2, pp. 519-526; 1946.
- (93) C. A. Laws, "A precision-ranging equipment using a crystal oscillator as a timing standard," *Jour. I.E.E.*, vol. 93, part IIIA, no. 2, pp. 423-440; 1946.
- (94) W. M. Kellogg, "Navy fire-control radars," *Bell Lab. Rec.*, vol. 25, pp. 64-69; February, 1947.
- (95) H. A. M. Clark, "Centimetre radar for precision gun-laying," *Proc. R.S.G.B.*, no. 1, pp. 7, 15; Spring, 1947.
- (96) C. R. Taft, "SCR 545A—A completely automatic tracking radar," *Bell Lab. Rec.*, vol. 25, pp. 378-382; October, 1947.
- (97) J. H. Cook, "Airborne search radar," *Bell Lab. Rec.*, vol. 24, pp. 321-325; September, 1946.
- (98) H. W. Secor and E. Leslie, "Anti-collision radio," *Radio Craft*, vol. 18, pp. 17-49, 51, 55, 75; October, 1946.
- (99) M. G. Scroggie, "Air navigation: survey of radio aids to civil aviation," *Wireless World*, vol. 52, pp. 352-356; November, 1946.

- (100) J. B. Maggio, "Radar eyes for the black widow," *Bell Lab. Rec.*, vol. 25, pp. 221-226; June, 1947.
- (101) "Metrovick-marine radar set," *Engineering* (London), vol. 162, pp. 79-80; July, 1946.
- (102) E. D. Hart, "Navigational radar in merchant ships," *Electronic Eng.*, vol. 18, pp. 265-267; September, 1946.
- (103) N. I. Hall, "The SL radar," *Bell Lab. Rec.*, vol. 24, pp. 353-357; October, 1946.
- (104) C. L. Van Inwagen, "SJ radar for submarine," *Bell Lab. Rec.*, vol. 24, pp. 402-406; November, 1946.
- (105) M. G. Scroggie, "Postwar Marine Radar in Great Britain," *Communications*, vol. 26, pp. 9-11; December, 1946.
- (106) "Radar specifications for the Merchant Marine," *Onde Elec.*, vol. 26, pp. 481-487; December, 1946.
- (137) Robert I. Colin, "Survey of radio navigational aids," *Elec. Commun.*, vol. 24, pp. 219-261; June, 1947.
- (138) Fred J. Kitty, "Radar system for airport traffic and navigation control—part 1," *Tele-Tech*, vol. 6, pp. 40-44, 102, 104; August; pp. 56-59, 105-107; September; pp. 49-51, 93-94; October, 1947.
- (139) Irwin C. Nye, "ATA presents its case on airborne radar," *Air Transport*, vol. 5, pp. 45-46; August, 1947.
- (140) Lawrence LeKashman, "Electronic navigation to date," *Aero Digest*, vol. 55, pp. 54-55, 128-129; August, 1947.
- (141) F. C. Williams, W. D. Howell, and B. H. Briggs, "Plan-position indicator circuits," *Jour. I.E.E.* (London), vol. 93, part IIIA, No. 7, pp. 1219-1255; 1946.
- (142) F. C. Williams, F. J. V. Ritson, and T. Kilburn, "Automatic strobos and recurrence-frequency selectors," *Jour. I.E.E.* (London), vol. 93, part IIIA, No. 7, pp. 1275-1300; 1946.
- (143) H. R. Whitfield, "Light-weight radar: its dependence on low-consumption circuits," *Jour. I.E.E.* (London), vol. 93, part IIIA, no. 7, pp. 1215-1218; 1946.

Airborne Radar

- (107) R. A. Smith, "Radar navigation," *Jour. I.E.E.* (London), vol. 93, part IIIA, No. 1, pp. 331-342; 1946.
- (108) W. A. S. Butement, B. Newsam, and A. J. Oxford, "Precision radar," *Jour. I.E.E.* (London), part IIIA, No. 1, pp. 114-126; 1946.
- (109) "Block system for airway control," *Electronic Ind.*, vol. 5, pp. 54-56; December, 1946.
- (110) M. G. Scroggie, "Air navigation: Survey of radio aids of civil aviation," *Wireless World*, pp. 352-356; November, 1946.
- (111) C. J. Carter, "H₂S: An airborne radar navigation and bombing aid," *Jour. I.E.E.* (London), part IIIA, No. 2, pp. 449-467; 1946.
- (112) K. A. Wood, "200-Mc/s radar interrogator-beacon systems," *Jour. I.E.E.* (London), vol. 93, part IIIA, No. 2, pp. 481-495; 1946.
- (113) F. E. Jones, "Oboe: A precision ground-controlled blind bombing system," *Jour. I.E.E.* (London), vol. 93, part IIIA, No. 2, pp. 496-511; 1946.
- (114) "U. S. demonstrates radio aids to air navigation," *Electronics*, vol. 19, pp. 280, 282, 284, 286, 289; December, 1946.
- (115) "Radar-guided bomb," *Electronics*, vol. 19, pp. 186, 190, 194; December, 1946.
- (116) J. W. Rieke, "Low-altitude radar bombsight," *Bell Lab. Rec.*, vol. 25, pp. 13-16; January, 1947.
- (117) "Lanac two-signal navigation system," *Tele-Tech*, vol. 6, pp. 49-53, 129; February, 1947.
- (118) D. H. Ewing and R. W. K. Smith, "Teloran," *RCA Rev.*, vol. 7, pp. 601-621; December, 1946.
- (119) Ralph C. Ayres and Richard M. Davidson, "TWA looks at radar," *Air Transport*, vol. 5, pp. 35-37; February, 1947.
- (120) D. H. Pain, "International plan for air navigation," *Electronics*, vol. 20, pp. 80-83; February, 1947.
- (121) H. Gregory Shea, "PICAQ recommends CAA instrument landing," *Tele-Tech*, vol. 6, pp. 40-43, 124; February, 1947.
- (122) "Airborne radar specifications," *Electronics*, vol. 20, p. 132; February, 1947.
- (123) G. W. A. Dummer, "H₂S trainer," *Wireless World*, vol. 53, pp. 65-66; February, 1947.
- (124) Frederick H. Sanders, "Radar development in Canada," *Proc. I.R.E.*, vol. 35, pp. 195-200; February, 1947.
- (125) H. Gregory Shea, "Radar aids in air navigation," *Tele-Tech*, vol. 6, pp. 73-75, 124-126; March, 1947.
- (126) E. A. Blasi and Gerald C. Schutz, "Test equipment and techniques for airborne-radar field maintenance," *Proc. I.R.E.*, vol. 35, pp. 310-320; March, 1947.
- (127) Robert B. Hotz, "Army flies all weather," *Air Transport*, vol. 5, pp. 31-33; April, 1947.
- (128) J. A. McGillivray, "Safety in the air—a user's views on radio aids," *Wireless World*, vol. 53, pp. 146-149; April, 1947.
- (129) D. H. Ewing and R. W. K. Smith, "Teloran—Air navigation and traffic control by means of television and radar," *Proc. Nat'l Electronics Conference*, vol. 2, pp. 299-316; 1946.
- (130) P. L. Hammann, "A compact lightweight amplifier for radar," *Bell Lab. Rec.*, vol. 25, pp. 146-149; April, 1947.
- (131) R. W. Treharne, J. A. Kammerer, and R. Hofstadter, "Rate-of-change meter," *Electronics*, vol. 20, pp. 106-107; May, 1947.
- (132) "Blueprint for future airways," *Aero Digest*, vol. 54, pp. 35-37, 132; June, 1947.
- (133) Briton Chance, "The interconnection of dead-reckoning and radar data for precision navigation and prediction," *Jour. Frank. Inst.*, vol. 242, pp. 355-372; November, 1946.
- (134) W. J. Tull and N. W. MacLean, "GPI—An automatic navigational computer," *Jour. Frank. Inst.*, vol. 242, pp. 373-398; November, 1946.
- (135) "Guided missiles," *Jour. Frank. Inst.*, vol. 243, pp. 489-491; June, 1947.
- (136) M. G. Scroggie, "Oboe—A precision radar system," *Radio News*, Radio-Electronic Eng. Dept., vol. 9, pp. 6-7, 21; August, 1947.

Marine Radar

- (144) N. A. Schorr, "Radar on the Great Lakes," *Radio News*, vol. 37, pp. 35-38, 144-147; February, 1947.
- (145) "Radar for river towboat traffic," *Electronics*, vol. 20, p. 150; April, 1947.
- (146) "Commercial radar on American owned and operated merchant vessels," *Jour. Frank. Inst.*, vol. 243; p. 90; January, 1947.
- (147) "River-mapping by radar," *Electronics*, vol. 20, pp. 166, 168; September, 1947.
- (148) F. E. Spaulding, Jr., "Radar for merchant marine service," *RCA Rev.*, vol. 8, pp. 312-330; June, 1947.
- (149) B. B. Talley, "Peacetime radar," *Electronics*, vol. 20, pp. 113-115; October, 1947.
- (150) "Shore-based radar for port of Liverpool," *Electronics*, vol. 20, pp. 156, 158; July, 1947.
- (151) "Marine radar report," *Electronics*, vol. 20, pp. 144, 146, 244; July, 1947.
- (152) "Coast Guard improves radar navigation," *Marine Engineering*, vol. 52, p. 112; August, 1947.

Ground Radar

- (153) P. Charles, "Jungle surveys for oil exploration," *Eng. News Rec.*, vol. 138, pp. 519-521; April 3, 1947.
- (154) "Meteors detected by radar," *Electronics*, vol. 20, p. 166; January, 1947.
- (155) R. Bateman, A. G. McNish, and V. C. Pineo, "Radar observations during meteor showers, 9 October 1946," *Science*, vol. 104, pp. 434-435; November 8, 1946.

Hyperbolic Systems

Work continued on the development of low-frequency loran, and propagation studies were continued to obtain more extensive and useful data on sky-wave propagation of loran signals. The following list contains the principal papers of the year on hyperbolic navigation:

- (156) C. J. Pennill, "Navigating by loran," *Teleg. and Teleph. Age* vol. 64, pp. 17-18; September, 1946.
- (157) P. Giroud, "The Decca navigator," *Ann. Radioelec.*, vol. 1, pp. 409-433; October, 1946.
- (158) "New techniques in modern marine navigation," *Gen. Elec. Rev.*, vol. 55, pp. 419-426, November, 1946.
- (159) C. B. Bovill, "A review of radio aids in aviation," *Jour. British I.R.E.*, vol. 6, pp. 250-272; December, 1946.
- (160) R. J. Dippy, "Gee: A radio navigational aid," *Jour. I.E.E.* (London), vol. 93, part IIIA, No. 2, pp. 468-480; 1946.
- (161) "Decca navigator," *Wireless World*, vol. 53, p. 67; February, 1947.
- (162) "PICAQ report on navigational aids," North Atlantic Regional Office, 7 Fitzwilliam Place, Dublin; 84 pp., 3s9d.
- (163) "Demonstrations of radio aids to civil aviation," H. M. Stationery Office, London, 80 pp., 5 s.
- (164) "Radio navigation, radar and position fixing systems for use in marine navigation," H. M. Stationery Office, December, 1946, 5 s.
- (165) R. A. Smith, "Radio aids to navigation," Cambridge University Press, 114 pp., 9 s, 1947.

Directive Systems

Papers dealing with direction finders and directive systems included the following:

- (166) J. H. Moon, "Design of electromagnetic radiogoniometers for use in medium-frequency direction finding," *Jour. I.E.E.* (London), vol. 94, part III, pp. 69-77; January, 1947.
- (167) R. L. Smith-Rose and W. Ross, "The use of earth mats to reduce the polarization error of U-type Adcock direction-finders," *Jour. I.E.E.* (London), vol. 94, part III, pp. 91-98; March, 1947.
- (168) W. Ross, "Site and path errors in short-wave direction-finders," *Jour. I.E.E.* (London), vol. 94, part III, pp. 108-114; March, 1947.
- (169) R. R. Pearce, "Some experiments on conducting screens for a U-type spaced-aerial radio direction-finder in the frequency range 600-1200 mc/s," *Jour. I.E.E.* (London), vol. 94, part III, pp. 115-117; March, 1947.
- (170) "Assistance by radio to lost civil pilots is widely available," *CAA Jour.*, vol. 8, p. 72; June 15, 1947.
- (171) T. H. Clark, "Investigation of errors in spaced-collector direction-finder systems," *Elec. Commun.*, vol. 24, pp. 199-207; June, 1947.
- (172) R. I. Colin, "Survey of radio navigational aids," *Elec. Commun.*, vol. 24, pp. 219-261; June, 1947.
- (173) H. Busignies and M. Dishal, "Relations between bandwidth, speed of indication, and signal-to-noise ratio in radio navigation and direction finding." Presented, March, 1947 I.R.E. National Convention. *Elec. Commun.*, vol. 24, pp. 264-265; June, 1947.
- (174) P. R. Adams and R. I. Colin, "Navaglobe long-range radio navigation system," *Proc. Nat'l. Electronics Conf.*, vol. 2, pp. 288-298; 1946.
- (175) J. B. Hartranft, "CAA omni-range program will force private pilots off federal airways," *Aviation News*, vol. 7, p. 24; April 21, 1947.
- (176) "For safer blind flying; international conference proposes world wide agreement on navigation and landing aids," *Business Week*, pp. 38-44; January 4, 1947.
- (177) "Global navigation system projected by PICAQ," *Aviation*, vol. 46, pp. 79, 80, 83; February, 1947.
- (178) D. H. Pain, "International plan for air navigation," *Electronics*, vol. 20, pp. 80-83; February, 1947.
- (179) "Lower minimums set for airplanes landing on ILS," *CAA Jour.*, vol. 8, p. 37; April 15, 1947.
- (180) M. Mickel, "Picao council to approve air navigation program," *Aviation News*, vol. 7, pp. 27-28; January 6, 1947.
- (181) "CAA to continue fight for ILS omni-range airways," *Aviation Week*, vol. 47, p. 47; August 18, 1947.
- (182) R. Hotz, "Seven airlines approved to use ILS at 21 fields," *Aviation Week*, vol. 47, p. 11; September 1, 1947.
- (183) "International recommendations for marine electronic aids," *Electronics*, vol. 20, pp. 144, 146; August, 1947.
- (184) "ILS use assures more regularity in air schedules," *CAA Jour.*, vol. 8, pp. 109, 115; October 15, 1947.
- (185) "International meeting on Marine Radio Aids to Navigation." New York City and New London, April 28-May 9, 1947. (Papers dealing with radio and electronic aids to marine navigation.)
- (186) "CAA on spot in vhf omni-range controversy," *American Aviation*, vol. 11, pp. 25-26; December 1, 1947.
- (187) "ATA finds ILS installations ready for use this winter," *American Aviation*, vol. 11, p. 26; October 15, 1947.
- (188) "CAA sticks to ILS plans despite Ilinshaw criticism," *American Aviation*, vol. 11, p. 31; August 15, 1947.
- (189) D. Share, "Radar safety and comfort may attract new customers," *American Aviation*, vol. 11, pp. 35-36; August 1, 1947.
- (190) "Congress urges standardized aids," *American Aviation*, vol. 11, pp. 13-14; August 1, 1947.
- (191) "Private pilots fearful of neglect when CAA completes vhf omni-directional network," *American Aviation*, vol. 10, p. 16; March 15, 1947.
- (192) "More funds for air safety urged by house committee," *American Aviation*, vol. 10, p. 17; March 1, 1947.
- (193) "Congress weighs \$38 million program for landing aids," *American Aviation*, vol. 10, p. 18; February 15, 1947.
- (194) "Aids to air navigation and landing," House Report No. 885. United States Government Printing Office, Washington, 1947.
- (195) "Safety in Air Navigation," House Report No. 1065, United States Government Printing Office, Washington, 1947.

Government and Industry Activity

The year was marked by greater interest in navigational aids, on the part of the United States Government, than ever before. Several disasters in aviation, traceable to inadequate or improperly used navigation equipment, caused an investigation by Congressional committees. The Air Co-ordinating Committee asked the Radio Technical Commission for Aeronautics to establish technical groups which would formulate plans for present and future air navigational and traffic control policy. These groups were established and have met almost continuously since July, 1947; their work is as yet incomplete.

The International Civil Aviation Organization (ICAO) held three major meetings in 1947. These meetings have now completed the task of specifying air navigational aids for the entire world with the exception of the Far East.

The Civil Aeronautics Administration of the United States ordered, as a further link in its system of navigation aids, distance-measuring equipment (DME) operating in the range from 960-1215 Mc. Ground radars (obtained from military sources) were installed and placed in regular service, and bids were requested on ground radar equipment specifically for airport use.

In April and May, delegates from 31 nations met in New York City and New London, Conn., at the International Meeting on Marine Radio Aids to Navigation (IMMRAN). A report issued by this meeting specified characteristics desirable in radar for marine use.

- (175) W. Kroger, "CAA and airlines versus GCA," *Air Transport*, vol. 5, pp. 30-33, 77-78; March, 1947.
- (176) "CAA approves GCA, ILS for airlines use," *Aviation News*, vol. 7, pp. 10-11; April 28, 1947.
- (177) "CAA control towers equipped to guard vhf radio channel for private pilot use," *CAA Jour.*, vol. 8, p. 43; April 15, 1947.

Radio Receivers

The year 1947 did not mark any major improvements in the design of radio broadcast receivers, for either a.m. or f.m. reception. In the case of a.m. receivers the design trend was toward increased use of miniature tubes, selenium rectifiers, high-dielectric ceramic capacitors, midget intermediate-frequency transformers, and other components of reduced size. Commercial application was made of circuit components employing so-called printed-circuit techniques. Units comprising plate resistor and bypass capacitor, coupling capacitor, and grid resistor were used by some manufacturers in the audio-frequency circuits of low-priced receivers. Single components comprising one or two capacitors and a resistor were introduced for use as cathode-resistor-bypass-capacitor, oscillator-coupling-capacitor-grid-leak, and whistle-filter combinations. The industry, in general, turned to the use of tuning capacitors instead of permeability tuners as a result of increased availability of gang capacitors. Progress during the year, as far as a.m. broadcast receivers is concerned, resulted largely from the saving in space and reduction in assembly costs brought about by the use of new components rather than from any specific improvements in performance.

Since almost all f.m. receiver chassis include one or more a.m. bands, the use of new components and the trends mentioned above also apply to f.m. receivers.

The design of f.m. receivers was improved during the year as a result of the availability or increased use of new miniature tubes specifically developed for use as ultra-high-frequency radio-frequency amplifiers and converters. New high-perveance multiple diode-triode tubes were made available for use as a ratio detector, a.m. detector, and first-audio-amplifier stage in a.m./f.m. receivers. These tubes, along with increased knowledge and experience, resulted in appreciable improvement in f.m. receiver performance. Another f.m. design feature introduced during the year was the use in high-quality receivers of extremely precise mechanical tuning systems. These systems have reached a degree of perfection no longer requiring the use of automatic-frequency-control circuits to provide satisfactory results. However, their cost at present is prohibitive for all but the most expensive receivers.

Various attacks were made on the problem of frequency drift in f.m. receivers. Crystal control of the local oscillator was again proposed, and several production receivers were designed with automatic frequency control of the local oscillator.

The ever-present problem of a satisfactory tuning indicator for f.m. receivers received attention which resulted in the development of an electron-ray indicator tube which could be actuated from the discriminator circuit and yet be capable of distinguishing between the no-signal and the properly tuned signal condition.

- (199) "A new approach to F-M/A-M receiver design," *Electronics*, vol. 20, pp. 80-85; July, 1947.
- (200) L. O. Vladimir, "Permeability tuning of broadcast receivers," *Electronics*, vol. 20, pp. 94-99; August, 1947.
- (201) J. L. Hathaway and William Hotine, "The pocket ear," *RCA Rev.*, vol. 8, pp. 139-146; March, 1947.
- (202) N. P. Case, "All-purpose FM-AM receiver," *FM and Telev.*, vol. 7, pp. 34-35, 38; January, 1947.
- (203) J. J. Adams, "Intermediate-frequency amplifiers for frequency-modulation receivers," *Proc. I.R.E.*, vol. 35, pp. 960-964; September, 1947.
- (204) B. J. Cosman and A. W. Richardson, "Harvey double superheterodyne FM receiver," *FM and Telev.*, vol. 7, pp. 21-24, 51-52; June, 1947.
- (205) A. R. Miccioli and D. Pollack, "Design of FM receiver front ends," *Tele-Tech*, vol. 6, pp. 40-43; July, 1947.
- (206) F. E. Berhley, "Tuning without condensers," *FM and Telev.*, vol. 7, pp. 35-37; August, 1947.
- (207) N. L. Chalfin, "Crystal control for stability in VHF receivers," *Tele-Tech*, vol. 6, pp. 71-63; January, 1947.
- (208) Thomas Roddam, "Designing an FM receiver," *Wireless World*, vol. 53, pp. 143-145; April; pp. 203-206; June, 1947.
- (209) "F-M reception problems and their solution," *Electronics*, vol. 20, pp. 108-113; September, 1947.
- (210) F. M. Bailey, "An electron-ray tuning indicator for frequency modulation," *Proc. I.R.E.*, vol. 35, pp. 1158-1160; October, 1947.

The year 1947 saw the introduction to the market of extremely low-priced frequency-modulation receivers utilizing a superregenerative circuit. This circuit was also used in low-priced f.m. converters. Other converters priced somewhat higher were made available. Some of these were capable of providing excellent performance when used with a radio receiver having a good audio-frequency and reproducing system.

- (211) "Hazeltine FreModyne FM circuit," *Tele-Tech*, vol. 6, pp. 41-85-86; December, 1947.
- (212) "Cathode ray," "First steps in V.H.F. exploration," *Wireless World*, vol. 53, pp. 15-17; January, 1947.
- (213) C. E. Tapp, "The application of super-regeneration to frequency-modulation receiver design," *Proc. I.R.E.*, (Australia), vol. 8, pp. 4-7; April, 1947.
- (214) "Data on the FM Pilotuner," *FM and Telev.*, vol. 7, pp. 37, 40; September, 1947.

During the year economic factors involved in the design of f.m. receivers forced the reallocation of f.m. station assignments to provide a minimum separation of 400 kc. instead of 200 kc. This resulted from work on the selectivity of intermediate-frequency amplifiers for f.m. receivers. This work led to the conclusion that adequate adjacent-channel selectivity could most economically be secured by increasing the separation of the assigned carrier frequencies of f.m. stations located in the same geographical area.

- (215) R. B. Dome, "I.f. selectivity considerations in f.m. receivers." Presented, I.R.E. Rochester Fall Meeting, Rochester, N. Y., November 19, 1947.

Development trends in combination radio-phonographs comprised chiefly the increased use and improvement of noise-suppression circuits, low-distortion audio amplifiers, and a tendency to employ a greater variety of pickups. In addition to the well-known Rochelle-salt crystal units, devices utilizing variable-reluctance, variable-inductance, and magnetic-torsion principles were marketed. A trend during the year was toward console combinations of the solid-top type in which access is gained to the record changer and radio controls through front openings, various ingenious tilt-out or roll-out arrangements being employed in some cases to increase the convenience of operation.

- (216) H. H. Scott, "Dynamic noise suppressor," *Electronics*, vol. 20, pp. 96-101; December, 1947.
- (217) Harry F. Olson, "Audio noise reduction circuits," *Electronics*, vol. 20, pp. 118-122; December, 1947.

As of December 13, 1947, the total number of radio receivers produced was 14,375,000, of which 830,000, or a little more than 6 per cent, were f.m. receivers.

Antennas

Microwave Antennas

Microwave frequencies are notable because of the high directivity which can be obtained with an antenna system of reasonable physical dimensions. For the production of a narrow beam or pencil of radiation, the antenna system often takes the form of a simple dipole or waveguide source backed up by a relatively large spherical or parabolic reflecting surface.

Various aspects of the theory and operation of parabolic and spherical reflectors were considered in several papers. The term "parabola" is used generally to cover the circular paraboloid, the parallel-plate parabola, and the parabolic cylinder. While simple geometrical ray theory gives an approximate picture of operation, diffraction theory is required for accurate results. A parabola gives a better beam shape than a spherical re-

flector, but where the beam must be scanned over several degrees the spherical reflector has some advantages. An excellent summary of fundamental relations for parabolic radiators was presented by Cutler. A paper by Friis and Lewis covered the principles of radar antenna design.

- (218) C. C. Cutler, "Parabolic-antenna design for microwaves," *Proc. I.R.E.*, vol. 35, pp. 1284-1294; November, 1947.
 (219) Samuel Seely, "Microwave antenna analysis," *Proc. I.R.E.*, vol. 35, pp. 1092-1095; October, 1947.
 (220) Grote Reber, "Antenna focal devices for parabolic mirrors," *Proc. I.R.E.*, vol. 35, pp. 731-734; July, 1947.
 (221) J. Ashmead and A. B. Pippard, "The use of spherical reflectors as microwave scanning aeriels," *Jour. I.E.E.*, vol. 93, part III-A, No. 4, pp. 627-632; 1946.
 (222) H. T. Friis and W. D. Lewis, "Radar antennas," *Bell Sys. Tech. Jour.*, vol. 26, pp. 219-317; April, 1947.

For some purposes vertical directivity only is desired, with a uniform radiation in the horizontal plane, and in this case an "omnidirectional" radiator is used. A radiator of this type can be built by arranging curved dipoles in a horizontal ring and then stacking rings vertically. A typical omnidirectional array consists of 3 dipoles per ring with as many as 14 rings stacked at half-wavelength intervals to give a pattern having an 8-degree half-width. The work of the M.I.T. Radiation Laboratory on this problem was summarized in one paper.

- (223) Henry J. Riblet, "Microwave omnidirectional antennas," *Proc. I.R.E.*, vol. 35, pp. 474-478; May, 1947.

Low-Frequency, Standard-Broadcast, Frequency-Modulation, and Television Antennas

Little that was new was recorded in the broadcast antenna field. An extensive set of measurements were made at low frequencies on short vertical antennas (less than one-eighth-wavelength high) under various conditions of top-loading and ground systems. The results were in agreement with expected performance based on theoretical considerations. Due to the low radiation resistance of the antenna, extensive ground systems and high-*Q* loading coils were necessary to maintain antenna efficiency. Base-insulator losses become important, and in wet weather the loss resistance of a short, unloaded tower antenna may increase several times over its normal dry value.

The action of the Federal Communications Commission in authorizing, on an optional basis, the radiation of circular or elliptical polarization resulted in some attention being paid to the design of antennas which would produce such polarization. Circular polarization was radiated by at least one commercial station using a stacked array of the slotted dipoles of the type referred to below. Two types of helical antennas which will produce circular polarization were proposed. One of these antennas radiates a circularly polarized signal perpendicular to the axis of the helix, whereas the second type of helical antenna, which has dimensions different from those of the first, radiates its principal lobe along the axis.

- (224) C. E. Smith and E. M. Johnson, "Performance of short antennas," *Proc. I.R.E.*, vol. 35, pp. 1026-1038; October, 1947.
 (225) Harold A. Wheeler, "Helical antenna for circular polarization," *Proc. I.R.E.*, vol. 35, pp. 1484-1488; December, 1947.
 (226) Harold A. Wheeler, "Fundamental limitations of small antennas," *Proc. I.R.E.*, vol. 35, pp. 1479-1484; December, 1947.
 (227) John D. Kraus, "Helical beam antenna," *Electronics*, vol. 20, pp. 109-111; April, 1947.

Descriptions of antennas designed for television were published.

- (228) A. W. Deneke, "The WABD super-turnstile television antenna installation," *Communications*, vol. 27, pp. 12-15, 37-38; May, 1947.
 (229) G. E. Hamilton and R. K. Olsen, "Application of transmission line measurements to television antenna design," *Communications*, vol. 27, pp. 8-9, 35-36; January; pp. 32, 34, 37, 40; February; pp. 20-21, 24-25; March 1947.
 (230) L. J. Wolf, "Triplex antenna for television and FM," *Electronics*, vol. 20, pp. 88-91; July, 1947.

Slot Antennas

Slot antennas continued to receive attention for various v.h.f. and u.h.f. applications. Aircraft slot antennas became available commercially for altimeter and other service. For frequency modulation or other applications, slots in a cylinder can be stacked around the circumference of the cylinder as well as along its length, to give horizontal as well as vertical directivity. A narrow slotted cylinder fed both as a slot antenna and as an ordinary dipole antenna was used to produce circular polarization. A summary of slot-antenna developments in England and Canada was contained in the Proceedings of the Radiolocation Convention, referred to below.

- (231) N. E. Lindenblad, "Slot antennas," *Proc. I.R.E.*, vol. 35, pp. 1472-1479; December, 1947.
 (232) G. Sinclair, E. C. Jordan, and E. W. Vaughan, "Measurement of aircraft-antenna patterns using models," *Proc. I.R.E.*, vol. 35, pp. 1451-1462; December, 1947.
 (233) G. E. G. Bailey, "Slot feeders and slot aeriels," *Jour. I.E.E.*, vol. 93, part III-A, No. 4, pp. 615-619; 1946.
 (234) H. G. Booker, "Slot aeriels and their relation to complementary wire aeriels (Babinet's principle)," *Jour. I.E.E.*, vol. 93, part III-A, No. 4, pp. 620-626; 1946.
 (235) W. H. Watson, "Resonant slots," *Jour. I.E.E.*, vol. 93, part III-A, No. 4, pp. 747-777; 1946.

Direction-Finder Antennas

The antenna engineer has long been aware of the large differences that exist between theory and practice when comparing the theoretical signal pickup of an antenna above a smooth homogeneous earth with the actual pickup of an antenna located above a practical (i.e., irregular and heterogeneous) earth. These differences are especially apparent in direction finding, where they result in bearing errors. Observed bearing shifts of several degrees with small changes of frequency or azimuth were explained in a published paper on the hypothesis of reradiation from a large number of reflectors scattered at random around the receiving site. This reradiation occurred to some extent even at sites which appear to be ideal.

- (236) W. Ross, "Site and path errors in short-wave direction-finding," *Jour. I.E.E.*, vol. 94, part III, pages 108-114; March, 1947.

A summary of wartime direction-finder antenna developments in England was contained in a symposium.

- (237) Proceedings of the Radiolocation Convention, *Jour. I.E.E.*, vol. 94, Part III, March, 1947.

Antenna Theory

The problem of optimum current distribution for antenna arrays was again considered, and it was pointed out that for closely spaced elements it would be possible to obtain (theoretically) arbitrarily sharp directivity with an array of given length. For narrow beams from short arrays the required current distribution showed rapid phase reversals, and there resulted a very low radiation resistance. Therefore, extremely large currents are required to maintain a given radiated field strength, and the array may become impracticable.

In another paper the radiation from a high-frequency loop (perimeter less than one-half wavelength) was calculated on the basis of a hyperbolic cosine current distribution, and the resulting pattern was checked experimentally. The pattern in the plane of the loop was found to deviate from the circular, and to have a maximum in the direction of the feeder.

- (238) Discussion on "A current distribution for broadside arrays which optimizes the relationship between beam width and side-lobe level," H. J. Riblet and C. L. Dolph, *Proc. I.R.E.*, vol. 35, pp. 489-492; May, 1947.
- (239) G. Gilinski, "Note on circular loop antennas with non-uniform current distribution," *Jour. Appl. Phys.*, vol. 18, pp. 638-644; July, 1947.

Early in 1947 some experimentally obtained directivity patterns for thick antennas fed near one end were exhibited. These patterns all displayed a forward tilting of the radiation lobe, as would be obtained from a combination standing wave and traveling wave of current. A later investigation on thin (but not *very* thin) antennas showed a similar forward tilt for that case.

- (240) C. H. Page, R. D. Huntoon, and P. R. Karr, "Radiation Patterns of Thick End-Fed Antennas," Presented, 1947 I.R.E. National Convention, New York, N. Y., March 4, 1947.
- (241) D. C. Cleckner, "Effect of feed on pattern of wire antennas," *Electronics*, vol. 20, pp. 103-105; August, 1947.

Several new books covering antenna theory appeared during 1947. The first of those listed below gives an excellent discussion of the three general approaches to antenna theory, viz., as a boundary-value problem, the integral-equation approach (Hallen), and the waveguide approach (Schelkunoff). Notwithstanding its title, it is an advanced text. The other two are less specialized and more elementary.

- (242) J. Aharoni, "Antennae; an Introduction to Their Theory," Oxford, Clarendon Press, London, 1946.
- (243) W. H. Watson, "The Physical Principles of Wave-Guide Transmission and Antenna Systems," Oxford, Clarendon Press, London, 1947.
- (244) Nathan Marchand, "Ultra High Frequency Transmission and Radiation," John Wiley and Sons, New York, N. Y., 1947.

Radio Wave Propagation

Ionosphere

The Nobel Prize award for physics was made in November, 1947, to Sir Edward Appleton in recognition of his outstanding contribution to knowledge of the ionosphere.

A contribution of importance to ionospheric progress was made by an unusually complete survey of literature on the ionosphere. The author index and subject index were supplemented by a digest section summarizing the more important topics of ionospheric research. A concluding section contained recommendations for future work on the basis of the survey.

- (245) L. A. Manning, "A survey of the literature of the ionosphere," August 30, 1947, issued by Dept. of E.E., Stanford University, Calif. Unclassified report prepared for Air Matériel Command, U. S. Air Force, Wright Field, Dayton, Ohio.

The services of collection and dissemination of ionospheric data were continued and extended by the Central Radio Propagation Laboratory, National Bureau of Standards. Long-term and short-term forecasts of radio communication conditions, as well as results of special analyses and research projects, were distributed periodically to a large mailing list.

The basic theory of the earth's outer atmosphere and the ionosphere were extended. Several authors treated the problems of layer formation and equilibrium. It was concluded that observed electron densities may be accounted for without requiring high solar energy. Analyses of meteor showers indicated that power necessary for formation of an ionosphere layer may be a few watts per square kilometer—a value exceeded by the black-body radiation of the sun in the region of 1000 Angstroms. The occurrence of solar tides was proposed in order to account for anomalous behavior of the F_2 region. Interest in the propagation of low-frequency waves was revived. The subject received some much-needed theoretical and experimental attention.

- (246) D. R. Bates and H. S. W. Massey, "The basic reactions in the upper atmosphere: Part 1," *Proc. Roy. Soc., A*, vol. 187, pp. 261-296; November 5, 1946.
- (247) V. C. A. Ferraro, "On diffusion in the ionosphere," *Terr. Magn. Atmos. Elec.*, vol. 51, pp. 427-431; September, 1946.
- (248) R. v. d. R. Woolley, "The mechanism of ionospheric ionization," *Proc. Roy. Soc., A*, vol. 187, pp. 102-114; October 8, 1946.
- (249) J. A. Pierce, "Ionization by meteoric bombardment," *Phys. Rev.*, vol. 71, pp. 88-92; January 15, 1947.
- (250) D. F. Martyn, "Atmospheric tides in the ionosphere: Part 1—Solar tides in the F_2 region," *Proc. Roy. Soc., A*, vol. 189, pp. 241-260; April 17, 1947.
- (251) R. v. d. R. Woolley, "Radiative equilibrium in the ionosphere," *Proc. Roy. Soc., A*, vol. 189, pp. 218-240; April 17, 1947.
- (252) M. V. Wilkes, "The oblique reflexion of very long wireless waves from the ionosphere," *Proc. Roy. Soc., A*, vol. 189, pp. 130-147; March 27, 1947.
- (253) W. J. G. Beynon, "Oblique radio transmission in the ionosphere, and the Lorentz polarization term," *Proc. Phys. Soc. (London)*, vol. 59, pp. 97-107; January 1, 1947.

Eclipse measurements were reported and analyzed by several different groups. The panoramic motion-picture technique was applied to recordings of the Brazilian eclipse, May, 1947, by United States investigators. Anticipated ultraviolet eclipse effects in the E , F_1 , and F_2 regions were followed by the formation of an unusual stratification in the F_2 region. No evidence of a corpuscular eclipse was reported. Russian investigators had drawn attention to an effect suggestive of a corpuscular eclipse on July 9, 1945.

- (254) O. E. H. Rydbeck, "Chalmers solar eclipse ionospheric expedition 1945," *Chalmers Tekn. Högsk. Handl.*, No. 53, 44 pp., 1946 (in English).
- (255) W. Stoffregan, "Records of the ionosphere during the total eclipse in the north of Sweden on July 9, 1945," *Terr. Mag. Atmos. Elec.*, vol. 51, pp. 495-499; December, 1946.
- (256) N. D. Papalksi, "Radio observations during the solar eclipse of July 9, 1945," *Bull. Acad. Sci. (U.R.S.S.)*, ser. phys., vol. 10, No. 3, pp. 237-242; 1946 (in Russian).
- (257) N. Gorozhankin, "On radio observations during the solar eclipse of July 9, 1945," *Bull. Acad. Sci. (U.R.S.S.)*, ser. phys., vol. 10, No. 3, pp. 245-251; 1946 (in Russian).
- (258) A. N. Kazantseff, "On the results obtained in the investigation of the ionosphere during the solar eclipse of July 9, 1945," *Bull. Acad. Sci. (U.R.S.S.)*, ser. phys., vol. 10, No. 3, pp. 261-267; 1946 (in Russian).
- (267) J. C. Jaeger, "Equivalent path and absorption in an ionospheric region," *Proc. Phys. Soc. (London)*, vol. 59, pp. 87-96; January 1, 1947.
- (268) H. V. Griffiths, "Doppler effect in propagation," *Wireless Eng.*, vol. 24, pp. 162-166; June, 1947.

Tropospheric Propagation

During 1947 a flood of research papers was published on the subject of tropospheric propagation, containing the accumulated results of war research which at last has overcome the triple hurdles of military security classification, author inertia, and journal backlogs. By early 1948, the publication of wartime research should be essentially complete.

The term "tropospheric propagation" is here meant to include all radio propagation research on frequencies sufficiently high that the troposphere rather than the ionosphere plays the most important part in determining the propagation conditions. In general, this means propagation of frequencies above about 30 Mc. While the groundwork of the subject both on the theoretical and experimental sides was laid in the 1930's, the development of the microwave radio spectrum for radar purposes during the war incited the Anglo-American work in the field which has just reached the journals. The papers published during 1947 thus report on about five years of intensive war research in radio wave propagation through the troposphere, so that it would be impractical to list all articles within the confines of this review. The Abstracts and References now published monthly in the PROCEEDINGS OF THE I.R.E. furnish a more complete listing which is readily available to readers of the PROCEEDINGS. The following paragraphs aim to call attention only to the more important publications.

Books: Late in the year, there arrived from England the first full book on tropospheric propagation, entitled "Meteorological Factors in Radio Wave Propagation." The book contains some twenty papers, which were presented at a conference in London during the spring of 1946.

- (269) "Meteorological factors in radio-wave propagation," page 325, *The Phys. Soc. (London)*, 1947.

The lectures on propagation at the Radiolocation Convention in London, March-May, 1946, have appeared in the special issues of the *Journal* of the Institution of Electrical Engineers devoted to the conference.

- (270) Lectures on Propagation at the Radiolocation Convention, March-May, 1946, *Jour. I.E.E. (London)*, vol. 93, part III-A, No. 1, pp. 69-113; March, 1947.

Together, these two groups of papers contain a summary of most of the English wartime tropospheric propagation research, in which activity they pioneered during the war.

The Radiation Laboratory of the Massachusetts Institute of Technology has begun the publication of a series of volumes covering work done at that Laboratory during the war. Some brief but illuminating and up-to-date dis-

Where ionospheric trends with solar activity are well established, it was determined that reasonable estimates of sunspot numbers can be made from ionospheric data alone. Time coincidences were established between sudden fadeouts of high-frequency signals and augmentations of signal intensities of very low-frequency signals.

- (259) M. L. Phillips, "The ionosphere as a measure of solar activity," *Phys. Rev.*, vol. 70, p. 119; July 1 and 15, 1946.
- (260) R. Bureau, "Radio effects observed during the period of solar activity from 31st Jan. to 14th Feb. 1946," *Compt. Rend. Acad. Sci. (Paris)*, vol. 222, pp. 597-599; March 11, 1946.
- (261) R. Bureau, "Eruptions of the solar chromosphere and their influence on the ionosphere and on wave propagation. Their effects in different regions of the radio spectrum," *Onde Elec.*, vol. 27, pp. 45-56; February, 1947.

Rapidly moving ionospheric "clouds" were discovered in the outer atmosphere and tracked downward into the F_2 region. Merging of the clouds and F_2 layer was found to result in a sudden increase in ionization which was interpreted as evidence of a contribution of corpuscular ionization from the cloud to the normal F_2 layer. Experiments in Italy with the Luxemburg effect showed increased success when operating near the gyrofrequency. Interesting progress was made in the detection of meteors by doppler effects on radio waves. The technique offers promise as a research tool. Analyses of sporadic E extended knowledge of the effect but revealed further anomalies.

Extensive applications were made of ionospheric data to communications problems. Successful transatlantic communications on 50 Mc. were explained in terms of high ionization in the F_2 layer. Problems of ionospheric absorption and atmospheric noise received attention, but no comprehensive reports were made. Changes of 2 to 7 parts in 10^8 were observed in standard frequency transmissions which were interpreted as doppler effects resulting from changes in path length.

- (262) H. W. Wells, J. M. Watts, and D. E. George, "Detection of rapidly moving ionospheric clouds," *Phys. Rev.*, vol. 69, pp. 540-541; May 1 and 15, 1946.
- (263) M. Cutolo, M. Carlevaro, and M. Gherghi, "Observations on the interaction of waves in the ionosphere, relation to the gyrofrequency," *Alta Frequenza*, vol. 15, pp. 111-117; June, 1946.
- (264) L. A. Manning, R. A. Helliwell, O. G. Villard, Jr., and W. E. Evans, Jr., "On the detection of meteors by radio," *Phys. Rev.*, vol. 70, pp. 767-768; November 1 and 15, 1946.
- (265) H. W. Wells, "Sporadic E-region ionization at Watheroo Magnetic Observatory, 1938-1944," *Proc. I.R.E.*, vol. 34, pp. 950-955; December, 1946.
- (266) E. V. Appleton and W. J. G. Beynon, "The application of ionospheric data to radio communication problems: Part 2," *Proc. Phys. Soc. (London)*, vol. 59, pp. 58-76; January 1, 1947.

cussions of propagation as applied to radar are to be found in the first two volumes of this series.

- (271) "Radar System Engineering," Louis N. Ridenour, editor, vol. 1 of the Radiation Laboratory Series, McGraw-Hill Book Co., Inc., New York, N. Y., chap. 2, 3.
 (272) "Radar Aids to Navigation," John S. Hall, editor, vol. 2 of the Radiation Laboratory Series, McGraw-Hill Book Co., Inc., New York, N. Y., pp. 21-26; chap. 7; pp. 354-363.

Volume 13 of this series will contain a connected presentation of the present state of knowledge of tropospheric propagation, as well as of the extensive contributions by the Radiation Laboratory to this knowledge. Publication of this volume is scheduled for the spring of 1948.

- (273) "The Propagation of Short Radio Waves," D. E. Kerr, editor, vol. 13 of the Radiation Laboratory Series, McGraw-Hill Book Co., Inc., New York, N. Y.

The printing by Columbia University Press of the three volumes of the summary technical report of the Committee on Propagation of the National Defense Research Committee in the United States began late in 1947. Volume 1 contains the technical history of the Committee on Propagation, summary of laws of tropospheric propagation, conference reports on standard and nonstandard propagation, and a bibliography of reports on tropospheric propagation; volume 2 contains the major papers on tropospheric propagation prepared by the Wave Propagation Group of Columbia University; volume 3 is a handbook, "Propagation of radio waves through the standard atmosphere." Volumes 1 and 2 contain some of the research papers produced under N.D.R.C. auspices and hitherto available only in microfilm or photostat copies through the Office of Technical Services, Department of Commerce. The material in Volume 3 has not been published previously.

- (274) Summary Technical Report of the Committee on Propagation of the National Defense Research Committee; 3 vols., Columbia University Press. (Only copies ordered prior to printing are expected to be available to the public.)

Refraction Theory: Prior to the war, calculation of the effect of refraction in the troposphere was confined to the case where the index of refraction decreased linearly with height. In such an atmosphere, the effect of refraction can be very simply taken into account by use of an effective earth's radius, usually about $4/3$ the geometrical one, in the theory of diffraction of radio waves around the smooth earth, which had been developed in the late thirties. During the war, much more difficult distributions of refractive index with height were considered, and very considerable progress was achieved in numerical solutions, as well as in general understanding of the problem. The assumptions are always made of smooth earth, and horizontal homogeneity of the index of refraction structure. Spectacularly novel features enter the theory when a so-called duct exists in the atmosphere; that is, a horizontal layer where the decrease of index of refraction with height is greater than earth curvature. In a duct a radio ray will bend toward the earth instead of leaving it, and when the duct is near the surface, certain rays may be pictured as proceeding

around the earth in a series of hops, being "trapped" between the duct and the earth's surface. Such a conception based on trapped rays is completely inadequate to explain why the phenomenon is so frequently observed at centimeter wavelengths, and very rarely at meter wavelengths. The great triumph of the wave theories has been the demonstration that such a duct layer guides energy effectively around the earth only if the wavelength is sufficiently short in comparison with the thickness of the layer to prevent or diminish the leakage of energy from the layer. H. G. Booker in England was the principal expositor and developer of the theory of duct propagation, using a simple model of the index-of-refraction profile and Eckersley's approximate phase-integral method for solving the wave equation. The physical insight into the mechanism of propagation afforded by the phase-integral method compensates for the sacrifices of rigor in the method compared to the more exact methods of solving the wave equation.

- (275) H. G. Booker, "The mode theory of tropospheric refraction and its relation to wave-guides and diffraction," pp. 80-127 of book, "Meteorological Factors in Radio-Wave Propagation," The Phys. Soc. (London), 1947.

Hartree and his collaborators gave an extensive account of the details of numerical computation of the wave theory, both for power law and exponential profiles of modified refractive index.

- (276) D. R. Hartree, J. G. L. Michel, and Phyllis Nicolson, "Practical methods for the solution of the equations of tropospheric refraction," pp. 127-168 of book, "Meteorological Factors in Radio-Wave Propagation," The Phys. Soc. (London), 1947.

Pekeris published a detailed theoretical calculation of propagation of 10- and 3-cm. waves in low-level ocean ducts for comparison with Katzin's measurements in the Caribbean in 1945. While many of the facts of the experiment are in satisfactory quantitative agreement with the theory, several facts remain as yet unexplained, such as the decreased rate of attenuation on 10 cm. at distances greater than eighty nautical miles.

- (277) C. L. Pekeris, "Wave theoretical interpretation of propagation of 10-centimeter and 3-centimeter waves in low-level ocean ducts," Proc. I.R.E., vol. 35, pp. 453-462; May, 1947.

Contributions to the mathematical questions arising in the propagation problem were published by Furry and Pekeris.

- (278) W. H. Furry, "Two notes on phase-integral methods," *Phys. Rev.*, vol. 71, pp. 360-371; March 15, 1947.
 (279) C. L. Pekeris, "Asymptotic solutions for the normal modes in the theory of microwave propagation," *Jour. Appl. Phys.*, vol. 17, pp. 1108-1124; December, 1946.
 (280) C. L. Pekeris, "The field of a microwave dipole antenna in the vicinity of the horizon," *Jour. Appl. Phys.*, vol. 18, pp. 667-680; July, 1947.

Pekeris and Davis applied mode theory to a quantitative check on some propagation experiments at the Navy Electronics Laboratory, San Diego, Calif., at 63 and 170 Mc. Agreement is only fair, and there is definite evidence that theory predicts too much attenuation with distance, and too much variation with height beyond about 70 nautical miles.

- (281) C. L. Pekeris and M. E. Davis, "Preliminary analysis of microwave transmission data obtained on the San Diego coast under conditions of a surface duct," *Jour. Appl. Phys.*, vol. 18, pp. 838-842; September, 1947.

A systematic account of the mathematical theory of propagation in an atmosphere where the index of refraction variation with height may be approximated by two straight lines of different slopes is contained in the forthcoming volume 13 of the Radiation Laboratory Series, referred to above. A simplified scheme for calculating field intensities over a smooth earth where the lapse rate of refraction index is uniform with height was published by Domb and Pryce. This method proved useful in making comparison of field-intensity data with measured lapse rates of refractive index. It features a new method for calculating the field strength on the horizon, in place of the usual scheme of inferring the value by interpolation between calculations well within and well beyond the horizon.

- (282) C. Domb and M. H. L. Pryce, "The calculation of field strengths over a spherical earth," *Jour. I.E.E.* (London), vol. 94, part III, pp. 325-339; September, 1947.

Meteorology of the Refraction Problem

The meteorological factors responsible for radio refraction are the temperature and moisture distributions in the atmosphere, primarily the vertical gradients. The information required for analyzing the relation of atmospheric conditions to radio propagation is so much more detailed that only rarely do traditional meteorological measurements give sufficient information. It may be said that micro-meteorological measurements are really involved, rather than the gross average measurements characteristic of most weather data. The term "radio meteorology" is now applied to the study of how various refractive conditions occur in the troposphere. Probably the best introduction to the subject is a paper by Booker, in which historical background is discussed and the principal weather conditions involving super-refraction described, and which gives a rough outline of world climatic conditions involving superrefraction.

- (283) H. G. Booker, "Elements of radio meteorology: how weather and climate cause unorthodox radar vision beyond the geometrical horizon," *Jour. I.E.E.* (London), vol. 93, part III-A, no. 1, pp. 69-78, 1947.

A detailed account of the structure and refractive index of the lower atmosphere was given by Sheppard, and other contributions to the subject are scattered throughout the papers published in the same book.

- (284) P. A. Sheppard, "The structure and refractive index of the lower atmosphere," pp. 37-79 of book, "Meteorological Factors in Radio-Wave Propagation," The Phys. Soc. (London), 1947.

An important paper somewhat obscurely placed for the observation of radio workers was one by Craig which describes over 500 airplane soundings made over Massachusetts Bay in the summer of 1944 by a Radiation Laboratory team, for the determination of the refractive index profile. The paper included a careful study of selected soundings in relation to weather data from near-by

land stations in order to determine the meteorological processes which had led to the observed distributions. This investigation was undertaken for radio refraction studies exclusively, but has great interest for general synoptic meteorology as well.

- (285) Richard A. Craig, "Measurements of temperature and humidity in the lowest 1000 feet of the atmosphere over Massachusetts Bay," Papers in Physical Oceanography and Meteorology, published by Massachusetts Inst. of Tech. and Woods Hole Oceanographic Inst., vol. X, No. 1, p. 47.

A further theoretical contribution to the fundamental problem of vertical heat transfer by turbulence was made by Priestley and Swinbank.

- (286) C. H. B. Priestley and W. C. Swinbank, "Vertical transport of heat by turbulence in the atmosphere," *Proc. Royal Soc.* (London), vol. 189, pp. 543-561; June, 1947.

Experimental Studies

The so-called "3-6-9" experiments in England on microwave propagation over Cardigan Bay constituted perhaps the most elaborate experiments to date on the subject of tropospheric propagation.

- (287) E. C. S. Megaw, "Experimental studies of the propagation of very short radio waves," *Jour. I.E.E.* (London), vol. 93, part III-A, No. 1, pp. 79-97; 1946.
 (288) R. L. Smith-Rose and A. C. Stickland, "An experimental study of the effect of meteorological conditions upon the propagation of centimetric radio waves," pp. 18-37 of book, "Meteorological Factors in Radio-Wave Propagation," The Phys. Soc. (London), 1947.

An important field-intensity study of over a year's duration was published in a paper which contains some of the earliest statistics which have been available on v.h.f. and microwave fading within and beyond the horizon.

- (289) G. S. Wickizer and Arthur M. Braaten, "Propagation studies on 45.1, 474, and 2800 megacycles within and beyond the optical horizon," *Proc. I.R.E.*, vol. 35, pp. 670-680; July, 1947.

One of the most intensive studies of the phenomenon of propagation in low ocean ducts was that undertaken by several collaborators at the United States Naval Research Laboratory. In oceanic areas where trade winds prevail, a fairly rapid decrease of humidity was found in the first few tens of feet above the ocean, which give rise to a low duct near the surface where the attenuation is very much less than that calculated for earth curvature and standard refraction conditions alone. Many of the experimental facts can be explained in terms of measured refractive index profiles and the mode theory of refraction, but not all, such as the decreased rate of attenuation with distance of 9-cm. waves beyond 80 nautical miles.

- (290) Martin Katzin, Robert W. Bauchman, and William Binnian, "3- and 9-centimeter propagation in low ocean ducts," *Proc. I.R.E.*, vol. 35, pp. 891-905; September, 1947.

The very persistent subsidence inversion present off the coast of Southern California presents a rather unique opportunity for studying the radio effect of an elevated refracting layer. Smyth and Trolese published an extremely abbreviated account of the investigations of the Navy Electronics Laboratory at San Diego on this phenomenon.

- (291) J. B. Smyth and L. G. Trolese, "Propagation of radio waves in the lower troposphere," *Proc. I.R.E.*, vol. 35, pp. 1198-1202; November, 1947.

The reallocation of the f.m. broadcast band provoked considerable discussion concerning the differences in tropospheric propagation in the old and the new bands. Presentation of the Radiation Laboratory experiments will be found in volume 13 of the Radiation Laboratory Series referred to above.

- (292) Edward W. Allen, Jr., "Very-high-frequency and ultra-high-frequency signal ranges as limited by noise and co-channel interference," *Proc. I.R.E.*, vol. 35, pp. 128-136; February, 1947.
 (293) Discussion of above paper, *Proc. I.R.E.*, vol. 35, pp. 136-152, February, 1947.
 (294) C. W. Carnahan, Nathan W. Aram, and Edward F. Classen, Jr., "Field intensities beyond line of sight at 45.5 and 91 megacycles," *Proc. I.R.E.*, vol. 35, pp. 152-159; February, 1947.

Atmospheric Attenuation

Two papers in the *Physical Review* by Van Vleck and one by King, Hainer, and Cross brought to public view for the first time the theory underlying Van Vleck's wartime prediction of the water-vapor and oxygen absorption from the theory of their infrared molecular spectra. This achievement marked the first application of modern theory of molecular spectra to predict an effect of great practical importance at radio frequencies. Radio can no longer be considered solely as sufficiently described by classical physics in view of these developments.

- (295) J. H. Van Vleck, "The absorption of microwaves by uncondensed water vapor," *Phys. Rev.*, vol. 71, pp. 425-433; April 1, 1947.
 (296) J. H. Van Vleck, "The absorption of microwaves by oxygen," *Phys. Rev.*, vol. 71, pp. 413-424; April 1, 1947.
 (297) Gilbert W. King, R. M. Hainer, and Paul C. Cross, "Expected microwave absorption coefficients of water and related molecules," *Phys. Rev.*, vol. 71, pp. 433-443; April 1, 1947.

In two completely different types of experiments, brilliantly conceived and executed, R. H. Dicke, Lamb, and Becker and Autler verified most of the predictions of Van Vleck's theory with respect to water vapor.

- (298) Robert H. Dicke, Robert Beringer, Robert L. Kyhl, and A. B. Vane, "Atmospheric absorption measurements with a microwave radiometer," *Phys. Rev.*, vol. 70, pp. 340-348; September, 1946.
 (299) Willis E. Lamb, Jr., "Theory of a microwave spectroscopy," *Phys. Rev.*, vol. 70, pp. 308-317; September, 1946.
 (300) Gordon E. Becker and Stanley H. Autler, "Water vapor absorption of electromagnetic radiation in the centimeter wavelength range," *Phys. Rev.*, vol. 70, pp. 300-307; September, 1946.

The attenuation of microwaves by rain is the other factor which, together with the gaseous attenuation, determines how high a frequency can be used in many applications. On the theoretical side, the recent work on calculation of rain intensities is largely that of the Rydes, in England, and L. Goldstein. An abridged account of the results of the researches of the Rydes appeared during the year.

- (301) J. W. Ryde, "The attenuation and radar echoes produced at centimeter wave-lengths by various meteorological phenomena," pp. 169-189 of book, "The Meteorological Factors in Radio-Wave Propagation," The Phys. Soc. (London), 1947.
 (302) L. Goldstein, "The absorption and scattering of microwaves by the atmosphere." Originally issued as Report WPG 14 of the Columbia University Wave Propagation Group, NDRC. Now

available in photostat or microfilm version as PB No. 5850, Office of Technical Services, Dept. of Commerce. To be published, also, in Vol. 2 of the Summary Report of the Committee on Propagation of the N.D.R.C. referred to above.

An experimental study of rain attenuation was published by a Navy Electronics Laboratory Group.

- (303) Lloyd J. Anderson, John P. Day, Clemens H. Freres, and Alfred P. D. Stokes, "Attenuation of 1.25-centimeter radiation through rain," *Proc. I.R.E.*, vol. 35, pp. 351-354; April, 1947.

Meteorological Echoes

The great utility of radar echoes from precipitation in studying rainfall distribution is now well known. The volumes of the Radiation Laboratory series so far published are studded with fine photographs of radar scopes showing precipitation echoes, and Volume 13, referred to above, is to contain a systematic treatment of the phenomenon. Several short accounts of radar storm detection appeared during the year, doubtless to be followed shortly by more comprehensive treatment as this highly useful technique expands.

- (304) Raymond Wexler and Donald M. Swingle, "Radar storm detection," *Bull. Amer. Met. Soc.*, vol. 28, pp. 159-167; April, 1947.
 (305) Alan C. Bemis, "Weather radar research at M.I.T.," *Bull. Amer. Met. Soc.*, vol. 28, pp. 115-117; March, 1947.
 (306) Robert W. Miller, "The use of airborne navigational and bombing radars for weather-radar operations and verifications," *Bull. Amer. Met. Soc.*, vol. 28, pp. 19-28; January, 1947.

One of the minor mysteries in the realm of meteorological echoes is the appearance of weak microwave radar echoes from otherwise clear atmosphere. Two letters were published reporting observations on these phenomena, variously called "angels" or "ghost echoes."
 (307) H. T. Friis, "Radar reflections from the lower atmosphere," *Proc. I.R.E.*, vol. 35, pp. 494-495; May, 1947.
 (308) William B. Gould, "Radar reflections from the lower atmosphere," *Proc. I.R.E.*, vol. 35, p. 1105; October, 1947.

Ground Reflection and Diffraction around Obstacles

At microwave frequencies, irregularities of terrain become of increasing importance. Two papers marked the beginning of the careful experimental investigation of the phenomenon. Their principal experiments were made over ground of simple geometrical shape, for which the diffraction loss could be calculated and compared with experiment. Some experiments were made with trees as the obstacles. A third paper contained a contribution to the neglected subject of reflection of centimeter waves from real ground.

- (309) J. S. McPetrie and L. H. Ford, "An experimental investigation on the propagation of radio waves over bare ridges in the wavelength range 10 cm to 10 m," *Jour. I.E.E.* (London), vol. 93, part III-A, No. 3, pp. 527-530; 1946.
 (310) J. S. McPetrie and L. H. Ford, "Some experiments on the propagation over land of radiation of 9.2-cm wavelength, especially on the effect of obstacles," *Jour. I.E.E.* (London), vol. 93, part III-A, No. 3, pp. 531-538; 1946.
 (311) J. S. Ray, S. J. Parsons, and F. Jackson, "Reflexion of centimetric electromagnetic waves over ground, and diffraction effects with wire-netting screens," *Proc. Phys. Soc.*, (London), vol. 59, pp. 847-857; September 1, 1947.

Angle of Arrival of Microwaves

Since last year's review, several basic experimental papers were published in which direct measurements

were reported of the apparent angle of arrival of microwaves over optical paths. While deviations of over $\frac{1}{2}$ degree were observed in the vertical plane, deviations of less than 1/10 degree were the largest observed in the horizontal plane.

- (312) William M. Sharpless, "Measurement of the angle of arrival of microwaves," *Proc. I.R.E.*, vol. 34, pp. 837-845; November, 1946.
- (313) A. B. Crawford and William M. Sharpless, "Further observations of the angle of arrival of microwaves," *Proc. I.R.E.*, vol. 34, pp. 845-848; November, 1946.

Diversity Reception and Transmission

Several accounts appeared giving testimony to the value of comparatively small space diversity of microwave antennas as an antidote to fading, both on overland and overseas paths, both optical and slightly non-optical. Frequency-diversity transmission of only 20 kc., with antenna separations of as little as 100 feet, using amplitude modulation, proved to be very effective in improving coverage in irregular terrain for frequencies around 100 Mc. Some attention was given to the mathematical treatment of diversity reception on long microwave paths in reference.

- (314) George H. Huber, "Space diversity reception at super-high frequencies," *Bell. Lab. Rec.*, vol. 25, pp. 337-341; September, 1947.
- (315) G. G. Gerlach, "A microwave relay communication system," *RCA Rev.*, vol. 7, pp. 576-600; December, 1946.
- (316) J. R. Brinkley, "A method of increasing the range of V.H.F. communication systems by multi-carrier amplitude modulation," *Jour. I.E.E.* (London), vol. 93, part III, pp. 159-166; discussion pp. 167-176; May, 1946.
- (317) Z. Jelonek, E. Fitch and J. H. H. Chalk, "Diversity reception," *Wireless Eng.*, vol. 24, pp. 54-62; February, 1947.

Waveguides

Many papers, both theoretical and experimental, relating to waveguides appeared since the period covered by the preceding report. One book, in particular, gave an excellent summary of waveguide theory, and also covered many of the wartime developments in the use of waveguides as elements in transmission systems.

- (318) W. H. Watson, "The physical principles of wave guide transmission and antenna systems," International Monographs on Radio, Clarendon Press, Oxford, 1947.

One interesting topic was the use of waveguides partially filled with dielectric material to slow down the phase velocity of transverse magnetic waves. Some papers included formulas for the design of waveguides to give a preassigned phase velocity, and for the attenuation in waveguides of perfectly and imperfectly conducting walls.

- (319) G. E. Bacon and J. C. Duckworth, "Some applications of the principle of variation of wave length in wave guides by the internal movement of dielectric sections," *Jour. I.E.E.* (London), vol. 93, part III-a, No. 14, pp. 633-638; 1946.
- (320) G. G. Bruck and E. R. Wicher, "Slow transverse magnetic waves in cylindrical guides," *Jour. Appl. Phys.*, vol. 18, pp. 766-769; August, 1947.
- (321) S. Frankel, " $TM_{0,1}$ mode in circular wave guides with two coaxial dielectrics," *Jour. Appl. Phys.*, vol. 18, pp. 650-655; July, 1947.
- (322) Alice M. Woodward, "Transmission in wave guides. Cross-section partly of solid dielectric," *Wireless Eng.*, vol. 24, pp. 192-196; July, 1947.

A detailed discussion of the effects of curvature on the

different modes of propagation in waveguides appeared in a series of French articles.

- (323) M. Jouguet, "Propagation of electromagnetic waves in curved guides," *Ann. des Telecommun.* vol. 1, pp. 176-184; August-September, 1946.
- (324) M. Jouguet, "On the transmission of H_1 waves in guides of circular cross-section," *Compt. Rend.* (Paris), vol. 224, pp. 998-1000; March 31, 1947.
- (325) M. Jouguet, "The effects of curvature and of curvature discontinuities on the propagation of waves in guides of rectangular cross-section," *Cables and Transmission*, vol. 1, pp. 39-60; April, 1947.
- (326) M. Jouguet, "The effects of curvatures on the propagation of electromagnetic waves in guides of circular cross-section," *Cables and Transmission*, vol. 1, pp. 133-153; July, 1947.

Bends in rectangular waveguides were also discussed.

- (327) N. Elson, "Rectangular wave guide systems. Bends, twists, corners and junctions," *Wireless Eng.*, vol. 24, pp. 44-54; February, 1947.
- (328) J. W. Miles, "The equivalent circuit of a corner bend in a rectangular wave guide," *Proc. I.R.E.*, vol. 35, pp. 1313-1317; November, 1947.

Two other papers were concerned with waveguides of unusual shape.

- (329) S. B. Cohn, "Properties of ridge wave guide," *Proc. I.R.E.*, vol. 35, pp. 783-788; August, 1947.
- (330) P. Krasnooshkin, "Acoustic and electromagnetic wave guides of complicated shape," *Jour. Phys.* (U.S.S.R.), vol. 10, No. 5, pp. 434-445; 1946.

Papers on the reflection of waves at obstacles such as irises and mica windows in waveguides, or at the junction of two different waveguides, were numerous.

- (331) R. G. Fellers and R. T. Weidner, "Broad-band wave guide admittance matching by means of irises," *Proc. I.R.E.*, vol. 35, pp. 1080-1085; October, 1947.
- (332) M. D. Fiske, "Resonant windows for vacuum seals in rectangular wave guides," *Rev. Sci. Instr.*, vol. 17, pp. 478-483; November, 1946.
- (333) T. Kahan, "Reflection of an electromagnetic wave from a disc placed in a wave guide," *Compt. Rend.* (Paris), vol. 222, pp. 998-1000; April 24, 1946.
- (334) J. Levy, "Transmission of guided electromagnetic waves through a series of symmetrical equidistant obstacles," *Cables and Transmission*, vol. 1, pp. 103-113; July, 1947.
- (335) G. G. Macfarlane, "Quasi-stationary field theory and its application to diaphragms and junctions in transmission lines and wave guides," *Jour. I.E.E.* (London), vol. 93, part III-a, No. 4, pp. 703-719; 1946.
- (336) L. Malter, R. L. Jepsen and L. R. Bloom, "Mica windows as elements in microwave systems," *RCA Rev.*, vol. 7, pp. 622-633; December, 1946.
- (337) J. W. Miles, "The equivalent circuit for a plane discontinuity in a cylindrical wave guide," *Proc. I.R.E.*, vol. 34, pp. 728-742; October, 1946.
- (338) J. Ortusi, "Definition and measurement of reflection coefficients in guides," *Ann. des Telecommun.*, vol. 1, pp. 73-90; May-June, 1946. *Ann. de Radioelec.*, vol. 2, pp. 173-194; April, 1947.
- (339) J. Ortusi, "Filtering of guided waves," *Bull. Soc. Franc. Elec.*, vol. 6, pp. 589-596; November, 1946.

The use of slots cut in the walls of a waveguide as radiating systems, or as a means of coupling a waveguide to another part of a transmission system, was described.

- (340) J. N. Feld, "Laws of potential distribution along slots," *Compt. Rend. Acad. Sci.* (U.S.S.R.), vol. 55, No. 5, pp. 407-410; 1947.
- (341) W. H. Watson, "Resonant slots," *Jour. I.E.E.* (London), vol. 93, part III-a, No. 4, pp. 747-777; 1946.

The theory and development of directional couplers for use in transmission systems continued to be extended.

- (342) H. C. Early, "A wide-band directional coupler for wave guide," *Proc. I.R.E.*, vol. 34, pp. 883-886; November, 1946.

- (343) N. I. Korman, "The theory and design of several types of wave selectors," *Proc. Nat. Electronics Conf.* (Chicago), vol. 2, pp. 404-423; February, 1947.
- (344) W. W. Mumford, "Directional couplers," *Proc. I.R.E.*, vol. 35, pp. 160-165; February, 1947.
- (345) H. J. Riblet, "A mathematical theory of directional couplers," *Proc. I.R.E.*, vol. 35, pp. 1307-1313; November, 1947.
- (346) M. Surdin, "Directive couplers in wave guides," *Jour. I.E.E.* (London), vol. 93, part III-a, No. 4, pp. 725-736; 1946.

Other papers on waveguide theory which are not easily classified but which may be of general interest include:

- (347) C. J. Bouwkamp and N. G. de Bruijn, "The electrostatic field of a point charge inside a cylinder, in connection with wave guide theory," *Jour. Appl. Phys.*, vol. 18, pp. 562-577; June, 1947.
- (348) A. G. Clavier, "Attenuation and Q factors in wave guides," *Elec. Commun.*, vol. 23, pp. 436-444; December, 1946.
- (349) M. Cotte, "Propagation of a perturbation in an electric guide," *Ann. des Telecommun.*, vol. 1, pp. 49-52; March-April, 1946.
- (350) S. Kuhn, "Calculation of attenuation in wave guides," *Jour. I.E.E.* (London), vol. 93, part III-a, No. 4, pp. 663-678; 1946.
- (351) R. E. B. Makinson, "A mechanical analogy for transverse electric waves in a guide of rectangular section," *Jour. Sci. Instr.*, vol. 24, pp. 189-190; July, 1947.
- (352) J. C. Slater, "The theory of symmetrical wave guide T's," *Research Laboratories of Electronics, M.I.T., Tech. Rep. No. 37*, 15 pp.; April 3, 1947.
- (353) E. O. Willoughby and E. M. Williams, "Attenuation curves for 2:1 rectangular, square and circular wave guides," *Jour. I.E.E.* (London), vol. 93, part III-a, No. 4, pp. 723-724; 1946.

Some additional papers were mainly concerned with measurements in waveguides.

- (354) W. Altar, "Q-circles—a means of analysis of resonant micro-waves systems," *Proc. I.R.E.*, vol. 35, pp. 355-361; April; pp. 478-484; May, 1947.
- (355) W. Altar and J. W. Coltman, "Microwave impedance-plotting device," *Proc. I.R.E.*, vol. 35, pp. 734-737; July, 1947.
- (356) L. W. Brown, "Problems and practice in the production of wave-guide transmission systems," *Jour. I.E.E.* (London), vol. 93, part III-a, No. 4, pp. 639-646; 1946.
- (357) T. W. Dakin and C. N. Works, "Microwave dielectric measurements," *Jour. Appl. Phys.*, vol. 18, pp. 789-796; September, 1947.
- (358) E. Maxwell, "Conductivity of metallic surfaces at micro-wave frequencies," *Jour. Appl. Phys.*, vol. 18, pp. 629-638; July, 1947.
- (359) A. F. Pomeroy, "Precision measurement of impedance mismatches in wave guide," *Bell Sys. Tech. Jour.*, vol. 26, pp. 446-459; July, 1947.

Transmission Lines

With emphasis continually on increasingly high frequencies, it becomes difficult to draw a hard and fast line between waveguides and transmission lines. Some of the papers listed in this and in the preceding section are applicable to both methods of transmission. In this connection, two papers may be noted which dealt with the appearance of guided waves in a concentric line when the frequency increases beyond a certain critical value.

- (360) H. Bondi and S. Kuhn, "Concentric line; critical wave length of the higher modes," *Wireless Eng.*, vol. 24, pp. 222-223; August, 1947.
- (361) G. Goudet and J. Lignon, "Theory of guided waves in a coaxial line," *l'Onde Elec.*, vol. 27, pp. 152-159; April, 1947.

The theory of nonuniform lines was extended in several papers.

- (362) M. Parodi, "Propagation along a line with variable parameters satisfying a condition analogous to that of non-deformation at every point of the line," *Gen. Elec. Rev.*, vol. 55, pp. 414-415; October, 1946.
- (363) P. Parzen, "The capacity per unit length and characteristic

impedance of coaxial cables with one slightly non-circular conductor," *Jour. Appl. Phys.*, vol. 18, pp. 774-776; August, 1947.

- (364) F. H. Raymond, "Contribution to the study of propagation on a non-uniform line," *Jour. de Phys.*, vol. 7, pp. 171-177; June, 1946.
- (365) L. R. Walker and N. Wax, "Non-uniform transmission lines and reflection coefficients," *Jour. Appl. Phys.*, vol. 17, pp. 1043-1045; December, 1946.

One book on the general theory of transmission lines was published, as were several expository articles stressing different methods of dealing with line problems.

- (366) P. J. Selgin, "Electrical Transmission in the Steady State," McGraw-Hill Book Co., Inc., New York, N. Y., 1946.
- (367) H. G. Booker, "The elements of wave propagation using the impedance concept," *Jour. I.E.E.* (London), vol. 94, part III, pp. 171-198; discussion pp. 199-202; May, 1947.
- (368) E. W. Hamlin and R. A. Galbraith, "Transmission line impedance calculations," *Elec. Eng.*, vol. 66, pp. 743-744; July, 1947.
- (369) P. LeCorbeiller, "Voltage wave along a lossless line in the general case," *Amer. Jour. Phys.*, vol. 15, pp. 119-121; March-April, 1947.
- (370) P. M. Prache, "The reflection of power," *Cables and Transmission*, vol. 1, pp. 31-37; April, 1947.
- (371) R. M. Redheffer, "Elementary theory of transmission and reflection, fundamental relations and geometry," *Research Laboratory of Electronics, M.I.T., Tech. Rep. No. 24*, 20 pp.; November 20, 1946.
- (372) W. H. Watson, "Matrix methods in transmission-line and impedance calculations," *Jour. I.E.E.* (London), vol. 93, part III-a, No. 4, pp. 737-746; 1946.

On the experimental side there was emphasis on the use of transmission lines as impedance transformers.

- (373) W. N. Christiansen, "An exponential transmission line employing straight conductors," *A.W.A. Tech. Rev.*, Vol. 7, pp. 229-240; April, 1947. *Proc. I.R.E.*, vol. 35, pp. 576-581; June, 1947.
- (374) W. N. Christiansen and J. A. Guy, "An eight-wire transmission line for impedance transformation," *A.W.A. Tech. Rev.*, vol. 7, pp. 241-249; April, 1947.
- (375) A. W. Gent and P. J. Wallis, "Impedance matching by tapered transmission lines," *Jour. I.E.E.* (London), vol. 93, part III-a, No. 3, pp. 559-563; 1946.

The design of line junctions to maintain good standing-wave ratios over a wide range of frequencies was discussed.

- (376) S. B. Cohn, "Design of simple broad-band wave-guide-to-coaxial-line junctions," *Proc. I.R.E.*, vol. 35, pp. 920-926; September, 1947.
- (377) E. G. Fubini and P. J. Sutro, "A wide-band transformer from an unbalanced to a balanced line," *Proc. I.R.E.*, vol. 35, pp. 1153-1155; October, 1947.

Several papers dealt with impedance measurements.

- (378) E. G. Hills, "Impedance measurements at VHF," *Electronics*, vol. 20, pp. 124-128; July, 1947.
- (379) D. D. King, "Impedance measurement on transmission lines," *Proc. I.R.E.*, vol. 35, pp. 509-514; May, 1947.
- (380) F. M. Leslie, "R.F. generator load. Use of water-dielectric transmission line," *Wireless Eng.*, vol. 24, pp. 105-108; April, 1947.
- (381) H. H. Meinke, "Impedance standards at high frequencies," *Zeit. Naturforsch.*, vol. 29, pp. 55-59; January, 1947.
- (382) O. M. Woodward, Jr., "Comparator for coaxial line adjustments," *Electronics*, vol. 20, pp. 116-120; April, 1947.

Cavity Resonators

The general theory of cylindrical cavity resonators of constant cross-section was described in some interesting papers.

- (383) J. Bernier, "On electromagnetic cavities," *l'Onde Elec.*, vol. 26, pp. 305-317; August-September, 1946.
- (384) R. N. Bracewell, "Charts for resonant frequencies of cavities," *Proc. I.R.E.*, vol. 35, pp. 830-841; August 1947.

- (385) G. de Vries, "Electromagnetic cavity resonators," *Philips Tech. Rev.*, vol. 9, pp. 73-84; March, 1947.
- (386) J. P. Kinzer and I. G. Wilson, "End plate and side wall currents in circular cylinder cavity resonator," *Bell Sys. Tech. Jour.*, vol. 26, pp. 31-79; January, 1947.
- (387) J. P. Kinzer and I. G. Wilson, "Some results on cylindrical cavity resonators," *Bell Sys. Tech. Jour.*, vol. 26, pp. 410-445; July, 1947.
- (388) M. L. Levin, "Theory of toroidal endovibrators," *Jour. Tech. Phys. (U.S.S.R.)*, vol. 16, no. 7, pp. 833-844; 1946.

Re-entrant cavities were discussed, together with their use in dielectric measurements.

- (389) E. Mayer, "Resonant frequencies of the nosed-in cavity," *Jour. Appl. Phys.*, vol. 17, pp. 1046-1055; December, 1946.
- (390) S. I. Reynolds, "Improved re-entrant cavity for dielectric-loss measurements from 400 to 600 megacycles," *Gen. Elec. Rev.*, vol. 50, pp. 34-39; September, 1947.
- (391) C. N. Works, "Resonant cavities for dielectric measurements," *Jour. Appl. Phys.*, vol. 18, pp. 605-612; July, 1947.

Slots in the walls of a cavity and their effect on loading, internal-field distortion, and energy transfer were considered.

- (392) J. H. Owen Harries, "Apertures in cavities," *Electronics*, vol. 19, pp. 132-135; December, 1946.

The coupling of high-frequency resonators to waveguides is another topic which was considered.

- (393) L. W. Brown, "Problems and practice in the production of wave guide transmission systems," *Jour. I.E.E. (London)*, vol. 93, part III-a, no. 4, pp. 639-646; 1946.
- (394) I. I. Volman, "Receiver resonator in a wave guide," *Radiotekhnika*, vol. 2, no. 1, pp. 27-35; 1947.
- (395) I. I. Volman and A. I. Shpuntov, "Experimental determination of input impedances of resonators in the $H_{0,1}$ -excited wave guide," *Radiotekhnika*, vol. 2, no. 1, pp. 36-48; 1947.

The use of S-type plungers in a coaxial-line resonator was described.

- (396) W. H. Huggins, "Broad-band noncontacting short circuits for coaxial lines," *Proc. I.R.E.*, vol. 35, pp. 906-913, September; pp. 1085-1091, October; pp. 1324-1328, November, 1947.

Another paper on coaxial-line resonators appeared.

- (397) P. J. Sutro, "Theory of mode separation in a coaxial oscillator," *Proc. I.R.E.*, vol. 34, pp. 960-962; December, 1946.

Cavity resonators were also used for dielectric measurements at very-high frequencies.

- (398) B. Bleaney, J. H. N. Loubser, and R. P. Penrose, "Cavity resonators for measurements with centimetre electromagnetic waves," *Proc. Phys. Soc. (London)*, vol. 59, pp. 185-199; March 1, 1947.
- (399) R. Dunsmuir and J. G. Powles, "A method for the measurement of the dielectric properties of liquids in the frequency range 600-3,200 mc./sec (50-9.4 cm.)," *Phil. Mag.*, vol. 37, pp. 747-756; November, 1946.

Two papers on charged-particle accelerators may be mentioned here, since they were mainly concerned with the design of cavity resonators to produce the desired acceleration.

- (400) E. S. Akeley, "The study of a certain type of resonant cavity and its application to a charged particle accelerator," *Jour. Appl. Phys.*, vol. 17, pp. 1056-1060; December, 1946.
- (401) J. H. Owen Harries, "Cavity resonators and electron beams," *Wireless Eng.*, vol. 24, pp. 71-80, March; pp. 109-118, April; pp. 135-142, May, 1947.

Noise

This coequal partner in the signal-to-noise ratio began to receive the attention it has always deserved in the study of communication of all types of intelligence; this

may be seen by the large number of current papers relating to all aspects of the noise problem. Studies of atmospheric radio noise revealed its general nature, the variations of the general level to be expected in various parts of the radio spectrum, its use in connection with the location of thunderstorms, and its use as a convenient source of radiation for the study of radio propagation.

- (402) H. Norinder and W. Stoffregen, "The nature and variation of atmospherics caused by lightning discharges," *Ark. Mat. Astr. Fys.*, vol. 33, part 3, Section 4, 44 pp. February 6, 1947.
- (403) R. Bureau, "Effect of wavelength on the general level of atmospherics," *Compt. Rend. Acad. Sci.*, vol. 219, pp. 349-351; Oct 9, 1944.
- (404) C. Clarke, "Atmospherics and their location," *Jour. I.E.E.*, Part I, vol. 94, pp. 54-55; January, 1947.
- (405) R. Bureau, "Ionospheric fluctuations of sudden origin and the eleven-year solar cycle," *Compt. Rend. Acad. Sci.*, vol. 219, pp. 461-463; November 5, 1944.
- (406) R. Bureau, "Eruptions of the solar chromosphere and their influences on the ionosphere and on wave propagation. Their effects in different regions of the radio spectrum," *Onde Elec.*, vol. 27, pp. 45-56; February, 1947.

Further information was made available on man-made radio noise and its elimination.

- (407) S. F. Pearce, "The suppression of radio interference from electrical appliances," *Beama Jour.*, vol. 54, pp. 40-47; February, 1947.
- (408) L. F. Shorey and S. M. Gray, "Preliminary study of radio interference as caused by fluorescent lamps in the home," *Illum. Eng.*, vol. 42, pp. 365-376; March, 1947.

A general discussion of the limitations to reception at v.h.f. and higher frequencies showed that noise originating in extraterrestrial sources is, in general, controlling at frequencies less than about 100 Mc., but that the noise generated in the receiver itself is the controlling factor at frequencies in excess of 100 Mc. Emphasis was placed on extensions in maximum range made possible by a reduction in the receiver noise figure on these higher frequencies. The published information on cosmic and solar noise was extensive. A good survey of the information available up until January, 1947, was published by Reber and Greenstein. Theories of solar noise radiation received considerable attention.

- (409) K. A. Norton and A. C. Omberg, "The maximum range of a radar set," *Proc. I.R.E.*, vol. 35, pp. 4-24; January, 1947.
- (410) G. Reber and J. L. Greenstein, "Radio-frequency investigations of astronomical interest," *Observatory*, vol. 67, pp. 16-26; February, 1947.
- (411) J. Denisse, "Study of condition of emission of metre radio waves by the solar atmosphere," *Rev. Sci. (Paris)*, vol. 84, pp. 259-262; September 15, 1946.
- (412) D. F. Martyn, "Origin of radio emissions from the disturbed sun," *Nature*, vol. 159, pp. 26-27; January 4, 1947.
- (413) J. V. Garwick, "On the radio-frequency emission from the sun," *Compt. Rend. Acad. Sci.*, vol. 224, pp. 377-379; February 10, 1947.
- (414) J. V. Garwick, "On radio-frequency emission from the sun," *Compt. Rend. Acad. Sci.*, vol. 224, pp. 551-553; February 24, 1947.

An interpretation was given of a possible source for cosmic radio noise.

- (415) C. H. Townes, "Interpretation of radio radiation from the milky way," *Astrophysical Jour.*, vol. 105, pp. 235-240; March, 1947.

Additional measurements were reported on solar radio noise.

- (416) G. Reber, "Solar radiation at 480 mc/sec.," *Nature*, vol. 158, p. 945; December 28, 1946.
- (417) A. E. Covington, "Micro-wave solar noise observations during the partial eclipse of November 23, 1946," *Nature*, vol. 159, pp. 405-406; March 22, 1947.
- (418) K. F. Sander, "Radio noise from the sun at 3.2 cm.," *Nature*, vol. 159, pp. 506-507; April 12, 1947.

The measurements of noise were facilitated by advances in noise-generator techniques.

- (419) J. D. Cobine and J. R. Curry, "Electrical noise generators," *Proc. I.R.E.*, vol. 35, pp. 875-879; September, 1947.
- (420) W. P. Dolphin, "Noise signal generator," *R.S.B.G. Bull.*, vol. 22, pp. 158-160; April, 1947.

The theory of the statistical distribution in the various circuits of the receiver was the subject of further development.

- (421) Mark Kac and A. J. F. Siegert, "On the theory of noise in radio receivers with square law detectors," *Jour. Appl. Phys.*, vol. 18, pp. 383-397; April, 1947.
- (422) A. Blanc-Lapierre, "Study of fluctuations produced in a counting effect in amplifiers," *Rev. Sci. (Paris)*, vol. 84, pp. 75-94; June-July, 1946.
- (423) D. Middleton, "The response of biased, saturated linear and quadratic rectifiers to random noise," *Jour. Appl. Phys.*, vol. 17, pp. 778-801; October, 1946.
- (424) R. L. Bell, "Linearity range of noise-measuring amplifiers," *Wireless Eng.*, vol. 24, pp. 119-122; April, 1947.

Attention was given to the design of the early stages in the receiver for optimum performance in the presence of noise.

- (425) J. E. Browder and Victor J. Young, "Design values for loop-antenna input circuits," *Proc. I.R.E.*, vol. 35, pp. 519-525; May, 1947.
- (426) L. A. Moxon, "Noise factor," (Part 3), *Wireless World*, vol. 53, pp. 171-176; May, 1947.
- (427) W. M. Breazeale, "A note on noise and conversion-gain measurements," *Proc. I.R.E.*, vol. 35, pp. 31-34; January, 1947.
- (428) W. J. Stolze, "Input circuit noise calculations for FM and television receivers," *Communications*, vol. 27, pp. 12-13, 15, 44-46, 48-49, 51; February, 1947.

Extensive work was reported on other aspects of receiver noise.

- (429) M. J. O. Strutt, "Noise-figure reduction in mixer stages," *Proc. I.R.E.*, vol. 34, pp. 942-950; December, 1946.
- (430) J. M. Pettit, "Specification and measurement of receiver sensitivity at the higher frequencies," *Proc. I.R.E.*, vol. 35, pp. 302-306; March, 1947.
- (431) S. Roberts, "Some considerations governing noise measurements on crystal mixers," *Proc. I.R.E.*, vol. 35, pp. 257-265; March, 1947.
- (432) D. Williams, "Visual measurement of receiver noise," *Wireless Eng.*, vol. 24, pp. 100-104; April, 1947.

The problems involved in the design and construction of radio noise meters were outlined.

- (433) H. E. Dinger and H. G. Paine, "Factors affecting the accuracy of radio noise meters," *Proc. I.R.E.*, vol. 35, pp. 75-81; January, 1947.

The noise characteristics of various electronic devices were reported.

- (434) J. D. Cobine and C. J. Gallagher, "Effects of magnetic field on oscillations and noise in hot-cathode arcs," *Jour. Appl. Phys.*, vol. 18, pp. 110-116; January, 1947.
- (435) J. D. Cobine and C. J. Gallagher, "Noise in gas tubes," *Electronics*, vol. 20, pp. 144, 116, 196, 198; March, 1947.
- (436) P. H. Miller, Jr., "Noise spectrum of crystal rectifiers," *Proc. I.R.E.*, vol. 35, pp. 252-256; March, 1947.
- (437) F. Lüdi, "Shot effect and the receiving sensitivity of transit-time valves of different types," *Helv. Phys. Acta*, vol. 19, pp. 355-374; September 21, 1946.

Extensive contributions were made in defining the

characteristics of signals which are useful in distinguishing these signals from the noise.

- (438) Leo L. Beranek, "The design of speech communication systems," *Proc. I.R.E.*, vol. 35, pp. 880-890; September, 1947.
- (439) J. H. Van Vleck and D. Middleton, "A theoretical comparison of the visual, aural, and meter reception of pulsed signals in the presence of noise," *Jour. Appl. Phys.*, vol. 17, pp. 940-971; November, 1946.
- (440) N. R. French and J. C. Steinberg, "Factors governing the intelligibility of speech sounds," *Jour. Acous. Soc. Amer.*, vol. 19, pp. 90-119; January, 1947.

An experimental study showed the ways in which amplitude limiting and frequency selectivity influence the performance of voice communication receivers.

- (441) W. J. Cunningham, S. J. Goffard, and J. C. R. Licklider, "The influence of amplitude limiting and frequency selectivity upon the performance of radio receivers in noise," *Proc. I.R.E.*, vol. 35, pp. 1021-1025; October, 1947.

General

Papers of general interest in the field of wave propagation which appeared during the year included the following:

- (442) H. Arzelies, "Selective and metallic reflection," *Ann. Phys. (Paris)*, Series 12, vol. 2, pp. 133-194; March, April, 1947.
- (443) J. F. Carlson and A. E. Heins, "The reflection of an electromagnetic plane wave by an infinite set of plates," *Quart. Appl. Math.*, vol. 4, pp. 313-329; January, 1947; vol. 5, pp. 82-88; April, 1947.
- (444) V. Fock, "The field of a plane wave near the surface of a conducting body," *Jour. Phys. (U.S.S.R.)* vol. 10, no. 5, pp. 399-409; 1946.
- (445) E. B. Moullin, "The field of a coil between two parallel metal sheets," *Jour. I.E.E. (London)*, vol. 94, part III, pp. 78-84; January, 1947.
- (446) L. Pincherle, "Refraction of plane non-uniform electromagnetic waves between absorbing media," *Phys. Rev.*, vol. 72, pp. 232-235; August 1, 1947.
- (447) A. A. Pistoljkers, "Propagation of electromagnetic energy along a slot in a conducting plane," *Jour. Tech. Phys. (U.S.S.R.)* vol. 16, no. 1, pp. 11-34; 1946.
- (448) A. A. Pistoljkers, "Radiation from the longitudinal slits in a circular cylinder," *Jour. Tech. Phys. (U.S.S.R.)* vol. 17, no. 3, pp. 365-376; 1947.
- (449) A. A. Pistoljkers, "Radiation from the transversal slits on the surface of a circular cylinder," *Jour. Tech. Phys. (U.S.S.R.)*, vol. 17, no. 3, pp. 377-388; 1947.
- (450) S. A. Schelkunoff, "Generalized boundary conditions in electromagnetic theory," *Proc. Nat. Electronics Conf. (Chicago)*, vol. 2, pp. 317-322; February, 1947.
- (451) J. C. Slater, "Microwave electronics," *Rev. Mod. Phys.*, vol. 18, pp. 441-512; October, 1946.
- (452) R. P. Wakeman, "Analyzing television propagation at VHF," *Tele-Tech*, vol. 6, pp. 62-65, 113-115; June, 1947.

Television

The most significant single event affecting television in 1947 was the decision of the Federal Communications Commission to deny commercial status to color television at this time. As a result of this action by the Commission, a general state of indecision on the part of many participants was ended, and the full energy of the industry was concentrated on commercialization of television according to present RMA standards. The number of active television broadcast stations increased from 6 to 16 during the year, with further expansion indicated by a rising number of construction permits on file.

- (453) Decision of FCC issued March 18, 1947—Docket No. 7896. "Television topics dominate NAB technical conference," *Tele-Tech*, vol. 6, pp. 56-59, 103-104; November, 1947.

During the year, approximately 175,000 television receivers were manufactured with a total retail value of \$74,000,000. Received picture size varied from $3\frac{1}{2} \times 5$ inches to 16×22 inches. Developments of interest included an optical system for projection television receivers of improved performance, and almost universal use of high-voltage supplies of low energy storage for reasons of safety.

- (454) W. E. Bradley and E. Traub, "A new television projection system," *Electronics*, vol. 20, pp. 84-89; September, 1947.
 (455) Robert S. Mautner and O. H. Schade, "Television high-voltage RF supplies," *RCA Rev.*, vol. 8, pp. 43-81; March, 1947.
 (456) A. W. Friend, "Television deflection circuits," *RCA Rev.*, vol. 8, pp. 98-138; March, 1947.

One of the factors limiting the sale of television receivers in central metropolitan areas was the lack of a suitable antenna system for multiple distribution in apartment houses and large buildings. Several systems for overcoming this difficulty were introduced during the year, and installations of these systems are now under way.

- (457) R. J. Ehret, "Television antenna installations giving multiple receiver outlets," *Tele-Tech.*, vol. 6, pp. 26-29, 99-100; June, 1947.
 (458) "Apartment house television antenna," pamphlet published by Radio Manufacturers Association, Engineering Dept., October, 1937, Document Number ED-2498-A.

The increase in number of receivers has emphasized the problem of interference with television signals in many locations. This is rapidly becoming a serious problem, and a committee of the Television Broadcasters Association is investigating the matter.

- (459) A. Francis, "Engineering problems involved in television interference," *Tele-Tech.*, vol. 6, pp. 42-45, 109-109; September, 1947.

In the transmitter design field, no developments of major significance have been noted. Work has been concentrated on improving existing equipment and designing additional transmitters along lines well established within the industry.

Various manufacturers announced their commercial lines of television pickup equipment. A new design of film pickup camera, using a flashing light source, was developed and successfully demonstrated during the year. An improved version of the 2P23 image-orthicon type of pickup tube was made available to station owners. This tube gave improved signal-to-noise ratio and was generally recommended for use in studio-type shows. The Zoomar lens, in which the effective focal length can be varied continuously from about 4 to 20 inches without changing the focus, was developed and successfully used on television cameras, permitting increased flexibility in camera operation.

- (460) Leonard Mautner, "Portable camera chain for field use," *Tele-Tech.*, vol. 6, pp. 26-31, 100-102, 104, 106-109; May, 1947.
 (461) John H. Roe and N. S. Bean, "Television field equipment," *FM and Telev.*, vol. 7, pp. 31-35; November, 1947.
 (462) L. Mautner and A. J. Barackett, "Engineering television master control equipment," *Tele-Tech.*, vol. 6, pp. 42-46, 142-146; March, 1947.
 (463) R. V. Little, Jr., "Film projectors for television," *Jour. Soc. Mot. Pic. Eng.*, vol. 48, pp. 93-110; February, 1947.
 (464) Frank G. Back, "The physical properties and the practical application of the Zoomar lens," *Jour. Soc. Mot. Pic. Eng.*, vol. 49, pp. 57-63, July, 1947.

The importance of network operation to television broadcasting was developed before the F.C.C. in June, 1947. One important question still unresolved is whether broadcasters and independent technical organizations could better provide such facilities, or whether this field can best be served by the common carriers. At the end of the year, radio relays were in use between New York and Boston, New York to Washington, via Philadelphia, and New York and Schenectady. Plans were announced for radio relays between Schenectady, Rochester, and Syracuse, San Francisco and Los Angeles, and New York to Chicago. The coaxial cable from New York to Washington, via Philadelphia and Baltimore, continued in operation.

- (465) "FCC studies television relays for inter-city network systems," *Tele-Tech.*, vol. 6, pp. 34-37; August, 1947.
 (466) L. G. Abraham and H. I. Romnes, "Television network facilities," *Elec. Eng.*, vol. 66, pp. 477-482; May, 1947.

A coast-to-coast coaxial cable was completed between Atlanta and Los Angeles during 1947. This facility is being equipped initially for telephone use. Additional terminal and repeater equipment will be required for television transmission. Plans for a broad-band radio relay circuit between New York and Pittsburgh were announced, but this circuit is not equipped for television network operation at this time. Additional development work is in progress to determine the suitability of these circuits for television relaying.

Experimental work was carried out in England in relaying television programs by radio. The General Post Office announced its plans for a radio relay for this purpose between London and Birmingham.

- (467) "Television relay—television wireless link demonstration by the Marconi Co., Ltd.," *Electronic Eng.*, vol. 19, p. 240; August, 1947.
 (468) "London-Birmingham television," *Electrician*, vol. 138, pp. 1593-1594; June 13, 1947.

The motion-picture industry has shown an increased interest in television. Several methods have been proposed and demonstrated for presenting television images in theaters. These include direct projection from the cathode-ray tube, and a method using intermediate film, involving some delay of the program. Theater interests showed increasing concern in the allocation of frequencies for relaying television programs to theaters.

- (469) "Statement of SMPE on revised frequency allocations," *Jour. Soc. Mot. Pic. Eng.*, vol. 48, pp. 183-202, March, 1947.
 (470) H. G. Shea, "Color television for theaters," *Tele-Tech.*, vol. 6, pp. 44-45; June, 1947.

Developments in progress which were not completed at the end of the year include the intercarrier method of sound reception, and continuing research on color television. On the intercarrier system, work was concentrated on analyzing possible troubles introduced by phase shifts in the transmitter. In color, events of note include the demonstration of color images $7\frac{1}{2} \times 10$ feet, detailed descriptions of color systems, ultra-high-frequency propagation studies, and new reproducing-tube developments.

- (471) L. W. Parker, "Television intercarrier sound system," *Tele-Tech*, vol. 6, pp. 26-28, 94-97; October, 1947.
- (472) R. B. Dome, "Carrier-difference reception of television sound," *Electronics*, vol. 20, pp. 102-105; January, 1947.
- (473) "RTPB investigates TV sound systems for color," *Tele-Tech*, vol. 6, pp. 63, 140-141; March, 1947.
- (474) R. D. Kell (Pt. I), G. C. Sziklai, R. C. Ballard, A. C. Schroeder (Pt. II), K. R. Wendt, G. L. Fredendall, and A. C. Schroeder (Pt. III), "An experimental simultaneous color television system," *Proc. I.R.E.*, vol. 35, pp. 861-875, September, 1947.
- (475) R. P. Wakeman, "Analyzing television propagation at UHF," *Tele-Tech*, vol. 6, pp. 62-65, 113-115; June, 1947.
- (476) A. B. Bronwell, "The chromoscope, a new color television viewing tube," presented, National Electronics Conference, Chicago, Ill., October, 1947.

Piezoelectric Crystals

Among the more notable advances during 1947 may be mentioned investigations on Seignette-electric (ferroelectric) crystals and the cause of their anomalies, the appearance of new artificial crystals offering promise of useful applications, and investigation of the piezoelectric properties of barium titanate.

Measurements and Theory

Three papers appeared on measurements of equivalent electrical constants and on the theory of transducers, and one on the elastic, dielectric, and piezoelectric equations in tensor form.

- (477) E. Burstein, "The approximate determination of piezoelectric properties by measurements on small crystals," *Rev. Sci. Instr.*, vol. 18, pp. 317-327; May, 1947.
- (478) W. D. George, M. C. Selby, and R. Scolnik, "Electrical characteristics of quartz-crystal units and their measurement," *Jour. Res. Nat. Bur. Stand.*, vol. 38, pp. 309-328; March, 1947.
- (479) W. P. Mason, "First and second order equations for piezoelectric crystals expressed in tensor form," *Bell Sys. Tech. Jour.*, vol. 26, pp. 80-138; January, 1947.
- (480) W. Roth, "Piezoelectric transducers. I. Electromechanical impedance matrix. II. Electrical driving point impedance and admittance," *Res. Lab. of Electronics, M.I.T.*, Report No. 43, July 3, 1947.
- (481) P. Vigoureux, "Sensitivity and impedance of electro-acoustic transducers," *Proc. Phys. Soc. (London)*, vol. 59, pp. 19-30; January 1, 1947.

Investigations on Quartz

In addition to a paper on torsional vibrations, there were several on the subject of twinning.

- (482) R. Rao, "Torsional oscillations in quartz plates," *Proc. Ind. Acad. Sci. A*, vol. 25, pp. 195-200; February, 1947.
- (483) W. A. Wooster, "A theory of the control of twinning in quartz," *Nature*, vol. 159, pp. 94-95; January 18, 1947.
- (484) W. A. Wooster and N. Wooster, "Control of electrical twinning in quartz," *Nature*, vol. 157, pp. 405-406; March 30, 1946.
- (485) J. J. Vormer, "Artificial electrical twinning in quartz crystals," *Proc. I.R.E.*, vol. 35, pp. 789-790; August, 1947.

New Crystals

The EDT and DKT crystals were described in the following paper:

- (486) W. P. Mason, "New low-coefficient synthetic piezoelectric crystals for use in filters and oscillators," *Proc. I.R.E.*, vol. 35, pp. 1005-1012; October, 1947.

Seignette-electrics

The long-standing problem of the anomalies in Rochelle salt was again attacked by Lichtenstein and by Mason. The former investigator attributed the anomalies to a deformation of the lattice as a whole with tem-

perature, while the latter, using X-ray data, located the "ferroelectric dipole" in a certain hydrogen bond; his experimental and theoretical results strengthened the view already held that the anomalies lie in the clamped dielectric constant.

Interesting changes were found in the properties of ADP crystals when some of the ammonium ions were replaced with tellurium.

- (487) R. M. Lichtenstein, "Electromechanical properties of Rochelle salt at the lower Curie point," *Phys. Rev.*, vol. 72, pp. 491-501; September 15, 1947.
- (488) W. P. Mason, "Theory of the ferroelectric effect and clamped dielectric constant of Rochelle salt," *Phys. Rev.*, vol. 72, pp. 854-865; November 1, 1947.
- (489) B. Matthias, W. Merz, and P. Scherrer, "The seignette-electric lattice of the KH_2PO_4 -type and the behavior of the NH_4 -rotation transformation with $(NH_4, Tl)H_2PO_4$ mixed crystals," *Helv. Phys. Acta*, vol. 20, pp. 273-306; August 4, 1947.

Barium Titanate

Within recent years attention has been given to certain peculiarities in the elastic, dielectric, and piezoelectric properties of barium titanate. This crystal is strongly piezoelectric, has two Curie points, and is now classed among the Seignette-electric substances. Considerable progress was reported in the experimental study of these effects and also in their theory.

- (490) A. De Bretteville, Jr., "Oscillographic study of the dielectric properties of barium titanate," *Phys. Rev.*, vol. 69, p. 687; June 1 and 15, 1946.
- (491) V. Ginsburg, "On the dielectric properties of ferroelectric (Seignette-electric) crystals and barium titanate," *Jour. Phys. (U.S.S.R.)*, vol. 10, pp. 107-115; 1946.
- (492) W. P. Mason, "Electrostrictive effect in barium titanate," *Phys. Rev.*, vol. 72, pp. 869-870; November 1, 1947.
- (493) B. T. Matthias, R. G. Breckenridge, and D. W. Beaumont, "Single crystals of barium titanate," *Phys. Rev.*, vol. 72, p. 532; September 15, 1947.
- (494) S. Roberts, "Dielectric and piezoelectric properties of barium titanate," *Phys. Rev.*, vol. 71, pp. 890-895; June 15, 1947.

Use of Crystals in Ultrasonics

Great progress is taking place in the field of ultrasonics, in which crystals, chiefly of quartz or ADP, play an important part. This is not the place for a survey of the entire field, especially since many of the reports have not yet been released. The following papers, dealing largely with the use of crystals, may, however, be mentioned.

- (495) L. F. Epstein, W. M. A. Andersen, and L. R. Harden, "High intensity ultrasonics: The power output of a piezoelectric quartz crystal," *Jour. Acous. Soc. Amer.*, vol. 19, pp. 248-253; January, 1947.
- (496) A. C. Keller, "Submarine detection by sonar," *Bell Lab. Rec.*, vol. 25, pp. 55-60; February, 1947.
- (497) F. N. D. Kurie and G. P. Harnwell, "The wartime activities of the San Diego laboratory of the University of California Division of War Research," *Rev. Sci. Instr.*, vol. 18, pp. 207-218; April, 1947.

Electron Tubes

Power-Output High-Vacuum Tubes

Several new types of triodes of comparatively high power for very-high-frequency use were made commercially available. They were intended primarily for f.m. and were to be used in a grounded-grid circuit. Some of them were also recommended for television. The list of triodes included low-power tubes with 100 to 200 watts

output at frequencies from 100 to 250 Mc. However, in individual cases it was possible to boost the operating frequency by designing the tube as an integral part of the oscillatory circuit. Thus, with a special concentric circuit with a "grid bell" of an adjustable length attached to the grid, there was obtained from a triode the same output at frequencies up to 600 Mc. In another tube with an attachable resonant cavity, the limit was raised to 1200 Mc., which is a frequency previously practicable only with the disk-seal triodes.

- (498) S. Frankel, J. J. Glauber, and J. P. Wallenstein, "Medium-power triode for 600 megacycles," *Elec. Commun.*, vol. 24, pp. 179-186; June, 1947.
 (499) "Type GL-592 plotron transmitting tube," *Radio News*, vol. 37, p. 33; January, 1947.
 (500) "UHF power triode for grounded-grid circuits," *Elec. Ind. and Instr.*, vol. 1, p. 20; June, 1947.

Medium-output triodes with 1.5 to 5 kilowatts output for f.m. in the 100-Mc. band were also announced by various designers. Grounded-grid circuits were also preferred here. The possibility of combining as many as eight tubes in the final stage by embedding their anodes in a solid copper plate was successfully explored. A total power of 50 kilowatts at 110 Mc. was realized in this circuit. Most of the tubes mentioned in this paragraph were built with thoriated-tungsten filamentary cathodes.

- (501) P. I. Corbell, Jr., and H. R. Jacobus, "Triodes for 3- and 10-kilowatt frequency-modulated transmitters," *Elec. Commun.*, vol. 24, pp. 187-191; June, 1947.
 (502) "New tubes," *Radio News*, vol. 37, p. 28; April, 1947.
 (503) "RCA tubes," *Radio News*, vol. 37, p. 28; July, 1947.
 (504) "Hytron VHF triode," *Communications*, vol. 27, pp. 33-34; July, 1947.
 (505) R. L. Norton, Byron O. Ballou, and R. H. Chamberlain, "K5BR's 50-kw high-band FM transmitter," *Electronics*, vol. 20, pp. 80-84; October, 1947.

Announcement was made that thoriated-tungsten filaments were used in some of the high-output tubes designed for broadcasting at frequencies below 20 Mc. with operating voltages from 10,000 to 15,000 volts. This showed that, with accumulated experience and improved vacuum techniques, the tube designers felt themselves in a position to take responsibility for this type of cathode in large tubes. Several years ago the upper practicable limit of the c.w. operating voltage was considered to be 3000 or 4000 volts.

- (506) "New Tubes," *Radio News*, vol. 37, p. 37; April, 1947; p. 28; June, 1947.
 (507) "FTR thoriated-tungsten filament AM tubes," *Communications*, vol. 27, p. 40; May, 1947.

Although some of the f.m. triodes were also recommended for television uses in the 100- and 200-Mc. bands, other designers preferred tetrodes both for television and f.m. As a result, a number of low- and medium-power tetrodes or beam tetrodes were made available for these purposes. Tetrodes with an output power of 1000 and 2000 watts were reported with an extremely low driving power. The frequency band covered by tetrodes was extended from 50 to 430 Mc.

- (508) "Hytron instant-heating VHF beam tetrode," *Communications*, vol. 27, p. 44; April, 1947.

- (509) "Eimac 65 watt tetrode 4-65A," *Communications*, p. 30; August, 1947.
 (510) Vin Zeluff, "Four-tetrode FM power amplifier," *Electronics*, vol. 20, pp. 132-134; August, 1947.
 (511) "UHF power tetrode for mobile applications," *Elec. Ind. and Instr.*, vol. 1, p. 18; May, 1947.
 (512) "Transmitting tetrode," *Elec. Ind. and Instr.*, vol. 1, p. 17; August, 1947.
 (513) "Beam power transmitting tubes," *Elec. Ind. and Instr.*, vol. 1, p. 17; August, 1947.

Not much new work on tubes for microwave operation was reported during 1947, except for some results of the wartime activities. One interesting development was reported in three correlated papers dealing with frequency-modulated multicavity magnetrons at 1000 and 4000 Mc. in c.w. operation. The modulation was effected by shooting electron beams through one or several cavities longitudinally. However, no practical application of these devices was announced. Another paper described a new approach to the problem of frequency control at ultra-high frequencies.

- (514) Lloyd P. Smith and Carl I. Shulman, "Frequency modulation and control by electron beams," *Proc. I.R.E.*, vol. 35, pp. 644-657; July, 1947.
 (515) G. R. Kilgore, Carl I. Shulman, and J. Kurshan, "A frequency-modulated magnetron for super-high frequencies," *Proc. I.R.E.*, vol. 35, pp. 657-664; July, 1947.
 (516) J. F. Donal, Jr., R. R. Bush, C. L. Cuccia, and H. R. Hegbar, "A 1-kilowatt frequency-modulated magnetron for 900 megacycles," *Proc. I.R.E.*, vol. 35, pp. 664-669; July, 1947.
 (517) L. Greenwald and A. Fischler, "Diode magnetron as a reactance tube for ultra-high frequencies." Presented, Joint URSI-I.R.E. Meeting, Washington, D. C., October 20, 1947.

No new developments were reported either on velocity-modulation tubes or on traveling-wave tubes. In Europe, especially in France, concrete experimental work was done to develop high-output klystrons and high-output traveling-wave tubes. Klystrons with several hundreds of watts and even kilowatts producing oscillations of 23-centimeter wavelength were used experimentally for television broadcasting.

The theoretical and laboratory development of a high-efficiency velocity-modulation tube, the Prionotron, was reported. It consisted of two cavity resonators of the fundamental frequency (numbers one and four along the electron beam) and of two second-harmonic cavities (numbers two and three). By choosing the phase and the amplitude relation of the two oscillations, the efficiency of the tube was considerably increased. This was effected through a more efficient bunching of the electrons than in the conventional klystrons.

- (518) R. Helm, K. Spangenberg, and L. M. Field, "Cathode design procedure for electron beam tubes," *Elec. Commun.*, vol. 24, pp. 101-107; March, 1947.
 (519) L. M. Field, K. Spangenberg, and R. Helm, "Control of electron beams at high vacuum," *Elec. Commun.*, vol. 24, pp. 108-121; March, 1947.
 (520) "Magnetron suitable for use in high-power FM and television transmitters," *Electronics*, vol. 20, p. 84; May, 1947.
 (521) R. Warnecke, "Sur Quelques Realizations Modernes de Tubes Electroniques Pour La Reception et L'Emission des Ondes Electromagnetiques Ultra-Courtes," *Bull. de la Societe Francaise des Electriciens*, 6-e series, vol. 7, pp. 1-14; Fevrier, 1947.

A high-output traveling-wave tube, of the order of several watts, designed by one of the French laboratories, had a circular (cylindrical) form. In one form, the structure consisted of a multicavity magnetron split along

one of its radial planes; in another form, it was designed with a flat, cylindrical "zigzag" spiral. A cylindrical electron sheath beam moved concentric with the spiral and in close proximity to it. The energy exchange between the two proceeds in the same way as in a rectilinear traveling-wave tube.

A giant cyclotron was built by the University of California capable of accelerating electrons to 200 Mev., protons to 350 Mev., and alpha particles to 400 Mev. It is operated at a frequency of 10 Mc.

(522) "FM cyclotron," *Electronics*, vol. 20, p. 119; March, 1947.

A description was given of an experimental investigation of a c.w. magnetron, the magnetic field being provided by an electromagnet energized by the anode current of the tube. During operation, the anode current assumed the value necessary to provide the optimum magnetic field. It was reported that the operational stability was good and that the danger of excessive anode current was largely removed.

(523) L. H. Ford, "A magnetron oscillator with a series field winding," *Jour. I.E.E. (British)*, vol. 94, Part III, pp. 60-; January, 1947.

A few tubes were reported designed for application in dielectric heating, especially in processing foods. A magnetron operated at 1050 Mc. with 5 kilowatts output was one of them. Another was a triode for intermittent operation at 50 Mc. with 4 kilowatts output.

(524) Philip W. Morse and H. Earl Revercomb, "UHF heating of frozen foods," *Electronics*, vol. 20, pp. 85-89; October, 1947.
 (525) "Triode for Electronic heating applications," *Elec. Ind. and Instr.*, vol. 1, pp. 19, 23; March, 1947.

A trend to develop more efficient air-coolers for electron tubes with external anodes had an important bearing on widening the scope of application of such tubes. The designers found themselves confronted with two main limitations inherent in the conventional air-cooling systems or "radiators." One difficulty was the limited dissipative capacity of the coolers for smaller tubes; another was the inconveniently large weight of coolers for larger tubes, demanding special devices for handling in the factory, in transportation, and at the places of their use. The solution of the latter problem was looked for during the last seven years in making coolers of aluminum. While aluminum cooling fins have been successfully employed in other fields, the particular problems of application to vacuum tubes with copper anodes have not been satisfactorily resolved as yet.

As to the increase of efficiency of heat transfer in the coolers of any size, interesting solutions were found by two European firms. In one of them a relatively large number of thin fins of short radial length was used. The air was blown to the tube and conducted away from the tube radially by means of sectioned annular ducts. The latter were formed in the "air-jacket" constituting part of the permanent equipment supporting the tube, and thus the tube weight was considerably reduced. Because of the short radial length, the entire cooling surface was essentially at the same temperature, thus permitting

higher power dissipation for any given maximum temperature. Another solution was based on a considerable boosting of the Reynold's number of the airflow through the channels. This was achieved by dividing the longitudinal fins in small sections by radial cuts and by twisting individual sections so that they were hit by passing air. This expedient increased the turbulence of the flow, and hence the Reynold's number. Since the rate of heat transfer per unit area is proportional to this number, heat dissipation from a cooler of a given size proportionally increases. This method of cooling vacuum tubes was described in a paper published in 1942, which is referred to below.

(526) D. de Bray and H. Rinia, "An improved method for the air-cooling of transmitting valves," *Philips Tech. Rev.*, vol. 9, pp. 171-176; June, 1947.

(527) R. H. Norris and W. A. Spofford, "High-performance fins for heat transfer," *Trans. A.S.M.E.*, vol. 64, pp. 489-496; July, 1942.

Small High-Vacuum Tubes

The literature of 1947 has reflected the intense activity in electron-tube research both during and since the war years. A number of interesting summaries of general tube development have appeared. A brief outline of the main consecutive stages in the development of electron tubes during the last quarter century was presented from the viewpoint of a large electrical manufacturing company. Wartime improvements in electron tubes and the development of new tubes was reported upon in some detail. Another paper traced the history of miniature receiving tubes from their introduction in 1939 through the war period and up to the present time.

Another general discussion of electron tubes took the form of a resumé of the methods of generation of centimeter waves. The electronic devices used most extensively for the generation of centimeter waves were discussed. The basic physical principles of operation of triode, velocity-variation, and magnetron oscillators were presented, and there was a comprehensive review of reflex-oscillator theory and practice.

(528) I. E. Mouromtseff, "A quarter century of electronics," *Elec. Eng.*, vol. 66, pp. 171-177; February, 1947.

(529) John E. Gorham, "Electron tubes in World War II," *Proc. I.R.E.*, vol. 35, pp. 295-301; March, 1947.

(530) N. H. Green, "Miniature tubes in war and peace," *RCA Rev.*, vol. 8, pp. 331-341; June, 1947.

(531) J. R. Pierce and W. G. Shepherd, "Reflex oscillators," *Bell Syst. Tech. Jour.*, vol. 26, pp. 460-681; July, 1947.

(532) H. D. Hagstrum, "The generation of centimeter waves," *Proc. I.R.E.*, vol. 35, pp. 548-564; June, 1947.

(533) A. M. Gurewitsch and J. R. Whinnery, "Microwave oscillators using disk-seal tubes," *Proc. I.R.E.*, vol. 35, pp. 462-473; May, 1947.

Measurement Applications: Special-purpose tubes used for measurement applications were described. A vacuum tube was developed for the measurement of acceleration, consisting of two elastically mounted plates with a fixed cathode between them. Acceleration was measured by the change in current between the cathode and the respective plates. Change in current is proportional to the component of acceleration normal to the plane of the plates.

Refinements in the techniques of building and using electrometer tubes were described. The causes of instability are largely related to the instability of the emission of the filament. An investigation of mechanical characteristics required of vibrating members for mechano-electronic transducers was published. There were included descriptions and characteristics of an electronic phonograph pickup and an electronic microphone.

- (534) Walter Ramberg, "A vacuum tube for acceleration measurement," *Elec. Eng.*, vol. 66, pp. 555-556; June, 1947.
 (535) J. M. Lafferty and K. H. Kingdon, "Improvements in the stability of the FP-54 electrometer tube," *Jour. Appl. Phys.*, vol. 17, pp. 894-900; November, 1946.
 (536) Harry F. Olsen, "Mechano-Electronic transducers," *Jour. Acous. Soc. Amer.*, vol. 19, pp. 307-319; March, 1947.

Random Noise and Microphonics: A number of studies of random noise were contributed. A rather comprehensive analysis of some aspects of random noise and its reduction in mixer stages was presented. The noise figure of diode mixer stages was derived from their basic operational data. Signal and noise in microwave tetrodes is dependent on space-charge conditions in the grid screen or drift region. There was an analytical discussion of microphonic voltages arising from grid vibration. It was indicated that certain optimum operating voltages exist at which microphonic noise will be minimized.

- (537) M. J. O. Strutt, "Noise-figure reduction in mixer stages," *Proc. I.R.E.*, vol. 34, pp. 942-950; December, 1946.
 (538) L. C. Peterson, "Space-charge and transit-time effects on signal and noise in microwave tetrodes," *Proc. I.R.E.*, vol. 35, pp. 1264-1272; November, 1947.
 (539) A. H. Waynick, "Reduction of microphonics in triodes," *Jour. Appl. Phys.*, vol. 18, pp. 239-245; February, 1947.
 (540) V. W. Cohen and A. Bloom, "Note on the reduction of microphonic noise in triodes," *Jour. Appl. Phys.*, vol. 18, pp. 847-848; September, 1947.
 (541) A. Van der Ziel, and A. Versnel, "Total emission noise in diodes," *Nature*, vol. 159, pp. 640-641; May 10, 1947.
 (542) R. Fürth and D. K. C. MacDonald, "Statistical analysis of spontaneous electrical fluctuations," *Proc. Phys. Soc. (London)*, vol. 59, pp. 388-403; May, 1947.

Emission Theory and Oxide Cathodes, and Silicon Rectifiers: There was extensive interest during 1947 in electron-emission theory and the theory of semiconductors. There have been undertaken a considerable number of studies of a fundamental nature concerning the mechanism of emission from oxide-coated cathodes and the effect of the composition of the base metal on emission both under low-frequency and pulse conditions. The following references are concerned with the variations in emission with the potential drop in the coatings and in the interphase between the coating and the base. The sixth paper studies poisoning of emission due to the heating of glass to 400°C. with the evolution of hydrogen chloride and the formation of barium strontium chloride.

- (543) H. P. Rooksby, "Identification by x-rays of interface compounds on 'oxide' cathodes," *Nature*, vol. 159, pp. 609-610; May 3, 1947.
 (544) R. Loosjes and H. J. Vink, "The i-V-characteristics of the coating of oxide cathodes during short-time thermionic emission," *Phillips Res. Rep.*, vol. 2, pp. 190-204; June, 1947.
 (545) A. Eisenstein, "A study of the barium silicate interface of oxide coated cathodes," *Phys. Rev.*, vol. 71, p. 473; April 1, 1947.

- (546) A. Eisenstein, "Some electrical properties of an oxide cathode interface," *Phys. Rev.*, vol. 72, p. 531; September 15, 1947.
 (547) W. E. Mutter, "Rectification characteristics of an oxide cathode interface," *Phys. Rev.*, vol. 72, p. 531; September 15, 1947.
 (548) H. C. Hamaker, H. Bruining, and A. H. W. Aten, Jr., "On the activation of oxide coated cathodes," *Phillips Res. Rep.*, vol. 2, pp. 171-176; June, 1947.
 (549) John Bardeen, "Surface states and rectification at a metal semi-conductor contact," *Phys. Rev.*, vol. 71, pp. 717-727; May 15, 1947.
 (550) Walter E. Meyerhof, "Contact potential difference in silicon crystal rectifiers," *Phys. Rev.*, vol. 71, pp. 727-735; May 15, 1947.
 (551) O. Weinreich, "The experimental, theoretical and industrial development of oxide-coated cathodes," *Gen. Electr. Rev.*, vol. 56, pp. 75-90; February, 1947.

Analysis of Tube Behavior: As an aftermath of the intensified research during World War II, there were published a number of interesting papers on the analysis of electron-tube behavior. Although the number of these references is too extensive for individual comments on each one, they have considered the effects of transit time in u.h.f. class-C operation of triodes and tetrodes; the detailed theory of reflex klystron oscillators and the effect of loading; the division of space current between electrodes of a tetrode; a theoretical and experimental study of the frequency variation of gain of magnetic electron multipliers; the effects of transit time in klystron gaps; the use of a graphical method for calculating the effect on the ideal value of drift distance of a finite spacing of buncher grids; a method for measuring electrode dissipation in a tube operating at ultra-high frequency; a study of the electron paths in a uniform magnetic field under the influence of forces transverse to the magnetic field; an extension of method of computing the amplification factor with thick grid wires and close grid-cathode spacing; and a study of methods of measuring primary grid emission. Attention was called to the usefulness of dimensional analysis in the solution of electron-tube problems and an outline of improved methods has been given; two papers have considered the circuit behavior of diodes or equivalent diodes and have described methods for determining the properties of the equivalent diode.

- (552) W. G. Dow, "Transit-time effects in ultra-high-frequency class-C operation," *Proc. I.R.E.*, vol. 35, pp. 35-42; January, 1947.
 (553) Ernest G. Linder and R. L. Sproull, "The maximum efficiency of reflex-klystron oscillators," *Proc. I.R.E.*, vol. 35, pp. 241-248; March, 1947.
 (554) Clifford M. Wallis, "Space-current division in the power tetrode," *Proc. I.R.E.*, vol. 35, pp. 369-377; April, 1947.
 (555) J. M. Lafferty, "Velocity-modulated reflex oscillator," *Proc. I.R.E.*, vol. 35, pp. 913-919; September, 1947.
 (556) L. Malter, "The behavior of 'magnetic' electron multipliers as a function of frequency," *Proc. I.R.E.*, vol. 35, pp. 1074-1076; October, 1947.
 (557) Zigmund W. Wilchinsky, "Electrode dissipation at ultra-high frequencies," *Proc. I.R.E.*, vol. 35, pp. 1155-1157; October, 1947.
 (558) Paul K. Weimer and Albert Rose, "The motion of electrons subject to forces transverse to a uniform magnetic field," *Proc. I.R.E.*, vol. 35, pp. 1273-1279; November, 1947.
 (559) A. P. Kauzmann, "Determination of current and dissipation values for high-vacuum rectifier tubes," *RCA Rev.*, vol. 8, pp. 82-97; March, 1947.
 (560) J. H. Fremlin, R. N. Hall, and P. Q. Shatford, "Triode amplification factors," *Elec. Commun.*, vol. 23, pp. 426-435; December, 1946.
 (561) A. H. Hooke, "A method of measuring grid primary emission in thermionic valves," *Elec. Commun.*, vol. 23, pp. 471-478; December, 1946.

- (562) Gerard Lehmann, "Dimensional analysis applied to very-high-frequency triodes," *Elec. Commun.*, vol. 24, pp. 391-405; September, 1947.
- (563) G. B. Walker, "Theory of the equivalent diode," *Wireless Eng.*, vol. 24, pp. 5-7; January, 1947.
- (564) W. R. Bennett, "The biased ideal rectifier," *Bell Sys. Tech. Jour.*, vol. 26, pp. 139-169; January, 1947.
- (565) F. H. Raymond, "Similitude in vacuum tubes," *Onde Elect.*, vol. 27, pp. 209-212; May, 1947.

Wide-Tuning Oscillator Tubes: The need for wide-band search receivers for radar systems during World War II resulted in the development of a wide-tuning-range microwave oscillator tube, the 2K48. The tube construction was described. It included a resonator which consisted of a coaxial-line type of resonating cavity built entirely external to the evacuated portion of the tube.

The tunable magnetron, known as the donutron, is a multisegment magnetron with a single resonant structure which may be tuned by the relative axial displacement of alternate anode segments.

- (566) John W. Clark and Arthur L. Samuel, "A wide-tuning-range microwave oscillator tube," *Proc. I.R.E.*, vol. 35, pp. 81-83; January, 1947.
- (567) G. H. Crawford and M. D. Hare, "A tunable squirrel-cage magnetron—the donutron," *Proc. I.R.E.*, vol. 35, pp. 361-369; April, 1947.

Beam Traveling-Wave Tubes: The beam traveling-wave tube held a prominent place in the literature of 1947. Publications included the mechanical design and construction of the beam traveling-wave amplifier. The small-signal theory of the tube was also set forth.

- (568) J. R. Pierce and L. M. Field, "Traveling-wave tubes," *Proc. I.R.E.*, vol. 35, pp. 108-111; February, 1947.
- (569) J. R. Pierce, "Theory of the beam-type traveling-wave tube," *Proc. I.R.E.*, vol. 35, pp. 111-123; February, 1947.
- (570) Rudolf Kompfner, "The traveling-wave tube as amplifier at microwaves," *Proc. I.R.E.*, vol. 35, pp. 124-127; February, 1947.
- (571) Frank Rockett, "Wideband microwave amplifier tube," *Electronics*, vol. 19, pp. 90-92; November, 1946.
- (572) J. R. Pierce, "The beam traveling-wave tube," *Bell Labs. Rec.*, vol. 24, pp. 439-442; December, 1946.
- (573) J. Bernier, "A preliminary theory of the traveling-wave tube," *Ann. Radioélectrique*, vol. 2, pp. 87-101; January, 1947.
- (574) E. Roubine, "On the helical circuit used in traveling-wave tubes," *Compt. Rend. Acad. Sci. (Paris)*, vol. 224, pp. 1101-1102; April 14, 1947; pp. 1149-1151; April 21, 1947.

Measurements of Tube Properties: Measurements of the properties of electron tubes were reported in a number of interesting papers. Measurements were made of the transadmittance and input conductance of a lighthouse triode at 3000 Mc. A method was described for evaluating the push-pull class-B performance of receiving tubes by a simple test on a single tube. A radio-frequency bridge method for the measurement of direct interelectrode capacitance was described. A new circuit was described using electronic switches to vary voltages so as to obtain the static characteristics of electron tubes. Another paper described the use of the dynatron as a means of measurement of dynamic resistance up to 100 Mc.

- (575) Norman T. Lavoo, "Transadmittance and input conductance of a lighthouse triode at 3000 megacycles," *Proc. I.R.E.*, vol. 35, pp. 1248-1251; November, 1947.
- (576) D. P. Heacock, "Power measurements of class B audio amplifier tubes," *RCA Rev.*, vol. 8, pp. 147-157; March, 1947.
- (577) C. H. Young, "Measuring inter-electrode capacitances," *Tele-Tech.*, vol. 6, pp. 68-70, 109; February, 1947.

- (578) Henry E. Webking, "Producing tube curves on an oscilloscope," *Electronics*, vol. 20, pp. 128-131; November, 1947.
- (579) G. A. Hay, "Negative resistance circuit element. The dynatron at high radio frequencies," *Wireless Eng.*, vol. 23, pp. 299-305; November, 1946.

Electronic-Switching or Special-Purpose Tubes: Electronic-switching, or other special-purpose tubes, were described in four papers. The cyclophon and its application as a modulator and as a demodulator for pulse-time modulation, transmission, and reception were discussed. Numerous other applications of the cyclophon were suggested. There was a discussion of the beam-deflection amplifier tube in which beam deflection replaces grid control for amplifier use. The development of the 6AS7-G booster scanner tube was described in a paper which included a discussion of the operation of this tube in magnetic deflection circuits. The use of a cathode-type diode for magnetic control of plate current for direct-coupled amplifiers was described.

- (580) G. R. Kilgore, "Beam-deflection control for amplifier tubes," *RCA Rev.*, vol. 8, pp. 480-505; September, 1947.
- (581) O. H. Schade, "Magnetic-deflection circuits for cathode-ray tubes," *RCA Rev.*, vol. 8, pp. 506-538; September, 1947.
- (582) C. R. Knight, "Magnetic control of anode current," *Electronic Ind.*, vol. 5, pp. 72-73, 108; December, 1946.

Generation of Millimeter Waves: Very little material on millimeter-wave tubes was published during 1947. A millimeter-wave reflex oscillator was described.

- (583) J. M. Lafferty, "A millimeter-wave reflex oscillator," *Jour. Appl. Phys.*, vol. 17, pp. 1061-1066; December, 1946.

Tube Construction Techniques: A paper of some interest, dealing with tube construction techniques, included a general review of the scientific control of glass-working techniques in radio tube manufacture.

- (584) F. Violet, A. Danzin, and A. Commin, "Glass in the radio industry," *Ann. de Radioélect.*, vol. 2, pp. 24-74; January, 1947.

Miniature Tubes: The miniaturization of tubes was extended from the use of miniature tubes in battery and low-power a.c.-d.c. service by the addition of rectifiers and output tubes so that a.c. sets requiring an audio output of 4.5 watts can be made with all-miniature tubes. In addition, tubes with new characteristics for television and similar applications were produced in a miniature version only. A description was published of the 396A, a small twin triode somewhat similar to the 6J6 but with separate cathodes rather than a common cathode for the two sections.

- (585) G. C. Dalman, "A new miniature double triode," *Bell Lab. Rec.*, vol. 25, pp. 325-329; September, 1947.

Cathode-Ray Tubes and Television Tubes

The year 1947 represented the first full year of television tube and equipment production. About 175,000 television receivers were produced. The industry committees under the Joint Electron Tube Engineering Council continued their standardization activities, mainly completing details on types developed during the previous two years. Television met with enthusiastic public acceptance in the metropolitan areas and other localities where it was available.

The Federal Communications Commission ruled

against commercialization of color television at this time because of new developments in color which may take several years to build into a commercial service. Demonstrations were given with a simultaneous color system involving the use of a new flying-spot cathode-ray tube.

(586) R. D. Kell, G. C. Sziklai, R. C. Ballard, and A. C. Schroeder, "An experimental simultaneous color-television system," *PROC. I.R.E.*, vol. 35, pp. 861-870; September, 1947.

Continued development work on the image-orthicon television camera tube has resulted in a new commercial type for television studio pickup, having improved signal-to-noise ratio and resolution, and with response to color through the visible spectrum. The theory and design of an electrostatic-deflection dissector have been worked out and described.

(587) H. W. Salinger, "The electrostatic dissector," *Proc. Nat. Elect. Conf.*, vol. 11, pp. 82-88; October 3-5, 1946.

Relatively few new cathode-ray tubes appeared for television, most of the effort along this line being put into the solution of production problems. However, the flying-spot tube having a very short-persistence phosphor, mentioned above in connection with color television, promised to supply other important needs in television. For example, it provided an excellent source of fixed-pattern signal such as that from a monoscope but with greatly increased flexibility. Any picture or pattern which can be produced on photographic film could be converted readily into a television signal by means of the flying-spot tube and its associated equipment.

Several cathode-ray tubes for special applications were developed, such as the one having a cylindrical fluorescent screen and capable of showing a continuous pattern when the tube is rotated about its axis in a magnetic deflection field. A cathode-ray "memory" tube, which permitted the recording and storing of an image or other intelligence in the form of an electrical charge on an insulating surface was developed. The image or other stored intelligence could be read out of the tube an indefinite number of times without disturbing the recorded pattern. The recorded pattern could, however, be erased at any desired time. A simple form of cathode-ray "memory" tube is described in a general discussion of the subject of video storage by secondary emission from mosaics.

(588) J. B. Johnson, "A cathode-ray tube for viewing continuous patterns," *Jour. Appl. Phys.*, vol. 17, pp. 891-894; November, 1946.

(589) Andrew V. Haeff, "A memory tube," *Electronics*, vol. 20, pp. 80-83; September, 1947.

(590) R. A. McConnell, "Video storage by secondary emission from simple mosaics," *Proc. I.R.E.*, vol. 35, pp. 1258-1264; November, 1947.

Several new electronic commutator tubes were described by Grieg, Glauber, and Moskowitz. The name "Cyclophon" has been assigned to these new cathode-ray tubes, which open up a new field of high-speed switching.

(591) D. D. Grieg, J. J. Glauber, and S. Moskowitz, "The cyclophon: A multipurpose electronic commutator tube," *Proc. I.R.E.*, vol. 35, pp. 1251-1257; November, 1947.

An interesting version of an electron-ray tuning indicator for f.m. is described which makes use of a simple triode structure and translucent fluorescent screen.

(592) F. M. Bailey, "An electron-ray tuning indicator for FM," *Proc. I.R.E.*, vol. 35, pp. 1158-1160; October, 1947.

A cathode-ray compass tube employing a low-velocity electron beam and having a four-quadrant collector was developed to feed through a servomechanism to the autopilot gyroscope. Several new types of cathode-ray tubes employing medium- and short-persistence P12 and P11 phosphor screens were developed for use in the Teleran air navigation and traffic control system. An interesting development of a cathode-ray oscillograph for the study of very high frequencies up to 10,000 Mc. was reported in the previous year. This unusual performance was attained by the use of a high-voltage beam and very short deflection electrodes.

(593) R. T. Squier, "Cathode-ray compass," *Electronics*, vol. 20, pp. 121-123; April, 1947.

(594) D. H. Ewing and R. W. K. Smith, "Teleran air navigation and traffic control by means of television and radar," *RCA Rev.*, vol. VII, pp. 601-621; December, 1946.

(595) G. M. Lee, "A three-beam oscillograph for recording at frequencies up to 10,000 megacycles," *Proc. I.R.E.*, vol. 34, pp. 121W-127W; March, 1946.

A number of interesting and important papers contributed to the field of electron optics and to application to cathode-ray and television tubes. A study of the electron optics of strip-cathode emission systems under space-charge-limited and nearly space-charge-free conditions showed that the laws of electron optics can be applied only for very small current densities, and that space-charge conditions reveal that the beam spread, due to mutual electron repulsion, completely changes the current distribution in the beam. A fine probe electron beam was employed to study the space charge in high-current-density beams. An investigation of spherical aberration of compound magnetic lenses led to the conclusion that the spherical aberration of strong lenses may be reduced by combination with a weak lens. A formula for the reduction in aberration was developed for a bell-shaped magnetic field. Interesting papers on the subject of electrostatic-deflection defocusing of electron beams in cathode-ray tubes were published in two parts. Part I covered the theory of small-angle deflection where expressions were derived to describe the magnitude of deflection and the distortion of an electron beam. Part II applied the theory developed in Part I to a number of typical deflection fields between parallel plates, cylinders, coplanar sheets, and bent plates. The distortions were calculated, and the problem of reduction of deflection distortion was discussed.

(596) "Electron optics and space charge in strip-emission systems," *Proc. Phys. Soc. London*, vol. 59, part 2, pp. 302-323; March, 1947.

(597) L. Morton and K. Bol, "Spherical aberration of compound magnetic lenses," *Jour. Appl. Phys.*, vol. 18, pp. 522-529; June, 1947.

(598) R. G. E. Huter, "Electron beam deflection." Part I, Small angle deflection theory," *Jour. Appl. Phys.*, vol. 18, pp. 740-758; August, 1947. Part II, "Applications of the small angle deflection theory," *Jour. Appl. Phys.*, vol. 18, pp. 797-810; September, 1947.

The equations for electron paths entering a retarding axially symmetric electrostatic field with a quadratic axial potential distribution were developed. The electrodes to produce the above field are defined, and electron incident angles were determined for focus-neglecting space-charge effects.

(599) J. M. Lafferty, "Electron reflectors with quadratic axial potential distribution," *Proc. I.R.E.*, vol. 35, pp. 778-783; August, 1947.

The study of the application of electron microscopes continued to be a very active and interesting field. A number of papers on electron microscopes and their applications were presented at the annual meeting of the Electron Microscope Society of America in Pittsburgh, Pa., December 5-7, 1937. The report of the Electron Microscope Society of America's Committee on Resolution discussed terminology, methods of measurement of resolution, and factors which affect resolution. Its conclusions indicate that more work needs to be done to develop a satisfactory method of measuring resolution of micrographs, and that the resolving power of a microscope is best determined by Fresnel fringes. The limiting resolving power of magnetic electron microscopes was shown to be mainly due to magnetic saturation of the pole pieces. The determined value of limiting resolving power of 10-12Å at 50 kv. agrees well with values published by other workers in the field. A rather comprehensive theoretical and experimental study of the factors influencing resolution in the electron microscope was reported wherein it was concluded that high resolution depends on the correction of several instrument defects. Procedures for making these corrections were presented. The optics of an electrostatic-focus three-electrode electron gun was worked out in detail and compared with experimental results. A new electron microscope having a continuously variable magnification from 1000 to 80,000X and a resolution of 25Å was described.

(600) Abstracts of Electron Microscope Papers Presented at Melon Institute before Electron Microscope Society of America, *Jour. Appl. Phys.*, vol. 18, pp. 269-273; March, 1947.

(601) Report of Electron Microscope Society of America's Committee on Resolution, *Jour. Appl. Phys.*, vol. 17, pp. 989-996; December, 1946.

(602) G. Liebmann, "The limiting resolving power of the electron microscope," *London Phil. Mag.*, vol. 37, pp. 677-685; October, 1946.

(603) J. Hillier and E. G. Ramberg, "The magnetic electron microscope objection: Contour phenomena and the attainment of high resolution," *Jour. Appl. Phys.*, vol. 18, pp. 48-71; January, 1947.

(604) S. G. Ellis, "The optics of three-electrode electron guns," *Jour. Appl. Phys.*, pp. 879-890; October, 1947.

(605) J. B. Poole, "A new electron microscope with continuously variable magnification," *Philips Tech. Rev.*, vol. 9, pp. 33-45; 1947.

A method of correcting the spherical aberration of conventional electron lenses used in electron microscopes by the addition of a three-element lens produced by electrostatic fields between coaxial cylinders was described.

(606) J. W. Dungey and C. R. Hull, "Coaxial electron lenses," *Proc. Phys. Soc. London*, vol. 59, pp. 828-843; September, 1947.

Applications of electron microscopes are too numer-

ous to discuss in detail, but the following references are representative examples.

(607) C. H. Gerould, "Preparation and uses of silica replicas in electron microscopy," *Jour. Appl. Phys.*, vol. 18, pp. 333-343; April, 1947.

(608) J. H. Watson and K. Kaufmann, "Electron microscope examination of the microphysical properties of the polymer cuprene," *Jour. Appl. Phys.*, vol. 17, pp. 996-1005; December, 1946.

Phototubes

Interest in the photoelectric effects and in light-sensitive cells increased during 1947. An analysis of the fatigue of Ag-O-Cs photoelectric surfaces confirmed an increase in the maximum sensitivity and a shift of the threshold to shorter wavelengths upon exposure of the photosurface to "blue" light. Exposure to "red" or tungsten light, however, decreased the maximum without affecting the threshold.

(609) S. Pakswar, "Fatigue of Ag-Cs₂O, Ag-Cs photoelectric surfaces," *Jour. Appl. Phys.*, vol. 18, pp. 203-206; February, 1947.

Two discussions of causes and reduction of noise in photocells appeared. A thorough discussion of multiplier-phototube characteristics described their application to low light levels. The tubes were linear at currents up to the point where space charge in the output stages reduced the ratio of anode current to cathode light flux. Dark currents and the limitations which they introduce in practice were discussed. In another paper, the relation $\Delta I^2 = 2eIT^2\Delta f$ for the fluctuation in current I in frequency band Δf was confirmed for a high-vacuum photocell, and the space-charge reduction factor Γ was shown to approach 1 at saturation and in the retarding-field region for very small currents.

(610) R. W. Engstrom, "Multiplier phototube characteristics; application to low light levels," *Jour. Opt. Soc. Amer.*, vol. 37, pp. 420-431; June, 1947.

(611) R. Fürth and D. K. C. MacDonald, "Spontaneous fluctuations of current in a photoelectric cell," *Nature*, vol. 159, pp. 608-609; May 3, 1947.

Photomultiplier tubes found considerable use during the past year as detectors of alpha, beta, and X-rays. One method involved wrapping a sheet of the proper fluorescent material around the tube. Results of this work began to appear in the literature.

(612) F. H. Marshall, J. W. Coltman, and L. P. Hunter, "Photomultiplier X-ray detector," *Rev. Sci. Instr.*, vol. 18, pp. 504-513; July, 1947.

(613) J. S. Allen, "Improved electron multiplier particle counter," *Rev. Sci. Instr.*, vol. 18, pp. 739-749; October, 1947.

The war-born impetus given photoconductive cells did not slacken. Of particular interest was a theory of the mechanism of lead-sulphide cells. It was shown that maximum sensitivity was obtained when both lead and oxygen impurity centers were present in sufficient quantity to cause minimum conductivity and zero thermoelectric power. The layers were predominantly excess conductors or defect conductors.

(614) L. Sosnowski, J. Starkiewicz, and O. Simpson, "Lead sulphide photoconductive cells," *Nature*, vol. 159, pp. 818-819; June 14, 1947.

Lead-sulphide photoconductive cells were described as so sensitive as to permit the use of an indirectly

heated low-temperature lamp in sound-picture reproducing systems.

- (615) R. J. Cashman, "Lead-sulphide photoconductive cells for sound reproduction," *Jour. Soc. Mot. Pic. Eng.*, vol. 49, pp. 342-348; October, 1947.

Synthetic single crystals of CdS, CdSe, and CdTe were used to make photoconductive cells sensitive from infrared region through the ultraviolet, X-ray, and gamma-ray regions and for corpuscular, alpha, and beta rays.

- (616) R. Frerichs, "Photo-conductivity of 'incomplete phosphors,'" *Phys. Rev.*, vol. 72, pp. 594-601, October 1, 1947.

A study appeared on filters for use in correction of changes in the spectral characteristics of the eye as it becomes light or dark adapted.

- (617) W. S. Plymale, Jr., "Filters for spectral corrections of multiplier phototubes used from scotopic to photopic brightness levels," *Rev. Sci. Instr.*, vol. 18, pp. 535-539; August, 1947.

A method for obtaining logarithmic response to light intensity with a multiplier phototube was described.

- (618) M. H. Sweet, "Logarithmic photometer," *Electronics*, vol. 19, pp. 105-109; November, 1946.

Gas-Filled Tubes

An electronic method of driving d.c. motors from an a.c. power source was described, the main feature being that the armature current is held constant and the field current is varied or reversed to obtain speed and torque regulation. The problem of regeneration is simplified.

- (619) O. W. Livingston, "Electronic constant-current motor systems," *Elec. Eng.*, vol. 66, pp. 432-437; May, 1947.

A paper was published which described a method of paralleling alternators operating at different frequencies by means of frequency changers employing gas tubes.

- (620) O. E. Bowlus and P. T. Nims, "Electronic frequency changers for Aircraft," *Elec. Eng.*, vol. 68, pp. 463-466; May, 1947.

A description was given of a method of regulating the output voltage of an alternator by changing the current drawn by a gas-tube rectifier connected to the output terminals of the alternator. The rectifier acted as a variable-reactance load on the alternator, the reactance of which was adjusted by the phase retard of the tube grid potentials.

- (621) E. F. W. Alexanderson and D. C. Prince, "Electronic stabilizer for power transmission," *Elec. Eng.*, vol. 66, pp. 1053-1057; November, 1947.

Experience in operation of very large electronic pool-type rectifiers was described.

- (622) D. I. Bohn, "Station design," *Elec. Eng.*, vol. 66, pp. 957-958; October, 1947.
 (623) J. W. Ward, "Operation in aluminum plants," *Elec. Eng.*, vol. 66, pp. 958-960; October, 1947.
 (624) A. G. Dickinson, "Operation in metallurgical and chemical plants," *Elec. Eng.*, vol. 66, pp. 960-962; October, 1947.
 (625) C. G. Marshall, "Operation in mines," *Elec. Eng.*, vol. 66, pp. 962-963; October, 1947.

A paper was published which described a concentrated-arc-tube light source and its use in light-beam telegraphy.

- (626) W. D. Buckingham, C. R. Deibert, and R. V. Morgenstern, "The concentrated-arc lamp in a light beam communication system," *Elec. Eng.*, vol. 66, pp. 975-979; October, 1947.

In a paper on the operation of small thyratrons at frequencies of 300 to 3500 c.p.s., twelve sets of curves were shown describing the tube characteristics as measured on type 2D21, 3D22, 2050, and 2051 thyratrons.

- (627) Hubert H. Wittenburg, "Frequency performance of thyratrons," *Trans. A.I.E.E. (Elec. Eng.)*, December, 1946) vol. 65, pp. 843-848; December, 1946.

The design of an ignitron rated for power rectification service was described. The current rating was 400 amperes average per tube. As normally used, a rectifier containing six of these tubes would have an output rating of 2400 amperes at 300 volts d.c.

- (628) H. C. Steiner and H. N. Price, "A 400-ampere sealed ignitron," *Trans. A.I.E.E. (Elec. Eng.)*, October, 1946) vol. 65, pp. 680-685; October, 1946.

A report on characteristics of ignitors was sponsored by the Pool Tube Committee of the Joint Electron Tube Engineering Council. The report contains twelve sets of curves showing characteristics as influenced by the wave form of the firing pulse, and data relative to uniformity of characteristics.

- (629) D. E. Marshall and W. W. Rigrod, "Characteristics of resistance ignitors," *Electronics*, vol. 20, pp. 122-126; May, 1947.

Electroacoustics

The field of electroacoustics, in its many phases and applications, was expanded and improved by numerous investigators during 1947. The present summary confines itself to pointing up some of the most interesting publications dealing with war research, the study of speech and hearing characteristics, acoustic treatment, the art of measurement, and the design of microphones and recording equipment.

War Research

Additional results of acoustic research carried on during the war were published. The material on underwater sound covered many different phases of this important war subject. The matter of sound propagation through a liquid containing bubbles was discussed, together with studies on the transmission of explosion waves in liquids. Underwater sound apparatus was described.

- (630) E. L. Carstensen and L. L. Foldy, "Propagation of sound through a liquid containing bubbles," *Jour. Acous. Soc. Amer.*, vol. 19, pp. 481-501; May, 1947.
 (631) J. M. Ide, "Sonar, secret weapon of the sea," *U. S. Naval Inst. Proc.*, vol. 73, pp. 439-443; April, 1947.
 (632) M. F. M. Osborne and A. H. Taylor, "Non-linear propagation of underwater shock waves," *Phys. Rev.*, vol. 70, pp. 322-328; September 1 and 15, 1946.
 (633) E. A. Walker and P. M. Kendig, "Acoustic locating system," *Electronics*, vol. 20, pp. 124-127; February, 1947.
 (634) L. E. Holt, "German use of sonic listening," *Jour. Acous. Soc. Amer.*, vol. 19, pp. 678-681; July, 1947.

Speech and Hearing Characteristics

Acoustical engineers have been puzzled by tests showing that listeners did not like high-quality reproduction of sound which included the entire audio range, but preferred a limited frequency range, especially the absence of high frequencies, in reproduced programs. It was recently found that this result was due to imperfec-

tion in the reproduction of the high frequencies, and that, where these imperfections are eliminated, there is a preference for high fidelity on the part of the audience.

In the 1947 literature there were discussed items covering the design of speech communication systems; the characteristics of speech, hearing, and noise in relation to the recognition of speech sounds; diffraction effects of the human head; the effects of high altitude on speech, microphones, and receivers; the effect of various types of nonlinear distortion on intelligibility, etc.

- (635) H. F. Olson, "Frequency range preference for speech and music," *Jour. Acous. Soc. Amer.*, vol. 19, pp. 549-555; July, 1947.
- (636) N. D. Webster and F. C. McPeak, "Experiments in listening," *Electronics*, vol. 20, pp. 90-95; April, 1947.
- (637) L. L. Beranek, "Design of speech communication systems," *Proc. I.R.E.*, vol. 35, pp. 880-890; September, 1947.
- (638) N. R. French and J. C. Steinberg, "Factors governing the intelligibility of speech sounds," *Jour. Acous. Soc. Amer.*, vol. 19, pp. 90-119; January, 1947.
- (639) F. M. Wiener, "On the diffraction of a progressive sound wave by the human head," *Jour. Acous. Soc. Amer.*, vol. 19, pp. 143-146; January, 1947.
- (640) G. A. Miller and S. Mitchell, "Effects of distortion on the intelligibility of speech at high altitudes," *Jour. Acous. Soc. Amer.*, vol. 19, pp. 120-125; January, 1947.
- (641) K. D. Kryter, J. C. R. Licklider, and S. S. Stevens, "Pre-modulation clipping in AM voice communications," *Jour. Acous. Soc. Amer.*, vol. 19, pp. 125-131; January, 1947.

Acoustic Treatment

The matter of sound treatment of enclosed spaces was discussed from the standpoint of obtaining optimum acoustics for auditoriums and broadcast studios, of quieting industrial areas, and of reducing the noise level in airplane cabins. New methods of achieving these results were studied. Consideration was given to the proportioning of rooms to minimize the "piling up" of resonant frequencies. Certain subjective effects of monaurally reproduced sound were explained as a function of the "liveness" of the room in which the original sound is picked up. The absorption of sound by coated rubber wall covering was investigated.

- (642) H. J. Sabine, "Sound absorption and impedance of acoustical materials," *Jour. Soc. Mot. Pic. Eng.*, vol. 49, pp. 262-278; September, 1947.
- (643) G. M. Nixon, "Recording studio 3A," *RCA Rev.*, vol. 7, pp. 634-640; December, 1946.
- (644) L. L. Beranek and H. W. Rudmose, "Sound control in airplanes," *Jour. Acous. Soc. Amer.*, vol. 19, pp. 357-364; March, 1947.
- (645) R. H. Nichols, Jr., H. P. Sleeper, Jr., R. L. Wallace, Jr., and H. L. Ericson, "Acoustical materials and acoustical treatments for aircraft," *Jour. Acous. Soc. Amer.*, vol. 19, pp. 428-443; May, 1947.
- (646) R. H. Bolt, "Normal frequency spacing statistics," *Jour. Acous. Soc. Amer.*, vol. 19, pp. 79-90; January, 1947.
- (647) H. F. Olson, "Functional sound absorbers," *RCA Rev.*, vol. 7, pp. 503-521; December, 1946.
- (648) J. P. Maxfield and W. J. Albersheim, "An acoustic constant of enclosed spaces correlatable with their apparent liveness," *Jour. Acous. Soc. Amer.*, vol. 19, pp. 61-79; January, 1947.

Measurement

Further advances were made in the field of sound measurement and calibration. A method of rating microphones and loudspeakers was proposed which is consistent from the over-all system viewpoint. The reciprocity theorem was closely studied. This theorem is extremely valuable as a means of calibrating electro-

acoustic transducers. It provides calibrations which are very accurate and gives results which do not depend on the availability of a calibrated standard instrument. However, there are certain difficulties in the application of this theorem in specific cases, and the conditions for the validity of the reciprocity theorem are by no means simple to establish.

- (649) F. F. Romanow and M. S. Hawley, "Proposed method of rating microphones and loudspeakers for systems use," *Proc. I.R.E.*, vol. 35, pp. 953-960; September, 1947.
- (650) H. Primakoff and L. L. Foldy, "A general theory of passive linear electroacoustic transducers and the electroacoustic reciprocity theorem," *Jour. Acous. Soc. Amer.*, vol. 19, pp. 50-58; January, 1947.
- (651) P. Ebaugh and R. E. Mueser, "Practical application of the reciprocity theorem in the calibration of underwater sound transducers," *Jour. Acous. Soc. Amer.*, vol. 19, pp. 695-700; July, 1947.
- (652) J. W. Miles, "Coordinates and the reciprocity theorem in electromechanical systems," *Jour. Acous. Soc. Amer.*, vol. 19, pp. 910-913; September, 1947.

Microphones

A number of papers were published covering the design and application of microphones. The condenser microphone found further favor for high-fidelity pickup in view of the facility inherent in this instrument for absolute calibration. Further advances were also made in the reduction of the size of this microphone, so that it became essentially a nondirectional device. The other common types of microphone, i.e. dynamic, crystal and carbon, received further study; in addition a novel type, the mechano-electronic transducer, was described, in which a voltage is developed by the motion of one or more of the elements in a diode, triode, or multielement electron tube. This principle can also be applied to phonograph pickups and other devices.

- (653) A. L. Di Mattia and F. M. Wiener, "On the absolute pressure calibration of condenser microphones by the reciprocity method," *Jour. Acous. Soc. Amer.*, vol. 18, pp. 341-344; October, 1946.
- (654) H. F. Olson, "Mechano-electronic transducers," *Jour. Acous. Soc. Amer.*, vol. 19, pp. 307-319, March, 1947.

Recording

In the present state of the recording art, one of the greatest handicaps to further progress is the lack of standards. This has been widely recognized, and The Institute of Radio Engineers requested the American Standards Association to form a subcommittee to consider recording standards. Such a committee has now been set up under joint sponsorship of the I.R.E. and SMPE, and it is expected that rapid progress will henceforth be made along these lines.

As regards the literature published during 1947 in the field of recording, a large proportion of the material is concerned with magnetic recording. This is to be expected, as this is a new field now taking its place beside the older, established methods.

- (655) S. J. Begun, "Recent developments in the field of magnetic recording," *Jour. Soc. Mot. Pic. Eng.*, vol. 48, pp. 1-13, January, 1947. Discussion by M. Camras and others, pp. 14-28.
- (656) W. C. Miller, "Magnetic recording for motion picture studios," *Jour. Soc. Mot. Pic. Eng.*, vol. 48, pp. 57-62, January, 1947.
- (657) M. Camras, "Recent developments in magnetic recording for motion picture film," *Jour. Acous. Soc. Amer.*, vol. 19, pp. 322-325, March, 1947.

A number of interesting papers were published on the measurement of recorder characteristics. Apparatus was developed for the dynamic measurement of the lateral compliance and mechanical resistance of phonograph pickups. In this system the mechanical resistance was obtained from the output frequency characteristic of the system when it is driven with constant force, and the needle-point compliance was determined from the resonant frequency. An f.m. calibrator for disk recording heads was described in another paper. Advance of the art, unquestionably, is dependent on further improvement of calibration techniques, which in this field are somewhat complicated and require further study.

- (658) B. B. Bauer, "Measurement of mechanical compliance and damping of phonograph pick-ups," *Jour. Acous. Soc. Amer.*, vol. 19, pp. 319-321; March, 1947.
 (659) H. E. Roys, "Force at the stylus tip while cutting lacquer disk-recording blanks," *Proc. I.R.E.*, vol. 35, pp. 1360-1363; November, 1947.
 (660) R. A. Schlegel, "FM calibrator for disc recording heads," *Audio Eng.*, vol. 31, pp. 18-20; May, 1947.
 (661) H. A. Chinn, "Disc recording," *Electronic Ind.*, vol. 5, pp. 64-66, November, 1946.
 (662) M. Morse, "Sound embossing at the high frequencies," *Jour. Acous. Soc. Amer.*, vol. 19, pp. 169-172; January, 1947.

Facsimile

Developments in the facsimile field during 1947 were shown mostly in the nontechnical press, as broadcasters, publishers, and advertisers became more fully aware of the possibilities of this new medium. Many of the articles in publications of large national circulation tended to acquaint the general public with the home radio newspaper of the future.

- (663) R. M. Yoder, "Will your newspaper come by radio?" *The Saturday Evening Post*, vol. 219, pp. 20, 21, 136, 138; November 23, 1946.
 (664) C. F. H. Robling, "All they know is what they read on the radio!" *Better Homes and Gardens*, vol. 25, pp. 48, 49, 164, 166, 167; February, 1947.
 (665) "The electronic newspaper is coming," *Steel Horizons*, vol. 9, pp. 12, 13, 14; 1947.
 (666) M. B. Sleeper, "Facsimile is ready for home use," *FM and Telev.* vol. 7, pp. 19-20, 54, 55; June, 1947.
 (667) J. Walker, "What about facsimile if White bill passes?" *Editor and Publisher*, vol. 80, p. 34; June 14, 1947.

As a preview of things to come, several large newspaper-owned broadcasting stations staged mass demonstrations using prototype equipment similar to that in the process of manufacture. It was predicted that a score or more f.m. broadcasting stations will initiate facsimile transmissions during the early months of 1948.

- (668) K. Lee, "Facsimile newspapers," *Editorial Research Reports*, vol. 1, March 26, 1947.
 (669) E. H. Felix, "Miami Herald transmits facsimile newspaper," *FM and Telev.*, vol. 7, pp. 36-39; April, 1947.
 (670) "Radio-paper combine trend grows," *Broadcasting*, vol. 32, pp. 13, 75; April 28, 1947.
 (671) W. G. H. Finch, J. V. L. Hogan, and L. H. Nafzger, "Facsimile is evaluated by experts," *Broadcasting*, vol. 31, pp. 44, 128, 210, 220; October 21, 1946.

Agreement on industry standards was reached by facsimile committees of both the Radio Manufacturers Association and the Radio Technical Planning Board in the United States, and the industry awaited a ruling

by the Federal Communications Commission on standards for commercial home broadcasting of facsimile using frequency modulation on the new high-frequency channels.

- (672) "FCC okay seen on editorials via facsimile," *Billboard*, vol. 59, p. 10; April 12, 1947.
 (673) M. Alden, "Elements of home facsimile standards," *FM and Telev.*, vol. 6, pp. 22, 52; November, 1946.
 (674) M. B. Sleeper, "FM, facsimile and television show gains," *FM and Telev.*, vol. 6, pp. 19-21, 45, 50, 60; November, 1946.
 (675) "Facsimile progress reported by FCC," *Radio Daily*, July 9, 1947.
 (676) "Status of facsimile," *Electronics*, vol. 20, pp. 246, 248; September, 1947.

"Ultrafax" and "Colorfax" were revealed as technical advances. "Ultrafax," a high-speed photographic system using a bandwidth similar to television, was described as being capable of transmitting and receiving a million words per minute. "Colorfax," a slow-speed system using colored crayons on a mechanical recorder, was proposed for eventual use on home broadcasting when engineering and development have been completed.

- (677) "Facsimile gets color," *Electronic Markets*, p. 8; August, 1947.
 (678) "Colored pictures by radio," *Science News Letter*, vol. 52, p. 102; August 16, 1947.
 (679) "Faster facsimile," *Newsweek*, vol. 30, Science, p. 53; July 7, 1947.
 (680) A. A. McKenzie, "Color facsimile," *Electronics*, vol. 20, pp. 104-105; October, 1947.
 (681) "Ultrafax defined," *Broadcasting*, vol. 32, p. 19; June 30, 1947.

Increased interest in facsimile for specialized communications was shown by the police and railroad organizations. Commercial and military aviation departments expressed desires to develop airborne and ground facsimile for airport traffic control, landing instructions, and in-flight weather maps and reports, together with general printed information and news. Wartime usage of facsimile message scrambling was described as being of value for secrecy of communication in tactical and strategical military situations.

- (682) "Aircraft communications systems," *Teleg. and Teleph. Age*, vol. 65, pp. 8, 10, 28, 29; March, 1947.
 (683) "The U. S. Army Air Forces are planning to use facsimile," *New York City Journal of Commerce*, July 31, 1947.
 (684) "AAF plans use of facsimile equipment," *American Aviation Daily*, August 4, 1947.
 (685) "Secret message transmission by facsimile," *Teleg. and Teleph. Age*, vol. 65, pp. 8, 10, 30; August, 1947.

Standards

The year 1947 marked a rapid growth of radio manufacturing for civilian uses with accompanying increased activity of the technical committees of the Institute. Substantial progress was made in the revision of a number of existing I.R.E. Standards on Methods of Testing.

During the year the Institute issued the following standards:

- (686) "Standards on Methods of Testing Television Transmitters."
 (687) "Standards on Methods of Testing F.M. Broadcast Receivers."

During the early part of 1948, it is planned to print the following:

- (688) "Standards on Methods of Testing Television Receivers."
 (689) "Glossaries of Definitions from the Antennas, Electroacoustics, Television, Transmitter, and Modulation Systems Committees of the Institute."

The Standards Manual was revised, approved by the Executive Committee, and submitted to the chairmen of all of the Institute's technical committees and subcommittees.

The Institute, along with certain other organizations, established several joint technical committees to expedite the preparation of standards and minimize duplication of effort. Included in such joint action were the American Standards Association, Radio Manufacturers Association, American Institute of Electrical Engineers, and Society of Motion Picture Engineers.

Acknowledgment

As in previous years, this summary for 1947 covers generally, for the subjects dealt with, developments described in publications issued up to about the first of November. The material has been prepared by members of the 1947 Annual Review Committee of the Institute, with editing and co-ordinating by the Chairman. The members of the Annual Review Committee are:

E. A. Laport	Radio Transmitters
P. S. Carter	Antennas
W. O. Swinyard	Radio Receivers
R. S. Burnap	Electron Tubes
S. A. Schelkunoff	Radio Wave Propagation and Utilization
M. G. Crosby	Modulation Systems
P. J. Larson	Television
W. G. Cady	Piezoelectric Crystals
Eginhard Dietze	Electroacoustics

G. M. Brown	Railroad and Vehicular Communications
D. G. Fink	Navigation Aids
A. B. Chamberlain	Standards
E. W. Schafer	Symbols
J. V. L. Hogan	Facsimile
G. P. Bosomworth	Industrial Electronics
F. E. Terman	Research
I. S. Coggeshall	
B. S. Ellefson	
Keith Henney	
W. B. Lodge	
H. A. Wheeler	
L. E. Whittemore	Chairman

The chairmen of the above committees wish to acknowledge the assistance given them in many cases by individual members of the Committees. Special acknowledgment is due N. H. Young, H. T. Lyman, E. D. Goodale, and W. T. Wintringham for the preparation of material on Television; A. R. Hodges for the preparation of material on Radio Receivers; E. C. Jordan for the preparation of material on Antennas, and to the several chairmen of subcommittees of the Committee on Electron Tubes for the preparation of material in their respective fields: E. M. Boone, Small High-Vacuum Tubes; I. E. Mouromtseff, Large High-Vacuum Tubes; D. E. Marshall, Gas-Filled Tubes; L. B. Headrick, Cathode-Ray Tubes and Television Tubes; and A. M. Glover, Phototubes. Acknowledgment is also due Miss M. C. Gray for the preparation of material on Waveguides, Transmission Lines, and Cavity Resonators; to H. W. Wells for material on the Ionosphere, T. J. Carroll for material on Tropospheric Propagation, and K. A. Norton for material on Noise.

The Duct Capacitor*

ALAN WATTON, JR.†, SENIOR MEMBER, I.R.E.

Summary.—This paper describes a new type of feed-through capacitor having outstanding capabilities in the suppression of radio interference, particularly at the higher frequencies. It is shown that the filtering obtained is of the nature of attenuation along a transmission line of high loss and low characteristic impedance. Furthermore, the construction is such that complete shielding can be obtained between the input and output leads. A description is given of a typical duct capacitor; also, two of the principal applications are discussed.

* Decimal classification: R381.1. Original manuscript received by the Institute, July 15, 1947. The opinions expressed herein are those of the author and do not necessarily reflect the official viewpoint of the U.S. Air Force.

† Headquarters, Air Matériel Command, Wright Field, Dayton, Ohio.

INTRODUCTION

PRESENT-DAY DEMANDS for interference-free operation of the radio equipment on military aircraft place severe requirements upon the means used for elimination of the interference. The range of frequencies of interest extends from 150 kc. to beyond 200 Mc. One of the most frequently used elements for radio-interference elimination is the capacitor. With the development of radio science has come a corresponding development in the capacitor.

The original type of paper capacitor evolved into the "noninductive" type so commonly used today. It is

possible to show that the behavior of the foil-dielectric roll portion of either of these two capacitors is similar to that of a high-loss transmission line.^{1,2} However, there is actually associated with the "noninductive" type of capacitor an appreciable magnetic (induction) field. In consequence, the unit as a whole displays a significant amount of inductance, and its impedance versus frequency characteristic shows a single series resonance typical of a single-mesh circuit of lumped parameters. Most of this inductance, both self and mutual, is associated with the leads and terminals; it can be reduced considerably by shortening the leads. However, in the usual method of construction, the connections to the foil-dielectric roll are made to the opposite ends of the roll. The result is that a certain portion of the magnetic (induction) field is associated with the roll itself, this field being the result of the flow of current from one end of the capacitor to the other. There are two effects of this magnetic field. First, it sets the minimum value (usually about 0.01 microhenries) to which the inductance of the capacitor can be reduced. Thus the "noninductive" capacitor is not universally effective as a radio-interference filtering means, particularly toward the upper end of the frequency range of interest. Second, the field limits the attenuation obtainable when using two "noninductive" capacitors in combination with an inductor in the familiar pi-section configuration to form a radio-interference filter, because the field results in stray mutual inductances between the elements of the filter.

The next step in the development has been the feed-through capacitor, whereby a further reduction in inductance can be obtained by proper design.

There comes next the "bypass" capacitor.³ The design is such that there is placed in shunt across the line to be filtered the input impedance of what again is essentially a transmission line of high loss and low characteristic impedance. This type is now in current production. Another type utilizing effectively the properties of a transmission line is the so-called "spark-plate" capacitor sometimes used in connection with automobile radio sets.

DUCT CAPACITOR

The duct capacitor^{4,5} can be viewed as a further development of the idea of utilizing the properties of transmission lines as a means of obtaining even better character-

istics in a radio-interference-filtering capacitor. The original development was apparently done by two workers associated with the German firm of Robert Bosch G.m.b.H.

The capacitor is so designed that the filtering obtained is of the nature of attenuation along a transmission line of high loss and low characteristic impedance. Furthermore, the construction is such that complete shielding can be obtained between the input and output leads, with effective elimination of the mutual inductance between the leads. This latter property is not displayed by any of the capacitors previously discussed.

A sketch of the mode of construction of the duct capacitor is given in Fig. 1. A roll is formed of two strips of foil interleaved with dielectric in a manner identical

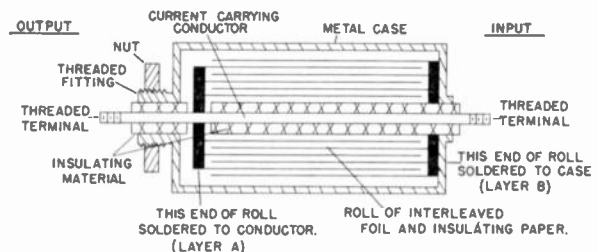

Fig. 1—Method of construction of the duct capacitor.

with that in present-day "noninductive" capacitors. One edge of one strip of foil is soldered into intimate contact with the metal case. The opposite edge of the other foil strip is bonded intimately with solder to the current-carrying conductor centrally located in the roll of foil. Insulating material is placed as required. The end of the case is threaded for a nut so that the capacitor may be placed in the wall of a metallic shielding enclosure, and the nut is drawn down tight to establish a firm, continuous metallic contact between the wall and the case

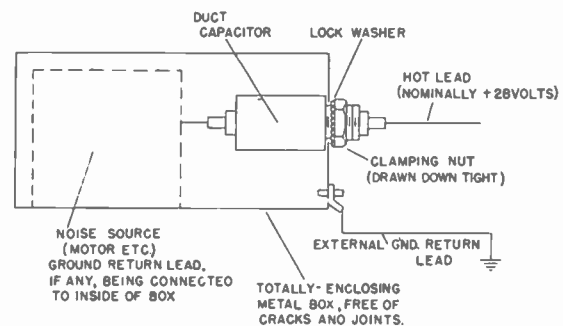

Fig. 2—Illustrating the method of installation of a duct capacitor in the wall of a metallic shielding enclosure surrounding a source of radio interference.

over a closed path encircling the central conductor, as illustrated in Fig. 2. An arrangement of this type is essential if the performance at high frequencies is not to be impaired. It is not advisable, for example, to use a flange with several screws as a means of attaching the capacitor to the wall of the shielding box.

¹ M. Brotherton, "Capacitors—Their Use in Electronic Circuits," D. Van Nostrand Co., Inc., New York, N. Y., 1946, pp. 25-27.

² L. Linder and J. Schnidermann, "The effect of the self-inductance of rolled-paper capacitors on their impedance," *Elektrotech. Zeit.*, vol. 60, pp. 793-798; July 6, 1939.

³ W. M. Allison and N. E. Beverly, "A new high-frequency capacitor," *Trans. A.I.E.E.*, (*Elec. Eng.*, December, 1944) vol. 63, pp. 915-916; 1944.

⁴ W. Thormann and R. Zechall, "Research on capacitors to eliminate interference from airborne electrical equipment," *Jahr. der Deuts. Luft.*, Part 3, pp. 1-8; 1940.

⁵ W. Mennerich, "Structural elements for eliminating radio interference," *Elektrotech. Zeit.*, vol. 65, pp. 6-9; January 13, 1944.

A photograph of a typical duct capacitor is shown in Fig. 3. It was built to specifications by a well-known American capacitor manufacturer⁶ for use in the present study. Its rating is 2.5 μ fd. nominal capacitance, 50 volts d.c. working potential, with the terminals and central conductor capable of carrying 100 amperes d.c. The volume, exclusive of the terminals and the threaded fitting, is slightly over 4.7 cubic inches, and the total weight including terminals and the fitting is about 8.5 ounces.

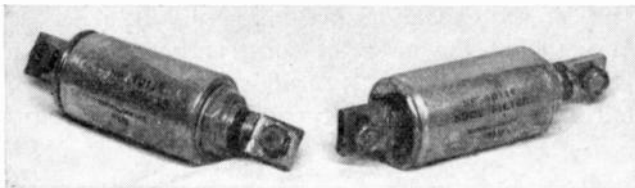

Fig. 3—Photograph of a typical duct capacitor.

PERFORMANCE

The performance of capacitors and filters used for radio-interference suppression is commonly evaluated in terms of their insertion loss in a standardized circuit^{3,7,8} having an impedance level of 20 ohms (resistive). However, in order to evaluate correctly the performance of duct capacitors, it is necessary that certain modifications of the usual test setup be made, as illustrated in Fig. 4. It is essential for the obtaining of correct results that the capacitor be mounted in the wall of a sealed metallic compartment.

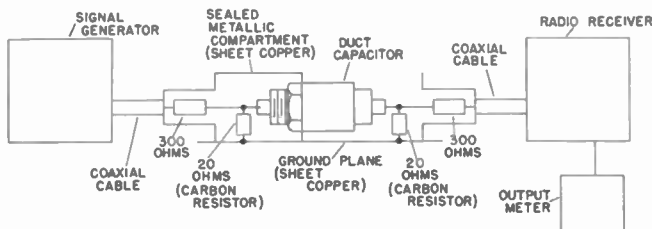

Fig. 4—Experimental setup for evaluating the performance of duct capacitors.

The insertion loss is then measured in terms of the ratio of the signal-generator output voltage E_0' for a given reading on the receiver output meter with the filter in the circuit, to the signal-generator voltage E_0 , required to give the same reading with the capacitor removed and replaced with a straight wire. The input level to the receiver is held to a sufficiently low level to be within the range of linear operation of the receiver. Then the insertion loss L is given in decibels by

$$L = 20 \log_{10} (E_0'/E_0). \quad (1)$$

⁶ Cornell-Dubilier Electric Corporation, South Plainfield, N. J.
⁷ Army Air Forces Spec. 32331-A; "Filter, Noise, Radio-Frequency," January 6, 1943.

⁸ C. W. Frick and S. W. Zimmermann, "Radio-noise filters applied to aircraft," *Trans. A.I.E.E. (Elec. Eng., September, 1943)*, vol. 63, pp. 590-595; 1943.

A typical insertion-loss characteristic of the 2.5- μ fd. duct capacitor shown in Fig. 3 is given in Fig. 5. It is seen that the curve at low frequencies follows closely that of a pure capacitance. The curve then bends back approximately horizontally for an interval. Above this interval the insertion loss again rises, so that, with increasing frequency, the insertion loss increases indefinitely.

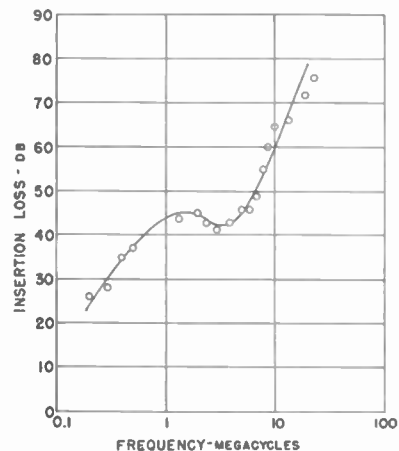

Fig. 5—Typical insertion-loss characteristic of a 2.5- μ fd. duct capacitor as measured in the standard 20-ohm circuit.

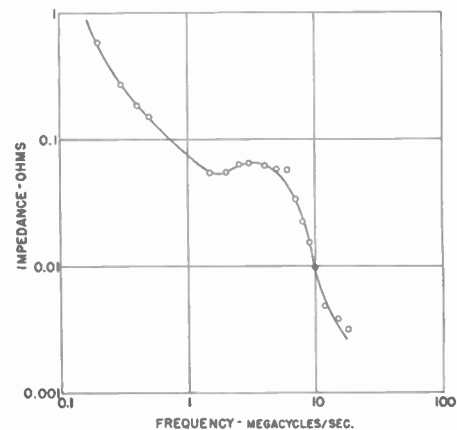

Fig. 6—Typical open-circuit transfer-impedance characteristic of a 2.5- μ fd. duct capacitor.

The performance of the capacitor in the standard test circuit is not, of course, the same as that obtained in an actual application. In the latter case, recourse must be had to a more fundamental measure of the capacitor performance; namely, its open-circuit transfer impedance. This quantity is readily calculated from the insertion-loss characteristic by the relation

$$Z_{12} = \frac{9.68}{\text{Antilog}_{10} (L/20)}, \quad (2)$$

provided L is greater than 20 db.

Using this relation, the curve of Fig. 6 was calculated from that of Fig. 5. Using the values of this transfer

impedance together with a knowledge of the values for the other impedances of the circuit of a given practical application, the performance of the duct capacitor in the circuit can be calculated.

From a broad viewpoint, the operation of the capacitor can be visualized in terms of the properties of transmission lines. An exact treatment would appear to present formidable analytical difficulties. However, by idealizing the foil-dielectric roll as a series of concentric nested cylinders of foil and dielectric, expressions can be developed which account for the principal characteristics of the unit rather well; this treatment can be found elsewhere.⁴ Pertinent to the problem is the work of Leiterer.⁹

Note that if the end layers of solder (*A* and *B* in Fig. 1) have sufficient thickness, then at radio frequencies the input connection is effectively shielded from the output connection. Thus the electromagnetic fields (principally induction electric and magnetic fields) present about the input conductor can reach the output conductor only by traveling through the dielectric layer of the capacitor in a manner similar to the way that waves travel along a line.

The waves are rapidly attenuated because of the skin effect in the foil and the losses in the dielectric. The velocity of propagation is, of course, very much less than that of electromagnetic waves in free space.

It is interesting to consider the input impedance of the capacitor. The setup of Fig. 4 was modified as illustrated in Fig. 7, in order to measure this quantity experimentally. The insertion loss is again measured in the same manner as before, with the capacitor now playing the role of a shunt element. The input impedance is then readily calculated by the relation given by (2).

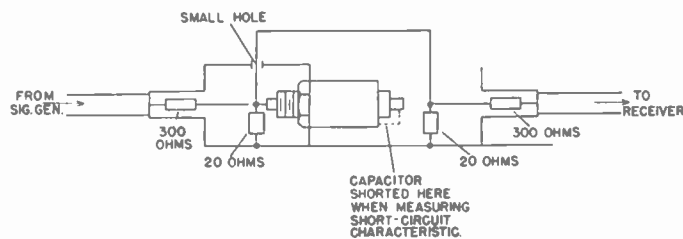

Fig. 7—Modification of experimental setup of Fig. 4 required in order to measure the input-impedance characteristics of a duct capacitor.

The impedance measured with the output of the capacitor both open-circuited and short-circuited (as shown in Fig. 7) is shown in Fig. 8 for the capacitor of Fig. 3. It is seen that, in a general way, the capacitor acts as a line having a very low characteristic impedance.

The lowest resonance frequency, corresponding to a quarter-wave distribution on the line, occurs in the vicinity of 0.9 Mc. Two other less-prominent resonances at higher frequencies are present. At still higher frequencies the attenuation has become so great that the

input is effectively separated from the output, so that there is no difference between the open and shorted con-

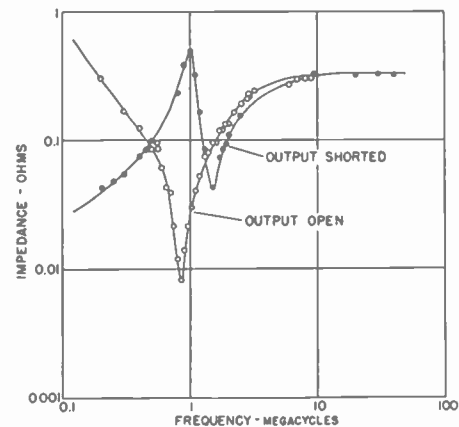

Fig. 8—Input-impedance characteristics of the 2.5- μ fd. duct capacitor illustrated in Fig. 3.

ditions, and the input impedance is the characteristic impedance of the "line."

APPLICATIONS

The first principal application of the duct capacitor is in connection with the filtering of radio interference produced by commutator motors and similar devices having a relatively high internal impedance at the frequencies of interest. A typical arrangement was illustrated above in Fig. 2. It is essential that the metal box be free of nonconducting joints or cracks so that a complete short-circuited turn is provided in the shield in each plane or direction. The result is that the radio-frequency magnetic and electric induction fields from the noise source are completely enclosed within the box.

The capacitor alone is not particularly effective in filtering the interference produced by the opening and closing of switch and relay contacts. It is necessary to combine with the capacitor various other means, principally inductors, in order to obtain appreciable filtering action. The duct capacitor, by its negligible external magnetic field, makes possible the construction of filters having high attenuation at the higher frequencies where ordinarily the existence of appreciable interaction between filter elements (due to stray mutual inductances) limits the maximum obtainable attenuation.

The second principal application is in the power-input and signal-output leads of aircraft radio equipment, particularly receivers, to reduce the susceptibility of such equipment to interference brought into this equipment from the electrical system of the aircraft.¹⁰ However, such beneficial effects can be obtained only if the receiver case is so fashioned as to form a tight shielding container. As was true above for shields to be used about noise sources, it is essential that the receiver case be

⁹ L. Leiterer, "Current and potential distribution in shorted-edge roll-type capacitors," *Elek. Nach. Tech.*, vol. 20, pp. 170-182; July, 1943.

¹⁰ G. Weinstein, H. H. Howell, G. P. Lowe, and B. J. Winter, "Radio-noise elimination in military aircraft," *Trans. A.I.E.E. (Elec. Eng., November, 1944)*, vol. 63, pp. 793-795, 1944.

free of nonconducting cracks or joints, so that a complete short-circuited turn is provided in the case in each plane or direction. In addition, the signal-input (antenna) lead should be brought in through a coaxial cable having good external shielding. It is noteworthy that the above arrangements are quite different from present practice in the design of aircraft-radio receiving equipment.

For application on present-day aircraft, it is desirable that the duct capacitor be manufactured in a variety of nominal capacitance values between 0.05 and 3.5 $\mu\text{fd.}$, and in a variety of current ratings for the central conductor between 10 and 200 amperes d.c.

A rating of 50 volts d.c. is satisfactory for most ap-

plications on aircraft having 24-volt power systems; however, in certain cases where surge voltages exist due to the operation of switch or relay contacts in inductive circuits, a higher voltage rating would, of course, be required.

ACKNOWLEDGMENT

The author wishes to express his appreciation of the work of his colleagues in connection with this study, which was conducted at the Propeller Laboratory, Engineering Division, Wright Field, Dayton, Ohio, as part of a program for the elimination of radio interference originating in electrical equipment associated with aircraft propellers.

Contributors to Waves and Electrons Section



E. FINLEY CARTER

E. Finley Carter (A'23-F'36) was born in Elgin, Texas, on July 1, 1901. He received the B.S. degree in electrical engineering from Rice Institute in 1922, and upon graduation became associated with the General Electric Company, engaged in radio development. In 1929 he became director of the radio division of the United Research Corporation in New York City, designing radio circuits and receivers.

Mr. Carter joined Sylvania Electric Products Inc. as a consulting engineer in 1932, later becoming assistant chief engineer, and in 1941 was appointed to organize and head the industrial relations department. Mr. Carter is now vice-president in charge of engineering of that organization.

He is a member of the American Institute of Electrical Engineers, of the American Radio Relay League, and of Tau Beta Pi, and was a member of the Board of Directors of The Institute of Radio Engineers in 1944 and 1945.



C. H. Crawford (A'47) was born near Dewese, Neb., on February 28, 1898. In 1925 he received the B.S. degree in electrical

engineering from the University of Nebraska. Upon graduation he was engaged by the General Electric Company, where he is at present. After completing several special assignments in the G. E. Test Course, he joined the transmitter engineering department in 1929, where he has been engaged in the application of power equipment and



C. H. CRAWFORD

components to radio transmitting equipment, with considerable emphasis on standardization in the last several years. He is currently in charge of the component parts engineering section of the Transmitter Division, Electronics Department.

Mr. Crawford worked on the mica-capacitor committee which was organized and sponsored in 1942 by the War Production Board. When this activity was expanded under the American Standards Association, he became an alternate member of the War Committee on Radio, C75. After these activities were taken over by the armed services, he was active in many conferences and meetings where the suggestions and recommendations of industry were discussed in connection with the JAN series of specifications. In 1945 he became a member of the newly



ALAN WATTON, JR.



organized Committee on component standardization of the Transmitter Section, RMA Engineering Department.

Mr. Crawford is a member of the A.I.E.F., an associate of Sigma Xi, and a licensed professional engineer in the State of New York.



Alan Watton, Jr., (A'43-SM'46) was born in Seattle, Wash., on August 9, 1915. He received the B.S. degree in electrical engineering with a minor in physics from the University of Washington in 1939. From 1939 to date, he has been associated with the Propeller Laboratory, Engineering Division, at the Headquarters, Air Matériel Command, Wright Field, Dayton, Ohio, in a civilian capacity, with the exception of the period from 1942 to 1946, when he was in military service with the same organization. He has been in charge of a group engaged in a variety of engineering studies related to the application of electrical and electronic devices to aircraft propellers.

Abstracts and References

Prepared by the National Physical Laboratory, Teddington, England, Published by Arrangement with the Department of Scientific and Industrial Research, England, and *Wireless Engineer*, London, England

NOTE: The Institute of Radio Engineers does not have available copies of the publications mentioned in these pages, nor does it have reprints of the articles abstracted. Correspondence regarding these articles and requests for their procurement should be addressed to the individual publications and not to the I.R.E.

Acoustics and Audio Frequencies.....	555
Aerials and Transmission Lines.....	555
Circuits and Circuit Elements.....	556
General Physics.....	558
Geophysical and Extraterrestrial Phenomena.....	559
Location and Aids to Navigation.....	559
Materials and Subsidiary Techniques...	560
Mathematics.....	561
Measurements and Test Gear.....	561
Other Applications of Radio and Electronics.....	562
Propagation of Waves.....	563
Reception.....	563
Stations and Communicating Systems...	564
Subsidiary Apparatus.....	564
Television and Phototelegraphy.....	564
Transmission.....	565
Vacuum Tubes and Thermionics.....	566
Miscellaneous.....	568

The number in heavy type at the upper left of each Abstract is its Universal Decimal Classification number and is not to be confused with the Decimal Classification used by the United States National Bureau of Standards. The number in heavy type at the top right is the serial number of the Abstract. U.D.C. numbers marked with a dagger (†) must be regarded as provisional.

ACOUSTICS AND AUDIO FREQUENCIES

- 534.114 **627**
A Note to Appraise Some Possible Causes of the Pressure/Frequency Effect of the Tuning Fork.—M. P. Johnson. (*Jour. Sci. Instr.*, vol. 24, pp. 253-254; October, 1947.) The causes considered are (a) variation of damping, (b) variation of physical dimensions, (c) change in density of the carried air, (d) change in thickness of the carried moisture. Comparison with an observed pressure versus frequency coefficient shows that (c) is the most important.
- 534.132 **628**
On the Radiation of Sound from an Unflanged Circular Pipe—H. Levine and J. Schwinger. (*Phys. Rev.*, vol. 72, p. 742; October 15, 1947.) Summary of Amer. Phys. Soc. paper. A rigorous solution has been obtained for the propagation of waves along a semi-infinite pipe, valid throughout the wavelength range of the dominant mode. The gain and radiation pattern are derived, and the absorption cross section for a wave incident normally on the mouth is found to be the geometrical area. When λ is large compared to the pipe diameter, the end correction is shown to be 0.6133.
- 534.321.9:534.24 **629**
The Vertical Reflection of Supersonic Sound from the Sea Bottom—R. W. Raïtt. (*Phys. Rev.*, vol. 72, p. 745; October 15, 1947.) Summary of Amer. Phys. Soc. paper. Experimental results all indicate diffuse reflection.
- 534.43+621.395.625.2:621.396.813 **630**
Intermodulation Distortion Analysis as Applied to Disk Recording and Reproducing Equipment—H. E. Roys. (PROC. I.R.E., vol. 35, pp. 1149-1152; October, 1947.) A more sensitive method than the single-frequency har-

monic method is the measurement of intermodulation frequencies. An abrupt increase in distortion occurs when the groove velocity falls below a certain value dependent on and increasing with the radius of the stylus. Various forms of distortion, including that caused by wear of the stylus tip or groove walls, can be readily measured by the intermodulation method.

- 534.43:621.395.61 **631**
High-Frequency Equalization for Magnetic Pickups—C. G. McProud. (*Audio Eng.*, vol. 31, pp. 13-15; September, 1947.) Methods of using shunt capacitance, for Pickering and General Electric pickups, to provide low-pass filter action and compensation for the recording characteristic of disk records. See also 3760 of January, U.D.C. of which should read as above.
- 534.43:621.395.61 **632**
A New Phonograph Pickup Principle—A. E. Hayes, Jr. (*Audio Eng.*, vol. 31, p. 14; October, 1947.) A method enabling a capacitive pickup to give an audio output equal to that of the magnetic type while retaining the advantages of low vibratory mass, relative freedom from resonance peaks in the desired spectrum, and good linearity.
- 534.43:621.396.665 **633**
High-Fidelity Volume Expander—Pickering. (See 696.)
- 534.614(25) **634**
An Acoustic Interferometer for the Measurement of Sound Velocity in the Ocean—R. J. Urick. (*Phys. Rev.*, vol. 72, p. 746; October 15, 1947.) Summary of Amer. Phys. Soc. paper. A fixed-path variable-frequency instrument which records small changes of sound velocity when it is lowered from a surface vessel. Results are compared with calculations made from bathythermograph and thermopile observations.
- 534.86:534.322.1 **635**
Factors Influencing Studies of Audio Reproduction Quality—N. M. Haynes. (*Audio Eng.*, vol. 31, pp. 15-17, 35; October, 1947.) See also 10 of February (Olson) and back references.
- 534.861.1 **636**
Dynamic Symmetry and Acoustic Room Design—M. Rettinger. (*Audio Eng.*, vol. 31, pp. 12-13, 48; October, 1947.) Discusses the acoustic and aesthetic advantages of choosing the dimensions of a rectangular studio so that there shall be a suitable relationship between the shape of the whole and that of any parts into which it may be divided. Noncircular cross sections for wood splays are also considered.

The Institute of Radio Engineers has made arrangements to have these Abstracts and References reprinted on suitable paper, on one side of the sheet only. This makes it possible for subscribers to this special service to cut and mount the individual Abstracts for cataloging or otherwise to file and refer to them. Subscriptions to this special edition will be accepted only from members of the I.R.E. and subscribers to the PROC. I.R.E. at \$15.00 per year. The Annual Index to these Abstracts and References, covering those published from February, 1947, through January, 1948, may be obtained for 2s. 8d., postage included, from the *Wireless Engineer*, Dorset House, Stamford St., London S. E., England.

- 621.395.623.8 **637**
Multi-Lingual Interpreting Systems—C. A. Tuthill. (*Audio Eng.*, vol. 31, pp. 10-12, 46; September, 1947.) Describes the a.f. installation in three conference rooms at the United Nations headquarters at Lake Success. The output from each delegate's microphone is led through an amplifier and control system to five interpreters in separate soundproof booths. The output from each interpreter's microphone is fed through separate amplifiers and local selector switches to the delegates' headphones. A brief description is given of the installation, which uses a low-power f.m. radio transmitting system. See also 1992 of 1947.
- 621.395.625.2 **638**
Force at the Stylus Tip While Cutting Lacquer Disk-Recording Blanks—H. E. Roys. (PROC. I.R.E., vol. 35, pp. 1360-1363; November, 1947.)
- 621.395.625.2:621.317.79 **639**
F. M. Calibrator for Disc Recording Heads—Schlegel. (See 773.)
- 621.395.625.2:621.317.79 **640**
Applications of the F.M. Calibrator—Schlegel. (See 774.)
- 621.395.625.3 **641**
The Magnetophon—D. V. R. Drenner. (*Audio Eng.*, vol. 31, pp. 7-11, 35; October, 1947.) A magnetic tape recorder developed by the German General Electric Company and I. G. Farben. Plastic-base tapes eliminate background "hiss" and h.f. current biasing in the recording process reduces noise level and increases frequency response. Typical tape and electrical troubles and their causes are discussed and performance details given. See also 2320 of 1947 and back references.
- 621.395.625.3:016 **642**
Bibliography of Magnetic Recording—N. M. Haynes. (*Audio Eng.*, vol. 31, pp. 30-31, 45; October, 1947.) A chronological list including American and foreign articles.
- AERIALS AND TRANSMISSION LINES
- 621.315.212 **643**
Broad-Band Noncontacting Short Circuits for Coaxial Lines: Part 2—Parasitic Resonance in the Unslotted S-Type Plunger—W. H. Huggins. (PROC. I.R.E., vol. 35, pp. 1085-1091; October, 1947.) These resonances may occur in the gap between the plunger and the outer conductor when λ is somewhat less than a submultiple of the mean circumference of this gap. Resonances for the gap between the plunger

and the inner conductor are affected by resonator tuning; for a $3\lambda/4$ resonator, two such resonances occur for values of λ a little greater and a little less than the mean circumference of the gap. Plunger eccentricity produces strong coupling of the principal resonator mode with "one-cycle" circumferential resonances, but only slight coupling with "multiple-cycle" circumferential resonances. Part 1: 330 of March.

621.315.212 644

Broad-Band Noncontacting Short Circuits for Coaxial Lines: Part 3.—W. H. Huggins. (Proc. I.R.E., vol. 35, pp. 1324–1328; November, 1947.) A theory of the resonances in a slotted plunger based upon a loaded-transmission-ring model. The wavelengths at which the parasitic resonances occur as calculated from this model are in satisfactory agreement with experimental measurements made upon a typical plunger. Ordinarily an odd number of slots is preferable to an even number; parasitic resonances are more readily controlled in the Z-type than in the British S-type plunger. Part 1: 330 of March. Part 2: 643 above.

621.315.212: [621.395+621.397.5] 645

Coaxial-Cable Networks.—F. A. Cowan. (Proc. I.R.E., vol. 35, pp. 1364–1367; November, 1947.) A general discussion on the technique of cable communication, with particular reference to telephony and to television links.

621.392.029.64: 621.395.521.1 646

Hybrid Circuits for Microwaves.—Tyrrell. (See 678.)

621.392.029.64: [669.71/.721+679.5] 647

Aluminum Waveguides for Lightweight Communications Equipment.—Sherman. (See 755.)

621.392.029.64.012.8 648

The Equivalent Circuit of a Corner Bend in a Rectangular Wave Guide.—J. W. Miles. (Proc. I.R.E., vol. 35, pp. 1313–1317; November, 1947.) The impedance representations are calculated for right-angle bends in, and transverse to, the plane of the electric field. The results are obtained as infinite series and shown graphically. See also 634 of 1947.

621.392.43 649

Broad-Band Wave-Guide Admittance Matching by Use of Irises.—R. G. Fellers and R. T. Weidner. (Proc. I.R.E., vol. 35, pp. 1080–1085; October, 1947.) A stationary wave detector is used to determine the optimum position and dimensions of a purely susceptive iris for matching the admittance of the load to that of the waveguide over a broad band of frequencies.

621.395.73: 621.396.97 650

Short Telephone Lines in Broadcast Operation.—A. Sobel. (Communications, vol. 27, pp. 16–18, 21; September, 1947.) A discussion of methods of improving the frequency response of lines as short as 3000 feet, by lowering the terminating impedance, at the expense of higher attenuation.

621.396.67 651

Performance of Short Antennas.—C. E. Smith and E. M. Johnson. (Proc. I.R.E., vol. 35, pp. 1026–1038; October, 1947.) The performance of vertical aerials having a physical height of less than $\lambda/8$, under various conditions of top loading, is deduced from experimental data. Aerial resistance and reactance were measured between 120 and 400 kc., and field intensity was measured between 139 and 260 kc. Top loading increases the radiation resistance and lowers the capacitive reactance component of the driving-point impedance. This lowers the effective Q of the aerial and improves wide-band operation. With short aerials having a small resistance and a large capacitive reactance, extra precautions must be taken to mini-

mize base-insulator losses. Extensive ground systems and high- Q loading coils are also of prime importance.

621.396.67 652

Element Spacing in 3-Element Beams.—P. C. Erhorn. (QST, vol. 31, pp. 37–42, 118; October, 1947.) A series of tests on parasitic arrays to determine optimum element lengths for various standard spacings. A tuning procedure leading to consistently good performance is described.

621.396.67: 621.397.5 653

WTTG TV Antennas.—G. E. Hamilton and R. K. Olsen. (Communications, vol. 27, p. 14; September, 1947.) Photographs and constructional features. See also 2262 and 3303 of 1947.

621.396.67: 621.397.5 654

Biconical Television Antenna.—(See 839.)

621.396.67.029.62 655

A "Halo" for Six Meters.—F. H. Stites. (QST, vol. 31, pp. 24–27; October, 1947.) A compact aerial system for horizontally polarized radiation, consisting of a folded dipole bent into a circle and end-loaded. It has an essentially circular polar diagram.

621.396.67.029.64 656

Microwave Antenna Analysis.—S. Seely. (Proc. I.R.E., vol. 35, pp. 1092–1095; October, 1947.) "The diffraction theory of Stratton and Chu is applied to a calculation of the vertical polar diagram and the gain of a parabolic cylindrical antenna. This antenna is fed by a line source having a known energy distribution and polarization. A numerical calculation for a particular profile is carried out, and the results are compared with those obtained experimentally. Satisfactory agreement between these results is found."

621.396.67.029.64 657

Parabolic-Antenna Design for Microwaves.—C. C. Cutler. (Proc. I.R.E., vol. 35, pp. 1284–1294; November, 1947.) The fundamental properties and formulas relating to parabolic radiators are given and the relation of the phase, polarization, and amplitude of the primary source or "feed" to the over-all radiation characteristics is investigated theoretically. The characteristics of practical feed systems for parabolic aerials are discussed.

621.396.671 658

Mutual Impedance between Vertical Antennas of Unequal Heights.—C. R. Cox. (Proc. I.R.E., vol. 35, pp. 1367–1370; November, 1947.) An expression is derived for the resistive and reactive components of the mutual impedance, the aerials being located above perfectly conducting ground. Mutual-impedance curves for typical combinations of aerial heights are plotted for spacings between 0.1 λ and 1.0 λ .

621.396.671 659

Partially-Screened Open Aerials.—R. E. Burgess. (Wireless Eng., vol. 24, pp. 309–310; October, 1947.) Author's reply to comment on 2681 of 1947 by Colino (3800 of January). By rearranging the differential equations for the screened portion of the aerial, it is shown that a coaxial mode exists, and independently an "outer" mode responsible for radiation from the screen. See also 2564 and 3158 of 1944.

CIRCUITS AND CIRCUIT ELEMENTS

621.314.222.018.42† 660

Theory and Design of High-Power Pulse Transformers.—W. S. Melville. (Jour. I.E.E. (London), part IIIA, vol. 93, no. 6, pp. 1063–1080; 1946.) "Describes the function and practical design of high-power pulse transformers as applied to radar pulse transmitters. The effects of pulse-transformer constants on the load pulse-shape are analyzed and optimum values

for the various relationships derived. The characteristics of magnetic core-materials under conditions of pulse magnetization, and practical and theoretical methods of measuring and estimating them are discussed. Apparatus for measuring pulse-magnetization characteristics is described." The paper is mainly practical; the mathematical analysis forms a convenient and useful appendix.

621.314.222.018.42†: 518.61 661

A Method of Virtual Displacements for Electrical Systems with Applications to Pulse Transformers.—P. D. Crout. (Proc. I.R.E., vol. 35, pp. 1236–1247; November, 1947.) The transient behavior of electrical systems with distributed constants is determined by a method which involves the association of a number of assumed "current modes" with generalized co-ordinates, and gives a set of equations which duplicates the mesh equations of a corresponding equivalent lumped network. The procedure can be applied to many types of problem. Equivalent networks, and procedures for calculating the constants in these networks, are obtained for the pulse transformer.

621.314.222.018.424†: 621.392.43 662

A Wide-Band Transformer from an Unbalanced to a Balanced Line.—E. G. Fubini and P. J. Sutro. (Proc. I.R.E., vol. 35, pp. 1153–1155; October, 1947.) A discussion of the frequency characteristics of a $\lambda/4$ type of transformer. Two $\lambda/4$ sections of different characteristic impedance are placed in tandem in order to reduce the standing-wave ratio to less than 1.25 over a 4 to 1 frequency range.

621.314.26.029.64: 621.396.622.6 663

Microwave Converters.—C. F. Edwards. (Proc. I.R.E., vol. 35, pp. 1181–1191; November, 1947.) The operation and design of cartridge-crystal frequency-changer circuits for wavelengths below 10 centimeters are discussed, with particular reference to impedance matching. Various coaxial and waveguide arrangements (both narrow- and wide-band) are described in detail. The use of a hybrid junction in a waveguide enables a balanced frequency changer to be used to eliminate both transfer of signal power into the beating oscillator and output from the noise side-bands of the oscillator. Summary noted in 1649 of 1946.

621.314.3†: 518.5 664

Special Magnetic Amplifiers and Their Use in Computing Circuits.—H. S. Sack, R. T. Beyer, G. H. Miller, and J. W. Trischka. (Proc. I.R.E., vol. 35, pp. 1375–1382; November, 1947.) The nonlinear transformer, which is the core of this apparatus, is based on the principle that both even and odd harmonics are generated if d.c. and a.c. are applied together to the primary of a transformer operating at saturation. Two equal transformers connected in opposition give even harmonics only, the amplitudes of which are proportional to the d.c. applied. They give an amplification of about 5000 for the second harmonic. See also 159 of February (Beyer) for which the above U.D.C. would have been preferable.

621.316.728+621.316.935 665

Saturable Reactors for Load Control: Parts I and 2.—P. A. Vance. (Gen. Elec. Rev., vol. 50, pp. 17–21 and 42–44; August and September, 1947.) Part 1: General consideration of saturable reactors of the "power-sized" range, their mode of operation and how they are applied. Part 2: Discussion of core construction, methods of eliminating second harmonics by parallel operation of the a.c. coils, and calculation of circulating current and impedance.

621.316.86 666

Temperature-Dependent Resistors.—W. H. B. Cooper and R. A. Seymour. (Wireless Eng., vol. 24, pp. 298–306; October, 1947.)

"An approximate analysis is given of the behavior of a temperature-dependent resistor in an electrical circuit; only relatively small changes of temperature are considered. The results are applied to the case of an oscillator which includes a temperature-dependent resistor as a control element."

621.317.35 667

Analysis of Lengthening of Modulated Repetitive Pulses—S. C. Kleene. (PROC. I.R.E., vol. 35, pp. 1049-1053; October, 1947.) An expression for the output after passage through a "pulse lengthener" circuit was obtained by Ming-Chen Wang and G. E. Uhlenbeck (appendix of Radiation Laboratory Classified Report S-10, dated May 16, 1944, edited by J. L. Lawson). The present paper gives a derivation of the result in more detail, without restriction to the ideal case. An example of a pulse-lengthening circuit is given.

621.317.733:621.316.7 668

Bridge Unbalance Used as a Process Control Factor—(Electronic Ind., vol. 1, pp. 4-5, 45; October, 1947.) Detailed analysis of the detector response in terms of the applied voltage and values of the resistances, for various types of bridge.

621.318.74 669

Single-Phase and Polyphase Filtering Devices Using Modulation—G. B. Madella. (Wireless Eng., vol. 24, pp. 310-311; October, 1947.) Comment on 2697 of 1947 (Barber). Barber's system is regarded as a "polyphase" filtering device, and its chief advantage over a simple single-channel system is shown to be the ability to translate a frequency f_1 , by modulating it with f_0 , to a low frequency $f_1 - f_0$ (negative frequency indicating phase reversal), to filter it and restore it to f_1 by modulation with f_0 , without introducing a "mirror" frequency $f_0 - (f_1 - f_0)$.

621.392 670

A Square-Law Circuit—J. H. P. Draper and D. G. Tucker. (Jour. Sci. Instr., vol. 24, pp. 257-258; October, 1947.) A method for obtaining a voltage proportional at any instant to the square of the applied voltage. A low-level input is applied across a rectifier in series with a small resistance. The voltage across this resistance is connected in series opposition with a suitable proportion of the applied voltage. The output approximates closely to the square of the input voltage.

621.392.001.1 671

Nodal Method of Circuit Analysis—A. Preisman. (PROC. I.R.E., vol. 35, p. 1335; November, 1947.) Comment on 39 of 1947 (Huggins).

621.392.43 672

The Exponential Conductor as Transformer—O. Zinke. (Funk. und Ton., pp. 119-129; September, 1947.) The work of Ruhrmann (620 of 1942) and of Wagner (3200 of 1942) is extended by means of diagrams relating the transfer ratio to l/λ , where l is the length of the exponential line. General equations and formulas are given, various loading conditions are discussed and compensation by the use of capacitors and inductors is described. It is found that the length of an exponential transformer can be reduced by a whole power of 10 if, on the high-ohmic side, a certain capacitance is connected in series and, on the low-ohmic side, an inductance is connected in parallel. The ratio of maximum to minimum wavelength for compensated transformers may in some cases exceed 15, but in others will be about 6. A numerical example is given.

621.392.5:518.5 673

Design of Mercury Delay Lines—T. K. Sharpless. (Electronics, vol. 20, pp. 134-138; November, 1947.) Mercury transmits compression waves relatively slowly, introduces

negligible loss and has an impedance comparable to that of crystal transducers. A mercury delay line, suitable for storing forty 0.3-microsecond pulses spaced 1 microsecond apart, consists of a 2-inch stainless steel tube of internal diameter one-half inch. End caps are 7.5-mc. X-cut circular quartz crystals soldered to ceramic end pieces which are cut at an angle to reduce the reflected wave. Temperature compensation to within $\pm 3^\circ\text{C}$ is provided. Auxiliary circuits for recirculation of pulse data are described briefly, with block and circuit diagrams. See also 2828 of 1947.

621.392.5:621.396.619.13 674

Network Transmutation of a Frequency-Modulated Wave—L. J. Giacometto. (PROC. I.R.E., vol. 35, pp. 1105-1106; October, 1947.) Comment on 1463 of 1946 (Frantz).

621.392.5.029.64 675

A Mathematical Theory of Directional Couplers—H. J. Riblet. (PROC. I.R.E., vol. 35, pp. 1307-1313; November, 1947.) By suitable generalization of concepts used in discussing the lumped loading of a single transmission line, it is possible to discuss the interaction of the coupling elements of these more complicated circuits in a reasonably complete and elementary manner. Input impedances are analyzed in terms of equivalent T and Π sections. The transformation of line impedances is shown to commute with similarity transformations, so that the circuit problem is equivalent to one involving independent but properly loaded transmission lines. The behavior of many aperture-coupled directional couplers may be analyzed by the use of a single conventional impedance diagram. A small-hole theory is given which predicts previously unexplained results.

621.392.52.011.2 676

The Direct Setting-Up of $Y_{\alpha\beta}$ for Junction Networks for the Network Diagram—S. A. Stigant. (Beama Jour., vol. 54, pp. 348-353 and 385-389; October and November, 1947.) Articles complementary to those describing the setting-up of $Z_{\alpha\beta}$ for closed-mesh networks (2033 of 1947 and 3820 of January). "A comparison of the two will disclose the 'dual' nature of the two types of circuits and their response characteristics. Each is self-contained."

621.392.53 677

Automatic Audio Phase Reverser—A. H. Smith. (Electronics, vol. 20, pp. 156, 162; November, 1947.) Comprises a 2-stage bridging audio amplifier, a balanced rectifier, and a RC delay network with output connected to the grid of a thyatron which actuates a polarity-switching relay. A switch presets the circuit so that, on modulation peaks, a transmitter will be modulated more positively than negatively, thereby reducing distortion. A complete circuit diagram is given.

621.395.521.1:621.392.029.64 678

Hybrid Circuits for Microwaves—W. A. Tyrrell. (PROC. I.R.E., vol. 35, pp. 1294-1306; November, 1947.) The fundamental behavior of hybrid circuits is reviewed and discussed, largely in terms of reciprocity relationships. The phase properties of simple waveguide T -junctions are considered briefly. Two kinds of hybrid circuits are then described, the one involving a ring or loop of transmission line, the other relying upon the symmetry properties of certain four-arm junctions. The description is centered about waveguide structures for microwaves, but the principles may also be applied to other kinds of transmission line for other frequency ranges. Experimental verification is provided, and some of the important applications are outlined.

621.395.61/.621.012.8 679

Approximate Equivalent Circuit for a Resonator Transducer—W. R. MacLean.

(PROC. I.R.E., vol. 35, pp. 1095-1096; October, 1947.) The equivalent circuit of a high- Q transducer is given as a set of unit tank-circuit transducers connected in series on both ends. See also 1319 of 1941 (Condon).

621.395.645.33:578.088.7 680

Electro-Encephalograph Amplifier—D. L. Johnston. (Wireless Eng., vol. 24, pp. 231-242, 271-277; and 292-297; August-October, 1947.) An amplifier with frequency response from 0.15 to 10,000 c.p.s. requiring a 15-microvolt peak-to-peak input signal for full output drive, and using a.c. supplies. Degenerative circuits eliminate critical balancing adjustments. A bibliography of 61 items is given.

621.396.611.21 681

Resonant Frequencies of n -Meshed Tuned Circuits—L. A. Zadeh. (PROC. I.R.E., vol. 35, p. 1335; November, 1947.) Comment on 2352 of 1947 (Parzen).

621.396.611.4:621.396.615.142 682

Loading of Resonant Cavities by Electron Beams—W. G. Abraham. (Phys. Rev., vol. 72, p. 741; October 15, 1947. Summary of Amer. Phys. Soc. paper.) In cavities with grids, the loading is found to be greater than that calculated from transit-time theory. This has been found experimentally to be due to two forms of secondary emission, the elimination of which enabled the loading to be reduced to its transit-time value.

621.396.615.14:621.385.3 683

Triodes for Very Short Waves—Oscillators—J. Bell, M. R. Gavin, E. G. James and G. W. Warren. (Jour. I.E.E. (London), Part IIIA, vol. 93, no. 5, pp. 833-846; 1946. Discussion, *ibid.*, part III, vol. 94, no. 31, pp. 364-368; 1947.) Suitable circuits for v.h.f. operation are discussed. Electron transit time is reduced by the use of very small grid-cathode spacings and by increasing the space-current density to as much as 5 A per centimeter² under pulse conditions. Electrode-lead inductance is reduced by the use of disk seals, thus making the tube an integral part of the circuit. Several types of tubes are described to illustrate the new techniques used; these include (a) a common-anode transmitting tube, Type NT99, a pair of which give 200 kw. at 600 Mc.; (b) a common-grid transmitting tube, Type CV288 a pair of which give 100 kw. at 1000 Mc., and (c) a common-grid receiving tube, Type CV273, giving 5 Watts at 1000 Mc. and 0.5 watt at 3000 Mc.

621.396.615.17 684

A Pretuned Bandpass Frequency Multiplier—M. Silver. (QST, vol. 31, pp. 29-31, 114; October, 1947.) Broad-band fixed-tuned circuits are applied to a frequency-multiplier unit which requires only the addition of the v.f.o. or crystal oscillator to give an output of 40 watts on all amateur bands from 80 meters to 6 meters.

621.396.615.17:621.317.755 685

Oscilloscope Time-Base Circuit—H. den Hartog and F. A. Muller. (Wireless Eng., vol. 24, pp. 287-292; October, 1947.) The normal method of synchronization of a Puckle time-base is analyzed. A new method is described providing synchronization to an external signal from 150 to 1700 c.p.s. without adjustment of the timebase frequency control, and with a change in sweep amplitude of only 15 per cent.

621.396.619 686

Selective Demodulation—B. Starnecki. (PROC. I.R.E., vol. 35, p. 1335; November, 1947.) Comment on 3059 of 1947 (Harris). The method there described was checked experimentally in Poland in 1934.

621.396.622.63 687

Crystal Valves—B. Bleaney, J. W. Ryde, and T. H. Kinman. (Jour. I.E.E. (London),

Part IIIA, vol. 93, no. 5, pp. 847-854; 1946. Discussion *ibid.*, part III, vol. 94, no. 31, pp. 339-343; 1947.) Design details are given for the high mechanical and electrical stability required for frequency conversion and detection at centimeter λ . The h.f. performance is analyzed and measurements of conversion loss and noise temperature are described. The burn-out of crystals when used with pulsed radar sets is discussed and tests using d.c. pulses are described. Summary in *Wireless World*, vol. 53, p. 89; March, 1947.

621.396.645 688

High-Frequency Amplification—H. Jungfer. (*Funk. und Ton.*, pp. 130-141; September, 1947.) Discussion of the amplification and selectivity of a single stage anode reaction and particular features of short-wave amplification, multistage amplifiers and heterodyne receivers and interference and methods of reducing it.

621.396.645 689

Dynamic Performance of Peak-Limiting Amplifiers—D. E. Maxwell. (Proc. I.R.E., vol. 35, pp. 1349-1356; November, 1947.) Dynamic requirements for peak-limiting amplifiers are discussed briefly with respect to such factors as attack time, signal-to-thump ratio, gain-reduction characteristics, and recovery time. A novel measurement technique and apparatus for visual analysis are described.

621.396.645:621.396.96 690

Considerations in the Design of a Radar Intermediate-Frequency Amplifier—A. L. Hopper and S. E. Miller. (Proc. I.R.E., vol. 35, pp. 1208-1219; November, 1947.) A discussion of the choice of tubes and the design of inter-stage coupling networks suitable for a mass-produced instrument with a bandwidth of 10 Mc. and center frequency either 60 or 100 Mc. Detailed circuits, construction, and performance are given of 60-db amplifiers (about 13 db per stage, with over-all noise factor of 4.5 db at 60 Mc. and 5.6 db at 100 Mc. using 6AK5 short-base pentodes with double-tuned transformer couplings).

621.396.645.029.62 691

H.F.F.M. Quadriline R.F. Amplifier—R. G. Peters. (*Communications*, vol. 27, p. 36; September, 1947.) For another account see 70 of February.

621.396.645.029.63 692

A Wide-Band 550-Megacycle Amplifier—R. O. Petrich. (Proc. I.R.E., vol. 35, pp. 1371-1374; November, 1947.) A 5-stage amplifier with an over-all bandwidth of 20 Mc. and a gain of 10 db. per stage. "It uses a 2C43 triode in a grounded-grid circuit with an impedance-transforming band-pass filter in the output to give the desired bandwidth. A visual method of alignment with a sweep-frequency oscillator is described, and important design considerations are given."

621.396.645.35 693

Electromechanical D.C. Amplifier—C. G. Roper and J. F. Engelberger. (*Electronics*, vol. 20, pp. 117-119; November, 1947.) An account of the operating principles, mechanical details and applications of a compact instrument suitable for low-impedance low-current inputs. A moving-coil galvanometer system actuates a metal flag between the oscillator coils, providing high gain and stable amplification. Feedback from the output voltage may be applied to an extra coil in the galvanometer. Circuit diagrams and frequency characteristics are given, and also a mathematical analysis of the feedback.

621.396.645.35 694

Sensitive D.C. Current-Amplifier operated from A.C.—S. Chapman. (*Phys. Rev.*, vol. 72, p. 745; October 15, 1947.) Summary of

Amer. Phys. Soc. Paper. A simple 3-stage d.c. amplifier, with electrometer-tube input and variable negative feedback, operated from a stabilized supply. A meter deflection of 100 microamperes is produced by about 0.033 volt.

621.396.662.3:621.392.029.64 695

Microwave Filters Using Quarter-Wave Couplings—R. M. Fano and A. W. Lawson, Jr. (Proc. I.R.E., vol. 35, pp. 1318-1323; November, 1947.) A theoretical and detailed practical discussion of an adaptation of the conventional ladder-type filter in which the series elements are replaced by $\lambda/4$ -line sections and the parallel elements by resonant elements of the cavity or iris type.

621.396.665:534.43 696

High-Fidelity Volume Expander—N. C. Pickering. (*Audio Eng.*, vol. 31, pp. 7-9, 39; September, 1947.) The controlled amplifier consists essentially of a single stage of push-pull amplification arranged to handle the loudest sound levels required. The gain is smoothly decreased over a range of 8 to 12 db by placing in parallel with the amplifier tubes, two control tubes, whose grids are biased by the rectified output from an independent signal amplifier. With the control tubes cut off, the amplifier tubes work into their designed load impedance; as current is allowed to increase in the control tubes, the load impedance diminishes, and with it the gain of the stage. The effect is reinforced by variations of the common cathode bias. The control is arranged to function immediately after a change of input signal, but best results are obtained if the release is delayed for some seconds.

621.396.611.4:621.396.662.34 697

Kettenförmige Ultrakurzwellen-Bandfilter aus Quasistationären Schwingtöpfen [Book Review]—F. Staub. Gebr. Leeman and Co., Zurich, 89 pp., 10 Swiss francs. (*Wireless Eng.*, vol. 24, p. 308; October, 1947.) A doctorate thesis, dealing with theory, design, construction and testing of various types of u.s.w. band-pass filters for which cavity resonators are used.

GENERAL PHYSICS

530.14 698

The Interaction of Electrons and an Electromagnetic Field—C. J. Eliezer. (*Rev. Mod. Phys.*, vol. 19, pp. 147-184; July, 1947.) The present state of knowledge of particle dynamics is discussed critically and the difficulties encountered in connection with the development of the various theories are considered briefly. The main body of the paper follows the lines of Dirac's quantum electrodynamics. The generalized Lorentz-Dirac equations are expressed in Hamiltonian form, and translated into the quantum theory. An investigation of the interaction of an electron and a radiation field is based on these new equations. The solution for the interaction is shown to be entirely free from divergent integrals to all orders of approximation in the perturbation theory.

530.162:519.2 699

On the Problem of Random Flights—M. H. Quenouille. (*Proc. Camb. Phil. Soc.*, vol. 43, Part 4, pp. 581-582; October, 1947.) Comment on 2866 of 1943 (Chandrasekhar). See also 701 below.

530.162:519.2 700

The Resultant of a Large Number of Events of Random Phase: Part 2—C. Domb. (*Proc. Camb. Phil. Soc.*, vol. 43, Part 4, pp. 587-589; October, 1947.) Coulson's criticism (701 below) of part 1 (278 of 1947) is accepted. For certain problems, however, the treatment of part 1 is a sufficiently good approximation. The theory is used to estimate the coherent contribution to the energy scattered back to a beamed radar equipment. In practice, the coherent contribution is generally negligible com-

pared with the incoherent term. The dependence of the coherent contribution on pulse shape, on the distance of the scattering cloud of particles, and on the operating wavelength is indicated briefly. See also 515 of 1947 (Ryde).

530.162:519.2 701

Note on the Random-Walk Problem—C. A. Coulson. (*Proc. Camb. Phil. Soc.*, vol. 43, part 4, pp. 583-586; October, 1947.) An alternative treatment to that used by Domb (278 of 1947) for obtaining the probability function of the sum of a number of vectors, each of random phase ϕ but each having an amplitude which is some given function of ϕ . The results of the analysis are critically compared with those of Domb. See also 700 above.

530.19:621.396.615.141.2 702

Scalar and Vector Potential Treatment—P. I. Richards. (Proc. I.R.E., vol. 35, pp. 1334-1335; November, 1947.) Smith and Shulman (3699 of January) have applied a variational method to the calculation of the change in the resonant frequency of a magnetron cavity due to the introduction of an electron beam. The derivation of their result numbered (74) can be simplified and considerably shortened by a so-called gauge transformation.

537.122:538.3 703

On the Self-Accelerating Electron—S. Ashauer. (*Proc. Camb. Phil. Soc.*, vol. 43, part 4, pp. 506-510; October, 1947.) After solving the equations of motion of Dirac's self-accelerating electron, a physical picture of it is formed by plotting graphically the surfaces of constant scalar potential when the electron has built up a velocity close to the velocity of light. See also 3459 of 1945 (Eliczer and Mailvaganam).

537.32 704

The Theory of the Thermoelectric Power of Metals—E. H. Sondheimer. (*Proc. Camb. Phil. Soc.*, vol. 43, part 4, pp. 571-576; October, 1947.)

538.122:518.4 705

Graphs of the Induced Magnetic Moment and Shielding Effect of a Spherical Shell in a Uniform Magnetic Field—B. Tuckerman. (*Terr. Mag. Atmo. Elec.*, vol. 52, pp. 369-373; September, 1947.)

538.221 706

Oscillations of Elementary Magnets—V. Arkadiev. (*Nature*, (London), vol. 160, p. 397; September 20, 1947.) From a comparison with experimental data on magnetic dispersion and absorption bands for ferromagnetic materials, it is suggested that the theory of magnetic viscosity spectra is applicable to the lower frequencies but that the theory of elastic-viscous rotation of magnetic dipoles with a moment of inertia is more suitable in the centimeter λ region.

538.569.4:546.171.1 707

The Hyperfine Structure and the Stark Effect of the Ammonia Inversion Spectrum—J. M. Jauch. (*Phys. Rev.*, vol. 72, pp. 715-723; October 15, 1947.)

538.569.4.029.64 708

Microwave Spectra and Zeeman Effect in a Resonant Cavity Absorption Cell—C. K. Jen. (*Phys. Rev.*, vol. 72, p. 986; November 15, 1947.) A gas-filled resonant cavity is tuned to a spectral line at low pressure, using a klystron source with a linear frequency sweep. The absorption line appears on the normal resonance curve displayed on a c.r.o. A method of increasing the sensitivity of the spectroscopy is described and used to demonstrate the Zeeman effect for microwave spectral lines. See also 3867 of January (Coles and Good).

- 538.691:621.397.331.2 709
The Motion of Electrons Subject to Forces Transverse to a Uniform Magnetic Field—P. K. Weimer and A. Rose. (Proc. I.R.E., vol. 35, pp. 1273-1279; November, 1947.) The motion is investigated analytically for forces varying with time, and a graphical method of solution is described and applied to the electron motion in the orthicon type of television pickup tube.
- GEOPHYSICAL AND EXTRATERRESTRIAL PHENOMENA**
- 521.15:538.12:523.3 710
The Magnetic Field of the Moon?—S. Chapman, (*Nature*, (London), vol. 160, p. 395; September, 1947.) With reference to Blakett's recent theory of magnetism of massive bodies due to their rotation (3112 of 1947.) the possibility is discussed of measuring the moon's magnetic field by rocket methods. This would check the theory for moments smaller than those hitherto considered. See also 3891 of January (Babcock).
- 523.72:621.396.822.029.62 711
Relative Times of Arrival of Bursts of Solar Noise on Different Radio Frequencies—R. Payne-Scott, D. E. Yabsley, and J. G. Bolton. (*Nature*, (London), vol. 160, pp. 256-257; August 23, 1947.) Discussion of observations made at Chippendale, N.S.W., mainly during July and August, 1946, at frequencies of 200, 75 and 60 Mc., together with a few observations at 30 Mc. There is little correlation between the smaller bursts on different frequencies, while the larger bursts are similar in shape and nearly coincident in time; these associated bursts occur first on 200 Mc., then on 75 Mc., then on 60 Mc., the delays usually being of the order of 2 seconds between consecutive frequencies; but delays of several minutes have occurred for exceptionally large outbursts, particularly that of March 8, 1947, for which diagrams are reproduced, and heights and velocities of the sources of the disturbances estimated according to Martyn's suggestions (2088 of 1947). See also 96 of February (Ryle and Vonberg).
- 523.746:550.385 712
Sunspots and Telegraphy—C. H. Cramer. (*Telegr. Teleph. Age*, vol. 65, pp. 9-10, 50; October, 1947.) Reprint of 3878 of January.
- 523.746"1947.04/.06" 713
Provisional Sunspot-Numbers for April to June, 1947—M. Waldmeier. (*Terr. Mag. Atmo. Elec.*, vol. 52, pp. 397-398; September, 1947.)
- 537.591 714
The Latitude Effect of the Hard Component as a Function of Altitude—P. S. Gill, M. Schein, and V. Yngve. (*Phys. Rev.*, vol. 72, p. 733; October 15, 1947.)
- 537.591 715
On the Mass and the Disintegration Products of the Mesotron—C. D. Anderson, R. V. Adams, P. E. Lloyd, and R. R. Rau. (*Phys. Rev.*, vol. 72, pp. 724-727; October 15, 1947.)
- 537.591:519.331 716
Investigations on the 27-Day Period of Cosmic Radiation—II. Gheri and R. Steinmaurer. (*Terr. Mag. Atmo. Elec.*, vol. 52, pp. 343-355; September, 1947. In German.) Modern statistical methods confirm the existence of the 27-day period. The variations show at times a close connection with the passage of large sunspot groups across the sun's disk and with magnetic storms.
- 550.38(52) 717
Recent Geomagnetic Data from Observatories and Stations in Japan—K. Wadachi. (*Terr. Mag. Atmo. Elec.*, vol. 52, pp. 410-412; September, 1947.)
- 550.38"1947.01/.06" 718
Cheltenham [Maryland] K-Indices for January to June 1947—W. E. Wiles. (*Terr. Mag. Atmo. Elec.*, vol. 52, pp. 403-409; September, 1947.)
- 550.38"1947.04/.06" 719
K-Indices, April to June, 1947, and Sudden Commencements, January to June, 1947, at Abinger—H. Spencer Jones. (*Terr. Mag. Atmo. Elec.*, vol. 52, pp. 399-403; September, 1947.)
- 550.385"1947.04/.06" 720
Principal Magnetic Storms [April-June, 1947]—(*Terr. Mag. Atmo. Elec.*, vol. 52, pp. 413-424; September, 1947.)
- 551.510.5:621.396.822.029.64 721
Microwave Sky Noise—A. E. Covington. (*Terr. Mag. Atmo. Elec.*, vol. 52, pp. 339-341; September, 1947.) Noise received on a 3000-Mc. aerial system with a 6° beam pointed toward the zenith was measured by the Dicke modulation technique (475 of 1947). The sky temperature fluctuations showed correlation with sudden magnetic disturbances and with auroral displays; on some occasions the sky temperature rises some minutes before sunrise and drops some minutes after sunset.
- 551.510.52:621.396.812.029.64 722
Radar Reflections from the Lower Atmosphere—W. B. Gould. (Proc. I.R.E., vol. 35, p. 1105; October, 1947.) Comment on 2769 of 1947 (Friis).
- 551.510.535 723
Critical Survey of Recent Theoretical Work on the Ionosphere—A. Pande. (*Terr. Mag. Atmo. Elec.*, vol. 52, pp. 375-396; September, 1947.) The relative merits of the work of numerous authors are discussed and particular attention is given to (a) determination of ionization density and collision frequency, (b) propagation through the ionosphere, (c) dissociation, detachment, and the reverse processes, and (d) composition and temperature of the upper atmosphere. A list of 118 references is included.
- 551.510.535 724
Rate of Electron Production in the Ionosphere—S. L. Seaton. (*Phys. Rev.*, vol. 72, pp. 712-714; October 15, 1947.) Methods are developed for determining the rate throughout the 24 hours. Application of the theory to experimental data shows that the rate of electron production varies more or less systematically from zero before sunrise to values around 800 electrons centimeter⁻³ second⁻¹ near noon at the equator for an equinoctial interval at sunspot minimum. The results are in general agreement with values determined over restricted time intervals during eclipse of the sun.
- 551.510.535 725
The Determination of Ionospheric Electron Distribution—L. A. Manning. (Proc. I.R.E., vol. 35, pp. 1203-1207; November, 1947.) "The virtual height versus frequency integral is derived, neglecting absorption and the earth's magnetic field. It is shown how solution of this integral equation can be obtained using the Laplace transformation, and how true height versus frequency can be determined graphically from virtual height versus frequency curves. Application of the method is made to some typical nighttime and daytime ionosphere records."
- 551.510.535 726
Differential-Penetration Theory—T. L. Eckersley. (*Terr. Mag. Atmo. Elec.*, vol. 52, pp. 305-314; September, 1947.) When a neutral cloud of electrons and positive particles encounters the upper atmosphere, the electrons, owing to their short free path, are soon retarded while the positive particles penetrate to much greater depths. This sets up an electric field which is horizontal at sunrise and sunset and vertical at noon; it is also crossed by horizontal and vertical components of the earth's magnetic field.
- The crossed fields cause drifts of the ions and these drifts explain the fall in F_2 -layer ionization during magnetic storms, the F_2 -layer ionization maxima north and south of the magnetic equator, and the sunrise G layer observed in Ceylon. See also 3500 of 1942.
- 551.510.535:523.745 727
The Ionosphere as a Measure of Solar Activity—M. L. Phillips. (*Terr. Mag. Atmo. Elec.*, vol. 52, pp. 321-332; September, 1947.) Experimental data show that, at any geographical location and for any ionized region, the relation between monthly mean critical frequency (f^o) and sunspot-number (S) is well represented by $f^o + (S+A)F(t)$ where $F(t)$ is a function of the time of day and A is a constant. The standard deviations of the monthly from the yearly average of S are considerably greater than those of f^o .
- 551.510.535:523.78"1947.07.09" 728
Coronal Radiation and Ionospheric Variations During the Solar Eclipse, July 9, 1945—M. Waldmeier. (*Terr. Mag. Atmo. Elec.*, vol. 52, pp. 333-338; September, 1947.) "From the ionospheric observations made by O. Rydbeck (1777 of 1947), and from the coronal observations made by the author, it is deduced that the source of the solar ultra-violet light, producing the E -layer, lies in the innermost part of the corona in the regions of highest intensity of the 5303-radiation. Very strong support to this conclusion is given by the fact that in these regions the temperature of the corona reaches its highest values."
- 551.510.535:550.385:621.396.812.3 729
Polar Radio Disturbances During Magnetic Bays—H. W. Wells. (*Terr. Mag. Atmo. Elec.*, vol. 52, pp. 315-320; September, 1947.) In 1942 in Alaska, 69 magnetic bays were observed and were accompanied by high absorption of radio signals below the E region, both for vertical and oblique incidence. It is suggested that both this ionization and sporadic- E ionization are caused by particle bombardment.
- 551.593.9+551.594.5 730
The Radiations from the Earth's Atmosphere—S. Chapman and D. R. Bates. (*Nature*, (London), vol. 160, pp. 250-251; August 23, 1947.) Discussion of existing knowledge of auroras and the night sky light. A conference on these subjects was organized by the Gassiot Committee of the Royal Society and held in London in July, 1947. Papers read at the conference will be published by the Physical Society in *Reports on Progress in Physics*.
- LOCATION AND AIDS TO NAVIGATION**
- 621.396.96 731
Detectability and Discriminability of Targets on a Remote Projection Plan-Position Indicator—W. R. Garner and F. Hamburger, Jr. (Proc. I.R.E., vol. 35, pp. 1220-1225; November, 1947.) Quantitative results were obtained on minimum detectable signals and minimum separation between two targets as a function of the following variable factors: video gain, c.r.t. bias, signal clipping, light-source intensity, type of diffraction screen, and position of the operator. The projection (p.p.i.), using a dark-trace tube, appeared to be 1 db worse than a standard 5-inch p.p.i., when each instrument was operated under its optimum conditions.
- 621.396.96:531.55 732
Naval Fire-Control Radar—J. F. Coales, H. C. Calpine, and F. S. Watson. (*Jour. I.E.E.* (London), part III, vol. 94, p. 346; September, 1947.) Discussion on 1798 of 1947.

621.396.96:531.55:621.396.621 733

The Development of Gun-Laying Radar Receivers Type G. L. Mk. 1, G.L. Mk.1* and G.L./E.F.*—L. H. Bedford. (*Jour. I.E.E.* (London), part IIIA, vol. 93, no. 6, pp. 1115-1122; 1946.) The early types used a null method of range measurement by means of an accurate potentiometer. The design of the basic gun-laying system is described, with brief reference to the receiver, timebase and display, and details of the potentiometer arrangement. Later a self-contained unit was evolved in which elevation was determined by comparison of field strengths, using a goniometer and a high-angle aerial system.

621.396.96:621.317.79 734
Quantitative Radar Measurements—Katzin. (*See* 779.)621.396.96:621.385.832:535.371.07 735
Cathode-Ray-Tube Screens for Radar—Garlick, Henderson, and Puleston. (*See* 885.)621.396.96:621.385.832.087.3 736
Visibility of Cathode-Ray-Tube Traces in Radar Displays—Hopkinson. (*See* 889.)621.396.96:621.396.61/.62 737
Various Papers on Radar Transmitters, Receivers, Modulators, etc., for Radar—*See* Transmission and Reception sections.621.396.96:621.396.645 738
Considerations in the Design of a Radar Intermediate-Frequency Amplifier—Hopper and Miller. (*See* 690.)

MATERIALS AND SUBSIDIARY TECHNIQUES

537.228.1 739
Culturing Crystals—(*Electronics*, vol. 20, p. 144; November, 1947.) A brief account of the commercial production of piezoelectric crystals of ethylene diamine tartrate (EDT) for crystal filters.538.228.1 740
New Low-Coefficient Synthetic Piezoelectric Crystals for Use in Filters and Oscillators—W. P. Mason. (*Proc. I.R.E.*, vol. 35, pp. 1005-1012; October, 1947.) Crystals of ethylene diamine tartrate (EDT) and dipotassium tartrate (DKT) can be cut so that they have zero temperature coefficients within useful temperature ranges. These crystals have high Q , little or no water of crystallization, high electromechanical coupling, and are a suitable substitute for quartz for use in electrical wave filters. DKT has higher stability than EDT under varying conditions of temperature, but is harder to grow and requires more careful handling. The properties of EDT are described, with details of the 13 elastic constants, 8 piezoelectric constants, and the 4 dielectric constants, which have been measured over a temperature range in order to locate the regions of low temperature coefficients and high electromechanical coupling. The properties of six cuts with low temperature coefficient are discussed. These cuts are being applied in the crystal channel filters of a long-distance telephone system. With a crystal 0.3 mm. thick, frequencies as high as 13 Mc. may be used in the control of oscillators. For a very high degree of frequency stability, the quartz crystals are preferable.537.228.1:546.431.823:621.315.612.4 741
Piezoelectric Effect in Polycrystalline Barium Titanate—W. L. Cherry, Jr. and R. Adler. (*Phys. Rev.*, vol. 72, pp. 981-982; November 15, 1947.) A polycrystalline BaTiO₃ ceramic will become piezoelectric if subjected to a field strength of the order of 20 kv. per centimeter for an hour. When the field is removed, the piezoelectric effect at first decreases rapidly but eventually reaches an equilibrium value about 85 per cent of its

initial value. This equilibrium value can be maintained for several months.

The piezoelectric axis lies in the direction of the applied field. An alternating field applied in the same direction produces axial vibrations while an applied field at right angles to the axis produces shear vibrations. The electromechanical coupling coefficient exceeds that of quartz by a factor of 4 or 5.

539.232:546.77 742

Thin Oxide Films on Molybdenum—E. A. Gulbransen and W. S. Wysong. (*Metals Tech.*, vol. 14, Tech. Publ. No. 2226, 17 pp.; September, 1947.) Vacuum microbalance measurements on the oxidation of Mo at temperatures of 250°C to 450°C, the reduction of surface films of oxide at temperatures of 500°C to 600°C, the volatility of oxide films, and vacuum oxidation of the metal at high temperatures.

539.232:546.78 743

Thin Oxide Films on Tungsten—E. A. Gulbransen and W. S. Wysong. (*Metals Tech.*, vol. 14, Tech. Publ. No. 2224, 17 pp.; September, 1947.) Vacuum microbalance measurements on the oxidation of tungsten and the reduction of the oxides under various conditions of temperature and pressure. Oxidation is studied at temperatures up to 550°C and reduction at temperatures of 500°C to 700°C. The vacuum behavior of the oxide film at temperatures of 600°C to 1025°C is also described.

539.233:669.15.26 744

Passivity in Chromium-Iron Alloys: Adsorbed Iron Films on Chromium—H. H. Uhlig. (*Metals Tech.*, vol. 14, Tech. Publ. No. 2243, 10 pp., September, 1947.) Iron electroplated or evaporated on to a chromium surface is found to be passive at the interface. An adsorption process similar to that occurring with alkali metals on tungsten is suggested. The amount of passive iron adsorbed by an etched chromium surface indicates an adsorbed layer about one atom thick.

539.87 745

Stratosphere Chamber—(*Engineer* (London), vol. 184, pp. 296-298; September 26, 1947.) A full description, with detail drawings and dimensions, of the Vickers-Armstrongs chamber for reproducing atmospheric conditions at any altitude up to 70,000 feet, for testing aircraft components.

The temperature range is +70°C to -55°C and later will be extended to -70°C, the minimum pressure is 0.05 atmosphere and the rate of evacuation is equivalent to a rate of climb of 1000 feet per minute which can be increased to 3000 feet per minute.

546.287:621.315.62:621.315.612.6 746

Silicone Coatings for Glass Insulators—A. E. Williams. (*Elec. Times*, vol. 112, pp. 507-508; October 30, 1947.) Liquid dimethylsilicones have recently been developed to produce water-repellent surfaces on glass insulator bodies. Their use has been investigated by O. K. Johansson and J. J. Torok, of Corning Glass Works, United States. They are water-white, inert, nontoxic, noncorrosive and oxidation resistant. Their electrical volume resistivities are at least 10¹⁴ ohms-centimeter and power factors less than 0.0002 at frequencies up to 8 Mc. The surface of the article to be treated should be thoroughly cleaned before dipping in a dilute solution of the liquid silicone in an inert solvent. The article is then drained, allowed to dry, and baked.

546.97 747

Rhodium—Engineering Properties and Uses—L. B. Hunt (*Metal Ind.* (London), vol. 71, pp. 339-342; October 24, 1947.) Rhodium is a typical metal of the platinum group; it has a high melting point, great stability and out-

standing resistance to corrosion. It is mainly used as a finishing material in electrodeposited form, when its resistance to mechanical wear is excellent. Rhodium can maintain a low and stable contact resistance, because surface films are not formed. Therefore, it is particularly suitable for low-voltage electrical contacts.

620.178.1 748

A Non-Destructive Magnetic Hardness Tester—W. H. Meiklejohn. (*Electronic Ind.*, vol. 1, pp. 14-15, 45; October, 1947.) Describes an instrument suitable for accurate testing of the hardness of small homogeneous steel pivots. The instrument depends on the linear relationship between the magnetic and hardness properties of the steel.

620.197.1:621.396.69 749

The Hermetic Sealing of Transformers and Chokes used in Communication Equipment—C. F. Bays and D. Slater. (*Jour. I.E.E.* (London), part III, vol. 94, pp. 347-357; September, 1947.) Existing methods of protection have not been found completely satisfactory for tropical use and hermetic sealing is necessary. The design and suitability of plastic containers and of containers for bitumen-filling and air-filling are considered in detail. The properties of possible filling media are discussed and the methods of filling described. X-ray photographs of bitumen-filled transformers indicate the extent of filling under pressure. Measurements of insulation resistance and temperature rise of loaded transformers of various types and under various conditions are given. Air-filling is recommended for small transformers with working voltages less than 5 kv.

621.3.015.5.029.63/.64:546.217 750

Experiments on the Electric Strength of Air at Centimetre Wavelengths—R. Cooper. (*Jour. I.E.E.* (London), part III, vol. 94, pp. 315-324; September, 1947.) The spark gaps used for the experiments took the form of constrictions in coaxial-line or waveguide transmission systems for wavelengths of 10.7 centimeters or 3.06 centimeters respectively. The electric stress was applied in the form of recurrent impulses. The power transmitted was measured by means of a water calorimeter and the electric stress at the gap was found by calculation. Details of the apparatus and the experimental techniques are given. Measurements were made with both irradiated and un-irradiated gaps of different lengths and the results compared with the continuous direct breakdown stress at atmospheric pressure. Measurements at pressures less than atmospheric were also made.

621.315.61 751

Insulation of Electrical Machines—P. N. Vickerman. (*Trans. S. Afr. Inst. Elec. Eng.*, vol. 38, part 8, pp. 205-224; August, 1947. Discussion, pp. 224-229.) Detailed discussion of some natural and certain of the newer synthetic insulating materials, with particular reference to the windings of rotary machines. The importance of complete impregnation and selection of a suitable varnish is stressed and the use of silicone resins and greases recommended for increased operating temperatures.

621.315.612:621.315.59 752

Semiconducting Ceramic Materials—H. H. Hausner. (*Jour. Amer. Ceram. Soc.*, vol. 30, pp. 290-296; September 1, 1947.) The principles of electrical conductivity are reviewed briefly. The conductivity of compositions consisting mainly of oxides such as TiO₂, Fe₂O₃, Fe₃O₄, and ZrO₂ is investigated and correlated with theory.

621.318.23 753

Magnet Design for Large Air-Gaps—E. C. S. Megaw. (*Jour. I.E.E.* (London), part IIIA, vol. 93, no. 5, pp. 939-948; 1947.) By electric circuit analogy, supplemented by experimental

data, design formulas are developed for magnets of uniform and tapered cross section for given field strengths in the air gaps and given gap dimensions. The relationship between gap dimensions and the degree of nonuniformity in the gap field is also discussed with reference to magnetron magnets.

621.318.323.2:669.15 754

High-Frequency Excitation of Iron Cores—J. D. Cobine, J. R. Curry, C. J. Gallagher, and S. Ruthberg. (PROC. I.R.E., vol. 35, pp. 1060-1067; October, 1947.) Techniques for studying the core loss and exciting impedance of iron alloys intended for use in wide-band transformers are described. H.f. sine-wave and wide-band random-noise excitation were used. The frequency range was 0.1 to 5 Mc. The alloys investigated included hipersil, monimax, molybdenum permalloy, and B9W4A.

669.71/.721+679.5:621.392.029.64 755

Aluminum Waveguides for Lightweight Communications Equipment—R. Sherman. (Communications, vol. 27, pp. 28-35; October, 1947.) Methods of bending, machining, brazing, and copper-plating aluminium to make waveguides are discussed. For plating, a stainless-steel rod anode is used to improve the inner surface. Magnesium and certain plastics are also considered briefly as possible waveguide materials.

679.5:621.397.5:535.316/.317 756

British [plastic] Lenses Combine Molding, Casting—D. Starkie. (Mod. Plast., vol. 25, pp. 107-109; October, 1947.) A general survey of the uses and methods of manufacture of plastic mirrors and lenses. See also *Nature*, (London), vol. 160, p. 99; July 19, 1947.

MATHEMATICS

518.5 757

The Present State and Trends of Development of Calculating Technique—N. E. Kobrin-ski and L. A. Lyusternik. (*Vestnik Akad. Nauk.*, nos. 8/9, pp. 97-116; 1946. In Russian.) A general discussion, covering analogue and digital machines. Sources of error are considered. A theorem due to S. A. Gershgorin states that a rod mechanism can be built representing any algebraic integral function of a complex variable. By combining a number of simple mechanisms almost any mathematical relationship can be realized. The operation of a machine developed by L. I. Gutenmacher for integrating differential equations in terms of partial derivatives of Laplace's equation is explained.

Devices dealing with discrete values are considered with special reference to those using punched cards.

518.5:621.314.3† 758

Special Magnetic Amplifiers and Their Use in Computing Circuits—Sack, Beyer, Miller, and Trischka. (See 664.)

518.5:621.392.5 759

Design of Mercury Delay Lines—Sharpless. (See 673.)

518.61:621.314.2.015.33 760

A Method of Virtual Displacements for Electrical Systems with Applications to Pulse Transformers—Crout. (See 661.)

MEASUREMENTS AND TEST GEAR

529.78 761

Synchronous Clock Control—(Electrician, vol. 139, p. 1077; October 10, 1947.) A 50-c.p.s. output of 15 watts or 30 watts, sufficient to drive 10 or 20 clocks, is derived by frequency division and subsequent amplification from a 100-kc. quartz crystal with an absolute accuracy better than 1 in 10⁶. Arrangements are provided for comparison with a mechanical

standard clock and for correction of the driven clocks.

531.761:621.317.39 762

The Measurement of Ultra-Short Time Intervals—S. H. Neddermeyer, E. J. Althaus, W. Allison, and E. R. Schatz. (*Rev. Sci. Instr.*, vol. 18, pp. 488-496; July, 1947.) Brief description noted in 3662 of 1946 (Neddermeyer). The superposition locus of transient pulses traveling in opposite directions along a transmission line is used to determine the interval between the times of generation of the pulses.

531.761:621.317.39 763

Recorder and Timer for Short Intervals—W. H. Bfliss. (*Electronics*, vol. 20, pp. 126-127; November, 1947.) For intervals up to 16 microseconds. Accuracy is within 0.25 microseconds. Intervals to be measured may occur at random and be widely separated.

531.761:621.317.755 764

Spiral Sweep Oscilloscope Timer—R. B. Moran, Jr. (*Electronics*, vol. 20, pp. 120-123; October, 1947.) Circuit details are given for an oscilloscope whose spiral trace revolves with uniform angular velocity 180° per microsecond; the display is photographed. Intervals from 25 to 100 microseconds between two pulses can be measured within 0.05 microsecond by determining the angular distance between the corresponding traces on the photograph.

621.317.374.029.62/.63:621.396.611.4 765

Improved Re-entrant Cavity—S. I. Reynolds. (*Gen. Elec. Rev.*, vol. 50, pp. 34-39; September, 1947.) A high-Q cavity has a capacitor, adjustable by micrometer, across an inductance in series with the main air gap. The cavity is used for dielectric loss measurements at 400 to 600 Mc. An oscillator is coupled through a low-pass filter and an attenuator, and Q measurements are made before and after the specimen is inserted. An accuracy of ±1 per cent is claimed. Observations on fused quartz are tabulated.

621.317.725:518.3 766

Voltmeter Loading—R. E. Lafferty. (*Electronics*, vol. 20, pp. 132-133; November, 1947.) An abac giving true voltage in a high-impedance circuit when measurements are made with two different voltage ranges of an ordinary low-sensitivity voltmeter.

621.317.725:621.385.2 767

The Diode as an A.C. Voltmeter—C. S. Bull. (*Jour. Sci. Instr.*, vol. 24, pp. 254-256; October, 1947.) Existing methods are subject to error when measuring very low or very high voltages. The proposed method demands less stability in the tube and supply voltages. Using a calibrated d.c. voltmeter and a microammeter, the calibration curve can be expressed in the form $y + I_0(BV_0)$ where B is determined experimentally and V_0 is the peak a.c. voltage. For a typical diode this curve is suitable for voltages from a few millivolts to 0.4 volt. The range may be extended by a method similar to the slide-back method but having a precisely calculable calibration capable of experimental verification. The power absorbed from the source can be calculated.

621.317.727.027.213 768

Self-Balancing Potentiometer—T. A. Rich and G. F. Gardner. (*Gen. Elec. Rev.*, vol. 50, pp. 29-32; September, 1947.) A sensitive galvanometer provided with a mirror reflects light into two photo cells which are connected to amplifiers whose opposed outputs are fed into a standard resistor. Deflection of the galvanometer causes unequal beams to fall on the photo cells and, therefore, a current flows through the resistor. For inputs up to 24 mv., the maximum in-balance current is 10⁻⁸ ampere. Suggested applications include measure-

ment of temperature differences, flux measurements, use as a d.c. amplifier, and measurement of d.c. supply regulation voltage.

621.317.75 769

Wide-Range Double-Heterodyne Spectrum Analyzers—L. Apker, J. Kahnke, E. Taft, and R. Watters. (PROC. I.R.E., vol. 35, pp. 1068-1073; October, 1947.) The instrument, which covers the range 10 to 3000 Mc. is described and its performance discussed. The signal frequency is converted to 24,600 Mc. by a crystal mixer and special beating oscillator with a modulation frequency of about 1 Mc. A band-pass filter, made up of tuned cavities and a $\lambda/4$ guide, rejects undesirable frequencies and passes the output to a second crystal where the frequency is converted to 115 Mc., using a beating oscillator with automatic frequency control. The signal is then amplified and applied to a c.r. display unit.

Two other analyzers using production oscillators and covering smaller ranges are also mentioned.

621.317.755 770

Oscillograph Recording Systems: Part 1—Single Frequency Timing—(*Electronic Ind.*, vol. 1, pp. 6-7; October, 1947.) Various deflecting circuits are discussed and the patterns given by them are illustrated.

621.317.755:621.317.73 771

An Oscillographic Method of Presenting Impedances on the Reflection-Coefficient Plane—A. L. Samuel. (Proc. I.R.E., vol. 35, pp. 1279-1283; November, 1947.)

621.317.755:621.385.1.012. 772

Producing Tube Curves on an Oscilloscope—H. E. Webking. (*Electronics*, vol. 20, pp. 128-131; November, 1947.) A general description, with block and simple circuit diagrams, of equipment in which all types of tubes may be tested. Characteristic curves can be obtained under most combinations of operating conditions by means of calibrated controls. The effect of cathode and screen degeneration may also be observed. A family of curves is produced simultaneously by using a stepping circuit to vary the grid voltage.

621.317.79:621.395.625.2 773

F.M. Calibrator for Disc Recording Heads—R. A. Schlegel. (*Audio Eng.*, vol. 31, pp. 18-20 and 20-23; May and June, 1947.) A device for making various measurements of the behavior of a recording head during actual recording, including changes in frequency response, distortion, linearity, etc.

621.317.79:621.395.625.2 774

Applications of the F.M. Calibrator—R. A. Schlegel. (*Audio Eng.*, vol. 31, pp. 28-30; July, 1947.) See also 773 above.

621.317.79:621.396.615:621.397.62 775

Television Signal Generator—J. Fisher. (*FM and Telev.*, vol. 7, pp. 24-28; October, 1947.) A 6-channel crystal-controlled generator with video and frequency modulation, for testing over-all television receiver performance. A standard R.M.A. television signal is produced, and all standards such as negative modulation, transmission of the d.c. component, percentage of the r.f. signal devoted to synchronizing pulses, depth and linearity of modulation, and crystal control of carrier frequency are maintained. Block and circuit diagrams of the various units are given, together with component ratings, constructional and calibration details.

621.317.79:621.396.615.14 776

Wide-Range Ultra-High-Frequency Signal Generators—A. V. Haeff, T. E. Hanley, and C. B. Smith. (PROC. I.R.E., vol. 35, pp. 1137-1143; October, 1947.) The war-time development by the United States Naval Research

Laboratory of signal generators covering the frequency range 90 to 9700 Mc. is surveyed, with brief descriptions of the design, performance, and limitations of the various models. These are capable of giving c.w. or pulse outputs which have a range in output level of more than 100 db below 0.1 volt across a 50-ohm output impedance, with an absolute accuracy of approximately 1 db. The output attenuators are of the mutual inductance, cylindrical waveguide type; they are discussed in some detail. For several of the generators, external a.m. or internal f.m. can be provided.

621.317.79:621.396.641.001.4 777

Testing Repeaters with Circulated Pulses—A. C. Beck and D. H. Ring. (Proc. I.R.E., vol. 35, pp. 1226–1230; November, 1947.) An extension of square-wave and pulse-testing techniques is described which permits the signal pulse to be observed after circulating many times through the transmission system under test. This method is particularly useful for measuring the cumulative effect of a number of similar units, such as those used in carrier or microwave radio repeater systems, when only one unit is available. Applications to video-frequency, i.f., and r.f. testing with a.m. or f.m. signals are discussed.

621.317.79:621.396.812 778

Recording Sky-Wave Signals from Broadcast Stations—W. B. Smith. (Electronics, vol. 20, pp. 112–116; November, 1947.) A Canadian system in which signal strength is recorded on a strip chart for several hours. A photoelectric scanner determines the fraction of the time for which the signal exceeds any selected value. Analysis of the charts takes about 10 minutes for a 2-hour recording period, compared with several hours when using manual methods. Summary in Proc. I.R.E., vol. 35, p. 1053; October, 1947.

621.317.79:621.396.96 779

Quantitative Radar Measurements—M. Katzin. (Proc. I.R.E., vol. 35, pp. 1333–1334; November, 1947.) Substitution methods used at the United States Naval Research Laboratory for measuring echo power, aerial gain, etc., are described. Standard test sets, combining the functions of power meters and signal generators, are used and only power ratios are measured, so that accuracy depends essentially on the calibration of the test-set attenuator.

621.317.79:621.397.62.001.4 780

Television Receiver Production Test Equipment—J. A. Bauer. (Communications, vol. 27, pp. 8–11, 35, and 18, 47; September and October, 1947.) A description of equipment set up at Camden, N. J., to test up to 500 receivers a day. Units described include a composite video generator unit with synchronizing generator, monoscope camera, master monitor, grating generator, and distributing amplifiers.

621.396.61/.62/.001.4:621.396.96 781

A Technique for the Production Testing of Radar Responders—H. Wood. (Jour. I.E.E. (London), part IIIA, vol. 93, no. 6, pp. 1113–1114; 1946.) Describes the development of laboratory and production test equipment and methods, discusses signal-generator and c.r.o.-display requirements and gives a method for testing the suppression system necessarily associated with the responder when this is operated in close proximity to transmitters.

OTHER APPLICATIONS OF RADIO AND ELECTRONICS

531.767:629.135:621.396.9 782

Radio Doppler Effect for Aircraft Speed Measurements—L. R. Malling. (Proc. I.R.E., vol. 35, pp. 1357–1360; November, 1947.) Technical details of system using signals

transmitted from the ground, received in the aircraft and retransmitted to the ground for measurement of the Doppler effect.

539.16.08. 783

Carbon Dioxide Filled Geiger-Müller Counters—S. C. Brown and W. W. Miller. (Rev. Sci. Instr., vol. 18, pp. 496–500; July, 1947.) Description of a CO₂-CS₂ counter which has satisfactory properties for routine studies of C¹⁴.

621.316.718.5.076.7 784

Electronic Motor Control—(Beams Jour., vol. 54, p. 360; October, 1947.) A short general description of the Philips system, which provides a flexible variable-speed drive with fingertip controls.

621.317.733:621.316.7 785

Bridge Unbalance Used as a Process Control Factor. (See 668.)

621.317.755:[531.714+531.781] 786

Cathode-Ray Recording Micrometer and Force Gauge—J. Ewles and C. Curry. (Jour. Sci. Instr., vol. 24, pp. 261–265; October, 1947.) The movement of a coil attached to the object under test produces a voltage which may be examined by means of a c.r.o. Rapidly varying movements of the order of 3 mm. may be measured to an accuracy of 0.0025 mm.

621.317.755:531.787:614.83 787

Measuring Pressures of Industrial Explosions—N. J. Thompson and E. W. Cousins. (Electronics, vol. 20, pp. 90–93; November, 1947.) A capacitance-type pickup feeds a c.r.o. through a 10-kc. bridge and gives pressure/time diagrams; it is calibrated on static pressures. An automatic tripper circuit responds to explosions.

621.317.39:531.714.7 788

Technical Data on Electronic Micrometer—(Electronics, vol. 20, pp. 172, 180; November, 1947.) Designed to measure insulation thickness. The instrument has two ranges, 0–0.005 inch and 0–0.05 inch. Accuracy about 1 per cent. Detailed circuit diagram given.

621.38:621.316.718:655.324.5 789

Electronic Computer for Printing Control—J. W. Ludwig. (Electronics, vol. 20, pp. 108–111; November, 1947.) An electronic-hydraulic system which controls the position of a running register to within 0.001 inch.

621.38.001.8:623.95 790

Developments on Magnetic and Acoustic Mines at the Admiralty Mining Establishment—A. J. Baggott and C. H. Fawcett. (Jour. I.E.E. (London), part I, vol. 94, pp. 509–526; November, 1947.) An outline of basic principles and historical development. Methods of detecting ships and countering the effects of explosions and sweeps are described, the development of mine circuits from the single-contact circuit to the combined dual detection circuits is traced and details are given of mines and components. The use of magnetic detection as a trigger device for heavy battery-current electronic circuits is also described and British and German mining are compared briefly.

621.383+621.385.381:621.316.74 791

Continuous Control Thermoregulator—P. Wright. (Jour. Sci. Instr., vol. 24, pp. 258–261; October, 1947.) A photo cell-thyratron type controlling an electric furnace by means of a saturated choke in series with the furnace windings. Temperature fluctuations due to variations in supply voltage were reduced by a factor of 1/100.

621.384 792

The Radiation Transformer—R. Wideröe. (Schweiz. Arch. Angew. Wiss. Tech., vol. 13, pp. 225–232 and 299–311; August and October,

1947.) An account of the historical development of devices such as the cyclotron and their mode of operation, with derivation of the fundamental equations and description of new types of construction. Magnetic lens stabilization is discussed and a description given of a 15-Mev. radiation transformer.

621.384.6 793

Theory of the Synchro-Cyclotron—D. Bohm and L. L. Foldy. (Phys. Rev., vol. 72, pp. 649–661; October 15, 1947.) In the synchro-cyclotron, f.m. of the alternating dee potential compensates for the reduction of angular velocity as the electrons approach the speed of light, but at the expense of reduced efficiency of electron capture. The maximum obtainable capture efficiency is proportional to the square root of either the dee voltage or the rate of f.m., and is the order of 0.1 to 2 per cent for present designs.

621.384.6 794

The "Gigator" [1 Gigavolt = 10⁹ V]—A Proposed New Circular Accelerator for Heavy Particles—R. Wideröe. (Phys. Rev., vol. 72, p. 978; November 15, 1947.) A device in which two separate accelerating systems operate alternately on the ions. In each system, the frequency of the accelerating voltage may be chosen to be an integral multiple of the circulation frequency of the ions. As the velocity of the ions increases, the frequency of the accelerating field is changed by discontinuous steps to a lower multiple of the circulation frequency. The various possible accelerating frequencies in one system fall between successive pairs of such frequencies in the other. It is thus possible to bring the ions from one synchronous condition to another without excessive loss of ions from the beam.

621.384.6 795

Internal Cyclotron Targets—A. F. Reid. (Rev. Sci. Instr., vol. 18, pp. 501–503; July, 1947.) The preparation and design of targets to be used within the dee enclosure for the production of radio active elements are discussed.

621.385.15 796

The Behavior of "Magnetic" Electron Multipliers as a Function of Frequency—L. Malter. (Proc. I.R.E., vol. 35, pp. 1074–1076; October, 1947.) A theoretical and experimental study of the frequency variation of gain. The variation is shown to be similar to that obtained with electrostatic multipliers (1063 of 1941) when expressed as a function of over-all electron transit angle. For frequencies up to 500 Mc., loss in gain can be ascribed to the spread in transit angle.

621.395.645.33:578.088.7 797

Electro-Encephalograph Amplifier—Johnston. (See 680.)

623.978+550.838]:538.71 798

A Magnetic Airborne Detector Employing Magnetically Controlled Gyroscopic Stabilization—V. Vacquier, R. F. Simons, and A. W. Hull. (Rev. Sci. Instr., vol. 18, pp. 483–487; July, 1947.) An experimental type of airborne magnetometer is described using three mutually perpendicular saturable-core magnetometers. Signals from two of these magnetometers are used to process an air-driven gyroscope so as to align its spin axis with the earth's total magnetic field, thus providing stabilization for the third magnetometer which can then measure anomalies of a few gammas along the line of flight. With this method of stabilization, the magnetometer can be used in vehicles subjected to the most violent angular accelerations. It can also be made smaller than nongyroscopically stabilized airborne magnetometers. See also 220 of February (Felch et al.).

621.38/.39 799

Electronics [Book Review]—B. Lovell (Ed.). Pilot Press, London, 660 pp., 42s.

(*Wireless Eng.*, vol. 24, pp. 306-307; October, 1947.) Contains 14 chapters by 13 different authors on different subjects having in common only their dependence on electronics. Subjects covered include electron physics, photo cells, television, tubes, radar, h.f. heating, servomechanisms, electronics in medicine, the betatron, and electron microscopy. Each chapter has a bibliography and there is a good subject index.

PROPAGATION OF WAVES

621.396.11 800

The Calculation of Field Strengths over a Spherical Earth—C. Domb and M. H. L. Pryce. (*Jour. I.E.E.* (London, part III, vol. 94, pp. 325-336; September, 1947. Discussion, pp. 337-339.) Curves and formulas are given for the calculation of the field strength at any height and distance from the transmitter for the case of horizontally polarized waves over a curved earth or sea. Well within the optical range, the field is calculated by ray theory (perfect ground conductivity assumed). At exact optical cutoff, the field is calculated from the diffraction formula by an approximate method and for points well beyond optical range, the field is given by the first term of the diffraction formula. The field-strength/distance curve is then completed smoothly through the optical cutoff point. The case of vertically polarized waves is also discussed briefly and curves and formulas given for the regions well within and well beyond optical cutoff. See also 2892 of 1947 (Booker and Walkinshaw).

621.396.11:551.510.52 801

Propagation of Radio Waves in the Lower Troposphere—J. B. Smyth and L. G. Trolese. (*Proc. I.R.E.*, vol. 35, pp. 1198-1202; November, 1947.) The reflection coefficient of the transition layer between an underlying mass of cold air and an overlying mass of warm air is calculated from formulas given by Epstein (1931 Abstracts, *Wireless Eng.*, p. 31) and Eckart (*Phys. Rev.*, vol. 35, pp. 1303-1309; June, 1930.) Reflections from this layer explain some propagation characteristics of a 90-mile nonoptical link at San Diego, for various frequencies between 50 and 600 Mc.

621.396.11.029.6 802

Radio Propagation at Frequencies Above 30 Megacycles—K. Bullington. (*Proc. I.R.E.*, vol. 35, pp. 1122-1136; October, 1947.) The theory of propagation over a smooth spherical earth is presented in a simplified form made possible by restricting the frequency range. The effects of frequency, distance, aerial heights, curvature of the earth, atmospheric conditions, and the presence of hills and buildings are discussed, most of the quantitative data being presented in a series of abacs. By means of these, an estimate of received power and field intensity for a given point-to-point transmission can be obtained quickly. The empirical methods used in estimating the effects of hill and atmospheric refraction are compared with experimental data on shadow losses and fading ranges.

621.396.11.029.62.63 803

Ultra-Short-Wave Propagation Studies beyond the Horizon—A. H. Waynick. (*Proc. I.R.E.*, vol. 35, p. 1334; November, 1947.) Certain results previously reported (671 of 1941) have been re-examined. They appear to confirm conclusions of Wickizer and Braaten (3628 of January) and to indicate that, for the experimental conditions involved, the portion of the atmosphere effective in returning signals toward the earth is that below about 1.5 km.

621.396.812.029.64:551.510.52 804

Radar Reflections from the Lower Atmosphere—W. B. Gould. (*Proc. I.R.E.*, vol. 35, p. 1105; October, 1947.) Comment on 2769 of 1947 (Friis).

621.396.812.3:551.510.535:550.385 805
Polar Radio Disturbances During Magnetic Bays—Wells. (See 729.)

RECEPTION

621.396.61/.62 806

A Lightweight Mobile Transmitter-Receiver—(See 848.)

621.396.619.16:621.396.96 807

Time Demodulation—B. Chance. (*Proc. I.R.E.*, vol. 35, pp. 1045-1049; October, 1947.) Description of methods for precision demodulation which depend upon a time modulator synchronized with the input information, a time discriminator, and negative feedback connections to control the local time modulator, in order to reproduce the modulating signal in an electrical or mechanical form. Accuracy is usually determined by the bandwidth of the receiver, and may be 5 parts in 10^4 or better.

621.396.621:621.396.96:621.396.66 808

Some Automatic Control Circuits for Radar Receivers—L. A. Moxon, J. Croney, W. G. Johnston, and C. A. Laws. (*Jour. I.E.E.* (London), Part IIIA, vol. 93, pp. 1143-1158; 1946.) Application of automatic frequency control and automatic gain control to radar receivers. The importance of automatic frequency control depends chiefly on the ratio of bandwidth to operating frequency. Automatic frequency control appears generally to be a desirable refinement at $\lambda 10$ centimeters and becomes essential with further increase in frequency. A discriminator circuit derives a d.c. voltage from the wanted signal, positive or negative according to the tuning error. The discriminator output is applied after amplification to either a mechanical or an electronic frequency-changing device. The limitation of clutter is one of the main functions of automatic gain control. "Swept gain," quick acting automatic gain control and differentiation are among the devices used. Gain equalization on two receiving channels may be achieved by feeding a locally generated r.f. signal through equal paths into the two channels during idle periods. This signal can be used to operate automatic gain control systems on each receiving channel.

621.396.621:621.396.96.029.62 809

The Development of C.H.-Type Receivers for Fixed and Mobile Working—J. W. Kenkins. (*Jour. I.E.E.* (London), Part IIIA, vol. 93, no. 6, pp. 1123-1129; 1946.) The development of the chain or C.H. type of radar receiver between the years 1937 and 1942, including (a) mechanical construction: accuracies of 0.2 to 0.4° were achieved with mass-produced goniometers; (b) r.f. circuits: anti-paralysis features assured constant gain; (c) pulse circuits: mobile receivers derived all pulses from the power-supply waveform; (d) auxiliary functions, including identification and anti-jamming devices.

621.396.621.029.62 810

A Compact and Inexpensive Superhet for 144 Mcs.—B. C. Barbee. (*QST*, vol. 31, pp. 33-36; October, 1947.)

621.396.621.54:621.396.82 811

Exit Heterodyne QR—J. L. A. McLaughlin. (*QST*, vol. 31, pp. 13-16; October, 1947.) An improved method of receiving signals through heterodyne beat-note interference, by use of a triple-detector superheterodyne circuit. Either of two crystal-controlled oscillators at 405 kc. and 505 kc. convert the first i.f. of 455 kc. to a second i.f. of 50 kc. The 50-kc. i.f. system acts as a high-pass filter, so that by using one or other of the oscillators either sideband can be rejected, and with it the undesired signal.

621.396.82:551.57:629.135 812

621.319.74:551.57:629.135
Electrostatic Ills—J. H. Willox; R. Beach.

(*Flec. Eng.*, vol. 66, pp. 1044-1046; October, 1947.) Criticism of 2916 of 1947 and the author's reply.

621.396.82:621.396.619.13 813

Investigation of Frequency-Modulation Signal Interference—I. Plusc. (*Proc. I.R.E.*, vol. 35, pp. 1054-1059; October, 1947.) The causes of interference between two f.m. signals are analyzed. Co-channel interference is practically independent of receiver design. Off-channel interference depends on the shape of the discriminator curve more than 120 kc. off resonance. The amount of interference for a given receiver is calculated in terms of the relative strength of the interfering signal. Circuit modifications to reduce interference are suggested.

621.396.822:621.396.621:534.78 814

The Influence of Amplitude Limiting and Frequency Selectivity upon the Performance of Radio Receivers in Noise—W. J. Cunningham, S. J. Goffard and J. C. R. Licklider. (*Proc. I.R.E.*, vol. 35, pp. 1021-1025) October, 1947.) An experimental study of the relations between the effectiveness of voice communication as measured in terms of intelligibility of received speech, and the amplitude- and frequency-selective characteristics of a.m. receivers. Amplitude limiters, although ineffective against fluctuation noise, provide marked improvement in performance against impulse noise when the receivers have appropriate selectivity. With no limiter, narrow-band circuits have a slight advantage over wide-band circuits. When a limiter is used, narrow-band circuits have a slight advantage for fluctuation noise. For optimum reception in the presence of impulsive noise, the frequency selective circuits which precede the limiter should have broad-band characteristics to preserve the waveform of the pulse.

621.396.822:621.396.65:621.396.41 815

Fluctuation Noise in Pulse-Height Multiplex Radio Links—L. L. Rauch. (*Proc. I.R.E.*, vol. 35, pp. 1192-1197; November, 1947.) "Expressions are obtained for the channel fluctuation noise of pulse-height multiplex systems used over f.m. and a.m. radio links. A comparison shows the f.m. channel fluctuation-noise improvement to be 4.15 times the deviation ratio, in contrast to the familiar $\sqrt{3}$ times the deviation ratio for single-channel radio links."

621.396.822:621.396.96 816

The Noise Characteristics of Radar Receivers—L. A. Moxon. (*Jour. I.E.E.* (London), Part IIIA, vol. 93, no. 6, pp. 1130-1142; 1946.) Of the quantities which determine the performance of radar receivers, noise factor in amplifiers and mixers has received most attention. Equivalent circuits, particularly as developed by Herold and Malters (3357 of 1943 and 797 of 1944) are of value in the theoretical treatment of noise in amplifiers, and give results in close agreement with experiment. Results indicate that bandwidth and noise are independent for bandwidths up to about 4 Mc. The VR136 pentode in which screen current is reduced by alignment of the grids, the grounded-grid triode and the neutralized triode circuit are among important amplifier developments of the last few years. The two best methods of obtaining low noise factor use either a low i.f. or a neutralized triode. In the region of 90 to 600 Mc., the grounded-grid triode is at present the best method of r.f. amplification. Among mixer problems, local oscillator noise at low i.f. can best be combated by the balanced-mixer system recently developed in America.

To realize the best performance of crystal mixers, an over-all performance measurement or its equivalent should be included in the factory selection of crystal tubes. Methods which use only i.f. or high level measurements and

neglect noise may pass crystals as identical which actually have a spread of several db. An average improvement of 2 db should be realized with proper test methods.

STATIONS AND COMMUNICATING SYSTEMS

621.395./396 817
Radio versus Line for Communication Systems—(*Jour. I.E.E.* (London), Part III, vol. 94, pp. 357–358; September, 1947.) I.E.E. discussion, opened by A. H. Mumford, on the particular features and relative merits of the two systems.

621.395.43:621.396.619.16 818
Pulse Code Modulation—(*Audio Eng.*, vol. 31, pp. 31, 43; October, 1947.) For other accounts of pulse-code modulation systems see 258 of February (Batcher) and 545 of March (Goodall).

621.395.44:621.315.052.63 819
Power-Line Carrier Communications—R. C. Cheek. (*Communications*, vol. 27, pp. 20–21, 46; August, 1947.) An analysis of systems operating in the 50 to 150 kc. band.

621.396.65:621.396.97 820
F.M. Chain Broadcasting—A. A. McK. (*Electronics*, vol. 20, pp. 94–98; November, 1947.) A general account of methods used since 1939 to relay high-fidelity programs from station to station in North America, including one technique eliminating conversion to a.f.

621.396.65.029.64:621.316.726.029.64 821
Simplified Microwave A.F.C.: Part 1—Jenks. (See 847.)

621.396.712 822
Planning an F.M. Broadcast Station—R. S. Lanier. (*FM and Telev.*, vol. 7, pp. 35–38 and 28–30; October and November, 1947.) A review of the facilities required and of modern methods of design, based on the replies of broadcast engineers and consultants to a detailed questionnaire.

621.396.712:69 823
F.M. and A.M. Broadcast Transmitter Buildings—(*Communications*, vol. 27, pp. 20–21, 38; October, 1947.) "Factors to be considered in laying out the building and choosing a building site."

621.396.712(73) 824
F.M. Broadcasting Stations in the U.S.—(*FM and Telev.*, vol. 7, pp. 39, 54; October, 1947.)

621.396.712.3 825
Planning a [broadcasting] Studio Installation: Parts 2 and 3—J. D. Colvin. (*Audio Eng.*, vol. 31, pp. 30–31, 41 and 25–28; August and September, 1947.) Part 2: the arrangement of the console panel and the associated cables and conduits. Part 3: suggestions concerning (a) equipment to be purchased before construction begins, and (b) the preparation of wiring diagrams. Part 1: 4034 of January. To be continued.

621.396.931 826
Two-Way Taxicab Radio Fleet Installation—R. W. Malcolm. (*Communications*, vol. 27, pp. 12–13, 43; October, 1947.) A system supplementing the company's elaborate telephone network and enabling taxicabs to report their destination and to receive instructions en route. See also 272 of February.

621.396.931.029.62 827
Power Company F.M. System—E. W. Brown. (*Communications*, vol. 27, pp. 14–16; October, 1947.) For maintaining two-way communications between breakdown service crews and a central office, which has a 60-watt 31.46-Mc. transmitter whose aerial is 212 feet

above ground, giving a service range of 25 miles. The mobile units are rated at 30 watts.

621.396.933 828
V.H.F. Airborne Communications System—S. A. Meacham. (*Communications*, vol. 27, pp. 22, 36 and 18–19; October and December, 1947.) Description of 2-way equipment operating at 118 to 132 Mc., with a transmitter output of 50 watts. Based on wartime equipment, the system is of unit construction. Any of 70 channels, each of which is crystal controlled in both transmitter and receiver, can be selected by a motor-driven switch. Circuit diagrams of transmitter and receiver are given.

SUBSIDIARY APPARATUS

621-526 829
I.E.E. Convention on Automatic Regulators and Servo Mechanisms—(*Jour. I.E.E.* (London), part I, vol. 94, pp. 527–549; November, 1947.) Abstracts of the papers noted in 4039 of January and of the following papers: Data-Transmission Systems, by J. Bell. Automatic Control applied to Modern High-Pressure Boilers, by L. Young.

621.314.653:621.3.032.43 830
The Ignition Mechanism of Relay Tubes with Dielectric Igniter—N. Warmoltz. (*Philips Tech. Rev.*, vol. 9, no. 4, pp. 105–113; 1947.) Ignition methods for which a pool of mercury is used as cathode are surveyed, with particular reference to the capacitive method in which a positive voltage of several kilovolts is applied to a conductor separated from the mercury cathode by a thin insulating wall. The action is explained with the aid of Tonks' theory (1324 of 1936). It is suggested that the mercury surface becomes unstable and is drawn out to sharp points at which the field strength is sufficient to produce field emission, after a certain time lag.

621.316.722.1 831
A.C. Voltage Stabilizers—L. L. Heltelrine, Jr. (*Audio Eng.*, vol. 31, pp. 23–24, 43; September, 1947.) A specially made tungsten filament diode is used as one arm of a bridge network. Alteration of line voltage causes a corresponding change in anode resistance of the diode, unbalancing the bridge. The unbalance voltage is fed into the grid of a beam power tube which draws its anode current through the d.c. winding of a saturable reactor, the a.c. coils of which act as a variable reactance in the line circuit.

Characteristic curves are given showing output voltage constant to within less than 0.5 per cent for a line voltage varying from 90 to 135 volts.

621.319.51:621.316.91 832
An Enclosed Spark-Gap for Overvoltage Protection—H. de B. Knight and L. Herbert. (*Jour. I.E.E.* (London), part IIIA, vol. 93, no. 6, pp. 1058–1062; 1946.) A sealed, hydrogen-filled spark-gap with glass envelope is described which satisfies the conditions (a) that breakdown should occur, with no time lag, at a voltage slightly above the normal operating voltage, (b) that deionization should be rapid, and (c) that breakdown should be independent of previous breakdowns and also of atmospheric pressure and temperature. Breakdown voltages of 5 and 16 kv. were standardized, but experimental units for 22 kv. were made. Hydrogen pressures up to 2 atmospheres were used. A robust design with a ceramic envelope is also described.

621.319.51:621.396.96 833
The Development of Triggered Spark-Gaps for High-Power Modulators—J. D. Craggs, M. E. Haine, and J. M. Meek. (*Jour. I.E.E.* (London), part IIIA, vol. 93, no. 5, pp. 963–976; 1946.) The factors governing the design

of rotary and triggered spark-gaps capable of passing impulses of high peak power are described. The influence of different gas fillings and electrode materials for sealed spark-gaps is shown, together with the variations in performance obtained with different gas pressures.

621.396.662 834
An Electron-Ray Tuning Indicator for Frequency Modulation—F. M. Bailey. (*Proc. I.R.E.*, vol. 35, pp. 1158–1160; October, 1947.) The indicator has a translucent fluorescent target, a rectangular divided pattern and adequate sensitivity for both a.m. and f.m. detectors without additional amplifiers.

621.396.682:621.316.722.1.076.7 835
Stabilizing Direct-Voltage Supplies—W. H. P. Leslie. (*Wireless Eng.*, vol. 24, p. 309; October, 1947.) Comment on 4045 of January (Hughes). The usefulness of the calculation of the performance of voltage regulating tubes is disputed because of the large variation in regulated voltage and control obtained with different individual tubes, and with the same tubes after different periods of use.

TELEVISION AND PHOTOTELEGRAPHY

621.397.331.2 836
Video Storage by Secondary Emission from Simple Mosaics—R. A. McConnell. (*Proc. I.R.E.*, vol. 35, pp. 1258–1264; November, 1947.) A qualitative investigation of the storage properties of mosaics in iconoscope tubes.

621.397.331.2:538.691 837
The Motion of Electrons Subject to Forces Transverse to a Uniform Magnetic Field—Weimer and Rose. (See 709.)

621.397.5:535.88 838
A New French System for Large-Screen Television—P. Hémarinquer. (*Jour. Telev. Soc.*, vol. 5, pp. 28–30; March, 1947.) Translated from the French. The Toulon screen is composed of 276,480 movable vane electrodes, each 8×6 mm., made of thin Al foil. They are arranged side by side in rows and attached to a series of brass rods. The screen is illuminated by an external source and each vane has a matt surface which diffuses the rays within an angle of about 20°. When the vane is normal to the eye, the screen surface appears white, changing through grey to black as the vane is tilted. It is possible to obtain a linear relation between the angle of tilt and the light intensity. Each vane is at earth potential and is situated close to a modulating electrode, the potential of which controls the inclination of the vane and hence the light intensity. See also 1609 of 1947.

621.397.5:621.396.67 839
Biconical Television Antenna—(*Elec. Eng.*, vol. 66, p. 1011; October, 1947.) Will pick up local programs from mobile units without being aimed at the units. Two Al cones of wide vertical angle have their vertices facing each other and joined by a vertical dipole. A photograph is included.

621.397.5:621.396.67 840
WTTG TV Antennas—Hamilton and Olsen. (See 653.)

621.397.5:621.396.97 841
The Television Outside Broadcast Service—T. H. Bridgewater. (*Jour. Telev. Soc.*, vol. 5, pp. 13–21; March, 1947.) Discussion, pp. 21–22.) A general description of the equipment used and the organization and methods for relaying the signals to Alexandra Palace for transmission. The apparatus is transported in 6 vehicles containing respectively scanner, transmitter, aerial, generator, emulon transport, subsidiary apparatus. The sound link is normally by standard telephone line and the vision by either radio or special cable link. See also 3685 of 1947.

621.397.5:679.5:535.316/.317 842
British [plastic] Lenses Combine Molding, Casting—D. Starkie. (*Mod. Plast.*, vol. 25, pp. 107-109; October, 1947.) A general survey of the uses and methods of manufacture of plastic mirrors and lenses. See also *Nature* (London), vol. 160, p. 99; July 19, 1947.

621.397.5:778.5 843
The Film in Relation to Television—M. Cooper. (*Jour. Telev. Soc.*, vol. 5, pp. 3-9, 22; March, 1947.)

621.397.62:621.317.79:621.396.615 844
Television Signal Generator—Fisher. (See 775.)

621.397.62.001.4:621.317.79 845
Television Receiver Production Test Equipment—Bauer. (See 780.)

621.397.743 846
Interconnecting Facilities for Television Broadcasting—W. E. Bloecker. (*Electronics*, vol. 20, pp. 102-107; November, 1947.) Video facilities now available, or to be completed by 1950, include a 12,000-mile nation-wide system using coaxial cable, local networks employing shielded-pair telephone cables, and microwave radio circuits. Provisions are made for direct connections of broadcasters' equipment to shielded-pair systems.

TRANSMISSION

621.316.726.029.64:621.396.65.029.64 847
Simplified Microwave A.F.C.: Part 1—F. A. Jenks. (*Electronics*, vol. 20, pp. 120-125; November, 1947.) The automatic frequency control carrier is coupled to a cavity resonator with a resonant-frequency sweep of given rate. The resonator detector registers a phase-reversed, variable-magnitude voltage of the fundamental sweep frequency, this voltage being zero when resonator and carrier frequencies coincide. In the mechanical automatic frequency control system this output, after amplification, is applied directly to the control winding of a 2-phase motor, the fixed winding being energized from the frequency sweeping source. For electronic automatic frequency control, the motor is replaced by a phase detector, whose output is fed to the reflector circuit of a klystron.

A combination of these two systems with push-button and automatic scanning can be used for a 3000-Mc. radio-relay system that remains within 200 kc. of the assigned frequency. This will be described later.

621.396.61/.62 848
A Lightweight Mobile Transmitter-Receiver—(*Engineer* (London), vol. 184, p. 349; October 10, 1947.) For R/T communication between fixed and mobile units. Forced ventilation makes possible a compact design measuring 18 inches×8 inches×8 inches and weighing 35 pounds. The transmitter has a r.f. power output of 20 watts at about 100 Mc. The unit can be used as a public-address amplifier. The receiver is a double superheterodyne using miniature tubes throughout. Center frequency stability better than 0.001 per cent is claimed. The set is suitable for 6-volt or 12-volt battery input.

621.396.61:621.316.3 849
Versatile Control Systems for Transmitters—L. Kanoy. (*QST*, vol. 31, pp. 58-59; October, 1947.) Discussion of power-switching circuit arrangements to provide convenience and safety for operator and equipment.

621.396.61:621.396.712 850
Collins F.M. Broadcast Transmitters—N. H. Hale. (*F.M. and Telev.*, vol. 7, pp. 32-34; October, 1947.) The transmitter consists of a basic phasotron modulator unit with an output of 250 watts or 1 kw., and amplifiers of 3, 10,

25 and 50 kw. Great emphasis has been put upon simplicity, ruggedness and accessibility. A circuit diagram is given of the 250-watt modulator followed by the 3-kw. amplifier; the 1-kw. modulator differs only in the output tubes. Grounded-grid circuits are used in the other amplifiers, which are driven by the 3-kw. amplifier. Separate circuit breakers are provided for the various units. Motor drives are used for tuning adjustments.

621.396.61.029.62 851
The Lazy Kilowatt—L. Le Kashman. (*CQ*, vol. 2, pp. 11-15, 55; July, 1946.) An inexpensive amateur transmitter for R/T or c.w. which can be built without special workshop facilities. Low driving requirements eliminate the exciter problem. The final amplifier uses Eimac 4-250A tetrodes.

621.396.61.029.62 852
Practical Crystal Control for 144-Mc. Mobile Work—P. H. Hertzler. (*QST*, vol. 31, pp. 54-55; October, 1947.) The number of tubes, and consequently, the current drain on the power supply, is greatly reduced by crystal control of transmitters. Details are given of a transmitter, using a 48-Mc. crystal, and a 6C 4 triode oscillator with a tripler stage. Power is supplied by a conventional vibrator.

621.396.61.029.62:621.396.96 853
The C.H. [Chain-Home] Radiolocation Transmitters—J. M. Dodds & J. H. Ludlow. (*Jour. I.E.E.* (London), part IIIA, vol. 93, pp. 1007-1015; 1946.) A general description of the development work leading up to the final design of the C.H. type transmitters for the Air Ministry. The original specifications called for at least 200 kw. of r.f. pulse energy of four preselected frequencies in the 20 to 55 Mc. band, the r.f. pulses to be timed to ± 2 microseconds relative to zero phase of the 50 c.p.s. supply. The final design produced an average of 750 kw. with a stability of ± 10 c.p.s. at 20 Mc., the variations of the timing of the pulses being less than 0.025 microsecond. The original combination of master oscillator, doubler and power amplifier was abandoned in favor of a pulsed self-oscillator, to prevent radiation during quiescent periods. Thyratrons of special design were used in the modulator stages.

621.396.61.029.62:621.396.96 854
Mobile Metre-Wave Ground Radar Transmitters for Warning and Location of Aircraft—R. V. Whelpton. (*Jour. I.E.E.* (London), part IIIA, vol. 93, no. 6, pp. 1027-1042; 1946.) A record of the development of R.A.F. p.m. transmitters for the 10 to 200 Mc. band, with a detailed account of the circuits used in M.B. (Mobile Base) and C.H.L./G.C.I. (Chain Home Low and Ground-Controlled Interception) transmitters. Details are also given of early prototype transmitters and the development of suitable tubes is reviewed.

The M.B.1 transmitter produced 10- or 20-microsecond pulses, with a peak power of 25 to 40 kw., on λ 7 to 13 meters, while the M.B.2 gave 5 to 30 microsecond pulses on λ 6 to 15 meters, with a peak power of 400 kw. and a recurrence frequency of 50, 25 or 12½ pulses per second.

The C.H.L./G.C.I. transmitter operated at about 200 Mc., with pulses of 4 to 6 microsecond peak power 80 kw. and a recurrence frequency between 350 and 900 pulses per second.

621.396.61.029.63:621.396.931 855
Transmitter for the Citizens Radio Service: Part 1—W. C. Hollis. (*Electronics*, vol. 20, pp. 84-89; November, 1947.) Full constructional and design details of a portable f.m. unit with output $\frac{1}{2}$ watt at 465 Mc. The ph.m. of 28.6° produces a frequency deviation of 16 kc. at a modulation frequency of 300 c.p.s. and noise reduction is sufficient provided the maximum modulation frequency is restricted to 3000

c.p.s. The expected optical path range is 25 miles with 20 db carrier/noise ratio.

621.396.61.029.63:621.396.96 856
The Development of Decimetre-Wave Radar Transmitters for the Royal Air Force—T. S. England. (*Jour. I.E.E.* (London), part IIIA, vol. 93, no. 6, pp. 1016-1026; 1946.) A review of decimetre-wave transmitter developments at the establishment now known as the Telecommunications Research Establishment, during the period 1940 to 1945. The discussion is limited to wavelengths in the region of 50 centimeters. Urgent operational requirements dictated the whole progress of the work, which was first concentrated on the development of suitable tubes, the NT99 being the outcome. A pair of these tubes gave an output of about 100 kw. Various transmitter and modulator circuits are given, including those used in A.M.E.S. Type 11 [mobile ground radar] and Type 16 fixed fighter direction stations]. Details are given of suitable common-aerial switches using the V1507 argon spark gap. The development of the CV288, a grounded-grid triode capable of 50 kw. with a grid drive of 12 kw., made possible the use of power amplifier technique in the 50-centimeter band.

621.396.61.029.64:621.316.726 857
Frequency Instability of Pulsed Transmitters with Long Wave Guides—B. W. Lythall. (*Jour. I.E.E.* (London), part IIIA, vol. 93, no. 6, pp. 1081-1089; 1946.) The frequency of oscillation, frequency instability and its elimination are considered for a pulsed magnetron, loaded with a long mismatched feeder. The frequency variations during the transient state are discussed qualitatively, and details of experimental results are given.

621.396.615.141.2:530.19 858
Scalar and Vector Potential Treatment—Richards. (See 702.)

621.396.619.13 859
Variation of Bandwidth with Modulation Index in Frequency Modulation—M. S. Corington. (*Proc. I.R.E.*, vol. 35, pp. 1013-1020; October, 1947.) Equations are derived for the carrier and side-frequency amplitudes obtained in f.m. of a carrier wave by a complex audio signal. Sinusoidal, square, rectangular and triangular modulation are considered. For large modulation indices, when the deviation is much greater than the repetition rate, the bandwidth is only slightly greater than the actual variation in frequency. For small indices, the bandwidth may be several times the actual frequency deviation. Curves are given for indices from 0.1 to 10,000. For complex modulation, the total bandwidth can be estimated by computing the bandwidth that would be required by each separate a.f. component, and adding the results.

621.396.619.13:621.316.726 860
Center-Frequency-Stabilized Frequency-Modulation System—E. M. Ostlund, A. R. Vallarino, and M. Silver. (*Proc. I.R.E.*, vol. 35, pp. 1144-1149; October, 1947.) Frequency division of part of the oscillator output by 256 reduces the modulation swing to less than $\pm 24^\circ$. The phase of the resulting oscillation is compared with that of an oscillation of the same frequency, derived from a crystal source, using a balanced phase detector whose output is fed back to the reactance tube controlling the master oscillator. Any phase difference produces a correcting voltage which acts so as to maintain synchronism with the reference frequency.

621.396.619.16:621.396.813 861
Distortion in Pulse-Duration Modulation—E. R. Kretzmer. (*Proc. I.R.E.*, vol. 35, pp. 1230-1235; November, 1947.) Pulse-duration modulation inherently gives rise to a certain amount of audio distortion. The analysis presented in this paper relates the distortion to

system parameters. The method of analysis is exact, and, therefore, correct for any degree of modulation. However, it does not lend itself to periodic sampling. The results are applied to three specific cases.

621.396.619.16:621.396.96 862
Time Modulation—B. Chance. (PROC. I.R.E., vol. 35, pp. 1039-1044; October, 1947.) A brief review of basic processes. Representative practical circuits are given. In military applications such as radar range-finders, high precision is required and many methods for achieving a linearity and stability of 1 part in 10^4 are available.

621.396.619.23 863
Hard-Valve Pulse Modulators for Experimental Use in the Laboratory—R. H. Johnson. (JOUR. I.E.E. (London), part IIIA, vol. 93, no. 6, pp. 1043-1057; 1946.) The general nature of modulation circuits, their technique and practical limitations are reviewed briefly. A comprehensive discussion of hard-tube modulators is then given, with details of the design of each stage and the manner in which load requirements are met. Several different types of driver circuit are described and their relative advantages and disadvantages are discussed. Methods of measurement of the length, current, voltage, and repetition rate of the pulses are also considered. The wide range of applications of a laboratory modulator requires great flexibility in its design. A detailed description is given of two hard-tube modulators in which the pulse length can be varied from 0.2 to 2 microseconds, the repetition frequency from zero to 5000 pulses per second and with maximum peak power of 1 milliwatt.

621.396.619.23:621.396.96 864
Some Developments in High-Power Modulators for Radar—K. J. R. Wilkinson. (JOUR. I.E.E. (London), part IIIA, vol. 93, no. 6, pp. 1090-1112; 1946.) Modulators which depend upon the discharge of a pulse-shaping network depend also upon the related but separate action of charging. The method of charging from a d.c. source, using a series thyatron, is given. The principles and theory of alternator charging are described for thyatron and spark modulators, and the effect of overswing in the modulator is discussed. A.c. rectifier charging is considered and compared with the alternator method. The use of cable circuits to generate higher pulse-voltages than are possible by the discharge of a single pulse-shaping network is discussed. The action and behavior of the Blumlein cable circuit, and of the Marx connection of cables, with its auxiliary charging problem, are considered. Two forms of 4-electrode air-blown triggered spark-gaps are introduced, together with an account of the mechanisms of their triggering and of jitter. A theory is outlined for the series-peaking transformer. A short description is given of certain complete modulators incorporating the above features.

VACUUM TUBES AND THERMIONICS

621.385.032.3 865
Electrode Dissipation at Ultra-High Frequencies—Z. W. Wilchinsky. (PROC. I.R.E., vol. 35, pp. 1155-1157; October, 1947.) A simple method of measurement, with results for a 2C43 triode oscillator.

621.385.1 866
Improvements in Small Tubes—(ELECTRONICS, vol. 20, pp. 144, 182; November, 1947.) A short account of some subminiature tubes now in production, with brief mention of an experimental tube recently produced in the tube laboratory of the National Bureau of Standards.

621.385.1 867
Tube Production Techniques—V. G. Jarman. (ELECTRONICS, vol. 20, pp. 160 to 164; October, 1947.) Brief description of a new type of electrode holder on bench welders and an adjustment fixture for examining the alignment of grid laterals.

621.385.1 868
Advantages of Space-Charge-Grid Output Tubes—N. C. Pickering. (AUDIO ENG., vol. 31, pp. 20-21, 45; October, 1947.) Long summary of I.R.E. paper. Pentodes and beam-power tubes are easier to drive than triodes, but have intrinsically higher distortion. The space-charge-grid tube combines the advantages of both. Graphs showing the comparative performance of all three types are given.

621.385.1:003.62 869
Letter Symbols for Electronic Valves [Book Notice]—British Standards Institution, London, 1947, 2s. (BRIT. STAND. INSTN. MON. INFORM. SHEET, p. 2; October, 1947.) "The letter symbols laid down in this standard apply to electrodes and other components of electronic valves, designations of different types of valves and electrical quantities in connection with valve technique. They are intended for use by valve manufacturers and users and in technical literature generally."

621.385.1.012:621.317.755 870
Producing Tube Curves on an Oscilloscope—Webbing. (See 772.)

621.385:029.63/.64+621.396.615.14 871
Transmitting Valves for Communication on Short Wavelengths—W. H. Aldous. (JOUR. BRIT. I.R.E. vol. 7, pp. 167-181; September, 1947.) The characteristics of space-charge control, velocity-modulation, magnetron and traveling-wave types of tubes are reviewed. New triodes for use up to 3700 Mc. and a new modulator are described briefly.

621.385.1.032.216:537.533.1:537.583 872
Influence of Space Charge on Thermionic Emission Velocities—O. Klemperer. (PROC. ROY. SOC. A, vol. 190, pp. 376-393; August 12, 1947.) Apparatus and experimental methods are described for obtaining the distribution of tangential velocity components of the electron emission from oxide cathodes under space-charge conditions. Results show the distribution to be either Maxwellian or to consist of discrete velocity groups, some of which include large numbers of electrons having velocities far in excess of that expected from the cathode temperature. This splitting into groups is explained by space-charge oscillation phenomena, the wavelength of which is compared with that obtained from measurements of the average angular distance of the elementary velocity groups.

621.385.3 873
A New Miniature Double Triode—G. C. Dalman. (BELL LAB. REC., vol. 25, pp. 325-329; September, 1947.) Describes the manufacture and design of the 396A (2C51) double triode. It has a 9-pin base, high transconductance and very low interelectrode capacitance. Characteristic curves and figures are given.

621.385.3:621.396.615.14 874
Triodes for Very Short Waves—Oscillators—Bell, Gavin, James, and Warren. (See 683.)

621.385.3:621.396.822 875
Electrical Noise Generators—J. D. Cobine and J. R. Curry. (PROC. I.R.E., vol. 35, pp. 875-879; September, 1947.) The noise source consists of a miniature gas triode placed in a transverse magnetic field which not only increases the level of the h.f. noise but also eliminates undesirable oscillations. The dependence

of the noise spectrum upon the magnitudes of the magnetic field, the load resistance and the anode current is shown. The noise spectrum falls off rapidly at frequencies over 700 kc., but it is found that by the use of suitable equalizing circuits in the output amplifier, a substantially level noise spectrum up to 5 Mc. may be obtained. The circuits of two wide-band noise generators having ranges of 0.1 to 2.5 Mc. and 0.1 to 5 Mc. are given. See also 3487 of 1946 (Cobine and Gallagher) and 3722 of 1947 (Johnson).

621.385.3.029.62 876
Triodes for 3- and 10-Kilowatt Frequency-Modulated Transmitters—P. I. Corbell, Jr. and H. R. Jacobus. (ELEC. COMMUN. (London), vol. 24, pp. 187-191; June, 1947.) Complete discussion of low and medium power transmitting triodes 7C26 and 7C27 for use in the f.m. broadcasting band 88 to 108 Mc. See also 877 below.

621.385.3.029.63 877
Medium-Power Triode for 600 Megacycles—S. Frankel, J. J. Glauber and J. P. Wallenstein. (ELEC. COMMUN. (London), vol. 24, pp. 179-186; June, 1947.) Reprint of 1635 of 1947. The tubes described are known as L600E and 6C22; see also 2288 of 1947 (Glauber) and 876 above.

621.385.3.029.64 878
Transadmittance and Input Conductance of a Lighthouse Triode at 3 000 Megacycles—N. T. Lavoie. (PROC. I.R.E., vol. 35, pp. 1248-1251; November, 1947.) Measurements at 3000 Mc. indicate that for transit-angles of 10 radians, the transadmittance falls to about 20 per cent of its i.f. value. The conductance also falls, but never becomes negative as transit-time theory would suggest.

621.385.38:621.396.96 879
The Development of Mercury-Vapour Thyratrons for Radar Modulator Service—H. de B. Knight, and L. Herbert. (JOUR. I.E.E. (London), part IIIA, vol. 93, no. 5, pp. 949-962; 1946.) The design of thyratrons to meet Service requirements is reviewed, with special reference to the design of electrodes to reduce disintegration of the cathode by bombardment by positive ions, anode erosion due to sputtering, and deposition of sputtered material on the control grid, all of which occur under the required operating conditions of high peak current and rapid build-up. The effects of the cathode operating temperature, of Hg vapor condensation temperature, and of ionization and deionization of the Hg vapor are also considered, and experimental results are given showing the effect of these factors on the performance of the thyratrons.

621.385.4.029.64 880
Space-Charge and Transit-Time Effects on Signal and Noise in Microwave Tetrodes—L. C. Peterson. (PROC. I.R.E., vol. 35, pp. 1264-1272; November, 1947.) A theoretical analysis of conditions in the grid-screen region of long-transit-angle microwave tetrodes, assuming the electron stream velocity to be single-valued. A minimum noise figure can be obtained by proper adjustment of the space charge in the grid-screen region, so that the noise produced by random cathode emission is cancelled.

621.385.831 881
Beam-Deflection Control for Amplifier Tubes—G. R. Kilgore. (RCA REV., vol. 8, pp. 480-505; September, 1947.) The basic principles involved in obtaining high transconductance are discussed. With conventional grid control, a limitation is set by the ratio of transconductance to anode current, which in practice seldom exceeds $2 \mu\text{mho}/\mu\text{A}$.

Deflection control, coupled with the concept that the above ratio is a function of current density rather than beam current, offers possibilities of obtaining substantial transconductance with low capacitance and low beam currents, and with a very high ratio of transconductance to anode current. Expressions are derived for the ultimate transconductance at both low and high frequencies. Elementary electron optics and the design of a simple beam-deflecting gun are discussed.

It is found experimentally that useful values of transconductance with low capacitance and low current can be obtained with a simple deflection gun combining focusing and deflection. This type of control is ideally suited for use with a high-gain secondary emission multiplier to obtain very high transconductance without excessive capacitance, thus making possible a tube with a bandwidth figure of merit many times greater than for conventional tubes.

Confirmation of some of the properties of deflection control in agreement with the analysis has already been obtained in experimental amplifier tubes combining beam deflection control and a multistage secondary-emission multiplier.

621.385.831.029.63/64 882
Grounded-Grid Amplifier Valves for Very Short Waves—J. Foster. (*Jour. I.E.E.* (London), part IIIA, vol. 93, no. 5, pp. 868-874; 1946. Discussion, *ibid.*, part III, vol. 94, no. 31, pp. 364-368; 1947.) A theory of the common-grid earthed-grid amplifier, commonly called the grounded-grid amplifier, for medium transit angles is presented, showing the advantages this tube possesses over the earthed-cathode amplifier. A description of a range of tubes using disk seals is given and their performance indicated, mention being made of the circuit advantages offered by the use of disk seals in tubes. The results obtained on experimental tubes are presented, and for signal-to-noise ratio improvement, the probable upper limit of 2 000 Mc. with present techniques is suggested, 5 000 Mc. being the probable limit for oscillators.

"The two important problems awaiting theoretical attack are 'total-emission damping' and high-frequency slope."

621.385.832:621.318.572 883
The Cyclophon: A Multipurpose Electronic Commutator Tube—D. D. Greig, J. J. Glauber, and S. Moskowitz. (*PROC. I.R.E.*, vol. 35, pp. 1251-1257; November, 1947.) The cyclophon is a conventional c.r. tube whose screen is replaced by 25 positively charged target-anodes or "dynodes" arranged uniformly in a circle and located opposite sector-shaped holes in a metal aperture-plate a short distance away. A circular time-base applied to the tube causes each dynode to be energized in turn by the electron beam, which may be regarded as the rotating arm of a multipole switch. The current obtained from each dynode may be increased to about 30 ma. by secondary emission if the potential of the aperture plate is raised above that of the dynodes. Details of design, construction, and characteristics are given, and cross talk between dynodes is analyzed. Applications include modulation and demodulation in pulse-time multiplex systems, pulse generation, delay and phasing, frequency multiplication and voltage dividing. See also 3657 of 1947 (Altman and Dyer).

621.385.832:535.371.07 884
An Examination of Cathode-Ray-Tube Screen Characteristics—R. G. Hopkinson. (*Jour. I.E.E.* (London), part IIIA, vol. 93, no. 5, pp. 779-794; 1946. Discussion, p. 832.) An optical analogy to the operation of a c.r. tube screen leads to the measurement of the

total transmission of the screen which provides a sensitive indication of the powder concentration for maximum luminous efficiency. The direct transmission measures the screen coverage and texture and the effect of the processing method on the texture. The effect of different screen preparations upon color and efficiency are determined by means of demountable c.r. tube which enables a range of phosphors to be scanned at various screen potentials and beam currents. An appendix covers the routine measurement of screen transmission and the subjective assessment of screen texture.

621.385.832:535.371.07:621.396.96 885
Cathode-Ray-Tube Screens for Radar—G. F. J. Garlick, S. T. Henderson, and R. Puleston. (*Jour. I.E.E.* (London), part IIIA, vol. 93, no. 5, pp. 815-821; 1946. Discussion, p. 832.) Theoretical and experimental studies show that afterglow is a complex function of the excitation conditions. Two types of screen-testing apparatus are described which simulate the operational behavior of p.p.i. displays, and results are given for H₂S. Factors affecting the operator's response are considered and some details given of the screen materials used.

621.385.832:535.371.07:778 886
The Photography of Cathode-Ray-Tube Traces—R. G. Hopkinson. (*Jour. I.E.E.* (London), part IIIA, vol. 93, no. 5, pp. 808-814; 1946. Discussion, p. 832.) The actinic properties of some luminescent materials under c.r. excitation are tabulated and their spectral distributions are shown. The recording of fast transients is studied, the results being presented in the form of an exposure table. The effects of changes in anode voltage, beam current, and focus adjustment are noted.

621.385.832:621.396.96 887
War-Time Developments in Cathode-Ray Tubes for Radar—L. C. Jesty, H. Moss, and R. Puleston. (*Jour. I.E.E.* (London), part III, vol. 94, pp. 344-345; September, 1947.) Discussion on 2983 of 1947.

621.385.832:621.396.96 888
The Siatron or Dark-Trace Tube—P. G. R. King and J. F. Gittins. (*Jour. I.E.E.* (London), part IIIA, vol. 93, no. 5, pp. 822-831; 1946. Discussion, p. 832.) For another description of the skiatron see 2404 of 1946 (King; Watson).

621.385.832.087.3:621.396.96 889
Visibility of Cathode-Ray-Tube Traces in Radar Displays—R. G. Hopkinson. (*Jour. I.E.E.* (London), part IIIA, vol. 93, no. 5, pp. 795-807; 1946. Discussion, p. 832.) Apparatus is described for the measurement of signals of different shapes and sizes seen against uniform and nonuniform backgrounds; the results are applied to the use of light filters to improve visibility. The visual persistence effects associated with p.p.i. displays were examined experimentally and a display was redesigned to give better discrimination between adjacent signals.

621.396.615.141.2 890
The Cavity Magnetron—H. A. H. Boot and J. T. Randall. (*Jour. I.E.E.* (London), part IIIA, vol. 93, no. 5, pp. 928-938; 1946.) An account of the development from the first demountable 6-resonator model which showed that such an oscillator was possible. Pulse models for various frequencies which were then made showed that the principle of operation was very general. Experiments on a cold Al-cathode tube showed that secondary emission was an important factor in improving the efficiency. Frequency jumping caused by a change of mode of the oscillations resulted in the introduction of strapping, in which alternate anode segments are joined by metal bridges. Finally, theoretical work on mode selection and the ef-

fect of loading on mode change behavior is reviewed.

621.396.615.141.2 891
The High-Power Pulsed Magnetron: A Review of Early Developments—E. C. S. Megaw. (*Jour. I.E.E.* (London), part IIIA, vol. 93, no. 5, pp. 977-984; 1946.) An account of the progressive steps leading to the development in June, 1940, of the first 10-centimeter pulsed magnetron. The multiresonator system developed by Boot and Randall (890 above) and the large oxide cathode developed by Gutton in Paris, were combined in a construction designed for use with a small permanent magnet, and produced a system suitable for airborne work. Systematic development of design procedure based on pre-war work was an important contribution to the great increase of pulse output power obtained between June and December, 1940.

621.396.615.14.2:621.396.96 892
The High-Power Pulsed Magnetron. Development and Design for Radar Applications—W. E. Willshaw, L. Rushforth, A. G. Stainsby, R. Latham, A. W. Balls, and A. H. King. (*Jour. I.E.E.* (London), part IIIA, vol. 93, no. 5, pp. 985-1005; 1946.) An account of the development of the multiresonator magnetron from the first manufactured designs to the latest models. Details of the construction of early tubes are followed by an account of strapping, strap breaks, wavelength presetting and the difficulties encountered. The electronic theory is given briefly in calculating the operating performance. Design problems for λ 3 centimeters, constructional techniques and production line test equipment are discussed. Examples of tubes for the highest output powers on λ 10 centimeters and λ 3 centimeters are given and mode change problems are considered. The design of cathodes presents unusual problems which are covered in detail. An appendix deals with some aspects of magnetron circuit design, using equivalent circuits.

621.396.615.142 893
Principles of Velocity Modulation—(*Jour. I.E.E.* (London), part IIIA, vol. 93, no. 5, pp. 875-917; 1946. Part 1: Single-Transit Velocity-Modulated Oscillators, by J. H. Fremlin. An introduction covering resonator and coaxial-line oscillators and an explanation of the physical meaning, without detailed proof, of starting current, energy interchange between the beam and the resonator, averaging of current over the beam cross section, the calculation of circuit conductance, and the dependence of starting current on the drift tube length and on the beam voltage. The importance of starting current in determining the performance is shown and the choice of optimum mechanical dimensions is considered with reference to the design of oscillators with as little recourse to experiment as possible.

Part 2: Small-Amplitude Theory and Starting Current, by A. W. Gent. This section gives the theory of the operation of velocity-modulated tubes on the assumption that the h.f. voltage swing across the gaps is very small compared with the resonator voltage. From the expression for the exit velocity of an electron from a gap as a power series in the depth of modulation, and the expression for the time spent in traversing a gap, the energy transfer between the electron beam and the resonator is found. The general expression for the efficiency of a tube with n gaps is given. This leads to the equations for the starting current, and to the possibility and advantages of optimizing tubes for minimum starting current.

Part 3: Gap Efficiency Factors, by D. P. R. Petrie. The nature and properties of the gap efficiency factors β and γ are discussed, β being a measure of the efficiency of a gap in effecting energy interchange between the elec-

tron beam and the high-frequency field, and γ being proportional to the derivative of this efficiency with respect to entrance velocity.

An important theorem is proved that the law of variation of β across a parallel beam is independent of the potential distribution in the gap, and hence the same for all gaps, but depends on the type of symmetry. This enables the general expression for the beam efficiency to be averaged across the beam.

β , γ and the average beam efficiency are evaluated for types of gap in common use and the results applied to the particular case of the coaxial-line oscillator.

Part 4: Power Output and Efficiency of Velocity-Modulated Valves, by P. J. Wallis. This paper obtains and discusses an approximate formula for the efficiency of velocity-modulation tubes when the voltage modulation is no longer small. For both theoretical and experimental reasons, the bunching formula given previously by Webster has to be modified by including the gap-efficiency factor β , although this still neglects the effect of the variation in the speed of the electron bunches due to the voltage modulation α . It is also necessary to take into account the absorption of power from a uniform electron stream in a single gap. The approximate formula is compared with exact results obtained by numerical integration for the case of infinitely-short gaps, and by means of a differential analyzer for one particular wide gap.

Several possible extensions of the approximate formula are discussed. The final sections use the formula to deduce the power delivered into the useful load and show how tubes can be designed for maximum power output.

Part 5: Electronic Frequency Control of Oscillators, by S. G. Tomlin. A physical explanation of the fact that the frequency of a velocity-modulated oscillator may be varied by adjustment of the electron beam velocity is given, and the problem is treated by calculating the currents induced in the modulating gaps of the resonators. In this way, it is shown that the electron beam effectively connects a complex admittance across the modulating gaps. The real part of this admittance may be negative, in which case oscillations may be maintained at a frequency partly determined by the beam susceptance.

The theory is applied in detail to the case of a single-transit double-gap oscillator of the coaxial line type and the conditions for maximum frequency change are obtained.

Some consideration of reflex oscillators is given, and the large-signal theory of electronic frequency control is discussed briefly.

621.396.615.142. 894
Elementary Theory of Velocity-Modulation Oscillators—N. G. Barford and M. Borman-Manifold. (*Jour. I.E.E.* (London), part III, vol. 94, pp. 302-314; September, 1947.) A first-order theory of velocity-modulation oscillators is developed, leading to an expression for their efficiency which takes into account the resonator losses and the corrections due to beam damping. The bunching properties of various field distributions are investigated and formulas are given which enable them to be calculated in all cases on the assumption that space-charge effects may be neglected.

621.396.615.142 895
Velocity-Modulation Valves—L. F. Broadway, C. J. Milner, D. R. Petrie, W. J. Scott, and G. P. Wright. (*Jour. I.E.E.*, part IIIA, vol. 93, no. 5, pp. 855-867; 1946. Discussion, *ibid.*, part III, vol. 94, no. 31, pp. 359-363; 1947.) A detailed survey of the war-time development, application and construction of high

power c.w. buncher-catcher klystrons including (a) type CV80, which has an output of 100 to 300 watts at wavelengths of about 7 centimeters, (b) reflection klystrons for λ 7 centimeters and λ 3 centimeters with outputs of the order of 100 milliwatts, which are suitable for electronic frequency control, (c) wide frequency range coaxial-line oscillators, such as type CV234 covering the range λ 8 to 16 centimeters and type CV288 covering λ 6 to 7 centimeters, and (d) a wide tuning-range reflector oscillator developed for λ 5 to 10 centimeters and λ 7 to 14 centimeters, which uses a cavity with a non-contact plunger developed from the $\lambda/4$ line filter.

621.396.615.142:621.396.611.4 896
Loading of Resonant Cavities by Electron Beams—Abraham. (See 682.)

621.396.615.142.029.64 897
The CV35—A Velocity-Modulation Reflection Oscillator for Wavelengths of about 10 cm.—A. F. Pearce and B. J. Mayo (*Jour. I.E.E.* (London), part IIIA, vol. 93, no. 5, pp. 918-927; 1946.) A description of a low power c.w. oscillator developed in 1940 to 1941. The resonator is of the disk-seal type, tuning being obtained by screw plungers. Dimensional details and characteristics are given, as well as a short account of the experimental development of the tube. The factors affecting the performance are mentioned and the efficiency and stability discussed on the basis of the first order theory of Barford and Manifold (894 above). Finally, the theoretical efficiency is calculated and seen to be in good agreement with the observed value.

621.396.615.142.2 898
Transit-Time Effect in Klystron Gaps—H. B. Phillips and L. A. Ware. (*Proc. I.R.E.*, vol. 35, pp. 1076-1079; October, 1947.) A graphical method of calculation gives the effect of grid spacing on the so-called ideal drift distance S . For a modulation depth of 0.5, S increases by 47 per cent as the grid spacing is varied from 0 to 2 mm. for an accelerating voltage of 1200 volts and a frequency of 3 000 Mc. See also 1355 of 1942 (Kompfner).

621.396.822:621.385 899
Noise in Electrometer Tubes—A. T. Forrester. (*Phys. Rev.*, vol. 72, p. 747; October 15, 1947.) Summary of Amer. Phys. Soc. paper. North's theory (769 of 1941) of noise in tubes having positive grids, when applied to a particular electrometer tube, gives an equivalent noise resistance 11.4 times the value obtained from the usual triode terms $3/g_m$. An approximation to the noise may be obtained by assuming the anode-current fluctuations to be temperature-limited shot noise.

MISCELLANEOUS

389.6:[53.081+621.3.081 900
Standardization—P. Good. (*Beame Jour.*, vol. 54, pp. 337-340; October, 1947.) An outline of the basic principles underlying industrial standardization as applied to all industries, with a record of some historical steps taken by the I.E.E. to encourage the development of standardization.

537.311.2 901
Ohm and his Law—G.W.O.H. (*Wireless Eng.*, vol. 24, pp. 284-287; October, 1947.) Biography of Georg Simon Ohm, with an account of his experiments and description of his papers published in 1826 first formulating the laws of electrical conduction. See also 1063 and 2393 of 1947.

62:371.3 902
Postwar [Engineering] Curriculum Emphasis—O. J. M. Smith. (*Proc. I.R.E.*, vol. 35, pp. 1346-1348; November, 1947.)

62.3"17" 903
The Frog that led to Electrical Science—E. Hardy. (*Beame Jour.*, vol. 54, pp. 357-358; October, 1947.) The frog was intended for Professor Galvani's soup; its leg muscles were brought into action when his wife touched them with a scalpel which had been accidentally charged electrically.

621.396 904
British Research in the Radio Field—(*Jour. I.E.E.* (London), part I, vol. 94, pp. 502-508; November, 1947.) Summaries of this report by the Research Committee of the Institution of Electrical Engineers were noted in 320 of February. It is recommended that increased financial support should be given to academic laboratories, that industrial research programs should be planned on a long-term basis, and that new buildings for research purposes should be erected. Various suggestions are made with the object of encouraging potential research leaders to undertake radio research; a much wider exchange of personnel between universities, industry and Government establishments is recommended. No attempts at rigid coordination should be made, but research workers should be enabled to form a ready assessment of work already in hand and of the results obtained. For this purpose, informal contacts between heads of research establishments should continue and colloquia and conferences on research subjects should be held. For the coordination of advanced development, the setting up of Sir Stanley Angwin's Committee on Fundamental Research in Telecommunication is welcomed, and the work of the Radio Components Research and Development Committee of the Ministry of Supply should continue. The vital importance of the dissemination of research results inspires the recommendation that an agency generally resembling the Central Radio Bureau should be set up to serve as a focal point for the dissemination of details of work proceeding in academic, Service and industrial laboratories. Finally, the importance of timely application of research results is stressed.

621.396"1946/1947" 905
F.C.C.'s Review of Radio Progress [1946-1947]—C. R. Denny, Jr. (*FM and Telev.*, vol. 7, pp. 19-21, 51; October, 1947.) Report of address to the National Association of Broadcasters at Atlantic City by the F.C.C. Chairman.

621.3:42+3-3-4 906
Technical Dictionary [Book Review]—H. Thali. Distributor, W. S. Heinman, New York, 1946, 275 pp., \$6.25. (*Electronics*, vol. 20, p. 261; October, 1947.) English terms are in alphabetical order; each is followed by its German and French equivalents. Coverage of English radio and electronic terms is "commendably complete"; most-used terms of acoustics, illumination, mathematics, optics, and related fields are also given.

621.38/.39 907
Electronic Engineering Principles [Book Review]—J. D. Ryder. Prentice-Hall, New York, 1947, 397 pp., \$6.65. (*Tele-Tech*, vol. 6, p. 94; September, 1947.) "... a book that covers the fundamentals of electron tube operation that will serve either as a text or reference on this subject for either engineering students or engineers in the field."

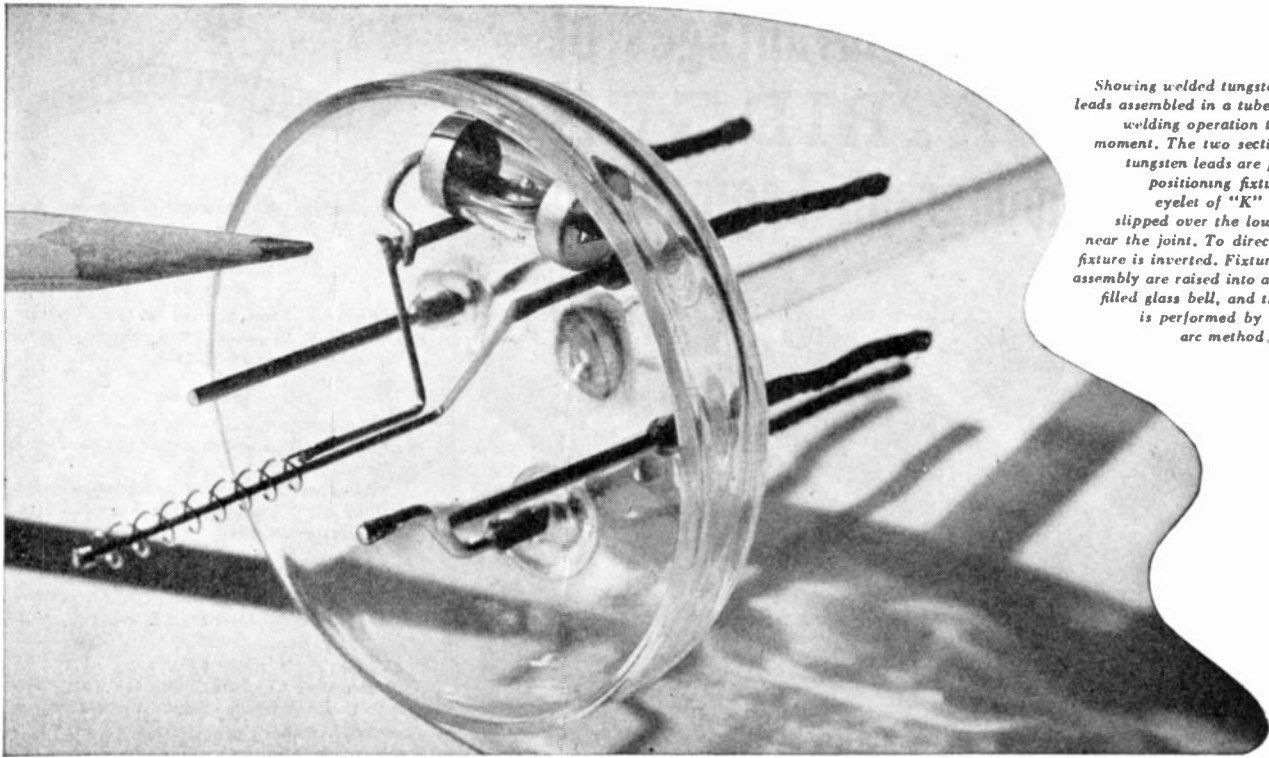

Showing welded tungsten filament leads assembled in a tube base. The welding operation takes but a moment. The two sections of the tungsten leads are placed in a positioning fixture. A tiny eyelet of "K" MONEL is slipped over the lower section, near the joint. To direct flow, the fixture is inverted. Fixture and lead assembly are raised into a hydrogen-filled glass bell, and the welding is performed by the carbon arc method.

How a problem in welding tungsten was solved

While improving the design of their VHF beam tetrodes, the United Electronics Company ran into a difficult technical problem.

In their tube types 5D22 and 4D21, tungsten filament leads are brought out to conventional base prongs. However, to locate the filament at the center of the structure, the two internal filament leads had to be sharply offset. It was necessary, also, that the leads be accurately aligned with the base outlet holes, to eliminate stresses which might crack the glass envelope when the tube was put in service.

Bending the tungsten leads to shape proved too inaccurate a method. So it was decided to make the leads in two sections — one straight, and one bent — welding them together in precision positioning fixtures.

This method of assembly proved satisfactory, but difficulty was immediately encountered in finding a suitable joining metal.

Several metals were tried without success. Either they failed to "wet" the tungsten, or caused it to embrittle.

VHF beam tetrode tube, manufactured by the United Electronics Co., Newark, N. J. ▶

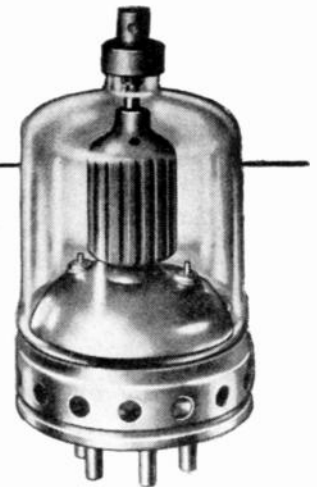

Finally, United Electronics Company engineers tried "K"* MONEL — and it proved to be the answer to their problem.

"K" MONEL "wet" the tungsten satisfactorily; flowed well; made strong, smooth joints; was resistant to oxidation and corrosion. In addition, "K" MONEL's melting point was safely above both exhausting and tube operating temperatures.

This is but one of countless ways that Nickel and its alloys are helping industry to build better products. If you have a problem in metal selection, get to know the family of INCO Nickel Alloys with their unique combination of properties. Our technical department is always ready to assist you. Write for "Inco Nickel Alloys for Electronic Uses."

The International Nickel Company, Inc.

67 Wall Street • New York 5, N. Y.

EMBLEM OF SERVICE
NICKEL  **ALLOYS**

MONEL • "K"* MONEL • "S"* MONEL • "R"* MONEL • "KR"* MONEL • INCONEL • NICKEL • "L"* NICKEL • "Z"* NICKEL
*Reg. U. S. Pat. Off.

Incorporate the Advantages of "LT" CARTRIDGES in New Phonograph Engineering



ATLANTA

"Operation of Pentagrid Frequency Converters," by W. T. Clary, Georgia School of Technology; January 17, 1948.

BOSTON

"Electrical Flash Sources for Color Photography," by H. E. Edgerton, Massachusetts Institute of Technology; January 22, 1948.

BUENOS AIRES

"The Engineer and his Relation to Economic Problems," by W. Klappenbach, Engineer; December 5, 1947.

"Rules and Regulations on Radiocommunications," by A. T. Cosentino, Pan American Argentina; December 19, 1947.

BUFFALO-NIAGARA

"Electronics in Miniature," by C. Brunetti, National Bureau of Standards; January 21, 1948.

CEDAR RAPIDS

"Two-Way Communications for Taxi Cabs," by W. L. Cunningham, Bendix Radio Company; January 21, 1948.

Election of Officers; January 21, 1948.

"Methods and Procedures in Power Tube Development," by W. H. Kohl and J. W. Clark, Collins Radio Company; February 11, 1948.

CHICAGO

"Some Equipment and Systems Aspects of Emergency Radio Communications," by L. P. Morris, Motorola, Inc.; January 16, 1948.

"Equipment and Allocation Problems in Maximum Frequency Spectrum Utilization for Mobile Radio Telephone Services," by D. E. Noble, Motorola, Inc.; January 16, 1948.

CINCINNATI SECTION

"Very-High-Frequency Tuner Design," by G. Wallin and C. W. Dymond, Motorola, Inc.; January 20, 1948.

CLEVELAND

"Science, Engineering, and Society," by G. F. Leydorf, Radio Station WJR; January 22, 1948.

COLUMBUS

"Seam Deflection Mixer Tubes for Ultra-High Frequencies," by E. W. Herold, Radio Corporation of America; November 19, 1947.

"Infrared and Its Relation to the Radio Spectrum," by E. Bell, Ohio State University; January 9, 1948.

DALLAS-FORT WORTH

Election of Officers; January 16, 1948.

"Waveguide Bridge Circuits," by C. F. Crandell, Southwestern Bell Telephone Company; February 12, 1948.

DES MOINES-AMES

"Voice of America—Transmitters of OWI," by J. L. Hollis, Collins Radio Company; January 28, 1948.

Election of Officers; January 28, 1948.

EMPORIUM

"Nucleonics and Electronics," by H. W. Parker, Sylvania Electric Products Inc.; December 8, 1947.

HOUSTON

"New Types of Capacitors and Resistors for Electronic Apparatus—The Practical Results of Wartime Research," by L. Podolsky, Sprague Electric Company; November 14, 1947.

"Engineering Problems in Mobile Radio-Telephony in Texas," by J. D. Mathis, Southwestern Bell Telephone Company; December 15, 1947.

(Continued on page 36A)

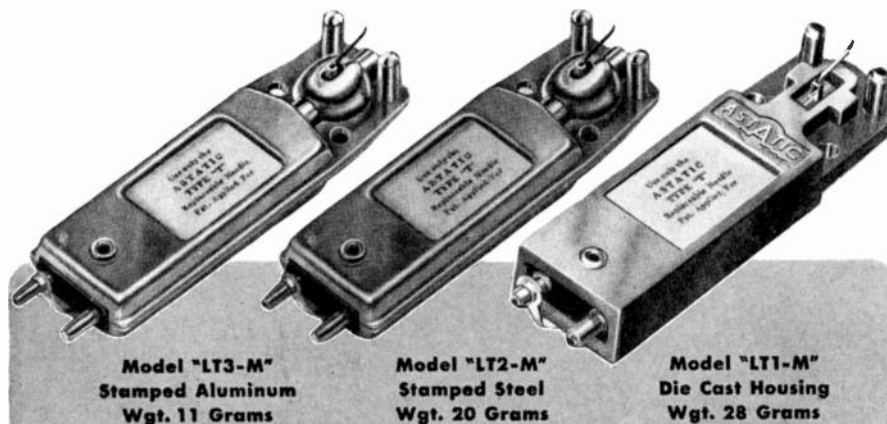

Model "LT3-M"
Stamped Aluminum
Wgt. 11 Grams

Model "LT2-M"
Stamped Steel
Wgt. 20 Grams

Model "LT1-M"
Die Cast Housing
Wgt. 28 Grams

LOW NEEDLE TALK, Low Needle Pressure and Low Price combine to make Astatic's new "LT" Series Cartridges particularly desirable for new installations in all types of automatic record changers and manually operated phonographs. Now available with stamped steel and aluminum as well as die cast housings, "LT" Cartridges may be selected in the proper weight to provide optimum needle pressure and pickup inertia characteristics with various types of arms.

The response of these cartridges is exceptionally smooth over the entire frequency range from 50 to 10,000 c.p.s., with a gradual roll-off commencing at approximately 4,000 c.p.s. Minimum Needle Pressure, $\frac{3}{4}$ oz. Output Voltage, 1.0 Volt average at 1,000 c.p.s.

All models in the "LT" Cartridge employ Astatic's replaceable, Type "T" stainless steel Needle with electroformed precious metal tip.

Also highly recommended is Astatic's de luxe "QT" Series (Quiet Talk) Cartridge, employing a matched, replaceable Type "Q" Needle with sapphire or precious metal tip.

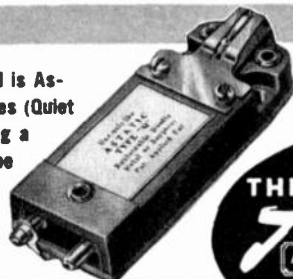

Literature is Available



You get two complete transmitters . . .

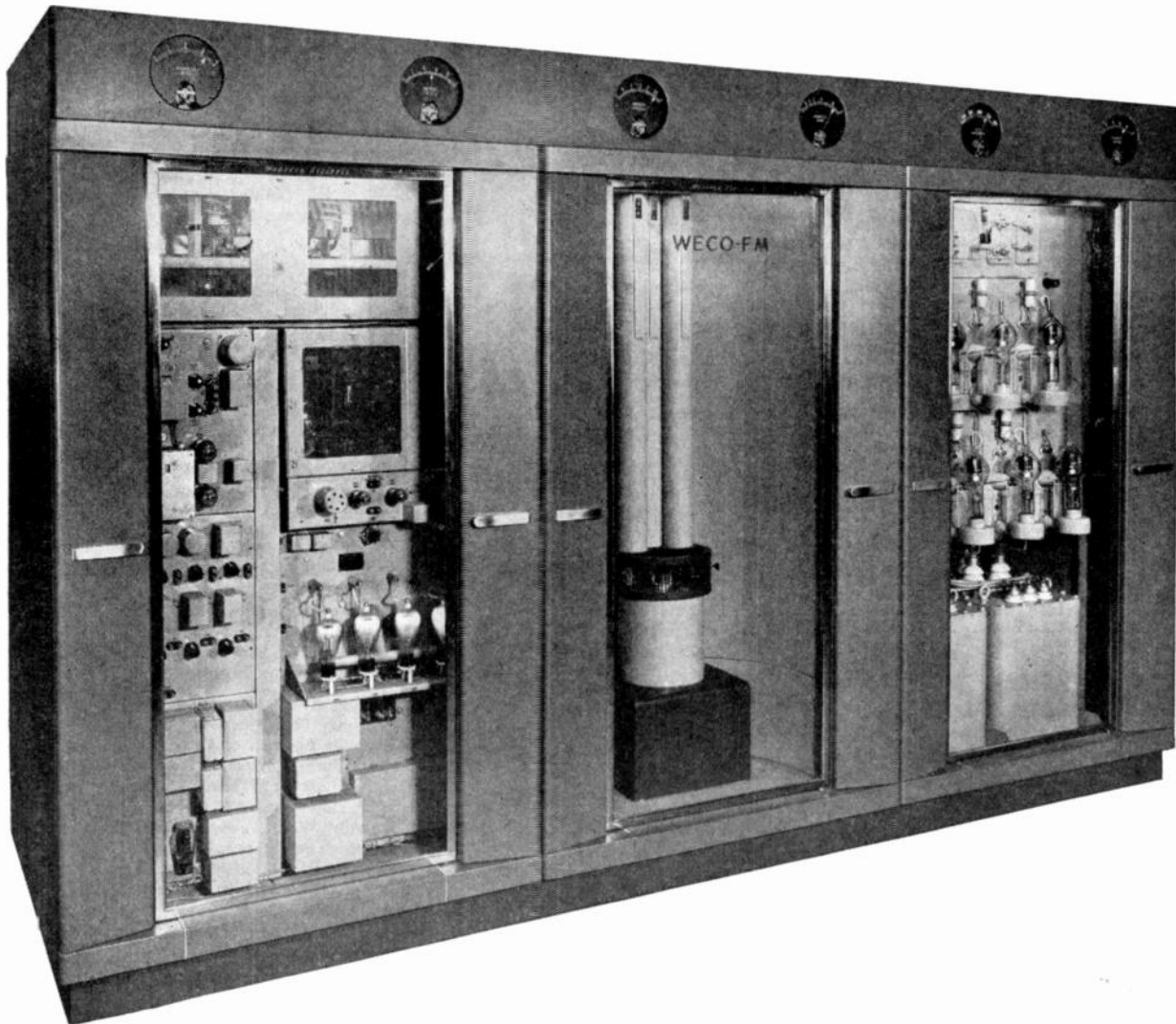

. . . when you buy the Western Electric 10KW FM!

In this 10 kw transmitter the 1 kw driver is your standby equipment. If your final amplifier or its power supply should fail, a simple operation (taking less than a minute) puts you back on the air—with the driver itself as your emergency transmitter!

This Western Electric feature gives you still another safeguard against off-the-air time. If your main source of power fails, your

emergency power source may be too small to handle a 10 kw transmitter. In that case, just cut back to 1 kw operation!

This is only one of many reasons why you should consider Western when you go to 10 kw FM. For complete information, please call your local Graybar Broadcast Representative—or write Graybar Electric Co., 420 Lexington Ave., New York 17, N. Y.

Western Electric
— QUALITY COUNTS —

DISTRIBUTORS: IN THE U. S. A.—Graybar Electric Company. IN CANADA AND NEWFOUNDLAND—Northern Electric Company, Ltd.



New WILEY BOOKS

VACUUM TUBE CIRCUITS

By LAWRENCE B. ARGUIMBAU

Contains the most recent information on the subject. The treatment is carefully developed from simple circuits to those of a more complex nature. Emphasis is given to frequency modulation*as opposed to amplitude modulation. Also includes much basic material on transient response and the generation of micro-waves.

1948 668 Pages \$6.00

BATTLEFRONTS OF INDUSTRY

By DAVID O. WOODBURY

The dramatic story of Westinghouse at war. The book stresses the ingenuity of engineers and scientists, the application of mass production techniques to war machines, and the speedy completion of "impossible" assignments.

1948 329 Pages \$3.50

INDUSTRIAL ELECTRONICS REFERENCE BOOK

By Electronic Engineers of the Westinghouse Electric Corp.

This book was written to satisfy the need for a digest covering the application as well as design data for industrial electronic equipment. It gives sufficient theoretical data and application information on electronic subjects to enable the reader to have a better understanding of the possibilities and limitations of new electronic devices.

Ready in June Approx. 719 Pages Probable Price \$7.50

ULTRAHIGH FREQUENCY TRANSMISSION & RADIATION

By NATHAN MARCHAND

A book for practicing engineers who have to use UHF in systems of mobile and relay communications; frequency modulation; relay and color television; pulse time modulation, etc. M.K.S. units have been used throughout.

1947 322 Pages \$4.50

NOMOGRAPHY

By ALEXANDER S. LEVENS

A study of the fundamentals of nomography and graphical methods. Includes nomographs which will be valuable to workers in many fields not only directly, but as indicators of what can be done to eliminate tedious mathematical computations.

1948 176 Pages \$3.00

ELECTRIC TRANSFORMERS AND CIRCUITS

By REUBEN LEE

Presents material directly related to radar and communications. The author stresses applications rather than pure theory, and clarifies each point by illustrations.

1947 284 Pages \$4.50

PREPARATION AND CHARACTERISTICS OF SOLID LUMINESCENT MATERIALS

Edited by GORTON R. FONDA and FREDERICK SEITZ

Twenty-nine papers by leaders in the field. Covers theory of various phenomena connected with luminescence; the purification, crystallization and constitution of luminescent materials; new information collected during the war years; summary of the present status of luminescence; etc.

1948 Approx. 424 Pages Probable Price \$5.00

ELECTRONICS FOR INDUSTRY

By WALDEMAR I. BENDZ,

Assisted by CHARLES A. SCARLOTT

Clearly and concisely explains the principles of industrial electronics, describing the various types of electronic tubes, their functioning, and the basic circuits in which these are used in many industrial devices.

1947 501 Pages \$5.00

TECHNIQUES IN EXPERIMENTAL ELECTRONICS

By C. H. BACHMAN

A practical working aid which discusses control, assembly, utilization, and techniques of working with controlled beams of charged particles in vacua or at very low pressures. Supplemented by numerous charts, tables, and illustrations.

1948 252 Pages \$3.50



(Continued from page 34A)

"Solution of Transmission Line Problems by Graphical Methods," by C. Wischmeyer, Rice Institute; January 15, 1948.

"The Applications of Inverse Feedback," by L. W. Erath, Schlumberger Well Surveying Corporation; February 16, 1948.

INDIANAPOLIS

"Network Broadcasting," by E. C. Belzer, Indiana Bell Telephone Company; December 19, 1947.

"Microphones," by C. M. Chorpeneing, Astatic Corporation; January 23, 1948.

LONDON (ONTARIO)

"Some Practical Engineering Factors to be Considered in Planning a Radio Communication Service," by P. Field, Station CFPL; January 30, 1948.

"Frequency Modulation," by B. Graham, Sparton of Canada Ltd.; January 9, 1948.

LOS ANGELES

"The Design of Self-Excited Oscillators for Cyclotrons," by J. Backus, University of Southern California; January 20, 1948.

"The Use of Plasma Sheaths as Variable Condensers," by W. Parkins, University of Southern California; January 20, 1948.

NEW YORK

"New Techniques in Waveguides—Special Waveguide Systems of Extreme Bandwidth," by F. J. Gaffney, Polytechnic Research and Development Corporation; January 22, 1948.

"A Nonreflecting Branching Filter for Microwaves," by W. D. Lewis and L. C. Tillotson, Bell Telephone Laboratories; January 22, 1948.

"Field Patterns of Aircraft Antenna," by D. F. Bowman, Airborne Instruments Laboratory; February 4, 1948.

OTTAWA

"Ultrasonics and Their Application," by T. D. Northwood, National Research Council; January 8, 1948.

"The Use of Directional Antennas for Broadcasting in the Standard Band," by K. A. MacKinnon, Consulting Radio Engineer; January 29, 1948.

PHILADELPHIA

"New York-Boston Relay System," by G. N. Thayer, Bell Telephone Laboratories; February 4, 1948.

PITTSBURGH

"Frequency-Modulation Detectors," by S. W. Seeley, RCA Laboratories; February 9, 1948.

PORTLAND

"An Analysis of the Intermodulation Method of Distortion Measurement," by W. N. Eldred, Hewlett-Packard Company; February 4, 1948.

"The Use and Adjustment of Feedback in A.M. Transmitters," by J. C. Herber, Western Electric Company; February 13, 1948.

PRINCETON

"The Baldwin Electronic Organ," by J. F. Jordan, The Baldwin Company; February 12, 1948.

ROCHESTER

"The New Cyclotron at the University of Rochester," by S. W. Barnes, University of Rochester; January 22, 1948.

"Applications of the Cathode-Ray Oscilloscope in Industry," by E. G. Nichols, Allen B. DuMont Laboratories; February 5, 1948.

ST. LOUIS

"Use of Radio in Providing Telephone Service," by H. P. Lawther, Southwestern Bell Telephone Company; January 22, 1948.

(Continued on page 38A)

ON APPROVAL COUPON

JOHN WILEY & SONS, INC.
440 Fourth Ave., New York 16, N.Y.

Please send me, on ten days' approval, the books I have checked in this advertisement (or I am attaching to this coupon a separate list of the books I want). At the end of that time, if I decide to keep the books, I will remit indicated price plus postage; otherwise I will return the books postpaid.

Name
Address
City & State
Employed by

(Offer not valid outside U.S.)

IRE-4-48

SYLVANIA RESEARCH NEWS



APRIL

Prepared by SYLVANIA ELECTRIC PRODUCTS INC., Bayside, L. I.

1948

ANOTHER TYPICAL LABORATORY OPERATION MAKES FOR SYLVANIA RADIO TUBES OF UNSURPASSED QUALITY

Hot rolling of an alloy bar is typical of pilot plant production in the Metallurgical Research Laboratories of Sylvania Electric, where tungsten and alloy wire and rod are exhaustively studied at every stage of manufacture. Alloy wires for electron tube structures must have good electrical conductivity at high frequencies, be suitable for spot welding and have thermal expansion and contraction characteristics close to those of commercial glasses. It's operations like this that make for Sylvania radio tubes of unsurpassed quality
*Sylvania Electric Products Inc.,
500 Fifth Ave., New York 18, N. Y.*

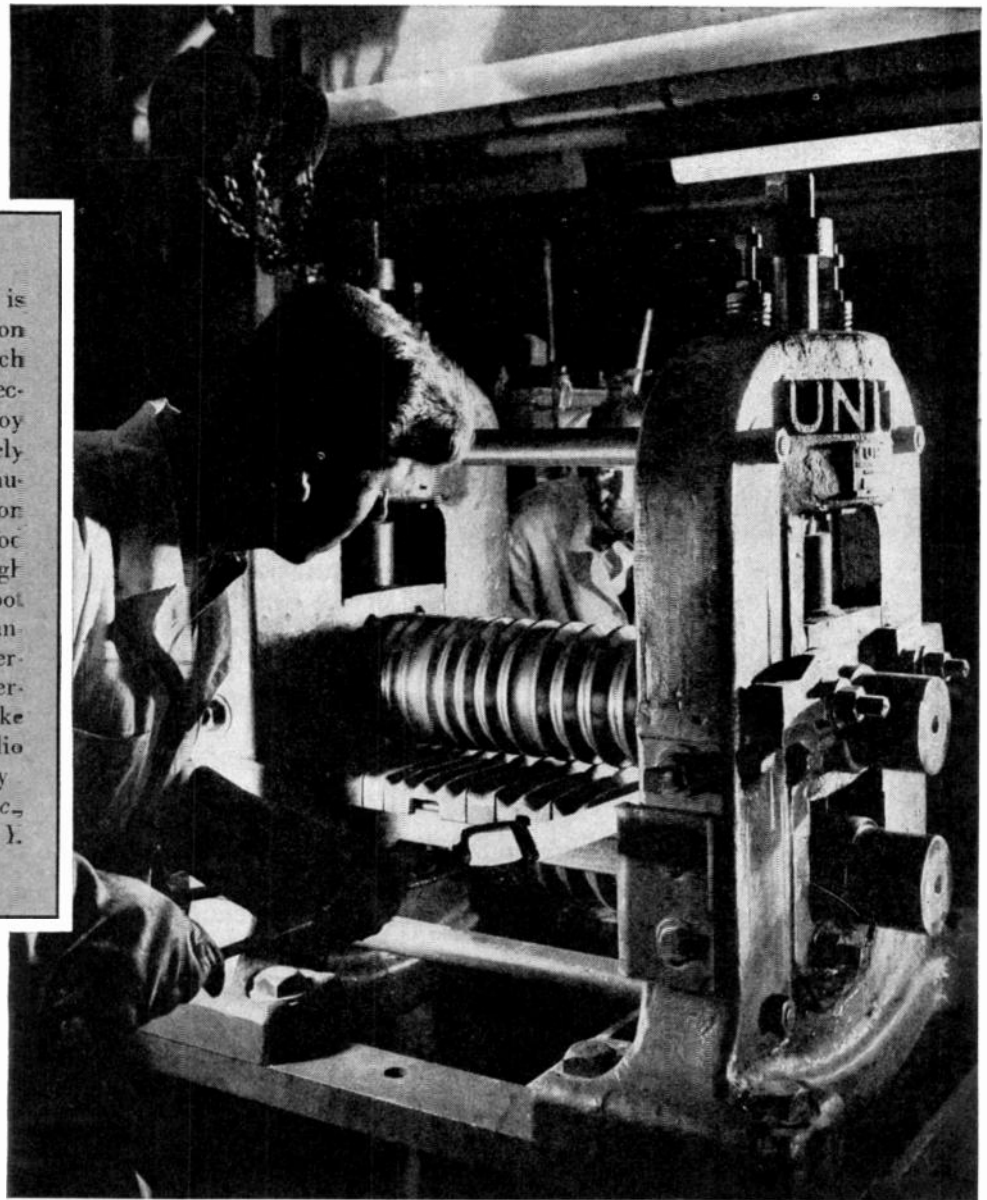

SYLVANIA ELECTRIC

MAKERS OF RADIO TUBES; CATHODE RAY TUBES; ELECTRONIC DEVICES; FLUORESCENT LAMPS, FIXTURES, WIRING DEVICES; ELECTRIC LIGHT BULBS

Remove LIMITATIONS ON EQUIPMENT DESIGN

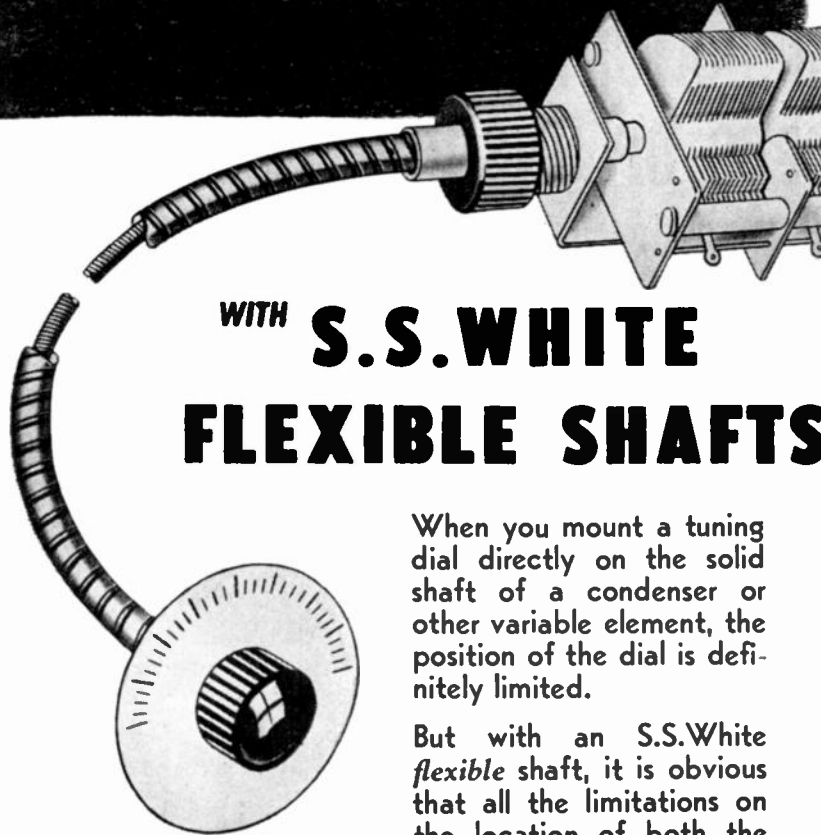

WITH **S.S. WHITE** **FLEXIBLE SHAFTS**

When you mount a tuning dial directly on the solid shaft of a condenser or other variable element, the position of the dial is definitely limited.

But with an S.S. White flexible shaft, it is obvious that all the limitations on the location of both the element and its control

are removed. Each can be positioned independently of the other, because an S.S. White flexible shaft is designed especially to transmit rotary movement smoothly and positively between two points regardless of curves or distance.

The result is that when you use an S.S. White flexible shaft, you have unlimited freedom in designing for both optimum circuit efficiency and maximum tuning convenience.

If you'd like the full story about flexible shafts,

WRITE FOR THE FLEXIBLE SHAFT HANDBOOK

It gives facts and technical data about flexible shafts and how to select and apply them. A free copy will be sent if you write for it on your business letterhead and mention your position.



S.S. WHITE INDUSTRIAL
THE S. S. WHITE DENTAL MFG. CO. DIVISION
DEPT. G 10 EAST 40th ST., NEW YORK 16, N. Y.



FLEXIBLE SHAFTS • FLEXIBLE SHAFT TOOLS • AIRCRAFT ACCESSORIES
SMALL CUTTING AND GRINDING TOOLS • SPECIAL FORMULA RUBBERS
MOLDED RESISTORS • PLASTIC SPECIALTIES • CONTRACT PLASTICS MOLDING

One of America's AAAA Industrial Enterprises



(Continued from page 36A)

SAN DIEGO

"Development of Ground-Controlled Approach System," by K. Mealey, Consolidated-Vultee Aircraft Corporation; February 3, 1948.

SAN FRANCISCO

"An Experimental Television Studio," by F. R. Brace, Consulting Engineer; January 14, 1948.

"A Zero- to 200-Mc. Video Amplifier Using Conventional Tubes," by J. Noe, Hewlett-Packard Company; February 4, 1948.

SEATTLE

"An Analysis of the Intermodulation Method of Distortion Measurement," by W. N. Eldred, Hewlett-Packard Company; February 5, 1948.

SYRACUSE

"Nucleonics," by W. R. G. Baker, General Electric Company; February 5, 1948.

"Seeing with Echoes," by F. Slaymaker, Stromberg-Carlson Company; February 16, 1948.

TWIN CITIES

"Three Dimensional Presentation of Data on Cathode-Ray Oscilloscopes," by O. Schmidt, University of Minnesota; January 29, 1948.

WASHINGTON

"Printed Circuits and Miniature Electronics," by C. Brunetti, National Bureau of Standards; February 9, 1948.

SUB-SECTIONS

LANCASTER

"The Teleran Air Navigation and Traffic Control System," by D. H. Ewing, Radio Corporation of America; February 11, 1948.

NORTHERN NEW JERSEY

"Two-Signal Performance of Some F.M. Receiver Systems," by B. D. Loughlin, Hazeltine Laboratories; January 14, 1948.



UNIVERSITY OF ARKANSAS, I.R.E. BRANCH

"Obtaining Federal Communications Licenses," by B. A. Vizzier, Student; February 4, 1948.
Election of Officers; February 4, 1948.

ALABAMA POLYTECHNIC INSTITUTE, I.R.E. BRANCH

"Microwave Towers and Carbon in Telephones," by H. W. Stephens, Southern Bell Telephone Company; February 16, 1948.
Election of Officers; February 17, 1948.

UNIVERSITY OF ILLINOIS, I.R.E.-A.I.E.E. BRANCH

"A Good Man is Hard to Find," by G. D. Lobinger, Westinghouse Electric Company; January 22, 1948.
Election of Officers; January 22, 1948.

(Continued on page 40A)

MARION'S "SPECIAL" SALESMAN WINS ANOTHER CLIENT . . .



Builds CONSUMER CONFIDENCE In Radio Wave's Precision Permanent

A Marion "special" gives the *RADIO WAVE* Precision Permanent the critical accuracy that brings consistently fine results . . . constantly expanding sales . . . unqualified consumer confidence.

Prospective customers can see the Marion "special" indicate when the chemical change in the hair has reached the point where optimum results may be obtained from this revolutionary permanent wave machine.

The "special" Marion Meter designed for

Radio Wave is connected in series with electrodes that transmit variations in electrical resistance occurring inside the cortex of the hair to the Marion Meter which indicates the change . . . reveals the correct waving time for perfect results.

The Marion "special" has contributed immeasurably to the extensive consumer acceptance Radio Wave is enjoying. Let Marion "specials" give your product the type of critical accuracy that builds consumer confidence.

MARION "SPECIALS" SOLVE YOUR INSTRUMENT PROBLEM

QUICKLY...

ECONOMICALLY...

ACCURATELY!

Marion "special" instruments incorporate the same high quality of materials and precision workmanship common to the standard line of Marion Meters . . . your assurance special order jobs produced by Marion will give the utmost in satisfaction, service and value.

Write *TODAY* for complete information.

There's a Marion Meter for You!

You'll find a meter to fit your specific needs in our complete line of electrical indicating instruments. Marion Glass-to-Metal Truly Hermetically Sealed Instruments are a feature of our standard line . . . cost no more than most unsealed meters . . . are 100% guaranteed.

THE NAME "MARION" MEANS THE "MOST" IN METERS

Export Division
458 Broadway
New York 13, U. S. A.
Cables MORHANEX

In Canada:
The Astral Electric Company
Scarboro Bluffs, Ontario



**MARION ELECTRICAL
INSTRUMENT COMPANY**
Manchester, New Hampshire

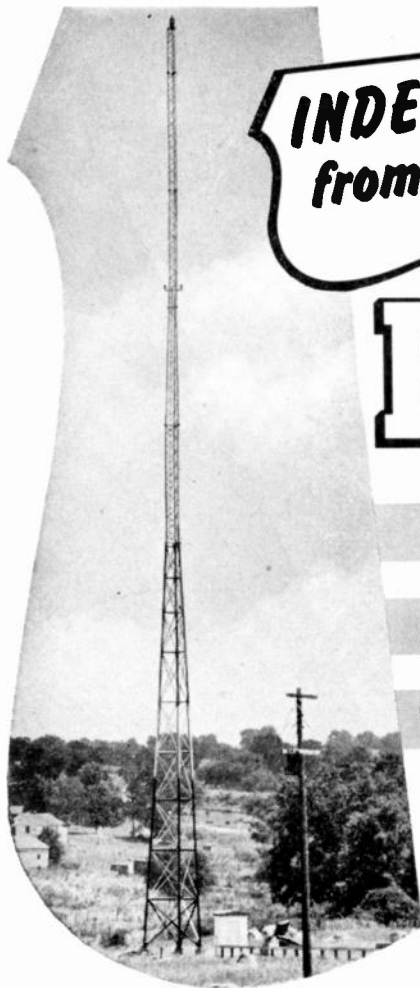

INDEPENDENCE
from Tower Trouble...
 at INDEPENDENCE, MO.

KIMO

**USES A TRUSCON
 SELF-SUPPORTING
 TOWER 187 FT. HIGH**

The scientific design, quality materials and skilled workmanship that were put into KIMO's

Truscon Radio Tower enable it to serve its midwest audience with maximum efficiency.

Truscon experience encompasses every modern radio tower need. There are hundreds of Truscon Radio Towers in America and foreign lands, and each tower exactly meets specific requirements. The knowledge gained from such a wide diversity of installations assures you highly competent engineering service.

Truscon Radio Towers are available in guyed or self-supporting types, either tapered or uniform cross section, for AM or FM broadcasting. Experienced Truscon radio tower engineers will be glad to help solve your radio tower problems of today and tomorrow.

TRUSCON STEEL COMPANY
 YOUNGSTOWN 1, OHIO
 Subsidiary of Republic Steel Corporation

Manufacturers of a Complete Line of Self-Supporting Radio Towers . . . Uniform Cross-Section Guyed Radio Towers . . . Copper Mesh Ground Screen . . . Steel Building Products.



(Continued from page 38A)

KANSAS STATE COLLEGE, I.R.E. BRANCH
 "Industries and Job Opportunities," by L. S. Hobson, Kansas State College; February 4, 1948.

THE COLLEGE OF THE CITY OF NEW YORK, I.R.E. BRANCH
 "High-Voltage Pulse Power Supplies," by P. J. Reich, North American Phillips Corporation; December 16, 1947.
 Election of Officers; January 6, 1948.

NORTH CAROLINA STATE COLLEGE, I.R.E. BRANCH
 "Audio Systems," by D. K. Briggs, Western Electric Company; January 26, 1948.

STANFORD UNIVERSITY, I.R.E.-A.I.E.E. BRANCH
 "Mathematics in the Making," by G. Polya, Stanford University; January 28, 1948.

UNIVERSITY OF TEXAS, I.R.E.-A.I.E.E. BRANCH
 Election of Officers; January 12, 1948.
 "Insurance Liabilities as Related to Industry," by D. Whiffen, State Insurance Board; February 16, 1948.

UNIVERSITY OF UTAH, I.R.E.-A.I.E.E. BRANCH
 "Power Distribution Problems in Utah Valley," by W. Clark, Utah Valley Power Company; January 27, 1948.

"The Westinghouse Training Program," by S. M. Johns, Westinghouse Electric Corporation; February 3, 1948.

"Construction of the Boulder Dam," a film prepared and distributed under the direction of the United States Bureau of Reclamation; February 10, 1948.

UNIVERSITY OF WASHINGTON, I.R.E.-A.I.E.E. BRANCH
 "Professional Society Affiliation," by R. E. Kistler, Pacific Telephone & Telegraph; January 16, 1948.
 Election of Officers; January 16, 1948.



The following transfers and admissions were approved on March 2, 1948, to be effective as of April 1, 1948:

Transfer to Senior Member

- Albrecht, A. P., 4260 Stillwell Ave., Los Angeles, Calif.
- Blom, B. V., 38 Lafayette St., Rumson, N. J.
- Butterworth, J. W., 36 Katz Ave., Paterson, N. J.
- Cox, C. R., 1661 W. 105 St., Chicago 43, Ill.
- Early, H. C., 165 Stein Rd., Ann Arbor, Mich.
- Field, G. S., 53 Fentiman Ave., Ottawa, Ont., Canada
- Greibach, E. H., 80 Pryer Terr., New Rochelle, N. Y.
- Martel, C. W., 3 Sunny Knoll Ave., Lexington 73, Mass.
- Miller, A. C., 213 Buttonwood Way, Glenside, Pa.
- Miller, H. R., 217 Tennessee Ave., N.E., Washington, D. C.
- Osterland, E. H., Mountain Lakes, N. J.
- Rogers, G. F., 129 Moore St., New Hyde Park, L. I., N. Y.

(Continued on page 42A)

"For Unfailing Dependability Give Me OHMITE"

You can be sure the resistors, rheostats, and tap switches you buy will provide accurate, dependable service if they're made by *Ohm-ite*. Every Ohmite product is designed and constructed to stand up under severe operating conditions . . . to give extra performance . . . to withstand the effects of shock, vibration, temperature extremes, altitude, and humidity. This *extra* performance is the reason thousands of particular parts buyers are regular Ohmite customers.

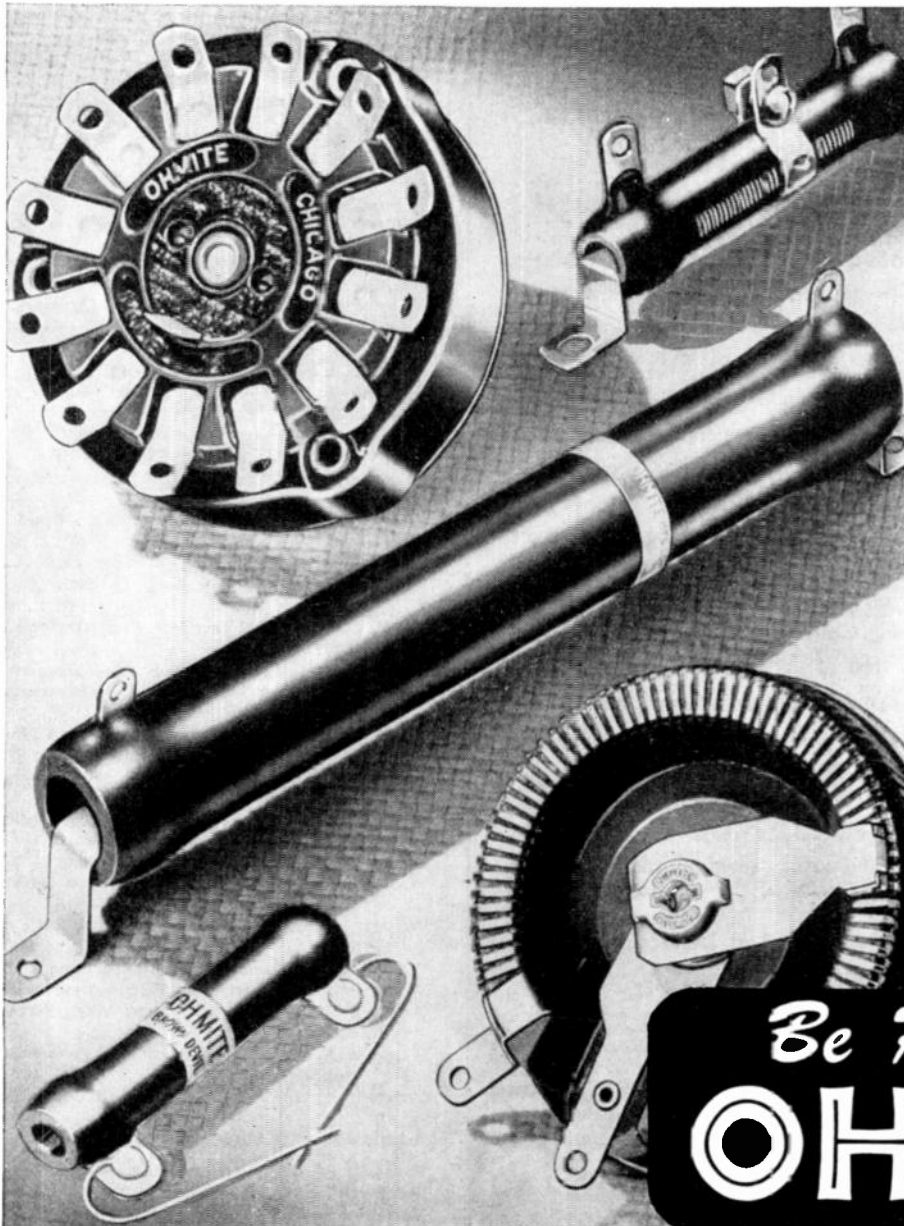

● Close Control RHEOSTATS

All ceramic and metal. Winding is permanently locked in vitreous enamel. Metal-graphite contact brush insures perfect contact with negligible wear on the wire. Available in 10 sizes from 25 to 1000 watts.

● Vitreous-Enameled RESISTORS

Vitreous enamel permanently locks and insulates each turn of wire on ceramic core. Prevents shorts, conducts generated heat away. All types and resistance values from 5 to 1500 watts.

● High Current TAP SWITCHES

Compact, dependable, and convenient to operate. Heavy, one-piece ceramic body is unaffected by arcing. Five models, A.C. ratings 10 to 100 amperes.

Write on Company
Letterhead for
Catalog and Engineering
Manual No. 40



**OHMITE
MANUFACTURING COMPANY**
4860 Flournoy St., Chicago 44, Ill.

Be Right with
OHMITE

RHEOSTATS • RESISTORS • TAP SWITCHES • CHOKES • ATTENUATORS

KFI's NEW 50,000 WATT VERTICAL ANTENNA
750' high, tallest on the West Coast. Erected by IDECO,
this tower is equipped with "Guardian" Tower and
Obstruction Lights.

LOWER Maintenance Costs!

WITH H & P *Guardian* TOWER LIGHTS

"Guardian" 300 mm Tower Lights, Obstruction Lights and Code Flashers, furnished as standard equipment by leading tower manufacturers, are consistently specified by outstanding radio engineers because of dependable performance under every operating condition..

**"Guardians" INCREASE Safety Factor
PROLONG Lamp Life . . . LOWER Maintenance Costs!**

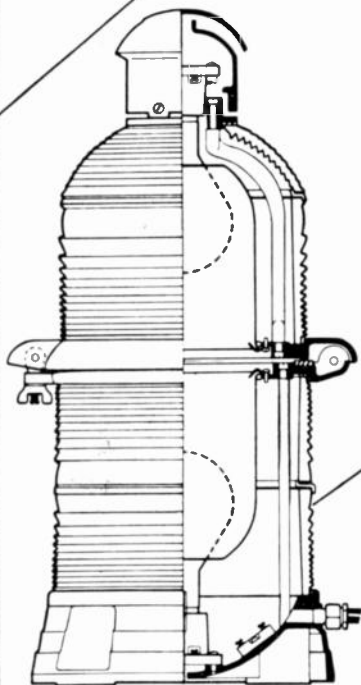

Patented Ventilator Dome circulates the air—reduces internal temperature—increases lamp life. Water cannot enter vents even during most severe rainstorm.

Concave Base with drainage port at lowest point dissipates condensation moisture, prevents short-circuits.

Spun-Glass Shielding on color-screen supports provides glass-to-glass contact with color screens, equalizing contraction and expansion due to temperature changes. Color-screen breakage virtually eliminated.

Recessed Neoprene Gasket and completely concealed center hinge provides **positive protection** against dirt and moisture at this most vulnerable point. Neoprene gaskets used throughout in place of cork. Compounded to last indefinitely.

Improved Locking Device with butterfly clamp maintains secure center seal.

"Guardian" complete lighting kits can be furnished for conduit installation subject to availability, or exposed wiring installations in any quantity.

**SOLD ONLY THROUGH JOBBERS and
TOWER MANUFACTURERS**

HUGHEY & PHILLIPS

326 NORTH LA CIENEGA BLVD.
LOS ANGELES 36, CALIFORNIA

**FOR COMPLETE
INFORMATION
AND NAME OF
NEAREST DEALER
WRITE TO**



(Continued from page 40A)

Speakman, E. A., 2119-B Suitland Terr., S.E.,
Washington 20, D. C.
Thompson, LeRoy, Jr., 526-18 St. So., Arlington,
Va.
Young, L. G., Bell Telephone Laboratories, Inc.,
Deal, N. J.

Admission to Senior Member

Ahmad, Riaz, ATCI Bldg., Willingdon Airport,
New Delhi, India.
Belock, H. D., c/o Reeves Instrument Corporation,
215 E. 91 St., New York, N. Y.
Fife, S. T., University of Louisville, Louisville 8,
Ky.
Fink, L. R., 1149 Millington Rd., Schenectady 8,
N. Y.
Lundstrom, A. A., 62 Fernwood Rd., East Orange,
N. J.
MacWilliams, W. H., Jr., Bell Telephone Labora-
tories, Inc., Whippany, N. J.
Smyth, H. R., 36 Kinnear St., Ottawa, Ont., Canada
Trott, B. S., c/o Garod Radio Corporation, 70
Washington St., Brooklyn 1, N. Y.
Wagner, S. J., 486 South Main St., Bradford, Mass.

Transfer to Member Grade

Bagg, T. C., National Bureau of Standards, Wash-
ington, D. C.
Burke, A. T., 3306 Mission Blvd., San Diego 8,
Calif.
Cameron, J. A., 129 Eddywood St., Springfield 8,
Mass.
Davis, W. C., 3007 Neil Ave., Columbus, Ohio
Dettman, M. C., 9527 Glenwood Rd., Brooklyn 12,
N. Y.
Egenes, O. K., c/o Wireless Station, Klipheuwel,
South Africa
Ellis, W. C., 5648 East Side, Dallas 14, Tex.
Goodyear, W. F., 104 Cherydell Rd., Baltimore,
Md.
Greer, P. A., 17 Spears Ave., Asheville, N. C.
Hart, W. E., 616 Mt. Zoar St., Elmira, N. Y.
Hedrich, A. L., 3712 Second St., S.E., Washington,
D. C.
Horwitz, S. J., 4731 West Schubert Ave., Chicago,
Ill.
Kahgan, J. J., 78 Eighth Ave., Brooklyn 15, N. Y.
Kelk, G. F., 477 Bayview Ave., Toronto, Ont.,
Canada
Littell, C. C., Jr., 222 Lonsdale Ave., Dayton 9,
Ohio
Marshall, F. M., 4280 South 35 St., Arlington, Va.
May, J. C., Dunham Laboratory, Yale University,
New Haven, Conn.
Mayer, R. H., 2728 Brentwood, St. Louis 17, Mo.
Ogg, R. D., 670 Creston Rd., Berkeley 8, Calif.
Pettengill, G. W., 421 Taylor Ave., W. Collings-
wood, N. J.
Rasley, D. R., Farnsworth Television and Radio
Corporation, Fort Wayne 1, Ind.
Smith, C. A., 22 Flower Lane, Roslyn Heights, N. Y.
Wadham, C. W., Patent Office, Lambton Quay,
Wellington, New Zealand
Walters, LeRoy, 8217 Schrider St., Silver Spring,
Md.
Ward, J. W., 36 Marion St., Forestville, Conn.
Weiss, W. I., Sr., 99 Livingston St., Brooklyn, N. Y.
Williams, R. E., 23 Roberts Court West, Ports-
mouth, Va.
Winzemer, A. M., 265 Newcomb St., S.E., Washing-
ton 20, D. C.
Yoder, J. R., 12 Wenzel Terr., Stamford, Conn.

Admission to Member Grade

Brown, H. B., 1733 Vermont St., Lawrence, Kan.
Coleman, E. F., 333 E. 43 St., New York 17, N. Y.
Davidson, G. K., 517 Golden Ave., Ottawa, Ont.,
Canada

(Continued on page 44A)

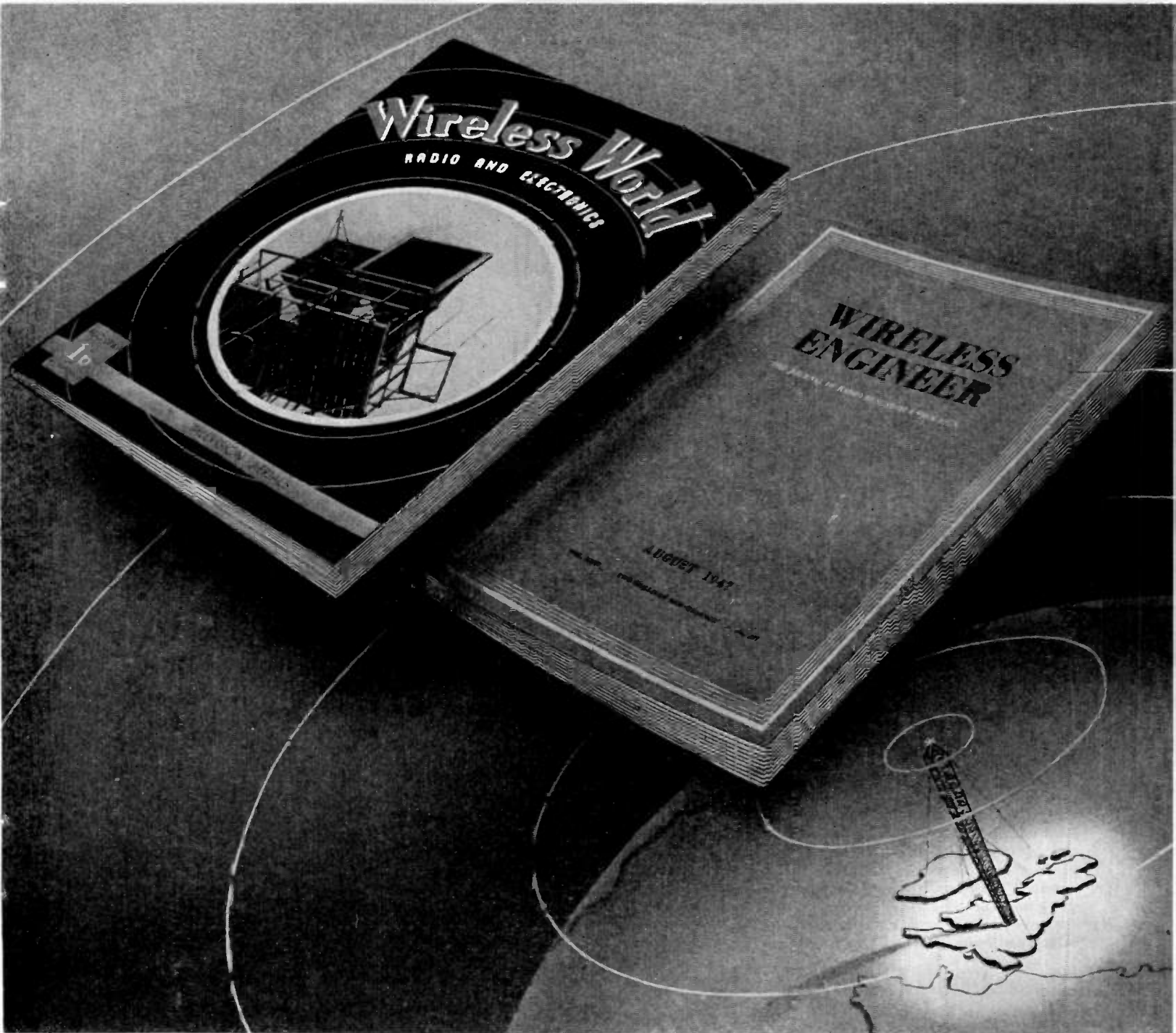

FOR ACCURATE & UP-TO-DATE NEWS OF EVERY BRITISH DEVELOPMENT IN RADIO, TELEVISION & ELECTRONICS

WIRELESS WORLD is Britain's leading technical magazine in the general field of radio, television and electronics. For over 35 years it has consistently provided a complete and accurate survey of the newest British technique in design and manufacture. Articles of a high standard include reviews of equipment, broadcast receivers and components, while theoretical articles deal with design data and circuits for every application.

WIRELESS ENGINEER is read by research engineers, designers and students, and is accepted internationally as a source of information for advanced workers. The Editorial policy is to publish only original work, and representatives of the National Physical Laboratory, the British Broadcasting Corporation and the Engineering Department of the British Post Office are included on the Editorial Advisory Board.

Subscriptions can be placed with British Publications Inc., 150 East 35th Street, New York 16, N.Y., or sent direct by International Money Order to



The Subscription Dept., Iliffe & Sons Ltd., Dorset House, Stamford Street, London, S.E.1, England. Cables "Iliffres. Sedist, London."

ASSOCIATED TECHNICAL BOOKS: "Television Receiving Equipment" (4th Edition), by W. T. Cocking, M.I.E.E. One of the most important British books on television 13 shillings (\$2.60): "Wireless Direction Finding" (4th Edition), by R. Keen, B.Eng. (Hons.), A.M.I.E.E. An up-to-date and comprehensive work on the subject, 45 shillings (\$9.25): available from the British address above.

Want a radio station designed and built?

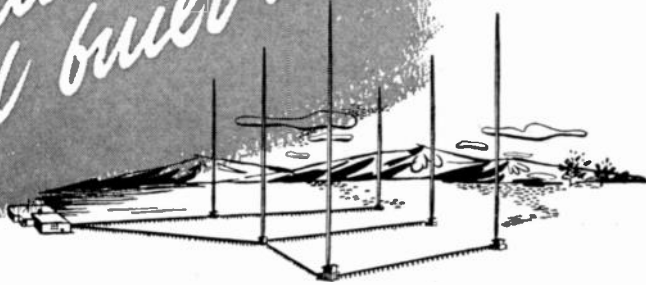

LET Andrew DO IT!

The Monona Broadcasting Company, Madison, Wisconsin, had the money but no station. Faced with "impossible" allocation difficulties, they called on Andrew engineers, who succeeded in finding a frequency and designing a directional antenna system. Thus, WKOW was born. Within ten months after the construction permit was granted, Andrew engineers completely designed, built, tuned, and proved performance of a six-tower 10 kw. station — an unusually difficult engineering feat accomplished in record-smashing time. A complete "package" of Andrew transmission line and antenna equipment was used, again emphasizing Andrew's unique qualifications: Complete

engineering service with unsurpassed equipment.

Mr. Harry Packard, General Manager of WKOW, wrote:

"Speaking for the entire staff of WKOW, I would like to congratulate the Andrew Corporation on the remarkable engineering job it performed in helping us get WKOW on the air."

We feel that the technical perfection of our installation is due in great part to the efficiency of Andrew equipment and engineering service.

In particular we wish to thank Mr. Walt Kean of the Andrew Broadcast Consulting Division who was responsible for conceiving and designing the installation, supervising construction of all antenna equipment, and doing the final tuning and coverage surveys."

A total of 13,618 feet of Andrew transmission line and complete phasing, antenna tuning, phase sampling and tower lighting equipment went into this job, complementing the best in engineering with the ultimate in radio station equipment.

So, just write Andrew when you are ready to enter the broadcasting field. Andrew will get you on the air.

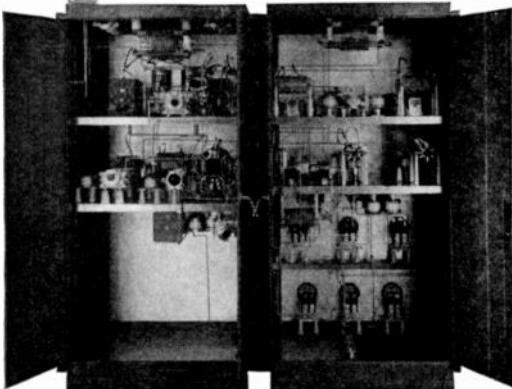

Andrew
CORPORATION

363 EAST 75th STREET · CHICAGO 19

TRANSMISSION LINES FOR AM, FM, TV · DIRECTIONAL ANTENNA EQUIPMENT · ANTENNA TUNING UNITS · TOWER LIGHTING EQUIPMENT · CONSULTING ENGINEERING SERVICE



(Continued from page 42A)

- Fuller, C. M., Box 73, Hato Rey, P. R.
 Gade, C. P., 825 Westcott St., Syracuse 10, N. Y.
 Greer, W. R., 7772 Signal Group, APO 757, c/o Postmaster, New York, N. Y.
 Grimm, A. C., RCA Victor Division, Lancaster, Pa.
 Gulden, W. W., 3154 Brackenwoods Lane, Cincinnati, Ohio
 Halligey, P., 8, Princes Gardens, London, W. 5, England
 Hill, L. P., Headquarters Air Materiel Command, Box 1362, Wright Field, Dayton, Ohio
 Jahrling, R. J., c/o Premier Crystal Laboratories, Inc., 53-63 Park Row, New York 7, N. Y.
 Johnson, W. R., 141 N. Vermont, Los Angeles 4, Calif.
 Jones, J. D., 617 Seventh Ave., Asbury Park, N. J.
 Kriegel, H. C., Box 346, Wharton, Tex.
 Laub, R. E., 2367 North Quebec, Arlington, Va.
 Martin, L. B., 196 Colorado St., Mattapan, Mass.
 Matthews, R. B., 1736 Church St., Wauwatosa, Wis.
 McKirdy, R. W., 21 Ridgecrest East, Scarsdale, N. Y.
 McLean, D. F., c/o Turnbull Elevator Company, Ltd., 126 John St., Toronto 2B, Ont., Canada
 Mort, J., 42, Barn Lane, Golborne, Nr. Warrington, England
 Nachtigall, S., 183 Ocean Parkway, Brooklyn 18, N. Y.
 Newman, R. W., Bldg. 269, General Electric Company, Schenectady, N. Y.
 North, C. W., 909 Elmwood, Evanston, Ill.
 Nuttall, E. D., Box 1407, Shreveport, La.
 Quirk, W. B., So. New England Telephone Company, 227 Church St., New Haven, Conn.
 Rider, D. V., 10 East 40, Kansas City 3, Mo.
 Ryan, H. J., Gen. Del. Box 107, Haskell, N. J.
 Sutton, R. A., 1734 Wroxton Ct., Houston 5, Tex.
 Tucker, S. A., 620 W. 149 St., New York 31, N. Y.
 Warner, D. F., 715 Grand Ave., Syracuse, N. Y.
 Worne, B. E., 64 Pierson Rd. South, Maplewood, N. J.
 Zetekoff, A., 326 Lincoln Pl., Brooklyn, N. Y.

The following admissions to Associate were approved on March 2, 1948, to be effective as of April 1, 1948:

- Abell, C. W., 3561-92 St., Jackson Heights, L. I., N. Y.
 Aberer, J. C., 215 East North Ave., Elmhurst, Ill.
 Anderson, S. E., 1 Napoleon St., Valparaiso, Ind.
 Angwin, B. S., 238 N. Frederic St., Burbank, Calif.
 Arbo, O., Peru 165, Buenos Aires, Argentina
 Barkley, M. M., Sunrise Ave., Trotwood, Ohio
 Barrera, J., San Martin 379, Buenos Aires, Argentina
 Bay, R. J., R.F.D. 1, Elmore, Ohio
 Bedal, G. K., 18 Everett St., Belleville, Ont., Canada
 Bernardi, A. R., 25 Oakwood Ave., White Plains, N. Y.
 Berry, F. W., Joint Staff, Headquarters Alaskan Command, Ft. Richardson, Alaska
 Blight, A. F., Jr., 7363 W. Manchester Blvd., Los Angeles 45, Calif.
 Boyes, W. E., Sandia Base Branch Post Office, Albuquerque, N. Mex.
 Burns, M. C., 335-21 St., Richmond, Calif.
 Buttler, J. L., 203-B South John St., Angola, Ind.
 Calobrisi, P. A., 8783-16 Ave., Brooklyn 14, N. Y.
 Caprara, L., 900 West Maumee St., Angola, Ind.
 Cavileer, F. E., 2812 North 9 St., Philadelphia 33, Pa.
 Chaikin, M., 21 Schenck Ave., Great Neck, L. I., N. Y.
 Church, R. W., 78-40-86 St., Glendale 27, N. Y.
 Cohen, M., 1337 Randolph St., N.W., Washington 11, D. C.

(Continued on page 46A)

Do Radio Engineers Know What You Make?



Now—A Radio Engineer's Directory

MARKET

Radio Engineers control the technical buying of a two-billion-dollar radio-electronic and radar market. These men alone are competent to do the specifying and purchasing of complicated radio tubes, components, and materials that only a trained and experienced engineer really understands.

More than 15,000 radio-and-electronic engineers and engineers in training, will receive and use the 1948 I.R.E. Yearbook. This membership roster and radio product index has a close personal relationship to each engineer because it lists the reader himself and his fellow members in the radio profession. It is his own property with a permanent place on his desk — at his fingertips, a reference to both friends and radio-product data he needs and wants.

FEATURES

- Complete membership list of The Institute of Radio Engineers.
- An alphabetical list of over 2000 firms serving the radio-electronic industry, with addresses, and —
- Names of the chief engineers of most of these firms, plus,
- Coding for 25 basic product classifications of each.
- Detailed product classifications (more than 100 headings) for all kinds of radio-electronic components and equipment listed for the firms advertising in the Yearbook.
- **PRODUCT ADVERTISING** of equipment and component-parts manufacturers, displaying and giving specifications for their products and providing engineering data.

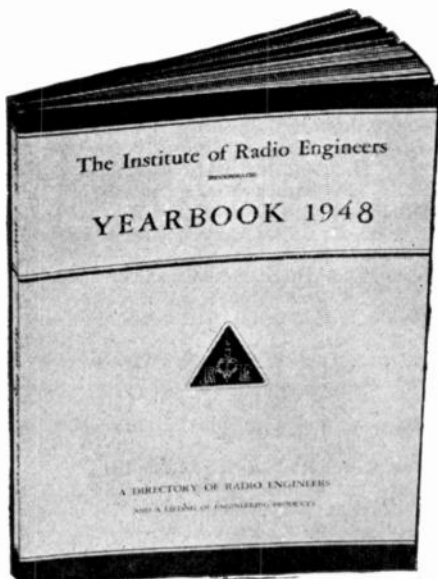

RATES			For "Proceedings of I.R.E. Contract Advertisers"	
Space	Rate	Size	6 Times	12 Times
1 page	\$250.	7" x 10"	\$225.	\$200.
3/4 page	180.	4 5/8" x 10"	160.	140.
1/2 page	100.	{ 2 1/4" x 10" { 4 1/2" x 4 7/8"	90.	80.
1/4 page	60.	{ 2 1/4" x 4 7/8" { 4 5/8" x 2 3/8"	55.	50.

Agency Discount 15%. Cash Discount 2% 10 days.

IMPORTANT!

Deadline April 20 for last forms

For further information write:

William C. Copp

THE INSTITUTE OF RADIO ENGINEERS

Adv. Dept., 303 West 42nd St., New York 18, N.Y.

Chicago Representative, Scott Kingwill, 35 East Wacker Drive, Chicago 6

West Coast Representative, The Willson Co., 412 West Sixth St., Los Angeles 14



The MAGIC of VHF

OMNI-DIRECTIONAL RANGES
RUNWAY LOCALIZERS
VISUAL-AURAL RANGES
SIMULTANEOUS VOICE
GCA

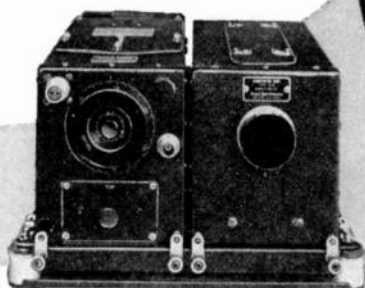

All the outstanding advantages of VHF communication and navigation are combined in two new Systems designed and manufactured by Aircraft Radio Corporation.

THE TYPE 15A VHF OMNI-DIRECTIONAL RANGE RECEIVING SYSTEM

provides an unlimited number of courses from the new VHF Omni-Directional Ranges, as well as operation on VHF Runway Localizers and Visual-Aural Airways Ranges. Simultaneous voice feature is included on these ranges. The *tunable* A.R.C. Receiver makes it possible to receive VHF communications on any frequency selected while in flight — no need for several receivers to cover the entire VHF band.

THE TYPE 18 VHF TRANSMITTING SYSTEM normally is used in

combination with the Type 15A to provide complete 2-way VHF Communication—or it may be used alone for dependable, powerful VHF Transmission. Additional transmitters may be added to cover a wider range of frequencies if such coverage is required.

Units of the type 18 System have been Type-Certificated by the CAA for use by scheduled air carriers. Yet their light weight and moderate cost make them ideally suited to the operational requirements of executive-type aircraft. Other combinations of A.R.C. equipment are available to meet every operational need.

The dependability and performance of these VHF communication and navigation systems spells increased safety in flight, more efficient aircraft operation. Specify A.R.C. for your next installation.



Membership

(Continued from page 44A)

- Costa, E. F., Jovellar No. 16, Apt. No. 7, Havana, Cuba
- Craig, G. H., Box 251, College Station, Tex.
- Craig, L. E., 3703 N. Harding Ave., Chicago 18, Ill.
- Crowe, F. S., Jr., 702 Danforth St., Syracuse 8, N. Y.
- Cunningham, H. W., 1812 Mound, Springfield, Ohio
- Davenport, E. J., 278 Cottage St., Bridgeport, Conn.
- Davis, D. A., Chester Rd., R.F.D. 1, Verona, Pa.
- Davis, F. W., 554 Park Ave., Huntington, L. I., N. Y.
- Deal, B. W., Box 203, Norris, Tenn.
- DeBrosse, K. L., 417 Brightwood Ave., Dayton 5, Ohio
- DeClerck, C. E., 142-33—58 Ave., Flushing, L. I., N. Y.
- D'Emidio, B., 327 Washington St., Bristol, Pa.
- Denny, C. R., National Broadcasting Company, Rockefeller Plaza, New York, N. Y.
- Densem, A. N., 1102 E. Fulton St., Grand Rapids, Mich.
- DeTanti, A. E., Bernardo de Irigoyen 1508, Buenos Aires, Argentina
- Edwards, P. L., 107—10 St., N.E., Washington, D. C.
- Ellis, C. R., 116 Pammel Ct., Ames, Iowa
- Farnsworth, R. L., 728 N. Pine Ave., Chicago 44, Ill.
- Frantz, S. G., 64 Battle Rd., Princeton, N. J.
- Friedland, S., 363 Victory Blvd., Staten Island, N. Y.
- Fulmer, J. A., 14 West Vernon Lane, Ft. Thomas, Ky.
- Grill, C., 2399 Grand Concourse, New York 53, N. Y.
- Groder, M. L., 2003 E. 12 St., Brooklyn 29, N. Y.
- Gudis, R. S., 6800 No. 9 St., Philadelphia 26, Pa.
- Guerrini, J. G., 124 Lincoln Ave., Torrington, Conn.
- Halbrooks, C. N., 1121 New Hampshire Ave., Washington, D. C.
- Hall, R. C., 2820 Bellaire Blvd., Houston 5, Tex.
- Hinkle, N. G., 210 Walnut Ave., Cranford, N. J.
- Hoffman, H. L., 125 E. 23 St., New York 10, N. Y.
- Hoffman, M., American Television Laboratories, 5050 N. Broadway, Chicago 40, Ill.
- Hunter, P. H., 1015 Sherwood Dr., Winston-Salem, N. C.
- Insley, D. T., 120 W. Schiller St., Chicago 10, Ill.
- Ishii, F. K., 797 E. Broadway, Stratford, Conn.
- Jefferson, G., Box 1023, Anchorage, Alaska
- Jeffery, T. A., 6334 So. Ellis, Chicago 37, Ill.
- Jones, A. C., 20 West 35, Wilmington, Del.
- Katre, V. S., c/o K. S. Rao, M.A., 3-Palit St., Ballygaunge, Calcutta 19, India
- Kelly, R. W., 421 Lake St., Waukesha, Wis.
- Kennedy D. T., Connaught Garden Post Office, Aylmer East, Que., Canada
- King, R. L., Jr., 2129 Oak St., Los Angeles 7, Calif.
- Kistner, H. R., 421 Fifth St., Toledo 5, Ohio
- Kuba, R. E., 110 E. Hancock, Detroit 1, Mich.
- Legault, E. G., 4845 Park Ave., Montreal, Que., Canada
- Lehr, L. R., 5329 W. Galena St., Milwaukee 8, Wis.
- Lisandi, O. A., Freire 4876, Buenos Aires, Argentina
- Lob, C. G., Dept. 950, RCA Laboratories, Special Development Group, Lancaster, Pa.
- Lukowski, G. L., 1638 N. Bell Ave., Chicago 47, Ill.
- Maguire, N. L., 434 North Maple, Albuquerque, N. Mex.
- Mason, C. A., Radar and Communications School, R.C.A.F., Clinton, Ont., Canada
- Medina, S. P., Escobar 2330, Buenos Aires, Argentina
- Meltzer, H. S., 1 W. 85 St., New York 24, N. Y.
- Merzbacher, A. A., 103 W. 91 St., New York 24, N. Y.
- Mik, O. C., San Martin 379, Buenos Aires, Argentina
- Mills, C. W., 319 Fifth St., Angola, Ind.
- Mitchell, R. M., 3621—210 St., Bayside, L. I., N. Y.
- Muckley, M., 969 First Ave., New York, N. Y.
- Naumburg, W. Jr., 276 Fourth Ave., New York, N. Y.

(Continued on page 48A)



**EXPERIENCE
PLUS
COOPERATION
*DOES IT!***

There's a lot of satisfaction in working with radio engineers who know exactly what they need to get top efficiency from the transmitter. To their specifications Blaw-Knox applies an experience in antenna tower building that dates back to the days of "wireless" . . . Together we get results that reflect credit on our structural designers and the station's technical experts . . . If your plans call for more effective coverage or directional changes we would welcome an engineering interview at your convenience.

BLAW-KNOX DIVISION

OF BLAW-KNOX COMPANY
2037 FARMERS BANK BUILDING
PITTSBURGH 22, PA.

◀ Blaw-Knox 550' Heavy Duty Type H40 Tower supporting a Federal 8 square loop FM antenna 74' high. Station WTMJ-FM, Richfield, Wisconsin.

BLAW-KNOX ANTENNA TOWERS

THE COMPLETE RADIO HANDBOOK

1000 pages

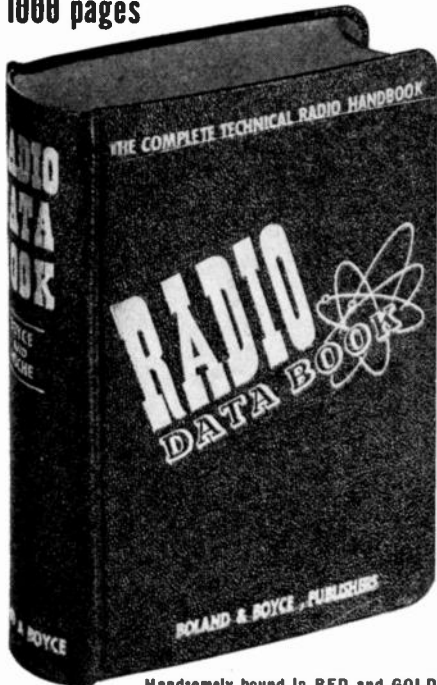

Handsome bound in RED and GOLD

All data and basic knowledge at your fingertips digested into 12 sections . . . in a complete, quick to find, easy to read, handbook form.

Plan every operation in radio and electronics with the Radio Data Book. This new radio bible will be your lifelong tool . . . you will use it every day, on the board, at the bench, in the field! Use it for engineering, construction, trouble-shooting and testing. The RADIO DATA BOOK will be your invaluable aid in design, experiment and in layout. It will help make your production better, faster and easier. In any and every operation in radio and electronics, you will use the RADIO DATA BOOK! The RADIO DATA BOOK is a work of complete authority, prepared by engineers with many years of practical experience. They have been assisted by the Boland & Boyce staff of editors skilled in preparing electronics manuals for the U. S. Signal Corps for many years. These men have worked for several years gathering material for this book . . . all the knowledge of radio principles and operation . . . all the statistics . . . all the newest developments in electronics . . . every possible angle and detail. Eighteen months were spent digesting this material into the most concise, the clearest, and the most readable form. The result is this invaluable manual . . . The RADIO DATA BOOK. Whether you use this book for general reference, for scientific instruction, or for education, one thing is certain—the practical help, the daily usefulness you will derive from it will prove to be worth many, many times its astonishingly low price!

Advanced Sale . . . first printing. Only 10,000 available. To make sure to get your RADIO DATA BOOK, mail your order NOW!

12 sections . . . 1000 pages . . . Completely Illustrated

Section 1. THE 150 BASIC CIRCUITS IN RADIO.
Section 2. COMPLETE TEST EQUIPMENT DATA.
Section 3. TESTING, MEASURING AND ALIGNMENT.
Section 4. ALL ABOUT ANTENNAS.
Section 5. SOUND SYSTEMS.
Section 6. RECORDING.
Section 7. COMPLETE TUBE MANUAL.
Section 8. CHARTS, GRAPHS AND CURVES.
Section 9. CODES, SYMBOLS AND STANDARDS.
Section 10. 50 TESTED CIRCUITS DESIGNED FOR OPTIMUM PERFORMANCE.
Section 11. DICTIONARY OF RADIO AND ELECTRONIC TERMS.
Section 12. RADIO BOOK BIBLIOGRAPHY.

12 complete books in one only **\$5.00!**
Less than 42c per book!

MAIL THIS COUPON TO YOUR JOBBER TODAY OR DIRECT TO: IRE-4
BOLAND & BOYCE INC., PUBLISHERS
460 BLDDMFIELD AVE., MDNTCLAIR 4, N. J.
Please send me a copy of THE RADIO DATA BOOK. Enclosed is \$5.00.

NAME _____
ADDRESS _____
CITY _____ ZONE _____
STATE _____

BOLAND & BOYCE INC., PUBLISHERS

Membership

(Continued from page 46A)

- Neary, J. F., 298 Richmond Ave., South Orange, N. J.
Neher, B., 3112 York St., Des Moines 16, Iowa
Newell, G. R., 55 Kinderhook St., Randolph, Me.
Nixon, I. H., 143 Royal York Rd. North, Toronto, Ont., Canada
Pearlman, L., 202 Snediker Ave., Brooklyn 7, N. Y.
Peedo, E., Sodra Kungsvagen 104, Lidingo 2, Sweden
Picard, A., Virrey Melo 2065-5°C., Buenos Aires, Argentina
Pitts, M. J., Alexandria, S. Dak.
Rahnert, R. G., 6012 N. Navarre Ave., Chicago 31, Ill.
Rao, D. L. Narasimha, Garden Rd., Kilpauk, Madras, S. India
Rathjen, J. C., 9th Floor, City Hall Bldg., Kansas City 6, Mo.
Regnier, L. A., 231 Delaware Ave., Dayton 5, Ohio
Reiner, J. A., 36 Lincoln Rd., Hempstead, L. I., N. Y.
Richter, L., 2486 No. Clark St., Chicago 14, Ill.
Riege, P. H., 1517 E. 69 Pl., Chicago 37, Ill.
Roberts, C. A., 100 Cumberland Ave., Southend on Sea, Essex, England
Rogers, C. E. Jr., 717 Santander Ave., Coral Gables, Fla.
Root, V. B., 2139 Addison Rd., Houston, Tex.
Samuelian, B., 1692 Washington Ave., New York 57, N. Y.
Sarma, G. V., c/o G. Srirama Sastri, 272 Thippara-juvuri St., Nellore Post Office, South India
Sarquis, R. H., Box 355, R.F.D. 4, Visalia, Calif.
Sauber, P. T., 4136 Lexington Place, Seattle 8, Wash.
Schneider, H. U., 40 E. Main St., Columbus 15, Ohio
Semenhuk, M. H., 1092 E. 143 St., Cleveland 10, Ohio
Shearer, S. L., 250 N. E. 104 St., Miami 38, Fla.
Sheridan, C. J., 426 So. Jackson St., Bluffton, Ohio
Shirley, G., 484 W. 238 St., New York 63, N. Y.
Simonton, L. J., 1879 Newton St., N.W., Washington, D. C.
Smith, C. B., 1315 E. 49 St., Kansas City 4, Mo.
Smith, J. L., 1325 No. Hunter, Stockton, Calif.
Thomas, R. K., 49-09 Hanford St., Douglaston, N. Y.
Thompson, L. G., 1445 Erving Ct., Willow Run Village, Mich.
Trueblood, D. B., 313 N. James, Goldsboro, N. C.
Unger, R. J., 660 St. Anns Ave., New York 55, N. Y.
Walen, R. S., Arthur D. Little, Inc., 30 Memorial Dr., Cambridge 42, Mass.
Walker, K. E., Box 172, R.F.D. 2, Hamilton, Ind.
Wenning, W. B., 388 High Ridge Rd., Stamford, Conn.
White, J. G., 700 W. 175 St., New York 33, N. Y.
Womack, J. R., 1028 Euclid Ave., El Centro, Calif.
Yuenger, R. L., 114-48-178 St., St. Albans 13, N. Y.
Yunk, G. W., 1914 Harvard Dr., Louisville 5, Ky.

THESE EXTRA SMALL COIL FORMS FIT INTO TIGHT PLACES



Graphs show frequency ranges covered by the five standard sizes of LSM and LS3 Coils. Write for full-size copies.

If small space is your problem — as in peaking coils in strip amplifiers, chokes, R. F. coils, oscillator coils, single-turned I. F. coils, etc.—you'll find space-saving one of many advantages in CTC Slug Tuned Coil Forms.

Coil forms are of quality paper-base phenolic, high frequency grade. Mounting bushings and ring-type terminals are brass, the bushings cadmium plated and terminals silver plated. Necessary mounting hardware is supplied.

DIMENSIONS

LSM — Extreme small size; only 27/32" high when mounted; coil form, 1/4" diameter; mounts in single #18 hole; mounting bushing has 8-32 thread.

LS3 — Moderate small size; 1 1/8" high when mounted; coil form, 3/8" diameter; mounts in single 1/4" hole; mounting has 1/4-28 thread.

WINDINGS

CTC LSM and LS3 Coil Forms are available unwound or in any of five standard windings: 1, 5, 10, 30 and 60 megacycles. They are also wound to specifications. (Standard slug is high-frequency type.) CTC will custom-engineer special coils of practically any size and winding . . . Let us talk over your requirements.



CAMBRIDGE THERMIONIC CORPORATION
456 Concord Avenue, Cambridge 38, Mass.

PROCEEDINGS OF THE I.R.E. April, 1948



TIME-SAVERS ON THE ASSEMBLY LINE

FOR MANY A MANUFACTURER, parts and sub-assemblies of Taylor Laminated Plastics save time on the production line . . . because they can be fabricated with such precision that inspection is speeded, rejects reduced, and assembly accelerated.

Are you interested in making your own parts of Phenol Fibre, Vulcanized Fibre, or special laminates? Taylor can supply you with sheets, rods, or tubes . . . and with helpful assistance in fabrication.

Are you seeking a dependable source of supply for parts fabricated to your specifications? Taylor's Fabricating Service is ready to solve your problem, with on-schedule de-

liveries of precision-made parts possessing the exact physical and electrical characteristics you require.

It will pay you to find out, now, what Taylor can do for you. Please make your inquiry as specific as you can . . . including, if possible, a sketch or blueprint. Our engineers will give it their immediate attention.

Samples illustrated, from top to bottom:

Terminal plate, punched from Phenol Fibre sheet.

Pulley, machined from Vulcanized Fibre sheet.

Switch back plate. Phenol Fibre.

End lamination for small motors. Vulcanized Fibre.



TAYLOR FIBRE COMPANY

LAMINATED PLASTICS: PHENOL FIBRE • VULCANIZED FIBRE • Sheets, Rods, Tubes, and Fabricated Parts
NORRISTOWN, PENNA. • Offices in Principal Cities • Pacific Coast Plant: LA VERNE, CAL.

DEVELOPMENT ENGINEERS WANTED

Requirements are a thorough knowledge of principles and three or more years of experience in the development of new electronic equipment in the communication or radar fields.

Enlargement of staff creates several openings with opportunity for advancement in long-established company. Laboratories and plant situated in pleasant, open surroundings on Long Island within half-hour of Times Square, New York.

Write details of education and experience (all inquiries confidential) to

Director of Engineering Personnel

HAZELTINE ELECTRONICS CORPORATION

Little Neck, L.I., N.Y.

LOS ALAMOS SCIENTIFIC LABORATORY

Has present need for physicists of Ph.D. grade with research and development experience in various phases of nuclear physics, electronics, optics, and physical chemistry. Both field and laboratory experimentation involved, depending on interests and capabilities. Also included is design and development of special laboratory electronic, mechanical and optical apparatus. Interviews at project expense can be arranged for qualified applicants.

Write direct to Employment Director, P.O. Box 1663, Los Alamos, New Mexico for further particulars, giving brief résumé of education and experience.



The following positions of interest to I.R.E. members have been reported as open. Apply in writing, addressing reply to company mentioned or to Box No. . . .

The Institute reserves the right to refuse any announcement without giving a reason for the refusal.

PROCEEDINGS of the I.R.E.

1 East 79th St., New York 21, N.Y.

ELECTRONIC THEORIST

Our New York laboratory is seeking an electrical engineer or physicist to carry on theoretical investigations of problems associated with vacuum tubes, thermions and microwave equipment and to interpret theoretical developments in terms of experimental results. M.S. or equivalent in experience in the field of thermions and microwave engineering desired. Send résumé outlining age, education, experience, salary requirements to: Supervisor of Employment, Industrial Relations Department, Sylvania Electric Products, Inc., 40-22 Lawrence Street, Flushing, N.Y.

MECHANICAL DESIGN ENGINEER

Having experience in quantity production of small metal stampings and component assemblies. Pleasant working conditions with electronics equipment manufacturer in small Minnesota town. Box 493.

ELECTRONIC CIRCUIT ENGINEERS

For design, construction and test of electronic circuit components and systems in forms suitable for field operation of a complete electronic field installation. Ingenuity, imagination and capable theoretical inclinations suitable for research laboratory work are desired. Send résumé outlining age, education, experience and salary requirements to: Supervisor of Employment, Industrial Relations Department, Sylvania Electric Products, Inc., 40-22 Lawrence Street, Flushing, New York.

ELECTRONIC ENGINEERS

Unusual opportunities for senior engineers experienced in recording sound on film and magnetic tape recording; microwave-antennae, wave guides, mixers, cavity resonators; receiver engineer-design experience in broad band receivers. Radar preferred. Two or three years experience in U.H.F. work. Outstanding opportunity for top flight men with small aggressive company. Write Melpar, Inc., Employment Section, 452 Swann Ave., Alexandria, Virginia.

ELECTRONIC ENGINEERS

Opportunity for experienced electronic engineers in established and expanding development company. We design and produce electronic controls and computer equipment. Contact Electronic Associates, Inc., Long Branch, New Jersey. Telephone: L.B. 6-1100. Att: Mr. Arthur L. Adamson.

DEVELOPMENT ENGINEER

Development engineer needed to design and develop electronic instruments for research work. Excellent opportunity for a

(Continued on page 52A)

Engineers—Electronic

Senior and Junior, outstanding opportunity, small growing company. Forward complete resumé giving education, experience and salary requirements to

Box 509

The Institute of Radio Engineers
1 East 79th St., New York 21, N.Y.

Physicists — Electronic Engineers Needed For Research and Development Laboratory

Interesting opportunities for qualified GRADUATE ENGINEERS with ELECTRONIC RESEARCH, DESIGN and/or DEVELOPMENT experience.

Please furnish complete resume of education, experience and salary expected to Personnel Manager

**BENDIX RADIO DIVISION of Bendix Aviation Corporation
BALTIMORE 4, MARYLAND**

VARIABLE VOLTAGE

with

POSITIVE PROTECTION

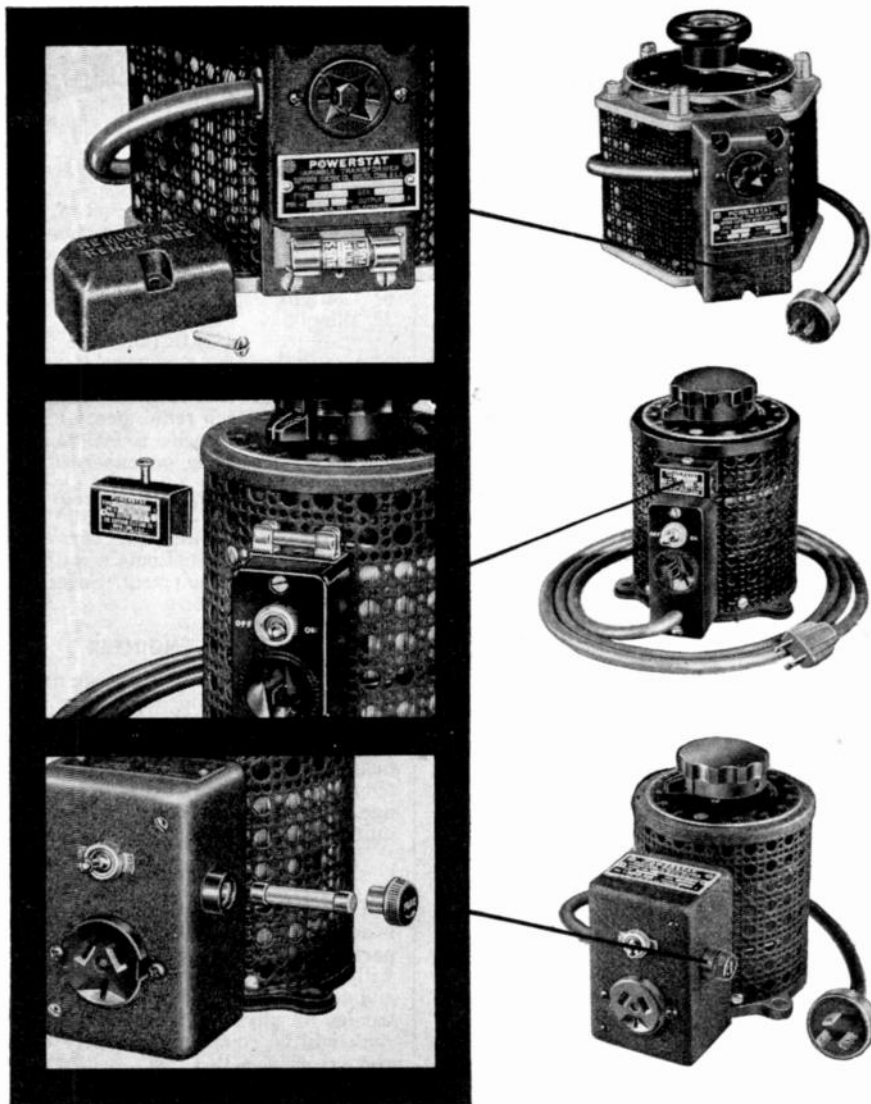

A POWERSTAT is the only variable transformer of comparable design that offers a fuse in the output circuit for user and instrument protection. This fuse is conveniently located on the terminal board of POWERSTATS of one and two KVA ratings and provides insurance against large loads or shorts ruining expensive equipment or burning out the POWERSTAT. This is only one of many features that makes POWERSTAT variable transformers the most desirable equipment where dependable, continuously adjustable a-c voltage is required.

POWERSTAT variable transformers are rugged, quality manufactured controls that can be adapted easily to fit any and all variable voltage a-c requirements . . . offering over 50 possible combinations of connections and voltages for single or three phase operation and featuring:

- EXCELLENT REGULATION
- EASY INSTALLATION
- RUGGED MECHANICAL CONSTRUCTION
- HIGH EFFICIENCY
- ZERO WAVEFORM DISTORTION
- SMOOTH CONTROL

Rely on the experience of The Superior Electric Company's staff of voltage control engineers to help solve your voltage control problems.

An engineering data catalog, Bulletin 547, is available on request.

Write The Superior Electric Co.
804 Meadow St., Bristol, Conn.



Powerstat Variable Transformers ● Voltbox A C Power Supply ● Stabiline Voltage Regulators.

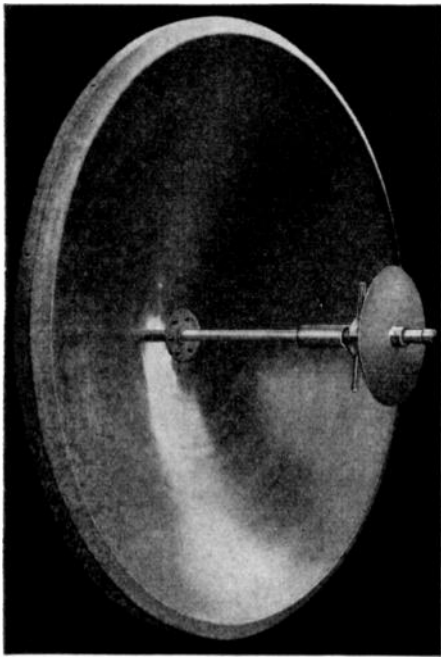

PARABOLIC ANTENNAS

FOR

- FM and AM Studio-to-Transmitter Link
- Television and Facsimile Relay Work
- Multi-channel Point-to-Point Relay
- Research and Development Laboratories

The Workshop can supply parabolic antennas in a wide range of types, sizes and focal lengths, plus a complete production and engineering service on this type of antenna.

Workshop test equipment and measurements for the determination of antenna characteristics is outstanding in the industry. These facilities, coupled with the wartime experience of its engineers on high frequency antennas, assure exceptional performance.

PARABOLAS — Precision-formed aluminum reflectors. Can be supplied separately, if desired.

MOUNTINGS — Various types of aluminum reinforced mountings can be supplied with all antennas.

R. F. COMPONENTS — Precisions machined and heavily silver plated. Critical elements protected by low-loss plastic radome.

PATTERN AND IMPEDANCE DATA — A series of elaborate measurements of both pattern and impedance are made to adjust the settings for optimum performance. Pattern and impedance data is supplied with each antenna.

POLARIZATION — Either vertical or horizontal polarization can be obtained easily by a simple adjustment at the rear of the reflector.

SPECIAL ANTENNAS — Parabolas can be perforated to eliminate wind resistance or sectioned to produce a specified antenna pattern.

OTHER ANTENNAS — FM and television receiving antennas. A complete line of amateur antenna equipment.

Prices on Request

The Workshop invites your inquiry on any type of high frequency antenna problem — no obligation. Write, or phone Boston, BIGelow 3330.

The WORKSHOP ASSOCIATES, Inc.
66 NEEDHAM STREET
Newton Highlands, Massachusetts



(Continued from page 50A)

man with a degree and practical experience in test equipment construction. Write giving full details of education and experience to Personnel Office, University of Chicago, 956 E. 58th Street, Chicago 37, Illinois.

INSTRUCTOR

Southwestern church-related university. Man with Master's degree and teaching experience to teach radio theory and electronics. Salary range: \$3,000-\$3,300 for 9 months, depending on experience. Box 505.

ELECTRONICS ENGINEER

Electronics engineer for carrier telephone work by a St. Louis manufacturer of public utility equipment. Several positions open. Box 506.

SENIOR ENGINEER

Fine opportunity with a large midwestern radio corporation. Must have a minimum of three years' experience in loud-speaker design and materials used in manufacturing. College education in electronics or equivalent. In replying state age, education, experience and salary requirements. Box 507.

ENGINEERS

Technical college in northern New York is adding several staff members to the Department of Electrical Engineering. Men with some experience in research or design and development in communications—electronics or physics preferred. Salary and rank will be commensurate with training and experience. Box 508.

ELECTRONICS ENGINEER

Graduate electronics engineer, experienced in the application of electronic controls on airborne equipment. Some production and development experience is essential. In reply, give training, experience and other pertinent facts. Box 510.

ENGINEER

Engineer—Transformer (power, audio and pulse). Thoroughly familiar with electronic circuits; production methods. Contact customers for technical purposes. Location about midway between New York and Chicago. Box 511.

ELECTRICAL ENGINEERS

Wanted: Electrical engineers with B.S. degree or equivalent experience for engineering application and operational work with electronic equipment—company conducting airborne geophysical surveys involving extensive United States or foreign travel—bonus for flying and overseas duty. Box 512.

MICROWAVE ENGINEERS

Engineers or physicists for research and development in microwave field. Bachelor's degree essential, Master's degree preferred. Positions open at both senior and junior levels. Salary commensurate with ability. Company has long term program and offers excellent working conditions including opportunity for advanced study. Location Brooklyn, N.Y. Give complete information in reply. Box 513.

Improved PRESSURE TRANSDUCER

The improved type 4512 Giannini Pressure Transducer is smaller and lighter than standard instruments. This instrument combines smaller size with high outputs and accurate readings. Even of low pressures, it retains all of its accuracy.

This absolute, differential, or gauge-type Pressure Transducer is available in ranges up to 40 psi. The new type 4512 is available for immediate delivery.



Write for engineering details.

Giannini & CO INC

REACTION POWER PLANTS • AUTOMATIC FLIGHT EQUIPMENT
285 WEST COLORADO STREET • PASADENA 1, CALIFORNIA

WANTED PHYSICISTS ENGINEERS

Engineering laboratory of precision instrument manufacturer has interesting opportunities for graduate engineers with research, design and/or development experience on radio communications systems, electronic & mechanical aeronautical navigation instruments and ultra-high frequency & microwave technique.

WRITE FULL DETAILS

TO

EMPLOYMENT SECTION

SPERRY GYROSCOPE

COMPANY, INC.

Marcus Ave. & Labville Rd.
Lake Success, L.I.

Now

is your OPPORTUNITY TO BUY TUBES

at *Ridiculously Low Prices*
Transmitting - Special Purpose
 Every tube is *Brand New* in original unbroken factory package



Magnetron - 2J38 w/magnet

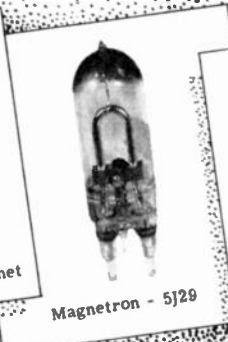

Magnetron - 5J29



Rectifier - 250R



Transmitting - GL434A

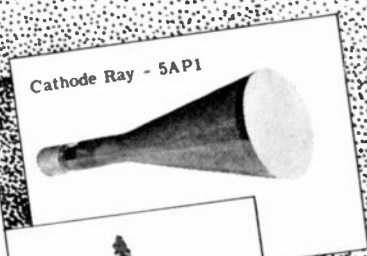

Cathode Ray - 5AP1

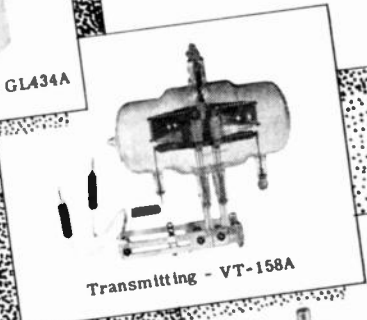

Transmitting - VT-158A

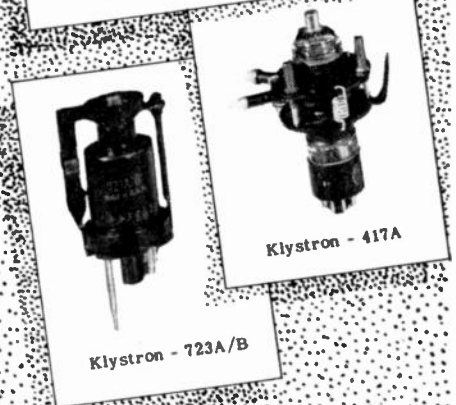

Klystron - 417A

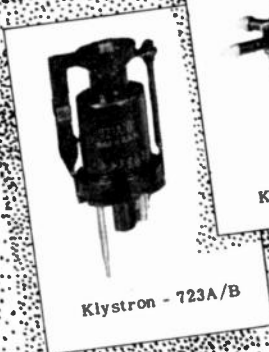

Klystron - 723A/B

Magnetrons		Klystrons	
2J22	\$15.95	417A	\$9.80
2J38 w/magnet	15.95	723A/B	3.95
2J48	15.95	726A	4.75
4J26	15.95		
5J23	15.95		
5J29	15.95		
714AY	9.80		
725A	12.50		

Cathode Ray		Rectifiers	
3CP1/S1	\$2.95	CRP-72	\$2.95
5AP1	2.95	250R	4.95
5JP2	3.95	WL531	29.95
12GP7	12.50	866A/866	.98
		WL869B	29.95
		1641/RK60	.85

Receiving		
VT-25A	(Special 10)	.69
VT-52	(Special 45)	.69
6J6	Twin Triode	.69
717A	(6AK5 w/octal base)	.98
9002	Miniature UHF Triode	.95

Special Purpose		
1B24	T-R Tube	2.95
724B	Spark Gap Tube	1.95
2051	Thyratron	.50
"	" (in lots of 100) ea	.35
VR-150	Voltage Regulator	.69
6AMP	Tungar Rectifier	3.00

Transmitting		
2C22	UHF Triode	\$7.99
5D21	Tetrode	9.95
15E	UHF Triode	2.95

24G	UHF Triode . Plate Diss. 25W . 2000V at 75 ma . good up to 300 Mc .	.69
-----	---	-----

VT-158A	UHF Triode with Tuned Circuits Built-in	4.90
388A	Door Knob Triode	4.95
GL434A	Lighthouse	7.95
GL446A	Lighthouse (2C40)	.74
WL530	Water Cooled Triode	39.50
715B	Tetrode	9.95

804	Pentode	3.75
807	Beam Power Tetrode	1.19
813	Beam Power Tetrode	6.95
829	Beam Power Tetrode	2.95

841	Triode	.69
1625	Beam Power Tetrode	.49
1626	Low Drift Osc. Triode	.49
7193	UHF Triode	.39
8011	(VT-90) Micro-Pup	.98

TERMS - Orders under \$3.00, cash with order; orders over \$3.00 require 20% deposit, balance C.O.D.

ALL PRICES ARE NET, F.O.B. DAYTON, O.

Everything in Electronics

SREPCO

STANDARD RADIO & ELECTRONIC PRODUCTS CO.
 135 E. SECOND ST. DAYTON 2, OHIO.

Don't Delay - Order Today!

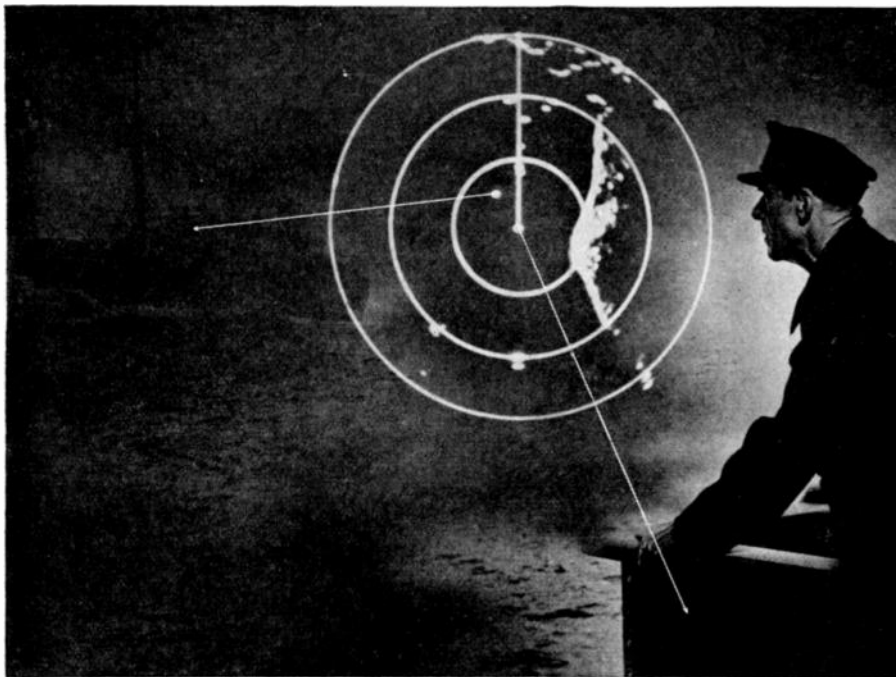

Radio Corporation of America has excellent opportunities for Electronic Development Engineers

At all levels of experience in
the fields of Radar, Television
and Guided Missile Control

TO DO

System, Video, Microwave,
Antenna, Transmitter, Receiver,
Computer and Servo Development

Write in detail to Camden Personnel Division,
RCA Victor, Camden, N. J.



RADIO CORPORATION of AMERICA



Positions Wanted By Armed Forces Veterans

JUNIOR ENGINEER

B.S.E.E., B.S.M.E. 1939 University of Paris. Age 28 Completing graduate work EE electronics at B.P.I. New York. 2½ years Army Signal Corps experience on RDF and communications equipment. Seeks position as junior engineer, physicist or instructor in New York City area. Box 130 W.

TECHNICAL EDITOR

Former AAF officer with four years experience in writing and editing technical project reports and summaries, budget defenses, press releases, technical papers, etc. Assigned during this period to Radiation Laboratory, M.I.T. and Aircraft Radio Laboratory, Wright Field. Additional experience as sales engineer (2 years), radio and radar technician (2 years), and two years of college credits towards E.E. degree. Box 131 W.

ELECTRONIC ENGINEER

B.E.E. Ohio State University, June 1948. Two years as electronics technician, U. S. Navy. Would like position in research or development. Vicinity New York or Cleveland. Box 136 W.

RADIO ENGINEER

B.E.E. from N.Y.U. 1947; Graduate work B.S. in physics from C.C.N.Y. 1943. Signal Corps radio and repeater man telephone experience. Desires design and development work in radio, industrial electronics or communications. Box 137 W.

ELECTRICAL ENGINEER

B.S. in E.E. 1944, University of New Brunswick (Canada). M.S. 1947 University of Western Ontario. Age 23. Single. Former officer Royal Canadian Signals. Limited experience in telephone work. Desires electrical engineering employment abroad, preferably in tropics. Box 138 W.

ELECTRONIC ENGINEER—PHYSICIST

Electronic Engineer—Physicist. Graduated Princeton University. Wide research experience. Circuits, aircraft-servomechanisms, microwave plumbing, antennas. Able to take full charge of project from design specifications through preliminary manufacture. Prefer small aggressive company with aircraft connections. Box 141 W.

(Continued on page 56A)

MICROWAVE EQUIPMENT

Communications

EXPERIMENTAL EQUIPMENT

3 CM. PLUMBING

(Standard 1" x 1/2" guide unless otherwise specified)

- TR cavity for 724-A TR tube, transmission or absorption types \$3.50
- 724-A TR tube \$3.50
- 150 deg. bend, with 90 deg. twist type "N" output pick-up loop, pressurizing nipple \$2.50
- Waveguide sections, 10" choke to cover (circ. choke to circ. cover) \$2.00
- Waveguide section, CG 251/A1'S-15A, 26" long choke to cover, with 180 deg. bend of 2 1/2" rad. at one end \$4.00
- Rotary joint with slotted section and type "N" output pickup \$8.50
- Waveguide section, 12" long choke to cover, 45 deg. twist, & 2 1/2" radius, 90 deg. bend \$4.50
- Stabilizer cavity feeding waveguide section, with filtered output and attenuating slugs \$20.00
- Thermistor mount in waveguide with tunable termination \$8.00
- Slug Tuner/attenuator, W.E. guide, gold plated \$3.75
- TR-ATR section with waveguide iris flange \$4.00
- CG/APS-3, straight waveguide section, 10" choke to cover \$1.75
- Right angle elbow, 5/8" choke to cover, 2 1/2" radius, E or H plane \$5.00
- Twist, 90 deg., 6" choke to cover \$5.00
- Waveguide sections 2 1/2" long, silver plated, with choke flange \$3.50
- Waveguide, 90 deg. bend E plane, 18" long \$4.00
- Waveguide, 90 deg. bend, E plane with 20 db. directional coupler \$4.75
- Rotary joint, choke to choke \$6.00
- Ring joint, choke to choke, with deck mounting \$6.00
- S-curve waveguide, 8" long cover to choke \$2.50
- Duplexer section for 1B24 \$10.00
- 3 cm. waveguide, 1 1/2" x 1 1/2" JD, 1/16" wall per ft. \$1.25
- Choke flanges, circular, solid brass55
- "T" section (TR-ATI) choke to choke, supplied with circ. or sq. flanges \$3.50
- Band, 180 deg., 2 1/2" radius ea; curve, 12" cover to cover, with pressurizing nipple \$3.00
- Directional coupler CG 124 APS-15A on 18" section cover to cover 15 deg. bend \$5.00
- Feedback dipole with 90 deg. twist, 7 1/2" \$3.50

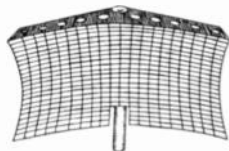

MICROWAVE ANTENNA EQUIPMENT

AS 125/APR Cone type receiving antenna, 1000 to 3200 mc. cycles. New \$4.50

APS-3, 3 carrying antenna. Complete. \$49.00

- 14 1/2" dish. Cutler feed dipole directional coupler, all standard 1" x 1/2" waveguide. Drive motor and gear mechanism for horizontal and vertical scan. New, complete \$65.00
- AN/TPS-3, Parabolic dish type reflector approx. 10' diam. Extremely lightweight construction. New, in 3 carrying cases \$49.00
- RELAY SYSTEM PARABOLIC REFLECTORS: approx. range: 2000 to 6000 mc. Dimensions: 4 1/2" x 3", rectangular, new \$85.00
- TOY "JAM" RADAR ROTATING ANTENNA, 10 cm. 30 deg. beam, 115 v.a.c. drive, New \$100.00
- 140-600 MC. CONE TYPE ANTENNA, complete with 25" sectional steel mast, guy's, cables, carrying case, etc. New \$49.50
- SO-13 ANTENNA, 24" dish with feedback dipole. 360 deg. rotation, complete with drive motor and selsyn. New \$75.00
- Used \$45.00

CONNECTORS

- UG 10/U, type "N" chassis receptacle \$1.00
- UG 14/U, type "N" cable receptacle85
- UG 21/U, type "N" male connector85
- UG 58/U, type "N" chassis receptacle85
- UG 86 U, chassis receptacle, gold plated95
- UG 57/U, male to male adapter \$1.25
- UG 146/U, male type "N" to female 83 series85
- Homedel male to type "N" male adapter \$1.25

AMPHENOL "83" SERIES

- 831R chassis receptacle \$3.35
- 831SP male connector \$3.35
- 831AP right angle adapter \$3.35
- 831HP hood \$3.35

MICROWAVE SPECIALS

- 10 CM. RF Package. Consists of: 80 Xmtr.-receiver using 2J27 magnetron oscillator, 250 KW peak input, 707-B receiver-mixer \$150.00
- Modulator-motor-alternator unit for above 75.00
- Receiver rectifier power unit for above 25.00
- Rotating antenna with parabolic reflector, New 75.00
- 11T3S/APG-15 Transmitter-receiver, Lighthouse tube oscillator, .5 KW. App. 2700 Mc. operation 100.00

1.25 CENTIMETER

- "K" band mixer section \$10.00
- Waveguide directional coupler 25.00
- Wave Guide Section 1" cover to cover 4.50
- T Section choke to cover 3.00
- Mitred Elbow cover to cover 3.50
- Mitred Elbow and "S" sections choke to cover 3.50
- Flexible Section 1" long choke to choke 3.00

MICROWAVE TEST EQUIPMENT

- "S" BANO LAB. BENCH SET-UP. Consists of one direct-reading wavemeter, app. 2600-3400 mc. (cavity type); one dummy load with crystal probe, one line stretcher full wave; two waveguide to RG 18/U coax couplers, two 1" sections w/flanges. All standard 3" x 1 1/2" waveguide \$250.00
- 10 CM WAVEMETER, Model "SL". Micrometer adjust cavity with microammeter resonance indicator. Includes 115 VAC operation converter section. In great metal carrying case, complete with cables & spares. Made by Western Electric \$135.00
- W.E. I 138 A. Signal generator, 2700-2900 Mc. range, Lighthouse tube oscillator with attenuator & output meter. 115 VAC input, reg. Pwr. supply. With circuit diagram \$50.00
- 10 cm oscillator cavity for 2C40 Lighthouse tube, with attenuator, thermistor, pickup loop, heavy silver-plated casing \$50.00
- TS-238 GP, 10 cm. Echo box with resonance indicator and micrometer adjust cavity \$85.00
- 3 cm. wavemeter; transmission type with square flanges. (Also available in absorption type with square and circular flanges) \$15.00
- 3 cm. stabilizer cavity, tunable transmission type, Model 1551 (TFX 11GA) \$20.00

MICROWAVE TUBES

TUBE	FRQ. RANGE	PK. PWR. OUT.	PRICE
2J31	2820-2960 mc.	285 KW.	\$15.00
2J21A	9345-9405 mc.	50 KW.	\$25.00
2J22	3267-3333 mc.	285 KW.	\$15.00
2J26	2992-3019 mc.	275 KW.	\$15.00
2J27	2965-2992 mc.	275 KW.	\$15.00
2J32	2780-2820 mc.	285 KW.	\$15.00
2J38 Pkg.	3249-3263 mc.	5 KW.	\$25.00
2J55 Pkg.	9345-9405 mc.	50 KW.	\$25.00
3J31	24,000 mc.	24,000 W.	\$17.50
W.E. 700A	680-710 mc.	100 KW.	\$35.00
W.E. 720BY	2800 mc.	1000 KW.	\$25.00

MAGNETS

- For 2J21 (725-A), 2J23, 2J26, 2J27, 2J31, 2J32, and 3J31 Each, \$8.00
- 4850 Gauss, 1/2" bet. pole faces, 1/2" pole diam. \$8.00
- 1500 Gauss, 1 1/2" bet. pole faces, 1 1/2" pole diam. \$8.00
- 1000 Gauss, electromagnet, adjustable 3/8" to 3" bet. pole faces, 2 1/2" pole diam. \$12.00
- 2100 Gauss, 1 1/2" bet. pole faces, 1 1/2" pole face diam. \$4.00

CATHODE RAY TUBES

- 5BP1 \$1.20
- 5BP17 \$1.75
- 3FP17 \$1.20
- 5JP2 \$4.00

LABORATORY ACCESSORIES

- Pressurizing unit, MK 23/AP. For transmission line, used with APS-15 \$12.50
- Sperry klystron tuner, model 12 \$2.00
- 30 mc. receiver I.F. strip, 2 mc. bandwidth, 20 db gain per stage, 120 db gain overall \$25.00
- Sine potentiometers, G.E. # 251 x 96 or W.E. # KS 15138 L01 \$4.50
- CG 27, type "N" cable ass'y, 3' long, male to female \$2.50
- Fl. xfmr for 872, with socket mounted atop, Pri: 115 v. 60 cy. sec: 5 v @ 10 amps, 35 KV RMS test \$12.00
- Transformer, Pri: 117 v, 60 cycle, Sec. 17,000 v. @ 144 ma. Oil immersed, with choke \$65.00
- Phase-shifting capacitor, 180 deg. W.E. # D-150734 \$2.50
- Klystron sockets for 723 A/B and similar types 2 for \$1.00
- 10 cm. McNally cavity type SG each \$3.00
- Crystal mixer, "S" band, Complete with type "N" fitting and 1N22 crystal \$3.85
- 10 cm. Dipole and Reflector with type "N" fitting \$2.75
- TS 115/APS-2F, 10 cm. antenna in lucite ball, with type "N" fitting \$4.50
- O.A. Navy type CYT86ADL, 10 cm. antenna in lucite ball, with Sperry fitting \$4.50
- 10 cm. feedback dipole antenna, in lucite ball, for use with parabola \$8.00

DELAY NETWORKS

- W.E. # D-168184 \$4.00
- W.E. # D-165997, 1% microsecond \$7.50

INVERTERS

- PE 206-A. Input: 28 VDC @ 38 amp. Output: 80 volts @ 500 volt-amps, 800 cycles, Leland, New, complete with enclosed relay, filter, instruction book \$12.50
- PE 218. Input: 25-28 VDC @ 92 amps. Output: 115 volts @ 1500 volt-amps, 380-500 cycles New \$15.00

MICROWAVE PLUMBING 10 Centimeter



- Band Load (Dummy Antenna) wave guide section with cooling fins, app. 23" high \$28.00
- 10 cm. waveguide, 5'9" choke to cover, Per section 12.00
- Per set of 4 sections 45.00
- Pick-up loop with adjustable tuning section, used in duplexer cavity 1.50
- Waveguide to flexible coax coupler (RG 18/U), with flange Gold plated, App. 10" high (as shown) 17.50
- 10 cm. Horn, rectangular-to-square-to-circular RF assembly ending in horn, radiating circularly polarized beam, Waveguide input. Complete with flange 35.00
- Magnetron to waveguide coupler with 721-A duplexer cavity, gold plated \$45.00

3/8" RIGID COAX—3/8" I.C.

- Right angle bend, with flexible coax output pickup loop \$3.00
- Short right angle bend, with pressurizing nipple \$2.00
- 30 ft. flexible section, 3/8" rigid to 3/8" rigid \$7.50
- Rigid coax to type "N" adapter, gold plated, 5' lengths, Per length \$5.00
- Stub-supported rigid coax, gold plated, 5' lengths, Per length \$5.00
- Rt. Angles for above \$2.50
- 3/8" coax, rotary joint \$8.00
- Magnetron coupling to 3/8" rigid coax \$4.00
- 3/8" coax, rt. angle bend 15" L. OA \$2.00
- Rigid coax slotted section CU-60/AP \$5.00

3/8" RIGID COAX—1/4" I.C.

- Short right angle bend \$2.50
- Rotating joint, with deck mounting \$5.00

PULSE EQUIPMENT

- APQ-13 Pulse modulator. Contains multivibrator, amplifier, rectifier, air and oil sections, W.E. #D151756. Contains following tubes: 1-3E29, 1-6AG7, 1-8016, 1-705-A \$49.00

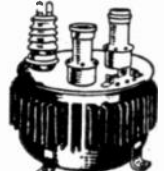

PULSE NETWORKS

- G.E. #25E5-1-350-50P2T, 25 KV, 5 sections, "E" circuit, 1 microsecond pulse length, 350 PFS, 50 ohms impedance \$45.00
- G.E. #25E3-5-2000-50P2T, 6KV, "E" circuit, 3 sections, .5 microsecond, 2000 PFS, 50 ohms impedance \$6.50

PULSE TRANSFORMERS

- W.E. # D166713 Hi-Volt input transformer, W.E. Impedance ratio 50 ohms to 800 ohms. Freq. range: 10 kc to 2 mc. 2 sections parallel connected, potted in oil \$12.00
- W.E. KS 9800 Input transformer. Winding ratio between terminals 6-7 and 1-2 is 1:1:1, and between terminals 6-7 and 1-2 is 2:1. Frequency range: 380-520 c.p.s. Permalloy core \$2.00
- G.E. # K2731 Repetition Rate: 635 PFS, Pri. Imp: 50 Ohms, Sec. Imp: 450 Ohms, Pulse Width: 1 Microsec. Pri. Input: 9.5 KV PK, Sec. Output: 28 KV PK, Peak Output: 800 KW. Bifilar 2.75 Amp. \$19.50
- G.E. K2450A Will receive 13KV, 4 micro-second pulse on pri., secondary delivers 14KV, Peak power out 100KW GE \$15.00
- W.E. # D16927 Hi Volt input pulse transformer \$9.95
- G.E. # K2748A Pulse Input, line to magnetron Utah Pulse or Blocking Oscillator Transformer Freq. limits 790-810 cy-3 windings turns ratio 1:1:1 Dimensions 1 13/16 x 1 1/2 \$1.25
- 705-A Rectifier Tube, with ceramic socket \$1.25

PULSE CONNECTORS

- UG 34/U \$1.50
- UG 215/U \$1.50

RADAR SETS

- S09-10CM. SURFACE SEARCH 4, 20 and 80 mile ranges Raytheon, 250 KW peak power input to 2J27 magnetron. Complete set including: spare parts, tubes, wave guides and fittings. Send for price and add'l info.
- SN RADAR-G.E. low power, 5 and 25 miles ranges. Uses GL446 as pulsed oscillator, 5" "A" scope, "S" band, Extremely compact, ideal for demonstration and laboratory work, 115V 60C operation. Used, Excel. cond. \$600.00
- SE 10 CM. SURFACE SEARCH RADAR, W.E., input to 80,000 yds. range, 250 KW. pk. power input to 706 magnetron, Thyatron modulator, variable pulse rate. Complete set including spare parts, tubes, waveguide and fittings. Send for price and additional information.

- WESTERN ELECTRIC (\$95 ea.)
- D-167332 (Bead)
- D-170396 (Bead)
- D-163392 (Button)
- D-168391 (Bead)

All merchandise guaranteed. Mail orders promptly filled. All prices, F.O.B. New York City. Send Money Order or Check. Shipping charges sent C.O.D.

COMMUNICATIONS EQUIPMENT CO.

131-R Liberty St., New York City 7, N.Y. (Mr. Rosen) Digby 9-4124

- VARISTORS (\$95 ea.)
- Western Electric
- D-167176
- D-170225
- D-162356
- D-171121

BENDIX-SCINTILLA

the finest ELECTRICAL CONNECTORS
money can build or buy!

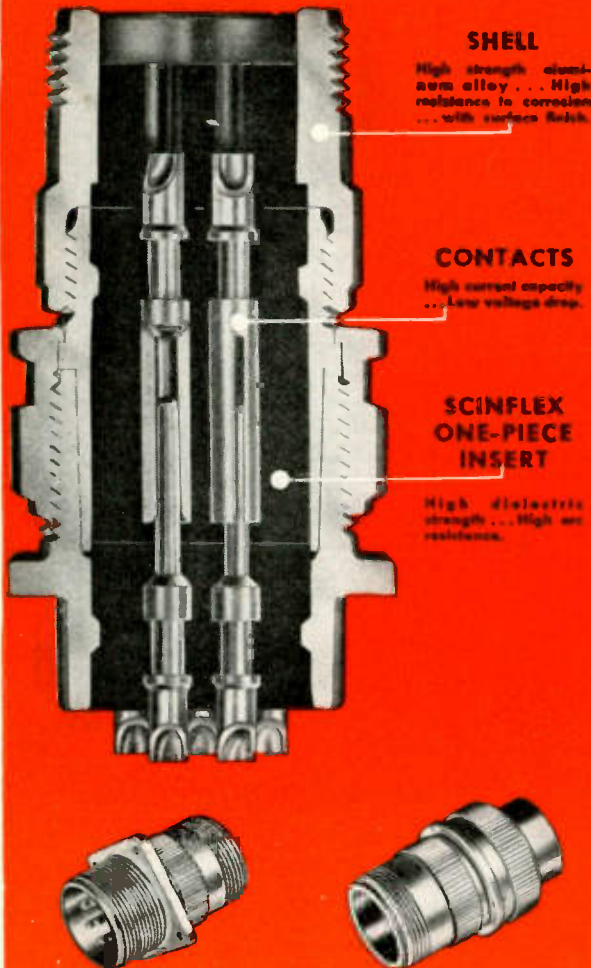

SHELL

High strength aluminum alloy... High resistance to corrosion... with surface finish.

CONTACTS

High current capacity... Low voltage drop.

SCINFLEX ONE-PIECE INSERT

High dielectric strength... High arc resistance.

AND THE SECRET IS SCINFLEX!

Bendix-Scintilla* Electrical Connectors are precision-built to render peak efficiency day-in and day-out even under difficult operating conditions. The use of "Scinflex" dielectric material, a new Bendix-Scintilla development of outstanding stability, makes them vibration-proof, moisture-proof, pressure-tight, and increases flashover and creepage distances. In temperature extremes, from -67° F. to $+300^{\circ}$ F., performance is remarkable. Dielectric strength is never less than 300 volts per mil.

The contacts, made of the finest materials, carry maximum currents with the lowest voltage drop known to the industry. Bendix-Scintilla Connectors have fewer parts than any other connector on the market—an exclusive feature that means lower maintenance cost and better performance.

*REG. U.S. PAT. OFF.

Write our Sales Department for detailed information.

- Moisture-proof, Pressure-tight • Radio Quiet • Single-piece Inserts
- Vibration-proof • Light Weight • High Arc Resistance • Easy Assembly and Disassembly • Less parts than any other Connector

Available in all Standard A.N. Contact Configurations

BENDIX
SCINTILLA

SCINTILLA MAGNETO

SIDNEY, N. Y.

DIVISION OF



Positions Wanted

(Continued from page 54A)

ENGINEER

Engineer, 25 years old desires personnel or contact position where three years as a Signal Corps officer followed by two years of electronic laboratory and factory experience will pay dividends. Married and will locate anywhere. Box 142 W.

DESIGN AND DEVELOPMENT ENGINEER

Design and development engineer—extensive experience FM and VHF, broadcast equipment and audio, some microwave. Both theoretical and practical background.

Registered Professional Engineer. Employed but good reason for desiring change. Box 143 W.

ENGINEER

Ph.D. candidate (physics) completing second year scholastic requirements by May. Available June 1st for employment in metropolitan area. Vacuum tube, electronics, etc. B.S., M.S. physics. Strong minor in chemistry. Captain, radar, A.U.S. Graduate Harvard, M.I.T. Electronic Training Center. Box 153 W.

PHYSICIST

B.S. 1942. Age 26. Single. Four years research laboratory experience, with some electronics training received in Service. Desires development work preferably in southwestern U. S. Box 154 W.

EXECUTIVE ENGINEER

Desires administrative position in Los Angeles area. Extensive administrative and electronic engineering experience. M.S. degree Harvard. Box 155 W.

JUNIOR ENGINEER

Graduating University of Michigan in June 1948 with B.S.E.E. (communications) and B.S.E. (mathematics). Tau Beta Pi, Eta Kappa Nu. One year experience Navy electronics. Interested in television broadcasting, production or development. Details on request. Box 156 W.

ELECTRONIC ENGINEER

B.S.E.E. Jan. 1948, Cooper Union. Age 23. Two years experience as electronics technician, U. S. Navy. Would like position preferably in the vicinity of New York. Box 157 W.

JUNIOR ENGINEER

B.S.E.E. from University of Illinois in 1948. Navy Experience in radar and sonar. Seeks position as junior engineer in electronics. Prefer vicinity around New York City. Box 158 W.

ADMINISTRATIVE ENGINEER

Business administration plus engineering training. M.B.A. Harvard Business School, June 1948. B.E.E. Rensselaer, 1942. Tau Beta Pi, Sigma Xi. Age 26. Navy radar and patent experience. Desire job in small to medium size concern. Box 159 W.

News—New Products

These manufacturers have invited PROCEEDINGS readers to write for literature and further technical information. Please mention your I.R.E. affiliation.

New Tube Sockets

The American Phenolic Corporation, 1830 South Fifty-fourth Ave., Chicago 50, Ill., has developed three new tube sockets to meet the requirements for mounting industrial tubes on the face side of vertical control panels.

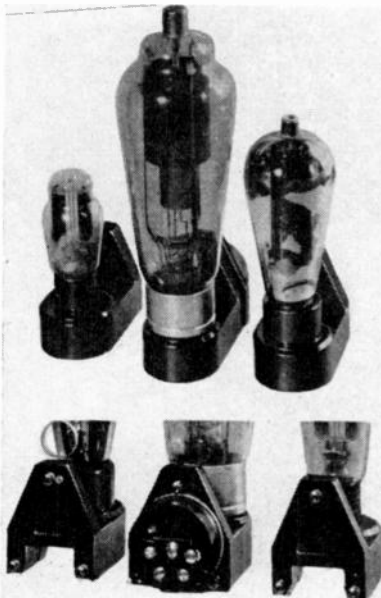

Conservation of floor space necessitates the design of many electronic control equipments into vertical arrangements. Previously, the equipment manufacturer has had to employ cumbersome box-like brackets on these vertical panels as supports for the tube sockets normally intended for application only on horizontal panels.

These new sockets of phenolic material are designed to meet NEMA requirements and feature high-conductivity cloverleaf contacts to insure very low contact resistance at the tube base pins. Individually supported, these sockets permit spacing to allow convection air-current cooling of the tubes.

Omnidirectional Antenna

An omnidirectional antenna, Type 624, is announced by Technical Appliance Corp., Sherburne, N. Y. This "S" folded dipole fills the need for a nondirectional horizontally polarized antenna for reception from several television or f.m. transmitters located at various points of the compass from the receiver. A new type of mounting clamp assures rigid construction. The bakelite terminal block also mounts a strain insulator for attaching the 300-ohm ribbon-type transmission line. A 5-foot mast is supplied for mounting the antenna above the roof. Screw eyes and other mounting hardware is supplied, as well as a 60-foot 300-ohm transmission line.

(Continued on page 58A)



PILOT LIGHT ASSEMBLIES

PLN SERIES—Designed for NE-51 Neon Lamp



Features

- THE MULTI-VUE CAP
- BUILT-IN RESISTOR
- 110 or 220 VOLTS
- EXTREME RUGGEDNESS
- VERY LOW CURRENT

Write for descriptive booklet

The DIAL LIGHT CO. of AMERICA

FOREMOST MANUFACTURER OF PILOT LIGHTS
900 BROADWAY, NEW YORK 3, N. Y.
Telephone—Spring 7-1300

COMMUNICATIONS—ELECTRONICS—TELEVISION for **DEPENDABLE** performance **F R E E D** TRANSFORMERS

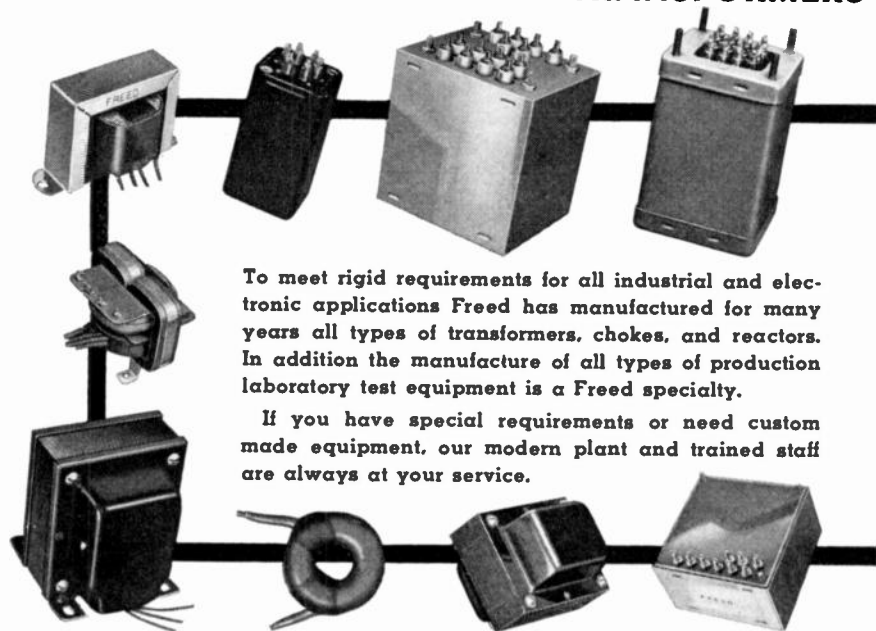

To meet rigid requirements for all industrial and electronic applications Freed has manufactured for many years all types of transformers, chokes, and reactors. In addition the manufacture of all types of production laboratory test equipment is a Freed specialty.

If you have special requirements or need custom made equipment, our modern plant and trained staff are always at your service.

FREED TRANSFORMER CO., Inc.
78 SPRING STREET NEW YORK CITY 12, N. Y.

News—New Products

These manufacturers have invited PROCEEDINGS readers to write for literature and further technical information. Please mention your I.R.E. affiliation.

(Continued from page 57A)

Decade Scaler for Radiation Measurements

Designed specifically for radioactivity measurements, the new Model 2092 Decade Scaler is a completely self-contained instrument being produced by Potter Instrument Co., Inc., 136-56 Roosevelt Ave., Flushing, N. Y.

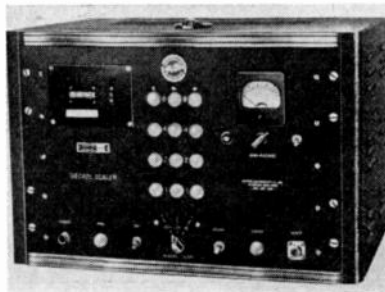

This instrument includes an input sensitivity of 0.25 volt, three scale-of-10 counter decades, a four-digit mechanical register, control for a clock timer, and an adjustable high-voltage regulated power supply for the operation of Geiger-Mueller tubes.

The Decade Scaler will resolve two pulses which are 5 microseconds apart and will count continuously with accuracy at rates up to 130,000 counts per second.

Pocket Dosimeter

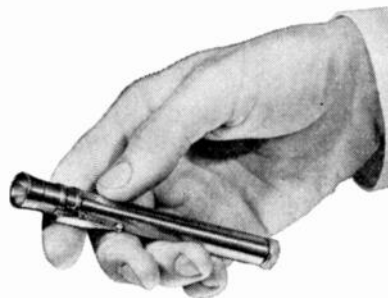

A new Model 3360 Pocket Dosimeter, which provides an easily read indication of the amount of radioactivity to which the carrier of the instrument has been exposed, is announced by Instrument Development Laboratories, 229 West Erie St., Chicago 10, Ill.

The dosimeter is for the use of scientific personnel who are associated with X-ray work or nuclear research, and can be read at any time by looking through the cupped eyepiece toward a light source. Thus it differs from the Model 3340 Meter, which can be read only on an electrostatic voltage indicator. In the new meter the observer sees a magnified scale upon which an indicating line shows, in milliroentgens, the amount of radiation to which the instrument has been exposed.

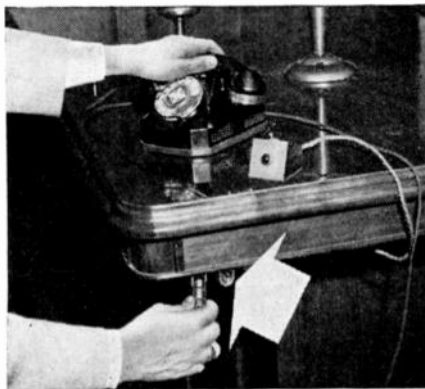

"X" MARKS THE SPOT

... where the X-3-42 Receptacle (shown just above) unobtrusively reposes underneath the table top so that the intercommunication phone may be moved around the executive conference table. The Type "X" Series is particularly adapted to plug-in intercom systems such as shown above, and is also widely used in sound service, instruments, radio and public



X-3-11 Plug
\$1.75 List



X-3-12 Plug
\$1.25 List

address systems. Two plug and 3 receptacle types are available with 3 different insert arrangements (interchangeable): one 15-amp.; three 15-amp.; and three 10-amp. and one 15-amp. contacts. Shells are diecast zinc



X-3-13 Receptacle
\$1.75 List



X-3-14 Receptacle
\$1.25 List

with bright nickel finish, and have accommodation for 3/16" to 9/32" cable. Friction engagement. Available direct from more than 225 distributors over the U.S.A. or from factory.

Listed and priced in the RJC-2 and C-47 Condensed Catalogs. Engineering drawings of the "X" in P&O Bulletin. Specify bulletin desired. Address Dept. D-377.

SINCE 1915

CANNON
ELECTRIC

Development Company

3209 HUMBOLDT ST., LOS ANGELES 31, CALIF.

IN CANADA & BRITISH EMPIRE:
CANNON ELECTRIC CO., LTD., TORONTO 13, ONT.

WORLD EXPORT (Excepting British Empire):
FRAZAR & HANSEN, 301 CLAY ST., SAN FRANCISCO

MICRODIMENSIONAL
WIRE & RIBBON
FOR VACUUM TUBES

Wires drawn to .0034" diameter.

Ribbon rolled to .005" thickness.

Alloys for Special requirements.

WRITE for list of stock alloys.

SIGMUND COHN CORP.
44 GOLD ST., NEW YORK

SINCE 1911

News—New Products

These manufacturers have invited PROCEEDINGS readers to write for literature and further technical information. Please mention your I.R.E. affiliation.

Frequency Monitor for Television Video Transmitters

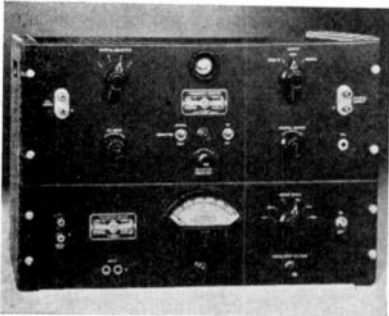

For monitoring the frequencies of television video transmitters, the General Radio Co., 275 Massachusetts Ave., Cambridge 39, Mass., announces the Type 1175-BT Frequency Monitor, to be used in conjunction with the Type 1176-A Frequency Meter. The monitor is designed for single-channel operation over a frequency range from 1600 kc. to 220 Mc. and the accuracy of monitoring is 0.001 per cent.

A low-pass filter eliminates the picture line frequency and allows a maximum frequency deviation of ± 12 kc. to be monitored.

Monitor and frequency meter are in separate units, both designed for relay-rack mounting. Over-all panel dimensions for the complete assembly are 19 by 12½ inches; depth behind panel is 11½ inches. Walnut end frames are available for adapting the assembly for table mounting. Net weight is 42 pounds.

New Tube Sockets

Electronic tube sockets for transmitting and industrial tubes have been made available by the Tube Division of the Electronics Department, General Electric Co., Schenectady, N. Y.

Available in a wide range of sizes, the sockets include panel-mounted and chassis-mounted styles, and are built to NEMA specifications. The body of the sockets is molded in one piece from BM120 black bakelite with barriers for insulation and creepage paths.

Constructed from phosnic bronze, the socket's contacts are designed to be full floating with four lines of contact for the length of the whole pin. Each is removable and the spacing between leads and terminals is maintained at a maximum.

(Continued on page 60A)

ANOTHER

TECH
LABORATORIES, INC.

TECH LAB FIRST!

NOW ON ALL
ATTENUATORS
AND
POTENTIOMETERS

Silver Alloy Contacts

New Silver Alloy contacts make possible improved Attenuators and Switches in smaller sizes.

- 1 Greater Creepage Distance—thus better insulation.
- 2 No silver migration.
- 3 Greater silver surface to carry current.
- 4 Lower contact resistance.
- 5 Better mechanical operation of switch.
- 6 Less capacity between contacts—better frequency characteristics.
- 7 Better clearance to ground.

TYPE 800 UNIT
with new contacts

Manufacturers of Precision Electrical Resistance Instruments
337 CENTRAL AVE. • JERSEY CITY 7, N. J.

RH-9

12 TO 75 MC.
VHF HARMONIC MODE
CRYSTAL UNITS

These frequencies can be generated with RH-9 in a one-tube oscillator circuit, operating in 3rd, 5th, or 7th mechanical mode.

Frequencies can be multiplied to higher frequencies as desired.

For RH-9 Specifications Write for Bulletin RHC-4

REEVES-HOFFMAN CORPORATION

CHERRY and NORTH STREETS • CARLISLE, PA.

Sign of Transformer Reliability

KENYON For over 20 years, the KENYON "K" has been a sign of transformer reliability. Ever since the cat's-whisker, crystal-set days, KENYON has pioneered high quality transformers. Skillful engineering, progressive design and sound construction have resulted in dependable, conservatively-rated transformers with an enviable record for minimum field rejections. Cut engineering and replacement costs. Improve products. Insure repeat business. Specify KENYON!

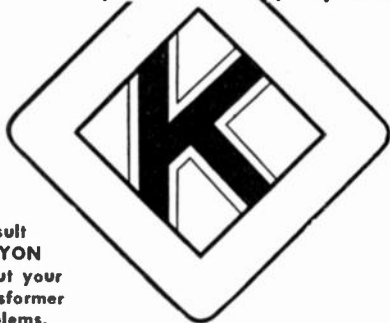

Consult KENYON about your transformer problems.



KENYON TRANSFORMER CO., Inc. 840 BARRY STREET NEW YORK 59, N. Y.

News—New Products

These manufacturers have invited PROCEEDINGS readers to write for literature and further technical information. Please mention your I.R.E. affiliation.

(Continued from page 59A)

Regulated Power Supply

The Atomic Instrument Co., 200 Charles St., Boston 14, Mass., has announced a compact power supply designed for use wherever a 500- to 2000-volt source of regulated high voltage at low current is required.



Typical applications for which this unit is particularly suited include Geiger-Mueller counters, electron-multiplier tubes, and cathode-ray tubes, as well as for general laboratory use. The supply delivers 500 μ a. at 2000 volts and 1 ma. for voltages up to 1500. Regulation is maintained within 1% for $\pm 10\%$ line-voltage variations and load variations up to maximum rated load. At any voltage setting the drift is within 0.1%. An illuminated 3-inch meter indicates the output voltage to an accuracy of better than 5%.

Voltage step-up, rectification, and filtering are carried out at radio frequencies. This makes possible the use of very small capacitors which insure safety. Six miniature tubes are used, and the complete unit is housed in an oak cabinet measuring 7½ inches high by 12 inches wide by 5½ inches deep, and weighing 9½ pounds.

New Swivel Television Screen

A departure from the television receivers on the market today is the new Hollywood model being produced by the Cleervue Television Corp., 81 Willoughby St., Brooklyn 1, N. Y.

The 12-inch direct-view swivel screen can be focused 180 degrees in any direction. Another feature of this receiver is its five-deck chassis construction, which is virtually five separate instruments designed to reduce service problems to a minimum. Each of the five chassis sections is a plug-in unit which can be removed and replaced instantaneously.

NOW! SELF-CONTAINED, EXPERIMENTAL SCHOOL & INDUSTRIAL LAB EQUIPMENT

Kepco Electronic Instruction Panel Model 104, available separately.

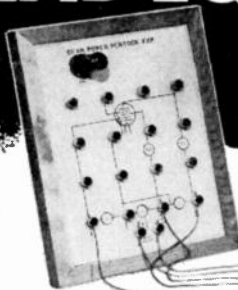

Kepco Laboratory Multiple Power Supply Model 103, available separately.



Now you can perform electronic experiments simply, easily with the Kepco Electronic Instruction Panel. Here is a teaching aid that graphically illustrates vacuum tube principles — enables all students to grasp fundamentals in the laboratory.

Extremely versatile, the Kepco Electronic Instruction panel covers a wide range of tubes, comes with a packet of 23 keyed interchangeable circuit charts, 3 master charts and 12 blank keyed sheets for additional experiments. Panel contains 3 actual tube sockets, 18 binding posts. By placing a keyed circuit diagram on the panel and wiring the circuit, students determine tube and circuit characteristics.

For a basic electronic instructional aid that vastly simplifies the teacher's task, it's the Kepco Electronic Instruction Panel!

Now you can eliminate the use of cumbersome separate voltage supplies with the Kepco Laboratory Multiple Power Supply. Designed to be used with the Kepco Electronic Instruction Panel, this versatile, compact, easy-to-use unit supplies four commonly used voltages, is invaluable for the school or industrial laboratory.

CHECK THESE FEATURES:

Two continuously variable B supplies, adjustable from 0-300 volts at 120 m.a.
Variable (grid) supply, adjustable from minus 50 to plus 50 volts at 5 m.a.
6.3 volt filament supply at 5 amperes.
All connections made to sturdy, front panel binding posts.
Input: 105 to 125 volts, 50 to 60 cycles.
Two 5Y3 rectifiers, Two 6Y6 control tubes.
16" long, 8" high, 8¾" deep. Wgt.: 28 lbs.

WRITE FOR FULL INFORMATION TODAY!

Kepco LABORATORIES
Electronic Instruments

142-45 Roosevelt Avenue
Flushing, New York

News—New Products

These manufacturers have invited PROCEEDINGS readers to write for literature and further technical information. Please mention your I.R.E. affiliation.

Type TMC-187 Tubular Capacitor



Increasing the scope of their line of capacitors designed specifically for television applications, Cornell-Dubilier Electric Corp., South Plainfield, N. J., has introduced the type TMC-187. This extremely compact tubular capacitor is made in a rating of 0.005 μ f.d., 3500 working volts d.c., with dimensions of $1\frac{1}{4}$ inches diameter by $1\frac{1}{2}$ inches long. It is available in both single and dual capacitances and other voltage ratings with small physical dimensions.

Type TMC-187 is housed in a hermetically sealed cylindrical metal container, and a wax-impregnated cardboard sleeve with rolled-over ends insulates the case. The capacitor is self-mounted on No. 18 solid tinned-copper wire leads.

New Selenium Rectifiers

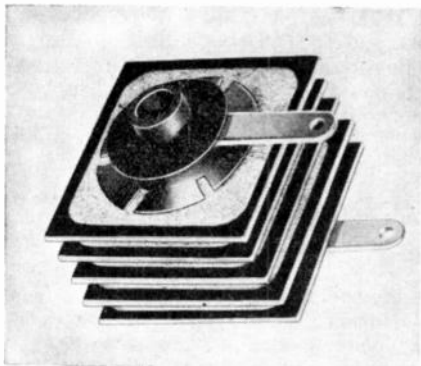

Two models of selenium rectifiers for radio receivers and other electronic applications have been made available by the Tube Division of General Electric Co.'s Electronics Department at Schenectady, N. Y. Both models, 6RS 5GHI and 6RS 5GH2, are 1 inch square and have a high inverse-peak voltage rating with a low inverse current, even with peak voltages up to 350 volts. The latter type, $\frac{1}{4}$ inch shorter than the former, is recommended for limited-space applications.

Each rectifier will withstand safely the inverse peak voltages obtained when rectifying (half-wave) 100–125 volts r.m.s., and feeding a capacitor as required in various radio circuits. Ratings are based on ambient temperatures of 50° C. to 60° C.

(Continued on page 62A)

NEY

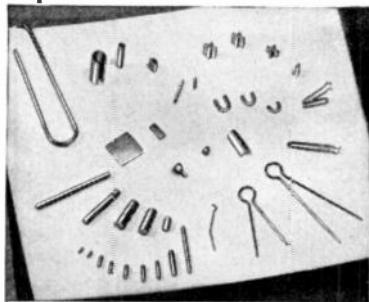

Standard Ney precious metal alloys with accurately defined properties are now available for prompt delivery in commercial quantities, and our Research Laboratory is ideally equipped to develop and test other special alloys to meet your rigid specifications.

Precious Metal Alloys

for

ELECTRICAL CONTACTS ON POTENTIOMETERS
SLIP RINGS, RELAYS AND SWITCHES

PALINEY #7

SLIDING CONTACTS FOR POTENTIOMETERS

PALINEY #7 is being used for a contact material on potentiometers wound with a nickel-chrome alloy resistance wire. This combination is consistently producing units with life of better than one million cycles and maintained accuracy of 0.1% or better throughout the life of the unit.

NEY-ORO #28 SLIP RING BRUSHES

NEY-ORO #28 is a special alloy developed as a contact brush material for uses against coin silver slip rings. Laboratory tests and reports from users indicate life of better than 10 million revolutions with no electrical noise.



Write or telephone (Hartford 2-4271) our Research Department.

THE J. M. NEY COMPANY 171 ELM STREET • HARTFORD 1, CONN.
SPECIALISTS IN PRECIOUS METAL METALLURGY SINCE 1812

New! RMC aural AMPLIFIERS TYPE 115 SERIES

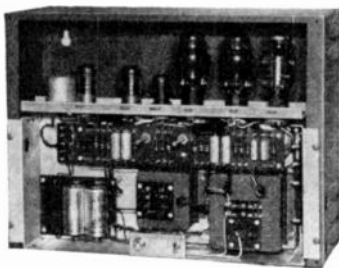

Interior view. Note front servicability feature.

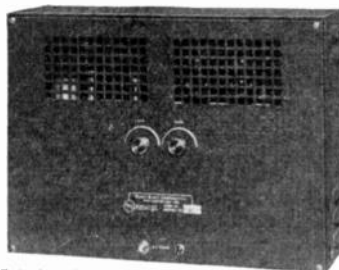

Exterior view

Here is a three-stage, push-pull throughout Amplifier with high gain, low noise and distortion, the result of engineers' twenty years' experience, and long study of customers' needs before perfection. Designed for many uses in high quality sound systems, such as: (1) Reproducing systems for Vertical and Lateral disc reproduction. (2) Public address system working from Microphone to Speakers. (3) Used with bridging input attenuator as Monitor Amplifier for broadcast stations. (4) With bridging attenuator as Subscriber Amplifier for wired music installations. (5) For sound distribution systems in locations where available space is limited. Installation, service and maintenance operations all facilitated from front of Type 115 Amplifier. Can be permanently installed in wall cabinet; or for standard rack mounting.

TYPICAL ELECTRICAL CHARACTERISTICS

Gain 100 DB maximum with provision for reduction in gain to 44 DB.
Frequency Response plus and minus 1 DB over range 30 to 16,000 cycles.
Operates from 150 or 600 ohm source.
Operates into 4 ohm (2 to 8 ohm).
Operates into 16 ohm (8 to 32 ohm).
Operates into 150 ohm (75 to 300 ohm).
Operates into 600 ohm (300 to 1200 ohm).
Output power approximately 15 watts, 5% total harmonic distortion.
Output noise equivalent to an input signal of minus 120 DB below .006 W. at maximum gain unweighted (approx. minus 130 DB weighted). Frequency characteristic plus and minus 1 DB over the range 30 to 16000 cycles.

Sold through local Jobber
Write for Bulletin A1-51

Export: Rocke International Corporation, 13 East 40th Street, New York 16, N.Y.

RADIO-MUSIC CORPORATION
PORT CHESTER • NEW YORK

MEASUREMENTS CORPORATION MODEL 80 STANDARD SIGNAL GENERATOR



2 to 400 MEGACYCLES

MANUFACTURERS OF
Standard Signal Generators
Pulse Generators
FM Signal Generators
Square Wave Generators
Vacuum Tube Voltmeters
UMF Radio Noise & Field
Strength Meters
Capacity Bridges
Megohm Meters
Phase Sequence Indicators
Television and FM Test
Equipment

MODULATION: Amplitude modulation is continuously variable from 0 to 30%, indicated by a meter on the panel. An internal 400 or 1000 cycle audio oscillator is provided. Modulation may also be applied from an external source. Pulse modulation may be applied to the oscillator from an external source through a special connector. Pulses of 1 microsecond can be obtained at higher carrier frequencies.

**FREQUENCY
ACCURACY $\pm .5\%$**

**OUTPUT VOLTAGE
0.1 to 100,000
microvolts**

**OUTPUT
IMPEDANCE
50 ohms**

MEASUREMENTS CORPORATION
BOONTON  NEW JERSEY

News—New Products

These manufacturers have invited PROCEEDINGS readers to write for literature and further technical information. Please mention your I.R.E. affiliation.

(Continued from page 61A)

Slip-Drive Volume Controls

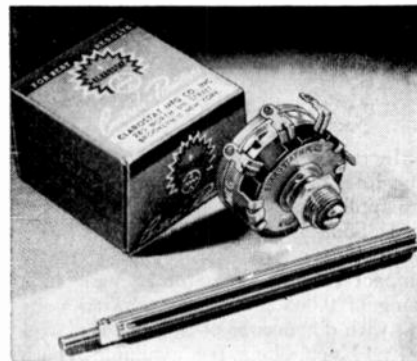

Slip-Drive (Clutch Type) volume controls to take attachable shafts are announced by **Clarostat Manufacturing Co., Inc.**, 130 Clinton St., Brooklyn, N. Y.

These controls, used mainly in auto sets and also in home radios with motor-driven operation, provide the essential slippage if the control shaft is turned beyond the end limits, thereby avoiding damage. This "SD" series is available in "Z" taper values from 250,000 ohms to 2 megohms, and in tapped units of the same total ohmage but tapped at 125,000, 250,000, and 500,000 ohms, working with a wide choice of Clarostat attachable shafts.

Your Most Complete Source of Supply for RADIO and ELECTRONIC EQUIPMENT • COMPONENTS • ACCESSORIES

**TREMENDOUS
STOCKS**



**TRAINED
PERSONNEL**



is Newark!

No matter what your need — whether Tubes, Components, Test Equipment, Receivers, Transmitters, or Public Address, you can save time and **SAVE MONEY** by shopping "Newark" first! As one of the largest distributors of radio and electronic components in America, we've got what you want — **IN STOCK!**

You'll like dealing with "Newark" because —

- Our tremendous stocks of standard brand merchandise always on hand insure speedy shipment of your order.
- Our highly specialized and competent personnel will know what you're talking about.
- Our Special Order Department performs miracles in getting those hard-to-find items that nobody else has!
- Two centrally located warehouses — New York and Chicago — at your service!

**MAIL AND PHONE ORDERS
FILLED PROMPTLY**

NEW YORK
Offices & Warehouse
242 W. 55th St., N.Y. 19

NEWARK
ELECTRIC COMPANY, INC.

CHICAGO
323 W. Madison St.
Chicago 6, Ill.

New York City Stores: 115-17 W. 45th St. & 212 Fulton St.

Speedy, Efficient Service
AS NEAR AS YOUR PHONE!
in **NEW YORK**
Phone: **Cl. 6-4060**
in **CHICAGO**
Phone: **STAt 2950**

Dual Iconoscope Film Pickup System

Appreciative of the vital role which film must continue to play in the lengthening hours of television programming, the Television Equipment Division of **Allen B. DuMont Laboratories, Inc.**, 42 Harding Ave., Clifton, N. J., announces the DuMont Model TA-512-A Dual Iconoscope Film Pickup System with latest refinements and innovations.



(Continued on page 63A)

NEWS—NEW PRODUCTS

The manufacturers have invited PROCEEDINGS readers to write for literature and further technical information. Please mention your I.R.E. affiliation.

In the form of sectional units for the control console, cabinet racks, and pickup units, this equipment can keep step with telecasting requirements from the modest start to the most elaborate commercial operations, yet with minimized investment and obsolescence.

Housed in rectangular, upright metal cabinets, the film-pickup units are either floor-mounted or mounted on a track attached to the wall, allowing rapid-positioning before one projector or another.

Voice-Activated Magnetic-Tape Recorders

The development of a voice-activated instantaneous start-stop clutch mechanism, now available as optional equipment on any *Magnetape Recorder*, has been announced by the Magnephone Division of Amplifier Corp. of America, 398-1 Broadway, New York 13, N. Y.



Activated by the voice of the speaker, singer, or other preselected sounds, the voice-clutch-equipped recorder continues to record as long as the sound is maintained, and for approximately five seconds thereafter to compensate for any pause. Actually, the time the recorder will operate after the sound has ceased depends upon the length of time the speech or music has been going on, and on its volume. Thus, the instrument's period of expectation increases with the increased possibility of additional sounds following.

The sensitivity of the voice clutch may be manually regulated by manipulation of the instrument's recording volume control to match the normal volume of any voice. This also serves to prevent activation of the Magnetape Recorder by extraneous room noises.

Further information may be obtained by writing to the manufacturer for Catalog 4901.

Model GL-22 Sweep Calibrator

The Browning Laboratories, Inc., of Winchester, Mass., recently announced the Model GL-22 Sweep Calibrator as an addition to their line of electronic equipment.

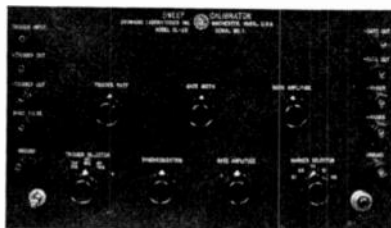

This is a pulsed timing-marker oscillator designed for use with standard oscilloscopes and synchoscopes for the measurement of time intervals on either triggered or recurrent sweeps. Variable-amplitude markers of either polarity are provided with sufficient amplitude for use as intensity markers or directly on the cathode-ray-tube plates as deflection markers. Markers available are 0.1, 0.5, 1.0, 10, and 100 μ s. A positive or negative variable-width gate pulse output is provided for test purposes. The duration of this pulse corresponds to the duration of the marker group. All controls and output connections are brought to the front panel for operational convenience. The instrument weighs 20 pounds and its size is 14 \times 7 \times 7 inches.

Model 125-A Oscillator-Wavemeter

The Brown Engineering Co., 4635-37 S.E. Hawthorne Blvd., Portland 15, Ore., are producing a small, light-weight, oscillator-wavemeter known as Model 125-A. This compact multipurpose instrument is convenient for use in the laboratory or field, and the carrying handle is located so there is complete accessibility of controls when in use. The frequency dial is provided with a vernier control for ease of adjustment and all controls are plainly marked as to their use. A panel meter is provided to indicate resonance when coupled to a circuit.

Model 125-A may be operated as an r.f. oscillator, modulated or unmodulated, with a frequency range of 400 kc. to 150 Mc. Coils are supplied to cover the standard broadcast intermediate frequency ranges. It may also be operated as an r.f. or a.f. signal tracer with visual and aural indication available simultaneously. Other applications are: heterodyne wavemeter; transmitter monitor; and a 400-cycle audio signal source. Write to the manufacturer for descriptive bulletin.

(Continued on page 64A)

JUST OUT! ENERGY UNLIMITED

THE ELECTRON AND ATOM IN
EVERYDAY LIFE

by
Harry M. Davis
Science Editor of Newsweek

323 pages—104 illustrations
many of them but recently released from secrecy restrictions

\$4



KEEP abreast of all the developments in these fields of current scientific achievement and challenging future. This new book covers the whole range of electronic and atomic development particularly in their peacetime and industrial applications—from power sources to super X-rays and microscopes, the "brainplane," radioisotope medical research, induction heating, and many others. "Up-to-date—indeed, almost ahead of the times—and it is accurate." . . . *New York Times*. "Pleased with the clarity of his presentation and the accuracy of his treatment of atomic physics." . . . Professor Henry Semat. Use coupon below to send for a copy subject to your examination, today.

CHECK LIST of other

Murray Hill Books in
ELECTRONICS and ELECTRICITY

1. RADIO PHYSICS COURSE, Ghirardi, \$5.00 (Outside U.S.A. \$5.50)
2. MODERN RADIO SERVICING, Ghirardi, \$5.00 (Outside U.S.A. \$5.50)
3. RADIO TROUBLESHOOTER'S HANDBOOK, Ghirardi, \$5.00 (Outside U.S.A. \$5.50)
4. THE ELECTROLYTIC CAPACITOR, Georgiev, \$3.00 (Outside U.S.A. \$3.25)
5. ELECTRIC MOTOR REPAIR, Rosenberg, \$5.00 (Outside U.S.A. \$5.50)
6. INDUSTRIAL ELECTRIC WIRING, Lincoln, \$2.75.
7. CONDUCTORS AND WIRING LAYOUTS, \$2.75.
8. ELECTRIC MOTORS AND GENERATORS, Lincoln, \$2.75.
9. INDUSTRIAL ELECTRIC CONTROL, Lincoln, \$2.75.
10. ELECTRICAL MEASURING INSTRUMENTS, \$2.50.
11. ELECTRIC PROTECTIVE EQUIPMENT, Lincoln, \$2.50.
12. PRIMARY AND STORAGE BATTERIES, Lincoln, \$2.25.
13. SWITCHBOARDS AND PANELBOARDS, Lincoln, \$2.25.
14. INDUSTRIAL ELECTRIC LAMPS AND LIGHTING, Lincoln, \$2.75.
15. INDUSTRIAL ELECTRIC HEATING, Lincoln, \$2.25.
16. RADIO'S CONQUEST OF SPACE, McNicol, \$4.00

5 DAY MONEY-BACK GUARANTEE

Dept. IR-48, Murray Hill Books, Inc.
232 Madison Ave., New York 16, N.Y.

Enclosed find \$..... for books checked below or, send C.O.D. (in U.S.A. only) and I will pay postman this amount plus postage upon delivery. In either event, it is understood I may return any book within 5 days for refund of the purchase price.

ENERGY UNLIMITED (\$4)

Check from above list the numbers you are ordering:
1 2 3 4 5 6 7 8 9 10
11 12 13 14 15 16

Name

Address

City & Zone State

At last...

**AN IMPROVED AND FASTER MEANS
FOR AUDIO WAVEFORM ANALYSIS**

**PANORAMIC
SONIC ANALYZER**

Model AP-1

Now, in a matter of seconds, you can observe differences in waveform content produced by parameter variations. Model AP-1 indicates graphically the frequency distribution and amplitude of audio wave components. Slow painstaking point-by-point frequency checks are eliminated. Ease of operation and simplicity of presentation make Model AP-1 ideally suited for production line as well as for laboratory usage.

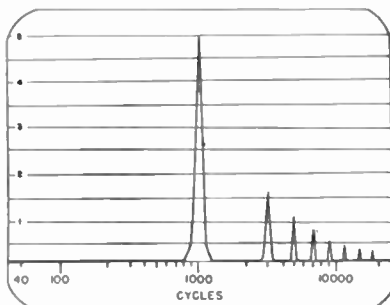

CHECK THESE FEATURES...

- Panoramic graphic presentation of frequency versus voltage amplitude
- Continuous scanning from 40-20,000 c.p.s. in one second
- Wide voltage range 0.05V to 500V
- Simple operation
- Direct simultaneous reading of voltage and frequency
- Automatic variable selectivity for optimum resolution throughout frequency range (see graph below)
- Both linear and log voltage calibrations
- Built-in voltage calibrator
- Frequency scale closely logarithmic

APPLICATIONS...

- Intermodulation measurements
- Harmonic analysis
- Noise investigations
- Acoustic studies
- Vibration analysis
- Material testing

Write now for detailed specifications, price and delivery

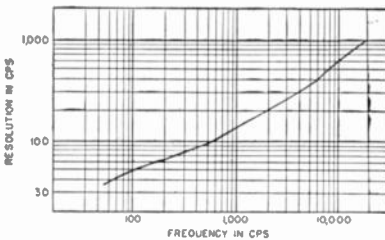

PANORAMIC
RADIO CORP.
92 Gold St.
New York 7, N. Y.
Cable Address
PANORAMIC, NEW YORK
Exclusive Canadian Representative: Canadian Marconi, Ltd.

News—New Products

These manufacturers have invited PROCEEDINGS readers to write for literature and further technical information. Please mention your I.R.E. affiliation.

(Continued from page 63A)

Klipsch Speaker System

A new two-way sound reproducer is being manufactured by Brociner Electronics Laboratory, 1546 Second Ave., New York 28, N. Y. A basically new design, the unique feature of the Klipsch Speaker System is its use of a horn for the low frequencies as well as for the high-frequency range. Conventional two-way speaker systems use a direct radiator for the low frequencies.

The Klipsch low-frequency horn is folded, and uses the corner of the room as an integral part of the acoustic system, so that, occupying only 14 cubic feet of space, it provides performance equivalent to conventionally designed horns 8 to 16 times as bulky. Such large horns could

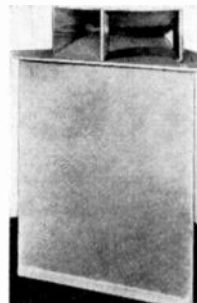

not practically be used in a living room, while the Klipsch Speaker System fits unobtrusively into a corner, where it utilizes the converging walls and floor as an extension of the low-frequency horn. The listener is literally inside the loudspeaker.

With both the high- and low-frequency speakers coupled to horns, their relative efficiencies are nearly equal. Thus, it is not necessary to attenuate the high-frequency unit markedly to match the low-frequency output, as in the case of direct radiators. The gain in efficiency permits the use of a relatively simple, high-quality triode amplifier of moderate cost, for most applications.

The nonresonant character of the speaker system affords reproduction of transients without hangover; there is no resonant frequency in the bass range to be excited by all notes in its vicinity. Bass instruments are clearly recognized. Fundamentals from 30 to 15,000 cycles are cleanly reproduced and uniformly distributed throughout the room.

The Klipsch Speaker System is available as a complete unit, and the individual components such as the high- and low-frequency horns, drivers, and dividing network, can be obtained separately. The Model 1A, illustrated, is rated at 20 watts. Other models provide power-handling capability up to 60 watts in one unit.

New Metal Signs

Engraved brass, aluminum, or stainless-steel signs with letters engraved to 0.02 inch depth and filled with any desired color of baked enamel, fitted in new slide-type wood or metal frames, are now being made by The Acromark Co., 9-13 Morrell St., Elizabeth 4, N. J.

(Continued on page 66A)



Elements

**Designed For
Experimental
and Beam Arrays**

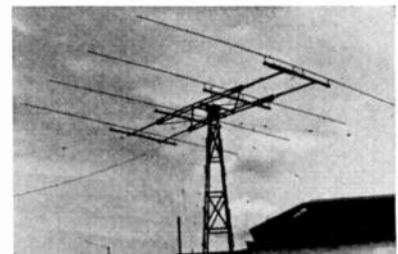

Designed to meet the demand for suitable light-weight elements for use in horizontal arrays and similar applications, Premax Tubular Elements are of a special construction that assures exceptional strength, light weight and rigidity, so essential in horizontal arrays. They are fully adjustable and possess the electrical conductivity you have been seeking.

CORULITE ELEMENTS—A tubular element with reeded design which gives extra rigidity. Available in 1-, 2-, 3- and 4-section designs, giving extended lengths from 5 to 17 ft.

CORULITE ELEMENT KITS—Contain elements and mountings, together with working drawings for wood frame and support. Available for 3-element 10 Meter, 4-element 10 Meter, 3-element 20 Meter and 4-element 20 Meter.

ROTARY BEAM KIT—Includes frame and three pairs of seamless duraluminum tubular elements with necessary insulators and hardware including T-match accessories but without transmission line. Adjustable for 6-, 10- and 11-meter bands.

Ask Your Jobber



4811 Highland Ave., Niagara Falls, N.Y.



**TELEVISION-
SET
DESIGNERS!**

Follow this
Ken-Rad tube
pattern for
finest
picture
quality



12AT7
Nine-pin miniature twin triode. Converter and r-f amplifier.



6AU6
Miniature r-f amplifier pentode. Best intermediate-frequency tube from standpoint of design economy.



12AU7
Nine-pin miniature general-purpose twin triode. Serves in place of the 6SN7-GT (common in earlier television-set designs) in synchronizing circuits and as a multi-vibrator.



6BG6-G
Power-amplifier pentode. Driver tube for the horizontal sweep circuit.



1B3-GT/8016
Half-wave high-vacuum rectifier. Used to rectify the high-voltage picture-tube supply.

CHARACTERISTICS AND TYPICAL OPERATION, 12AT7

(Center-tapped heater permits either a 12.6-v or 6.3-v supply)

	Series	Parallel
Heater voltage (a-c or d-c)	12.6 v	6.3 v
current	0.150 amp	0.300 amp
Direct interelectrode capacitances, approx value without external shield (grounded cathode operation):		
Grid-to-plate (each section)	1.45 mmfd	
Input (each section)	2.5 mmfd	
Output (Section No. 1)	0.45 mmfd	
Output (Section No. 2)	0.35 mmfd	
As Class A amplifier, each triode section:		
Plate voltage	180 v	
Grid bias voltage	-1 v	
Amplification factor	62	
Transconductance	6,600 micromhos	
Plate current		11 ma

CHARACTERISTICS AND TYPICAL OPERATION, 6AU6

Heater voltage (a-c or d-c)	6.3 v
current	0.3 amp
Direct interelectrode capacitances (measured without external shield):	
Grid-to-plate (max)	0.0035 mmfd
Input	5.5 mmfd
Output	5.0 mmfd
As Class A amplifier:	
Plate voltage	250 v
Screen (Grid No. 2) voltage	125 v
Grid bias voltage	-1 v
Transconductance	4,450 micromhos
Plate current	7.6 ma
Screen current	3 ma

TYPICAL OPERATION, 12AU7

(Center-tapped heater permits either a 12.6-v or 6.3-v supply)

	Series	Parallel
Heater voltage	12.6 v	6.3 v
current	0.15 amp	0.3 amp
As Class A ₁ amplifier, each triode section:		
Plate voltage	250 v	
Grid voltage	-8.5 v	
Amplification factor	17	
Plate resistance	7,700 ohms	
Transconductance	2,200 micromhos	
Plate current		10.5 ma

TYPICAL OPERATION, 6BG6-G

Heater voltage (a-c or d-c)	6.3 v
current	0.9 amp
As deflection amplifier:	
D-c supply voltage	400 v
Peak positive surge plate voltage (approx)	4,000 v
Peak negative surge grid voltage (approx)	-100 v
D-c Grid No. 2 current	6 ma
D-c Grid No. 1 current	25 microamperes
D-c plate current	70 ma

RATINGS, 1B3-GT/8016

Heater voltage, a-c	1.25 v
current	0.2 amp
<i>Design center values</i>	
Peak inverse plate voltage (max)	40,000 v
Peak plate current (max)	17 ma
D-c plate current (max)	2 ma
Freq. of supply voltage (max)	300 kc

● Experienced tube engineers will be glad to work closely with you in applying these and other Ken-Rad types to new circuits in the development stage. Write KEN-RAD, Electronics Department, General Electric Company, Schenectady 5, New York.

KEN-RAD Radio Tubes

PRODUCT OF GENERAL ELECTRIC COMPANY

Schenectady 5, New York

178-61-0090

What procedures must you use to make A-1 experimental equipment?

Find the answers in

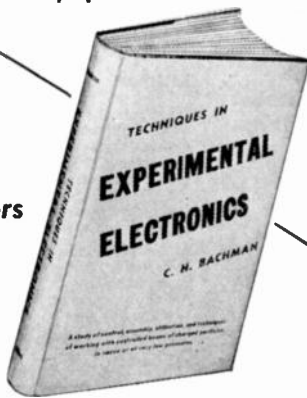

TECHNIQUES IN EXPERIMENTAL ELECTRONICS

By C. H. BACHMAN, Associate Professor of Physics, Syracuse University

Professor Bachman has assembled the results of his twelve years' experience in developing vacuum and electronic devices for industry in this excellent working manual. A unique feature is the inclusion of as many as possible of those techniques which the author learned "the hard way"—through personal effort.

He discusses equipment and techniques for the production and measurement of vacua, the preparation and design of glass tubulations, the production of glass seals, the preparation of cathodes and other electrodes, and the preparation and application of fluorescent materials. Many useful tables are included, as well as explanatory diagrams for such operations as severing glass tubing, preparing an end, beading a wire, hole patching, etc.

1948 252 pages \$3.50

ON APPROVAL COUPON

JOHN WILEY & SONS, INC.
440 Fourth Ave., New York 16, N.Y.

Please send me, on ten days' approval, a copy of Bachman's *TECHNIQUES IN EXPERIMENTAL ELECTRONICS*. If I decide to keep the book, I will remit \$3.50 plus postage; otherwise I will return the book postpaid.

Name
Address
City State
Employed by
(Offer not valid outside U.S.) IRE-4-48

News—New Products

These manufacturers have invited PROCEEDINGS readers to write for literature and further technical information. Please mention your I.R.E. affiliation.

(Continued from page 64A)

New 20-Ampere Variac Autotransformer

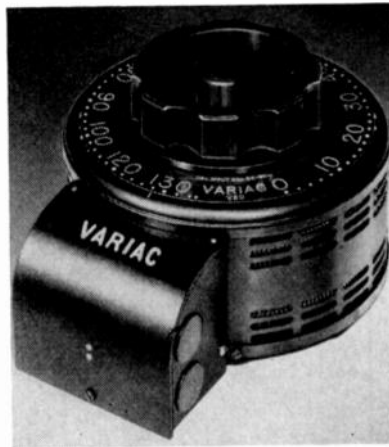

General Radio Co., 275 Massachusetts Ave., Cambridge 39, Mass., recently introduced the Type V-20 as the latest item in a new line of Variacs. It is capable of handling 20 amperes in the 115-volt model. Like the previously announced V-5 and V-10, the new V-20 delivers considerably more kva. per pound than older models. The 115-volt model, Type V-20M, is rated at 3.45 kva., and the 230-volt model, Type V-20HM, at 2.3 kva.

Output voltage is continuously adjustable from zero to 17% above input line voltage. Both models are supplied with case and terminal box cover. Terminal box is designed for use with BX or conduit.

Exposed surfaces are made of corrosion-resistant materials with a durable black baked finish. Over-all dimensions are $7\frac{1}{4} \times 9\frac{1}{2} \times 5\frac{1}{2}$ inches, and the net weight is $22\frac{1}{2}$ pounds.

Starting Switch for Motors of 1 Horsepower or Less

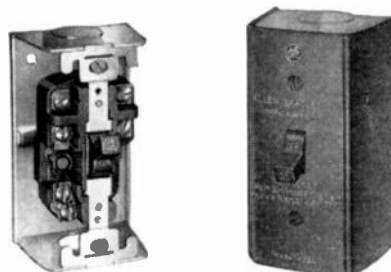

Allen-Bradley Co., 114 W. Greenfield Ave., Milwaukee 4, Wis., announces the new *Bulletin 600* manually operated snap switch for starting motors of 1 horsepower or less. It is a streamlined unit with molded plastic cover, and has an overload device which operates on the soldered ratched principle. It is impossible to hold the switch closed under sustained overload, but it can be reset easily, with the regular



first in facsimile for broadcasting and point-to-point communication!

FINCH TELECOMMUNICATIONS
INCORPORATED
SALES OFFICE:
10 EAST 40th STREET, NEW YORK
FACTORIES: PASSAIC, N. J.

switch lever, after the overload is cleared

The switch unit can be furnished without enclosure for mounting in a standard switch box or machine base. Various types of enclosures are also available to meet any industrial requirement.

New R.F. Capacitometer

According to an announcement from the Specialty Division of General Electric Co., at Electronics Park, Syracuse, N. Y., a new r.f. capacitometer, Type YCL-1, has been designed to measure capacitance from 0 to 10,000 μ h. at a fixed radio frequency of 75 kc.

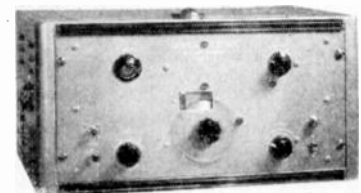

This new instrument is expected to have wide application in the component manufacturing, research and development laboratories fields.

News—New Products

These manufacturers have invited PROCEEDINGS readers to write for literature and further technical information. Please mention your I.R.E. affiliation.

Suitable for portable use, the YCL-1 may also be removed from its cabinet and installed in a 19-inch relay rack. To provide stable operation despite line fluctuations, the internal measurement circuits are operated from a self-contained, electronically regulated power supply.

Calibration charts are used to convert dial readings for the measurement of capacitance in the range of 0 to 20,000 $\mu\text{fd.}$, and of inductance up to 10,000 $\mu\text{h.}$

The new r.f. capacitometer weighs 50 pounds, and is 11 inches high by 21 inches wide by 15 inches long.

New Crystal Microphone



Described as the Velvet Voice Beauty, a new, convertible-type crystal microphone has recently been introduced by The Astatic Corp., Conneaut, Ohio.

Made with a detachable quick-lock base, this microphone may be used as a hand or desk mike or mounted on a floor stand. It is made with bright chrome grille, gold-finish housing and handle, and dark brown baked-enamel base. There are two models: No. 200, with smooth, even frequency-response characteristics from 30 to 10,000 c.p.s.; and No. 241, with similar range but with rising characteristics between 1500 and 5500 c.p.s. for added brilliance in the speech range. Either model may be supplied with or without switch, as illustrated.

New Type S Time Switch

A new design in an unusually small, compact, low-priced time switch is being introduced to the trade by the Sangamo Electric Co., Springfield, Ill. The over-all dimensions of the new switch are approximately 3 inches wide by 5 $\frac{3}{4}$ inches high by 3 inches deep.

(Continued on page 68A)

NEW R-F OSCILLATOR

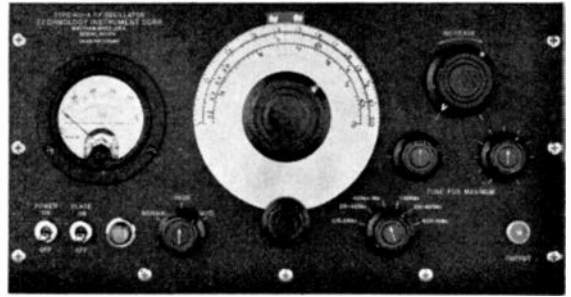

for general laboratory use and as a signal source for R-F bridges

NOTE THESE FEATURES

- 100 kc to 10 Mc
- High output—approximately 30 volts
- Low output impedance
- Internal modulation
- Output voltmeter
- Compact design

Write today for Bulletin 408 containing complete information and specifications on the Type 410-A R-F Oscillator.



TECHNOLOGY INSTRUMENT CORP.
1058 MAIN STREET, WALTHAM 54, MASS.

THE WORLD'S BEST WIRE AND CABLE For the Radio-Electronic Industry!

We have spent the last few years gathering huge stocks of communication wire and cable of nearly every conceivable type from our government. This material is all new and perfect and made to the stringent specifications of the military services.

We offer primarily QUALITY; also prices much under market, and immediate delivery.

May we have a full list of your wire and cable requirements? Our lists will be mailed regularly upon request.

COLEMAN WIRE & CABLE CORP.

4515 W. Addison St., Chicago 41, Ill.

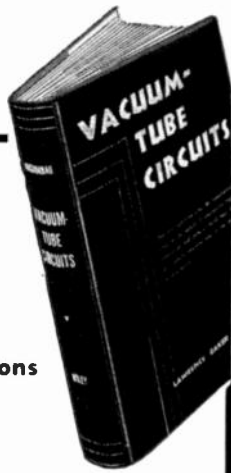

A basic book for communications technicians

VACUUM TUBE CIRCUITS

By LAWRENCE B. ARGUIMBAU, Assistant Professor, Department of Electrical Engineering, Massachusetts Institute of Technology

This book has been written in answer to the need for up-to-date literature on the subject of vacuum tube circuits. The selection of material contained in the book, and its presentation, have been carefully designed to cover the problems encountered in the field of communications.

The most recent information on the subject has been compressed and edited so that topics of major importance receive more detailed attention. The first chapter comprises an overall introduction with a comprehensive presentation of the interrelation of the various component parts to be discussed.

The treatment is developed carefully from simple circuits to those of a more complex nature. Emphasis is given to frequency modulation as opposed to amplitude modulation. In view of the rapid developments in the field of television, the book also includes much basic material on transient response and on the generation of micro-waves. Unusually full explanations throughout insure readability and understanding.

Contents: Radio Communication; Diodes and Rectifiers; Triodes, Pentodes, and Linear Amplifiers; Transient Response of Video Amplifiers; Amplitude Modulation and Tuned Amplifiers; Power Amplifiers; Oscillators; Inverse Feedback; Amplitude Modulation; Frequency Modulation; Pulses and Television; Micro-waves.

1948 668 Pages \$6.00

ON APPROVAL COUPON

JOHN WILEY & SONS, INC., 440 Fourth Ave., New York 16, N.Y. Please send me, on ten days' approval, a copy of Arguimbau's VACUUM TUBE CIRCUITS. If I decide to keep the book, I will remit price plus postage; otherwise I will return the book postpaid.

Name
 Address
 City Zone State
 Employed by
 (Offer not valid outside U.S.A.) IRE-4-48

News—New Products

These manufacturers have invited PROCEEDINGS readers to write for literature and further technical information. Please mention your I.R.E. affiliation.

(Continued from page 67A)



Designated as the Sangamo Type S Time Switch, it is powered by a newly developed high-torque, synchronous, self-starting low-speed motor that is lubricated for life. The switch is designed for easy mounting on a standard switch box, or for surface mounting on any wall.

Dynamic Noise Suppressor

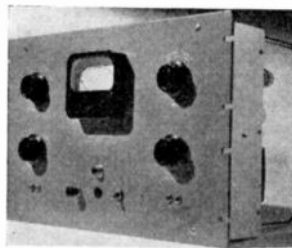

A new and improved dynamic noise suppressor, Type 910-C, allows broadcast stations to transmit recorded music with a wide frequency range and greatly reduced background noise is now available from Hermon Hosmer Scott, Inc., of Cambridge, Mass. It functions on the exclusive dynamic-band-pass principle, which is inherently distortion free. The new model features improved control circuits, extended frequency range, a continuous suppression control, and more flexible remote-control facilities.

(Continued on page 69A)

Attention Associate Members!

Many Associate Members can qualify for higher membership grades and should certainly do so. Members are urged to keep membership grades up in pace with their present development.

An Associate over 24 years of age who is occupied as a radio engineer or scientist, and is in this active practice three years may qualify for Member Grade.

An Associate who has taught college radio or allied subjects for three years may qualify.

Some may possibly qualify for Senior Grade. But transfers can be made only upon your application. For fuller details request transfer application-form in writing or by using the coupon below.



Coupon

Institute of Radio Engineers
 1 East 79th St.,
 New York 21, N.Y. 4-48

Please send me the Transfer Application Membership-Form.

Name

Address

Place

State

Present Grade

News—New Products

These manufacturers have invited PROCEEDINGS readers to write for literature and further technical information. Please mention your I.R.E. affiliation.

Projection Lens

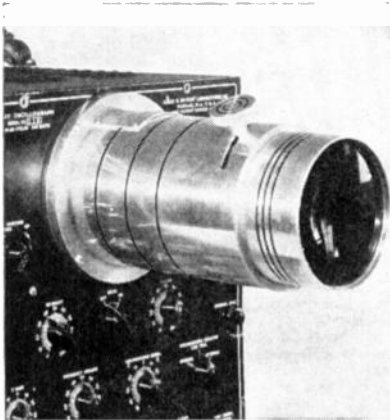

Oscillograms may be projected on a large screen for lecture and demonstration purposes or for critical study of involved waveforms by means of a new lens offered as a cathode-ray oscillograph accessory by Allen B. DuMont Labs., Inc., Clifton, N. J. The two-element symmetrical objective lens has a relative aperture of $f/3.3$ and focal length of 7.7 inches. It projects an oscillographic pattern of an area 3×3 inches from the tube screen to distances beyond 8 feet for a screen image up to 12 feet square. The lens is focused by means of a knob working in a diagonal slot.

It is especially satisfactory with DuMont Types 247-A and 248-A cathode-ray oscillographs which use the high-voltage extra-brilliant Type 5RP-A cathode-ray tube. The lens flange has four mounting holes aligning with threaded holes in the front panel of the oscillograph.

Thermistors

Introduction of thermistors, electrical semiconductors that respond to temperature variations as small as 0.0001°C . is announced by the Metallurgy Division, Chemical Department, General Electric Co., at Pittsfield, Mass. The devices are made from mixtures of semiconducting metallic-oxides and possess a high negative temperature coefficient.

Available in the forms of rods, disks, and beads, the thermistors are adaptable as the sensitive element in flow meters, time-delay relays, switching devices, and other types of indicators and controls. Since they are pure electrical resistances, they can be used with either a.c. or d.c. current. These thermistors may be actuated either by ambient temperatures or by internal heating of the element. Their negative coefficient of resistance may be used to offset the positive coefficient of resistance of conventional types of electrical conductors, so they can be used in instruments, meters, or other circuit components to correct errors caused by extreme temperature conditions.

FOUR NEW **B&W** INSTRUMENTS

B & W SINE WAVE CLIPPER

Model 250

A device for generating a test signal particularly useful for examining the transient and frequency response of audio circuits.



B & W FREQUENCY METER

Model 300

An accurate and convenient means of making direct measurements of unknown audio frequencies up to 30,000 cycles. Integral power supply.



B & W AUDIO OSCILLATOR

Model 200

A source of stable, accurately calibrated frequencies between 30 and 30,000 cycles. Self-contained power supply.



B & W DISTORTION METER

Model 400

Ideal for measuring low level audio voltages and determining their noise and harmonic content. Self-contained power supply.



Write for descriptive folders and prices.

BARKER & WILLIAMSON

Dept. PR-48, 237 Fairfield Ave., Upper Darby, Pa.

BEAT FREQUENCY GENERATOR

TYPE 140-A

FREQUENCY COVERAGE

20 cycles to 5 mc.

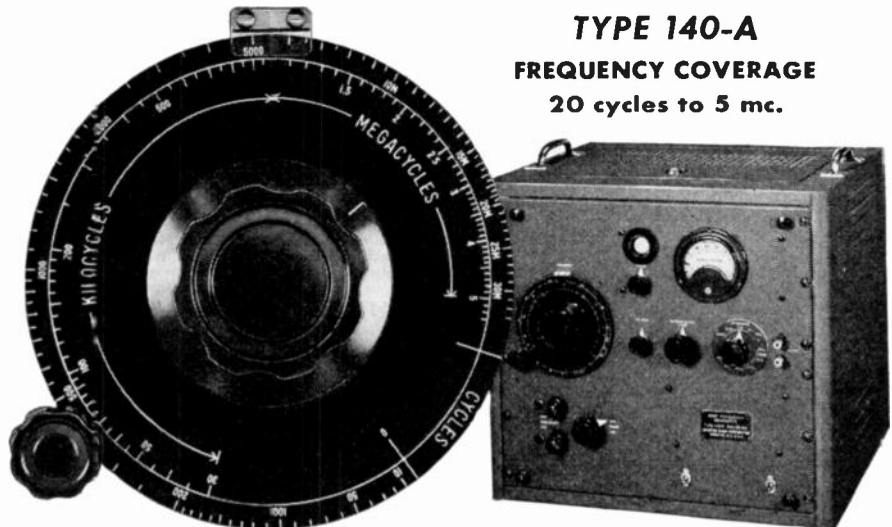

The six inch frequency dial of the Type 140-A Beat Frequency Generator has been planned for maximum readability and rapid setting, with combined scale lengths of the low and high ranges exceeding 22 inches. Continuous coverage of the entire audio spectrum is possible without bothersome range switching.

Frequency Range: 20 cycles to 5 megacycles in two ranges. Low Range: 20 to 30,000 cycles. High Range: 30 kc to 5 megacycles. Frequency Calibration: Accuracy ± 2 cycles up to 100 cycles, $\pm 2\%$ above 100 cycles. Adjustment: High and low range; have individual zero beat adjustments. Low range may be checked against power line frequency with front panel 1 inch cathode ray

tube. Output Power and Impedances: Rated power output: one watt, available over the low frequency range from output impedances of 20, 50, 200, 500, 1000 ohms, and over both ranges from an output impedance of 1000 ohms. Output Attenuator: Five steps: X1.0, X0.1, X0.01, X0.001. Distortion: 5% or less at 1 watt output; 2% or less for $\frac{1}{2}$ wattage output. Write for Catalog "D"

Limited stock available for immediate delivery

BOONTON RADIO
Corporation
BOONTON - N. J. - U. S. A.



DESIGNERS AND MANUFACTURERS OF
THE Q METER · QX CHECKER
FREQUENCY MODULATED SIGNAL GENERATOR
BEAT FREQUENCY GENERATOR
AND OTHER DIRECT READING INSTRUMENTS

PROFESSIONAL CARDS

W. J. BROWN
Electronic & Radio Engineering Consultant
 Electronic Industrial Applications, Commercial and Broadcasting Transmitter and Receiver Design, Test Equipment, etc.
 23 years experience in electronic development
 P.O. Box 5106, Cleveland, Ohio
 Telephone, Superior 1241
 Office, 912 Park Building

EDWARD J. CONTENT
Acoustical Consultant
Functional Studio Design
 FM - Television - AM
 Audio Systems Engineering
 Roxbury Road Stamford 3-7459
 Stamford, Conn.

STANLEY D. EILENBERGER
Consulting Engineer
INDUSTRIAL ELECTRONICS
 Design—Development—Models
 Complete Laboratory and Shop Facilities
 6309-13—27th Ave.
 Kenosha, Wis. Telephone 2-4213

HERMAN LEWIS GORDON
Engineering Consultant—Registered Patent Attorney
 Product Development and Design
 Electronics — Mechanical Devices — Optics
 100 Normandy Drive 1416 F Street, N.W.
 Silver Spring, Md. Washington 4, D.C.
 Shepherd 2433 National 2497

DAVID C. KALBFELL, Ph.D.
Engineer — Physicist
 Complete Laboratory facilities
 Industrial instrumentation and control
 Broadcast engineering and measurements
 1076 Morena Boulevard Jackson 1939
 San Diego 10, California

PATENTS
 Electronics—Electricity
 Mechanics—Chemistry—Metallurgy
I. JORDAN KUNIK
 Registered Patent Attorney
 75-1 Pearl Street Hartford 3, Connecticut

FAirmount 5105 EXpress 7766
FRANK MASSA
 Electro-Acoustic Consultant
 3393 Dellwood Road 3868 Carnegie Avenue
 CLEVELAND, OHIO

EUGENE MITTELMANN, E.E., Ph.D.
Consulting Engineer & Physicist
**HIGH FREQUENCY HEATING
 INDUSTRIAL ELECTRONICS
 APPLIED PHYSICS &
 MATHEMATICS**
 549 W. Washington Blvd. Chicago 6, Ill.
 Phone: State 8021

INDEX AND DISPLAY ADVERTISERS

Section Meetings	34A
Student Branch Meetings	38A
Membership	40A
Positions Open	50A
Positions Wanted	54A
News—New Products	57A

Finch Telecommunications, Inc.	66A
Freed Transformer Co.	57A
General Aniline & Film Corp.	18A
General Electric Co.	10A & 11A, 45A
General Radio Co.	Cover IV
G. M. Giannini & Co., Inc.	52A
H. L. Gordon	70A

DISPLAY ADVERTISERS

Aircraft Radio Corp.	46A
Allen-Bradley Company	31A
American Lava Corp.	17A
Andrew Corporation	44A
Arnold Engineering Co.	22A
Atstatic Corporation	34A
Audio Devices, Inc.	21A

Hazeltine Electronics Corp.	50A
Hewlett-Packard Co.	7A
Hughey & Phillips	42A

Barker & Williamson	69A
Bell Telephone Laboratories	2A 3A 35A
Bendix Aviation Corp. (Scintilla Magneto Div)	56A
Bendix Aviation Corp. (Radio Div.)	50A
Blaw-Knox	47A
Biley Electric Company	27A
Boland & Boyce, Inc.	48A
Boonton Radio Corp.	69A
W. J. Brown	70A
Burnell & Co.	1A

Illiffe & Sons	43A
International Nickel Co.	33A

Cambridge Thermionic Corp.	48A
Cannon Electric Development Co.	58A
Capitol Radio Engineering Institute	70A
Centralab	12A
Cleveland Container Co.	19A
Sigmund Cohn Corp.	58A
Coleman Wire & Cable Corp.	67A
Communications Equipment Co.	55A
E. J. Content	70A
Cornell-Dubilier Electric Corp.	Cover III

D. C. Kalbfell	70A
Ken-Rad	65A
Kenyon Transformer Co., Inc.	60A
Kepeco Laboratories	60A
I. J. Kunik	70A

Tobe Deutschmann Corp.	6A
Dial Light Co. of America	57A
Allen B. DuMont Laboratories	24A

Linde Air Products Co.	26A
Los Alamos Scientific Lab.	50A

Stanley D. Eilenberger	70A
Eitel-McCullough, Inc.	16A
Electrical Reactance Corp.	25A
Electro-Motive Mfg. Corp.	5A

P. R. Mallory & Co., Inc.	20A
Marion Electrical Instrument Co.	39A
Frank Massa	70A
Measurements Corporation	62A
Eugene Mittelmann	70A
Murray Hill Books	63A
Mycalex Corp. of America	28A

Stanley D. Eilenberger	70A
Eitel-McCullough, Inc.	16A
Electrical Reactance Corp.	25A
Electro-Motive Mfg. Corp.	5A

Newark Electric Co., Inc.	62A
J. M. Ney Company	61A

IRVING RUBIN
 Physicist
 Radio interference and noise meters. Interference suppression methods for ignition systems and electrical devices. Laboratory facilities.
 P.O. Box 153, Shrewsbury, New Jersey
 Telephone: REDBANK 6-4247

Ohmite Mfg. Co.	41A
-----------------	-----

ARTHUR J. SANIAL
 Consulting Engineer
 Loudspeaker Design; Development; Mfg. Processes. High Quality Audio Systems. Announcing Systems. Test and Measuring Equipment Design.
 168-14 32 Ave. Flushing, N.Y.
 FLushing 9-3574

Panoramic Radio Corp	64A
Premax Products	64A
Polytechnic Research & Dev. Co., Inc.	14A

Radio Corp. of America	32A, 54A, 71A
Radio Music Corporation	61A
Reeves-Hoffman Corporation	59A
Revere Copper & Brass, Inc.	4A
Irving Rubin	70A

A. J. Sanial	70A
Sherron Electronics Co.	15A
Simpson Electric Co.	29A
Sola Electric Co.	13A
Sorensen & Co.	23A
Sperry Gyroscope Co., Inc.	52A
Sprague Electric Co.	8A
Stackpole Carbon Co.	30A
Standard Radio & Electronic Products Co.	53A
Superior Electric Co.	51A
Sylvania Electric Prod. Co., Inc.	37A

Taylor Fibre Co.	49A
Tech Laboratories	59A
Technology Instrument Corp.	67A
Truscon Steel Company	40A

Union Carbide & Carbon Co.	26A
United Transformer Corp.	Cover II

Western Electric Company	2A & 3A, 35A
S. S. White Dental Mfg. Co.	38A
Wilcox Electric Co.	9A
John Wiley & Sons	36A, 66A, 68A
Workshop Associates	52A

"Where Professional Radiomen Study"

CAPITOL RADIO ENGINEERING INSTITUTE

An Accredited Technical Institute
 16th and Park Rd., N. W.
 Washington 10, D. C.



Advanced
 Home Study and Residence
 Courses in Practical Radio-
 Electronics and Television.
 Approved for Veteran Training.



RCA scientists—pioneers in radio-electronics—apply the “radio tube” to communications, science, industry, entertainment, and transportation.

This “magic lamp” makes Aladdin’s look lazy

You will remember the fabulous lamp—and how it served its master, Aladdin. Serving you, today, is a real “magic lamp”... the electron tube.

You are familiar with these tubes in your radio, Victrola radio-phonograph or television set... but that is only a small part of the work they do. Using radio tubes, RCA Laboratories have helped to develop many new servants for man.

A partial list includes: all-electronic television, F.M. radio, portable ra-

dios, the electron microscope, radio-heat, radar, Shoran, Teleran, and countless special “tools” for science, communications and commerce.

The electron microscope, helping in the fight against disease, magnifies bacteria more than 100,000 diameters, radar sees through fog and darkness, all-electronic television shows events taking place at a distance, radio-heat “glues” wood or plastics, Shoran locates points on the earth’s surface with unbelievable accuracy, Teleran adds to the safety of air travel.

Constant advances in radio-electronics are a major objective at RCA Laboratories. Fully developed, these progressive developments are part of the instruments bearing the name RCA, or RCA Victor.

When in Radio City, New York, be sure to see the radio, television and electronic wonders on display at RCA Exhibition Hall, 36 West 49th Street. Admission is always free. Radio Corporation of America, RCA Building, Radio City, New York City 20, N. Y.



RADIO CORPORATION of AMERICA

Radars...1948

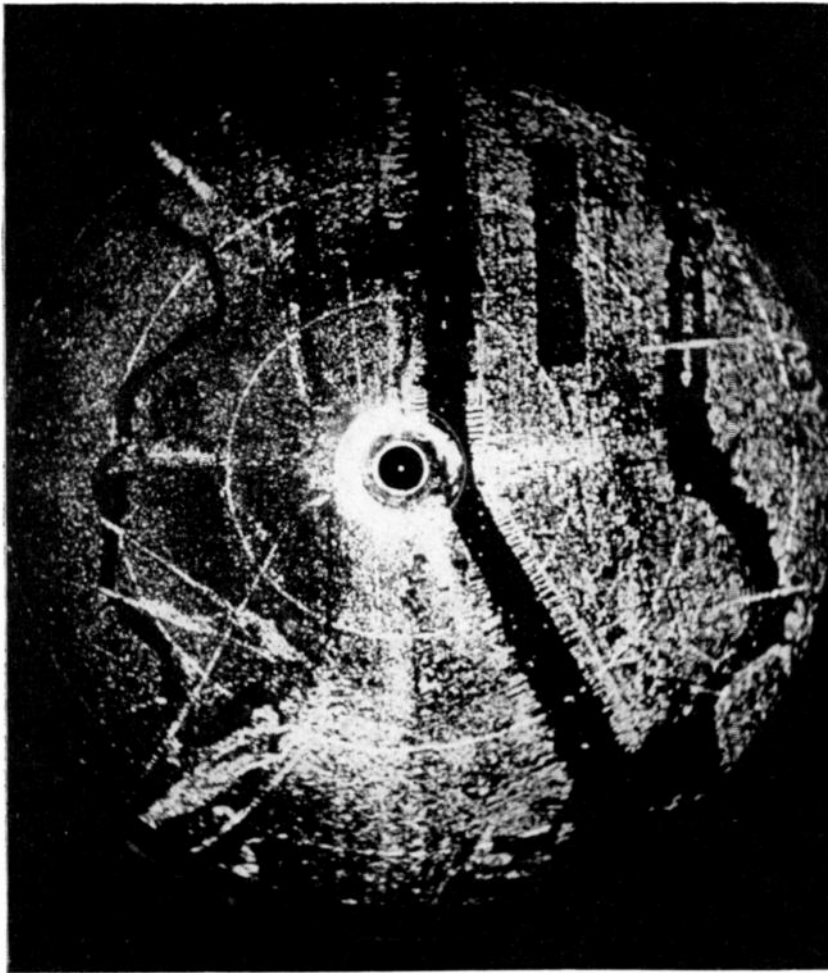

Lower half of Manhattan Island, the Hudson and East Rivers, as seen through the Radar Scope.

Not quite like the omnipotent crystal ball that Merlin used in the days of good King Arthur, but much more revealing . . . for in the growth of Radar in the armed forces, lies a prophecy for the future.

All about us we see the rapid re-conversion of military electronic devices to peacetime pursuits . . . and certainly we must realize that in a field so young and so dynamic the horizons are unlimited.

The future of the electronic industries is immeasurable and keeping pace with progress is a full time job for the man who controls its advance and growth . . . the Radio Engineer. Creating . . . specifying . . . purchasing . . . he must depend on his own publication . . . The Proceedings of the I. R. E. for up-to-the-minute technological data. Always on his desk, it is the constant authoritative reference, to which he turns with confidence for

editorial guidance and technical content . . . because he knows that it is written by Radio Engineers . . . for Radio Engineers.

Small wonder, then, that among those who have successfully sold this market, the byword has always been . . . to Sell the Radio field . . . Tell the Radio Engineers . . . in the Engineers' own publication . . . The Proceedings of the I. R. E. . . . the media you cannot overlook in selling this market.



PROCEEDINGS OF THE
I·R·E
THE INSTITUTE OF RADIO ENGINEERS

WILLIAM C. COPP—*Nation's Advertising Manager*

303 West 42nd Street, New York 18, N. Y.

CI. 6-6357

SCOTT KINGWILL Central States Representative 35 East Wacker Drive, Chicago 1, Ill.

THE WILLSON CO. West Coast Representative 1316 Park Central Bldg., Los Angeles 14



YOUR PRODUCT, TOO

CAN BE RADIO NOISE-PROOFED WITH C-D *Quietones* Reg. U.S. Pat. Off.

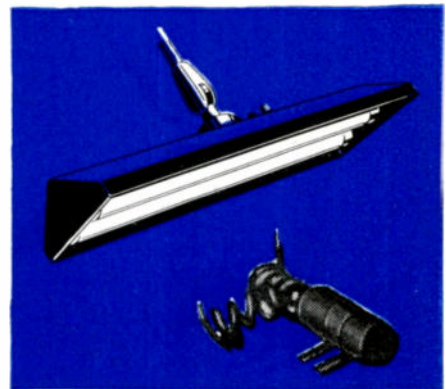
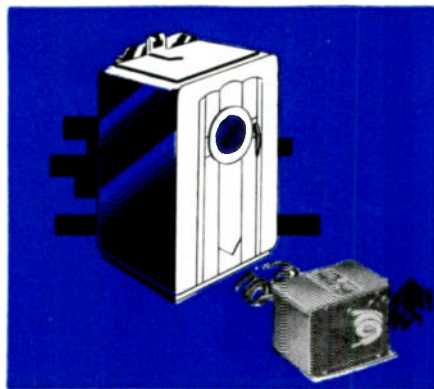
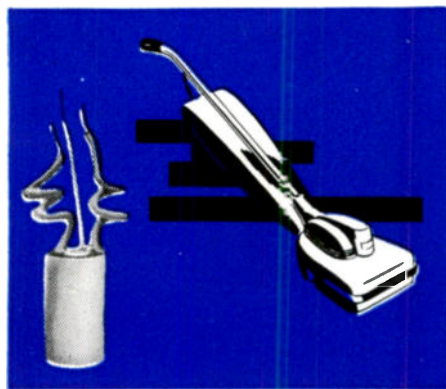
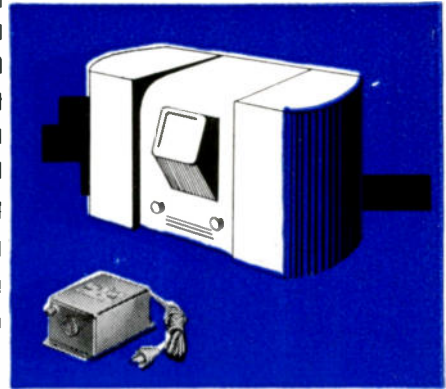
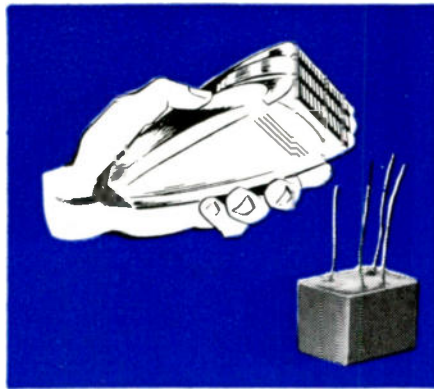
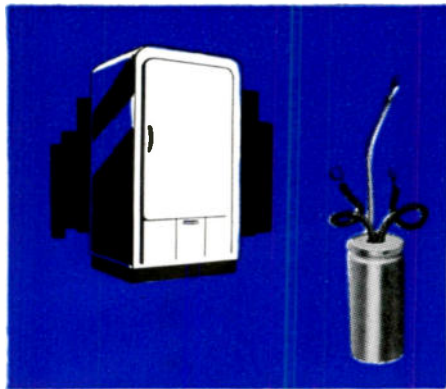

When we say Radio Noise-Proofed—we mean Radio Noise-Proofed. It's no trick at all to build a filter with high attenuation at 150 kc or 100 mc . . . but to build one which filters at 150 kc and 100 mc—as well as all points in between—is a horse of a different color. We know because we've done it. It is only one of hundreds of available types of C-D Quietones designed for all standard requirements.

Among these stock types there may be one which will bring the interference level of your product down to the level of a rabbit's bark. If not, we invite you to make full use of our Radio noise-proofing laboratory and our engineers for the development of a unit designed for your specific needs.

Your inquiries are cordially invited. Address: Cornell-Dubilier Electric Corporation, Dept. M-4, South Plainfield, N. J. Other large plants in New Bedford, Worcester and Brookline, Mass., and Providence, R. I.

Make Your Product More Saleable
With C-D Quietone Radio Noise
Filters and Spark Suppressors

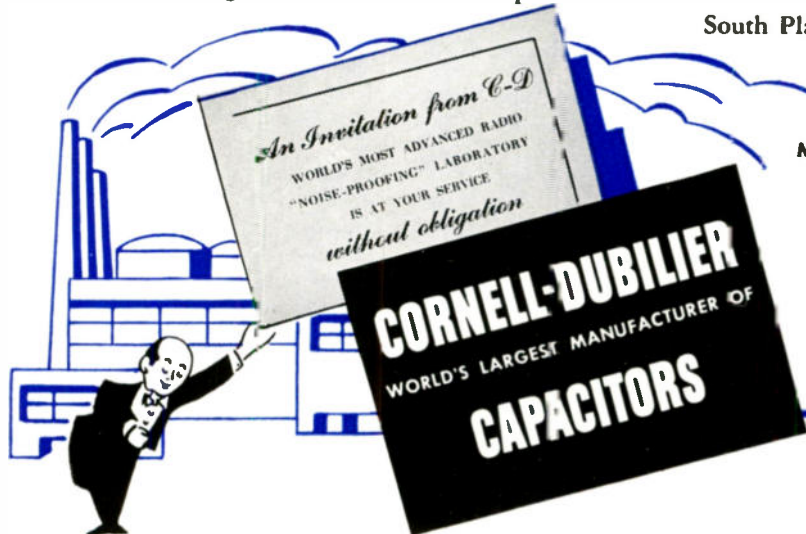

MICA • DYKANOL • PAPER • ELECTROLYTIC

METERS—by



**TYPE 727-A
VACUUM-TUBE VOLTMETER**

This general-purpose, battery-operated v-t voltmeter is for use at frequencies up to about 100 megacycles.

RANGE—0.05 volt to 300 volts ac, in seven ranges (0.3, 1, 3, 10, 30, 100, 300 volts, full scale)

ACCURACY—With sinusoidal voltages applied, the accuracy is $\pm 3\%$ of full scale on the 0.3-volt range and $\pm 2\%$ of full scale on all other ranges. Periodic checking of the full-scale sensitivity will give corrections to be made to eliminate effects of aging on the higher voltage ranges.

WAVEFORM ERROR—On lowest ranges the instrument approximates a true square-law device. It is calibrated to read the r-m-s value of a sinusoidal voltage. On the higher voltage ranges it is essentially a peak-reading instrument calibrated to read 0.707 of the peak values and on distorted waveforms the percentage deviation from r-m-s values may be as large as the percentage of harmonics present.

FREQUENCY ERROR—Less than 1% between 20 cycles and 30 Mc. At 65 Mc the error is about +5% and at 100 Mc about +10%.

INPUT IMPEDANCE—The input capacitance is about 16 micromicrofarads. Parallel input resistance (at low frequencies) is about 5 megohms on the lower ranges and about 3 megohms on the upper.

PRICE: \$180



**TYPE 728-A
D-C VACUUM-TUBE VOLTMETER**

This battery-operated v-t voltmeter is designed for measuring d-c voltages in low-power circuits where no appreciable power can be taken by the meter.

RANGE—0.05 to 3000 volts in seven ranges (3, 10, 30, 100, 300, 1000, 3000 volts, full scale)

ACCURACY—Within $\pm 3\%$ of full scale on all ranges. If the full-scale sensitivity is checked occasionally the effect of aging, on the higher voltage ranges, can be eliminated.

INPUT RESISTANCE—1000 megohms on the ranges above 100 volts; greater than 5000 megohms on the lower

TERMINALS—Two sets of input terminals are provided; one for measurements at the 0 to 30 volts end of the range and the other for higher voltages.

POLARITY—A reversing switch on the panel permits measurements with either the positive or the negative of the source grounded to the panel of the instrument.

EFFECT OF A-C—A superimposed a-c voltage of as high as 200 volts has negligible effect on meter indication.

PRICE: \$155



**TYPE 729-A
MEGOHMMETER**

This battery-operated megohmmeter is particularly useful where portability is required. It is well suited to field measurements of leakage resistance of cables and insulation.

RANGE—2000 ohms to 50,000 megohms in five overlapping ranges

SCALE—Standard direct-reading ohmmeter calibration is used; center scale values are .1, 1, 10, 100 and 1000 megohms

ACCURACY—Within $\pm 5\%$ of the indicated value between 30,000 ohms and 3 megohms when the central decade of the scale is used; otherwise the error is increased because of the compressed scale.

TEMPERATURE AND HUMIDITY—Effects of these are negligible over normal range of room conditions (65 to 95 deg. F.; 0 to 95% relative humidity)

VOLTAGE ON UNKNOWN—Voltage applied to the unknown does not exceed 22½ volts and varies with meter indication.

PRICE: \$105

THESE three accurate, highly stable and portable meters are all battery-operated and completely self-contained. They are housed in identical walnut cabinets 11 inches by 6½ inches by 5½ inches in size. Their accuracy is sufficient for a wide variety of measurements both in the laboratory and in the field.

Other G-R meters include a portable a-c operated vacuum-tube voltmeter for audio and radio frequency measurements up to several hundred megacycles, a crystal galvanometer direct-reading in voltage between 30 and 1,000 megacycles, an a-c operated megohmmeter with a range of 2,000 ohms to 50,000 megohms, a counting rate meter for measuring random emanations from radio-active materials, three models of output-power meters, and an audio-frequency microvolter with an output voltage range of 0.1 microvolt to 1 volt.

G-R meters are carefully designed, correctly engineered, ruggedly constructed and accurately calibrated to insure many years of useful life.

A FEW OF EACH IN STOCK FOR PROMPT SHIPMENT

GENERAL RADIO COMPANY

Cambridge 39,
Massachusetts

90 West St., New York 6

920 S. Michigan Ave., Chicago 5

650 N. Highland Ave., Los Angeles 38