

YOUR ONE-STOP SOURCE OF ELECTRONICS INFORMATION

ICD 08559

MODERN ELECTRONICS™

DECEMBER 1985 \$1.95
CANADA \$2.50

THE MAGAZINE FOR ELECTRONICS & COMPUTER ENTHUSIASTS

THE LASER AT 25 YEARS

COMMODORE'S NEW C128 PERSONAL COMPUTER

Three computers in one

PREVENTING HEAT DAMAGE TO ELECTRONIC DEVICES

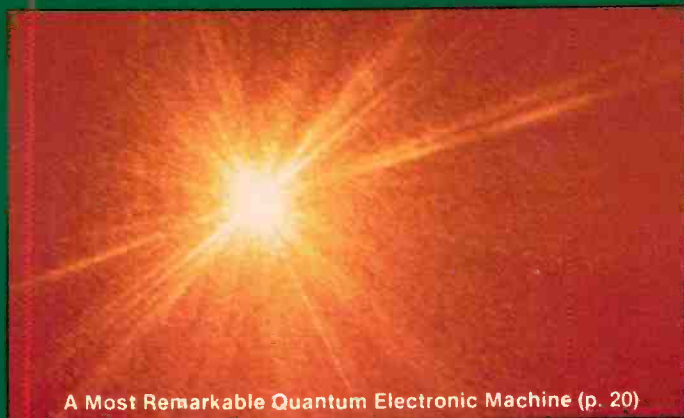

A Most Remarkable Quantum Electronic Machine (p. 20)

Tests

- Review of the awesome Black & White Video Monitor
- Do you need a mouse for the Macintosh Really Boogie?
- Review of the "Full-Spectrum" 26" Color TV/Monitor

Full Construction Plans

- Touch-Sensitive Lamp Controller
- High-Frequency Dual-Pulse Generator
- Adapter For Hidden FM Subchannels

Extra: Cumulative Article Index

NOV86 ME 9WKKP 00028192 12
DAN RAYMOND
5830 ROCKINGHAM DR
LANSING MI 48910

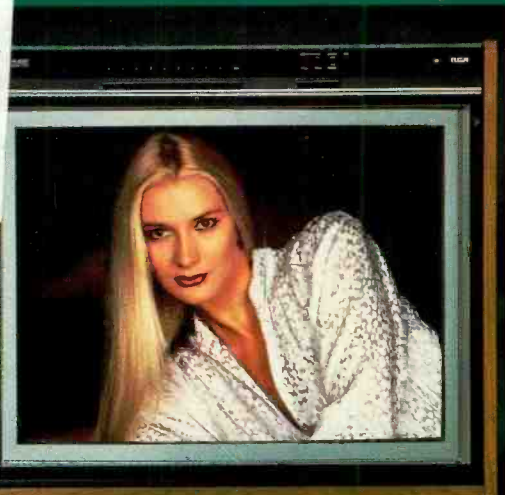

RCA's FLR2622 26" Color TV Receiver/Monitor (p. 14)

The Three Faces of Commodore's C128 Computer (p.30)



Bulk Rate
Permit No. 79
U.S. Postage Paid
Gordonsville, VA 22942

Plus: Examining Dick Smith's Rock-Bottom-Priced Digital Frequency Meter • Forrest Mims' "Experiments with CW Laser Diodes" • Satellite TV Scene • Latest Technical Books & Literature ... and more.

**F
A
S
T
A
N
D
E
A
S
Y**



**AT THE PUSH OF
JUST ONE BUTTON !**

THE MARK III HV CIRCUIT SCANNER

- ★ Checks the horiz output circuit for open / shorts,
- ★ Checks the flyback, yoke, PC, and HV mult,
- ★ Checks all scan derived B+ sources,
- ★ Checks all circuits that rely on scan derived B+ voltage,
- ★ Checks for open safety capacitor,
- ★ Checks the emitter circuit of the horiz output,

THEN,

- ★ Provided the green normal light is lit, the Mark III will safely power up the TV set so that **you** can "look" for open circuits by examining the picture on the CRT.
- ★ Circumvents all start up and horiz drive related shut down circuits.

APPLICATIONS: The Mark III will analyze the horiz, flyback, hi-voltage, scan derived B+ sources, yoke, pin cushion, HV multiplier circuits in any TV set that employs either an **NPN** transistor or a single **SCR** for its horiz output device. This applies to any age, any model, any chassis, any brand - - - including Sony.

In brief, the "test" function scans for shorts, the "run" function permits you to observe any "open" circuits via the symptoms that appear in the CRT screen.

HOOK - UP: Simply remove the set's horiz output device and replace it with the scanner's interface plug. No wires to disconnect, no other connections required (not even a ground connection).

MISTAKE PROOF: No damage will result if an error is made during hook up. The scanner simply won't turn on until the error is corrected.

PUSH THE TEST BUTTON Just one of the four lights will lite.

RED OPEN LIGHT means the emitter circuit of the horiz output stage is open (no ground path).

YELLOW SHORT LIGHT means the flyback primary, HV multiplier, vertical output, horiz driver, and R-B-G color output stages are **not** shorted. Instead, a circuit that normally draws a small amount of current is shorted (i.e. the tuner, IF, AGC, video chroma, matrix, vertical or horiz oscillator).

RED SHORT LIGHT means either the flyback, the HV multiplier, the vertical output, horiz driver or one of the **R-B-G** output transistors is shorted.

GREEN NORMAL LIGHT means the TV set's entire flyback circuit is totally free of shorts. It also means that it is safe to power up the TV set with the "run" button so that you can look for open circuits by observing the symptoms on the CRT screen.

FEATURES: All **start up** circuits and all horiz drive related **shut down** circuits are automatically circumvented by the Mark III during all test and run functions. During the test function all flyback secondary output is limited to approx 80% of normal. 2nd anode voltage is limited to approx 5 KV.

This means all circuits that are not shorted will have some 80% of their normal B+ voltage during the "test" phase. It also means that any shorted circuit will have zero DC volts on it. This feature makes any short easy to isolate.

The MARK III sells for only \$595⁰⁰

The money you are now spending for unnecessary flybacks alone will easily pay for your Mark III. Why not order yours today!

Visa and Mastercharge Welcome !

Diehl Engineering • 6661 Canyon Drive "F" • Amarillo, TX 79110

Phone: (806) 359-0329 or (806) 359-1824

CIRCLE 99 ON FREE INFORMATION CARD

**A
M
A
Z
I
N
G**

**THE
MARK V
HV CIRCUIT ANALYST**



- ★ Checks the horiz output stage for opens / shorts,
- ★ Checks flyback, yoke, PC, and HV mult,
- ★ Checks all scan derived B+ sources,
- ★ Checks for open safety capacitors
- ★ Checks for open ground path for horiz output stage
- ★ Checks for open primary LV supply,
- ★ Checks for error in interface connections,
- ★ Checks for proper LV regulation,
- ★ Checks for proper start up circuit operation,
- ★ Checks for shorted horiz driver transistor,
- ★ Checks the operation of the horiz osc / driver circuits,
- ★ Checks B+ "run" supply for the horiz osc / driver circuits,
- ★ Checks all circuits in the TV set that rely on scan derived B+.
- ★ Automatically circumvents all start up circuits and horiz drive related shut down circuits.

HOOK UP: (Identical to Mark III)

OPERATION: Turn the Mark V on, turn the TV set on, then, simply look at the lights.

RED "HOOK UP" LIGHT means that you have made an error in hook up. No damage has been done, correct the problem then continue.

RED "EMITTER" LIGHT means that the ground path for horiz output stage is open. Correct the problem then continue.

RED "B + OPEN" LIGHT means that the primary LV supply in the TV set is open. Correct the problem then continue.

No "top row lights" equals normal.

Look at the middle row of lights

RED "START UP" LIGHT means that the start up circuit in the TV set is not working (no start up pulse).

GREEN "START UP" LIGHT means the start up circuit in the TV set is working normally. Yes, it is 100% accurate. Even on Zenith's single pulse start up circuit !

RED "HORIZ DRIVE" LIGHT with a green start up light means that the horiz driver transistor in the TV is shorted (E to C).

GREEN HORIZ DRIVE LIGHT means that the horiz oscillator and driver circuits are operational.

**READ THE DC VOLTAGE METER THEN,
PUSH THE TEST BUTTON**

If the meter comes up to, or, falls back to, factory specified DC collector voltage, the LV regulator circuit is working. If it fails to do so, it is not working!

RED "B + RUN" LIGHT means that the B+ source that normally keeps the horiz osc / driver circuits running after the start up B+ pulse has been consumed has become open.

GREEN "B + RUN" LIGHT means that the B+ resupply voltage (scan derived) is being provided. All is normal if all three lights are now green.

The scan circuit short detector in the Mark V is identical in all ways to that which is used in the Mark III. Operation is also identical. Both units are virtually indestructible when simple directions are followed. Both units carry a full year's warranty against defects in materials and workmanship (parts and labor). Either unit can be easily repaired by almost any technician in his own shop.

If the green "circuits clear" light is now lit

It is now safe to push the "run" button and examine the symptoms that appear on the CRT screen, for the purpose of isolating any "open" circuits.

Except for hook up and CRT filament warm up time, this test can easily be completed in two to five seconds!

The Mark V sells for only \$995⁰⁰

Stop losing money on start up / shut down scan derived B+ problems; order your Mark V today!

Visa and Mastercharge Welcome !

Diehl Engineering • 6661 Canyon Drive "F" • Amarillo, TX 79110

Phone (806) 359-0329, or (806) 359-1824

CIRCLE 49 ON FREE INFORMATION CARD



20

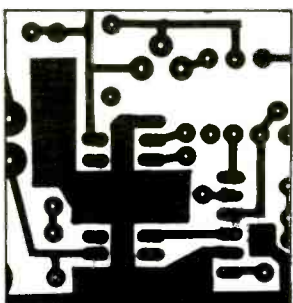

39

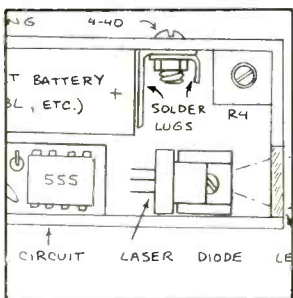

54

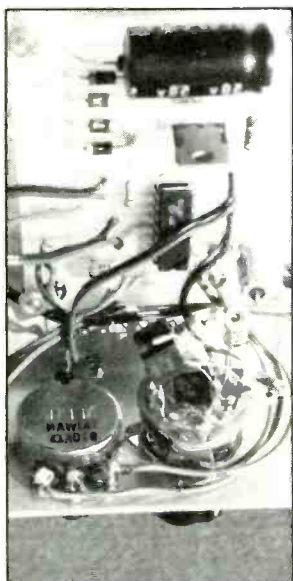

50

FEATURES

- 20 **The Laser at Twenty-Five**
Status report on a most remarkable quantum electronic machine. *By Forrest M. Mims III*
- 30 **The Three Faces of Commodore's C128 Computer**
Multiple operating modes, a better disk drive, promised peripherals. *By John Richardson*
- 34 **Cool It, Baby!**
How to dissipate damaging heat in electronic circuits. *By Joseph J. Carr*
- 39 **Discover the "Hidden World" of FM Broadcasting**
Project lets you tune in on SCA subchannels with an FM receiver. *By Gary McClellan*
- 44 **The Touchmaster**
Touch-sensitive controller you can add to any lamp. *By J. Daniel Gifford*
- 50 **A High-Frequency Dual-Pulse Generator**
Project generates high-speed square-wave pulses up to 75 MHz. *By Desi Stelling*
- 80 **Article Cumulative Index**
Oct. 1984 through Dec. 1985

PRODUCT EVALUATIONS

- 14 **RCA Model FLR2622 26" Color TV Receiver/Monitor**
By Stan Prentiss
- 18 **Dick Smith Electronics' Digital Frequency/Period Meter**
By J. Daniel Gifford

DEPARTMENTS

- 4 **Editorial**
The Merry Season Begins. *By Art Salsberg*
- 4 **Letters**
- 6 **Modern Electronics News**
- 8 **New Products**
- 54 **Electronics Notebook**
Experimenting with CW laser diodes, Part I. *By Forrest M. Mims III*
- 62 **PC Papers**
Awesome Technology's "Multiple Choice," Roland DG's Monochrome Monitor & Norton-Lambert's "Lync." *By Eric Grevstad*
- 64 **Books & Literature**
- 69 **Software Focus**
Jazz: Does Macintosh Boogie or Sing the Blues? *By Joseph Deposito*
- 76 **Satellite TV Scene**
USCI Subscribers Take Heart. *By Stan Prentiss*
- 78 **Communications Scene**
Shortwave Propagation Basics. *By Glenn Hauser*
- 90 **Advertisers Index**

EDITORIAL STAFF

- Art Salsberg**
Editor-in-Chief
- Alexander W. Burawa**
Managing Editor
- Dorothy Kehrwieler**
Production Manager
- Elizabeth Ryan**
Art Director
- Barbara Scully**
Artist
- Pat Le Blanc**
Richard Kishanuk
Phototypographers
- Hal Keith**
Illustrator
- Leonard Feldman, Glenn Hauser,
Don Lancaster, Forrest Mims III,
Stan Prentiss, Charles Rubenstein**
Contributing Editors

BUSINESS STAFF

- Richard A. Ross**
Publisher
- Art Salsberg**
Associate Publisher
- Dorothy Kehrwieler**
General Manager
- Anthony C. Sparacino**
Newsstand Sales Director
- Arlene Caggiano**
Accounting
- Cheryl Chomicki**
Subscriber Services

SALES OFFICES

- Modern Electronics**
76 North Broadway
Hicksville, NY 11801
(516) 681-2922
- Eastern Advertising Representative
Paul McGinnis Company
60 East 42nd Street
New York, NY 10017
(212) 490-1021
- Midwest Advertising Representative
Market/Media Associates
435 Locust Road
Wilmette, IL 60091
(312) 251-2541
Ted Rickard
- Western Advertising Representative
JE Publishers Representatives
6855 Santa Monica Blvd., Suite 200
Los Angeles, CA 90038
(213) 467-2266
Jay Eisenberg, Director
San Francisco: (415) 864-3252
Denver: (303) 595-4331

Offices: 76 North Broadway, Hicksville, NY 11801. Telephone: (516) 681-2922. Modern Electronics (ISSN 0748-9889) is published monthly by Modern Electronics, Inc. Application to mail at second class rates pending at Hicksville, NY and other points. Subscription prices (payable in US Dollars only): Domestic - one year \$16.97, two years \$31.00, three years \$45.00; Canada/Mexico - one year \$19.00, two years \$35.00, three years \$51.00; Foreign - one year \$21.00, two years \$39.00, three years \$57.00. Foreign Air Mail - one year \$74.00, two years \$145.00, three years \$216.00. Entire contents copyright 1985 by Modern Electronics, Inc. Modern Electronics or Modern Electronics, Inc. assumes no responsibility for unsolicited manuscripts. Allow six weeks for delivery of first issue and for change of address. Printed in the United States of America. Postmaster: Please send change of address notice to Modern Electronics, Inc., 76 North Broadway, Hicksville, NY 11801.

Where's Your **ELECTRONICS** Career Headed?

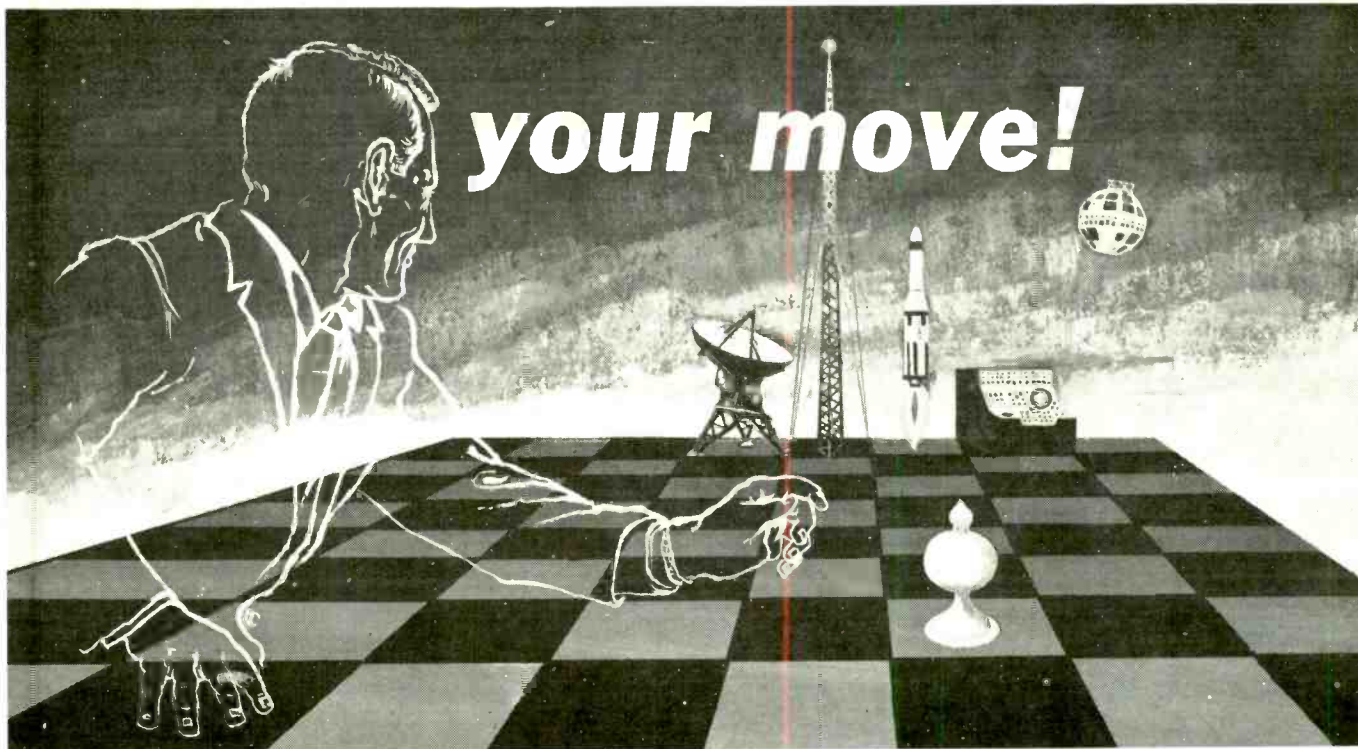

The Move You Make Today Can Shape Your Future

Yes it's your move. Whether on a chess board or in your career, you should plan each move carefully. In **electronics**, you can *move ahead* faster and further with a

B. S. DEGREE

Put professional knowledge and a COLLEGE DEGREE in your electronics career. Earn your degree through independent study at home, with Grantham College of Engineering. No commuting to class. Study at your own pace, while continuing your present job.

The accredited Grantham non-traditional degree program is intended for mature, fully employed workers who want to upgrade their careers . . . and who can successfully study electronics and supporting subjects through

INDEPENDENT STUDY, AT HOME

Free Details Available from:

Grantham College of Engineering
10570 Humbolt Street
Los Alamitos, California 90720

Independent Home Study Can Prepare You

Study materials, carefully written by the Grantham staff for independent study at home, are supplied by the College, and your technical questions related to those materials and the lesson tests are promptly answered by the Grantham teaching staff.

Recognition and Quality Assurance

Grantham College of Engineering is accredited by the Accrediting Commission of the National Home Study Council.

All lessons and other study materials, as well as communications between the college and students, are in the English language. However, we have students in many foreign countries; about 80% of our students live in the United States of America.

Grantham College of Engineering M-12-85
10570 Humbolt Street, Los Alamitos, CA 90720

Please mail me your free catalog which explains your B.S. Degree independent-study program.

Name _____ Age _____

Address _____

City _____ State _____ Zip _____

The Merry Season Begins

It's almost winter as this is being written; the beginning of the "Merry Season," 1985. The beginning of the biggest sales part of the year for so many companies; a time when electronics and computer products move off dealers' shelves like no other time.

Electronics and computers pervade our lives more and more. They virtually envelop us now. I recently spent a three-day weekend in Atlantic City, New Jersey, staying at one of the major casino-hotels. Walking into its casino, I was struck by a cornfield of video gaming machines integrated within a field of electronic "one-arm bandits."

In an elevator, I slid a magnetic card into a slot and pressed a floor number (#18) that the lift ordinarily passes by. The elevator indeed stopped, the door opened, and I entered a lobby with a locked-door area to a side that also had a "slot." Sliding my card into it, a green light was illuminated and the door was automatically unlocked. This gained me entrance to a sumptuous "private club" environment where drinks, and hors d'oeuvres, breakfast, projection TV viewing, etc.,

were all available at no charge—access made available through the magic of electronics (and a casino rating).

The video machines in the lobby are really computers; dedicated ones. Typically, a big casino here has about 1000 of them: progressive jackpot, spinning ones with representations of fruits and bells, poker, blackjack, dice, Keno (with light pens), and so on. Most of the video gaming machines use 8-bit CPUs.

What's the foregoing mean? The video action and simulations are certainly nicer to behold. It's easier to alter payoffs whenever management decides to change the program, too. Also, a casino slot mechanic doesn't know how many symbols are programmed, whereas with a mechanical reel there's a fixed number that makes it easier to work out some funny business. Equally important, with computerized slots, the house can know at any moment they wish what the cash flow is like, as well as checking on operation and payout of individual machines. Aren't electronics and computers glorious?

In another electronics invasion, a rela-

tive of mine recently bought an automobile that "talks" to you. Seems that there are talking everything nowadays. The retail stores and electronic mail-order catalogs will be filled soon with all sorts of appealing electronic and computer devices, as you know, talking and otherwise. The greatest and latest will be laid out for you as the merry season begins.

It won't be a merry season for everyone, of course. Apple Computer's founder and former chairman, Steve Jobs, who left the company after being stripped of any real power, won't be too happy. David Ahl, founder of *Creative Computing*, the pioneer personal computer magazine that recently closed shop, will not likely have a merry year end. Deposed Computerland king, William Millard, who faced a franchisee revolution, won't. Neither will U.S. solar-cell makers facing massive cuts in government R&D research, among others.

Nonetheless, here's wishing all of you a Merry Season and a happy New Year.



LETTERS

An Experimenter's Forrest

• Let me step out of the silent majority to express my sincere appreciation for Forrest Mims' work in M.E. His column (and books) fill a void that is critical to the fledgling and seasoned experimenter. Most of us out here in "readerdom" are up to our ears in books on design theory and heavy, college-level engineering text, but his "down-to-earth" approach to difficult concepts is a welcome and refreshing change. He has helped me to absorb some design concepts that I had been heretofore unable to grasp, including enough theory and formulas to allow "going further," but not so much as to be overwhelming. I look forward to his "op-amp notebook" when it becomes available at Radio Shack, and to your future offerings in *Modern Electronics*.

Don Gaynor, Sr., President
Marketch International
Marysville, WA

Ex C&E Readers

• I recently received *Modern Electronics* as a replacement for *Computers & Electronics*. I am impressed with the subject matter and look forward to future issues. I have already dropped a number of magazines and will drop what I have retained, except for yours. Keep up the good work.

A. L. Hill
Lodi, CA

• What a pleasant surprise! I just discovered your magazine in the computer section of the local branch of a national bookstore chain. Your editorial aptly described me as "... into computers, but want(ing) electronics as well" I subscribe to a raft of "computer-only" magazines. I understand your need for some computer-oriented content, but, catering to my interest in electronics is the reason for the enclosed subscription.

I envy the writer of the letter who received *Modern Electronics* in lieu of the late, lamented *Computers & Electronics*; Murphy decreed that I receive yet-another computer magazine from its publisher, which, in a crowning touch, is dedicated to a machine I would not think of owning. Naturally, my requests for cancellation have been ignored. Please don't ever let that happen to me again. Keep up the good work.

Neal E. Tornberg
San Diego, CA

• I subscribed to *Popular Electronics* when it originally came out, and enjoyed it very much until they changed to *Computers & Electronics*, which was a worthless magazine. I am thankful that you have taken over my subscription.

Herbert Buss
Columbus, OH

NEW! Lower Price Scanners

Communications Electronics™, the world's largest distributor of radio scanners, introduces new lower prices just in time for the holiday season.

Regency® MX7000-BB

List price \$699.95/CE price \$379.00/SPECIAL
10-Band, 20 Channel • Crystalless • AC/DC
Frequency range 25-550 MHz, continuous coverage and 800 MHz, to 1.3 GHz, continuous coverage
The Regency MX7000 scanner lets you monitor military, F.B.I., Space Satellites, Police and Fire Departments, Drug Enforcement Agencies, Defense Department, Aeronautical AM band, Aero Navigation Band, Fish & Game, Immigration, Paramedics, Amateur Radio, Justice Department, State Department, plus thousands of other radio frequencies most scanners can't pick up. The Regency MX7000 is the perfect scanner for intelligence agencies that need to monitor the new 800 MHz cellular telephone band. The MX7000, now at a special price from CE.

Regency® MX4000-BB

List price \$629.95/CE price \$279.00/SPECIAL
Multi-Band, 20 Channel • No-crystal scanner
Search • Lockout • Priority • AC/DC
Selectable AM-FM modes • LCD display
Bands: 30-50, 118-136, 144-174, 440-512, 800-950 MHz
The Regency MX4000 is gives coverage in the standard VHF and UHF ranges with the important addition of the 800 MHz, and aircraft bands. It features keyboard entry, multifunction liquid crystal display and variable search increments.

Regency® Z60-BB

List price \$379.95/CE price \$199.00/SPECIAL
8-Band, 60 Channel • No-crystal scanner
Bands: 30-50, 88-108, 118-136, 144-174, 440-512 MHz
Cover your choice of over 15,000 frequencies on 60 channels at the touch of your finger.

Regency® RH250B-BB

List price \$613.00/CE price \$329.00/SPECIAL
10 Channel • 25 Watt Transceiver • Priority
The Regency RH250B is a ten-channel VHF land mobile transceiver designed to cover any frequency between 150 to 162 MHz. Since this radio is synthesized, no expensive crystals are needed to store up to ten frequencies without battery backup. All radios come with CTCSS tone and scanning capabilities. A monitor and night/day switch is also standard. This transceiver even has a priority function. The RH250 makes an ideal radio for any police or fire department volunteer because of its low cost and high performance. A UHF version of the same radio called the RU150B covers 450-482 MHz, but the cost is \$449.00. To get technician programming instructions, order a service manual from CE with your radio system.

NEW! Bearcat® 50XL-BB

List price \$199.95/CE price \$129.00/SPECIAL
10-Band, 10 Channel • Handheld scanner
Bands: 29.7-54, 136-174, 406-512 MHz
The Untiden Bearcat 50XL is an economical, hand-held scanner with 10 channels covering ten frequency bands. It features a keyboard lock switch to prevent accidental entry and more. Also order part # B5 which is 5 AA ni-cad batteries for \$13.00, a plug in wall charger, part # AD100 for \$14.95 and also order optional cigarette lighter cable part # PS001 for \$14.95.

NEW! JIL SX-400-BB

List price \$799.95/CE price \$469.00/SPECIAL
Multi-Band, 20 Channel • No-crystal Scanner
Search • Lockout • Priority • AC/DC
Frequency range 26-520 MHz, continuous coverage.
With optionally equipped RF converters 150KHz-3.7 GHz.
The JIL SX-400 synthesized scanner is designed for commercial and professional monitor users that demand features not found in ordinary scanners. The SX-400 will cover from 150 KHz to 3.7 GHz, with RF converters. Order the following RF converters for your SX-400 scanner: **RF-1030-BB** at \$234.00 each for frequency range 150 KHz - 30 MHz USB, LSB, CW and AM. (CW filter required for CW signal reception); **RF-8014-BB** at \$194.00 each for 500-800 MHz; **RF-1014-BB** at \$194.00 each for 800 MHz-1.4 GHz. Be sure to also order **ACB-300-BB** at \$99.00 each which is an antenna control box for connection of the RF converters. The **RC-4000-BB** data interface at \$259.00 each gives you control of the SX-400 scanner and RF converters through a computer. Add \$3.00 shipping for each RF converter, data interface or antenna control box. If you need further information on the JIL scanners, contact JIL directly at 213-926-6727 or write JIL, at 17120 Edwards Road, Cerritos, California 90701 U.S.A.

SPECIAL! JIL SX-200-BB

List price \$499.95/CE price \$154.00/SPECIAL
Multi-Band - 16 Channel • No-Crystal Scanner
Frequency range 26-88, 108-180, 380-514 MHz.
The JIL SX-200 has selectable AM/FM receiver circuits, tri-switch squelch settings - signal, audio and signal & audio, outboard AC power supply, DC at 12 volts built-in, quartz clock - bright vacuum fluorescent blue read-outs and dimmer, dual level search speeds, tri-level scan delay switches, 16 memory channels in two channels banks, receive fine tune (RT) ± 2KHz, dual level RF gain settings - 20 db pad, AGC test points for optional signal strength meters all for this special price.

Regency® HX1000-BB

List price \$329.95/CE price \$189.00/SPECIAL
6-Band, 30 Channel • No Crystal scanner
Search • Lockout • Priority • Scan delay
Sidelit liquid crystal display • Digital Clock
Frequency range: 30-50, 144-174, 440-512 MHz.
The new handheld Regency HX1000 scanner is fully keyboard programmable for the ultimate in versatility. You can scan up to 30 channels at the same time. The LCD display is even sidelit for night use. Order **MA-256-BB** rapid charge drop in battery charger for \$68.95 plus \$3.00 shipping/handling. Includes wall charger, carrying case, belt clip, flexible antenna and nicad battery. Order now.

NEW! Bearcat® 100XL-BB

List price \$349.95/CE price \$209.00/SPECIAL
9-Band, 16 Channel • Priority • Scan Delay
Search • Limit • Hold • Lockout • AC/DC
Frequency range: 30-50, 118-174, 406-512 MHz.
The world's first no-crystal handheld scanner now has a LCD channel display with backlight for low light use and aircraft band coverage at the same low price. Size is 1 3/4" x 7 1/2" x 2 1/2". The Bearcat 100XL has wide frequency coverage that includes all public service bands (low, High, UHF and "T" bands), the AM aircraft band, the 2-meter and 70 cm, amateur bands, plus military and federal government frequencies. Wow... what a scanner!
Included in our low CE price is a sturdy carrying case, earphone, battery charger/AC adapter, six AA ni-cad batteries and flexible antenna. Order your scanner now.

NEW! Regency® HX2000-BB

The World's First 800 MHz Handheld Scanner
List price \$569.95/CE price \$244.00/SPECIAL
7-Band, 20 Channel • No-crystal scanner
Priority control • Search/Scan • AC/DC
Sidelit liquid crystal display • Memory backup
Bands: 118-136, 144-174, 440-512, 800-950 MHz.
The HX2000 scanner operates on 120V AC or 6 VDC. Scans 15 channels per second. Size 3" x 7" x 1 1/2". Includes wall charger, carrying case, belt clip, flexible antenna and nicad batteries. Selectable AM/FM modes.

SPECIAL! Bearcat® DX1000-BB

List price \$649.95/CE price \$339.00/SPECIAL
Frequency range 10 KHz. to 30 MHz.
The Bearcat DX1000 shortwave radio makes tuning in London as easy as dialing a phone. Features PLL synthesized accuracy, two time zone 24-hour digital quartz clocks and more. Add \$12.00 for shipping.

NEW! Bearcat® 800XLT-BB

List price \$499.95/CE price \$294.00/SPECIAL
12-Band, 40 Channel • No-crystal scanner
Priority control • Search/Scan • AC/DC
Bands: 29-54, 118-174, 406-512, 806-912 MHz.
The Untiden 800XLT receives 40 channels in two banks. Scans 15 channels per second. Size 9 1/4" x 4 1/4" x 1 1/4".

OTHER RADIOS AND ACCESSORIES

Panasonic RF-2600-BB Shortwave receiver	\$179.95
Panasonic RF-B300-BB Shortwave receiver	\$195.95
RD95-BB Untiden Remote mount Radar Detector	\$139.95
RD55-BB Untiden Visor mount Radar Detector	\$119.95
BC20/20-BB Bearcat 40 channel scanner SALE	\$224.95
BC210XW-BB Bearcat 20 channel scanner SALE	\$209.95
BC260-BB Bearcat 40 channel scanner SALE	\$194.95
BC300-BB Bearcat 50 channel scanner SALE	\$254.95
BC-WA-BB Bearcat Weather Alert	\$39.95
DX1000-BB Bearcat shortwave receiver SALE	\$339.00
PC22-BB Untiden remote mount CB transceiver	\$99.95
PC55-BB Untiden mobile mount CB transceiver	\$59.95
Z45-BB Regency 45 channel scanner SALE	\$169.95
R1060-BB Regency 10 channel scanner	\$98.95
MX3000-BB Regency 30 channel scanner	\$189.95
C403-BB Regency 4 channel scanner SALE	\$65.95
R106-BB Regency 10 channel scanner	\$99.95
RH250B-BB Regency 10 channel VHF transceiver	\$329.00
RU150B-BB Regency 10 channel UHF transceiver	\$449.00
RPH410-BB 10 ch handheld no-crystal transceiver	\$399.00
BC10-BB Battery charger for Regency RPH410	\$79.95
MA256-BB Drop-in charger for HX1000 scanner	\$68.95
MA257-BB Cigarette lighter cord for HX1000	\$19.95
MA917-BB Ni-Cad battery pack for HX1000	\$29.95
EC10-BB Programming tool for Regency RPH410	\$20.00
SMRH250-BB Service man. for Regency RH250	\$20.00
SMRU150-BB Service man. for Regency RU150	\$20.00
SMRPH410-BB Service man. for Regency RPH410	\$20.00
SMMX7000-BB Svc. man. for MX7000 & MX5000	\$20.00
SMMX3000-BB Service man. for Regency MX3000	\$20.00
B-4-BB 1.2 V AAA Ni-Cad batteries (set of four)	\$9.00
A-135C-BB Crystal certificate	\$3.00
FB-E-BB Frequency Directory for Eastern U.S.A.	\$12.95
FB-W-BB Frequency Directory for Western U.S.A.	\$12.95
TSG-BB "Top Secret" Registry of U.S. Govt. Frequ.	\$15.00
TIC-BB Techniques for Intercepting Comm.	\$15.00
RRF-BB Railroad frequency directory	\$10.00
CIE-BB Covert Intelligence, Elect. Eavesdropping	\$15.00
A60-BB Magnet mount mobile scanner antenna	\$35.00
A70-BB Base station scanner antenna	\$35.00
USAMM-BB Magnet mount VHF/UHF ant w/ 12' cable	\$39.95
USAK-BB 3/4" hole mount VHF/UHF ant w/ 17' cable	\$35.95
USATLM-BB Trunk lip mount VHF/UHF antenna	\$35.95
Add \$3.00 shipping for all accessories ordered at the same time.	
Add \$12.00 shipping per shortwave receiver.	
Add \$7.00 shipping per scanner and \$3.00 per antenna.	

BUY WITH CONFIDENCE

To get the fastest delivery from CE of any scanner, send or phone your order directly to our Scanner Distribution Center. Michigan residents please add 4% sales tax or supply your tax ID number. Written purchase orders are accepted from approved government agencies and most well rated firms at a 10% surcharge for net 10 billing. All sales are subject to availability, acceptance and verification. All sales on accessories are final. Prices, terms and specifications are subject to change without notice. All prices are in U.S. dollars. Out of stock items will be placed on backorder automatically unless CE is instructed differently. A \$5.00 additional handling fee will be charged for all orders with a merchandise total under \$50.00. Shipments are F.O.B. Ann Arbor, Michigan. No COD's. Most products that we sell have a manufacturer's warranty. Free copies of warranties on these products are available prior to purchase by writing to CE. Non-certified checks require bank clearance.

Mail orders to: Communications Electronics,™ Box 1045, Ann Arbor, Michigan 48106 U.S.A. Add \$7.00 per scanner for U.P.S. ground shipping and handling in the continental U.S.A. For Canada, Puerto Rico, Hawaii, Alaska, or APO/FPO delivery, shipping charges are three times continental U.S. rates. If you have a Visa or Master Card, you may call and place a credit card order. Order toll-free in the U.S. Dial 800 USA-SCAN. In Canada, order toll-free by calling 800-221-3475. Telex CE anytime, dial 810-223-2422. If you are outside the U.S. or in Michigan dial 313-973-8888. Order today.

Scanner Distribution Center™ and CE logos are trademarks of Communications Electronics Inc.
+ Bearcat is a registered trademark of Untiden Corporation.
† Regency is a federally registered trademark of Regency Electronics Inc. AD #010186-BB
Copyright © 1986 Communications Electronics Inc.

For credit card orders call
1-800-USA-SCAN

**COMMUNICATIONS
ELECTRONICS INC.**

Consumer Products Division
P.O. Box 1045 □ Ann Arbor, Michigan 48106-1045 U.S.A.
Call 800-USA-SCAN or outside U.S.A. 313-973-8888

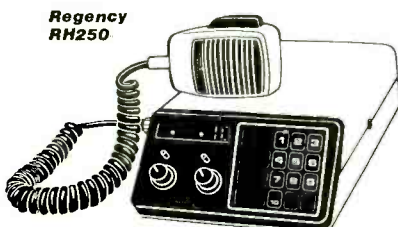

CIRCLE 26 ON FREE INFORMATION CARD

APPLE OVERHAUL. Apple II's live on...and on. A phenomenon among personal computers. Consequently, Apple Computer is overhauling the line: an external 3½" disk drive, an add-on board for 1-meg total memory, and software that simulates Macintosh icons. Topping this, Apple cut its prices from 10 to 25% across its entire line. Lisa, Apple's Big Mac, went the way of all flesh. Now the Mac with 128K does the same, except for education institute sales. It's now 512K or nothing at dealers, which, with the 128K'ers directly soldered chips, is just as well. The company successfully challenged DRI's GEM software package that makes it possible to simulate a Mac's graphics. DRI will have to change its icons so that they don't resemble a Mac's.

COOKING BY VIDEO. The Public Broadcast Systems' "Master Chefs" programs are being transferred to videocassettes for less than \$20 per recording (there are six of them) by SQN. The videos feature fine-cuisine cooking guidance from master chefs at six of Manhattan's finest restaurants.

TECH OPPORTUNITIES HIGH. Employment opportunities for electronics-trained people and computer systems and programmers continue to grow fast. The job outlook is especially good in the Pacific region, finds Data Resources, which conducted an analysis for DeVRY, a technical educational school. By 1995, it's projected that 134,300 new jobs will be opened for electronic technicians, 132,920 for electrical engineers, 129,000 for computer programmers, and 61,650 for data processing and office-machine mechanics. In the Pacific region, new jobs for electronic techs are expected to increase by 27,520; in the South Atlantic, 26,500; in Los Angeles, New York City, and Chicago, average number of tech openings are expected to be 5,213 each; Phoenix, AZ, 2,090.

GaAs DEVELOPMENT KIT. Faster than a speeding....That's where gallium arsenide ICs sit in the high-speed device race. A modestly priced GaAs prototype development kit has been made available by GigaBit Logic, Newbury Park, CA (805-499-0610) to help designers test and prototype the company's new GaAs integrated circuits. A complete kit is \$750, which includes a three-layer pc board and power-supply card.

ELECTRONIC SHOPPING STORE DEBUTS. Interactive electronic shopping kiosks will be installed in a number of retail locations by Electronistore Services, Inc., a subsidiary of R.R. Donnelley and Sons. The free-standing units incorporate two video monitors, a video laserdisc player and a stereo system that presents still-frame and full-motion product presentations, all controlled by a microcomputer. The system is activated by a shopper touching a 13" video screen, where operating instructions appear. Using the touch-screen, the shopper selects product categories and products within each. When items are selected for purchase, the shopper is asked to pass a credit card through the system's card reader. When entered and verified, the system's printer issues a paper receipt that includes estimated delivery time. Donnelly predicts that electronic retailing like this will generate \$256 million in 1985 and increase to \$17 billion by 1990.

Radio Shack Parts Place™

START YOUR HOLIDAY PROJECT AT RADIO SHACK!

New Special-Order Service

Now Radio Shack Can Replace Almost Any Industrial or Entertainment IC Or Semiconductor Device . . . Fast!

**MORE THAN
200,000
SUBSTITUTIONS!**

If the IC or semiconductor you need is not part of our regular stock, our store manager will check our new in-store substitution guide and special-order a replacement from our warehouse. Your order will be sent ASAP to your Radio Shack store and we'll notify you when it arrives. We also offer this service on selected tubes, crystals, phono cartridges and styli. Visit the store nearest you for details!



- No Minimum Order
- No Postage Charge

1/4-Watt, 5% Resistors

39¢
Pkg. of 5



Ohms	Cat. No.	Ohms	Cat. No.
10	271-1301	4.7k	271-1330
100	271-1311	10k	271-1335
150	271-1312	15k	271-1337
220	271-1313	22k	271-1339
270	271-1314	33k	271-1341
330	271-1315	47k	271-1342
470	271-1317	100k	271-1347
1k	271-1321	220k	271-1350
1.8k	271-1324	470k	271-1354
2.2k	271-1325	1 meg	271-1356
3.3k	271-1328	10 meg	271-1365

Speech Synthesizer ICs

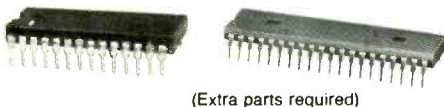

(Extra parts required)

Now You Can Add Voice Output to Almost any Computer or ASCII Terminal

SPO256-AL2. Preprogrammed with 59 speech sounds and five pauses. Complete data and application notes included. 28-pin DIP. #276-1784 . . . 12.95

CTS256-AL2. Converts standard ASCII characters into control data for the IC above. 40-pin DIP with data and circuit examples. #276-1786 . . . 16.95

CMOS Timer ICs



Low As **139**

TLC555. New high-performance version of standard 555 with same pinout. Silicone CMOS design offers very low power drain—typically one milliwatt with 5 VDC supply. Operates up to 2 MHz, sinks 100 mA. 8-pin DIP with data. #276-1718 . . . 1.39

TLC556. Dual version of above. 14-pin DIP with data. #276-1704 . . . 1.59

Electronics Textbook

NEW!
795

Developed by Texas Instruments Learning Center



Basic Electronics Technology. The "hows" and "whys" of modern electronics presented in plain language. Learn how semiconductors work as amplifiers, oscillators, in power supplies, radio/TV, and computers. Illustrated. 464 pages. #62-1394

Plug-in Boards



Jumbo 2-Bus Board. 4 1/2 x 9 9/16". Fits 44-position socket. Accepts up to 24 16-pin DIP sockets with plenty of room for discrete components. Two supply busses. #276-190 . . . 5.95

Jumbo IC/Discrete Plug-in Board. Like above, but accepts up to 40 16-pin DIPs. One buss. #276-191, 5.95

Socket for Above. #276-1551 . . . 2.99

Tantalum Capacitors

Low As **49¢**

20% tolerance

µF	WVDC	Cat. No.	Each
0.1	35	272-1432	.49
0.47	35	272-1433	.49
1.0	35	272-1434	.49
2.2	35	272-1435	.59
10	16	272-1436	.69
22	16	272-1437	.79

DPDT Knife Switch

Ideal for Projects, Model Railroads, Antenna Switching

99¢



Plated spring contacts rated 0.5 amp at 250 VAC. Screwdriver terminals for every hookup. Molded base with mounting holes. 1 5/8 x 2 3/8 x 3/4". #275-1537

CMOS Digital ICs

All Include Pin-Out and Specs



Type	Cat. No.	Each
4001	276-2401	.99
4011	276-2411	.99
4013	276-2413	1.19
4017	276-2417	1.49
4049	276-2449	1.19
4066	276-2466	1.19

TTL Digital ICs

All Include Pin-Out and Specs



Type	Cat. No.	Each
7400	276-1801	.89
7404	276-1802	.99
7408	276-1822	1.29
7447	276-1805	1.69
7490	276-1808	1.19

Precision Driver Set

895

High quality, low price! Great for electronics and jewelry. 4 phillips, 6 slots, 3 nut drivers, 3 hex keys. #64-1961

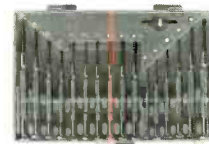

Big 8 1/2 x 5" case with individual compartments

Digital Logic Probe

1995

Makes digital testing easy! LEDs and tone output indicate high, low or pulsed logic states. For TTL/LS and CMOS circuits. Overload and polarity protected. With instructions. #22-302



SALE! Fold-Up Multimeter

Cut 25%

Reg. 29.95

21⁸⁸

Big 4" Scale



You get durability and famous Micronta® quality at \$8.07 off. Features 25 switch-selected ranges, built-in meter movement shunt when closed as well as fuse and surge absorber protection. Four detented hinge positions for easy viewing. Measures AC/DC voltage, DC current and resistance. 7 1/4 x 4 5/16 x 1 1/4" when open. Includes probes, manual. Battery extra. #22-211

Over 1000 items in stock: Binding posts, Books, Breadboards, Buzzers, Capacitors, Chokes, Clips, Connectors, Fuses, Hardware, ICs, Jacks, Knobs, Lamps, Multimeters, PC Boards, Plugs, Rectifiers, Relays, Resistors, Switches, Tools, Transformers, Transistors, Wire, Zener Diodes, and more!

Radio Shack®
A DIVISION OF TANDY CORPORATION

Prices apply at participating Radio Shack stores and dealers

For more information on products described, please circle the appropriate number on the Free Information Card bound into this issue or write to the manufacturer.

New Remote Control Eliminates Separate Ones

General Electric has introduced a remote-control device that can command virtually any infrared remote-controllable audio or video product currently being manufactured. Called "Control Central," it eliminates the need for separate remote controllers for your TV receiver, videocassette recorder and stereo system. Up to four infrared remote control products can be handled.



When placed "head to head" with a component's original remote-control transmitter, Control Central learns the infrared codes required to command all of the component's features. Control Central also has a computerized memory bank and a liquid-crystal display (LCD) panel that shows specific functions programmed into memory.

Control Central can easily be programmed to permit new electronic products to be added to a home-entertainment system without eliminating the convenience of a single master controller. \$149.95.

CIRCLE NO. 122 ON FREE INFORMATION CARD

Keyless Door Lock

New from Heath is the Model GD-3830 keyless door lock kit that

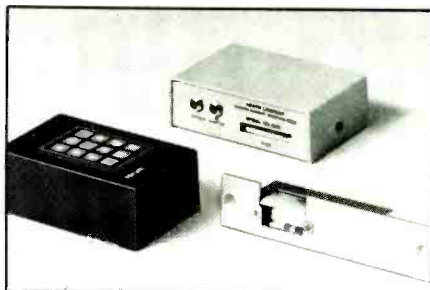

uses a 12-button keypad to control a solenoid-activated latch. The keypad mounts outside the door at doorknob level, and the solenoid replaces the conventional strikeplate. You can program the lock to accept any four-digit sequence and change the code as often as desired. You can also select an entry code time range from 2 to 20 seconds. The door remains locked if it takes longer than the programmed time to enter the code. Also, you can program the lock to remain unlocked for up to 45 seconds.

Powered by a power-cube transformer, the GD-3830 lock has a jack for 12-volt rechargeable battery backup in case of power failure. However, a key will always open the door under normal conditions and during a power failure. The lock is designed for use with all conventional residential door locks and with lock bolts measuring $\frac{1}{2}$ " or $\frac{3}{8}$ " from edge of door to tip of bolt. \$99.95.

CIRCLE NO. 123 ON FREE INFORMATION CARD

Satellite TV Receiver

Computer technology in Kenwood's new satellite TV receiver system per-

forms virtually all receiver functions. The system consists of a KSR-1000 4-GHz stereo receiver, KSP-1000 antenna positioner, LNB-1000 low-noise block downconverter and KSA-1000 antenna actuator, all designed to function as a single unit.

A single switch selects satellite broadcasts, and a single knob tunes transponder frequencies. You can store up to 18 satellites and fine-position the antenna to any of 360 points for full-sky coverage. All transponder frequencies currently broadcasting are factory preset to eliminate post-installation modification. You can lock out any two transponder frequencies on a locked-in satellite and lock the antenna with a preprogrammed code.

Dolby B noise reduction is built in, and the KSR-1000 can receive mono/multiple stereo, discrete stereo and matrix stereo signals and automatically reproduces the audio mode being received. A single infrared remote-control unit activates all system operations. \$2390 (does not include antenna and feed horn).

CIRCLE NO. 124 ON FREE INFORMATION CARD

Versatile Printer Buffer Kit

"BufferLink" from Alpha Electronics is a new printer buffer that accepts both parallel and serial data from a computer and outputs the data to a parallel (Centronics) or serial (RS-232C) printer. It offers 63,232 bytes of RAM buffering between com-

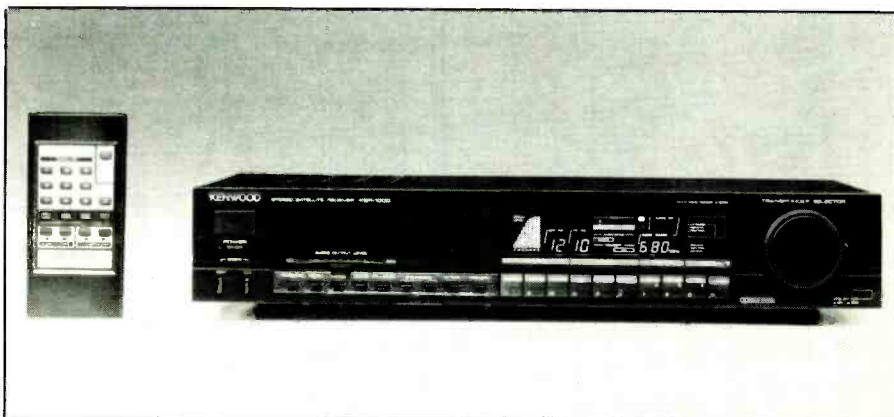



puter and printer. Input and output combinations are switch-selectable, allowing any input to be routed to any output. Available serial data transfer rates are 300, 600 and 1200 baud, and setup is no parity, 8 bits and hardware handshake.

BufferLink can download Z80 machine code to customize the operation of the system or to use it as a Z80 hardware development system. It also has a PROM programmer option that permits reading and programming of 2716, 2732 and 2764 EPROMs.

Sold only in kit form, BufferLink requires builder assembly skills. Computer and printer cables are not included. \$130 (plus \$5 S&H); \$49 for PROM Programmer option kit.

CIRCLE NO. 125 ON FREE INFORMATION CARD

Leadless-Chip Extractor

OK Industries now has a hand tool for safely and reliably extracting leadless chip carriers (LCCs) from board-mounted sockets. Designated the Model EX-4, the lightweight extraction tool helps to prevent over-stress to chip carrier pins by maintaining even pressure on contacts during removal. Also, when you are properly grounded, the tool safely



dissipates static charge to prevent damage to components. The EX-4 can be used with minimum socket spacing of 0.100". Models are available for extracting 20-, 28-, 44-, 52-, 68-, 84- and 124-contract chip carriers. From \$13.95.

CIRCLE NO. 126 ON FREE INFORMATION CARD

Accelerometer Automotive Alarm Sensor

A new easy-mount automotive alarm sensor from Electromotive Technologies, called Accelerometer III, is a

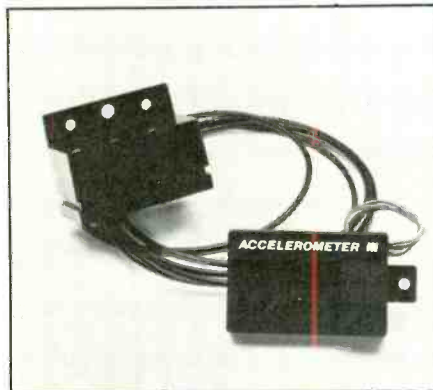

miniature two-piece unit with separate sensor housing and electronics control module. The 2½" × 1⅛" × 1½" sensor housing is easy to install anywhere in any vehicle and is compatible with all O.E. systems, such as those used in Toyota, Nissan, GMC, Ford and Chrysler vehicles. It is waterproof and weather resistant for engine-compartment compatibility.

The 2¾" × 1¾" × ¾" solid-state electronics module features separate dual adjustments for motion and impact sensing and has a LED status indicator. It is also compatible with all alarm systems and is equipped with a 5-ft. shielded cable to the sensor housing.

CIRCLE NO. 127 ON FREE INFORMATION CARD

Noise Suppressor

Kalgo Electronic's QPC Plus "Spike-Spiker" is a power protection device that is designed to respond in 1 picosecond to clean up noisy ac lines to sensitive electronic

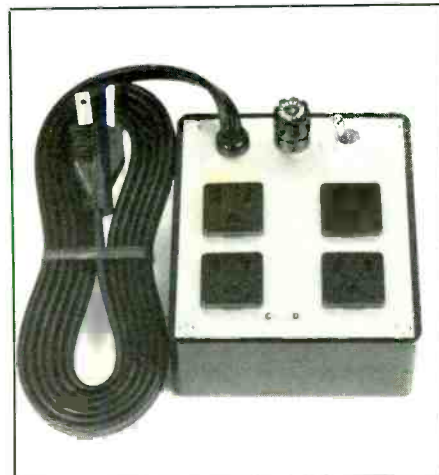

equipment. It has a suppression capacity of 18,200 amperes (318 joules). Clamping starts at 131 volts, with maximum let-through of 232 volts at 50 amperes. Noise at 10 MHz is suppressed 38 dB common mode, 50 dB differential mode.

The suppressor contains six stages of surge suppression. It has four ac receptacles, a master on/off switch and 7-ft. line cord. It provides five filtering stages in each of two circuits (there are two outlets per circuit). Two LEDs indicate when each mode of suppression is operational and provide a quick check that the ac outlet into which the suppressor is plugged is correctly wired for proper phase integrity.

CIRCLE NO. 128 ON FREE INFORMATION CARD

Wireless Sound System

From Hi-Work SA/Ltd. of Switzerland comes a home sound system that sends signals from a stereo receiver to any room in a house via existing ac wiring. The Hi-Work Satellite Sound System's micro-transmitter plugs into the ac line and the tape output of your stereo receiver, and a small speaker system plugs into the ac line anywhere else in your home. The speaker has its own volume control that operates independently of receiver volume.

(Continued on page 61)

Only NRI gives you professional hands-on training and equipment to prepare you for today's high-tech video electronics servicing careers.

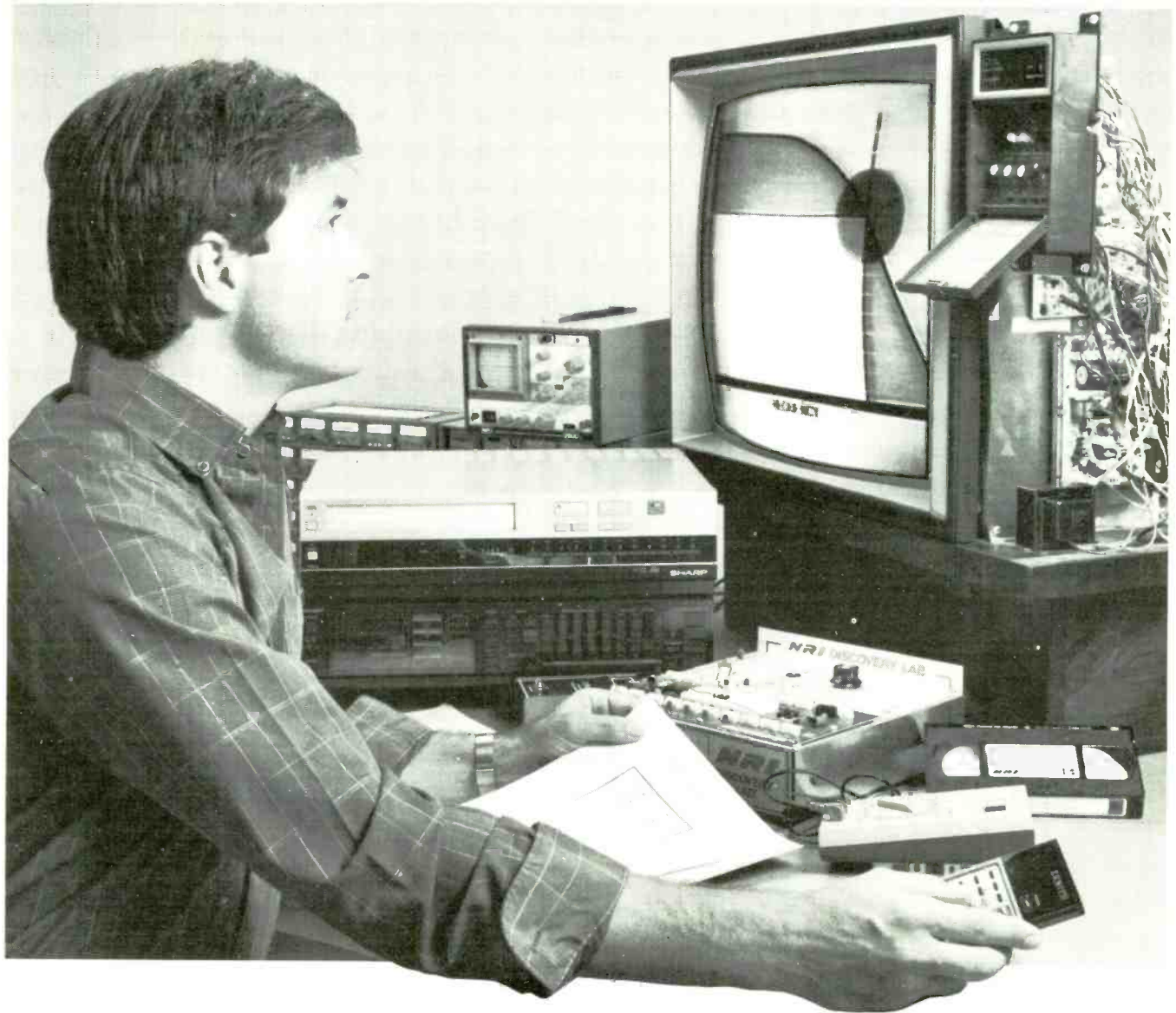

**Become One of America's Most Sought-After Technicians...
Put Your Talents and Spare Time To Work for You in the
"Explosive-Growth" World of Home Entertainment Electronics**

Train in state-of-the-art video/audio servicing and become a fully qualified professional the uniquely successful NRI way. It's hands-on training, at home . . . designed around the latest state-of-the-art electronic equipment you build as part of your training. You start from scratch and "discover by doing." You conduct key experiments . . .

perform vital tests . . . build your own systems . . . and do it all at the pace that suits you best.

There's no stopping the incredible boom in consumer electronics. Soaring sales, new and improved products, entirely new technologies have opened up new opportunities for the trained technician as never before.

The \$25 billion consumer electronics industry is creating a whole new servicing and repair market at home. This year, TV sales alone are expected to hit 16.2 million units. That's \$5.5 billion dollars. Every day, sales of home VCRs, a product barely conceived of ten years ago, reach 20,000 units. Every day!

And the revolution has spread to the business sector as tens of thousands of companies are purchasing expensive high-tech video equipment used to train their employees and store important company data.

The High-Tech Revolution Is Just Starting

Already, disc players can handle both audio CDs as well as laser video discs. And coming are machines that will accommodate laser computer discs. Camcorders are becoming smaller, lighter and more versatile, 8mm video cassettes will produce high resolution pictures. Soon, our TVs will become interactive computer terminals, giving us entertainment, information and communications in one sophisticated unit.

Join the Future or Be Left Behind

Can you see the opportunity? The servicing and repair market that's there already . . . the enormous need created by the millions upon millions of electronic devices yet to come. If you're looking for a high-potential career in a clean, respected industry . . . if you'd like to get started in a field that's still wide open for the independent business person . . . even if you'd like to find a way to make extra money "moonlighting," now's the time to look into NRI at-home training.

Start Right and There'll Be No Stopping You!

NRI training in Video/Audio Servicing is the perfect way for you to profit from the era of consumer electronics. You study at home in your spare time at your own pace. No classroom pressures, no night school grind.

Even if you've never had electronics training, NRI prepares you properly with a thorough grounding in the fundamentals . . . a

foundation that you build on to achieve advanced electronic skills. With this kind of understanding and practical bench experience built into NRI's exclusive training methods, you are on your way to take advantage of the new opportunities that are opening up every day.

Totally Integrated Hands-On Training

The secret of NRI's training success lies in the unique way multimedia instructions are fully integrated with the equipment you use. NRI's Action Audio and Video cassettes combine with brilliantly illustrated and well thought out lesson materials to give you a thoroughly stimulating and productive learning experience.

Since NRI training is built around learning by doing, right from the start you conduct important experiments and tests with your professional digital multimeter.

You assemble the remarkable NRI Discovery Lab[®] and perform a complete range of

Only NRI's video training includes a state-of-the-art TV you build, the latest VCR, professional test equipment, and NRI Action Video tapes. All yours to keep as part of your training.

demonstrations and experiments in the process. You build your own 25"

Heath/Zenith color TV and train with the latest model front-loading VCR, also included as part of your course.

NRI has purposely designed your training around equipment that has the same high-tech circuitry you'll encounter in commercial equipment. That means your training is real-world training. And *that's* unique.

Inside Your TV

The 25" TV included with your training has an expanded 178 channel, cable-ready tuning system, microprocessor for complete computerized digital control, stereo audio system, electronic time display, wireless remote control, and a space phone that lets you answer the phone and make calls from your chair.

Only NRI trains you with Action Video tapes for step-by-step professional servicing skills reinforcement. You'll watch complicated troubleshooting techniques come to life!



Your NRI Training Has Another Special Element

Also built into your NRI training is the enormous experience of our development specialists and instructors. Their long-proven training skills and personal guidance come to you on a one-to-one basis. They are always available for consultation and help.

Step Into the Future Today

The richest reward you gain from your NRI Video/Audio training is a firm grip on the future. Your knowledge and know-how provide you with the soundest possible foundation for further learning and growth with the industry.

Send For Free Catalog

But now is the time to act. Return the post-paid card to us today. You will receive our 100-page catalog free. It's filled with all the details you'll want to know about our training methods and materials and our more than 70 years of successful innovation in at-home, hands-on career training. (If someone has beaten you to the card, write to us at the address below.)

NRI Schools

McGraw-Hill Continuing Education Center
3939 Wisconsin Avenue, NW
Washington, DC 20016

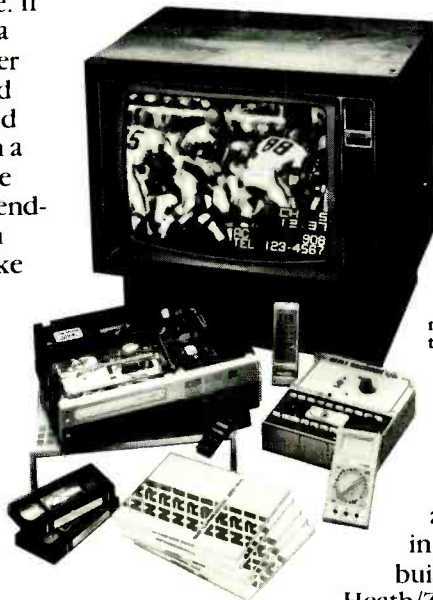

Video

The 1986

RCA Model FLR2622 26" Color TV Receiver/Monitor

Take the best there is in modern analog TV technology, including a square-cornered 26"-diagonal dark-faced picture tube, and package it in a tabletop cabinet with a footprint about the size of that of most 19" receivers. This only begins to describe the RCA Model FLR2622 color TV receiver/monitor.

Look deeper, and you will find a tightly controlled 27-kV high-voltage supply, full-resolution luminance and chroma, three sets of auxiliary inputs, stereo audio/video outputs plus external speaker outputs, virtually complete automatic picture control system and BTSC-dbx stereo and SAP (second audio program) sound. Now add 127-channel vhf/uhf/CATV tuning capability and a Digital Command Center remote-control system that does just about everything you could wish a wireless device to do.

What we have been describing is RCA's "full-spectrum" ColorTrak 2000 series Model FLR2622, a color TV receiver/monitor that's packed with features that everyone will appreciate. Housed in a tawny oak-finish (on fiberboard and hardboard) cabinet, it measures 26¼" W × 23¾" H × 20" D. Suggested retail price for this deluxe system is \$999.95.

Technical Details

On just its main circuit board, this CTC 131M chassis contains 32 transistors, 47 test points, five large integrated circuits and literally hundreds of capacitors and resistors. The stereo board and expander add another six ICs, plus there are more on the audio amplifier board and others still in the tuner. In short, this TV receiver/monitor is just about as high tech as you will find here or abroad.

Several of the receiver/monitor's subsystems are worthy of description. The first of these is the square-cornered picture tube that measures 26" diagonally, providing more inches of viewing area than rounded-corner CRTs do with the same diagonal measurement. It has a 110° deflection angle. Light emissivity



from this face-darkened CRT is 52%, which contrasts sharply with the 85% figure for older clear tubes.

With a few adjustments to the beam limiter, drive potentials and a slight change in high voltage, this dark-faceplate CRT delivers additional contrast, absorbs more light reflections, and produces an extremely colorful and detailed image. In addition, unlike with old CRTs, you can walk right up to this one and still view an excellent image only inches from the faceplate.

The improvements cited above are due primarily to RCA's COTY-29 self-converging picture tube, first introduced in 1983. This tube contains an improved electron gun and has a 29-mm neck for sharp focus "substantially independent of beam spacing," a miniature deflection yoke and good reliability. Since most convergence errors are generally proportional to beam spacing, a 23% reduction in the latter means the same improvement in the former, and highlight spot beam size (for better focus) has been reduced by 10% to 15%.

Funnel tube contours and yoke lengths are also now related, combined with a constant "pullback" method. This arrangement eliminates the usual four magnets attached to the yoke to compensate for edge screen beam landings.

Heretofore, TV receivers have usually processed only half of the available 2 MHz of chroma information, amounting to 500 kHz in each of the I and Q double sidebands. Respectively, the I portion has had an additional 1 MHz of single-sideband-producing colors from bluish-greens to orange and the 0.5-MHz Q sideband supplies yellowish-greens to purple. At I in-phase and Q quadrature (90° out-of-phase), the eye is more sensitive to I than Q influence.

A luminance/chrominance separating comb filter must do its job so that striped shirts, edges of boxes, etc., do not arbitrarily appear in annoying wavy scintillations. With chroma now combed and fully separated from normally wideband luminance, broadband demodulation is applied to both I and Q signals in their differing bandwidths, extracting full

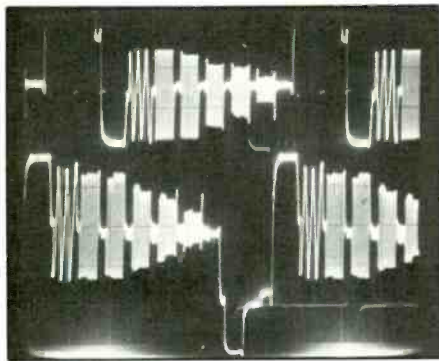

Multiburst r-f inputs were clean to 4.2 MHz at both video detector and CRT.

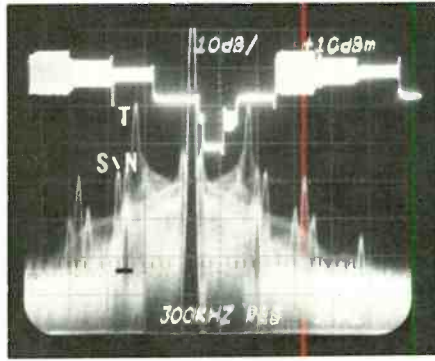

The luminance S/N (signal-to-noise) ratio measured 43 dB at 3-MHz.

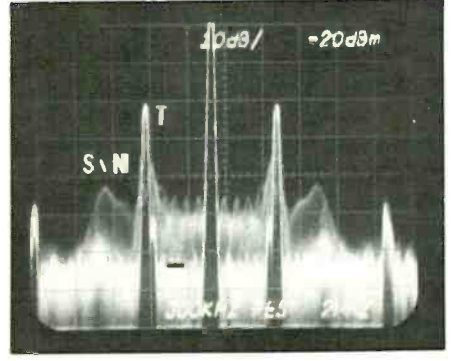

Chroma S/N was also very good, measuring a healthy 42 dB at 3.58-MHz.

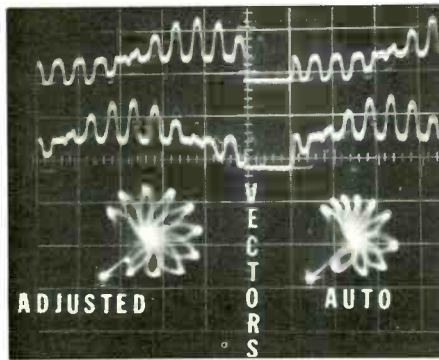

You can avoid color distortion (vector) by hand tuning luminance and color.

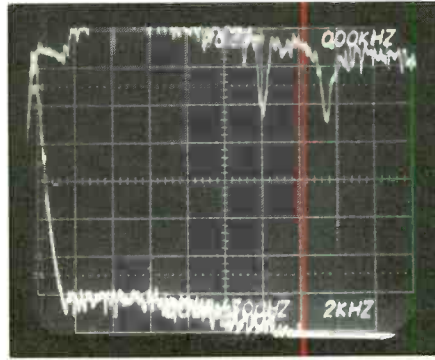

L and R (audio) channel separation was greater than 60 dB at 10 kHz.

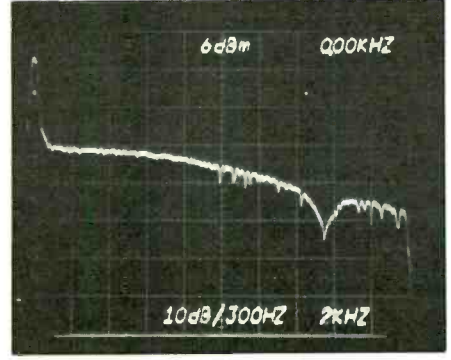

Audio response with BTSC/dbx on; 15.7-kHz dip is probably HV pickup.

chroma detail by careful filtering. To the viewer, colors will still be retained in scenes longer and truer than with the old "equiband" system of 1-MHz double-sideband detection.

The receiver uses two 5" speakers and two 2" speakers with independent amplifiers for each channel. Also featured are separate bass and treble controls.

Much of the "stereo" sound programming sent out over the airwaves until fairly recently has been pseudo-stereo. Now that the real thing is being broadcast, true stereo processed through this receiver/monitor's BTSC/dbx decoder is very impressive. To make certain that the stereo sound is clean, RCA has included National Semiconductor's LM1894 DNR (Dynamic Noise Reduction) IC that effectively attenuates high-frequency noise with-

out producing noticeable changes in program material.

The ColorTrack 2000 series of TV receivers offers a wide range of features. Among these are PLL and quartz crystal tuning accuracy, wideband afc for CATV capture, and a large Digital Command Center wireless remote controller. Add to this up/down memory chairside programming for all channels, including last-channel flashback and on-screen time and channel numbers. You will also find a host of picture controls and circuits. Still other features include full-resolution color, video noise reduction, a picture detail processor and multiband vhf/uhf/cable quartz-crystal tuning.

The picture controls and circuits include: CRT color balance correction that compensates for tube aging; automatic

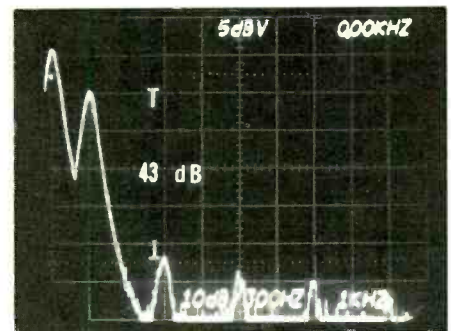

Total harmonic distortion (THD) was 43 dB, (0.796%) at 1 to 2 kHz.

color and fleshtone correction; a sharpness control; a regulating BlackLock contrast circuit that helps maintain detail in all picture areas regardless of overall brightness; and sharpness control circuitry that self-adjusts to your preset level of

PRODUCT EVALUATIONS...

RCA Model FLR2622 continued...

preference. Finally, there is a light sensor that brightens and dims the picture when room lighting changes.

The Digital Command Center remote controller provides full control over all the receiver/monitor's functions and adjustments. It can also be used to control a compatible RCA videocassette recorder. And for the ultimate in convenience, it is also capable of controlling a variety of new RCA audio components.

Evaluation & Comments

In my opinion, the RCA ColorTrak 2000 series generally rates as the best among analog TV receivers widely available on the U.S. market for the second time in two years. The Model FLR2622 evaluated here is one example of this series. It may well be the world's only 2-MHz full-color, 4.2-MHz full-luminance and wide-range audio set available.

Superior signal-to-noise (S/N) ratios for chroma and luminance, better-than-adequate monophonic and stereophonic sound, highly responsive controls, delightful picture detail, and good tuner sensitivity all contribute to making this set tops in our evaluation.

The TV receiver/monitor can do just about everything any other makes in its price class can do with but few minor exceptions. One exception is that there is no specific RGB input to allow this receiver/monitor to be used optimally with computers, though it will handle 40 columns; nor is there a Teletext plug. On the plus side, however, there are two vhf/uhf inputs instead of the usual single input and an extremely versatile remote controller that also allows you to remotely set channels and program time of day.

The vhf/uhf inputs are each equipped with their own high/low channel frequency filters. This allows a single coaxial antenna cable to be connected directly to an RCA AH047 shielded RCA combiner/splitter to obtain excellent all-channel reception. Then only two short lengths of

RCA Model FLR2622 TV Receiver/Monitor Laboratory Analysis

Tuner/system sensitivity	
vhf channels 3/10	-4/-8 dBmV
uhf channels 15/50	-4/-1 dBmV
Agc range (before video change)	-4 to +51 dB (or 61 dB)
Chroma S/N	42 dB
Luminance S/N	43 dB
Maximum vertical resolution	406 lines
AUX 2 (baseband) video inputs/outputs	-3 dB at 13.5 MHz
Maximum horizontal resolution (at r-f)	4.2 MHz
Horizontal overscan	8%
Convergence	99%
Barrelling/pincushioning/flagwaving	Slight barrelling on right corner
Picture tube color temperature	7800 °K
Audio S/N with correction at 5-kHz baseband	>48 dB
Audio frequency range	-8 dB at 13 kHz
Audio dynamic range (noise to clipping)	38.89 dB
L and R audio channel separation	>60 dB
Stereo Separation (audio in/out jacks)	55 dB
Total harmonic distortion (THD)	0.796%
Ac power drain with signal	120 W rms
Ac operating range	<100 to >130 V
Voltage regulation with signal (100/130 V)	
Low voltage (12 volts)	12.06/12.06 V (100%)
(128 volts)	127.1/127.5 V (99.6%)
High voltage (27 kV)	27.2/27.2 kV (100%)
Dc restoration	83.5%

Note: To convert horizontal frequency to "lines," multiply 80 lines times MHz. For example, 4.2 MHz is said to equal 336 lines, but this is not really accurate.

Test Equipment: Tektronix Models 7L5 and 7L12 spectrum analyzers; Hameg Model 605 oscilloscope; B&K-Precision Models 1260 NTSC, 3020 function and 2007 stereo generators; Sadelco Model FS-3D VU field-strength meter; Data Precision Models 245, 945, 1350 and 1750 multimeters; Sencore Model VA48 (modified) video analyst; Winegard Model DX-300 r-f amplifier; Gosens Luna-Pro light meter; Polaroid 677 film with Tektronix Model C-5C oscilloscope camera.

coaxial cable are required to mate the two receiver inputs to your system.

If you have a 300-ohm twin-lead antenna system, you must insert a 300-to-75-ohm balanced-to-unbalanced transformer between the receiver/monitor and lead-in which invites additional signal losses. However, this TV receiver/monitor just begs for a first-class antenna system. So if you want magnificent-quality color pictures, you will almost certainly want to replace any mediocre twin-lead

feed system you might have with a first-rate coaxial system.

We like the overall quantity and quality of features provided in this fine TV receiver/monitor. The remote control center is about the most complete one we've used; especially appreciated is getting time and channel number on screen at the press of a button at chairside. It's a pleasure, too, to find all the controls lined up at the topmost part of the front section, above the screen. The remote is too big

COMPUTERS AT WHOLESALE !!!

Deluxe Diskette File

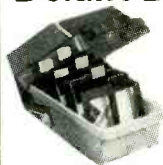

Holds 100 5 1/4" diskettes. Easy access handle for opening and carrying. Comes with lock and key for security.

#90060 **\$8 50**

MURA MODEM MM-100



Sends and receives at 300 baud. Selectable originate/answer modes. Full duplex operation. Direct connect to phone. Bell 103 compatible. Comes with AC adapter.

Compatible with all computers having RS 232 port. #10005 **\$18 00**

SmarTEAM 103/212A Modem

Operates at 300 baud and 1200 baud. Bell 103 and 212A compatible. Hayes compatible. Auto answer, dial and redial. External speaker for monitoring of calls. AC adapter supplied.

Uses RS 232-C connector. #91990 **\$179 95**

Shielded CABLES

Full end-to-end shield. Hand soldered.

Model 8510 - 6 ft. IBM computer to printer. DB25 pin male to 36 pin Centronics male. #90230 **\$9 90**

Model 8511 - 6 ft. RS 232 DB25 pin female to female. #90270 **\$9 90**

Model 8512-25 - 6 ft. Centronics 25 pin wired male to male. #90265 **\$9 90**

Model 8512-36 - 6 ft. Centronics 36 pin male to male. #90260 **\$11 90**

Model 8513 - 6 ft. RS 232 DB25 pin male to female. #90280 **\$9 90**

Model 8514 - 6 ft. RS 232 25 pin male to male. #90240 **\$9 90**

Model 8515 - 6 ft. IBM computer to modem. DB25 pin male to female. (Pins 1-8, 12, 20, 22 wired) #90250 **\$8 50**

All Cables Available In 10 ft. & 15 ft. Lengths

BUILD YOUR OWN PC!

IBM® PC/XT-Type Mother Board

16 bit 8088 processor; optional 8087 IBM PC-XT keyboard port. 8 expansion slots. 8K-Bios ROM installed. 128K RAM installed, expandable to 640K. #92250 **\$175 00**

IBM® XT-Type Keyboard



5150 keytronic type. Fully IBM-XT compatible. Cherry brand keys. LED caps & Num lock. #90130 **\$59 00**

Floppy Disk Drive Controller Board

Includes cable for 2 drives. #92260 **\$39 00**

IBM® PC/XT-Type Case

Accepts XT-type mother board and eight expansion boards. Side mount for power supply. Flip up cover with locking hinges. #90180 **\$49 00**

150 Watt SWITCHING POWER SUPPLY

Will power hard drive. 4 disk drive power cable. Same dimensions & power plugs as IBM. #90155 **\$95 00**

Monochrome Graphic Printer Board

Parallel printer port. Text mode: 80x25; Graphics: 720x348. #92270 **\$85 00**

Mitsubishi 5 1/4 Half-Height Disk Drives

#93140 **\$85 00**

IBM Type Add On Boards

Multi function board expandable to 384K. 1 serial port. 1 parallel printer port. 1 Joy stick port. Clock and calendar w/Ni-Cad battery back up. #92290 **\$99 00**

Color Graphics Board

RGB color port. Light pen interface. Graphic mode 320x200 (color); 640x200 (B & W). Text mode: 40x25 (low res.); 80x25 (high res.) #92280 **\$80 00**

512K RAM Expansion Board

Upgrade RAM memory in 64K increments. Fully buffered. #92300 **\$59 00**

RS-232 Serial Board

Provides a RS 232 serial port. Fully buffered. #92310 **\$35 00**

Game I/O Board

Provides two joy stick ports. #92850 **\$29 00**

Parallel Printer Card #92700 **\$29 00**

Gender Changers

Model 8524 - Gender Changer DB25 pin male to male. #90080 **\$7 95**

Model 8525 - Gender Changer DB25 pin female to female. #90070 **\$7 95**

IBM XT-AT TYPE KEYBOARD

#5060AT **\$99 95**

IBM XT-5151 TYPE KEYBOARD

#5151 **\$89 95**



Swivel Base Monitor

Swivels 360°. Tilts up/down. Two sizes.

12" #89980 **\$9 90** 14" #89990 **\$11 90**

TTL AMBER MONITOR HIGH RESOLUTION

#928050 **\$140 00**

MULTIPLE OUTLET POWER STRIP

Features Surge Protectors. 6 outlet 3-prong plug. 6' cord & 15 amps!



#90140 **\$13 00**

BROTHER DOT MATRIX PRINTER

#96220 **\$99 00**

ANTI-GLARE SCREEN

Reduces eye strain & glare.

Monochrome Monitors

#90210 **\$13 95**

Color Monitors

#90220 **\$16 95**

EASY DRAWER



Slide drawer for your keyboard. Includes platform to support your computer. Drawer holds a keyboard up to 2 3/4"(L) x 19 3/4"(W) x 9 1/2"(D). #90190 **\$49 00**

THE WHOLESALE OUTLET



Dept. ME, 1 Interstate Avenue, Albany, NY 12205. To order call: 1-800-344-4387 (Non-NYS Res.) or 518-459-7883 (NYS Res.) Customer pays freight & handling FOB Albany, NY. Non-credit card order shipped UPS, C.O.D.. Minimum order \$25.

Dealer and large quantity orders call: 518-459-7883 ask for Computer Department. Some Items Not As Pictured. IBM is a registered trademark of International Business Machines.

PRODUCT EVALUATIONS...

for our liking, but you can't have your cake and eat it.

It's amazing, too, how those few extra inches of viewing area gained by using a square-corner picture tube can seem to so greatly increase the apparent size of the picture. This 26-incher is plenty big for most anyone. There are 27" tubes on the market now, also with square corners *and* a flat face, but why quibble?

If you're an audio buff, you'll doubtlessly find that you simply must use external speaker systems to squeeze the most

available out of the set's amplifiers. An internal-external switch and outputs permit one to do this with ease. Since this model isn't equipped with powerful audio amplifiers, you should use high-efficiency speakers, of course.

The overall color-picture quality is just super, from resolution to color depth to contrast. It's interesting that RCA, among other makers, is following the lead that Sylvania established years ago in achieving better picture contrast through room-light-change sensors and other

tricks. This feature makes a difference for the better.

Our laboratory analysis (see table) for this RCA TV set bears out our bullish evaluation. As you can see, the RCA Model FLR2622 is justifiably a leading light among 1986 models we've examined thus far. You'd have to go to separate monitor types and add individual components such as a hi-fi stereo amplifier to do better.—*Stan Prentiss*

CIRCLE 50 ON FREE INFORMATION CARD

Dick Smith Electronics' Digital Frequency/Period Meter Kit

A **frequency counter**, although regarded as a luxury by some hobbyists, is an extremely useful piece of equipment for any electronics experimenter's bench. Although there are dozens of counters on the market, both in finished and kit form, the price vs. features tradeoff is often too steep to make the reasonably-priced units worthwhile.

The Dick Smith Electronics' "Digital Frequency/Period Meter" kit (#K-3439) is an exception: at \$89.00, the DSE kit packs more features than some counters costing three or more times as much. The base unit can measure up to 50 MHz in two ranges, with four—count 'em, four!—gating periods from 0.01 to 10 seconds. The DSE kit also has period measurement, with 1, 10, 100, and 1000 cycle counting times, for accurate low-frequency measurement.

And, if 50 MHz isn't high enough, a prescaler kit (#K3432) is available to extend the meter's range up to 500 MHz. This add-on, which fits onto the existing PC board, costs an additional \$22.50. (The prescaler is visible in the rectangular area at the rear center of the PC board.)

The Kit

The kit comes complete with screened and punched case, detailed Heath-type instructions—even solder. All components, including the four switches, mount on two PC boards, which are then joined

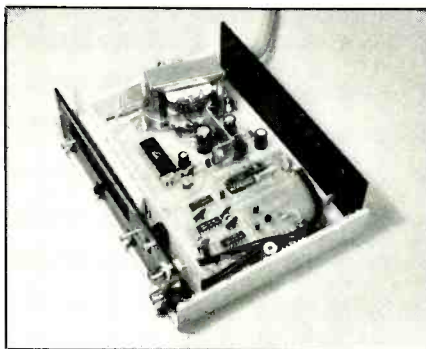
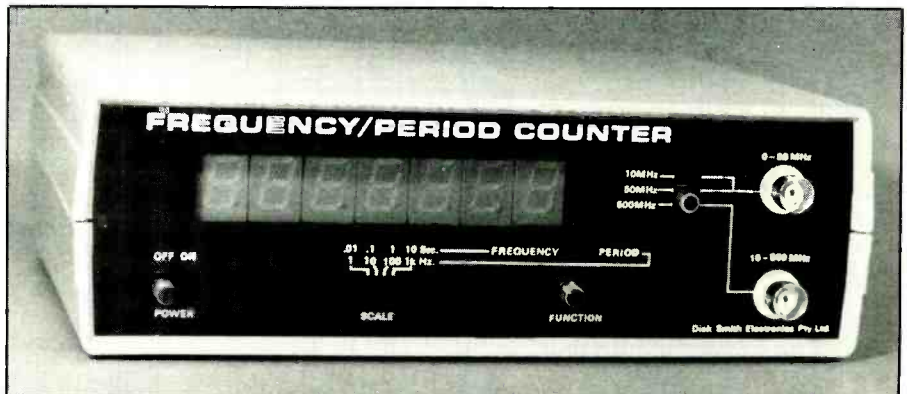

An inside view of the frequency/period counter instrument.

by bridging edge pads on each with solder. This results in a minimum of wiring within the kit: the only conventional wiring is that for the primary and secondary ac and the two coaxial input cables.

The component count is deceptively

low because of the Intersil 7216 counter that forms the heart of the meter. This IC combines almost all of the counter's functions, as well as display multiplexing and driving, into one package. The kit is reasonably easy to assemble; the average hobbyist should be able to complete it in an evening or two.

In Use

The only alignment that the DSE Frequency/Period Meter requires is trimming of its 10-MHz timebase. This can be done for a small fee by an instrument repair and calibration service, or by borrowing another frequency counter, or by applying a known frequency to the counter's input. Accuracy of the meter is fairly good even without such trimming.

The test unit was trimmed using a re-
(Continued on page 85)

YOUR TIME HAS COME

YOU MUST TAKE CONTROL

PROGRAMMABLE CONTROLLER WITH BASIC AND ON BOARD EPROM PROGRAMMER

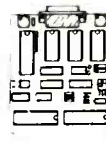

HARDWARE

11 MEG CLK
Pulse width mod output
Serial printer port
48 Input-Output lines (six 8 bit ports).
On board voltage regulation for EPROM programming voltage selection
Up to 16k on board RAM + 16k EPROM
Address and data lines fully buffered.
With MB-1's, addresses 256 peripherals

***Requirements:** * Dumb Terminal, +5 @ 1A, +-12V @ .1A, +30 @ .1A

SOFTWARE

Fully featured basic. Auto-run on power-up option. Auto Baud rate detection
Real time clock
Call basic subroutines from machine level or opposite. Directly access ports and interrupts in basic. Powerful error-handled routines

EPROM/EEPROM PROGRAMMER

Programs 2716, 2732, 2764, 27128, 2816.
Store and retrieve basic programs in or to EPROM/EEPROM in one command

APPLICATIONS

Automatic Test Equipment
Robotics
Data Acquisition System
Assembly Line Control
Milling Machine Controller
Turning Machine Controller
Automatic Feed Controller
Commercial Light Display
Disco Light Sequencer
Printer Buffer
Security System Controller
Scrambler-Discribler
Programmable Modem
Home Control System
Stepper Motor Controller
Pressure Monitoring System
Temperature Monitoring System
Programmable Power Supply
Material Handling System

NEW
X-MAS SPECIAL

MLC-1K KIT

SAVE \$20.00

ONLY \$168.87

MLC-1 ONLY \$188.87 PERIPHERALS

AD12-1 12 bit A/D with 8 channel input mux; with on board precision ref \$132.00
AD8-8 8 bit 8 channel A/D Board; AD7581 Based 56bus conv. rate \$117.00
DA12-1 12 bit D/A Board; 8 channel output (500ns conv. before mux) \$ 99.00
PS-2 Power Supply \$ 50.00
DA8-8 8 channel 8 bit D/A (8 independent channels); (dual AD7226 s) \$164.00
DA8-4 4 channel version \$128.00
AC-8 Isolated 8 channel AC Solid State Relay Board; each channel 12A 600V. With output transient protection and fused outputs 150V \$179.00
DC-8 Isolated 8 channel DC Power Switching Board; each channel 8A 200V with protection diodes and fused outputs. (8 channel with common (GND)) \$158.00
DC-8A Same as above only with 8 channels, 8 separate grounds \$209.00
ME-1 Memory Expansion Board; expands total memory to 64K RAM, ROM AND 32K of EPROM. Add \$9.00 each for 8Kx8 ram (up to 6) \$ 64.00
MB-1 Mother Board. Can chain up to eight MB-1's to control up to 255 peripherals. 100 pin edge card connectors add \$8.00 each \$ 49.00
SM-1 Step Motor Driver; steps 3 motors independently \$159.00
SM-1 Intelligent Step Motor Driver; same as SM-1 plus individual programmable rate and number of increments \$194.00
HK 8052 Kit 8052AH - Basic Chip. 11 0592 mHz crystal Intel Basic manual and application notes \$ 74.00
HK-MLC-BD Kit MLC-1 P.C. Board, Micro Linear Kit Assy. Manual and Micro Linear Application notes \$ 47.00



MICRO LINEAR CONTROLS

4900 Memco Lane
Racine, WI 53404 - 1099

For technical information call (414) 639-1105
Call for OEM and Quantity Pricing.

FREE WATTS OUTSIDE WISCONSIN

ORDERS ONLY

1-800-222-2298

TERMS: C.O.D. orders add \$3.00. Wisconsin residents add 5% sales tax. Personal checks must clear before shipping. S & H add \$4.00 per board. All orders refused or returned are subject to a 10% restocking fee. Prices and specifications subject to change without notice.

CIRCLE 87 ON FREE INFORMATION CARD

MODERN ELECTRONICS

Now you can reach out every month and learn about the latest innovations in consumer electronics and personal computers—what's new, how products and circuits work, and what leading authorities think of them.

***Stereo *Video *Home & Car Electronics**
***Test Instruments *Circuitry & Devices *Servicing**
***Personal Computers *Communications *Construction Projects**

In every issue, authors lucidly explain how exciting, new electronics ideas are applied . . . issue forthright buying counsel . . . present complete plans to build electronic devices to enhance products, even unique ones that are not yet being sold in the marketplace.

Just fill out the coupon and mail with your check, money order, or credit card information (Visa or MasterCard) to enter your subscription. Do it today to ensure earliest delivery!

MODERN ELECTRONICS 76 North Broadway, Hicksville, NY 11801

Please send me Modern Electronics for 2 Years 1 Year

Name _____
Street _____
City _____
State _____ Zip _____

Charge My Order To: Payment Enclosed \$ _____ 2 Years (24 Issues) \$22.97
 MasterCard My account number is: _____ 1 Year (12 Issues) \$12.97
 VISA  _____

MODERN ELECTRONICS

76 N. Broadway, Hicksville, NY 11801

FREE INFORMATION SERVICE

For further information on products, dealers, or literature in this issue, circle the appropriate numbers below. Be sure to include your name and address before mailing.

1	2	3	4	5	6	7	8	9	10	11	12
13	14	15	16	17	18	19	20	21	22	23	24
25	26	27	28	29	30	31	32	33	34	35	36
37	38	39	40	41	42	43	44	45	46	47	48
49	50	51	52	53	54	55	56	57	58	59	60
61	62	63	64	65	66	67	68	69	70	71	72
73	74	75	76	77	78	79	80	81	82	83	84
85	86	87	88	89	90	91	92	93	94	95	96
97	98	99	100	101	102	103	104	105	106	107	108
109	110	111	112	113	114	115	116	117	118	119	120
121	122	123	124	125	126	127	128	129	130	131	132
133	134	135	136	137	138	139	140	141	142	143	144
145	146	147	148	149	150	151	152	153	154	155	156
157	158	159	160	161	162	163	164	165	166	167	168
169	170	171	172	173	174	175	176	177	178	179	180

Insert issue date here _____
(month) (year)
(must be completed to process)

Name _____

Company Name _____

Address _____

City _____ State _____ Zip _____

Phone _____

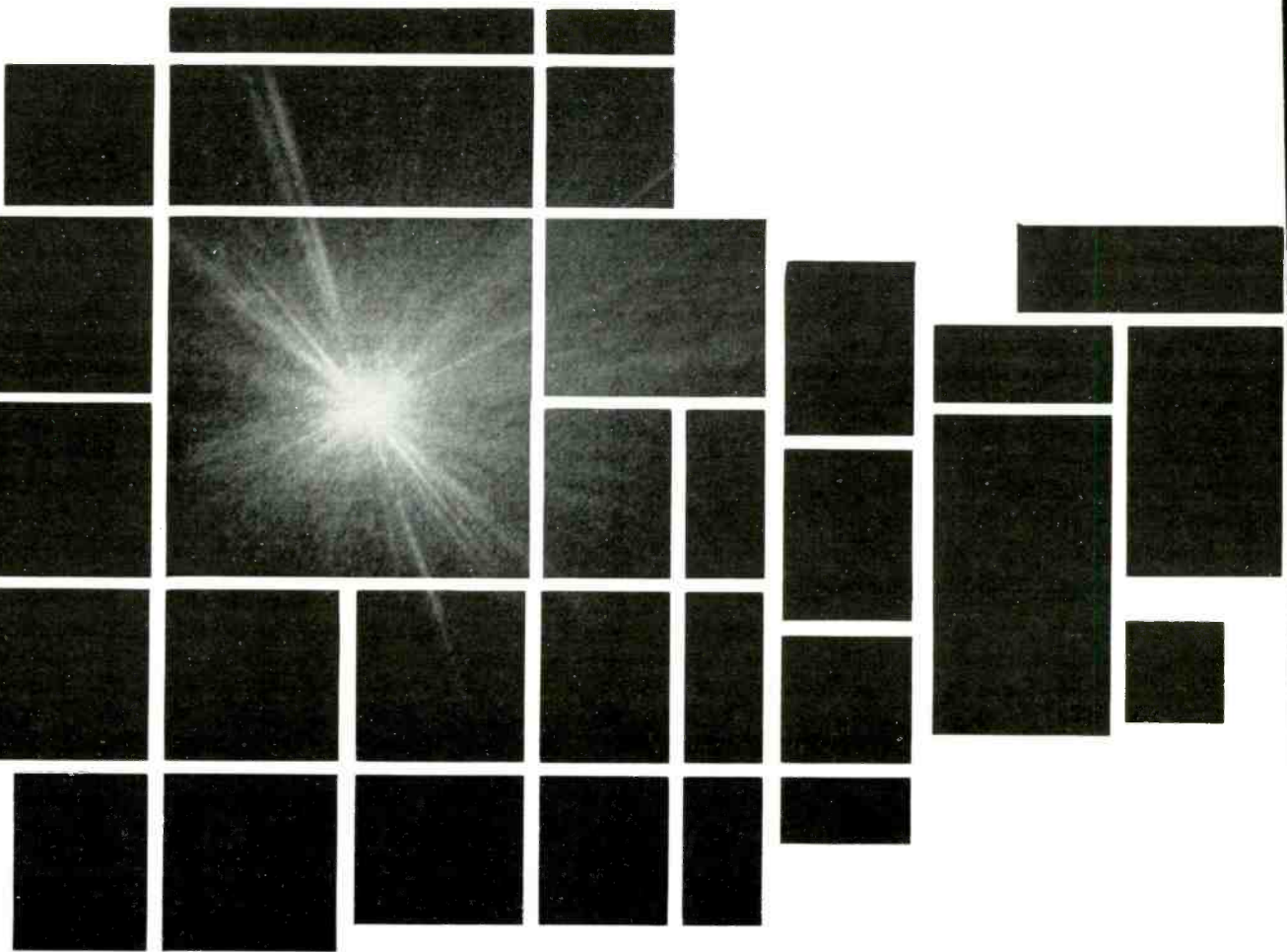

The Laser At Twenty-Five

A status report on a most remarkable quantum electronic machine

By Forrest M. Mims III

Imagine a beam of light so incredibly powerful it can melt holes through steel girders, a light so intense it can produce instant blindness. Then imagine a similar light so precise it can repair the delicate retina of the eye or detect objects for a blind person. This is certainly no ordinary light. It is laser light.

The world's first laser was operat-

ed for the first time in May 1960 by Dr. Theodore Maiman, then a scientist at Hughes Research Laboratories. That a laser could be built had been predicted several years earlier by scientists in the United States and the Soviet Union. Most observers expected Bell Laboratories to be the first to build a working laser. After all, Charles Townes, one of its consultants, and Arthur Schalow, one of its scientists, were among the very first to propose the laser. In view of the formidable competition from

Bell Labs and others, Maiman's victory in the race to build the first working laser was all the more remarkable.

While the scientists at the competing research labs wrote technical papers and speculated about how best to make a laser, Dr. Maiman put theory into practice by designing and building the hardware that evolved into the first working laser. Working largely on his own and with limited funding provided by skeptical management personnel, Dr. Maiman

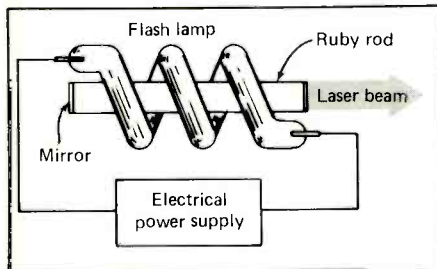

Fig. 1. Shown here are the essential ingredients of a ruby laser.

concentrated his efforts on ruby. In Fig. 1 are shown the key elements of his first laser.

In retrospect, Dr. Maiman's laser was surprisingly simple. Bell Labs was trying to make a laser using complicated gas-discharge tubes. Maiman used a ruby rod about 1 centimeter in diameter and 2 centimeters long. The two ends of the rod were cut parallel to one another, polished and then coated with a film of silver. It was then mounted inside a coiled General Electric FT506 xenon flashlamp. Discharging a capacitor through the flashlamp illuminated the ruby rod with a brilliant burst of white light. A brief pulse of highly intense, red light then emerged through a small aperture formed in one of the end mirrors of the rod. In later ruby lasers, the mirror with the hole was replaced with a thin-film coating that permitted some of the light within the ruby to escape.

Ruby Laser Basics

Ruby is sapphire (aluminum oxide) containing a trace of chromium. Like many other materials, ruby fluoresces (glows) when illuminated by light. If we could magnify a chromium atom to the size of a baseball, we would see that it, like all other atoms, consists of a nucleus surrounded by a cloud of negatively-charged electrons. Normally, all the electrons occur at certain fixed distances (or energy levels) from the nucleus.

If a chromium atom is illuminated by light having green or blue wave-

lengths, one of its outermost electrons will immediately jump to one of two higher energy levels. Within about 100 nanoseconds, the excited electron will fall back to another energy level—still more distant from the nucleus than its original level—and remain there for several milliseconds. During this time, the so-called fluorescent lifetime, the chromium atom is said to be in a metastable state. The excited electron then spontaneously falls back to its original level, the so-called ground state.

This is when the phenomenon of fluorescence occurs. Since the electron absorbs energy when it is kicked upward to a higher energy level, it must somehow give off this excess energy when it returns to the ground state. In most substances, excited electrons give off as heat the energy

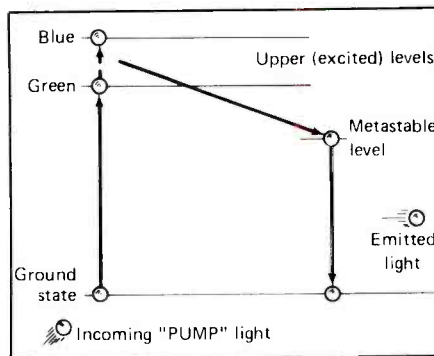
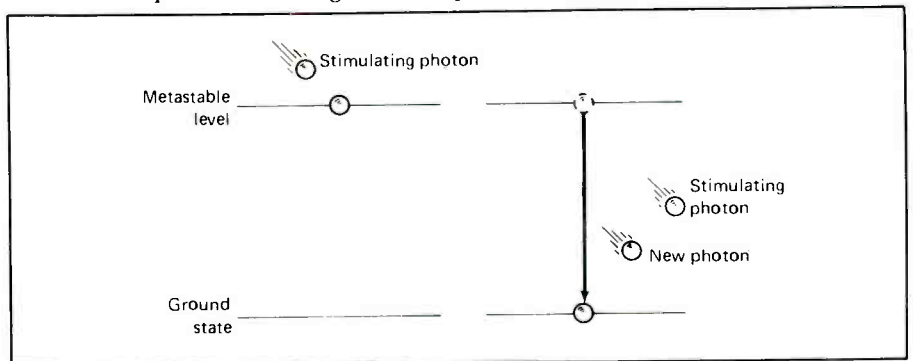

Fig. 2. How an outer-most electron in a chromium atom is "pumped" to higher energy levels, from where it eventually collapses and releases a photon of light.

Fig. 3. How a photon stimulates an excited electron to fall to the ground state, in the process emitting a second photon in-phase with the first.



they have absorbed. In the case of ruby and other fluorescent materials, some or even most of the absorbed energy is given off as a photon of light. The photons emitted by ruby have a wavelength of 694.3 nanometers in the deep red portion of the visible spectrum.

Figure 2 summarizes this three-level fluorescence process in ruby. What happens when a single excited electron spontaneously falls back to the ground state and emits a photon that strikes a second, still excited electron is illustrated in Fig. 3. The second electron also immediately collapses to the ground state, emitting a photon in perfect phase with the stimulating photon. This simple amplification process is called stimulated emission of radiation, and it is the key to what makes a laser possible: Light Amplification by the Stimulated Emission of Radiation.

Some stimulated emission occurs in many natural fluorescent substances and in devices like light-emitting diodes (LEDs) and gas-discharge lamps. Before laser action can occur, three conditions must be met: First, more electrons must be in an excited state than at the ground state. Second, the fluorescent material must be optically transparent and free of anything that might interfere with the passage of stimulated emission. Finally, the stimulated emission process must be encouraged by keeping some of the resultant radiation inside the active material where it can con-

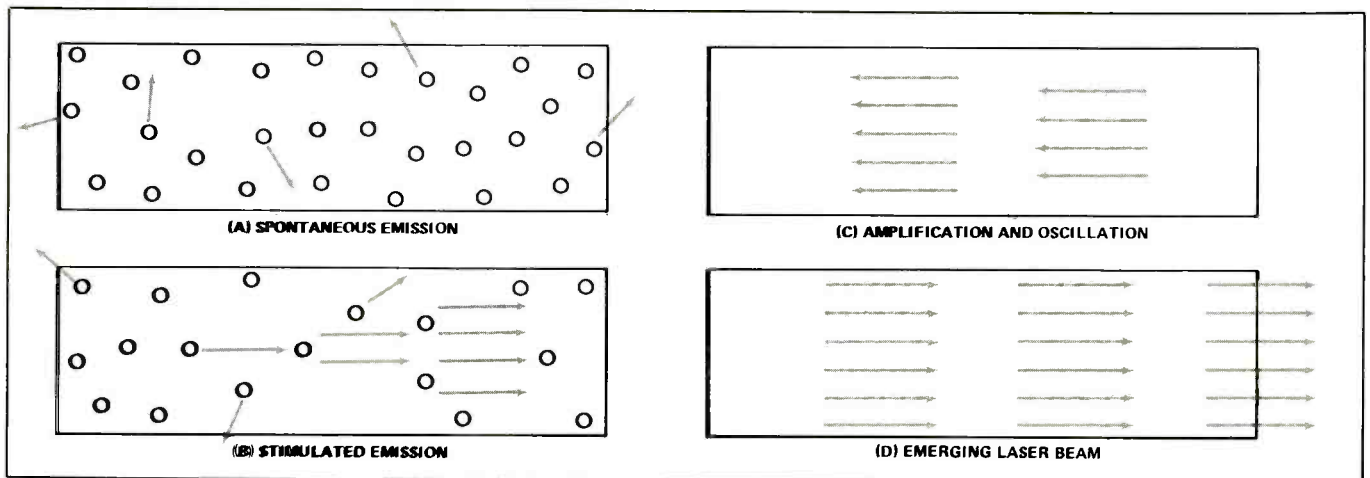

Fig. 4. How stimulated emission leads to laser action in a ruby rod equipped with facing end mirrors.

tribute to a chain-reaction of photon emission.

Dr. Maiman met the first requirement by bombarding his ruby rod with a powerful burst of white light containing plenty of the blue and green wavelengths capable of exciting chromium atoms. He satisfied the second requirement by using a transparent ruby rod free of imperfections. The facing mirrors applied to the end of the rod took care of the final requirement by keeping inside the ruby rod some of the photons spontaneously emitted by the excited electrons. There they bounced back and forth through the rod, with each pass stimulating the in-phase emission of additional photons. On each pass some of the photons in this cascading wave escaped through the hole in one end mirror, forming an intense beam of light.

Figure 4 summarizes the various processes that took place in Maiman's ruby laser. This illustration clearly shows how the end mirrors on the laser rod form what physicists call an optically resonant cavity. The mirrors provide the feedback that transforms the ruby rod from an amplifier to a quantum-electronic oscillator.

Ruby lasers are very inefficient, transforming less than one percent of the energy from the flashlamp that stimulates or "pumps" the laser rod

into laser light. Nevertheless, the light from Maiman's simple laser was more coherent than the light generated by any previous source. In other words, it possessed an amazing degree of spectral purity (monochromaticity) and was millions of times more intense than any other man-made light, or even sunlight. Moreover, the light generated by Dr. Maiman's laser formed a very narrow beam that could be focused to a point much smaller than light from any other source. A ruby laser can easily emit a 100-microsecond pulse of radiation having a power of 100,000 watts. When focused with a suitable lens, this much power can zap a hole through a 3/8-inch steel plate in a single shot.

Types of Lasers

Since 1960, literally hundreds of substances have been used in many different kinds of lasers. Shortly after Maiman proved a laser could be built, scientists at IBM made a laser that used a crystal of calcium fluoride doped with samarium instead of Maiman's crystal of aluminum oxide doped with chromium (ruby). IBM scientists then made a laser using a calcium fluoride crystal doped with uranium. Scientists at Bell Labs eventually joined the action with an infrared laser in which an ionized

mixture of helium and neon served as the active material. This laser led to the development of the well known helium-neon (HeNe) laser whose bright red beam is widely used as a laboratory tool and has many applications in industry.

Rare crystals and noble gases aren't the only materials that can be used to make lasers. Over the past 25 years many hundreds of materials have been made to "lase" (exhibit laser action), including gelatin deserts, plastic rulers, liquor fumes, liquid dyes, semiconductors and the hot gases given off by flaming aviation fuel. Lasers made from most of these materials are very different from Maiman's pioneering device, ranging in size from a barely visible speck of semiconductor to a three-bedroom house. Though they differ widely in configuration and appearance, all lasers satisfy the basic requirements of Maiman's original ruby laser. They include an optically transparent active material, a method of stimulating the material, and a means for feeding the resultant optical emission back into the material to produce in-phase stimulated emission.

Solid-State Ion Lasers

In solid-state ion lasers, the active material is an optical-quality glass or crystal laced with certain metallic or

rare-earth ions having fluorescent properties. Ruby, of course, is a prime example of a solid-state ion laser material.

Recall that ruby is a 3-level laser system in which chromium electrons can reside at one of three states. Materials in which the electrons can reside at *four* levels can provide a much more efficient laser material. The reason for this is that far fewer excited electrons are necessary for the onset of laser action.

One of the best known four-level materials is glass that has been doped with neodymium ions. Just as sapphire serves as the matrix that suspends chromium atoms inside a ruby laser rod, glass provides a host material for neodymium ions. Even better results can be had by placing neodymium ions in certain crystals. Yttrium-aluminum-garnet (YAG) is the best example, but other crystals have also been used.

Most neodymium lasers are "pumped" by flashlamps. Some are smaller than a toothpick and are pumped by an infrared-emitting laser or diode. When perfected, these miniature lasers may find an important role in optical-fiber communications. Other neodymium lasers are pumped by high-intensity lamps that are operated continuously. These

continuous wave (CW) neodymium lasers produce beams having up to hundreds of watts of power and must be cooled by flowing water. CW neodymium lasers are used for cutting, machining and drilling.

Neodymium lasers generally emit an invisible beam having a wavelength of 1.06 micrometers (1060 nanometers). Even a relatively small neodymium laser can generate pulses having a peak power of a million watts or more. Huge arrays of such lasers developed for nuclear fusion experiments have rods the size of fence posts and generate trillions of watts per pulse.

Gas Lasers

The gas-discharge lamps used to make advertising signs are only a few steps removed from being lasers. Consider the popular helium-neon laser. This laser consists of a discharge tube containing a mixture of helium and neon and a pair of discharge electrodes. When an electrical discharge is established in the gas mixture, the helium atoms are translated to higher-than-normal energy levels. When the excited helium atoms collide with neon atoms, they transfer their energy to the neon. The characteristic orange glow of the

neon lamp occurs as the molecules resume their normal energy level, emitting photons in the process.

Most HeNe lasers incorporate a narrow internal capillary tube coaxial with the length of the tube. Only the gas inside the bore of this tube lases. At either end of the bore are installed a pair of facing mirrors. One mirror is a 100 percent reflector, the other allows a small percentage of light to pass. These mirrors form the optically resonant cavity that permits laser action to take place.

Typical HeNe lasers are low-power devices that consume some 5 to 10 watts and emit from 0.5 to 10 or more milliwatts, about the range of light generated by an assortment of flashlights. But if you've ever seen the beam from a HeNe laser, you know how startlingly bright it appears.

Experimenters and educators use low-power HeNe lasers that sell for several hundred dollars to make holograms and to perform many kinds of experiments that require a coherent light source. In industry, HeNe lasers are used in surveying equipment, straight-line guides for heavy equipment and tunnel drilling rigs, and level indicators at construction sights. HeNe lasers are also used in laser printers and to read data stored on optical disks and bar codes on consumer merchandise. Figure 5 shows a low-power HeNe laser being used to transmit a television signal to a nearby receiver.

Though HeNe lasers are by far the most common gas lasers, hundreds of other gases and gas mixtures can be used to make lasers. Argon is used to make lasers that emit brilliant blue or green beams having an output of up to several watts. Therefore, considerable care must be exercised when working with this kind of laser. I well remember the time a careless scientist wandered into the path of an argon laser beam only to have his flapping lab coat set afire! Argon lasers have applications in eye surgery, underwater communications, and

Fig. 5. A low-power helium-neon laser transmitting a television signal.

(Courtesy Metrologic Instruments.)

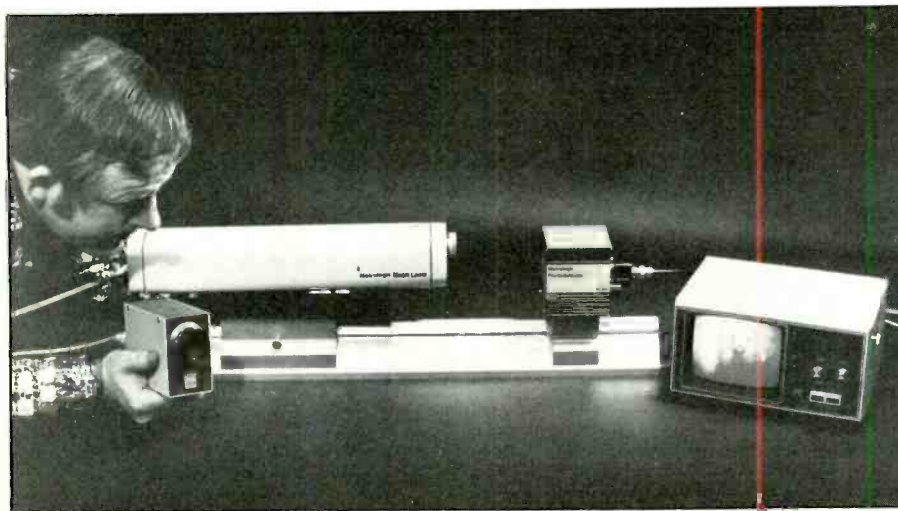



Fig. 6. An Air Force scientist looks on as a multi-kilowatt laser beam penetrates a plastic block.
(Photo by Forrest Mims)



Fig. 7. A carbon-dioxide laser can weld, drill or (shown here) cut intricate patterns in a sheet of metal.
(Courtesy Coherent Radiation)

scientific research. They are also popular for laser light shows.

By far the most spectacular gas lasers are those that use carbon dioxide (CO_2). The HeNe laser transforms into laser light only about 0.1 percent of the electrical power it consumes. The CO_2 laser easily converts 20 or 30 percent of the electricity that powers it into a beam of invisible infrared having a wavelength of 10.6 microns. Even a small CO_2 laser can produce a beam having a power of 10 watts or more. Larger ones produce beams having powers of hundreds or even thousands of watts.

Figure 6 dramatically illustrates how the beam from an early 8,000-watt flowing-gas CO_2 laser at the Air Force Weapons Laboratory bored its way through a Plexiglas block in only a second or two. Having stood only a few feet away from that laser to take the Fig. 6 photograph, I can assure you that I gained a great deal of respect for the power of that device.

Figure 7 nicely illustrates how the focused beam from a relatively low-powered CO_2 laser can cut intricate patterns in a metal sheet. Carbon-dioxide lasers have many other applica-

tions, including welding, sealing, drilling and use as a surgical scalpel.

Powerful as they are, the lasers whose effect is pictured in Figs. 6 and 7 are dwarfed by enormous gas dynamic lasers (GDLs). GDLs are much larger and more complicated than most other kinds of lasers. These awesome machines generate hot CO_2 molecules by burning aviation fuel or gases in a jet-like engine. The CO_2 molecules are excited to higher-than-normal energy levels when blown through a rocket-like nozzle at supersonic speed. Laser action occurs when the excited exhaust passes between two mirrors located near the nozzle.

The GDL can produce more than 100,000 watts of power in a burst lasting several seconds—enough power to melt a gaping hole through a car or aircraft wing. Even higher output powers are possible.

Semiconductor Lasers

The physical contrast between the huge GDL and a crystal chip smaller than the dot on this letter "i" is so great it's difficult to comprehend that both can function as a laser.

Since hundreds of semiconductor lasers can be made from a single wafer of gallium arsenide and similar crystals, they are much cheaper than any other laser. Though the light emitted by most semiconductor lasers is more divergent than that emitted by most other lasers, it can be compressed into a pencil-thin beam by simple lenses.

Though many kinds of semiconductor lasers have been developed, the most common resemble ordinary light-emitting diodes. The first such lasers were made by diffusing zinc into a wafer of n-type gallium arsenide (GaAs) to form a pn junction. The wafer was then scribed and cleaved into a series of bars. Individual laser diodes were produced by cutting each bar into chips with a wire saw.

GaAs has an index of refraction higher than that of diamond. Therefore, the cleaved surfaces at opposite ends of each diode formed ready-to-use mirrors with a reflectance of about 30 percent. Though this is much less than the reflectance of the mirrors used in most other lasers, the power-to-light conversion efficiency of a GaAs diode is so high that even mirrors having a reflectance of only a few percent will permit laser action.

When an electrical current is applied across a GaAs laser diode, electrons are stimulated to higher-than-normal energy levels when they cross the pn junction. When they recombine with holes on the other side of the junction, the excess energy they absorbed is given off as photons having a wavelength of about 904 nanometers in the near-infrared spectrum.

Thus far, the laser diode functions as an LED. When current through the diode is increased, the odds that stimulated emission will occur become much higher. As the current is raised still higher, photons reflecting back and forth between the end facets establish a microscopic standing wave within the diode. In other words, the light emitted at the junction is amplified by the in-phase stimulated emission of radiation, and laser action occurs.

EXPAND YOUR CAREER HORIZONS...



The C'E Microprocessor Trainer helps you to learn how circuits with microprocessors function in computers.

START WITH CIE.

Microprocessor Technology. Satellite Communications. Robotics. Wherever you want to go in electronics ... start first with CIE.

Why CIE? Because we're the leader in teaching electronics through independent study. Consider this. We teach over 25,000 students from all over the United States and in over 70 foreign countries. And we've been doing it for over 50 years, helping thousands of men and women get started in electronics careers.

We offer flexible training to meet your needs. You can start at the beginner level or, if you already know something about electronics, you may want to start at a higher level. But wherever you start, you can go as far as you like. You can even earn your Associate in Applied Science Degree in Electronics.

Let us get you started today. Just call toll-free **1-800-361-2155** (in Ohio, 1-800-362-2105) or mail in

the handy reply coupon or card below to:
Cleveland Institute of Electronics,
1776 East 17th Street, Cleveland, Ohio 44114.



Cleveland Institute of Electronics
1776 East 17th St., Cleveland, Ohio 44114

MO-46

Please send your free independent study catalog. For your convenience, CIE will try to have a representative contact you — there is no obligation.

Print Name _____

Address _____ Apt. _____

City _____ State _____ Zip _____

Age _____ Area Code/Phone No. _____

Check box for G.I. Bill bulletin on Educational Benefits

Veteran Active Duty

MAIL TODAY!

The Nature of Laser Light

Laser light is unlike any other light in the universe. The light emitted by a twinkling star, a glowing light-emitting diode, a flashing firefly, a brilliant arc lamp and a pocket penlight is a jumble of confusing wavelengths spraying outward in all directions.

The drawing shows how to transform ordinary light from chaos to order. Ordinary light waves are out-of-phase with each other. Placing a pinhole in their path permits a tiny amount of in-phase waves to be selected. Ordinary light usually has many different wavelengths but a spectral filter can be used to block all but a selected wavelength. Ordinary light spreads outward in all directions, but a lens can be used to collimate some of the light into a narrow beam.

If ordinary light is passed through a pinhole and a filter and then focused by a lens, it will begin to approach the nature of light produced by a laser. However, since only a minuscule fraction of the light emitted by ordinary sources will survive passage through these three devices, the resulting light will have little practical use.

Laser lightwaves are in-phase with one another and are spectrally pure. Moreover, since they are emitted in a distinct beam, they form an incredibly brilliant source. On a wavelength basis, laser light is millions of times brighter than that from any ordinary light source. The filament of an incandescent lamp would have to be heated to the impossible temperature of 10,000,000,000,000,000 degrees Celsius, filtered to a single wavelength and concentrated with lenses to equal the beam produced by a small helium-neon laser only a tenth as powerful as a pocket penlight. The beam from such a laser is as bright as or brighter than the sun!

The best way to appreciate the incredible intensity of laser light is to visualize it in human terms. Several years ago, some students and I mounted a 6-milli-

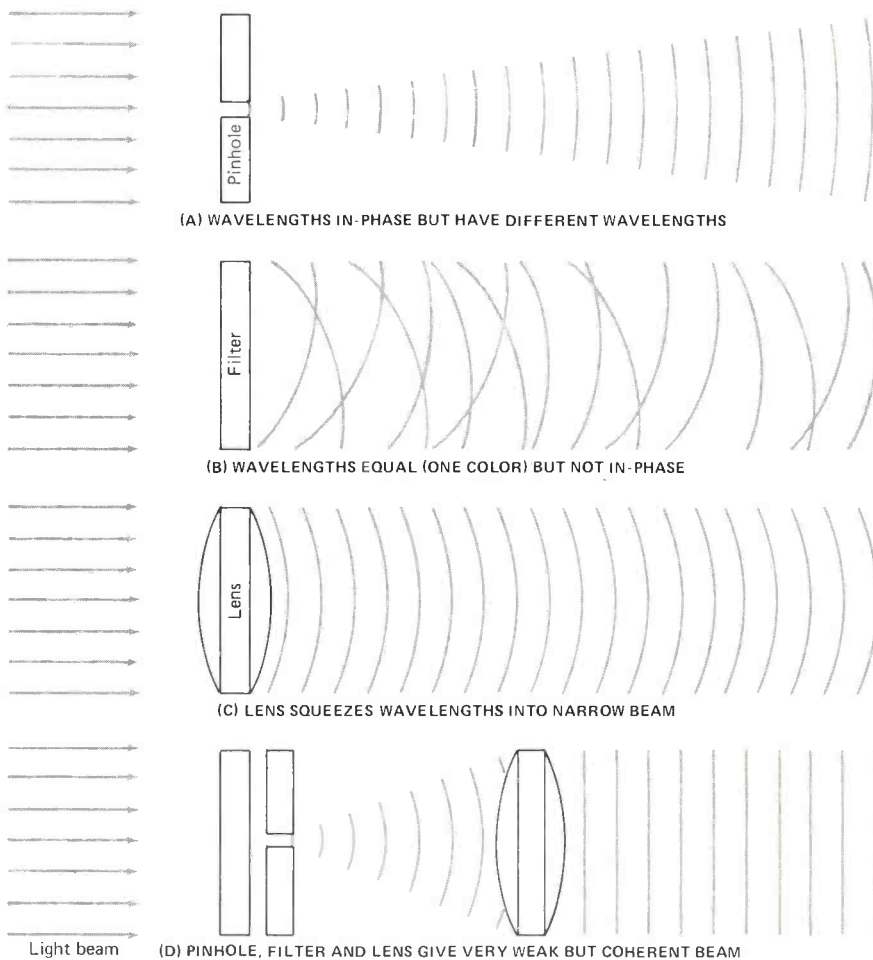

(A) WAVELENGTHS IN-PHASE BUT HAVE DIFFERENT WAVELENGTHS

(B) WAVELENGTHS EQUAL (ONE COLOR) BUT NOT IN-PHASE

(C) LENS SQUEEZES WAVELENGTHS INTO NARROW BEAM

(D) PINHOLE, FILTER AND LENS GIVE VERY WEAK BUT COHERENT BEAM

How ordinary light can be selectively filtered and collimated to produce a beam having similar properties but less than a trillionth the power of a weak laser beam.

watt HeNe laser atop an office building in Albuquerque, New Mexico and pointed the beam toward the base of a mountain 12.5 miles away. We then drove to the spot where the laser was pointed and looked back at the scintillating lights of the city. At first we didn't see the laser. But as we walked down a slope, we were awestruck by a dazzling red beam. Though the laser was less powerful than a flashlight, it far outshone the lights of the city and the rotating beacon at the airport.

I observed a similar phenomenon while testing a laser diode communicator some months later. An infrared image converter was required to see the invisible beam from the laser. Since the test was during the day, I mounted on the image converter a narrow-band optical filter that passed only the narrow band of wavelengths emitted by the laser. On viewing the laser through the converter from a distance of about a mile, I was startled to observe that it was far brighter than the sun!

The current level at which the laser diode actually lases is called the threshold current. Below threshold, the diode functions much like a low-powered LED and emits radiation

from all its surfaces. Above threshold, distinct beams emerge from the two end facets of the device. Since the dimensions of the junction region are so small, diffraction effects cause the

beam to be much more divergent than the beams emitted by most other types of lasers.

The first laser diodes required currents on the order of 100,000 amperes

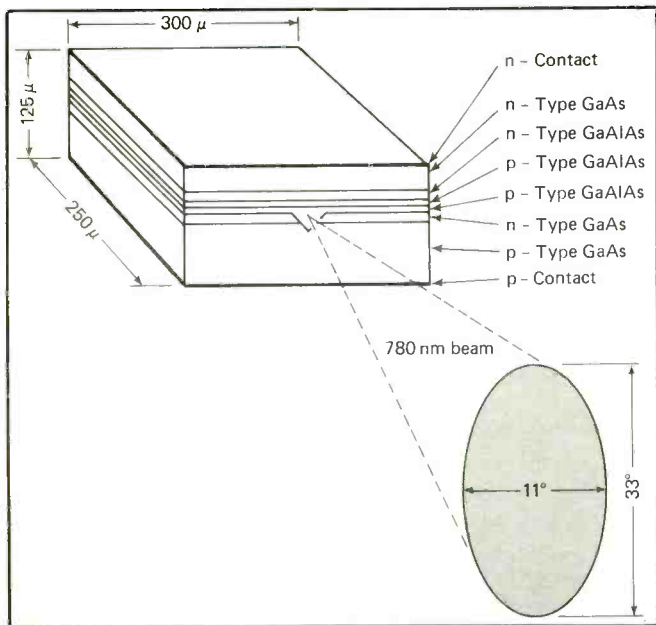

◀ Fig. 8. Sharp's V-channeled substrate, inner stripe (VSIS) CW laser diode.

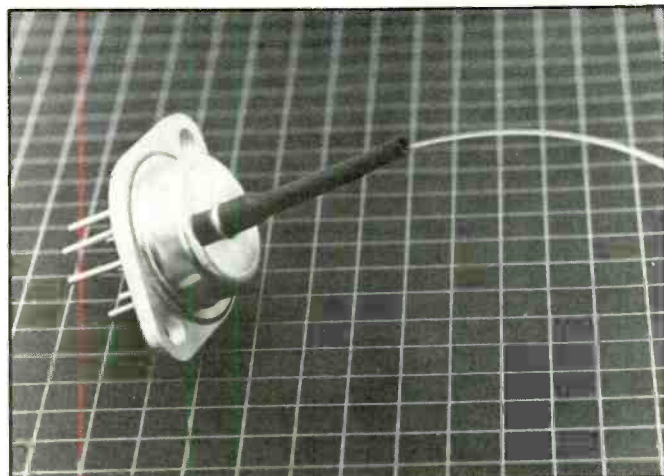

Fig. 10. A high-power (100-milliwatt) optical fiber-coupled laser diode made by Spectra Diode Labs.

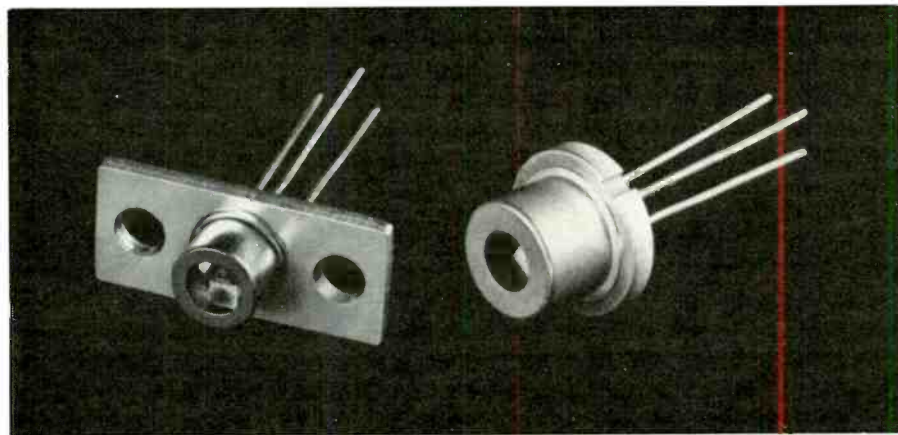

Fig. 9. Continuous-wave Mitsubishi laser diodes for use in CD players.

per square centimeter of junction area. Therefore, practical devices could be formed only from exceptionally small chips. Nevertheless, a single diode required 30 to 50 amperes to function as a laser. Since this much current would quickly overheat and melt the chip, the current was applied in pulses of no more than a few hundred nanoseconds in duration. Some laser diodes emitted as much as 50 watts per pulse, with lifetime in only tens or hundreds of hours.

Today's laser diodes have threshold currents that range from several tens of thousands of amperes to as little as a few thousand amperes per

square centimeter. These lower currents permit the devices to function for tens of thousands of hours.

Most of these new laser diodes are based on heterojunction technology. Recall that the first laser diodes were made from GaAs. Since a single material forms the entire device, it is called a homojunction diode. A heterojunction is formed when a layer of slightly different crystalline material is deposited or grown on one or both sides of the junction.

The simplest heterojunction laser diodes have a GaAs junction region capped by a layer of aluminum gallium arsenide (AlGaAs). Since GaAs

has a higher index of refraction than AlGaAs, the AlGaAs-GaAs interface appears like a mirror to light generated in the GaAs junction region. Therefore, the AlGaAs helps confine the emitted light to the junction, thus improving both the optical and electrical efficiency of the device. These so-called single-heterojunction (SH) lasers are usually 3 to 12 mils wide and emit several watts or more at 10 amperes of forward current. Because this current is too high for continuous operation, SH lasers must be operated in a pulse mode.

A double-heterojunction (DH) laser is formed by sandwiching a GaAs junction region between two AlGaAs layers. This provides much more optical confinement than the SH structure. DH lasers made in this fashion were the first laser diodes to operate continuously at room temperature. By varying the aluminum concentration in the AlGaAs, the wavelength emitted by DH laser diodes can range from about 900 to 680 nanometers in the visible red part of the spectrum.

A logical extension of DH technology is to surround a narrow GaAs junction region with AlGaAs. Many

(Continued on page 87) ▶

The Three Faces of Commodore's C128 Computer

This new personal computer offers multiple operating modes, a better disk drive and a promised host of peripherals

By John Richardson

The Commodore 64 personal computer has been a winner in the marketplace, following on the heels of the company's successful VIC-20 machine. Both had flaws, but they hung in there in their time and knocked out competitors through wide distribution in mass-market stores, availability of loads of software, and lower and lower selling prices.

Now, however, the C-64 is about four years old, which is a double lifetime in the computer field, though it still attracts buyers. Thus, a newly introduced Commodore personal computer with a starting price (before discounting) for the basic CPU section/keyboard of only \$300, with an optional disk drive that's much speedier than the C-64 one for another \$300, seems destined to supplant it—Commodore's new C128 model.

Before we report on our findings when examining a C128 sample model with its new disk drive, some background is in order to place the new offering in its proper perspective.

A Little History, Please

Introducing a new computer nowadays has to be risky. It's a volatile market with all manner of model and price changes (continually lowered).



Moreover, new computers traditionally don't have satisfactory software support for at least a year after they have been introduced, if then. In this respect, the C128 is different, as you shall see soon enough.

Commodore's original VIC-20 had a successful home/family/school installed base, with thousands upon thousands sold. It had many shortcomings, though, and users and prospective buyers were hoping for a more advanced model that ran the same software to replace it. The advanced-model part happened in 1982

when Commodore debuted its C-64, a marvelous little machine that had much more user memory (64K vs 16K), great music synthesizer sound capability, sprites (movable graphics objects for animation), and other features. But it was *not* compatible with VIC-20 software!

It seems that designers did originally pursue VIC-20 compatibility and, in fact, locked themselves into the slow, hare-like speed of the VIC-20's disk-drive system in order to do so, using the same economy serial bus. But they ran into all sorts of

problems with the interface driver and wound up with drive incompatibility anyway while retaining all the burdens of the old drive.

The C-64 was a price-driven design throughout its development and subsequent production runs, using the same VIC-20 case dimensions, the same printed-circuit board, etc. A host of reliability problems plagued the machine during much of its life. Disk drives didn't perform properly, computers broke down along the Model's production-life way due to various component changes, such as switching some devices to plastic casing instead of the more reliable ceramic, and so on. Nonetheless, sales blossomed, prices were dropped with the assistance of lower-cost LSI devices produced in volume in the company-owned silicon-device factory, etc. And thousands of C-64 programs were created by the fertile minds of software authors.

But low selling price and plenty of software can't be appealing forever. So Commodore introduced its Plus/4 computer last year. It, too, was not compatible with software for the company's previous model, the C-64, though it used the same s-l-o-w model 1541 disk drive, with the promise of a faster parallel-drive model in '85. Its hallmarks were built-in, integrated application programs and a very good BASIC. The programs were fair at best, though versatile. We slammed the machine in a review (*Modern Electronics*, March 1985), largely for its non-C-64 software compatibility. "Won't they ever learn?" we thought.

Guess they finally did learn, as evidenced by the new C128, which is designed to be both hardware and software compatible with several popular computer systems. Foremost, it is hardware and software compatible with the C-64; it can run CP/M and access much of the CP/M library of programs; and it is hardware compatible with several popular and commonly used CP/M disk formats.

The latter means you can actually run programs in a foreign disk format (when using Commodore's new model 1571 disk drive).

Three Computers in One

Essentially, the C128 is three independent computer systems sharing a common cabinet and peripherals, and the peripherals can be those originally intended for the VIC-20 and the C-64, or newly designed "business-quality" models specifically intended to complement the C128. The new peripherals presently include the model 1571 high speed disk drive (also available in a dual configuration); the model 1902 Hi-Resolution color monitor, which features both RGBI and composite inputs; the model 1350 two-button "mouse"; and the model 1660 300-baud and model 1670 1200-baud modems. At the time this report was prepared only the model 1571 high speed disk drive was available to us, so we cannot comment on any of the new accessories other than this peripheral.

The C128 contains 128K of internal RAM and two microprocessors—a Z80 and an 8502—which are used to emulate three independent computer systems. The 8502 CPU provides two of the three emulations. The first is a complete emulation of the C64 (using 64K of RAM). Any software, cartridges, or peripherals that the user might have from his old C64 computer will run on the C64 emulation. Thus, as far as we can tell, the C-64 emulation is 100% accurate, which means that even though the C128 has outputs for both 40 and 80 character-per-line monitors, in the C64 mode it is always 40 characters per line because that's the way it is in the original C64 computer.

The 8502 microprocessor also generates the C128 mode, which is best described as an upgraded or enhanced 128K RAM version of the C64. The major difference here is that the C128 mode utilizes the full

128K of RAM, which can be further upgraded up to 512K of user memory through expansion modules (cartridges). Although the C128's BASIC can be considered as an enhanced version of the C64's because it has extensive new commands and capabilities compared to the C64's BASIC (which is a rather excellent version of BASIC to begin with), the new functions are not simply kluged on to those of the C64.

BASIC for the C128 mode is known as BASIC 7.0. Each of its two screen formats (80 and 40 characters) is controlled by a separate microprocessor chip. The 40-character chip provides 16 colors and high-resolution bit-mapped graphics. The 80-character chip also provides 16 colors, displays characters and character graphics; high-res graphics, however, must be done in the 40-character mode. The C128's graphics features include 13 specialized graphics commands, the 16 colors previously mentioned, six display modes, eight programmable movable objects (called Sprites), add combined text/graphics displays. For users into "performance level" music synthesis, the C128 provides a three-voice sound generator complete with waveform, pulse width, and ADSR (attack, decay, sustain, release) control, using the same SID (sound interface device) as in the C-64, the 6581 integrated circuit.

While the C128 BASIC can load and run some of the simpler BASIC programs from the C64, we found that the C128 BASIC cannot run programs that employ special C64 graphics and sound commands. As an example, the computer might load the programs from a C64 disk, but won't run them. C64 BASIC programs only work when the computer runs in the C64 mode, using a 16K ROM with BASIC 2.0. A 48K ROM contains BASIC 7.0 and that's used in the C128 mode. Other C128 features are monitor, 40 and 80 column monitor outputs, and a full

numeric keypad that contains "+", "-", and ENTER keys, and dual-model disk-drive capability. A 16K ROM provides DOS support.

The Z80 microprocessor, which runs at 4 MHz, sets up the C128 CP/M+, which can run any generic CP/M program. Here we mean a program that is not hardware-specific for a particular computer. Commodore's implementation of CP/M is somewhat unusual. It has a rather extensive HELP utility program that actually displays detailed examples on how to use CP/M's commands and utilities.

Although Commodore's version of CP/M+ can be used with the old 1541 disk drive, it is really intended for the new model 1571 drive. This drive supports (emulates) the disk formula of the Epson QX-10, IBM single and double-sided CP/M-86, Osborne single-sided double-density, and Kaypro II and 4. In practical terms, this means that once you have loaded the C128 with CP/M+, you can remove the CP/M+ disk, insert disks from any of the aforementioned computers, and the 1571 disk drive will automatically recognize and read or write the foreign disk format.

The basic C128 consists of a unitized computer/keyboard, an external power supply, and a coupling device for using a conventional TV receiver as the monitor. The computer/keyboard unit measures 17" wide x 12 3/4" deep x 2 1/4" high at the top of the sloping keyboard section. Thus, it takes up much more space than does the C64 computer.

The keyboard itself is divided into three sections, with a total of 92 keys: the main keyboard, a numeric keypad, and a row of miscellaneous control and function keys. The main keyboard section is a clone of the C64's keyboard. Although the C128 has individual cursor control keys, the main keyboard has the C64's CRSR dual-direction cursor movement keys—either can be used. To the right of the C64's keyboard is a separate

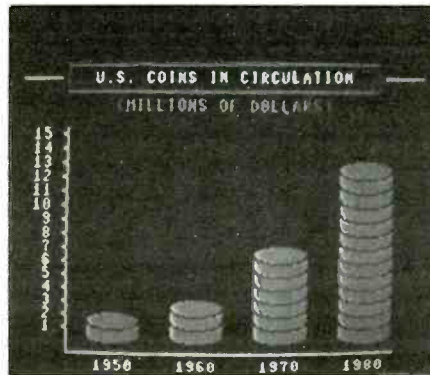

As shown by this TV monitor display, the C128's emulation of the C64 is so accurate that even C64 graphics-based software can be run error-free on the C128.

numeric pad with its own ENTER, "+", and "-" keys.

Above the main keyboard and the numeric pad are four groups of 4 keys. The left-hand group provides a conventional ESCAPE and TAB, ALTERNATE (a supershift), and a CAPS LOCK. The next group of four keys calls up HELP, a LINE FEED, 40- or 80-character display, and NO SCROLL. The next group of keys provides for left and right cursor control, and the final group of four keys, which are on the right side of the keyboard, provide eight software-programmable function keys.

Peripheral connections and switches are arranged along the rear and right side as they are on the C64. Although most resemble those of the C64 at first glance, there are several new connectors which are needed for the C128 and CP/M modes. On the right side are the power switch and connectors for the external power supply and two "control ports" that can be used for the optional mouse, joysticks, or a light pen. Adjacent to the power switch is a pushbutton RESET for resetting the computer in the C64 and C128 modes without having to turn it off. Across the rear of the unitized keyboard are three edge-card connections used for the expansion port (which is used for software cartridges or memory-ex-

pansion modules), the user port (used for modems, RS-232 I/O, etc.), and a datasette (Commodore's integrated data cassette recorder). Also, the rear apron has the usual serial input-output (I/O) socket used for up to five disk drives, and r-f output jack along with a TV channel 3/4 selector switch, a composite video and sound output jack, and a new 9-pin D-connector for an RGBI monitor.

Before going any further we'd best take time out to explain why there are three output connectors because they contribute toward a better understanding of the C128's formidable computing power. In any computer mode the number of characters per line is indigenous to the particular monitor: 80 characters appear only on the RGBI monitor, while 40 characters appear only on the composite and r-f (TV) monitors. The C64 mode always comes up in 40 characters for the composite and r-f outputs; the RGBI monitor is inoperative. Although the C128 and CP/M modes can be toggled between 40 and 80 characters, the toggle controls the monitors as well as the number of characters per line. Selecting 80 characters always forces the display to the RGBI monitor; selecting 40 characters always forces the display to both the composite and r-f monitors.

When power is initially applied, the computer always boots on all three displays so that the user doesn't accidentally boot to a dead screen (a monitor that's turned off). On boot-up, all three monitors "come up" in 40 characters; after the initial sign-on, only the selected monitor(s) is active. (In the 40-character mode both the composite and r-f outputs are active.) Similarly, if the user toggles from 80 to 40 characters or vice-versa the "old" screen will show the display up to the moment the toggle took place. The normal 80-character display of CP/M is accommodated on a 40-character composite or r-f monitor by using the screen as a window that can be shifted to the right to

view “off the screen” characters.

In a way, the key to an individual's success and pleasure with the C128 will be the new Commodore disk drive. As many users of the C64 well know, the earlier model 1541 disk drive is deadly slow. The new model 1571 drive, however, is considerably faster than the earlier drive and has twice the storage capacity. Just as important, it automatically recognizes and sets itself for the correct operating mode.

When the computer is set for the C64 mode, the disk drive automatically reads and writes in the single-density, single-sided C64 mode. Software originally written on the older 1541 drive can be used on the 1571 drive. However, even though the new disk drive is working in the C64 mode, it reads and writes at least twice as fast as the older drive. When the computer runs in the C128 mode, the 1571 drive shifts to a double-density, double-sided mode providing 340K of data storage. When the computer runs CP/M, the drive automatically shifts to a double-density, double-sided mode that provides 410K of storage, and will support, if necessary, one of the foreign formats discussed earlier.

Though the C128 claims to “support” the foreign formats, you should be aware that it doesn't mean everything becomes hassle-free. Firstly, there is little, if any, commonly used software in CP/M-86 format. We could locate none with which to test the C128. Secondly, even when the C128 could run the software, it didn't necessarily come out correctly.

To start with, the program had to be “pure CP/M,” meaning it was not hardware dependent. Then, we found that a document file from the Kaypro version of WordStar put a false character on the beginning of every line on the C128. On the other hand, an Osborne version of WordStar ran flawlessly; somewhat slower than on the Osborne, but neverthe-

less flawlessly. (In fact, because of a computer breakdown caused by Hurricane Gloria, this report was written on the C128 using an Osborne format WordStar disk that was originally created on a Radio Shack computer. The C128's “Osborne” disk was then converted to IBM WordStar so it could be run through a spelling checker.)

For those who require greater floppy storage or the convenience of two disk drives, a dual-version Model 1572 of the new drive is available.

Although the C128 is intended to be used with the new disk drive, it will indeed work with the older model 1541. Therefore, you don't have to scrap what you have simply to upgrade the computer. But a few practical examples show the limitations of the C128 with the older disk drives. First, a C64 game program that takes 22.41 seconds to load using the 1541 drive requires only 6.16 seconds with the 1571 drive! Not enough of a difference you say? Then how about a small financial program that takes 100.05 seconds to load from a 1541 drive, but only 12.6 seconds from the 1571 drive. Or how about CP/M. It takes more than 3 minutes to load from the old drive, but, in contrast, only about a minute from the new drive.

Conclusions

To say that the C128 is jam-packed with features is an understatement; we would have to reprint Commodore's somewhat extensive manuals in order to list all the features. The C128 seems to have something for everyone in the 8-bit world. But it's difficult to see where the C128 fits into the present computer marketplace.

If the BASIC and graphic enhancements of the C128 are of particular interest, upgrading from a C64 would be advantageous; but if a C64 otherwise suits one's needs, there's little need for the C128. Much of the C64's primary limitation, which is disk access speed, can be corrected by

simply using a faster disk drive. Even as this report was being prepared, an aftermarket vendor was offering software that doubled the access speed of the older disk drive.

As for the C128s addressable 512K RAM, few 8-bit programs need even 128K. Business-quality spreadsheets and integrated software packages are among the few programs that require extensive memory, but the nagging question exists whether enough C128s will find their way into the business office to justify someone investing the time and effort to write programs of the caliber of Lotus' Symphony, and the other office standards. If you need business software, you'll find the widest assortment available for those computers already common in the business office.

As for the CP/M mode, while it permits using the software written for other 8-bit computers, Commodore simply doesn't provide sufficient documentation in its manual. Consequently, the manual is generally inadequate for the newcomer to CP/M, or confusing at best. For example, the information on using foreign disk formats is buried as a subtopic in the CP/M HELP screen. For those users who really want to know what's what with CP/M, Commodore does provide a coupon to order more detailed documentation at \$19.95 from Digital Research.

Although the documentation on CP/M is sparse, it is excellent for BASIC and all the associated functions. Commodore has had a lot of experience with manuals for the C64 and they know how to do it right when it comes to BASIC, graphics, SPRITES, color and sound. In fact, if you're a beginner just starting out in personal computing and you want to learn what it's all about at a budget price (about \$250 in the discount stores) you would be hard pressed to find anything that approached the C128 as an instructional machine.

(Continued on page 86)

Cool It, Baby!

How to dissipate damaging heat in electronic circuits

By Joseph J. Carr

Cool it . . . you'll last a lot longer!" Good advice for both hot-tempered people and for electronic equipment, too. Heat is the great killer of electronic equipment, especially solid-state equipment. Many device ratings are based on maintaining certain operating temperatures. One "hobbyist grade" power transistor, for example, offers a seemingly tremendous collector power dissipation (which is prominently advertised!). The catch is that the power is available only at room temperature (25-30 °C). At temperature above 30 degrees Celsius, the transistor must be derated substantially. Almost *anyplace* that the transistor is used inside a cabinet or box the temperature will exceed 30 °C!

Reliability experts measure equipment performance in terms of "Mean Time Between Failure" (MTBF); the MTBF is usually stated in hours. For example, an MTBF of 1000-hours implies that, for a large number of samples of the equipment, the average will be one soul-destroying failure per thousand hours of operation. One source claims that a 10 °C rise in operating temperature will cut the MTBF almost in half.

How important is cooling in electronic equipment? Let's consider some examples. About ten years ago I worked in a university hospital repairing patient monitoring equipment. The oscilloscopes at the nurses' Central Station were a reliability nightmare. About once a week, usually at 3 AM, the nurses would call me to come repair one of the four oscilloscopes. Yet the same

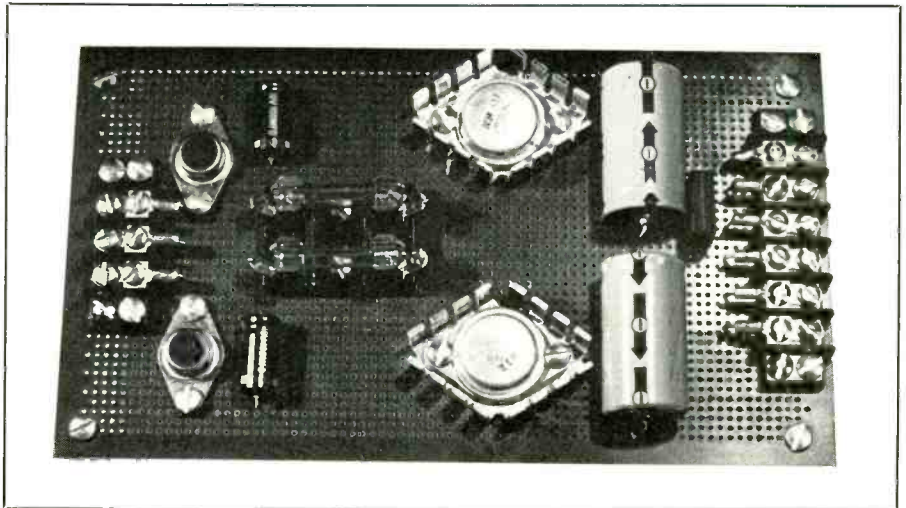

model 'scopes at bedside operated reliably. The problem was overheating of the Central Station 'scopes, which were mounted inside of a completely closed desk/console. After cutting ten 1" ventilation holes, and installing a pair of 100-c.f.m. fans, the Central Station instruments became as reliable as the bedside ones.

A second example is a story of tragedy prevented. My first personal computer was a *Digital Group, Inc.* Z80-based machine with 26K of static (2102 chips) memory. In those days, my kilobuck bought (in kit form) a motherboard, three 8K memory boards, a CPU board, a 64 line TV/cassette interface board (with some static memory chips on-board), and several input/output boards. All of those boards contained lots of TTL devices, and they generated a large amount of heat. The builder had to supply the cabinet, a -/+ 12-VDC at 1 ampere dual-polarity power supply and a +5-volt dc at 10 amperes regulated power supply.

At first, all those cards and the two

dc power supplies were buttoned up inside an almost unvented aluminum cabinet. Needless to say the temperature of the cabinet rose to egg-frying levels, and the HEP S-7000 power transistor used as the series-pass element in the voltage regulator operated hot enough to take off skin when touched. That computer would have been a reliability headache (with my kilobuck!) if the heat wasn't removed. I installed a pair of 40-50 c.f.m. fans: a 3.5" model blowing across the S-7000 heat sink and a 4.5" model cooling the printed wiring board compartment.

No one with any electronics experience at all, however slight, can deny that heat is the great killer of electronic devices. Projects or equipment that passes or delivers large amounts of either current or power must be kept cool for proper operation. The methods given in this article are simple and sufficient for most reader's applications. While the reliability engineer and the thermodynamicist will flinch at the lack of mathematical ele-

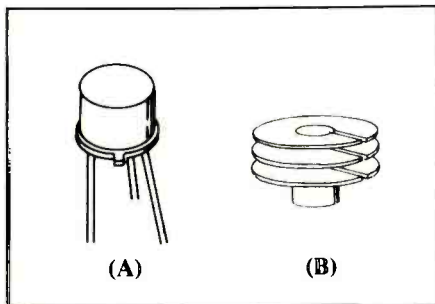

Fig. 1. A metal TO-5 transistor package as in (A) sometimes requires a "top-hat" finned heat sink, as in (B).

gance, the implementations are nonetheless effective.

There is only one simple rule: *where there is excessive heat, remove it.* What's "excessive" mean? If the equipment feels too hot to the touch, or has a history of unexplained failures and/or repairs, then it is probably running too hot. An engineer will have specifications to meet and calculations to make, but they are beyond the scope of this article. The empirical "skin of the thumb" rule, however, suffices for our needs.

There are three basic tactics that can be used either singly or in combination: (1) radiate more heat, (2) improve natural ventilation, or (3) add or increase forced-air cooling. For most readers, water cooling is not a consideration even though some commercial electronics equipment (e.g. broadcast transmitters) use circulating water for cooling.

Protecting Transistors & IC Regulators

On small projects, where it is not practical (or possible) to use forced-air cooling, you will have to provide heat sinking for the semiconductors. In fact, even most air-cooled projects will need these metal radiators. Figure 1A shows the metal TO-5 transistor package, most of which are mounted on printed-wiring boards, and are low-signal (and low-heat) devices. One would think that heat

problems wouldn't occur. But certain TO-5 transistors, such as the 2N3053, operate at moderate power levels in audio drivers. In such instances, a "top-hat" finned heat sink such as in Fig. 1B, is mounted on the TO-5 package to radiate heat. There are also certain other "spring clip" versions of this same kind of heat sink. Should you ever remove such devices, be sure you don't discard the heat sink when you replace them.

Figure 2A illustrates two forms of plastic power package. You will find these packages in power transistors (for instance, 2N5249) and three-terminal IC voltage regulators. In the regulator case, the devices are often rated at 750-mA in free air and 1000-mA when heat sinked. Either vertical or horizontal finned sheet metal heat sinks, such as in Fig. 2B, are used to provide heat dissipation. Be sure to use a thin layer of silicone heat-transfer grease between the metal tab surface on the transistor (or regulator) and the heat sink. Also be

Fig. 2. Two forms of plastic power packages are shown in (A). Finned sheet-metal heat sinks (B) are often used to draw heat away.

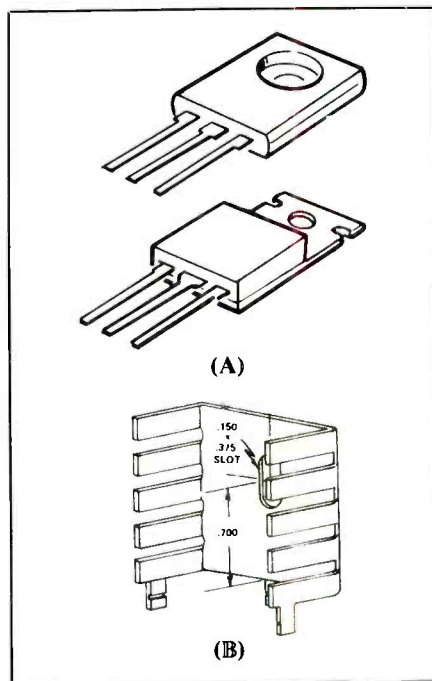

certain to tighten the mounting screw properly in order to facilitate heat transfer to the heat sink.

The lead photograph shows heat sinking for TO-3 transistors and three-terminal regulators. The bent sheetmetal heat sinks pictured here are good for up to about 10 watts of power, or regulators up to 1.5 amperes. For the 3-ampere, 5-ampere and 10-ampere regulators that also use a TO-3 package, it would be better to use a larger finned heat sink.

In much equipment the metal chassis itself is used for heat sinking. In those cases the transistors are bolted either directly to the metal chassis or mounted via mica insulators. In both instances, silicone heat transfer grease is used between the semiconductor device and the chassis. This method is especially successful when the chassis is large or when it is particularly thick.

Some printed wiring boards (PWB) use large areas of unetched copper foil and/or large metal ridges or blocks to provide better heat sinking. This method is used especially where there are not single particular devices that can be individually heat sinked (for example, a TO-220 transistor), but rather when there are a large number of heat-producing devices (such as TTL ICs).

There are many different forms of large, finned heat sink used for TO-3 (and other) transistors, high-current voltage regulators and high-current diodes and SCRs; Figure 3A shows a side view of one of these heat sinks. In this case, the TO-3 transistor (or other device) is mounted on the flat central surface of the heat sink with screws. In most situations, it is wise to use a thin smear of silicone heat transfer grease between the device and the heat sink. This grease is especially needed when a mica insulator is placed between the semiconductor device and the heat sink. Again, it is necessary to make sure that the mounting screws are cinched down tight enough to allow maximum heat

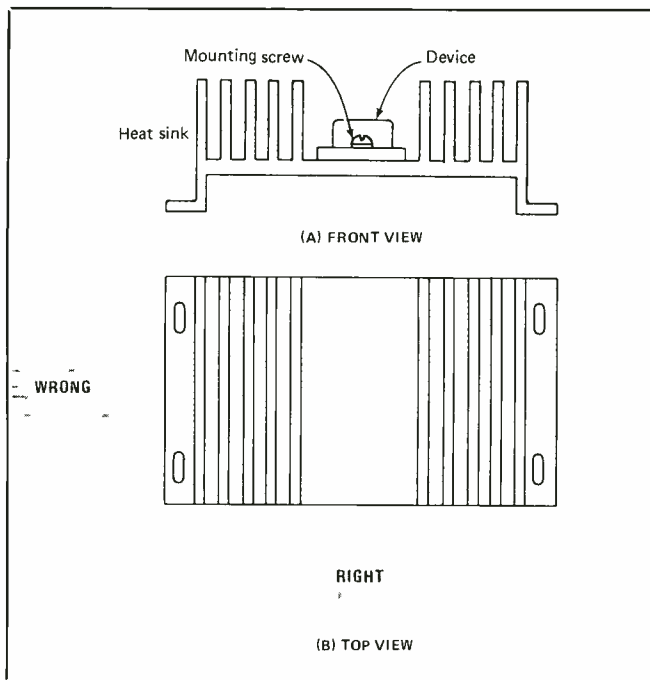

Fig. 3. Another type of heat sink is shown in (A), while (B) illustrates the use of forced air to cool the heat sink.

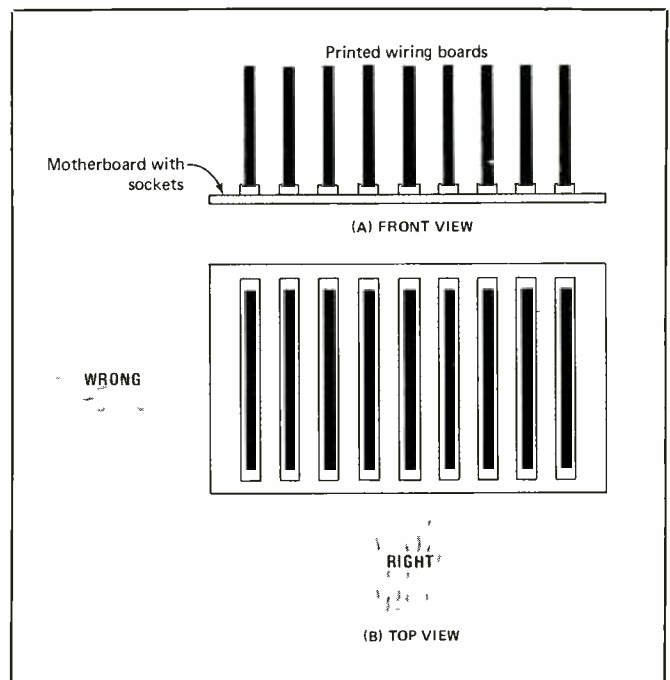

Fig. 4. In (A), plug-in wire boards are shown in a socketed motherboard, while (B) illustrates a top view with correct and incorrect air-flow direction for cooling purposes.

transfer (but not enough to distort the device package).

The big issue in selecting a heat sink is the surface area in square inches. There is a technical discipline used by engineers to calculate the amount of heat sinking needed, and these calculations can be found in various engineering textbooks.

When forced air is used to cool a heat sink—a good idea when the power and/or current is high—then the orientation of the heat sink with respect to the airflow is sometimes important. Figure 3B shows the right and wrong ways to force air over the finned surfaces. Keep in mind, however, that orientation is not always critical, especially when air from the “wrong” direction is sufficient or blows over the entire surface. The designations “right” and “wrong” are merely general considerations for some critical applications.

Other Components

Certain components other than pow-

er transistors also generate heat. Rectifier diodes and power resistors are examples, and should be mounted with their bodies 0.125 to 0.250 inch off the PWB. This procedure allows the heat to dissipate into the air instead of the PWB material. I have seen many phenolic and some fiberglass printed wiring boards badly damaged from the effects of a 10-watt power resistor mounted flush to the surface. Some “bargain basement” rectifier diodes can meet their rated forward current only when the rectifier is (a) mounted 0.50” off the board and (b) has the axial leads cut to 0.75” or longer. Those diodes are overrated and should be either used only in lower-current applications or shunned entirely.

Layout is important when power components are mounted on the PWB. Try to avoid clustering power components in a small area of the PWB, especially on cheap phenolic boards. Also, avoid placing heat-sensitive parts near power components.

For example, never mount 10-watt resistors adjacent to polystyrene capacitors or small transistors.

Large Digital Projects

When I first felt the temperature of my *Digital Group, Inc.* cabinet, I took steps to get rid of the heat—and reliability was improved! Rarely does the homebrew builder have the flexibility that I had with my *Vector Electronics S-100* cabinet. In most cases, the builder must do with only a single fan and must be clever to make best use of it. Figure 4A shows a typical large-scale digital project—such as a microcomputer—in which plug-in printed wiring boards are installed on a socketed motherboard. Usually, these PWBs will be mounted in a closed cabinet. If we apply air broadside to the PWBs, then only the first one in the line-up will benefit. Figure 4B shows a topview that permits you

(Continued on page 86)

Discover the “Hidden World” of FM Broadcasting

*Project lets you tune in on SCA subchannels
with almost any FM-stereo tuner or receiver*

By Gary McClellan

If you are like most people, your FM listening is probably restricted to the usual music and news. You may not even be aware that there are buried within the signals of many FM stations hidden programming meant for special audiences. Even if you are aware they exist, you may not know how widespread and diverse this programming has become. Without a special decoder, available to commercial subscribers for a rental fee, you cannot receive these programs with an ordinary FM receiver or tuner. However, if you build and use the “Explorer” SCA adapter described here, you can save the cost of the monthly rental fee of a decoder and still be able to listen to SCA broadcasts, though you will not get the benefit of program guides and other helpful materials.

If you live in or near a major city and can clearly receive FM stations, you are a candidate for the Explorer. To obtain the greatest benefit from this project, you need a high-quality FM-stereo tuner or receiver, which should be solid-state in design and have an ac power transformer. You must also know something about electronic circuitry so that you can “install” the Explorer in your receiver.

The Explorer will not decode stock

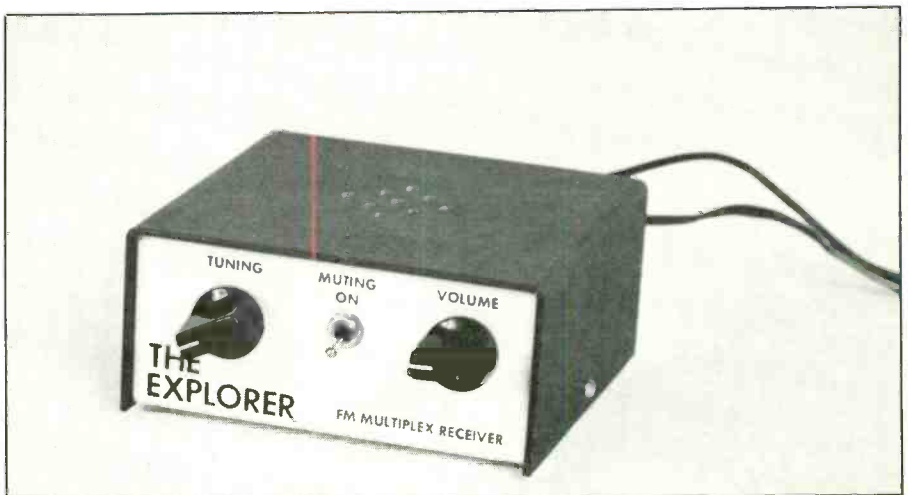

quotation services or receive ARI broadcasts. Both services require leased decoders for proper reception. Also, you should know that these broadcasts are copyrighted. While it is okay to listen to them in the privacy of your own home, you cannot under law use them to promote a business or use them for profit, nor can you

record them or divulge their contents to other people.

SCA Theory

Before we discuss how the Explorer works, let us look at a cross-section of a typical SCA-carrying FM broadcast signal, shown in graph form in Fig. 1. Note that the zero point is the

Fig. 1. Anatomy of FM Spectrum.

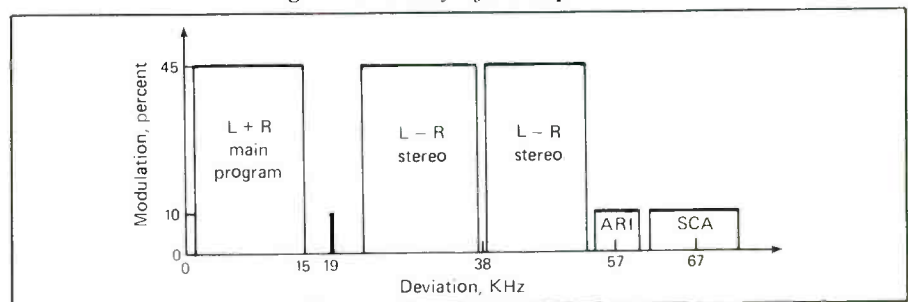

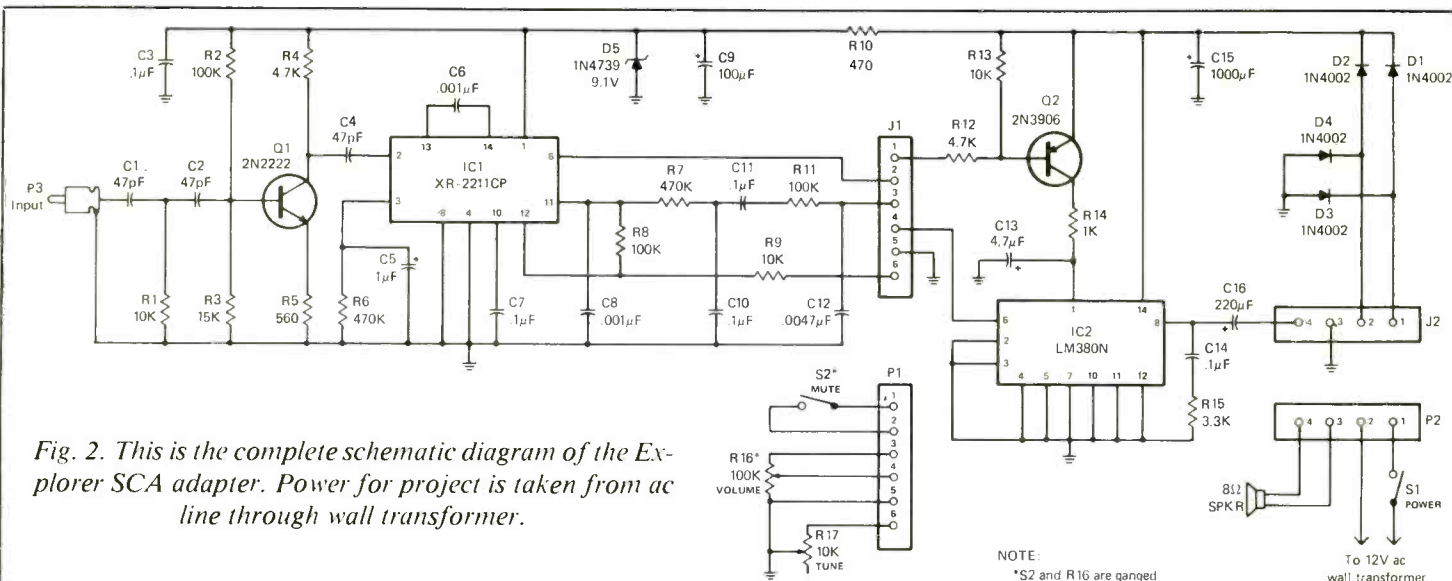

Fig. 2. This is the complete schematic diagram of the Explorer SCA adapter. Power for project is taken from ac line through wall transformer.

PARTS LIST

Semiconductors

- D1 thru D4—1N4001 rectifier diode
- D5—1N4739 (9.1-volt) zener diode
- IC1—XR-2211CP linear FSK decoder (EXAR)
- IC2—LM380N linear audio amplifier (National)
- Q1—2N2222 npn transistor
- Q2—2N3906 pnp transistor

Capacitors

- C1, C2, C4—47-pF disc
- C3, C7, C14—0.1-µF, 16-volt disc
- C5—1-µF, 16-volt radial-lead tantalum
- C6, C8—0.001-µF polyester
- C9—100-µF, 16-volt radial-lead electrolytic
- C10, C12—0.0047-µF polyester
- C11—0.1-µF polyester
- C13—4.7-µF, 25-volt radial-lead electrolytic
- C15—1000-µF, 25-volt radial-lead electrolytic

- C16—220-µF, 16-volt radial-lead electrolytic

Resistors (1/4-watt, 5% tolerance)

- R1, R9, R13—10,000 ohms
- R2, R7, R8, R11—100,000 ohms
- R3—15,000 ohms
- R4, R12—4700 ohms
- R5—560 ohms
- R6—470,000 ohms
- R10—470 ohms
- R14—1000 ohms
- R15—3300 ohms
- R16—100,000-ohm linear-taper potentiometer with pull-on/push-off switch (Radio Shack No. 271-1722)
- R17—10,000-ohm linear-taper potentiometer

Miscellaneous

- J1—6-pin socket header (Calectro No. 41-046)—optional; see text
- J2—4-pin socket header (Calectro No. 41-044)—optional; see text
- P1—6-pin plug (Calectro No. 41-126)—optional; see text

NOTE:
*S2 and R16 are ganged

- P2—4-pin plug (Calectro No. 41-124)—optional; see text

- P3—Phono plug
- S1—Spst switch (part of R16)
- S2—Miniature spst toggle switch
- SPKR—2½" 8-ohm speaker
- 12-volt ac, 250-mA plug-in wall transformer; printed circuit board; 14-pin IC socket; 4" × 4" × 2" metal box (see text); 2 control knobs; RG-174 or microphone cable; phono jack; ¼" spacers (threaded for 4-40 hardware); rubber grommet; No. 6 solder lug; heat-shrinkable tubing (optional); dry-transfer lettering kit; clear acrylic spray; 4-40 machine hardware; solid and stranded hookup wire; solder; etc.

Note: Etched and drilled No. EXP1 printed circuit board is available for \$10.00 (+ 60¢ tax for California residents) from: Mendakota Products, P.O. Box 2296; 1001 W. Imperial Hwy., La Habra, CA 90631.

frequency of the FM station tuned. Figure 1 is an idealized representation of the signals and shows only the basics. The lower sideband from -75 kHz to 0, for example, is left out because it is a mirror image of the drawing. In practice, the bandwidths of the various programs will vary with the program material. Also, the amplitudes of the L - R stereo and ARI subcarriers will vary with pro-

gram peaks. The L + R main program is the audio you would hear if you were using a mono FM receiver. It covers a 50-Hz to 15-kHz range.

The 19-kHz "pilot" carrier is the key to receiving stereo and Automobile Radio Information (ARI) programs. It does not carry any audio signals. Centered on 38 kHz, the L - R stereo signal covers the 23-to-53-kHz range. It is a double-sideband

signal. The stereo decoder inside your FM receiver doubles the 19-kHz pilot carrier to 38 kHz, which is used to detect the L - R signal. Ultimately, the L + R and L - R signals are combined (matrixed) to form left and right-channel stereo sound.

ARI signals are also in double-sideband format and are centered on 57 kHz. The decoder inside the receiver multiplies the 19-kHz pilot

carrier to 57 kHz that is then used to detect ARI announcements.

The ARI system is a lot more than a 57-kHz signal. Also broadcast is a 20-to-120-Hz tone, related to different traffic zones and selected by the listener who wants to hear traffic announcements that apply to a particular area. The decoder rejects unselected tones, preventing the listener from hearing unwanted ARI reports. (Note that you cannot receive ARI signals with the Explorer because it does not contain the circuitry for detecting double-sideband signals.)

Topping the FM spectrum is the SCA signal. It is a narrow, low-level FM signal that is centered at 67 kHz. SCA covers 59.5 to 74.5 kHz, giving only a 7.5-kHz bandwidth. This explains why background music heard in stores and other places tends to lack treble sounds.

About the Circuit

Our Explorer SCA adapter, shown schematically in Fig. 2, contains a tunable phase-locked loop (PLL) with squelch and an amplifier that drives a small speaker. Tuning range is 53 to 97 kHz, permitting reception of any signal within that range, including SCA signals.

Incoming SCA signals are tapped from the FM detector inside your receiver or tuner and are coupled into the Explorer via P3. (Proper connection of the Explorer to your receiver/tuner will not affect stereo reception nor degrade overall performance in any way.)

A high-pass filter consisting of C1, C2 and R1 strips regular FM audio from SCA signals to reduce annoying interference. Then the SCA signals are amplified by Q1, which compensates for filter losses. The output from Q1 drives the IC1 PLL circuit through C4, which serves as another high-pass filter.

The Exar XR-2211 PLL used for IC1 was originally designed for computer modems, but it gives excellent

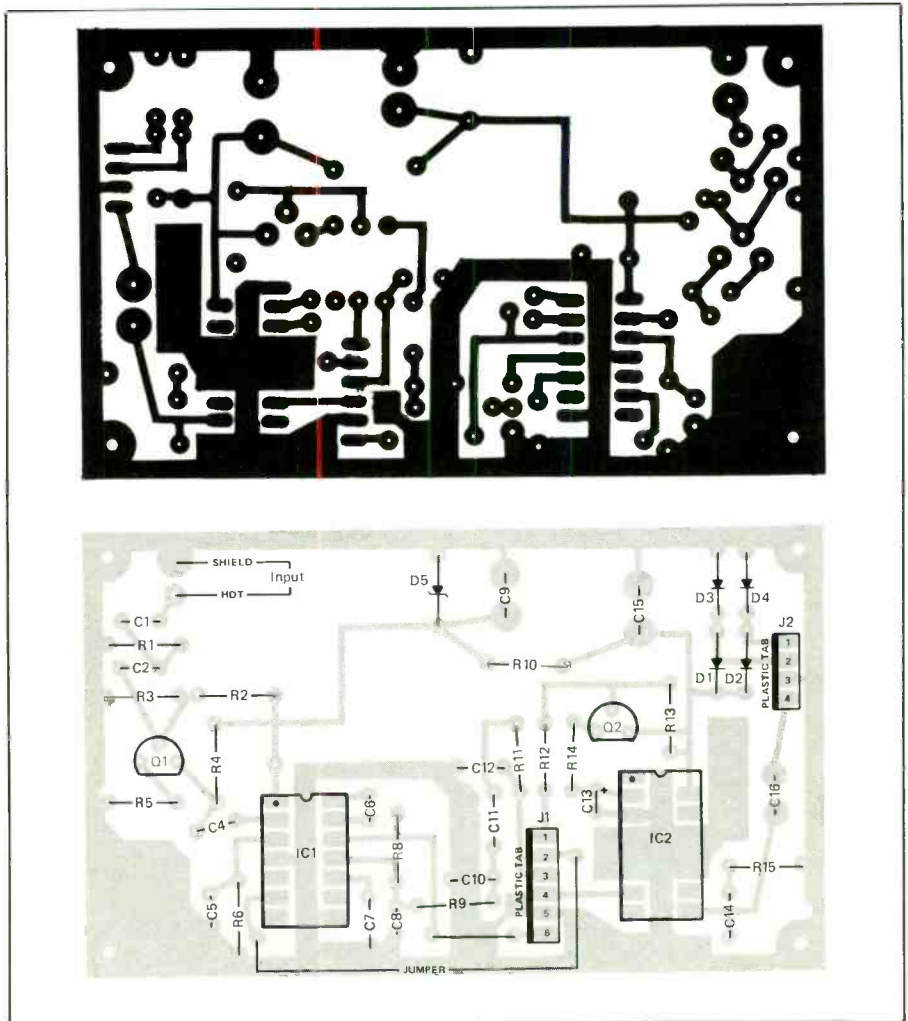

Fig. 3. Shown at the top is the actual-size etching-and-drilling guide to use when fabricating your own printed-circuit board. Install components on this board as shown in placement/orientation diagram at the bottom.

results as a tunable decoder and contains a detector for a squelch circuit. Squelch is desired in this application because it prevents you from hearing background noise when the SCA sub-carrier goes off-the-air.

Capacitor C5 and resistor R6 affect the response time of the squelch circuit. They keep noise and interference from falsely triggering the squelch. Capacitor C6, resistor R9 and TUNING control R17 set the tuning frequency of the Explorer. They vary the frequency of a voltage-controlled oscillator (vco) inside IC1. Capacitors C8 and C10 and resistors R7 and R8 make up a loop filter that

stabilizes the IC1 PLL circuit. At the same time, the filter reduces high-frequency content of the audio signal, which is intentionally boosted (pre-emphasized) by FM broadcasters.

Audio at the output of the PLL circuit is filtered by a low-pass filter comprised of C12 and R11 and is passed through J1 and P1 to VOLUME control R16.

Next comes the squelch circuit. The output of the squelch circuit is at pin 6 of IC1. When the Explorer detects that the SCA channel has gone off-the-air, the signal at pin 6 of IC1 goes low. Then through MUTE switch S2, transistor Q2 turns on and shuts

Timesaving Service for Motorists

The Automobile Road Information service (ARI for short) is a relatively new—in the U.S.—broadcast service designed to help motorists from being caught in traffic tieups. ARI is transmitted as a subchannel program on FM stations in a manner similar to that used for standard SCA broadcasts. A special decoder, available only by rental, is required to receive these broadcasts. Therefore, the Explorer SCA adapter described in the body of this article cannot be used to receive this service. We mention the ARI service here because it is similar in operating principle to standard SCA services and because of its importance to the motorist.

ARI can provide you with advance warning of accidents, road closings and other conditions that can snarl traffic. By advising you of hazardous driving conditions on roads, caused by bad weather, it can save lives during an emergency where seconds count.

ARI made its first appearance in the U.S. in 1981 (it has been in use in Europe since the early 1970s) when it quietly underwent tests to determine if interference problems existed. Passing the tests handily, the system was inaugurated in New York in April 1983 with four FM stations covering the metropolitan New York City area. By the end of 1985, a projected 20 more metropolitan U.S. areas were to have ARI service, plus a few areas in Canada. Considering the importance of this service, you can expect its popularity—and coverage—to grow in the near future.

Stereo receivers used for ARI reception look and install like other auto-sound units, except that they have ARI controls. The equipment ranges from two manually operated decoders that mount under the dashboard to complete receivers with built-in ARI decoders. At present, all ARI receivers and accessories are manufactured by Blaupunkt

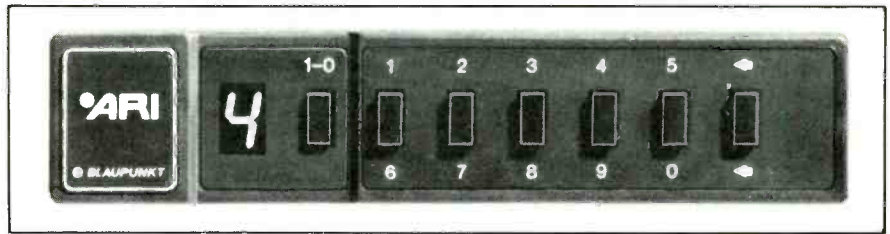

A low-cost ARI decoder accessory made by Blaupunkt.



A Blaupunkt electronically tuned AM/FM stereo cassette car radio equipped with night illumination and a built-in ARI decoder.

(distributed in the U.S. by Robert Bosch Sales), but other manufacturers are expected to introduce ARI-equipped models this year.

Manually operated decoders are low-cost accessories intended to upgrade older Blaupunkt radios for ARI reception. One Model is for analog-tuned, the other is for digital-tuned radios. Either decoder plugs into a jack on the radio, with no other modifications required. Reception of an ARI broadcast is simply a matter of turning on the decoder and tuning in the station assigned to the area. An indicator light shows the "traffic zone," verifying that the proper station is being received. If the ARI signal is lost, a warning tone sounds 30 seconds later.

There is an important distinction between analog and digital accessories. With the analog model, tuning is done by FM station at the receiver, while with

the digital model, tuning is done by traffic zone at the decoder. More effort is required with the analog model, with tuning proceeding until the proper traffic zone is displayed. With the digital model, the desired traffic zone is selected by pushing a button. The receiver then scans the FM band until the station broadcasting the corresponding code is found and then stops scanning. Thus, the digital model is easier to use. However, the ultimate choice is determined by receiver choice—not convenience.

Deluxe model car radios have the ARI decoder built in. They have only an on/off switch and zone display for the ARI function. In operation, the user simply selects the desired traffic zone by pushing a button. The radio scans for the proper station and announces reports from that zone. As with manual decoders, a warning tone sounds if the ARI signal is lost.

off IC2, silencing the speaker when an SCA program goes off the air. Capacitor C13 minimizes turn-on thump that occurs every time the squelch circuit deactivates and re-

duces hum from the speaker.

The speaker is directly driven by IC2. Power is provided by an ac adapter, with 15 volts dc going to IC2 and 9 volts dc (via zener diode D5) go-

ing to the PLL circuit.

This concludes Part 1. Next month's conclusion will cover construction details and explain how to set up and use the Explorer. **ME**

INCLUDING
800 MHz COVERAGE!

Regency hand held scanners

*bring you all the action...
wherever you are!*



HX1000



HX2000



HX750



HX650

When you need to hear the action from wherever you are, Regency delivers. Our portable scanners keep you in touch with the local news. Whether it's bank hold ups, three alarm fires, weather, business, marine radio, or aircraft calls, Regency portables bring you the on the scene action. While it's happening from where it's happening . . . in your neighborhood.

PROGRAMMABILITY WITH A CHOICE

Regency offers you two new exciting keyboard programmable hand held scanners. First there's the HX2000 20 channel, no crystal scanner. It offers UHF and VHF ranges with the important addition of 800 MHz and aircraft frequencies. And with features like search and scan, priority, liquid crystal display, and selectable search

increments, the HX2000 is a sure winner.

If you don't need the extended coverage, there's the HX1000. It let's you cover your choice of over 15,000 frequencies on 30 channels at the touch of your finger. No crystals are necessary. Six band coverage, search and scan, priority control, and a liquid crystal display with special programming messages and clock are all part of the package. And with the sealed rubber keyboard and die-cast aluminum chassis, the HX1000 is the most rugged and durable hand held on the market.

CRYSTAL-CLEAR

If you don't need all the features of programmables, but you want the convenience of portability, we've got you covered. Our two crystal controlled hand held scanners, the HX650 and HX750, offer

six channels, individual channel lock outs, LED channel indicators, step control, two antennas and an adaptor/charger. Both cover VHF high and low, UHF and "T" public service bands, with the HX750 offering the additional coverage of VHF aircraft band.

DECIDE FOR YOURSELF

Your Regency Scanner dealer would be happy to give you a free demonstration of these and other new Regency Scanners. Stop in today. Or, write Regency Electronics, 7707 Records St., Indpls., IN 46226.

Regency®

ELECTRONICS, INC.

7707 Records Street
Indianapolis, IN 46226

The Touchmaster

A touch-sensitive lamp controller that can be added to any lamp

By J. Daniel Gifford

You've probably seen—and played with—one of those fascinating lamps that are controlled by the touch of a finger on their metal surfaces. They seem to be irresistible to everyone. As an electronics hobbyist, you've probably wondered how they work or, more likely, how you could build one. Here's how.

The "Touchmaster" discussed here is a small module that can be added to any lamp that has room to hide it in. It will control an ordinary 3-way bulb or, if you like, two separate bulbs, all with the barest touch of a finger.

The first touch will light the 3-way bulb's low-wattage filament or the first of two bulbs, depending on which type of lamp you use it in. The second touch will light the high-wattage filament or second bulb, and the third will light both filaments or bulbs. Either filament or bulb (or both, in the latter case) can be as much as 100 watts. (If you can contrive adequate heatsinking, much higher wattage bulbs can be used, but it's not recommended unless you're expert at this.)

The Touchmaster is also completely safe: the ac and dc halves of the circuit are completely isolated from each other via the power supply transformer and the output optocouplers. Just follow the construction precautions noted in the article.

Circuit Description

There are four parts to the Touchmaster circuit (Fig. 1). The first is the



This simple 3-way lamp is controlled by the touch of a finger on the brass band of the wooden base that contains the Touchmaster module.

power supply for the control side. A 12-volt center-tapped transformer supplies approximately 9 volts dc to the circuit through full-wave rectifier *D2* and *D3*. Capacitors *C2* and *C3* filter and smooth the dc; since the circuit is all CMOS, no regulator is needed.

The second part of the circuit is the touch switch, formed from the four gates of *IC1*, a CD4093B Quad CMOS Schmitt Trigger NAND gate. All four gates have their inputs tied together and thus act as Schmitt Trig-

ger inverters. (If desired, a CD4584B or 74C14 Hex CMOS Schmitt Trigger Inverter IC may be used instead; be certain to tie the two unused inputs to circuit ground.)

The four inverters are used in pairs to form two Schmitt Trigger buffers. The input of the first buffer is tied to circuit ground via *R2*, a 5 to 15 megohm resistor, and to the touch control surface via *R1*, a 100k resistor. *R1* limits the input current and prevents possible static damage to *IC1*'s inputs, while *R2* determines the input impedance and, thus, the touch sensitivity of the circuit. *R2*'s value must be found experimentally once the circuit has been built and installed: generally, the larger the area of the touch surface, the smaller the value of this resistor.

The output of the first buffer is normally low until the touch-control surface is touched. Then the body of the person touching it acts as an antenna and picks up the 60-Hz power line hum that radiates from the lamp itself and from the power lines of the building around it. This hum is rectified and amplified by the first buffer and emerges as a 60-Hz square wave. This waveform is rectified into dc by *D1* and charges *C1* until it reaches the input threshold (about 6 volts) of the second buffer. When this threshold is reached, the second buffer switches high and remains high until the finger is removed from the control surface. At this time, the 680k resistor, *R3*, rapidly discharges *C1* until the second buffer's low threshold (about 4 volts) is reached, whereby its output again drops low. The charging and discharging of *C1* takes about 0.05 sec-

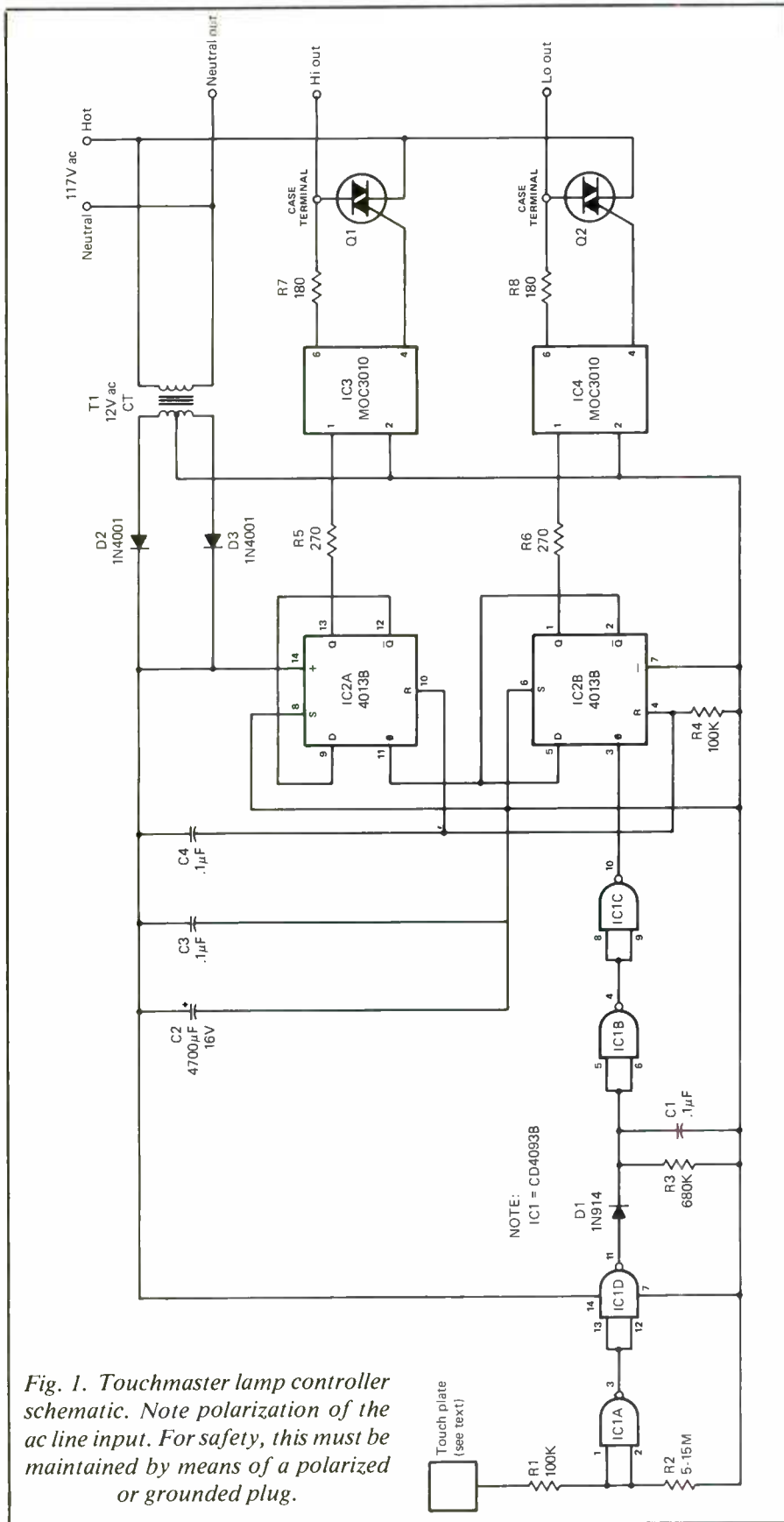

Fig. 1. Touchmaster lamp controller schematic. Note polarization of the ac line input. For safety, this must be maintained by means of a polarized or grounded plug.

PARTS LIST

Semiconductors

- D1—1N914 diode
- D2,D3—1N4001 rectifier diode
- IC1—CD4093B quad CMOS Schmitt trigger NAND gate
- IC2—CD4013B dual D-type flip-flop
- IC3,IC4—MOC3010 triac-output optocoupler (Radio Shack No. 276-134)
- Q1,Q2—200-volt, 4-ampere triac (Radio Shack No. 276-1001 or similar)

Capacitors

- C1,C3,C4—0.1-µF polypropylene/disc
- C2—4000-µF, 16-volt electrolytic

Resistors (¼-watt, 10%)

- R1,R4—100,000 ohms
- R2—5M to 15M ohms (see text)
- R3—680,000 ohms
- R5,R6—270 ohms
- R7,R8—180 ohms

Miscellaneous

- T1—12-volt center-tapped, 120-mA transformer (Radio Shack No. 274-1360 or similar); case (see text); perforated board; 14-pin IC sockets (3); 5-point barrier strip; 2 pc-board pins; MOV transient suppressor (Radio Shack No. 276-570 or similar—see text); machine hardware; hook-up wire; solder; etc.

onds each way, so even three very fast taps on the touch surface will bring the lamp to full brightness.

The third part—and core of the Touchmaster—is a two-bit binary counter formed from the CD4013B CMOS Dual D-type flip-flop. The two flip-flops are connected to divide by two or toggle: the first clock impulse will drive the Q output high (and the \bar{Q} output low); the second impulse will drive the Q output low. The touch switch is connected to the clock input of the first flip-flop (the low filament controller), and the \bar{Q} output of the first flip-flop is connected to the clock input of the second (the high filament controller). We now have a 4-state binary counter that is clocked by successive touches on the touch surface.

The counter starts at 00, or off, and the first touch will advance it to 01 (low filament on), the second to 10



Satisfying Mail Order
Customers for 17 Years

DICK SMITH ELECTRONICS

Everything for the Electronics Enthusiast!

We've got your Christmas all wrapped up - except for the ribbons & paper of course!

Meet
Compurobot!

\$39⁹⁵

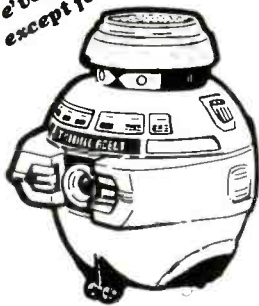

Battery operated and compact - it's only 6.5" high - it features a powerful built-in microcomputer which you can program easily using the compact 25 button keyboard on the robot's head. Programs can have up to 48 steps, and can tell it to move forward or backward at any of three speeds for 9 different time periods; to turn or curve right or left; or to make various sounds. It's not only educational, but terrific fun as well! COMPUROBOT also features flashing lights, and a one-button 'demonstration' mode to get it to show you it's tricks. It's the most exciting product we've seen in years!

Here's your chance to discover
a whole new world of electronics -

SATELLITE RECEIVER KIT

Unlock the world of television programming that you have never before experienced. The diversity of reception is phenomenal. From sports to international politics, to movies, to the major news as it happens right before your very eyes. Months of research by top engineers has produced this state-of-the-art reputable design with a minimum of adjustments necessary for correct operation. Gone are the days of sweeping iron filters and borrowing expensive spectrum analyzers. All you need to align this kit is a multimeter.

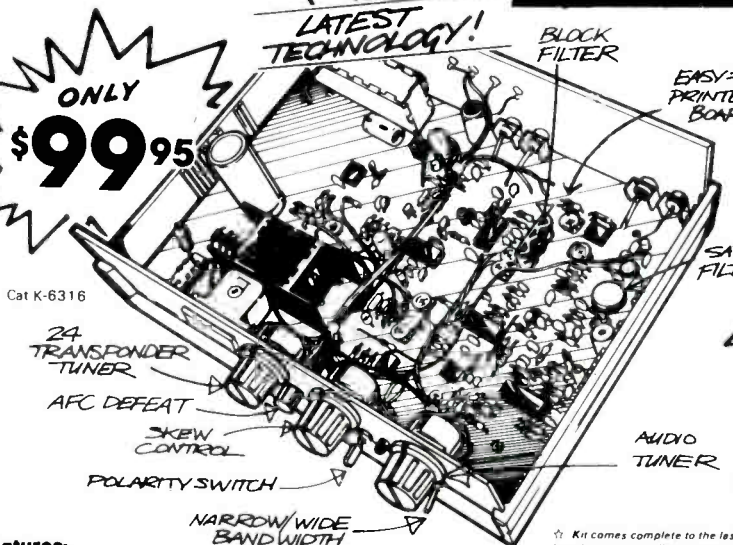

Here's what Richard Maddox author of Tab Books' "Trouble-Shooting and Repair of Satellite Systems" said when he saw the Dick Smith Australls I:

"I couldn't believe the video quality... The overall performance rivals commercial receivers costing hundreds of dollars more. The ease of assembly and the way they have used field of proven circuitry is fantastic. The quality of the board was better than expensive commercial units I'd worked with..."

* Unit requires a 17 to 18 volt AC supply Use M-2155 or similar

- Just Look At These Features:**
- ★ Easy to build Printed Circuit Board. Our specially designed boards are silk screened with a component overlay and coated with a protective solder mask. This component overlay makes soldering the board a cinch. Just look at the list of components in the construction manual. Next to the component you'll see a number, e.g. R1 = 1k 1/2w resistor. Find R1 on the board, plug the resistor in and solder. It's as simple as painting by numbers.
 - ★ Easy to Tune - Our 17 years of experience has taught us to keep our kits simple. Extra time went into the research of our satellite receiver kit to make tuning the receiver easy. No broken ferrite plugs and coils, no Stanford test lab - we did away with those. All you'll need is a multimeter - any multimeter with a 20v and 500ma scale!
 - ★ Latest Technology - Uses state of the art high quality Siemens bandpass filter for IF filtering to provide low group delay distortion without the need for additional equalization networks. Provides greater selectivity, reproducibility and stability than IC or helical filters as used in military communications.
 - ★ Incredible Performance - Compare with receivers priced hundreds of dollars higher. Specifications like:
 - IF Input Frequency: 70MHz
 - IF Input Level: -35dBm to -58m
 - IF Input Impedance: 75 Ohms
 - IF Band Width: 26MHz standard 12MHz optional
 - Carrier to Noise Threshold: Less than 7dB
 - Video De-emphasis: CCIR 525 lines
 - Video Output Level: 1 volt (peak to peak)
 - Video Output Impedance: 75 Ohms
 - Video Polarity: Internally linked
 - Energy Dispersal Removal: 30dB or better
 - Audio Subcarrier Tuning Range: 5.4MHz to 8.0MHz
 - Audio De-emphasis: 75 micro seconds
 - Audio Output Impedance: 600 Ohms
 - Audio Output Level: -dB Nominal

If all adds up to a superb receiver!

Specifications may change without notice

TELETEXT I

Build This Low-Cost TELETEXT DECODER KIT And SAVE A FORTUNE!



Cat No. K-6315



LATEST NEWS • NEWS FLASHES • BUSINESS HEADLINES • SPORTS SCORES • WEATHER • NYSE, AMES AND OTC STOCK PRICES • SPORTS QUIZ • STATISTICS • COMMODITY REPORTS

After I have decoded... You're don't being squeezed blanking ordinary are lite of info

Easy to build circuit screened overlay component layout for Comes with pre-assembled decoder very little adjustment case with screw - You'll be proud - Just wait until you - Comes complete - Teletext service scrambled signal pages, or see the Decoder can be news stories.

The largest teletext service available there on WKRC, CH 9,000 cable-TV systems w transponder 18, and on the Along with Electra, the cor 11 pages of 15-minute delay business headlines. (Cable) Electra is a 100-page ma headlines, and statistics, and press of a button (REVEAL) Another very large teletext and available on television s reports and prices, and gen Two other services are K Teletext will be the hottest

NOTE:

DON'T DELAY...ORDER TOLL FREE 1-800-

IS HERE!

GET IT ALL THE TIME

It's finally here!

After months of hard work our engineers designed this easy-to-build teletext receiver. NEVER HEARD OF TELETEXT? It's not the only one. Many people now know that text & graphics are transmitted as digital data and can be viewed on your television set. There are really hundreds of pages of information & graphics!

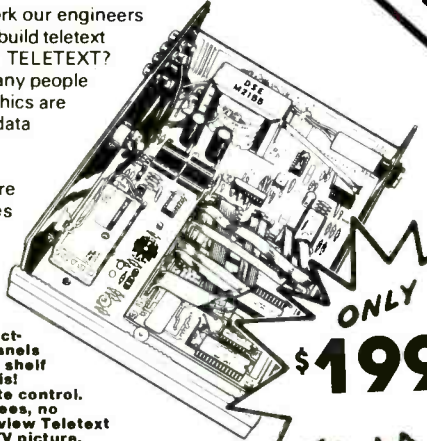

• Board with showing complete assembly. • Adjusted and pre-tested module. Requires no solder. • Housed in attractive front and rear panels. • Have it on your video shelf. • Friends ask what it is! • Comes with 21 button remote control. • All parts are FREE - no user fees, no tax. • Watch regular TV, view Teletext text over the regular TV picture. • Text over newsflash page warning you of hot

ONLY \$199⁰⁰

is a general interest one called Electra. It is produced by Taft Broadcasting of Cincinnati, Ohio, and is on channel 12. It is also linked to the VBI of Superstation WTBS-Atlanta, and is thus available to some 100 million homes. It is also available to anyone with a TVRO dish on the Galaxy 1 satellite. The SPN channel of Satcom 3, transponder 6.

Company that links WKRC with WTBS also produces a business "magazine" called Cabletext, which is syndicated NYSE, AMEX and OTC stock prices, along with a long "rolling page" of stock information and text is available simultaneously with Electra: Electra starts on page 100, Cabletext on page 201. Magazine with fast-breaking news, "soft news", business headlines and information, sports scores, features such as weather, trivia pages, and a daily sports quiz question whose answer appears at the

service is the agriculturally-oriented INFOTEXT service produced by the University of Wisconsin stations throughout that state. INFOTEXT provides general news, detailed weather, commodities and market information.

TV - Los Angeles' Metrotel and WFLD - Chicago's Keyfax.

communications issue of the late 1980's and beyond!

Requires Pre-tuned composite video and audio outputs from your VCR (Beta or VHS), Satellite receiver, component - TV tuner, some cable - TV decoder, or some newer TV's with composite tuner outputs.

DICK SMITH SATELLITE SYSTEM II

Even in California where satellite dishes are weaker we've been using this beauty at Redwood City to demonstrate the Australis I - ask our staff, they'll put it up and down outside our showroom every day. No Holes and pouring concrete necessary - sturdy ring mount for easy installation and simple assembly. This system is also ideal for sight surveys, and it gains 360 DBF/D equals 375 Focal Length 27". Manufactured in the USA of sturdy one piece formed aluminum.



The Home Satellite TV Installation & Troubleshooting Manual

This huge 311 page manual will explain everything you need to know to understand, select equipment, install, and troubleshoot Satellite TV Systems. Written in clear easily readable style, this is a must for every Satellite TV dealer and people who want to install their own System.

\$29⁹⁵
Cat B-1846

Save over \$135.00!
\$799⁰⁰

SYSTEM II INCLUDES:

- 6' Antenna Dish - complete with all Hardware and Instruction for assembly D-6326
- 85° Low Noise Amplifier D-6327
- Feed Horn D-6328
- Down Converter D-6329
- Australis I Receiver Kit K-6316
- 125' RG6 Direct Burial Cable. (No conduit Required) 100% swept tested to 1450 MHz
- Cable Includes all other necessary cables - receiver, actuator, and polarity control combination and connectors W-2075
- Satellite TV & You - 31 pages of what you can watch, explains the basics, great glossary of terms B-1844

Items Also Available Separately

- Australis Receiver Kit K-6316... \$99.00
- 6' Dish Antenna D-6326... \$399.00
- 85° Low Noise Amplifier D-6327... \$189.00
- 125' Cables w/ Connectors W-2075 \$99.00
- Feed Horn D-6328... \$49.00
- Down Converter D-6330... \$99.00
- Satellite TV & You B-1844... \$1.95

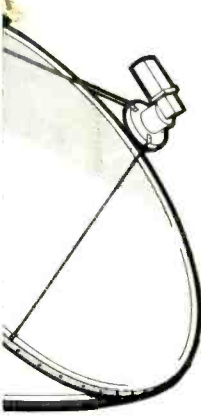

Get Professional Quality & Substantial Savings When You Build

AS REVIEWED IN THIS ISSUE



The DICK SMITH 500 MHz Digital Frequency Counter

Superb design uses the latest IC technology. The low component count makes it very reliable and easy to build. It will measure frequency to 500MHz (with optional pre-scaler) and period both with a 7 digit resolution. It rivals the performance of commercial units costing many times the price. This kit is supplied with the exclusive Dick Smith simplified circuit board wiring, step-by-step instructions and a quality pre-punched and silk screened front panel and case.

Cat K-3439

Features include:

- Professional design and finish, uses high quality instrument case.
- Extremely easy to build, virtually no PC board wiring and all of the switches are integrated to the display board and front panel.
- Huge, bright high efficiency, 7 segment display.
- 3 frequency ranges, 0-10MHz, 0-50MHz, 10-500MHz (with optional pre-scaler).
- 4 gating times, .01, .1, 1, 10 seconds.
- 4 period measuring ranges, 1, 10, 100 and 1000 input cycles to give a 0.1 uS resolution.
- High input sensitivity, 10mV to 30MHz, 100mV to 50MHz @ 1M input impedance.
- High accuracy, typically better than ±.005%.
- 110V operated.

INCLUDES THE DICK SMITH MOULDED INSTRUMENT CASE

ONLY \$89⁹⁵
(50MHz version)

CRYSTAL
3.58MHz - as used in frequency counter kit.
Cat K-6031
\$1.50
10 up \$1.40 ea



And expand the usefulness of your counter with our

PRE-SCALER KIT \$22⁵⁰

Improve the performance and increase the range of your K-3439 Frequency Counter to a more professional range of operation... 10-500MHz. This kit adapts to the existing frequency counter PC board. Cat K-3432

WHERE THE ELECTRONIC ENTHUSIAST IS # 1!

DICK SMITH ELECTRONICS

INCORPORATED IN THE STATE OF CALIFORNIA

BERKELEY: 2474 Shattuck Ave. (415) 486 0755
REDWOOD CITY: 390 Convention Way, (415) 368 8544
SAN JOSE: 4980 Stevens Creek Blvd. (408) 241 2266
STORE HOURS: San Jose & Berkeley 10 AM - 6PM EVERYDAY
Redwood City 10AM - 6PM Mon - Sat; 12-5PM Sun
MAIL ORDERS: PO Box 8021, Redwood City, CA 94063
HEAD OFFICE: 390 Convention Way, Redwood City, CA 94063

ORDER BY MAIL,
PHONE (Toll-Free),
OR VISIT OUR STORES
(Call for Hours)

See Our Giant Color Catalog For More!

Mail this coupon with just \$1 for shipping and we'll send you our huge 132 page color catalog crammed with Data, Kits & Books plus bonus coupons worth \$2 redeemable off your first order.

Name _____
Address _____
City _____ State _____ Zip _____

332-5373

Mon-Fri, 8 am - 6 pm
Pacific Time

CIRCLE 36 ON FREE INFORMATION CARD

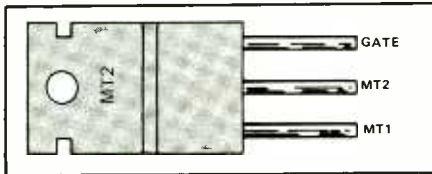

Fig. 2. Pinout of the triacs specified.

(high filament on), the third to 11 (both on), and the fourth back to 00. The components *R4* and *C4* act as a power-on reset. Therefore, when the lamp is plugged in or after a power failure, the lamp will be in the 00 or off state. The time constant of the RC pair is such that a power-line flicker or momentary power loss will not cause the lamp to reset.

The fourth and final part of the Touchmaster circuit is the power output section. Outputs of the counter drive the input sides of the two triac optocouplers, *IC3* and *IC4*. Output sides of the optocouplers drive the two power triacs, *Q1* and *Q2*, that, in turn, control power to the lamp(s). Triacs are fairly efficient devices, so very small heatsinks can be used with output loads up to the recommended 100-watt limit. About 1 to 1½ square inches of dissipation area for each device is needed; if insulators are used, a common 2 to 3 square-inch heat-sink may be used instead.

As mentioned earlier, there is no limit to the amount of power that the Touchmaster can control, as long as adequately rated triacs are used and adequate heat sinking is provided them. The devices specified in the parts list can handle up to 500 watts each with adequate heatsinking. Most lamps, however, have limited space for heatsinks and even more limited ventilation to carry away the heat, so 100 watts per bulb or filament will be the practical limit for most applications.

Construction

Construction of the Touchmaster revolves around two points: space and safety. The space available to mount the module and the shape that the cir-

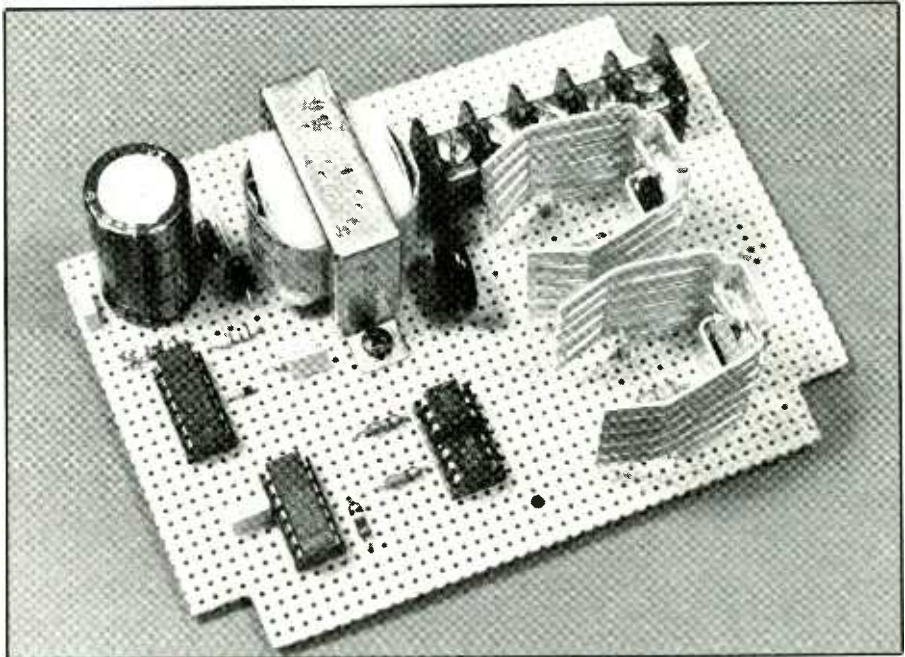

Fig. 3. The Touchmaster module. Note how the two opto devices share a common 14-pin socket. The screw-terminal barrier strip could be replaced with solder pins instead. Note also the MOV spike-suppressor (black disc near transformer) used on this prototype to prevent false switching from line transients.

cuit board must be will be dictated by the lamp that the Touchmaster will be mounted in.

The shape of the perfboard may need to be square, rectangular, long and narrow, or even circular in order to fit into the base or body of the chosen lamp. It's best to pick or design the lamp first and then build the Touchmaster to fit: don't make the (author's) mistake of building the module to fit a standard board or case and then try to fit it into a lamp. (Incidentally, the prototype in the photos was built about twice as large as necessary, both to allow possible reworking of the circuit and to more plainly show the layout.)

The second construction point, safety, is by far more important. What we have here is an ungrounded metal surface on one end and an ac power line at the other: a dangerous combination if strict precautions are not followed. The Touchmaster is inherently safe by virtue of its isolated

design, but if it is improperly constructed, a chance accident could result in the touch surface and the ac power coming in contact.

The primary protection against this happening is clearly shown in Fig. 4. A gap is left on the circuit board between the ac and dc halves, bridged only by the transformer and optocouplers. No matter how the layout is modified, this "no-man's land" must be maintained, and no wire may cross it or come near it. This wide and total separation of the circuit's halves ensures that no fluke of loose wire or faulty insulation can result in a mishap.

The second safety precaution is that the complete ac side of the module, if not the entire device, must be enclosed in a nonconducting environment. In some lamps, a separate case for the Touchmaster may be unnecessary if a hiding place enclosed in wood, plastic, or ceramic is available. If the lamp is metal or the space

is tight, a separate plastic case should be used to shield the module against metal parts.

No matter how the ac circuitry is shielded, some provision for ventilation must be provided. The transformer and triacs do not produce much heat, even with a full 100-watt load on both outputs, but the heat they do produce must have an outlet. If a case is used, a number of small holes will preserve the safety of the enclosure, yet permit the heat to escape. Most lamps, even well-constructed ones, have enough gaps between their parts to dissipate the released heat without additional holes.

One addition may be needed on the Touchmaster module. If you have a noisy ac environment (lamps flicker, TVs and radios exhibit static, etc.) some protection against transients may need to be included to prevent such transients from causing the lamp to switch states by itself. If you have such a noisy environment, or if you want to guard against such occurrences, a metal-oxide varistor (MOV) such as Radio Shack's #276-570 or -571 should be installed across the incoming ac power conductors. Such a device will eliminate most, if not all such false switching.

Installation

Once a space has been found or made for the Touchmaster and the module has been built to fit, it should be firmly mounted in the space using screws and standoffs or a strong adhesive such as epoxy. Some provision should be left to remove the circuit board for repairs. Use of a barrier strip like that on the prototype is recommended for the ac and lamp connections.

The touch surface must be of metal, of course, but it must be isolated from any other metal parts of the lamp that are grounded or in contact with the lamp sockets. This isolation can be achieved a number of ways, the simplest of which would be a metal band, patch, or decorative piece on a wooden or ceramic surface. Something along this line can be

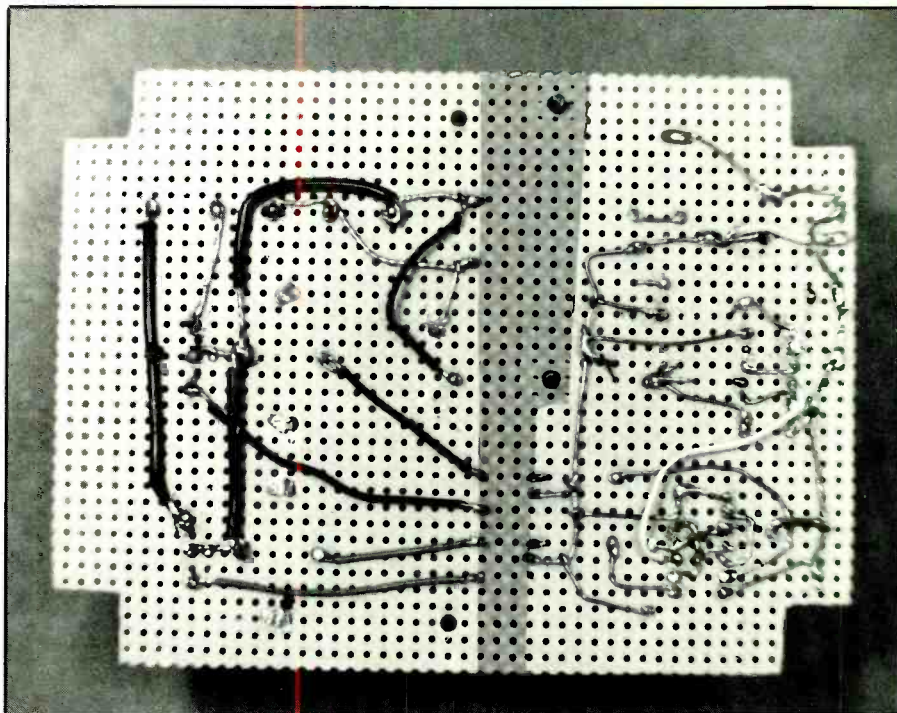

Fig. 4. Underside of the module shows the required "no-man's land" between the ac and dc halves of the circuit. Eliminating this gap means risking a shock!

added to or designed into almost any sort of lamp. A good second choice is to use an existing metal part of the lamp, such as a base, support, or separator and, if necessary, isolate it using fiber or plastic washers, sheet plastic, electrician's tape, or other means. If an all-metal lamp is used, the lamp socket and its support tube can be isolated from the rest of the lamp. Then, a touch on the lamp anywhere from its base to the shade finial will control it.

When the board is constructed, resistor R2 should not be soldered in. Instead, a pair of pins spaced about 0.6" apart should be installed in its place. When the module is installed and the touch surface is connected, temporarily install a 15-meg resistor across the pins and check the touch response of the lamp. If it switches before the finger actually reaches the surface or jitters through several states on one touch, reduce the value of R2 and try again. When a value is

found that lets the lamp switch cleanly without either jitter or hesitation, solder it in place and finish assembling the lamp.

Note that in the schematic, a distinction is made between the hot and neutral conductors of the ac cord. This polarization must be maintained; in keeping with standard wiring safety practice, the outgoing neutral connection must be made to the lamp socket shell, *not* the center contact. (A 3-way bulb will not work properly unless the neutral connection is made to the shell.) For 3-way lamps, the standard switched socket must be replaced with a switchless 3-wire socket. The center terminal is for the high filament, and the ring terminal is for the low.

A polarized plug must be used to keep the hot and neutral connections straight. Even better would be a grounded plug, with the ground lead connected to all the metal parts not used for touch control. **ME**

A High-Frequency Dual-Pulse Generator

Easy-to-build project generates high-speed square-wave pulses at frequencies up to 75 MHz

By Desi Stelling

To be able to do meaningful work in modern digital electronic circuits, you often need a source of square-wave pulses with a minimum range of from 1 MHz to 20 MHz. Most current high-speed pulse generators are quite expensive, especially if you need an instrument capable of operating beyond 20 MHz. A very practical alternative is to build such a pulse generator, using readily available parts.

In this article, we will discuss construction of a very reliable High-Frequency Dual-Pulse Generator whose output is capable of exceeding even 75 MHz. Component count for the project is minimal since the Generator is built around an integrated-circuit device that requires very few external parts.

At the heart of the Generator is a voltage-controlled oscillator (vco) chip that can be implemented for FM modulation and/or gate input for precision gating of a pulse train. The IC is an LS124 high-speed, low-power or simply an S124 high-speed but not low-power device containing two independent vcOs in a 16-pin package. You can use either the 74 or 54 series of this device in this application. The output frequency of each vco is determined by either a capacitor or a crystal and two voltage-controlled inputs. Since it is rarely necessary for the output frequency of such an oscillator to be right on the head,

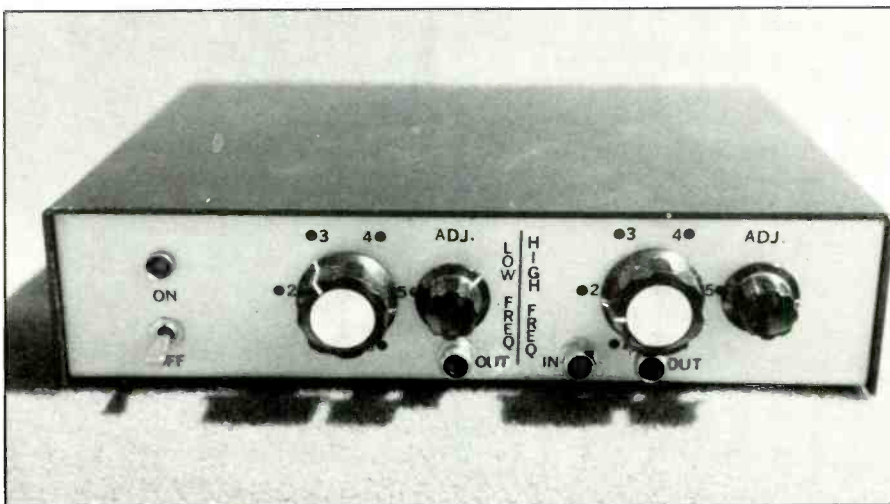

in our Generator, a series of capacitors are switched into the circuit as needed for selecting a particular frequency range.

Even if you were to buy all the components needed for this project at single-unit prices, they should not cost more than about \$50.

About the Circuit

Shown in Fig. 1 is the pinout diagram of the dual vco integrated circuit used in this project. Pin designations and internal details of this IC are identical for the LS and S versions of the 54 and 74 series of the 126 dual-vco integrated circuit.

Note that there are two sets of V_{CC} and GND pins provided for the dc supply voltage for the enable, gate and output sections, the other for the oscillator and associated frequency-

control circuits for isolation purposes. The latter are indicated by the circled sine-wave symbols at pins 15 and 8, respectively. The enable input starts and stops output pulses when it is low and high, respectively. Duty cycle of the output signal is fixed at approximately 50%.

Figure 2 illustrates the schematic diagram of the two voltage-controlled oscillators that make up the High-Frequency Dual-Pulse Generator. Observe that the oscillator system is divided into two high-frequency ($IC2A$) and low-frequency ($IC2B$) oscillators. The frequency-determining capacitors that control the range of the high-frequency oscillator are switched in via rotary switch $S2$, while $S3$ performs the same task for the low-frequency oscillator.

The frequency-determining capacitors connect to $IC2$ via the vco's

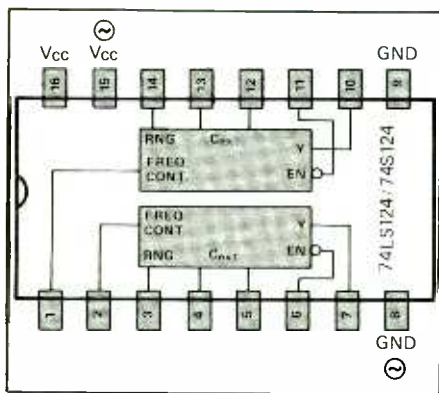

Fig. 1. Shown here are internal details of 54LS124, 54S124, 74LS124 and 74S124 series voltage-controlled oscillators (vcos).

C_{ext} inputs. The output frequency of each vco can be approximated in a single formula as follows:

$$F_o = \frac{1 \times 10^{-4}}{C_{ext}} \quad (\text{for LS124})$$

$$F_o = \frac{5 \times 10^{-4}}{C_{ext}} \quad (\text{for S124})$$

where F is frequency in Hz and C_{ext} is in farads.

Each oscillator has its own separate output— $J1$ is the LO FREQ OUTPUT, while $J2$ is the HI FREQ OUTPUT.

Additionally, the high-frequency oscillator has a GATE input at $J3$.

High and low oscillator frequencies are available simultaneously, since the circuits are completely independent of each other. A rough frequency range is selected via $C1$ through $C6$ for the low-frequency oscillator and $C7$ through $C12$ for the high-frequency oscillator. Once a range is selected, you can zero in on a more exact frequency with LF ADJUST control $R1$ or HF ADJUST control $R2$.

A very stable 5-volt dc power supply is required for the Generator to assure accurate operation of the os-

Fig. 2. Independent low- (left) and high-frequency (right) oscillators are obtained from a single vco IC.

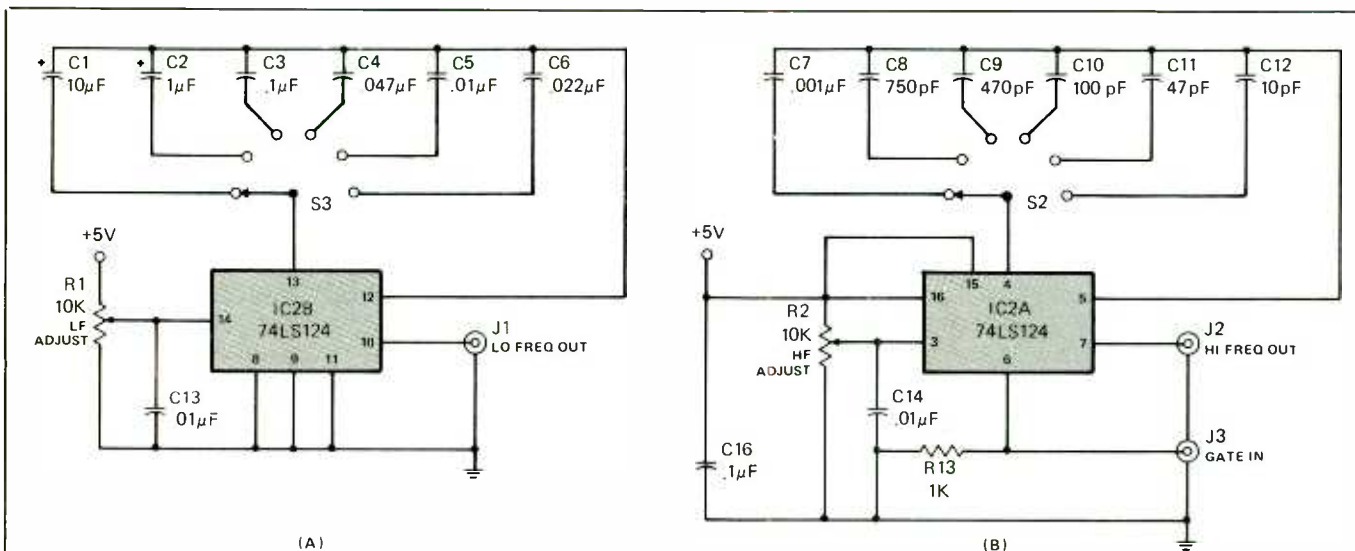

PARTS LIST

Semiconductors

D1 thru D4—1N4001 rectifier diode
 IC1—LM317T +5-volt regulator
 IC2—54LS124, 54S124, 74LS124 or 74S124 (see text)
 LED1—Panel-mount type light-emitting diode

Capacitors

C1—10 μ F, 20-volt nonpolarized
 C2—1- μ F, 20-volt nonpolarized
 C3, C16, C17—0.1- μ F disc
 C4—0.47- μ F disc
 C5, C13, C14—0.1- μ F disc
 C6—0.0022- μ F disc
 C7—0.001- μ F disc
 C8—750-pF disc
 C9—470-pF disc

C10—100-pF disc
 C11—47-pF disc
 C12—10-pF disc
 C15—150- μ F, 20-volt electrolytic

Resistors (1/2-watt, 10% tolerance)

R3—1000 ohms
 R4—240 ohms
 R5—760 ohms
 R6—300 ohms
 R1, R2—10,000-ohm potentiometer

Miscellaneous

F1—0.5-ampere slow-blow fuse
 J1, J2, J3—Phono jack
 S1—Spst slide or toggle switch
 S2, S3—6-position, nonshorting rotary switch

T1—12.6-volt, 300-mA transformer
 Printed-circuit board; suitable metal enclosure; socket for IC1 (optional); ac line cord; fuseholder; control knobs (4); line-cord strain relief or rubber grommet; shielded cable; dry-transfer lettering kit; clear acrylic spray; heat-shrinkable tubing or electrical tape; ac line cord with plug; hookup wire; machine hardware; spacers (4); solder; etc.

Note: The following are available from DDS Systems, P.O. Box 5715, Glendale, AZ 85023: pc board for \$4.95; complete kit of parts, excluding S2 and S3, for \$29.95 plus \$3.50 S&H.

cillators. An ac line-powered supply is shown in Fig. 3. Incoming 117 volts ac is stepped down to 12.6 volts ac by *T1*, rectified by *D1* through *D4* and smoothed by *C15*. The resulting dc is then regulated by *IC1* and then fed out to the oscillator circuits.

Construction

Due to the high frequencies involved in this project, the only way of obtaining reliable operation is by wiring it on a printed-circuit board. You can fabricate your own pc board, using the actual-size etching-and-drilling guide given in Fig. 4 or purchase one ready to wire from the source given in the Parts List. You will note from the components-placement guide, also in Fig. 4, that all components, except frequency-determining capacitors *C1* through *C12*, the switches and controls, POWER LED, fuse holder and power transformer mount directly on the pc board.

Temporarily mount *S2* and *S3* in their respective holes on the front panel and place a control knob on the shaft of each. Rotate the knobs and mark the positions of the stops on the panel. Remove the knobs and controls. Then use a dry-transfer lettering kit to label the switch positions and jack, control, and power switch/LED legends. Spray two or three

light coats of clear acrylic, allowing each coat to dry before spraying on the next, over the entire surface of the front panel.

When the acrylic spray has completely dried, mount the controls, jacks, LED and switches in their respective holes. Strip $\frac{1}{4}$ " of insulation from all four leads of the power transformer. Mount the transformer on the floor of the box with machine hardware. Plug the secondary wires of the transformer into the holes labeled 12.6V AC on the circuit board and solder them to the copper pads. Mount the assembly to the floor of the box with $\frac{1}{4}$ " or $\frac{1}{2}$ " spacers and

Wire the board exactly as shown in the components-placement diagram. Make sure you observe proper component orientations and polarities before soldering them into place. A socket for *IC2* is optional.

Remove $\frac{1}{4}$ " of insulation from both ends of 13 6" lengths of hookup wire. Plug in and solder one end of these wires at the holes labeled *C_x* on both sides of *IC2* (accounts for four wires), *R1* and *R2* (six wires), LED1 (two wires) and GATE (one wire). Then remove $\frac{3}{4}$ " of outer insulation from both ends of two 5" lengths of shielded cable. Separate the shields all the way back to the remaining insulation, twist together the fine wires and lightly tin with solder. Strip $\frac{1}{4}$ " of insulation from the inner conductors from all four ends. Then install and solder one end of these cables in the holes labeled LF OUT and HF OUT. Make sure the shields plug into the indicated holes.

Drill the mounting holes for the various items that make up the project.

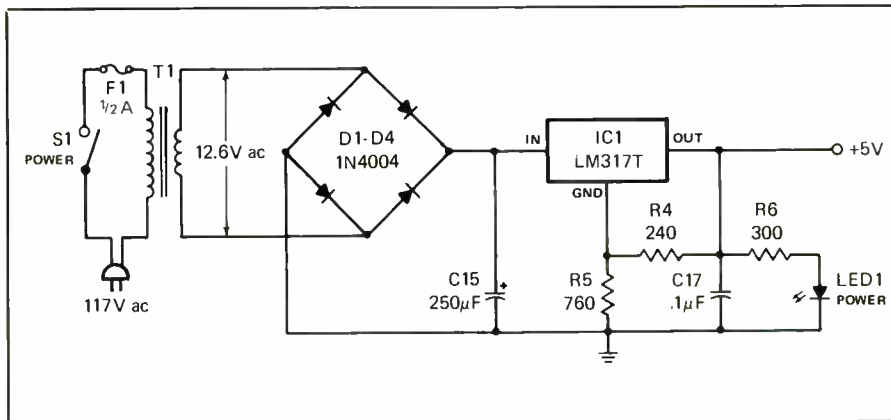
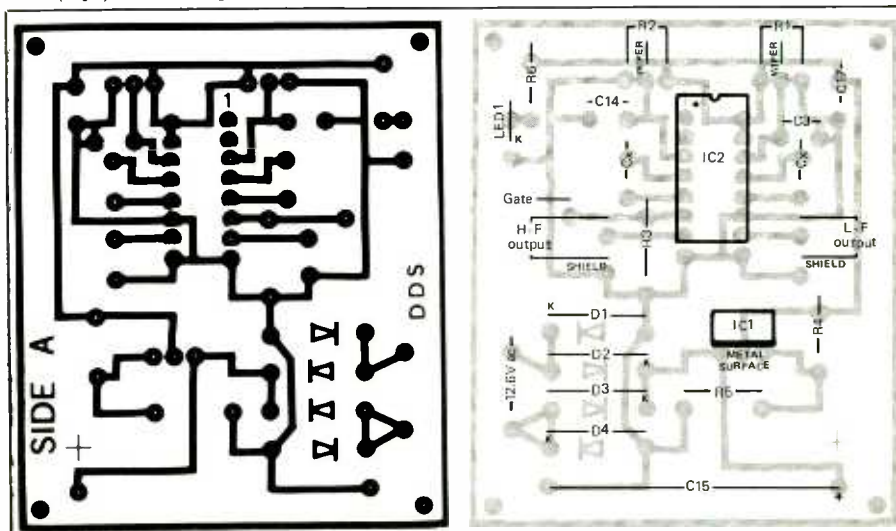

Fig. 3. Generator's ac-line-driven power supply.

You need nine holes in the front panel for the jacks, controls, LED and switches; six holes in the floor for the circuit-board assembly and power transformer; and two holes in the rear panel for the fuse holder and ac line cord.

Temporarily mount *S2* and *S3* in their respective holes on the front panel and place a control knob on the shaft of each. Rotate the knobs and mark the positions of the stops on the panel. Remove the knobs and controls. Then use a dry-transfer lettering kit to label the switch positions and jack, control, and power switch/LED legends. Spray two or three

Fig. 4. Actual-size etching-and-drilling guide for fabricating your own pc board (left) and components placement diagram. Socket for *IC1* is optional.



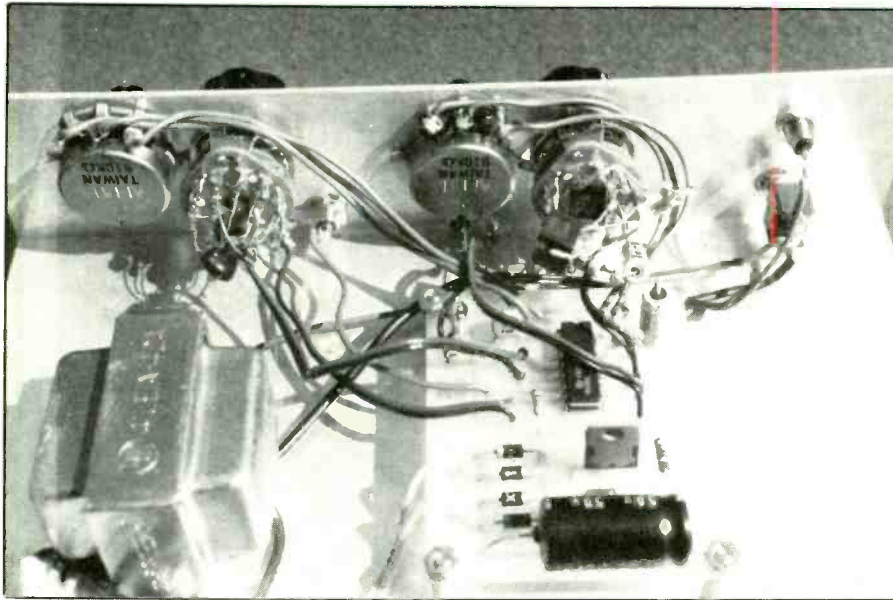

Controls, LED and switches mount on front panel as shown. Range capacitors mount directly on S2 and S3—not on pc board—as shown.

machine hardware. Mount the fuse holder on the rear panel.

Place a rubber grommet in the line cord hole (or use a plastic strain relief). Strip $\frac{1}{4}$ " of insulation from both conductors of the line cord. Tightly twist together the fine wires in each conductor and lightly tin with solder. Pass the line cord through its rubber-grommet-lined hole and tie a knot in it about 6" from the prepared end (or secure it in place with the strain relief so that there is 6" of cord inside the box).

Note from the photo that all frequency-determining capacitors are mounted directly to the lugs of S2 and S3, with the free leads of the two sets tied together into separate bundles.

Locate the cable coming from board holes HF OUT and connect and solder the inner conductor to the center lug and shield to the ground lug of J2. Do the same with the cable coming from the LF OUT holes to J1. Connect and solder the GATE wire from the circuit board to J3's center lug.

With the circuit board oriented as shown in the components-placement diagram in Fig. 4, the wires from the holes labeled C_x to the left of IC2 go to the S2/C7 through C12 assembly, while those to the right of IC2 go to the S3/C1 through C6 assembly.

Locate the wires connected to the LED1 holes on the circuit board and connect the K wire to the cathode lead of the LED and the other lead to the anode lead. Next, connect and solder the six wires at the top of the board to the lugs of R1 and R2. Make sure the wires identified as WIPER go to the center lugs of the respective controls.

Slip a 1" length of heat-shrinkable tubing over one of the primary leads of the transformer. Separate the conductors of the line cord for a distance of about 6". Then connect and solder one conductor to the transformer lead that has the tubing on it. When the connection cools, push the tubing over it, making sure no portion of the connection is visible and shrink it into place. (If you wish, you can substitute plastic electrical tape for the tubing.) Connect and solder the other transformer primary to one lug of the fuse holder.

Use a heavy-duty stranded hookup wire to connect the remaining lug on S1 to the remaining lug on the fuse holder. Install a $\frac{1}{2}$ -ampere slow-blow fuse in the fuse holder. Then assemble the box. Install the knobs on the range switches and frequency ADJUST controls. The project is now ready to be put into service.

Fig. 5. The risetime of the oscillator is less than 20 ns (left), demonstrating the speed of the device. Synchronously gated pulses (right) may be desirable for producing a pulse train of any type.

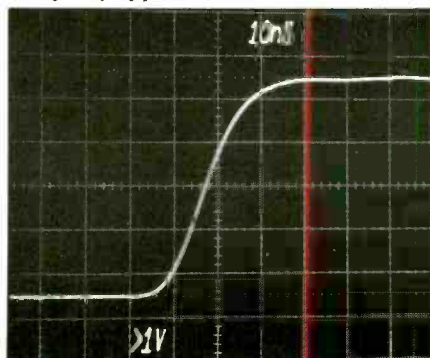
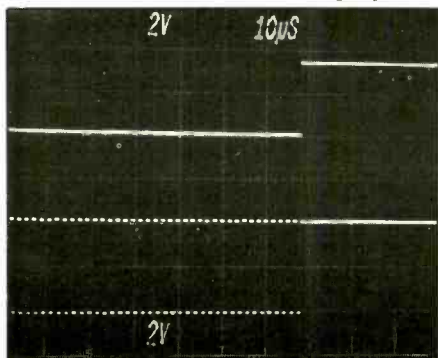

In Closing

From the foregoing, it should be obvious that the High-Frequency Dual-Pulse Generator described here may be relatively simple from a parts-count point of view, but is big on performance. You will find that this instrument will fill virtually any need for a source of square-wave pulses, whether low or high frequency. **ME**

Experimenting with CW Laser Diodes

Part 1: How-To Basics and a Laser Pulse Transmitter

By Forrest M. Mims III

Thanks in large part to the success of compact disk audio technology, laser diodes capable of continuous wave (CW) operation at room temperature are now available at very reasonable prices. When I first built circuits incorporating such lasers in 1975, individual lasers cost several hundred dollars or more. Now several different low-power CW laser diodes are available for as little as \$26 each in single quantities from electronics distributors that represent Sharp Electronics (10 Sharp Plaza, Paramus, NJ 07652).

These new low-power laser diodes are designed to emit up to about 3 milliwatts at a wavelength of 780 nanometers near the extreme end of the visible spectrum. Newly developed, highly visible red "super" LEDs made from AlGaAs can emit twice this power level when driven at similar current levels (50 to 60 milliamperes). But the laser diode is the preferred choice when a very narrow optical beam is required for applications like free-space communications and intrusion alarms.

Emission from each end facet of a laser diode chip generally forms a fan-shaped beam having a divergence of about 15×30 degrees. Virtually all the radiation emitted from the front facet of a laser diode can be collected and collimated into a pencil-thin beam by means of a simple lens. Since LED chips are much larger than laser diode chips, it's not possible to focus their emission into as tight a beam. Moreover, because LEDs emit radiation in all directions, only a small fraction can be collected by a lens.

An important advantage of laser diodes over LEDs in some applications is the highly coherent nature of their emission. The new generation of CW laser diodes emit beams having a coherence that rivals or even exceeds that of the popular helium-neon laser.

Though CW laser diodes offer several

important advantages over noncoherent LEDs, they are easily damaged if handled or operated improperly. For instance, most LEDs can withstand momentary surges of drive current. The drive current applied to a CW laser diode must never exceed the rated level or the device will be permanently damaged. Though the chip may continue to function as a low-power LED, the portions of the facets that provide the end mirrors for the laser will be destroyed by the high optical power (several hundred thousand watts per square centimeter) produced by a current surge.

Most CW laser diodes can be damaged or destroyed by electrostatic charges or

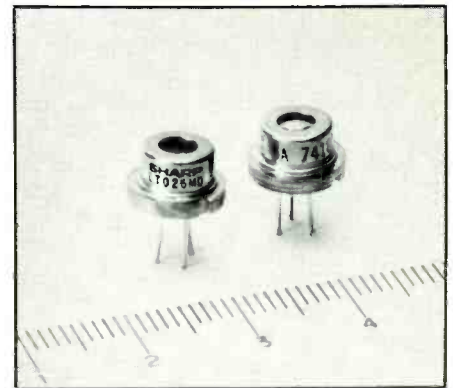
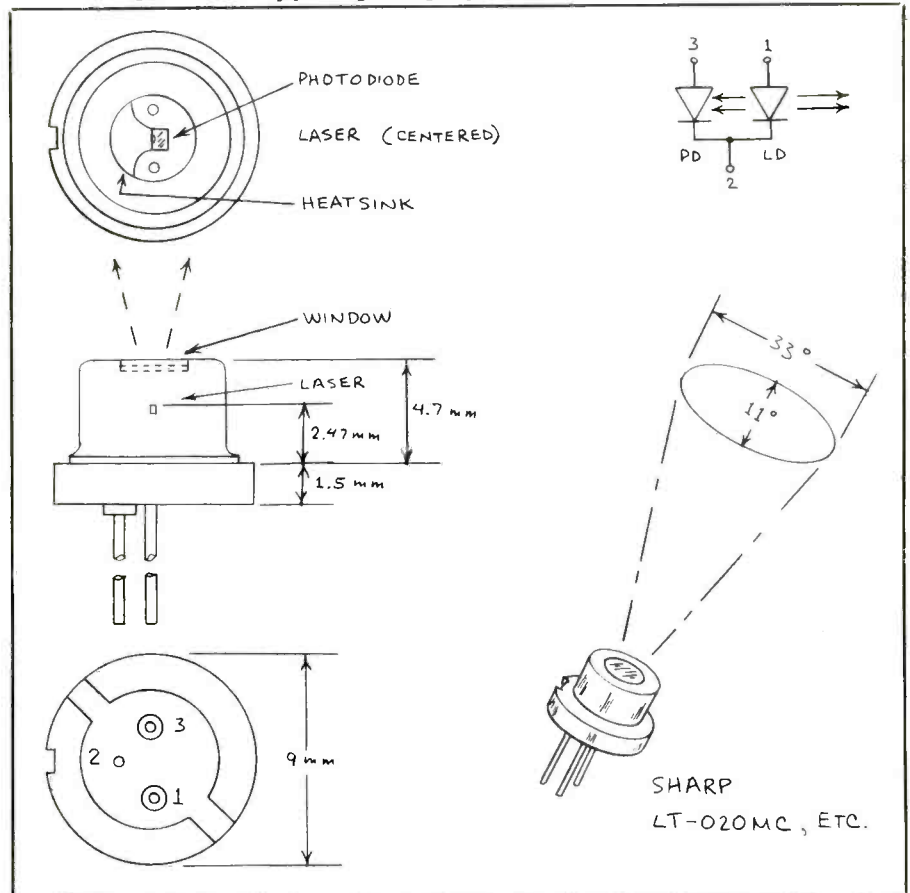

Fig. 1. Photo shows Sharp's LT026MD visible-spectrum (780-nanometer) CW laser diodes. Note windows at top.

Fig. 2. Details of package design of Sharp's LT-020MC laser diode.



even the voltage spike that often occurs when a switch is flipped on or off. For these reasons, I have devoted a substantial portion of what follows to safe operating procedures for CW laser diodes. For best results, it is essential that you read and heed these procedures. Having zapped my fair share of CW laser diodes over the years, I can assure you it pays to be very careful when installing and working with these devices.

Low-Cost Laser Diodes

While preparing this column, I contacted most manufacturers of laser diodes and managed to receive price information from several. Of these, the CW lasers made by Sharp Electronics Corp. are by far the least expensive and the easiest to buy. Single-mode CW laser diodes having lower thresholds and operating currents are available from Ortel, M/A-COM Laser Diode, Mitsubishi and others, but they cost four to fifty times more than the \$26 Sharp lasers used in the circuits in this and a subsequent column.

Figure 1 shows a pair of Sharp LT026MD CW laser diodes housed in packages similar to those used by other makers of CW laser diodes. The LT026MD and other members of the Sharp laser diode family include a photodiode to monitor the power emitted from the rear facet of the laser chip. The current from this photodiode is proportional to the light emitted from both facets of the laser. Therefore, the photodiode provides an effective sensor for a closed-loop regulator circuit designed to apply sufficient current to the laser so that its output remains stable as ambient temperature changes.

Figure 2 shows details of Sharp's LT020MC single-mode laser diode package, along with its beam dimensions. (The package dimensions shown in the figure apply to many CW laser diodes.)

Note the internal connection of the laser diode and photodiode. This common-

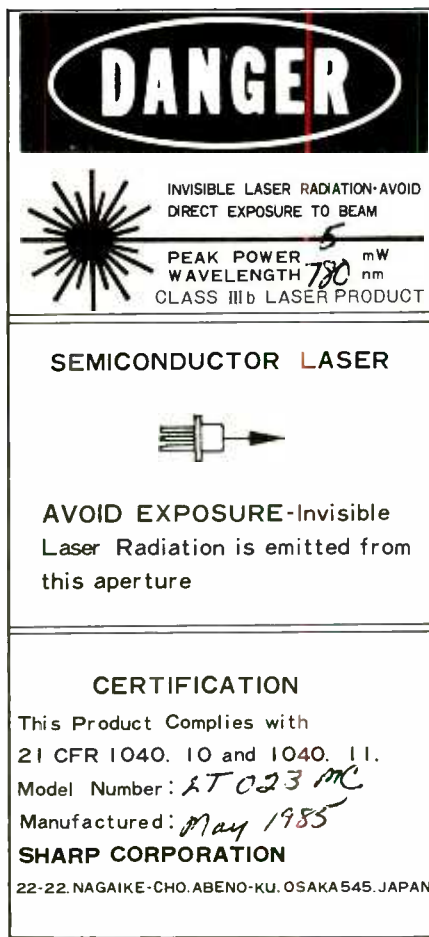

Fig. 3. An example of a Class IIIb laser safety warning label.

cathode configuration is by no means universal. In some Mitsubishi lasers, for example, the anode of the laser is internally connected to the cathode of the photodiode. In other devices the laser diode and photodiode are not internally connected, and all four points are available externally.

Handling Precautions

There are many different kinds of laser diodes, and most being among the most delicate of semiconductor devices. Because of the very narrow width of their

stripe-geometry junction, CW laser diodes are as susceptible to damage from destructive electrostatic breakdown as MOS semiconductors and integrated circuits. For this reason, CW laser diodes must be shipped and stored in packaging materials that do not generate or store electrostatic charges. Similarly, you must remove any charge on your body before handling a CW laser diode. This can be done by touching a grounded object immediately before handling the laser. A ground strap affixed to a wrist is even better. When soldering, it is important to make sure the iron is either battery-powered or free of voltage leaks.

The laser diode's glass window should be considered a precision optical component. Dust and scratches on it will reduce the output power and disturb the beam pattern. Sharp recommends that the windows of its laser diodes be cleaned with cotton soaked in ethanol.

The design of the laser diode package plays a vital role in removing heat from the delicate laser chip. Therefore, never cut, drill or machine the package. Since the laser chip is affixed to its heatsink with a low-melting point solder, never attempt to solder a heatsink or wire to it.

Operating Precautions

Laser diodes can be instantaneously and irreversibly damaged or destroyed by current surges that exceed the maximum allowable. Consider a CW laser diode that emits 5 milliwatts. For a typical stripe-geometry device, the light is emitted from regions of the front and rear facets measuring about 0.6×3 micrometers each. This corresponds to a power density of about 280,000 watts per square centimeter! From studies conducted at RCA and elsewhere, the facets of CW laser diodes can be irreversibly damaged when power falls in the range of 200,000 to 400,000 watts per square centimeter. Therefore, a current only slightly greater than the

rated maximum can cause a CW laser to emit enough power to damage its reflecting facets.

Because of their exceptional vulnerability to damage, it is essential that you exercise great care when using CW laser diodes in circuits. Here are some precautions which, if followed, can save your lasers from the unfortunate fate several of mine have met:

(1.) Never connect the probes of a multimeter across the leads of a laser diode.

(2.) Always make sure the leads of a laser diode are installed correctly.

(3.) Never connect a CW laser diode to a battery through a series resistor. For CW operation, always drive the laser with a closed-loop current regulator that derives its feedback signal from the photodiode inside the laser package.

(4.) Never connect a laser diode directly to a line-powered power supply. Voltage spikes generated when the supply is turned on can destroy the laser.

(5.) When testing or troubleshooting a drive circuit, use great care to avoid shorting the leads of the laser diode to other circuit leads.

(6.) If your workbench is metal, it should be at the same potential as the ground line of the laser's power supply.

(7.) Use care when operating laser diodes near equipment that generates high-frequency surges. The leads of the laser may couple such surges into the chip and destroy it.

(8.) The threshold current of a laser diode increases with temperature. For this reason alone, it is important to drive CW laser diodes with a photodiode-coupled current regulator (see 5 above).

(9.) Follow the manufacturer's recommendations about proper heat sinking. Sharp recommends a copper or aluminum heatsink measuring about $20 \times 30 \times 2$ millimeters. Some lasers include heat sink attachment holes. Use a spring-loaded or push-on heat sink for those that do not. A solderless RG59/U cable connec-

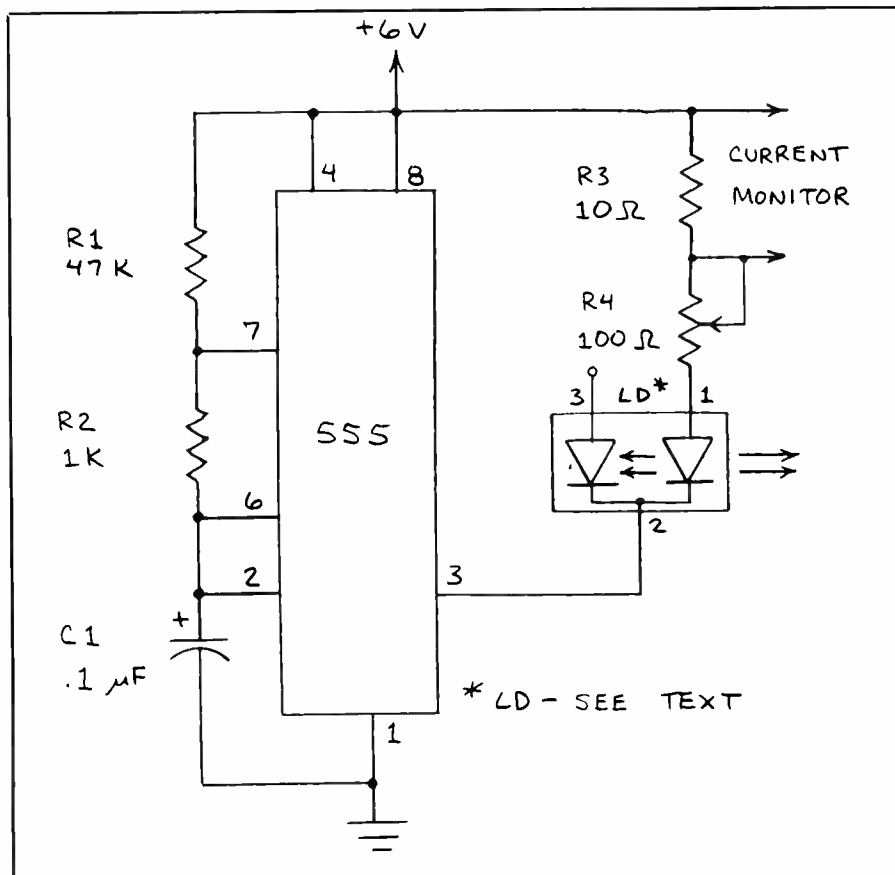

Fig. 4. Schematic diagram of a miniature laser diode pulse transmitter.

tor (Radio Shack No. 278-215) snaps snugly over laser diodes made by Sharp.

Laser Safety

It's important to be aware of safety precautions that apply to the use of laser diodes. The Bureau of Radiological Health, now the National Center for Devices and Radiological Health (NCDRH), has formulated extensive regulations governing the safe operation of all types of lasers. Under these regulations, Class I lasers are exempt from regulation. Most laser diodes are Class 3B devices and are required to bear a warning label that reads in part: "Danger—Invisible laser radiation.

Avoid Direct exposure to beam." Since laser diodes are much too small for such a verbose warning label, manufacturers usually include a replica of the label in the laser's specification sheet or attach a label to the box in which the laser is shipped. Figure 3 shows the label supplied with Sharp laser diodes.

There is an ongoing controversy about the government's efforts to regulate laser diodes. Since the beam from such lasers is much more divergent than that from most other kinds of lasers, the safety hazard may be more imagined than real. Indeed, some light-emitting diodes can produce a greater power density at the eye than low-power (3-to-5-milliwatt) CW la-

ser diodes when both devices are viewed at the same distance (but the laser radiation will be focused to a smaller spot on the retina).

A recent research project funded by Bell Labs and the U.S. Army explored the effect on the eyes of monkeys exposed to CW and pulsed beams from various kinds of laser diodes. One conclusion of this project is worth including here: "It required from 6 to 8.4 mW of GaAs radiation entering the eye for periods ranging from 400 to 3000 seconds to produce a detectable lesion [on the retina]. Since the spot size on the retina was > 50 micrometers in diameter, it is difficult if not impossible to imagine how the human eye could remain focused on such a source for an appreciable time, even if 8 mW were entering the pupil." (William T. Ham, *et al*, *Applied Optics*, July 1, 1984, pp. 2181 through 2186.)

Though this study seems to indicate that low-power CW laser diodes are relatively safe, the authors recommend that government safety standards be followed until more data becomes available. Therefore, you should follow these safety precautions when working with CW laser diodes:

- (1.) Avoid staring at the raw beam from a laser diode closer than arms length.
- (2.) Never stare at the beam of a laser diode whose emission has been focused into a narrow beam by a lens.
- (3.) Never point the beam from a collimated laser diode toward the eyes of on-lookers or toward specular surfaces that might reflect the beam toward you or on-lookers.
- (4.) Observe the beam from laser diodes with an infrared image converter or infrared phosphor screen. If the wavelength of the beam falls in the visible spectrum, you can safely observe the beam by directing it toward a nearby white card (with matte, not glossy, surface) in a dark room.

Should you wish to use laser diodes in a

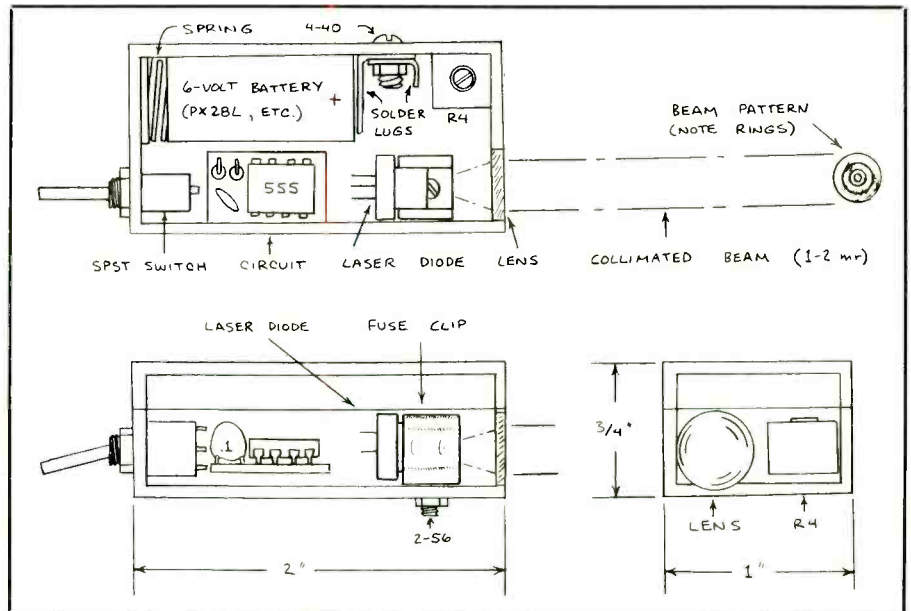

Fig. 5. Assembly details for the Fig. 4 laser-diode pulse transmitter.

product to be sold, you may be considered a "laser manufacturer" by the NCDRH and the governments of some 11 states. For additional information, obtain a copy of "Performance Standards for Laser Products" (21CFR 1040) from the NCDRH (8757 Georgia Avenue, Silver Spring, MD 20910) and "ANSI Standard for the Safe Use of Lasers" from the American National Standards Institute (1430 Broadway, New York, NY 10018).

Laser Diode Transmitter

Figure 4 shows a simple circuit designed to deliver current pulses to low-power CW laser diodes such as Sharp's LT020MC or LT022MC. In operation, the 555 timer is connected as a pulse generator whose oscillation frequency is given by $1.44 / [(R1 + 2R2) \times C1]$. With the values in Fig. 4, frequency is about 320 Hz and pulse duration is 60 microseconds.

Resistor R4 permits current applied to the laser to be adjusted to a safe operating

level, a procedure which requires an oscilloscope. The scope's probe is connected across R3, a 10-ohm resistor that serves as a current monitor. From Ohm's law, the current in amperes passing through R3 is the voltage across R3 divided by 10. Since R3 is in series with the laser, the current flowing through R3 also flows through the laser.

Incidentally, reducing R1 will increase pulse repetition rate of the circuit. This may also affect the current delivered to the laser diode. Therefore, always monitor R3 when the circuit's pulse repetition rate is altered.

Important: Before applying power to the circuit for the first time, it is absolutely essential that R4 be set for maximum resistance. If you have any doubts, practice performing the adjustment that follows with a red LED installed in place of the laser diode. Before removing the LED, adjust R4 for highest resistance and switch off power to the circuit.

Adjust R4 to give a current midway be-

tween the laser diode's threshold (usually about 50 milliamperes) and the maximum allowable operating current (usually about 60 milliamperes). Though this means the laser will not emit the full 3 milliwatts of which it is capable, the likelihood of irreversible damage will be greatly lessened.

Important: If you did not receive a data sheet giving threshold and operating current levels for the laser(s) you purchased, check with your supplier. Each individual laser has unique operating specifications. Never attempt to guess the specifications of a laser or operate a laser without knowing its specifications! Some companies (Mitsubishi, M/A-COM Laser Diode Labs, etc.) provide threshold and operating current values on the packages or boxes in which lasers are shipped. In the case of Sharp laser diodes, these numbers are given on a batch printout that lists the specifications of 50 serially numbered lasers. The serial numbers are marked on small adhesive labels affixed to each laser.

The circuit in Fig. 4 does not take advantage of the laser's monitoring photodiode. Therefore, it is important to adjust R_4 when the transmitter is at the temperature at which you plan to operate it. Should the temperature later rise, the threshold of the laser will rise, and the laser's output power will then be reduced. Should the temperature later fall, the threshold of the laser will also fall. The output of the laser will then increase, perhaps to a point at which the laser may be irreversibly damaged.

Figure 5 shows how the laser transmitter, complete with battery and lens, can be installed in a small plastic box. I used a box measuring $\frac{3}{4}$ " \times 1" \times 2" which was purchased from an arts and crafts store. Note how the laser diode is installed in a fuse clip mounted inside the box. The clip secures the laser in place and doubles as a heat sink.

The collimating lens should be a convex lens with a small f /number. I used a 10-mm diameter lens having a focal length of 12 mm ($f/1.2$). The lens is installed in an aperture carefully reamed in-

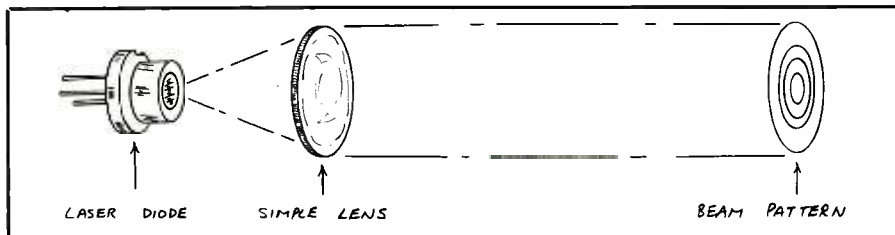

Fig. 6. Using a lens to collimate the beam emitted from a laser diode.

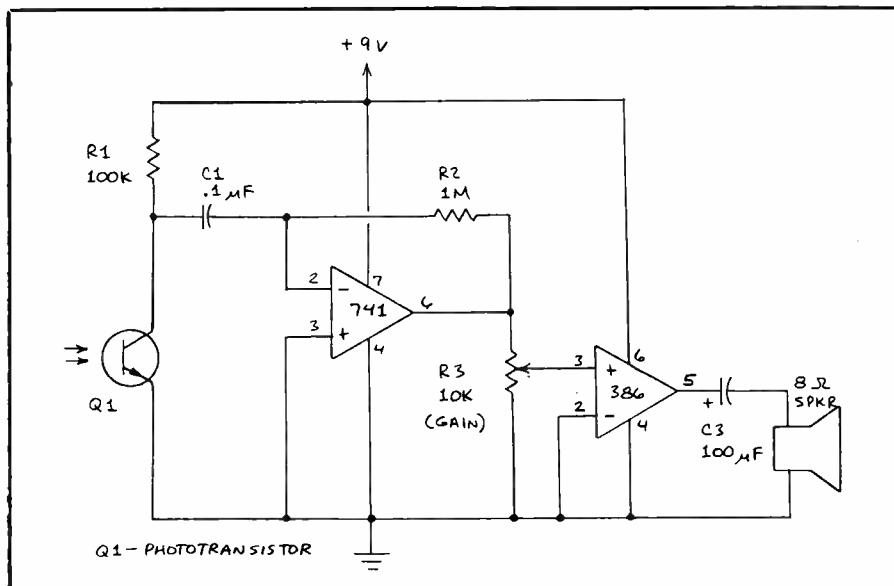

Fig. 7. Schematic diagram for a simple pulsed laser-diode receiver.

to the end of the box and secured in place with silicone cement. An excellent variety of lenses is available from Edmund Scientific (101 E. Gloucester Pike, Barrington, NJ 08007).

The mounting hole for the fuse clip should be made larger than necessary so the laser can be properly focused. Then the clip can be secured in place. Since the beam from the laser is just barely visible when focused onto a white card in a dark room, this difficult task will take time.

I have adjusted the laser in the prototype transmitter to give a perfectly circular pattern 6 inches in diameter at a distance of 285 feet. This corresponds to a divergence

of 1.75 milliradians, about the same as that of many helium-neon gas lasers.

Figure 6 shows the beam pattern produced by the prototype transmitter. The concentric rings of light that form the beam are caused by spherical aberration of the lens. This effect can be eliminated and the beam made narrower by using a more expensive achromatic lens. A 35-mm camera lens can also be used with excellent results.

Laser Receiver

Figure 7 is the schematic diagram of a

simple lightwave receiver you can build to transform the pulsed emission from the laser transmitter into an audible tone. If the divergence of the laser beam is adjusted to be as narrow as possible, this receiver will detect the laser at ranges in excess of 1,000 feet. Detection range can be extended by placing a lens in front of the phototransistor.

The receiver allows the laser to be used as a remote signalling device or for demonstrations. If a missing pulse detector is added to the receiver, an excellent break-beam intrusion alarm can be built. A 567 tone decoder circuit can be added to the basic receiver to form a long-range remote-control system. Suitable circuits are given in *The Forrest Mims Circuit Scrapbook* (McGraw-Hill, 1983) and various other books I've written for Radio Shack.

It's important to realize that receiving the laser beam can be very difficult if you don't have an infrared image converter. One possibility is to place a large bicycle reflector at the receiver's location. Then place the transmitter on a camera tripod and, while looking along the top of the transmitter, carefully adjust the device until you observe a red reflection from the reflector. The laser beam will now be centered on the reflector, where it can be easily detected with the receiver.

This method works only when it is dark. Of course, this makes it difficult to know where to point the laser. In other words, be prepared to spend lots of time learning how to align the laser. I have problems pointing the laser in Fig. 4 across a room. At 20 feet the beam is not much larger than the end of a thumbtack.

Caution: Do not stare at a nearby reflector illuminated by the laser. The reflector should be placed far enough away so that the laser beam spreads to at least several inches in diameter where it strikes the reflector.

Going Further

This is the first of two columns about using CW laser diodes. In the next installment I'll discuss applications for the laser transmitter described here. And I'll describe in detail two miniature CW laser-diode illuminators that have several interesting applications that were once possible only with bulky helium-neon lasers costing several hundred dollars. Be sure to keep this column handy, since much of what has been covered here will be applicable in the next installment. **ME**

NEW PRODUCTS ...

(from page 9)



After installation, any program you play through your receiver is distributed throughout your house via the ac wiring and can be picked off and reproduced by the speaker system, no matter where it is located. To change listening location, you

simply unplug the speaker system, move it to another room and plug it into any ac outlet there.

Initial U.S. Hi-Work Satellite Sound System sales will be through Crazy Eddie stores in the northeast; additional retail outlets in other parts of the country are planned to follow. \$99.95.

CIRCLE NO. 129 ON FREE INFORMATION CARD

RGB Computer Monitor

A high-resolution RGB color video monitor with a tinted-glass, nonglare 12" screen and 0.31-mm dot pitch and 14-MHz bandwidth is now available from Thomson Consumer Products Corp., a new subsidiary of a \$2-billion French electronics conglomerate, The Model CM 31311 SI monitor features RGBI and positive TTL inputs; 25 × 80-character text and 560 horizontal and 240 vertical

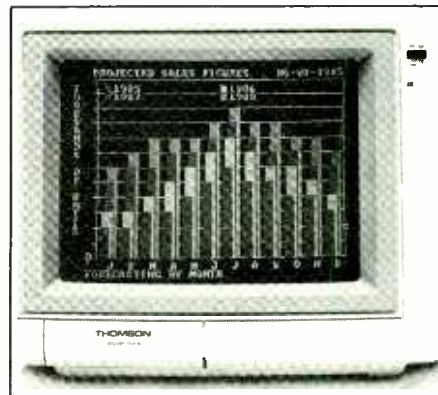

dot graphics format; 15.7-kHz horizontal scan frequency (50 to 60 Hz vertical); a D-9 attached shielded input cable; a green/amber/blue text color selector switch; and a built-in speaker. The monitor can be powered from any 90- to 250-volt ac, 50- to 60-Hz source and consumes 54 watts. It measures 15.2"D × 13.6"W × 11"H and weighs 19.3 lbs. \$599.

CIRCLE NO. 130 ON FREE INFORMATION CARD

First Impressions: Awesome Technology's "Multiple Choice," Roland DG's Monochrome Monitor & Norton-Lambert's "Lync"

By Eric Grevstad

"No, I'm not jealous," I said, watching my friend's Macintosh and wondering why a company would write a slick graphics animation program and package it with a cartoon demo showing the death of Abraham Lincoln. President and Mrs. Lincoln sat in their box at Ford's Theatre; John Wilkes Booth came in, fired, and said "Sic semper tyrannis" in a balloon over his head. "Video-style graphics are cute, but MS-DOS systems are superior for business applications."

"But I've heard you praise Macintosh features," countered the Apple owner. "What about that night at the pub when you admitted that black text on a white screen looked better than green on black? And what about the Mac Switcher, the background utility that lets me toggle among four programs at once? You said yourself in last month's *Modern Electronics* column that you were waiting for DOS 4.0 for real multi-tasking."

"That was last month," I told him. "I'm going home to write the December column in black text on a white screen, running up to eight programs at once." On the Mac, Booth jumped off the balcony and the screen faded to black.

Changing Channels

To be honest, the "Multiple Choice" MS-DOS program can't provide true multi-tasking (programs running as background tasks behind each other); the PC's 8088 processor hasn't the strength for the job. But as a way to keep several programs in memory and do some limited cutting and pasting between them, Awesome Technology's accessory is terrific!

Multiple Choice costs \$99 and installs in seconds: Simply type *mc*, and your PC's memory splits into two to eight channels. (As shipped, the program makes three—24K, enough to use the help file or DOS commands; 55K, which will run WordStar if you don't mind go-

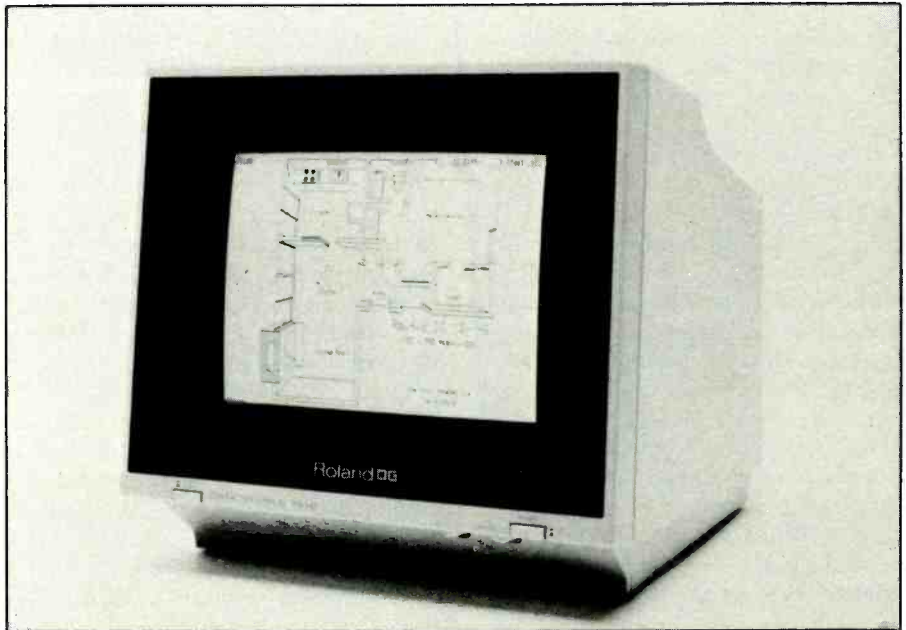

Roland DG Model MB-142 monochrome video monitor.

ing to disk even more often than usual; and the rest of RAM, an indicated 128K in a 256K IBM running DOS 2.10).

Each channel has its own screen and keyboard, from which you can enter any command or run any program that fits (though Multiple Choice occasionally checks COMMAND.COM, which must be left on its boot disk or the root directory of your hard disk, and you're asking for trouble if you have different programs use the same data file). You can give each channel its own batch file, which will execute when the channel's first called.

Meanwhile, the other channels are invisible—until you press the Ctrl key and the numeric keypad's 1 through 8, instantly switching to the specified screen, with your program and cursor where you left them. Should you forget where you are, Ctrl and the keypad plus remind you with a status line such as "Channel #4 - Size 89K."

Programs in the background are frozen in place; if you switch during a directory

scroll or search and replace, the job will resume when you return. (DOS's own background utility, PRINT.COM, printed ASCII files as usual while I ran a program in its channel, but stopped when I switched to another.) Saving its place and video image requires Multiple Choice to set aside 6K RAM per channel; to run graphics programs, you must add one or more additional 12K buffers at startup. Specifying such changes, the number and size of your channels, or another command key such as Alt instead of Ctrl, is as easy as starting Multiple Choice with *mc k1 g2 64 192* or whatever; adding a *p* to the startup line makes your new settings permanent defaults.

Finally, there's Multiple Choice's modest answer to the Mac Clipboard; Ctrl and keypad 0 (Ins) invoke a data capture mode, in which WordStar block commands like Ctrl-KB and Ctrl-KK mark part of the display and write or append it to an ASCII disk file named TRANSFER.TXT (or write it to another filename on whichever directory you like). The

feature didn't work with the graphics-oriented Microsoft Word, but was fine with other programs that take "insert from disk" commands (in the classic example, pasting spreadsheet rows into a letter to the boss).

I've rarely felt the need for Borland's popular Sidekick (which will work with this program, popping up in any channel), but I think Multiple Choice is sensational. The Word capture failure, and each channel's proving 3K smaller than indicated, are almost my only complaints. (The switcher's memory space did clash with two other things I tried; both GEM Desktop and DOS PROMPT command brought "Out of environment space" errors.)

Considering that formatting a disk within an application is multi-tasking enough for many users, Multiple Choice makes it easier to wait for Intel's gigabyte-addressing 80386 and Unix Window-DOS or whatever its operating system will be. For the vintage PC, Awesome's switcher is easy, cheap, and efficient; a RAM-based clipboard for programs that don't take blocks from disk would be nice, but what do you want for 16K plus 6K per channel plus optional graphics buffers? This column's too young to do a "Best Products of '85" tally, but my love of neat, affordable tools would make Multiple Choice a sure finalist.

As Plain As Black and White

This month's hardware product is similarly simple and draws similar murmurs of pleasure from onlookers. Roland DG's MB-142 is a monochrome monitor, larger than most green or amber screens (14" diagonally) but with an identical 9-pin TTL interface. Using the same "D" connector and scan frequencies (18.432-kHz horizontally, 50-Hz vertically) as the IBM Monochrome Display and its imitators, the Roland plugs into the same video boards, whether IBM's text-only model or one of the monochrome graphics cards from Paradise, Everex, or whoever.

Like some other monitors, the MB-142

can show not only the usual 640 × 200, but up to 720 × 350 pixels, supporting the Hercules or other cards' high-resolution modes. Roland boasts its bigger screen makes such displays more readable, even with some cards' spreadsheet-squeezing 132-column modes. With my not-very-good graphics adapter, the Roland's text was only slightly larger than my 12"-green screen's, but a card such as STB's Chauffeur, which can generate a graphics display that fills a screen, will have a 12.5" diagonal (7.5" by 10") to play with.

The Roland's real advantage, though, is that it isn't green or amber. Its phosphor shows white text on a black screen, in a display that's average-looking except for an impressively fast fade (with almost no "ghosting" as you delete a block or move the cursor). But press the "Inverse/Normal" button beneath the screen, and the image shifts to reverse video; the white dots that form characters vanish, and you're left with virtually solid black letters on an off-white background. (If you try for pure white, turning the brightness and contrast all the way up, the letters wash out a little.)

I can't scientifically testify that the newsprint-color display is easier on the eyes or saves trauma for typists glancing between a printed page and the monitor; the MB-142 proved headache-free through late-night sessions, but my eyes are hardened by years of CRT abuse. But its solid letters certainly seemed nicer, as did its shades-of-gray graphics. From any kind of distance, standing a yard across the room instead of sitting at my desk, the Roland was far sharper—genuinely more readable, as well as an attractive novelty.

I'd like to buy one, but its eye-saving appeal packs an eyebrow-raising price—\$375, twice the cost of a high-resolution 12" green monitor. Still, if you spend a lot of time staring at a text screen, I haven't seen anything better.

Skip the Stop Bits

Finally, Norton-Lambert Corp. has answered the cry of everyone who's ever

sent files over phone lines: "What's all this #@\$%*! with parity, word length, and stop bits?" As long as you match the two modems' speed (300, 1200, or 2400 baud), the communications program "Lync" will sense the other computer's parameters and adjust itself automatically (except when, calling a PC which had deliberately weird Hayes Smartcom II setting, I had to add a switch for extra linefeeds).

Even more impressive, Lync (\$95) can send non-ASCII files, such as Lotus worksheets, through electronic mail services in ASCII format. Once you master its slightly awkward command syntax, the program can convert an 8-bit binary file into 7-bit ASCII, or password-encrypt it according to the federal Data Encryption Standard scheme, or both—all on the fly, while it's going out over the wire. Your recipient's copy of Lync can reverse the process, decoding and reformatting the file while downloading it.

Add "smart" log-on sequences that loop through instructions, reanswering a "Password?" query even if several log-on steps have passed in the meantime; the usual XON/XOFF and Xmodem protocols plus two-way remote commands for Lync-to-Lync communications; and you'll forgive Lync's lack of a toggled command screen, specific character filtering, and terminal emulation like that of Microstuf's Crosstalk XVI. Its parameter sensing makes Lync relatively easy, while its real-time conversion and encryption make it exceptional. **ME**

Names and Addresses

Awesome Technology, Inc.
177 Webster St., Suite A-416
Monterey, CA 93940
(408-646-1384)

Roland DG
7200 Dominion Circle
Los Angeles, CA 90040
(213-685-5141)

Norton-Lambert Corp.
P.O. Box 4085
Santa Barbara, CA 93140
(805-687-8896)

The latest technical books and literature in the electronics and computer field.

IBM PC Troubleshooting & Repair Guide by Robert C. Brenner. (Howard W. Sams & Co., Inc; soft cover; 204 pages; \$18.95.)

Whether you own an IBM PC computer or service them, this book will surely help you troubleshoot the machines efficiently when faced with breakdowns. After a tightly written runthrough on IBM PC operations that includes details on data transfers, keyboard operation (down to a chart of scan codes generated by pressing keys), followed by a brief introduction to troubleshooting, the ground is set for more specific troubleshooting and repair information. This is the core of the manual in fact.

The specific-troubleshooting section covers startup problems, run problems, display problems, keyboard problems, and other I/O problems. Here, symptom and troubleshooting procedures are given, the latter in a flow-chart-type format with one step following the next. Circuits, block diagrams and component layouts are given where appropriate. Additionally, a host of tables accompany each problem that lists problem/possible cause/repair action, as well as chip designation/description/location tables. Using a second color (blue), makes it easy to trace information, whether in text or component location on boards.

In essence, then, this is a *speedy* troubleshooting guide section, with little formal text. The latter isn't needed here, since the diagrammatic step-by-step procedures are so clear, helping you to rapidly localize the cause of a given malfunction.

Chapters 5 and 6, the final ones, are devoted to preventive maintenance and advanced (with instruments) troubleshooting. These are weaker than the preceding key chapter on troubleshooting, but are helpful nevertheless if you're an experienced service person. The book closes with an extensive appendix, glossary and bibliography relating to the IBM PC.

Signal Processing Chips edited by David Quarmby. (Prentice-Hall; 179 pages; \$14.95 soft cover, \$24.95 hard cover.)

Widespread use of microcomputers has placed increasing emphasis on the

need for systems designers and experimenters to become familiar with signal processing techniques and the devices to implement them. Contained in this book is the information you will need to implement three popularly distributed signal-processing integrated circuits: the Intel 2920, NEC 7720 and Texas Instruments TMS 320 family. The book starts off with a short chapter that traces the background of signal processing and discusses applications for this technique. It then goes into a rather extensive chapter on algorithms. The three chapters that follow this are each devoted *in toto* to one of the three signal-processor ICs. Here you will find complete descriptions of the devices, function block by function block, pin-outs, instruction tables, machine-language routines, and other pertinent information that will help you understand and use each device. The book concludes with a brief chapter that summarizes what went before and discusses future trends.

Computer Entrepreneur by Robert H. Morrison. (Computer Information Ltd., 1330 Orange Ave., Coronado, CA 92118.) \$32.45 postpaid U.S.A.

There have been literally dozens of books and magazine articles about how to make money with your computer. This one is different both outside and inside. Firstly, it's a beautifully printed 8½" × 11" book that's almost 2" thick and with almost 1,000 pages!

Bulk alone should not be the measure of the quality of a book, of course. As I flipped through the book, however, I became more impressed. The printing was large and clear with hundreds of illustrations to break up the text. The book organization was logical and orderly, and the Table of Contents alone occupied ten pages. Admittedly, this is a great first impression just from the "cosmetics." But how about the content?

The author has adapted his business, promotion and personal computer expertise towards the development of 100 microcomputer-related businesses he describes in detail in this book. This is not just another one of those "101 ways" books with a paragraph or two of information about each business. Each business plan presented is fully detailed: how to start up, how to operate, how to sell the service, how to keep the books, number

of working hours required, capital needed, best location. There's even a self-evaluation section to help you choose the best kind of business for you.

And it's not necessary for you to be a programmer or have a large computer. These business ventures were chosen to be practical with most microcomputers. Whether you have a Commodore from K-Mart or an IBM PC from Computerland, you can join the computer revolution by starting a part-time business you'll enjoy, and one that could lead to financial independence.

The book has seven sections. Section One provides easy-to-follow instructions for finding the business best suited to your personality, background and circumstances. Section Two provides condensed outlines of each business venture so you may quickly find those of greatest interest. Section Three provides the full details of each. Every business has its own number for convenient cross-referencing throughout the book.

Once you choose a business, Section Four explains the special details for setting up your business. These include what kind of operating name to choose, what type of business structure is best suited, how to insure it, and other operational details involved in opening any new business.

Section Five is the marketing guide: how to advertise, promote and sell your services to the right people at the right time. Section Six covers capital requirements. It describes how much capital is needed for each business venture and, if you don't have it, how to get it!

These last three sections (Four, Five and Six) would be useful to anyone planning on starting a business of their own. The information is nontechnical, practical, and offers suggestions for circumventing the bureaucratic obstacles in the path of the young and innocent.

Section 7 is an enormously valuable 72 pages of sources and resources specifically oriented toward the microcomputer field. It contains thousands of names, titles, and product sources for hardware, software and information on the 100 businesses described.

I'm enthusiastic about this book. It's well-written, detailed, and easily worth its weight-in-gold to the willing entrepreneur. Go for it!

4 Good Reasons to Get Your New MCM ELECTRONICS Catalog TODAY!

1. NEW, EXPANDED VERSION

We're constantly adding products and in this issue you'll find over 500 new parts and accessories!

2. WIDE VARIETY

MCM can be your one and only source. We carry a full line of test equipment, computer accessories, speakers, CATV equipment, television parts and more. MCM also has the largest selection of original Japanese semiconductors in the country!



3. LOW PRICES

MCM's money-saving, low prices mean you get more value for your money on every order you place!

4. FAST, FRIENDLY SERVICE

This is our trademark. Courteous sales people make sure your order is correct and delivered to you on time. With our nationwide toll-free numbers, we're as close as your phone!

Call TODAY for your FREE copy –
No Obligation To Buy!



MCM ELECTRONICS

A DIVISION OF PREMIER INDUSTRIAL

MCM Electronics
858 E. Congress Park Drive
Centerville, OH 45459

CALL TOLL FREE 1-800-543-4330

(in Ohio call 1-800-762-4315)

(in Hawaii or Alaska 1-800-858-1849)

SOURCE NO. ME-6

CIRCLE 85 ON FREE INFORMATION CARD

FREE

high-tech catalog



A trustworthy guide to what's new in computers and electronics.

For many years, the illustrated Heathkit Catalog has been a guide to new and exciting kit products for people like you to build. To enjoy and learn from them, while saving money in the process. Discover over 450 fascinating products in computers and peripherals • microprocessors • robotics • Ham radio • computerized weather instruments • energy and home security • stereos and TVs • test instruments • electronics education and more.

Send for your free catalog now.

Please send me the latest **FREE**
HEATHKIT CATALOG

SEND TO: HEATHKIT® Heath Company, Dept. 079-362
Benton Harbor, Michigan 49022

Name _____

Address _____

City _____ State _____ Zip _____

CL-779

Heathkit products are also displayed, sold and serviced at 64 Heathkit Electronic Centers nationwide. Consult telephone directory white pages for location. Operated by Veritechnology Electronics Corporation, a wholly-owned subsidiary of Zenith Electronics Corporation.



CIRCLE NO. 148 ON FREE INFORMATION CARD

NEW LITERATURE

Industrial Electronic Parts Catalog. The new 1985-86 edition of the Allied Electronics catalog offers an expanded selection of industrial electronic parts, components and supplies. You will find listed in the catalog's 430 pages such items as surge protectors, headsets, power conditioners, wire and cable, rectifiers and silicon bridges, switches, panel meters and much more. Included are convenient manufacturers' cross-references and product and manufacturer indexes, and handy mini-indexes lead off each product section. Manufacturers are identified on each page of the 9" x 11" catalog. For a free copy, write on company letterhead to: Allied Electronics, Dept. C-856, 401 East 8 St., Fort Worth, TX 76102.

Educational Programs Catalog. Resource Software International's expanded "Thinkers' Exercises" brochure/catalog lists more than 40 CP/M-based educational software packages for the Commodore 128 computer with 1571 disk drive. It provides descriptions of educational titles for early learning, the middle years and advanced learning. Subjects span the gamut from basic arithmetic and gram-

mar through calculus, trigonometry and algebra, writing skills, college boards and chemistry. The software is available in formats to run on more than 60 personal computers that use MS-DOS, CP/M and CP/M-86. For a free copy of "Thinkers' Exercises" brochure/catalog, write to: Resource Software International, Inc., 330 Brunswick Ave., Fords, NJ 08863.

Electronic Components Catalog. American Design Components has just published its new 48-page 1985-86 catalog of electronic and computer-related parts. The catalog lists thousands of items ranging from ICs and other semiconductors to blowers and fans to ac, dc, fractional-horsepower and stepping motors and much more. Items are described in detail and each is accompanied by a unit-quantity price. For a free copy, write to: American Design Components, 64 Joseph St., Moonachie, NJ 07074.

Video Accessories Catalog. This new 38-page catalog from RCA is printed in full color and provides illustrations and explanations of nearly 180 products for use with VCRs, video cameras and TV receivers. The listed accessories are designed to simplify installation, improve operation, expand usage and protect video equipment. New entries include updated VCR cases, video camera cases, stereo microphones, broadcast stereo adapters, accessory kits, replacement and extension cables for RCA's "Dimensia" system, as well as numerous hardware items. For a free copy of Form No. 1J7674, write to: RCA Distributor and Special Products Div., Deptford, NJ 08096, Attn.: Sales Promotion Services.

Chemicals Brochure. The Distributor & Special Markets Div. of Philips ECG, Inc. has just published an eight-page, four-color brochure that describes the company's new High Technology Chemical line. The illustrated brochure reviews each of the 18 aerosol-spray products in the line, explains how they are used, and summarizes their specifications. It categorizes the various products by principal application and provides packaging information for the entire line. The products include a variety of cleaning, lubricating, shielding, and testing agents for commercial, industrial/MRO and high-technology applications. For a copy of the High Technology Chemical brochure, call 1-800-225-8326 (1-890-6107 in Massachusetts), or write to Philips ECG, Inc., Communications Dept., 100 First Ave., Waltham, MA 02254.

SAVE MONEY!

CALL FREE



1-800-237-3063

7 A.M. TO 5 P.M. MON-THURS
(IN CONTINENTAL U.S. EXCEPT FL)

FOR ALL YOUR CRYSTAL NEEDS!

General Communication Industry • Marine VHF Amateur • Scanners CB Standard & Special Microprocessor

GET YOUR FREE 1986 CATALOG



Call or write:
JAN CRYSTALS
P.O. Box 06017
Fort Myers, FL
33906-6017
(813) 936-2397

SINCE 1965



CIRCLE NO. 121 ON FREE INFORMATION CARD

Jazz: Does Macintosh Boogie or Sing the Blues?

By Joseph Desposito

Lotus Development Corp., the company that produced the premier business software product for the IBM PC, Lotus 1-2-3, has introduced a new business product for the Apple Macintosh called Jazz. Will Jazz do for the Macintosh what Lotus 1-2-3 did for the IBM PC? On the surface it appears to have the potential. Jazz is a product that includes not three, but five of the most common applications used in business.

Jazz has word processing, spreadsheet, database, graphics and telecommunications software all tied together in one package. And because the software is "integrated," data from one application can easily be transferred to another. For example, figures calculated in the spreadsheet portion of the program can be easily moved into a letter written in the word-processing part of the program.

At a suggested retail price of \$595, users will expect Jazz to be an exceptional product. Usually, though, integrated software falls flat on its face when compared piece-by-piece with similar stand-alone products. Sometimes, however, the parts of the integrated package work together so well that a synergistic effect occurs in which the total product becomes much more powerful than the sum of its parts. To find out how Jazz measures up, we compared it to some popular Macintosh products, both stand-alone and integrated packages. But we were careful to investigate whether or not Jazz had the magic that would make it more than just five applications tied together.

The Worksheet is the Workhorse

What It Has. It appears that Jazz, just as Lotus 1-2-3 did, will make its reputation on the worksheet portion of the product. You can build very large worksheets with Jazz, which you can't do with products such as Microsoft's Multiplan. There are 8192 rows and 256 columns available.



However, you can't use all this space, on a 512K Mac, there is just 256K of memory available for your work.

There is some degradation in performance as you build a large worksheet, but Jazz outperforms Multiplan with ease. We built a worksheet of 175 rows by 20 columns and did a recalc in both products. The recalc took Jazz 7 seconds and Multiplan 12 seconds. When we tried to double the size of the worksheet in Multiplan, we were notified that there was insufficient memory. We doubled the size of the worksheet in Jazz without any problems and did a recalc. It took 13 seconds.

Though Jazz is powerful, it is easy to use. Jazz gives the user two ways of performing operations—with the mouse or from the keyboard. For example, if you want to highlight a range of cells with Jazz, you can type in A1.D25, as well as scroll through the worksheet with the mouse. There is also a way to scroll page-by-page rather than line-by-line. You just click on a page icon in the scroll box of the

Jazz window. Other ways of moving around the worksheet are with the End Navigator and Corner Navigator icons. As in Multiplan, you also have the ability to name a range of cells instead of working with coordinates.

Formatting is sometimes tedious with a worksheet, but not with Jazz. Not only can you select your formatting conventions from pull-down menus, but you can also do it on the fly. For example, typing an accent mark before an entry makes it right aligned, while typing a caret makes it center aligned.

Jazz has 100 functions that make it easy to create complicated formulas. All are available from a submenu of the Edit menu called "Enter into formula . . ." If you have a decent memory, though, you can just type a function in at the keyboard. The functions cover eight different areas: mathematical, trigonometric, logical, calendar, statistical, data range, text, database report, and a few special functions. The text functions of Jazz are something that you won't find in

SOFTWARE FOCUS...

Lotus 1-2-3, although Multiplan and Lotus' Symphony offer them.

What's Missing? The most obvious omission from the Jazz worksheet is the ability to create macros. Macros enable users to automate their worksheets. For example, a typical macro automatically enter the months of the year along the top row of the spreadsheet with a press of a key. Another feature that's lacking is the ability to split a screen. This means you cannot view two different parts of the spreadsheet at the same time. And you cannot link spreadsheets together as you can do with Multiplan. So if you have individuals doing expense reports, for example, you can't link the reports to a summary report.

There is a problem when you input data into a worksheet. A significant time delay occurs between pressing return and Jazz posting the entry. Also, there is a problem with horizontal scrolling. Jazz does it so slowly that it becomes irritating. One final problem occurs when you select a range of cells to input data. The range becomes reverse highlighted, but then blinks on and off each time an entry is made. I think this feature could cause severe eyestrain to users who are inputting data for extended periods of time.

Comments on the Worksheet. It took

me a while to adjust to using Jazz due to the data-entry quirks just mentioned. If it were not for the overall power of the worksheet, I think I would have given up on the product. I transferred a few Multiplan files to Jazz, and encountered more problems. Jazz has a convert feature that allows you to use Multiplan sylk files with the program. Jazz converted some of the files, but not others. The ones that it couldn't convert were those that used text formulas. If you want to use Lotus 1-2-3 or Symphony files with Jazz, you can send them by modem over to the Macintosh, and Jazz will convert them.

Overall, I was impressed by the power and versatility of the worksheets. Although I didn't mention each one individually, the Jazz worksheet has all the features you would expect, such as cell protection, sorting freeze titles, What-If tables, and others. But, again, I was disappointed in the way it handled data entry.

The Database: Solid Yes; Sexy No

What It Has. The database portion of Jazz is a file manager that sets up infor-

mation in a row and column format. When you open a new database file, Jazz asks you to define the fields that will be used. You can create up to 100 fields per record with 254 characters per field. After fields are defined, a window appears that shows the fields in a row along the top with a number 1 along the left side, which designates the first record. Any time you want to add a record, you select Add Record from the menu or press command N. The Jazz database can hold about 2000 small-size records.

You can enter data into the database using the row and column format, or Jazz will automatically create a data input form for you. The form isn't too fancy, but it is functional.

The database, like the worksheet, is flexible. If you change your mind and want to add or delete fields, it can be done quickly and easily. Fields can be changed and edited, too, without a problem. Records can be deleted using the usual Macintosh Cut feature. A record navigator icon allows you to step through the database record by record, or jump to the first or last record of the file.

If requested, Jazz will check an entry to determine if it is text or a number. If it is not a predetermined format, Jazz beeps to notify the user. A field can be locked so

It takes about 90 seconds to reach the Jazz desktop shown above. From this point it will take 20 seconds and up (depending on the size of the file) to load a document.

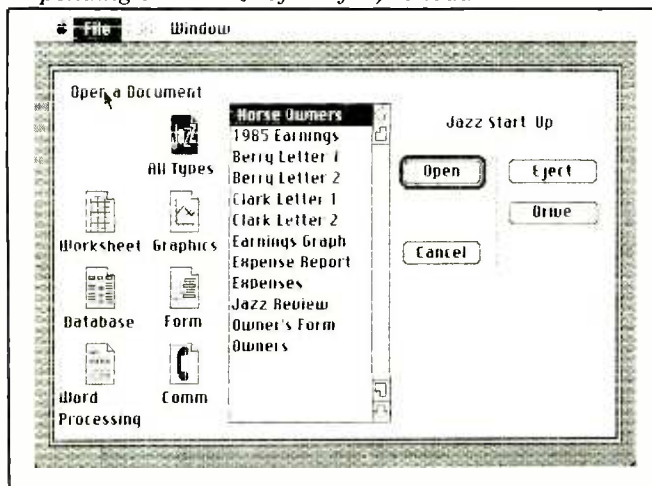

The Jazz word processor is very similar to the old Mac-Write, except that it uses different icons. The Jazz page extends out to 14 inches.

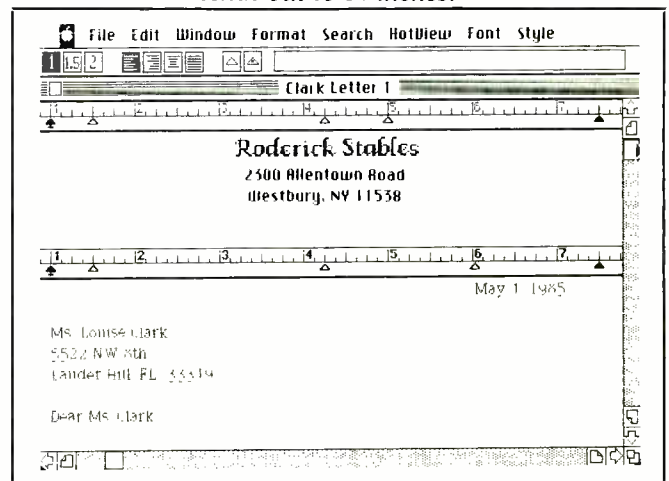

Owner	Month	Jan	Feb	Mar	Apr
Cherry's Lad	Week 1	\$2,200.00	\$0.00	\$0.00	\$2,500.00
	Week 2	\$1,800.00	\$4,000.00	\$5,000.00	\$1,250.00
	Week 3	\$520.00	\$1,000.00	\$5,000.00	\$6,000.00
	Week 4	\$520.00	\$0.00	\$2,500.00	\$7,000.00
	Week 5			\$0.00	\$700.00
	Totals	\$5,040.00	\$5,000.00	\$12,500.00	\$16,750.00
Lou's Idol	Week 1	\$2,200.00	\$4,700.00	\$2,500.00	\$1,400.00
	Week 2	\$0.00	\$1,500.00	\$1,250.00	\$1,400.00
	Week 3	\$0.00	\$1,500.00	\$0.00	\$2,800.00
	Week 4	\$800.00	\$0.00	\$5,000.00	\$700.00
	Week 5			\$1,000.00	\$5,200.00
	Totals	\$3,000.00	\$7,700.00	\$8,750.00	\$11,500.00

The Jazz worksheet is the most powerful of the five applications. Notice the End Navigator icon in the upper right-hand corner of the screen and the smaller Corner Navigator to its left.

Last Name	First Name	Address	City
1 Anderson	Allen	85 Jason Street	Hoonachie
2 Perry	Ruth	175 Aker Street	Yuba City

Owner's Form

Enter Last Name of Owner:

Enter First Name:

Enter Address:

Enter City: Enter State: Enter Zip:

Enter Horse Number:

Enter Horse:

Jazz will automatically create a form for a database file. The form can be enhanced by moving and resizing fields, changing fonts, and adding text to it.

that values cannot be entered into the field (an alert box appears, informing you of this). Fields can be generated from information contained in other fields. For example, if you have a field for salary, you can generate a field for hourly wage through an appropriate formula that is easily entered in a section of the field attributes box.

When entering data, often there are fields, like the date, which must be included in every record. Jazz contains a section in a field attributes box called Initial Value that automatically inserts the listed value in each record.

Other database functions such as sorting and querying can be done easily with the Jazz database through selections on a pulldown menu. Operators such as <, >, and wildcards can be used whenever performing a query. Queries can be saved for use again at a later time.

Jazz can create reports from information in the database. Reports can be as simple as listing all records in the database, or more detailed. For example, reports can be broken down into sections, each section can be given a title, and total can be taken. A report is generated by sorting the database and setting up a report definition.

What's Missing? One of the failings of the Jazz database is that it doesn't take advantage of the graphics capability of the Macintosh. As a file manager, it is incapable of storing graphic images, which Microsoft File and others can do. As a report generator, it lacks the pizzazz of some products such as FileMaker from MacWare, which can create very fancy records and reports using graphics integrated with text.

It is important to remember that the Jazz database is a low-level, easy-to-use file manager and report generator. This means it is not a relational database and it doesn't have a database language associated with it. In effect, it's a "plain vanilla" product. This is not to say it is inferior. It does have some shortcomings, as will be described below, but it is easily as powerful as the combined PFS: File and PFS: Report products that are so popular on the Macintosh and other computers.

Comments on the Database. I built one database file from scratch, and another I transferred to Jazz from a Multiplan worksheet. I had no problems with the "pure" Jazz file. However, when a file is transferred from another application you have to prepare the database to receive the file. So if you have a few hundred rec-

ords to transfer, you must press command N a few hundred times. You cannot just hold down the key, since automatic repeat is apparently disabled.

Another problem arises during the transfer process. The database automatically enters blank records, which cannot be deleted. This becomes a problem when you sort since blank records are placed at the front of the file when you sort in ascending order. To the user, it looks as though the records have disappeared after the sort. It should be noted that this does not occur when you build a Jazz database from scratch.

The sort function is fast enough, taking 4½ seconds to alpha sort 250 records. One of my relational databases took 10 times as long, 45 seconds, to do the same thing! But a relational type is faster if an Index command is available.

I was disappointed in the report feature of the database simply because it allows the user very little flexibility in design. You cannot even move it to the word processor to enhance the look of the report. If you try to enhance it within the database—for example making the headings bold—the whole report is changed to bold. But overall, the database is an easy-to-use, powerful file manager whose ma-

SOFTWARE FOCUS...

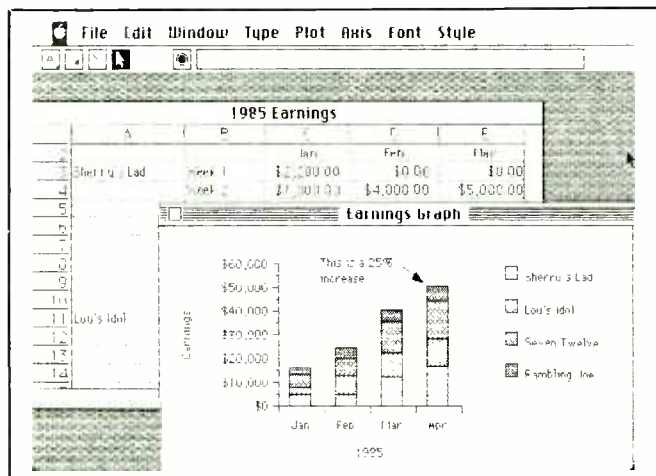

A Jazz graph is generated automatically from data on a worksheet. The stacked bar graph shown has been enhanced with legends, an arrow, and explanatory text.

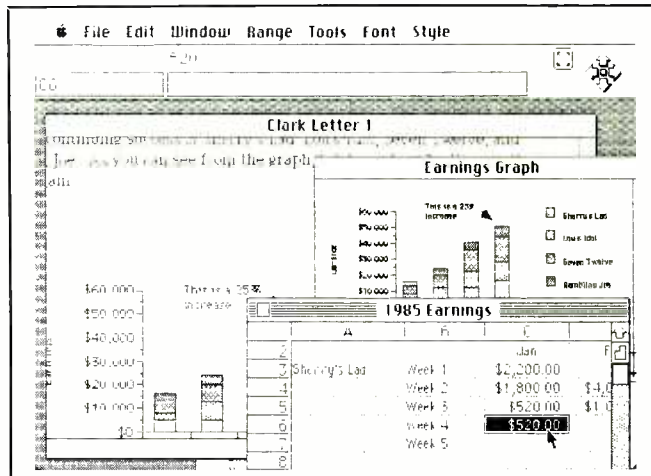

The HotView feature of Jazz dynamically links documents together. As a figure in the spreadsheet is changed, the graph and the graph in the word-processing document changes, too.

major drawback is that the number of records it can hold is limited.

Graphics From the Worksheet or Database

What It Has. Jazz graphics can graph data from either a worksheet or database file. The graph types that are available are pie (with one or more exploded wedges, if desired), line, area, bar, overlapped bar, stacked bar, point, and stock market. The procedure for drawing a graph is the same no matter which graph is chosen.

Drawing a graph is fairly simple. If you are graphing from a worksheet you can select any range; if you are graphing from a database, you are limited to selecting a field. After selecting values, you switch to the graphics window and select a graph type from a menu. The graph is automatically plotted. You can plot one or more graphs or graph types on a single set of axes. If you have a set of plots, and want to delete one of them, you can do it by using a feature called the Plot Selector.

The basic graph can be enhanced with text and tick marks. With text, you can add titles, legends, notations and axis labels. Tick marks can be inside, outside or across an axis. Scaling of the graph is au-

tomatic, but can be done manually, too. Other graph enhancements are grids, arrows and lines.

What's Missing? The graphics portion of Jazz is fairly complete. It compares very favorably with stand-alone packages such as Microsoft Chart. One of the fil- lips missing is the ability to draw three-dimensional graphs. Admittedly, this isn't terribly important. But one of the other integrated packages, Hayden's Ensemble, can draw graphs with height, width and depth, though the graphs are not true three-dimensional types (that is, graphed on x, y, and z axes).

Comments on Jazz Graphics. Jazz graphics are very simple to use, yet flexible and powerful. I think this portion of Jazz is excellent!

Word Processing: More "No Frills" Than Jazzy

What It Has. All Macintosh owners receive a copy of MacWrite, Apple's word processor, when they buy their machine. For those who switch to Jazz, its word processor will seem awfully familiar, especially if you never bothered to upgrade MacWrite. There is very little in the Jazz

word processor that is different from the old MacWrite besides different icons.

When you open the word-processor window, you see the familiar ruler. It shows the margins and tabs. Icons indicating spacing and justification, as well as tab and decimal tab "wells," are above the ruler.

Common word-processing features such as cut and paste, search and replace, and headers and footers are available from the menus. In normal Mac style, fonts and point size can be easily changed by a menu selection or a command key sequence. Any time a document needs to have its format changed, a new ruler can be inserted.

Like the Jazz worksheet, the word processor also allows page-by-page scrolling by clicking the page icon in the scroll bar.

What's Missing? The Jazz word processor is lacking many of the features of a high-quality program. For example, you cannot take a word count of a document, there is no keyboard cursor control, no integrated spelling checker, no print spooling, no footnote feature, no subscripts or superscripts control, and no way to delete hard carriage returns.

Another drawback of the Jazz word-processor is that documents are limited in

size to about 20 pages. This was true of the old MacWrite, too. But the new MacWrite uses virtual memory so that document size is dependent on disk space rather than available memory.

Comments on the Word Processor. As a long time Macintosh user, I have to say that I liked MacWrite and also like the Jazz word processor. But I use Microsoft Word, since I need the additional features it provides such as a character count and the ability to strip hard carriage returns. If these items are not important to you (and it won't be to very many users), you will find that the Jazz word processor is an excellent writing tool. One further comment is in order here. I have not yet commented on the effect of Jazz integration. As you will see, integration gives the word processor an added dimension of power.

Jazz Communications: A MacTerminal Clone

What It Has. The million-dollar question is this: Did Apple give Lotus its old code for Jazz word processing and communications, or is the similarity of MacWrite and MacTerminal to the Jazz versions just a coincidence? In Jazz communications, the menus look a little different, but the overall product is the same.

With Jazz communications, you can send to or receive files from another Macintosh running Jazz or any other computer. The protocols available are a special Jazz protocol and XModem. If you want, you can send files back and forth without using any protocol at all.

Like MacTerminal, Jazz communications lets your Macintosh emulate a Digital Equipment Corporation VT100 or VT 52 terminal. You can save settings for frequently called numbers just by saving the document associated with them.

There is a menu choice called the Answerback Message. This lets you send a stored message to whomever you connect to. In the case of an information service like CompuServe, you might want to store your ID number.

Jazz does have a feature that MacTer-

minal doesn't. It uses indicators to show carrier detection and to show when a file is being received. Also, because of its integrated nature, Jazz communications lets you download directly into a word-processing worksheet or database document. Parse settings can be used to ensure that incoming data is received in a meaningful way.

What's Missing? The obvious feature that Jazz communications is missing is a macro facility. With macros, you can automate your communications. In contrast, a new production from Prometheus, ProComm-M, lets you construct macros quickly and easily on the Mac.

Another feature that Jazz communications lacks is multitasking. If you are downloading a long file, for example, and want to leave the communications window to work in the database window, the receive function halts until you make the communications window active again.

Comments on Jazz communications. As a MacTerminal user, I find Jazz communications suitable for my needs. Although I would like to have the macro feature, I'm not enough of an on-line junkie to really miss it.

Jazz Integration: Tying All The Elements Together

One of the problems of the Macintosh from *Day One* has been the time it takes to open and close an application. Jazz is no exception. After you insert the Jazz disks, it takes more than half a minute to reach the Finder (Macintosh operating system), almost a minute to load Jazz, and about 20 seconds to load a new document from any of the applications. So if you wanted to open windows for all five applications it would take about three minutes before everything was ready.

However, the beauty of Jazz is that once you endure those three minutes, switching between applications takes just a few seconds. What a user luxury!

Jazz has a few conveniences to cope with multiple windows. There is a menu selection called Zoom Up that enlarges the active window to full screen. You can

shrink the window again by choosing Zoom Down. Also included in the pull-down menu entitled Window is a list of all the files that are currently open. You can click on the name of the file and its window comes to the front.

You move data between applications by choosing Cut or Copy from the Edit menu, switching to a different application, and then choosing Paste from the same menu.

With Jazz, you can exchange either static views or something called HotViews of data. A HotView dynamically links a word-processing document to its originating data. For example, if you were to include a HotView of a Jazz graph in a document, any further changes to the graph or its associated worksheet or database would automatically be reflected in the HotView of the graph in the word-processing document. Besides graphs, HotViews can be ranges from worksheets or areas from databases. If you "Freeze" a HotView, links to the original data are broken. Static views do not contain links between documents.

Listed on the HotView menu are choices for date and time. If you wanted to include the date as a HotView in a form letter, for example, the correct date would always be on the form whenever you called it up.

The Jazz word processor has a powerful function residing on the HotView menu. It is called Merge Field. With this option, you can create form letters that use information from a worksheet or database file. Wherever you would use a name in the letter, for example, you click Merge Field instead. When the first letter is printed, Jazz inserts the first name from the database and adjusts the spacing in the letter according to the size of the entry. Jazz continues printing until all selected names are used.

Jazz can print mailing labels, too, by using the Merge Field option. This process is somewhat tedious since you have to keep switching between the word processor and database to construct the label "shell," but it only has to be done once. Jazz allows you to create labels in three

cable TV

DESCRAMBLER PARTS

We stock the exact parts and PC Board for Radio Electronic's February Article on building your own Cable TV Descrambler.

#701 PARTS PACKAGE \$29.95

Includes all the original resistors, capacitors, diodes, transistors, integrated circuits, coils and IF transformers (BKAN-K5552AXX).

#702 PC BOARD \$12.95

Original etched & drilled silk-screened PC Board used in the article.

#704 AC ADAPTOR \$12.95

(14 volts DC @ 285MA)

Both #701 & #702 \$39.00

FREE!! Reprint of Radio Electronics Article on Building Your Own Cable TV Descrambler with any purchase.

Add \$4.00 Postage & Handling

TOLL FREE

1-800-227 8529 (Orders Only)

1-617-339-5372 (Information)

J & W ELECTRONICS, INC.

P.O. Box 800A
Mansfield, MA 02048

CIRCLE 30 ON FREE INFORMATION CARD

SOFTWARE FOCUS...

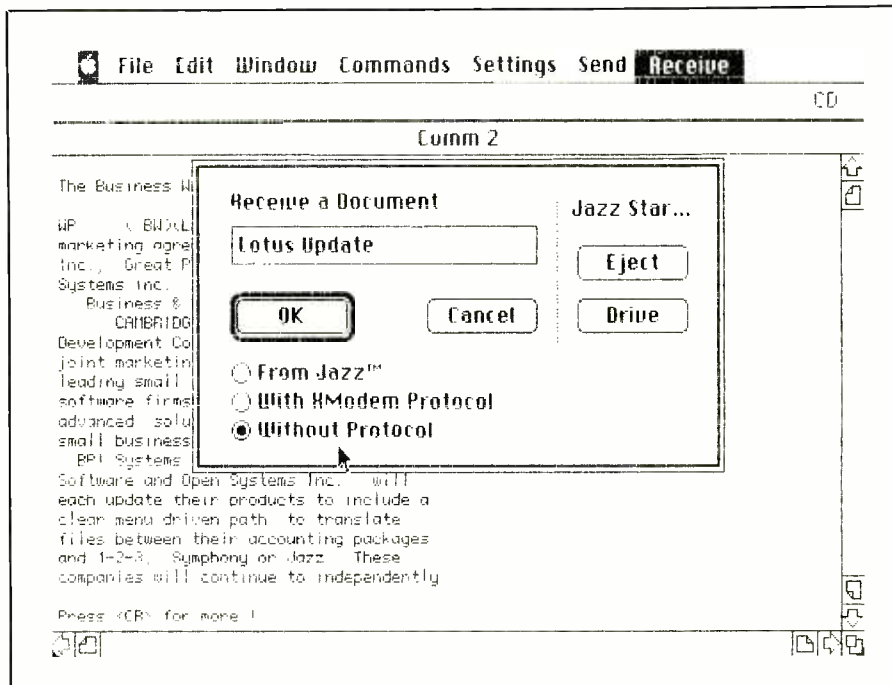

With Jazz communications, information can be down loaded directly into a word processing, worksheet, or data base document with Set File from the Receive menu.



sizes, which can be printed in single columns only.

Jazz users always have to keep in mind that there is a memory limit of 256K for all documents together. If you open a large worksheet file and a large database file and attempt to write a long document with the word processor, you will run out of memory. You can check the amount of memory remaining by clicking About Jazz under the Apple menu.

Disks, Printers, and Modems

Jazz resides on two disks, a Start-up disk and a Program disk. The Start-up disk can be copied, but the Program disk is copy protected. (Lotus includes a back-up Program disk.) The Start-Up disk is not one that you can remove from the system once it is booted up. Well, you can remove it, but it will cause all sorts of disk swapping problems if you do.

Since there are two disks, you need two drives to run Jazz. You can use either an outboard floppy or a hard disk as your second drive.

The only printer that Jazz supports is

Apple's Imagewriter. If you have a different printer, the Jazz Handbook suggests that you "see the manual that came with the printer for information on how to set up Jazz . . ." Good luck with that one! I used Epstart, a program from SoftStyle to enable Jazz to print on an Epson FX-80 printer, you should know, so it can be done.

Another peripheral that you need with Jazz is a modem for communications. Jazz supports modems from Hayes, Apple and "other." I have one of the "other" modems, a General DataComm model. It didn't work with Jazz when I selected "other," but worked when I selected the Apple modem.

Documentation

My first reaction to Jazz was this: "Why is the box so heavy?" I expect Mac products to have rather limited documentation. But the Jazz Reference manual has 351 pages. Additionally, there is a Jazz Primer (with accompanying disk) and Jazz Quick Reference. These can all be kept neat with the Jazz manual holder

that is included. For the disks, there is a Jazz disk holder. So that's why it's so heavy! The package, externally and inside content, is impressive and fortifies the decision for such a large expenditure.

The manuals are truly excellent. Veteran Mac users as well as beginners should find the illustrations very helpful. The only problem with the documentation is the lack of specific technical information on Jazz. For example, the word processor has a limit of about 20 pages, but you can't find this fact in the manual.

Conclusions

This is a tough one to call. On the plus side, Jazz, is a *very useful* program with some *powerful* features such as the Worksheet and the HotView function. On the minus side is the high price, at least three mediocre modules (word processing, database, and communications), and flaws such as the problem the worksheet has with horizontal scrolling. However,

mediocrity for some sophisticated users may be a welcome relief to others who don't want complex work challenges.

The integrated property of the program is really its redeeming value, I think. To switch so quickly between applications is a true pleasure. But many Mac users have already achieved some form of integration either by adding desk accessories or using Apple's "Switcher," which allows multiple programs to reside in memory at the same time.

When compared to other integrated programs on the market, such as Hayden's Ensemble and Haba Systems' Quartet, I think Jazz emerges a clear *winner on the strength of its worksheet*. New spreadsheet products that have just come to market, however, such as Microsoft's Excel and Crunch from Paladin, might be just as capable as the Jazz worksheet. If you purchased Excel and downloaded a terminal program from CompuServe to use as a desk accessory, you would have a

powerful spreadsheet, graphics, and communications program for about \$200 less than the cost of Jazz.

One of the reasons Lotus 1-2-3 made such a big splash in the IBM PC market was that its speed and programmability (through macros) attracted the so-called *power users*. I don't think the same thing will happen with Jazz. And if power users don't flock to Jazz, who will? It would have to be the next echelon lower in terms of handling computer application programs. There are certainly plenty of them.

To conclude, I think that Jazz is a nice, appealing program though it's not a great one. And because it doesn't hit that high note, many people might think that the cost of the Jazz ticket is too great. Lotus Development did a fine job, I think, considering the inherent limitations of the Macintosh computer, especially in terms of user memory. So I have believe that Jazz does indeed Boogie, though it misses a beat at times. **ME**

QUALITY COMPONENTS - NOT MAIL ORDER "SECONDS"

Send \$1.00 postage and handling for FREE COMPLETE CATALOG which includes coupon for \$1.00 OFF purchase.

ARIES ZERO INSERTION FORCE SOCKETS

cam actuated, true zero insertion - tin plated solder tail pins - capable of being plugged into dip sockets, including wire wrap.

Stock No.	No. of Pins	1-9	10-49	50
11055	24	4.98	\$4.35	\$3.90
11056	28	5.15	4.50	4.05
11057	40	6.81	5.95	5.35
11058	64	12.02	10.50	9.45

IC-KOOLERS™ from UNITRACK™ dissipate over 2 watts of heat from IC's producing longer life and better performance. Just push IC-Kooler on - heat is collected from top and bottom of IC and dissipated. Won't shake loose!



Stock No. Price
22225 14 \$.29
22226 16 \$.29

WILD ROVER
Touch switch capsule. Operating motion is 005" without the use of a levered arm. Extremely fast on and off with low noise. Normally open - 115 VAC, 1/8 amp-30 milliohm resistance - .615 radius by 160 thick.

Stock No.	1-24	25 & Up
12098	1.85	\$1.60

SCREW MACHINED SOCKET PINS, loose, packaged in bags of 100. Stock No. 11310 is solder tail with gold collet in shell. Stock No. 11311 is wire wrap with gold collet gold shell.

Stock No.	Description	1 Bag	5 Bags	10 Bags
11310	solder tail pins	\$ 4.95	\$ 4.45	\$ 3.95
11311	wire wrap pins	11.95	10.75	9.50

3 X 4 Elastomeric Keyboards
Each keyboard has a p.c. board, elastomeric pad with contacts, ABS bodies and double shot molded keys. Max rating: 12 VDC @ 20mA.

Contact Res.	less than	Stock	Operating	Key	Price
500 ohms	Bounce: less than	11261	120°40g	2.02	5mm \$5.25 \$4.20
		11262	60°40g	1.52	5mm \$4.75 \$3.80

TI WIRE WRAP SOCKETS

Tin plated phosphor bronze contact - 3 wrap

Stock No.	No. of Pins	1-99	100-499	500
11301	8	\$4.00	\$3.60	\$3.30
11302	14	59	54	.45
11303	16	64	58	.48
11304	18	.73	.66	.55
11305	20	.99	.90	.75
11306	22	1.12	1.02	.95
11307	24	1.25	1.14	.95
11308	28	1.52	1.38	1.15
11309	40	2.05	1.86	1.55

TI LOW PROFILE SOCKETS

Tin plated copper alloy 688 contact pins with gas tight seal.

Stock No.	No. of Pins	1-24	25-99	100
11201	8	\$1.00	\$0.99	\$0.98
11202	14	.14	.13	.12
11203	16	.16	.15	.14
11204	18	.18	.17	.15
11205	20	.20	.18	.16
11206	22	.22	.20	.18
11207	24	.24	.22	.20
11208	28	.28	.26	.25
11209	40	.40	.37	.33

SUB CUB I and SUB CUB II are high quality, complete LSI Counter Modules with LCD readout. Modules plug in p.c. board (Stock No. 51071). Complete function evaluation kit (Stock No. 51070) contains: p.c. board, 4.5V battery and variable frequency oscillator to supply train of count pulses. Stock No. 51070 has LATCH, RESET and TEST functions (3 buttons). P.C. board unplugs for bread-board work.

6 Digit LSI Counter Modules with LCD Readouts and Associated Mounting Assemblies

Stock No.	Description	Price
51070	Complete Function Evaluation Kit (includes batteries but does not include display counter)	\$45.00
51071	Mounting P.C. Board only	7.50
51072	SUB-CUB I display counter module only	18.00
51073	SUB-CUB II display counter module only	24.00
51074	Panel Bezel Evaluation Kit for SUB-CUB II (does not include SUB-CUB II counter module)	12.00
51075	DATA SHEET	.25

SINGLE ROW SOCKETS
Strip of 25 collet sockets/pins mount odd-center components easily. Gold plated contacts.

Stock No.	1-24	25	50	100
10240	\$1.70	\$1.50	\$1.30	\$1.10

Both styles breakable to any number of contact positions wanted.

Stock No.	1-99	100	500	1000
10850	\$1.09	\$0.90	\$0.82	\$0.72

OPCOA Single Digit Displays - Common Cathode

Stock No.	Color	1-99	100 & up
12082	Red	\$1.25	\$1.00
12085	Green	1.85	1.65
12087	Yellow	2.25	1.75
12089	Orange	2.00	1.50

Right Angle Socket for Above Displays

Stock No.	1	100
11010	\$1.24	\$0.99

OPTEL LCD's with pins

Stock No.	Description	1-24	25
47005	3 1/2 dig. 5'	\$ 7.43	\$ 7.00
47006	4 dig. 5'	7.43	7.00
47007	4 dig. 7'	14.35	13.50

Stock No. 47007

The Battery Just Wrap™ Tool
New battery powered tool-wasps regulated wire around .025" square posts without need for pre-cutting and pre-strapping. Complete with bit and 100 ft. 30 AWG wire.

Stock No.	Description	Price
13340	Battery just-wrap tool with bit and 100 ft. 30 AWG wire	\$62.95
13341	Replacement bit	10.85
13342	100 ft blue replacement wire	7.90
13343	100 ft white replacement wire	7.90
13344	100 ft yellow replacement wire	7.90
13345	100 ft red replacement wire	7.90

MICRO Charts - colorful 8 1/2" x 11" charts eliminate the need to stumble through manuals and summaries. Fully decoded - instant access - totally comprehensive - gives pin outs, cycle times, buy notes, etc.

Stock No.	Reference	Price
23010	280 CPU	\$3.95
23011	8080A/8085A	\$9.95
23012	6502 (65X0)	\$9.95
23013	8085 and relatives	\$9.95
23014	5477400 TTL Pinouts	\$9.95
23015	Basic Algorithms	\$9.95
23016	8086/8088A	\$9.95
23017	How to generalize from a sample	\$9.95
23018	Wegmaster	\$9.95

PIN FORMING TOOL
puts IC's on their true row to row spacing. One side is for 300 centers. Flip tool over for devices 600 centers. Put device in tool and squeeze.

ONE TOOL DOES 8 thru 40 PINS!

Stock No.	Price
11059	\$12.95
10200	\$14.95

NEW! ANTI-STATIC MODEL

Scotchflex™ Breadboard Systems Basic kit
comes with 24 various Dual Sockets, 40 various Plug Strips, wire and tools. Kit can be used with any of the six boards.

Stock No.	Description	Price
03500	Basic Kit	\$86.41
03511	Basic board, 4.5 x 5.5	19.50
03506	Intel SBC-8010 Board, 12 x 6.75	61.88
03507	Motorola M-6800 Board, 9.75 x 6	41.88
03508	S-100 Board, 10 x 5.3	35.00
03509	Z-10 Board, 7.7 x 7.5	39.38
03510	Eurocard Board, 6.3 x 3.9	18.75

OK MACHINE AND TOOL
IC INSERTION/EXTRACTION KIT
Includes DIP IC extractors and inserters to accommodate all IC's from 14 to 40 pins. Tools that engage conductive surfaces are CMOS safe and include grounding lug. Stock No. 13309 \$43.40

SOCKET WRAP ID
Dip socket-size and plastic panels with numbered holes in place. Slip onto socket before wire wrapping to identify pins. Also write on them for location, IC part number, function, etc. Simplifies initial wire wrapping, troubleshooting and repair.

Stock No.	Price
13295	14 pin
13296	16 pin
13297	18 pin
13298	20 pin
13299	22 pin
13300	24 pin
13301	28 pin
13302	40 pin
13303	96 pin

\$2.05 per pack

THERMOPROBE: Identifies Dead Components - Replaces Volt Meters!
Identify dead components which do not emit heat. Just point thermistor probe within 1/16" of board - move over components and see which are dead.

Stock No.	Price
22300	\$21.95

Scotchflex™ Breadboard Systems Basic kit
comes with 24 various Dual Sockets, 40 various Plug Strips, wire and tools. Kit can be used with any of the six boards.

Stock No.	Description	Price
03500	Basic Kit	\$86.41
03511	Basic board, 4.5 x 5.5	19.50
03506	Intel SBC-8010 Board, 12 x 6.75	61.88
03507	Motorola M-6800 Board, 9.75 x 6	41.88
03508	S-100 Board, 10 x 5.3	35.00
03509	Z-10 Board, 7.7 x 7.5	39.38
03510	Eurocard Board, 6.3 x 3.9	18.75

SINTEC

28 8th St., Box 410
Frenchtown, NJ 08825



TOLL 800-526-5960
FREE in NJ (201) 996-4093

We accept VISA, MC, C.O.D., CHECK or M.O. *INCLUDE SHIPPING CHARGES - \$10.00 to \$50.00 - \$4.00 over \$50.00 - \$5.00

USCI Subscribers Take Heart

By Stan Prentiss

When United Satellite Communications, Inc. shut down on March 31, 1985 and subsequently filed for Chapter 11 reorganization, backers may feel they lost their multi-million dollar investments. Some 9,000-10,000 good-faith subscribers—mainly in Illinois, Indiana, Pennsylvania, and Maryland—might be losers too, or so it seems. But that really isn't so.

That equipment sitting on the roof (if in good condition) is still usable. All you have to do is buy a new satellite receiver and aim your dish in the right direction. True, the receiver has to have certain requisites and must be of good quality, but it will positively perform and, in most instances, deliver excellent pictures. Some, like ours, may be double banded.

You must, however, have video-polarity inversion resulting from high side (51.5-MHz) oscillator injection to low side (10.75-MHz), provisions for eventual scrambling, common 950- to 1450-MHz intermediate-frequency amplifier block downconversion frequencies, variable audio tuning, signal level and agc (video level) indicators.

Having all the foregoing and polarization skew with vertical/horizontal auto or manual controls, you can operate this receiver on both C and Ku bands with the proper 12- and 4-GHz feeds coupled to matched 950 to 1450 block converters. Under these conditions, you may use either a regular C-band solid reflector or the 1.2-meter (4-ft.) receptors supplied originally by USCI. But the latter, of course, restricts reception to Ku and, for the moment, permits only one satellite to be accessed without manually orienting the dish to another.

Well-made, standard C-mount automated satellite trackers, however, should include most, if not all the new Ku group, and could easily be retrofitted to the general 1-meter class whenever any earth station or mount manufacturer takes the initiative.

Ku Birds Are Flying

Meanwhile, 22 Ku-band satellites are either flying or have been approved for

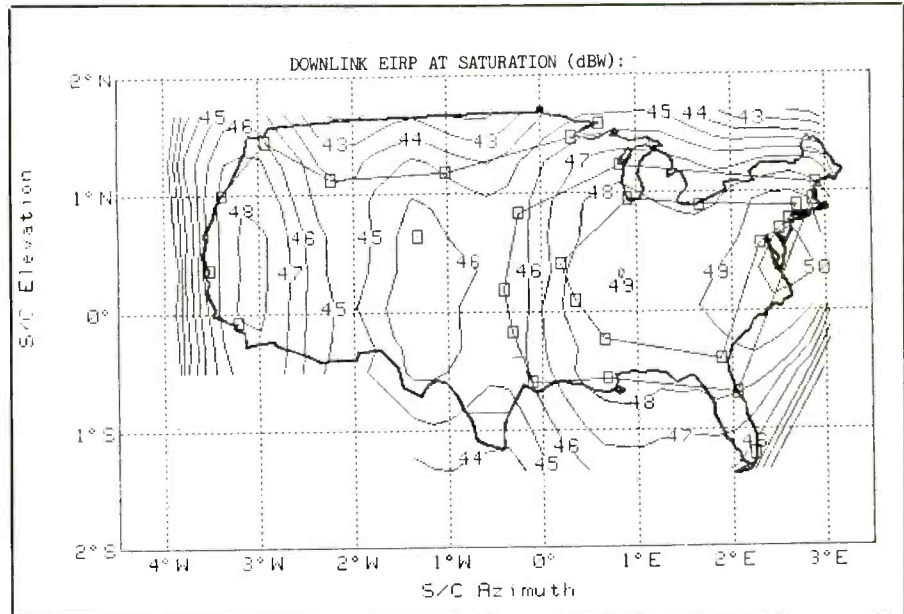

Fig. 1. The SBS-3 "footprint" for Conus with a 1.2-meter satellite antenna, block downconverter and Ku-band receiver.

construction by the FCC, augmented by another nine C- and Ku-band hybrids. There's no guarantee they'll all be carrying video, but with 6 to 16 transponders each, there should be enough programming of interest to satisfy almost everyone, especially at the doubled and tripled projected power levels.

At the moment, SBS-3 carries the NBC network feeder loads to 22 affiliates between New York and California, which are the principal network broadcast centers. But in 1986, NBC will also use the RCA Americom Ku-band satellites for primary network feeds as they attain operational status with their powerful 45 watts/channel outputs and 16 transponders per satellite.

Targeted for operation in January 1985, the SBS system and NBC combine resulted from "a several hundred-million-dollar," 10-year contract between the NBC television network and COMSAT General Corp. for the first satellite network program distribution system using Ku-band 12/14-GHz frequencies. Ground station equipment, including six mobile "transportable" 42-foot trucks with 5-meter, fold-out antennas, is the responsibility of the Harris Corp., which

also supplies continuing maintenance. All receiving and transmitting equipment for ground affiliates is monitored by Sky-path™, which directs electronic traffic and also aims the various satellite receptors. Even at this early date, we understand that AT&T land lines are now only used by NBC between Washington, D.C. and New York since other feeder traffic is already on satellites.

For now, SBS-3 is supplying two 40-W and three 20-W channels to NBC at bandwidths of 43 MHz—a footprint of which is shown in an accompanying illustration.

WRC-TV, channel 4 in D.C., joined the system during March-April. It's being equipped with a 6.1-meter main dish and a 3-meter secondary, both with full deicing equipment. Operating electronics for the two receptors consists of five 7-ft. racks of equipment for both transmit and receive, all housed in an outside air-conditioned 26 x 8 ft. shelter.

Besides SBS-3 and the forthcoming RCA series, there's Spacenet 1 and 2, and GSTAR 1 will be coming on the air initially in September with lots of hotel programming that will include Showtime/The Movie Channel, Cable News Network, ESPN, Satellite Cinema, and

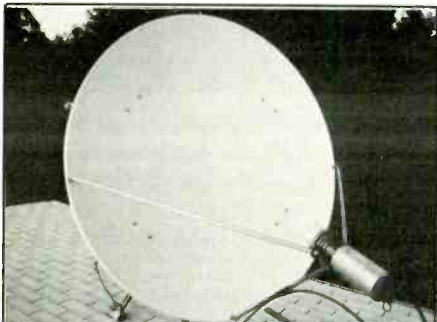

Typical USCI 1.2-meter antenna with G.I. LNB and feed.

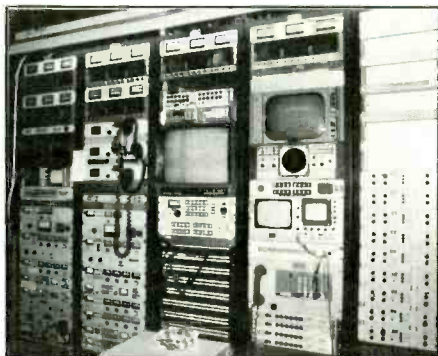

Partial interior of a TV network station showing patch panels and tester-monitors. This one is WRC-TV in Washington, D.C.

other "live" events. Three transponders of GSTAR's 16 are already booked and there are options outstanding from HINET Communications for more to carry the various shows.

How This Applies to Users

By law, you can't decode either C- or Ku-band programming without the originator's authorization (usually a decoder box and monthly fees). But Capitol Hill legislators, such as Senator Goldwater and legislative assistant Terry Emerson, are adamant in their view that you're legally within your rights to receive anything that's not scrambled. There's never been a test case, however, and the question may some day go to court. Therefore, we're not advocating anything, simply reporting on what's available and the means to get it should that be your wish.

With more and more programming and the further introduction of additionally sophisticated TVRO satellite earth station equipment, however, the skies remain substantially clear for Sam Satowner with lots of entertainment and information all around.

At the moment, we're using a M/A-COM T-2 receiver with some 60-ft. of 75-ohm #9116 Belden coax connected to a M/A-COM mount and dish and a General Instrument LNB-125C (20.5-V, 41-W max.) block downconverter. It has all the requisites cited earlier and then some, plus remote control, polarization and skew select, audio bandwidth selector, channel up/down, scrambled/unscrambled switching, parental supervision, outputs for both types of polarization con-

trollers, audio/video baseband, plus age and signal-level adjusts.

The foregoing may be used for either C or Ku bands with appropriate 950- to 1450-MHz block downconverters. Then, when you turn off satellite receiver power, the T-2 automatically switches to normal TV reception (if connected to a TV antenna, of course). West-longitude positions for these satellites (see Modern Electronics, August 1985) require one note of caution, however. When changing dish positions to other satellites, remember that the USCI antennas have offset feeds amounting to between 20 and 22 degrees, so make allowances accordingly. As an example, a 40-degree look (elevation) angle would now become either 18 or 20 degrees.

ME

USE
YOUR
FREE
INFORMATION
CARD

NEW FOR '85
DATA
CABLE
PRODUCTS

AUGAT **PACKAGED PRODUCTS**

The Single Source
for Sockets, Alcoswitches,
Knobs, Ribbon Cable Products,
RDI Terminal Blocks, D-Subs,
Edge Cards, Telecon,
RS-232 & Co-Axial Cables,
Gender Changers, UHF & BNC,
Flat Cable, Accessories

1985 Catalog Available

1985 Catalog features Sockets, Switches, Knobs, Ribbon Cable Products
Data Cable Products Catalog features D-Subs, Edge Cards, Telecon, RS-232 Cables, UHF & BNC, Flat Cable, Accessories
1985 Supplement features RDI Terminal Blocks

GUARANTEED SALE

AUGAT **PACKAGED PRODUCTS**

Call these TOLL FREE numbers for the name of the distributor or sales rep nearest you.
Nationwide (800) 336-3613 / In Mass. (800) 428-5700
P.O. Box 659, 40 Perry Avenue, Attleboro, MA 02703
Service Is Our Business No Order Too Small

PREPAID* FREIGHT

CIRCLE 60 ON FREE INFORMATION CARD

Shortwave Propagation Basics

By Glenn Hauser

The newcomer to shortwave listening is faced with some perplexing problems. The main one is the lack of consistent reception we are all accustomed to on AM, FM and TV. A station heard in the morning is gone in the evening; a station heard one day may be gone the next, even when there's no doubt about the frequency readout. Large portions of the dial seem to be completely dead. Is something wrong with the receiver?

Shortwave propagation—the way a radio signal reaches you from the transmitter—depends on the ionosphere, the top layers of the atmosphere just this side of space, and far above the troposphere, where our weather takes place. The ionosphere is a very flimsy and delicate medium, heavily influenced by radiation from the sun. If there were as much variability in visible light and infrared radiation from the sun as there is in ultraviolet and shorter wavelengths which affect the ionosphere, life on earth would be at risk, or might never have developed.

Four basic cycles of different durations interact, making shortwave propagation rather complex and not completely predictable. But understanding each one will go a long way toward making the most of your shortwave radio.

Diurnal. Night and day are extremely important. The longer the sun shines on the ionosphere, the better it functions on the higher frequencies, and the worse it functions on the lower frequencies. Shortly after local sunrise there is a rapid increase in the maximum usable frequency (MUF) for signals coming from points east. This may peak in the afternoon and declines after sunset, but the decline is less abrupt since there is some residual ionization which gradually decays. The lowest MUFs are typically a few hours before sunrise. Absorption of lower frequencies, however, lessens before sunset and is gone as soon as there is darkness, the absorption resumes quickly with sunrise. The point below which absorption takes place is called the lowest usable high frequency (LUHF). The "window" between the LUHF and the MUF is the span of frequencies capable of bringing in

shortwave signals at any given time. Exact boundaries are always fluctuating, dependent on the other cycles.

Monthly. Actually, this has nothing to do with the month, but the period of time it takes the sun to rotate; about 27 days. Sunspots and solar disturbances, if they have not abated in the meantime, reappear 27 days after their debut. They are also bound to be out of sight for two weeks. However, if something on the sun disrupts shortwave on earth just before it rotates out of sight, it may be only two weeks before it's back in view and have another two weeks of potential. This repeatability is a major factor in medium-term propagation forecasting.

Seasonal. This is closely related to diurnal, especially at higher latitudes. During the winter, there's much less solar illumination of the ionosphere, and at a lower angle. Nights are much longer than days, which means the MUF sinks lowest overnight during this season. However, the opposite is happening in the other hemisphere, enhancing trans-equatorial signals which manage to get through. In the summer, not only are days longer, but absorption of lower frequencies is increased, and there is a higher level of thunderstorm activity, masking what signals there are with noise. In spring and fall, these factors even out.

Solar Cyclic. Our star happens to vary in a cycle averaging about 11 years. At the peak of solar activity, coinciding with the greatest number of sunspots and the highest solar flux readings, the MUF can exceed 30 MHz, even 50 MHz, making for fantastic transcontinental communications on the 6-meter ham band and the lowest TV channels. Shortwave stations make heavy use of the 21-MHz band; some use the 25-MHz band, and more would if it was thought the average receiver covered it. Now, however, we are in the trough, just about the lowest point in the cycle, which means that 25 MHz is useless and 21 MHz of very limited usefulness. Stations typically go to lower bands for daytime paths, increasing the crowding on those bands. Fortunately, we have a new 13-MHz band (13.6-13.8) that should relieve congestion on the 11- and 15-MHz bands; however, only a few countries are

using it yet, led by the Soviet Union.

Solar cycles vary considerably from one to the next. The peak some of us remember from 1957-58 may prove to be a once-in-a-lifetime experience. Typically, there is a more rapid buildup than decline, and since the first spots of a new solar cycle have already been detected earlier this year, we may hope for a considerable improvement in the next few years. However, there have also been periods when the cycle stayed almost "flat," and this could happen again.

Geographical factors are also very important in understanding shortwave propagation. Except for short distances, flat maps are very misleading in determining the true direction of a given station. Although there can be considerable variations, the first assumption is that a signal arrives along the shortest (great-circle) route. In North America, European signals come from the northeast, Africa from the east, Australia from the west, Asia from the north. But the more distant a signal is, the closer it is to the antipodal point (distance equal in all directions).

Signal paths avoiding the polar zone are far more advantageous. Since auroral activity disrupts them heavily, there is no daytime at all during the winter, and absorption can be counted on. That's why reception from Europe is so poor and unreliable in western North America, and signals from the Far East are the same way in eastern North America. It's also a big incentive to establish relay stations in the Caribbean area, which can serve North America with no such problems.

However, to almost every "rule" of propagation there are exceptions, which is what makes shortwave DX listening so exciting. There are times when signals from Asia will make a good showing right across the polar barrier, for example.

In central North America, Europe is a borderline case, sometimes blocked by polar absorption, sometimes not. It becomes obvious that stations in Portugal have an advantage over stations in Finland, simply because their signals traverse a lower-latitude path.

Those who concentrate on the tropical bands (below 6 MHz) develop an understanding of the best times for reception

from different regions of the world.

Not only are sunrise and sunset times at your location important, but also those at the transmitting station. The "darkness window" varies considerably from month to month depending on the relationship between the two locations. A device such as the *DX Edge* (see *Modern Electronics*, Oct. 1985) or computer tables help to make this clear. On the higher frequencies, the important factor in determining peak MUF is not local time, but an hour or two after midday at the midpoint of the path.

Also of importance, but not often considered, is the vertical angle of arriving signals. The more distant the station, the more "hops" involved, and the lower the angle of arrival. Thus, it's advantageous to have your antenna as high as possible and with as little horizon blockage as possible. An oceanside bluff is hard to beat, unless it's right next to a mountain range!

Shortwave propagation is a topic you can study to whatever depth you like. *The World Radio TV Handbook* carries tables each year showing the most suitable meter bands for different paths at different times of year. Our sister publication *CQ* has an excellent propagation column primarily for hams, but which can be adapted for shortwave listening. An excellent book, not too technical, is the *Shortwave Propagation Handbook*, by George Jacobs and Theodore J. Cohen.

Shortwave itself can bring you very useful propagation information. WWV has an hourly report of recent activity and a short-term forecast every hour at :18 past, on 2.5, 5, 10, 15 and 20 MHz. There's usually a brief forecast for the next week or two on WRNO's *World of Radio*, Sats. 0400 UTC on 6185, Suns. 0030 UTC on 7355, and 1400 on 9715; or on Radio Canada International's *SWL Digest*, Sats. 1935 UTC on 15325, 11945; 2135 UTC on 17820, 15325, 15150, 11945; Suns. 2305 on 11710, 9755; Mons. 0405 on 9755, 5960.

Radio Australia and Radio Netherlands have been cooperating with a weekly propagation report, on the several Sunday airings of *Talkback*, and Thursday airings of *Media Network*, respectively.

Good listening!

ME

MUST LIQUIDATE AT FAR BELOW DEALER COST! Computer Products

PUBLIC NOTICE

We are authorized liquidators of consumer products that must be quickly sold by manufacturers at drastic price reductions for many reasons, such as:

Discontinued lines. Last year's models. Distributor surplus. Cancelled orders. Out-of-season products. Tailends of inventories.

Whatever the reason for the liquidation, you are assured of fine quality at money saving low prices! Supplies are limited. Order now!

Famous U.S. Brand Dot Matrix PRINTER

Factory reconditioned!
Factory warranty!

Compatible
with C64,
SX64, VIC20,
Educator 64,
Plus/4 and C16

Here's a great opportunity to add a fine quality printer to your Personal Computer...at a **BIG SAVINGS!**

Now you can get neat, clean printouts of reports, correspondence, mailing lists, charts, inventories, financial figures...or anything else you have in computer memory. And it all comes out at the speed of 60 characters per second.

These are factory reconditioned units that look and work as good as brand new. And they're backed by the manufacturer's standard new product warranty!

Sorry, we're NOT permitted to print the famous brand name in this ad. But we can "tell all" if you phone us Toll-Free: 1-800-328-0609.

PRINT METHOD: Bi-directional impact dot matrix.

CHARACTER MATRIX: 6 x 7 dot matrix.

CHARACTERS: Upper and lower case letters, numerals and symbols. All PET graphic characters.

GRAPHICS: 7 vertical dots, maximum 480 columns. Dot addressable.

CHARACTER CODES: CBM ASCII code.

PRINT SPEED: 60 characters per second.

MAXIMUM COLUMNS: 80 columns.

CHARACTER SPACING: 10 per inch.



LINE FEED SPACING: 6 lines per inch in character mode or 8 lines per inch selectable. 9 lines/inch in graphic mode.

LINE FEED SPEED: 5 lines per second in character mode. 7.5 lines per second in graphics mode.

PAPER FEED: Friction feed (Tractor feed is optional. Available from dealers nationwide.)

PAPER WIDTH: 4 1/2" to 8 1/2" width. Up to 10" with optional tractor feed.

MULTIPLE COPIES: Original, plus two.

SIZE: 13"W x 8"D x 3 1/4" H. **WEIGHT:** 8 1/2 lbs.

Mfr. List When New **\$199.95**

Liquidation
Price Now Only

\$119

Item H-806-63831-00 Ship, handling: \$7.00



FCC Approved!
Factory
New!

90
day
Limited
Factory
Warranty

64K MODEM

Liquidation due to manufacturer's overproduction. The modem plugs into Commodore 64K or SX64, so you can access new worlds of information on a subscription basis. Has modular jacks for quick hookup to phone. Works on TouchTone® and Rotary (Pulse) systems (not PBX). Super intelligent software, completely menu-driven. 30K software buffer. Auto dial, auto answer. Price includes FREE trial subscription to over 52 database services.

Mfr. List: **\$124.95**

Liquidation Price

\$19

Item H-806-63646-00 Ship, handling: \$4.00

Price subject to change after 60 days. Sales outside continental U.S. are subject to special conditions. Please call or write to inquire.

Credit card customers can order by phone, 24 hours a day, 7 days a week.



Toll-Free: 1-800-328-0609



Your check is welcome!
No delays in orders paid by check.

C.O.M.B. Direct Marketing Corp.® Item H-806
14605 28th Ave. N./Minneapolis, MN 55441-3397

Send the following items. (Minnesota residents add 6% sales tax. Allow 3-4 weeks delivery. Sorry, no C.O.D.)
— Dot Matrix Printer(s) Item H-806-63831-00 at \$119 each plus \$7 shipping and handling.
— 64K Modem(s) Item H-806-63646-00 at \$19 each plus \$4 shipping and handling.

My check or money order is enclosed. (No delays in processing orders paid by check, thanks to Telecheck.)

Charge to my: MasterCard® VISA

Acct. No. _____ Exp. _____

PLEASE PRINT CLEARLY

Name _____

Address _____

City _____

State _____ Zip _____

Phone _____

Sign here _____

C.O.M.B. Direct Marketing
Corporation
Authorized Liquidator

14605 28th Ave. N. • Mpls., MN 55441-3397

Article Cumulative Index

Oct. 1984 through Dec. 1985

Audio

- Audio Amplifier Chip, A Versatile
by Michael A. Covington..... Jun 85
- Audio Amplifier, Testbench
by C.R. Fischer..... Oct 85
- Audio and Video In Your Future
by Len Feldman..... Sep 85
- Compact Disc Player, Carver
by Len Feldman..... Jun 85
- Compact Disc Player, Sony CDP-302
by Len Feldman..... Jul 85
- Compact Disc Player, Sony CDX-R7 Car
by Len Feldman..... Dec 84
- Compact Disc Player Deluxe, Luxman DX-103
by Len Feldman..... Oct 84
- Performance Specs, Stereo Tape Deck
by Leonard Feldman..... Aug 85
- Processor-Controller, Sansui AV-77
by Len Feldman..... Feb 85
- Receiver, Pioneer SX-V90 Stereo
by Len Feldman..... Nov 84
- Speaker Design Breaks Size Barrier, New
by Len Feldman..... Mar 85
- Speakers to an Audio System, Adding Extension
by Norman Eisenberg..... Nov 84
- Spectrum Analyzer, Heath's AD-1308 Real-Time Lab Analysis
by Len Feldman..... Mar 85
- Kit Report
by Alexander W. Burawa..... Apr 85
- Stereo & Mono Together
by Michael A. Covington..... Jan 85
- Stereo FM That's as Quiet as Mono
by Len Feldman..... Oct 85
- "Surround Sound" Enhancer
by John H. Roberts..... Feb 85
- Tape Dubbing for Car Stereo
by Norman Eisenberg..... Dec 84
- Tuner, Yamaha T-80 AM/FM-Stereo
by Len Feldman..... Jan 85
- VCR, JVC VHS Hi-Fi
by Len Feldman..... Oct 84
- VCR, Sharp VC-5F7U VHS Hi-Fi
by Stan Prentiss..... Oct 85

Columns

Communications

- 50 Countries for SW Listening
by Glenn Hauser..... Oct 84
- FCC Goes Public With Ham Radio Tests
by Gordon West..... Dec 84
- SW Station News by Glenn Hauser
Jan 85/Feb 85/Mar 85/Apr 85/Jun 85/Jul 85
- Warm-Weather Scanning
by Tom Kneitel..... May 85
- English-Language SW Broadcast Listing
by Glenn Hauser..... Aug 85
- Combating the Russian Woodpecker
by Glenn Hauser..... Sep 85
- SW Station News & Schedule Updates
by Glenn Hauser..... Oct 85
- International SW Program Updates
by Glenn Hauser..... Nov 85

Editorial by Art Salsberg

- A Warm Welcome..... Oct 84
- The TV Tube..... Nov 84
- Buffalo Bill..... Dec 84
- Author! Author!..... Jan 85
- Price Wars..... Feb 85
- The Age of Consumer Electronics..... Mar 85
- The New Pirates..... Apr 85
- Ruminating..... May 85
- Silicon's Challenger..... Jun 85
- A \$40-Billion Lifestyle..... Jul 85
- Where Have the Holes Gone?..... Aug 85
- Leapfrogging..... Sep 85
- Our First Milestone..... Oct 85
- Buying by Mail..... Nov 85
- The Merry Season Begins..... Dec 85

Electronic Gadgets by Eric Grevstad

- Jun 85/Jul 85/Aug 85
- ### Electronics Notebook by Forrest M. Mims III
- Lightwaves in Communications..... Oct 84
- Optical Fiber Sensors & Systems..... Nov 84
- Cassette Recorder Analog Data Logger
..... Dec 84
- Experimenting With a Touch-Tone DTMF Receiver..... Jan 85
- Experimenting With the Analog Comparator..... Feb 85
- Universal Active Filter..... Mar 85
- Super-Bright LEDs..... Apr 85
- An Experimental Security Alarm..... May 85
- Infrared Temperature Transmitter..... Jun 85
- Two-Transistor Multifunction Oscillator
..... Jul 85
- Measuring the Flow of Air..... Aug 85
- Experimenting With Small dc Motors..... Sep 85
- Detecting Sound..... Oct 85
- Pressure-Sensitive Resistors..... Nov 85
- Experimenting With CW Laser Diodes
..... Dec 85

Hardware Hacker by Don Lancaster

- Author answers readers' questions
..... Jan 85 thru Nov 85

PC Papers by Eric Grevstad

- Epson LX-80 printer, Ericsson Portable PC, Commodore Amiga..... Oct 85
- DRI's GEM software, Kaypro 2000 laptop computer..... Nov 85
- Awesome Technology's "Multiple Choice," Roland DG's Monochrome Monitor, Norton-Lambert's "Lync"..... Dec 85
- ### Satellite TV Scene by Stan Prentiss
- USCI Subscribers Take Heart..... Dec 85
- ### Software Focus
- Home-Finance Software Packages
by Art Salsberg..... Apr 85
- Skill-Learning Software Packages
by Art Salsberg..... May 85
- Desktop Accessories
by Art Salsberg..... Jun 85
- Newstar "NewWord"
by Eric Grevstad..... Jul 85
- Inside the IBM PC With Programming Access Tools by Charles Rubenstein..... Sep 85

Computerized DX Edge

- by John Richardson..... Oct 85
- ### Health & Fitness Programs
- by Charles M. Salsberg..... Nov 85
- ### Jazz: Does Macintosh Boogie or Sing the Blues?
- by Joseph Desposito..... Dec 85

Computing

- "Absolute Reset" for Newest Apple IIs
by Don Lancaster..... Nov 85
- Apple IIc Fall From the Tree?, Does the
by Charles Rubenstein..... Oct 84
- Apple IIe's ROM Monitor, Upgrading
by Don Lancaster..... Feb 85/Mar 85
- Buffer, Stewart Instruments "PC" Spooler
by Fred Blechman..... Jul 85
- Coleco's Adam: The "Born-Again" Computer
by Charles Rubenstein..... Dec 84
- Color Graphics, Smart BASIC
by Forrest M. Mims & Eric Mims..... Jan 85
- Commodore's C128 Computer
by John Richardson..... Dec 85
- Commodore Plus/4 Computer... Is It Really a Plus?
by Eric Grevstad..... Mar 85
- Computer Clutter, Cure
by Jeffrey I. Lackey..... Oct 85
- "Father of Personal Computers"
by Art Salsberg..... Oct 84
- Graphics Tablet, Suncom
by Charles Rubenstein..... Aug 85
- Hero, Jr., Your Personal Robot
by Alexander W. Burawa..... Oct 84
- Heath/Zenith IBM-Compatible PC (H/Z-150)
by Charles Rubenstein..... Jan 85
- Interface Device, Experimenter's
by K.R. & D.M. Bonnett..... Apr 85/May 85
- Interface Device, Using the Experimenter's
by D.M. & K.R. Bonnett..... Sep 85
- Interface Kit, CompuLogic RS-232
by Fred Blechman..... Apr 85
- Jazz: Does Macintosh Boogie or Sing the Blues?
by Joseph Desposito..... Dec 85
- Junior, A Second Chance for
by John M. Woram..... Nov 84
- Light Pen, Tech-Sketch Apple Computer
by Charles Rubenstein..... Nov 84
- Modem, AT&T Model 4000 External
by Charles Rubenstein..... May 85
- Monitors for Personal Computers, Color Video
by Fred Blechman..... Dec 84
- Ohm's Law the Easy Way
by Michael A. Covington..... Jun 85
- Portable Computers '85: One Lap Ahead
by Eric Grevstad..... Jul 85/Aug 85
- Power Controller, A Computer System
by Paul M. Spannbaauer..... Nov 85
- Printer, Juki 6000 Daisywheel
by Joseph Peters..... Oct 85
- Printer, Star Micronics Power Type Daisy-wheel
by Fred Blechman..... Oct 84
- Programs, Transferring BASIC
by Fred Blechman..... Apr 85

RS-232 Switches by Fred Blechman
 IQ Industries Smart Cable; Litek Hacker-Switch; Tigertronics Model S-8 RS232 Switch.....Sep 85
 Sinclair "QL" Computer
 by Fred Blechman.....Jun 85
 Tandy's New Model 1000 Computer: King of the IBM Clones? by Eric Grevstad..May 85
 Tunes on Your Apple IIc, Simple
 by Fred Blechman.....Sep 85

Features

"Absolute Reset" for Newest Apple IIs
 by Don Lancaster.....Nov 85
 Adam: The "Born-Again" Computer,
 Coleco's by Charles Rubenstein...Dec 84
 Anti-Theft Alarms, Electronic Automotive
 by Ron Cogan.....Feb 85
 Akihabara—Electronic Shopper's Paradise
 by David A. Wolf.....Aug 85
 Apple IIc Computer Fall Far From the Tree?,
 Does the by Charles Rubenstein...Oct 84
 Apple IIe's ROM Monitor, Upgrading
 by Don Lancaster.....Feb 85/Mar 85
 Audio Amplifier Chip, A Versatile
 by Michael A. Covington.....Jun 85
 Audio and Video in Your Future
 by Len Feldman.....Sep 85
 Camcorders—Revolution in Home Movie
 Making by Len Feldman.....Nov 84
 Circuit Boards, The "Easy Circuit" Way to
 Make by Harold Wright.....Mar 85
 Circuit Design From Scratch
 by Jules H. Gilder...Nov 84/Feb 85/Apr 85
 Color From a Monochrome CRT
 by Vaughn D. Martin.....Jan 85
 Color Graphics, SmartBASIC
 by Forrest M. & Eric Mims.....Jan 85
 Color TV, A New Era of Go-Anywhere
 by Alexander W. Burawa.....Oct 84
 Color TV Receivers for 1985, Showcase of
 by Stan Prentiss.....Jan 85
 Color Video Monitors for Personal Computers
 by Fred Blechman.....Dec 84
 Commodore's C128 Computer
 by John Richardson.....Dec 85
 Commodore Plus/4 Computer
 by Eric Grevstad.....Mar 85
 Consumer Electronics, The Booming World of
Apr 85/May 85
 Cool It, Baby!
 by Joseph J. Carr.....Dec 85
 "Digital" Color TV Has Arrived!
 by Stan Prentiss.....Apr 85
 Dress Up Your Projects
 by C.R. Ball.....Sep 85
 Extension Speakers to a Stereo System, Adding
 by Norman Eisenberg.....Nov 84
 "Father of Personal Computers"
 by Art Salsberg.....Oct 84
 555 IC, The Versatile
 by Duane M. Perkins.....Oct 84
 Get Started in Electronics, How to
 by Forrest M. Mims III...Oct 84/Dec 84
 Heath/Zenith's IBM-Compatible Personal
 Computer by Charles Rubenstein...Jan 85
 Hero Jr., Your Personal Robot", "I Am
 by Alexander W. Burawa.....Nov 84
 Ignition, Electronic by Ron Cogan...Oct 84
 Junior, A Second Chance For
 by John M. Woram.....Nov 84

Laser at Twenty-Five, The
 by Forrest M. Mims III.....Dec 85
 Ku Band, RCA Goes
 by Stan Prentiss.....Nov 85
 Metal Detecting For Fun & Profit
 by Gerald S. Pattee.....Jul 85/Aug 85
 Multimeters, Using & Misusing
 by Gary McClellan.....Dec 84
 Ohm's Law the Easy Way
 by Michael A. Covington.....Jun 85
 Op-Amps, Beyond
 by Joseph J. Carr.....Nov 84
 Op Amps, Using
 by Robert A. Witte.....Oct 85
 Oscilloscope User's Guide
 by Vaughn D. Martin.....Jun 85/Jul 85
 Performance Specs, Stereo Tape Deck
 by Leonard Feldman.....Aug 85
 Portable Computers '85: One Lap Ahead
 by Eric Grevstad.....Jul 85/Aug 85
 Power Supplies, Designing dc
 by Joseph J. Carr.....Mar 85
 Programs, Transferring BASIC
 by Fred Blechman.....Apr 85
 Radar Detectors
 by Ron Cogan.....Nov 85
 Radio Communications, Small Boat
 by Ed Noll.....Jul 85
 Reception From Your Clock Radio, Better FM
 by Michael A. Covington.....Aug 85
 Satellite TV For 1985 and Beyond, Home
 by Stan Prentiss.....Feb 85
 Satellite News, TVRO
 by Stan Prentiss.....Aug 85
 Satellite TV Receiver, Evaluating a Home
 by Stan Prentiss.....Jun 85
 Satellite TV Systems, Guidelines to Home
 by Art Salsberg.....Jun 85
 Satellite TV—The "Quiet" Video Revolution
 by Stan Prentiss.....Dec 84
 Scanner Being Wasted?, Is Your
 by Tom Kneitel.....Nov 84
 Service Tips, Connector Replacement
Sep 85
 Siliconconnection, The
 by Art Salsberg.....Nov 85
 Sinclair "QL" Computer, The
 by Fred Blechman.....Jun 85
 Speaker Design Breaks Size Barrier, New
 by Len Feldman.....Mar 85
 Stereo FM That's as Quite as Mono
 by Len Feldman.....Oct 85
 Switching Regulators, Designing With
 by Anthony J. Caristi.....Sep 85
 Tandy's New Model 1000 Computer
 by Eric Grevstad.....May 85
 Tape Dubbing For Car Stereo
 by Norman Eisenberg.....Dec 84
 Timebase/Dividers, Programmable
 by C.R. Ball Jr.....Jan 85
 Time Connection
 by Fred Blechman.....May 85
 Tunes on Your Apple IIc, Simple
 by Fred Blechman.....Sep 85
 TV, Hang-on-the-Wall
 by Alexander W. Burawa.....Jun 85
 Voltage Comparators, Using
 by Robert Witte.....May 85
 Voltage Standards, Precision
 by Joseph J. Carr.....Apr 85
 Wrist Receiver, Army.....Nov 85

Product Evaluations

Buffer, Stewart Instruments "PC Spooler"
 by Fred Blechman.....Jul 85
 Camcorder, Kodak Model 2400
 by Stan Prentiss.....Jan 85
 Camcorder, Zenith VM6000 VHS
 by Stan Prentiss.....Feb 85
 Compact Disc Player, The Carver
 by Len Feldman.....Jun 85
 Compact Disc Player Deluxe, Luxman DX-103
 by Len Feldman.....Oct 84
 Compact Disc Player, Sony CDP-302
 by Len Feldman.....Jul 85
 Compact Disc Player, Sony CDX-R7 Car
 by Len Feldman.....Dec 84
 Computer Fall Far From the Tree? Does the
 Apple IIc by Charles Rubenstein...Oct 84
 Computer, Coleco's Adam
 by Charles Rubenstein.....Dec 84
 Computer, Commodore's C128
 by John Richardson.....Dec 85
 Computer, The Commodore Plus /4
 by Eric Grevstad.....Mar 85
 Computer, Heath/Zenith's New IBM-
 Compatible Personal
 by Charles Rubenstein.....Jan 85
 Computer, Tandy's New Model 1000
 by Eric Grevstad.....May 85
 Frequency/Period Meter, Dick Smith's
 Digital by J. Daniel Gifford.....Dec 85
 Graphics Tablet, Suncom
 by Charles Rubenstein.....Aug 85
 Interface Kit, CompuLogic RS-232
 by Fred Blechman.....Apr 85
 Junior, A Second Chance for
 by John M. Woram.....Nov 84
 Light Pen, Tech-Sketch Apple Computer
 by Charles Rubenstein.....Nov 84
 Modem, AT&T Model 4000 External
 by Charles Rubenstein.....May 85
 Multimeter, Beckman DM50 Digital
 by Alexander W. Burawa.....Jun 85
 Multimeter, Beckman HD110T Handheld
 Digital by Alexander W. Burawa...Nov 84
 Printer, Juki 6000 Daisywheel
 by Joseph Peters.....Oct 85
 Printer, Star Micronics "Power Type"
 Daisywheel by Fred Blechman...Oct 84
 Processor-Controller, Sansui AV-77
 by Len Feldman.....Feb 85
 Receiver, Pioneer SX-V90 Stereo
 by Len Feldman.....Nov 84
 Receiver, Yamaha R-9: Do-it-all Audio/Video
 by Len Feldman.....Nov 85
 RS-232 Switches: IQ Industries Smart Cable;
 Litek Hacker Switch; Tigertronics Model
 S-8 RS232 Switch
 by Fred Blechman.....Sep 85
 Satellite TV Receiver, Regency SR5000 Home
 by Stan Prentiss.....Jun 85
 Scope Multiplexer, Global Specialties Model
 8001 by Stan Prentiss.....Nov 85
 Spectrum Analyzer, Heath's AD-1308 Real-
 Time Lab Analysis
 by Len Feldman.....Mar 85
 Kit Report
 by Alexander W. Burawa.....Apr 85
 Time Connection, The
 by Fred Blechman.....May 85
 Tracer, Heath IT-2232 Component
 by Alexander W. Burawa.....Oct 84

Transmitter, Audio Whizz Wireless Sound
by Fred Blechman Aug 85

Tuner, Yamaha T-80 AM/FM-Stereo
by Len Feldman Jan 85

TV Receiver/Computer Monitor, GE's Color
by Stan Prentiss Jun 85

TV Receiver/Monitor, Sony KV-20XBR Color
by Stan Prentiss May 85

TV Receiver/Monitor, RCA's FLR2622" Color
by Stan Prentiss Dec 85

VCR, JVC VHS Hi-Fi
by Len Feldman Oct 84

VCR, Magnavox Portable VHS System
by Stan Prentiss Sep 85

VCR, Mitsubishi HS-400UR
by Stan Prentiss Dec 84

VCR, RCA's VKP900 Convertible
by Stan Prentiss Mar 85

VCR, Samsung VT-210T VHS
by Stan Prentiss Jul 85

VCR, Sanyo VCR3 Mini-Size Tabletop
by Stan Prentiss Nov 84

VCR, Sharp VC-5F7U VHS Hi-Fi
by Stan Prentiss Oct 85

VCR Accessory, Vidicraft's CCU-120
by Stan Prentiss Apr 85

Projects

Audio Amplifier, Testbench
by C.R. Fischer Oct 85

Auto Thieves, How To Short-Circuit
by Anthony J. Caristi Nov 84

Beeper, A Pilot-Lamp
by Dan Becker May 85

Circuit Boards, "Easy Circuit" Way to Make
by Harold Wright Mar 85

Circuit Design From Scratch
by Jules Gilder

Water Pump Controller Nov 84

Car Anti-Theft Alarm Feb 85

EPROM Tester Apr 85

Coil Tester, A Universal
by TJ Byers Oct 84

Communications System, A Simple Cable
by Duane M. Perkins Sep 85

Computer Clutter, Cure
by Jeffrey I. Lackey Oct 85

Dress Up Your Projects
by C.R. Ball Apr 85

FM Broadcasting, Discover the "Hidden
World" of
by Gary McClellan Dec 85

Frustrator, The
by Anthony J. Caristi Mar 85

Fuel Miser, Heating Costs too High?, Try a
by Anthony J. Caristi Oct 84

Gas Detector, Portable
by Larry D. Gray Jul 85

Generator, A High-Frequency Dual-Pulse
by Desi Stelling Dec 85

Generator, Low-Frequency Dual-Pulse
by Duane M. Perkins Jul 85

Humidity Control, A Digital
by Eugene Weber Jan 85

Impedance Bridge, A Simple
by William R. Hoffman Nov 85

Interface Device, Experimenter's
K.R. & D.M. Bonnett Apr 85/May 85

Interface Device, Using the Experimenter's
by D.M. & K.R. Bonnett Sep 85

Light Dissolver, A Solid-State
by Imre Gorgenyi Nov 85

Logic Analyzer, Store Soft: A 16-Bit
by Desmond Stelling Sep 85

Looker, The by J. Daniel Gifford Aug 85

Microwave Leak Detector
by Ralph Neal May 85

Oil-Furnace Controller, An Advanced
by Duane M. Perkins Oct 85

Power Controller, A Computer System
by Paul M. Spannbauser Nov 85

Power Supply, Experimenter's Multi-Voltage
by William R. Hoffman May 85

Radio Control System, Experimenters
by Robert C. Frosthalm Aug 85

Rear End, A Universal
by Joseph J. Carr Apr 85

Remote Pause Switch, VCR Wireless
by Rich Vettel Oct 84

Santa Switch, A
by Rick Vettel Dec 84

Stereo & Mono Together
by Michael A. Covington Jan 85

Street Number Sign, An Automatic LED
by Hank Olson Mar 85

Surge Protection
by TJ Byers Nov 84

"Surround Sound" Enhancer
by John H. Roberts Feb 85

Tachometer for Any Automobile, A Bargraph
by Steve Pence Dec 84

Teleguard, The
by Anthony J. Caristi Jun 85/Jul 85

Teleguard, Solid-State Sensing Moduels for
by Anthony J. Caristi Aug 85

Telephone Ringer, A Super Musical
by Steve Lympany Nov 85

Thermometer Accessory, A °C/°F
by Bill Owen Oct 85

Timebase/Dividers, Programmable
by C.R. Ball Jr. Jan 85

Touchmaster, The
by Daniel Gifford Dec 85

True-rms Adapter, A
by John T. Bailey Jun 85

Voltage Standards, Precision
by Joseph J. Carr Apr 85

Test Equipment & Servicing

Audio Amplifier, Testbench
by C.R. Fischer Oct 85

Beckman DM50 Digital Multimeter
by Alexander W. Burawa Jun 85

Beckman HD110T Digital Multimeter
by Alexander W. Burawa Nov 84

Coil Tester, A Universal
by TJ Byers Oct 84

Frequency/Period Meter, Dick Smith's
Digital by J. Daniel Gifford Dec 85

Gas Detector, Portable
by Larry D. Gray Jul 85

Generator, A High-Frequency Dual-Pulse
by Desi Stelling Dec 85

Generator, Low-Frequency Dual-Pulse
by Duane M. Perkins Jul 85

Global Specialties 8001 Scope Multiplexer
by Stan Prentiss Nov 85

Heath IT-2232 Component Tracer
by Alexander W. Burawa Oct 84

Heath AD-1308 Real-Time Spectrum Analyzer
Laboratory Report
by Len Feldman Mar 85

Kit Report
by Alexander W. Burawa Apr 85

Impedance Bridge, A Simple
by William R. Hoffman Nov 85

Logic Analyzer, Store Soft: A 16-Bit
by Desmond Stelling Sep 85

Looker, The
by J. Daniel Gifford Aug 85

Microwave Leak Detector
by Ralph Neal May 85

Multimeters, Using & Misusing
by Gary McClellan Dec 84

Oscilloscope User's Guide
by Vaughn D. Martin Jun 85/Jul 85

Power Supply, Experimenter's Multi-Voltage
by William R. Hoffman May 85

Service Tips, Connector Replacement Sep 85

Tachometer for Any Automobile, A Bargraph
by Steve Pence Dec 84

Thermometer Accessory, A °C/°F
by Bill Owen Oct 85

Timebase/Dividers, Programmable
by C.R. Ball Jan 85

True-rms Adapter, A
by John T. Bailey Jun 85

Voltage Standards, Precision
by Joseph J. Carr Apr 85

Video

Audio & Video in Your Future
by Len Feldman Sep 85

Camcorder, Kodak Model 2400 8-mm
by Stan Prentiss Jan 85

Camcorder, Zenith Model VM6000 VHS
by Stan Prentiss Feb 85

Camcorders—A Revolution in Home Movie
Making by Len Feldman Nov 84

Color From a Monochrome CRT
by Vaughn D. Martin Jan 85

Color TV, A New Era of Go-Anywhere
by Alexander W. Burawa Oct 84

Color TV Receivers for 1985, A Showcase of
by Stan Prentiss Jan 85

Color Video Monitors for Personal Computers
by Fred Blechman Dec 84

"Digital" Color TV Arrives!
by Stan Prentiss Apr 85

Ku Band, RCA Goes
by Stan Prentiss Nov 85

Processor-Controller, Sansui AV-77
by Len Feldman Feb 85

Remote Pause Switch, VCR Wireless
by Rich Vettel Oct 84

Satellite TV—The "Quiet" Video Revolution
by Stan Prentiss Dec 84

Satellite TV for 1985 and Beyond, Home
by Stan Prentiss Feb 85

Satellite News, TVRO
by Stan Prentiss Aug 85

Satellite TV Receiver, Regency SR5000 Home
by Stan Prentiss Jun 85

Satellite TV Receiver, Evaluating a Home
by Stan Prentiss Jun 85

TV, Hang-on-the-Wall
by Alexander W. Burawa Jun 85

TV Receiver/Computer Monitor, GE's Color by Stan Prentiss..... Jun 85
 TV Receiver/Monitor, Sony KV-20XBR Color by Stan Prentiss..... May 85
 VCR, JVC VHS Hi-Fi by Len Feldman..... Oct 84
 VCR, Magnavox Portable VHS System by Stan Prentiss..... Sep 85
 VCR, Mitsubishi HS-400UR VHS by Stan Prentiss..... Dec 84

VCR, RCA VKP900 Convertible VHS by Stan Prentiss..... Mar 85
 VCR, Samsung VT-210T VHS by Stan Prentiss..... Jul 85
 VCR, Sanyo VCR3 Mini-Size Tabletop VHS by Stan Prentiss..... Nov 84
 VCR, Sharp VC-5F7U VHS Hi-Fi by Len Feldman..... Oct 85
 VCR Accessory, Vidircraft CCU-120 by Stan Prentiss..... Apr 85

BACK ISSUE ORDER FORM

Please send me the following issues of *Modern Electronics* @ \$2.50 each:

Month(s) & Year(s): _____

Number ordered @ \$2.50 each: _____

Total Payment Enclosed: _____
 (Check or M.O. only.)

NAME: _____

COMPANY (Optional): _____

STREET ADDRESS: _____

CITY: _____ STATE: _____ ZIP: _____

(Your order may be tax deductible.)

cently calibrated Hewlett-Packard frequency counter, which was then used for comparison purposes. When checked against a variety of sources from 100 Hz to 450 MHz, the DSE meter matched the 6-times-costlier HP unit within 3 counts up to about 150 MHz, slipping to about a 25-count difference at 450 MHz—a minuscule 5 part-per-million difference.

The 0-50-MHz input has an impedance of 1 megohm, and a sensitivity of 10 mV up to 30 MHz, rising to about 100 mV at 50 MHz. The 10-500 MHz input has an impedance of 75 ohms; sensitivity was not specified, but in testing was shown to be better than 20 mV at 350 MHz. The minimum frequency that the meter would respond accurately to was about 25 Hz.

The only thing that the DSE Period/Frequency Meter lacks is a probe. (A 100 MHz probe set, #Q-1245, with a variety of accessories is available from Dick Smith for \$29.95). Even with this minor shortcoming, it's hard to call this frequency meter anything but an outstanding value. (All are available from Dick Smith Electronics, P.O. Box 8021, Redwood City, CA 94063. 1-800-332-5373).

—J. Daniel Gifford

CIRCLE NO. 131 ON FREE INFORMATION CARD



**508 Central Ave.
Westfield, N.J. 07090
(201) 654-6008**

<p>15 Pin Header & Mating Socket, Vert MT/PC</p> <p>155' Centers 5/1.00 Crystal Clock Oscillator 50 Miniature Speaker, 2", 8 OHM 50</p> <p>Coils For Radio Elec's Feb. 84 TV Project, Toko #S T-1, T-2, L-1 (12uH) & L-2 (.071uH) Complete Set Of All 4 Coils 8.50</p> <p>MC1330—Prime (Moto) 2/1.00 BFO 85 Transistor 1.50 Disc Caps. 001uF 20/1.00 74123-Prime (Nat) 3/1.00 470uF 35V (Radial) 3/1.00 470uF 16V (Axial) 4/1.00 2N3904 10/1.00 2N3906 10/1.00 1N914 40/1.00 1N4148 40/1.00 1N5231B (5.1V Zener Diode) 5/1.00 Voltage Regulators (Prime TO-220) 7805, 7812, 7824, 7905, 7912, Mix or Match 3/1.00 Mica Insulators For TO-220 Pkg 20/1.00 Voltage Reg's (Unmarked, 60% Prime) May Include Positive/Neg & Adjust 15/1.00 78L08 Voltage Reg (DM106, TO-92) 20/1.00 PN2222A 20/1.00 2N3055 50 2N5308 20/1.00</p> <p>15 Cent (.15) Per IC TTL</p> <p>7403 7442 74126 74126 7404 7450 74151 74151 7410 7474 74163 74163 7437 7476 74365 74365 7438 7495 74393 74393 7440 74107</p> <p>15 Cent (.15) Per IC 74LSXX</p> <p>74LS02 74LS32 74LS158 74LS158 74LS08 74LS74 74LS257 74LS257 74LS10 74LS86 74LS257 74LS257 74LS20 74LS153 74LS273 74LS273</p> <p>20 Cent (.20) Per IC CMOS</p> <p>4001B, 4011B, 4050B 4050B MC838 (DTL) 10/1.00 Opto Isolator (H11G2-6PIN DIP) Specs 40 2716 EProm 1.45 2732 EProm 1.95 2764 EProm 2.45 27128 EPROM 4.95 256K Dram 150ns Prime Hitachi (Ideal For Mac Upgrades & Expansion Projects) 4.95 8243 (I/O Expander IC) W/Specs 2.95 UDN 6118 (Display Driver IC) Specs 85 UDN 6128 85 UCN 4116B-Osc/Freq Div Clock IC Specs 5/1 UCN 4801 (8 Chan Bt-Mos Latch/Driver) 1.00 LM339 45 LM380 (ULN280) 45 555 Timers (TI) 4/1.00 NE556 (Dual Timer-Moto) 50 741J Op Amp (Mini Dip) Hi Rel Pkg 4/1.00 LM1310 (Unmarked, Tested Prime) 50</p>	<p>LM1889 95 LM3900 45 AM/FM Radio IC (#2204 W/Specs/Hobby) 15/1.00</p> <p>IC Sockets</p> <p>8 PIN/ .07 14 PIN/ .13 16 PIN/ .15 16 PIN/ .15 18 PIN/ .17 20 PIN/ .19 22 PIN/ .21 24 PIN/ .22 28 PIN/ .24 40 PIN/ .39 7 Segment Display (3 Common Cath) 15 7 Segment Display (6 Common An) 65 Tri State LED's 3/1.00 Jumbo Red LED's Diffused Lens, Prime (1) 1.00 All 100K Prime 15/51, 100/56, 1.000/57.50 15/1.00 LED Mounting Clips & Rings 15/1.00 Texas Inst/ #994A Keyboard-Inc/Data For Pns Made When Each Key Depressed 4.95 Dip Switch-12 Position 2/1.00 Dip Switch-8 Position 4/1.00 Keyboard Push Button Tops 30/1.00 Audio Cable 30 Feet/1.00 22AWG Wire 50 Feet/1.00 27AWG Wire 50 Feet/1.00 Mini Lubricator (& Lubricant) 1.00 Molex Pins (7 Pin/Strp) 100/\$2.50/54, 1K/56 2.69 Clock Module-Crystal Controlled (Green) 2.69 Display/12VDC/Time Set Switches/Data 4.95 Rotary Switch (5 Position, 5A 125V) 3/1.00 Giant Alpha Numeric Display 1-1/2" x 2" 7X5 (35 Total) Red LED Matrix/Specs 4.95 11 LED Bar Graph Display 2-3/4" Rect 1.00 LED's (Specify Red, Gr, Amber) Specs 2.69 Seven Amp (7) Tapped Transformer Can Be Wired For (7.5V, 9V, 15V, 18V) Reg Spg 2.95 Wall Plug Transformer-24V 525mA 1.50 Zener Diodes 13V 1W Glass 30/1.00 6.3V 1.2A Transformer 1.20 Mini Audio Transformers 10/1.00 1N4007 20/1.00 1N5059 (200V 1 Amp) 15/1.00 1N5060 (400V 1 Amp) 10/1.00 Zener Diodes 20V 1W 30/1.00 Zener Diodes 13V 1W Glass 30/1.00 2560 0K Crystal 50 3.579545 Color Burst Crystal (HC-18) 50 1.0 Mhz Crystal 1.95 6.0 Mhz Crystal 1.95 TO-5 Heat Sinks (Bern) 10/1.00 TO-18 Heat Sinks (Bern) 10/1.00</p> <p>Super Sub-Mini Ceramic Caps (All 100V)</p> <p>0015uF 100V (152) 30/1.00 0022uF 100V (182) 30/1.00 0027uF 100V (272) 30/1.00 0033uF 100V (332) 30/1.00 0039uF 100V (392) 30/1.00 0056uF 100V (562) 30/1.00 0082uF 100V (822) 30/1.00 47uF 40V Lytic (Radial) 20/1.00 47uF 25V Lytic (Radial) 10/1.00 1000uF 18V Twist Lock 1.00 3200uF 50V (Ideal For Power Supplies) 1.00 5600uF 25V (Comp Grade 3-5/8" X1) 3/1.00 1uF 50V Monolithics 10/1.00 22uF 50V Monolithics 20/1.00</p>	<p>Chip Caps-Set of 4, 2 Each 2.7 & 3.3pF 1.00 33uF 100V Dip Mylar 10/1.00 1,000 PC Resistor Ass't (30 Values) 1/2W \$3 5/1.00 Pots-1 Meg, Linear Taper 7/10.00 Motion Defector Bds (Inc IC-\$2) 7/10.00 Mot Det (IC Only-ULN232A) 3/5-2-20/10.00 1.95 Project Box/Lid For Deflector 25 Miniature Speaker For Deflector 15/1.00 Extensive Construction Article For Det. \$1 4.95 TV Knobs 2.95 Ammeter (0-15 A.C. Amperes) 50 Volt/OHM Meter MVMNT (0-1K OHM, 0-300V) 2.95 6V Miniature Gear Motor 50 RF Chokes 1.8uH, 8.2uH, 12uH, 22uH 10/1.00 50 22/44 Pin Edge Card Connector 75 34 Pin Connector (For Drives) W/Hood 95 BNC "T" Connector (UG-274) 10/1.00 Mixed Connector Ass't 1.50 15AMP 50V Bridge (GI, TO-5 Pkg) 1.50 25AMP 200V Bridge (Solder Lug Term) 1.50 Zenith TV Replacement IC Special \$1 Each 221-42, 221-43, 221-45, 221-48, 221-69, 221-78, 221-87, 221-96, 221-104, 221-105, 221-106, 221-140 2.50</p> <p>25D900 (Horiz Output W/Damper Diode)-2.95 25D1172B (Toshiba-Horiz Output Trans)-1.95 Winegard 4 Bay Bowtie UHF Antenna-19.50 IC Storage (Bag) Box (Holds) 30 IC's-1.75 Precision (Multi-Turn) Trim Pots (Copal) 100 OHM, 500 OHM, 1K, 2K, 5K, 10K, 20K, 50K, 100K, 200K, 500K, 1M, 85 Each-3/\$2 Pher PT-10V Hor Mt (Single Turn) Trimmers 100 OHM, 1K, 10K, 25K, 50K, 100K 4/\$1 Heat Sensitive Switch/150° C 10/1.00 Mixed Coil Ass't 10/1.00 Buzzers 3/1.00 Chip Resistor (6.8K) 20/1.00 Chip Resistor (470K) 20/1.00 Chip Cap (330pF) 20/1.00 Jumbo Red LED W/Built In Resistor-30/\$1 MPF 901 (Hobby Grade-60K, Good) 10/1.00 IC Ass't (Hobby Grade, Some Marked)-30/\$1</p> <p>74SC374-D Type Flip-Flop, Non/Inv 2.50 74SC533 Transparent Latch-Inverted 2.50 74SC534-D Type Flip-Flop, Inverted 2.50 74SC540 Octal Buffer/Line Driver-Inv 2.50 74SC541 Octal Buffer/Line Driver-N/Inv 2.50 74SC563 Transparent Latch, Inverted 2.50 74SC564-D Type Flip-Flop, Inverted 2.50 74SC573 Transparent Latch, Non/Inv 2.50 74SC574-D Type Flip-Flop, Non/Inv 2.50 Data Book For All Above #s 2.50</p> <p>Cypher IV Micro-Controller Kit- \$129.50</p> <ul style="list-style-type: none"> • 4 MHz 8-Bit Microprocessor (NAT 1N52073) • Control Basic Interpreter-On-Chip • Auto-Start Operation At Power-On • Fast 16-Bit Multiply And Divide • RS-232C Supports CRT & Serial Link • 24 Bit Directional I/O Lines (8255A) • RAM Memory-2K Expandable To 16K • EPROM Memory-Expandable To 16K • Built In EProm Programmer • Parr (Centronix) Printer Interface • Optional Real-Time Clock W/Backup <p>Pay TV Hardware Installation Kit Blow Out As Low As \$2.95 + \$3.50 Shipping Per Unit</p> <p>All Kits Contain 5 F Connectors, 300 to 75 OHM Baitun 300 OHM Terminal Block 2 Ft, 75 OHM Patch Cord 2 Ft 300 OHM Twin Lead, Nylon Cable Ties, And UHF Antenna</p> <p>Model #124-\$2.95 Includes All Of The Above Plus 25 Feet Coaxial Cable And Mounting Hardware For Indoor Wall/Ceiling Installation</p> <p>Model #480-\$2.95 Includes All Of The Above Plus 25 Feet Coaxial Cable And Attractive Expandable Pole/U Bolt For Easy Indoor Installation</p> <p>Model #484-\$3.95 Includes All Of The Above Plus 65 Feet Coaxial Cable And All Necessary U-Bolt Hardware</p>
---	--	--

20 Cent (.20) 74SCXX Series Special

- Octal Interface Circuits
- Equivalent To 74LSXX Series
- Low Power ISO-CMOS Technology
- Short Propagation Delay
- Improved Noise Margins
- High Current, Sink/Source Capability

74SC137-1 Of 8 Inverted Decoder, Latched
 74SC138-1 Of 8 Inverted Decoder
 74SC139-1 Of 4 Inverted Decoder
 74SC237-1 Of 8 Non-Inverted, Latched
 74SC238-1 Of 8 Non-Inverted
 74SC239-1 Of 4 Non-Inverted
 74SC240-Octal Buffer/Line Driver-Inv
 74SC241-Octal Buffer/Line Driver-N/Inv
 74SC244-Octal Buffer/Line Driver-N/Inv
 74SC245-Octal Bus Transceiver Non/Inv
 74SC373-Transparent Latch-Non/Inv

MODEL 705 Digital Multimeter

DC Voltage	100uV to 1000V
AC Voltage	100uV to 750V
DC Current	0.1uA to 10A
AC Current	0.1uA to 10A
Hi-Z Resistance	0.1Ω to 20MΩ
Capacitance	1pF to 20uF
Diode Test	forward voltage testing
HxZ Test	transistor testing

\$51.95

UHF-TV PREAMP
 (As featured in Radio Electronics March/May articles, 1982)

This inexpensive antenna mounted pre-amp can add more than 25 dB of gain to your system. Lots of satisfied customers and repeat orders for this high quality kit, which includes all component parts, PC BD, Case, Power Supply and Baitun \$34.50 Assembled Version \$37.50

Terms: MICRO-MART accepts Visa, MC and telephone COD's. Minimum order \$10.00. Shipping—U.S. orders, \$2.00. Canada and other countries \$3.50 (includes ins.). Shipping rate adjusted where applicable. NJ residents add 6% sales tax.

MICRO-MART • 508 CENTRAL AVE., WESTFIELD, NJ 07090 • (201) 654-6008

CIRCLE 58 ON FREE INFORMATION CARD

85

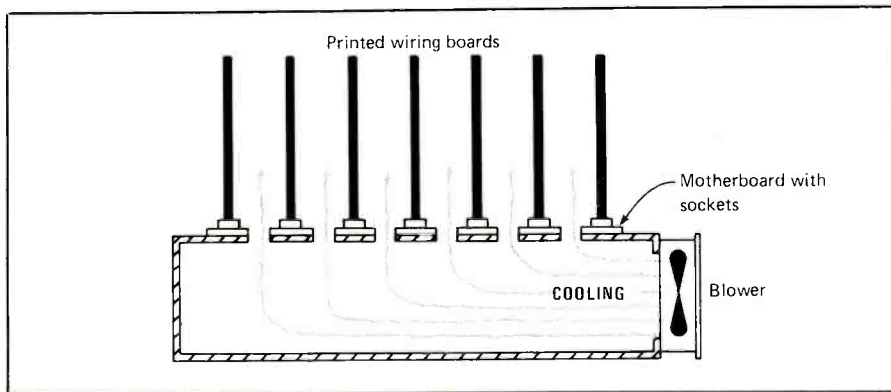

Fig. 5. A home-brew chassis to hold a motherboard with a blower fan circulating cool air, up through openings and across components on PWBs.

to see right and wrong airflow directions. Obviously, air coming in from the sides is able to remove heat from more of the PWBs more effectively.

Figure 5 shows a method used by a friend of mine who built a home-designed 6502-based computer. He used a large metal chassis with a motherboard mounted on it to hold the PWBs. There were 0.75" holes cut in both the chassis top and the motherboard to admit air between the boards. Although only one hole is pictured between each board in this sideview, there were four per row in the actual project. Air from the blower flowed up through the holes and across the electronics components on the PWBs.

Temperature Measurement

In some cases we will want to provide either temperature monitoring on a continuous basis or for temporary measurement of the actual operating temperatures. Although there are elegant methods using thermocouple junctions, we can use a simple, low-cost PN junction temperature sensor. National Semiconductor and others manufacture such devices. Figure 6 shows the simplest circuit for the National Semiconductor LM-335 diode device. The LM-335 will measure temperature over the range -10 to $+100$ °C. In the circuit shown, the output across the diode

will be 10 millivolts per degree Kelvin ($\text{mV}/^\circ\text{K}$). Degrees Kelvin are the same as degrees Celsius, except they are referenced to "absolute zero" instead of the freezing point of water (note: 0 °C = 273 °K).

If you merely want to measure the temperature, then install the LM-335 "diode" on the PWB and solder-tack the wires to it. The temperature can then be measured with an ordinary voltmeter. Otherwise, mount it permanently on the PWB. Another application is to use the voltage from the LM-335 to turn on a fan or an alarm when the temperature reaches a certain critical limit. One commercial computer uses one of these devices on each PWB, and then moni-

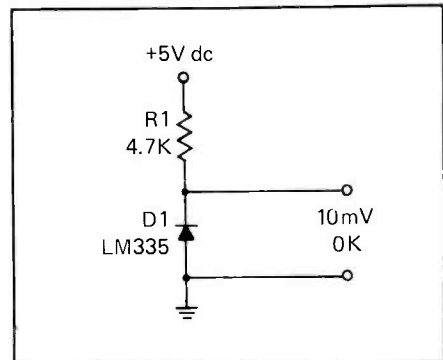

Fig. 6. An LM-335 is used in a simple circuit for monitoring actual operating temperatures.

tors all 16 of them in an analog to digital (A/D) converter connected to the computer. A shut-down program turned off the machine in an orderly (data saving) manner when the temperature got too high.

Conclusion

Always keep in mind that heat is the great destroyer of electronic components. If a piece of equipment runs too hot, then the result might well be flakey operation and/or frequent breakdowns. The simple methods shown in this article will permit you to build and/or modify projects to gain the longest and most reliable use possible. **ME**

Commodore's C128 Computer (from page 33)

Problems arise only if you start to think in terms of business or advanced educational use because the "heavyweight" programs simply don't exist and how soon they will appear, if ever, is an unknown factor.

On the other hand, if you already work with a CP/M machine and you're happy with the programs, and if the C128 supports your CP/M machine, and you're attracted to the allure of combining C-64 color programming within one machine, the

new C128 may be your ticket to two good computing worlds.

Our experience indicates that you're free and clear with Osborne I CP/M programs on double-density disks, and much, but not all of Kaypro's version. Keep in mind, too, that programs with direct calls to the BIOS won't work properly.

Summing up, it's too bad the C128 wasn't here a year or so ago. Now it may be too much too late to duplicate the C-64's wide success. **ME**

The Laser At Twenty-Five

different methods of doing this have been developed, all of which provide a threadlike active region of GaAs immersed in AlGaAs. The result is laser diodes that have threshold currents measured in milliamperes instead of amperes. Though these lasers are low-power devices that usually emit a few milliwatts, they have many practical applications in communications, optical radar, electrostatic printers, and data recording and readout. Figure 8 shows the internal construction of a particularly simple kind of DH laser developed by Sharp Corp. DH lasers whose internal structure is more complex can provide lower lasing thresholds and tighter beam divergences.

Though DH lasers capable of continuous operation were first invented in 1970, until recently their high cost has precluded their widespread use. The commercial success of compact-disk (CD) audio recording has made a significant impact on the demand for continuously operating (CW) laser diodes. In very large volume, such lasers can be purchased for less than \$8 each. The single-quantity price of some Sharp laser diodes is as low as \$26. The beam emitted by these lasers is much more coherent than that generated by older SH and DH and even the venerable HeNe laser. Figure 9 shows two Mitsubishi DH laser diodes intended for CD players that emit radiation having a wavelength of 780 nanometers.

Though most DH lasers are low-power devices, Spectra Diode Laboratories has developed experimental DH devices containing a parallel array of forty individual stripe-like lasers that emit a total of 2.6 continuous watts. A commercially available CW laser made by this company that couples 100 milliwatts into an optical fiber is shown in Fig. 10. Since the market for high-power laser diodes is very limited, they are produced in small quantities and their price is correspondingly high.

Laser diodes can be made from

semiconductors other than GaAs/AlGaAs. Indium gallium arsenide, for instance, is used to make lasers that emit radiation having a wavelength of 1.3 microns or more. Such lasers are well-suited for use in optical-fiber communications.

Further Reading

The various kinds of lasers are so numerous that we don't have enough space to list all of them here. There are excimer lasers and free-electron lasers and lasers that incorporate as active media colorful organic dyes and the ionized gases of metals. There are also the plumber's nightmares known as chemical lasers. In one such device, nitrogen gas is heated by an electric arc and then mixed with highly corrosive sulfur hexafluoride. The hot mixture is jetted through an array of nozzles, and hydrogen is injected into the exhaust. Laser action occurs when the highly poisonous exhaust passes between a pair of mirrors.

Many books and articles about lasers can be found in any good library. A very simple introduction I have written is *Lasers, The Incredible Light Machines* (David McKay Co., 1977). For an excellent understanding of laser principles at a more technical level, see A.E. Siegman's *An Introduction to Lasers and Masers* (McGraw-Hill, 1971). Though this book may seem dated, Professor Siegman's text is still among the best. An outstanding recent book is *The Hologram Book* by Joseph E. Kasper and Steven A. Feller (Prentice-Hall, 1985). This book provides an excellent introduction to the nature of laser light and gives detailed instructions for making holograms.

Several trade magazines are devoted to lasers and related topics. These include *Lasers & Applications*, *Laser Focus* and *Photonics Spectra*. These magazines publish annual directories that describe in detail the lasers manufactured by dozens of companies.

The May 1985 *Lasers & Applications* featured as its cover photo a life-size hologram of the first ruby laser. **ME**

Forrest Mims has worked with lasers for 20 years, first as a development engineer at the Laser Division of the Air Force Weapons Laboratory and then as an independent experimenter. Forrest has had many fascinating laser-related experiences, some of which he has related in Siliconconnections, his latest book published by McGraw-Hill. —Editor

A Great Gift Idea. Send **MODERN ELECTRONICS** To A Friend.

AMAZING
SCIENTIFIC and ELECTRONIC
DEVICES

LASER DEVICES	
• LC5 BURNING CUTTING CO2 LASER	\$20.00
• RUB3 RUBY LASER RAY PISTOL	20.00
• LRG3 IR LASER RIFLE/PISTOL	10.00
• LGU3 VISIBLE RED LASER RIFLE	10.00
• LBT1 LIGHT BEAM COMMUNICATOR	10.00
• LHC2 BEGINNER simulated VISIBLE LASER	5.00
SCIENTIFIC & ELECT	
• TCL3 SOLID STATE TESLA COIL 35KV	7.00
• BTC3 250 THOUSAND VOLT TESLA COIL	10.00
• BTC5 1.5 MILLION VOLT TESLA COIL	15.00
• GRA1 GRAVITY GENERATOR	10.00
• IOG3 ION RAY FORCE FIELD GUN	10.00
• PTG1 PLASMA TORNADO GENERATOR	10.00
ULTRASONIC ACOUSTICAL	
• PPF1 PHASOR PAIN FIELD GENERATOR	15.00
• PSP3 PHASOR SHOCK WAVE PISTOL	8.00
• IPG5 POCKET PAIN FIELD GENERATOR	8.00
• RAT2 RAT AND PEST ELIMINATOR	7.00
• HT9 HIGH FREQ LISTENING DEVICE	8.00
SECURITY & PROTECTION	
• BLS1 BLASTER WAND	10.00
• PPG1 PHASOR PROPERTY GUARD	15.00
• MFT1 MINI VOICE XMTR 2.3 MILE	7.00
• INF1 INFINITY TRANSMITTER	15.00
• STG1 STUN AND PARALYZING GUN	7.00
• SD5 SEE-IN-DARK NIGHT EYE	10.00

WE STOCK ALL PARTS NECESSARY FOR CONSTRUCTION OF THE ABOVE PROJECTS

• CATALOG CONTAINING HUNDREDS MORE OF ALL NEW AMAZING and FASCINATING PLANS EASY TO BUILD KITS AND ASSEMBLED ITEMS \$1.00 CATALOG INCLUDED FREE WITH ANY OF THE ABOVE PROJECT PLANS. SEND CASH, CHECK, MO, VISA, MC TO:

INFORMATION UNLIMITED
P.O. BOX 716, DEPT. ME3, AMHERST, NH 03031

CIRCLE #6 ON FREE INFORMATION CARD

MODERN ELECTRONICS MART

Classified Commercial Rates: 90¢ per word, 15-word minimum (\$13.50) prepaid. (Word count includes name and address, ZIP code and abbreviation each count as one word; P.O. Box number and telephone number count as two words each.) Indicate free category heading. A special heading is available for a \$6 surcharge. *First word only is set boldface caps at no charge.* Add 20% for additional boldface words.

Mart Display Rates: 1" x 1 col., \$120; 2" x 1 col., \$230; 3" x 1 col., \$330. Prepayment discount 5% for 6 issues; 10% for 12 issues prepaid at once.

(All advertisers with PO Box addresses must supply permanent address and telephone number. Copy is subject to publisher approval.)

Mailing Information: Copy must be received by the publisher by the 20th of the third month preceding the cover date. Send Advertising material with check or money order to: Modern Electronics, Classified Department, 76 North Broadway, Hicksville, NY 11801.

ELECTRONICS

LOW priced components - unusual surplus items. Free flyer. ELECTRONIX LTD, 3214 South Norton, Sioux Falls, SD 57105.

PRESSURE SENSORS. Xducer alone, \$11.00. With 0-10v electronics, \$19.95. Sensitivities range from 0.1"-1.0" H₂O F/S (to more than 0-100psi F/S. Send SASE to: SYNODULE ELECTRONICS, 38 Montvale Ave., Stoneham, MA 02180.

ELECTRONIC Parts. 600 resistors, capacitors, diodes. All new, long leads. \$6.00 ppd. Star-Tronics, Box 683, McMinnville, OR 97128.

CAR stereo, C.B.'s, radar detectors, alarms, accessories. Dirt cheap! Free catalog. **ELECTROMANIA**, 51B Sunrise Highway, Lynbrook, NY 11563.

PRINTED CIRCUIT BOARDS - TORCCC

Electronics will print any schematic, 6" by 9" maximum, on a circuit board; or design any Electronic Circuit, according to your specifications (must fit on a 3" by 4" PC board), either service \$1.50 (For larger circuits, add \$1.25 per additional 50 square inches, per service.) Also, TORCCC will design, from your specifications, a schematic and print it on a circuit board for \$2.50. Mail circuit specifications or schematic(s) and a check to: TORCCC, 2161 North California, Chicago, Illinois 60647.

ELECTRONIC CATALOG. Over 4,500 items. Parts & components. Everything needed by the hobbyist or technician. \$2.00 postage & handling (U.S. Only), refundable with first \$15.00 order. T&M Electronics, Dept. M, 472 East Main St., Patchogue, NY 11772. (516) 289-2520.

DIGITAL KLOCK KIT plays 1-of-12 melodies each quarter hour. Displays time, date, and other features. Send \$2.25 for complete assembly plans and pricing to **KERBER KLOCK CO.**, 36117 Hillcrest, Eastlake, Ohio 44094.

PICTURE Flyer lists quality electronic surplus at low prices. Since 1970. Send for the last 3 issues. Star-Tronics, Box 683, McMinnville, OR 97128.

ELECTRONIC Test equipment, Parts, lowest prices. Free catalog. EF Electronics, 10 Alton, Aurora, IL 60538.

AUTOMOTIVE radio replacement parts. Delco, Ford, Chrysler, Panasonic, etc. Laran Electronics, 3768 Boston Rd., Bronx, NY 10469 (212) 881-9600; NY State: 800-446-4430; National: 800-223-8314.

VIDEO

FREE PAY-TV RECEPTION. "How-To" Book \$5.00. DIPTRONICS, Box 80-M3, Lake Hiawatha, NJ 07034.

CABLE and SUBSCRIPTION TV secret manual. Build your own **DESCRAMBLERS**, Converters. Instructions, schematics for Sine Wave, Inband/Outland Gates Sync, SSAVI (HBO, Showtime, Cinemax, UHF, etc.) Send \$8.95 to **CABLETRONICS**, Box 30502ME, Bethesda, MD 20814.

CABLE TV Secrets - the outlaw publication the Cable Companies tried to Ban. HBO, Movie Channel, Showtime, Descramblers, Converters, etc. Suppliers list included. \$8.95. Cable Facts, Box 711-ME, Pataskala, Ohio 43062.

Durable Desoldering Tools

Sterling™ Brand from Wahl Clipper Corporation

- High quality at a low price. You pay a little and get a lot.
- Anti-static or static-free desoldering tools available. End all worries about static electricity harming your components.
- Replaceable tips last twice as long as regular teflon tips (approximately 2,000 suction).
- Easy one-hand operation. Grooved handgrip and curved thumb-holder reduce fatigue during long desoldering operations.
- Self-cleaning. Plunger clears the tip of hardened solder. You'll always get a high-vacuum suction.

For more information on anti-static or static-free desoldering tools, or our full line of soldering irons, call or write.



WAHL CLIPPER CORPORATION

2900 Locust Street
Sterling, Illinois 61081
(815) 625-6525

Sterling™ is a trademark of Wahl Clipper Corporation.

QUALITY ETCHED PC BOARDS IN LESS THAN 5 MINUTES.

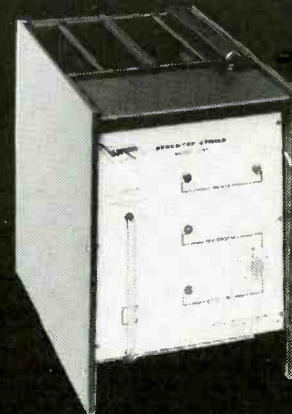

Convenient economical, high quality production of 12" x 12" panels is obtained using Kepro's Bench-Top Spray Etcher, only \$765. Kepro - the one stop source for all your Prototype and Short Run PCB needs.

kepro

kepro
Kepro Circuit Systems, Inc.

Write for full line catalog or call
1-800-325-3878 • 1-314-343-1630 (Missouri)

630 Axminster Drive • Fenton, MO 63026-2992

★ QUALITY PARTS ★ DISCOUNT PRICES ★ FAST SHIPPING!

ALL ELECTRONICS CORP.

SEND FOR
FREE
FALL 1985 CATALOG...
48 PAGES!

EDGE CONNECTORS

ALL ARE 1.56" SPACING.

- 22/44 EDGE CONNECTOR
PC style \$2.00 each
10 for \$18.00
- 22/44 EDGE CONNECTOR
solder lug style \$2.50 each
- 28/56 EDGE CONNECTOR
PC style \$2.50 each
10 for \$22.00
- 36/72 EDGE CONNECTOR
PC style \$3.00 each
- 43/86 EDGE CONNECTOR
PC style \$4.50 each

- ### TRANSISTORS
- 2N706 4 for \$1.00
 - 2N2222A 3 for \$1.00
 - PN2222A 4 for \$1.00
 - 2N2904 3 for \$1.00
 - 2N2904 3 for \$1.00
 - 2N2905 3 for \$1.00
 - MJ2955 \$1.50
 - 2N3055 \$1.00
 - PMD 10K40 \$1.00
 - TIP 121 75¢
 - TIP 125 75¢

- ### "SPECIAL PRICE" TRANSISTOR
- PN3569 TO-92 N.P.N. plastic transistor
100 for \$8.00
1000 for \$60.00
LARGE QUANTITIES AVAILABLE

- ### TRANSFORMERS
- 120 volt primaries
- 5.6 volts @ 750 ma. \$3.00
 - 6 volts @ 150 ma. \$1.25
 - 12 v.c.t. @ 200 ma. \$3.50
 - 18 volts @ 650 ma. \$2.00
 - 18 volts @ 1 amp \$4.50
 - 24 v.c.t. @ 200 ma. \$2.50
 - 24 v.c.t. @ 400 ma. \$3.00
 - 28 v.c.t. @ 15 amps \$20.00
 - 30 v.c.t. @ 2 amps \$5.00

- ### WALL TRANSFORMERS
- all plug directly into 120 vac outlet
- 4 VDC @ 70 ma. \$2.00
 - 6 VDC @ 500 ma. \$3.50
 - 6 VDC @ 750 ma. \$6.50
 - 9 VDC @ 500 ma. \$5.00
 - 12.5 VDC @ 265 ma. \$3.00
 - 24 VDC @ 250 ma. \$3.00
 - MULTI-VOLTAGE @ 500 ma. \$7.50
 - 3.4", 6.7", 9 or 12 VDC

- ### MINI-BOX
- Pomona #2104
- Heavy-duty black phenolic project box with cover and screws. 2 1/2" X 1 1/2" X 1 1/2"
- \$1.00 EACH

SOUND AND VIDEO MODULATOR FOR T.I. COMPUTER

T.I. # UM1381-1. Designed for use with T.I. computers. Can be used with video sources. Built-in A/B switch. Channel 3 or 4 selection switch. Operate on 12 vdc. Hook-up diagram included.

\$10.00 EACH



SLIM LINE COOLING FAN

Etri # 99XMI82 low noise fan. Measures 3 1/2" square x 1" deep. 21 cfm. 23 db. 1700 rpm.

SPECIAL PRICE... \$12.50 each



2K 10 TURN MULTI-TURN POT

SPECTROL #MOD 534-7161

\$5.00 EACH



SOLID STATE BUZZER

Star # SMB-06L
6 vdc
TTL compatible.

\$1.00 each
10 for \$9.00



12Vdc or 24Vdc POWER SUPPLY

DELTRON MODEL QD12/15-1.7
Dual plus and minus 12Vdc open frame power supply. Can be used as 24Vdc @ 1.5 amp. INPUT: either 115 Vac or 230 Vac. Fully regulated computer grade supply. 7" x 4 3/4" x 2 3/4"

\$12.50 each 10 for \$110.00

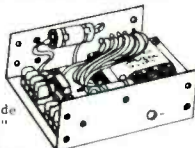

SUB-MINIATURE D TYPE CONNECTORS

- DB-15 PLUG \$2.75
- DB-15 SOCKET \$4.00
- DB-15 HOOD \$1.50
- DB-25 PLUG \$2.75
- DB-25 SOCKET \$3.50
- DB-25 HOOD \$1.25



8" P.A. SPEAKER

C.T.S. Model 8B3079
8 ohms coil
3.0 oz ferrite magnet
Typical response range: 100 - 10,000 Hz
Power rating 15 watts max
Drilled to mount line matching transformers.

\$5.00 each
CASE OF 8 SPEAKERS \$32.00



"SPECIAL PRICE" DUAL L.E.D. DISPLAYS

MAN-6640 orange, c.c. 75¢ each
FND-5148 red, c.c. 75¢ each
DL-527 red, c.a. 75¢ each



CASSETTE MECHANISM

New stereo cassette mechanism includes record/playback and erase heads 2-12VDC motors. drive belts, pulleys, 3-12VDC solenoids, pinch wheels and other mechanical parts. These parts used on our current model decks. would cost several times our selling price if purchased separately. Build your own audio or data recorder or use for spare parts. 5 1/4" X 3 1/2" X 3 1/8"

\$7.50 EACH 2 FOR \$12.50

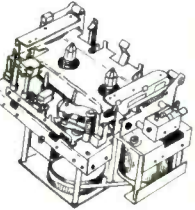

PARALLEL PRINTER CONNECTORS

Solder style 36 pin used on parallel data cables.

MALE CONNECTOR \$5.50 each
FEMALE CONNECTOR \$5.50 each



LINE CORDS

TWO WIRE

- 6' 18/2 SPT-1 flat 3 for \$1.00
- 6' 18/2 SPT-2 flat
- 6' 16/2 SJT round \$1.25 each

THREE WIRE

- 6' 18/3 flat \$1.50 each
- 8' 18/3 round \$2.00 each
- 8' 16/3 round \$4.00 each

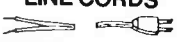

RELAYS

5 AMP SOLID STATE

Heinemann Electric #101-5A-140-SAMP
CONTROL: 3-32 vdc
LOAD: 140 vac 5 amp
SIZE 2" x 1" x 3/4"

\$5.00 each 10 for \$45.00

ULTRA-MINIATURE 5 VDC RELAY

Fujitsu # FBIR211NE005M20
High sensitivity
COIL: 120 ohms
CONTACTS: 1 amp
Mounts in 14 pin DIP socket

\$1.25 each 10 for \$10.00



3 1/2" SPEAKER

8 ohm impedance. Full range speaker. 8 oz magnet 4" diagonal mounting centers.

\$2.50 each 10 for \$20.00



SPRING LEVER TERMINALS

Two color coded terminals on a sturdy 2 3/4" x 3 3/4" bakelite plate. Great for speaker enclosures or power supplies.

\$1.00 each 10 for \$9.00



I.D.C. CONNECTORS

Will press fit on standard ribbon cable

- DB-25 PLUG \$6.25
- DB-25 Socket \$6.75
- 36 PIN MALE \$5.50
- 36 PIN FEMALE \$5.50



COMPUTER GRADE CAPACITORS

- 2,000 mfd. 200 VDC 1 1/4" DIA. x 5" HIGH \$2.00
- 3,600 mfd. 40 VDC 1 3/8" DIA. x 3 3/4" HIGH \$1.00
- 6,400 mfd. 60 VDC 1 3/8" DIA. x 4 1/4" HIGH \$2.50
- 9,700 mfd. 50 VDC 1 3/8" DIA. x 4 1/2" HIGH \$3.00
- 31,000 mfd. 15 VDC 1 3/4" DIA. x 4" HIGH \$2.50
- 72,000 mfd. 15 VDC 2" DIA. x 4 3/8" HIGH \$3.50
- 185,000 mfd. 6 VDC 2 1/2" DIA. x 4 1/2" HIGH \$1.50



MINIATURE 6 VDC RELAY



Aromat #RSD-6V
Super Small S.P.D.T. relay
GOLD cobalt contacts rated 1 amp @ 30 vdc. Highly sensitive. TTL direct drive possible. 120 ohm coil. Operate from 4 - 6 vdc.

COIL: 120 ohms \$1.50 each
1 7/16" x 1 3/32" x 1 7/16" 10 for \$13.50

13 VDC RELAY

CONTACTS: S.P.N.C
10 amp @ 120 vac
Energize coil to open contact.
COIL: 13 vdc 650 ohms

SPECIAL PRICE \$1.00 each

MINIATURE TOGGLE SWITCHES

ALL ARE RATED 5 AMPS @ 125 VAC

S.P.D.T. (on-on)	S.P.D.T. (on-off)	S.P.D.T. (on-off-on)
PC style non-threaded bushing. 75¢ each 10 for \$7.00	Solder lug terminals. \$1.00 each 10 for \$9.00 100 for \$80.00	Solder lug terminals. \$1.00 each 10 for \$9.00 100 for \$80.00
S.P.D.T. (on-off-on)	S.P.D.T. (on-on)	D.P.D.T. (on-on)
PC style non-threaded bushing. 75¢ each 10 for \$7.00	PC lugs threaded bushing. \$1.00 each 10 for \$9.00 100 for \$80.00	Solder lug terminals. \$2.00 each 10 for \$19.00 100 for \$180.00

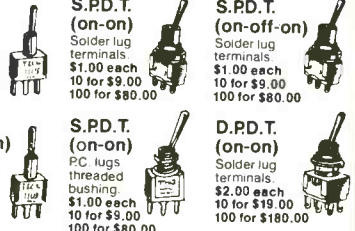

TWIST-LOCK CONNECTOR

Same as Switchcraft #12CL5M. 5 conductor in-line plug and chassis mount jack. Twist-lock style.

\$2.50/SET



TI SWITCHING POWER SUPPLY

Compact, well-regulated switching power supply designed to power Texas Instruments computer equipment.

INPUT: 14 - 25 vac @ 1 amp
OUTPUT: +12 vdc @ 350 ma.
+5 vdc @ 1.2 amp
-5 vdc @ 200 ma.

SIZE: 4 1/4" x 4 1/4" x 1 1/4" high \$5.00 each



13.8 VDC REGULATED POWER SUPPLY

These are solid state, fully regulated 13.8 vdc power supplies. Both feature 100% solid state construction, fuse protection, and L.E.D. power indicator. U.L. listed

- 2 amp constant, 4 amp surge \$18.00 each
- 3 amp constant, 5 amp surge \$25.00 each



4PDT RELAY

14 pin KH style.
3 amp contacts
USED but fully tested \$1.70 each
Specify coil voltage desired
Either 24 vdc or 120 vac

LARGE QUANTITIES AVAILABLE
SOCKETS FOR KH RELAY 75¢ each



ROTARY ACTION MICRO

OMRON #C-5G3-C41
Clock-wise action micro used in coin operated mechanisms and low torque operations. RATED: 5 amps @ 125 Vac. \$1.25 each 10 for \$11.00
LARGE QUANTITIES AVAILABLE.



STANDARD JUMBO DIFFUSED T 1 1/2

- RED 10 for \$1.50 100 for \$13.00
- GREEN 10 for \$2.00 100 for \$17.00
- YELLOW 10 for \$2.00 100 for \$17.00



D.P.S.T. LIGHTED ROCKER SWITCH

115 vac lighted rocker. snap mounts in 1/2" x 1 1/2" hole. Orange lens. 16 amp contact.

\$1.50



D.C. CONVERTER

Designed to provide a steady ±5 vdc @ 240 ma. from a battery supply of 3.5 to 6.25 volts.

2 7/16" x 1 1/8" x 1 1/16" \$1.50 each



7 CONDUCTOR RIBBON CABLE

Spectra-strip red marker strip. 28 ga. stranded wire

\$5.00 per 100' roll



SNAP ACTION SWITCH

Cherry elect. #E-21 N.O. or N.C. 0.1A contacts. Suitable for alarms and other low energy circuits. 1 1/8" lever.

45¢ EACH 10 FOR \$4.20



FLASHER LED

5 volt operation red jumbo T 1 1/2 size \$1.00 each

BI-POLAR

jumbo T 1 1/2 size 2 for \$1.70



MINI-PUSH BUTTON

S.P.S.T. momentary normally open 1/4" bushing. Red button. 35¢ each 10 for \$3.00



LED HOLDERS

Two piece holder for jumbo LED 10 for 65¢ 100 for \$5.00

CLEAR CLUPLITE LED HOLDER

Make LED a fancy indicator. Clear. 4 for \$1.00



KEY ASSEMBLY

5 KEY \$1.00 each
contains 5 single-pole normally open switches. Measures 3/4" long.

6 KEY \$1.25 each
contains 6 single-pole normally open switches. Measures 4 1/4" long.



ALL ELECTRONICS CORP.
LOS ANGELES, CA STORE
905 S. Vermont Ave.
213 380-8000

VAN NUYS, CA STORE
6228 Sepulveda Blvd.
818 997-1806

MAIL ORDERS TO:
P.O. BOX 20406
Los Angeles, CA 90006

TWX - 5101010163 ALL ELECTRONIC
EASYLINK MBX - 62887748



TOLL FREE ORDERS ONLY
1-800-826-5432
(ORDER ONLY)
(IN CALIFORNIA: 1-800-258-6666)
ALASKA, HAWAII, OR INFORMATION
(213) 380-8000 NO C.O.D.!

QUANTITIES LIMITED
MINIMUM ORDER \$10.00
USA: \$3.00 SHIPPING
FOREIGN ORDERS:
INCLUDING SUFFICIENT SHIPPING
CALIF. RES. ADD 6 1/2%

METAL OXIDE VARISTOR

Popular GE # 130LA10A varistor. 1/4" diameter.
\$1.25 each



ADVERTISERS' INDEX

RS#		Page #
55	All Electronics Corp.	89
60	Augat	77
-	C.O.M.B. Co.	79
5	Cleveland Institute of Elec	27
26	Communications Electronics	5
-	Computel	90
43, 99	Diehl	Cov. II, 1
103	Digi-Key Corp.	91
-	Grantham College of Engrg.	3
51	Heath Co.	66
178	ICOM, America	Cov. IV
86	Information Unlimited	87
30	J&W Electronics	74
46, 47	Jameco Electronics	92, Cov. III
121	Jan Crystals	66
32	Kepru Circuit Systems	88
85	MCM Electronics	65
-	McGee Radio	90
87	Micro Linear Controls	19
58	Micro Mart	85
-	NRI Schools	10, 13
-	Phillips-Tech Electronics	90
48	Radio Shack	7
12	Regency Electronics	43
95	Sintec Co.	75
36	Smith Electronics, Dick	46, 47
-	Unity Electronics	90
120	Wahl Clipper Corp.	88
151	Wholesale Outlet	17

Uniden DESK or WALL PHONE (Rotary & Tone)
Automatic Last Number Redial
Reg \$49.95 **\$19.95**
FREE Catalog of Hobby Kits, Car Stereos, CB's, Radar Detector w/order
Nationwide NYS
1-800-645-4441 | 1-800-632-4441
ELECTROMANIA
51 SUNRISE HWY. LYNBROOK, NY 11563

SPEAKER CATALOG
1001 bargains in electronics. Save up to 50% call toll free 1-800-346-2433 for ordering only. Order by VISA/MC/AMX. No COD's. Missouri, Alaska, Hawaii call 1-816-842-5092, or write McGee Radio, 1901 McGee St., K.C., MO 64108. Postage for catalog \$1.00.

SUBSCRIBE NOW!
Learn the secrets of your computer!
PUT BIG MONEY IN YOUR BANK ACCOUNT
A unique periodical that dares to publish what the others won't!
Computel TM
PUBLISHED MONTHLY
ONE YEAR SUBSCRIPTION: \$14.00
CASH/AMX: \$18.00 • FOREIGN: \$24.00
SUBSCRIPTION & 2 PROGRAMS \$20.00
Post Office Drawer 7765 / VAN NUYS, CA 91409-7765

NEW 20-PAGE CATALOG FREE
7 MILLION TUBES
Includes all current, obsolete, antique, hard-to-find receiving, transmitting, industrial, radio/TV types. **LOWEST PRICES.** Major brands in stock
Unity Electronics Dept. M
P.O. Box 213, Elizabeth, N.J. 07206

Quality Microwave TV Antennas
Multi-Channel 1.9 to 2.7 GHz
40dB Gain True Parabolic 20 Inch Dish
Complete System \$84.95 (Shipping incl.)
Dealerships. Qty. Pricing. Replacement Parts
Phillips-Tech Electronics
P.O. Box 34772 • Phoenix, AZ 85067
(802) 947-7700 (\$3.00 Credit all phone orders!)
LIFETIME WARRANTY MasterCard • Visa • CDD's

CABLE TV CONVERTERS/DESCRAMBLERS. Jerrold, Hamlin, Zenith—many others. Factory Units/Lowest Dealer Prices. Complete illustrated catalog, \$2.00. Pacific Cable Co., Inc., 7325½ Reseda Blvd., Dept 507, Reseda, CA 91335. 818/716-5914.

CABLE TV CONVERTERS! Why pay an outrageous monthly fee? All Jerrold Products including new Jerrold Tri-Mode or Bi-State, SB-3, Hamlin, M-35-B, Oak VN-12, Zenith, and more. "New volt-guard surge protector." Dealers wanted. (Quantity Discounts). Send self addressed stamped envelope. (60¢ postage) or call for information, (312) 637-4408 Midwest Electronics. (C.O.D. orders accepted). 5143 W. Diversey, Chicago, Illinois 60639. **NO ILLINOIS ORDERS ACCEPTED.**

CABLE TV CONVERTERS & EQUIPMENT. Plans and parts. Build or buy. FREE Information. C & D ELECTRONICS, 626 Flowerdale, Dept. ME, Ferndale, MI 48220.

CABLE TV converters and descramblers. Low prices. Quantity discounts. **FREE INFORMATIVE CATALOG.** R&M Distributors, P.O. Box 1285, Boston, MA 02205.

SATELLITE TV ANTENNAS - Save money. Design your own parabolic dish. Illustrations, formulas, for perfect parabola, F/D ratio, declination, polar mount. Sample plans for owner built mesh antennas. \$9.95 **CABLETRONICS** Box 30502ME, Bethesda, MD 20814.

THE LNA SPECIALISTS! Brand name! Lowest noise! Lowest prices! We will not be undersold! Send for prices: LNA, 201 E Southern, Suite 100, Dept. A, Tempe, AZ 85282.

DESCRAMBLER manuals, Sinewave, Gated Pulse, SSAVI, \$4.00 each, all three \$10.00, DNF, 6690 7 Mile, So. Lyon, Mich. 48178.

DEALERS wanted: Channel 2, 3, and 4 notch filters. Money back guarantee. Send \$15.00 for sample and quantity price list. Specify channel(s). Gary Kurtz, P.O. Box 291394, Davie, FL 33329.

BUILD Your Own Satellite TV Receiving System And Save! Instruction manuals, schematics, circuit boards, parts kits! Send stamped envelope for complete product listing: XANDI, Box 25647, Dept. 30H, Tempe, AZ 85282.

SUPER powered notch filters. Equivalent of cable company "cylinders." Eliminate undesirable signals. Any channel 2 through 8; 14(A) through 22(1). (Please specify). Send \$20.00 each. Money back guarantee. Quantity discounts, CATV, Box 17621, Plantation, FL 33318.

ZENITH SSAVI MANUAL. Original manual used by technicians. Theory of scrambling, schematics, parts list, repair. For UHF and cable. For speedy delivery send \$15.00 cash or money order. **BAY STATE ELECTRONICS**, PO Box 263, Accord, MA 02018.

TUNEABLE notch filters, brochure \$1.00. D.K. Video, Box 63/6025, Margate, FL 33063. 305-752-9202.

COMPUTERS

MacPAINT™ PRINTED CIRCUIT LAYOUT PACKAGE Kiss tape and dots goodbye forever. Faster, much more accurate, cheaper, far more fun. New Don Lancaster package gives you professional results every time. Diskette and bonus book, only \$23.50. SYN-ERGETICS, Box 809-ME, Thatcher, AZ 85552. VISA/MC. (602) 428-4073.

TI-99/4A Discount Softwares: FREE Catalog from Microbiz Hawaii, POB 1108 Pearl City, HI 96782.

TI-99/4A Software/Hardware bargains. Hard to find items. Huge selection. Fast Service. Free Catalog. TYNAMIC, Box 690, Hicksville, NY 11801.

INVENTORS

INVENTORS Can you profit from your idea? Call AMERICAN INVENTORS CORPORATION for free information. Over a decade of service. 1-800-338-5656. In Massachusetts call (413) 568-3753.

COUNTERMEASURES

BUGGED? Wiretapped? Find out fast. **COUNTERMEASURES** equipment catalog \$1. Capri Electronics, Route 1Z, Canon, GA 30520.

COMMUNICATIONS

FREE CB MODIFICATIONS catalog! Frequencies, sliders, FM, amplifiers, books, kits, repairs, high-performance accessories. CBCI, Box 31500ME, Phoenix, AZ 85046. (602) 996-8700.

COMMUNICATIONS plans, kits, books. 1750 Meter transceivers, AM/FM broadcast transmitters, ham/CB amplifiers, surveillance bugs, much more! Catalog \$1.00. PANCOM, Box 130-ME12, Paradise, CA 95969.

CB'ERS ONLY: Antennas, Radios, Modulators, Voice Scramblers, Base and Mobile Kickers, Books, Modifications, Professional Repairs! **FREE CATALOG. PRESIDENT CB SALES** 101 W. Adams-14, Long Beach, CA 90805. (213) 631-3552.

MISCELLANEOUS

PC-4 Games \$10. Schematic \$5. RICHARD TOY, 217 South Pennsylvania Ave., Fremont, OHIO 43420.

ANTIQUE Radio Classified, the Publication for buyers & sellers of old radios \$1.50 sample. 9511-23 Sunrise, Cleveland, Ohio 44133.

TUBES \$2.49, I.C.'s 33, send SASE for newly expanded lists, EDNF, 6690 7 Mile, So. Lyon, MI 48178.

SINGLE?! 18-80?! MEET STEWARD-ESSES, Secretaries, Mechanics, Doctors, Retirees! All Backgrounds! Local/National! 916-944-4444 XDS MODTRONICS.

ASIAN LADIES want correspondence for friendship, marriage. SUNSHINE INTERNATIONAL, Dept. TR, Box 260, North Hollywood, CA 91603.

ROBOTS "Movit" line, Easily assembled. You control. Great fun, educational. Free catalog. **ELECTROMANIA**, 51A Sunrise Highway, Lynbrook, NY 11563.

NATIONAL SEMICONDUCTOR • PANASONIC
OK MACHINE • EWC, INC. • INTERSIL • AD
EAC, INC. • J. W. MILLER • AAVS ENGINEER
E. F. JOHNSON • ATLANTIC SEMICONDUCTOR

256K (262,144 x 1) DRAM 150NS \$5.70/1; \$39.95/91
Factory Firsts

JIDES • DIAMOND TOOL • UNGAR •
E.C. • CW INDUSTRIES • AMDEN • G.E.
IGAR • YAGED • J.W. MILLER • LUXO
3C CHEMICALS • ARIES • PLESSEY

INTEGRATED CIRCUITS

Part	Price	Part	Price
7400 TTL	1.50	74151	1.50
7400N	1.50	74152	1.50
7401	1.50	74153	1.50
7402	1.50	74154	1.50
7403	1.50	74155	1.50
7404	1.50	74156	1.50
7405	1.50	74157	1.50
7406	1.50	74158	1.50
7407	1.50	74159	1.50
7408	1.50	74160	1.50
7409	1.50	74161	1.50
7410	1.50	74162	1.50
7411	1.50	74163	1.50
7412	1.50	74164	1.50
7413	1.50	74165	1.50
7414	1.50	74166	1.50
7415	1.50	74167	1.50
7416	1.50	74168	1.50
7417	1.50	74169	1.50
7418	1.50	74170	1.50
7419	1.50	74171	1.50
7420	1.50	74172	1.50
7421	1.50	74173	1.50
7422	1.50	74174	1.50
7423	1.50	74175	1.50
7424	1.50	74176	1.50
7425	1.50	74177	1.50
7426	1.50	74178	1.50
7427	1.50	74179	1.50
7428	1.50	74180	1.50
7429	1.50	74181	1.50
7430	1.50	74182	1.50
7431	1.50	74183	1.50
7432	1.50	74184	1.50
7433	1.50	74185	1.50
7434	1.50	74186	1.50
7435	1.50	74187	1.50
7436	1.50	74188	1.50
7437	1.50	74189	1.50
7438	1.50	74190	1.50
7439	1.50	74191	1.50
7440	1.50	74192	1.50
7441	1.50	74193	1.50
7442	1.50	74194	1.50
7443	1.50	74195	1.50
7444	1.50	74196	1.50
7445	1.50	74197	1.50
7446	1.50	74198	1.50
7447	1.50	74199	1.50
7448	1.50	74200	1.50
7449	1.50	74201	1.50
7450	1.50	74202	1.50

INTEGRATED CIRCUITS

Part	Price	Part	Price
4000 CMOS	2.00	74203	1.50
74204	1.50	74204N	1.50
74205	1.50	74205N	1.50
74206	1.50	74206N	1.50
74207	1.50	74207N	1.50
74208	1.50	74208N	1.50
74209	1.50	74209N	1.50
74210	1.50	74210N	1.50
74211	1.50	74211N	1.50
74212	1.50	74212N	1.50
74213	1.50	74213N	1.50
74214	1.50	74214N	1.50
74215	1.50	74215N	1.50
74216	1.50	74216N	1.50
74217	1.50	74217N	1.50
74218	1.50	74218N	1.50
74219	1.50	74219N	1.50
74220	1.50	74220N	1.50
74221	1.50	74221N	1.50
74222	1.50	74222N	1.50
74223	1.50	74223N	1.50
74224	1.50	74224N	1.50
74225	1.50	74225N	1.50
74226	1.50	74226N	1.50
74227	1.50	74227N	1.50
74228	1.50	74228N	1.50
74229	1.50	74229N	1.50
74230	1.50	74230N	1.50
74231	1.50	74231N	1.50
74232	1.50	74232N	1.50
74233	1.50	74233N	1.50
74234	1.50	74234N	1.50
74235	1.50	74235N	1.50
74236	1.50	74236N	1.50
74237	1.50	74237N	1.50
74238	1.50	74238N	1.50
74239	1.50	74239N	1.50
74240	1.50	74240N	1.50
74241	1.50	74241N	1.50
74242	1.50	74242N	1.50
74243	1.50	74243N	1.50
74244	1.50	74244N	1.50
74245	1.50	74245N	1.50
74246	1.50	74246N	1.50
74247	1.50	74247N	1.50
74248	1.50	74248N	1.50
74249	1.50	74249N	1.50
74250	1.50	74250N	1.50

T.T.C. SOCKETS

Part	Description	Price
TS1	1 pin socket	1.10
TS2	2 pin socket	1.10
TS3	3 pin socket	1.10
TS4	4 pin socket	1.10
TS5	5 pin socket	1.10
TS6	6 pin socket	1.10
TS7	7 pin socket	1.10
TS8	8 pin socket	1.10
TS9	9 pin socket	1.10
TS10	10 pin socket	1.10
TS11	11 pin socket	1.10
TS12	12 pin socket	1.10
TS13	13 pin socket	1.10
TS14	14 pin socket	1.10
TS15	15 pin socket	1.10
TS16	16 pin socket	1.10
TS17	17 pin socket	1.10
TS18	18 pin socket	1.10
TS19	19 pin socket	1.10
TS20	20 pin socket	1.10
TS21	21 pin socket	1.10
TS22	22 pin socket	1.10
TS23	23 pin socket	1.10
TS24	24 pin socket	1.10
TS25	25 pin socket	1.10
TS26	26 pin socket	1.10
TS27	27 pin socket	1.10
TS28	28 pin socket	1.10
TS29	29 pin socket	1.10
TS30	30 pin socket	1.10

SOLDER TAP DR SOCKETS

Part	Description	Price
SD1	1 pin solder tap	1.10
SD2	2 pin solder tap	1.10
SD3	3 pin solder tap	1.10
SD4	4 pin solder tap	1.10
SD5	5 pin solder tap	1.10
SD6	6 pin solder tap	1.10
SD7	7 pin solder tap	1.10
SD8	8 pin solder tap	1.10
SD9	9 pin solder tap	1.10
SD10	10 pin solder tap	1.10
SD11	11 pin solder tap	1.10
SD12	12 pin solder tap	1.10
SD13	13 pin solder tap	1.10
SD14	14 pin solder tap	1.10
SD15	15 pin solder tap	1.10
SD16	16 pin solder tap	1.10
SD17	17 pin solder tap	1.10
SD18	18 pin solder tap	1.10
SD19	19 pin solder tap	1.10
SD20	20 pin solder tap	1.10
SD21	21 pin solder tap	1.10
SD22	22 pin solder tap	1.10
SD23	23 pin solder tap	1.10
SD24	24 pin solder tap	1.10
SD25	25 pin solder tap	1.10
SD26	26 pin solder tap	1.10
SD27	27 pin solder tap	1.10
SD28	28 pin solder tap	1.10
SD29	29 pin solder tap	1.10
SD30	30 pin solder tap	1.10

5% Carbon Film Resistors

Part	Value	Price
R100	100 ohms	0.10
R101	100 ohms	0.10
R102	100 ohms	0.10
R103	100 ohms	0.10
R104	100 ohms	0.10
R105	100 ohms	0.10
R106	100 ohms	0.10
R107	100 ohms	0.10
R108	100 ohms	0.10
R109	100 ohms	0.10
R110	100 ohms	0.10
R111	100 ohms	0.10
R112	100 ohms	0.10
R113	100 ohms	0.10
R114	100 ohms	0.10
R115	100 ohms	0.10
R116	100 ohms	0.10
R117	100 ohms	0.10
R118	100 ohms	0.10
R119	100 ohms	0.10
R120	100 ohms	0.10
R121	100 ohms	0.10
R122	100 ohms	0.10
R123	100 ohms	0.10
R124	100 ohms	0.10
R125	100 ohms	0.10
R126	100 ohms	0.10
R127	100 ohms	0.10
R128	100 ohms	0.10
R129	100 ohms	0.10
R130	100 ohms	0.10

DISC CAPACITORS

Part	Value	Price
C100	100 pF	0.10
C101	100 pF	0.10
C102	100 pF	0.10
C103	100 pF	0.10
C104	100 pF	0.10
C105	100 pF	0.10
C106	100 pF	0.10
C107	100 pF	0.10
C108	100 pF	0.10
C109	100 pF	0.10
C110	100 pF	0.10
C111	100 pF	0.10
C112	100 pF	0.10
C113	100 pF	0.10
C114	100 pF	0.10
C115	100 pF	0.10
C116	100 pF	0.10
C117	100 pF	0.10
C118	100 pF	0.10
C119	100 pF	0.10
C120	100 pF	0.10
C121	100 pF	0.10
C122	100 pF	0.10
C123	100 pF	0.10
C124	100 pF	0.10
C125	100 pF	0.10
C126	100 pF	0.10
C127	100 pF	0.10
C128	100 pF	0.10
C129	100 pF	0.10
C130	100 pF	0.10

TANTALUM CAPACITORS

Part	Value	Price
T100	100 uF	1.00
T101	100 uF	1.00
T102	100 uF	1.00
T103	100 uF	1.00
T104	100 uF	1.00
T105	100 uF	1.00
T106	100 uF	1.00
T107	100 uF	1.00
T108	100 uF	1.00
T109	100 uF	1.00
T110	100 uF	1.00
T111	100 uF	1.00
T112	100 uF	1.00
T113	100 uF	1.00
T114	100 uF	1.00
T115	100 uF	1.00
T116	100 uF	1.00
T117	100 uF	1.00
T118	100 uF	1.00
T119	100 uF	1.00
T120	100 uF	1.00
T121	100 uF	1.00
T122	100 uF	1.00
T123	100 uF	1.00
T124	100 uF	1.00
T125	100 uF	1.00
T126	100 uF	1.00
T127	100 uF	1.00
T128	100 uF	1.00
T129	100 uF	1.00
T130	100 uF	1.00

7400 TTL

Part	Price	Part	Price
7400	1.50	7400N	1.50
7401	1.50	7401N	1.50
7402	1.50	7402N	1.50
7403	1.50	7403N	1.50
7404	1.50	7404N	1.50
7405	1.50	7405N	1.50
7406	1.50	7406N	1.50
7407	1.50	7407N	1.50
7408	1.50	7408N	1.

Commodore® Accessories

RS232 Adapter for VIC-20 and Commodore 64

The JE232CM allows connection of standard serial RS232 printers, modems, etc. to your VIC-20 and C-64. A 4-pole switch allows the inversion of the 4 control lines. Complete installation and operation instructions included.

- Plugs into User Port
- Provides Standard RS232 signal levels
- Uses 6 signals (Transmit, Receive, Clear to Send, Request to Send, Data Terminal Ready, Data Set Ready)

JE232CM \$39.95

VOICE SYNTHESIZER FOR COMMODORE VIC-20 AND C-64

Plug-in - Talking in Minutes!

JE520CM. (NEW Software-see right) . \$99.95

TRS-80 Accessories

MPI 5 1/4" DISK DRIVE

Use as a second disk drive - Single-sided - Single/double density - Full-height drive - 48 TPI - Documentation included - Weight: 3.7 lbs.

MPI51S. \$69.95

EXPAND TRS-80 MEMORY

TRS-80 MODEL I, III

Each Kit comes complete with eight MM5290 (UPD4164) 16K Dynamic RAMs and documentation for conversion. Model I: 16K equipped with Expansion Interface can be expanded to 48K with 2 Kits. Model III: Can be expanded from 16K to 48K using 2 Kits. Each Kit will expand computer by 16K increments

TRS-16K3 200ns (Model III) \$5.95
TRS-16K4 250ns (Model I) \$5.49

TRS-80 COLOR AND COLOR II

Easy to install Kit comes complete with 8 each 4164N-20 (200ns) 64K Dynamic RAMs and documentation for conversion. Converts TRS-80 Color Computers with D, E, ET, F and NC circuit boards to 92K. Also converts TRS-80 Color Computer II to 64K. Fits DOS or OS-9 requires to utilize full 64K RAM on all computers

TRS-64K-2. \$9.95

Update! TRS-80 MODEL IV, 4P Update!

Easy to install Kits come complete with TRS-64K-2 (8 ea. 4164N-20 (200ns) 64K Dynamic RAMs), TRS-64K-2PAL (8 ea. 4164's plus PAL chip) and documentation for conversion

TRS-64K-2 Expands Model IV from 16K-64K to Model IV & 4P from 64K-128K (w/Mem. Drk.) \$ 9.95
TRS-64K-2PAL Expands Model IV (w/Black & White Monitors only) from 64K to 128K \$29.95

TRS-80 Model 100 • NEC • Olivetti

Easy to install Module plugs right into the socket increasing memory in 8K increments. Three modules will increase your memory to its full capacity. Complete with module and documentation for installation.

M1008K (TRS-80 Model 100 Expansion) \$29.95 ea. or \$379.95
NEC8KR (NEC PC-8201A) \$29.95 ea. or \$379.95
OM108K (Olivetti M10) \$29.95 ea. or \$379.95

TANDY 200

Easy to install module plugs right into the socket increasing memory in 24K increments. Complete with module and documentation for installation.

M200R (Tandy 200 Expansion) . . . \$99.95 ea. or 2/\$189.95

PROMETHEUS MODEMS

Intelligent 1200/300 Baud Modem with Real Time Clock/Calendar

The ProModem™ is a Bell 212A (1200/300) intelligent stand-alone modem. Hayes command set compatible plus an additional extended command set. Shown with alphanumeric display option.

PM1200 RS-232 Stand-Alone Unit. \$299.95

OPTIONS FOR ProModem 1200

PM-COM (ProCom Communication Software) \$ 79.95
Please specify Operating System -
Apple: ProDOS or CP/M - or
IBM: PC DOS or MS-DOS.

PM-OPS12K (Communication Buffer Option) \$129.95
PM-BUF12K (512K Memory for PM-OPS12K) \$ 54.95
PM-ALP (Alphanumeric Display) \$ 79.95

PM-Special #2 (Includes PM-OPS12K, BUF12K and PM-ALP) \$249.95

DATA BOOKS

- 30009 Intel® Data Book (1985) \$9.95 Complete Line (1075 pages)
- 30013 Zilog Data Book (1985) \$9.95 Microprocessors and Support Chips (1045 pages)
- 210830 Intel Memory Components Hndbk. (1983/84) \$14.95 Contains all Applications Notes, Article Reprints, Data Sheets & other design information on Intel's RAMs, DRAMs, EPROMs, EEPROMs and Bubble Memories (880 pages)
- 230843 Intel Microsystem Components Hndbk. (1983/84) \$19.95 Contains Data Sheets on all of Intel's Microprocessors & peripherals - 2 editions (2275 pages)
- 30022 National Logic Data Book Set (1984) \$24.95 Volumes 1 & II (3485 pages)
Contains information on National's TTL product line and CD4000 family. This includes 7400, 7410, 7415, 7418, 7420, 7421, 7423, 7424, 7425, 7426, 7427, 7428, 7429, 7430, 7431, 7432, 7433, 7434, 7435, 7436, 7437, 7438, 7439, 7440, 7441, 7442, 7443, 7444, 7445, 7446, 7447, 7448, 7449, 7450, 7451, 7452, 7453, 7454, 7455, 7456, 7457, 7458, 7459, 7460, 7461, 7462, 7463, 7464, 7465, 7466, 7467, 7468, 7469, 7470, 7471, 7472, 7473, 7474, 7475, 7476, 7477, 7478, 7479, 7480, 7481, 7482, 7483, 7484, 7485, 7486, 7487, 7488, 7489, 7490, 7491, 7492, 7493, 7494, 7495, 7496, 7497, 7498, 7499, 7500, 7501, 7502, 7503, 7504, 7505, 7506, 7507, 7508, 7509, 7510, 7511, 7512, 7513, 7514, 7515, 7516, 7517, 7518, 7519, 7520, 7521, 7522, 7523, 7524, 7525, 7526, 7527, 7528, 7529, 7530, 7531, 7532, 7533, 7534, 7535, 7536, 7537, 7538, 7539, 7540, 7541, 7542, 7543, 7544, 7545, 7546, 7547, 7548, 7549, 7550, 7551, 7552, 7553, 7554, 7555, 7556, 7557, 7558, 7559, 7560, 7561, 7562, 7563, 7564, 7565, 7566, 7567, 7568, 7569, 7570, 7571, 7572, 7573, 7574, 7575, 7576, 7577, 7578, 7579, 7580, 7581, 7582, 7583, 7584, 7585, 7586, 7587, 7588, 7589, 7590, 7591, 7592, 7593, 7594, 7595, 7596, 7597, 7598, 7599, 7600, 7601, 7602, 7603, 7604, 7605, 7606, 7607, 7608, 7609, 7610, 7611, 7612, 7613, 7614, 7615, 7616, 7617, 7618, 7619, 7620, 7621, 7622, 7623, 7624, 7625, 7626, 7627, 7628, 7629, 7630, 7631, 7632, 7633, 7634, 7635, 7636, 7637, 7638, 7639, 7640, 7641, 7642, 7643, 7644, 7645, 7646, 7647, 7648, 7649, 7650, 7651, 7652, 7653, 7654, 7655, 7656, 7657, 7658, 7659, 7660, 7661, 7662, 7663, 7664, 7665, 7666, 7667, 7668, 7669, 7670, 7671, 7672, 7673, 7674, 7675, 7676, 7677, 7678, 7679, 7680, 7681, 7682, 7683, 7684, 7685, 7686, 7687, 7688, 7689, 7690, 7691, 7692, 7693, 7694, 7695, 7696, 7697, 7698, 7699, 7700, 7701, 7702, 7703, 7704, 7705, 7706, 7707, 7708, 7709, 7710, 7711, 7712, 7713, 7714, 7715, 7716, 7717, 7718, 7719, 7720, 7721, 7722, 7723, 7724, 7725, 7726, 7727, 7728, 7729, 7730, 7731, 7732, 7733, 7734, 7735, 7736, 7737, 7738, 7739, 7740, 7741, 7742, 7743, 7744, 7745, 7746, 7747, 7748, 7749, 7750, 7751, 7752, 7753, 7754, 7755, 7756, 7757, 7758, 7759, 7760, 7761, 7762, 7763, 7764, 7765, 7766, 7767, 7768, 7769, 7770, 7771, 7772, 7773, 7774, 7775, 7776, 7777, 7778, 7779, 7780, 7781, 7782, 7783, 7784, 7785, 7786, 7787, 7788, 7789, 7790, 7791, 7792, 7793, 7794, 7795, 7796, 7797, 7798, 7799, 7800, 7801, 7802, 7803, 7804, 7805, 7806, 7807, 7808, 7809, 7810, 7811, 7812, 7813, 7814, 7815, 7816, 7817, 7818, 7819, 7820, 7821, 7822, 7823, 7824, 7825, 7826, 7827, 7828, 7829, 7830, 7831, 7832, 7833, 7834, 7835, 7836, 7837, 7838, 7839, 7840, 7841, 7842, 7843, 7844, 7845, 7846, 7847, 7848, 7849, 7850, 7851, 7852, 7853, 7854, 7855, 7856, 7857, 7858, 7859, 7860, 7861, 7862, 7863, 7864, 7865, 7866, 7867, 7868, 7869, 7870, 7871, 7872, 7873, 7874, 7875, 7876, 7877, 7878, 7879, 7880, 7881, 7882, 7883, 7884, 7885, 7886, 7887, 7888, 7889, 7890, 7891, 7892, 7893, 7894, 7895, 7896, 7897, 7898, 7899, 7900, 7901, 7902, 7903, 7904, 7905, 7906, 7907, 7908, 7909, 7910, 7911, 7912, 7913, 7914, 7915, 7916, 7917, 7918, 7919, 7920, 7921, 7922, 7923, 7924, 7925, 7926, 7927, 7928, 7929, 7930, 7931, 7932, 7933, 7934, 7935, 7936, 7937, 7938, 7939, 7940, 7941, 7942, 7943, 7944, 7945, 7946, 7947, 7948, 7949, 7950, 7951, 7952, 7953, 7954, 7955, 7956, 7957, 7958, 7959, 7960, 7961, 7962, 7963, 7964, 7965, 7966, 7967, 7968, 7969, 7970, 7971, 7972, 7973, 7974, 7975, 7976, 7977, 7978, 7979, 7980, 7981, 7982, 7983, 7984, 7985, 7986, 7987, 7988, 7989, 7990, 7991, 7992, 7993, 7994, 7995, 7996, 7997, 7998, 7999, 8000

Muffin-Style & Sprite-Style Fans

- MUF60 (SPN3-15-2462) Howard Industries (4.6" sq., 60cfm) \$9.95
- SUG27 EG&G Rotron (3 1/2" sq., 32cfm) \$9.95

******* APPLE® Accessories *******

GIVE YOUR COMPUTER A GIFT THIS SEASON... A VOICE!

Voice Synthesizers for Apple, Commodore, IBM & RS232 Computers

NEW Demonstration Software Available!

JE520 VOICE SYNTHESIZER

FOR COMMODORE 64, VIC-20 - APPLE II, II+, IIe

ADD SPEECH CAPABILITY TO YOUR COMMODORE 64 OR VIC-20, APPLE II, II+, IIe COMPUTER WITH JAMECO'S JE520 SERIES VOICE SYNTHESIZER. SPEECH - THE MOST EFFECTIVE MEANS OF COMMUNICATION AVAILABLE TO MAN - IS NOW IMMEDIATELY AVAILABLE FOR YOUR COMPUTER.

Applications: Education - Entertainment - Instrumentation - Games - Telecommunications - Handicap Aids

JE520 Features:

- More than 250 basic words, prefixes, suffixes, which allow the formation of well over 500 total words
- Allows music, graphics and speech simultaneously
- Programs in BASIC and/or Assembler
- Very understandable and realistic male voice
- Built-in amplifier, speaker, volume control and audio jack
- Plug-in user ready with complete documentation and sample software

The JE520 will plug right into your computer and be talking in minutes. It produces a very clear, natural male voice. The outstanding speech quality is produced using National Semiconductor's DigiTalker™ speech processor IC with four JAMECO custom memory chips. Case size: 7 1/2" x 3 1/2" x 1 1/2" - Weight: 1 lb.

COMMODORE 64 or VIC-20

PRICE

JE520CM Voice Synthesizer for Commodore 64 or VIC-20 (includes JE232 Interface Module) \$ 99.95
JE521TS Text-to-Speech Program for Commodore 64 or VIC-20 (5 1/4" Disk) \$ 9.95
JE521 Commodore Interface Module \$ 19.95

APPLE II, II+ and IIe

PRICE

JE520AP Voice Synthesizer for Apple II, II+ or IIe (includes JE232 Interface Module) \$119.95
JE521TS Text-to-Speech Program for Apple II, II+ or IIe (5 1/4" Disk) \$ 9.95
JE523 Apple Interface Module \$ 39.95

JE520 VOICE SYNTHESIZER FOR IBM OR ANY RS232 COMPUTER

The JE520 Voice Synthesizer for IBM or RS232 computers has the same features as listed above. The JE525 Interface Module allows the JE520 Series Voice Synthesizer to be interfaced with most popular microcomputers with the use of the standard RS232 port and logic levels. The JE525 Interface Module is powered from a wall transformer. Sample program is included in the User Manual.

JE525 Interface Module Features:

- IBM compatible
- CP/M Compatible
- Power On Indicator
- Switch for DTE and DCE RS232 formats
- Indicators for DTE or DCE modes
- Standard DB25 female connector

IBM or Computers with RS232

PRICE

JE520IBM Voice Synthesizer for IBM or RS232 Computers (includes JE525 Interface Module) \$199.95
JE525TS Text-to-Speech Program for IBM (5 1/4" Disk) \$ 9.95
JE525 IBM/RS232 Interface Module \$119.95

NEW! QUALITY APPLE COMPATIBLE CARDS For Apple II, II+ and IIe*

Five Key Software Programs! For Apple II, II+ and IIe*

128K RAM Card

The JE868 is functionally compatible with the Apple II language card and can be utilized with all software that can be used with a standard 16K card. The JE868 requires no modifications to your Apple computer. Five key software programs are included: Memory Management Utilities, diagnostics, demos, and RAM disk emulators for DOS 3.3, CP/M and Apple Pascal. Also features DOS relocater. Complete with instructions.

JE868 (Expand-A-RAM) \$119.95

Applurance Diagnostic Disk Controller Card Prevents Crashes! For Apple II, II+ and IIe*

The JE877 serves as a diagnostic tool and an applurance interface tool and a dual disk drive controller. The JE877 will verify and check the operating hardware of your system each time you turn on your Apple II, II+ or IIe. Test your RAM, ROM, CPU, and disk drives. Diagnostic routines may be cancelled at the touch of a key. Complete with instructions.

JE877 (DRV-1/Applurance II) \$69.95

Parallel Printer Card For Apple II, II+ and IIe*

The JE880 Printer Interface board is an intelligent interface to most of today's popular dot-matrix graphics printers. The JE880 is fully compatible with Apple CP/M, Apple Pascal (or FORTRAN) and most other operating systems and software packages available for Apple II, II+ and IIe. The JE880 is shipped configured for the Centronics standard and can be re-configured for other standards. If necessary, Advanced text printing features include: video screen echo ON or OFF, auto/diagnostic, linefeed after carriage return, carriage return in the bit of the output data, set left margin and more. Complete with instructions.

JE880 (PRT-1) \$59.95

Parallel/Serial Buffer Card For Apple II, II+ and IIe*

The JE883 provides the user with up to 64K of additional or buffered memory (18 pages of information). Using the parallel jumper cable supplied, the JE883 will attach to the parallel port with both parallel and serial (RS232) buffered outputs. With these features you may access and buffer information to two types of printers (one serial, one parallel) simultaneously. Complete with instructions.

JE883 (P/S Buffer) \$79.95

NEW! QUALITY APPLE COMPATIBLE CARDS For Apple II, II+ and IIe*

RAM Disk!

Documentation Included

RFD480 (Remex 5 1/4" DS full-ht.) \$69.95
FD55B (Teac 5 1/4" DS half-ht.) \$99.95
SA455 (Shugart 5 1/4" DS half-ht.) \$99.95
TM100-2 (Tandem 5 1/4" DS half-ht.) \$99.95

JMR 5 1/4" DISK DRIVE ENCLOSURES

Complete with power supply, switch, power cord, fuseholder and connectors

DDE-1FH (Houses 1 full-ht. 5 1/4" floppy drive) \$ 69.95
DDE-2HH (Houses 2 half-ht. 5 1/4" floppy drives - vertically) \$ 79.95
HDDE-1FH (Houses 1 hard drive) \$199.95

General Application Keyboards

Mitsumi 54-Key Unencoded Keyboard

- SPST keyswitches
- 20 pin ribbon cable connection
- Low profile keys
- Features: cursor controls, control, caps (lock), function, enter and shift keys
- Color (key-caps): grey
- Weight: 1 lb.
- Pinout incl.
- Size: 13 1/2" L x 4 1/4" W x 3/4" H

KB54 \$9.95

74-Key ASCII Cherry Keyboard

- 7-bit parallel ASCII
- Full Upper Case, Full Lower Case
- Include i, m, n, o and p
- Cursor keypad
- SPST mechanical keyswitches
- 26-pin header connector
- Color: white
- Size: 18" L x 6 1/4" W x 1 1/4" H
- Spec included

KB8201 (1500 available) \$14.95

Jameco's New 1986 Catalog!

Filled with New Products, Reduced Pricing and Valuable Pin-out Data.

Send \$1 Postage for FREE 1986 Jameco Catalog!

\$20 Minimum Order - U.S. Funds Only CA Residents: Add 6% or 8 1/2% Sales Tax Spec Sheets - 30¢ each Shipping: Add 5% plus \$1.50 Insurance Send \$1 Postage for FREE 1986 Jameco Catalog Prices Subject to Change Send stamped, self-addressed envelope to receive a Quarterly Sales Flyer - FREE!

MasterCard **Jameco** ELECTRONICS VISA

1355 SHOREWAY ROAD, BELMONT, CA 94002
12/85 PHONE ORDERS WELCOME - (415) 592-8097 - Telex: 176043

CIRCLE 46 ON FREE INFORMATION CARD

IBM® Accessories

IBM PC/XT Compatible Keyboard



IBM-5151 (Equivalent to Keytronic's 5151) \$129.95

Additional Add-Ons Available!

MEMORY EXPANSION KITS

IBM PC, PC XT and Compatibles

The IBM64K Kit will increase memory in 64K byte increments. The Kit is simple to install - just insert the 9 - 64K RAM chips in the provided sockets and set the 2 groups of switches. Conversion documentation included.

IBM64K (Nine 200ns 64K RAMs) \$7.95

IBM PC AT

Each kit comes complete with nine 128K dynamic RAMs and documentation for conversion.

IBM128K (Nine 200ns 128K RAMs) \$43.95

IBM PCXT Equivalent 130 Watt Power Supply

UPGRADE YOUR PC!

- Input: 110V @ 60Hz
- Output: +5VDC @ 15A, -5VDC @ 0.5A, +12VDC @ 4.2A, -12VDC @ 0.5A
- Plug compatible connectors
- Fits into IBM PC
- Weight: 6 lbs.

IBM-PS. \$99.95

Prometheus Modems

The ProModem 1200B/5S is a 1200/300 baud modem card which plugs into IBM PC and XT. Provides a third serial comport. Two versions available: 1200B (without software) and 1200BS (with software). The PM1200BS is supplied with powerful MITE communications software from Mycroft Labs. Software available: PC DOS or MS DOS.

PM1200B (without Software) \$239.95
PM1200BS (with MITE Software) \$274.95

IBM Compatible! DISK DRIVES

Documentation Included

RFD480 (Remex 5 1/4" DS full-ht.) \$69.95
FD55B (Teac 5 1/4" DS half-ht.) \$99.95
SA455 (Shugart 5 1/4" DS half-ht.) \$99.95
TM100-2 (Tandem 5 1/4" DS half-ht.) \$99.95

JMR 5 1/4" DISK DRIVE ENCLOSURES

Complete with power supply, switch, power cord, fuseholder and connectors

DDE-1FH (Houses 1 full-ht. 5 1/4" floppy drive) \$ 69.95
DDE-2HH (Houses 2 half-ht. 5 1/4" floppy drives - vertically) \$ 79.95
HDDE-1FH (Houses 1 hard drive) \$199.95

General Application Keyboards

Mitsumi 54-Key Unencoded Keyboard

- SPST keyswitches
- 20 pin ribbon cable connection
- Low profile keys
- Features: cursor controls, control, caps (lock), function, enter and shift keys
- Color (key-caps): grey
- Weight: 1 lb.
- Pinout incl.
- Size: 13 1/2" L x 4 1/4" W x 3/4" H

KB54 \$9.95

74-Key ASCII Cherry Keyboard

- 7-bit parallel ASCII
- Full Upper Case, Full Lower Case
- Include i, m, n, o and p
- Cursor keypad
- SPST mechanical keyswitches
- 26-pin header connector
- Color: white
- Size: 18" L x 6 1/4" W x 1 1/4" H
- Spec included

KB8201 (1500 available) \$14.95

UV-EPROM ERASER

8 Chips - 21 Minutes

1 Chip - 15 Minutes

Erases all EPROMs. Erases up to 8 chips within 21 minutes (1 chip in 15 minutes). Maintains constant exposure distance of one inch. Special conductive foam liner eliminates static build-up. Built-in safety lock to prevent UV exposure. Compact - only 9.00" x 3.70" W x 2.60" H. Complete with holding tray for 8 chips.

DE-4 UV-EPROM Eraser. \$74.95
UVS-11EL Replacement Bulb. \$17.95



CALL FOR QUANTITY DISCOUNTS SPECIAL!! SPECIAL!! SPECIAL!! EPROM

Table with columns: Part No., Pcs, Price. Rows include SN7400N, SN7401N, SN7402N, SN7403N, SN7404N, SN7405N, SN7406N, SN7407N, SN7408N, SN7409N, SN7410N, SN7411N, SN7412N, SN7413N, SN7414N, SN7415N, SN7416N, SN7417N, SN7418N, SN7419N, SN7420N, SN7421N, SN7422N, SN7423N, SN7424N, SN7425N, SN7426N, SN7427N, SN7428N, SN7429N, SN7430N, SN7431N, SN7432N, SN7433N, SN7434N, SN7435N, SN7436N, SN7437N, SN7438N, SN7439N, SN7440N, SN7441N, SN7442N, SN7443N, SN7444N, SN7445N, SN7446N, SN7447N, SN7448N, SN7449N, SN7450N, SN7451N, SN7452N, SN7453N, SN7454N, SN7455N, SN7456N, SN7457N, SN7458N, SN7459N, SN7460N, SN7461N, SN7462N, SN7463N, SN7464N, SN7465N, SN7466N, SN7467N, SN7468N, SN7469N, SN7470N, SN7471N, SN7472N, SN7473N, SN7474N, SN7475N, SN7476N, SN7477N, SN7478N, SN7479N, SN7480N, SN7481N, SN7482N, SN7483N, SN7484N, SN7485N, SN7486N, SN7487N, SN7488N, SN7489N, SN7490N, SN7491N, SN7492N, SN7493N, SN7494N, SN7495N, SN7496N, SN7497N, SN7498N, SN7499N.

MOTOROLA MC68701 - Microcomputer with EPROM. The MC68701 is an 8-bit single chip microcomputer unit (MCU) which significantly enhances the capabilities of the MC6800 family of parts. On-chip resources include 2048 bytes of EPROM, 128 bytes of RAM, Serial Communications Interface (SCI), Internal I/O, and a three function Programmable Timer. MC68701... \$24.95

2816A 24 2048x8 16K EPROM 350ns... \$8.95. Features: On-board Address/Data Latches - Auto-Timed Byte Write (on chip memory) - 5V External Memory - Optional High Voltage Program (HV-15V) - Power Up/Down Write Protection - Auto Erase Before Write. The 2816A is an ideal nonvolatile memory providing in-system alterability with the same ease and with the same features as 28x8 Static RAMs.

Table with columns: Part No., Pcs, Price. Rows include SN74100N, SN74101N, SN74102N, SN74103N, SN74104N, SN74105N, SN74106N, SN74107N, SN74108N, SN74109N, SN74110N, SN74111N, SN74112N, SN74113N, SN74114N, SN74115N, SN74116N, SN74117N, SN74118N, SN74119N, SN74120N, SN74121N, SN74122N, SN74123N, SN74124N, SN74125N, SN74126N, SN74127N, SN74128N, SN74129N, SN74130N, SN74131N, SN74132N, SN74133N, SN74134N, SN74135N, SN74136N, SN74137N, SN74138N, SN74139N, SN74140N, SN74141N, SN74142N, SN74143N, SN74144N, SN74145N, SN74146N, SN74147N, SN74148N, SN74149N, SN74150N, SN74151N, SN74152N, SN74153N, SN74154N, SN74155N, SN74156N, SN74157N, SN74158N, SN74159N, SN74160N, SN74161N, SN74162N, SN74163N, SN74164N, SN74165N, SN74166N, SN74167N, SN74168N, SN74169N, SN74170N, SN74171N, SN74172N, SN74173N, SN74174N, SN74175N, SN74176N, SN74177N, SN74178N, SN74179N, SN74180N, SN74181N, SN74182N, SN74183N, SN74184N, SN74185N, SN74186N, SN74187N, SN74188N, SN74189N, SN74190N, SN74191N, SN74192N, SN74193N, SN74194N, SN74195N, SN74196N, SN74197N, SN74198N, SN74199N.

CUSTOM COMMODORE CHIPS for VIC-20, C-64 and C-128 Personal Computers. Table with columns: Part No., Description, Price. Rows include '6510 CPU... \$19.95', '6525 TPL... \$20.95', '6560 VIC-II... \$29.95', '6581 SID... \$32.95', '825100PLA... \$37.95'. SPECIALS AVAILABLE @ \$1.50 EA. '6567 VIC-II... \$44.95'. NOTE: 32S10A = U17 (C-64)

Digitalizer™ DT1050 - Applications: Teaching with applications, checks, automatic, communications, inventory, insurance, etc. The DT1050 is a standard 1024x1024 dot grid enclosed with 137 separate and useful words, 2 zones, and 5 different sentence durations. The words and lines have been assigned discrete addresses, making it possible to input single words or words containing multiple characters in even sentences. The "voice" output of the DT1050 is a highly intelligible male voice. The DT1050 consists of a Speech Processor, MM51014 (40 pin), a highly intelligible male voice MM5154551 and MM5154552 (24 pin) using a Master Word List and a recommended schematic diagram.

Table with columns: Part No., Pcs, Price. Rows include SN74200N, SN74201N, SN74202N, SN74203N, SN74204N, SN74205N, SN74206N, SN74207N, SN74208N, SN74209N, SN74210N, SN74211N, SN74212N, SN74213N, SN74214N, SN74215N, SN74216N, SN74217N, SN74218N, SN74219N, SN74220N, SN74221N, SN74222N, SN74223N, SN74224N, SN74225N, SN74226N, SN74227N, SN74228N, SN74229N, SN74230N, SN74231N, SN74232N, SN74233N, SN74234N, SN74235N, SN74236N, SN74237N, SN74238N, SN74239N, SN74240N, SN74241N, SN74242N, SN74243N, SN74244N, SN74245N, SN74246N, SN74247N, SN74248N, SN74249N, SN74250N, SN74251N, SN74252N, SN74253N, SN74254N, SN74255N, SN74256N, SN74257N, SN74258N, SN74259N, SN74260N, SN74261N, SN74262N, SN74263N, SN74264N, SN74265N, SN74266N, SN74267N, SN74268N, SN74269N, SN74270N, SN74271N, SN74272N, SN74273N, SN74274N, SN74275N, SN74276N, SN74277N, SN74278N, SN74279N, SN74280N, SN74281N, SN74282N, SN74283N, SN74284N, SN74285N, SN74286N, SN74287N, SN74288N, SN74289N, SN74290N, SN74291N, SN74292N, SN74293N, SN74294N, SN74295N, SN74296N, SN74297N, SN74298N, SN74299N.

MICROPROCESSOR COMPONENTS. Table with columns: Part No., Pcs, Price. Rows include 2801, 2802, 2803, 2804, 2805, 2806, 2807, 2808, 2809, 2810, 2811, 2812, 2813, 2814, 2815, 2816, 2817, 2818, 2819, 2820, 2821, 2822, 2823, 2824, 2825, 2826, 2827, 2828, 2829, 2830, 2831, 2832, 2833, 2834, 2835, 2836, 2837, 2838, 2839, 2840, 2841, 2842, 2843, 2844, 2845, 2846, 2847, 2848, 2849, 2850, 2851, 2852, 2853, 2854, 2855, 2856, 2857, 2858, 2859, 2860, 2861, 2862, 2863, 2864, 2865, 2866, 2867, 2868, 2869, 2870, 2871, 2872, 2873, 2874, 2875, 2876, 2877, 2878, 2879, 2880, 2881, 2882, 2883, 2884, 2885, 2886, 2887, 2888, 2889, 2890, 2891, 2892, 2893, 2894, 2895, 2896, 2897, 2898, 2899, 2900, 2901, 2902, 2903, 2904, 2905, 2906, 2907, 2908, 2909, 2910, 2911, 2912, 2913, 2914, 2915, 2916, 2917, 2918, 2919, 2920, 2921, 2922, 2923, 2924, 2925, 2926, 2927, 2928, 2929, 2930, 2931, 2932, 2933, 2934, 2935, 2936, 2937, 2938, 2939, 2940, 2941, 2942, 2943, 2944, 2945, 2946, 2947, 2948, 2949, 2950, 2951, 2952, 2953, 2954, 2955, 2956, 2957, 2958, 2959, 2960, 2961, 2962, 2963, 2964, 2965, 2966, 2967, 2968, 2969, 2970, 2971, 2972, 2973, 2974, 2975, 2976, 2977, 2978, 2979, 2980, 2981, 2982, 2983, 2984, 2985, 2986, 2987, 2988, 2989, 2990, 2991, 2992, 2993, 2994, 2995, 2996, 2997, 2998, 2999, 3000.

Digitalizer™ DT1050... \$24.95 ea. MM51404 Processor Chip... \$12.95 ea. DT1057 - 1024x1024 resolution from 137 to over 250 words/sec. (2.0MHz) and 2000 words/sec. Part No. DT1057... \$11.95 ea.

Table with columns: Part No., Pcs, Price. Rows include SN74300N, SN74301N, SN74302N, SN74303N, SN74304N, SN74305N, SN74306N, SN74307N, SN74308N, SN74309N, SN74310N, SN74311N, SN74312N, SN74313N, SN74314N, SN74315N, SN74316N, SN74317N, SN74318N, SN74319N, SN74320N, SN74321N, SN74322N, SN74323N, SN74324N, SN74325N, SN74326N, SN74327N, SN74328N, SN74329N, SN74330N, SN74331N, SN74332N, SN74333N, SN74334N, SN74335N, SN74336N, SN74337N, SN74338N, SN74339N, SN74340N, SN74341N, SN74342N, SN74343N, SN74344N, SN74345N, SN74346N, SN74347N, SN74348N, SN74349N, SN74350N, SN74351N, SN74352N, SN74353N, SN74354N, SN74355N, SN74356N, SN74357N, SN74358N, SN74359N, SN74360N, SN74361N, SN74362N, SN74363N, SN74364N, SN74365N, SN74366N, SN74367N, SN74368N, SN74369N, SN74370N, SN74371N, SN74372N, SN74373N, SN74374N, SN74375N, SN74376N, SN74377N, SN74378N, SN74379N, SN74380N, SN74381N, SN74382N, SN74383N, SN74384N, SN74385N, SN74386N, SN74387N, SN74388N, SN74389N, SN74390N, SN74391N, SN74392N, SN74393N, SN74394N, SN74395N, SN74396N, SN74397N, SN74398N, SN74399N.

MICROPROCESSOR COMPONENTS. Table with columns: Part No., Pcs, Price. Rows include 3001, 3002, 3003, 3004, 3005, 3006, 3007, 3008, 3009, 3010, 3011, 3012, 3013, 3014, 3015, 3016, 3017, 3018, 3019, 3020, 3021, 3022, 3023, 3024, 3025, 3026, 3027, 3028, 3029, 3030, 3031, 3032, 3033, 3034, 3035, 3036, 3037, 3038, 3039, 3040, 3041, 3042, 3043, 3044, 3045, 3046, 3047, 3048, 3049, 3050, 3051, 3052, 3053, 3054, 3055, 3056, 3057, 3058, 3059, 3060, 3061, 3062, 3063, 3064, 3065, 3066, 3067, 3068, 3069, 3070, 3071, 3072, 3073, 3074, 3075, 3076, 3077, 3078, 3079, 3080, 3081, 3082, 3083, 3084, 3085, 3086, 3087, 3088, 3089, 3090, 3091, 3092, 3093, 3094, 3095, 3096, 3097, 3098, 3099, 3100.

30099 1985 Intersil Data Book (1075 pgs)... \$9.95. 74HC HIGH SPEED CMOS. Table with columns: Part No., Pcs, Price. Rows include 74HC00, 74HC02, 74HC04, 74HC05, 74HC06, 74HC07, 74HC08, 74HC09, 74HC10, 74HC11, 74HC12, 74HC13, 74HC14, 74HC15, 74HC16, 74HC17, 74HC18, 74HC19, 74HC20, 74HC21, 74HC22, 74HC23, 74HC24, 74HC25, 74HC26, 74HC27, 74HC28, 74HC29, 74HC30, 74HC31, 74HC32, 74HC33, 74HC34, 74HC35, 74HC36, 74HC37, 74HC38, 74HC39, 74HC40, 74HC41, 74HC42, 74HC43, 74HC44, 74HC45, 74HC46, 74HC47, 74HC48, 74HC49, 74HC50, 74HC51, 74HC52, 74HC53, 74HC54, 74HC55, 74HC56, 74HC57, 74HC58, 74HC59, 74HC60, 74HC61, 74HC62, 74HC63, 74HC64, 74HC65, 74HC66, 74HC67, 74HC68, 74HC69, 74HC70, 74HC71, 74HC72, 74HC73, 74HC74, 74HC75, 74HC76, 74HC77, 74HC78, 74HC79, 74HC80, 74HC81, 74HC82, 74HC83, 74HC84, 74HC85, 74HC86, 74HC87, 74HC88, 74HC89, 74HC90, 74HC91, 74HC92, 74HC93, 74HC94, 74HC95, 74HC96, 74HC97, 74HC98, 74HC99, 74HC100.

Table with columns: Part No., Pcs, Price. Rows include SN74400N, SN74401N, SN74402N, SN74403N, SN74404N, SN74405N, SN74406N, SN74407N, SN74408N, SN74409N, SN74410N, SN74411N, SN74412N, SN74413N, SN74414N, SN74415N, SN74416N, SN74417N, SN74418N, SN74419N, SN74420N, SN74421N, SN74422N, SN74423N, SN74424N, SN74425N, SN74426N, SN74427N, SN74428N, SN74429N, SN74430N, SN74431N, SN74432N, SN74433N, SN74434N, SN74435N, SN74436N, SN74437N, SN74438N, SN74439N, SN74440N, SN74441N, SN74442N, SN74443N, SN74444N, SN74445N, SN74446N, SN74447N, SN74448N, SN74449N, SN74450N, SN74451N, SN74452N, SN74453N, SN74454N, SN74455N, SN74456N, SN74457N, SN74458N, SN74459N, SN74460N, SN74461N, SN74462N, SN74463N, SN74464N, SN74465N, SN74466N, SN74467N, SN74468N, SN74469N, SN74470N, SN74471N, SN74472N, SN74473N, SN74474N, SN74475N, SN74476N, SN74477N, SN74478N, SN74479N, SN74480N, SN74481N, SN74482N, SN74483N, SN74484N, SN74485N, SN74486N, SN74487N, SN74488N, SN74489N, SN74490N, SN74491N, SN74492N, SN74493N, SN74494N, SN74495N, SN74496N, SN74497N, SN74498N, SN74499N.

MICROPROCESSOR COMPONENTS. Table with columns: Part No., Pcs, Price. Rows include 3101, 3102, 3103, 3104, 3105, 3106, 3107, 3108, 3109, 3110, 3111, 3112, 3113, 3114, 3115, 3116, 3117, 3118, 3119, 3120, 3121, 3122, 3123, 3124, 3125, 3126, 3127, 3128, 3129, 3130, 3131, 3132, 3133, 3134, 3135, 3136, 3137, 3138, 3139, 3140, 3141, 3142, 3143, 3144, 3145, 3146, 3147, 3148, 3149, 3150, 3151, 3152, 3153, 3154, 3155, 3156, 3157, 3158, 3159, 3160, 3161, 3162, 3163, 3164, 3165, 3166, 3167, 3168, 3169, 3170, 3171, 3172, 3173, 3174, 3175, 3176, 3177, 3178, 3179, 3180, 3181, 3182, 3183, 3184, 3185, 3186, 3187, 3188, 3189, 3190, 3191, 3192, 3193, 3194, 3195, 3196, 3197, 3198, 3199, 3200.

74C-C/MOS. Table with columns: Part No., Pcs, Price. Rows include 74C00, 74C02, 74C04, 74C05, 74C06, 74C07, 74C08, 74C09, 74C10, 74C11, 74C12, 74C13, 74C14, 74C15, 74C16, 74C17, 74C18, 74C19, 74C20, 74C21, 74C22, 74C23, 74C24, 74C25, 74C26, 74C27, 74C28, 74C29, 74C30, 74C31, 74C32, 74C33, 74C34, 74C35, 74C36, 74C37, 74C38, 74C39, 74C40, 74C41, 74C42, 74C43, 74C44, 74C45, 74C46, 74C47, 74C48, 74C49, 74C50, 74C51, 74C52, 74C53, 74C54, 74C55, 74C56, 74C57, 74C58, 74C59, 74C60, 74C61, 74C62, 74C63, 74C64, 74C65, 74C66, 74C67, 74C68, 74C69, 74C70, 74C71, 74C72, 74C73, 74C74, 74C75, 74C76, 74C77, 74C78, 74C79, 74C80, 74C81, 74C82, 74C83, 74C84, 74C85, 74C86, 74C87, 74C88, 74C89, 74C90, 74C91, 74C92, 74C93, 74C94, 74C95, 74C96, 74C97, 74C98, 74C99, 74C100.

Table with columns: Part No., Pcs, Price. Rows include SN74500N, SN74501N, SN74502N, SN74503N, SN74504N, SN74505N, SN74506N, SN74507N, SN74508N, SN74509N, SN74510N, SN74511N, SN74512N, SN74513N, SN74514N, SN74515N, SN74516N, SN74517N, SN74518N, SN74519N, SN74520N, SN74521N, SN74522N, SN74523N, SN74524N, SN74525N, SN74526N, SN74527N, SN74528N, SN74529N, SN74530N, SN74531N, SN74532N, SN74533N, SN74534N, SN74535N, SN74536N, SN74537N, SN74538N, SN74539N, SN74540N, SN74541N, SN74542N, SN74543N, SN74544N, SN74545N, SN74546N, SN74547N, SN74548N, SN74549N, SN74550N, SN74551N, SN74552N, SN74553N, SN74554N, SN74555N, SN74556N, SN74557N, SN74558N, SN74559N, SN74560N, SN74561N, SN74562N, SN74563N, SN74564N, SN74565N, SN74566N, SN74567N, SN74568N, SN74569N, SN74570N, SN74571N, SN74572N, SN74573N, SN74574N, SN74575N, SN74576N, SN74577N, SN74578N, SN74579N, SN74580N, SN74581N, SN74582N, SN74583N, SN74584N, SN74585N, SN74586N, SN74587N, SN74588N, SN74589N, SN74590N, SN74591N, SN74592N, SN74593N, SN74594N, SN74595N, SN74596N, SN74597N, SN74598N, SN74599N.

MICROPROCESSOR COMPONENTS. Table with columns: Part No., Pcs, Price. Rows include 3201, 3202, 3203, 3204, 3205, 3206, 3207, 3208, 3209, 3210, 3211, 3212, 3213, 3214, 3215, 3216, 3217, 3218, 3219, 3220, 3221, 3222, 3223, 3224, 3225, 3226, 3227, 3228, 3229, 3230, 3231, 3232, 3233, 3234, 3235, 3236, 3237, 3238, 3239, 3240, 3241, 3242, 3243, 3244, 3245, 3246, 3247, 3248, 3249, 3250, 3251, 3252, 3253, 3254, 3255, 3256, 3257, 3258, 3259, 3260, 3261, 3262, 3263, 3264, 3265, 3266, 3267, 3268, 3269, 3270, 3271, 3272, 3273, 3274, 3275, 3276, 3277, 3278, 3279, 3280, 3281, 3282, 3283, 3284, 3285, 3286, 3287, 3288, 3289, 3290, 3291, 3292, 3293, 3294, 3295, 3296, 3297, 3298, 3299, 3300.

74C-C/MOS. Table with columns: Part No., Pcs, Price. Rows include 74C101, 74C102, 74C103, 74C104, 74C105, 74C106, 74C107, 74C108, 74C109, 74C110, 74C111, 74C112, 74C113, 74C114, 74C115, 74C116, 74C117, 74C118, 74C119, 74C120, 74C121, 74C122, 74C123, 74C124, 74C125, 74C126, 74C127, 74C128, 74C129, 74C130, 74C131, 74C132, 74C133, 74C134, 74C135, 74C136, 74C137, 74C138, 74C139, 74C140, 74C141, 74C142, 74C143, 74C144, 74C145, 74C146, 74C147, 74C148, 74C149, 74C150, 74C151, 74C152, 74C153, 74C154, 74C155, 74C156, 74C157, 74C158, 74C159, 74C160, 74C161, 74C162, 74C163, 74C164, 74C165, 74C166, 74C167, 74C168, 74C169, 74C170, 74C171, 74C172, 74C173, 74C174, 74C175, 74C176, 74C177, 74C178, 74C179, 74C180, 74C181, 74C182, 74C183, 74C184, 74C185, 74C186, 74C187, 74C188, 74C189, 74C190, 74C191, 74C192, 74C193, 74C194, 74C195, 74C196, 74C197, 74C198, 74C199, 74C200.

Table with columns: Part No., Pcs, Price. Rows include SN74600N, SN74601N, SN74602N, SN74603N, SN74604N, SN74605N, SN74606N, SN74607N, SN74608N, SN74609N, SN74610N, SN74611N, SN74612N, SN74613N, SN74614N, SN74615N, SN74616N, SN74617N, SN74618N, SN74619N, SN74620N, SN74621N, SN74622N, SN74623N, SN74624N, SN74625N, SN74626N, SN74627N, SN74628N, SN74629N, SN74630N, SN74631N, SN74632N, SN74633N, SN74634N, SN74635N, SN74636N, SN74637N, SN74638N, SN74639N, SN74640N, SN74641N, SN74642N, SN74643N, SN74644N, SN74645N, SN74646N, SN74647N, SN74648N, SN74649N, SN74650N, SN74651N, SN74652N, SN74653N, SN74654N, SN74655N, SN74656N, SN74657N, SN74658N, SN74659N, SN74660N, SN74661N, SN74662N, SN74663N, SN74664N, SN74665N, SN74666N, SN74667N, SN74668N, SN74669N, SN74670N, SN74671N, SN74672N, SN74673N, SN74674N, SN74675N, SN74676N, SN74677N, SN74678N, SN74679N, SN74680N, SN74681N, SN74682N, SN74683N, SN74684N, SN74685N, SN74686N, SN74687N, SN74688N, SN74689N, SN74690N, SN74691N, SN74692N, SN74693N, SN74694N, SN74695N, SN74696N, SN74697N, SN74698N,

ICOM 25-1000MHz Plus!

IC-R7000



ICOM's commercial quality scanning receiver...Top quality at a gem of a price.

ICOM introduces the IC-R7000 advanced technology 25-2000MHz* continuous coverage communications receiver. With 99 owner programmable memories, the IC-R7000 covers low band, aircraft, marine, business, FM broadcast, amateur radio, emergency services, government and television bands.

Keyboard Entry. For simplified operation and quick

tuning, the IC-R7000 features direct keyboard entry. Precise frequencies can be selected by pushing the digit keys in sequence of the frequency or by turning the main tuning knob.

99 Memories. The IC-R7000 has 99 memories available to store your favorite frequencies, including the operating mode. Memory channels may be called up by simply pressing the Memory switch, then rotating the memory channel knob, or by direct keyboard entry.

Scanning. A sophisticated scanning system provides instant access to most used frequencies. By depressing the Auto-M switch, the

IC-R7000 automatically memorizes frequencies in use while the unit is in the scan mode. This allows you to recall frequencies that were in use.

Other Outstanding Features:

- FM wide/FM narrow/AM/upper and lower SSB modes
- Six tuning speeds: 0.1, 1.0, 5, 10, 12.5 or 25KHz
- Dual color fluorescent display with memory channel readout and dimmer switch
- Compact Size: 4-3/8"H x 11 1/4"W x 10 7/8"D
- Dial lock, noise blanker, combined S-meter and center meter

- Optional RC-12 infrared remote controller
- Optional voice synthesizer. When recording, the voice synthesizer automatically announces the scanned signal frequency.

*Specifications guaranteed from 25-1000MHz and 1260-1300MHz. No coverage from 1000-1025MHz. No additional module required for coverage to approximately 2.0GHz.

See the IC-R7000 receiver at your local authorized ICOM dealer. Also available is the IC-R71A 0.1-30MHz general coverage receiver.

ALL THIS AT A PRICE YOU'LL APPRECIATE.

CIRCLE 115 ON READER SERVICE CARD

 **ICOM**
First in Communications