

45635



# POPULAR COMMUNICATIONS

DECEMBER 2001

## Black Tuesday Monitored!



U.S. \$4.99 / Canada



02 000380028 2202 2112  
MR. DAVID C STEARNS KCODAA  
109 W 98 TER  
KANSAS CITY MO 64114-4122

\*\*\*\*\*3-DIGIT 641 1 91

### East Radio mber-Johnson Side Mount

# PROFESSIONAL-GRADE MONITORING IN THE FIELD

Rugged and compact, the new Yaesu VR-120 Hand-Held Communications Receiver provides leading-edge performance on the shortwave, public safety, and military-communications bands. All at a surprisingly affordable price.

- RUGGED OUTDOOR-READY CASE CONSTRUCTION
- ULTRA-LONG BATTERY LIFE
- BNC-TYPE ANTENNA CONNECTOR
- STRAIGHTFORWARD 4-BUTTON OPERATION
- WIDEBAND FREQUENCY COVERAGE WITH EASY ACCESS
- SPECIAL "PRESET MODE" AIDS IN QUICK TUNING
- CATCH ALL THE SHORTWAVE BROADCAST ACTION FROM AROUND THE WORLD
- SUPER-SIMPLE ONE-TOUCH MEMORIES FOR HIGH PRIORITY STATIONS
- VERSATILE 640-CHANNEL MEMORY SYSTEM
- WIDE SELECTION OF SCANNING MODES
- EXPANDED FUN AND GAMES
- AND MUCH, MUCH MORE...

## COMMUNICATIONS RECEIVER **VR-120**

Wideband Coverage: 0.1 ~ 1299.995\* MHz AM/FM/WFM

\*Cellular / Image / restricted frequencies Blocked

Actual Size



## Tomorrow's Technology - Today **THE PROFESSIONAL STANDARD**

### COMMUNICATIONS RECEIVER **VR-500**

0.1 ~ 1299.99995 MHz\*  
LSB/USB/CW/AM/FM/WFM  
All-Mode Wide-Band Receiver

\*Cellular blocked



### COMMUNICATIONS RECEIVER **VR-5000**

0.1 ~ 2599.99998 MHz\*  
LSB/USB/CW/AM-N/AM/  
WAM/FM-N/WFM

All-Mode Wide-Band Receiver

\*Cellular blocked

For the latest Yaesu news, visit us on the Internet:  
<http://www.vxstd.com>

Specifications subject to change without notice. Some accessories and/or options may be standard in certain areas. Frequency coverage may differ in some countries. Check with your local Yaesu Dealer for specific details.

**YAESU**  
Choice of the World's top DX'ers™

Vertex Standard  
US Headquarters  
17210 Edwards Road,  
Cerritos, CA 90703 (562)404-2700



# LENTINI

COMMUNICATIONS, INC.

Toll Free  
1-800-666-0908  
In CT 860-666-6227

## ICOM

### PCR1000



**Special**  
**\$349.95**  
UPS Included

#### Communications Receiver For Computer

- Covers .01-1300MHz.
- All Mode WFM, FM, AM, SSB, CW.
- Employs Band-Tracking RF Filters.
- Connects to Your PC.

### IC-R10



- Wideband, All Mode Receive Capability From 100 kHz to 1300 MHz.
- 1000 Memory Chan. With 8-Character Alphanumeric Names.

Many Other Features!

**Special**  
**\$299.95**  
UPS Included

### IC-R3

Call For \$\$



- Wide Band RX (.5-2450MHz)
- 2 Inch TFT Displ.
- Lithium Ion Bate
- PL Decode/Scan
- Computer Programmable
- 450 Mem., 6 Char. Alpha-Numeric
- BNC Connector
- More!!

### IC-R75



**\$579.95**  
UPS Inc.

#### NEW IC-R75 HF Receiver

- Receives .03-60MHz. AM/FM/SSB/CW/RTTY
- Triple Conversion Receiver
- Synchronous AM detection
- Twin Passband Tuning
- Automatic Notch Filter
- Front Mounted Speaker
- Optional Digital Signal Processing
- Up to Two Optional Filters

### IC-R2

Ultra Compact, Super Wide Band

**SPECIAL**  
**\$159.95**

The New Mini-Size Scanner From ICOM is Now Available.

- 500kHz-1.3GHz (Less Cellular) AM/FM/WFM.
- Loud And Crisp Audio, Backlit LCD.
- Triple Conversion, Built-In Attenuator.
- 400 Memories, 8 Banks of 50 Chan.
- CTCSS Tone Squelch and Tone Search.
- Includes 2 AA Size Ni-Cd Batteries and Charger.
- PC Programmable (Software and Connection Cable Optional).
- More!



## YAESU

### Call For \$\$ VR-500



#### High Performance Miniature Communications Receiver

- Freq Range: 100kHz to 1300 MHz (Less Cellular)
- All-Mode! AM/WFM/NFM/LSB/USB/CW
- 8 Character Alpha Display, 1000 Memories
- Much More!

### VR-120

Call For \$\$

#### Communications Receiver

- Freq Range: 100kHz to 1300 MHz (Less Cellular)
- AM/WFM/NFM modes, 640 Memories
- Straight-Forward 4 Button Operation



### VR-5000

#### All-Mode Wideband Receiver



**\$889.95**

- 100kHz-2599.99 MHz (less cellular).
- CW, LSB, USB, AM, FM, WFM.
- 2000 Memory Channels.
- Real-Time Band Scope.
- More!
- Pending FCC Type Acceptance.

## KENWOOD

### TH-F6A FM Tribander



- 144/220/440MHz TX/RX
- 0.1 - 1,300MHz RX
- FM/WFM-WFM-N/AM, plus SSB/CW receive
- Dual-Channel Receive
- Weather Band
- 435 Memory Channels

Call For \$\$

## ALINGO

### DJ-X2T

- Mini Size Multi-Mode Wide Band Comm Receiver
- AM/FM/WFM
- 700 Memories
- Freq Coverage .5-1000MHz Less Cellular



Call For \$\$ **NEW!**

### DJ-X10

- Wide Range Receiver
- Multi-Mode Reception From 1 to 2000MHz.
- Channel Scope.
- AM/WFM/FM/SSB/CW.
- 1200 Memories.
- Superb Sensitivity, Clear Sound.



Call For \$\$

### AR8200 MARK IIB

**NEW!**

- .5-2040MHz (Less Cellular)
- AM/NFM/WFM/SSB/CW.
- New TCXO Black Case.
- Telescopic Antenna Included
- Much More!

**\$559.95**

## AOR USA, Inc

### AR8600



**\$849.95**

- New Mobile/Base Unit.
- Freq Range 530kHz-2040MHz (Less Cellular)
- Supplied With TCXO
- All-Modes.
- Much More!

**ALSO AVAILABLE**  
MMT TDF-370

AR5000+3  
AR7030 Plus  
SDU5500  
ARD-2

FULL LINE OF AOR ACCESSORIES

CALL FOR MORE INFO & PRICING  
Unblocked versions available to qualified agencies

## uniden BC245XLT Handheld "TrunkTracker II"



**\$219.95**  
UPS Included

SC180 \$174.95  
SC200 \$199.95  
UPS included

## BC780XLT Trunktracker III



- 500 Channel; 10 Banks, 10 Priority Channels
- Continuous Band Coverage: 25MHz to 1.3GHz
- Tracks EDACS™, Motorola, E.F. Johnson
- Alpha Tagging, 2 Line Alpha Display
- CTCSS/DCS
- AM/FM/WFM Modes
- Base/Mobile Design
- More

**\$219.95**  
UPS Included

**\$349.95**

**WinScan 780** Software **\$69.95**  
Optional programming cable included FREE!

SONY	ICF-2010.....CALLSS	RCI-2980	10 Meter Base.....\$429.00
	ICF-7600G.....CALLSS		RCI-2990DX
	ICF-SW07.....CALLSS		10 Meter Base, 100W \$629.00
	ICF-SW77.....CALLSS		RCI-S054 6 Meter All Mode Mobile.....\$299.95
MAGNUM	MAGNUM 257 30W		RCI-6300 FTB
	10 Meter Mobile.....\$199.95		10 Meter Mobile.....\$439.00
RANGER COMMUNICATIONS	RCI-2950DX		RCI-6900 FTB
	10/12 Meter Mobile.....\$299.00		10 Meter Mobile, SSB \$479.00
	RCI-2970DX		TR-296 FDX CB Mobile, AM/SSB, 5-Digit Counter, All Chrome.....\$229.95
	10/12 Meter Mobile.....\$429.00		

## GRUNDIG Shortwave

**NEW!**  
Grundig Satellit 800  
**\$499.95**  
\$15 UPS  
Call for Availability

Yacht Boy 400PE  
**\$199.00**  
UPS Included

Yacht Boy 205 Analog Shortwave  
**SALE \$49.95**

HOURS: M-F 10am - 6pm SAT 10am-4pm (June-August-Saturday 10am-1pm) UPS Ground (48 states)

C.O.D.'s OK  
SAME DAY SHIPPING

Conn Sales Infor. & Tech Help 860-666-6227  
Web Site: www.lentini.com



21 Garfield St. Newington, CT 06111

# Contents

## POPULAR COMMUNICATIONS

Volume 20, Number 4

December 2001



18

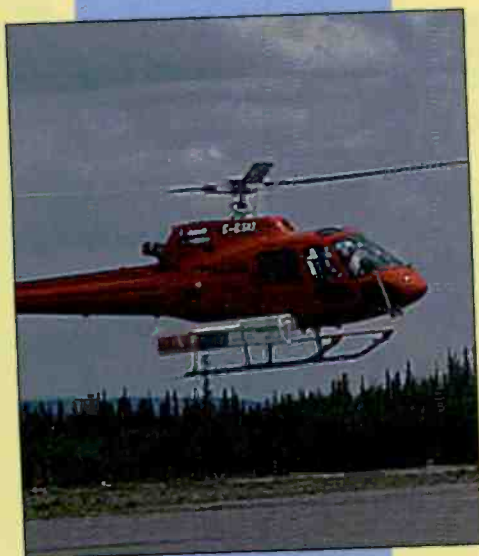

46

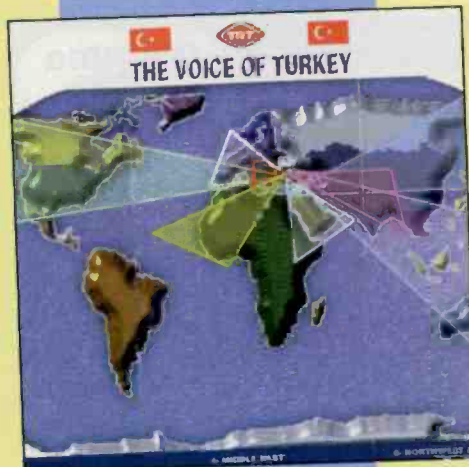

59

- 6 Marconi's Transatlantic Triumph—A Skip Into History**  
100th Anniversary Report On How Marconi Bridged The Atlantic  
by Bart Lee
- 12 Understanding Marconi And His Accomplishments In Wireless Telegraphy**  
It All Hinged On A Huge Kite  
by Joe Cooper
- 16 America's Black Tuesday Monitored**  
by Keith Stein
- 44 Technology Showcase: Gamber-Johnson Super Slide™ Mount**  
by Harold Ort, N2RLL
- 18 *George's Modified Haynes Receiver* The Wireless Connection
- 22 *Happy Holidays! What's On Your Wish List* Overheard
- 28 *The Conrad Project* Broadcast Technology
- 32 *Ninth Circuit Rules On Cordless Phone Case* Washington Beat
- 38 *Resource Of The Month: About.com's Pirate/Free Radio Page With John Anderson* Radio & The Internet
- 40 *Navigating International SW Bands The Easy Way* World Band Tuning Tips
- 46 *Using The Internet To Enhance Your Aircraft Monitoring* Plane Sense
- 54 *Two New Programs Targeting Addis Ababa YOU Can Hear* Clandestine Communiqué
- 56 *Improving Your Online Access Speed* iWaves
- 59 *Special: Middle East English Broadcasts* Global Information Guide
- 66 *The "Black Box" Radio Part II—Software Definition And Control* Utility Radio Review
- 77 *KIPM On AM And USB Heard In Illinois* Pirate & Alternative Radio
- 80 *Bill Almost Shoots His Eye Out* Loose Connection

### Departments

- 4 *Tuning In* — An Editorial
- 37 *Our Readers Speak Out* — Letters
- 42 *Power Up: Radio & High-Tech Gear*
- 53 *VIP Spotlight*
- 78 *Readers' Market*

### On The Cover

Flying over lower Manhattan's destruction on September 11, 2001—the day that changed everything. Check Keith Stein's article on page 16 and Gerry's Middle East broadcast listing on page 59. Photo courtesy Sikorsky Aircraft Corporation.

Visit us on the Web: [www.popular-communications.com](http://www.popular-communications.com)

# Universal Radio - Quality equipment since 1942.

New 2002 Edition!



## PASSPORT TO WORLD BAND RADIO 2002

NEW

By Larry Magne. A **must have** book for every worldband listener. Here is everything you need to know about when and where to hear the world; hour by hour, country by country and frequency by frequency. Also includes candid, hard-hitting reviews of current portable and worldband radios. An expanded station address section is also featured. **Passport** is the world's number one selling shortwave guide. An indispensable reference with over 500 pages. Special early-bird price!

Order #1000 ..... \$49.95 **Sale \$15.90**

## GRUNDIG

### YB-300PE & YB-400PE



The Grundig YB-300PE provides affordable AM, FM and shortwave reception (2.3-7.3 and 9.5-26.1 MHz). Enjoy keypad entry, 24 memories, backlit digital display, clock. With AC adapter, stereo earphones and case. New with one year warranty. #0300 **\$79.95**

Reconditioned. Save \$20 #2300 **\$59.95**

Reconditioned radios have the same warranty and supplied accessories as new.

The deluxe Grundig YB-400PE covers all LW, AM, FM and SW frequencies. It features two bandwidths, SSB, 40 memories, clock and keypad. With AC adapter, stereo earphones, wind-up antenna and case. New with one year warranty. #0400 **\$149.95**

Reconditioned. Save \$50 #4073 **\$99.95**

## WIDEBAND RECEIVERS & SCANNERS



Universal carries an extensive line of scanners and wideband receivers from all major manufacturers including AOR, Alinco, ICOM, Sony, Yaesu and Uniden-Bearcat. The AOR AR8200 is shown. All major ham lines are also stocked.

## COMMERCIAL RECEIVERS



The Ten-Tec RX-340 is the ultimate receiver! Advanced D.S.P. at under \$4000.

## UNIVERSAL M-450v1.5

The Universal M-450v1.5 reader displays: RTTY, SITOR, FEC-A, ASCII, SWED-ARQ and Weather FAX (to the printer port) plus the ACARS aviation teletype mode.

DTMF, CTCSS and DCS are also supported. Features a big two-line, 20 character LCD and parallel port. Operates from 12 VDC or with the supplied AC adapter. No computer or monitor is required. Made in U.S.A. #0450 **\$399.95**



**Universal Radio, Inc.**  
6830 Americana Pkwy.  
Reynoldsburg, Ohio  
43068-4113 U.S.A.

800 431-3939 Orders & Prices  
614 866-4267 Information  
614 866-2339 FAX Line  
dx@universal-radio.com

## COMMUNICATIONS RECEIVERS



Universal Radio carries an excellent selection of new and used communications receivers. JRC NRD-545 shown.

## RADIO BOOKS

### ● A Family Affair - The R.L. Drake Story

By J. Loughmiller KB9AT.

Learn the fascinating inside history of the famous R.L. Drake Co. Plus 150 pages of circuits and modifications for many Drake amateur radios. An entertaining read and great technical reference. 300 pages, 23 chapters. #1487 **Sale \$26.90**

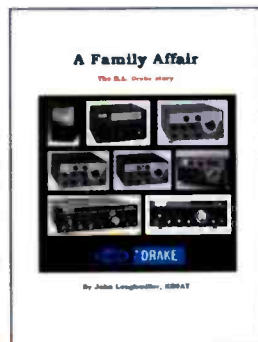

### ● World Radio TV Handbook 2002 New Edition

A special pre-publication price. #2000 **Sale \$22.90**

### ● Joe Carr's Receiving Antenna Handbook

Arguably the best book devoted to receiving antennas for longwave through shortwave. #3113 **Sale \$15.90**

### ● Joe Carr's Loop Antenna Handbook

Here is the low-down on all types of loop antennas for listening and amateur applications. #0016 **Sale \$17.90**

### ● Pirate Radio By A. Yoder With audio CD!

Here is the incredible saga of America's underground illegal broadcasters (with audio CD). #3038 **Sale \$19.90**

### ● Worldwide Aeronautical Frequency Dir. By R. Evans

The definitive guide to commercial and military, HF and VHF-UHF aeronautical communications including ACARS. Second Ed. 260 Pages. #0042 **Sale \$15.90**

### ● Comprehensive Guide To Military Monitoring

Learn how to monitor all kinds of military comms on shortwave, VHF and UHF. 280 Pgs. #3301 **Sale \$11.90**

### ● Shortwave Receivers Past & Present Third Edition

This huge 473 page guide covers over 770 receivers from 98 manufacturers, made from 1942-1997. Entry information includes: receiver type, date sold, photograph, size & weight, features, reviews, specifications, new & used values, variants, value rating & availability. 840 Photos. Become an instant receiver expert! #0003 **Sale \$22.90**

### ● Discover DX'ing! By J. Zondlo Second Edition

How to hear distant AM, FM and TV stations. #0019 **\$5.95**

### ● Communications Receivers - The Vacuum Tube Era

By R. Moore. Your guide to the golden era of tube shortwave radios, 1932-1981. Fourth Edition. 141 Pages. #2945 **Sale \$17.90**

### ● Transmitters Exciters & Power Amps 1930-1980

By R. Moore. This historical reference has 550 transmitters from 118 companies with 470 photos. 144 Pages. #0338 **Sale \$19.90**

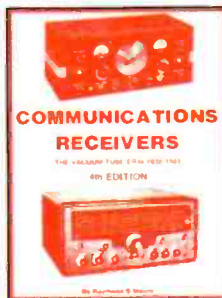

U.S. orders under \$100 ship for \$4.95, under \$500 for \$9.95.

## www.universal-radio.com

- Visa
- MasterCard
- Discover
- Prices and specs. are subject to change.
- Returns subject to a 15% restocking fee.
- Free 100 page catalog on request.

universal  
radio inc.

# tuning in

by Harold Ort, N2RLL, SSB-596

an editorial

## This Changes Everything

Under ordinary circumstances, this would be the place for our end-of-year holiday greetings. Most certainly we at *Popular Communications* do wish our readers, their families, and friends a happy, prosperous, and healthy holiday season. Your continued interest in everything radio is what brings us together as a family — camaraderie that goes beyond racial, ethnic, and religious lines. It's that same family support and glue that's bringing us together as a strong nation right now in the aftermath of the most barbaric crime committed against the USA in our existence.

As this is written, the circumstances are far from ordinary. It's three days after the hijacked jets, controlled by sick minds that only other sick minds can fully understand, took so many lives here in the USA. Right now, because we're human beings, America is sad. America is also very angry. America is sometimes hard to provoke, and often slow to launch a response, even to barbaric inhumane actions, even if it's well deserved, as it is in this case. But as sure as the sun rises in the East, those responsible will not merely be openly and publicly denounced by America and our allies, but will suffer the torment they obviously desire so much. Look to the skies and over your shoulder, and pray to your god, because you're about to be granted your wish of becoming martyrs for your cause.

As I listen to the radio — scanner and regular AM radio here in the New York area during this time of crisis — an unbreakable American bond of patriotism and kindness, something sorely missing from the Neanderthal mind which is crucial to understanding not just we Americans, but other compassionate, peace-loving beings on this planet, shines through these dark times. Those responsible may think we're down and out because innocent civilians were killed. They may think our will has been broken, and they've brought us to our knees. Wrong on all counts. Because terrorists aren't capable of meeting adversaries face-to-face on the battlefield, because they can't distinguish their own inner mental torment from decades of living like dogs under repressive regimes, they don't understand the civilized world. It's they who don't understand us, not the other way around. Children hide in the bushes and throw snowballs at passing cars and trucks, not adults.

What's also missing — despite the outpouring of compassion from many foreign

shortwave voices, print media, and governments — is help. Have you ever noticed how we Americans are always there to help everyone else? From Normandy to Kuwait, and earthquakes to typhoons, Americans are always there with money, troops, and machines. Sadly, though, as this is written we're largely facing this crisis on our own. And face it we will, with or without outside help. But I would hope that when life here returns to whatever "normal" is today we would remember these long, difficult hours, days and weeks when we Americans pitched in together in harmony without much outside help. It seems to me that it's high time we stood tall, spoke our mind — world opinion be damned — and did the right thing for a change. It's time to take a united stand against terrorism and break the arms of those that would thumb their noses at us for being so brave and understanding for so many years.

One of the many notes I received during this crisis came from my friend and colleague, Joe Cooper, a Canadian. He said, in part, "... no country deserves to have to carry the burden of this much tragedy, particularly when it is directed against innocent people." Carry the burden we will. And sadly, we know this may not be the last time. But overcome, we most certainly will — this time and the next. We're Americans, and proud of it.

Please pray for those thousands of Americans that lost their lives in this tragedy, and their families and friends. And please pray for America and the rest of the free world that the decisions made by those in government in the coming days and weeks will, in the final analysis, be the correct ones. Because it's the right thing to do, pray also for the children of those that have done, and would do, us harm. They need all the prayers humanity can muster. Even though we hurt beyond words, remember that final judgment is not ours to make. But, rest assured, the cowardly terrorists' journey to their heaven, is at hand, one by one, if necessary. They probably don't understand that their violent actions have changed everything, forever.

We dedicate this issue to those Americans that are no longer with us because of this tragedy, and to the selfless work of our dedicated public safety and military personnel who work through the night as we sleep.

Merry Christmas and Happy Hanukkah. God bless America!

## POPULAR COMMUNICATIONS

### EDITORIAL STAFF

**Harold Ort, N2RLL, SSB-596**, Editor  
(Internet e-mail: PopularCom@aol.com)  
**Tom Kneitel, K2AES/SSB-13**, Senior Editor  
(Internet e-mail: tsksktsk@juno.com)  
**Alycia Nichol森**, Assistant Editor  
**Richard S. Moseson, W2VU**, Online Coordinator  
(Internet e-mail: W2VU@amsat.org)

### CONTRIBUTING EDITORS

**Ed Barnat, TCA-44**, CB SSB  
**Peter J. Bertini, K1ZJH**, Restoration/Electronics  
**Paul Carr, N4PC**, Antennas  
**Bruce Conti**, AM/FM Broadcasts  
**Joseph Cooper**, Utility Radio  
**Gerry L. Dexter**, Shortwave Broadcast  
**Laura Quarantello**, Legislative Affairs  
**Jock Elliott, SSB-734**, Citizens Band and FRS  
**Eric Force**, Radio and the Internet  
**Bill Hoefler, KB0ULJ**, Aviation Communications  
**Kirk Kleinschmidt, NT0Z**, Amateur Radio  
**Bill Price, N3AVY**, Humor/Communications  
**Ken Reiss**, Technical/Scanning  
**Keith Stein**, Space Comms  
**Edward Teach**, Pirate and Alternative Radio  
**Gordon West, WB6NOA**, Radio Resources

### BUSINESS STAFF

**Richard A. Ross, K2MGA**, Publisher  
**Donald R. Allen, W9CW**, Advertising Mgr.  
**Emily Leary**, Sales Assistant  
**Sal Del Grosso**, Accounting Manager  
**Ann Marie DeMeo**, Accounting Department  
**Catherine Ross**, Circulation Manager  
**Melissa Gilligan**, Operations Manager  
**Cheryl DiLorenzo**, Data Processing

### PRODUCTION STAFF

**Elizabeth Ryan**, Art Director  
**Barbara McGowan**, Associate Art Director  
**Dorothy Kehrwieler**, Production Manager  
**Emily Leary**, Assistant Production Manager  
**Hal Keith**, Technical Illustrator  
**Larry Mulvehill, WB2ZPI**, Photographer

A publication of



CQ Communications, Inc.  
25 Newbridge Road  
Hicksville, NY 11801-2953 USA

Offices: 25 Newbridge Road, Hicksville, NY 11801. Telephone (516) 681-2922. FAX (516) 681-2926. Web Site: <http://www.popular-communications.com/> Popular Communications (ISSN-0733-3315) is published monthly by CQ Communications, Inc. Periodical class postage paid at Hicksville, NY and additional offices. Subscription prices (payable in U.S. dollars): Domestic—one year \$28.95, two years \$51.95, three years \$74.95. Canada/Mexico—one year \$38.95, two years \$71.95, three years \$104.95. Foreign Air Post—one year \$48.95, two years \$91.95, three years \$134.95.

U.S. Government Agencies: Subscriptions to Popular Communications are available to agencies of the United States government, including military services, only on a cash with order basis. Requests for quotations, bids, contracts, etc. will be refused and will not be returned or processed.

Entire contents copyright © 2001 by CQ Communications, Inc. Popular Communications assumes no responsibility for unsolicited manuscripts, photographs, or drawings. Allow six weeks for change of address or delivery of first issue.

Printed in the United States of America.  
Postmaster: Please send change of address to Popular Communications, 25 Newbridge Road, Hicksville, NY 11801.

November 23 & 24 ONLY! See your participating dealer for details!

# THE AFTER THANKSGIVING SALE YOU'VE BEEN WAITING FOR!

SAVE \$10 ON ANY ICOM HANDHELD INCLUDING THE IC-R2 • IC-R3 • IC-R10

# \$10

SAVE \$10 ON ANY ICOM MOBILE INCLUDING THE IC-PCR100 • PCR1000

# \$20

SAVE \$10 ON ANY ICOM BASE INCLUDING THE IC-R75 • IC-R8500

# \$50



Download frequencies right from the web!  
[www.icomreceivers.com](http://www.icomreceivers.com)

ICOM makes it easy to get the frequencies you want. Our database, from PERCOM, provides frequencies for your area. You download them to your computer and easily load into your ICOM radio. Some models require optional software and PC connection cable.

\*SAVE ON ICOM AMATEUR AND RECEIVER PRODUCTS ON 3% OFFER AVAILABLE FOR A LIMITED TIME ONLY. SEE YOUR AUTHORIZED ICOM DEALER FOR DETAILS. ©2001 ICOM America, Inc. 2380 216th Ave NE, Bellevue, WA 98004, 425-454-8155. The ICOM logo is a registered trademark of ICOM, Inc. All specifications are subject to change without notice or obligation. #TSPOPCOM901

Gobble up the savings!

[www.icomamerica.com](http://www.icomamerica.com)

# ICOM

# Marconi's Transatlantic Triumph — A Skip Into History

## *100th Anniversary Report On How Marconi Bridged The Atlantic*

by Bart Lee <blee@slksf.com>

**O**n the afternoon of December 12, 1901, Guglielmo Marconi heard the first radio signals (three “dots” of Morse Code) to cross the Atlantic Ocean. The Morse “S” of three dots was transmitted from England to Newfoundland using his new system of wireless telegraphy. Graphics of Marconi’s calendar and that of his assistant, George Kemp noting date and time they heard the pre-arranged signals, are reproduced here. Marconi noted “Sigs at 12:30, 1:10 and 2:20.” Kemp notes “Got Sigs 3 Dots” and of their 500-foot long kite antenna “... kept it up three hours which appeared to give sigs good.”

The kite’s antenna was then affixed to a pole from which the kite remained aloft, as shown in the drawing. The site in Newfoundland, known as Cabot Tower, Signal Hill, is commemorated on a 1930s postage stamp. Marconi thus opened the century of telecommunications. One hundred years has brought even hand-held transceivers (ironically, Nikola Tesla’s dream) linking to the world’s telephone systems. The world now enjoys worldwide, high-bandwidth data, video and voice links, including broadcasting. Parabolic antennas, pioneered by Marconi, listen to radio telemetry from deep space probes.

### How’d He Do It?

It is, however, not at all clear, even now, how Marconi’s spark signals managed to get across the Atlantic, from Cornwall in England (at Poldhu on the Lizard Peninsula) to St. John’s in Newfoundland, more than 1,800 nautical miles in the middle of the day. The leading authority, Professor Hugh G. H. Aitken in *Syntax and Spark*, notes the apparently poor propagation conditions, by most modern understandings of the phenomena: “... the transmission times and frequencies were, as later learned, the worst possible in view of propagation conditions on the North Atlantic path.” Daylight does not promote propagation of Marconi’s system of relatively low frequency, long wave wireless. Marconi himself found this out the next year. Using an inker and coherer for reception, he could no longer record signals at sea at 700 miles, as he later recalled in his 1926 article, *Looking Back Over Thirty Years of Radio*. Yet, on that same 1902 voyage on the S.S. Philadelphia, Marconi replicated the more than 1,800 miles distance from Poldhu to St. John’s with shore-to-ship reception, but only at night, reaching out statute 2,099 miles. He had earlier in the

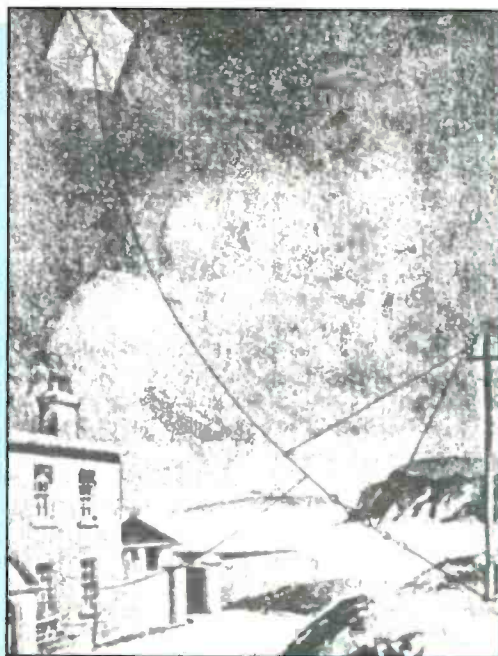

*Keeping the kite flying by attaching it to a pole.*

year identified what he called this “night effect.” Soon enough, higher power and longer wavelength stations regularly crossed the oceans. Later familiarity with shortwave propagation by reflected sky wave has led to some speculation that perhaps Marconi managed to hear a high order harmonic of his transmitter’s fundamental frequency. We’ll look at propagation conditions for the afternoon of December 12, 1901. Those conditions, taken together, suggest that Marconi enjoyed a rare confluence of circumstances. Unusual propagation conditions permitted his first transatlantic signaling on his likely fundamental frequency or close to it. Conversely, higher order harmonic propagation is unlikely.

The first issue is the frequency on which Marconi’s Poldhu transmitter operated. The very question is misleading. A spark transmitter works by production of a radio frequency hash. This emission centers on a band of frequencies around its inductance



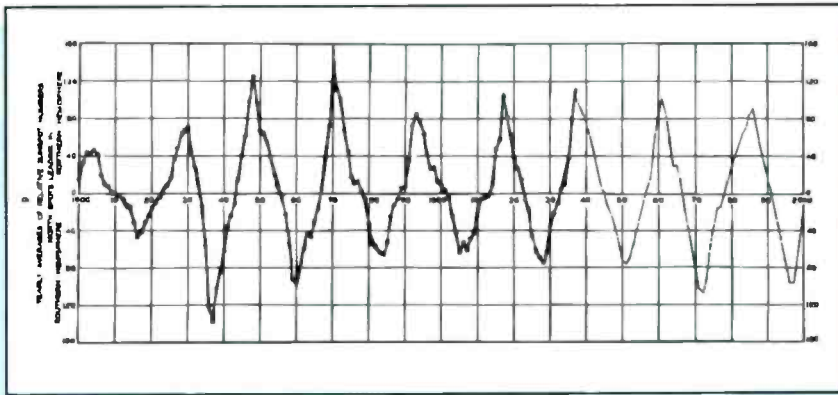

*Sunspot records from a Bell System study, showing the situation in December 1901. These are measured and computed sunspot numbers from 1800 to 2000 AD. The solid line represents measured values, while the dashed line is a computer projection from the measured values.*

— and capacitance — determined resonant peak frequency. Perhaps the most widely known contemporary explanations of this technology are in Marconi engineer Elmer Bucher's 1917 *Practical Wireless Telegraphy* and the U.S. Navy's *Robinson's Manual of Radio Telegraphy*. The bandwidth of the hash is great, and measured logarithmically in terms of its "decrement" or spread. Moreover, the antenna system often, if not usually, resonated on a different frequency. This "coupling" mismatch resulted in a second peak of a second band of frequencies, usually of a shorter wavelength than the transmitter's peak. Engineers came to call this condition a "double hump" because it looked like a camel's back when graphed. A nearby illustration from Bucher's book shows the graphs resulting from close coupling an antenna to a transmitter. It would be only in the period before the First World War that techniques of tuning regularly focused the radio frequency energy of spark transmitters into a single relatively sharp peak. Marconi enjoyed no such precision in 1901.

Marconi had set up a large antenna array of circular form, to put his 25,000-watt spark signal into the ether; as shown in the illustration. A storm took it down shortly before the tests, perhaps providentially. He then put up a jury-rigged antenna of about 50 nearly vertical wires in a narrow fan. The more fully reconstructed shore side Poldhu site is also illustrated nearby for comparison. It is likely that the resonant characteristics of the new antenna differed significantly from the earlier version, and likely that its

resonant frequency was higher, because it was so much smaller. This circumstance lends itself to a second, higher frequency peak band being transmitted along with a fundamental peak band of frequencies. Moreover, the emitted radio frequency electromagnetic waves perhaps took on a vertical polarization because of the accidental antenna configuration, which would have been good for reception by the kite wire. Still, the fundamental frequency is not known. Reports are 820 kilocycles per second (kilohertz, or kHz) (366 meters) and 100 kHz (3000 meters), a full order of magnitude disparity. The 366-meter conclusion is that of H.M. Dowsett, a Marconi engineer at the time, as well as Marconi's later, 1908 report.

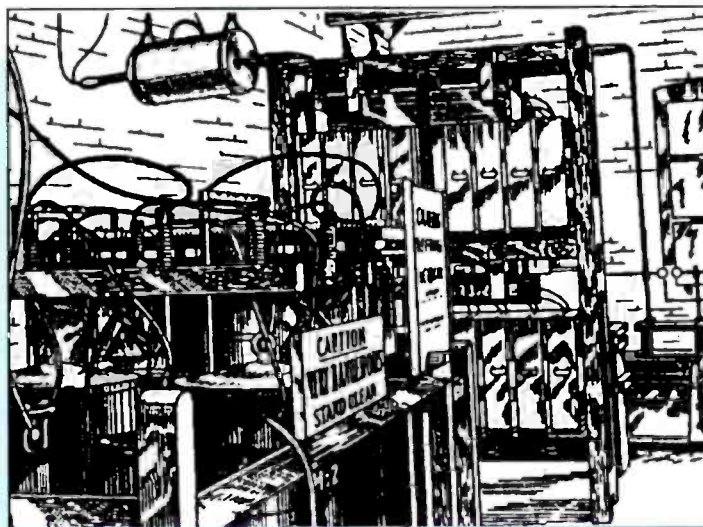

*The transmitter at Poldhu in England, done from a contemporary photo, artist unknown.*

Harmonics and what were later called spurious and parasitic emissions were inherent in the nascent technology. Poldhu's signals were likely all over the ether, what would now be called the radio frequency spectrum. On the other hand, there was hardly anyone to interfere with (perhaps only Tesla), and no one else "on the air" that winter day. Marconi's receiving circuits tuned very broadly, optimizing the chance of reception. Modern concepts such as maximum useable frequency and minimum useable frequency were unknown and unanticipated in 1901. Indeed, they were not initially appreciated for another 25 years.

## Sunspot Records

Examination of sunspot records for a century ago shows a nearly unique datum: on December 12, 1901 the number of sunspots was exactly zero, a dead-low minimum. It was a transition year between the sun's hemispheres. A chart from a Bell System study shows solar ionizing radiation on the atmosphere was at a minimum. Thus useable frequencies for skip propagation, bounded at the lower end by the absorption frequency, would be at near absolute minima. A zero sunspot number means ionospheric propagation at the lowest frequencies the band of useable frequencies ever reaches. This effect was noticed as early as 1931, with the refinement that the more northerly the path, the longer the useable wavelength (i.e., the lower the useable frequency), by as much as a 90 percent increase for upper

# GRUNDIG



# The

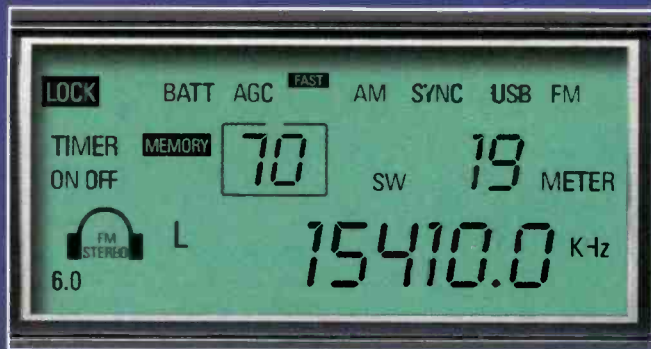

### The LCD

Eig! Bold! Brightly Illuminated 6" by 3 1/2". Liquid Crystal Display shows all important data: Frequency, Meter band, Memory position, Time, LSB/USB, Synchronous Detector and more.

### The Signal Strength Meter

Elegant in its traditional Analog design, like the gauges in the world's finest sports cars. Large. Well Lit. Easy to read.



### The Frequency Coverage

Longwave, AM and shortwave: continuous 100-30,000 KHz. FM: 87-108 MHz VHF Aircraft Band: 118-137 MHz.

### The Tuning Controls

• For the traditionalist: a smooth, precise tuning knob, produces no audio muting during use.



Ultra fine-tuning of 50Hz on LSB/USB, 100Hz in SW, AM and Aircraft Band and 20 KHz in FM.

- For Fixed-step Tuning: Big, responsive Up/Down tuning buttons.
- For direct frequency entry: a responsive, intuitive numeric keypad.



THESE ARE THE SATELLIT 800 MILLENNIUM'S MAJOR FEATURES. FOR A DETAILED SPECIFICATION SHEET, CONTACT GRUNDIG.

# Ultimate in Digital Technology!

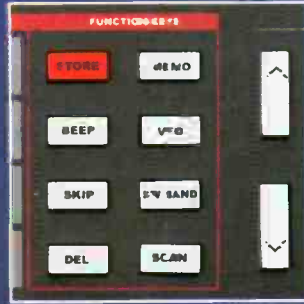

## The Operational Controls

Knobs where you want them; Buttons where they make sense. The best combination of traditional and high-tech controls.

## The Sound

Legendary Grundig Audio Fidelity, with separate bass and treble controls, big sound from its powerful speaker and FM-sterero with the included high quality headphones.



## The Technology

Today's latest engineering:

- Dual conversion superheterodyne circuitry.
- PLL synthesized tuner.

## The Many Features

- 70 user-programmable memories.
- Two, 24 hour format clocks.
- Two ON/OFF sleep timers.
- Massive, built-in telescopic antenna.
- Connectors for external antennas - SW, AM, FM and VHF Aircraft Band.
- Line-out, headphone and external speaker jacks.

## The Power Supply

A 110V AC adapter is included for North America (a 220V AC adapter is available upon request). Also operates on 6 size C batteries. (not included)



Dimensions: 20.5" L X 9" H X 3" W

Weight: 14.50 lbs.

by **GRUNDIG**

Lextronix / Grundig P.O. Box 2307, Menlo Park, CA 94025 • Tel: 650-361-1511 • Fax: 650-361-1724  
Phones: (US) 1-800-872-2223 (CN) 1-800-637-1648 • Web: [www.grundigradio.com](http://www.grundigradio.com) • Email: [grundig@ix.netcom.com](mailto:grundig@ix.netcom.com)

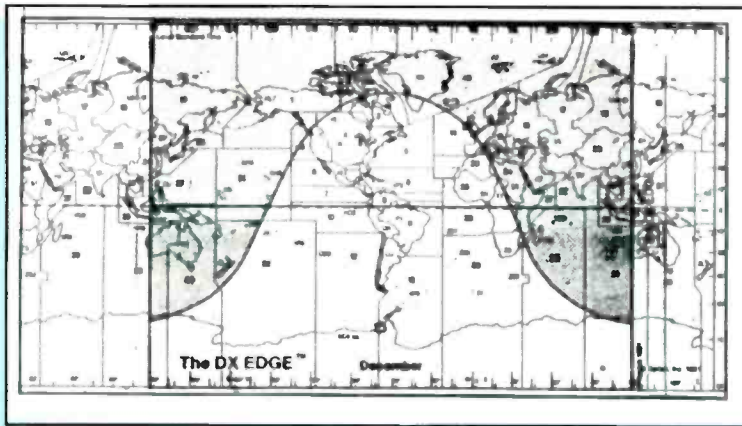

The DX Edge™ propagation mapping system for December.

latitude paths as opposed to 10 percent for equatorial paths. Nighttime skywave propagation at 800 kHz is common under such conditions, albeit detected on modern high sensitivity receivers. A Branly metal filings coherer, connected to a direct current circuit to actuate a landline or marine telegraph inker, is a low sensitivity device. Marconi, however, used a highly sensitive "Italian Navy" self-restoring coherer, really a mercury oxide detector — a drop of mercury between two conducting rods of iron or carbon.

Marconi also listened on a telephone earpiece, rather than employing an inker. He did this deliberately to take advantage of the telephone earpiece's much higher sensitivity, as well as the extraordinary sensitivity of the ear itself. (Within about a dozen years, wireless operators using galena crystal detectors alone, and they were not much more sensitive than the Italian Navy coherer, would copy spark signals occasionally several thousand miles distant.) The historical price Marconi paid in 1901 was the absence of

an inker's paper record, a fault he remedied in 1902 on the *S.S. Philadelphia*, but at the price of reduced sensitivity.

The season and time of day also lend themselves to enhanced lower frequency propagation. December 12 is within 10 days of the winter solstice, leaving the Northern Hemisphere in maximum darkness. At this time of year, the thunderstorms of the tropics and temperate latitudes are farthest away. The likelihood of noise interference is minimum. Through an Italian Navy coherer, lightning-generated random static would not sound like the repetitive pattern of three clicks Marconi and Kemp listened for, the Morse code "S." At this depth of winter, the days are shortest as well, minimizing the cumulative effects of solar radiation on the lower, blocking, ionospheric layers. The lower, D, layer results from solar x-rays. It usually blocks reflection or refraction of radio waves or "skip," by the E or F layers above it. The winter D layer would have been relatively weak during the short day, having had less time to build. Moreover, Marconi himself noted in 1924 regarding his 3.25 MHz (92 meter wavelength) tests: "... the intensity of the signals vary ... inversely in proportion to the mean altitude of the sun when above the horizon." He is likely reporting a "D" layer phenomenon. Newfoundland and Southern England are at about 50 degrees North latitude; the Arctic Circle is at 66.7 degrees North. Winter sunlight at this latitude is at a very low angle, even at noon, well filtered atmospherically and thus also less destructive of nighttime ionization patterns, especially to the North. Marconi noted the effect in his 3.25 MHz shortwave tests of 1924, out to 1,400 miles at sea: "... the signals' intensity is symmetrical to the mean altitude of the sun at all times ..."; in other words, the further North, the stronger was the reception. Day and night come as sunrise and sunset, but from a global perspective, dawn moves around the world followed by sunset. The edge of daylight or darkness is often called the "terminator." It is necessarily a great circle, the light of the sun on a revolving Earth. As the axis of the Earth points towards the sun in summer, the terminator extends up to the far side of the Arctic Circle (the "midnight sun" phenomenon). Then in winter the terminator is but tangent to the Arctic Circle, leaving the polar region without any daily winter sun. The terminator may be visualized on a Mercator or similar projection

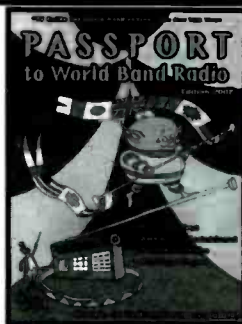

## Your Favorite Books at Special Prices

- ◆ **Passport To World Band Radio 2002** By L. Magne. An indispensable must-have book for every shortwave listener. Graphic presentation of all SWBC stations. Equipment reviews too. .... \$49.95 \$15.90
- ◆ **World Radio TV Handbook 2002** All SWBC stations by country with schedules, addresses, power, etc. Reviews too. Will ship about 12/27/01 ... \$24.95 \$22.90

- ◆ **Worldwide Aeronautical Frequency Directory** By R. Evans. The definitive guide to commercial and military, HF and VHF-UHF aeronautical communications including ACARS.... \$49.95 \$11.90
- ◆ **Joe Carr's Receiving Antenna Handbook** By J. Carr. Arguably the best book devoted to receiving antennas for long-wave through shortwave. Easy to understand. .... \$49.95 \$15.90
- ◆ **Shortwave Listening Guide Book** By H. Helms. Over 300 pages of understandable info. on: selecting and operating a shortwave receiver, simple antennas, time stations, pirates and more. With informative tables and diagrams. \$49.95 \$15.90
- ◆ **Pirate Radio (With audio CD!)**. By A. Yoder. Here is the incredible saga of America's underground illegal broadcasters. Includes an audio CD of famous pirates. ... \$29.95 \$19.90
- ◆ **A Family Affair - The R.L. Drake Story** By J. Loughmiller. Read the fascinating "inside" history of the famous R.L. Drake company. Plus loads of technical mods for Drake. \$29.95 \$26.90

✓ USA Shipping is \$4.95 for orders under \$100.00

**universal radio inc.**

**Universal Radio**  
6830 Americana Pkwy.  
Reynoldsburg, OH 43068  
◆ Orders: 800 431-3939  
◆ Info: 614 866-4267  
◆ Fax: 614 866-2339

**www.RFfun.com**  
New and used radios with on-line ordering.  
**www.DXing.com**  
Your web resource for radio hobbyists.

map of the Earth as an inverted "U" shaped curve in winter. Apparent refraction and long path "ducting" often enhance radio propagation along the terminator. This phenomenon is familiar to amateur radio operators and shortwave listeners as grey-line propagation. It is experienced more as a band rather than a sharp line, with signals intensifying, peaking and then diminishing as the terminator approaches and then recedes.

On the afternoon of every December 12, including 1901, the grey line runs just west of England and well west of Newfoundland. Between 12:30 p.m. and 2:20 p.m. both the Poldhu, England, transmitter and the St. John's, Newfoundland, receiver were within a few degrees of the terminator, with Poldhu on the sunset side. See the accompanying illustration using the DX EDGE propagation mapping system. Marconi thus enjoyed several phenomena: an optimal solar season of zero sunspots for enhanced lower frequency and daytime propagation, an optimal Winter season of minimal atmospheric noise and as well as enhanced daytime propagation, and a good time of day at his latitude for grey line propagation. That Marconi heard the three clicks of his coherer in his telephone receiver earpiece has always been a matter of faith in the integrity of the man, true enough borne out by all later successes. Yet Marconi could hardly have chosen a better time or place to make his attempt, knowing as he did that the human ear is a very sensitive instrument.

Recent work on radio propagation suggests the importance of these aspects of Marconi's triumph. In 1991 a group of experimenters traveled to St. John's, Newfoundland, in November to listen for DX signals in the broadcast band, 500 kHz to 1600 kHz, or roughly 600 meters to 200 meters wavelength, bracketing Marconi's likely 366 meter wavelength and 820 kHz frequency. With modern receivers and long wire Beverage antennas, and despite auroral interference, even low power stations in Europe, South America, and Africa provided "a tidal wave of transatlantic DX" to the radios at St. John's, confirming that "the best medium wave location is next to the ocean." Recent research also suggests that at lower frequencies (circa 2 MHz) signals from a transmitter newly within the sunset terminator may be enhanced for a receiver on the other side of the terminator, which was the situation between England after sunset and Newfoundland, between local 12:30 p.m.

and 2:20 p.m., at 50 degrees North in December. This is sometimes attributed to temporary formation just behind the terminator of an "F layer" in the ionosphere, providing a reflecting or refracting surface for low frequencies across the terminator into the areas not yet in sunset or darkness. Such conditions, if indeed they did obtain on December 12, 1901, would have provided yet another etheric facilitation of the one skip needed by Poldhu's three dots to get the 1800 miles to St. John's and into history.

Marconi's achievement is still celebrated in many ways; two of the most interesting are a French "phone card" with a silicon chip on it, and on Italian money, shown here. The United States Postal Service also honored Marconi in 1973.

Editor's Note: Bart Lee's original article appeared in *Greenthumbs Press and Antique Wireless Review*. The numerous footnotes in his article can be viewed there if readers are interested in further details. ■

## BEYOND Family Radio!

### Stay in touch with your family and friends!

The new PRYME Radio Products PR-460: SportConnect™ and PR-460: ClearConnect™ transceivers use frequencies in the General Mobile Radio Service (GMRS) to provide long range personal communications. Unlike half-watt FRS radios these new two-way radios provide a full **FOUR WATTS** output power.

The 8-channel PR-460: SportConnect™ model has a range of **up to 5 miles**, while the PR-460: ClearConnect™ has 23 channels including all GMRS repeater frequencies, for a range of **up to twenty-five miles** or more!

**Family Radio PLUS!** Family Radio users upgrading to GMRS can still communicate with their existing FRS radios! Channels 1-7 in both our ClearConnect™ and SportConnect™ are the **same as Family Radio channels 1-7**, so you can still talk with any FRS radios in your group!

**FCC License Required:** Operation on the General Mobile Radio Service requires an FCC issued GMRS license. Information on obtaining a license is included with your transceiver. The FCC license fee is \$80 for five years, which breaks down to a little more than \$1.00 per month. One license covers you and everyone in your immediate family, including your children and parents.

### PR-460: SportConnect

8 Channels up to 5 miles range!

**\$199.95\***

### PR-460: ClearConnect

23 Channels including repeater operation for range up to 25 miles!

**\$219.95\***

Range may vary due to obstructions, weather, low battery, or other factors. Access to repeaters may require a fee.

\* NOTE: The prices shown above are estimated street prices. Actual dealer prices may vary.

**PRYME**  
Radio Products

by **PREMIER Communications Corp.**  
480 Apollo St. #E • Brea, CA 92821  
Phone: 714-257-0300 • Fax: 714-257-0600  
Web: <http://www.adi-radio.com>



- \* **4 Watts Output Power**
- \* **Just 4.25 inches tall!** (excluding antenna)
- \* **Includes CTCSS (38 tones)**
- \* **Communicate with the FRS Radios that you already have!**
- \* **One touch access to the 462.675 MHz emergency channel**
- \* **Up to 5 miles range. Use the repeater mode on the ClearConnect model to increase your range up to 25 miles!**

# Understanding Marconi And His Accomplishments In Wireless Telegraphy

## *If All Hinged On A Huge Kite*

by Joe Cooper

One hundred years ago this December a milestone was accomplished that has continued to have an impact upon all of us that enjoy the use of radio. What really took place during that event, and how should we interpret its importance today?



*Marconi watches at a distance as his staff struggles with the kite that was needed to lift the receiving antenna.*

It was a miserably cold and windy day in early December. A gale was blowing in from the North Atlantic and the barren Newfoundland coast provided absolutely no protection. Yet a scene that was almost comical was taking place beside an abandoned military hospital on top of a hill on the coastline.

Fighting the strong winds and cold, a group of three men attempted to launch a huge kite into the air. The winds lashed at the cloth material of the kite, and tried to wrench it from their hands. It took the efforts of all of them to keep it from flying away, out of control.

Standing off at a short distance was a fourth man who was observing the efforts of the kite flyers. From the seriousness of his features it was obvious that he found nothing humorous in the actions of the men in front of him. Indeed, the big kite was at that moment the most important thing in the world for the observer.

The planning that had brought this group together had started a year and a half earlier. Everything had been undertaken

with a great sense of urgency and secrecy. The man looking at the kite being prepared was young, ambitious, and not well liked by many people with power and authority.

But the fellow did have friends, many of them in high places. When he had arrived in Newfoundland a high-ranking minister of the government had met him. The building he was using, while run down and decrepit, was offered at no charge by the government. It was what he needed, and the out of the way location was perfect for his task.

They had actually suffered one setback already. Their original intention was to use a gas-filled balloon rather than the kite that they were struggling with now. It, however, had quickly been picked up by the wind and lost. The kite was their only hope at this point. It had to work because it was the second of only two, and the first had already been lost that morning.

If it were lost it would mean the man who was watching it from a distance would lose decades of investment and hard work — not to mention his reputation and credibility.

The date of this event was December 12, 1901 — 100 years ago this month. The man was Marconi, and what he was watching was his staff trying desperately to place an antenna into the air using the wind-blown kite. The site, known as Signal Hill, was the location chosen by Marconi for an ambitious experiment — that was to test the ability of a primitive radio receiver to pick up radio signals transmitted from an equally primitive spark gap transmitter located on the other side of the Atlantic Ocean.

Nobody really knew if the experiment was going to work. There was no real knowledge of how radio waves propagated in the earth's atmosphere at that time. All Marconi knew was that he had been able to send radio signals further and further, and that in doing so, the longest distance achieved at that point was far beyond line of sight.

### **Marconi's Gamble**

In short, the entire enterprise he was undertaking was a gamble. It would either work, or it would not. If it did, Marconi would have the technology needed to compete directly with the

# AOR AR8200 Mark II B & AR8600 Receivers

## Welcome to the Top Shelf



*AOR wide-range communications receivers are designed and built for the serious user. Among our customers are governments and government agencies, news gathering operations, military units, laboratories, public safety operations and more. If you are a demanding user who expects the best, you're ready for AOR, The Serious Choice in Advanced Technology Receivers.™ Don't look for AOR on the bottom shelf at your local discount store, you won't find us there. For dealer locations, check our web site, [www.aorusa.com](http://www.aorusa.com)*



**Technology so advanced,  
it's patented** (US Patent 6,002,924).

### **AR8200 Mark II B**

**Base performance in a hand-held receiver!**

- 530 KHz ~ 2040 MHz \* coverage
- 1,000 memory channels (20 banks) with alphanumeric labeling
- Computer control and programming (requires optional cable)
- Download free control software from AOR web site
- "All Mode" reception includes "super narrow" FM plus wide and narrow AM and USB, LSB, CW and standard AM and FM modes
- True carrier reinsertion in USB and LSB modes  
Includes 3 KHz SSB filter!
- Detachable MW antenna with negative feedback
- Optional internal slot cards expand capabilities. Choose from Memory Expansion (up to 4,000 memories), CTCSS Squelch & Search, Tone Eliminator, Voice Inverter\*\* and Record Audio (saves up to 20 seconds of audio)
- Tuning steps programmable in multiples of 50 Hz in all modes
- 8.33 KHz airband step is correctly supported
- Noise limiter and attenuator
- Lighted keys
- Band activity "scope" display with "save trace" capability
- Four-way side panel rocker switch allows one-hand operation
- Large display includes A and B VFO frequencies and signal strength meter
- Battery Save function with Low Battery indicator
- Operates on 12 VDC external power
- 4 AA Ni-Cd batteries supplied, also uses standard AA dry cells
- BNC antenna connector
- Wide choice of accessories

### **AR8600 Base/Mobile**

**Think of it as a magnet for signals.**

- Temperature Compensated Crystal Oscillator (TCXO) ultra-stable frequency reference
- Coverage from 530 KHz ~ 2040 MHz\*
- Receive Modes: WFM, NFM, SFM, WAM, NAM, USB, LSB, CW
- New front end and RF stages for superior sensitivity
- 2 VFOs (A/B)
- 1000 memory channels (20 banks x 50 memories/bank)
- Alphanumeric channel labels
- Scan rate up to 37 channels/second
- Add up to 3 optional slot cards: Tone eliminator, CTCSS, Voice Inversion\*\*, Recording, External memory
- Accommodation for Collins® Mechanical Filters
- RS-232C port
- 10.7 MHz IF output (WFM mode only) can be used with SDU 5500 Spectrum Display Unit.
- 12 VDC operation
- BNC antenna connection
- Download free control software from AOR web site

**AOR**<sup>™</sup>  
Authority On Radio

AOR U.S.A., Inc.  
20655 S. Western Ave., Suite 112, Torrance, CA 90501, USA  
Tel: 310-787-8615 Fax: 310-787-8619  
[info@aorusa.com](mailto:info@aorusa.com) • [www.aorusa.com](http://www.aorusa.com)

\*Cellular blocked. Unblocked version available to authorized users, documentation required. \*\*Available to authorized users only. Specifications subject to change without notice or obligation. All trademarks remain the property of their respective owners.

trans-Atlantic telegraph companies who used undersea cables to carry their messages. He would do more than just compete — he would beat them because his system did not require the high expense of laying and maintaining cables.

The cable companies knew this, and had made it as difficult as possible for Marconi to raise money or perform his experiments. Half the reason for the great secrecy around the experiments was to keep the cable companies from knowing that he was in Newfoundland — the terminus of the first, and subsequent, trans-Atlantic cables. If they had known he was there, they would be using whatever influence they had to get him off the island.

Originally, Marconi had intended to stay as far away from Newfoundland and its cable interests as he could. His first choice had been Cape Cod due to its proximity to the commercial interests of New York City. A great deal of money and energy had been put into building a proper receiving station at that site. However, everything was new, and many lessons had to be learned. One of them was how to build antennas. The first one put up had been improperly designed, and collapsed when the first strong breeze had come along.

Running out of money and time (for there were others working on their own wireless communications systems) Marconi needed to be first in successfully making that trans-Atlantic transmission in order to get further funding for his business. There was no additional money available to set up a proper antenna or building. All they could do was put up a wire into the sky using the primitive method of a kite and hope that by being closer to the transmitter in England it would overcome the lack of sophistication in their methods.

What had made the events of December 12 particularly tense had been the fact that the test had actually begun on December 11 and nothing had been heard so far. The bad weather had brought about the loss of two balloons and one kite. The actual window for hearing the signals was very narrow, being only three hours a day, with transmissions of the letter “S” being made at specific intervals.

Using a highly tuned receiver circuit only marginal results had been accomplished. In a last ditch effort Marconi hooked up a broadly tuned receiver that would pick up anything — though weakly — being transmitted. It worked. At 12:30 p.m. local time a faint, but distinct “dot-dot-dot” was finally heard — it was a true triumph of scientific planning and execution.

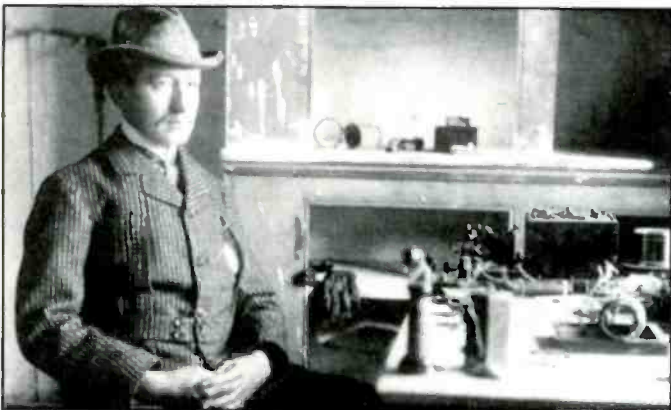

*Marconi sitting in front of his receiver after having just received the letter “S” from his transmitter in England. The room of the abandoned military hospital is decrepit, and he is exhausted, but it is a moment of true historic importance.*

Would Marconi’s word alone be enough to convince people that he had indeed succeeded at what he had claimed to do? He took another gamble and had the news released to the press. The news was presented to the public on December 16. Proof that Marconi had won came with the Anglo-American Telegraph Company threatening legal action against him for performing successful wireless experiments on “their” island.

Such a bullying attack could not have worked better for Marconi. He immediately became the underdog, and the favorite of the public. Local politicians congratulated him, and honored him with lavish feasts. Alexander Graham Bell offered him land on the Island of Cape Breton so he could get away from the cable monopoly in Newfoundland. Both the American and Canadian governments officially offered him assistance.

Yet, despite this acclaim, there were still detractors — some being scientists of high standing and reputation. Despite the respect that many people in high places had given to him, Marconi still felt he had not been completely successful. He needed to have his accomplishments totally accepted if his ambition was to be fully satisfied.

The event that would provide the final proof to the world that Marconi had in fact developed and perfected a truly new and unique method of communications came several years *after* his successful trans-Atlantic test. In January of 1909, over 1,700 people were rescued at sea from the S.S. Republic.

While the ship slowly sank off the East Coast of the United States, the two Marconi radio operators on board sent out over 200 messages. Through their efforts, rescue ships were guided to the site — something that had never happened before in the history of world.

What fixed Marconi’s reputation forever took place on the night of April 14, 1912 when the S.S. *Titanic* struck an iceberg and sank. While events made it impossible to reproduce the success of the Republic’s rescue, the coverage that the newspapers gave to the events changed the world. This was because radio gave the newspapers real information to publish about an event that they were not able to personally witness.

Marconi’s successfully receiving of the letter “S” across the Atlantic was actually not that significant, though certainly a praiseworthy engineering accomplishment. The simple fact of the matter was that his technology was not yet radio, as we understand it, but rather “wireless telegraphy.” All he had demonstrated was that he had developed an alternative method of sending messages that was cheaper than conventional underwater cable.

It would not be until the technology had come to be perfected and placed aboard ships at sea that the real technology emerged. Only when the signals came to be broadcast — in the true sense of the word — to anyone who could receive them, rather than reproducing the point-to-point send and receive technology of conventional telegraphy — was radio truly born.

Like many great things that have come out of the human experience, radio, as we know it was created accidentally. It was really only after the fact that people came to realize the potential of this brand new medium of communication. Marconi must be recognized and thanked for having the drive and courage to bring a laboratory curiosity to the point where it could be used commercially as a wireless alternative to conventional telegraphy.

However, in the final analysis I would have to say that he couldn’t lay claim to being the inventor of radio as conventional wisdom often claims. Like many great inventions, the real credit for that accomplishment must rightfully go to the originator of most enduringly useful things — necessity. That is why today this technology — now called radio — properly belongs to everyone, as it should be. ■



**New for 2002**

# PASSPORT to World Band Radio

**World's #1 Selling Shortwave Guide**

**T**he "must have" companion to shortwave listening. PASSPORT TO WORLD BAND RADIO bulges with essential information, including international broadcast schedules country by country, hour by hour and frequency by frequency.

PASSPORT's Blue Pages are nearly a book by themselves—20,000 entries packed with just the information you need for every transmitter on the air. There's also a separate report on shortwave broadcasting in Asia.

PASSPORT's "What's On Tonight" contains 88 pages detailing news, music, sports and entertainment shows in English. Need station contacts and Webcasts? PASSPORT's "Addresses PLUS" chapter is the industry bible, 277 pages crammed with juicy tips.

If you're on the hunt for new equipment, PASSPORT REPORTS rates virtually every receiver from under \$30 to over \$5000—outdoor and active antennas, too. *Outside* magazine minces no words, "The best. They tell you what's good about the good, bad about the bad, and advertisers be damned."

**Trusted by over a million readers since 1985.**  
[WWW.PASSBAND.COM](http://WWW.PASSBAND.COM)

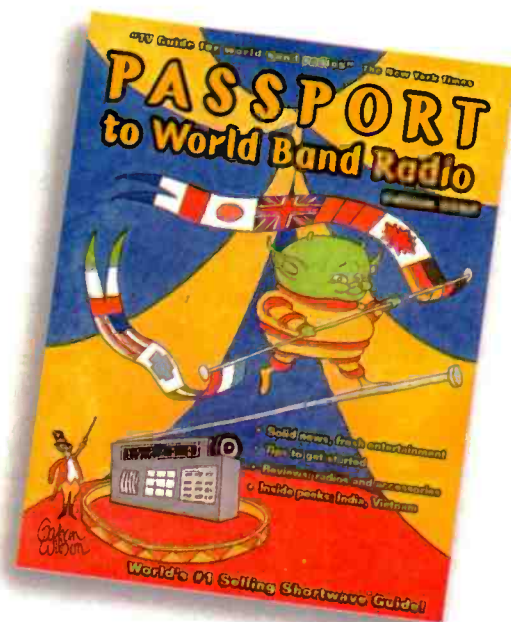

No wonder PASSPORT TO WORLD BAND RADIO is the world's favorite guide to shortwave listening. Available from major dealers and bookstores, or direct from the publisher at:

**PASSPORT TO WORLD BAND RADIO — Edition 2002**

Box 300, Penn's Park, PA 18943 • 24/7 Order Recorder (215) 598-9018 • Fax (215) 598 3794  
[mktg@passband.com](mailto:mktg@passband.com) • [www.passband.com](http://www.passband.com)

# America's Black Tuesday Monitored

## September 11, 2001: The Conflict Begins

By Keith Stein

Of course it's been several months now since the terrorist attacks in New York and Washington, but I wanted to take a step back from space monitoring and relay what I monitored and experienced during one of America's darkest days.

U.S. combat air patrols (CAP) responding to the terrorist attack used a modified version of the procedures the armed forces would use to clear U.S. skies in the event of a nuclear war.

Listening to air-traffic communications on a scanner minutes after the attack on September 11, 2001 was one of the most interesting monitoring days I've ever had. Slowly, normal communications with aircraft from Continental Airlines, United, TWA and USAir slowly went silent, and was replaced with call signs like "Wild," "Bully," "Angry," "Angel," "Huntress," and hundreds more, as U.S. warplanes scrambled into the air.

Approximately five hours after the first plane struck the World Trade Center, the commander of North American Aerospace Defense Command (NORAD), the U.S. strategic defense command in Colorado Springs, Colo., issued a military "notice to airmen" that said U.S. forces "will follow SCATANA procedures." The NORAD commander was referring to Security Control of Air Traffic and Navigation Aids—the command's rules for emptying the air so nuclear bombers and missiles can fly.

"In the event of a confirmed warning of nuclear attack, NORAD, in conjunction with the Federal Aviation Administration (FAA) and Federal Communications Commission (FCC), would order the immediate grounding of all commercial aircraft in U.S. airspace and off the U.S. coast," according to a 1998 Brookings Institution report, "Atomic Audit."

"Developed in the 1960s, this little known plan — Security Control of Air Traffic and Navigation Aids (SCATANA) — authorizes NORAD, the FAA and the FCC to impose these restrictions in order to clear the skies for bomber and missile operations," the report said. The procedures had never been implemented, just simulated, except for a six-minute-long false alarm in 1979 that was triggered when a NORAD technician accidentally inserted a tape simulating a nuclear attack in NORAD's on-line warning system, the Brookings report said.

### Black Smoke On The Horizon

The Washington, D.C., area saw an unprecedented force of mostly D.C. Air National Guard (ANG), Air Force, and Navy jet fighters flying combat air patrols under the control of NORAD. At one point, "Wild One," a D.C. Air National Guard F-16, based at Andrews AFB, Md., advised forces that there were "about 12 fighters over the D.C. area."

Davison Army Airfield, Virginia, a few miles south of Washington, advised its aircraft in the local area to get on the ground as soon as possible after the attack. Pilots questioned Davison air traffic control tower (126.500 MHz) about black



smoke visible on the horizon from the airfield. "There is black smoke on the horizon up near Washington National, do you know anything about that?" one pilot questioned the tower during landing. "Sir, I can't talk about this over the radio," the tower quickly responded.

All fighter aircraft were "fully configured" with live munitions and were detecting, intercepting, identifying, and classifying unknown aircraft in the area.

"Wild One is locked to a contact heading 300, 30 [nautical miles] from bullseye at 1,000 feet," said one pilot, following orders to track and ID every aircraft in the sky that day. The fighters were grouped as pairs and stationed over different areas and altitudes to cover as much territory as possible, according to the transmissions.

### Fighters Aloft

The following is a small portion of forces supporting air patrols over the Washington, D.C., area between Sep. 11-12/A-18 Hornets from Marine Fighter Attack Squadron (VMFA-321), Andrews AFB, covered altitudes from 27,000 feet and above over Washington, D.C. KC-10 tankers from Ohio Air National Guard and KC-135 tankers from McGuire AFB, N.J., supported mid-air refueling over Washington Dulles International airport and east of Andrews AFB. F-15 Eagles from Langley AFB, Va., covered altitudes from 22,000-24,000 feet over Washington, D.C. F-16 Falcon's from D.C. Air National Guard, Andrews AFB, covered altitudes from 5,000-14,000 feet south of Washington, D.C. F-16 Falcon's from North Dakota Air National Guard, deployed to Langley AFB, escorted aircraft landing at Washington Dulles International. ■

#### Combat Air Patrol Frequencies Used Sep. 11-12

123.025	AM	Pentagon Medical & VIP Transport
125.650	AM	Washington Approach
138.425	AM	Fighter Aircraft air-to-air
303.000	AM	KC-10 & KC-135 Tanker Boom Frequency
360.700	AM	Washington Center
364.200	AM	E-3 AWACS

# *Experience Events and Places Around the World...*

*...while in the comfort of your own chair.*

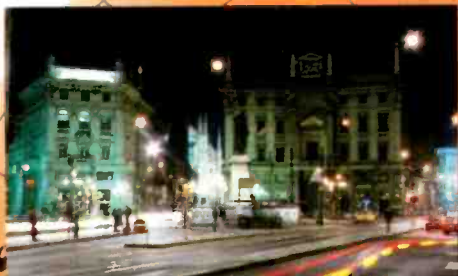

Drake's R8B world band communication receiver preserves its history of excellence, with something for every level of skill or interest. You will appreciate the high standard of craftsmanship, quality, and performance, built into each receiver.

## **R8B Communications Receiver -**

For the avid enthusiast, the top of the line R8B offers serious performance with Selectable Sideband Synchronous Detection and five built-in filters. Available at local dealers or factory direct. Size: 13.13" L x 5.25" H x 13" D.



## **Also available from Drake -**

For the listener on the go, the Grundig Satellit 800 worldband receiver provides all the advanced features of a table top unit. It is battery powered, portable and includes an AC Adapter and FM Stereo Headphones. Size: 20.5" L x 9" H x 8" D.

## **Order Now Risk Free! 15 Day Money Back Trial.**

We are so confident you'll be impressed with the performance of our radios, we'll give you a full refund on your factory direct order, less shipping charges, if the receiver doesn't meet your expectations. Call for complete details.

**Order Today, By Calling 1-800-937-2531 or On-line at [www.rldrake.com](http://www.rldrake.com).**



***The Finest Products For The Shortwave Enthusiast.***

**R.L. Drake Company**  
phone: 513-746-4556

230 Industrial Dr.  
fax: 513-743-4510

Franklin, OH 45005 U.S.A.  
on-line: [www.rldrake.com](http://www.rldrake.com)



### George's Modified Haynes Receiver

Reader George Hawkins was kind enough to write about his interesting solid-state version of a very early one-tube regenerative receiver design. The original circuit, which first appeared in the old *Popular Radio* magazine, has been reprinted by Lindsay Publications. George wrote: "One of the things that intrigued me was the mechanical design of the of the Haynes variocoupler — mounting the rotor and stator coils at 45 degrees to the rotor axis of rotation caught my fancy!" While we haven't tested George's version in the "Wireless Connection" workshop, it should be a fairly simple lash-up for our more technically inclined readers.

George adds these further comments: "The original coupler was bank-wound using 75 turns on a 3.5" diameter form for the primary and secondary, and 35 turns on a 3" form for the tickler winding using #22 d.s.c. (double silk covered) wire. I single-layer-solenoid-wound mine, as it seemed easier that way. The stator is wound on a schedule 20 polystyrene pipe coupling, and the rotor is wound on a piece of nominal two-inch PVC pipe. I used #24 enamel wire because it was easy to get locally, and I have no idea where one could find d.s.c. wire these days!

"To compensate for the smaller form, I increased the number of turns on the rotor coil to 40 turns, to keep the inductance values the same. Eventually I rewound the rotor using a 2-7/8" form cut from a short section of soda bottle, but more on this later. The frame of the coupler was made from 3/16" plywood, dowels and other wood scrapes, glued or pinned together and painted with a clear lacquer to seal it from moisture. Only one metal screw was used to hold the stator form to the frame.

#### Transistor Replaces Tube

"Not wanting to mess with high voltages, and not having any WD11 tubes handy, I chose the ubiquitous MPP102 J-FET as the active device. The tuning capacitor came from the junk box, and was close to the 230-pF value recommended. With exception of the filament rheostat (not needed) and those noted above, I duplicated the circuit as shown in the book. Its initial performance was disappointing, nothing like the advertised 500 to 1500 mile range! I only received two stations, one a 50-kW powerhouse and the other the nearest station to my location.

"This was my first real experience with a regenerative receiver, I could not get the thing to oscillate! The Internet provided several sites dealing with regenerative receivers, and one Indian Trick (as the site referred to it) was to add or remove turns from the tickler coil, or change the connections, to achieve regeneration. Having just spent all this time making a coil I was hesitant to go and change my masterpiece. I reasoned the smaller rotor diameter was not allowing enough feedback, so I made a new coil, the one from the soda pop bottle. The new coil improved oscillations. I could now hear weak heterodynes from other stations, but only the two original stations were still audible. What to do?



*Earlier version of the Haynes receiver before the bandspread tuning was added.*

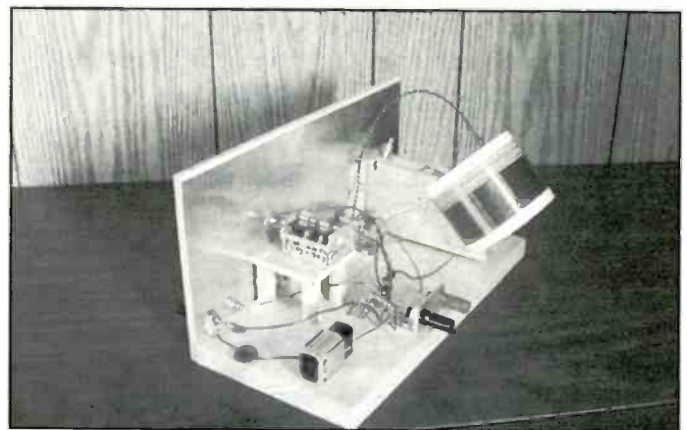

*An interior view of the set. Note the aluminum flashing shielding on the rear of the front panel to reduce hand capacity effects. The shielding is grounded. Most of the electronics are mounted on a small terminal strip located behind the tuning capacitor.*

"For the next step, I decided to investigate what happens when I changed bias on the FET. Playing around with the series grid leak value appears to make a difference, but adding a source resistor had a big impact (1000 ohms paralleled by a .1 mFd bypass capacitor). It made the receiver so squirrely I added a shield — made from aluminum roof flashing — to reduce hand capacitance effects. More stations could be received, but the set was overly sensitive to adjustments. There was too much regeneration, so the

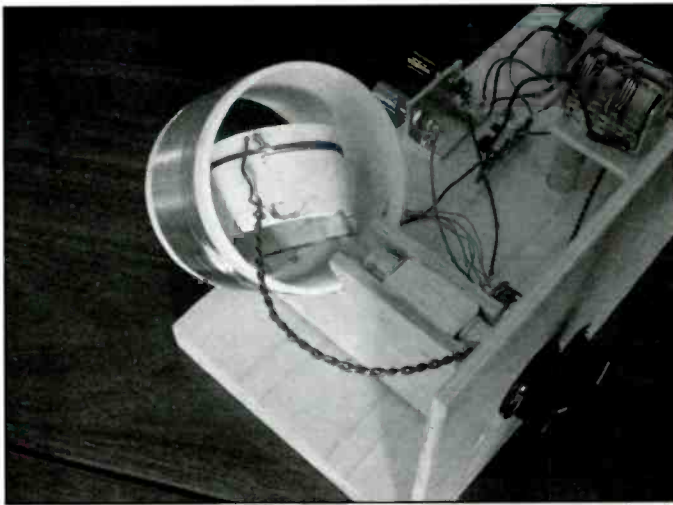

A close-up view of the variocoupler used to control the receiver's regeneration level.

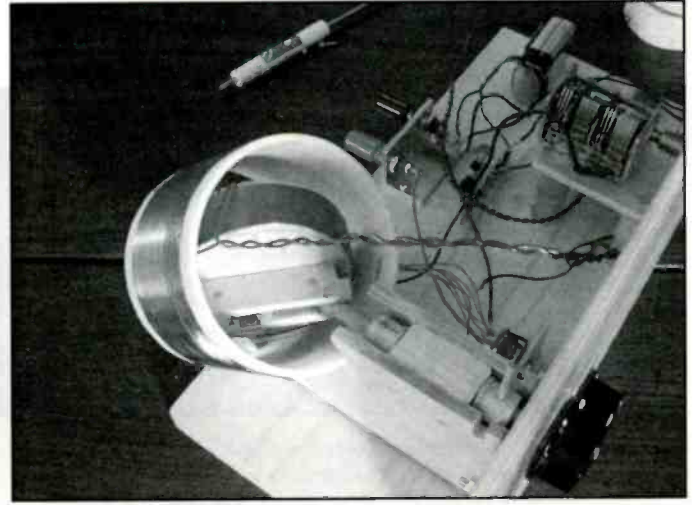

Another view of the rotor coil mounting.

next logical step was to reduce turns on the tickler. So back to where I started: I reinstalled the smaller PVC rotor coil.

### A Ticklish Tickler Coil

"First I removed one turn, then two and then 10 turns! I started to change the performance of the radio — now I could hear five stations. It was better, but I had a long way to go! Stations at lower frequencies started coming in as I reduced the tickler turns. One of the features I noted on the Internet web pages I visited was that the headset should be bypassed with nothing less than .001 mf. This seemed like a good idea, but the cap made the set squall like a cat! I finally reduced the tickler to 10 turns (remember I started at 40!) and things then seemed to be close to what I expected from the descriptions I had read on the web. I ended up with five turns on the tickler, and the bypass cap in place. Tuning is still sensitive. I think a mechanical bandspread would help and will be adding one later.

I felt it was time to relax and enjoy the moment! By now my tuning ability had improved (look Ma, two hands!) I skillfully brought in a country music station close to my local 50-kW power-

house — WSM, from Nashville, about 600 miles away. At last, the advertised reception range. I had achieved what I had set out to do, or maybe the situation is 'on a clear channel you can hear forever.' At any rate, I slept content that night.

### More Comments

I had some further correspondence with George, as I was surprised at the high value resistance — 47,000 ohms — used in

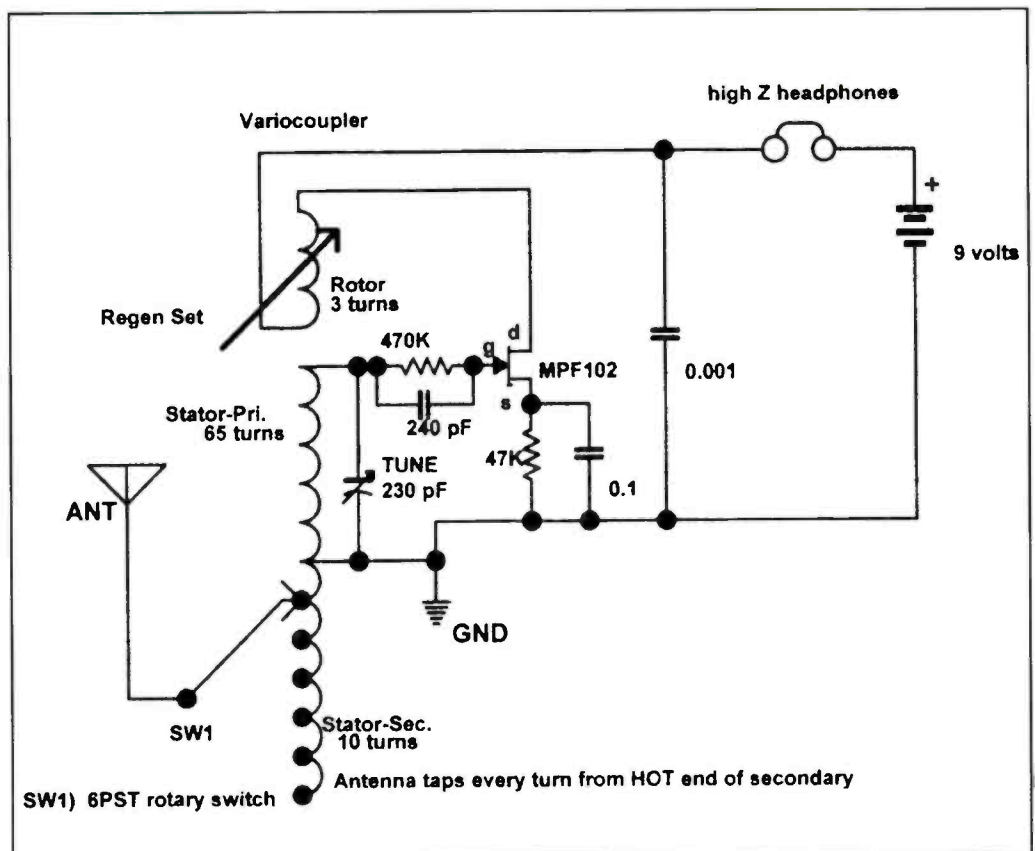
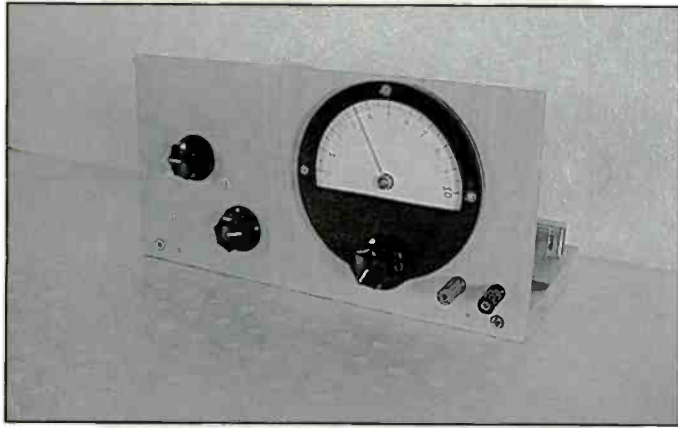
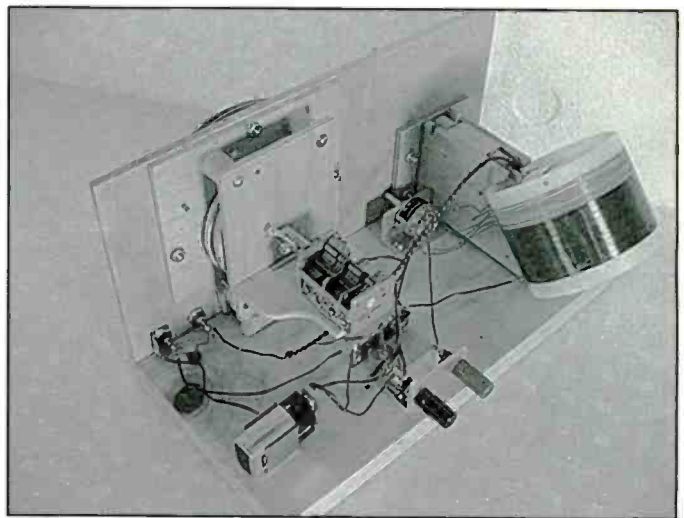

Figure 1: Schematic of the modified Haynes regenerative receiver.



The set with the added bandspread tuning dial. The dial is made from plywood, and is painted black to simulate a plastic bezel. The shape and size were chosen to give a '30s or '40s look to the radio.



Rear view of the finalized version of the receiver with the added bandspread tuning components.

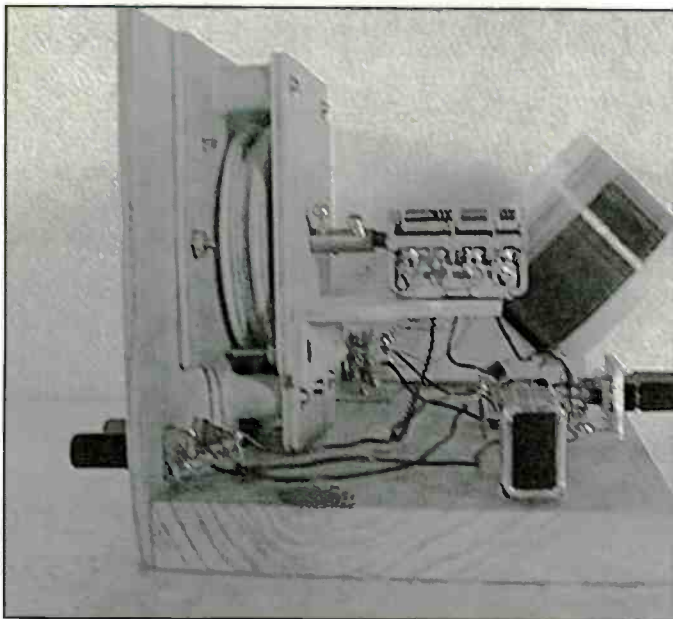

The drive pulley/shaft was made on a hobby lathe out of some cold rolled shaft. The dial pulley was made from three pieces of plywood (about 3/16-inch thick) laminated together with glue, and glued to a cold rolled shaft — also turned on my lathe.

George's antenna is about 30 feet of wire strung around the ceiling molding of his apartment bedroom, and a ground made from 3/16-inch brass rod driven into the earth outside of his bedroom window. George has a real woodworking talent, as you can see from the intricate details of his homemade dial and pulley drive system.

## Peter Catches Heck

Jeff K., from Burkville, VA, shared these comments: "This is to let you know how much I have enjoyed the September column in which you demonstrated veneer and cabinet repair . . . your work shows why no radio should be parted out or thrown away . . ." Jeff continues: "Now, I wish to address the October column in which yet another fine Hallicrafters is completely destroyed in the name of making it solid state and portable. This is the second time your column has done in a Hallicrafters . . ."

Jeff, thanks for your comments. I am concerned about preserving radios for future generations, and when dealing with restoration topics I try to give the best advice possible. But, this column is trying to cover several other aspects of the hobby as well. Since Ed owns the radio, he is free to do with it as he sees fit. His first effort, an S42 junker, was redone and given to his grandchildren to enjoy. Neither it, nor the TW2000, is particularly rare. I really doubt there are many folks out there ambitious enough to undertake the extensive modifications Ed has performed on these two radios. As a technical editor, I was very impressed with the technical accuracy of Ed's design work, and felt his circuits were reproducible, properly executed and worthy of publication. Neither Ed nor I are condoning wholesale unwarranted reworking of vintage radios just for the sake of doing so. I would expect anyone with the technical expertise to undertake such an adventure would also be well versed in the value of the set (monetarily and historically) before hand. I have only reprinted a few brief comments from Jeff's long and well thought out hand written letter to view his concerns. Since Jeff's letter was marked "personal," his last name is not given.

All of us from the "Wireless Connection" wish you a joyous holiday season, and a better start to a New Year than what has transpired these last few weeks in September as this column is being written. God bless America, and all of you. ■

the source return for the FET. George replied with these comments: "Peter, I revisited the biasing of my FET regenerative receiver. I found that increasing the source resistance to 41,000 ohms caused a dramatic improvement in performance, with regard to sensitivity, but at some sacrifice of volume. This seems to be contradictory, but strong stations are not as loud, and I can now set the regen control at one point and receive stations across the dial. Reducing the grid leak from 1 megohm to 470,000 ohms also improved signal clarity on weaker stations. George." As you can see from George's comments, some further circuitry refinement is possible. MPP102 manufacturing tolerances are not particularly tight, so a biasing scheme that works for one device might require some changes to work with another. Experimentation, good old empirical engineering, is the name of the game!



# Ace your **Ham Radio** license exam!



## ARRL Video Courses

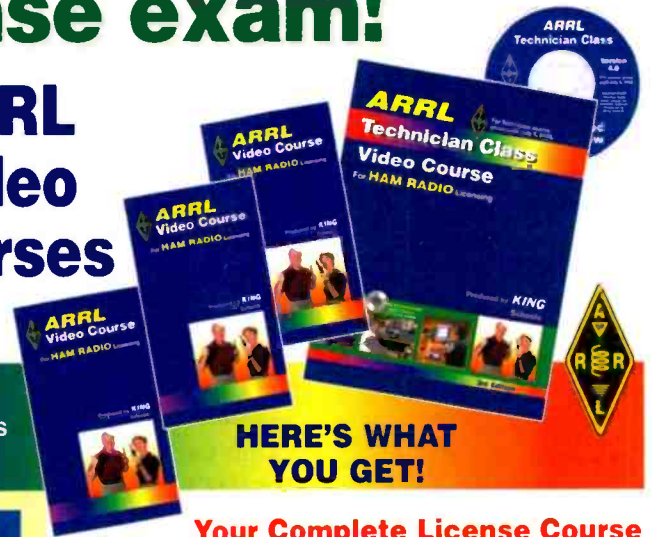

**High Quality Instruction!** Your ARRL video course was produced in partnership with King Schools—a world leader in the production of exam preparation video courses. You will enjoy the enthusiastic instruction and talent of John, KD6SCY & Martha King, KD6SCZ, as they lead you to passing your license exams.

**Why do things the hard way?** Sit back, relax and learn everything you need to know. Each ARRL video course gives you everything you need to ace your written license exam.

**HERE'S WHAT YOU GET!**

### Your Complete License Course

Look at all you get with your ARRL Video Course:

- 3 Videos—hours of fast, fun instruction
- Coursebook with detailed notes
- Every exam question, with thorough step-by-step explanations
- 3 Practice Exams (test yourself before exam day)
- ARRL's Computerized Exam Review CD-ROM
- Personalized Graduation Certificate (suitable for framing)

### F - LAYERS MERGE AT NIGHT



### COLORED BANDS SHOW RESISTOR VALUES



**Order with total confidence—No Risk!** Your ARRL Video Course comes with a full 30-day, no hassles-no risk-guarantee. If this program is not what you expected, for any reason, simply return it to us for a prompt, full (& friendly) refund. Include a dated proof of purchase with your return.

### Included with EVERY course! Practice Exam Software

Every video course includes the ARRL Computerized Exam Review CD-ROM\*. Use it with your video course to emphasize important points, and to provide practice using questions from the actual examination question pool! View detailed explanations for questions that cause you difficulty. The computer will record your answers, and issue a Report Card. We'll make sure you're ready on exam day!

**SCORE 90, 95 AND EVEN 100%. OUR GRADUATES EARN TOP SCORES!**

### Ship me my Complete Course!

Order by phone, toll free 1-888-277-5289 or on the web [www.arrl.org/shop/video](http://www.arrl.org/shop/video)

**1** Shipping Address: Name \_\_\_\_\_ Call \_\_\_\_\_ Optional \_\_\_\_\_  
 Street Address \_\_\_\_\_  
 City \_\_\_\_\_ State/Prov. \_\_\_\_\_  
 ZIP/Postal Code \_\_\_\_\_ Country \_\_\_\_\_  
 Telephone \_\_\_\_\_ Email \_\_\_\_\_

**JUST \$149!**  
(plus S&H)

\*Requires Microsoft Windows, Pentium 133 (minimum) or compatible computer, and 50 MB available hard drive space.

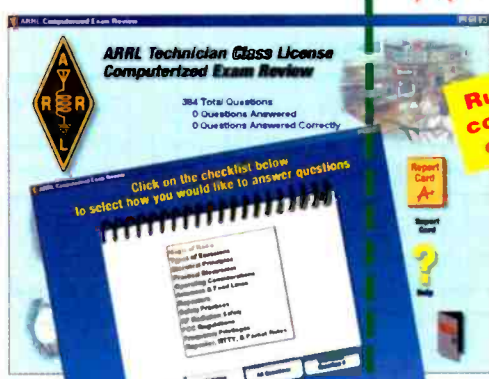

**Rush my complete course!**

**2**  **Technician Class Video Course.** Earn your **FIRST HAM RADIO LICENSE!** Includes 3 videotapes, coursebook, and software. Third edition. ARRL Order No. 8330 ..... **\$149** plus shipping & handling, and sales tax.\*

**General Class Video Course.** Upgrade with confidence! Includes 3 videotapes, coursebook, and software. Third edition. ARRL Order No. 8349 ..... **\$149** plus shipping & handling, and sales tax.\*

Shipping within US (select one):  
 \$8 UPS ground     \$15 UPS 2-day     \$20 UPS Overnight  
 \*Sales Tax required for shipments to CA, CT, VA, and Canada.

**3**  Amount enclosed, payable to ARRL in US funds \$ \_\_\_\_\_  
 Charge to     VISA     MasterCard     Amex     Discover

Card Number \_\_\_\_\_ Expiration Date \_\_\_\_\_  
 Name on Card \_\_\_\_\_

## Happy Holidays! What's On Your Wish List?

Wow, I can't believe another year has flown by! Time really does fly whether you're having fun or not! As usual at this time, I thought we'd take a quick look at some items you might want to put on your wish list for the holiday season.

### A New Radio?

New radios are always a great gift for the scanner enthusiast. The problem can be choosing which one and letting Santa know what's on your list without being too blunt. I'll leave that problem to you and Santa as I haven't found a good solution either.

There were several new radios introduced this year ranging from ICOM's TV sporting R3 to the AOR-AR8600 receiver. The new RadioShack catalog for 2002 also lists a few that are scheduled to be out by the time you read this column. These include the PRO-93 handheld and the PRO-2053 base/mobile unit. Both are trunktracker units that look very interesting. Stay tuned for a full review once the units are available, but if you are stuck for something on your wish list, you might consider one of these.

Probably the biggest news in terms of receivers that are already out for the year is the Uniden BC-780XLT. This capable receiver is the most versatile trunktracker to date. Five hundred channels with alpha tags make for a versatile unit. It can trunk track Motorola type I and II systems, EDACS, and LTR. Add the computer interface and it's quite a package. We'll be taking a closer look at this receiver soon, but in the meantime I can recommend it highly based on what I've seen and heard.

Many software applications are also available for this new receiver. ScanCat and ScanStar both have added support for the 780 to their jack-of-all-trades applications. There are also several specialty applications available as well including the much discussed WinScan 780 from Pozilla software. Look at the range and find one that has the features you're after.

If you haven't played with any of the computer-aided or computer-controlled scanning applications, a present from Santa might be the way to get your first taste. Remember that you'll need a computer interface on the scanner you're trying to hook up, so check that out first! ScanStar and ScanCat are by far the two leading contenders in broad support for the most radios. There are however, some specialty applications available for particular radios that can be easier to use with that radio and in some cases support the special features of the radio better. Neither will be a bad choice, but do look around before you write your letter to St. Nick.

How about exploring some other parts of the band? If you're into scanning, you might want to think about asking for a receiver that covers a portion of the frequency ranges that you don't currently have. If you're using an older scanner, an upgraded model with 800 MHz coverage or trunktracking might be just the ticket. If you're covered in that department, how about a

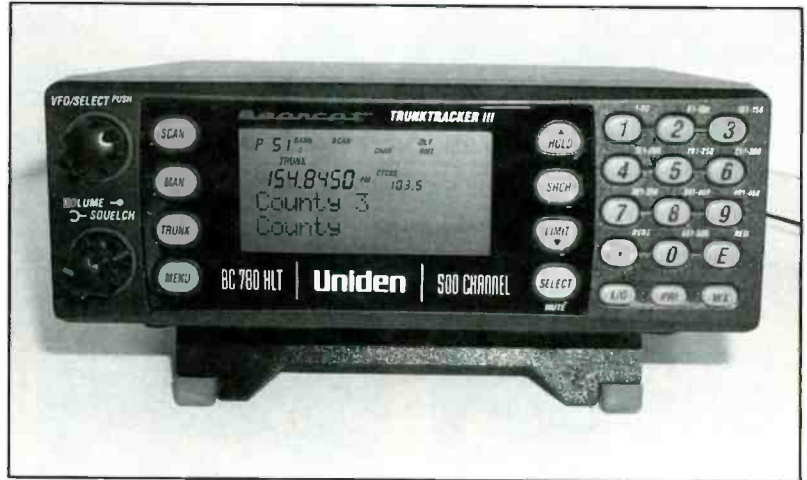

*One of the most exciting receivers I've seen in a long time. Computer control, trunking, and alpha tags make this an attractive receiver for base or mobile use.*

shortwave receiver to check out the action below 30 MHz? I'd strongly recommend a receiver capable of SSB reception so you can listen to both the broadcasters and the utility stations that are to be found in the HF range. Many of the utility stations operate just like the scanner frequencies you're used to listening to, but at longer range.

### Become Part Of The Action!

You might want to get out of the listening habit and become part of the action you're listening to! Many transmitters no longer require a license and can be extremely handy for home or work applications. However, what I had in mind for your wish list was a study guide for one of the radio amateur exams. Getting your ham license has become a very good idea for scanner listeners in many states, and having a transmitter handy just in case something happens is never a bad idea either. There are many study guides available from all sorts of sources including RadioShack, the American Radio Relay League, and *Pop'Comm's* own Gordon West's school! Check them out and see how easy it can be to be a licensed ham! Harold did it, you can too!

### Antennas

Scanner nuts can never seem to have enough antennas. Of course, on a handheld, they're easy to change, so swapping back and forth can be advantageous for various conditions or frequencies of interest. Base users can also gain some mileage from changing antennas from time to time too. Perhaps you've been using a model that you're not quite satisfied with, or perhaps you've got a second scanner that could use a little signal boost, too. On the other hand, if you're hearing all that you care to, a new antenna is probably not a good choice.



SCANNER USERS • COMMUNICATIONS PROFESSIONALS

# Buy Police Call 2002 and get a CD at no extra cost!

## POLICE CALL

2002 EDITION

COMPLETELY REVISED THROUGH JUNE, 2001

- With Fully Searchable Nationwide CD.
- 20,000 Codes and Signals.
- Trunking Talkgroup IDs.
- Includes U.S. Government, Rail & Air.
- Illustrated 27-Page Listener's Guide.

### GOT A SCANNER? GET POLICE CALL

At your scanner dealer and all Radio Shack stores.  
Visit our web site at [www.policecall.com](http://www.policecall.com)

More People Buy **POLICE CALL** Than All Other Frequency Guides (VHF/UHF) Combined.

CD-ROM  
Version 3.0  
2002



Handheld antennas are self-contained, so the only real issues are performance versus what you're willing to be seen carrying with you. Some of these antennas get to the point of being larger than the radio, and that always makes me wonder just how practical they are. If you don't have a telescoping antenna that can be adjusted for various frequencies, you probably should. If you're still using the antenna that came with your radio, you are really a good candidate for an upgrade. Look around and see what strikes your fancy, but keep in mind the other major consideration in handheld antennas — frequency coverage.

All antennas, not just handhelds, are built with particular frequency ranges in mind. The telescoping system that I mentioned above has the advantage of having adjustable length, which means adjustable frequency response too. I have a tendency to use ham antennas for my scanners because they are so widely available, and because they are close to the frequency ranges that I'm interested on the scanners. You may be able to get significant performance increases on a single band by using commercial antennas built for just that frequency range, but you are quite likely to sacrifice bandwidth — the ability of the antenna to perform over a wide range of frequencies. On a handheld, that's not a major concern, depending on what the intended use for the antenna is. For instance, if you mostly listen to stuff in the 154–158 range, finding a commercial antenna that operates in that range will probably improve performance. You may not hear much outside that range, however, so you'll have to assess the frequencies you listen to. Trunktracker users who listen mostly to the trunked system in their city tend to benefit considerably from an antenna designed for the 800-MHz range.

Base antennas, however present a whole different set of prob-

lems. The major concern with a base antenna is likely to be performance over a broad range of frequencies that you are interested in, followed by how much room the antenna takes up in the attic or outside. Are you going to have to add structural support to the mast or tower in order to support the "wind load" of the antenna? It's something to keep in mind as you're shopping.

### Other Accessories

If you're all set for radios, you might want to look at some accessory items. One of the biggest problems in my shack has always been having enough power in the right place at the right time. Power strips are the answer and the MFJ power strip for 12V items is a very convenient item. You run your equipment off a 12V supply that can handle a large number of radios and accessories. By using this method, you cut down on the heat generated by each radio's power supply, as well as cut down the number of AC outlets you need and the number of wall wart transformers that have to be plugged into them! It's a great system!

Perhaps a speaker upgrade would be worthwhile. External speakers come in all shapes and sizes for all purposes and they're very easy to install, assuming your radio has an external speaker jack. If you've never used anything but your scanner's built-in speaker, I'll warn you that you might not want to try this — it's addicting!

External speakers can do a number of things for you. Most scanners have the speaker mounted so that it faces up or down. Up is definitely better, since that's where we're more likely to be listening to it, but up doesn't direct the audio *out* into the



*This small speaker packs quite a punch. It helps fire the audio out into the room so you can hear all the details without sacrificing shelf space!*

room (or car) as well as it might. By using an external speaker that faces forward, you can hear more of the sound.

Speakers can also be tailored to the voice range that you listen to on your scanner. Sometimes, depending on the radio you have, just a bigger speaker will make the audio a bit easier to listen to. You might want a communications speaker available from the major retailers for a variety of applications. Even RadioShack has a few speakers that work well for scanner applications. I have been using the Radio Shack Minimus 0.3 (40-1254, now discontinued) with some success for years. While not the best possible speaker, it does serve the purpose of getting the audio out into the room, and is cheap and small enough that a number of them can be used without making a major dent in shelf space.

I just recently discovered a new very small speaker that's not bad for its \$14.95 price tag. It's 19-318 and billed as a small



*The larger speaker has a better sound, and this one is optimized for communications range. Don't hook it to your Walkman — you'll be very disappointed, but it will help your scanner considerably.*

communications speaker. While not a powerhouse speaker, it will sit on the shelf and direct the audio forward without much loss of shelf space. If you'd like something a little larger, try the 21-549A. It's also \$14.95, but its larger cabinet gives it a bit more bass sound — great for scanner applications!

If you can't get enough audio from your radio, you might consider any of the various amplified speakers that are on the market. This trick works extremely well with handhelds. With the proliferation of multimedia computer systems, amplified speakers are available everywhere at all price ranges. Keep in mind that you don't need a real high fidelity speaker to reproduce the voice information that most of us

listen to on our scanners.

In fact, a high fidelity speaker may work against you. These speakers will often have a "whine" or ringing sound to them. This isn't anything wrong with the speaker, but rather the speaker's attempt to reproduce some of the CTCSS or tone squelch that your scanner is allowing through to the audio amp. It's annoying to listen to, but doesn't hurt anything either.

Finally, external speakers can be used to separate the audio. That is, if you have more than one radio, the simple concept of using your ears to determine where the sound is coming from can help you distinguish what radio is active. External speakers can be mounted in the ceiling or walls, or can just be placed at opposite ends of a desk. The idea is to put them in spots that you will hear the difference!

## Headphones Anyone?

Depending on where your scanner is located in relation to the rest of the house, and more importantly the activity in your house, it might be helpful for domestic tranquility to have a set of headphones around. These can come in very handy for those late-night listening sessions, or for listening to the scanner while others are watching TV nearby. Some shortwave listeners find that they prefer listening through headphones all the time, while others almost never use them. The only problem I've found with headphones is picking a pair that you'll be comfortable with might be a difficult task for anyone but you.

Also be aware that headphones come in stereo and mono (mostly stereo for obvious reasons). Some of our receivers will support the stereo headphones by putting the signal into both ears, but most do not — you'll only get audio in one ear under these circumstances. That might not be all bad, as it leaves the other ear open for room noises, but it can be annoying if you want to concentrate on the radio. There are adapter plugs to solve this problem, or you might prefer a pair of headphones that are optimized for communications listening, which are available from any of the major manufacturers of ham and shortwave equipment.

## Audio Filters

Another audio accessory that I get asked about with some regularity is audio filters. For shortwave listeners, these are a great help, depending on your receiver's capabilities. However, for scanner listeners, I don't think they are quite as useful. Every



If you use a lot of mobile or base units with 12-volt supplies, you might find this power strip a handy item. You can replace a whole slew of wall wart supplies with a single 12-volt converter, and use a power strip like this MFJ-1116 to make connections easy. Your radios will run cooler too!

once in a while on the AOL conference (Thursday night 9-11 ET at keyword SCAN — Follow the links for conferences or chat) someone will come forward and say that they use this or that audio filter and really like what it does for them, or not, but for the most part these tend to be expensive white elephants for your scanner.

In my opinion, you'll get much more mileage out of a pure amplified speaker (which I think is how a lot of scanner listeners wind up using filters anyway). If you also listen to shortwave you might well find a use for one, and then you can hook it to your scanner to see how well it works. Some units, including the TimeWave 599+ have dual receiver inputs! By the way, if you're into short wave listening, I can highly recommend the Timewave if the price doesn't put you off. MFJ also has a nice

DSP filter that's also worth a look, which I've heard good things about but never actually used.

Another audio accessory that might be of interest is the NiteLogger (BMI \$69.95 available through many dealers including Universal Radio in Ohio) allows you to set up a tape recorder and only record the activity, not the quiet times. This can be a great way to find active frequencies, or to help identify traffic on an unknown frequency, or a channel that's only busy when you're at work or asleep. Of course, you'll need a suitable tape recorder to go with this accessory, but hey, maybe Uncle Hank can provide that instead of the usual assortment of handkerchiefs? You can also do this with software into your computer and then convert the files to MP3 or something if you want.

Finally, you might want to have a look at the new generation of MP3 players beginning to hit the market. Once you've converted those recorded files I mentioned above, you can take them with you and listen on the move. This can be a fun way to pass the time of a commute. But you can also use them to listen to many other things.

While not strictly related to radio, a few of them (including the Creative Nomad Jukebox) have the ability to record to hard disks at prices quite a bit lower than other hard disk recorders we've seen. Their use as a recorder is fairly impressive, and the internal hard drive makes lots of space available. I'm just starting to research the whole MP3 thing as related to radio nuts, but it appears that there could be lots of uses for this. Many of the memory-based players operate for hours on a AA battery

# HEAR THE WEAK ONES

## with Ten-Tec Shortwave Receivers



### RX-350 NEW!

RX-350 is a full-featured HF DSP receiver for today's demanding shortwave listener. 100 kHz-30 MHz. Modern IF-DSP architecture accommodates 34 built-in bandwidth filters, DSP automatic notch, and DSP noise reduction. Flash ROM updateable via Internet file downloads. Large LCD graphics panel for display of all receiver functions. Selectable sideband/Sync AM, SAM, AM, FM, CW, and SSB modes. Momentary SWEEP function shows band activity on LCD screen. 128 memories. Timer and squelch activation circuitry. 12/24-hour clock. Hi Z and Lo Z antenna inputs. 115/230 VAC or 13.8 VDC operation.

**\$1,199**



### 302 REMOTE/ENCODER KEYPAD

Allows armchair tuning of the RX-350. Function buttons allow operation of various receiver controls. Direct frequency entry via keypad.

**\$139**



### RX-320 PC Radio

SWling is a mouse click away. General coverage HF from 100 kHz-30 MHz. "Black box" receiver connects to your PC via one serial port. Your PC provides the operation horsepower. Download the actual operating software from our web site for a pre-purchase test drive.

**\$295**



### RX-340 "The Ultimate"

The Ultimate HF SWL receiver. 50 kHz-30 MHz. IF stage DSP. Sync AM/selectable sideband, SAM, AM, SSB, ISB, CW, FM. 57 bandwidth filters, programmable AGC, built-in high stability TCVCXO. Completely remote controllable via RS-232 interface. 115/230 VAC operation.

**\$3,950**

**TEN-TEC**

1185 Dolly Parton Parkway  
Sevierville, TN 37862  
Sales Dept: 800-833-7373  
Monday - Friday 9:00 - 5:30 EST  
We accept VISA, Mastercard, and Discover  
Office: (865) 453-7172  
FAX: (865) 428-4483  
Repair Dept.: (865) 428-0364 (8 - 4 EST)

[www.tentec.com](http://www.tentec.com)

Call  
Toll-Free

**(800) 833-7373**

or two, and at audio quality can hold many hours. Music takes a lot more memory than speech.

## A Completely Different Resource!

If you're looking for something completely different as a scanner accessory, how about a subscription to America On-Line? What? Well, the "Radio Listener's Conference" is one of very few dedicated to the hobby of listening on all frequency ranges. It meets every Thursday night from 9 to 11 Eastern in the Conference Room of the HAM RADIO forum. If you need instructions on how to get there, just E-mail me from your America On-Line address and I'll be glad to give you a hand.

Every week we meet for this two-hour block to discuss radio listening as a hobby and anything else that might come along. Most weeks we have a topic that starts at the top of the second hour and runs until people run out of questions. The first hour is always an "open discussion" and sometimes the entire two-hour block is open. There are topics ranging from antennas to bank usage to how the receiver works, and even an occasional "cyber-dxpedition" where everyone tunes in and reports what they're hearing. On shortwave and mediumwave, there's a good chance that you'll be able to hear the signal someone else has found. Join us for the discussion, or just to drop in and share your knowledge of a particular topic. It's about the most fun you can have relating to scanners without actually scanning.

## Don't Forget To Scan!

Holiday scanning can be interesting too. Police, fire, and ambulance services all tend to be busy this time of year with the increased activity and traffic problems. One of the first things you should do is to plug in the frequencies for your local mall, if you don't already have them in your scanner. Even small shopping centers have maintenance people and often security for the holidays that use radios.

You can find store and mall security on just about any business frequency, so you may have to do some hunting to find just what you're after. In some cases, the security is provided by off-duty officers but equipped with police frequencies and a special unit number. Larger malls will all have their own system.

Another good place to look is the itinerant frequencies, particularly within individual stores (larger stores all have security staff of their own these days). Equipment operating on these channels is widely available to anyone. They are required by definition to operate at low power levels and while it's plenty to carry the signal within a building, you may not be able to hear them unless you are close by. Larger centers will have dedicated frequencies, possibly several channels to keep security and maintenance functions separated. Two of our local centers even use repeaters which makes listening all that much easier since you can hear both sides of the conversation.

Finally, you may have some luck finding frequencies in more traditional references like *Police Call* and *Monitor America*. Both of these excellent references should be in your library as a good starting point for frequency information. For some cities, *Monitor America* in particular actually lists mall and shopping center frequencies directly.

It's pretty interesting listening from time to time, and very entertaining the rest. Most of the security officers and others that are to be heard on the radio are not professional communications specialists, to say the least. And during the holidays,

there are likely to be a number of part-time staff added to help with the increased workload. Part-time staff who need directions and answers to questions that customers may ask hundreds of times a day, but for this particular employee hasn't come up before, and must be answered over the radio by a senior employee. Sometimes that particular senior employee answers it for the 100th time, and the answer is somewhat "less than polite."

Our particular mall also runs into parking problems around the holidays, and a whole detail of folks are dedicated to helping solve that problem and transporting staff and guests to other off-site parking that is available. And to say the least, security is tighter and there are likely to be more problems in general during the holiday shopping season with so many people coming and going, and unfortunately, more opportunities for unscrupulous types to take advantage of as well.

Check it out. If you don't have the frequencies already, it's a bit of a fun challenge to identify them. If you can't find anything listed, or don't have access to the frequency directories, go have a look around the store or mall you're interested in. See if you can spot any antennas on the roof, or if you can spot someone using a handheld radio. The length of the antenna may give you some indication, but not always.

In the good old days, you could tell just by how long the antenna was on the handheld transceiver what frequency band they were operating on. That information was very helpful to narrow the search. However, today's modern antennas, particularly on portables have many shapes and sizes and don't always correlate well to the band they're designed for. As an example, I have an 800 MHz rubber duck antenna that's much longer than several VHF-Hi antennas that are common. Perhaps you can find a friendly mall employee and get them to let you look at the radio itself. Sometimes they have meaningful labels (sometimes even the frequency itself), but sometimes not. Good hunting!

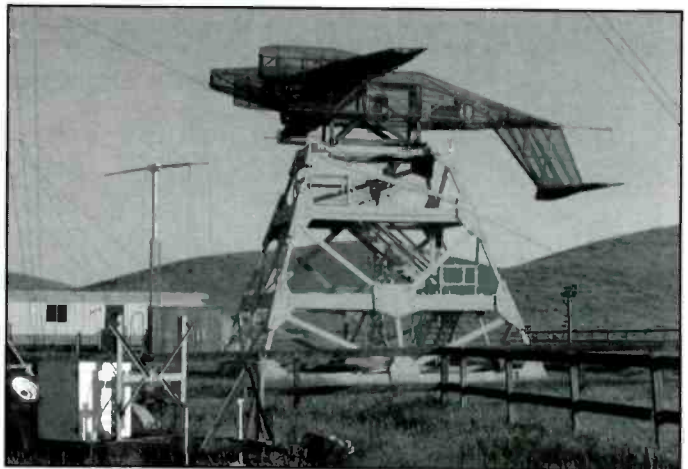

*Has the mystery been solved?*

## Mystery Solved!

Back in October we ran a series of photos and asked you to send in your guess as to what it was. Many of you had guesses similar to mine, but a plain white envelope showed up with the real definitive answer. Thanks to the anonymous contributor, and to those who wrote or E-mailed their information! It was very interesting!

According to the printout from <http://www.accesscom.com/~gsellani/esl.htm>, the site is located in Alameda County, CA.

The land next to the site is a park, so it doesn't appear to be a particularly secret site.

It is believed the upside down plane is used to test antenna radiation patterns for aircraft antenna and avionics. "The goal is to measure the radiation pattern aimed downward from the airplane. If the plane were not upside down, then the antenna would radiate towards the ground, which would be difficult to measure as there would be reflections from the ground. By mounting the airplane upside down, the measurements are made from above where there is little chance of reflections." Many of you reported similar sites in New York as well used for similar purposes. My apologies if I was not able to respond to your letter or E-mail directly, but I got quite a flood of mail.

## Frequency Of The Month

If you've just joined us, let me explain how all this works. I came to the conclusion long ago and far away that for me to keep a central database of frequency information was simply not practical. There's just too much of it out there, and there are many sources of license listings — [www.perconcorp.com](http://www.perconcorp.com) is an excellent resource if you don't try anything else.

So we decided to play this backwards. I give you the frequency; you tell me what's on it in your area. What you see here is just a sampling of the entries for this particular frequency. And everyone who sends in an entry benefits because they find out what's on that frequency, and we throw all the names into the *Pop'Comm* random number generator to pick a winner from time to time!

## Frequency Entry

Our frequency for this month will be **154.740**. Let me know what you can hear. Even if you don't hear anything on that frequency in your local area, you can still enter with that information! We'll put them all in the drawing when it comes up!

## Your Input Needed

"Overheard" is your column (but I didn't name it!). Please don't hesitate to write in with questions or suggestions. Send things via regular mail to Ken Reiss, 9051 Watson Rd. #309, St. Louis, MO 63126, or questions and suggestions via E-mail to [armadillo1@aol.com](mailto:armadillo1@aol.com). Until next month, good listening!

### The Adventures of Scanner Dweeb

by M.A. Coletta

This wind generator hat powers my scanner while I'm out and about...

The problem is.. when the wind gets above 30 mph..

[www.ScannerDweeb.com](http://www.ScannerDweeb.com)

# CALL TOLL-FREE C&S SALES

(800) 292-7711 Orders Only

Se Habla Español **Secure On-line Ordering @ [cs-sales.com](http://cs-sales.com)** (800) 445-3201

CALL OR WRITE FOR OUR FREE 64 PAGE CATALOG!

Digital Multimeters	LCR Bridge	Deluxe Soldering Stations
<p><b>Elenco Model M-1740</b> \$19.95</p> <p>11 Functions:</p> <ul style="list-style-type: none"> <li>- Freq. to 20MHz</li> <li>- Cap. to 20µF</li> <li>- AC/DC Voltage</li> <li>- AC/DC Current</li> <li>&amp; MORE!</li> </ul>	<p><b>Elenco Model LCR-1810</b> \$89.95</p> <ul style="list-style-type: none"> <li>- Capacitance</li> <li>- Inductance</li> <li>- Resistance</li> <li>- Temperature</li> <li>- DC Volts</li> <li>- Frequency</li> <li>- Diode / Audible Continuity Test</li> </ul>	<p><b>Elenco Model LCM-1950</b> \$65</p> <ul style="list-style-type: none"> <li>- Autorange Frequency</li> <li>- Capacitance</li> <li>- Inductance</li> <li>- Resistance</li> <li>- Logic Test</li> <li>- Diode &amp; Transistor Test</li> </ul>
<p><b>B&amp;K Model 878</b> \$229</p> <ul style="list-style-type: none"> <li>- Accurately measures capacitance, resistance, and inductance</li> <li>- Measures dissipation factor of capacitors and Q of inductors</li> </ul>	<p><b>Elenco SL-5 Series</b></p> <p>Electronically controlled, ideal for professionals, students, and hobbyists. Available in kit form or assembled.</p> <p style="text-align: right;"><b>As Low As \$24.95</b></p> <p>Works w/any iron. Turn any soldering iron into a variable iron.</p> <p>Features:</p> <ul style="list-style-type: none"> <li>- Custom Grip Handle</li> <li>- Soldering Iron (optional) with Grounded Tip for Soldering Sensitive Devices</li> <li>- Easily Replaceable Ukes</li> <li>- Long Life, Potted Conical Tip</li> <li>- Heavy Steel Non-Slip Base</li> <li>- Heavy Holder Furner - Removable, left or right side</li> <li>- Steel Tray for Sponge Pad</li> <li>- Sponge Pad</li> </ul> <p>Quantity Discounts Available</p>	
Test Equipment		
<p><b>Elenco Four Functions in One Instrument Model MX-9300B</b></p> <p>Features:</p> <ul style="list-style-type: none"> <li>- 1-30MHz Frequency Counter</li> <li>- 20MHz Sweep Function Generator</li> <li>- Digital Multimeter</li> <li>- Digital Triplet Power Supply</li> </ul> <p style="text-align: right;"><b>\$450</b></p>	<p><b>Elenco Handheld Universal Counter Model F-2800</b></p> <p>1MHz - 2.8GHz</p> <p>Sensitivity:</p> <ul style="list-style-type: none"> <li>- &lt;1.5mV @ 100MHz</li> <li>- &lt;5mV @ 250MHz</li> <li>- &lt;5mV @ 1GHz</li> <li>- &lt;100mV @ 2.4GHz</li> </ul> <p>Features: 10 digit display, 16 segment and RF signal strength bargraph.</p> <p>Includes antenna, NiCad battery, and AC adapter.</p> <p>C-2800 Case w/ Belt Clip <b>\$14.95</b></p>	<p><b>Elenco Quad Power Supply Model XP-581</b></p> <p>4 Fully Regulated Power Supplies in 1 Unit</p> <p>4 DC Voltages: 3 fixed, 1 variable: 2.5, 20V @ 2A - Fully Regulated &amp; Short Protected - Voltage &amp; Current Meters - All Metal Case</p> <p style="text-align: right;"><b>\$75</b></p>
<p><b>Elenco 3MHz Sweep Function Generator with built-in 60MHz Frequency Counter Model GF-8046</b></p> <p><b>\$199.95</b></p> <p>Generates square, triangle, and sine waveforms, and TTL, CMOS pulse.</p> <p>GF-8025 Without Counter <b>\$139.95</b></p>	<p><b>Elenco RF Generator with Counter Model SG-9500</b></p> <p>1MHz - 150MHz</p> <p>Features: internal AM mod of 1kHz, RF output 100mV - 35MHz, Audio output 1kHz @ 1V RMS</p> <p>SG-9000 (antenna, w/o counter) <b>\$225</b></p>	<p><b>Elenco Power Supply Model XP-603</b></p> <p>0-30VDC @ 3A Output</p> <p>3A Fused Current Protection</p> <p>Current Limiting Short Protection</p> <p style="text-align: right;"><b>\$75</b></p>
<p><b>20MHz Sweep / Function Generator with Frequency Counter Model 4040A</b></p> <ul style="list-style-type: none"> <li>- 0.2Hz to 20MHz</li> <li>- AM &amp; FM Modulation</li> <li>- Burst Operation</li> <li>- External Frequency Counter to 30MHz</li> <li>- Linear and Log Sweep</li> </ul> <p>10MHz Model 4017A <b>\$325</b></p> <p>30MHz Model 4011A <b>\$259</b></p> <p>2MHz Model 4010A <b>\$225</b> <small>NEW PRECISION</small></p>	<p><b>Elenco 10Hz - 1MHz Digital Audio Generator Model SG-9300</b></p> <p>Features: built-in 150MHz frequency counter; low distortion and sine/square waves</p> <p>SG-9200 (w/o counter) <b>\$119</b></p>	<p><b>Elenco Model SL-30</b></p> <p>Tip temperature changeable from 300°F (150°C) to 900°F (480°C)</p> <ul style="list-style-type: none"> <li>- The tip is isolated from the AC line by a 24V transformer.</li> <li>- The tip is grounded to eliminate static charges.</li> </ul> <p>SL-10 - Same as SL-30 w/o digital display <b>\$54.95</b></p>
<p><b>Elenco Oscilloscopes</b></p> <p>Free Dust Cover and 2 Probes</p> <p>5-125 25MHz Dual Trace <b>\$325</b></p> <p>5-125 40MHz Delayed Sweep <b>\$549</b></p> <p>5-125 25MHz Delayed Sweep <b>\$439</b></p> <p>5-125 40MHz Delayed Sweep <b>\$725</b></p> <p>5-125 40MHz Dual Trace <b>\$475</b></p> <p>5-125 120MHz Delayed Sweep <b>\$895</b></p>		<p><b>Weller® Low Cost Soldering Iron Model WLC100</b></p> <ul style="list-style-type: none"> <li>- Variable power control produces 5-40 watts</li> <li>- Ideal for hobbyists, DIYers and students</li> <li>- Complete with 40W iron</li> </ul> <p style="text-align: right;"><b>\$34.95</b></p>
<p><b>Elenco Educational Kits</b></p> <p><b>Model XK-150</b> \$89.95</p> <p>Digital Analog Trainer</p> <p><b>Model OWI-007</b> \$82.95</p> <p>Robotic Arm Trainer</p> <p><b>Model AM-780K</b> \$9.95</p> <p>Two IC Radio Kit</p> <p><b>Model AK-700</b> \$14.95</p> <p>Pulse Tone Telephone Kit</p> <p>Testing Test Lights</p> <p>Line Driver Project</p> <p><b>Model RCC-7K</b> \$27.95</p> <p>Radio Control Car Kit</p> <p>77 Functions</p> <p>Transmitter Included</p> <p><b>Model M-1005K</b> \$18.95</p> <p>DMM Kit</p> <p>Built-in Clock Generator</p> <p>Variable Power Supply</p> <p><b>Model K4001</b> \$12.95</p> <p>7W Amplifier</p>	<p><b>Electronic Science Lab</b></p> <p>MaxTronix 500-in-1 Electronic Project Lab Model MX-909</p> <p>Everything you need to build 500 exciting electronic projects:</p> <ul style="list-style-type: none"> <li>- Learn the basics of electronics. 500 different electronic experiments, special lighting effects, radio transmitter and receivers, sound effects, cool games and MORE!</li> <li>- Includes built-in breadboard and an LCD</li> <li>- Explore amplifiers, analog and digital circuits plus how to read schematic diagrams</li> <li>- Includes 11 parts</li> <li>- Lab style manual included</li> <li>- Requires 6 "AA" batteries</li> </ul> <p>MX-908 - 300-in-1 Lab <b>\$59.95</b></p> <p>MX-907 - 200-in-1 Lab <b>\$44.95</b></p> <p>MX-906 - 130-in-1 Lab <b>\$29.95</b></p> <p>EP-50 - 50-in-1 Lab <b>\$18.95</b></p> <p style="text-align: right;"><b>\$149</b></p>	
<p><b>Guaranteed Lowest Prices</b> <b>C&amp;S SALES, INC.</b> <b>15 DAY MONEY BACK GUARANTEE</b></p> <p>UPS SHIPPING: 48 STATES 5% (Minimum \$5.00)</p> <p>OTHERS CALL FOR DETAILS</p> <p>150 W. CARPENTER AVENUE WHEELING, IL 60090</p> <p>2 YEAR FACTORY WARRANTY</p> <p>OTHERS CALL FOR DETAILS FAX: (847) 541-9904 (847) 541-0710</p> <p>SEE US ON THE WEB <a href="http://www.cs-sales.com">http://www.cs-sales.com</a> PRICES SUBJECT TO CHANGE WITHOUT NOTICE</p>		

## The Conrad Project

**A**n on-going effort to establish a museum dedicated to the birthplace of broadcasting in Pittsburgh, Pennsylvania, is moving forward despite the loss of an important historic site. Rick Harris, Chairman of the Wilkesburg Commission and the National Museum of Broadcasting presented an informative progress report at the 2001 National Radio Club/DX Audio Service Convention in Pittsburgh. The commission has identified a potential site for the museum and expects to start raising money to complete what has become known as "The Conrad Project" to include the restoration of a significant part of broadcast history.

### History In Brief

Pioneer radio station KDKA in Pittsburgh is widely accepted as the first broadcaster, thanks to the work of Dr. Frank Conrad and his experimental station 8XK in Wilkesburg, Pennsylvania, and the vision of Westinghouse Vice President Harry Davis. Conrad first signed on in 1916 as amateur radio station 8XK from a laboratory in his garage. When other stations were required to shutdown during wartime, Conrad's station remained on the air to serve the military. After the war in 1919, the station returned to broadcast operation taking advantage of wartime improvements. Conrad coined the term "broadcast" borrowed from agriculture meaning to scatter or sow seeds. The first radio advertising was by arrangement with the Hamilton Music Store to provide music for the broadcasts. Harry Davis took notice of a newspaper ad for wireless receivers to pick up Conrad's broadcasts and proposed manufacture of receivers at the Westinghouse East Pittsburgh Works idled by the ending of the war. Davis realized the potential profitability of the radio broadcast medium. A new studio and 100-watt transmitter was installed in a shack on the roof of the "K Building" in the Westinghouse industrial complex, and KDKA commenced on 360 meters with the famous Harding-Cox election returns broadcast of November 2, 1920. Conrad didn't stop there. Later in 1924, he continued pioneering work with the advent of KDKA shortwave. Programs were broadcast around the world and to a network of stations from a transmitter site in Forest Hills, Pennsylvania, attracting the attention of fellow radio pioneer Guglielmo Marconi. Back home in his garage laboratory, Conrad didn't limit his experiments to radio either, as his inventions led to 200 patents including the kilowatt-hour meter still used today to measure electricity consumption.

### Preservation Versus Demolition

Some may dispute the KDKA claim to fame, but no one can argue the significance of Conrad's broadcasts and KDKA's place in history. Conrad's home should be worthy of preservation as a national historic site, yet little attention has been given by the broadcast industry and historians. The site of 8XK at the corner of Penn and Peebles in Wilkesburg was last used as part of

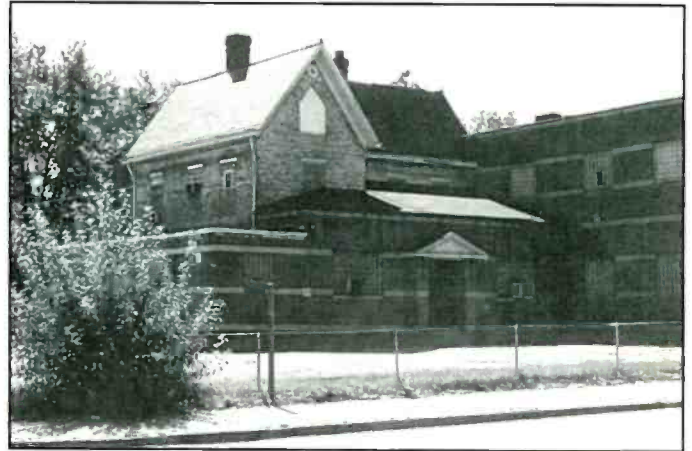

*Frank Conrad's home and the attached Elks Lodge await demolition to make way for a Wendy's restaurant.*

the local Elks Lodge with construction of a larger building attached to Conrad's home. The deteriorating garage was to be knocked down and paved over in 1972 to provide additional parking space for the lodge, but thanks to the efforts of the Wilkesburg Commission it was saved from destruction. The garage was carefully dismantled brick-by-brick and placed in storage for future restoration as part of a proposed national museum of broadcast history. The fate of Conrad's home was less fortunate, slated for demolition this past September to make way for a new Wendy's restaurant. Even a piano marked Hamilton Music Store and possibly the one used in 8XK broadcasts could not be rescued from the attic of the neglected home. Photographs decorating the walls of the restaurant and historical markers will be the only indication that something big happened there.

The sites of the famous Harding-Cox broadcast and KDKA shortwave remain standing today. The eight-story red brick K Building in the former Westinghouse East Pittsburgh Works is now part of the subdivided Keystone Industrial Park. Two historical plaques erected in the K Building parking lot by the Institute of Electrical and Electronics Engineers and the Turtle Creek Bicentennial Commission commemorate the milestone. (The K Building designation bears no connection with the KDKA call letters. Westinghouse used to identify separate buildings alphabetically.) The former KDKA shortwave transmitter building in Forest Hills looks nothing like the original, extensively remodeled where it served as the Westinghouse Recreation Center for over 70 years until donated to the community in 1999. Located on the Greensburg Pike at Perry Ave., only two plaques provide an indication that this was a place of historical significance. This is the site that the Wilkesburg Commission has targeted for the National Museum of Broadcasting and restoration of Conrad's garage.



Paul Johnson stands by the "On Q" WQED van. "On Q" is a magazine program aired on WQED-TV.

The K Building in the former Westinghouse East Pittsburgh Works, where KDKA first broadcast from a radio shack on the roof.

To learn more about KDKA history and The Conrad Project, visit [www.kdkaradio.com](http://www.kdkaradio.com) and click on "Timeline." There you'll be able to read about KDKA, listen to historic broadcasts with Real Player, and monitor the progress of the Wilkinsburg Commission and the National Museum of Broadcasting.

## Another Pittsburgh First

KDKA isn't the only Pittsburgh broadcaster claiming to be the first. A historical marker in front of the WQED radio and television studios tells the story: "Station WQED located here, opened April 1954 as the first community-sponsored educational television station in America. In 1955, it was the first to telecast classes to elementary schools." Classical music radio program host Paul Johnston provided National Radio Club members an inside look at the WQED radio and television studios. Outside the TV studios were parts of the set from Mister Roger's Neighborhood after taping of the final episode on August 31. WQED-FM 89.3 is unique among public radio stations because programming is dedicated exclusively to classical music rather than the variety of programs typically heard on public radio. Much of the music heard on WQED-FM is also unique as they record and produce their own digital archives of local musicians and concerts. Visit WQED on the web at [www.wqed.org](http://www.wqed.org).

## DX Test

**1230 AM WODI** Brookneal, Virginia, will be conducting a DX test on Sunday, November 4, beginning at 1 a.m. Eastern time. The test will consist of Morse code, distinctive music, and voice announcements. Please send all QSL requests to Dave Marthouse, WODI Radio, 1230 Radio Road, Brookneal, VA 24528. You may also send reception reports via E-mail to [wodi@lynchburg.net](mailto:wodi@lynchburg.net). The frequency 1230 kilohertz is one of six graveyard frequencies on the AM broadcast band, called so

because of the huge number of stations on each frequency. Most are licensed to transmit 1000 watts omnidirectional 24 hours a day. The graveyard frequencies are **1230, 1240, 1340, 1400, 1450, and 1490** kilohertz. There are well over 150 radio stations broadcasting on 1230 kilohertz in the U.S., so odds are that you'll encounter plenty of interference when trying to receive WODI. Surprisingly a Morse code DX test can be heard over thousands of miles under these circumstances. As any amateur radio operator will attest, Morse code can break through the worst conditions.

## QSL Information

**1060 KGFX** Pierre, South Dakota, verification letter received in 12 days for a taped report, signed Paul Rollie-PD. Address: 214 W Pleasant Drive, Pierre, SD 57501. (Martin, OR)

**1330 KLBO** Monahans, Texas, no-data verification letter and a Radio Free Texas bumper sticker received in seven days, signed Rick Anderson. Address: 1706 E. Sealy, Monahans, TX 79756. (Griffith, CO)

## Broadcast Loggings

Winter approaches and mediumwave DX heats up as indicated by this month's selected logs. Mark Connelly pulls in the transatlantic signals from prime coastal locations and Patrick Martin has rebuilt his Beverage and Ewe antennas for peak transpacific and transcontinental performance. All times are UTC.

**549 DeutschlandRadio**, Nordkirchen & Thurnau, Germany, at 0036 parallel 756 kHz with opera, atop presumed United Christian Broadcasters-Ireland. (Connelly, MA)

**576 IXLR** Hamilton, New Zealand, at 1330 good with Southern Star 1D and easy listening Christian music. This little 2 kilowatt gets out well. (Martin, OR)

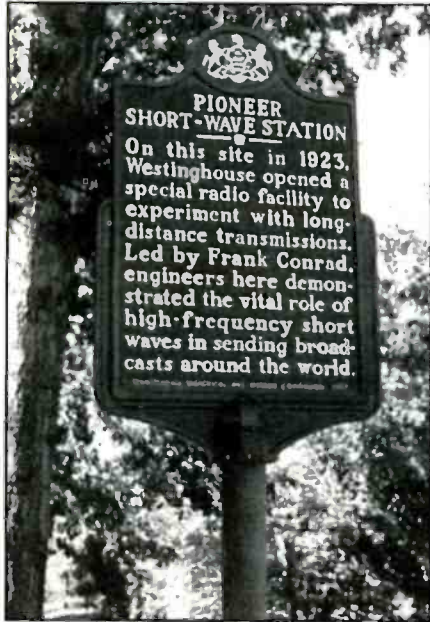

Historical marker on the grounds of the Westinghouse Recreation Center in Forest Hills, PA, former site of KDKA shortwave.

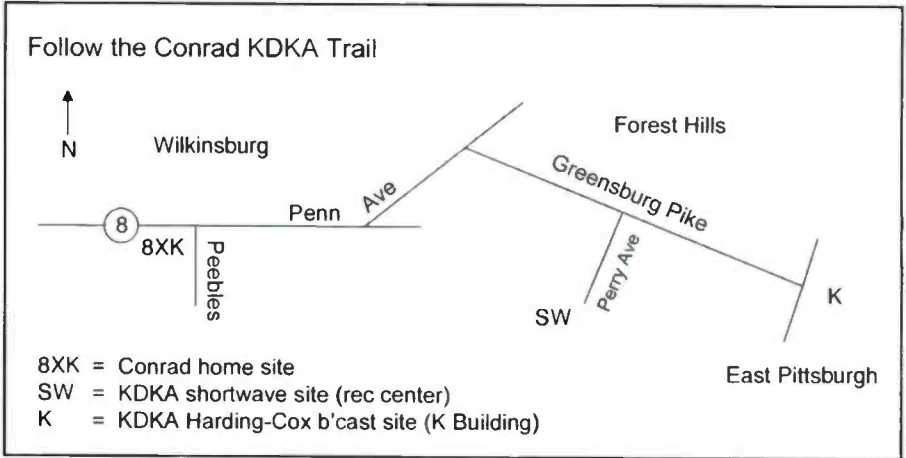

**603 France Bleu**, Lyon, France, at 0026 fair with spirited musical theater style French vocal parallel 1206 kHz. (Connelly, MA)

**610 CKTB** St. Catharines, Ontario, at 0633 with a promo for Buffalo Bills football and ID as "The Voice of the Niagaras." (Walker, CT)

**702 IXP** Auckland, New Zealand, at 1325 fair over 2BL with telephone talk and mention of Radio Pacific. (Martin, OR)

**738 RFO** Mahina, Tahiti, at 1340 a beautiful S9+ signal with island music and a woman in French and Tahitian. (Martin, OR)

Pending				New Call	Location	Freq.	Old Call
New Call	Location	Freq.	Old Call				
				WGES	Key Largo, FL	90.9	New
				WMBL	Mitchell, IN	88.1	New
KDBV	Salinas, CA	980	KCTY	KIHS	Adel, IA	88.9	New
KRLH	San Bernardino, CC	590	KSZZ	WOCs	Lerose, KY	88.3	WSPE
KYAA	Soquel, CA	1200	KOQI	WCUZ	Bear Lake, MI	100.1	WSRQ
KHDV	King City, CA	93.9	KZSL	WKMJ-FM	Hancock, MI	93.5	WMPL-FM
KEBV	Salinas, CA	97.9	KHMZ	WLDR-FM	Traverse City, MI	101.9	WLDR
KMJV	Soledad, CA	106.3	KHNZ	KRGY	Aurora, NE	97.3	KLRB
WSAB	Clarksdale, MS	101.5	WWUN-FM	WKVU	Utica, NY	100.7	WVVC
KCVK	Otterville, MO	107.7	KOTT	WUND-FM	Manteo, NC	88.9	New
WICE	Clarksville, VA	98.3	WJLC	WJIJ	Norlina, NC	94.3	WBDS
				KGBZ	Harwood, ND	100.7	KRKH
				KSPY	Williston, ND	98.5	New
				WFHM-FM	Cleveland, OH	95.5	WHK-FM
				WFXJ-FM	North Kingsville, OH	107.5	WCUZ
				KOCU	Altus, OK	90.1	New
				KKFC	Coalgate, OK	105.5	KLIS
WHBS	Moultrie, GA	1400	New	KUFO-FM	Portland, OR	101.1	KUFO
KZEZ	Honolulu, HI	1170	KBNZ	KWRX	Redmond, OR	88.5	New
WLDR	Kingsley, MI	1210	WJZZ	WKWL	Palmyra, PA	92.1	WNCE-FM
WHK	Cleveland, OH	1220	WHKC	WPKL	Uniontown, PA	99.3	WPQR-FM
WCCD	Parma, OH	1000	WHK	KKHG	Flandreau, SD	107.9	KSQB-FM
WHKW	Warren, OH	1440	WFHM	WYYL	Germantown, TN	107.5	WKSL
KUFO	Portland, OR	970	KUPL	KQQK	Beaumont, TX	107.9	KXTJ
WCZZ	Greenwood, SC	1090	WMTY	KXMG	Cedar Park, TX	93.3	KLNC
KBAI	Bellingham, WA	930	KIXT	KQBB	Center, TX	100.5	KDET-FM
KDRK	Dishman, WA	1050	KEYF	KOVE-FM	Galveston, TX	106.5	KQBU-FM
KYSC	Fairbanks, AK	96.9	New	KQBU-FM	Port Arthur, TX	93.3	KOVE-FM
KXTS	Calistoga, CA	100.9	KGRP	KQSI	San Augustine, TX	92.5	KCOT
KWTM	June Lake, CA	90.9	KIHS	KGNT	Smithfield, UT	103.9	KBET
KOKO-FM	Kerman, CA	94.3	KKPW	KCMG	WFFX-FM	102.3	WVAO-FM
KHHT	Los Angeles, CA	100.3	KCMG	KFXM	Crozet, VA	102.3	WVAO-FM
KGBB	Temecula, CA	103.3	KFXM	WJWD	Marshall, WI	90.3	New
KYKL	Tracy, CA	90.7	New	KZZS	Thermopolis, WY	98.3	KHWC



**783 ORTM** Nouakchott, Mauritania, at 2335 good with news in Arabic parallel 4845 kHz. (Connelly, MA)

**890 KBBI** Homer, Alaska, at 0859 good with "Blues Before Sunrise" program and ID. This is KBBI AM 890 Homer, public radio for the southern Kenai Peninsula." KBBI and KTKN are the most commonly heard stations from Alaska. (Martin, OR)

**900 CKTS** Sherbrooke, Quebec, at 0417 fair with several "CJAD AM 800 Montreal" IDs, but I was listening on AM 900. (Walker, CT) CKTS relays CJAD.

**907.81 R. Syd**, Banjul, Gambia, monitored at 0152 with bits of audio, mostly just a het against the BBC on 909 kHz. (Connelly, MA)

**970 KBUL** Billings, Montana, at 0400 very good on top of the channel with the end of Mustangs baseball. This station was never heard here until 1995, but now has been heard twice during local sunset. (Martin, OR)

**1110 XERED** Mexico City, Mexico, at 0458 over KBND with national anthem and Radio Red IDs, never heard before and Mexico is not that common here. (Martin, OR)

**1134 HRT** Zadar, Croatia, at 0440 briefly fair with music, otherwise just a carrier detected while demonstrating phased longwire antennas at the National Radio Club Convention in Pittsburgh. (Conti, PA)

**1280 CJSI** Estavan, Saskatchewan, at 0439 good with C&W music and ID, "Today's best country and your all-time favorites, this is CJ-1280." (Martin, OR)

**1310 CIWW** Ottawa, Ontario, at 0602 strong with oldies music and ID, "There's only one oldies specialist in Ottawa, and that's Oldies 1310." (Walker, CT)

**1377 France Bleu**, Lille, France, at 0123 parallel 945 and 1206 kHz with a romantic French vocal, a huge signal better than St. Pierre on 1375 kHz. (Connelly, MA)

**1390 WDCW** Syracuse, New York, heard at 0559 fair with ID, "This is AM 1390 WDCW Syracuse, part of the Crawford Broadcasting Company" and sign-off, interference from WPLM Plymouth, Massachusetts, also on 1390. (Walker, CT)

**1490 WMRC** Milford, Massachusetts, at 0406 "1490 WMRC" coming out of a commercial break, then oldies music and fade out of a very poor signal. (Walker, CT)

**1530 R. Vaticana**, Vatican City, Vatican, at 0324 way over WSAI with the Latin phrase "Laudetur Jesus Christus" and interval signal. (Connelly, MA)

**1600 KATZ** St. Louis, Missouri, at 0835 very strong with gospel music, "The best in gospel music is on Gospel 1600," the best signal in a long time after replacing the 1500-ft terminated Eastern Beverage wire. (Martin, OR)

Thanks to Ben Dangerfield and John Malicky of the National Radio Club for

their help in locating Pittsburgh landmarks, to Rick Harris and the Wilksburg Commission for promulgating the struggle to save remnants of broadcast history, to Paul Johnston at WQED-FM, and to DXers Mark Connelly, Patrick Griffith, Dave Marthouse, Patrick Martin, and Paul Walker. 73 and good DX! ■

# Affordable Multi-Mode 6 Meters



You just got your ham ticket, the club has been looking at increasing 6 Meter activity or it's just time to get away from 2 meters. You look at the ads, check the bank account and figure, maybe next year...Not anymore!

Need a reliable rig for 6-meter band openings or public service and emergency operations? Wondering why you have to pay for bands you don't plan to or can't use with your present license?

We have the answer.

Ranger Communications again sets the standard for value with a multi-mode, 6 Meter transceiver that is long on performance and short on price. The RCI-5054DX is perfect for the newly licensed ham who wants to try his hand at local FM operation as well as the experienced DX enthusiast who wants an economical SSB or CW 6 meter rig featuring a quiet receiver, all-mode squelch, extensive shielding and the performance and reliability that up to now you could only get with the multi band "high dollar" rigs.

The RCI-5054DX covers the full 6 meter band with an output power of 10W RMS or 25W PEP. Like the popular RCI-2950DX 10 & 12 Meter rig, the RCI-5054DX also has programmable repeater split (up to  $\pm 2$  MHz in this model), optional CTCSS tone, 10 frequency memory and two programmable scanning modes. Add a large easy to read display and you have the perfect rig for home, mobile or field day. At a suggested retail price of only \$329.00, the RCI-5054DX is an excellent buy for new or old hams alike.

Come see the new RCI-5054DX at the Ham Radio store near you. Don't know where? Call us Toll Free for help in finding the dealer nearest you.

**RANGER**  
Communications, Inc.

**Toll-free:** (877) 536-0772

**Email:** rci@rangerusa.com

**website:** www.rangerusa.com

401 West 35th Street National City, CA 91950

### Ninth Circuit Rules On Cordless Phone Case

The United States Court of Appeals for the Ninth Circuit (Eastern District of California) recently ruled in favor of a radio hobbyist who intercepted cordless telephone conversations. Leora Price, the plaintiff in the case, frequently made calls to or from Laura Beckman's cordless phone. One of the defendants in the case, neighbor Frank Turner monitored those calls on a RadioShack scanner. The intercepts began in 1989, however in June of 1991, Turner called the El Dorado Sheriff's Department to report that he had overheard illegal drug transactions. The Sheriff's Department told him to keep listening and gave him a voice-activated recorder. Turner recorded conversations and turned them over the Sheriff.

The recordings came to the attention of Price's lawyer, who filed a lawsuit alleging violations of state and federal law by Turner and El Dorado County. The district court granted motions for summary judgment relating to the federal claims, but sent the state claims back to the superior court. Price appealed the ruling, saying that Turner's conduct was a violation of the Wiretap Act (18 U.S.C. Sec. 2511) that forbids nonconsensual interception and disclosure of wire, oral, and electronic communications. At the time, the Act did not include the radio portion of a cordless telephone communication that is transmitted between the cordless telephone handset and the base unit. Congress amended the Wiretap Act in 1994 to change this loophole. Though Price tried to argue that the interceptions were a violation of her constitutional right to privacy, the court ruled that at the time her phone conversations "were readily susceptible to interception" and therefore were not protected by the Wiretap Act.

Turner almost didn't get away with this one. None of the interceptions could be identified as having occurred after 1994, when the law was changed. For the actual text of the law, see 18 U.S.C. § 2510(1), (12) (2000).

#### New Amateur Band?

The Federal Communications Commission is seeking comments on a proposal to create a new amateur band. The U.S.-only band, located between 5250 and 5400 kHz, would be for domestic use only and international communications here would be prohibited. The ARRL is behind the petition, citing the need to close a propagation gap that currently exists between 40 and 80 meters, as well as overcrowding on these bands. The new band, if approved, would be open to all General Class or higher licensees for voice, CW, data, image, and RTTY. Comments can be filed online at the FCC's Electronic Comment Filing System (ECFS) at [www.fcc.gov/e-file/ecfs.html](http://www.fcc.gov/e-file/ecfs.html) and should reference RM-10209.

#### FCC Seeks Comment On More Spectrum Reallocation

The FCC is asking for comments on the possible reallocation of spectrum in the 1910-1930 MHz, 1990-2025 MHz,

2150-2160 MHz, 2165-2200 MHz, and 2390-2400 MHz bands. Among the frequencies being considered is a segment of the 13-centimeter amateur band at 2390-2400 MHz, as well as frequencies in the Mobile Satellite Service, Personal Communications Service and Multipoint Distribution Service. The channels would be set aside for use by 3G (Third Generation) wireless systems. Those interested in commenting on this new proposal should visit the FCC Website and reference ET Docket No. 00-258, ET Docket No. 95-18, and IB Docket No. 99-81.

#### CTIA On Spectrum Reallocation

Saying that "we can't afford to fall behind," in the search for spectrum for next generation wireless services, Steve Berry, Senior Vice President for Government Affairs at the Cellular Telecommunications & Internet Association (CTIA), released a statement commenting on the GAO's report on the 1755-1850 MHz band, saying "Finding more spectrum to deliver advanced wireless services to American consumers is a time-sensitive priority for the wireless industry. If the United States is to remain globally competitive, we must make sure no party drags its feet. Other nations have already begun to identify and auction spectrum for next generation services . . . in the meantime, the FCC can provide temporary relief by removing spectrum caps, which limit the wireless industry's ability to provide new, innovative and quality services to an ever-increasing customer base." The FCC is expected to lift the cap on spectrum ownership by wireless companies by the end of the year.

#### The Military On Spectrum Reallocation

In a letter to Congress, top military officials said that selling critical airwaves for 3G wireless systems could threaten national security. The letter, signed by Gen. Henry Shelton (Chairman of the Joint Chiefs of Staff) and Secretary of Defense Donald Rumsfeld, stated that "forced relocation will have serious consequences on our national security and increase the risk to military personnel . . . No solution is feasible unless and until comparable spectrum has been identified for the displaced DoD functions." The military and other government agencies are among those currently occupying some of the primary bands identified for 3G spectrum.

#### U.S. Court Rules On Nextwave Licenses

The U.S. Court of Appeals for the District of Columbia has ruled that the FCC must begin delivering disputed wireless spectrum licenses to NextWave Telecom. The FCC had hoped to delay the transfer until the U.S. Supreme Court decided whether or not to hear the NextWave case, but that decision is not expect-

ed until the end of the year. NextWave has agreed not to use the licensed spectrum until the Supreme Court comes to a decision.

## San Francisco Not Ready For Cellular 911 Emergency Call

The city of San Francisco has said that they will not be able to meet a deadline for locating people making emergency calls from cellular telephones. The FCC has set October 1, 2001, as the date by which wireless companies must have enhanced emergency 911 locating technology in place and operating. All of the major wireless carriers have applied for extensions, saying that the technology just isn't ready. Currently, when a 911 call is made from a cellular telephone, emergency operators are unable to pinpoint the caller's location, unlike landline-based 911 calls, which display the caller's name and address.

## Federal Government Spectrum Available For Public Safety

The National Telecommunications and Information Administration (NTIA) has listed 40 federal government frequencies that are available for use by non-federal government public safety entities for communications involving coordination and cooperation with federal government agencies. Non-federal public safety entities that wish to use these frequencies must obtain an FCC license. The application must include written certification from a federal government agency that use of the requested frequency or frequencies is necessary to improve interoperability communications between the applicant and the federal government agency

during emergencies. The rules governing the use of these frequencies (power, bandwidth, etc.) can be found in Section 4.3.16 of the NTIA Manual (Manual of Regulations and Procedures for Federal Radio Frequency Management ([www.ntia.doc.gov/osmhome/redbook/redbook.html](http://www.ntia.doc.gov/osmhome/redbook/redbook.html))).

### Law Enforcement Plans

Nat'l Call 167.0875 (S) 167.0875		Nat'l Call 414.0375 (S) 414.0375	
Inop 1	162.0875 167.0875	Inop 1	418.9875 409.9875
Inop 2	162.2625 167.2500	Inop 2	419.1875 410.1875
Inop 3	162.8375 167.7500	Inop 3	419.6125 410.6125
Inop 4	163.2875 168.1125	Inop 4	414.0625 (S) 414.0625
Inop 5	163.4250 168.4625	Inop 5	414.3125 (S) 414.3125
Inop 6	167.2500 (S) 167.2500	Inop 6	414.3375 (S) 414.3375
Inop 7	167.7500 (S) 167.7500	Inop 7	409.9875 (S) 409.9875
Inop 8	168.1125 (S) 168.1125	Inop 8	410.1875 (S) 410.1875
Inop 9	168.4625 (S) 168.4625	Inop 9	410.6125 (S) 410.6125

### Incident Response Plans

VHF Calling 164.7125 169.5375		UHF Calling 419.2375 410.2375	
VHF 1	165.2500 170.0125		
UHF 1	419.4375 410.4375		
VHF 2	165.9625 170.4125		
UHF 2	419.6375 410.6375		
VHF 3	166.5750 170.6875		
UHF 3	419.8375 410.8375		
VHF 4	167.3250 173.0375		
UHF 4	413.1875 (S) 413.1875		
VHF 5	169.5375 (S) 169.5375		

you asked  
for it;  
now it's here!

**The entire 22+ year collection of Ham Radio magazine on this 12 CD-ROM set.**

Every article, every ad, every cover of all 269 issues of Ham Radio magazine. They're all as close as the click of the mouse. Over 30,000 pages in all. Trade 6 feet of shelf space for 3 inches of CD ROM jewel cases. Powerful search engine searches by title, author, year, issue. Research or browse one of the most acclaimed Amateur Radio magazines ever published.

**In three volumes of 4 CDs each.**

1968-1976 - Order No. **HRCD1**.....\$59.95

1977-1983 - Order No. **HRCD2**.....\$59.95

1984-1990 - Order No. **HRCD3**.....\$59.95

Please add \$3 shipping & handling for 1 set; \$4 for 2 or more sets.



**Entire Set  
\$149.95**

**Order all three volumes and save \$29.95  
Full set of Ham Radio CD ROMs \$149.95**

**Order No. HRCD Set**

**CQ Communications, Inc.**  
25 Newbridge Road, Hicksville, NY 11801  
[www.cq-amateur-radio.com](http://www.cq-amateur-radio.com)

**Order today!  
1-800-853-9797**

UHF 5	413.2125 (S) 413.2125
VHF 6	170.0125 (S) 170.0125
UHF 6	410.2375 (S) 410.2375
VHF 7	170.4125 (S) 170.4125
UHF 7	410.4375 (S) 410.4375
VHF 8	170.6875 (S) 170.6875
UHF 8	410.6375 (S) 410.6375
VHF 9	173.0375 (S) 173.0375
UHF 9	410.8375 (S) 410.8375

## New Mobile Satellite Services

The FCC's International Bureau has authorized eight new mobile satellite service systems (MSS) in the 2-GHz band.

The systems, capable of providing mobile voice, data, Internet access, and other services to all parts of the United States, are authorized to operate in an equal 3.5 MHz segment of spectrum in each of the 1990–2025 MHz and 2165–2200 MHz bands. Authorizations were issued to The Boeing Company; Celsat America, Inc.; Constellation Communications Holdings, Inc.; Globalstar, L.P.; ICO Services Ltd.; Iridium LLC; Mobile Communications Holding, Inc.; and TMI Communications and Company, Limited Partnership. "These innovative, technologically-sophisticated MSS systems will promote greater competition among communica-

tions services, creating a wider range of choices for U.S. consumers," said International Bureau Chief Donald Abelson.

## Bad Boy Update

Remember Leslie D. Brewer (see the June 2001 "Washington Beat"), the guy who wouldn't quit broadcasting from a pirate FM radio station, even after the FCC repeatedly told him to knock it off? Well, he finally got his, losing both his Amateur Radio and GMRS licenses. Here's the story: back in 1996, the Commission investigated Brewer for unlicensed transmissions on 102.1 MHz in the Tampa, Florida, area. After tracing the transmissions to Brewer's home, they warned him that "except when operating certain low power devices, it is a violation of Section 301 of the Communications Act to transmit on the FM band without a license." He was warned by letter to cut it out, but he didn't. An FCC follow-up found Brewer still operating his unlicensed FM station. As a result, he was slapped with a \$1,000 fine. Brewer fired back, calling into question the accuracy of field strength measurements taken of his transmissions and the competency of Commission engineers. Bad move. The FCC issued a Forfeiture Order and demanded that he pay the fine. Commission technicians continued to keep a close eye on Brewer throughout the rest of 1996 and well into 1997. Brewer kept at it, even requesting Special Temporary Authority to operate an FM broadcast station and to construct a Class A noncommercial educational station. Of course the FCC said no way. Then they said they'd had enough. On November 19, 1997, Brewer's equipment was seized by U.S. Marshals. That shut Brewer up for about two years, but on the second anniversary of the seizure, he again went on the air. This time Brewer was operating from a warehouse and using an illegal Studio-to-Transmitter Link to send audio from his home to the warehouse. To make things worse, he was also marketing unauthorized FM equipment through his business, L.D. Brewer 2-Way Radio. After a warning, an FCC agent went undercover and bought equipment from Brewer. Armed with this evidence, the Commission slapped him with a \$11,000 fine and found him "unqualified to be and remain a Commission licensee." His amateur radio and GMRS station licenses were revoked. About time. ■

*When seconds count,  
**REACT**  
needs you....*



...to summon for help for an injured motorist, an elderly woman trapped in a fire, a trucker stranded in a blizzard, a drowning child!



As a REACT volunteer radio monitor, you may be the only communication life-line for someone in serious trouble. You relay messages from those desperate for help to police, fire, or emergency services.



Your REACT team may also use CB, GMRS, Amateur, and other

radio services to provide safety communications for events like parades, marathons, and even balloon races. The fellowship with other REACT members at team meetings and annual conventions is an added bonus, as is help with licensing, equipment advice, and radio training.

*"The mission of REACT International is to provide public safety communications to individuals, organizations, and government agencies to save lives, prevent injuries, and give assistance wherever and whenever needed. We will strive to establish a monitoring network of trained volunteer citizen-based communicators using any and all available means to deliver the message."*

*Add a new, exciting challenge to your life.  
Volunteer. Help save lives and property,  
JOIN TODAY!*

**REACT INTERNATIONAL, INC.**

Phone (301) 316-2900

Fax (301) 316-2903

Web: [www.reactintl.org](http://www.reactintl.org)

5210 Auth Road, Suite 403

Suitland, MD 20746



• PROUD RECIPIENT OF THE PRESIDENT'S VOLUNTEER ACTION AWARD •

**RADIO EMERGENCY ASSOCIATED COMMUNICATIONS TEAM**

# our readers speak out

Each month, we select representative reader letters for our "Our Readers Speak Out" column. We reserve the right to condense lengthy letters for space reasons and to edit to conform to style. All letters submitted must be signed and show a return mailing address or valid E-mail address. Upon request, we will withhold a sender's name if the letter is used in "Our Readers Speak Out" Address letters to: Harold Ort, N2RLL, SSB-596, Editor, Popular Communications, 25 Newbridge Road, Hicksville, NY 11801-2909, or send E-mail via the Internet to <popularcom@aol.com>.

## A Cat And Mouse Story — Or Is There A Bit More?

Dear Editor:

When I got interested in scanners I didn't know a whole lot about scanning, so I did a lot of research which kept me from getting my radio taken away by the police. Most importantly, the research kept me from being jailed.

I decided one day to monitor outside. It was a nice day and I wanted to be outdoors. I knew that the Chicago Police Department has a radio direction finding team and they're good, but they didn't expect me to be turning my radios off and on. It took them three days before they caught up with me, and they have been trying to get some charges on me ever since. There isn't any law on the books saying I could do what I did. But they sure are mad at me. I'm a United Parcel truck driver and they went undercover on my job, thinking I was some drug smuggler for almost two years. They followed me at feverish pitch. They are really mad at me. Scanners beware in Chicago. They're out to nail you just for listening. They were following everywhere I go hoping to get some charges on me to make me stop listening, but it just fuels me even more. I'm going to further my communication skills and electronic knowledge. I would like you guys to invest time in informing us on radio direction finding equipment, technologies, any theory of operation. The magazine is very informative.

Thank you,  
Victor Beard, Illinois

Dear Victor,

Thanks for your comments about our magazine, but please know that scanning and monitoring for the sake of being an informed or entertained citizen is one thing, and anything beyond that, including unauthorized, illegal transmitting, or even publicly testing the patience of our public safety officials is against all we stand for in the radio hobby. If indeed you feel your rights are being violated, get a lawyer — and from now on, for your own sake, please use a headset or earphone when out in public.

## Ottawa Information, Please

Dear Editor:

I found your magazine while studying electronics in college back in 1996–1998. I am mostly interested in DXing short-wave frequencies and your monthly pull-out works well for me.

I use a RadioShack DX-397 and also own a RadioShack TRC-234 CB walkie-talkie with 10 weather channels. I find the weather channels useful because Environment Canada broadcasts the weather for whatever region you're located. This is most helpful if you're a Boy Scout leader like me. I would really like to purchase a handheld scanner, as I would like to listen to the Ottawa Fire Department. They have a station at the end of my street and I see them go by my apartment building, and really wonder

where they're going. I've been told that all their frequencies are "trunked" but I have to learn more about them.

I am employed as a cellular telephone repair technician with Rogers AT&T and wish to listen to the cellular traffic at 842 MHz. Now scanners sold in Canada are unblocked for cellular frequencies, but I really want to get listening to the Ottawa Fire Department. I love your magazine and enjoy the new format as well. Thanks for a great magazine and best wishes from a newcomer to the communications field at 36 years old.

Sincerely,  
David Giles  
Canada

Dear David,

Many thanks for the letter and comments. I don't have a list of Canadian frequencies here in the office, but would suggest you run back down to your local RadioShack store. They'll certainly have the frequencies you need. Short of that, why not strike up a conversation with the firefighters down the street. Most are very willing to provide the frequencies.

Go through some of our recent back issues and read Ken Reiss' scanning column for an excellent overview of trunking and what you need to monitor a trunked system. And readers: If there's anyone near David in Ottawa that can help him, please drop us a note and we'll gladly put you in touch with each other.

## High-Performance SWL Antennas

The award-winning Eavesdropper™ antennas include our Zap Trapper™ Electronic Gas Tube Lightning Arrestors. Receive-only design shunts damaging transients to ground at only 1/7th the voltage buildup as compared to the commonly available 200 watt transmit-type arrestors, providing maximum solid state receiver protection. Protect your investment—combine an excellent shortwave receiving antenna with the best receiver protection money can buy.



- Completely assembled and ready to use
- 8 trap circuits for 11-90 meter coverage.
- All connections soldered and enclosed in ultrasonically-welded, hermetically-sealed trap covers

- Only 42' overall length
- Includes 50' of 450 lb. test nylon rope
- Quick-acting transient suppression

Model C includes weatherproofed center connector for your coax & coax sealant

Model T includes 100' twinlead feedline

Model Sloper—End fed, coil-loaded, includes Zap Trapper™, 67 ft. length

Either model, \$89.95 ea. Please add \$6.00 for UPS shipment to lower 48 states. COD add an additional \$5.50. Illinois residents add 8.25% sales tax. Foreign shipping quoted.

## Antenna Supermarket

P.O. Box 563 Palatine, IL 60078 Tel (847) 359-7092 Fax (847) 359-8161

At your dealer or direct • Visa & Mastercard accepted

## the internet *our cyber sleuth checks out online resources and keeps you interactive!*

### Resource Of The Month: About.com's Pirate/Free Radio Page With John Anderson



with actions! I quoted him as saying: "We're gonna go nuts here. I'd like this to be the biggest, most comprehensive, and most useful site on the 'net, dedicated to those broadcasters and enthusiasts who worship on-the-edge radio. Everything is game." That was his page description in November of last year and it's still true today — with one difference. It's bigger and better than ever! From A to Z, if it deals with Pirate/Free Radio, John has it covered and then some!

One of the things I found most interesting, during a recent visit, was John's perspective on the current increased activity of pirate broadcasting. Find it in his "Shortwave Spike" commentary. Also DON'T MISS his "The Radio Hall of Shame." As John puts it, "We've categorized and classified more than 400 enemies of free radio, and given them a dose of much-needed vitriol. FCC Thugs, Industry Scum, and Political Hacks . . ." Can you guess who's included? Maybe you'll print some photos and throw some darts. Get the full scoop and much, much more at this exceptional resource! Visit and bookmark <http://pirateradio.about.com/>. ■

Exactly one year ago we visited John Anderson and his "About.com" section on Pirate/Free Radio. I stated then that John is one of those individuals who backs up his words

## Other Outstanding Resources:

Remember: ALL online resources and contacts appearing monthly in Pop'Comm are available at the Quick Links site: <http://www.dobe.com/ql/>

### RADIO INDUSTRY

Another excellent resource from the About.com folks.

<http://radioindustry.about.com/cs/shortwave/>

"Hosted" by Logan Hawkes, everything related to the industry itself is covered. Nice!

### LOW POWER FM (LPFM)

Here's a rather comprehensive FAQ (Frequently Asked Questions) about LPFM.

<http://www.panaxis.com/lpfmfaq.html>

Brought to you by none other than our own FCC Mass Media Division.

### WEB CONTROLLED RCVRs.

Web Controllable Receivers started in Sweden and are now around the world.

<http://www.javaradio.com/>

Recently updated with new links and information.

### NUMBERS STATIONS

Listen to actual recordings of Shortwave Numbers Stations from the '80s and '90s.

<http://home.freeuk.com/spook007/>

Although dated, still interesting listening. (RealPlayer/E required)

### IONOSPHERE INFO

From NOAA. Nice introduction to our Ionosphere. (Find link at URL below).

<http://www.ngdc.noaa.gov/stp/>

Particularly handy info as we near the Winter DX season.

### HF PROPAGATION

High Frequency Propagation Modeling Software from NTIA/ITS

<http://elbert.its.blrdoc.gov/hf.html>

Nice source for free software if HF propagation modeling is your bag.

### SHORTWAVE LISTENING

Excellent site containing information (FAQs) on SWL by Dan Atkinson.

<http://www.danatkinson.co.uk/html/sw/>

Actually much more than just FAQs, and well worth your time to explore.

### AVIATION SCANNING

Commercial site with some extraordinary software.

<http://www.airnavsystems.com/>

If you're REALLY into aviation scanning, this site is well worth a visit. Prices appear reasonable.

### THE MSN TERRASERVER

Amazing "aerial" photo resource founded by Microsoft.

<http://terraserver.homeadvisor.msn.com/advfind.asp>

Grab a photo of your shack from USGS aerial image archives. Slick!

# Tap into secret Shortwave Signals

Turn mysterious signals into exciting text messages with the MFJ MultiReader™!

Plug this self-contained MFJ MultiReader™ into your shortwave receiver's earphone jack.

Then watch mysterious chirps, whistles and buzzing sounds of RTTY, ASCII, CW and AMTOR (FEC) turn into exciting text messages as they scroll across an easy-to-read LCD display.

You'll read interesting commercial, military, diplomatic, weather, aeronautical, maritime and amateur traffic . . .

## Eavesdrop on the World

Eavesdrop on the world's press agencies transmitting unedited late breaking news in English -- China News in Taiwan, Tanjug Press in Serbia, Iraqi News in Iraq -- all on RTTY.

Copy RTTY weather stations from Antarctica, Mali, Congo and many others. Listen to military RTTY passing traffic from Panama, Cyprus, Peru, Capetown, London and others. Listen to hams, diplomatic, research, commercial and maritime RTTY.

Listen to maritime users, diplomats and amateurs send and receive error-free messages using various forms of TOR (Telex-Over-Radio).

Monitor Morse code from hams, military, commercial, aeronautical, diplomatic, maritime

## Super Active Antenna

"World Radio TV Handbook" says MFJ-1024 is a "first-rate easy-to-operate active antenna... quiet... excellent dynamic range... good gain... low noise... broad frequency coverage."

Mount it outdoors away from electrical noise for maximum signal, minimum noise. Covers 50 KHz-30 MHz.

Receives strong, clear signals from all over the world. 20 dB attenuator, gain control, ON LED.

Switch two receivers and auxiliary or active antenna.

MFJ-1024 6x3x5 inches. Remote has 54 inch whip, 50 feet coax. 3x2x4 inches. 12 VDC or 110 VAC with MFJ-1312, \$14.95.

## Indoor Active Antenna

Rival outside long wires with this tuned indoor active antenna.

"World Radio TV Handbook" says MFJ-1020B is a "fine value... fair price... best offering to date... performs very well indeed."

Tuned circuitry minimizes intermod, improves selectivity, reduces noise outside tuned band. Use as a preselector with external antenna. Covers 0.3-30 MHz. Tune, Band, Gain, On/Off/Bypass Controls. Detachable telescoping whip. 5x2x6 in. Use 9 volt battery, 9-18 VDC or 110 VAC with MFJ-1312, \$14.95.

## Compact Active Antenna

Plug this compact MFJ all band active antenna into your receiver and you'll hear strong, clear signals from all over the world, 300 KHz-200 MHz including low, medium, shortwave and VHF bands.

Detachable 20 inch telescoping antenna. 9 volt battery or 110 VAC MFJ-1312B, \$14.95. 3/16x1/8x4 in.

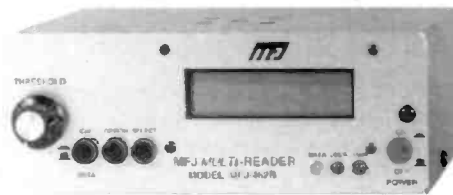

MFJ-462B  
\$179<sup>95</sup>

all over the world -- Australia, Russia, Japan, etc. **Printer Monitors 24 Hours a Day**

MFJ's exclusive TelePrinterPort™ lets you monitor any station 24 hours a day by printing transmissions on an Epson compatible printer. Printer cable, MFJ-5412, \$9.95.

**MFJ MessageSaver™** You can save several pages of text in an 8K of memory for re-reading or later review.

## High Performance Modem

MFJ's high performance PhaseLockLoop™ modem consistently gives you solid copy -- even with weak signals buried in noise. New threshold control minimizes noise interference --

greatly improves copy on CW and other modes.

## Easy to use, tune and read

It's easy to use -- just push a button to select modes and features from a menu.

It's easy to tune -- a precision tuning indicator makes tuning your receiver easy for best copy.

It's easy to read -- the 2 line 16 character LCD display with contrast adjustment is mounted on a brushed aluminum front panel for easy reading.

Copies most standard shifts and speeds. Has MFJ AutoTrak™ Morse code speed tracking.

Use 12 VDC or use 110 VAC with MFJ-1312B AC adapter, \$14.95. 5/16x2 1/4x5 1/4 inches.

## No Matter What™ One Year Warranty

You get MFJ's famous one year No Matter What™ limited warranty. That means we will repair or replace your MFJ MultiReader™ (at our option) no matter what for one full year.

## Try it for 30 Days

If you're not completely satisfied, simply return it within 30 days for a prompt and courteous refund (less shipping). Customer must retain dated proof-of-purchase direct from MFJ.

## Eliminate power line noise!



MFJ-1026  
\$179<sup>95</sup>

**New! Completely eliminate power line noise, lightning crashes and interference before they get into your receiver!** Works on all modes -- SSB, AM, CW, FM, data -- and on all shortwave bands. Plugs between main external antenna and receiver. Built-in active antenna picks up power line noise and cancels undesirable noise from main antenna. Also makes excellent active antenna.

## MFJ Antenna Matcher



MFJ-959B  
\$99<sup>95</sup>

Matches your antenna to your receiver so you get maximum signal and minimum loss.

Preamp with gain control boosts weak stations 10 times. 20 dB attenuator prevents overload. Select 2 antennas and 2 receivers. 1.6-30 MHz. 9x2x6 in. Use 9-18 VDC or 110 VAC with MFJ-1312, \$14.95.

## Dual Tunable Audio Filter



MFJ-752C  
\$99<sup>95</sup>

Two separately tunable filters let you peak desired signals and notch out interference at the same time. You can peak, notch, low or high pass signals to eliminate heterodynes and interference. Plugs between radio and speaker or phones. 10x2x6 in.

## High-Gain Preselector



MFJ-1045C  
\$99<sup>95</sup>

High-gain, high-Q receiver preselector covers 1.8-54 MHz. Boost weak signals 10 times with low noise dual gate MOSFET. Reject out-of-band signals and images with high-Q tuned circuits. Push buttons let you select 2 antennas and 2 receivers. Dual coax and phono connectors. Use 9-18 VDC or 110 VAC with MFJ-1312, \$14.95.

## CW, RTTY, ASCII Interface



MFJ-1214PC  
\$149<sup>95</sup>

Use your computer and radio to receive and display brilliant full color FAX news photos and incredible WeFAX weather maps. Also RTTY, ASCII and Morse code. Frequency manager lists over 900 FAX stations. Auto picture saver.

Includes interface, easy-to-use menu driven software, cables, power supply, manual and JumpStart™ guide. Requires 286 or better computer with VGA monitor.

## High-Q Passive Preselector



MFJ-956  
\$49<sup>95</sup>

High-Q passive LC preselector boosts your favorite stations while rejecting images, intermod and phantom signals. 1.5-30 MHz. Preselector bypass and receiver grounded positions. Tiny 2x3x4 inches.

## Super Passive Preselector



MFJ-1046  
\$99<sup>95</sup>

**New! Improves any receiver!** Suppresses strong out-of-band signals that cause intermod, blocking, cross modulation and phantom signals. Unique Hi-Q series tuned circuit adds super sharp front-end selectivity with excellent stopband attenuation and very low passband loss. Air variable capacitor with vernier. 1.6-33 MHz.

## Easy-Up Antennas

How to build and put up inexpensive, fully tested wire antennas using readily available parts that'll

bring signals in like you've never heard before. Antennas from 100 KHz to 1000 MHz.

## MFJ Antenna Switches



MFJ-1704  
\$64<sup>95</sup>

MFJ-1702C  
\$24<sup>95</sup>

MFJ-1704 heavy duty antenna switch lets you select 4 antennas or ground them for static and lightning protection. Unused antennas automatically grounded. Replaceable lightning surge protection. Good to 500 MHz. 60 dB isolation at 30 MHz. MFJ-1702C for 2 antennas.

## World Band Radio Kit

Build this regenerative shortwave receiver kit and listen to signals from all over the world with just a 10 foot wire antenna. Has RF stage, vernier reduction drive, smooth regeneration, five bands.

## 21 Band World Receiver

MFJ's MFJ-8121 new 21 Band World Receiver lets you travel the world from your armchair! Listen to BBC news from London, live music from Paris, soccer matches from Germany and more! Covers 21 bands including FM, Medium Wave, Long Wave and Shortwave. Sony® integrated circuit from Japan, multicolored tuning dial, built-in telescopic antenna, permanent silkscreened world time zone, frequency charts on back panel. Carrying handle. Operates on four "AA"s. Super compact size!

## Free MFJ Catalog

and Nearest Dealer . . . 800-647-1800

<http://www.mfjenterprises.com>

• 1 Year No Matter What™ warranty • 30 day money back guarantee (less s/h) on orders from MFJ

**MFJ ENTERPRISES, INC.**  
Box 494, Miss. State, MS 39762  
(662) 323-5869; 8:43-30 CST, Mon.-Fri.  
FAX: (662) 323-6551; Add s/h  
Tech Help: (662) 323-0549

Prices and specifications subject to change. (c) 1998 MFJ Enterprises, Inc.

# world band

## tuning tips *your monthly international radio map*

This listing is designed to help you hear more shortwave broadcasting stations. The list includes a variety of stations, including international broadcasters beaming programs to North America, others to other parts of the world, as well as local and regional shortwave stations. Many of the transmissions listed here are not in English. Your ability to receive these stations will depend on time of day, time of year, your geographic location, highly variable propagation conditions, and the receiving equipment used.

AA, FF, SS, GG, etc. are abbreviations for languages (Arabic, French, Spanish, German). Times given are in UTC, which is five hours ahead of EST, i.e. 0000 UTC equals 7 p.m. EST, 6 p.m. CST, 4 p.m. PST.

UTC	Freq.	Station/Country	Notes	UTC	Freq.	Station/Country	Notes
0000	3280	La Voz del Napo, Ecuador	SS	0300	15485	Radio Free Asia relay, No. Marianas	CC
0000	11734	Radio Tanzania — Zanzibar	Swahili	0300	15250	Voice of America relay, Sri Lanka	
0000	11665	Voice of Turkey		0300	4996	Radio Andina, Peru	SS
0000	12040	Radio Ukraine International		0300	17675	Radio New Zealand International	
0000	13675	UAE Radio, Dubai		0300	4824	La Voz de la Selva, Peru	SS
0100	9605	Vatican Radio	SS	0300	5020	Solomon Islands Broadcasting Corp.	
0100	7260	Radio Vanuatu		0330	15110	Radio Exterior de Espana	SS
0100	11870	Radio Yugoslavia		0330	11600	Far East Broadcasting Assn., Seychelles	
0100	9780	Republic of Yemen Radio	AA	0330	6985	Radio Gaalkacyo, Somalia	unid.
0100	5925	Voice of Vietnam	VV	0330	15705	Radio Norway International	NN
0130	7110	RTV Tunisienne, Tunisia	AA	0330	11635	Radio Norway International	NN
0130	11945	Adventist World Radio, via UAE		0330	5770	Radio Miskut, Nicaragua	SS
0130	7260	Radio Thailand	VV	0330	9685	Voice of Russia	
0130	9610	Radio Taipei International		0330	15315	Radio Netherlands	
0130	17505	Radio Sweden		0340	11865	Radio Netherlands	
0130	13610	Radio Damascus, Syria		0400	7255	Voice of Nigeria	
0200	13625	Radio Sweden		0400	9975	Voice of Korea, North Korea	
0200	9495	Radio Sweden		0400	21590	Radio Netherlands	
0200	9525	Channel Africa, South Africa		0400	13625	Radio Free Asia, Northern Marianas	CC
0200	7200	Radio Omdurman, Sudan	AA	0400	11920	RTV Marocaine, Morocco	AA
0200	9680	Radio Taipei International, via WYFR		0400	9575	Radio Medi-un, Morocco	FF
0200	7260	Voice of America relay, Thailand	unid	0400	15495	Radio Kuwait	AA
0200	3240	Trans World Radio, Swaziland	unid	0400	5055	Radio Tampa, Japan	JJ
0200	12005	RTV Tunisienne, Tunisia	AA	0430	5100	Radio Liberia	
0200	9535	Radio Korea Int'l		0430	7200	Radio Japan/NHK	JJ
0200	4991	Radio Apintie, Surinam		0430	15075	All India Radio	unid.
0200	9480	Voice of Russia		0430	12050	Egyptian Radio	AA
0230	6000	Radio Singapore International	CC	0500	9605	UAE Radio, Abu Dhabi	AA
0230	15420	BBC relay, Seychelles		0500	9525	Voice of Indonesia	CC
0230	15180	Radio Romania International		0500	4819	La Voz Evangelica, Honduras	SS
0230	9525	Radio Veritas Asia, Philippines	unid	0500	9930	KWHR, Hawaii	
0245	9665	Radio Singapore International	unid	0530	4800	Radio Buenas Nuevas, Guatemala	SS
0300	12000	Voice of Russia		0600	12105	Voice of Greece	Greek
0300	9940	Radio Studio, Russia		0600	13620	All India Radio	
0300	17795	Qatar Broadcasting Service	AA	0600	15475	Salama Radio, via England	
0300	9770	Voice of America relay, Philippines		0600	12035	BBC, England	
0300	6798	Ondas del Rio Mayo, Peru	SS	0630	9900	Egyptian Radio	
0300	9675	Radio del Pacifico, Peru	SS	0645	15115	HCJB, Ecuador	
0300	15365	Radio Romania International		0700	13690	Deutsche Welle, Germany	
0300	4830	Radio Tachira, Venezuela	SS; irreg.	0700	17630	Radio France International	
0300	15355	Radio Sultanate of Oman	AA	0700	17670	YLE/Radio Finland International	
0300	9885	Radio New Zealand International		0800	15150	Voice of Indonesia	



UTC	Freq.	Station/Country	Notes	UTC	Freq.	Station/Country	Notes
0800	9595	Radio Tampa, Japan	JJ	1300	11680	Korean Central Broadcasting Station	KK
0800	7125	RTV Guineenne, Guinea	FF	1300	6570	Burmese Army Station	BB
0800	17535	Kol Israel	HH	1330	7275	Radio Nigeria	
0810	11930	Radio Jordan	AA	1330	3230	Radio El Sol de los Andes, Peru	SS
0830	11590	Kol Israel		1330	3310	Radio Mosoj Chaski, Bolivia	SS
0830	9705	Radio Mexico International	SS/EE	1400	4800	Radio Lesotho	
0900	15385	Voice of the Islamic Republic of Iran		1400	4805	Rdf. do Amazonas, Brazil	PP
0900	4895	Radio Malaysia	Malay	1400	4980	Ecos del Torbes, Venezuela	SS; irreg.
0900	11800	RAI International, Italy		1500	5954	Radio Casino, Costa Rica	SS
0900	9635	Voice of the Islamic Republic of Iran		1500	6040	Radio Clube Paranaense, Brazil	PP
0930	17870	Adventist World Radio via Guam		1500	6135	Radio Santa Cruz, Bolivia	SS
0930	3325	Radio Maya, Guatemala	SS	1500	6265	Zambia National Broadcasting Service	
0930	13710	All India Radio		1500	6350	AFN/AFRTS, Hawaii	USB
0930	15630	Voice of Greece	Greek	1530	6900	United Patriot Radio, Kentucky	
0930	4890	NBC, Papua New Guinea		1530	7185	Radio Sonder Grense, South Africa	Afrikaans
1000	13800	Radio Norway International	NN	1530	7445	Voice of Asia, Taiwan	
1000	12085	Voice of Mongolia	Mandarin	1530	9685	Radio Gazeta, Brazil	PP
1000	6010	Radio Mil, Mexico	SS	1600	9737	Radio Nacional, Paraguay	SS
1000	15415	Radio Jamahiriya, Libya	AA	1600	9870	Trans World Radio, Monaco	
1000	6185	Radio Educacion, Mexico	SS	1600	11850	Radio Thailand	
1000	7270	Radio Malaysia		1600	15485	Radio Pakistan	Urdu
1030	3300	Radio Cultural, Guatemala	SS	1630	15705	Radio Denmark, via Norway	DD
1030	15575	BBC via Cyprus		1645	3250	Radio Luz y Vida, Honduras	SS
1030	15470	Radio Prague, Czech Republic		1700	4755	Radio Educacao Rural, Brazil	PP
1030	6115	Voice of the Strait, China	CC	1700	5020	La Voix du Sahel, Niger	FF
1030	17720	China Radio International		1700	5975	Radio Macarena, Colombia	SS
1100	13730	Radio Finland International		1800	6240	Trans World Radio via Albania	Slovak
1100	11700	Radio Bulgaria		1800	9470	Voice of Croatia, via Germany	
1100	15120	Radio Havana Cuba	SS	1930	9570	Radio Budapest, Hungary	
1100	5860	Voice of Jinling, China	CC	2000	9695	Radio Rio Mar, Brazil	PP
1100	11890	Radio Canada International		2000	9875	Radio Vilnius, Lithuania	
1100	6180	Radio Nacional Amazonia, Brazil	PP	2030	11787	Radio Iraq International	
1100	11915	Radio Gaucha, Brazil	PP	2030	12100	Trans World Radio, via Albania	Farsi
1100	4845	Radio Cultura Ondas Tropicais, Brazil	PP	2030	15170	Broadcasting Service of Kingdom of Saudi Arabia	AA
1100	6155	Radio Fides, Bolivia	SS				EE
1100	15565	Radio Vlaanderen Int'l, via Bonaire		2030	15185	Radio Africa, Equatorial Africa	
1130	11960	Radio Stalitsa, Belarus		2030	5985	Radio Vlaanderen Int'l, Belgium	
1130	21550	Christian Voice, Chile/Australia		2030	9525	Radio Polonia, Poland	
1130	21740	Radio Australia		2030	9610	Adventist World Radio, Italy	
1200	11650	Radio Australia		2030	9625	CBC No. Quebec Service, Canada	
1200	17865	Radio Austria International		2045	9905	Radio Free Asia via Palau	unid
1200	17865	Radio Austria International		2100	11570	Radio Pakistan	
1200	11710	RAE, Argentina		2100	11805	Radio Polonia, Poland	
1200	11955	Radio Nacional, Angola	PP	2100	11995	RDP International, Portugal	PP
1200	5985	Radio Congo	FF	2130	15190	Radio Filipinas, Philippines	Tagalog
1200	13680	Radio Havana Cuba	SS	2130	15270	Voice of Armenia	
1200	9380	China National Radio	CC	2130	15345	RAE, Argentina	SS
1200	17680	Voz Cristiana, Chile	SS	2200	15660	Radio Free Asia via Russia	Lao
1230	6060	Radio Nacional, Argentina	SS	2200	17500	Radio Bulgaria	
1230	11975	Adventist World Radio, via UAE	Amharic	2200	17555	Voice of Islamic Republic of Iran	unid
1230	6600	Voice of the People, Korea	KK, cland.	2230	17620	Radio France International	
1230	6498	Qinghai PBS, China	CC	2300	17870	Channel Africa, South Africa	FF
1230	11765	KNLS, Alaska		2300	21745	Radio Prague, Czech Republic	
1300	9630	Radio Aparecida, Brazil	PP	2300	17680	Swiss Radio International	GG
1300	4770	Radio Centinela del Sur, Ecuador	SS	2300	6025	Radio Amanacer, Dominican Republic	SS
1300	7265	Sudwestfunk, Germany	GG	2330	11565	Radio Telefis Eireann, Ireland, via USA	
1300	3291	Voice of Guyana		2330	15160	Radio Algiers Int'l, Algeria	
1300	5010	HRMI - Radio MI, Honduras	SS/EE	2330	15615	KSDA, Guam	CC

## radios & high-tech gear

review of new, interesting and useful products

### New Midland FRS Radio

Midland Consumer Radio announces availability of their much-anticipated FRS (Family Radio Service) model F-10 radio, the world's smallest 14 channel FRS transceiver with up to two-mile range.

This remarkable tiny new radio brings a whole new meaning to the phrase "The Art of Communication," with features previously found only on top-of-the-line models. With these compact two-way radios you stay connected with those who matter most at an affordable price. The ultimate in convenience and portability, you can use them at home, at the office or while hunting, fishing, or camping. Anywhere your adventures take you, bring along the ease and portability of the world's smallest FRS radio to connect you to the world.

With 14 channels available you can with ease anywhere you want. The F-10 also features eVOX voice activation that works without an accessory like a headset — just talk into the radio and it transmits. UHF-FM transmission supplies precision detailed sound for up to two miles away and comes equipped with strong output power for maximum range.

Features include:

Up to two-mile range (depending on terrain and conditions)

14 channels

Page/call — notifies others within your group

Tone and visual transmit indicators — verifies transmission

Channel Scan — searches all channels for signals

Key Lock — prevents accidental changes

Low battery indicator — early warning to replace batteries

Liquid Crystal (LCD) readout — easy sunlight viewing

Back lighted display — easy nighttime use

Rotary volume control — easy adjustment

Speaker jack — for addition of optional accessories

Charge system — allows in-unit charging of batteries

Stealth squelch — quiets noise between transmissions

Operates on three AAA batteries

Hand strap and flexible antenna included

This new Midland FRS transceiver is available in both single and pair clam shell packaging, and has an expected street price



The new Midland F-10 FRS transceiver is the "world's smallest" FRS radio.

of \$24.95 each or \$49.95/pair. A full line of accessories is available, including chargers, headsets, and lapel microphones.

Midland Consumer Radio is the leader in two-way and weather/hazard alert radios and carries an extensive line of CB and FRS handheld and mobile radios. The oldest manufacturer of CB radios in the U.S., they have been making quality two-way radios since 1959. An international company with affiliates in Europe, Asia and the U.S., Midland Consumer Radio also offers WeatherMax weather monitor alert radios, marine, and amateur radios and a line of quality antennas and accessories.

Midland Consumer Radio welcomes you to join our loyal customer base. For more information or personal assistance please contact us at the address above, or visit [www.midlandradio.com](http://www.midlandradio.com). Dealer inquiries are welcome.

### C. Crane Company's New CCRadio Plus™

C. Crane Company introduces the CCRadio Plus™, an updated version of the original CCRadio used by thousands of talk radio listeners across the country. CCRadio Plus™ the original radio designed specifically for long-distance AM radio reception now comes with a signal strength meter, a timer for recording, and audio input/output jacks. It's available now!

The CCRadio Plus was designed with Sangean Electronics. In 1998, C. Crane introduced the CCRadio and set a new standard in AM radio technology. Designed specifically for long-distance AM and equipped with audio tailored to the human voice, the CCRadio became the radio of choice among AM radio listeners. Building on the quality design of the original CCRadio, the plus edition continues to offer long-range AM reception, voice-tailored audio, and several new features.



C. Crane Company's new CCRadio Plus.

CCRadio plus features include:

- \* 1 kHz fine-tuning
- \* Signal strength meter aids in fine-tuning station reception
- \* External antenna jack can improve reception in a metal or brick building
- \* Audio input and output jacks
- \* New timer for taping programs or automatic station switching
- \* FM stereo headphone jack

\*Activated weather alert switches to weather band immediately when alarm sounds

\*Varying tones indicate FM, AM, TV or Weather band, ideal for the visually impaired

The new CCRadio Plus™ has a suggested retail price of \$169.95. "Generally, radio listeners tune in to programs on more than one station," says Bob Crane, president of the C. Crane Company. "With the CCRadio plus, listeners can tune in one station, and set the radio to automatically switch to another station at any time they specify. We also updated the external antenna jack on the CCRadio plus and added FM stereo sound to the headphone jack. The signal meter in the LCD display lets people fine tune their favorite stations for the best reception in their area."

C. Crane Company invites potential partners for distribution of their exclusive products. For more information on CCRadio plus and its accessories, readers can visit <http://www.ccrane.com/ccradio.asp>.

For more information about C Crane Company or their products, call 800-522-8863 (TUNE) or you can visit them on the web at [www.ccrane.com](http://www.ccrane.com).

### Cutting Edge's New Leather Pouch For Yaesu VR-120

It seems like every time a new radio comes out on the market, Cutting Edge has a new design to fit it! I just called them about a pouch for my new VR-120. Their Radio Glove™ is a fine leather pouch that fits the VR-120 like a glove. Not only does the leather feel great, it's just a better look when you're away from home.

The clip is very sturdy and the Velcro style cover gives easy access to the radio. And for those afternoons on the ball field, the NEO model for these radios offers extra cushion, a strong belt clip, and waterproof neoprene material to handle the rough terrain. The NEO has the same great workmanship, design, and attention to detail that is the hallmark of Cutting Edge products.

The new leather Radio Glove™ for Yaesu's VR-120 is \$19.95, and \$14.49 for the NEO. For more information, contact Cutting Edge Enterprises, 620 Highland Avenue, Santa Cruz, CA 95060 or phone 800-206-0115. You can also E-mail them at [info@powerportstore.com](mailto:info@powerportstore.com). As usual, tell them you read about it in *Pop'Comm*.



It protects your new Yaesu VR-120, but looks great too. The Cutting Edge Radio Glove™ is just what you need.

## DEDICATED TO THE SCANNING AND SHORTWAVE ENTHUSIAST. WE'RE MORE THAN JUST SOFTWARE!

### SCANCAT® GOLD for Windows

Since 1989, The Recognized Leader in Computer Control

Once you use SCANCAT with YOUR radio, you'll NEVER use your radio again WITHOUT SCANCAT!

SCANCAT supports almost ALL computer controlled radios by: AOR, DRAKE, KENWOOD, ICOM, YAESU and JRC (NRD) Plus PRO-2005/6/35/42 (with OS456/535), Lowe HF-150, and Watkins-Johnson.

#### Announcing Scancat-Gold for Windows Version 8.0

We've added a lot of new features to our latest Scancat. AND...We have made it EASIER than EVER! Scancat-Gold for Windows-New Features for Ver 8.0

- Supports all radios in ONE program - share files with all radios.
- Faster scanning speeds
- Completely revised trunking database management with expanded capabilities. Makes programming your radio a breeze!
- Two Scanning modules:
  - A Simple Basic Module - for beginners
  - An Advanced Scanning System for the "experts".
- Expanded import from databases such as EXCEL.
- New "Folder Tabbed" GUI puts everything at your fingertips
- EXPANDED trunking support for BC780, BC895, BC245 and Pro2052
- NO ONE supports your "Trunk Tracker" with more features!
- Completely revised printed manual - Over 160 pgs.
- Monitor and log all TalkGroup activity - Export to other files.



#### STILL THE SAME GREAT PRICE:

Scancat-Gold for Windows .....	\$99.95
Scancat-Gold for Windows-SE .....	\$159.95
Upgrades: Scancat-Gold for Windows.....	\$29.95 + S&H
Scancat-Gold for Windows-SE .....	\$59.95 S&H*

\*\$79.95 AFTER 1 YEAR OF PURCHASE      S&H \$5 U.S. \$7.50 FOREIGN

#### Scancat-Gold for Windows-SE - improved Features for Ver 8.0

All the features of our "Standard Scancat" plus these additional functions:

- Long term logging of frequencies to your hard drive.
- NEW - Records audio when "Trunktracking" or conventional scanning.
- Record Audio to hard drive using your computer's soundcard.
- Improved spectrum analysis with several great graphical analysis screens.

#### MAGIC for Windows

If You're Not Using MAGIC, You're Only Enjoying Half The Hobby. A Super File Conversion Utility—

Reads & Writes to over 10 database formats.

- Creates databases from plain ASCII text.
- Converts most popular file formats

**\$34.95**  
(plus \$5.00 S & H)

#### LIMITED TIME OFFER!

Limited Time Thru 12/31/2001

Scancat Gold for Windows .....	\$99.95
Magic for Windows .....	34.95
Disk of Frequency Files .....	15.00
Regular Price .....	\$149.90
<b>SPECIAL</b> .....	<b>\$124.95</b>
For "SE" Add: .....	\$59.95

"SPECIAL SCGM"

#### HOKA CODE-3 GOLD

Basic .....	\$425.00
Standard .....	\$595.00
Professional .....	\$795.00

Plus \$10 s&h (\$30 Foreign)

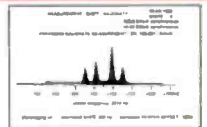

Simulated Speed Measurement Module

SCANCAT is a registered trademark of Computer Aided Technologies.

FREE FREQ FILES

WEBSITE - [www.scancat.com](http://www.scancat.com)

E-MAIL - [info@scancat.com](mailto:info@scancat.com)

FREE DEMOS

Order direct or contact your favorite dealer

**COMPUTER AIDED TECHNOLOGIES** P.O. Box 18285 Shreveport, LA 71138

Phone: (318) 687-4444

FAX: (318) 686-0449

Info/Tech Support: (318) 687-2555 (9 a.m. - 1 p.m. Central M-F)

**Toll-Free Orders**  
**888-SCANCAT**  
**888-722-6228**

## Gamber-Johnson's Super Slide™ Slide Mount

If you've struggled with figuring out how to mount your mobile radio — CB, ham, or scanner, your headaches are officially over. The Gamber-Johnson SS-100 mobile mount is a complete, easy-to-install solution to most mobile mounting situations.

If your vehicle is like mine — unlike those old metal dashboards of years ago — there's hardly room to mount a sunglasses case, let alone a mobile radio. Sure, they've included dozens of handy little cutouts and compartments, but all they're good for is holding cups, CDs, tapes, and maps.

Ours is a 1996 Chevy Lumina with an unused ashtray in bottom center of the dashboard, above which is the Lumina answer to a cup holder. (Please pray for those overpaid design engineers as they do ordinary household tasks that you and I accomplish with ease, without killing themselves or their loved ones!)

A few years ago, I tried one of those flimsy mobile mounting brackets from my local electronic retailer. They worked well years ago when there was ample under-dash room, but not with today's dashboard designs. Besides, the mount is really only designed for low current draw and mobile CB use. If you're using a mobile 10-meter rig, for example, or even a heavy classic Cobra mobile, you need a sturdier mount that's not going to fall apart when you go over the railroad tracks or repeatedly remove and install the radio. The Gamber-Johnson mount is far superior to any off-the-shelf mount I've ever used. It consists of two main parts: a cover plate and base assembly, which you attach to your vehicle's dashboard or console, and the slide, which attaches to your mobile radio with the provided brackets. The radio slides in and out — and locks firmly into place for a guaranteed secure, firm ride — regardless of those railroad tracks, or potholes. Going into the mall? Simply pull the release bar toward you, slide out the radio, and put it in the trunk.

### Putting It Together Is A Snap!

Your first step is to route the power, ground (and other leads for external speaker if you intend to use one) to where you'll be mounting the radio. I used machine screws, nuts, and lock washers to mount the assembly to the unused ashtray. That ashtray is at just the right angle — well, almost — and is positioned just close enough to the driver to work well for a radio location. I caution you to be very careful when drilling holes into the console/dashboard area; hit the wrong wire and it's goodbye something electronic. Don't make mounting your radio a rush project, because if you

*A look at the base/cover plate assembly mounted to the vehicle's ashtray, which has been epoxied shut. Yes, the visible incoming coax cable needs to be tucked under the vehicle's plastic before final installation so it doesn't interfere with the vehicle's operation.*

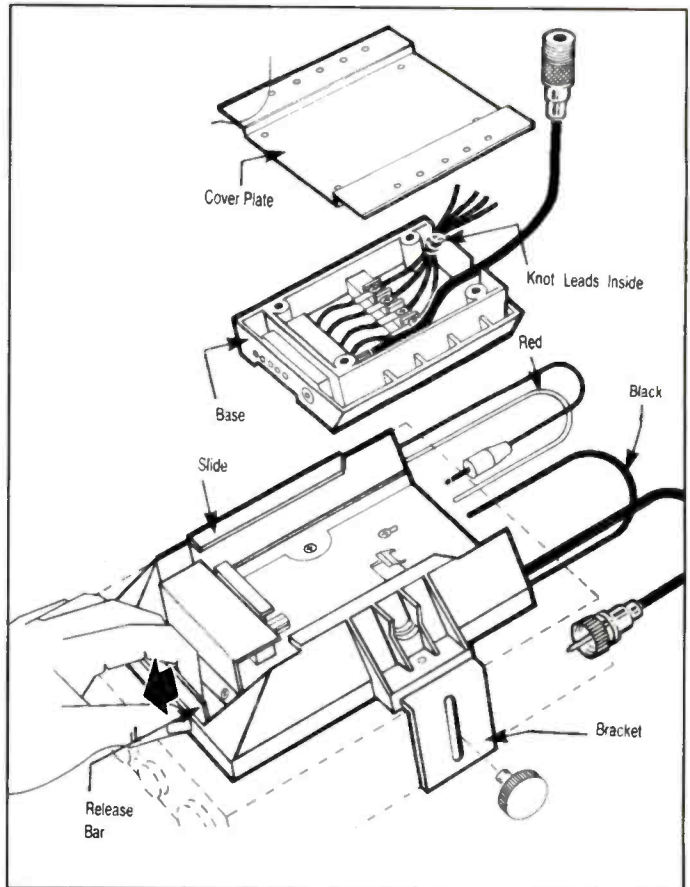

*Here's a drawing taken directly from the box showing how the radio is mounted to the SS-100 slide mount.*





My ICOM IC-2100 mobile ham radio mounted to the Lumina's ashtray using the Gamber-Johnson Super Slide™ Slide Mount.

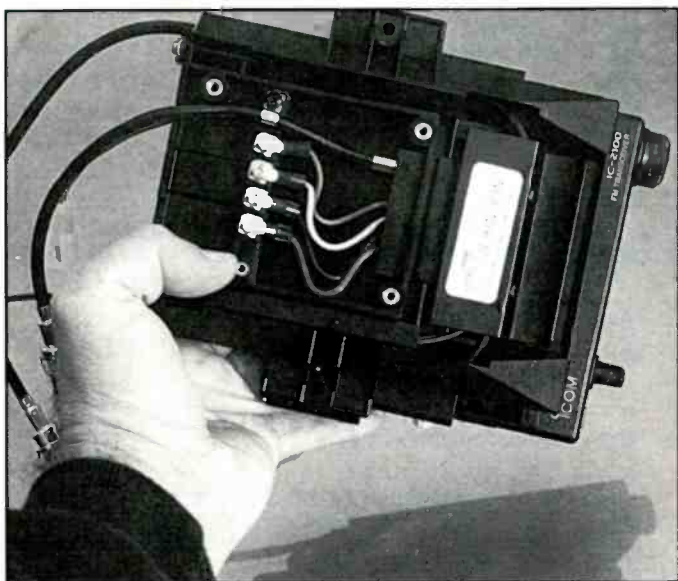

A top view of the base assembly. The wires are heavy duty and secured in place with quality screw mounts.

do, not only will it look like you did, but also you're likely to re-do the job the following weekend. Get someone to help by holding the radio in place precisely at the angle you intend to use it before drilling the holes. If there's no one around, use a couple pieces of Velcro™ as a quick temporary mount. Sit in the driver's seat, hold the microphone, and look at the radio's display. Is it visible without leaning or tangling the mic cord in the steering wheel? Remember, your first priority is the road, not the radio!

Because of the additional weight on the ashtray, after some normal driving and a few bumps in the road, it would actually open, and with the radio now a little lower to the floor, rattle incessantly. The solution? Not being a smoker I simply decided to "tack" the ashtray to the console with a dab of epoxy.

You've already got your coax cable properly routed to the mounting area. Connect the PL-259 to the female SO-239 on the Gamber-Johnson base, connect the DC power cables to a good

*"The radio slides in and out — and locks firmly into place . . ."*

vehicle power source, finish connecting the red and black wires on the base unit to the radio, and you're in business!

Now, I know a lot of folks go absolutely wild when I say it's up to you whether you wire your radio directly to the vehicle battery, an unused fuse terminal, or even the cigarette lighter. I've always found that going through the firewall to the battery to be a major pain in the posterior. First, finding the battery in many vehicles today is a challenge. You must always be concerned about keeping those radio wires away from other under-hood wires, and that they don't get cut by sharp metal. Frankly, if you're using relatively low current draw radios, such as that 2-meter radio on low power, a mobile CB, or even a low-power ham QRP transceiver as I do, the dreaded cigarette lighter plug works fine. Personally, I use a heavy-duty fused plug, don't get any engine noise, and am able to use my time saved not going through the firewall for other weekend projects more worthy of my time. For higher power operation, though, the direct-to-the-battery route is the way to go.

I found the Gamber-Johnson SS-100 slide mount to be the perfect mobile mounting system; it's well built, solid black metal construction gives you a professional radio installation. It's designed and made in the USA and sells with a list price of \$104. For more information, contact Gamber-Johnson at 3031 Borham Avenue, Stevens Point, WI 54481 or call 800-456-6868. Please tell the folks at Gamber-Johnson you read about their mobile mounting bracket in *Popular Communications*. ■

# Mobile DXer

NEW Book!  
Hot Off the  
Press!

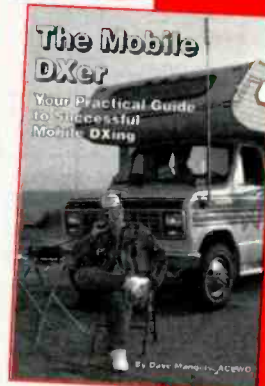

A practical guide to Mobile DXing - an exciting, challenging and rewarding facet of today's Amateur Radio!

Here's a sampling of what you'll find inside:

- ✓ Lightning Preparedness
- ✓ Tuning mobile HF Antennas
- ✓ Propagation & Mobile DXing
- ✓ Mobile HF Antennas & Tuners
- ✓ The Language of Mobile DXing
- ✓ The Versatility of Mobile DXing
- ✓ Selecting & Installing Mobile HF Radios
- ✓ Tools, Tactics & Techniques. . . and more!

Only \$12.95  
Plus \$2 shipping & handling

CQ Communications, Inc.

25 Newbridge Road, Hicksville, NY 11801  
Phone 1-800-853-9797 • Fax 516-681-2926  
Shop on line at [www.cq-amateur-radio.com](http://www.cq-amateur-radio.com)

### Using The Internet To Enhance Your Aircraft Monitoring

**Editor's Note:** As Bill's column was being finalized, our country has suffered the worst act of terrorism in history. Bill has just turned in this report.

The entire airspace system is, for all intents and purposes, shut down. Minimal flights of any type are allowed. Civilian commercial flights as well as all civilian flight training flights are curtailed until further notice. The bare minimum flights allowed are specific military, lifeguard (air ambulance), and law enforcement. Accordingly the air traffic communications system is, for the most part, dead as we speak.

Monitoring ATC frequencies will be somewhat of a challenge for the foreseeable future. The civilian communications structure (VHF) is from **118.000 MHz to 142.975 MHz** — roughly 1,000 frequencies. The military communications (UHF) lie between **220.000 to 399.975 MHz**.

All traffic heard in the UHF band will be military. Many of the military cargo and helicopter aircraft may also utilize the VHF or civilian frequencies. However, if you have a listing of aviation frequencies for your area I recommend you use them to monitor what's going on. Other frequencies you can monitor, though I do not guarantee their operations in any particular area, include:

- 121.5 — VHF Emergency\*
- 122.75 — Air to air government
- 123.1 — Civil Air Patrol Search and Rescue
- 126.2 — Military Control Towers
- 142.35 — FEMA
- 142.375 — FEMA
- 142.425 — FEMA
- 142.975 — FEMA
- 148.15 — Civil Air Patrol
- 149.925 — Civil Air Patrol

- 155.34 — Medical frequency
- 156.3 — Search and Rescue
- 162.687 — Air Force 1
- 237.9 — Coast Guard Search and Rescue
- 243.0 — UHF Emergency\*
- 249.8 — Hi Altitude Fighters
- 252.1 — Mid air refuel
- 257.8 — Military Control Towers
- 265.8 — Presidential Helicopters
- 282.8 — Coast Guard Search and Rescue
- 305.55 — Air Force 1
- 311.0 — Mid air refuel
- 319.1 — Hi Altitude
- 336.8 — Air Force 1
- 381.7 — Coast Guard
- 384.1 — North American Air Defense

In addition you might try the following Internet sites:  
<http://www.fallingrain.com/air/airports.cgi?NEW=1>  
<http://www.thirtythousandfeet.com/database.htm>

Near the US/Canadian border you might try:  
<http://www.canairradio.com>

Aeroplanner also has maps you may be able to use:  
<http://www.aeroplanner.com>

In closing I recommend three things, not necessarily in this order:

- 1) Keep the scanners running
- 2) Give blood
- 3) Pray

**M**erry Christmas, happy Hanukkah, happy Kwanzaa. As the first year of the 21st century draws to a close I trust you had a good year. I'm writing the final article of the year in my final month here in Alaska. In fact as I write this I have just under three weeks left here. My wife, family, and friends are all telling me they're sweating in the heat and humidity of Florida, but as I look over my left shoulder I can see many peaks of the Alaska range that turn more and more white with each passing day. Just three weeks ago everything was green. But now the aspens and birches are turning lovely shades of gold. And late at night if you look at the right area of the sky you can see the first shimmering curtains of the Aurora Borealis. I am going to miss this place. But I think that maybe I've made enough points with the powers that be in Fairbanks that I may just be able to report from up here again in a couple of years.

Much of the tourist air traffic has subsided in recent weeks. The military is preparing for winter flying, and the majority of what I'm doing now deals with the small air taxi operations tak-

ing hunters from airports to glaciers to lakes to rivers looking for the elusive moose or caribou.

What I'm going to do in this issue is show some rather interesting Internet sites that you can peruse that may enhance your monitoring of aviation. I know that one has been recommended in another *Pop'Comm* article, but that doesn't mean I can't recommend it, also.

The first site comes from the FAA itself. Found at: <http://www.fly.faa.gov/flyFAA/index.html> it is the opening pages to the Air Traffic Control System Command Center. The first page gives a map of the U.S. with notes as to airports with delays and those closed due to weather or perhaps a disabled aircraft on the runway. This is a great site to frequent especially if you are planning to take a flight and want to know if there are delays at your departure or destination airport.

What may frighten some people is the graphic under the "Products" drop down menu. When you go to the "General Overview of ATCSCC" you can get a brief tour of the center.

It's the photo in the middle of the page that gives people pause. On an average day there are about 50,000 aircraft flying — not all at once, mind you. At peak hours there can be 4 to 6 thousand up at one time. This is an average. During heavy flying periods, such as Thanksgiving weekend, the weeks of Oshkosh or Sun-Fun this number can go up, rather substantially. The photo is neither live nor real time. It merely shows you what can be on the screens at the ATCSCC. You can see the major corridors up and down the east and west coasts of the U.S. as well as the hubs in Atlanta, Dallas, Houston, St. Louis, Chicago, Denver, Salt Lake City, etc. With this graphic display controllers can coordinate with ATC facilities throughout the country in an effort to keep planes flying as smoothly as possible. For example, the weather in Miami and Atlanta may be outstanding, but weather in Chicago may be delaying aircraft getting out of Atlanta, which will not allow aircraft to leave Miami for Atlanta. There's a lot of space in the system to fly, but sometimes parking at the airport ramps may be at a premium.

At the bottom of the page with the map is a button to start the tour of the ATC-SCC. I recommend that you take the tour to see what it is all about.

The second site is <http://akweathercams.faa.gov/>, which is a web site the flight service station controllers use to help brief pilots in Alaska. (We get it up here on the Intranet, which gives us information not generally available to the public.) The site says, "The FAA in Alaska has been given the opportunity to deploy cameras at remote sites around Alaska. These cameras provide weather images to pilots via the Internet and are updated as often as every 10 minutes. The cameras are aimed to give the best indication of weather in the direction most relevant to VFR traffic." For some reason the photos sent out on this site are best viewed with Internet Explorer. Netscape operators can use the site, but don't necessarily have all the bells and whistles associated with viewing the site.

As of mid-September there are 26 camera sites, 24 owned by the FAA. When you first open up one of the camera sites, the biggest things you notice are the two images in the center of the screen. This is the default camera image. The image on the left is the most recent image taken with time (in UTC) and date in the upper left corner of the photo. On the right is an earlier and clearer photo of the same view

— a "clear day" image. This is for the pilots to compare the current weather with ideal weather. Beneath the two large photos are two or more smaller photos, showing different viewing angles from the same camera site. To see a larger view, just left click on the photo you wish to enlarge.

In the upper left corner of the page you will see the word "loop" with different camera angels, such as NE LOOP, or S LOOP. Left clicking on any of these opens a new page with the last few hours of photos from that particular camera in a time loop. With this the pilot or controller can get an idea of a weather trend.

These camera sites are important to pilots flying throughout Alaska, especially to sites without weather observers. This is one of those ideas that works. I would love to see its implementation throughout the rest of the country.

The third site was recommended by Eric Force in his "Radio & the Internet" column a few months back. I was hoping to put it in my column, but Eric beat me to it. "Flight Tracker," [http://www.trip.com/trs/trip/home/index\\_01.xsl](http://www.trip.com/trs/trip/home/index_01.xsl) was introduced to me by a non-scanner friend of mine in Oklahoma City last year when my

## Bill's 2 Way

CB Radio Equipment

uniden KENWOOD MIDLAND

CHEROKEE ICOM & Cobra

TEXAS RANGER maxon Galaxy

**FREE CATALOG!**

"We are the **DISCOUNT LEADER** in sales of scanners, FRS, CB, GMRS radios and accessories."

**1-888-710-4094**

**Bill's CB & 2-Way Radio Service**

PO Box 306, Morgan Hill, CA 95038-0306

Tech Line: (408) 782-0064 FAX: (408) 782-2985

e-mail: [sales@bills2way.com](mailto:sales@bills2way.com)

Website: <http://www.bills2way.com>

**Stocking Stuffers**

**POWERPORT** **VX-5**  
**Radio Glove**



800-206-0115 [www.powerportstore.com](http://www.powerportstore.com)

**Tubes**

[www.tubesandmore.com](http://www.tubesandmore.com)

**Parts**

**Books**

**Supplies**



Phone: 480.820.5411

Fax: 480.820.4643  
or 800.706.6789

e-mail: [info@tubesandmore.com](mailto:info@tubesandmore.com)

Phone, fax or e-mail today for our free 80 page 2001 catalog!



**High Performance CB Antennas**

For decades, MACO has meant high-performance CB base station and mobile antennas—made in the USA! Call us or visit our website for more information on our products.

- Base Station Antennas
- Mobile Antennas
- Cable Assemblies
- Mobile Hardware
- Power Supplies
- Accessories

Call or write for free catalog and name of reseller nearest you!

**(800) 238-7258**

MACO MANUFACTURING

4091 Viscount Avenue

Memphis, TN 38118

Ph. (901) 794-9494 Fax (901) 366-5736

[www.majestic-comm.com/maco](http://www.majestic-comm.com/maco)

**If you enjoy radio communications you'll love....**

**POPULAR COMMUNICATIONS**

**POPULAR COMMUNICATIONS**

**SAVE UP TO 62%**

**SUBSCRIBE TODAY!**

Get fast home delivery of *Popular Communications* and save \$30.93 a year over the newsstand price. Save even more on 2 or 3 year subs.

- 1 year - 12 issues **\$26.95** (Save \$32.93)  2 years - 24 issues **\$47.95** (Save \$71.81)  3 years - 36 issues **\$68.95** (Save \$110.69)

Canada/Mexico—One year \$36.95, two years \$67.95, three years \$98.95;

Foreign Air Post—one year \$46.95, two years \$87.95, three years \$128.95.

Payable in US dollars only Note: Allow 6-8 weeks for delivery of first issue.

**Popular Communications, 25 Newbridge Rd, Hicksville, NY 11801**

**FAX 516-681-2926**



*A Russian-built YAK-9 used by American pilots.*

*A homebuilt from Germany, and the same type used in the film "Conspiracy" that was on HBO earlier this year.*



wife and I were there for a wedding. (I did try to get him to start scanning, but his only scanning was the one for photos for his computer.) He found "Flight Tracker" while watching for a flight his wife was on. So I pulled the hand-held scanner out of my luggage and we started. We tuned in Oklahoma City approach (he only lived just a few miles north of the airport) and started listening. When we heard a specific airline flight, for example Delta 247 (this is a fictional flight. I don't know if it really exists. It is used only for demonstration purposes) we put that information into the computer and, voila. Graphically, on the screen, the flight materialized. We could view, in as close to real time as I could surmise, the position of the airliner over the ground, with simulated gauges showing speed, altitude, and heading. (Mental note: Ensure wife and children know about this to view flights from Fairbanks to Anchorage to Minneapolis to Tampa in 18 days.) Since we knew where the house was in relationship to the airport we were even able to go into the backyard and look up to see and identify the particular airliner we were listening to. It's truly marvelous 21st century technology!

I hope you all have a great holiday season and you get the comm gear you desire this season, but I wish you hope and peace most of all.

WASHINGTON (AFPN) — Secretary of the Air Force (Dr.) James G. Roche, Assistant Vice Chief of Staff Lt. Gen. Lance W. Lord and former first lady Mrs. Nancy Reagan boarded SAM 27000, the "Spirit of '76," after its final flight Sept. 8. The aircraft flew from Andrews Air Force Base, Md., to San Bernardino International Airport, Calif., where it will be retired and displayed at the Reagan Presidential Library in Simi Valley, Calif.

The ultimate decision to locate the aircraft in California was based not only on available resources, but also on the library's nearness to a large metropolitan area, Roche said.

"We are extremely pleased with the vision set forth by the Ronald Reagan Presidential Library Foundation," Roche said. "Not only do they have the commitment to preserve this significant piece of American history, but their proximity to the Los Angeles metropolitan area provides opportunities for millions of people to view this historic aircraft."

This modified version of the Boeing 707 commercial intercontinental aircraft was the first jet specifically purchased for

## An Old Trivia Question

Last year in one of my first columns I had a trivia question concerning the only aircraft to legally change callsigns in flight. That, of course, was Air Force 1, which, by law, had to change its callsign in flight. At the time President Nixon was enroute to California as Gerald Ford was sworn in as president. Since Mr. Nixon was no longer the president the callsign was changed, somewhere over Missouri, to SAM27000. SAM was the call sign for Special Air Mission, 27000 was the serial number of the plane itself. The first week of September Airforce 27000, a VC-137, was retired. The following is the press release from the Air Force concerning its retirement.

*Here's a Canadian owned Aerospatiale 65 helicopter used to fight forest fires in Alaska.*





use as Air Force One. While the body of the Boeing 707 and the C-137 are identical, the interior furnishings and electronic equipment are different.

The passenger cabin of the C-137 is divided into three sections:

— The forward area has a communications center, galley, lavatory, and an eight-seat compartment.

— The center section is designed as an airborne headquarters with conference tables, swivel chairs, a projection screen for films, and two convertible sofa beds.

— The rear section of the cabin contains double reclining passenger seats, tables, galley, two lavatories, and closets. Partitions could be placed throughout the cabin for added privacy. Air Force One was President Reagan's aircraft during his entire eight-year term in office, 1981-1989.

Once the plane was replaced and no longer Air Force One, it served as transportation for the vice president, cabinet and congressional members and other high-ranking U.S. and foreign officials. However, it still served as backup for the presidential aircraft.

The Ronald Reagan Presidential Library will build a hangar to properly maintain and display the aircraft. The library will also contract with Boeing to ensure the plane is properly maintained.

## NEW/CHANGED/DELETED FREQUENCIES

### NEW

#### AL

Floral Municipal (OJ4)  
Aph 133.45/ 237.5

#### AZ

Glendale Municipal (GEU)  
Aph 126.8/ 120.7/ 256.9/ 239.0  
Goodyear — Phoenix Goodyear (GYR)  
Aph 120.7/ 124.1/ 239.0/ 269.6

#### FL

Destin-Fort Walton Beach (DTS)  
Aph 121.6

Mary Esther — Hurlburt Field (HRT)  
Cmd Post 140.4/ 251.25

Jacksonville International (JAX)  
ANG Ops 273.9/ 381.0

#### KS

Elkhart — Morton County (EHA)  
AWOS-3 118.025

#### MS

Greenville — Mid Delta Regional (GLH)  
ASOS 125.525

#### PA

Philipsburg — Mid-State (PSB)  
AWOS-3 127.525

#### SC

Eastover — McEntire ANG (MMT)  
GC 127.625

Swansboro — Bogue Field MCALF (NJM)  
Aph 119.35/ 374.9

#### UT

Salt Lake City International (SLC)  
GC 121.9/ 133.65

## CHANGED

#### AZ

Peach Springs (PGS)  
RCO was 122.15, now 122.25

#### CA

Lompoc — Vandenberg AFB (VBG)  
PMSV was 343.3, now 342.4

#### CT

Groton New London (GON)  
CD was 118.55, now 119.85

Point Mugu NAS (NTD)

ANG Ops was 319.3, now 305.6

#### FL

Homestead — Dade County — Regional (HST)  
Aph was 269.575, now 354.1

Mary Esther — Hurlburt Field (HRT)  
PMSV was 335.45, now 390.75

#### MA

Beverly Municipal (BVY)  
ATIS was 118.7, now 119.2

#### NY

Elmira/Corning Regional (ELM)  
ATIS was 109.65, now 125.475

New York ARTCC (ZNY)

Ship Bottom NJ RCAG was 134.55, now 128.3

#### RI

Providence — Theodore Francis Green State (PVD)  
Aph was 118.55, now 119.85

#### UT

Ogden — Hill AFB (HIF)  
PTD was 122.85, now 139.3

## DELETED

#### CA

Sacramento — McClellan AFB (MCC)  
Primary 4746 kHz, 6738 kHz, 11239 kHz, 15031 kHz,  
18002 kHz

#### CO

Eagle County Regional Airport (EGE)  
Unicom 122.95



*Who is this bearded man? It's none other than columnist Bill Hoefer, in Alaska.*

**NY**

Bethpage — Nassau County Police Heliport  
CTAF 123.0

**PA**

Montrose — Zaveron Airport  
CTAF 122.9

**CHANGED IDENTIFIERS**

**FL**

Atlantic Beach — Travel Lodge Heliport was 9J6, now FA66  
Avon Park — Walker Memorial Center Heliport was  
0X6, now FA67  
Belle Glade — Duda Airstrip Airport was 0X9, now FA69  
Bellevue — Monroe Airpark Airport was 1X0, now 2FA2  
Bokeela — Henderson Heliport was X24, now 2FA3  
Bryant Air Strip Airport was 1X8, now FA70  
Cedar Key — The Cedars Airfield Airport was 2X1, now  
FA71  
Clermont — Hi-Acres Airport was 2X2, now 12FA  
Clewiston — Southern Ranch Airport was 2X4, now 2FA4  
Crescent City — Thunderbird Airpark Airport was 26J, now  
2FA5  
Crystal River — Post Oak Ranch Airport was 2X7, now  
1FA1  
Daytona Beach — Smokey's Heliport was 57J, now FL44  
Greenwood — Acres of Diamonds Airpark Airport was 74J,  
now FA72

**GA**

Cleveland — Mountain Airpark Airport was 83A, now 0GE5  
Stockbridge — Gordon E. Bellah International Airport  
was 8A5, now 4GE2

**IA**

Cedar Rapids — Chain Lakes Airpark was 5C7, now 89IA  
Hawarden Heliport was 06H, now 98IA  
Siender Airport was 7C1, now 011A

**KS**

Halstead Airport was 22K, now SN05

**ME**

Harrison — Maple Ridge Airport was 54B, now 03ME  
Mercer — Beech Hill Airport was 68B, now 04ME  
North Fairfield — Hapworths Private Landing Area Airport  
was 79B, now 55ME  
North Livermore — Long Pond Seaplane Base was 80B, now  
77ME

**MI**

Barbeau — Franklin's Airport was 3Y9, now 45MI  
Bath — Wisner Private Airport was 32D, now 46MI  
Bay City — Kenneth Hayward Airport was 49D, now 47MI  
Cedar Springs — North Kent Airpark Airport was 9C6, now  
52MI  
Crystal Falls — Huber Airport was 4Y2, now 39MI  
Kalamazoo — East Lake Airport was 72M, now 66MI  
Kaleva — Horaks Airport was D69, now 67MI  
South Branch — Timbers Sky Camp Airport was 7Y0, now  
84MI  
South Rockwood — Carls Airport was 99G, now 78MI  
Standish — Dudley Airport was 7Y1, now 79MI  
Watersmeet — NRC Airport was RXW, now 72MI  
Willis — Downwind Acres Airport was D18, now 86MI

**MN**

Ashby — Melby Airport was 37D, now 13MN  
Baudette Flying Service Seaplane Base was 7Y6, now 16MN  
Forest Lake — Waldref Seaplane Base was 9Y6, now 19MN  
Garden City — Bergemann Airport was 9Y8, now 24MN  
Halstad — Christianson Field Airport was Y61, now 26MN  
Lake Bronson Airport was 10Y, now 27MN  
Mabel — Sellman Field Airport was 15Y, now 43MN  
Minneapolis — Peterson Seaplane Base was 19Y, now 31MN  
Norwood — Sons Private-Commercial Airport was 45Y, now  
47MN  
Ray — Namakan Seaplane Base was 51Y, now 57MN  
Warroad — Northwest Angle Airport was 72Y, now 58MN  
Wheaton — Traverse Air Airport was 73Y, now 61MN  
White Bear Lake — Northport Airport was 74Y, now 64MN

**MO**

Alba — Cooper Flying Service Airport was 5K8, now 00MO  
California — Phillips Field Airport was 80K, now MO23  
East Lynne — Richters Airport was 86K, now 87MO  
Golden — Table Rock Airport was 36M, now MO32  
Gorin — Wileys Air Strip Airport was 93K, now MO42  
Jonesburg — Adventures Aloft Airport was 6M3, now MO07  
Rolla — Morgan Airport was K18, now MO02  
Shell Know — Turkey Mountain Estates Airport was 40M,  
now MO00

**NE**

Aurora — Aaron's Field Airport was 81Y, now 14NE  
Fort Calhoun — Bil Lo Airport was 95Y, now 51NE  
Hershey — George Airport was 2V0, now 89NE  
Merriman — Cole Memorial Airport was 9V4, now 57NE  
Taylor — W. Meeks Ranch Airport was 63V, now 95NE

**VA**

Bedford — Windy Ridge Airport was 94W, now VS27  
Boykins — Mann Airport was 95W, now VG28  
Bridgewater — Echols Airport was 96W, now VG29  
Broadway — Sager Field Airport was 97W, now VG31  
Buckingham — East View Airport was 7W3, now VG32  
Cape Charles — Bull Farm Airport was 99W, now VG33  
Cape Charles — Scott Farm Strip Airport was 98W, now  
VG30  
Clarksville — Merifield Airport was W14, now VG34  
Weirwood — Kellam Field Airport was W08, now VG26 ■

spotlight

Congratulations To Steve Rakczynski Of Michigan

**P**opular Communications invites you to submit, in about 150 words, how you got started in the communications hobby. Entries should be typewritten, or otherwise easily readable. If possible, your photo (no Polaroids, please) should be included.

Each month, we'll select one entry and publish it here. Submit your entry only once; we'll keep it on file. All submissions become the property of Popular Communications, and none will be acknowledged or returned. Entries will be selected taking into consideration the story they relate, and if it is especially interesting, unusual, or even humorous. We reserve the right to edit all submitted material for length, grammar, and style.

The person whose entry is selected will receive a one-year gift subscription (or one-year subscription extension) to Popular Communications. Address all entries to: "VIP Spotlight," Popular Communications, 25 Newbridge Road, Hicksville, NY 11801 or E-mail your entry to popularcom@aol.com, letting us know if you're sending photos. If you're E-mailing photos, please send them in a separate E-mail with your name in the "subject" line.

**Our December Winner: He Started With An Old Crystal Scanner**

Reader Steve Rakczynski of Ludington, Michigan, says, "I started in radio in 1975 with an old Regency crystal scanner. It picked up a lot of interference from nearby frequencies, but I was so fascinated by the radio I had it on constantly. Then I bought a CB (sideband) when it was the hot trend, and started collecting QSL cards. To date I have over 500 cards. During that same period in my life I was listening to FM/FM DX broadcast stations trying to log as many as I could. I bought a directory that helped me track down the call letters and cities.

I got my first use of a professional radio when I became a taxicab driver and dispatcher. During my breaks and off time,

I studied my ham manual and soon became an amateur operator. I'm also a RACES member for the state of Michigan.

*"I got my first use of a professional radio when I became a taxicab driver and dispatcher."*

My one-year old son, Jason is in the picture holding an FRS radio. When he hears Morse code from my ham radio he laughs and tries to imitate it.

Some of my equipment includes a Realistic DX302, BC890XLT, Kenwood 241A, and my favorite and newest radio, an ICOM R2 which I listen to all the time. I love the compact size, wide frequency coverage, and all its great features." ■

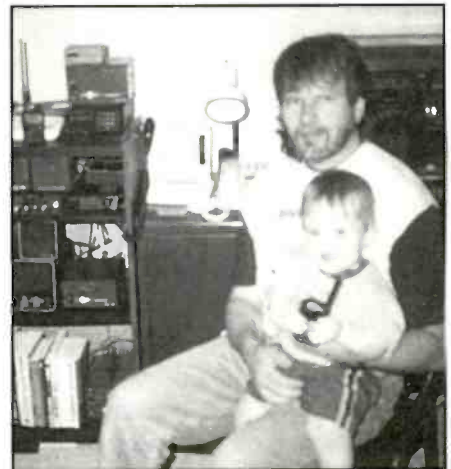

Here's our December winner, Steve Rakczynski of Michigan holding his son, Jason — likely a future radio enthusiast.



Ceramic  
Junghans Atomic Ceramic sapphire lens, ceramic band, LCD for day, date, zone luminous, w-resistant 100ft, all ceramic-harder than steel \$790



atomic radio with 2 alarms and temperature, day, date, LCD \$39.95



NEW  
Junghans Atomic Carbon Fiber Watch, stainless bezel, sapphire lens, LCD day, date, time zone, carbon/leather band. 7 models \$279

**ATOMIC TIME**™

...self setting  
...correct time  
...atomic clock

World's most exact time...  
atomic clocks, atomic watches and weather stations

- for any time zone
- synchronized to the u.s. atomic clock in colorado
- accurate to 1sec. in 1 mil. years
- engineered in germany

**complete line of atomic clocks**  
JUNGHANS MEGA CERAMIC Watch luminous, never scratches, 5 models  
JUNGHANS MEGA CARBON Watch  
JUNGHANS MEGA CLOCKS \$47-109  
JUNGHANS SOLAR WATCHES \$279  
ATOMIC SPORTS WATCHES \$129  
ATOMIC SCHOOL/OFFICE CLOCKS  
Oregon Scientific Weather Stations, Weather Forecast, World Time, NOAA Radios, Radio Controlled Clocks  
Atomic Digital Wall Clocks \$59...  
call for our FREE Brochure  
or go to [www.atomictime.com](http://www.atomictime.com)  
credit card orders call toll free  
**1-800-985-8463**  
30 Day Money Back Guarantee send checks incl. s&h \$6.95 to  
ATOMIC TIME, INC.  
1010 JORIE BLVD.  
OAK BROOK, IL 60523



Atomic dual alarm clock with temperature day and date. 2AA Batteries black 3.5x4.5x2" \$29.95



black arabic 12" wall clock for home or office • \$59.95 (wood \$69.95)



Atomic Sports Watch Silver Polymer Case, LCD for day, date or seconds 100 ft water resistant black leather band \$129

### Two New Programs Targeting Addis Ababa YOU Can Hear

The Tigre province of Ethiopia, which has been pushing for greater autonomy from Addis Ababa for decades, is a target of two new programs: The Voice of Tigrayans — also identifying as **Radio Tigrayana** — via WWCR in the Tigrinya language on **15685** on Thursdays at 2100. It should be a pretty easy pick for anyone in North America.

The second one is the **Voice of (the) Martyrs**, also airing over WWCR, but on Sundays at 0500 on **3215**. At this writing these programs are still “getting their legs” so it’s possible that times, days and frequencies may change as they try to find the right combination.

Another anti-Ethiopian broadcaster, the **Voice of Oromo Liberation** now airs on Wednesdays, Fridays, and Sundays from 1700-1759 on **15715**, all broadcasts are via Julich, Germany.

Other broadcasters with similar designs in the news recently are **Nesamet Radio**, aiming at Ethiopia, believed to air from Russia or one of the former Soviet Republics Wednesdays from 1700-1800 on **12110**.

Also active is **Radio Rainbow — The Voice of Peace and Brotherhood**, whose programming comes via Germany and airs Saturdays from 0800-0900 on **6180** and Fridays from 1900-2000. Both hours are in Amharic.

The **Voice of Mesopotamia** currently operates on **15230**. From 0800 to 0959 and 1400 to 1600 on **11530** (formerly 17770). The broadcasts are intended for Kurds living in Iraq, Iran, and Turkey.

**Radio Free Vietnam** is broadcasting via a Russian site using **15235** from sign-on at 1400. The Vietnamese language program runs only half an hour.

The **Voice of Khmer Krom** beams its programs to Vietnam in the hope one day of obtaining greater freedom for Cambodians living in Kampuchea Krom, an area in southern Vietnam. It is on the air in Cambodian Fridays from 1400-1500 on **15725**.

**Radio Barabari** is another anti-



This is the official web page of the Colombian narco-guerrilla group which operates *La Voz de la Resistencia*.

Iranian operation, but this one, somewhat unusually, is said to be coming from Jerusalem, although a Russian site is probably more likely since the Israelis aren’t known for getting into this sort of thing. The Farsi language broadcasts are on **7480** with sign-on at 1700 and running to 1730. Iran is apparently providing some intense jamming.

An odd, but apparently new anti-Iranian is “GHI” heard on **17520**. Station GHI **17520** is heard from tune-in at 1543 and past 1700. The sign-on occurs at about 1528 and programming runs to past 1700. There is some evidence indicating

that this may be a new name for the former Seday-e Iran station, which has been active for many years.

Remember your logs and other informational input is always needed and appreciated. If you run across schedules for these stations or information about the aims and purposes of the groups who operate them or the location of transmitters please pass it on. Copies of any QSLs you receive from clandestines are also much needed. As usual, thank you for your continued support!

Until next month, good hunting. ■

# Big Savings on Radio Scanners

## Uniden®

## SCANNERS

## AOR



### Bearcat® 780XLT Trunk Tracker III with free deluxe scanner headset

Manufacturers suggested list price \$529.95  
**Less -\$205 Instant Rebate / Special \$324.95**

**500 Channels • 10 banks • CTCSS/DCS • S Meter**  
**Size: 7<sup>5/8</sup> Wide x 6<sup>15/16</sup> Deep x 2<sup>3/16</sup> High**

**Frequency Coverage:** 25,000-512,000 MHz., 806,000-823,987.5 MHz., 849,012.5-868,987.5 MHz., 894,012.5-1,300,000 MHz.

When you buy your Bearcat 780XLTGV Trunktracker package deal from Communications Electronics, you get more. The GV means "Great Value." With your BC780XLT scanner purchase, you also get a **free deluxe scanner headphone** designed for home or race track use. Headset features independent volume controls and 3.5 mm gold right angle plug. The Bearcat 780XLT has 500 channels and the widest frequency coverage of any Bearcat scanner ever. Packed with features such as Trunktracker III to cover EDACS, Motorola and EF Johnson systems, control channel only mode to allow you to automatically trunk many systems by simply programming the control channel, S.A.M.E. weather alert, full-frequency display and backlit controls, built-in CTCSS/DCS to assign analog and digital subaudible tone codes to a specific frequency in memory, PC Control with RS232 port, Beep Alert, Record function, VFO control, menu-driven design, total channel control and much more. Our CEI package deal includes telescopic antenna, AC adapter, cigarette lighter cord, DC cord, mobile mounting bracket with screws, owner's manual, trunking frequency guide and one-year limited Uniden factory warranty. For maximum scanning enjoyment, operate your scanner from your computer running Windows. Order Scantat Gold for Windows, part number SGFW for \$99.95 and magnetic mount antenna part number ANTTMBNC for \$29.95. Not compatible with AGEIS, ASTRO or ESAS systems. For fastest delivery, order on-line at [www.usascan.com](http://www.usascan.com).

### Bearcat® 895XLT Trunk Tracker

Manufacturer suggested list price \$499.95  
**Less -\$320 Instant Rebate / Special \$179.95**

**300 Channels • 10 banks • Built-in CTCSS • S Meter**  
**Size: 10<sup>1/2</sup> Wide x 7<sup>1/2</sup> Deep x 3<sup>5/8</sup> High**

**Frequency Coverage:** 29,000-54,000 MHz., 108,000-174 MHz., 216,000-512,000 MHz., 806,000-823,987.5 MHz., 849,012.5-868,987.5 MHz., 894,012.5-956,000 MHz.

The Bearcat 895XLT is superb for intercepting trunked analog communications transmissions with features like TurboScan™ to search VHF channels at 100 steps per second. This base and mobile scanner is also ideal for intelligence professionals because it has a Signal Strength Meter, RS232C Port to allow computer-control of your scanner via optional hardware and 30 trunking channel indicator annunciators to show you real-time trunking activity for an entire trunking system. Other features include Auto Store - Automatically stores all active frequencies within the specified bank(s). Auto Recording - Lets you record channel activity from the scanner onto a tape recorder. CTCSS Tone Board (Continuous Tone Control Squelch System) allows the squelch to be broken during scanning only when a correct CTCSS tone is received. For maximum scanning pleasure, order the following optional accessories: **PS001** Cigarette lighter power cord for temporary operation from your vehicle's cigarette lighter \$14.95; **PS002** DC power cord - enables permanent operation from your vehicle fuse box \$14.95; **MB001** Mobile mounting bracket \$14.95; **EX711** External speaker with mounting bracket \$14.95; **EX711** External speaker with mounting bracket \$19.95. **CAT895** Computer serial cable \$29.95. The BC895XLT comes with AC adapter, telescopic antenna, owner's manual and one year limited Uniden warranty. Not compatible with AGEIS, ASTRO, EDACS, ESAS or LTR systems.



### Bearcat® 245XLT Trunk Tracker II

Mfg. suggested list price \$429.95/CEI price \$189.95

**300 Channels • 10 banks • Trunk Scan and Scan Lists**  
**Trunk Lockout • Trunk Delay • Cloning Capability**  
**10 Priority Channels • Programmed Service Search**  
**Size: 2<sup>1/2</sup> Wide x 1<sup>3/4</sup> Deep x 6" High**

**Frequency Coverage:** 29,000-54,000 MHz., 108-174 MHz., 406-512 MHz., 806-823,995 MHz., 849,012.5-868,995 MHz., 894,012.5-956,000 MHz.

Our Bearcat TrunkTracker BC245XLT is the world's first scanner designed to track Motorola Type I, Type II, Hybrid, SMARTNET, PRIVACY PLUS and EDACS® analog trunking systems on any band. Now, follow UHF High Band, UHF 800/900 MHz trunked public safety and public service systems just as if conventional two-way communications were used. Our scanner offers many new benefits such as Multi-Track - Track more than one trunking system at a time and scan conventional and trunked systems at the same time. 300 Channels - Program one frequency into each channel. 12 Bands, 10 Banks - Includes 12 bands, with aircraft and 800 MHz. 10 banks with 30 channels each are useful for storing similar frequencies to maintain faster scanning cycles or for storing all the frequencies of a trunked system. Smart Scanner - Automatically program your BC245XLT with all the frequencies and trunking talk groups for your local area by accessing the Bearcat national database with your PC. If you do not have a PC simply use an external modem. Turbo Search - Increases the search speed to 300 steps per second when monitoring frequency bands with 5 KHz. steps. 10 Priority Channels - You can assign one priority channel in each bank. Assigning a priority channel allows you to keep track of activity on your most important channels while monitoring other channels for transmissions. Preprogrammed Service (SVC) Search - Allows you to toggle through preprogrammed police, fire/emergency, railroad, aircraft, marine, and weather frequencies. Unique Data Skip - Allows your scanner to skip unwanted data transmissions and reduces unwanted birdies. Memory Backup - If the battery completely discharges or if power is disconnected, the frequencies programmed in your scanner are retained in memory. Manual Channel Access - Go directly to any channel. LCD Back Light - An LCD light remains on for 15 seconds when the back light key is pressed. Autolight - Automatically turns the backlight on when your scanner stops on a transmission. Battery Save - In manual mode, the BC245XLT automatically reduces its power requirements to extend the battery's charge. Attenuator - Reduces the signal strength to help prevent signal overload. The BC245XLT also works as a conventional scanner. Now it's easy to continuously monitor many radio conversations even though the message is switching frequencies. The BC245XLT comes with AC adapter, one rechargeable long life ni-cad battery pack, belt clip, flexible rubber antenna, earphone, RS232C cable, Trunk Tracker frequency guide, owner's manual and one year limited Uniden warranty. Not compatible with AGEIS, ASTRO, ESAS or LTR systems.

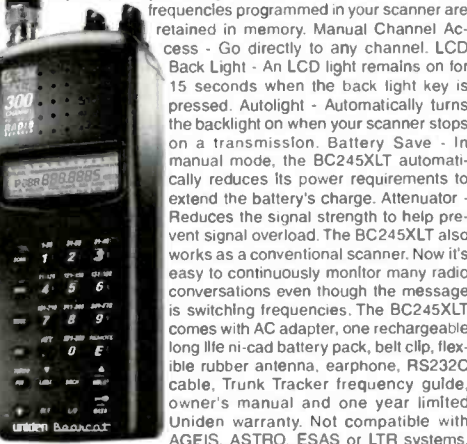

Hear more action on your radio scanner today. Order on-line at [www.usascan.com](http://www.usascan.com) for quick delivery. For maximum scanning satisfaction, control your Bearcat 245XLT from your computer running Windows. Order Scantat Gold for Windows, part number SGFW for \$99.95 or the surveillance enhanced version with audio recording part number SGFWSE for \$159.95.

### More Radio Products

Save even more on radio scanners when purchased directly from CEI. Your CEI price after instant rebate is listed below:

Bearcat 895XLT 300 ch. Trunktracker I base/mobile scanner.....	\$179.95
Bearcat 780XLT 500 ch. Trunktracker III base/mobile.....	\$324.95
Bearcat 278CLT 100 ch. AM/FM/SAME WX alert scanner.....	\$159.95
Bearcat 245XLT 300 ch. Trunktracker II handheld scanner.....	\$189.95
Bearcat 248CLT 500 ch. base AM/FM/weather alert scanner.....	\$89.95
Bearcat Sportcat 200 alpha handheld sports scanner.....	\$169.95
Bearcat Sportcat 180B handheld sports scanner.....	\$149.95
Bearcat 80XLT 50 channel handheld scanner.....	\$99.95
Bearcat 60XLT 30 channel handheld scanner.....	\$74.95
Bearcat BCT7 information mobile scanner.....	\$139.95
AOR AR8200 Mark II Wide Band handheld scanner.....	\$539.95
AOR AR16BQ Wide Band scanner with quick charger.....	\$209.95
ICOM PCR1000 computer communications receiver.....	\$379.95
ICOM R10 handheld wideband communications receiver.....	\$279.95
ICOM R3 handheld wideband receiver with video display.....	\$379.95
Uniden WX100 Weather Alert with S.A.M.E. feature.....	\$49.95

### AOR® AR8200 Mark IIB Radio Scanner

AOR8200 Mark IIB-A wideband handheld scanner/SPECIAL \$539.95

**1,000 Channels • 20 banks • 50 Select Scan Channels**  
**PASS channels: 50 per search bank + 50 for VFO search**  
**Frequency step programmable in multiples of 50 Hz.**  
**Size: 2<sup>1/2</sup> Wide x 1<sup>3/8</sup> Deep x 6<sup>1/8</sup> High**

**Frequency Coverage:** 500 KHz to 823,995 MHz, 849,012.5-868,995 MHz, 894,012.5-2,040,000 MHz (Full coverage receivers available for export and FCC approved users.)

The AOR AR8200 Mark IIB is the ideal handheld radio scanner for communications professionals. It features all mode receive: WFM, NFM, SFM (Super Narrow FM), WAM, AM, NAM (wide, standard, narrow AM), USB, LSB & CW. Super narrow FM plus Wide and Narrow AM in addition to the standard modes. The AR8200 also has a versatile multifunctional band scope with save trace facility, twin frequency readout with bar signal meter, battery save feature with battery low legend, separate controls for volume and squelch, arrow four way side rocker with separate main tuning dial, user selectable keypad beep/illumination and LCD contrast, write protect and keypad lock, programmable scan and search including LINK, FREE, DELAY, AUDIO, LEVEL, MODE, computer socket fitted for control, clone and record, Flash-ROOM no battery required memory, true carrier reinsertion in SSB modes, RF preselection of mid VHF bands, Detachable MW bar aerial. Tuning steps are programmable in multiples of 50 Hz in all modes, 8.33 KHz airband step correctly supported, Step-adjust, frequency offset, AFC, Noise limited & attenuator, Wide and Narrow AM in addition to the standard modes. For maximum scanning pleasure, you can add one of the following optional slot cards to this scanner: **CT8200** CTCSS squelch & search decoder \$89.95; **EM8200** External 4,000 channel backup memory, 160 search banks. \$69.95; **RU8200** about 20 seconds chip based recording and playback \$69.95; **TE8200** 256 step tone eliminator \$59.95. In addition, two leads are available for use with the option socket **CC8200A** personal computer control lead \$109.95; **CR8200** tape recording lead \$59.95. Includes 4 1,000 mAh AA ni-cad batteries, charger, cigarette lighter adapter, whip aerial, MW bar antenna, belt hook, strap and one year limited AOR warranty. For fastest delivery, enter your order on-line at <http://www.usascan.com>.

### Buy with Confidence

### Order on-line and get big savings

For over 32 years, millions of communications specialists and enthusiasts worldwide have trusted Communications Electronics for their mission critical communications needs. It's easy to order. For fastest delivery, order on-line at [www.usascan.com](http://www.usascan.com). Mail orders to: Communications Electronics Inc., P.O. Box 1045, Ann Arbor, Michigan 48106 USA. Add \$20.00 per radio receiver for UPS ground shipping, handling and insurance to the continental USA. Add \$13.00 shipping for all accessories and publications. For Canada, Puerto Rico, Hawaii, Alaska, Guam, P.O. Box or APO/FPO delivery, shipping charges are two times continental US rates. Michigan residents add sales tax. No COD's. Your satisfaction is guaranteed or return item in unused condition in original packaging within 61 days for refund, less shipping, handling and insurance charges. 10% surcharge for net 10 billing to qualified accounts. All sales are subject to availability, acceptance, verification and authentication. Prices, terms and specifications are subject to change without notice. We welcome your Discover, Visa, American Express, MasterCard, IMPAC and Eurocard. Call anytime 1-800-USA-SCAN or 800-872-7226 to order toll-free. Call +1-734-996-8888 if outside Canada or the USA. FAX anytime, dial +1-734-663-8888. Dealer and international inquiries invited. Order your radio products from CEI today at [www.usascan.com](http://www.usascan.com).

### For credit card orders call 1-800-USA-SCAN

e-mail: [cei@usascan.com](mailto:cei@usascan.com)  
[www.usascan.com](http://www.usascan.com)

PO Box 1045, Ann Arbor, Michigan 48106-1045 USA  
 For information call 734-996-8888 or FAX 734-663-8888  
Price schedule effective September 2, 2001 AD #90201 © 2001 Communications Electronics Inc.



# Visit WWW.USASCAN.COM • 1-800-USA-SCAN

## Improving Your Online Access Speed

This month, we're going to divert a little based on E-mail I've been receiving from many of you. One of your most frequent questions is (paraphrasing) "HELP! I'm constantly plagued with hesitation — is there any way I can improve the playback of my streaming media?" That question is usually prefaced with a reference to the use of a dial-up modem being used to access the Internet.

Well, no matter how you slice it, given today's technology, upgrading to "Broadband" access (cable, DSL, etc.) would have the most beneficial (but more expensive) overall effect. But, even then, you would still experience occasional delays (personal experience speaking) during playback. It's not because there's anything wrong with your connection, equipment, or software, but rather because of a slowdown of network traffic itself and/or an "overload of users" in the case of a popular resource. Cyberspace, worldwide, is a highly congested place, folks. In fact, given the complexity of the Internet and sheer number of people online at the same time, I'm constantly amazed that it works at all!

Regardless, there really IS something that you can do that could have a dramatic and positive effect on your online experience — no matter how you're connected. That "something" has to do with how your Windows Operating System is configured or, perhaps more appropriately stated, misconfigured.

When I first upgraded to cable access a couple of years ago, my initial download speeds were WORSE than with the standard 56K modem I had just replaced! Over the course of two days, two cable technicians (different tech each day) tried to figure out the problem. They changed modems and ethernet cards, rechecked their lines and reconfigured their hardware and software — all to no avail. (In their defense, cable access was brand new in this area and everyone, including me, was on a steep learning curve). Anyway, after they left scratching their heads, and just before I cancelled my cable account, I found the "answer" online and, after a period of reading the "how-to" and manually editing my Windows registry file, (yeah, that's the beast that can REALLY cause problems if you don't do it right) the end result was as if I had suddenly replaced a Model-T with an Indy 500 racecar.

Today, thanks to some innovative programming by some very talented people, you can optimize your configuration safely and easily without having to go through the hassles — and risk — of manual registry editing by using a program designed specifically for the task. (Geez! ANOTHER "goldmine" of a program that slipped through my fingers!) So, this month, we'll take a look at two such programs that I've recently tried. Both of them were extremely easy to install, offered a FREE (non-crippled) trial and yielded almost identical results in terms of online speed improvement. In my case, they only slightly bettered my previous manual configuration, but had I been starting from scratch (i.e. my original configuration of two years ago) the results would have been nothing short of remarkable! They're also designed to work with any type of connection so whether you're using a standard dial-up modem or have Broadband access, you should be able to improve your connection speed. The main difference between the two is the number and types of additional

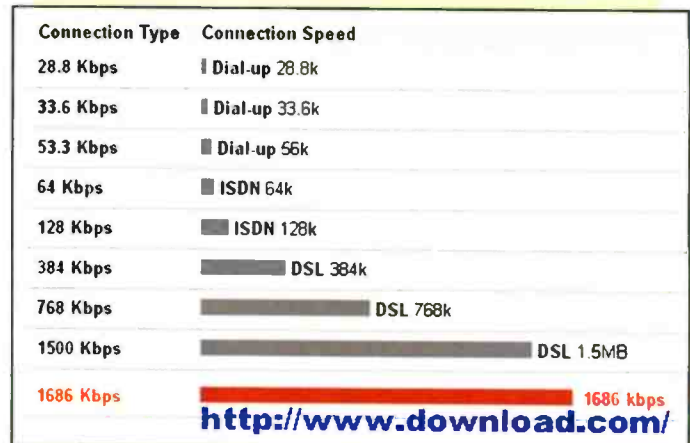

Shown in red are the results from download.com's "test your bandwidth" application for my system.

"bells & whistles" included with the software. There was one "glitch" with one of them (I'll explain below) but I think it had more to do with MY specific (and probably unusual) system than with their software — although it's a parameter that they could (should?) have considered.

As a suggestion, BEFORE you use these programs, you might want to establish a base line assessment of your current configuration. There are several online resources that will measure the speed of your current system that you should find useful for "before" and "after" comparisons. For best results, run several tests within a short period of time and average the results. Remember, when using these online resources, BE SURE to "Clear" your Web browser's disk and memory cache EACH time before a specific test. Otherwise, you'll be measuring how fast YOUR PC is supplying the data (after the initial test) making the test invalid. Also, try to pick a time of day when the 'net is least congested. For me, it's usually around 4–5 a.m. Eastern time. Here are a couple of test resources I've used:

### Here Are The Tests: Download.com

Simply, go to <http://www.download.com/>. And please note: scroll to the bottom of the page and click "Test Your Bandwidth." After the test completes, record the results, then clear your disk and memory cache and click your back button — the test will rerun automatically.

### Toast.net

Get to <http://www.toast.net/>. Once there, note that there are three different tests available (text download, graphic image, and streaming media) from several different servers. Be sure to clear your disk and memory cache after each test regardless of which server you use since the test files are identical.

## Tweakmaster

"Tweakmaster" works well! How well? Well, (the three wells intended) that will depend on how good or bad your current configuration is. It's definitely not going to make that dial up modem perform like Broadband, but it will maximize the performance of whatever you're using — in a flash! And, you can try it free for 30 days. Then, if you decide to keep it, registration is priced at a reasonable \$19.95. (Price as of September 2001 when I visited their site — it MAY be back to the normal \$29.95 by the time you read this). Tweakmaster also comes with some other built-in utilities including a PC clock synchronizer and a DNS accelerator (neat!) so give it a try. Currently, for \$29.95 you can get Tweakmaster and DU Meter (a little utility that shows your current online throughput) for \$29.95 as a package deal. America Online (AOL) users note: Tweakmaster has a "Keep Alive" function that will prevent AOL's software from disconnecting you during periods of inactivity — sounds like a nice accessory for AOL folks! More information and the latest version of Tweakmaster can be found at <http://www.tweakmaster.com/>.

## Tweakme/Tweakme Gold

"Tweakme" is also quite good for what it's designed to do. As noted early on, both Tweakmaster and Tweakme get to the heart of the matter and "do their thing" quickly in terms of automatically (and safely) configuring a system for maximum online speed. Tweakme and Tweakme-Gold are available for a free (50 uses) trial with a \$19.95 registration fee for the standard ver-

sion and \$29.95 for the enhanced "Gold" version. While the standard version, like Tweakmaster, has some nice "bells & whistles," the Gold version includes even more utilities for improving your overall system performance. In terms of overall comparison, I think you get more bang for your buck with Tweakme/Tweakme-Gold, but that's a personal opinion. Like life itself, it's "different strokes for different folks."

I suggest visiting each vendor's site to get the full scoop on their products then make a decision based on your needs. I think you'll get your money's worth regardless of which product you eventually settle on. While I downloaded the "Gold" version for my trial, I'd presume the standard version would run the same in terms of Internet performance enhancement. One nice touch (I thought) was Tweakme's offer to back-up up my registry file. Unfortunately, it completely locked up my system on two separate attempts requiring a reboot each time. I suspect the problem is that MY registry file far exceeds the capacity of a single 1.44MB diskette that Tweakme wants to use for that purpose. An option to save the file to CD (opposed to diskette) or the use of multiple diskettes might have taken care of the problem — don't know. But, other than that, Tweakme-Gold performed flawlessly in all respects. Check it out for yourself at <http://www.tweak-me.de/>.

For you "brave hearts," here's a URL that links to an article where you can learn about the different settings and how to edit your registry file manually. The article is aimed at cable modem users, but the procedure for dial-ups is essentially the same. The results should be nearly identical to what the above programs provide but you'll have the satisfaction of knowing you "did it yourself." Seriously, take a peek — it will give you a feel for

## If it's on the air, it's in



Are you interested in listening to distant ports of call? Exciting police and fire messages? Ham Radio? Emergency medical communications? Air-to-ground comms? Building home electronics projects? Then Monitoring Times® is your magazine! Open a copy of MT, and you will find 92 pages of news, information, and tips on getting more out of your radio listening. In fact, it's the most comprehensive radio hobby magazine in the U.S.

Packed with up-to-date information concisely written by the top writers in the field, Monitoring Times® is considered indispensable reading by government and newsgathering agencies.

### Here's what you'll get with a subscription to MT, every month:

- International broadcasting program schedules
- Shortwave and longwave DXing
- Satellite broadcasting
- Pirate and clandestine stations
- Two-way communications monitoring
- Listening tips and insights from the experts
- Frequency lists
- News-breaking articles
- Exclusive interviews
- New product tests and book reviews
- ...and much, much more!



## MT EXPRESS

For less than the cost of a subscription in the U.S., you can be reading the entire Monitoring Times magazine anywhere in the world before U.S. subscribers receive their printed copies! MT Express is the downloadable version of the exact same magazine that has gained a worldwide reputation for reliable radio information that's easy to understand, and products and projects of proven value.

For a mere \$19.95 U.S., **MT EXPRESS** gives you Monitoring Times magazine

- In PDF format viewable with free software
- Delivered by FTP (10 MB file)
- Viewable in brilliant color on your computer screen
- Easily navigated by clicking on the Table of Contents
- Printable using your own computer printer
- Searchable to find every mention of a topic or station schedule
- Importable into your frequency databases
- Compatible with software to convert text to audio for sight impaired listeners

One year subscription to **MT EXPRESS** — only \$19.95, or for even greater savings, \$11 in addition to your printed subscription.

### Subscribe to MT for as little as \$14.00 (U.S. Second Class Mail)

7540 Hwy. 64 W., Brasstown, NC 28902

1-800-438-8155 US and Can.; 828-837-9200; Fax 828-837-2216

e-mail [order@gravesent.com](mailto:order@gravesent.com)

	6 months	One Year	Two Years	Three Years
US Rates	<input type="checkbox"/> \$14.00	<input type="checkbox"/> \$25.95	<input type="checkbox"/> \$49.95	<input type="checkbox"/> \$73.95
US 1st Class	<input type="checkbox"/> \$29.50	<input type="checkbox"/> \$56.95	<input type="checkbox"/> \$111.95	<input type="checkbox"/> \$166.95
Canada Surface*	<input type="checkbox"/> \$21.00*	<input type="checkbox"/> \$38.50*	<input type="checkbox"/> \$73.95*	<input type="checkbox"/> \$109.95*
Foreign International*	<input type="checkbox"/> \$30.00*	<input type="checkbox"/> \$57.50*	<input type="checkbox"/> \$112.95*	<input type="checkbox"/> \$168.50*
Electronic Subscription		<input type="checkbox"/> \$19.95	<input type="checkbox"/> \$38.90	<input type="checkbox"/> \$57.85

\*All payments must be in U.S. Funds drawn on a U.S. Bank!



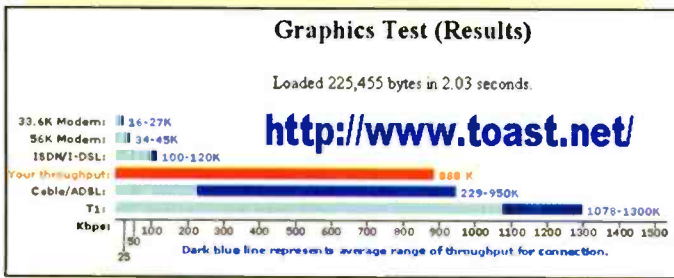

*Shown in red are the results from toast.net's "graphics" test for my system.*

what these programs do automatically (and safely) for you. Visit <http://twcnr.com/technofile/texts/cabletcp98.html>.

Well, we're almost out of space, but before we go, I think we have room for one media resource I think you'll enjoy. It's Let's Talk Computers.

According to website information, "Let's Talk Computers is the South's longest-running computer radio talk show," having been on the air since 1989. The show is produced in Nashville, Tennessee, USA, and is aired on traditional radio in seven states: Tennessee, Alabama, Kentucky, Illinois, Indiana, Texas, and New Mexico. Recently, they have expanded their reach to include a worldwide audience by offering streaming media broadcasts from their website.

<http://www.tweakmaster.com/>

*Slow Internet connections got you down? Tweakmaster can help chase away some of the blues.*

http://www.lets-talk-computers.com/"/>

*Listen to weekly interviews with industry leaders.*

Alan and Sandra Ashendorf, who interview representatives from the computer industry about products and industry trends, superbly host these informative and interesting shows. Guests have included representatives from Adobe, Microsoft, Novell, IBM, Lotus, "PC World," Seagate, Citrix, Compuserve, Computer Associates, Corel, Symantec, "Internet Wire," Ziff-Davis and a host of other companies. I think you'll agree that they more than meet their goal of letting you know what's happening in the computer industry. Interviews for Let's Talk Computers are updated weekly and archives of previous shows are available. A really nice resource — don't miss it: visit <http://www.lets-talk-computers.com/>.

Now, we really have run out of space. Thanks for tuning in and remember, if you have a favorite streaming media resource, or possibly looking for one, be sure to let me know about it. Chances are that other *Pop Comm* readers will be interested too. Until we meet again, enjoy your system tune-up and happy holidays! ■

http://www.tweak-me.de/"/>

<http://www.tweak-me.de/>

*In addition to improving your connection speed, Tweakme-Gold also offers other system enhancement utilities.*

### NEED MEDIA PLAYERS?

**REALPLAYER 8 BASIC**  
<http://www.real.com>

**WINDOWS MEDIA PLAYER**  
<http://www.microsoft.com/downloads/>

**APPLE'S QUICK TIME PLAYER**  
<http://www.apple.com/quicktime/download/>

**WINAMP**  
<http://www.winamp.com/>

*Get your player(s) or upgrades/updates at these URL's.*



### Special: Middle East English Broadcasts

*Editor's note: Gerry's column was prepared just before the terrorist attacks on the USA, however he has just provided the following last-minute radio guide to monitoring international broadcasts from the Middle East.*

UTC	STATION	COUNTRY	FREQUENCY
0020	UAE Radio	United Arab Emirates	13675
0030	UAE Radio	United Arab Emirates	15395
0030	UAE Radio	United Arab Emirates	17830
0030	UAE Radio	United Arab Emirates	21700
0130	UAE Radio	United Arab Emirates	13675
0200	UAE Radio	United Arab Emirates	15370
0200	UAE Radio	United Arab Emirates	15395
0220	UAE Radio	United Arab Emirates	21605
0300	UAE Radio	United Arab Emirates	13630
0320	UAE Radio	United Arab Emirates	13675
0330	UAE Radio	United Arab Emirates	15395
0330	UAE Radio	United Arab Emirates	21605
0400	UAE Radio	United Arab Emirates	13630
0400	UAE Radio	United Arab Emirates	13675
0500	UAE Radio	United Arab Emirates	15395
0500	UAE Radio	United Arab Emirates	21605
0500	Republic of Yemen Radio	Yemen	9780
0500	Radio Jordan	Jordan	11690
0500	Radio Damascus	Syria	12085
0500	Radio Damascus	Syria	13610
0530	Radio Oman	Oman	15355
0530	Radio Oman	Oman	15140
1030	VOIRI	Iran	9022
1030	VOIRI	Iran	9835
1030	VOIRI	Iran	11970
1030	VOIRI	Iran	15385
1100	VOIRI	Iran	15430
1100	VOIRI	Iran	15585
1100	VOIRI	Iran	7245
1140	VOIRI	Iran	9635
1215	VOIRI	Iran	11775
1300	VOIRI	Iran	9022
1330	VOIRI	Iran	11670
1330	VOIRI	Iran	13730
1330	VOIRI	Iran	9570
1330	VOIRI	Iran	13745
1400	Voice of Africa	Libya	15415
1530	Voice of Africa	Libya	15415
1530	Voice of Africa	Libya	15415
1530	Voice of Africa	Libya	15415
1530	Voice of Africa	Libya	15415
1600	Voice of Africa	Libya	15415
1600	Voice of Africa	Libya	15415
1630	Voice of Africa	Libya	15415
1630	Voice of Africa	Libya	15415
1630	Voice of Africa	Libya	15415
1630	Voice of Africa	Libya	15415
1630	Voice of Africa	Libya	15415
1630	Voice of Africa	Libya	15415
1735	Voice of Africa	Libya	15415
1800	Radio Cairo	Egypt	9475
1800	Radio Cairo	Egypt	17595
1820	Radio Cairo	Egypt	15255
1900	Radio Cairo	Egypt	15375
1920	Radio Cairo	Egypt	9990
1930	Radio Cairo	Egypt	9900
1930	Radio Algiers	Algeria	11715
1930	Radio Algeria	Algeria	15160
2000	Radio Algeria	Algeria	11715
2000	Radio Algeria	Algeria	15160
2000	Kol Israel	Israel	15640
2000	Kol Israel	Israel	17535
2000	Kol Israel	Israel	9435
2000	Kol Israel	Israel	6220
2005	Kol Israel	Israel	7410
2005	Kol Israel	Israel	17545
2030	Kol Israel	Israel	15640
2030	Kol Israel	Israel	17535
2115	Kol Israel	Israel	11605
2120	Kol Israel	Israel	15640
2130	Kol Israel	Israel	15650
2130	Kol Israel	Israel	9435
2220	Radio Kuwait	Kuwait	15110
2300	Radio Kuwait	Kuwait	11990
2330	Radio Baghdad Int'l	Iraq	11787

The Argentine government has decided to close most, if not all, of its military/scientific bases in Antarctica. The trickle down result of this decision is the closure of Radio Nacional Archangel San Gabriel at Base Esperanza. This station had provided news and entertainment to the staff at the various Argentine Antarctic bases for many years and was a fairly frequent visitor into the shacks of North American DX'ers. It operated for some eight months each year during the period when weather allowed activity at the bases. In more recent years the station — on **15476** — had cut back on its daily broadcast

hours and began closing too early in our afternoons to allow much in the way of successful reception.

#### A Real DX Challenge!

If you're one who likes a real DX challenge, try **Radio San Carlos** on **2420** (that's a frequency, not a time), now operating around the clock. The 120 meter (2 MHz) band is easily the least occupied part of the shortwave broadcast spectrum and, propagationally, as finicky as it's possible to be.

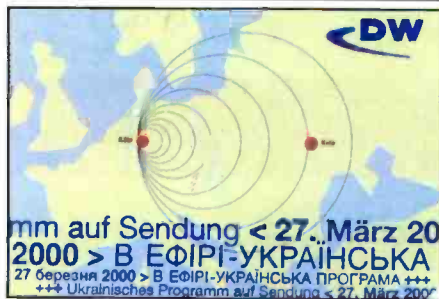

*This special QSL commemorates DW's broadcasts to the Ukraine. (Thanks to David Weronka, NC)*

Another reactivation is **Radio Burundi**, which hasn't been really "with it" in years, presumably due to the sad state of everything there, including the frequency involved — **6140**, which, most times, will suffer from heavy QRM. The good news is that, if they retain their schedule, sign on comes at 0300, which makes reception here at least theoretically possible!

Another new U.S. broadcaster on the horizon is WWCV, located near Morrison, Tennessee. And it looks as if it will be a fairly big operation. No start date, schedule, or frequency info is available yet. It's owned by Blue Ridge Communications. Anyone care to guess what the format might be?

Merlin Communications, a private firm that operates all of the BBC transmitters on a for-profit basis, has made a similar arrangement with UAE Radio, Abu Dhabi. Merlin now operates the four — 500 kW transmitters at Dhabayya (near Abu Dhabi) so you can expect many of the stations using Merlin's other facilities to begin using this site as well. First to sign up was Adventist World Radio. The AWR transmissions are on **11975** from

0300–0330 in Amharic, **17875** from 1700–1800 in Afar and Oro, **11945** from 0300–0400 in Oro and Tigrinia, **15520** from 1630 to 1800 in Somali, Amharic and Tigrinia, **15495** from 1330–1400 in English and **15385** from 1400–1430 in Urdu. Radio Canada International has recently began use of this site as well.

Salama Radio is a new independent program service aired via Merlin transmitters in England. The broadcast is on from 1930 to 2000 on **15475**, beaming religious programming to Nigeria.

Robert Brossell of Pewaukee, Wisconsin, is our book winner for this month. Bob receives a copy of the 2002 edition of *Passport to World Band Radio*, courtesy of Universal Radio, Reynoldsburg, Ohio. Having a copy of Universal's huge catalog in your shack is — almost — as important as having a copy of *Passport* near your radio. And unlike *Passport*, the Universal catalog is free! Call Universal at 614-866-4267 or E-mail your request [dx@universal-radio.com](mailto:dx@universal-radio.com). You can also drop them a note at 6830 Americana Parkway, Reynoldsburg, Ohio 43068.

Remember, we need interesting illustrations. That includes photos of you and your equipment, pictures of shortwave stations, spare QSL cards, schedules, station brochures — whatever you'd care to contribute.

Needless to say your reception logs are always wanted, too. We make every effort to use most, if not all, of the logs sent in, so don't be shy or feel yours aren't good enough. They are! Just be sure to list your logs by country and leave enough space between them so we can navigate scissors easily. Logs are cut into strips and then sorted by country, so be sure to use only one side of the paper, otherwise some of

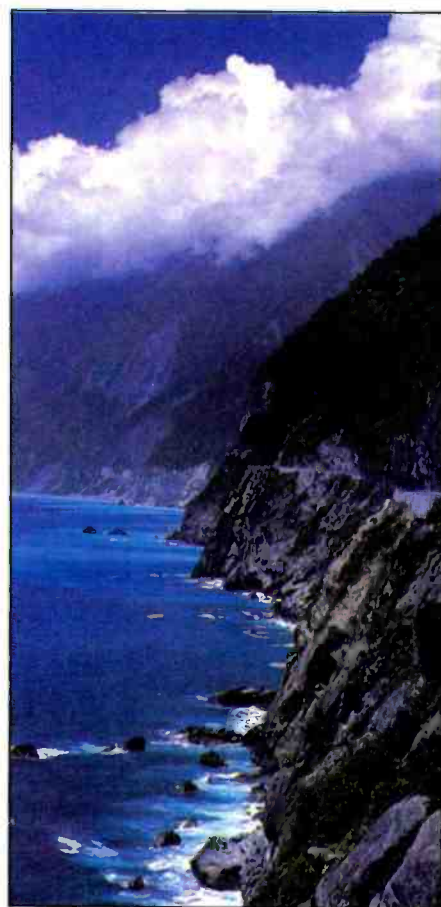

*This beautiful scene graces one of Radio Taipei International's QSL cards.*

your logs won't "make the cut." Also include your last name and state abbreviation after each logging. If you're not quite sure what works and what doesn't ask for a copy of our reporting guide and we'll be happy to send you one. As always, thanks so much for your continued interest and participation.

Here are this month's logs. All times are in UTC, which is five hours ahead of EST, i.e. 0000 UTC equals 7 p.m. EST, 6 p.m. CST, 5 p.m. MST and 4 p.m. PST. Double capital letters are language abbreviations (FF = French, AA = Arabic, SS = Spanish, etc.). If no language abbreviation is included the broadcast is assumed to have been in English.

**ANGOLA** — Radio Nacional, **4950** at 0032 with PP talks, some highlife vocals. Four time pips at top of the hour. ID, fanfare and news. (D'Angelo, PA) **11955** at 0147 with ballads and phone talks. (Paszkwicz, WI)

**ANTIGUA** — BBC relay, **6195** at 1332 with News Hour. (MacKenzie, CA)

**ARGENTINA** — Radio Nacional, **6060**, 0935 with news in SS, nice ID, and string of



*The Voice of Turkey gets pretty good coverage, considering they don't use any relays! (Thanks to David Weronka, NC)*

**Abbreviations Used in Listening Post**

AA	Arabic
BC	Broadcasting
CC	Chinese
EE	English
FF	French
GG	German
ID	Identification
IS	Interval Signal
JJ	Japanese
mx	Music
NA	North America
nx	News
OM	Male
pgm	Program
PP	Portuguese
RR	Russian
rx	Religion/ious
SA	South America/n
SS	Spanish
UTC	Coordinated Universal Time (ex-GMT)
v	Frequency varies
w/	With
WX	Weather
YL	Female
//	Parallel Frequencies

promos or ads at 0938, ID and time check 0941, then more news. (D'Angelo, PA) RAE, 11710 at 0218 with a report on labor demonstrations caused by high unemployment. (Brossell, WI)

**ASCENSION ISLAND** — BBC relay, 12095 at 0355 with comments and interviews. (MacKenzie, CA) 17830 at 1906. "From Our Own Correspondents."

**AUSTRALIA** — ABC Northern Territory Service. Alice Springs, 4835 at 0816 with music from Australian artists. (Miller, WA) Radio Australia, 5994.8 at 0950 in EE. Into Pidgin at top of the hour. Difficult reception. (Montgomery, PA) 6020 at 1320 with interviews about wine in Australia. 9580 at 1710. (MacKenzie, CA) 1128 with news. (Miller, WA) 1217 with "The Beginning of Things." Also 11650 at 1217 (Brossell, WI). 15240 at 0436 with jazz. (Jeffery, NY) 15415 at 0404 with Australian and regional news. (Burrow, WA) 17580 at 0540 mixing with Belgium. (Barton, AZ) 21740 at 2310. (MacKenzie, CA) 2110 with "Correspondents Report." (Limbach, PA) Christian Voice, tentative, 21550 with contemporary Christian music at 0200 to past 0330. (Alexander, PA) 0447 beamed to Africa and Indonesia with Christian rock. Very, very strong. (Foss, Philippines)

**AUSTRIA** — Radio Austria Int'l, 17865 at 1532 with news. (Wilden, IN) 1542 with "Report From Austria." (Limbach, PA)

**BELARUS** — Radio Stalitsa, 7210 from 0340 with chimes IS, woman with opening ID and into news. Covered by BBC at 0357. Poor; parallel 11960 was fair. (D'Angelo, PA)

**BELGIUM** — Radio Vlaanderen Int'l, 15565 (via Bonaire) heard at 0405 with news, features and press review. Off at 0430. (Limbach, PA)

**BOLIVIA** — Radio San Gabriel, 6085.2 at 0936 with music, talk in Aymara. No ID noted and buried by WYFR carrier at 0953 and IS and 0955 making ID impossible.

Drifting slightly. (D'Angelo, PA) Radio Fides, 6155.1 at 1050 with ID from fast talking male announcer. banco commercials and political talk in SS. (D'Angelo, PA)

**BRAZIL** — Radio Cultura Ondas Tropicais, 4845 at 0250 with continuous vocals to ID and sign-off announcements in PP at 0301. choral anthem and off at 0305. (D'Angelo, PA) Radio Record, 6150 at 2302 dominating channel until Singapore gained strength. Man with ID in PP and apparent sports coverage. (D'Angelo, PA) Radio Gaucha, 11915 with non-stop PP talk by various men until 2359 ID, pips at top of the hour, brief news bulletin. Slop from 11920. (D'Angelo, PA) Radio Nacional Amazonia, 6180 with DJ program in PP heard at 0824. (Miller, WA)

**BULGARIA** — Radio Bulgaria, 11700 at 2300 with IS and time pips, female with news. (Wilden, IN) 0214 with report tremors last year believed to have been caused by earthquakes in Turkey. (Brossell, WI)

**CANADA** — Radio Canada Int'l, 11890 at 0628 with Chinese music. (Miller, WA) 11980 via China at 1230. (Brossell, WI)

**CHINA** — China Radio Int'l, 5145 at 1232 in unid. language. 15500 at 2245 with comments and interviews. (MacKenzie, CA) 9565 at 1605 with regional news. (Burrow, WA) 17720 at 1505 with news and features. (Limbach, PA) Voice of Jinling, 5860 in CC at 1235 with comments and music. (MacKenzie, CA) Voice of the Strait, 6115 at 1123 in CC. (Foss, Philippines) China National Radio (CPBS) 5880 at 1238 with long talk, comments in CC. //6030, 6110, 6110 at 1327 with man and woman commentators. 11000 in CC at 1726 with long, opera-like vocals. (MacKenzie, CA) 9380 in CC at 1028. (Jeffery, NY)

**CHILE** — Voz Christiana, 17680 with Salsa heard at 1440. (Barton, AZ)

**CONGO** — Radio Congo, 5985 monitored at 2256 with highlife vocals to ID over music at 2259, followed by another formal ID and frequency announcements, then news in FF at 2300. (D'Angelo, PA)

**CUBA** — Radio Havana Cuba, 13680 at 2205 with SS comments. QRM from Radio Japan. 15120 at 2054 in SS with news. Cuban music. (MacKenzie, CA)

**CYPRUS** — BBC relay, 12095 at 0307 with report on Kosovo fighting. (Brossell, WI) 0315 with Mideast news. (MacKenzie, CA) 15575 at 1306. (Jeffery, NY)

**CZECH REPUBLIC** — Radio Prague 15470 with report on the Philip Morris smoking project there. (Brossell, WI) 21745 monitored at 0909 beamed to Asia and a program on the arts. (Montgomery, PA)

**ECUADOR** — HCJB, 12005 at 1225 with news, music. (Northrup, MO) 15115 with news at 1208. (Barton, AZ) 0100 with ID, news, Mission Network news and "DX Party Line" at 0110. (MacKenzie, CA) 17660 to India at 2355 with ID. (Limbach, PA) 1912 with science topics. (Wilden, IN)

**Full 800 MHz Scanners**



**AOR AR-8200MKII**  
**Wideband portable receiver**  
 - 0.5 to 2040 MHz continuous. (unblocked)  
 - NFM, WFM, NAM, WAM, USB, LSB & CW  
 - Alphanumeric memory identification  
 - Spectrum scan  
 - Computer control  
 - Flexible dynamic memory bank layout  
 - Optional CTCSS & Extra memory boards  
**\$699<sup>us</sup>**



**ALINGO DJ-X2000**  
**Intelligent Wideband Receiver**  
 - 0.1 to 2200 MHz continuous. (unblocked)  
 - NFM, WFM, AM, USB, LSB & CW  
 - Flash Tune nearby signals - Transweeper  
 - Channel scope  
 - 2000 memory channels  
 - Superb sensitivity, Clear sound  
 - Various scanning modes - Menu system  
**\$715<sup>us</sup>**



**ICOMIC-R2** (unblocked)  
**"Compact wideband portable receiver!"**  
 - Wide frequency coverage, 0.5 to 1300 MHz.  
 - Modes of operation AM, FM, WFM  
 - 400 memory channels, large LCD display  
 - Super compact (58W x 86 H x 27 D mm)  
**\$265<sup>us</sup>**

**AOR ICOM ALINGO OPTOELECTRONICS YUPITERU**

**Guaranteed Delivery to USA.**

**Radioworld**

Phone: **416-667-1000**  
 FAX: (416) 667-9995 sales@radioworld.ca  
 4335 Steeles Ave. W., Toronto, ON Canada M3N 1V7  
[www.radioworld.ca](http://www.radioworld.ca)

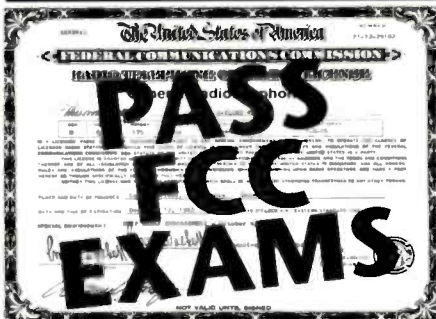

**Be an FCC LICENSED ELECTRONIC TECHNICIAN!**

The Original Home-Study course prepares you for the "FCC Commercial Radiotelephone License" at home in your spare time. No previous experience needed. Our proven audio cassettes make learning fast and easy! Get your FCC License and be qualified for exciting jobs in Communications, Radar, Radio-TV, Microwave, Maritime, Avionics and more...even start your own business!

**Call 800-932-4268 Ext. 97**  
 Visit our Website: [www.LicenseTraining.com](http://www.LicenseTraining.com)

**GUARANTEED TO PASS - You get your FCC License or your money refunded. Send for FREE facts now.**

**COMMAND PRODUCTIONS**  
 FCC LICENSE TRAINING - DEPT. 97  
 P.O. Box 2824 • San Francisco, CA 94126-2824  
 Please rush FREE details immediately!

Name \_\_\_\_\_  
 Address \_\_\_\_\_  
 City \_\_\_\_\_ State \_\_\_\_\_ Zip \_\_\_\_\_



*Radio Havana Cuba sent Gerry this certificate marking 25 years of listening to the station. It was news to us!*

**EGYPT** — Radio Cairo/Egyptian Radio. **9475** at 0206 and **9900** at 2345. (Burrow, WA) 0332 in AA. (Brossell, WI) **12050** with Koran recitations at 0305. (MacKenzie, CA) **15285** in AA at 0322. (Jeffery, NY)

**ENGLAND** — BBC. **9740** (Singapore) at 1235 and **17640** with news at 1230. (MacKenzie, CA) **9915** at 0230 with plug for BBC Magazine. (Wilden, IN) **11810** with news of India at 0047 and **21660** at 1505 with sports item. (Limbach, PA) **12035** at 0426 with "The World Today." (MacKenzie, CA) **15400** (Ascension) at 1904 with news. (Jeffery, WI) Salama Radio via Merlin facilities. **15475** at 1931. EE with man anner, inspirational music, inviting letters to Chessington, UK, and Jos. Nigeria. (D'Angelo, PA)

**FINLAND** — Radio Finland. **13730** with Finland Journal, ID, frequency, anthem and off at 0215. (Paszkievicz, WI) **17670** at 1225 with "Finland in the News." (Northrup, MO)

**FRENCH GUIANA** — Radio France Int'l relay, **17630** with man and woman in FF. (Northrup, MO)

**GERMANY** — Deutsche Welle. **9785** (Portugal) at 0510. (Limbach, PA) **13690** with news analysis at 0410. (Barton, AZ) **15135** via Rwanda at 2100 with "DW Radio News." **15250** via Sri Lanka at 2225 with comments on business stocks. **15275** via Rwanda at 2228 with comments on the Canadian dollar. (MacKenzie, CA) 2030 in GG to SE Asia. (Linonis, PA) **15410** (Antigua) in GG at 2307. (Wilden, IN) **17560** (Sri Lanka) with news in GG at 1320. **17650** in GG at 1220. (Northrup, MO)

**GREECE** — Voice of Greece. **9775** (via Delano) in Greek at 1225. (Northrup, MO) **12105** in Greek at 0310. (MacKenzie, CA) **15630** in Greek at 2047. ID and off at 2050. (Burrow, WA) VOA relay, **11985** in presumed Greek at 0340. (Brossell, WI)

**GUAM** — Adventist World Radio. **17870** at 2045 with talk on missionary work in Asia. (Linonis, PA)

**GUATEMALA** — Radio Buenas Nuevas. **4799** with SS religious programming at 1113. (Miller, WA) **4800** at 0231 with ID: "En Centro America, esta es Radio Buenas Nuevas. Guatemala." (Brossell, WI) Radio Maya. **3324.8** from 0905 sign-on with choral vocals, man with SS ID and sign-on announcements at 0909, brief music and another announcement and program previews. (D'Angelo, PA)

**GUINEA** — RTV Guineenne. **7125** at 2345 with highlife. FF talk, sign-off with instrumental anthem at 2359. (Alexander, PA) Radio Cultural, **3300** in SS with acoustic guitar at 1115. (Barton, AZ)

**HAWAII** — KWHR. **9930** with religious programming at 1214. (Brossell, WI) **17780** at 0715. (Barton, AZ)

**HONDURAS** — La Voz Evangelica. **4819** at 0235 with SS religious programming. (Brossell, WI) 1113 in SS. (Miller, WA)

**INDIA** — All India Radio. Delhi, **4860** at 0032 with woman announcer with news, then Hindi vocals. (D'Angelo, PA) AIR-Thiruvananthapuram. **5010** at 0030 with news and into music and local language at 0040. (Montgomery, PA) 0036 with woman announcer and EE news. ID."and that's the end of the news from All India Radio." At 0040, another ID by a man, then Hindi vocals. (D'Angelo, PA) AIR Bangalore. **11620** at 0211 in presumed Hindi with music and talk. (Brossell, WI) **13620** with IS at 0213. (Paszkievicz, WI) **13710** with sitar music at 1415. (Barton, AZ) **15075** in unid. language at 0314. Barely audible. (Jeffery, NY)

**INDONESIA** — Voice of Indonesia, **9525** in CC at 1034. (Jeffery, NY) 1215 in presumed Indonesian with news and mentions of Indonesia. (Brossell, WI) **15150** at 2044 with long talk in EE, man with ID and mention of web site. More talks, local music and news headlines followed by several IDs and sign-off announcements at 2057. Off at 2059. (D'Angelo, PA)

**IRAN** — Voice of the Islamic Republic of Iran, **9635** at 1539 in EE with ID, news. (Burrow, WA) **11970** in EE at 0040 with news, music and features. (Limbach, PA) **13635** in AA at 2155. News at 2200. (MacKenzie, CA) **13730** in SS at 0246. (Paszkievicz, WI) **15385** at 1106 with local news in EE and music breaks. Parallel 15430. (Montgomery, PA)

**ISRAEL** — Kol Israel, **11585** in HH at 2110. (Miller, WA) **11590** at 0330. (Brossell, WI) **13635** in HH at 2235. "Shalom" ID at 2300, continued with domestic service relay with talks, interviews, music and commercials. Off suddenly at 0056. (MacKenzie, CA) **17535** in HH at 1325. (Northrup, MO) 2030

in HH to South America. (Linonis, PA)

**ITALY** — RAI. **11800** in II at 2352. (Miller, WA) news at 0057. (Barton, AZ) 0100 in EE with national news and music. (Limbach, PA) 0320 in SS. (Brossell, WI)

**JAPAN** — Radio Tampa. **6055** in JJ at 1324. (MacKenzie, CA) **9595** at 0850 in JJ. //6055 was very weak. **9595** was good. (D'Angelo, PA) Radio Japan/NHK. **5975** at 1248. **6190** in RR at 1330. **7200** in JJ at 1344. **9505** in JJ at 1655. EE at 1700. **9835** in JJ at 1718 **15220** via Ascension in JJ at 2220. (MacKenzie, CA) **11740** via Singapore in JJ at 1226. (Brossell, WI)

**JORDAN** — Radio Jordan, **7155** at 1820 with AA music. (Foss, Philippines) **11930** with "Radio Jordan" ID at 0249 and AA music. talk. (Brossell, WI)

**KUWAIT** — Radio Kuwait. **15495** in AA at 2240. (MacKenzie, CA) 0340 with music and singing in AA. (Brossell, WI) **15505** in AA to North America at 2040 with instrumental pops and very Western-style announcer. (Linonis, PA)

**LIBYA** — Radio Jamahiriya/Voice of Africa. **15415** at 2031. AA narrative, music bridge and news in EE to 2048 when back into AA. (Burrow, WA)

**LIBERIA** — Radio Liberia, **5100** at 2310 with pops, man with ID at 2329 and into more pop. Mostly African music. ID and time check at 2347. (Montgomery, PA)

**MADAGASCAR** — Radio Netherlands relay, **9845** with news in FF heard at 0330. (Brossell, WI)

**MALAYSIA** — Radio Malaysia-Sarawak. **4895** in Malay heard at 1304. (Miller, WA) **7270** at 1128 with Indonesian music. (Foss, Philippines)



**MEXICO** — Radio Educacion, **6185** at 0955 with classical music and SS talk. (Miller, WA) Radio Mil, **6010** at 0851 with James Brown tune in SS, ID, and Tennessee Ernie Ford's "Sixteen Tons." IDs after each number. (D'Angelo, PA) Radio Mexico Int'l, **9705** with mariachi at 1415. (Barton, AZ) **9705** at 0320 in EE with "You are listening to a roundup of national and international news from Radio Mexico International." (Brossell, WI)

**MOLDOVA** — Voice of Russia relay, **9665** at 0315. (Brossell, WI)

**MONGOLIA** — Voice of Mongolia, **12085** in Mandarin at 1021. Woman with slow talks and occasional music interludes. Might have been a language lesson. IS at 1029, ID twice, then silence. Male and female announcers with what sounded like an ID at 1030. Into EE but difficult to hear. (Montgomery, PA)

**MOROCCO** — Radio Medi-un, **9575** in FF at 0720 with talk, music. (Jeffery, NY) **2345** in FF. (Barton, AZ) VOA relay on **7275** at 0332. (Brossell, WI) RTV Marocaine, **11920** in AA at 0335. (Brossell, WI)

**NETHERLANDS** — Radio Netherlands, (probably via WYFR) at 1500 with program guide subsequent to BBC changeover. (Limbach, PA) **15315** at 2015 in DD to Africa. (Linonis, PA) **17840** via presumed Sackville, with a dig at the BBC: "When national broadcasters get their priorities wrong, make the switch to Radio Netherlands." (Limbach, PA)

**NETHERLANDS ANTILLES** — Radio Netherlands relay, **13700** in DD at 2207. (MacKenzie, CA) **21590** at 2322 with "Letterbox." (Limbach, PA)

**NEW ZEALAND** — Radio New Zealand, **9885** at 0706 with IS, ID, interview. (Jeffery, NY) **11675** with Berlin Philharmonic playing Tchaikovsky at 1230. (Brossell, WI) **15160** at 2009 with news, sports, and ID. (Burrow, WA) **11675** at 0208 with "In Touch With New Zealand." 0258 with rugby match. (Brossell, WI) News at 0445. (Barton, AZ)

**NICARAGUA** — Radio Miskut, **5770** from 0000 with SS ballads, lots of SS talk. Off abruptly at 0156. Reduced carrier USB. (Alexander, PA)

**NIGERIA** — Voice of Nigeria, **7255** at 0451 with IS, ID. (Burrow, WA)

**NORTH KOREA** — Voice of Korea, **9975** at 1610. DPRK news and IDs. (Burrow, WA) Pyongyang Broadcasting Station, **3320** in KK at 1807. (Foss, Philippines)

**NORWAY** — Radio Norway, **11635** with presumed news in NN at 0305. // **9960** much stronger. (Brossell, WI) **13800** in NN at 1515. (Foss, Philippines) **15705** in NN 1310 and **15735** in NN at 1310. (Northrup, MO)

**OMAN** — Radio Sultanate of Oman, **15355** monitored at 2030 in AA and possible Holy Koran program. (Linonis, PA) BBC relay, **15310** with man talking. Too weak to copy. (Jeffery, NY)

**PAKISTAN** — Radio Pakistan, **15335.2** at 1715 with mix of local vocals and Urdu talks. Nice flute music and drums prior to three time pips at 1800, ID and man with world news.

(D'Angelo, PA) **15485.2** at 0049 with Pakistani music, Urdu talks, nice ID at 0200 followed by news. (D'Angelo, PA)

**PAPUA NEW GUINEA** — NBC, **4890** at 0848 with inspirational talks in EE/Pidgin. Full Pidgin ID at 0900 and program previews followed by EE ID "This is NBC" and national news. (D'Angelo, PA)

**PERU** — Radio Ancash, Huaraz, **4992.5** at 0940 with OA folk music, ID, SS announcements. (Alexander, PA) Radio Union, Lima, **6314.8** at 0810 in SS with music, ID. Continuous music with occasional short announcements. ID again at 0842. (Alexander, PA) Radio Andina, Huancayo, **4995.6** at 1000 with OA folk music, SS anmts. (Alexander, PA) 0315; woman anmer with IDs and hosting program of rustic OA vocals. (D'Angelo, PA) La Voz de la Selva, Iquitos, **4824.4** at 1000 sign-on. Opening ID and announcements in SS, female vocals at 1002. (D'Angelo, PA) Radio Libertad, Junin, **5039.3** at 1004. Man with long SS talk including ID. Female vocal and flute. (D'Angelo, PA) Ondas del Rio Mayo, Nuevo Cajamarca, **6797.5** at 0139 with rustic OA vocals and man with long talks in between. Long sign-off anmt at 0202, orchestral anthem at 0205. (D'Angelo, PA) Radio del Pacifico, Lima, **9674.8** at 0806 with fast-talking woman in SS with religious talks, some choir vocals. Fair, with // **4975** weak. (D'Angelo, PA)

**PHILIPPINES** — VOA relay, **9770** at 1715 with ID, "Talk to America" program. (MacKenzie, CA) Radio Veritas Asia, **9525** in unid. language at 1547. Music and narrative. EE ID at 1556 and off. (Burrow, WA)

**QATAR** — Qatar Broadcasting Service, **17795** at 1632 with music, man with telephone interview in AA, more music to news at 1700. Woman with ID and frequency anmt at 1702. Off at 1705. (D'Angelo, PA)

**ROMANIA** — Radio Romania Int'l, **11940** with letters program at 0250. (Brossell, WI) **15180** with EE news at 0210. (Paszkiwicz, WI) **15365** with features at 2103. (Limbach, PA)

**RUSSIA** — Radio Studio, **9640** at 0200 in several languages, mostly RR/EE. Transmitter came on about 0140 and series of tones began at 0150. Nothing but IDs for the first seven minutes. Mostly catchy RR tunes and announcements about the station. (Montgomery, PA) **9940** at 0155 with open carrier to 0200 sign-on with ID, phone number (781-216-7170), E-mail and postal addresses. Mostly RR talks and techno pop with some EE segments about the beauty of St. Petersburg. Off at 0300. (D'Angelo, PA) Voice of Russia, **9480** to SE Asia at 1350. (Barton, AZ) **9665** (Moldova) at 0410. **11750** at 0345 and **15455** at 2025. (Limbach, PA) **12000** at 0435. // **9665**, **11750**, **176565**, **17650**, **17660**, **17690**. (MacKenzie, CA)

**SEYCHELLES** — Far East Broadcasting Assn., **11600** at 1542 with sermon, ID, IS and off at 1545. (Burrow, WA) **11640** at 1643 in unid. language, IS and off 1659. (Miller, WA)

**Everhardt** Antennas™  
 "Quality Crafted 'Tiger' Products" SINCE 1975

**NEW!!!**  
**Mobile Antenna Line Released by Marvel Communications**  
**HF, VHF, UHF Cellular and More**

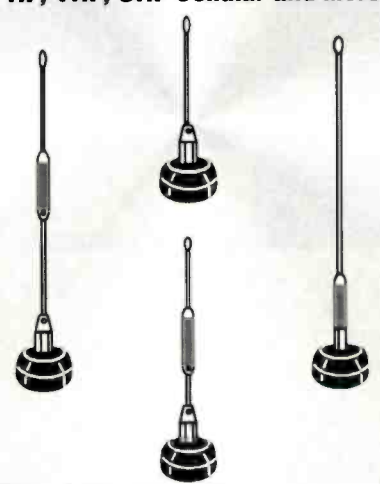

**MARVEL COMMUNICATIONS**  
 6000-D Old Hemphill Road  
 Fort Worth, TX 76134  
 Phone: 800-735-0176 or 817-568-0177  
 Fax 817-293-4441  
 Email: tigerever@aol.com  
 www.everhardtantennas.com

**electronic components**



**www.mouser.com**

**MOUSER**  
 ELECTRONICS

A COMPANY

**800-346-6873**



Old and new together in this striking QSL from RDP International, Portugal.

BBC relay, 11730 at 0328. African news at 0400. 15420 at 0340 to Africa. (Brossell, WI)

**SINGAPORE** — Radio Singapore Int'l, 6000 at 1252 man and woman with talks, pops. ID at 1259 and woman with news. (MacKenzie, CA) 6150 at 2307 with frequent IDs and news, traffic, weather. (D'Angelo, PA) 9665 in unid. Asian language at 1115. (Barton, AZ)

**SOLOMON ISLANDS** — SIBC, 5020 at 1013 with man anncr and local music. (Montgomery, PA)

**SOMALIA** (tentative) — Radio Gaalkacyo, 6995 at 0320 with Somalia-type music, talks in unid. language at 0330. (Alexander, PA)

**SOUTH AFRICA** — Channel Africa, 9525 at 1556 with IS, ID, and news. (Burrow, WA)

**SOUTH KOREA** — Radio Korea Int'l, 9535 (via England) at 0714 with talk by man in KK, then by a woman. (Jeffery, NY)

**SAIPAN** — Radio Exterior de Espana, 15067 at 0143 with EE press review and SS course. New frequency? (Jeffery, NT) (Sounds more like a spur or something — Ed) 15110 in SS at 22045. (MacKenzie, CA)

**SWAZILAND** — Trans World Radio, 3240 heard at 0319 with sermon in unid. language, vocal and EE ID at 0330. Singing and talk until music box IS and close at 0345. (D'Angelo, PA)

**SUDAN** — Radio Omdurman, 7200 at 0315 in AA with talks. ID and news at 0330. (D'Angelo, PA)

**SURINAM** — Radio Apinte, 4991 at 0356 with continuous rock/pop vocals, man giving ID between numbers. (D'Angelo, PA)

**SWEDEN** — Radio Sweden, 9495 at 0240. 11895 with EE ID at 0329 and opening of half hour broadcast. (Brossell, WI) 13625 at 0149 with "60 Degrees North" in progress. (Foss, Philippines) 17505 at 1230 with news in EE. (Northrup, MO)

**SYRIA** — Radio Damascus, 13610 at 2150. Woman with AA music. (MacKenzie, CA)

**TAIWAN** — Radio Taipei Int'l, 7130 in JJ at 1237. (MacKenzie, CA) 9610 at 1200 sign-on with ID, anmts "This is CBS, Radio Taipei International, broadcasting from the Republic of China." (D'Angelo, PA) 9680 (via WYFR) at 0215. (Burrow, WA) 15266 (nominal 15265) at 1416 with international trade program. (Barton, AZ)

**THAILAND** — Radio Thailand, 7260 at 1100. Carrier on while monitoring Vanuatu, ID 1101: "Radio Thailand World Service" and into VV service. (D'Angelo, PA) VOA relay, 7260 in unid. Asian language. VOA ID at 1200. (Brossell, WI)

**TUNISIA** — RTV Tunisienne, 7110 at 0359 with frequencies and website address in AA as ww.radiotunis.com. (Brossell, WI)

12005 in AA at 0432 with nice Arabic music. (MacKenzie, CA)

**TURKEY** — Voice of Turkey, 11655 with news in EE at 0305. (Brossell, WI) 0315 with history program. (Limbach, PA)

**UKRAINE** — Radio Ukraine Int'l, 12040 at 0305 with "That was the news from the studios of Radio Ukraine International. Now Ukrainian Diary.." (Brossell, WI)

**UNITED ARAB EMIRATES** — Adventist World Radio relay on 11945 at 0346 with talk and vocals, multi-language IDs at 0358 and brief IS to 0359 close. (D'Angelo, PA) UAE Radio, Abu Dhabi, 9605 at 1712 in AA with an interview. (MacKenzie, CA) UAE Radio, Dubai, 13675//15400 at 0333. News and ID. (Burrow, WA)

**VANUATU** — Radio Vanuatu 7260 at 1054 with romantic vocals, some talk and more music to ID and sign-off followed by orchestral anthem and off at 1117. (D'Angelo, PA)

**VATICAN** — Vatican Radio, 9605 at 0315 opening to Central and South America in SS and ID as "Radio Vaticana." (Brossell, WI)

**VENEZUELA** — Radio Tachira, 4830 in SS at 0300 with continuous lively Latin music and man announcer. (D'Angelo, PA)

**VIETNAM** — Voice of Vietnam, 5924 in VV at 1240. (MacKenzie, CA)

**YEMEN** — Republic of Yemen Radio, 9780 in AA at 0320. (Brossell, WI)

**YUGOSLAVIA** — Radio Yugoslavia, 11870 at 0010 with news about a war crimes trial, "Music Heritage" program and off at 0025. (Limbach, PA)

**ZANZIBAR** — Radio Tanzania-Zanzibar, 11734 at 1930 with U.S. pops to 2000, Middle Eastern music from 2002. Short national anthem at 2059 and off 2100. (Alexander, PA)

That's it! Party favors to the following who did the good thing this month: Jack Linonis, West Middlesex, PA; Sheryl Paszkiewicz, Manitowoc, WI; Richard D'Angelo, Wyomissing, PA; Stewart MacKenzie, Huntington Beach, CA; Robert Brossell, Pewaukee, WI; Bruce Burrow, Snoqualmie, WA; Mark Northrup, Gladstone, MO; Sue Wilden, Noblesville, IN; Rick Barton, Phoenix, AZ; Dave Jeffery, Niagara Falls, NY; Brian Limbach, Pittsburgh, PA; Marty Foss, Guinayang, Philippines. Mike Miller, Issaquah, WA and Robert Montgomery, Levittown, PA. Thanks to each one of you!

Until next month, good listening! ■

Ooops!! Over the years we've owned (and loved) several Hallicrafters and Hammarlund receivers and so obviously know the difference between them. So it could only have been a "senior moment" that caused the beautiful Hammarlund receivers to be given the Hallicrafter's name in one of the photos in our September issue.

**FREE SAMPLE COPY!**

**ANTIQUE RADIO CLASSIFIED**

*Antique Radio's Largest-Circulation Monthly Magazine*

Articles - Classifieds - Ads for Parts & Services  
Also: Early TV, Ham Equip., Books, Telegraph, 40's & 50's Radios & more...

Free 20-word ad each month. Don't miss out!

1-Year: \$39.49 (\$57.95 by 1st Class)  
6-Month Trial - \$19.95. Foreign - Write.

A.R.C., P.O. Box 802-T14, Carlisle, MA 01741  
Phone: (978) 371-0512; Fax: (978) 371-7129  
Web: www.antiqueradio.com

**YOU HAVEN'T HEARD NOTHIN' YET**

Since 1967, CRB Research has been the world's leading publisher and supplier of unique hobby and professional books and information including:

- Scanner Freq. Guides
- Broadcast Station Registries
- Shortwave Freq. Guides
- Military/Federal Comm.
- Undercover Communications
- & Other Related Topics!

**CRB RESEARCH**  
PO Box 56, Commack, NY 11725 (631) 543-9169 FAX: (631) 543-7486  
e-mail: sales@crbbooks.com www.crbbooks.com

**A.P. COMMUNICATIONS**

**Anttron 8010-B Base Antenna**

- 80-Thru-10 meters with Tuner
- 18 Ft. Overall Length 3-6 Ft. Sections Fiberglass
- Construction U.V. Protected
- HF Mobile AMP 10-80M
- Mobile 10M Radio
- P-225W P-250W P-400W P-600W
- M-650W M-1200W M-1500W M-1800W M-2000W
- Base 10M Radio

**Call or Fax 215-425-3073**

SELL TO LICENSED 26 PAGE PICTURE PRICE SHEETS \$5.00  
\$125  
1421 E. Hewson St., Philadelphia, PA 19125

# books calendars videos

## 2002/03 calendars

Only **\$10.95 ea.**

### The Mobile DXer

by Dave Mangels, AC6WO

An in-depth look at Mobile DXing- includes its language; versatility; selecting and installing mobile HF radios; mobile HF antennas and tuners; tuning HF antennas; utilizing tools, tactics, and techniques; and more!

Order No. DXER ..... **\$12.95**

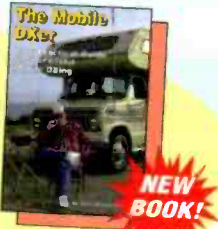

**NEW BOOK!**



Fifteen month calendars  
January 2002 through March 2003  
(Specify Amateur Radio or Classic Radio)

Classic Radio Calendar features 15 magnificent photos of some of the memory-jogging, heart-tugging gear that so many of us treasure or aspired to years ago!

Amateur Radio Calendar brings you 15 spectacular images of some of the biggest, most photogenic shacks, antennas, scenics and personalities.

### W6SAI HF Antenna Handbook

by Bill Orr, W6SAI

Inexpensive, practical antenna projects that work! Guides you through the building of wire, loop, Yagi and vertical antennas.

Order No. HFANT ..... **\$19.95**



### Building and Using Baluns and Ununs

by Jerry Sevick, W2FMI

This volume is the source for the latest information and designs on transmission line transformer theory. Discover new applications for dipoles, yagis, log periodics, beverages, antenna tuners, and countless other examples.

Order No. BALUN ..... **\$19.95**



## video special!

~~\$19.95~~ **NOW ONLY \$12.95 ea.**



Buy all 7 for your Club for only **\$69.95**

- Ham Radio Horizons: The Video ..... Order No. VHOR
- Getting Started in VHF ..... Order No. VVHF
- Getting Started in Ham Radio ..... Order No. VHR
- Getting Started in DXing ..... Order No. VDX
- Getting Started in Packet Radio ..... Order No. VPAC
- Getting Started in Amateur Satellites .. Order No. VSAT
- Getting Started in Contesting ..... Order No. VCON

### McCoy on Antennas

by Lew McCoy, W1ICP

Unlike many technical publications, Lew presents his invaluable antenna information in a casual, non-intimidating way for anyone!

Order No. MCCOY ..... **\$15.95**

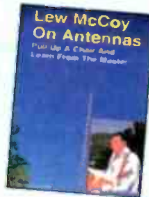

### The NEW Shortwave Propagation Handbook

by W3ASK, N4XX & K6GKU

A comprehensive source of HF propagation principles, sunspots, ionospheric predictions, with photography, charts

and tables galore!  
Order No. SWP..... **\$19.95**

### 33 Simple Weekend Projects

by Dave Ingram, K4TWJ

Do-it-yourself electronics projects from the most basic to the fairly sophisticated. You'll find: station accessories for VHF FMing, working OSCAR satellites, fun on HF, trying CW, building simple antennas, even a complete working HF station you can build for \$100. Also includes practical tips and techniques on how to create your own electronic projects.

Order No. 33PROJ ..... ~~\$15.95~~ **\$9.95**  
**NOW ONLY**



### The Quad Antenna

by Bob Haviland, W4MB

Second Printing  
An authoritative book on the design, construction, characteristics and applications of quad antennas.

Order No. QUAD ..... **\$15.95**



**Hot New Item!**



### Ham Radio Magazine on CD

Brought to you by CQ & ARRL

Here's what you've been waiting for! Enjoy quick and easy access to every issue of this popular magazine!

Three sets, each containing 4 CDs - broken down by years:

- 1968-1976 Order No. HRCD1 **\$59.95**
- 1977-1983 Order No. HRCD2 **\$59.95**
- 1984-1990 Order No. HRCD3 **\$59.95**

Buy All 3 Sets and **Save \$29.95!**  
Order No. HRCD Set ..... **\$149.95**

Visit Our Web Site  
[www.cq-amateur-radio.com](http://www.cq-amateur-radio.com)

Name \_\_\_\_\_ Callsign \_\_\_\_\_  
Street Address \_\_\_\_\_  
City \_\_\_\_\_ State \_\_\_\_\_ Zip \_\_\_\_\_

Qty	Item #	Description	Price	Total Price
U.S. and possessions - add \$4 shipping/handling. Foreign - shipping/handling charges are calculated by order weight & destination.			Shipping/Handling	
			Total	

Method of payment  Check  Money Order  Visa  MasterCard  Discover  American Express  
Credit Card No. \_\_\_\_\_ Expiration date \_\_\_\_\_

CQ Communications Inc., 25 Newbridge Rd., Hicksville, NY 11801/516-681-2922; Fax 516-681-2926

### “Black Box Radio” Part II — Software Definition And Control

In last month's column I began providing you with a detailed look at what I believe to be the future of radio monitoring technology. That is the new generation of “Black Box” radios that are computer software defined and controlled. Please make special note of that term “software defined.” That is because it is this particular feature that separates the new computer based technology that I will be writing about from the popular monitoring radios developed during the mid to late 1990s.

Most desktop and portable monitoring radios today have computer circuits built into them that allowed for sophisticated tuning and the digital processing of signals. Rather than using mechanical methods to tune and control these radios, radio signals are selected and processed in solid-state devices that are controlled by software programs. These software programs are built permanently into the radio in the form of “firmware” or allow alternative software programs to control the circuits by using an external software package run in a personal computer that is connected to the radio by a cable.

This approach allows a higher degree of tuning control than earlier model analog radios (e.g. those that used tuning capacitors and coils to tune signals) ever provided. For example, rather than having to “guesstimate” a frequency off of a slide rule dial, today you can tune a signal in 1 Hz steps and be certain of its accuracy by directly reading the frequency off of a digital read-out. Likewise many of these radios allow you to store hundreds of pre-set frequencies in the radio for instant retrieval. Depending upon the make of the radio, this feature allows you to scan groups or banks of frequencies in systematic ways.

The impact that this new computer based tuning and processing technology has had upon radio monitoring cannot be understated. Today our ability to find and listen to faint, distant or difficult signals has been greatly enhanced. At the same time the actual operation of most radios has been simplified as most tuning functions have been reduced to a single control with a direct and accurate read-out of the frequency tuned.

Indeed, today you can generally operate a monitoring radio by simply selecting a frequency where a signal is known to exist, and then adjust the sound volume to a comfortable level. Generally with today's technology a signal will either be heard because propagation conditions are optimal, or it will not. If a signal is missed, the fault generally is to be found in either the antenna system used (e.g. improperly installed or inadequate to the task) or in the lack of signal available to be picked up by the antenna.

So given the high state of sophistication that is already available to us with the current generation of desktop and portable radios, why do we want to go on to something different?

The answer to that lays in the term I used earlier, which is “software defined.” While it can be said that all radios are basically the same thing — a tuned circuit that captures a specific

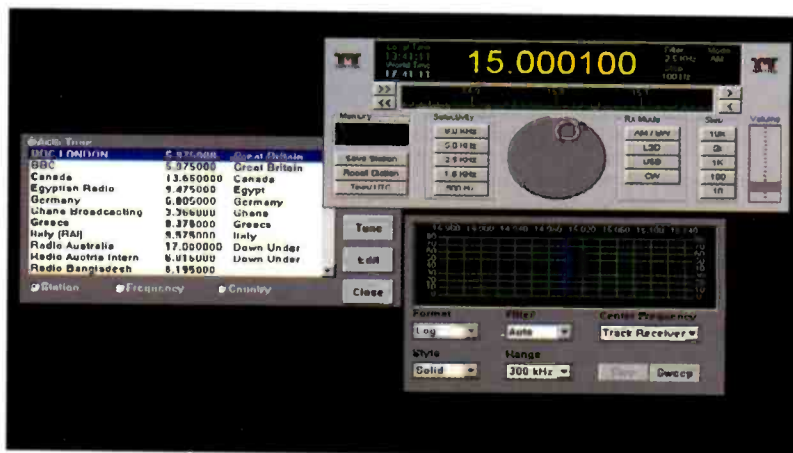

The default control software for the Ten-Tec RX-320 showing the tuning, scanning, and database modules. You can close and open these modules as needed.

frequency out of the radio spectrum, then detects information contained in a signal found there — not all radios satisfy the requirements of a given user. Once you begin to practice radio monitoring you quickly find that each type of radio service has its own particular demands that can only be satisfied by a particular set of features found with in a particular radio design.

As a result of this fact you will find that most people who monitor radio signals in a serious way will have more than one radio in their shack. Even those who are more relaxed in their monitoring requirements will find that they prefer one radio to another because of the way that certain features perform. One radio will have better tuning characteristics, while others will have a better sound. Yet another will cope better with noise and static, while others will simply “feel” better.

Up until recently these particular characteristics were something that was fixed and unchangeable in a particular make and model of radio. In some ways that fact was what defined a particular radio, and either made or broke it's reputation. Indeed you could even find variation in one make of radio due to variations in components or manufacturing.

Today all has changed with the “Black Box” radio. This is due to having its operational characteristics defined by the software that operates it, rather than its mechanical design. Indeed, as I will show you in this column, the skill and imagination of the software designer/programmer can now define the radio — and even make later change to that that definition “on the fly” by modifying their programming.

What the implications are for such an approach is that the “Black Box” radio that you buy today can be significantly changed and improved after it has been purchased. More importantly based upon the selection of a particular software package you can define the type of radio that you want with greater flexibility than is available with a standard radio.



Name	Type	Use	Website	Comments
Scan320	Free	UTE	<a href="http://www.mindspring.com/~tom2000/">http://www.mindspring.com/~tom2000/</a>	Has a very good scan function for use with banks of individual frequencies <a href="http://www.mindspring.com/~tom2000/rx320/Scan320.html">rx320/Scan320.html</a>
George Privalov	Free	SWL	<a href="http://www.apptd.com/rx320.htm">http://www.apptd.com/rx320.htm</a>	Third party database support (IGL). Has map on-screen of world and audio output oscilloscope.
GNRX320	Free	SWL	<a href="http://gniephaus.tripod.com/gnrx320/gnrx320.html">http://gniephaus.tripod.com/gnrx320/gnrx320.html</a>	Simple and robust. Third Party database support
Radio 320	Free	SWL	<a href="http://www.tufox.com/jim/rx320/">http://www.tufox.com/jim/rx320/</a>	Interesting scanning function with spectrum analyzer. Third party database support
Ten-Tec	Free	SWL	<a href="http://www.tentec.com/RX320FTP.htm">http://www.tentec.com/RX320FTP.htm</a>	Download and check out the default software package provided with the radio Dextra
Worldstation	Com	UTE/SWL	<a href="http://www.dextra.com/">http://www.dextra.com/</a>	JAVA programming allows use with UNIX, MAC, OS/2. Can be operated across a LAN using TCP/IP. Has advanced spectrum analysis
ERGO	Com	SWL	<a href="http://swldx.com/pd_ergo.htm">http://swldx.com/pd_ergo.htm</a>	Very good Propagation/Grey Line analysis built in. Best used to track DX stations
RXtra320	Com	SWL	<a href="http://www.ip.pt/coaa/rxtra320.htm">http://www.ip.pt/coaa/rxtra320.htm</a>	Record live audio at a pre-determined date and time
Scancat	Com	UTE/SWL	<a href="http://www.scancat.com/">http://www.scancat.com/</a>	"All in one" package that supports a wide range of radios. Can be enhanced with extra modules

Let's take a look at how that can be done using Ten-Tec's RX-320 as the example radio.

## Control Software For Ten-Tec's RX-320 "Black Box"

In last month's column I gave you a fairly detailed tour of the circuitry of the RX-320, which was originally made available to the public in 1998. It is a surprisingly simple device, being made up of only two integrated circuits and a handful of signal buffering components.

The box itself has no control features other than an on-off switch. Only plug-in points for the antenna, audio, power, and the serial port connection for the computer cable are accessible. (For more information about the performance specifications of this product, see Ten-Tec's product webpage for the RX-320 at <http://www.tentec.com/TT320.htm>).

The real control of the RX-320 comes from the software that can "talk" to the circuitry used in the radio. More specifically, it is from a series of computer commands placed into the software that tells the radio to perform specific functions, such as setting a particular level of audio volume.

At first glance the actual number of functions that can be software controlled appears to be very limited. Only eight specific functions can be directly controlled, and these are;

- Mode (AM, USB, LSB, CW)
- Frequency
- Filter (Bandwidth from 300 Hz to 8000 Hz)
- AGC (Slow, Medium, and Fast)
- Speaker and Line Output (individual or both)
- BFO (on/off)
- Signal Strength (adjust level shown)
- DSP Firmware (display)

Again, this may seem to be a limited number of things that can be done, but when software development is undertaken in a skilled way, the computer programmer can incorporate a number of additional features that use these commands as their foundation. Two examples of this type of programming enhancement can be the inclusion of variable rates of tuning (while scanning frequencies) and the selection of different frequency increments (e.g. 1 k, 10k, or 100k steps).

To really understand the potential that can be achieved by a software programmer when approaching the control of the RX-320, it is important to understand that they have four main areas that they can program for. These are;

1. The use of the command set controlling the radio functions (e.g. the commands mentioned above)
2. The control of the use of the command set (e.g. the setting of rates, ranges, or levels for those commands)
3. Control of events taking place outside of the radio (e.g. the managing of data bases of frequencies)
4. Communicate with other software programs or operating systems

What a good computer programmer attempts to achieve when combining these four areas into their final software product is a synergy of each component working together in order to have each complement the other in a balanced way. This balance is experienced in subjective ways, such as "ease of use," "logical layout" and most importantly "results."

I mention all this in order to make you aware of the framework that can be used to evaluate the success of a particular software program. The main criteria for measuring that success is evaluating how it uses the features of the RX-320 and the operating system of the personal computer in which the control program resides.

The ability of a software programmer to be able to achieve the aforementioned balance varies in proportion to their skill, knowledge and commitment to quality. This becomes particularly important as each of the four areas become incorporated into the final software design. The bottom line for a software product that successfully incorporates all four areas in a balanced way is that it must be very well written and tested.

For the simple reason that not all programmers do their work at the same level of skill and ability, there will always be variations in success between software products. The software that is available for the RX-320 is not exception to this fact. For this reason I will present a sampling of these software products to you, and then focus upon the one that appears to be the most successful in incorporating the four areas in a balanced way.

## Reviewing The RX-320 Software

When Ten-Tec released the RX-320 in 1998 they did so with an important policy. Even though they supplied the user with a

good control package of their own design, they decided to encourage experimentation. To do this they provided as much information as possible about the hardware and software components of the radio.

As a result of this enlightened policy, a significant number of third party software packages were developed. What was even more surprising, and as a way of saying "thank you" to Ten-Tec for their generosity, the majority of people who developed these packages have offered their software over the Internet for free.

In addition to these free packages, a number of commercial software products are also available for a reasonable price. What you get for your money is a group of programs that are notable for their high production values and innovative features. They are intended for the "professional" radio monitor, and in most cases carry a number of sophisticated addition to their design that make them more appropriate for more complex or demanding monitoring tasks.

Because of the level of detail that would be needed to provide a complete summary of each software package this will not be attempted here. Instead a list of webpages where you can find out more detail will be provided. (Note: Unless otherwise specified, these products work in the Microsoft Windows™ 95/98 operating system only).

Each of the software products has their own strength and weaknesses, each of which will impact upon your own particular monitoring needs. In the case of the freeware you can at least download and try each to see if they meet your own particular requirements. However, I would suggest that you first install and operate the RX-320 using the software package supplied with the radio. Once you have ensured that the radio is installed, configured, and working properly using the default software package, then you can then experiment using the alternative software packages.

Having said that I would like to introduce to you one package that stood out in my evaluation, and which deserves consideration by anyone whom is serious about their radio monitoring. That is DXtra's Worldstation software package.

## Worldstation 2.0 For The RX-320

One of the unique features of the RX-320 is that while the basic design has not been changed since it was first introduced in 1998, it still gets better every year. This is due to the fact that software development has continued to progress to the point where more and more potential is being extracted out of the original design.

This is particularly true in the case of DXtra's Worldstation software, which has been optimized to support the features of the RX-320. Original released in 1996 as a software control program for high-end monitoring radios such as the JRC 535D, the product has gone through several stages of development.

Originally written for the now defunct NEXT computer operating system, the developers of the software have always resisted being pushed into the Microsoft Windows programming environment due to the limitations found there. This is the rea-

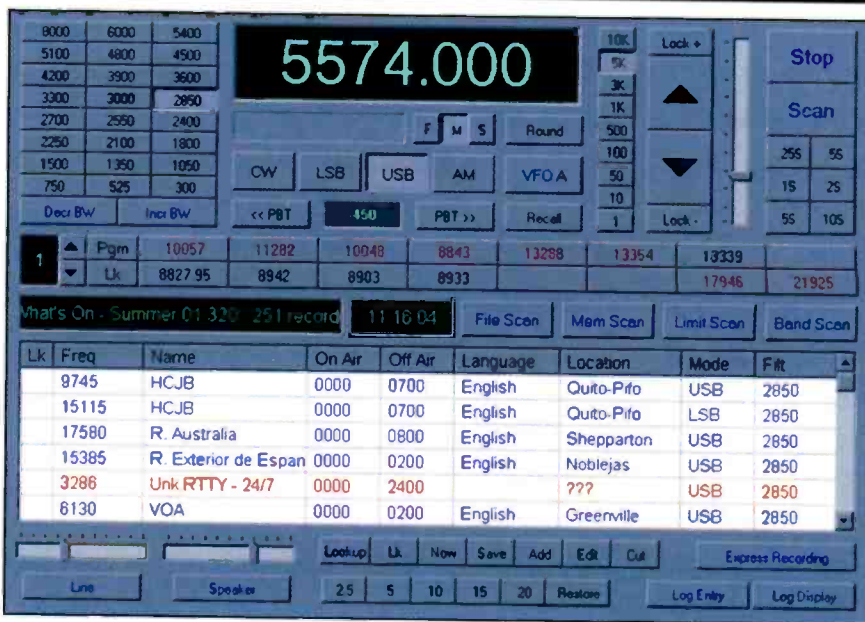

Picture 2 — Here's a popular third party control software for the RX-320, called "SCAN320" by Tom Lackamp. While it supports the same functions as the default software, it does so very differently.

son why it was decided to finally create the most current version using the Java programming language. This allows the Worldstation program to be used with virtually any computer operating system that will support the use of Java.

The fact that the Worldstation program has been written in Java means that you do not get a conventional software program. Yes, you can download free software that will operate your RX-320 or buy a commercial program that will run in your Windows operating system. However, what you not get by following these conventional paths is the unique look, feel, and operating stability that comes with Java programming.

If you take a look at the picture, you will see the unique looking interface that Worldstation presents to you when it is operating. Not only does it look nice, the controls operate better than what is experienced in standard Windows programs — with fewer tendencies to lock up or lose functionality over time. Likewise many of the controls are three dimensional, and will turn or move in a life-like way.

These points may not seem important now, but they do become appreciated when using the controls in "real world" situations where you may need precision control when monitoring a difficult station. Likewise the layout and design of the front panel has been undertaken with many usage considerations being well thought out ahead of time. Everything follows a logical pattern in the layout so that "must need" buttons are easy to get to, while "least need" buttons are placed out of the way.

But the system is more than just "a pretty face." There are a lot of brains built into the program that is put to use constantly. It must be understood that in the case of the RX-320 is not just a case where the software sends a command and then goes to sleep. Rather the software and the radio are in a constant state of communication, giving each other updates and new information all the time the radio is on and operating.

This becomes particularly apparent when the software is used in its more active roles, such as scanning. Here not only does the software sift through the frequencies in a systematic way, it

can also be undertaken with an analysis of the results that are both analysed and mapped using a color code. The result is a "water fall" display of activity over time, with blue colors indicating low activity, and red indicating high. You can jump to a frequency showing high activity by simply pointing and clicking on that location in the display.

You can manage your lists of frequencies in a variety of different ways. You can use existing data bases obtained from subscription services such as ILG. You can also build tables of frequencies using any software that can work with Excel spreadsheet files. Likewise you can also follow "audit trails" of frequencies that you may have punched into the radio as you were monitoring an event. These too can be saved in Excel spreadsheet file format for easy modification.

The truly unique feature that the Worldstation software possesses is its ability to control the RX-320 over a local area network (LAN). It is exceptionally simple to do for you — type in the TCP/IP address and COM port proxy into the COMM port settings window. As long as a serial cable is attached to LAN connected computer using the LINX operating system for use by the radio, the connection is virtually automatic. Increasingly LINX is becoming a popular due to its stability and open architecture (not to mention the fact that it is essentially free).

There are actually many more features that make the Worldstation stand out as an excellent control program for the RX-320 that are of real interest to those who monitor ute services. It's cost is reasonable, and given what you get for that cost, it really is a cost effective way to get the most out of the "Black Box." Do take some time to check out the website for this product, the address for which I have listed with those of the other software packages.

Really and truly this is the way in which radio monitoring is going to be heading from here on in. Take some time now to become aquatinted with this new technology, and you will be very impressed with its ease of use and what it can do for you.

## Reader's Letters

People are still writing, and this is a good thing. I'm already starting to get some responses to the issue of computer-controlled radios. Here is one example:

Hello, Joe!

Just wanted to drop a line about your article in September's issue of *Pop Comm*.

I wanted to put in my opinion on computers and radio. I am not an old fart but I am one of those with the mindset that the Internet is a great tool but I would gain no pleasure with "instant, brainless" tuning. I like the hobby because it is challenging, not easy. If I wanted easy, I'd listen to Art Bell (Also available on the Internet!) every night.

Now, in fairness, I am not a big Ute fan, although I read your column every month and have been known to twirl the dial in the "odd" sections of the spectrum.

I am the type of SWL that would rather listen to Radio Japan on 13630 from Japan when I could just as easily pick up 6110 relay from Sackville, Canada, and with better sound to boot.



Picture 3 — DXtra's Worldstation control software for the RX-320 is written in the JAVA programming language, so as a result it looks — and performs — very differently from the other available programs.

Yes, I have a wireless networked house (have had it since '99) so I consider myself cutting edge. In fact, I am happy just taping my good catches onto a Dolby HX Pro cassette recorder and then ripping them to my Mac so I can share with those who would like to know what I'm hearing in my corner of the world.

I have no doubt that sooner or later my version of radio will dry up and disappear on me. When that time comes, I may resort to flying a kite or find something else to do. When my hobby becomes so easy that anyone with a computer can get anything, any time I would consider that highly boring.

It was before my time but it is probably akin to when CBers stopped having to be licensed.

Keep up the great work with the column, I like the direction you're taking it. Indeed, you owe it to your readers to point out what direction our hobby is going and for that you should be commended.

Best regards and DX!!

Adam Christian Smith  
Washington State

These are all very good points, Adam. What's ironic is that today more people are using radios than ever before. But the form that this radio is going to take will be different in form than the ways that we have been used to (cell phones and other "wireless" devices for example).

But just in the same way that people did not give up on radio when vacuum tubes made crystal radios obsolete, we will find that radio — even shortwave — will persist much longer than we may expect. Rather than giving up now, let's hang in there and see what happens.

Whatever will happen, it promises to be interesting.

And speaking of interesting, do any of you have an answer for this question?

Joe.

What do the Stargate callsigns on USAFGHFS frequencies relate to? Are these general callsigns or do they relate to aircraft in specific squadrons or tasks?

73 de William Woodman  
Wiltshire UK

OK, can anyone out there help with an answer?

And speaking of answers here is one for Bob.P's question, which was published in the August 2001 issue. He asked "I often hear the Camslant CG guys telling the aircraft to shift to 3A11 HF and 23A FM and other alphanumeric frequencies. Do you have a decode for these alphanumeric frequency designations or would they be possibly classified?"

Here is an answer:

Hi Joe!

Re: *Pop'Comm* August 2001 Page 72 — "Utility Radio Review"

As a ham we use (in CW) the following:

3R11 which means 3.11 so probably 3A11 and 23A means 3.11 and 23 MHz respectively. Perhaps A is used because it is easier to send both in CW and voice — Alpha di-Da as opposed to Romeo di-Da-dit? Just a thought.

Phil Karras, KE3FL

Well Phil, that sounds reasonable to me. What do the rest of you think? Any alternative theory or does this one stand?

## Reader's Logs

Again we have an excellent group of logs. We have 12 contributors this month, including some new names. This month features some good military and embassy logs, as well as some interesting aviation catches. There are a number of logs that are UNID. If you have some solutions or suggestions as to who they are, please send them along.

All frequencies are in kHz, and times in Z.

**00000:** STATION. Anytown, USA, summary of traffic heard in MODE at 0000 Z (Z). personal comments here (JC)

**273:** Sept-Iles NDB Sept-Iles Canada 0444 CW w/id. (MADX)

**332:** Oxonn NDB Washington DC 0435 CW w/id. 25 watts. (MADX)

**342:** Martin State Airport NDB Baltimore MD 0402 CW w/id. (MADX)

**349:** Aberdeen Proving Grounds NDB Aberdeen, MD 0408 CW w/id. (MADX)

**355:** Cambridge NDB Cambridge MD 0433 CW w/id. (MADX)

**363:** Rainbow NDB Millville, NJ 0426 CW w/id. 50 watts. (MADX)

**366:** Maniwaki NDB Maniwaki Canada 0424 CW w/id. (MADX)

**371:** Ellicott NDB Baltimore MD 0356 CW w/id. (MADX)

**385:** Montgomery County Airport NDB Gaithersburg MD 0404 CW w/id. (MADX)

**391:** Dorado NDB San Juan, Puerto Rico 0416 CW w/id. (MADX)

**392:** Charlevoix NDB Charlevoix, Canada 0413 CW w/id. (MADX)

**404:** Institute NDB Baltimore MD 0358 CW w/id. 25 watts. (MADX)

**518:** USCG COMSTA New Orleans 0320 NAVTEX [G] (MADX)

**518:** USCG COMSTA Miami 0405 NAVTEX [A]. (MADX)

**2182:** Camslant calling motor vessel *Advance* 0148z (LH)

**2360:** UNID. Hispanic accented "illegal frequency...Cease operations... Up 2 kHz" in USB at 1935, repeated. Perhaps directed at south-bound II net. (RW)

**2582:** Bermuda Harbor Radio 0437 USB w/MIB. (MADX)

**2598:** Canadian Coast Guard Stephenville 0207 USB w/MIB. (MADX)

**2670:** Coast Station District 3 with WX info for mariners 7/28/01 0210z (LH)

**2670:** USCG Group Ft. Macon, NC 0108 USB w/MIB joined in progress. (MADX)

**2670:** USCG Group Hampton Roads VA 0203 USB w/MIB. (MADX)

**2670:** USCG Group Eastern Shore 0237 USB w/MIB joined in progress. (MADX)

**2749:** Canadian Coast Guard Fundy 0154 USB w/EE MIB joined in progress. (MADX)

**3137:** USAF Lajes 0341 Mil-STD 188-141A/USB sounding. Also on 3059. (MADX)

**4003:** U.S. Army MARS NET, AA4FR, AA4BC, etc., at 0140 in LSB. (RW)

**4012:** 5ST, ASECNA Antan 0340 ARQ-E3 48/400 Betas (RH2)

**4013:** U.S. Army MARS net, at 0148 in USB. lots of static, but more as I hear them. (RW)

**4026:** AAR3DY 0132 USB w/Army MARS net. Stations included AAT3HJ, AAR3DR, AAR3DA, AAR3DM, and AAT3GW. (MADX)

**4235:** UNID, UNID: 0330 FAX 120/576 Looked like Iceland & UK (RH2)

**4271:** CFH, CF HaliFAX 0433 RTTY 75/850 Aero WX (RH2)

**4295:** FUE, FN Paris 0326 RTTY 75/850 RY/ID/QWERTY etc (Call used to be HWN (?)) (RH2)

**4426:** USCG CAMSLANT 0500 USB w/highseas forecast. /6501/8764/ (MADX)

**4465.5:** PICC// 4465.510. On standby thru 18th/2100z (26 hrs) (10 min off QSX 1810-20z) (DW)

**4525:** 5ST, ASECNA Antan 1715 RTTY 100/400 WX codes (RH2)

**4525.3:** 5ST, ASECNA Antan 0315 RTTY 100/400 WX codes (RH2)  
**5096.8:** CFH, CF HaliFAX 0420 RTTY 75/850 NAWS de CFH etc (RH2)

**5097:** CANFORCE HaliFAX 0525 BAUDOT 75/834 w/zkr tape. (MADX)

**5450:** MVU, RAF London 0426 USB Volmet (RH2)

**5598:** U.S. NATIONAL GUARD (?) MIL.STD 188-141A ALE on USB. Clog 107 (DW)

**5598:** U.S. NATIONAL GUARD (?) MIL.STD 188-141A ALE on USB. Clog 116 (DW)

**5598:** U.S. NATIONAL GUARD (?) MIL.STD 188-141A ALE on USB. Clog 119 (DW)

**5598:** NATIONAL GUARD (?) MIL.STD 188-141A ALE on USB. Clog 119 (DW)

**5598:** U.S. NATIONAL GUARD (?) MIL.STD 188-141A ALE on USB. Sounding. (DW)

**5696:** Camslant wkg 1701, 1701 said that District 7 suggested sending a helicopter to the area. 2331z (LH)

**5696:** REACH 9019: 0004 USB wkg CAMSLANT w/HF radio check on two transmitters. (MADX)

**5845.5:** GYU, Gibraltar 20.05 Piccolo 6 Op chat to UNID station, requesting QSY (PT)

**6439.5:** CCZ (?), UNID 1644 ARQ No ID! Could be UDK (?) (RH2)

**6449.7:** PWZ33, BN Rio de Janeiro 0628 RTTY 75/850 Navarea Wngs in PP & EE (RH2)

**6496:** ZSD, SA Navy Durban 1608 MFSK32 54.5bd NEW FREQUENCIES!! //8605.0 (RH2)

**6496:** CFH, CF HaliFAX 0453 RTTY 75/850 Aero WX (RH2)

**6496:** UNID, FAPSI 2004 Crowd36 Mazielka (RH2)

**6501:** Camslant Wkg CGC Eagle and O5N Camslant say they will be sending traffic on 13 MHz 0008z (LH)

**6501:** Camslant wkg Blue Star Camslant said that they are still looking for the info that Blue Star requested. 2115z (LH)

**6632.5:** UNID, PICC// 6632.510. On standby thru 1917z (DW)

**6632.5:** UNID, British Mil/Dip(?) 08.20 Piccolo 12 After days on stand-by, now sending encrypted TFC (PT)

**6758:** UNID, alternating tones heard sounding like a "foghorn:" (USB) 1530. AFA6DJ, others, in MARS net @ 1530 (USB) 0040 utc. "Offutt" w/EAM broadcast. (USB) Mexican fishing vessels. Sea of Cortez area. (RB)

**6768:** Atencion Numbers Station 0434 AM YL/SS w/5FGs. (MADX)

**6816.4:** UNID, Unknown 19.45 Coquelet 8 Two stations sending online encryption to each other at 13.33 and 26.67 baud, one using 6816.38 and the other 6816.41. Very difficult to lock on, but definitely Coquelet 8 (PT)

**6940:** UNID: Russian MFA 0411 CROWD36 weak (MADX)

Only  
\$10.95 ea.  
+\$2 s/h

**CQ**

1994 1995 1996 1997  
1998 1999 2000 2001

and now...  
**the 2002**  
**CQ calendars**



*better than ever, all digitally photographed, and still 15 months of value.*

The new 2002/2003 CQ Radio Classics Calendar features fifteen magnificent photos of some of the memory-jogging, heart-tugging gear that so many of us treasure or aspired to years ago. (Publisher's Note: They're making antiques a lot newer than they used to!) This year's Radio Classics Calendar features some of the great equipment of the '50s and '60s, with a smattering of the 1940s and 1930s.

Here's what's featured this year:

Collins 75S-3 Receiver, 1961; Lakeshore Bandhopper VFO, 1957; Gonset Commander II Mobile HF Transmitter, 1955; Gonset 913A 6 meter amplifier, 1964; Technical Materiel Corporation (TMC) GPR-92 Receiver, 1964; Hammarlund HQ-170 Receiver, 1958; McElroy Model 100 Straight Key, 1941; Sonar XE-10 Modulator, 1947; National NC-300 Receiver, 1955; Hallicrafters S-85 Receiver, 1954; Heathkit SB-500 VHF Transverter, 1969; Sideband Engineers SB-34 Transceiver, 1965; Swan 400 Transceiver, 1964; Drake TR-3 Transceiver, 1963; Utah UAT-1 Transmitter, 1937.

How many do you recognize? How many did you own? How many did you wish you owned?

The 2002/2003 CQ Amateur Radio Calendar brings you fifteen spectacular digital images of some of the biggest, most photogenic Amateur Radio shacks, antennas, scenics, and personalities. These are the people you work, the shacks you admire, the antenna systems you dream about having, all digitally captured by the talented Larry Mulvehill, WB2ZPI, CQ's own roving cover photographer. Larry's travels this year took him to Colorado, Montana, Wyoming, Texas, Florida and New York, capturing some of the greatest Amateur Radio photos of the year especially for this annual favorite calendar. From winter scenes of the frosty northeast to pedestrian mobile in the Rockies, you'll love this traveling Amateur Radio photo show.

All calendars include dates of important Ham Radio events such as major contests and other operating events, meteor showers, phases of the moon, and other astronomical information, plus important and popular holidays. The CQ calendars are not only great to look at, but they're truly useful, too!

**Order both versions of the highly-acclaimed CQ Amateur Radio Calendars today. Keep your collection complete!**

Save shipping by ordering more! On orders of more than one calendar, you pay just one shipping charge. Order a few for your snack. Order one for the office. Order several for your Ham friends as Holiday gifts, or just to share the fun.

**available directly from CQ and from your local dealer!**  
**\$10.95 each plus \$2 shipping and handling.**



**For Fastest Service call 1-800-853-9797 or FAX 516-681-2926**

**www.cq-amateur-radio.com**

**CQ Communications, Inc.**

**25 Newbridge Road, Hicksville, NY 11801**



- 6940.5:** UNID. British Mil/Dip(?) 08.22 Piccolo 12 After days on stand-by, now sending encrypted TFC (PT)
- 7508:** ZSJ, SAN Silvermine 1710 RTTY 75/170 WX Bulletins file://13538.0 & 4014.0 khz (RH2)
- 7586:** RFVITT. FF Dzaoudzi 0400 ARQ-E3 192/400 Betas (RH2)
- 7614:** SOUGE. Bordeaux ((?)), France 21.00 ARQ-E 184.5/400 More than 100 service messages overnight to RFFHCARQ. Ajaccio acknowledging messages on EHQ, presumably the return cct (PT)
- 7657:** DEA-contracted Rockwell Collins Comms Center Cedar Rapids 0042 USB clg "station calling ATLAS...nothing heard,out." (MADX)
- 7657:** USCG HH-60J #6020 0131 USB wkg PANTHER: DEA Nassau. Request you assume my radio guard. Currently 7POB, airborne from E5, enroute position bearing 339 range 60. (MADX)
- 7684.5:** USCG PACTOR II Station Washington DC 2200 PACTOR 100/200 clg NNN0CLL: UNID USCGC. (MADX)
- 7710:** Canadian Coast Guard Iqaluit 0525 FAX 120/576 w/Ice Analysis Chart already in progress. (MADX)
- 7791.7:** UNID, UNID: 2030 RTTY 75/850 Genuine Baudot! Online crypto (RH2)
- 7831.6:** 5ST. ASECNA Antan 1522 ARQ-E3 48/400 Marine WX (RH2)
- 7880:** DDK3 HAMBURG MET FAX//120/576/N/800 Global model (sfc pres(?)). Unlisted (DW)
- 7945.7:** RFVIC, Le Port, Reunion 20.00 ARQ-E3 192/400 COMAR LA REUNION with weather report in FF to RFVICF/BATIMENTS VEILLANT XLV and RFVITT/DETMAR MAYOTTE on ITT, Reunion — Mayotte. circuit (PT)
- 7951.4:** WHW462: Pin Oak Digital 0133 PACTOR 100/200 w/id. At 0134,into PACTOR II. (MADX)
- 8010:** Atencion Station 0611 AM YL/SS/5FGs (XL) already in progress. (MADX)
- 8047:** UNID US National Guard 1327 MIL-STD 188-141A/USB w/sounding call. (MADX)
- 8090:** UNID, "rasper". 9 dot, 1 dash patterns. Frequently heard here. (RB)
- 8097:** Atencion Numbers Station 0533 AM YL/SS/5FGs already in progress. (MADX)
- 8105:** FAVIERES: Paris, France 20.10 ARQ-E 184.6/400 Service TFC to RFFXL,Naqoura, Lebanon via XXL cct (PT)
- 8187.7:** 9MR, Malay Navrad 1610 RTTY 50/850 RY/ID (RH2)
- 8246:** BRAVO FOXTROT, net control for USS Theodore Roosevelt CVBG wkg numerous single letter callsigns in USB throughout day and night. This was a JTFEX 01-3 link coordination net. (RM)
- 8246:** USB 0224 UT — USN Worldlink (Alligator) Voice Control Net, players including November Oscar. Foxtrot, Lima and High Fox. YL in the mix as well. (SW)
- 8303:** LOR, AN Puerto Belgrano 0624 RTTY 75/170 Radiovisos & Navarea Wngs (RH2)
- 8335.5:** UNID: German Navy 0130 USB/3-CH VFT wkg UNID (prob DHJ59). VFT was very clear, but voice was weak. (MADX)
- 8418:** LSD836 Buenos Aires. ID + message. CW/SITOR, 1530Z (EAW)
- 8478.5:** French Navy Fort de France. Martinique 0340 BAUDOT 75/850 w/test tape. (MADX)
- 8484:** HLF Soul, ID + ann Freq, CW, 2148Z (EAW)
- 8494.5:** USB 0241. CLA, Radio Habana, with CW marker. (SW)
- 8500:** VTH1/5/7 IN Bombay 1557 RTTY 50/850 RY/ID etc "VFTS de Golf (RH2)
- 8504:** NMG, USCG Boston 0610 FAX 120/576 Fair chart (RH2)
- 8574:** UNID, Unknown 18.30 ITA2 75/400 Sending endless RYRYRYRY's. Still going strong at 0845z (PT)
- 8600:** XSV Tianjin, ID + ann Freq, CW, 2210Z (EAW)
- 8636:** HLW Soul, ID, CW, 2214Z (EAW)
- 8764:** Camslant wkg UNID, UNID wanted to know if another vessel made it home. Camslant will check with HalIFAX, asked UNID to call back in an hour 8/5/01 0106z (LH)
- 8764:** USCG CAMSPAC 0500 USB w/end of Highseas Forecast /13089/ (MADX)
- 8764:** USCGC COMSTA Wahiwawa 1222 USB w/Highseas Forecast. (MADX)
- 8933:** UNID, SAA Coy Freq. 0456 USB Priority Msg to All Flights! Latest Rugby Score Australia V New Zealand (RH2)
- 8971:** GRAY KNIGHT 805. P-3C VP-46, wkg WESTERN SKY (USN TSC North Island(?)) in USB during the evening hours EST. (RM)
- 8971:** BLUE STAR, USN TSC Roosevelt Roads, Puerto Rico, wkg NEWPORT ##, MUSTANG ##, and ZIPPY ## in USB. Traffic with ZIPPY 05 was reference ZIPPY assuming net control over link. (RM)
- 8971:** GOLDENHAWK, USN TSC Brunswick, ME, wkg FIGHTING TIGER 750 (P-3C, VP-8) WAFER 751 (P-3C) USB (RM)
- 8972:** UNID NET (?) HQMIL.STD 188-141A Sounding on USB. (DW)
- 8980:** CG Rescue 1712 with pp to Command Post via CAMSLANT in reference to search and on-scene time remaining. RTB E-City when complete. (DS2 W1)
- 8983:** CAMSLANT: 1729 USB wkg 2109: USCG HU-25A w/flight ops and position. (MADX)
- 8983:** CAMSLANT: 1800 USB clg 2118: USCG HU-25B. No joy. At 1806z, "This is CAMSLANT issuing a lost comms." Finally established comms at 1843z. (MADX)
- 8992:** TURBO 79 calling MAINSAIL. No joy (DS2 W1)
- 9019:** STRIKESTAR, E-8C JSTARS (93rd ACW) wkg NIGHTSTAR, E-8C JSTARS (93rd ACW) in USB for link coordination throughout evening hours EST. (RM)
- 9040.5:** 5YE, Nairobi Meteo 1730 RTTY 100/850 Metar (RH2)
- 9062:** Cuban Numbers Station 0427 CW w/5FGs (cut) already in progress. (MADX)
- 9095.5:** FDG, Bordeaux, France 18.20 ITA2 50/170 Test with RY's and Le Brick using 170 shift now (PT)
- 9121:** UNID, raspy 13 dot, 1 dash pattern. (RB)
- 9130:** MGJ, RN Faslane 1739 RTTY 75/340 Carbs (RH2)
- 9247.3:** FJY2, DTRE Kerguelen I. 0446 ARQ-E3 200/401 Betas (RH2)
- 9262.3:** QCQ, UNID 0713 Ale/USB SND Can't find callsign! Might be Gabon R(?) (RH2)
- 9316.7:** RFFSYRS: Dahrhan, Saudi Arabia 19.15 ARQ-E3 200/400 DETAIR ALYSSE with op chat in FF then message to AIR ESIC PARIS with no routing ind. and cct ID/msg number given as FX 1. More op chat then another message from RFFSYRS - DETAIR ALYSSE to RFFVA — AIR ESIC PARIS. No ZCZC or cct id given this time (PT)
- 9323:** Atencion Numbers Station 0417 AM YL/SS/5FGs already in progress. (MADX)
- 10100.8:** DDK9, Hamburg Meteo 0007 BAUDOT 50/400 w/plaintext WX msgs. (MADX)
- 10101:** DDK9, Hamburg Meteo 1745 RTTY 50/400 Marine WXEE (RH2)
- 10111.5:** FJY2, DTRE Kerguelen I. 0440 ARQ-3 200/400 Betas (RH2)
- 10119:** UNID NET (?) LOC MIL.STD 188-141A ALE on USB. Sounding (DW)
- 10200:** UNID UKRAINIAN 3SC//50/R/250 Headers in clr. 3SC eg cryptogram zw14ajna legenda-887= agat -14 04 p/s 19 1850 = nr 673. Then telegrama legend refers Ukrain "ministru oboroni ukraini, generalu armii ukraini" etc. (DW)
- 10211:** AOG MEDERA MIL.STD 188-141A on LSB. (DW)
- 10211:** AOG IN AMENAS MIL.STD 188-141A on LSB. Sounding (DW)
- 10211:** AOG (?) LOC MIL.STD 188-141A on LSB. Sounding, also 2246z (DW)
- 10211:** AOG DEBDEBA MIL.STD 188-141A on LSB. Sounding. (DW)
- 10211:** AOG (?) LOC MIL.STD 188-141A on LSB. Sounding. Also 2220, 2251 (DW)
- 10238:** UNID NET (?) LOC MIL.STD 188-141A ALE on USB. Sounding (DW)
- 10244:** AOG TIN FOUYE TABANKORT MIL.STD 188-141A on USB. Sounding (DW)
- 10244:** AOG ALRAR MIL.STD 188-141A on USB. Sounding, also at 1737z (DW)
- 10244:** AOG OHANET MIL.STD 188-141A on USB. Sounding, also at 1756z (DW)
- 10244:** AOG HASSI R'MEL. MIL.STD 188-141A on USB. Sounding. (DW)
- 10261.5:** GXQ: London, England 16.00 Piccolo 6 Calling MTS, Port Stanley (PT)
- 10284.7:** LIBREVILLE, ARQ/E3//192/E/400 8rc. Betas. 2248z cct [JDK] Controle de voie svc RFTJ de RFTJ. (DW)
- 10285:** UNIDCW CIng "JRMQ de KSMZ qtc k" (DW)
- 10314:** SNN299 MFA WARSAW CW (FIA-250HZ) Periodic marker "VVV de SNN299 pse ga" (DW)
- 10335:** BRA, Angolan Emb Brazzaville 0517 Ale/USB SND (RH2)
- 10335:** BRA, Brazzaville Emb 0625 Ale/USB Sounding (RH2)

- 10335:** KIN, Kinshasa Emb 0638 Ale/USB Sounding (RH2)
- 10335:** LUA, MFA Luanda 0649 Ale/USB Sounding (RH2)
- 10341:** GW NODE BERN CW Chan free marker (Globe) "HEC" (DW)
- 10355.2:** USCG COMSTA Kodiak PACTOR II 100/200 w/calls. (MADX)
- 10360:** GW NODE GOETEBORG CW Chan free marker (Globe) "SAB" and wkng ship in Globedata (DW)
- 10373.7:** MGJ, RN Faslane 0606 RTTY 75/850 Carbs — used to be PP Navy, Porto Santo (RH2)
- 10375:** RPTMB, PP Navrad Porto Santo 0414 RTTY 75/850 Crypto (RH2)
- 10492:** UNID, CIS Mil/Rail 1650 81-81 81/120 Strangely narrow shift! (RH2)
- 10493:** FEMA (WGY908) Region Eight 1407 LSB wkg UNID station w/check-in for the National Emergency Coordination Net (NECN) quarterly test. (MADX)
- 10493.7:** PORT BOUET (?), ARQ/E3//48/E/400 8rc. Betas. No TFC thru 2204z (DW)
- 10520:** FDG FAF BORDEAUX CW Marker "vuv de FDG ar" (DW)
- 10536:** CF HALIFAX, FAX//120/576/N/800 4 day sfc prog. Grainy image when captured (DW)
- 10536:** CFH, CF HalifAX 0631 RTTY 75/850 WX forecasts (RH2)
- 10581:** SWED EMB HAVANA MIL.STD 188-141A on USB. Sounding (DW)
- 10588:** FEMA DENTON TX MIL.STD 188-141A on USB. Sounding (DW)
- 10588:** FEMA Region Eight Denver 0350 MIL.STD 188-141A/USB w/sounding call. (MADX)
- 10619:** AOG HASSI R'MEL MIL.STD 188-141A Sounding on USB. (DW)
- 10619:** AOG ALGIERS MIL.STD 188-141A Sounding on USB. (DW)
- 10746:** GW NODE GOETEBORG CW Chan free marker (Globe) "SAB" (DW)
- 10871.7:** CISN (?)LOC. CW Single letter [D] HF beacon (DW)
- 10871.9:** CISN ARKHANGELSK CW Single letter [S] HF beacon (DW)
- 10872:** CISN MOSCOW, CW Single letter [C] HF beacon (DW)
- 10873.7:** RFV1, FF Le Port 1745 ARQ-E3 100/400 CdeV on REI cid (RH2)
- 10895.5:** GYU, Gibraltar 10.10 Piccolo 6 Transmitting blind to unknown station (PT)
- 10909:** UNID: 0610 CW w/"1" repeated over and over. (MADX)
- 10910:** UNID, E. European(?) 18.00 RS-ARQ 228/170 8-bit TFC in UNID language with SSB chat in between (see separate post) (PT)
- 10945:** CFH CF HALIFAX RTTY//75/N/850 Marker "NAWS de CFH zkr fl 3287 4161 6236 8312 12380 16552 ar" (DW)
- 10991.7:** SARAJEVO ARQ/342//200/E/400 8rc. Two chan tdm. Ch A: B: betas. Variable sync, no app TFC thru 1838z (DW)
- 10995:** ALGERIAN EMB TUNIS MIL.STD 188-141A on USB. Cng MAE/Algiers (DW)
- 10995:** MFA ALGIERS MIL.STD 188-141A on USB. Cng TNS/Tunis (DW)
- 11023:** UNID UKRAINIAN MIL 3SC//50/N/250 TFC in 3sc. Cryptograms in offline encrypt. Offair 2010z (DW)
- 11039:** Hamburg Meteo 0616 BAUDOT 50/409 w/plaintext WX TFC. (MADX)
- 11086.5:** RN Northwood 0624 FAX 120/576 w/chart. (MADX)
- 11086.5:** UNID, FAPSI 1645 Crowd36 40bd Online crypto (RH2)
- 11090:** KVM70, Honolulu Meteo 0620 FAX 120/576 Lovely chart! (RH2)
- 11125:** HZN, Jeddah Meteo 1635 RTTY 100/850 WX codes- AAXX etc (RH2)
- 11175:** McClellan (call still used) in USB at 0042 with patch for doom 51 to mud bug. (RW)
- 11175:** SUMMIT 324 with comm check radios 1 and 2 with Hickam (DS2 WI)
- 11175:** TURBO 79 asking McClellan for pp to McConnell AFB. McClellan asks 79 to standby as they have higher priority traffic. 79 says they will try different freq and McClellan starts reading EAM. (DS2 WI)
- 11175:** Navy Y11 with pp thru Andrews. (DS2 WI)
- 11175:** CG Rescue 1712 with Andrews asking about WX in Bermuda. (DS2 WI)
- 11178:** HUNTER ##, RAF Nimrods wkg PJK in USB reference RATT traffic and communications with HOTEL OSCAR. (RM)
- 11232:** CANFORCE 81 with Trenton Military. Asking for WX reports and forecasts. Having trouble copying so QSY'ed to 13257. (DS2 WI)
- 11244:** ANDREWS 1447 USB w/28-character EAM (VYFJGN...) (MADX)
- 11253:** RAF VOLMET 0418 USB w/aviation WX. (MADX)
- 11396:** American Airlines flight 415 calling New York Radio requesting authorization to a lower altitude due to cabin pressurization problem. USB at 1738Z. NY requested QSY to 13330. Pilot and NY each called each other but no QSO. (CG)
- 11396:** Air Canada flight 967 calling New York Radio to request course deviation due to weather. USB at 2043Z. Was granted permission to go off course at 2046Z. At 2050Z, reported back on course. (CG)
- 11401.7:** UNID, UNHCR Geneva (?) 1614 Pactor 100/200 scrambled text (RH2)
- 11418.3:** FJY5, DTRE Crozet I. 0449 ARQ-E3 200/402 Betas (RH2)
- 11430:** UNID, CIS Mil/Rail 1100 81-81 81/240 (RH2)
- 11447.7:** UNID, Algeria 09.15 Pactor 200/200 Algerian Customs with TFC to ALA (Algiers) and DEB (Debdaba, Debadib(?)). Msg starts ZCZC RBE so is RBE cct ID(?) (PT)
- 11460:** UNID, FAPSI 1655 RTTY 75/450 5LG on Link 60047 (RH2)
- 11466:** AOG IN AMENAS MIL.STD 188-141A Sounding on USB. (DW)
- 11476.2:** KCNA Pyongyang 1236 BAUDOT 50/200 w/nx txt in UNID language. Weak and broken copy. (MADX)
- 11550:** UNID Rockwell Collins stn 2058 MIL-STD 188-141A/USB wkg RSCSIL: Rockwell Collins Ser Center w/ALE/modem. (MADX)
- 12101:** S53, Swed Emb Amman 1758 Ale/USB SND Rpt (RH2)
- 12101:** S61, Swed Emb New Delhi 1815 Ale/USB SND Rpt (RH2)
- 12101:** SOO, MFA Stockholm 1818 Ale/USB to S53/Amman Rpt (RH2)
- 12101:** SOO, MFA Stockholm 1835 Ale/USB to S53/Amman (RH2)
- 12101:** SOO, MFA Stockholm 1826 Ale/USB to "CCV" (cant find this call in any db (?)) (RH2)
- 12112.5:** GYU, Gibraltar 11.35 Piccolo 6 Lots of op chat to UNID station (PT)
- 12204:** ZSO, SA Navy Durban 1600 MFSK/32 54.5bd Unable decode (RH2)
- 12297:** UNID NET (?)LOC MIL.STD 188-141A ALE on USB. Sounding (DW)
- 12297:** UNID NET (?)HQ MIL.STD 188-141A Sounding on USB. (DW)
- 12359:** "Herb," south bound II (vax498) calling all stations at 1958 in USB. located Burlington, ON, Canada. (RW)
- 12525.8:** UNID, MT Arun Khetarpal 1700 ARQ Msg/EE to Atlantic Shipping Mumbai — Posn rpt etc (RH2)
- 12587:** LZW5 Varna, ID traffic, SITOR B.0045Z (EAW)
- 12690.7:** RFVIE, FN Le Port 1159 RTTY 75/850 RY/ID/SG Testing (RH2)
- 12745.5:** JJC, Tokio R 1605 FAX 60/576 JJ Nxpaper — large clear print! (RH2)
- 12789.9:** NMG USCG NEW ORLEANS FAXX//120/576/N/800 Hvy monitor hash. Tropical sfc analysis. 0630 wind/wa: (DW)
- 12790:** NMG, USCG New Orleans 0755 FAX 120/576 Satellite Imagery (RH2)
- 12947.7:** UNID, FAPSI 1559 Crowd36 40bd (RH2)
- 12980:** 4XZ: Haifa R 1637 CW ID then 5LG (RH2)
- 13089:** USCG CAMSLANT 1628 USB w/offshore forecast /6501/8764/ (MADX)
- 13155:** Nakhodka 10 Radio Nakhodka Russia 0620 USB wkg various Russian MVs w/pp's. ID'd as "Nakhodka 10". (MADX)
- 13200:** UNID Puerto Rico in USB at 0125 broadcasting a phonetic/numeric eam. (RW)
- 13257:** CANFORCE 81 with Trenton Military completing WX briefing that started on 11232. (DS2 WI)
- 13348:** Northwest 72 w/ company re an onboard "air rage" incident. Passenger did not threaten flight attendant, but did make threatening gesture at attendant, so company upgrades from "level 2" to "level 3." (RB)
- 13442:** UNID NET (?)HQ MIL.STD 188-141A ALE on USB. Sounding. Also 1654 (DW)
- 13442:** UNID NET (?)HQ MIL.STD 188-141A Sounding on USB. (DW)
- 13463:** Kosovo, Yugoslavia 12.55 ARQ-E 184.6/400 BATLOG TRIDENT KOSOVO with lots of 5-1g TFC and a little FF TFC to

RFFCCC — REGMAT COUVRON on RTC cct. RFFXCKO has prev. appeared as Kumanovo, Macedonia with CRT/RTC cct pair to Paris (PT)

**13464:** UNID Venezuelan Army 0121 MIL-STD 188-141A/USB clg CLC44: UNID Venezuelan Army then into MIL-STD 188-110A serial modem. (MADX)

**13476:** MONTECANO: Venezuelan Army/Navy Montecano 2305 MIL-STD 188-141A/USB clg CDDA: Venezuelan Army/Navy Ciudad Guyana. Again at 2238z. (MADX)

**13530:** Offutt AFB (?) 1638 RTTY 50/850 Scrambled! NB 50 bd - was 75 was it not(?) (RH2)

**13565:** UNID, UK mil Cyprus 1540 MFSK 195.3/300 file://18785.0 (RH2)

**13570:** HLL2 SEOUL MET FAX//120/576/N/800 Typhoon wng/fcst. Very weak. (DW)

**13580:** HMF, KCNA Pyongyang 1250 RTTY 50/250 NxAEE (RH2)

**13882.5:** DDK6 HAMBURG MET FAX//120/576/N/800 Dual global model charts. Good/streaky. Unlisted at this time. (DW)

**13956:** UNID, UNID 1648 RTTY 75/170 Crypto — related to 13956.5 (?) (RH2)

**13956.5:** CVF, MFA Tunis (?) 1645 FEC RY's and unusually a callsign! And "AMI UTILISER LOW LOW INT GRV UNE FOIS EN VOYER LE PAR MEME PM MERCI" Related to 13956.0(?) (RH2)

**13956.5:** CHB(?). UNID Tunis Diplo 2120 FEC RY's + WsZ + De CHB Zr ami INTOSA INTORK + 5LG (RH2)

**14350:** Mossad Navy's Station 0514 AM w/YL/EE/5LGs already in progress. "End of message, end of transmission" at 0518. (MADX)

**14367.5:** BAF8, Beijing Meteo 0756 FAX 120/576 better chart than usual! (RH2)

**14373.3:** MNRV, SANT Monrovia Net 1630 PACTOR 100/200 Personal Msgs/SS (RH2)

**14422:** ALGERIAN EMB NOUAKCHOTT MIL-STD 188-141A ALE (USB) Cng BKO/Bamako agn at 0911/1121 Cng GAO/Garoua (DW)

**14422:** UNID NET (?)HQ MIL-STD 188-141A ALE on USB. Sounding. Also 0751, 1436 (DW)

**14422:** UNID NET (?)LOC MIL-STD 188-141A Sounding on USB. (DW)

**14422:** UNID NET (?)LOC MIL-STD 188-141A Sounding on USB. (DW)

**14448:** UNID, CIS Navy 0931 36-50 50/240 Irregular short bursts (RH2)

**14451.7:** UNID Egyptian Diplo, prob MFA Cairo 0255 SITOR-A 100/170 w/plaintext ATU-80. (MADX)

**14463.5:** USNS Stalwart (T-AGOS-1) 0053 USB w/kg NNNOTWT: NAVMARCOR-MARS Sin Citra FL w/Navy MARS pp TFC (MADX)

**14467.3:** Hamburg Meteo 0457 BAUDOT 50/425 w/calltape. (MADX)

**14470.5:** GYU, Gibraltar 10.30 Piccolo 6 Op chat to UNID station (PT)

**14481.7:** RFTJ, FF Dakar 0738 ARQ-E3 48/400 CdeV on TJF cid (RH2)

**14481.7:** RFTJ, FF Dakar 1533 ARQ-E3 48/400 Admin Msg/FF relay fm Paris Sirpa Paris (RH2)

**14486.5:** UNID, French Mil(?) 19.20 ARQ-E 72/400 Idling with Alphas until fades away (PT)

**14535:** UNID NET (?)HQ MIL-STD 188-141A ALE on USB. Sounding (DW)

**14535:** UNID NET (?)LOC MIL-STD 188-141A ALE on USB. Sounding (DW)

**14535:** UNID NET (?)LOC MIL-STD 188-141A ALE on USB. Sounding, also 0617, 0800 (DW)

**14535:** UNID NET (?)LOC MIL-STD 188-141A ALE on USB. Sounding. Also 0733 (DW)

**14535:** UNID NET (?)HQ MIL-STD 188-141A Sounding on USB. (DW)

**14536:** UNID, FAPSI 1641 Crowd36 40bd Logged as RTTY before on Link 00051 (RH2)

**14575:** P6Z, Paris, France 15.05 FEC-A 192/400 MFA with svc TFC to Z4D, Nouakchott Embassy (PT)

**14613.2:** UNID, CIS Navy 1743 81-81 81/200 (RH2)

**14718.3:** French Forces Noumea 0527 ARQ-E3 100/383. No TFC noted for 13 minutes. (MADX)

**14719:** Oostende Radio 0540 SITOR-B 100/170 w/TFC list. (MADX)

**14731:** UNID NET (?)HQ MIL-STD 188-141A ALE on USB. (DW)

**14731:** UNID NET (?)HQ MIL-STD 188-141A ALE on USB. Sounding (DW)

**14731:** UNID NET (?)HQ MIL-STD 188-141A Sounding on USB. (DW)

**14731.7:** RFFK, FN Brest 1547 ARQ-E3 192/400 Admin Circ/FF - Promotions & Appointments (RH2)

**14731.7:** RFVITT, FN Le Port 1550 NATO Unclas Relay FM Guerre Dirltel Paris re FF Operation Ceres, Kosovo & Macedonia - new callsign RFFPET (RH2)

**14780:** UNID, UK Mil Cyprus 1805 MFSK 195.3/300 This freq seldom heard here! (RH2)

**14817:** UNID, FAPSI 1722 Crowd36 Mazielka calls (RH2)

**14817:** UNID, FAPSI 1714 Crowd36 Mazielka calls then online crypto (RH2)

**14830:** UNID 0546 81-81 40.5/500 (MADX)

**14863.8:** UNID, 18.25 ITA2 75/500 Sending mark only then "WAS033 OMIS" several times before shutting down (PT)

**14867.7:** MFA, Cairo 1624 ARQ TFCVAA to unk (RH2)

**14867.7:** UNID, MFA Cairo 1551 ARQ Selcal KXXU (Harare Emb) (RH2)

**14913:** UNID NET (?)HQ MIL-STD 188-141A sounding on USB. (DW)

**14944.2:** UNID, FAPSI 1540 Crowd36 Mazielka calls (RH2)

**15001.7:** DGD, Algiers, Algeria 15.30 Pactor 200/200 Customs TFC in FF from DGD to CTR ((?)(?)) on CTR cct (PT)

**15016:** UNID in Puerto Rico in USB at 2130 with patch for reach 6 hotel 3 to Charleston meteo. (RW)

**15016:** TURBO 79 calling MAINSAIL. No joy (DS2 W1)

**15603.5:** UNID: 0404 VFT BR6028 w/106 at 560hz (15604.06). (MADX)

**15633.4:** HMF26, KCNA Pyongyang 1650 RTTY 50/250 NxAEE Poor RX! (RH2)

**15673.2:** FF DJIBOUTI, ARQ/342//200/E/400 4rc. 2 chan tdm. Chan A: B: beats. A: 1924 cct [QRG] C de V svc RFQP de RFQP also 2035. 2213. B: 1924 cct [QPF] C de v svc also 2034 2214. (DW)

**15682:** SNN299 MFA WARSAW CW (FSK-250HZ) Periodic marker "VVV de SNN299 pse ga". (DW)

**15682:** SNN299, Warsaw, Poland 15.30 POL-ARQ 100/200 TFC in Polish, mentions Baghdad, then shuts down with CW-ID (PT)

**15730:** MOSCRIP: NMCB7 Det Camp Moscrip 2356 MIL-STD 188-141A/USB clg BAHAMAS: NMCB7 Det Andros Island (MADX)

**15794:** UNID, UK Mil Cyprus 1736 MFSK 195.3/300 (RH2)

**15898:** P6Z, Paris, France 08.40 FEC-A 192/400 MFA calling Z4D, Nouakchott embassy, with RYRY's and count (PT)

**15961.7:** RFLI, Fort de France, Martinique 09.49 ARQ-E3 192/400 CdeV via BFL cct to Paris (PT)

**16014:** RFQP, FF Jibouti 1725 ARQ-E3 100/400 CdeV on RUN cid (RH2)

**16014:** RFQP, FF Jibouti 0944 ARQ-E3 100/400 CdeV on RUN cid (RH2)

**16035:** 9VF252 KYODO SINGAPORE FAX//120/576/N/800 Japanese newsprint — poor copy (DW)

**16056.7:** UNID, FAPSI 0625 Crowd36 40bd (RH2)

**16056.7:** UNID, MFA Cairo 1601 ARQ Msg/AA to unk (RH2)

**16112:** UNID, CIS Navy 1553 36-50 50/240 (RH2)

**16125.2:** DJIBOUTI, ARQ/342//200/E/400 4rc. 2 chan tdm. Chans A: B: betas. 1227 A: cct [QPB] C de v svc RFQP de RFQP. 1250 TFC in offline encrypt. 1227 B: cct [QPC] C de v svc RFQP de RFQP (DW)

**16125.2:** RFQP, FF Jibouti 1550 ARQ-M2 200/400 Idling — as usual. (RH2)

**16135:** KVM70, Honolulu Meteo 0740 FAX 120/576 Good chart. (RH2)

**16135:** KVM70, Honolulu Meteo 0619 FAX 120/576 fuzzy chart (RH2)

**16143.7:** FT DE FRANCE, ARQ/E3//192/E/400 8RC. Betas. 1402 cct [BFL] C de v svc RFLI de RFLI (DW)

**16161.7:** MFA CAIRO SITOR/A//100/E/170 TFC in AA (ATU80) to Berlin. Selcals XBVM (Berlin) (DW)

**16193.5:** GYU, Gibraltar 18.45 Piccolo 6 Op chat to UNID station (PT)

**16200:** UNID, CIS Navy 1656 36-50 50/240 Crypto (RH2)

**16200:** UNID, CIS Navrad 1733 36-50 50/240 Crypto (RH2)

**16207:** UNID, CIS Navy 1710 36-50 50/200 Crypto (RH2)

**16223.7:** UNID, MFA Cairo 1622 ARQ Msgs/AA to All Stations! (RH2)

**16260:** P6Z, Paris, France 14.10 FEC-A 192/400 MFA with svc TFC to H6L, Algiers embassy (PT)



16278.8: Algiers, Algeria 14.15 Coquelet 8 TFC in FF at 13.3 baud. TFC ends with "FROM: 3 TO: 400 SUB: 227" (PT)

16314: UNID, FAPSI 1634 Crowd36 40bd Mazielka then normal 40bd (RH2)

16316: UNID, Polemb Kinshasa 0814 Pol-ARQ 100/240 ID & IRS - no msgs! (RH2)

16331.9: CISN ARKHANGELSK CW Single letter [S] HF beacon (DW)

16332: CISN MOSCOW, CW Single letter [C] HF beacon (DW)

16366.8: UNID, UNID 1606 G-Tor 200/200 Some words in GG (RH2)

16412.7: UNID, DRC Bank Circuit 1045 Pactor 200/200 Lubumbashi/Kinshasa Msgs/FF (RH2)

16421.7: RFTJ, Dakar, Senegal 17.50 ARQ-E3 48/400 CdeV to self sent over TJJ cct to Port Bouet (PT)

16421.7: RFFIC, Marine Sirpa Paris 0930 ARQ-E3 48/400 AFP NX Headlines (RH2)

16421.7: RFTJ, FF Dakar 1127 ARQ-E3 48/400 CdeV on TJJ cid (RH2)

16421.7: RFTJ, FF Dakar 1838 ARQ-E3 48/400 CdeV on TJJ cid (RH2)

16421.7: RFFIC, Marine Sirpa, Paris 0845 ARQ-E3 48/400 MCA Presse to ZOC/2135 info RFFXOC/Armees Centops Paris (RH2)

16606: UNID, UK Mil Cyprus 1612 MFSK 195.3/590 Note wide shift! (RH2)

16631.7: Egy Emb Luanda 1520 ARQ Msg\AA to Cairo (RH2)

16631.7: Egy Emb, Luanda 1140 ARQ Msg\AA to Cairo (RH2)

16803: UNID, PNA Resend 1600 FEC N\EE signed Pareng/George — Cavite City (RH2)

16814.5: BERN RADIO SITOR/B//100/E/170 Commands info and TFC list then reverts to chan free marker "HEC" (DW)

16905: FUV, Djibouti 18.05 ITA2 75/850 Testing with RY's and "FAAODEFUV FUV FUC FUC". They have made a typo on the marker tape or have they consolidated the services of Djibouti and Cherbourg. (PT)

16932: Boufarik Radio 1752 CW w/call tape. (MADX)

16951.3: RFTJE, FN Dakar 1150 RTTY 75/850 RY/ID/SG Testing (RH2)

16961.5: French Navy Fort de France Martinique 1750 BAUDOT 75/836 w/test tape. (MADX)

16971: JJC KYODO TOKYO FAX//60/576/N/800 Japanese news print. End of page. (DW)

16976.0: Buenos Aires R 1120 CW/ARQ ID Marker (RH2)

16985.7: CTP, NATO Lisbon 1605 RTTY 75/850 NAWS de CTP etc (RH2)

16992.8: UAT, Moscow R 1605 CW TFCList (RH2)

17045.7: 9MG, Malay Navrad 1633 RTTY 50/850 Penang R. - RY/ID (RH2)

17147: URL, Sevastopol R 1613 CW ID + some TFCRR (RH2)

17160.8: IAR, Rome Radio 1616 CW TFCList (RH2)

17184.8: KFS, San Francisco R 1619 CW ID/Marker (RH2)

17314: USCG CAMSPAC Point Reyes 0442 USB w/Highseas Forecast already in progress. /13089/4426/ (MADX)

17414: P6Z, Paris, France 08.32 FEC-A 192/400 MFA with TFC to D4B, Damascus Embassy (PT)

17414: P6Z, MFA Paris 0624 FEC-a 192/400 "QTC9INT ZBZ INT QTC A TOI" etc (RH2)

17430: 9VG235 KYODO SINGAPORE FAX//60/576/N/800 Japanese news print (DW)

17441.5: 5YE, Nairobi Meteo 0931 RTTY 100/850 continuous garbage! (RH2)

17484: CCM, CN Magellanes 1641 RTTY 100/850 5LG + some 4LG strings — not heard for many moons — nice to have you back! (RH2)

18064: SNN299, MFA Warsaw 1556 Pol-ARQ 100/240 Claris& Informuje msgs (RH2)

18169.5: UNID, 13.57 ARQ TFC in EE re prospective arrival of ship in port. Pause in transmission after every six or so pulses makes decoding difficult. Message ends "BRGDS. CEC FORCEY(?)B/(?)SME (PT)

18183.4: Algiers, Algeria 15.35 Coquelet 8 MFA with TFC to Maputo embassy (PT)

18183.5: 7RQ20, MAE Algiers 1440 Coq8 26.67 Msg\FF to Ambalgs Libreville, Kinshasa, Brazzaville, Yaounde, Tunis, Abidjan Dakar (egalement Cap Vert), & Lagos (egalement Lome) (RH2)

18183.5: 7RQ20, MAE Algiers 1455 Coq8 26.67 Msg\FF to Conakry (RH2)

18183.5: 7RQ20, MAE Algiers 1448. FF a Postes Niamey, Gao, Agades & Nouadhibou (RH2)

18204: UNID, Gao(?) (?) 1544 Ale/USB Sounding first, then four more Tx to MAE each with usual "Response Required — Multipath, Sinad 10db" etc etc. No response from MAE. GAO not listed: must be a rename — of where AnyWUN(?) (RH2)

18220: JMH5 TOKYO MET FAX//120/576/N/800 Hazy pix. Dual chart 500mB/700mB temp/dew point fcsts (DW)

18220: JMH5, Tokyo M 1308 FAX 120/576 Good chart! (RH2)

18238: SAN CAPETOWN FAX//120/576/N/800 Quad chartlets. Weak. Unlisted at this time. (DW)

18268: HBD20/6, MFA Berne 1701 ARQ

Strong betas then ID sign-off after "No Messages" (RH2)

18334.7: ykjkwl, Egy Emb, Bamako 1545 ARQ Msg\AA to Cairo (RH2)

18336: UNID NET (?)HQ MIL.STD 188-141A ALE on USB. (DW)

18336: UNID NET (?)HQ MIL.STD 188-141A Sounding on USB (DW)

18376.5: Joint Task Force Bravo Soto Cano Airbase Hondouras 1424 MIL-STD 188-141A/USB clg DAVISM: SITFA ALT NCS Davis Monthan AFB. (MADX)

18422: UNID, British Mil 18.00 Piccolo 6/12 Single channel on standby. Very weak, fades about 22.00 (PT)

18444.5: NAQOURA, ARQ/E//184.6//400 8rc. Betas thru 1401z (DW)

18447.7: NDJAMENA, ARQ/E3//200/E/400 8rc. Betas thru 1747z (DW)

18836: UNID NET (?)HQ MIL.STD 188-141A Sounding on USB. (DW)

19031.7: UNID, MFA Islamabad (?) 1747 ARQ 5LG (RH2)

19031.7: UNID, Foreign Islamabad 1626 ARQ 5LG to unk (RH2)

19036.5: UNID, Ambalg Luanda 1624 Coq8 13.33 Msg\FF to MAE Algiers (RH2)

19036.5: UNID, Ambalg Niamey 0800 Coq8 26.66 5LG to MAE Alger (RH2)

19043: UNID NET (?)HQ MIL.STD 188-141A ALE on USB. Sounding. (DW)

19043: UNID NET (?)HQ MIL.STD 188-141A Sounding on USB. (DW)

19242: UNID, UNID 1623 Pactor 200/200 Msg\GG fm mailto: Emilott@t-online.de to unk (RH2)

19242: UNID, UNID 1620 Pactor 100/200 Nil on screen — good sigs! SomeWUN has logged this freq before? (RH2)

19309: UNID NET (?)HQ MIL.STD 188-141A Sounding on USB. (DW)

19313: UNID, SANT Net (?) 0938 Pactor 200/200 Personal TFC\FF (RH2)

19554: UNID NET (?)HQ MIL.STD 188-141A ALE on USB. Sounding. Also 1955 (DW)

19622: OZU25, MFA Copenhagen 0803 Twinplex 100/400. Good synch in IRS mode — not heard for many months! (RH2)

19635: P6Z, MFA Paris 0950 FEC-a 192/400 Scrambled let/sub msg to unk (RH2)

SEE US ON THE WEB!  
www.vikingint.com

**Rave Review**  
Pop Comm  
April '96

# Professional 10 HOUR RECORDER

**"BUILT LIKE A BATTLESHIP"**

SPECIAL  
Pop Comm  
PRICE...

\$159



- Heavy duty commercial recorder - NOT improvised from consumer models
- 12, 14, and 16 hour models also available
- BUILT-IN voice activation (add \$30)
- Applications information included
- Dimensions: 11.5 x 7.0 x 2.75"

GOD'S OK. Calif. residents add tax. Sorry, no credit cards. Free catalog USA only, other countries \$5. Free Shipping to 48 Contiguous States on Prepaid Orders.

Viking Systems International

Factory Direct Phone: (415) 467-1220 • Fax: (415) 467-1221 "Since 1971"

100 North Hill Drive #42, Brisbane, CA 94005

- 19692.5: Globe Wireless Capetown 1805 SITOR-B 100/170 w/HYDROSAN msgs. (MADX)
- 20107: UNID NET (?)HQ MIL.STD 188-141A ALE on USB. Sounding. Also at 1436, 1631 (DW)
- 20107: 055. Algerian (?) 0802 Ale/USB SND & again at 0951 (RH2)
- 20141.5: UNID. Ambalg Niamey 0811 Coq8 13.33 Repeat of 5LG on 19036.5 — different freq. and baud — unusual! Must have been important! (RH2)
- 20179.7: RFVI, FN Le Port 1626 ARQ-E3 100/400 Betas — on IRE cid to Paris (RH2)
- 20266: UNID NET (?)LOC MIL.STD 188-141A ALE on USB. Sounding (DW)
- 20268: UNID: Russian Navy 1352 36-50 50/229. (MADX)
- 20604: UNID, MFA Berne(?) 1615 ARQ 5LG — not logged before! (RH2)
- 20633.4: UNID: 0548 ARQ-E3 100/400 idle. Probably RFVI off-freq. No TFC noted. (MADX)
- 20633.7: French Forces Le Port 1530 ARQ-E3 100/380 w/480x5LG msg joined in progress. At 1533. plain text FF msg on ckt [REI](Le Port to Paris). (MADX)
- 20633.7: RFVIC, FN Le Port 1137 ARQ-E3 100/400 5LG RR RFFLA/RFFKA (RH2)
- 20942: S97, Swed Emb Abidjan 0753 Ale/USB SND (RH2)
- 20942: S97, Swed Abidjan 1225 Ale/USB Sounding (RH2)
- 20942: S97, Swed Abidjan 1305 Ale/USB to SOO/Stockholm Response Req'd — Multipath etc (RH2)
- 20942: SOO, MFA Stockholm 1353 Ale/USB to S97/Abidjan Response Unknown Sinad = 18db (RH2)
- 20942: S97, Swed Abidjan 1408 Ale/USB Sounding (RH2)
- 20985: UNID: 1626 USB Spanish PTT phone conversations. Mexico(?) (MADX)
- 21866: Cherry Ripe Numbers Station 1311 AM YL/EE/5FGs(x2). Joined in progress. At 1343. into Cherry Ripe tune. Strong signal here on U.S. E. Coast. (MADX)
- 21973.7: TAD, MFA Ankara 1330 FEC-a 144/850 Idles for 25 mins -nil on screen! (RH2)
- 21974: TAD, MFA Ankara 1238 FEC-a 144/850 Nx/Turk (RH2)
- 22542: JJC, Tokio R 1251 FAX 60/576 JJ Nx/paper // 16971.3 (RH2)
- 22542: JJC, Tokyo R 1255 FAX 60/576 JJ Nx/Paper — clear! (RH2)
- 22769: UNID NET (?)HQ MIL.STD 188-141A Sounding on USB. (DW)
- 22857.5: RFVI, FN Le Port 0830 ARQ-E3 100/400 CdeV on V11 cid (RH2)
- 22857.7: RFHI: FF Noumea 0741 ARQ-E3 100/400 CdeV to itself On V11 cid (RH2)
- 22928: S97, Swed Emb Abidjan 0915 Ale/USB to "100" MFA Stockholm (RH2)
- 22935.7: UNID, CIS Navy 1556 36-50.50/230 (RH2)
- 23190: P6Z, MFA Paris 0635 FEC-a 192/400 calling N2G/SAN'A Emb (RH2)
- 23337: HIK, Hickham AFB 0739 Ale/USB SND - Many repeats! (RH2)
- 23337: PLA, Lajes Field, Azores 0739 Ale/USB SND - several repeats! (RH2)
- 23337: HAW, Ascension I 0827 Ale/USB SND — two repeats (RH2)
- 23337: JDG, Diego Garcia 0828 Ale/USB SND — two repeats (RH2)
- 23337: ADW, Andrews AFB 1021 Ale/USB SND (RH2)
- 23337: JNR, Salinas PRT 1034 Ale/USB SND (RH2)
- 23370: HZN50, Jeddah Meteo 0920 RTTY 100/850 WX codes — AAXX etc (RH2)
- 23428: UNID NET (?)HQ MIL.STD 188-141A ALE on USB. Sounding. Also 1719z (DW)
- 23428: 445, Alg/Mor(?) 1342 Ale/USB Snd — also calls to "172" & "586" (RH2)
- 23428: 586, Alg/Mor(?) 1402 Ale/USB Snd — also calls to "172" (RH2)
- 23428: 445, Algerian (?) 1337 Ale/USB SND (RH2)
- 23428: 7172, Algerian (?) 1349 Ale/USB SND (RH2)
- 23428: 586, Algerian (?) 1351 Ale/USB SND (RH2)
- 23522.9: TOKYO MET FAX//120/576/ N/800 Dual charts 500/700 MB temp/dew-point feast. 0651 24hr wave prog. Noisy. (DW)
- 23523: JMH6, Tokio Met 1250 FAX 120/576 nice chart (RH2)
- 24370: P6Z, MFA Paris 0710 FEC-a 192/400 New string "FEU FEU ZCGZ 5 ZCGZ 5 A TOI" rpt! (RH2)
- 24370: RFGW, MFA Paris 0940 FEC-a 192/400 Long Msg to N2G/San'a using letter substitution (RH2)
- 24711.7: Provence, Provence 1905 ARQ-E3 192/400 CdeV to self on AFL cid (RH2)
- 24711.7: RFTJ, FF Dakar 0955 ARQ-E3 192/400 CdeV on AFL cid (RH2)
- 24711.7: RFTJCF, Fm D'Entrecasteaux(?) 1255 ARQ-E3 192/400 5LG to RFFMVL/Meteofrance, Toulouse, info RFFMVR/ Metoc Data (RH2)
- 25103: UNID, ITA2 50/170 Sending some sort of report eg: 7/1/94 8/794 9/58/331 10/5 11/66.7 12/100.3 13/22 14/86/144 15/2000/1731= then on its own line the word NAWESKA. Very poor RX so rest garbled then shuts down (PT)
- 25120: Alg/Morocco (?) 0857 Ale/USB to "01" (RH2)
- 25120: OQ, Alg/Morocco (?) 1220 Ale/USB calls to 01, 050, 05C, 03U (RH2)
- 25120: KQ, Alg/Morocco (?) 1306 Ale/USB calls to 01, 02 (RH2)
- 25120: OUD, Alg/Morocco (?) 1307 Ale/USB to GLO (RH2)
- 25120: DPZ, Alg/Morocco (?) 1307 Ale/USB to 01, 03F (RH2)
- 25120: (?) ZE, Alg/Morocco (?) 1308 Ale/USB to 01 (RH2)
- 25120: WZH, Alg/Morocco (?) 1505 Ale/USB to 01 (RH2)
- 25120: OUF, Alg/Morocco (?) 1505 Ale/USB to 01; looks like "01" is the big enchilada! (RH2)
- 25120: 01F, Algerian (?) 1520 Ale/USB to "01F" (RH2)
- 25120: 01F, Algerian (?) Ale/USB to "GLO" (RH2)
- 25186: PRI, UK Mil Pristina 1440 Ale/USB SND (RH2)
- 26441.7: Paris, Paris 1105 ARQ-E3 100/400 CdeV to itself on IRE cid (RH2)
- 26441.7: RFFAB, Guerre Paris 1022 ARQ-E3 100/400 5 Pages of 5LG to unk (RH2)
- 26441.7: RFVI, FF Le Port 1735 ARQ-E3 100/400 CdeV on IRE cid (RH2)
- 26540: UNID 1900 LSB 2xOM/SS. (MADX)

This month's contributors were:

- Chris Gay — KU4A  
 R.C. Watts — ColonelDX, in Louisville, Ky.  
 Day Watson  
 Dwight Simpson  
 Enrique A. Wembagher — Buenos Aires, Argentina  
 Lenroy Hogan  
 MidAtlanticDXer — Maryland  
 Peter Thompson — North Wales, UK  
 Rick Barton — Arizona  
 Robert Hall — Capetown SA  
 Roland R. "Mac" McCormick III — Savannah, Georgia  
 Sue Wilden — Noblesville, Indiana  
 Thank you all very much. Your efforts are appreciated as always!

## Final Words

During the final completion of this column I heard the terrible news of the attack and destruction of the World Trade Center as I typed. I stopped and followed the events in shock as the horror unfolded.

There are no words that can fully express my feelings at what I saw on television and heard of the radio during the day of September 11, 2001. All I can say is that I wish to express my heart-felt condolences to all victims of that day.

In particular I must commend the true heroic acts of the far too many firefighters and police who selflessly entered into those burning towers, never to come out again. Likewise a special commendation must be given to the heroes who replaced them and equally selflessly gave their blood, sweat, and tears to overcome this tragedy.

This month's column is dedicated each and everyone who triumphed that day — either in life or in death. And may God help all of us in the years to come and prevent any further tragedies like this from happening ever again. ■

## KIPM On AM And USB Heard In Illinois

**Y**ou folks haven't exactly left my mailbox bulging at the seams lately, but I'll be a nice guy just the same and let you have what's come in over the past month or so.

KIPM has been very active and William T. Hassig of Illinois has had a number of receptions: **6950 USB** at 0300 with the program "Monsters of the Mind." Also on **6950 AM** mode at 0029. Also **6950 AM** at 0358, again at 0408 with a program called "Strange Cargo." Also in USB on the same frequency at 0504 to 0608 with something called "The Adversary." And at 0610 with "He Who Shrank." (Hassig, IL)

**Psycho Radio, 6950 USB** with heavy metal at 0300 and off suddenly at 0318. (Hassig, IL) 0330 with a program called "Adventures of Shortwave Man" and then some interval signals. They announced their E-mail address as psychoradiodh@yahoo.com. (Dave Bowling, VA)

**Paragon Radio, 6955 USB** at 0310 with music intended "for older listeners." (i.e. jazz, etc) (Bowling, VA)

**Radio KAOS, 6955** at 0120 with various rockish tunes. No mail drop address was announced, unfortunately. (Bowling, VA)

**WMFQ, 6955 USB** at around 0200 calling themselves "Super Power WMFQ" and yelling out their ID. Lots of rock tunes, which sounded a bit "off" from how they normally do! (Bowling, VA)

**WKUE, 6955 USB** at 0103 with music by a whole lot of different groups and artists presented by "Laughing Bill." They gave an address in Hilo, Hawaii, for reception reports but I couldn't copy all the info. (Bowling, VA)

**Crunch Radio, 6950** at 0318 with standards from the '50s or even earlier, many of them female vocals. (George Roberts, PA)

**Z-100, 6950 USB** at 0128 with lots of old rock tunes and mention of "while the others keep talking, we keep on rocking." Off at 0230. (Roberts, PA)

**Radio Bingo, 6945 LSB** at 0230 with the usual stuff and announcement of a bingo winner. (Roberts, PA)

**Blind Faith Radio, 6955 USB** hosted by Dock Napalm at 1540 with a tribute to Kirk somebody. (Roberts, PA) (*Probably pirate operator Kirk Trummel who passed away over the summer — Ed.*)

**Ultra Shortwave, 6955 USB** at 0532 with ID "This is Ultra Shortwave — are you plugged in?" Lots of tunes and closed shortly after 0600. Great signal. (Roberts, PA)

**Voice of Captain Ron Shortwave, 6950 USB** at 0100 with various tunes and comments by host Captain Ron. Closed at 0115. (Roberts, PA)

**Unidentifieds — 6950.15 USB** at 0324 to 0403 with the song "Rum and Coca-Cola" and a song by Al Jolson. Also an old radio program. (Hassig, IL)

**6950 USB at 0115** — 0209 with rock and pop tunes, music by Ramones, Alaska dial-up weather forecast, a song about venereal disease and sign-off with the "Merrie Melodies" theme music. (Hassig, IL)



You'd think "Take it Easy Radio" would feature a beach or a lawn chair on their QSL rather than this threatening image. (Thanks, Ben Fuller, MA)

**6950 USB** monitored at 0213 with pop tunes and comedy bits. (Hassig, IL)

**6953.15 USB** at 0120-0152 with lots of talk, heavy metal. Hosted by Captain Ron and Mrs. Prick. (Hassig, IL)

"**Krutch Radio, 6950** at 0200-0245. Signed on with marching band music, "Dixie" on an organ, patriotic songs and mentioned "high-fidelity plate modulated equipment." (Hassig, IL) (*Might be Crunch Radio — Ed.*)

And that wraps things up for this time. By now it should go without saying that I need your reports, so I hope you'll take the time to check in each month and let me know what you are hearing. I also need photocopies of pirate QSLs for use as illustrations. Thanks a lot for all your input and help and I'll see you again next month!

# readers' market

**Advertising Rates:** Non-commercial ads are 30 cents per word, including abbreviations and addresses; minimum charge \$6.00 per issue. Ads from firms offering commercial products or services are \$1.00 per word; minimum charge \$20.00 per issue. Boldface words are \$1.20 each (specify which words). Leading key words set in all caps at no additional charge. All ads *must be prepaid in full* at time of insertion; a 5% discount is offered for prepaid 6 time insertions. All ads must be typewritten double spaced.

**Approval:** All ad copy is subject to Publisher's approval and may be modified to eliminate references to equipment and practices which are either illegal or otherwise not within the spirit or coverage scope of the magazine.

**Closing Date:** The 10<sup>th</sup> day in the third month preceding date of publication. Because the advertisers and equipment contained in Readers' Market have not been investigated, the Publisher of *Popular Communications* cannot vouch for the merchandise listed therein. Direct all correspondence and ad copy to: Attention: Alycia Nicholse, PC Readers' Market, 25 Newbridge Rd., Hicksville, NY 11801.

**CB MODIFICATION SECRETS**, big new 200-page guide by Kevin Ross, author of "CB Radio Hacker's Guide." More great easy-to-do AM/SSB CB equipment upgrades and enhancements applicable to Cobra, Realistic, Uniden, President, etc. Freq. expansion, VFO, clarifier unlock, VOX, Roger Beep, anti-theft device, receive signal pre-amp, much more. Only \$21.95, plus \$5 s/h (\$6 to Canada) from CRB Research Books, P.O. Box 56, Commack, NY 11725. NY residents add \$2.22 tax. VISA/MC orders call: (631) 543-9169.

www.ScannerWorld.com Radio Scanners, CB Radios, Antennas, Batteries, Cases, Accessories. On line ordering. **Scanner World USA**, 17 Interstate Ave., Albany, NY 12205. (518) 436-9606 infor@ScannerWorld.com

**SCANNER ANTENNAS:** VHF/UHF Discone base antennas \$29.95 + S&H. 11F/VHF/UHF "Super" Discone \$45.95 + S&H. Super Scan Duck handheld antennas \$19.95 + S&H. Also antennas for amateur, CB, Cell, GMRS, MURS, SWL, TV. Antenna Warehouse, 811 9th Avenue, Camanche, IA 52730. MC/Visa toll free order line: 877-680-7818. [www.antennawarehouse.com](http://www.antennawarehouse.com)

**SCANNER CRYSTALS FOR SALE.** Send a long SASE for list and price to G E Jones, P.O. Box 467, Buckeye Lake, OH 43008.

**SATELLITE TV** — Large selection of items at reasonable prices. We specialize in Big Dish TVRO C & Ku Band equipment. Check us out at [www.davenswebshop.com](http://www.davenswebshop.com)

Quebec CD ROM contains over 13,000 scanner frequencies, over 44 electronic projects. 480 scanner and amateur radio modifications in BMP & TXT format. Radio Scanner, Box 193 Lac-Mégantic, Quebec, G6B 2S6 Canada. [ve2kgf@hotmail.com](mailto:ve2kgf@hotmail.com).

**CB MODIFICATIONS! 10M, frequencies, sliders, amplifiers, FM, books, plans, kits, high-performance accessories. The best since 1976. Find out why! Catalog \$3. CBCL BOX 30655A, TUCSON, AZ 85751. <[www.cbintl.com](http://www.cbintl.com)>**

Discover the world of scanning. Get more out of your scanner with Scanning USA, a monthly scanning magazine. 12 issues \$24.95, samples \$4.00 send to Scanning USA, P.O. Box 9580, Naperville, IL 60567-9580 or call 1-800-651-0922. [www.scanningusa.com](http://www.scanningusa.com)

**RF TRANSISTORS & TUBES.** SD1446, 2SC2879, MRF454, MRF455, SRF3749, 2SC2290, MRF247, MRF317, MRF448, SAV7, 3-500ZG, 3CX2500F3, 3CX3000A7, 4CX250B, 4CX1000A, 4CX1500B, 4CX5000A, 572B AND MORE. SAME DAY SERVICE. CATALOGUE AVAILABLE. WESTGATE 800-213-4563

**RECEIVERS FOR SALE:** Yaesu FRG-100B, 50 kHz-30 MHz. New \$569, will take \$295. Rare, Standard CCR708A scanner. 50 to 900 MHz, no gaps with spectrum display. AM, FM, FMW. New \$800, will take \$325. Both in excellent condition with manuals. Will ship. Mike 931-380-8867 after 6 p.m. CDT. E-mail [spikiedog2@aol.com](mailto:spikiedog2@aol.com).

**WANTED:** A UNIMAT lathe. Please call, write or E-mail: John, 215-884-9220. 1923 Susquehanna, Abington, PA 19001. [johnr750@aol.com](mailto:johnr750@aol.com).

**Super Video Sale!**

## getting started videos



- Getting Started in Ham Radio**— How to select equipment, antennas, bands, use repeater stations, grounding, basic soldering.
- Getting Started in VHF**—Intro to VHF. Repeater usage, packet, satellites and more exotic VHF op modes.
- Getting Started in DXing**— Top DXers share experiences with equipment, antennas, op skills and QSLing.
- Getting Started in Packet**—De-mystify packet. Info on making contacts, bulletin boards, networks, satellites.
- Getting Started in Amateur Satellites**— How ops set up stations. Locate and track ham satellites.
- Getting Started in Contesting**— Advice and op tips from Ken Wolf, K1EA, K1AR and others!
- Ham Radio Horizons**—Step-by-step instructions for the prospective ham on how to get involved.

~~\$19.95 each~~— Now **\$12.95** Buy more and save!  
**Buy 2 or 3 for \$11.95 each Buy 4 to 6 for \$10.95 each**  
**Buy all 7 for your Club for only \$99.95!! Now \$69.95!!**

Name \_\_\_\_\_  
 Address \_\_\_\_\_  
 City \_\_\_\_\_  
 State \_\_\_\_\_ Zip \_\_\_\_\_

Qty

_____ Getting Started In Ham Radio	_____ Getting Started in Contesting
_____ Getting Started in VHF	_____ Ham Radio Horizons
_____ Getting Started in DXing	_____ Total Videos X \$ _____
_____ Getting Started in Packet Radio	_____ = \$ _____
_____ Getting Started in Ham Satellites	Shipping/ handling \$ _____
	Total \$ _____

U.S. and possessions - add \$4 shipping/handling.  
 Foreign - shipping/handling charges are calculated by order weight & destination.

Credit Card No. \_\_\_\_\_ Expiration date \_\_\_\_\_  
 Method of payment  Check  Money Order  Visa  MasterCard  Discover  American Express

Also available in PAL format. **Call Toll-Free 1-800-853-9797**

**CQ Communications, Inc., 25 Newbridge Rd., Hicksville, NY 11801/516-681-2922; Fax 516-681-2926**

# ADVERTISERS' INDEX

Advertiser	Page Number	Website Address
ADI/Premier Communications	11	www.adi-radio.com
AOR USA, Inc.	13	www.aorusa.com
A.P. Communications	64	
ARRL	21	www.arrl.org
Antenna Supermarket	37	
Antique Electronic Supply	49	www.tubesandmore.com
Antique Radio Classified	64	www.antiqueradio.com
Atomic Time, Inc.	53	www.atomictime.com
Bill's CB & 2-Way Radio Service	49	www.bills2way.com
CQ Merchandise	71	www.cq-amateur-radio.com
C. Crane Company	Cov. III	www.ccrane.com
C & S Sales, Inc.	27	www.cs-sales.com
CQ Amateur Radio Calendars	65	www.cq-amateur-radio.com
CRB Research	49	www.crbbooks.com
Command Productions	61	www.licensetraining.com
Communications Electronics Inc.	55	www.usascan.com
Computer Aided Technologies	43	www.scancat.com
Cutting Edge Enterprises	49,79	www.powerportstore.com
DWM Communications	79	www.qth.com/dwm
Drake, R.L. Company	17	www.rldrake.com
Everhardt Antennas	63	www.everhardtantennas.com
Grundig	8,9	www.grundigradio.com
Hollins Radio Data	23	www.policecall.com
ICOM America, Inc.	5	www.icomamerica.com
Lee Electronics Company	79	www.LeesElect.com
Lentini Communications, Inc.	1	www.lentinicomm.com
Lextronix, Inc.	8,9	www.grundigradio.com
MACO Mfg. Div/Majestic Comm.	49	www.majestic-comm.com/maco
MFJ Enterprises, Inc.	39	www.mfjenterprises.com
Mobile DXer, The	53	www.cq-amateur-radio.com
Monitoring Times	57	www.grove-ent.com
Mountain-Ops Communications	79	www.mountain-ops.com
Mouser Electronics	63	www.mouser.com
Optoelectronics, Inc.	Cov. IV	www.optoelectronics.com
Passport to World Band Radio	15	www.passband.com
Phillips-Tech Electronics	79	www.phillips-tech.com
REACT International, Inc.	58	www.reactintl.org
Radioworld, Inc.	61	www.radioworld.ca
Ranger Communications, Inc.	31	www.rangerusa.com/PC
Shortwave Store, The	79	www.usa.shortwavestore.com
Ten-Tec, Inc.	25	www.tentec.com
Universal Radio, Inc.	3,10	www.universal-radio.com
Vertex Standard	Cov. II	www.vxstdusa.com
Viking Systems International	75	www.vikingint.com
Yaesu	Cov. II	www.vxstdusa.com

Reach this dynamic audience with your advertising message, contact Don Allen, W9CW at 217-344-8653, FAX 217-344-8656, or e-mail: PCAdvertising@aol.com.

**Stocking Stuffers**

**PowerPort**

**NEO**

Padded neoprene radio pouch in red or black with steel belt clip



800-206-0115  
powerportstore.com

**DWM Communications**

**NEAT STUFF!!!**

S.A.S.E. brings catalog!

P.O. Box 87, Hanover, MI 49241

<http://qth.com/dwm>

E-mail: [tinytenna@hotmail.com](mailto:tinytenna@hotmail.com)

Orders: 1-517-563-2613

**FREE Shipping & GREAT PRICING on**

**ALL Portable Digital Shortwave Receivers**

Offer expires Dec. 31, 2001

Visit [www.usa.shortwavestore.com](http://www.usa.shortwavestore.com) for details

**The Shortwave Store**

Whitby, Ontario L1N 2C3

1-888-426-1688

**Lee Electronics**

Scanners, SW, FRS and More:

AOR Cobra Bearcat BoyGen

SANGEAN ICOM uniden

1-800-578-6006

Tech: (724) 275-5822

[www.LeesElect.com](http://www.LeesElect.com)

**MOUNTAIN-OPS COMMUNICATIONS**

Self-Powered Multi band Short-wave receiver.

Kaito KA-007, Works anytime, anywhere, anyplace.

AC, DC, Hand Crank or Solar.

Includes AC Adapter, earphone, both rod and longwire antennas.

\$39.95 + shipping.

Visa • MasterCard • AmEx

Phone (503) 982-5786 • [sales@mountain-ops.com](mailto:sales@mountain-ops.com)

[www.mountain-ops.com](http://www.mountain-ops.com)

**Wireless Internet & TV**

WIRELESS CABLE • IFTS • MMDS

ATV • INTERNATIONAL • DIGITAL

Amplifiers • Antennas • Books • Components

• RF Frequency 2100-2700 MHz

• SASE For "FREE" Catalog or Send \$1

**PHILLIPS-TECH ELECTRONICS**

P.O. Box 737, 607 Parker St., Trinidad, CA 95570

CATALOG/INFO: 707-677-0159

ORDER LINE: 800-880-MMDS

FAX LINE: 707-677-0934

WEBSITE: [www.phillips-tech.com](http://www.phillips-tech.com)

E-MAIL: [product@phillips.tech.com](mailto:product@phillips.tech.com)

CHALLENGER SYSTEM  
31-Channel Complete \$240  
Other Systems Available  
3 Year Warranty  
FREE SHIPPING

Visa • M/C • AmEx • Discovery • C.O.D.'s • Quantity Pricing

## Bill Almost Shoots His Eye Out

**T**his is the season to be something. I'm not particularly jolly (but I am fat and I have a beard). Two out of three ain't bad.

In the days when I was a receiver and not a giver, planning for Christmas began around March. If any of you think I mean I planned my holiday shopping for friends and relatives - thanks for the vote of confidence. No, I started working on *my* Christmas list in March. My "Gimme" list. My "Want" list. My "Gotta have this and it has to be exactly this way, and this color, and no substitute will possibly do, and are you sure Santa knows the Sears stock number if I don't write it down?" list.

There was a time when I could not live without an air-rifle - not a BB gun - just the kind that made noise and smoked if you put a few drops of sewing-machine oil down the barrel. All my friends had them, and they were required for most of what we did for fun. Shooting each other. I wore one out every year, and that was good, because my folks got off cheap with that kind of thing being my major Christmas present. Throw in a few model cars, socks and underwear, and I was set.

The air rifles eventually gave way to BB guns, and I went the way of Ralphie. Constant admonitions about shooting my eye out rolled off me like water off a duck, but it's also interesting that like Ralphie, my very first shot was also at a metal sign, and it too ricocheted back and hit me in the forehead. Considering that I didn't wear glasses at the time, that was a good thing, because I wouldn't have been clever enough to parley broken glasses into a day of pity the way he did. Poor Ralphie.

I've mentioned Fred Hoffman before. K3DEY was the first ham I'd ever met. He was my friend's dad, and a Cub Scout leader who taught us to build crystal radios. From that moment forward, everything on my Christmas list included wires. Guns were no longer a necessity. Communication was the key.

From the day I saw him operate his novice rig (as KN3DEY), I was hooked. That week my dad brought me home a code practice oscillator (they were buzzers then) and a key. That Christmas left me with an ARRL License Manual and a Hallicrafters S-38-E receiver. I've never been the same since.

While other kids hid copies of girlie magazines under their mattresses, I had an Allied Catalog by my bed. My girlie magazines were hidden out in the barn, but that's beyond the scope of this article. I've always wanted to use that phrase.

It was around this time that I discovered electric guitars. Between the musical instrument section of the Sears Catalog and the entire Allied Catalog, I spent several years just day-dreaming of guitars, amplifiers, and radios.

Every year, my list included an electric guitar, an amplifier, and a ham radio transmitter. Every year, I got model cars, toys, some neat gadgets, accessories for my NON-ELECTRIC guitar, and appropriate books designed and selected to help me pass my novice exam and get an amateur radio operator's license, NO electric guitar and NO ham transmitter!

I was nothing if not a slow learner. I just kept asking for this stuff, and my dad kept saying no. I figured he was testing me - trying to determine how serious I was about getting this stuff, so I asked even harder, with more determination than ever, and more often. That was not what he was going for. It took me the longest time to catch on.

The guitar was easier than the Morse code and the electronics theory, and I began to play better and better. One day, near my birthday, my dad took me to a music store and we looked at electric guitars. We left without one, but soon thereafter, one appeared. Could it be that my nagging and begging had paid off? No, but it took me a while to realize that my playing had improved to a point where he thought I was due for a better guitar. All that time I thought he had given in to my wishes, so now that I had the guitar I began nagging for a ham radio transmitter in earnest. It didn't work.

A few years passed, and my playing improved (back then, very few people played guitar, even fewer played electrics, and played in bands). It was also the only way a dorky person could get girls, if as it were, so I worked very hard on my playing. I did not put the same effort into studying for an amateur radio license, which, to my knowledge, did not improve one's chances with the ladies.

My dad saw to it that I got better and better guitars, amplifiers, and a supply of records which he (correctly) thought would inspire me to play even better. The world recently lost Chet Atkins - it was more of a personal loss for me. My dad bought me my first Chet Atkins record in 1961 and warned me that if I thought I was good, I was in for a rude awakening when I played that record. He was right. I have learned how Chet Atkins played so well, but I've never learned to do it.

Many years passed, and many guitars and amplifiers, but my dad stayed true to his word on two counts: When I played better, he'd get me a better guitar. When I passed my test and got a ham license, he'd buy me a transmitter.

That offer expired when I got married, and strangely enough, it was shortly after I got married that I did pass my test and got a novice ticket. I didn't ask him for a transmitter - I just bought an old used one. It was fine.

I learned a lot from my dad. I can't tell you how much I miss him.

If any of you readers are still young--still "kids," still living at home - I wish I could bring you forward in time to where you are your father's age - for just a few minutes. During those few minutes, you might understand the value of a parent. Maybe two parents. If you could take that knowledge back with you, I guarantee it would change your life.

Merry Christmas, Happy Chanukah, or just have a nice December and may each New Year be better than the last. ■

# LISTEN AND YOU'LL KNOW™



## Sangean ATS505P

*The Most Features And Best Performance For The Price!*

- Continuous All Band SW Coverage
- Exceptional SSB Listening
- 45 Memory Channels/with Auto Memory Preset
- AM/FM Stereo thru Headphones
- Built-in SW Antenna Jack
- Dual Time Clock with Alarm
- Lighted LCD Display
- Carrying Case & Earbuds, SW Ant., AC Adapter

\$129<sup>95</sup> Includes U.S. Shipping



## Sangean ATS909

*The Last Shortwave Receiver You'll Ever Need to Buy!*

- 306 Memory Presets, 29 Separate Pages
- True Upper and Lower SSB Reception
- 5 Tuning Methods
- 42 World City Times
- RDS Reception
- AM/FM Stereo thru Headphones
- Built-in SW Antenna Jack
- Dual Time Clock with Alarm
- Lighted LCD Display
- Carrying Case, SW Ant., Earbuds, AC Adapter

\$259<sup>95</sup> Includes U.S. Shipping

# SANGEAN

## AMERICA, INC.

[www.sangean.com](http://www.sangean.com)

Broadcast Tower  
Southern Italy



## CCRadioplus

*The Best AM Radio Made Today Is Now Even Better!*

- ★ Programmable Station Record Timer
- ★ Audio INPUT/OUTPUT Jacks
- ★ Signal Strength Meter
- AM, FM, TV Audio, Weather Band + Alert
- Built-in 6V DC Input Jack & Charging Circuit
- Built-in LED Light Jack
- Audio Tuned for Human Voice
- 5 Memory Buttons Per Band
- Rotary Tuning Knob with 1kHz Fine Tuning
- Lighted Digital Display

\$159<sup>95</sup> Includes U.S. Shipping

C. CRANE

COMPANY, INC.

800-522-8863

[ccrane.com](http://ccrane.com)

**FREE CATALOG #12R • 800-522-TUNE**

# The **NEW** Digital Scout

**Find Frequencies That  
Were Never Before  
Detectable**



Now you can capture Digital and Analog frequencies

With a frequency range of 10MHz-2.6GHz, the *NEW* Digital Scout now captures signals that you only dreamed of. \*Digital signals such as TDMA, GSM, APCO25, TETRA, ON/OFF Keying, Pulsed RF and more. In addition, the Digital Scout captures all the same analog signals as the popular Scout. \*(Will not lock onto CDMA, Spread Spectrum or PCS)

The Digital Scout also performs the feature invented and patented by Optoelectronics, Reaction Tune. Interface the Digital Scout to a compatible receiver and watch as it automatically tunes the receiver to the frequency it captures, allowing you to instantly monitor the audio (analog only) from the captured signal. A beeper and vibrator will alert you when a frequency has been captured.

## \$459

Antenna sold separately

The Digital Scout has 1000 memories with up to 65,000 hits per frequency. All memory can be downloaded to the PC using the Optolinx PC interface (optional).

- |   |  |
|---|--|
| <ul style="list-style-type: none"><li>• Frequency Range 10MHz-2.6GHz</li><li>• Capture *Digital and Analog RF</li><li>• Reaction Tune (analog only) with ICOM R10, R7000, R7100, R8500, R9000; AR 8000, AR8200; Optoelectronics R11, Optocom, OS456/Lite, OS535; BC245, BC780</li></ul> | <ul style="list-style-type: none"><li>• 1000 memories with 65,000 hits</li><li>• Beeper and Vibrator alert</li><li>• Calibrated signal strength reading -5 to -45dBm</li><li>• +/- 5dBm signal strength accuracy</li><li>• Download memory to PC using Optolinx (optional)</li></ul> |
|---|--|

**Order Factory Direct 800-327-5912**

## **OPTOELECTRONICS**®

5821 NE 14th Avenue  
Ft Lauderdale, FL 33334  
Tel: 954-771-2050 Fax: 954-771-2052  
[www.optoelectronics.com](http://www.optoelectronics.com)



Optoelectronics, ICOM and AOR are registered trademarks. Digital Scout covered under Patent #5,471,402 and other \*Pat. Pending.

### SIGNAL STRENGTH

The Digital Scout can also be used as a field strength meter. The Digital Scout displays the power level of the nearfield RF in dBm, which is calibrated at the input. Signal levels can be measured from -45 to -5 dBm with accuracy of +/- 5dBm.

