

POPULAR COMMUNICATIONS

NOVEMBER 1990 \$2.95
\$3.95 CANADA

Tuning In On Search & Rescue Operations

Also in this issue:

- We Review: GRE's "Super Amplifier"
- Spies Like Us!
- Monitoring The World's Newsbreaking Events
- Scanning Tricks of the Trade



Plus: CB, Car Phones, Nostalgia, Ham Radio & More!



YOU EXPECT THE WORLD FROM ICOM RECEIVERS

ICOM's IC-R71A and IC-R7000 are the professional's choice for receiving international broadcasts, aircraft, marine, business, emergency services, television, and government bands. These people demand the finest in communications and so do you. ICOM puts the world at your fingertips with the IC-R7000 25-2000MHz* and IC-R71A 0.1-30MHz commercial quality scanning receivers.

Incomparable Frequency Control. Both the IC-R71A and IC-R7000 feature **direct frequency access** via their front keypad, main tuning dial, optional infrared remote control and/or computer interface adapter. **Incredible Flexibility!**

Full Coverage, Maximum Performance. The superb IC-R71A is your key to world-wide SSB, CW, RTTY, AM and FM (optional) communications plus foreign broadcasts in the 100kHz to 30MHz range. It features IF Notch, low noise mixer circuits and a 100db dynamic range. The pacesetter **IC-R7000** receives today's hot areas of interest, including aircraft, marine, public services, amateur, and satellite transmissions in the 25MHz

to 2000MHz* range. It includes **all mode operation** low noise circuits plus outstanding sensitivity and selectivity. The IC-R71A/R7000 combination is your window to the world!



The IC-R71A is a shortwave listener's delight. Its **32 tunable memories** store frequency and mode information, and they are single-button reprogrammable **independent of VFO A or VFO B's operations!** Dual width, an adjustable noise blanker, panel selectable RF preamp, and selectable AGC combined with **four scan modes** and all-mode squelch further enhance the IC-R71A's HF reception!

The IC-R7000 features 99 tunable memories and **six scanning modes**. It even scans a band and loads memories 80 to 99 with active frequencies without

operator assistance! Additional features include selectable scan speed pause delays, wide/narrow FM reception and high frequency stability.

Options. IC-R7000: RC-12 remote control, EX-310 voice synthesizer, CK-70 DC adapter, MB-12 mobile bracket. IC-R71A: RC-11 remote control, EX-310 voice synthesizer, CK-70 DC adapter, MB-12 mobile bracket, FL-32A 500Hz, FL-63A 250Hz and FL-44A filters.

See these quality ICOM receivers at your local authorized ICOM dealer today.

*Specifications of the IC-R7000 guaranteed from 25-1000MHz and 1260-1300MHz. No coverage from 1000-1025MHz.

ICOM America, Inc. 2380-116th Ave. N.E., Bellevue, WA 98004
Customer Service Hotline (206) 454-7619
 3150 Premier Drive, Suite 126, Irving, TX 75063
 1777 Phoenix Parkway, Suite 201, Atlanta, GA 30349
 ICOM CANADA, A Division of ICOM America, Inc.
 3071 - #5 Road, Unit 9, Richmond, B.C. V6X 2T4 Canada

All stated specifications are subject to change without notice or obligation. All ICOM radios significantly exceed FCC regulations limiting spurious emissions. Receivers 89

ICOM
 First in Communications



OPTOELECTRONICS

The only name in HANDI-COUNTERS

Check These Incredible Features
On The All New UTC3000

- **10Hz to 2.4GHz Range.**
Simply amazing!
 - **10 Digit LCD Display.**
1Hz resolution to over 150 MHz direct.
Readable in bright sunlight.
 - **RF Signal Strength Bargraph.**
16 Segment, Zero, & Full Scale adjustment.
SEE the input signal!
 - **Super Sensitivity.** <1mV 10-200MHz,
<5mV to 2GHz for efficient antenna pickup.
 - **6 Functions.** Frequency, Period, Ratio
Time Interval, Average, & Prescale.
 - **Hold Button.**
"Locks in" your exact Measurement FAST!
 - **Extruded Aluminum Enclosure.**
Designed to fit every hand.
 - **Priced Right! Only \$375.**
Includes Nicads, AC Charger/Adapter.
- Or Select Our Most Popular
HANDI-COUNTER, the model 2210
that set the standard in handheld
frequency counter technology!
Value Priced at only \$239.

Professionals and Hobbyists all over
the world have chosen OEI for 16
years! **Shouldn't YOU?**

HANDI-COUNTERS! ...Only from OEI!
Choose the model that fits your needs...
and your budget! **CALL NOW!**



UTC3000

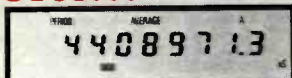

Period Average Mode



Display Showing All Annunciators

| Model | UTC3000 | 2600H | 2210 | 1300H/A | 2400H | CCA | CCB |
|---|---|--------------------------------------|-----------------|-----------------|------------------|-------------------------------------|--------------------------------------|
| Function | Freq, Period Ratio, Interval, Avg, Prescale | | | | | | RF Indicator |
| Range | 10Hz- 2.4GHz | 10MHz- 2.4GHz | 10Hz- 2.2GHz | 1MHz- 1.3GHz | 10MHz- 2.4GHz | 10MHz- 550MHz | 10MHz- 1.8GHz |
| Display | 10 Digit LCD w/Function Annunciators | 10 Digit LCD | 8 Digit LED | 8Digit LED | 8 Digit LED | 8 Digit LED | . |
| RF Signal Strength Indicator | 16 Segment Adjustable Bargraph | 16 Segment Adjustable Bargraph | . | . | . | LED with Adjustable Threshold | 10 Segment Adjustable Bargraph |
| Price | \$375. | \$325. | \$239. | \$179. | \$189. | \$299. | \$119. |

Sensitivity: <1 to <10mV typical. Time Base: ± 1 ppm, $\pm .5$ ppm, add \$75 - LED Models; ± 2 ppm add \$80. - LCD Models. Nicads & AC charger/adaptor included. (9V Alkaline - CCB.) Carry Case, Antennas and Probes extra. One year parts & labor warranty on all products.



OPTOELECTRONICS

5821 NE 14th Avenue • Ft. Lauderdale, FL 33334

Toll Free Order Line:

1-800-327-5912

FL(305)771-2050 • FAX(305)771-2052



Visa, MC, COD, Cash, M.O. accepted. Personal
Check allow 3 weeks. 5% Shipping, Handling,
(Maximum \$10) U.S. & Canada. 15% outside
continental U.S.A. In FL add 6% sales tax.



POPULAR COMMUNICATIONS

NOVEMBER 1990

VOLUME 9, NUMBER 3



10



49

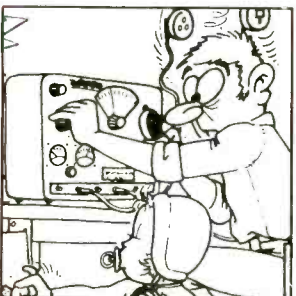

66

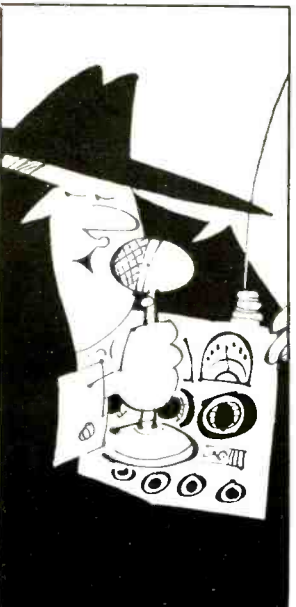

14

FEATURES

Tuning In On Search And Rescue Operations 10

It's A Big, Dangerous World Out There, So Keep These Frequencies Handy! *By Thurston Wainwright, KFL4PN*

Spies Like Us 14

Electronic Surveillance Has Become A Family Affair— & A Big Business! *Carl S. Kaplan*

The World's Newsbreaking Events— On Your Scanner! 18

Whether It's A Bank In Berlin Or A Racial Incident In The RSA, You Can Hear It While It's Happening *By Chuck Robertson*

Radio: Way Back When 22

Rattling Around In The Archives of Early Radio *By Alice Brannigan*

POP*COMM Reviews: Palomar Engineers' "Channel-Cleaner™" Antenna 29

Reviewed By Don Allen, N9ALK

Books You'll Like 30

How To Start Your Own Country, And Revolutionary Television *By R. L. Slattery*

POP*COMM Reviews: The GRE America Super Amplifier 32

Reviewed by Rick Maslav, KNY2GL

Scanning The Tricks Of The Trade 34

Receive Scanner Signals Where No Signal Has Gone Before, Passive Repeaters, Radiating Coax, And Other Exotic Devices *By Patrick M. Griffith*

COLUMNS

| | |
|---------------------------------------|----|
| You Should Know | 38 |
| Broadcast DXing | 43 |
| Communications Confidential | 46 |
| Telephones Enroute | 49 |
| Satellite View | 52 |
| RTTY | 54 |
| Ham Column | 59 |
| Listening Post | 60 |
| Emergency | 64 |
| How I Got Started | 65 |
| CB Scene | 66 |
| Washington Pulse | 69 |
| Pirate's Den | 72 |
| Scanning VHF/UHF | 74 |

DEPARTMENTS

| | |
|---------------------------------|----|
| Beaming In | 6 |
| Mailbag | 9 |
| New Products | 33 |
| Worldband Tuning Tips | 40 |
| Communications Shop | 77 |

This month's cover: USA—Emergency Fire Rescue helicopter is guided in by fireman. Photo by Larry Mulvehill.

EDITORIAL STAFF

Tom Kneitel, K2AES/KNY2AB, Editor
Jeanine M. O'Connor, Associate Editor

CONTRIBUTING EDITORS

Gerry L. Dexter, Shortwave Broadcast
Robert Margolis, RTTY Monitoring
Gordon West, WB6NOA, Emergency
Don Schimmel, Utility Communications
Edward Teach, Alternative Radio
Harold A. Ort, Jr., Military Consultant
Janice Lee, Radar Detectors
Chuck Gysi, N2DUP, Scanners
Havana Moon, Clandestine Consultant
Roger Sterckx, AM/FM Broadcasts
Ed Noll, W3FQJ, Thoughts and Ideas
Donald Dickerson, N9CUE, Satellites
Kirk Kleinschmidt, NT0Z, Amateur Radio

BUSINESS STAFF

Richard A. Ross, K2MGA, Publisher
Donald R. Allen, N9ALK, Advertising Mgr.
Emily Kreutz, Sales Assistant
Dorothy Kehrwieler, General Manager
Frank V. Fuzia, Controller
Catherine Ross, Circulation Director
Melissa Kehrwieler, Data Processing
Carol Minervini, Customer Service

PRODUCTION STAFF

Elizabeth Ryan, Art Director
Barbara Terzo, Artist
Dorothy Kehrwieler, Production Manager
Emily Kreutz, Production
Pat Le Blanc, Phototypographer
Florence V. Martin, Phototypographer
Linda Romanello, Typesetting
Hal Keith, Technical Illustrator
Larry Mulvehill, WB2ZPI, Photographer

A publication of

 CQ Communications, Inc.
76 North Broadway
Hicksville, NY 11801-2953 USA.

Offices: 76 North Broadway, Hicksville, NY 11801. Telephone 516 681-2922. FAX (516) 681-2926. Popular Communications (ISSN 0733-3315) is published monthly by CQ Communications, Inc. Second class postage paid at Hicksville, NY and additional offices. Subscription prices: Domestic—one year \$19.95, two years \$38.00, three years \$57.00. Canada/Mexico—one year \$22.00, two years \$42.00, three years \$63.00. Foreign—one year \$24.00, two years \$46.00, three years \$69.00. Foreign Air Mail—one year \$77.00, two years \$152.00, three years \$228.00.

U.S. Government Agencies: Subscriptions to Popular Communications are available to agencies of the United States government, including military services, only on a cash with order basis. Requests for quotations, bids, contracts, etc. will be refused and will not be returned or processed.

Entire contents copyright ©1990 by CQ Communications, Inc. Popular Communications assumes no responsibility for unsolicited manuscripts, photographs, or drawings. Allow six weeks for change of address or delivery of first issue. Printed in the United States of America.

Postmaster: Please send change of address to Popular Communications, 76 North Broadway, Hicksville, NY 11801.

UNIVERSAL SHORTWAVE

Monitor More With Advanced Equipment From Universal!

COMMUNICATIONS RECEIVERS

Japan Radio NRD-525



For the communications connoisseur. Covers .1-34 MHz. Incredible performance and features. In stock. \$1129.95 (+\$12 UPS)

Kenwood R-5000

A powerful receiver for the serious DXer. An exceptional value. \$849.95 (+\$11 UPS)

Kenwood R-2000

Many features: mems., scan, sweep, FM mode, 24 hr. clock etc. \$649.95 (+\$10 UPS)

Icom R-71A

A well-respected time-tested performer. Notch, 2 VFOs, keypad. \$849.95 (+\$9 UPS)

Yaesu FRG-8800

Beautiful LCD display, keypad, memories and more. \$689.95 (+\$9 UPS)

PORTABLE RECEIVERS

Sangean ATS-803A



Keypad, memories, BFO, clock, RF gain, etc. A strong performer and unbeatable value. \$189.95 (+\$5 UPS)

Sony ICF-2010

Super high performance and features. VHF air too. \$359.95 (+\$5 UPS)

Magnavox AE3805BK

A digital radio at an analog price. Covers 3.2-7.3 & 9.5-21.7MHz \$119.95 (+\$4 UPS)

Grundig Satellit 500

Hi-tech with beautiful fidelity and style. Synchronous tuning. \$499.00 (+\$5 UPS)

Note: Radios listed above are all LW-MW-SW-FM digital. Contact us for other models

SPECIAL RECEIVERS

Icom R-9000



Solid all-mode coverage from .1 to 1999.8 MHz. Multi-function CRT with spectrum analyzer. The ultimate receiver! CALL FOR PRICE.

SHORTWAVE ANTENNAS

Alpha Delta DX-SWL Sloper

MW +120-13 meter bands (60'). \$67.95+\$4

Alpha Delta DX-SWL Sloper-Short

90-13 meter bands (40') \$57.95+\$4

Eavesdropper Specify twin lead or coax type

9 SW bands (60-10 meters) \$74.95+\$4

McKay Dymek DA100D Active Antenna

The Cadillac of active antennas! .. \$179.95+\$4

Sony AN-1 Active Antenna

For portables, covers .15-30 MHz. \$84.95+\$4

Note: Many more antennas available. See catalog.

MULTI-MODE CONVERTERS

Universal M-7000



The Universal M-7000 will permit you to intercept and decode Morse code, various forms of RTTY, FDM and FAX. Simple connections to your receiver and video monitor will enable you to monitor with the most sophisticated surveillance decoder available. No computer is required. See the world of shortwave excitement you have been missing. Requires 115/230 AC 50/60 Hz. Starting at \$999.00. Please write for full details.

- ◆ Morse Code (CW)
- ◆ Regular Baudot RTTY
- ◆ Variable Speed Baudot
- ◆ Bit Inverted Baudot
- ◆ ASCII Low & High Speed
- ◆ Sitor Mode A (ARQ)
- ◆ Sitor Mode B (FEC)
- ◆ ARQ 2&4 chan. (TDM)
- ◆ ARQ-E and ARQ-E3
- ◆ VFT Modes (FDM)
- ◆ Russian 3rd Shift Cyrillic
- ◆ Facsimile (FAX) AM/FM
- ◆ Packet 300 & 1200 AX.25
- ◆ Remote Terminal
- ◆ Literal & Databit Modes
- ◆ Variable & Standard Shift
- ◆ Automatic Tuning
- ◆ Diversity Reception

MULTI-MODE CONVERTERS

Universal M-900



Here is a compact, easy to use decoder that copies all the most important shortwave transmission modes. The M-900 covers Morse code for monitoring hams, ships and coastal stations. Baudot RTTY is included for decoding weather and international press broadcasts. Both Sitor A and Sitor B are supported for monitoring the extensive maritime and diplomatic traffic. Facsimile (to the printer only) lets you receive maps and pictures from around the world. Requires 12 VDC @ .8A Text output to video monitor. \$499.95 (+\$8)

- ◆ Morse Code (CW)
- ◆ Regular Baudot RTTY
- ◆ Sitor Mode A (ARQ)
- ◆ Sitor Mode B (FEC)
- ◆ Facsimile (FAX) FM
- ◆ Variable & Standard Shift

M-900 System Components

A complete M-900 system would require:

- Universal M-900
- 12 VDC Power Supply
- Your SW Receiver
- Video Monitor
- Parallel Printer
- Cables for above

Please write to Universal for full information on the M-900 and the above optional items. Full system prices are available.

COMMUNICATIONS BOOKS

Passport To Worldband Radio 1991 Ed.

By L. Magne. Graphic presentation of all SWBC stations. Reviews too. \$16.95 Sale \$13.90

Shortwave Receivers Past & Present

By F. Osterman. Your guide to 200 receivers with new-used value, specs, features. \$6.95

Aeronautical Communications Handbook

By R. Evans. A mammoth book on all aspects of shortwave aero listening. 266 pages. .. \$19.95

Complete SWL's Handbook Third Edition

By Bennett, Helms, Hardy. Nearly 300 pages on all aspects of SWL'ing. \$16.95

Guide To Facsimile Stations

By J. Kligenfuss. The complete guide to FAX with freqs., schedules and addresses... \$24.95

Easy-Up Antennas for Listeners & Hams

By E. Noll. Low cost, easy to erect antennas for LW, MW, FM, SW, SCAN and HAM. \$16.95

World Radio TV Handbook 1990 Ed.

All SWBC stations by country with schedules, addresses, power, etc. Reviews too. .. \$19.95
✓ Please add \$1 per title for shipping.

COMMUNICATIONS CATALOG

Universal now offers a new combined communications catalog covering shortwave, amateur and scanner equipment. There is also an unbeatable selection of antennas, books, parts and accessories. This huge 92 page (8½" by 11") publication covers everything for the radio enthusiast. With prices, photos and full descriptions.

★ Available for \$1 postpaid ★

STORE HOURS

Monday - Friday 10:00-5:30
Except Thursday 10:00-8:00
Saturday 10:00-3:00

We ship worldwide
Visa, MC, Discover
Prices & specs. are
subject to change.
In business since 1942
Used equip.
list available

Universal Radio

1280 Aida Drive Dept. PC
Reynoldsburg, Ohio 43068 U.S.A.
Ohio: 614 866-4267 Toll Free: 800 431-3939



The ICOM EXPERTS

Minutes From
Washington, D.C.

CLASSIC



R71A .1-30 MHz

- World Class HF Receiver
- All Mode AM, CW, SSB, RTTY, FM (Opt)
- Keyboard And Memory Frequency Entry
- 32 Programmable Memory Channels
- Optional Filters, Voice, 12VDC, Computer Input
- Many EEB Options Listed In Our 1990 Catalog
- 117/220/234 VAC 13.8 VDC (Opt)
- 11.25W x 4.44 x 10.9D (Inch) 16.5 Lbs

List \$999

EEB Discount Price \$849.95 + UPS

Get The Details From
Our FREE 1990 Catalog.

CLASSIC



R7000 25-2000 MHz

- VHF/UHF Classic Nothing Like It Under \$4000
- Triple Conversion Eliminates Images
- Tuning Steps .1, 1.5, 10, 12.5, 25 MHz Increments
- 99 Programmable Memory Channels
- Sensitivity Better Than .5µV (12dB SINAD) FMN
- Multimode AM, FM, FMN, FMW, CW/SSB
- Many EEB Options Listed In Our 1990 Catalog
- 117/220/234VAC 13.8VDC (Opt)
- 11.25W x 4.4H x 10.9D (Inch) 17.5 Lbs

List \$1199.00

EEB Discount Price 1019.00 + UPS

CLASSIC



R9000 .1-2000 MHz

- Never Has So Much Been Offered In One Receiver
- Covers Everything VLF (100 kHz) To Super UHF 2 GHz
- Multimode AM, FM, FMN, FMW, CW, SSB, RTTY
- 1000 Programmable Memory Channels
- DDS (Direct Digital Synthesizer) Tuning
- CRT, Spectrum Analyzer, Multi Screen Readout
- Power 100-120VAC 220-240 12VDC (Opt)
- EEB Optional Power Supply And Filters
- 16.7W x 5.9H x 14.4D (Inch) 44.1 Lbs

List \$5495.00

Call
EEB Discount Price \$2795.00 + UPS

**FREE DETAIL LITERATURE ON ALL ICOM PRODUCTS
CALL 1-800-999-9877**

CLASSIC

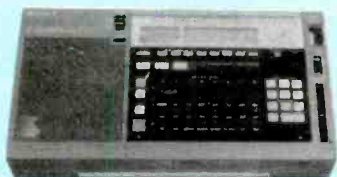

ICF2010 RECOGNIZED BY THE EXPERTS AS THE WORLDS BEST PORTABLE RECEIVER, "IT EVEN RIVALS SOME TABLE MODELS".

- AM/CW/LSB/USB .15-30MHz
- FM Wide 76-108MHz
- Air Band AM 116-136MHz
- 32 Memories-Keyboard Entry
- Synchronous Detection
- Separate Multi Function Clock
- 6.2 x 11.4 x 2 Inches 3.8 Pounds
- Power AC120V Adaptor Incl. Option 12VDC DCC127A 3 "D" Cell, 2 "AA" Not Included
- Free EEB RS-1 Radio Stand With Order

List \$429.95 EEB \$349.95 + \$6 UPS

CATALOG

NEW 1991



CATALOG

- Full Line SWL Receivers
- Many SWL Antennas
- Scanners & Accessories
- Books, Books & More Books
- Converters, Filters
- Clocks, Speakers & More
- Ask To Be Put On Our Mailing List For Future Publications

FREE Call Or Mail In
For Your FREE Copy

NEW



SONY ICF SW 7600

- SW All Bands .1-30 MHz
- FM Stereo With Headphones (Incl)
- 10 Memories & Clock Timer Alarm
- CW SSB (USB, LSB) AM FM
- Keyboard Frequency Entry
- Complete System Including Ext Ant, Headset, Book, AC Adapter
- New Replacement For ICF-2003
- Free EEB RS-1 Radio Stand With Order

List \$259.95 EEB \$219.95 + UPS



ELECTRONIC EQUIPMENT BANK
323 MILL STREET, N.E.
VIENNA, VA 22180

ORDERS: 800-368-3270
LOCAL TECH: 703-938-3350
FAX: 703-938-6911

- PRICES SUBJECT TO CHANGE
- PRICES DO NOT INCLUDE FREIGHT
- SORRY, NO CODs
- RETURNS SUBJECT TO 15% RESTOCK FEE



NATION'S LARGEST SWL DEALER

Minutes From
Washington, D.C.

NEW

PRO2006



REALISTIC® PRO2006 HYPERSCAN™ THE LATEST IN SCANNER TECHNOLOGY

- 25-520/760-1300MHz**
(Opt. 1-30MHz FC7300)
- 400 Channel Memory (10 Banks)
- AM/FM/FM-Wide Modes
- Scan Up to 26 Channels/Sec.
- Priority Channel • Lock Out
- Voice Squelch
- 120VAC 50/60 Hz
- 13VDC Option (80132 \$4.99)
- 2.9 x 8.1 x 8.3 Inches 4.8 Pounds

List \$399.95 **EEB \$379.95**

****Simple Mod Instructions Included for Full 760-1300MHz Coverage, Full 1 Year Limited Warranty By EEB.**

NEW

AX700



AX700 All the Functions Of A Hi-tech Scanner And Spectrum Analyzer In One Package

- 50-904.995MHz (Opt. 1-50MHz FC7300)
- AM/FM-N/FM-W Modes
- 100 Memory Channels (10 Banks)
- Scar 10/12.5/20/7.5KHz
(1/5MHz Manual)
- Spectrum Display 100, 250, 1000KHz
- 13VDC Power, AC Adaptor Incl.,
DC Cig Cord Incl.
- Plugs Into Your R71A IF Output As
Spectrum Display
- "Lock" At The HF Spectrum Using
Optional Novex FC7300 Converter
- SASE #10 For Full Details

EEB Target Price \$799 Call

NEW

FAIR

MATE HP100



- 8-600 And 805-1300MHz Full Coverage
- 1000 Memory Channels
- 40 Ch/Sec Search
- Steps 5 to 995KHz
- AM/FM N/FM W Modes
- Keypad And Manual Tuning
- 6.7 x 2.6 x 1.4 Inches 10 Ounces
w/o Battery
- Includes 4 "AA" Nicad. AC Charger,
DC Cig Cord, Case, Belt Clip,
Earphone
- 1 Year EEB Limited Warranty

EEB \$469.95 + \$4 UPS

FREE NEW 1991 SHORTWAVE CATALOG AVAILABLE

NEW

NOVEX FC7300



NOVEX FC 7300 CONVERTERS TURN YOUR SCANNER OR VHF RECEIVER INTO A HF SHORTWAVE RECEIVER

- Ideal for ICOM R7000, AX700,
FRG9600 Or Any Scanner Covering
100 to 150 MHz with AM Mode. Use
Some of Those Memory Channels
for S.W.
- DC-50MHz Input 100 To 150MHz
Output
- Auto Antenna Switching HF/VHF
- Easy Hookup No Mods
- Computer/Remote Control Option
- 10-15VDC-120VAC Adapter Included
- Complete With Connecting RF Cable
And Coax Adapters For Most Radios

EEB \$249.95 + \$4 UPS

NEW

TCM 38V



SONY TCM38V LOGGING CASSETTE RECORDER NOT ONLY RECORDS AUDIO IT ALSO RECORDS AND PRESENTS AN LCD READOUT, TIME, DAY, DATE AND IS VOICE ACTIVATED

- Log Voice, Date, Time From Scanner
- Turn Your Scanner Into A Logger
- Tune To Your Priority Station And
Log Everything For Up To 1 Week
Or Total Time of 60 Minutes
- Built In Mic, Speaker, Digital Tape
Counter, Auto Level And More
- 2AA (Not Incl.) AC Adaptor
Optional PA3N \$11.95

EEB Sale \$109.95 + \$4 UPS

NEW

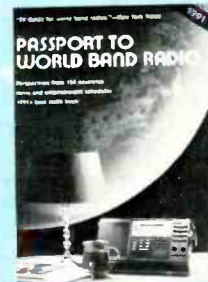

ALL NEW 1991 PASSPORT TO WORLD BAND RADIO YOUR BIBLE TO SHORTWAVE LISTENING

- All New 1991 Issue
- Data Listed On All Major SW Stations
- Names, Locations, Frequency, Time,
Target Area, Station Power
- English Programs By The Hour
- Magne/Sherwood Famous Test
Reports On All The Current SW Radios
- SW Buyers Guide
- Much More

WBR91 \$16.95 + \$1.95 S&H



ELECTRONIC EQUIPMENT BANK
323 MILL STREET, N.E.
VIENNA, VA 22180

ORDERS: 800-368-3270

LOCAL TECH: 703-938-3350

FAX: 703-938-6911

- PRICES SUBJECT TO CHANGE
- PRICES DO NOT INCLUDE FREIGHT
- SORRY, NO CODs
- RETURNS SUBJECT TO 15% RESTOCK FEE

Time To Byte The Bullet

Not long ago, a reader wrote in asking about the possibilities of submitting a manuscript to us prepared on a floppy disk. Over the months, we have received a number of other inquiries along those lines, so I ran his letter along with a reply in our August issue *Mailbag* column. Essentially, I said that we use PC compatibles here and could consider articles on floppies if they were set up to work in the computers we use.

This attracted several manuscripts on floppies (most still come in the old fashioned way, on paper). It also brought in a lively response from packet radio fans, computerized SWL's, computer cultists, hackers, and phreaks who were thrilled and delighted with my apparent revelation that I'm a member of their happy breed. It triggered far more than that, too.

Most interestingly, in addition, it sparked a surprisingly large amount of mail from readers who took my mention of computers as inspiration to seek out my opinions and advice on buying and using specific computer hardware and software. And I'm now getting invitations to participate in computer bulletin boards and networks. I even received an earnest plea from a dentist begging me to please come over and show him how to use a computer system he purchased last year but still can't figure out.

My mention of computers in *Mailbag* also seems to have gotten me added to the mailing lists of several computer-oriented communications newsletters. Two are excellent. The first is *Bits, Bytes & BBSs*, a quarterly publication available at \$16 per year from Moonbeam Press, P.O. Box 149, Briarcliff Manor, NY 10510. The other is *The Wireless Bitstream*, published bi-monthly by the Amateur Radio Special Interest Group of the Boston Computer Society, One Center Plaza, Boston, MA 02108. Membership in the Society (which includes a subscription to this fine publication) is \$40 per year.

As it turns out, when personal computers first began emerging into the big time, around 1980, I was on one of the earliest bandwagons to roll out. After extended shopping, comparing of specs, and painstaking deliberations over computers from Commodore, Kaypro, and others, I selected an *Atari 800* with disk drive, printer, and most of the available software. I then spent many enjoyable hours working with the simple DOS system Atari had created for exclusive use in its own equipment.

Next, in 1983, a delegation of my hot-shot pals who were into serious computing, bluntly let me know that my kindly *Atari 800*



"I can take 'most any transmitter, receiver, or other similar gizmo, new or old, figure it out intuitively, then patch it up with a chewing gum wrapper . . ."

was simplistic, slow, outdated and primitive; a ludicrous, glorified toy for which it would soon be impossible to get any new software. They couldn't understand why I didn't upgrade and get the latest, trendy, popular-manufacturer's super-whizbang development in computing, filled with enough additional cards, boards, fans, drives, microchips, whistles, horns, special doodads and modifications to allow it to match the speed, memory and power of one of the NSA's computers. How could I resist a pitch like that?

They then marched me over to their favorite computer store. There I stood, credit cards in hand, like a big dummy, while they ran up and down the aisles like kids in a candy store, selecting various goodies for my new computer installation. From there, they converged on my radio shack to first disassemble, then fix, redesign, replace, rewire, improve, change and reassemble everything. I was asked to stay out of the way and occupy myself with learning the basics of using my new fire-breathing computer. This could be accomplished by my slogging through the contents of dozens of instruction manuals for the software and every piece of hardware.

Believe me when I tell you that it would have been easier for me to learn to speak Albanian than to communicate fluently with the machine they had inflicted upon me. Meanwhile, they spent several days tweaking, taunting, torturing, testing, and tinkering with this thing in order to get it to do exactly what they wanted, which was obviously far more than its manufacturer had even fantasized as possible. It was only then that they revealed that all of this was necessary

because the engineer who had originally designed the basic model should never have been entrusted with devising anything more complex than a Number 2 pencil. That was encouraging.

Fact was, after they finally packed up their soldering guns and went home, I was left with a shelf full of manuals in many festive colors, lots of software, cartons of floppies, and the computer itself. The computer was a total monstrosity they had appropriately nicknamed *Ming The Merciless*. It had a monitor, a modem, a printer, disk drives and other peripherals, plus a wild, unkempt, tangle of cables. From many of the cables there dangled mysterious little solid-state homebrewed sort-of widgets and flibbertigibbets.

If there was such a thing as *The Computer from Hell*, this was that thing. Without a doubt, *Ming* was as menacingly wicked looking a conglomeration of electronics hardware as had ever been conceived and concocted by the mind and hand of man. But, I had been assured that it was ready, willing and able to do practically anything on behalf of the person who could incite it with the proper commands.

Never before had I been intimidated by any piece of technology. Just the contrary. I can take 'most any transmitter, receiver, transceiver, or other similar gizmo, new or old, figure it out intuitively, then patch it up with a chewing gum wrapper, a few rubber bands and a paperclip. In short order, it's mostly working. This, regardless of the mode or frequency band, and despite the language printed on the front panel or in the service manual. Those that I can't convince

(Continued on page 76)

COMPUTERIZE YOUR SHACK

Control up to eight digital radios simultaneously from your MS-DOS microcomputer! We offer a series of software/hardware packages that interface with most current synthesized rigs.

ICOM: IC-781, 765, 761, 751A, 735, 725, 726, 745 R71A, R7000, R9000, 271, 471, 1271, 275, 375 475, 575, CI-V

KENWOOD: TS-940, 440, 140, R-5000, 680, 711, 811
YAESU: FT-767, 757 GXII, 757 GX, 747, 9600, 736 212, 712

JRC: NRD 525

COLLINS: 651 S1

Knowledge of MS-DOS is not necessary - the installation program does it all! Datacom allows complete control of your rig from the keyboard. Move your cursor to the desired frequency and the radio will be set automatically.

A few of its many features:

- Adds sweep and scan to radios that don't allow this from front panel.
- Adds unlimited memories. Stores frequency, description call sign, sked time, and comments for each frequency, limited only by disk storage.
- Allows radio to be tuned from keyboard by use of arrow keys.
- Tabular screen display of all of the channels stored in memory, along with a full description of each including: MODE (LSB, USB, FM, etc.), eight character alphanumeric description, call sign, sked time, comments. Data files may be sorted by frequency, description, call sign, time, etc.
- Now with mouse control
- Built-in latitude/longitude calculator with database
- Pre-Program multiple schedules—sets frequency and mode at a given time and date.



- Full featured logging utility allows searching for previous entries by call sign. Separate log for each service.
- Able to automatically log hits while sweeping or scanning.
- Color coded program for easy use (will run on a monochrome system).
- Menus for amateur, AM-FM broadcast, television broadcast, S/W, aviation, marine, FAX, satellite with most popular frequencies stored. Menu maker utility allows custom menus defined by user.
- 50 page comprehensive user manual.
- Optional radio direction finder allows bearing information to be logged automatically.

Call or Write today for more information.

AVAILABLE FOR IBM PC,XT,AT, 80386 256K RAM 1 SERIAL PORT AND 1 FLOPPY MINIMUM

PROGRAM WITH INITIAL LIBRARIES 129.95
 RS-232 TO TTL INTERFACE (NEEDED IF DON'T HAVE MFRS INTERFACE) EXT. INTERFACE ALLOWS 4 RADIOS (WITH SQUELCH DETECT) 129.95
 INTERNAL PC INTERFACE W/1 SERIAL & 1 RADIO PORT 129.95
 may be addressed as com1, com2, com3, com4 includes cables to radio SPECTRUM ANALYZER MODULE (CALL FOR PRICE)
 DIAGNOSTIC PROGRAM 25.00
 COMSET ALLOWS OPERATION ON COM3 AND COM4 25.00
 PROG. FOR UNIVERSAL M-7000, AEA PK232, KANTRONICS KAM DIGITAL VOICE RECORDER OPTION!
 ICOM UX-14 INTERFACES IN STOCK
 COMPLETE SYSTEMS (RADIOS, INTERFACE, & COMPUTERS) .. (CALL)
 NEW! TSR COMMANDER, SETS FREQUENCY, MODE, ETC. POP-UPS OVER ANY OTHER APPLICATION \$50.00
 30 MINUTE VIDEO TAPE GUIDE TO SETUP AND OPERATION 19.95

| | | |
|--|------------------------------------|--------------------|
| CURRENT MENU | MAIN MENU | VERSION 9.1 |
| MEM 394 K STACK 1 K | | LOCAL : 16:54:00 |
| DATE: 10-24-1989 | SELECT FUNCTION | MODE= USB |
| U.T.C : 20:54:00 | | |
| 1. READ MEMORY CHANNELS | 7. MEMORY CHANNEL | DIAL |
| 2. INPUT DESIRED FREQUENCY | 8. WRITE MEMORY TO VFO | VFO A |
| 3. 500 KHZ UP | 9. UTILITY MENU | |
| 4. 500 KHZ DOWN | ALT-P. CHANGE MENU PAGE | |
| 5. ACTIVATE/DEACTIVATE CLARIFIER | ALT-Z. DISPLAY OR PRINT LOG | |
| 6. SWEEP BETWEEN 2 LIMITS | ALT-Q. END | |
| A. AVIATION (VHF) COMMUNICATION | D. F.M. BROADCASTING | |
| B. TELEVISION BROADCASTING | E. AMATEUR FREQUENCIES (VHF) | |
| C. COASTAL MARINE FREQUENCIES | F. MISCELLANEOUS FREQUENCIES (VHF) | |
| PORT= COM2 | BAUD= 9600 | CURRENT PARAMETERS |
| RDLY= 0.138 | | |
| UPPER - BAND LIMIT - LOWER | FREQUENCY | MODE |
| | | FILTER |
| | | SQ. ACTIV. |
| | | ADDR |
| 30.000 MHZ | 0.100 MHZ | 17 44300 MHZ |
| | | USB |
| | | WIDE |
| | | |
| | | 38 |
| - icom 781 MF/HF TRANSCEIVER - | | |
| F1 781 F2 R9000 F3 R9000 F4 R9000 F5XCH A/BF6 VFOA F7 VFOB | | |

UPDATE ANY PREVIOUS DATACOM TO NEW DATACOM V For \$50.

Order direct or from Universal Radio 800-431-3939, Gilfer Shortwave 800-GILFER-1

CALL FOR COMPETITIVE ICOM PRICING



IC-R9000



IC-R7000



IC-R71

NEW! IC-R72
 And All Your Other ICOM Favorites



Authorized Dealer
 JST-135 Transceiver
 NRD-525 General Coverage Receiver

DATACOM, INT.

7678 Venetian St., Miramar, FL 33023
 Orders: (800) 780-9505 • Info: (305) 987-9505



"The Largest Dealer of Scanners in the World"

SCANNER WORLD, USA

10 New Scotland Ave., Albany, NY 12208 • 518/436-9606

SCANNER WORLD EXCLUSIVE

UNIDEN BEARCAT BC205XLT

\$259.99 (\$7.00 shipping)

Digital programmable 200 channel hand held scanner with raised button keyboard for easy programming of the following frequency ranges: 29-54 MHz, 118-174 MHz, 406-512 MHz, 806-956 MHz. Features include: Scan delay, memory backup, key pad lock, sidelit liquid crystal display, channel lockout, 10 twenty channel banks, direct channel access, automatic search, full one year factory warranty, 10 priority channels, Ni-Cad battery pack, AC adapter/charger, flexible rubber antenna carry case are all included. Size is 2-11/16" Wx1-3/8" Dx7-1/2" high (Optional extended 2 yr warranty \$29.99, 3 yr. extended warranty \$39.99.) (* Excludes Cellular)

REGENCY TS-1 35 CHANNELS — MOBILE/BASE

Special



\$149.99 (\$7.00 shipping)

Features include simple programming of the following frequency ranges: 29-54 MHz, 118-175 MHz, 406-512 MHz. TurboScan, digital display, priority, search, lockout, delay, dim control, top mounted speaker, one year factory warranty. Includes AC & DC cords, mobile mounting bracket, telescope antenna. All for only \$149.99 plus \$7.00 shipping. (Optional extended warranty: 3 years \$39.99, 2 years \$29.99.)

UNIDEN RD9XL RADAR DETECTOR

SPECIAL LOW PRICE OF ONLY

\$129.99



(\$7.00 shipping)

RD9XL has been rated best radar detector for 1990 by Car & Driver Magazine. Better than Passport, Whistler, and all others. RD9XL includes cigarette lighter cord, mute/audio switch, city/highway switch, mounting bracket, carry case, signal strength meter, dual tone audible alarm, bright warning lamp, plus the very small size of only 2-5/32" Wx3 3/8" Dx11 1/16" H.

— RADAR DETECTORS —

| | | | |
|----------------|---------|----------------|----------|
| Cobra RD-2102 | \$64.99 | Cobra RD-3170 | \$168.99 |
| Cobra RD-2110 | 66.99 | Cobra RD-3112 | 98.99 |
| Cobra RD-3120 | 104.99 | Cobra RD-3168 | 138.99 |
| Cobra RD-5110 | 159.99 | Maxon RD-3 | 67.99 |
| Maxon RD-25KL | 86.99 | Maxon RD-65 | 126.99 |
| Maxon RD-21A | 69.99 | Maxon RD-2A | 49.99 |
| Uniden RD-9XL | 129.99 | Uniden RD-99GT | 129.99 |
| Uniden RD-95GT | 129.99 | Uniden RD-500 | 65.99 |
| Uniden Talker | 109.99 | Uniden RD-9 | 114.99 |
| Uniden RD-25 | 58.99 | Uniden RD-3XL | 154.99 |

REGENCY R-4010

\$106.99

(\$7.00 shipping each)

10 channel hand-held scanner (Same Scanner as Bearcat 55XLT), 29-54 MHz, 136-174 MHz, 406-512 MHz, digital programmable, keyboard lock switch, lockout, includes rubber flex antenna. (Optional accessory 5W-41 only \$19.99 includes rechargeable Ni-Cad batteries, AC adapter/charger and cigarette lighter cord.)

REGENCY Z-60

\$119.99



(\$7.00 shipping)

Programmable 60 channel, AC/DC digital, 30-50 MHz, 88-108 MHz, 118-136 MHz, 144-174 MHz, 440-512 MHz priority, clock, lockout, telescopic antenna, AC/DC cord, search, delay.

UNIDEN BEARCAT BC-400XLT

\$99.99



(\$7.00 shipping)

Our best selling mobile scanner, 16 channel, AC/DC programmable, digital, AC/DC cords, telescopic antenna, mobile mounting bracket, weather search, priority, 29.54 MHz, 136-174 MHz, 406-512 MHz, external speaker and antenna jack.

COBRA SR-925

\$99.99



(\$7.00 shipping)

Digital programmable, 16 channel AC/DC/mobile/base with raised button keyboard for easy programming of the following frequency ranges: 29-54 MHz, 118-174 MHz, 406-512 MHz. Covering aircraft, marine, police, fire, weather, trains, public service, plus much more. Features include: digital display, priority, scan delay, weather button, channel lockout, search, scan speed, automatic squelch, memory backup. One year factory warranty, external speaker jack. (Extended warranty 2 years extra \$29.99, 3 years extra \$39.99.)

REGENCY R-2066

\$109.99



(\$7.00 shipping)

Digital programmable, 60 channels, AC base scanner, 30-50 MHz, 144-174 MHz, 406-512 MHz. Size 7 1/2" x3" x9". Turbo-Scan scans 40 channels per second, 4 channel banks, weather alert, search, priority, lockout, AC cord, telescopic antenna, plus much more.

EXTENDED WARRANTY SERVICE

This extended service contract is for all scanners, CB radios, radar detectors, and cordless telephones that have been purchased anywhere in the USA in the past 30 days. This extended warranty service begins when your original manufacturer's warranty expires.

| | |
|--------------------------|--------------|
| 1 year extended warranty | only \$18.99 |
| 2 year extended warranty | only \$29.99 |
| 3 year extended warranty | only \$39.99 |

RADIO SCANNERS AND ACCESSORIES

| | | |
|-------------------------|----------|--------|
| Bearcat BC147XL | \$99.99 | (7.00) |
| Bearcat BC140 | 94.99 | (7.00) |
| Bearcat BC175XL | 139.99 | (7.00) |
| Bearcat BC55XLT | 119.99 | (6.00) |
| Bearcat BC800XLT | 264.99 | (7.00) |
| Bearcat BC100XLT | 199.99 | (7.00) |
| Bearcat BP205 | 34.99 | (*) |
| Bearcat BC210XLT | 189.99 | (7.00) |
| Bearcat BC-ONE | 129.99 | (7.00) |
| Bearcat AD-100U | 14.99 | (*) |
| Bearcat PS-001 | 12.99 | (*) |
| Bearcat VC-001 | 11.99 | (*) |
| Bearcat AD-140U | 14.99 | (*) |
| Bearcat AT-054 | 12.99 | (*) |
| President HR2600 | 219.99 | (8.00) |
| President HR2510 | 239.99 | (8.00) |
| Regency R3020 | 98.99 | (7.00) |
| Regency INF.7 | 99.99 | (7.00) |
| Regency INF.50 | 94.99 | (7.00) |
| Regency MA-917 | 24.99 | (*) |
| Regency MA-501 | 14.99 | (*) |
| LifeGuard 4 | 117.99 | (4.00) |
| RXD MRP-1 | 24.99 | (*) |
| GRE8001 | 62.99 | (4.00) |
| GRE8002 | 79.99 | (4.00) |
| Midland CB Radios | In Stock | |
| Cobra CB Radios | In Stock | |
| Uniden CB Radios | In Stock | |
| Silver Eagle Microphone | 69.99 | (*) |
| Antennas | In Stock | |
| Rechargeable Batteries | In Stock | |

BOOKS

| | | |
|---------------------|-------|-----|
| Covert Intelligence | 8.95 | (*) |
| Air Scan Directory | 14.99 | (*) |
| Betty Bearcat | 7.99 | (*) |
| Top Secret | 14.99 | (*) |
| Covert Techniques | 9.95 | (*) |
| Tomcat's Big CB | 13.95 | (*) |
| World Radio | 18.99 | (*) |
| Monitor America | 5.99 | (*) |
| Survival Directory | 6.95 | (*) |
| Rail Scan | 7.95 | (*) |
| Police Call | 6.99 | (*) |
| Embassy & Espionage | 13.99 | (*) |

TWO-WAY RADIOS REGENCY-RELM

| | | |
|-------------------|--------|--------|
| UC102 | 109.99 | (5.50) |
| UC102 (2 or more) | 99.99 | (5.50) |
| RH-256B | 329.99 | (9.00) |
| RH-606B | 469.99 | (9.00) |
| WHS-1 | 399.99 | (9.00) |
| RU-156B | 459.99 | (9.00) |
| UC-202 | 134.99 | (6.00) |

ORDERING INFORMATION: Call (518) 436-9606 to place orders or mail orders to Scanner World, USA, 10 New Scotland Ave., Albany, N.Y. 12208. Orders will be shipped within 24 hours by United Parcel Service if order is accompanied by MasterCard, Visa, cashier's check, money order, COD (COD shipped by United Parcel Service will be cash or money order only). (If a COD package is refused, customer will be billed for shipping and COD charges.) Mail orders with personal or business checks enclosed will be held 4 weeks for bank clearance. Prices, specifications, and terms subject to change without prior notice. If items are out of stock we will backorder and notify you of delivery date. All shipments are F.O.B. Scanner World's warehouse in Albany, N.Y. We are not responsible for typographical errors. All merchandise carries full manufacturer's warranty. Bid proposals and purchase orders accepted from government agencies only. Free full line catalog mailed 4 times per year. Merchandise delivered in New York State add 7% sales tax. No returns accepted after 7 days of merchandise receipt. *Add (\$5 per item, and \$3.00) for all accessories ordered at same time. COD orders will be charged an additional \$4.00 per package. Full insurance is included in shipping charges. All orders are shipped by United Parcel Service to street address only. (No P.O. Box). Shipping charges are for continental USA only. All others ask for quote on shipping charge.

BEARCAT 70XLT 20 CHANNEL HAND-HELD SCANNER

\$169.99

Small size 6" Hx11" Dx2 1/2" W. Full digital readout, priority, search, channel lockout, scan delay, key lock. Covers following frequencies: 29-54 MHz, 136-174 MHz, 406-512 MHz. Package includes rubber antenna, rechargeable Ni-Cad battery pack, AC adapter/charger and carry case.

REGENCY R-4020

100 Channel Digital Programmable Hand-Held Scanner

\$174.99

(\$7.00 shipping)



Our best price ever on a full featured complete package hand-held scanner. Manufactured by Uniden, this is the exact duplicate of the Bearcat 100XLT for a much lower price. Features include 11 bands of weather, aircraft, public service, trains, marine, plus more (29-54 MHz, 118-174 MHz, 406-512 MHz), 10 channel banks, 10 priority channels, lighted LCD display, earphone jack, channel lockout, AC/DC operation, scans 15 channels per second, track tuning. Special package deal includes following accessories: AC adapter/charger, rechargeable Ni-Cad battery pack, flexible rubber antenna, heavy duty carry case.

SANGEAN ATS-803A

SHORT WAVE RECEIVER

\$189.99

(\$7.00 shipping)



AM/FM/LW and 12 short wave bands plus FM stereo, BFO for SSB reception, clock radio. Includes AC adapter, telescopic antenna, stereo headphones, and a shoulder strap.

— SHORT WAVE WORLD BAND RECEIVERS AVAILABLE —

| | | |
|----------------------------------|----------|---------|
| Grundig Satellit 500 | \$548.99 | (10.00) |
| Grundig Yacht Boy 220 | 106.99 | (5.00) |
| Grundig Cosmopolit | 198.99 | (7.00) |
| Grundig Yacht Boy 230 | 149.99 | (5.00) |
| Grundig Satellit 650 | 899.99 | (20.00) |
| World Radio & TV Handbook (1990) | 18.99 | (*) |

UNIDEN BEARCAT BC-600XLT

\$199.99

(\$7.00 shipping)



Digitable Programmable 100 Channel Scanner

BC 600XLT covers the following frequencies: 29-54 MHz, 118-174 MHz, 406-512 MHz. Features compact size of 6-5/16" Wx1-5/8" Hx7-3/8" D, scan delay, priority, memory backup, channel lockout, bank scanning, key lock, AC/DC power cords, telescopic antenna, mounting bracket supplied, one year factory warranty, search, direct channel access, track tuning, service search including preprogrammed frequencies by pushing a single button for police fire/emergency, aircraft, weather, and marine services plus exclusive optional features never available on any scanner before. First is an RF receive amplifier for boosting weak signals for only \$24.99 plus a CTCSS tone board is available for only \$59.99 to make this the number one scanner available in the USA. Optional cigarette lighter plug #600MPC \$4.99.

BEARCAT BC-950XLT

Same features as BC-600XLT but also receives 800-954 MHz (Excludes cellular)

\$249.99 (\$7.00 shipping)

MAILBAG

LETTERS TO THE EDITOR

Each month we select representative reader letters for our Mailbag column. We reserve the right to condense lengthy letters for space reasons. All letters submitted for consideration must be signed and show a return address. Upon request, we will withhold sender's name should the letter be used in Mailbag. Address letters to Tom Kneitel, Editor, Popular Communications Magazine, 76 North Broadway, Hicksville, NY 11801.

Not Hung Up

In response to your July *Beaming In* entitled "My Hang-Ups," I'd like to suggest a solution to the unwanted phone call problems that generally works very well, and that is through the creative use of call forwarding. The idea is to forward your calls to numbers you know won't be answered, such as an office that is closed for the evening or weekend, or a non-working number. This idea works very well if you are single or live alone, since you don't have to worry about a spouse trying to reach you. You'll pay extra for call waiting, but it's less expensive than putting in a caller ID system.

Sam Rimell,
Arlington, VA

An office in which I worked had call-forwarding in its phone system, which was run by a refrigerator-sized computer kept in the store room. When I learned that the computer itself was assigned an extension number, I had it made. Any time I wanted to work without being disturbed by the phone, I call-forwarded all of my extension's calls right into the computer. The sound of the computer ringing, however, was invariably cause for no small amount of concern by anybody working in the store room at the time. — Editor

Getting Started

I am a newcomer to communications. I recently purchased a scanner, but I want to expand into a full listening post. Luckily, I found your magazine and am enjoying my first issue. I would like to hook up with an SWL club or group, can you suggest any? I also need advice from SWL's as to what equipment to get.

Dan Rhodes,
115 Harris Rd., #7,
East Peoria, IL 61611

We are running your address, Dan, so perhaps some hobbyists will contact you with thoughts on their favorite equipment.

Scanner and SWL clubs, groups, and newsletters vary greatly in quality, and seem

to come and go. Based upon the groups that support POP'COMM and have us on their mailing lists to regularly receive their publications, we can readily recommend the following to our readers:

Association of Clandestine Radio Enthusiasts, P. O. Box 11201, Shawnee Mission, KS 66207-0201 (\$18 per year, or US\$19 in Canada). Specializes in pirate station monitoring.

National Radio Club, P. O. Box 118, Poquonock, CT 06064 (\$24 per year, or US\$25 in Canada). Specializes in AM broadcast band.

North-East Scanning News, 212 West Broad St., Paulsboro, NJ 08066 (\$24 per year, make checks payable to Les Mattson). Specializes in scanner activities in northeastern states.

Ontario DX Association, P. O. Box 161 Station "A," Willowdale, Ont., Canada M2N 5S8 (\$28.75 per year, or US\$26 in the USA). Specializes in general DX'ing. Primarily for listeners in Ontario, but members accepted from all areas.

Worldwide TV-FM DX Association, P. O. Box 514, Buffalo, NY 1205-0514 (\$17 per year, or \$18 in Canada). Specializes in FM and TV broadcast DX.

American Shortwave Listeners Club, 16182 Ballad Lane, Huntington Beach, CA 92649. General DX'ing. Check with them regarding dues inasmuch as they don't provide the info in their newsletter.

Association of DX Reporters, 7008 Plymouthe Rd., Baltimore, MD 21208 (\$17 per year in US and Canada). General DX'ing.

The Numbers Factsheet, c/o Moonbeam Press, P. O. Box 149, Briarcliff Manor, NY 10510 (\$16 per year). Quarterly newsletter about unusual shortwave intercepts, spy stations, etc.

Umbra et Lux, c/o DX/SWL Press, 10606-8 Camino Ruiz #174, San Diego, CA 92126 (\$18 per year, US\$21 in Canada). Specializes in covert radio, spy stations, unidentified signals, etc.

Radio Monitors Newsletter of Maryland, P. O. Box 394, Hampstead, MD 21074 (\$12 per year). Specializes in scanner monitoring in mid-Atlantic states.

When writing, please mention that you read about them in *Popular Communications*. Yes, other scanner and SWL groups and newsletters do exist. They aren't listed here because we don't see their publications regularly (or at all), and therefore we can't adequately evaluate them. — Editor

Strongarm for Armstrong

POP'COMM's July article about Major Edwin Armstrong was the largest amount of information I have ever read about the inventor of FM, the superhet, the regenerative circuit, and the super regen circuit. I

have a generally low opinion of military officers, so it didn't come as any surprise to learn that he was obsessed with getting full credit for what he had accomplished. From your article, it seemed to me that Armstrong might well have had the genius to have invented the transistor years before it was developed by Bell Labs. Problem was that he was so wrapped up in getting what he considered full credit for his work with FM that it eventually caused him to jump out of a window.

Ed Jones, WB2DVL,
Somerset, NJ

Nobody ever said that it's necessary to be fully rational in order to be a genius. Fact is, few geniuses fit that mold. — Editor

Odd FM DX in WWII

In late 1943, after serving in the Central Pacific, I was stationed at Camp Chaffee, Arkansas. I was repairing a limited-range FM transceiver that had been removed from a Sherman Tank. While bench testing the repaired receiver, I was startled to pick up the BBC in London. I couldn't believe it was coming through from 5,000 miles away, and as clear as a local on the tank's FM radio. I never forgot the incident, and your story on Major Armstrong made me think that I'd share it with your readers. I was a Technician 4th Grade, and served in the U.S. Army from January of '42 to January of '46.

D. Palminteri,
Mechanicsburg, PA

Shore is Good DX!

In the May issue, there was mention of receiving ship-to-shore calls "which are repeated through powerful coastal base stations that send out both sides of the conversation for as far as fifty miles." Have I got news for you! As I listen to my Sony here in the south of Spain, I get ship-to-shore stations from all over the world, including Portsmouth, Virginia; Portishead, England; and Cyprus. Also, in the "Out of Band" feature on page 9 of that issue, under 9239 kHz, there was mention of AFRTS. I was pleased to learn of this frequency. I have been listening to them on 13650 kHz for more than a year and request that you pass this along to your readers.

Irvin K. Hohenstein,
Torremolinos, Spain

Our comments regarding the high powered coastal stations referred to VHF-FM Marine Operator service, your worldwide reception relates to HF-SSB High Seas Telephone service. Nevertheless, your point is valid and well taken! — Editor

Tuning In on Search & Rescue Operations

It's a Big, Dangerous World Out There, So Keep These Frequencies Handy!

BY THURSTON WAINWRIGHT, KFL4PN

Seems like every day you learn about people who turn up missing while camping, skiing, hiking, boating or flying. That invariably kicks off an intensive land or sea search for the missing persons, followed up by the rescue operations, starting with transporting any required emergency medical attention to the scene. After that, the persons must be quickly and safely removed, often while they are in shock or have broken bones or other problems requiring further medical attention.

Sometimes, there isn't as much a need for search as there is for rescue because the general location of the victims is known. This would be the case in a high-rise building fire, during a storm or flood, in the aftermath of an earthquake, explosion, or major transportation accident, for example. Sometimes, large numbers of victims must be transported to safety. In all cases, time is of the essence.

Search and rescue (SAR) operations lie within the realm of specialists trained in this dangerous, but life-saving, art. The tools of their trade may include bolt cutters, ropes, high intensity lights, ships, aircraft, scuba equipment, axes, cutting torches, skis and many other aids, depending upon the nature of the task at hand. The one universal aid used in every instance is communications equipment. It is used to summon, to coordinate, and to advise.

Tuned In

You, as a person with a communications receiver and/or a scanner, may already know some of the places to tune to hear this action while it's taking place. Your area fire and emergency services frequencies are certainly a good place to begin. But, there's more.

For starters, you may be interested in knowing the frequencies usually used to summon aid when there's a problem. At sea, larger vessels communicate in CW on 500 kHz, or might use voice (SSB) on 2182



This amphibious rescue vehicle is at home on land and sea.

kHz. All vessels within about 50 miles of shore will probably summon aid on 156.80 MHz. Lifeboats operate on 8364 kHz (CW), and voice on 156.80 and 157.10 kHz.

Most aircraft are equipped with Emergency Locator Transmitters (ELT's), and some vessels carry Emergency Position Indicating Radio Beacon (EPIRB) transmitters. These emergency devices manually or automatically transmit a (non-voice) distress signal when necessary that triggers an SAR response. The units operate on 121.5, 156.75, 156.80, 243.0, and 406.025 MHz. Personal units for use on land have not yet been approved, but have been suggested and several frequencies are under consideration for such use at some point in the future.

Land SAR's

Area police, fire, and emergency services frequencies should be the backbone of all

monitoring efforts, with extra attention given to searching the band 155.16 to 155.295 MHz, as these are popular with rescue squads, with 155.16 and 155.22 MHz being especially popular.

The *National Ski Patrol*, throughout the USA, operates on 155.175, 155.22, 155.235, 155.265, and 155.34 MHz. If you live in ski country, these are certainly channels to watch during the time of year when winter sports prevail.

Aircraft are frequently pressed into service for SAR operations, with the *Civil Air Patrol (CAP)* often actively involved. On your communications receiver, listen on 4585 kHz (SSB) for the CAP. On scanners, try 122.9, 123.1, and 148.15 MHz. Helicopter operations of various agencies might show up on 123.025, 123.05, and 123.075 MHz.

In the event an SAR operation is required within an area under the control of the De-



Realistic® Presents the Next Big Step in Scanners



HYPERSCAN™

Now, You Can Scan Up to 400 Channels Fast—in Less Than 16 Seconds

You'll be "on the scene" of local action in a flash with the Realistic PRO-2006. More than 196,000 exciting frequencies are at your command, including the new 800-MHz police and emergency bands. At up to 26 channels per second, you'll scan much faster than most scanners not equipped with HyperScan.

You get ten 40-channel memory banks, a 10-channel monitor bank, search mode and selectable priority function. Frequency coverage is 25-520, 760-823, 851-868 and 896-1300 MHz. Precise ZeroMatic® tuning locks on-frequency for best reception. A backlit LCD display, memory backup and full array of jacks are included.

Take the next big step in communications excitement—check out the Realistic PRO-2006, available at Radio Shack.

CREATING NEW STANDARDS

RELIABLE QUALITY—Over 1500 engineers and technicians develop, evaluate and test to our exacting standards—*NOBODY COMPARES*
PROMPT SERVICE—Over 7000 drop-off points nationwide insure dependable service to your satisfaction. Over 1,000,000 parts stocked. We service what we sell—*NOBODY COMPARES*

Radio Shack®
AMERICA'S
TECHNOLOGY
STORE™

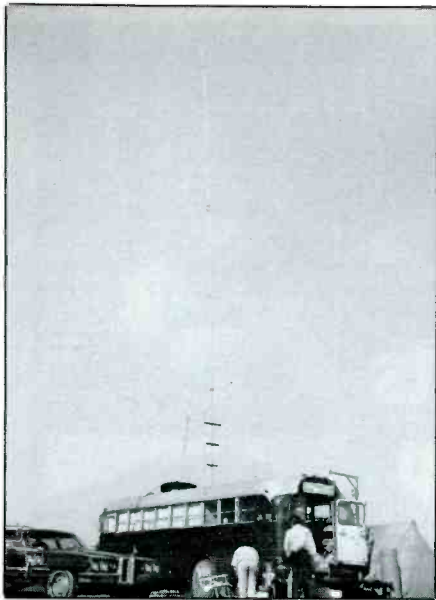

A mobile command post set up for an SAR mission.



Reaching the survivors of a disaster, providing emergency medical treatment, and then safely returning them to hospitals is part of an SAR mission. This must be carefully coordinated by two-way radio.

partment of The Interior (such as a National Park, or a National Forest), you'll want to monitor 132.0125 MHz for the aircraft of this agency. Likewise, US Army personnel participating in SAR's sometimes turn up on 138.75 MHz.

The Nuclear Emergency Search Team (NEST) is a federal activity that can be called in during any situations implied by its rather ominous name. NEST operates on 149.22, 150.5, 163.00, 164.025, 164.10, 164.2375, 164.225, 164.775, 166.225, 167.825, 167.85, 167.95, 169.60, 169.675, 172.30, and 410.80 MHz.

The Federal Emergency Management

Agency (FEMA) has many channels, but good ones to try on your communications receiver are 5212.5, 10494.5, and 17650.5 kHz (SSB). On your scanner, try 164.8625 and 165.6625 MHz.

All At Sea

SAR's at sea in the coastal waters of the USA will usually kick off activity on many frequencies, including the CAP previously mentioned. These operations will also produce communications on various HF/VHF/and UHF frequencies, especially those used by units of the US Coast Guard

and the US Coast Guard Auxiliary.

In the HF bands, listen for SSB traffic on 3023, 4125, 5680, 5692, 5696, 6215.5, 8257, 8564, 12392, and 16522 kHz. Scanner owners can monitor 156.30, 157.05, 157.075, 157.15, 157.175, 157.20, 164.30, and 282.8 MHz for the action.

Frequencies set aside for SAR missions looking for manned spacecraft are 10000.3, 14993, and 19993 kHz.

Warnings

SAR activities are triggered by alerts issued by various local, state, and federal agencies. The US Coast Guard coordinates



Helicopters are among the most versatile of SAR tools, and are great sources of communications fare for listeners.



A plane goes down in a remote area, kicking off a massive SAR effort to first locate the wreckage, then reach the site.

PC SWL \$99.00

A Complete Digital Reception System

PC SWL contains the hardware, software, instructions and frequency lists needed to allow you to receive a vast variety of digital broadcasts transmitted over shortwave radio with any IBM PC or Compatible computer. The product consists of:

Demodulator
Digital Signal Processing Software
80 Page Tutorial Reference Manual
World Press Frequency List
Tutorial Audio Cassette with Samples

PC SWL automatically decodes Morse code, Radio Teletype, FEC (forward Error Correcting Code), SELCAL (Selective calling transmissions), and NAVTEX.

ADVANCED FEATURES:

Tuning Oscilloscope
Digital Waveform Presentation
Auto Calibration and Code Recognition
Continuously Tunable Filter Frequencies
Variable Shift
Adjustable CW Filter Sensitivity
Farnsworth Code Compatibility
Unattended Capture and Printing

Software Systems Consulting
150 Avenida Cabrillo "C"
San Clemente, CA 92672
(714) 498-5784

CIRCLE 46 ON READER SERVICE CARD

The Best* Just Got Better!

The Eavesdroppers™ now includes our new Zap Trapper™ Electronic Gas Tube Lightning Arrestors. Receive-only design shunts damaging transients to ground at only 1/7th the voltage buildup of the available 200 watt transmit-type arrestors, providing maximum solid state receiver protection.

Protect your investment - combine an excellent shortwave receiving antenna with the best receiver protection money can buy.



- Completely assembled and ready to use
 - Only 42' overall length
 - 8 trap circuits permit reception on all shortwave bands, 11-90 meters
 - All connections soldered and enclosed in ultrasonically-welded, hermetically-sealed trap covers
 - Includes 50' of 450 lb. test nylon rope
- Model T** includes 100' twinlead feedline
Model C includes weatherproofed center connector for your coax & coax sealant
- Either model \$79.95
 - UPS for lower 48 states \$4.00
 - COD add \$3.00, IL add 7% sales tax
 - Foreign shipping quoted

"The best...built like an antenna should be." -Larry Magne in *World Radio TV Handbook*

"Our best seller." -EEB in their recent ads and catalogs

"Now in use in 45 countries." -Gilfer Shortwave in 1983

Antenna Supermarket

P.O. Box 563 Palatine, IL 60078 Tel (708) 359-7092 Fax (708) 359-8161

At your dealer or direct ▪ Visa & Mastercard accepted



SAR missions within its jurisdictional area. Aircraft that are overdue or reported down are handled by the FAA, also the US Air Force Rescue Coordination Center at Scott AFB, in Illinois.

At that point, several SAR units may be activated, including the CAP, Air National Guard, National Guard, Coast Guard and Coast Guard Auxiliary, plus local, county, state, and private organizations. One active SAR unit is the New York Air National Guard's 106th Aerospace Rescue and Recovery Group, stationed in Westhampton Beach, NY. SAR missions in the northeast very often produce activity on their operating frequencies, 251.9 and 287.5 MHz.

Lastly

There are any number of private ham-staffed groups utilizing frequencies in the Amateur Radio Service, especially in the 2 meter (144 MHz) band. Furthermore, there are also private groups operating in the General Mobile Radio Service (GMRS) band, 462.55 to 462.725 MHz. A favorite here is 462.675 MHz.

Lastly, don't overlook the CB channels for SAR activities as we have heard some of them being run on Channel 9 (27.065 MHz) and other channels. Very often, before a formal SAR mission can be organized and trained personnel dispatched, an impromptu SAR operation is immediately set up with local volunteers who are readily equipped for CB operation.

PC

Spies Like Us

Electronic Surveillance Has Become a Family Affair – & a Big Business!

BY CARL S. KAPLAN

High above New York City's 34th Street, in an 80th-floor suite in the Empire State Building that reeks of calm, Ed Sklar is giving a cooks tour of some of the most popular spy gadgets he sells to paranoid and security-conscious customers.

There's a black-leather attache case with hidden microphone and hide-away tape recorder—perfect for covertly taping conversations and promises that might otherwise be lost.

For women on the go, a recording purse that resembles a sleek, designer bag. At \$600, it can be used for documenting sexual harassment on the job or to help prove spouse abuse. "We originally built this at the request of a client who was referred to us by a divorce attorney," says Sklar, the president of Spy Tech. Pulling other gadgets off the shelves, the snoop maestro explains the uses of wiretap detectors, telephone-recording equipment, and something called the "Electronic Stethoscope," an under-

\$300, amplified hearing device that can detect faint sounds—and voices—behind walls.

"Let's go to covert video surveillance," the designer and vendor says cheerfully, pointing to a cuddly teddy bear. This \$1,200 stuffed animal contains a tiny video camera that peeks through the belly button—good for monitoring baby sitters.

James Bond Goes Public

Once upon a time, espionage devices such as the all-seeing bear were the stuff of James Bond fantasies and, perhaps, a government or industrial spook's arsenal. Not any more. Selling for consumer use is the new trend in surveillance gear, creating by one estimate a \$100-million industry—and a host of concerns about privacy.

"Maybe the Nineties are going to be the spy decade," said Steve Brown, a buyer for The Sharper Image, whose catalog is expanding its spy gadgetry. "We are doing it

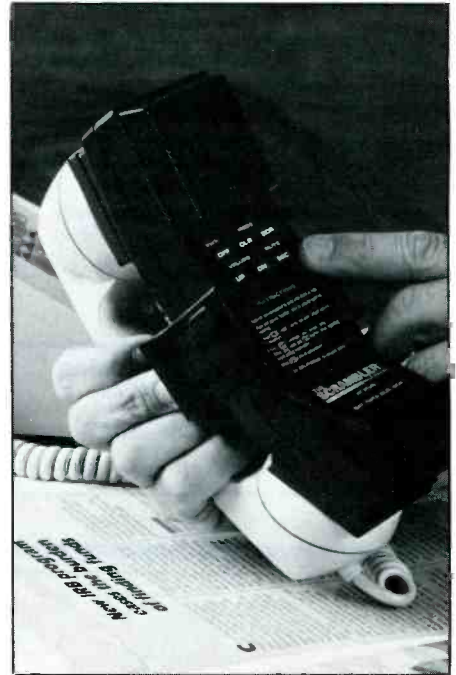

Telephone privacy, these days, can be assured only by the use of a high-tech voice scrambler. One unit is required for each party in the conversation. Cost runs several hundred dollars per unit. (Courtesy Research Electronics, Inc., Cookeville, TN.)



because it's fun and will cause excitement in the stores."

Privacy advocates are excited, too, but for a different reason. They claim that although some surveillance equipment is against federal law, legal loopholes, tax enforcement and a new social acceptance for spying allow the proliferation of equipment to go unchecked. "When people talk about Big Brother, they mean the government. But Big Brother is not the government—it's each of us," said Rudolph Brewington, a privacy advocate who says he was bugged—electronically—by his spouse after she filed for divorce. "The James Bond syndrome . . . people think of spy gadgets as romantic, wonderful. But they are despicable," he said.

Professionals such as Sklar, taking advantage of lower prices for the sophisticated wares and popular interest in electronics, say they are marketing to upscale retail



Wireless FM room monitors broadcast the sounds of a home as far as a mile or more. (Courtesy Radio Shack Division of Tandy Corp.)



A scanner can be legally used to tune in on cordless telephone calls and wireless FM room monitors. Although there are laws against eavesdropping on calls from car phones, and scanners can receive them (some can even pick up cellular frequencies), it's almost impossible to detect violations of those laws.

stores, glossy catalog companies and directly to shoppers and small business owners.

For example, The Sharper Image, which has retail stores and a mail order catalog, lists three spy gadgets: the Electronic Stethoscope, a phone-tap defeater, and a wireless transmitter/receiver kit for listening to sounds at a distance.

A particularly intrusive gadget is among those in Sklar's office: a seemingly conventional television set. "This TV watches you," he says. "It has a built-in video camera behind the speaker."

It works like this: If you think your spouse is cheating, bring the 1,500 set home as a gift, put it in the bedroom, then go away on business. Upon return, check the videotapes.

Many Motives

Demand for sophisticated audio and video surveillance devices is fueled by many factors, including yuppie toy lust, the desire to gain an advantage and high divorce rates—which promote spousal suspicion, according to experts.

Spy gadgets are "epidemic" among warring or litigating couples, said Maureen Gawler, a Maryland based private investigator. "I see over and over, men and women using different types of bugging devices, including video surveillance . . . just to find things out, for legal blackmail. They want to know what their spouses are doing," she said.

Raoul Lionel Felder, a New York divorce attorney for Robin Givens and Nancy Capasso, said he shuns "slimy" information from amateur spouse spies. But Felder acknowledged that evidence gathered by illegal eavesdropping might be used by some lawyers. "It's never so crude as using illegal as the evidence," he said. "They work backward. A husband taps a phone and finds his wife committing adultery. He takes the tape



A portable unit that nullifies (jams) any tape recording efforts taking place near this device. When closed, it looks like a plain attache case. (Courtesy CCS Communications Control, Inc.)

and destroys it, then hires someone to watch the 'Hotbed Hotel'" and gather legal evidence.

"The psychodynamics of it are, you gotta find out, punish, get the edge," Felder continued. "Many people get tap happy, start tape recording their lawyer. Whenever I see a woman with a large pocketbook, I assume she's taping me."

Varied Reasons

There are other users, though. Sklar—who founded his firm in Miami four years

ago with corporate accounts and targeted New York and consumer clients last year—said many of his clients are prudent professionals who wish to record oral agreements. He also caters to "people with problems."

"In today's society, with many parents working, the problem of abuse by baby sitters, nannies, is hitting the headlines," Sklar said. "That's generated a lot of interest" in video bugs.

By way of example, Sklar mentioned a notorious "video slapping" case: In 1989, a Chattanooga, Tenn. couple, fearful that their baby sitter was abusing their 6-month-



This portable secure-voice telephone system also contains detection components to let you know if the room is bugged or contains secret tape recorders. The case will sustain a direct hit from a .357 Magnum. (Courtesy CCS Communication Control, Inc.)



When you open this attache case, it reveals a sensitive transmitter detector that warns of any wireless room or telephone bugs, or nearby person wearing a hidden body transmitter (a "wire"). (Courtesy ESC.)

old baby, secretly videotaped her slapping the child. The sitter pleaded guilty to misdemeanor child-abuse charges, and a judge sentenced her to a year in jail after he watched the tape.

The wave of surveillance gadgets also has created a market for response products. Suzanne Harper, vice president of Digitech Telecommunications Inc., a New York-based distributor of security wares said one of her most popular items is "Phone Guard," a \$300 phone-tap detector and defector. Her company also sells various other "bugging" detectors and telephone voice scramblers—though experts said some "countermeasure" devices give consumers a false sense of security.

"Some of this stuff has no purpose but to feed a particular void in society that can be filled for \$200. It's paranoia," said Michael Goodrich, owner of Spectra Research Group, a New York-based supplier of security equipment.

One impact of the trend is the creation of spy victims who—through accident or ingenuity—discover that they have been bugged.

Brewington, a 43-year-old Washington, D.C.-based government worker, said he fell into the spy trap in Pittsburgh in 1987. "I was going through a very bitter divorce," he said. "One evening, under the pretext of reconciliation, my wife invited me into her bed . . . I was lying there holding her and she

started hollering as if I was raping her. My antennae went up.

"Two weeks later, I discovered a voice-activated tape recorder in the closet upstairs," he said. "It had about 45 minutes of secretly recorded conversations of the two of us." Brewington sued, claiming his wife illegally recorded his conversations without his consent, in violation of Pennsylvania law. The case is pending.

A Gray Area

The legality of selling and using some surveillance equipment is a "gray area," according to attorney Robert Ellis, publisher of *Privacy Journal* in Washington, D.C.

For one thing, while federal law makes it a felony to sell, manufacture, advertise, or possess an electronic device that's "primarily useful" for the surreptitious interception of wire or oral communications, there can be different interpretations of what is "primarily useful," Smith said. Many devices, such as the Electronic Stethoscope, can have benign uses, such as checking for water leaks.

Sellers of spy gadgets tend to protect themselves by citing legal uses for their devices, even though "it's pretty clear some devices could be used to overhear two strangers, Smith said.

Indeed, ads often can deliver mixed mes-

sages. One ad for the Electronic Stethoscope promotes the item with the text: "Monitor the baby breathing in the nursery . . . and even diagnose engine sounds." But the accompanying photo depicts a debonair man in a tuxedo pressing the gadget against a white plaster wall. There's also a disclaimer: "It's a Federal Offense to intercept oral communications, and these devices are not sold for that purpose."

An amplified hearing headset selling for under \$20 is widely sold directly via cable TV and newspapers. It has "dozens of uses," according to one ad. "Take a walk outdoors and you'll hear birds sing like you've never heard them before." Nevertheless, the *Washington Post* stopped accepting the ads, said a *Post* lawyer, "because we had some concern . . . about it being a surveillance device."

Loophole Department

Besides regulating the sale of the devices, federal law also restricts wiretapping and eavesdropping acts. But a loophole exists: "It's legal to bug people when you are party to the conversation," Smith said. That doctrine, called "one-party consent," enables a person equipped with a briefcase recorder to secretly tape a conversation he's included in. Fourteen states, including Pennsylvania, California, and Maryland,

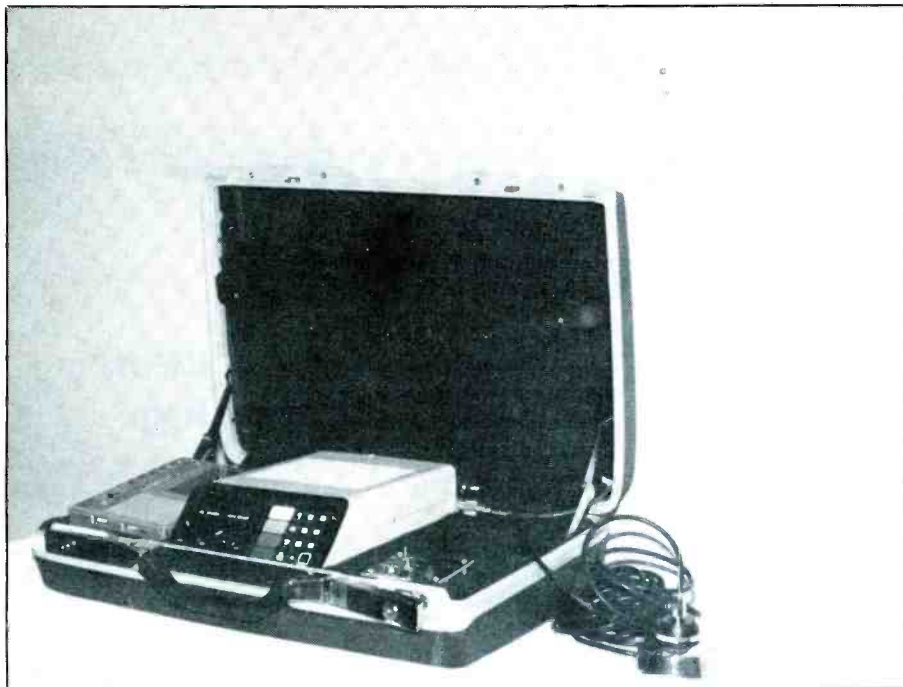

A completely portable, battery-powered, base station for VHF/UHF electronic surveillance. Contains everything, including the antenna and a voice-activated cassette recorder connected to the scanner. The whole thing weighs 19 lbs., is contained in an attache case. (Courtesy Innovative Intelligence Products, Westminster, CO.)

have adopted the more restrictive "two-party consent" rule, which requires that all members of a conversation give prior consent.

Covert video surveillance, meanwhile, is not covered by federal wiretapping statutes, Smith said. But general principles apply: A bugger can't criminally trespass to place a camera, or put a camera in an area where a victim has a reasonable expectation of privacy, such as a bathroom.

To help curb amateur spying, Rep. Ronald V. Dellums (D-Calif.) last year introduced a bill that would amend the federal Omnibus Crime Control and Safe Street Act by requiring two-party consent in non-law-enforcement cases. The bill would also require manufacturers to equip voice-activated tape recorders with beep tones to help prevent misuse.

Yet even some lobbyists supporting the measure give it little chance of quick passage because public concern has not yet caught up with technology. "Until we have more people who have been victimized and write to Congress, we're not going to get this legislation moving," said Janlori Goldman, a privacy attorney with the American Civil Liberties Union.

Some security experts opposed to the Dellums bill say that adequate laws exist to protect privacy. They say the problem is low-priority enforcement.

A spokesman for the FBI countered: "We pursue illegal surveillance rather vigorously when it comes to our attention." But Douglas Tillett, a spokesman for the U.S. Justice Department, acknowledged that ev-

idence to prompt an investigation can be hard to get. "As a practical matter, if your neighbor wants to put a device on the wall and listen to you, there's almost no way the government can know what is happening," Tillett said.

But Who's a Victim?

The problem of victims not knowing they are victims has caused at least one privacy advocate to adopt a fatalistic attitude toward amateur spying. "I think it is dreadful, but also I think it's hopeless to try and stop it," said Herman Schwartz of American University's Washington College of Law in Washington, D.C. "I'm afraid that given the pervasiveness of electronics stuff in society, it's just not feasible to enforce the law."

There's always the chance, however, that peer pressure can force changes. Private eye Gawler tells this story about one of her suburban neighbors: A mother, concerned about her children's possible drug use, secretly planted a video camera in her house. When the camera recorded one of her children's friends using marijuana, the bugger passed the evidence to the drug user's mother—who grew angry at the invasion of her child's privacy!

"The whole thing exploded in the neighborhood . . . all the parents were mad" at the bugger, Gawler said. "Now no kids go to that woman's house. Her kids lost all their friends."

Copyright (C) 1990 Newsday/Carl S. Kaplan.

MFJ SHORTWAVE ACCESSORIES REMOTE ACTIVE ANTENNA

MFJ-1024 Receive strong clear signals from all over-the-world with this 54 inch active antenna that rivals long wires hundreds of feet long.

\$129⁹⁵

"World Radio TV Handbook" rates the MFJ-1024 as "a first rate easy-to-operate active antenna . . . Quiet with excellent dynamic range and good gain . . . Very low noise factor . . . Broad frequency coverage . . . the MFJ-1024 is an excellent choice in an active antenna."

Remote unit mounts outdoors away from electrical noise for maximum signal and minimum noise pickup. Mount it anywhere - atop houses, apartments, ships, buildings, balconies.

Covers 50 KHz to 30 MHz. High dynamic range eliminates intermodulation. Control unit has 20 dB attenuator, gain control. Lets you switch

2 receivers and auxiliary or active antenna. 'On' LED. 6x2x5 inches. Remote has 50 ft. coax and connector. 3x2x4 in. 12 VDC or 110 VAC with MFJ-1312, \$12.95



INDOOR ACTIVE ANTENNA

Now you'll rival or exceed the reception of outside long wires with this tuned indoor active antenna.

"World Radio TV Handbook" says MFJ-1020 is a "fine value . . . fair price . . . best offering to date . . . performs very well indeed."

Its unique tuned circuitry minimizes intermod, improves selectivity, reduces noise outside tuned band. Functions as a preselector with external antenna. 0.3-30 MHz. Telescoping antenna. Controls are Tune, Band, Gain, On-Off/Bypass.

6x2x6 in. Use 9 Volt battery 9-18 VDC or 110 VAC with MFJ-1312, \$12.95



ANTENNA TUNER/PREAMP



MFJ-959B Don't miss rare DX because of signal power loss between your antenna and receiver.

The MFJ-959B provides proper impedance matching so you transfer maximum signal from your antenna to your receiver from 1.6 to 30 MHz. You'll be surprised by significant increases in signal strength.

20 dB preamp with gain control boosts weak stations. 20 dB attenuator prevents overload. Select from 2 antennas, 2 receivers. 9x2x6 inches. Use 9-18 VDC or 110 VAC with optional AC adapter, MFJ-1312, \$12.95

For your nearest dealer or to order:

800-647-1800

Order from MFJ and try it. If not satisfied return within 30 days for refund (less s/h). Add \$5.00 s/h. One year unconditional guarantee. Free catalog.

MFJ ENTERPRISES, INC.

Box 494, Miss. State, MS 39762
601-323-5869 Telex: 53-4590 MFJSTKV

MFJ . . . making quality affordable

CIRCLE 54 ON READER SERVICE CARD

The World's Newsbreaking Events – On Your Scanner!

*Whether it's a Bank Job in Berlin or a Racial Incident
in the RSA, You Can Hear it While it's Happening.*

BY CHUCK ROBERTSON

A scanner puts you in the middle of what's happening in your local area. That's why there's hardly a TV or radio station newsroom, or a newspaper editorial office, that doesn't employ scanners as vital tools in their newsgathering efforts.

Individual scanner owners, too, have learned that by programming their receivers to pick up channels used by police, fire, federal, environmental, and disaster agencies, they can get the same "finger on the pulse of the community" as the news professionals. Even power utilities, aero band, and ham frequencies can produce this type of high-energy information.

Military and National Guard frequencies aren't used only on the other side of the world, either. Right in range of your station they are active for maneuvers, war games and other things that show up in the news media. Moreover, when there is a natural disaster, like a flood, tornado, earthquake or a hurricane, these channels are alive with newsy activity (as described in the April '90 POP'COMM).

The Eyes & Ears of The World

But maybe you already knew about tuning in local activity. So let's turn our gaze beyond the borders of the next county and sharpen our ears to hear the news of the world on the very same equipment that lets you scan the local scene.

Are you aware that many nations of the world consider frequencies above 30 MHz to be so "hot" that laws have been passed to regulate the reception of communications there by unauthorized persons? In fact, several European nations have laws that prohibit hobby monitoring above 26 MHz.

Because the normal service range of VHF communications systems is generally considered to be local in nature, some governments have managed to rationalize that these bands are "private." That's why they don't permit their local citizens to monitor there. Of course, when it comes to 30 to 50 MHz "low band" signals, the "normal ser-

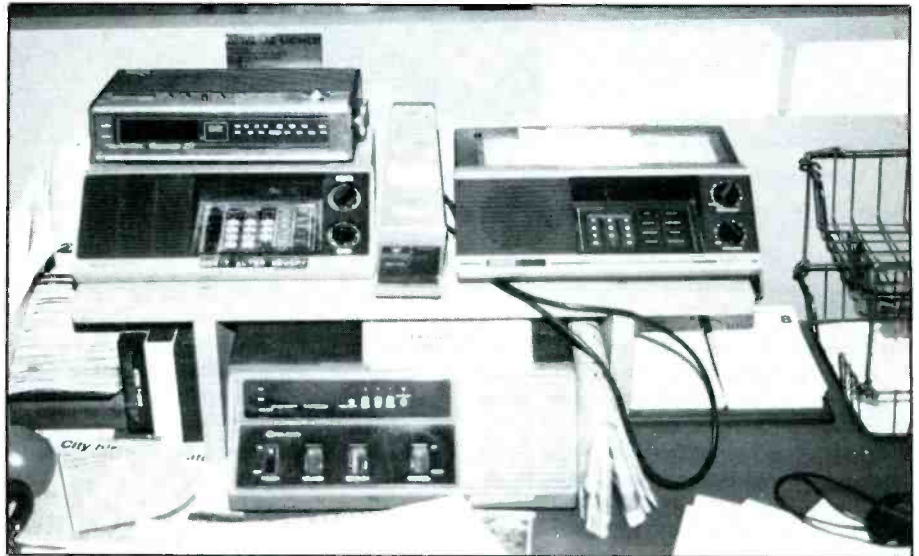

Scanners at work. These two are at the news desk of WSIL-TV/3 in Crainville, IL. If the pros use scanners to keep in touch with breaking news stories, why not you?

vice range" may well be local, but it's truly naive to consider that such "normal" conditions are always in effect.

Ionospheric conditions regularly permit signals in this band to be monitored by listeners located at great distances. So, notwithstanding their attempts to legislate the signals to remain private, low band skip reception allows you to quietly slip across their borders sans passport and eavesdrop on all of this newsworthy stuff they don't want anyone to hear.

Over the years, I have heard lots of scanner skip that turned into world headlines. You can do the same.

POP'COMM Had It First!

Here's an example of how scanning these frequencies put me on the forefront of where the news was happening far away. As it turned out, when I told of my experiences there was a commotion.

In my November, 1989 piece I wrote for POP'COMM, I told about monitoring the police in the Republic of South Africa. From

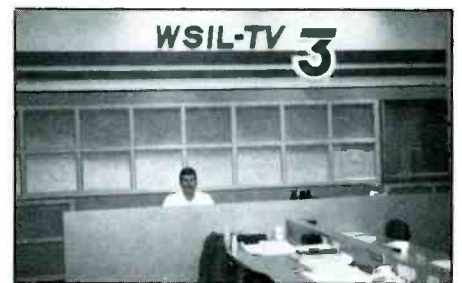

News anchor Rod Sievers at the WSIL-TV/3 news desk waiting his cue to go on the air. The scanners are out of sight, but just to Rod's left. Rod learned about monitoring the RSA police from an article in POP'COMM.

the mail that came in when the article appeared, it seems that it sent a shockwave through the monitoring community.

The RSA is very restrictive when it comes to allowing press coverage of the racial demonstrations, violence, and incidents there. But, by monitoring police comms there, it became possible to go behind the police

uniden®

\$12,000,000 Scanner Sale

Uniden Corporation of America has purchased the consumer products line of Regency Electronics Inc. for \$12,000,000. To celebrate this purchase, we're having our largest scanner sale in history! Use the coupon in this ad for big savings. Hurry...offer ends January 31, 1991.

★★★ MONEY SAVING COUPON ★★★

Get special savings on the scanners listed in this coupon. This coupon must be included with your prepaid order. Credit cards, personal checks and quantity discounts are excluded from this offer. Offer valid only on prepaid orders mailed directly to Communications Electronics Inc., P.O. Box 1045 - Dept. UN14, Ann Arbor, Michigan 48106-1045 U.S.A. Coupon expires January 31, 1991. Coupon may not be used in conjunction with any other offer from CEI. Coupon may be photocopied. Add \$12.00 for shipping in the continental U.S.A.

RELM RH606B-A \$419.95
 RELM RH256B-A \$294.95
 Bearcat 800XLT-A \$229.95
 Bearcat 200XLT-A \$229.95
 Bearcat 100XLT-A \$179.95
 Bearcat 70XLT-A \$139.95
 Bearcat 55XLT-A \$99.95
 Bearcat 210XLT-A \$164.95
 Uniden CARD-A1 \$144.95
 Uniden RD3XL-A \$144.95
 Uniden RD9XL-A \$119.95

★★★ VALUABLE COUPON ★★★

Bearcat® 760XLT-A

List price \$499.95/CE price \$254.95/SPECIAL 12-Band, 100 Channel • Crystalline • AC/DC Frequency range: 29-54, 118-174, 406-512, 806-956 MHz. Excludes 823.9875-849.0125 and 868.9875-894.0125 MHz. The Bearcat 760XLT has 100 programmable channels organized as five channel banks for easy use, and 12 bands of coverage including the 800 MHz band. The Bearcat 760XLT mounts neatly under the dash and connects directly to fuse block or battery. The unit also has an AC adaptor, flip down stand and telescopic antenna for desk top use. 6-5/16" W x 1 1/4" H x 7 3/4" D. Model BC 590XLT-A1 is a similar version without the 800 MHz band for a new low price of only \$194.95. Order today.

NEW! Uniden® Telephones

AM470D-A Uniden answering machine \$69.95
 AM484-A Uniden answering machine \$49.95
 AM488V-A Uniden answering machine \$49.95
 AM480-A Uniden answering machine \$49.95
 AM480-A Uniden answering machine \$69.95
 FP300-A Uniden feature phone \$34.95
 FP302-A Uniden feature phone \$49.95
 FP320S-A Uniden feature speakerphone \$49.95
 FP322S-A Uniden feature speakerphone \$59.95
 XE570-A Uniden cordless phone \$74.95
 XE422S-A Uniden cordless speakerphone \$109.95
 XE777S-A Uniden cordless speakerphone \$109.95
 BT100-A Uniden Trimstyle phone \$17.95
 KT280-A Uniden Family phone with 911 feature \$29.95
 FT150-A Uniden Executive phone \$39.95

RELM® RH256B-A

List price \$587.50/CE price \$299.95/SPECIAL 16 Channel • 25 Watt Transceiver • Priority The RELM RH256B is a sixteen-channel VHF land mobile transceiver designed to cover any frequency between 150 to 162 MHz. Since this radio is synthesized, no expensive crystals are needed to store up to 16 frequencies without battery backup. All radios come with CTCSS tone and scanning capabilities. A monitor and night/day switch is also standard. This transceiver even has a priority function. The RH256 makes an ideal radio for any police or fire department volunteer because of its low cost and high performance. A 60 Watt VHF 150-162 MHz version called the RH606B-A is available for \$429.95. A UHF 15 watt, 16 channel version of this radio called the RU156B-A is also available, and covers 450-482 MHz, but the cost is \$454.95.

★★★ Uniden CB Radios ★★★

The Uniden line of Citizens Band Radio transceivers is styled to compliment other mobile audio equipment. Uniden CB radios are so reliable that they have a two year limited warranty. From the feature packed PRO 810E to the 310E handheld, there is no better Citizens Band radio on the market today.

PRO310E-A Uniden 40 Ch. Portable/Mobile CB \$83.95
 PRO330E-A Uniden 40 Ch. Remote mount CB \$104.95
 ER100-A Uniden Emergency CB Mobile \$49.95
 GRANT-A Uniden 40 channel SSB CB mobile \$166.95
 PC122-A Uniden 40 channel SSB CB mobile \$119.95
 PRO510XL-A Uniden 40 channel CB Mobile \$38.95
 PRO510AXL-A Uniden CB Mobile with antenna \$49.95
 PRO520XL-A Uniden 40 channel CB Mobile \$56.95
 PRO640E-A Uniden 40 channel SSB CB Mobile \$137.95
 PRO810E-A Uniden 40 channel SSB CB Base \$174.95

★★★ Uniden Radar Detectors ★★★

Buy the finest Uniden radar detectors from CEI today.
 RD3XL-A Uniden 3 band radar detector \$159.95
 RD8-A Uniden visor mount radar detector \$89.95
 RD9GTL-A1 Uniden "Passport" size radar detector \$99.95
 RD9XL-A1 Uniden "micro" size radar detector \$124.95
 RD27-A Uniden visor mount radar detector \$54.95
 RD99GT-A Uniden remote mount radar detector \$119.95
 CARD-A1 Uniden credit card size radar detector \$159.95

Bearcat® 200XLT-A

List price \$509.95/CE price \$239.95/SPECIAL 12-Band, 200 Channel • 800 MHz. Handheld Search • Limit • Hold • Priority • Lockout Frequency range: 29-54, 118-174, 406-512, 806-956 MHz. Excludes 823.9875-849.0125 and 868.9875-894.0125 MHz. The Bearcat 200XLT sets a new standard for handheld scanners in performance and dependability. This full featured unit has 200 programmable channels with 10 scanning banks and 12 band coverage. If you want a very similar model without the 800 MHz band and 100 channels, order the BC 100XLT-A for only \$189.95. Includes antenna, carrying case with belt loop, ni-cad battery pack, AC adapter and earphone. Order your scanner now.

Bearcat® 800XLT-A

List price \$549.95/CE price \$239.95/SPECIAL 12-Band, 40 Channel • No-crystal scanner Priority control • Search/Scan • AC/DC Bands: 29-54, 118-174, 406-512, 806-912 MHz. Now...nothing excluded in the 806-912 MHz band. The Uniden 800XLT receives 40 channels in two banks. Scans 15 channels per second. Size 9 1/4" x 4 1/2" x 1 1/2". With nothing excluded in the 806-912 MHz band, this scanner is an excellent choice for law enforcement agencies. If you do not need the 800 MHz band, a similar model called the BC 210XLT-A is available for \$178.95.

NEW! Bearcat® 147XL-A

List price \$189.95/CE price \$94.95/SPECIAL 10-Band, 16 Channel • No-crystal scanner Priority control • Weather search • AC/DC Bands: 29-54, 136-174, 406-512 MHz. The Bearcat 147XL is a 16 channel, programmable scanner covering ten frequency bands. The unit features a built-in delay function that adds a three second delay on all channels to prevent missed transmissions. A mobile version called the BC580XLT-A featuring priority, weather search, channel lockout and more is available for \$94.95. CEI's package price includes mobile mounting bracket and mobile power cord.

NEW! Ranger® RC12950-A

List price \$549.95/CE price \$249.95/SPECIAL 10 Meter Mobile Transceiver • Digital VFO Full Band Coverage • All-Mode Operation Backlit liquid crystal display • Auto Squelch RIT • 10 Programmable Memory Positions Frequency Coverage: 28.0000 MHz to 29.6999 MHz. The Ranger RC12950 Mobile 10 Meter Transceiver by Ranger, has everything you need for amateur radio communications. The RF Power control feature in the RC12950 allows you to adjust the RF output power continuously from 1 watt through a full 25 watts output on USB, LSB and CW modes. The RC12950 also features a noise blander, roger beep, PA mode and more. The Mic Gain Control adjusts the gain in transmit and PA modes to maximize talk power. Digital VFO. Built-in S/R/ MOD/SWR meter. Frequency selections may be made from a switch on the microphone or the front panel. There is even a repeater split switch for repeater offsets. The RC12950 lets you operate AM, FM, USB, LSB or CW for full mode operation. The digitally synthesized frequency control gives you maximum stability. There's also RIT (Receiver Incremental Tuning) to give you perfectly tuned signals. With memory channel scanning, you can scan ten pre set frequencies to keep track of all the action. An optional CTCSS tone board is available (order # RTONE) for \$59.95. For technical questions, call Ranger at 714-858-4419. Order your Ranger RC12950 from CEI today.



BC760XLT
 800 MHz.
 mobile scanner
SPECIAL!

★★★ Extended Service Contract ★★★

If you purchase a scanner, CB, radar detector or cordless phone from any store in the U.S. or Canada within the last 30 days, you can get up to four years of extended service contract from Warrantech. This service extension plan begins after the manufacturer's warranty expires. Warrantech will perform all necessary labor and will not charge for return shipping. Extended service contracts are not refundable and apply only to the original purchaser. Warrantech does not have an extended warranty plan for handheld scanners. For mobile or base scanners, CB radios or radar detectors a 1 year extended warranty is \$19.99, two years is \$39.99 and four years is \$59.99. Order your service contract today.

OTHER RADIOS AND ACCESSORIES

BC55XLT-A Bearcat 10 channel scanner \$114.95
 AD100-A Plug in wall charger for BC55XLT \$14.95
 PS001-A Cigarette lighter cable for BC55XLT \$14.95
 VC001-A Carrying case for BC55XLT \$14.95
 BC70XLT-A Bearcat 20 channel scanner \$159.95
 BC172XL-A Bearcat 20 channel scanner \$134.95
 BC1-A1 Bearcat Information scanner with CB \$119.95
 BC310A-A Bearcat Information Radio \$79.95
 BC330A-A Bearcat Information Radio \$104.95
 UC102-A Regency VHF 2 ch. 2 Watt transceiver \$114.95
 UC202-A Regency VHF 2 ch. 2 Watt transceiver \$149.95
 VM200XL-A Uniden Video monitoring system \$179.95
 BP205-A Ni-Cad batt. pack for BC200/BC100XLT \$39.95
 FBE-A Frequency Directory for Eastern U.S.A. \$14.95
 FBW-A Frequency Directory for Western U.S.A. \$14.95
 RFD1-A MI, IL, IN, KY, OH, WI Frequency Directory \$14.95
 RFD2-A CT, ME, MA, NH, RI, VT Directory \$14.95
 RFD3-A DE, DC, MD, NJ, NY, PA, VA, WV Dir. \$14.95
 RFD4-A AL, AR, FL, GA, LA, MS, NC, PR, SC, TN, VA \$14.95
 RFD5-A AK, ID, IA, MN, MT, NE, ND, OR, SD, WA, WY \$14.95
 RFD6-A CA, NV, UT, AZ, HI, GU Freq. Directory \$14.95
 RFD7-A CO, KS, MO, NM, OK, TX Freq. Directory \$14.95
 SMH-A Scanner Modification Handbook \$14.95
 ASD-A Airplane Scanner Directory \$14.95
 SRF-A Survival Radio Frequency Directory \$14.95
 TSG-A "Top Secret" Registry of U.S. Govt. Freq. \$14.95
 TTC-A Tune in on telephone calls \$14.95
 CBH-A Big CB Handbook/AM/FM/Freeband \$14.95
 TIC-A Techniques for Intercepting Communications \$14.95
 RRF-A Railroad frequency directory \$14.95
 EEC-A Embassy & Espionage Communications \$14.95
 CIE-A Covert Intelligence, Elect. Eavesdropping \$14.95
 MFF-A Midwest Federal Frequency directory \$14.95
 A80-A Magnet mount mobile scanner antenna \$34.95
 A70-A Base station scanner antenna \$34.95
 USAMM-A Mag mount VHF ant. w/ 12' cable \$39.95
 USAK-A ¼" hole mount VHF ant. w/ 12' cable \$34.95
 Add \$4.00 shipping for all accessories ordered at the same time. Add \$12.00 shipping per radio and \$4.00 per antenna.

BUY WITH CONFIDENCE

To get the fastest delivery from CEI of any scanner, send or phone your order directly to our Scanner Distribution Center™. Michigan residents please add 4% sales tax or supply your tax I.D. number. Written purchase orders are accepted from approved government agencies and most well rated firms at a 10% surcharge for net 10 billing. All sales are subject to availability, acceptance and verification. On all credit card orders, the ship to address must exactly match the credit card billing address. If the billing address is a P.O. Box or a P.O. Box Zip® Code, UPS can not deliver to that address. When this occurs, the order must be shipped by mail at a higher cost to you. To avoid this extra charge, you may mail us a check with your order. Prices, terms and specifications are subject to change without notice. All prices are in U.S. dollars. Out of stock items will be placed on backorder automatically or equivalent product substituted unless CEI is instructed differently. A \$5.00 additional handling fee will be charged for all orders with a merchandise total under \$50.00. Shipments are F.O.B. CEI warehouse in Ann Arbor, Michigan. No COD's. Most items listed have a manufacturer's warranty. Free copies of warranties on these products are available by writing to CEI. Non-certified checks require clearance. Not responsible for typographical errors.

Mail orders to: Communications Electronics™, Box 1045, Ann Arbor, Michigan 48106 U.S.A. Add \$12.00 per scanner for U.P.S. ground shipping and handling in the continental U.S.A. For Canada, Puerto Rico, Hawaii, Alaska, or APO/FPO delivery, shipping charges are two times continental U.S. rates. If you have a Discover, Visa, American Express or MasterCard, you may call and place a credit card order. 5% surcharge for billing to American Express. Order toll-free in the U.S. Dial 800-USA-SCAN. In Canada, dial 800-221-3475. FAX anytime, dial 313-971-6000. If you are outside the U.S. or in Michigan dial 313-973-8888. Order from CEI today.

Scanner Distribution Center™ and CEI logos are trademarks of Communications Electronics Inc. Sale dates 7/15/90 - 1/31/91 AD #071590-A Copyright © 1990 Communications Electronics Inc.

For credit card orders call
1-800-USA-SCAN

COMMUNICATIONS ELECTRONICS INC.

Consumer Products Division
 P.O. Box 1045 □ Ann Arbor, Michigan 48106-1045 U.S.A.
 For orders call 313-973-8888 or FAX 313-971-6000

List #1: Autumn '90

Abbreviations: EE= English; BIWI= British West Indies English; PP= Portuguese; SS= Spanish; FF= French; RT= Full Duplex Telephone; BI= Business; MIL= Military

29.815: SS RT, Medellin mentioned.
29.93: Canadian trawlers on this bootleg freq.
30.00: US MIL in UK, NBFM mode.
30.125: Soviet MIL, clear & scrambled.
30.15: "We just took a real-world casualty." US mil chemical war games. Station X-04.
30.35: "We are extremely artillery-shy!" Personnel at Camp Pendleton, CA reporting a near hit by live mortar fire. Range Control ID: "Long Rifle."
30.86: PP, might be Brazil.
31.10: US MIL "White-2 to Black-1. Got problems here reference the people that got relocated last night."
31.45: African language? Beep at end of each xmsn.
31.70, 32.10, 32.8575, 32.8875: Soviet MIL.
31.725: Dutch West Indies National Guard station 21-Charlie in EE & Papiamentu.
31.75: Ft. Irwin, CA, "We're south of the Siberian Ridge."
32.05: BIWI, Jamaica "Shelphon Base."
32.0875, 32.125, 32.3375, 32.45, 32.4525, 32.5575, 32.8275, 32.8325, 32.8575, 32.925: Soviet MIL, clear & scrambled.
32.10: FF MIL station "Charlie," probably Caribbean.
32.20, 32.25: Italian MIL.
32.20, 32.45: FF MIL station "November." On 32.20 there's a US MIL station in the UK (NBFM).
32.25: US MIL range control, probably Calif. "Beach Radar to Range Control. We just had a hang glider enter the range area. You might want to shut down the range until he is gone." Also Guard Post-7.
32.30: Missile recovery "Recon Mobile to Base. We're out here doing an extraction." US MIL.
32.70: US MIL a/c on bombing run, "Gun Runner to Test Control."
32.75: UK mil stations 14 & 15.
33.00: German MIL. Also an SS repeater sometimes repeats US police skip.
33.05, 33.1825, 33.3775, 33.40, 33.45: Soviet government ministries.
33.06, 33.15, 33.20, 33.39, 33.80, 33.95: Soviet MIL.
33.25: FF MIL.
33.575: Soviet station with test count.
33.60: Havana-4 repeater out (37.125 in) sometimes repeats US police skip.
33.80, 33.875, 34.00: "Control," un-ID language.
34.31: White Sands Missile Range, NM repeater out (34.85 in), "Bounce up the laser." This is Channel 2 video recording net.
34.48: BIWI stations.
34.49: White Sands Missile Range, NM, "Get the laser gun."
34.60: US MIL a/c dogfight, "Got a padlock on this guy way up in the stratosphere."
34.6175, 35.125, 37.05: Soviet MIL.
34.70: US MIL, "Land Shark to Burnt Tree."
34.80: UK MIL station 70.
34.86: West German highway assistance, Dusseldorf.

Check between 34.76 & 35.00 MHz in 25 kHz steps for more of these repeaters.
35.04: US trawlers, "How did the Durango sink?"
35.2875: FF, French PD's. Check 34.90 to 36.20 MHz in 12.5 kHz steps for more of these.
36.30: EE, "Get fuel oil." Maybe UK or Canada.
36.35: SS MIL station ID'ing as Puma.
36.425: Soviet repeater out, beep after each xmsn.
36.50, 36.70: Mexican MIL in SS.
36.525, 36.625: Soviet ministries.
36.53, 36.57: USN fireboats, San Francisco Bay, ID as Fantail & Wild Bill Williams.
36.925, 37.675: Soviet MIL.
37.00: Roosevelt Roads Naval Station, PR ID as Bravo Base, Headquarters-50, 1-SG.
37.20: BIWI repeater out (34.20 in), Jamaica repeats US MIL skip.
37.25: German repeater out.
37.26: Repeater out rebroadcasts US PD or FD skip, but badly distorted.
37.275: Repeater out (34.275 in), Jamaica. Active.
37.425: Repeater out keys up on noise & US skip.
37.52: Repeater out (39.22 in), Channel 0, SS from South America.
37.55: Repeater out (34.55 in), Base-1 in Jamaica.
37.60: Repeater out, sometimes keys up on US skip.
37.75, 38.26: Italian stations.
38.675, 38.875: Soviet stations.
38.81: RT's, UK.
38.85: Repeater out (35.85 in), Jamaica.
38.95: Irish stations.
39.60: RSA, maybe RT or repeater with phone patch.
39.75: US MP's in S. Korea. ID is Protector Foxtrot. For S. Korean MIL & riot troops check around 34 MHz in 25 kHz steps.
40.25: US war games, "Mobile-1 this is Chomper."
40.30: East German stations with radio checks.
40.55: France, in FF.
41.55: Repeater out, sometimes has US paging skip.
42.15, 42.65: FF repeaters with tone access.
42.2425, 42.9125: Soviet MIL.
43.85: Repeater out keys up on noise & US MIL skip.
44.39: BIWI, Trinidad oil rig ID as Richman.
44.675: SS repeater out rebroadcasts Canadian skip.
45.43: Repeater out keys on US PD skip.
45.50: SS MIL.
45.64: RT, BIWI possibly British Virgin Islands.
46.07: Trinidad FD, ID's as Pyramid Point.
46.50: RT, France in FF.
46.55: France, in FF. Click between comms; data bursts before, during & after xmsns. Either repeater or RT.
47.325: SS with talk of the "commandante" & documentos (documents). Tone-burst access. See 48.50 MHz.
48.08: Repeater out, keys on distorted US skip.
48.50: SS, talk of PD patrols in Caracas, Venezuela. Tone-burst access. Plenty of these stations 47 to 50 MHz (25 kHz spacing).
48.66, 48.98: Repeater out, repeats US BI skip.
49.22: SS repeater out has distorted US skip.
49.60: Repeater out, "Standby...Roll the tape."

lines, behind the news restrictions, and get a behind-the-scenes impression of what was really going on. POP'COMM was the first to break the story about the RSA's police communications in this band, enumerate the specific frequencies, and tell how to monitor them in North America.

Among the letters that arrived in response to that article were several from readers in RSA who were appalled and outraged that I was not only monitoring their dirty laundry, but telling POP'COMM readers how to do the same. Meanwhile, here in North Amer-

ica, many readers wrote me to say that they were absolutely astonished and dazzled by reading my article and then actually tuning in on the police communications in this volatile nation.

Readers either loved the story or disliked it intently. Yanking the curtain open to reveal things that some have gone to some trouble to conceal usually manages to have that effect.

Professional Opinion

The response to the RSA revelations

from persons in the news media here was enthusiastic, to say the least. POP'COMM has many readers who are news professionals and they found that this direct pipeline into the "belly of the beast" was quite an education.

After reading the story, Gary Hart, News Director of WRAJ (1440 kHz/92.7 MHz), in Anna, IL contacted me for an interview on his news talkshow. He wanted me to explain how these frequencies were discovered and the methods I used to determine that what I was hearing was the RSA police.

RSA Police Update

As 1990 came into focus, RSA police comms became more active than ever before. There has long been racial tension in the RSA, but the rapidly changing political scene there has only made for more problems than ever before, as reflected in the communications being monitored.

In the springtime, President F. W. de Klerk legalized over 60 black opposition groups that had been outlawed for nearly three decades. Although this was an apparent effort to cool things down, it resulted in increased conflicts with the police, and clashes between the various newly legalized groups.

From my monitoring post in Illinois, I eavesdropped on police reports of stone throwing demonstrators, looting, cars being burned, and roving groups of youths firing guns into crowds. Then there were the body counts. Month after month the bloodshed continued. I've never before heard anything like it.

The police comms during the confrontations were riveting. On 37.70 MHz, Data Control urgently summoned an officer, "Delta Sierra, there is a large group of males shooting at people. Do you copy?"

On 37.80 MHz, Echo Control was asking, "Sergeant, were shots fired at you?" Echo-28 replied briskly, "That is affirmative!" A few minutes later Echo-28 radioed a chilling request, "Send someone to pick up three bodies."

On several occasions, protestors threw stones (and grenades) at police stations. One youth was killed when police fired handguns in an effort to disperse the crowd stoning a police station near Johannesburg. On 38.00 MHz, the dispatcher called the coroner to report, "We have a body at the station. Come fetch it."

Despite continuing efforts by the government to defuse the situation and shed some of its apartheid policies, racial animosity seems to be at a high level. Neo-Nazi type groups and white paramilitary organizations have been gaining in power and influence in response to any government speculation or efforts regarding lessening apartheid. Police communications recently confirmed that white militaries have been stockpiling weapons; I heard this on 37.80 MHz: "We just uncovered a whole cache of firearms."

RSA military often backs up the national and local police. Some frequencies that appear to be used by the military or police include: 31.30, 33.40, 34.35, 36.70, 36.95, 37.65, 38.05, 40.60, and 42.80 MHz.

RSA police usually provide the press with few details of the fighting, and what does show up in the media seems pretty tame compared to what's being monitored on the scanner frequencies. The primary RSA police channels in current use are: 37.00, 37.05, 37.20, 37.30, 37.40, 37.50, 37.60, 37.70, 37.80, 37.90, 38.00, 38.10, 38.20, 38.30, 38.40, and 38.50 MHz. Most of these frequencies are used by

several base stations and numerous mobile units in all areas. Also refer to the November '89 issue of POP'COMM for more information. Some additional data is included in this month's Table 1.

World Class News Scanning

But there's more than the RSA to monitor. Plenty of exotic skip is out there this time of the year. Europe, Africa and the Middle East come through during the morning hours here in North America. The Pacific region makes an appearance in the afternoons. The Caribbean and South America can be heard just about any time during the day, and, depending upon where you are

located in North America, other areas of the USA, Canada, and Mexico will also be coming through between 30 and 50 MHz.

Become a world class news hound in every sense of the word by tuning in to low band skip. Table 1 will direct you to some of the better frequencies providing chatter you'll want to try for this autumn. You may not be successful at picking up every station listed, but be patient and you're sure to be rewarded with an earful of information that you'll find worthwhile.

Remember, POP'COMM is where you get the hot frequencies that put you ahead of the news and behind the headlines. **PC**

Upgrade Your Scanner!

Nearly all Police, Fire & Rescue broadcasts will be moving to the 800MHz band during the next few years. Don't risk losing your ability to scan these exciting channels due to equipment frequency limitations.

GRE America, Inc. has the answer! GRE has two new frequency converters that work with your existing scanner and allows you to receive 810MHz to 912MHz on your 410MHz to 512MHz equipment. Two models are available:

◆ **SUPER CONVERTER 8001™**: The 8001 is a portable base model with Motorola antenna leads and will not interfere with reception quality. This model uses 9 volt battery or AC/DC adapter.



◆ **SUPER CONVERTER II™**: This model is perfect for handheld scanners. Has BNC connectors for fast installation, and can be returned to original frequencies at the flick of a switch. Very small and lightweight and uses a 9 volt battery or AC/DC adapter.

Need Handheld Amplification?

◆ **SUPER AMPLIFIER™**: Adjustable 20db amplification of VHF/ UHF frequencies (from 100MHz to 1GHz). Complete with BNC connectors and uses a 9 volt battery or AC/DC adapter.

◆ **GRE ALL-BAND ANTENNA™**: Attractive black with red antenna cap. BNC connector increases gain in 25MHz to 1GHz frequencies.

Become a GRE Dealer or Distributor!

GRE America is seeking new dealers and distributors to retail a growing product line. We offer excellent profit potential at the distributor and retail levels, complete national advertising support and responsive customer service. **For more information**, please call or write GRE as shown below:



GRE America, Inc.
425 Harbor Blvd.
Belmont, California 94002

Telephone (415) 591-1400
Outside CA: (800) 233-5973
Fax: (415) 591-2001

Radio: Way Back When

Rattling Around In The Archives Of Early Radio

BY ALICE BRANNIGAN

In several past issues we have looked at the claims of the different broadcasters who claim (or claimed) to hold the title of first on the air. We had KDKA, KCBS, WHA, and others. But we haven't presented any Canadian stations with that claim, at least not until now.

What brought it to mind was when reader Owen Williamson, of El Paso, TX, donated his large and beautiful collection of DX QSL's to the POP'COMM archives. These wonderful verities are mostly from the 1960's and cover AM, SW, and TV. As we took our first look through them, a '63 QSL from Montreal's CFCF caught our attention because it made the claim that CFCF was "the first broadcasting station in North America."

CFCF went on the air in November of 1919, being operated on 730 kHz with 7.5 kW by the Canadian Marconi Company. The station was located in the Canada Cement Building, at Phillips Square, Montreal.

Interestingly, CFCF began cutting down its transmitter power in the early years, which was the against the trend. In 1926, the station had reduced power to 1.65 kW, but during the 1930's it dropped down to as little as 400 watts. CFCF was on 1030 kHz for a brief time around 1931, then settled down on 600 kHz where it has remained until the present.

CFCF began raising its power again in the early 1940's, going to to 500 watts. In the 1960's, it had gone up to 5 kW. A few years ago, CFCF began running 10 kW days, 5 kW at night.

After its early location in the Canada Cement Building, in the early 1930's CFCF moved its studios and transmitters into the Mt. Royal Hotel. Many years later, the transmitter site was changed to a location on the Iroquois Indian Reserve at Caughnawaga, Quebec, across the St. Lawrence River from Montreal. Four 300-ft. towers had been installed there for CFCF.

CFCF is also a pioneer in shortwave broadcasting. You may have heard CFCX, its shortwave relay on 6005 kHz. CFCX was originally licensed as VE9DR from Drummondville, Quebec from 1930 to 1932. Then CFCX was moved into the Mt. Royal Hotel. The call sign became CFCX in 1936, and it remained in Montreal until 1948. In 1963, it was moved to the AM transmitter site.

An FM outlet, CFCF-FM (presently CFQR-FM, 92.5 MHz), was started with a 250 watt transmitter on the Sun Life Building in 1947. In 1948, it went to 7 kW ERP. In 1962, the site was changed to Mt. Royal tower and the power was brought up to 41.4 kW ERP.

For the past two years, CFCF and CFQR-FM have been owned by Mt. Royal Broadcasting, Inc. The AM station operates in English with an oldies format. The FM outlet is programmed separately with an adult contemporary format.

Remembering Colombia

SWL's may recall the name of *Radio Sutatenza*. This was a series of AM and



That's not the Eiffel Tower on top of this building. It's the antenna of station 2CH, Sydney, NSW, Australia. (Courtesy Hank Milten, IA.)

shortwave broadcasting stations in Bogota, Colombia. Started in 1948 by the church-affiliated Accion Cultural Popular, the stations were used to broadcast to Colombia's 30,000 "radio schools."

The Radio Sutatenza QSL of the 1960's displayed the transmitter and the generic callsign HJGC. (Courtesy Owen Williamson, TX.)

CFCF, if not the oldest broadcaster in North America (as claimed), is certainly one of the oldest. It dates back to 1919. (Courtesy Owen Williamson, TX.)

| | |
|-------------------------------------|------------------------------|
| TO | Owen Williamson |
| | Minneapolis, Minn. |
| WE ARE PLEASED TO CONFIRM RECEPTION | |
| of | CFCX on 6005 kcs |
| at | 2100 GMT on Dec. 24/63 |
| CFCF | |
| MARCONI RADIO-TV | |
| CFCF AM | 600 kcs 5,000 watts |
| CFCF FM | 92.5 mcs 41,500 watts ERP |
| CFCF TV | Channel 12 325,000 watts ERP |
| CFCX SW | 6005 kcs 500 watts |
| 405 OGILVY - MONTREAL, CANADA | |

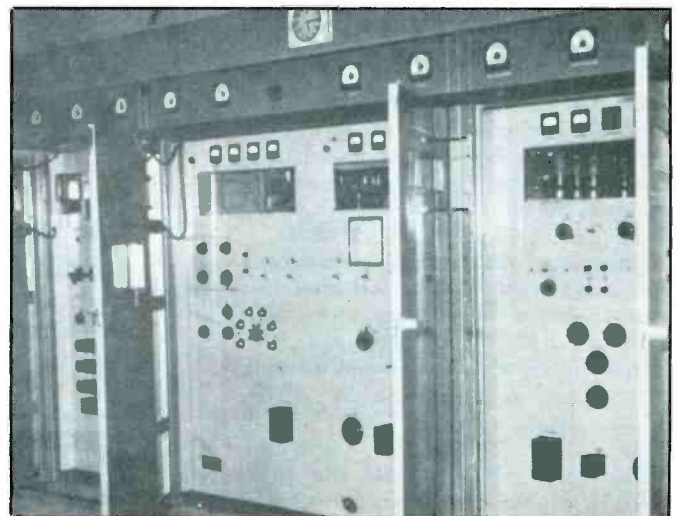



Dear D-X Friend:

It's better late than never! Anyway, I certainly hope you feel that way about it. This letter is written to verify the report given on the D-X broadcast from WRBL March 13th, 1932.

Your name has been added to our "Honor Roll" and you are now a full fledged member of our D-X Family. We are happy to say that since this folder was printed, several more states, together with a number of cities and a few hundred more new members have been added to our roll of honor.

In view of the fact that we waited so long to verify your report, I feel that a little explanation is in order. The main reason was that things have been happening down here at WRBL. As I like to give the D-Xers my personal attention, they have been neglected. I have been out of the city quite a bit, sometimes in Washington, D. C., and the good news is that WRBL has been granted a 100 watt station. Our new station will continue to operate on 1200 kcs. Will advise you of our next D-X broadcast which will not be until fall.

Most members have told us they do not care for stamps and so we are using this illustrated folder instead.

With best wishes from the entire staff and entertainers of this station, I am

Yours for more and better D-X programs,

David Parmer, director

WRBL RADIO STATION, INC.

"THE BIGGEST 'LITTLE' STATION IN THE WORLD"

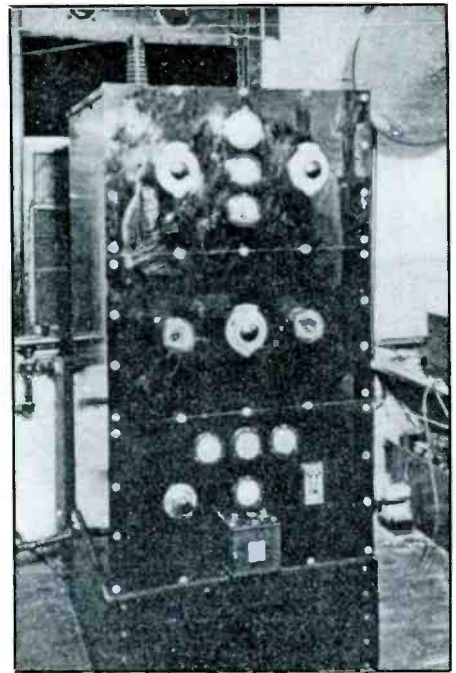

When WRBL verified reception of its 50-watt transmitter (which was sometimes run at only 25 watts), they sent along a photo of the rig. Reports regularly arrived from more than 30 states, and several provinces of Canada. (Courtesy Joe Hueter, PA.)

It's a photo of Australian station 2CH, a station that dates back to the early 1930's and is still in operation. This station was originally on 1190 kHz, then moving to 1170 kHz. Originally, 2CH ran 1 kW, but later dropped down to 750 watts. In 1956 it went back up in power, this time to 5 kW. Until the mid-1950's, it had been operated by the New South Wales Council of Churches. Then it apparently went dark for a brief period around 1958.

When it came back on again, in 1959, 2CH was still running 5 kW on 1170 kHz, but it was being operated by Amalgamated Wireless (A'sia) Ltd., which is what's shown in the photo Hank sent to us, the initials A.W.A. representing the name of the owners.

In the photo, just below the base of the tower, the large A.W.A. company logo is mounted on the building.

However, beginning in 1989, the new owners of the station were 2CH Pty. Ltd., as 2CH continues in operation on 1170 kHz. Wonder how the card got from Australia to Iowa!

Georgia On My Mind

May 20th, 1928 was the day that R.E. Martin, of Columbus, GA strung up a hunk of wire and put his 50 watt station, WRBL, on 1130 kHz. Six months later, the Federal Radio Commission told R.E. to plug in a new crystal and move WRBL over to 1200 kHz. This he did.

We liked this hand-designed 1932 letterhead from WRBL, Columbus, GA. (Courtesy Joe Hueter, PA.)

In radio schools, a battery-operated fixed-tuned receiver was set up next to a blackboard. Printed material was then handed out to the attending students by a volunteer who acted as an intermediary between the teachers who were heard via radio.

Using this system, more than 150,000 adults in remote areas were being taught each year to read and write. In addition, *Radio Sutatenza* had classes in farming and ranging, as well as hygiene, general culture, and other topics.

In the early 1960's, the stations used for this were: HJCT, 6075 kHz with 10 kW; HJGC, 5075 kHz with 25 kW; HJGG, 5095 kHz with 50 kW; HJGO, 3250 kHz with 10 kW; and HJGP, 1580 kHz with 1.1 kW. Usually, the generic call HJGC was used for all operations.

Last year, *Radio Sutatenza* became *Caracol Colombia*. The following Bogota stations are presently part of this system: HJCY, 810 kHz with 250 kW; HJGC, 5075 kHz with 25 kW; HJGG, 5095 kHz with 50

kW; and HJIA, 6075 kHz with 10 kW.

A 1961 QSL from *Radio Sutatenza* depicts some of the transmitters used at this facility. It was contained in the material sent to us by Owen Williamson.

Aussie Old Timer

Hank Milten, Decorah, IA found a photo postcard at a flea market and sent it along for our use. The photo shows an eleven story brick office building with what looks like a miniature of the Eiffel Tower on the roof. Although you won't be able to see them in our reproduction because they are difficult to see on the original, there are small masts at other points on the roof. Also, there seem to be wires strung from some of the masts to various points on the Eiffel Tower.

The only caption printed on the undated photo card reads "A.W.A. Building, Sydney, N.S.W." Hank thought that it looked like a broadcasting station, so he passed it along to us. Hank's guess was a good one, for it is a broadcaster.

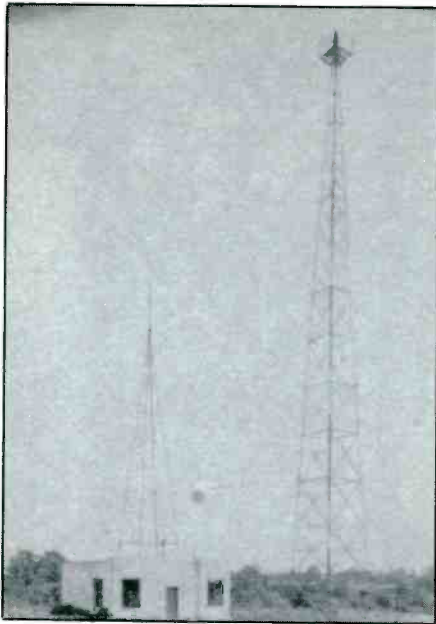

The Farnsworth W3XPF TV transmitter building and towers near Philadelphia in early 1937.

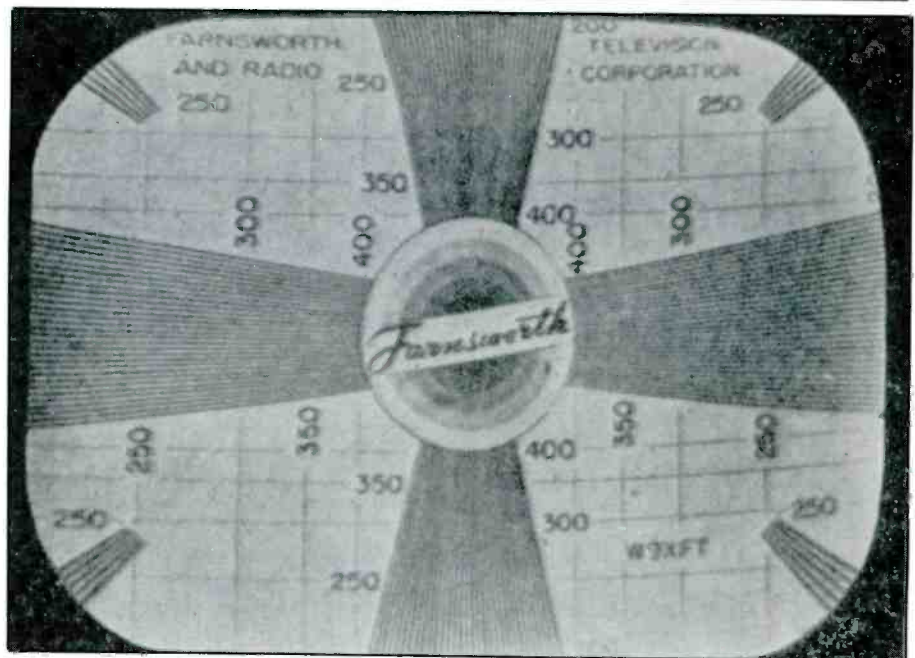

After Farnsworth moved his TV station to Fort Wayne, Indiana, it became known as W9XFT, on Channel 4. This is how its test pattern looked in 1945.

based largely upon Farnsworth's work) in 1939 were the birth of TV; a birthday still seriously promoted as "official" by the TV industry, regardless of how laughable the claim proves to be. By actual count, as early as 1930, the FCC had no less than thirty TV stations licensed!

Farnsworth's TV station was called W3XPF and it was located in a suburb of Philadelphia, PA known as Wyndmoor. W3XPF had a 4 kW video (441-line) signal on 62.75 MHz, with a 1 kW aural signal on 66.00 MHz, which is approximately equivalent to today's TV Channel 3. Remember that in 1937, the present TV channel allocations had not yet been established by the

FCC. The station used vertically polarized dipoles mounted on a 150-ft. tower.

Separate studio and transmitter buildings were built. The main studio was 40 by 24 ft. across, by 24 ft. high. It was equipped with lights, and sets. There was an adjoining control room, plus production rooms and facilities. This was hardly a backroom operation, it was as modern a TV facility as existed anywhere.

How and why this is all being ignored now, and the industry chooses to pretend it didn't exist, is a mystery. Possibly it's due to the publicity long given Sarnoff's 1939 efforts, which came after a long legal battle with Farnsworth, and which didn't give

Farnsworth credit for his earlier work. It was Farnsworth's work that opened the door for what came in 1939, and what we know today as television technology.

In 1939, Farnsworth purchased a factory facility at 530 Case Block, in Marion, IN. This was a building formerly used for manufacturing radios by a failed company that had been known under several names, including Apex Electric Mfg., United States Electric Corp., Indiana Mfg. & Electric Co. (Case radios), and the United States Radio & Television Corp.

Farnsworth then decided to sharpen the focus of his operations by bringing his TV station to Indiana. By 1941, W3XPF was history and had become Philco's WPTZ on Channel 3, Philadelphia (presently Westinghouse's KYW-TV). Farnsworth's TV operations moved to Indiana, and his station had become W9XFT, Fort Wayne. This station was on TV Channel 4 with a 6 kW video signal and a 4 kW aural signal.

Today, Fort Wayne has TV stations on Channels 15, 21, 33, 39, and 55, but the first of these (WKJG-TV, Channel 33) came on in 1953. That was several years after Farnsworth's station had been there.

North Dakota Old-timer

Not too many broadcasters with any significant longevity can trace any direct ties to their original licensees, nor can they say they're still operating on the same frequency they were using in the 1920's. We found one that can. That's KFYR, Bismarck, ND.

KFYR started up in late 1925 as a 10 watt station on 1210 kHz. It was licensed to Hoskins-Meyer, Inc., 200 4th Street. In less than three years, KFYR was running 500 watts (250 watts at night) on 1200 kHz. Late

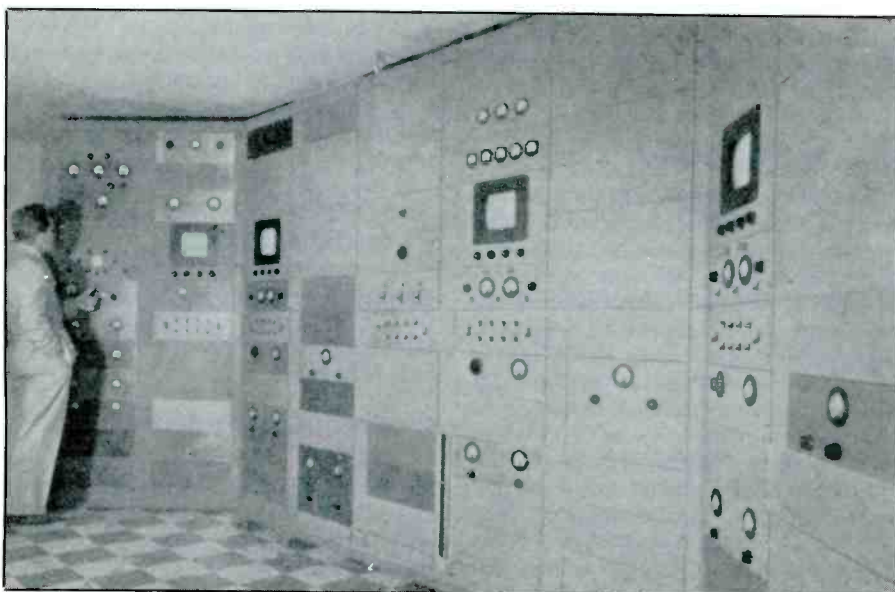

The W3XPF TV transmitters at Wyndmoor in 1937.



A photo of WRBL taken about 1963.

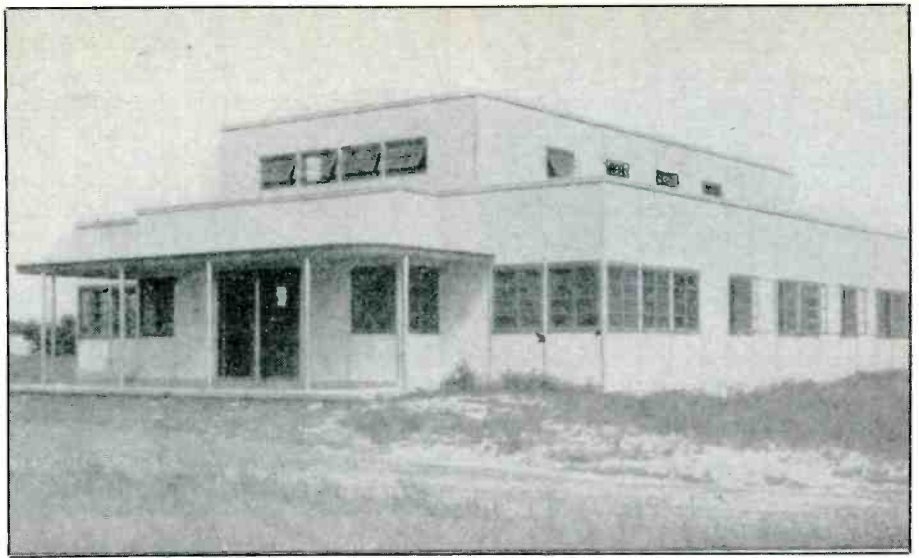

An early photo of Farnsworth's W3XPF TV studio before the landscaping was put in.

For whatever reasons, within a two year period of time R.E. had gotten his fill of broadcasting and sold WRBL to David Parmer, of 1307 Broadway, in Columbus. Parmer ran the station from the Royal Theatre Building, calling it "The Biggest Little Station In The World." During Parmer's early years, WRBL ran at half-power (25 watts), but in May of 1931, he brought it up to its full 50 watt strength. A year later, he obtained permission to bring it up to 100 watts, also changing the corporate name to WRBL Radio Station, Inc.

Under Parmer's ownership, WRBL was very hobby-oriented and regularly presented special DX test programs and QSL's for those listeners who wanted to verify the station at 50 watts. WRBL's programs during the Parmer years featured lots of live studio entertainment, including the eight-piece Nehi Orchestra. Parmer also had an *Amos n' Andy* rip-off comedy team called *Rufus and Roberta*.

By the time the early 1940's rolled around, WRBL was owned by the Columbus Broadcasting Co., 1420 2nd Ave., and it was on its new frequency of 1230 kHz with 250 watts. The transmitter site was at 3009½ Howay Avenue. Shortly after the end of WWII, there were more changes in store for WRBL, primarily its shift to 1420 kHz and increase in power to 5 kW.

A picture postcard we have of WRBL dates from 1963, when it was still owned by the Columbus Broadcasting Co., but operating from 1350 13th Avenue, in Columbus.

Still on 1420 kHz with 5 kW, you wouldn't recognize WRBL any longer. That's because, in 1977 new owners (WGBA, Inc.) took over. They changed the call letters to WRCG. It's come a long way in more than sixty years of broadcasting.

Our November Mystery

Ross Franklin, of Wenatchee, WA came up with an old picture postcard that relates

to wireless in Canada, but requires further identification. The card isn't dated, but looks to be quite old, and we would guess it to be from the early 1920's.

It shows a lagoon with several beachside homes. To the right of the photo, on the hill in the background, there is a large white structure flanked by two guyed masts supporting a two-wire antenna. The caption printed on the card reads, "Fowl Bay showing Government Wireless Station and Observatory, Victoria, B.C."

Just a stab, but we are going to tentatively identify this as a very early coastal telegraph station that, in 1906, was using the call letters BC. By 1919, the station was listed under the call sign VAK, with a location of Gonzales Hill, Victoria, B.C. The call sign of the Canadian Coast Guard Station in Victoria remains VAK to this day; currently it can

be heard on several voice and CW frequencies, but its primary CW frequency is 430 kHz.

If any reader has a better identification for the station shown, please let us know.

The Early Show

A mention in *POP'COMM* last year of TV pioneer Philo Farnsworth attracted letters requesting additional information on this clever gentlemen. He has managed to all but become lost in obscurity despite the fact that he was the father of modern electron scanning television. The original coverage of Farnsworth in *POP'COMM* didn't come from this column, but we can give you a look at the station Farnsworth put on the air in 1937. That was a full two years before RCA's Gen. Sarnoff came along and said that his company's own efforts (which were

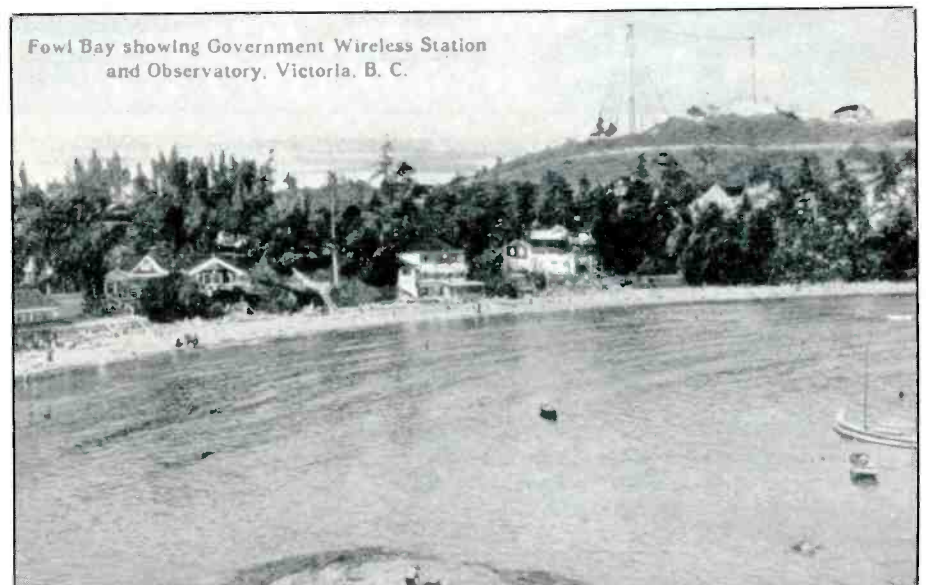

Our mystery photo may show Canadian coastal telegraph station VAK, Victoria, British Columbia, up on the hill at the right. (Courtesy Ross Franklin, Wenatchee, WA.)

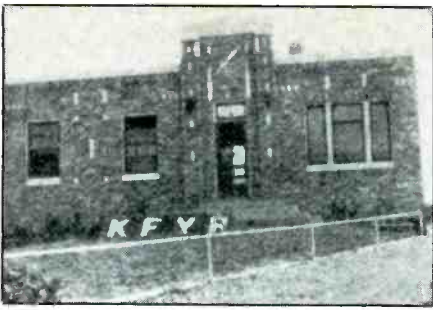

This 1936 view of KFYR shows the transmitter building after it was located in Menoken, ND.

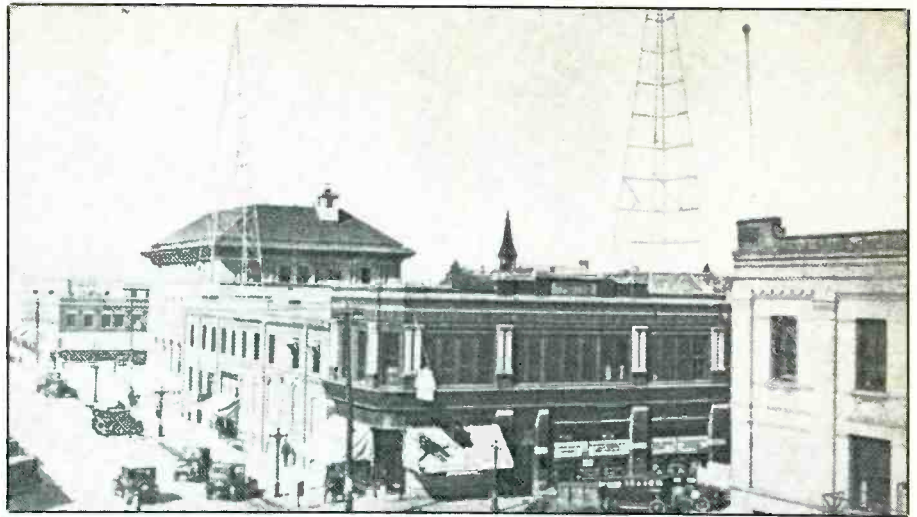

The KFYR studios and transmitting towers in the heart of Bismarck as they looked in 1931.

in 1928, the government shifted the station over to 550 kHz where it shared time with KFDY (Brookings, SD) and KFJM (Grand Forks, ND).

As of 1931, KFYR had upped its power to 1 kW, and had obtained permission to increase its power to 2.5 kW. But, by the mid-1930's it was still running 1 kW (100 watts at night). However, Hoskins had left and the station's licensee was the Meyer Broadcasting Co., 320 Broadway. It was being run by one of its founders, P.J. Meyer. The transmitter and 700 ft. tower was near Menoken, ND.

A dark day in KFYR's history almost came in the fall of 1936, when the FCC ordered the station deleted from its license records for running too much power. The

station didn't deny the charges, but presented evidence to the FCC that the violations occurred without the knowledge of the licensee. The FCC agreed, and granted a regular renewal of the station license.

By 1948, KFYR had moved up to 5 kW. Today, KFYR is still licensed to the Meyer Broadcasting Co., and this month marks its 62nd year on 550 kHz. It runs 5 kW with an adult contemporary format. Its affiliated FM station is KYYY, 92.9 MHz.

Here's a salute to KFYR, and a hope for

another big bunch of years holding down 550 kHz.

We'll be looking for you next month. And we do sincerely appreciate your kind letters and contributions to the POP'COMM archives in the way of old QSL's, station photos, station directories, postcards of radio and wireless, stations, and everything else. Materials submitted are not only on file for use in these pages, but are also used to provide vital reference data to serious researchers in radio history. Happy Thanksgiving!



Jammed with up-to-date information, **Monitoring Times**, is considered indispensable reading by a number of top government agencies.

If you are interested in communications — from shortwave broadcasting to utilities to scanning — let **Monitoring Times** be your guide.

Order your subscription today before another issue goes by! MT is only \$18 per year in the U.S., \$26 in Canada and elsewhere. Sample issue, send \$2.

Shortwave • Utility Monitoring • Scanning • Electronic Projects • Exclusive Interviews
Schedules • Insights from Experts • Features • New Product Reviews

MONITORING TIMES • PO Box 98, Dept. PC • Brasstown, NC 28902

- Send me a sample issue. I've enclosed \$2.
- Enter my subscription. I've enclosed a check.
- MC/VISA, please call 704-837-9200

Name _____

Mailing Address _____

City _____ State _____ Zip _____

CIRCLE 63 ON READER SERVICE CARD

SUPER LONG PLAY TAPE RECORDERS

12 Hour Model — USES 120 TAPE \$119.00*

Modified Panasonic Slimline, high quality AC-DC provide 6 continuous hours of quality recording & playback on each side of cassette for 12 hours total. Includes • Voice level control • Digital counter, etc. TDK — 120 Cassette Furnished.

PHONE RECORDING ADAPTER

Records calls automatically. All Solid state connects to your telephone jack and tape recorder. Starts recording when phone is lifted. Stops when you hang up. **\$28.50***

VOX VOICE ACTIVATED CONTROL SWITCH

Solid state. Self contained. Adjustable sensitivity. Voices or other sounds automatically activate and control or remote mike. **\$28.50***

*Add for ship & hdlg. Phone Adapter & Vox \$1.50 ea. Recorders \$4.00 ea. Cal. Res. add tax. Mail order. VISA/M/C, COD's OK. Money Back Guarantee. Qty. disc. avail. Dealer Inquiries invited. Free data.

AMC SALES INC. Dept. P 9335 Lubec St. Box 928. Downey, CA. 90241. Phone (213) 869-8519 FAX (213) 923-1478

CIRCLE 66 ON READER SERVICE CARD

POP'COMM Reviews:

Palomar Engineers' "Channel Cleaner™" Antenna

Have you been troubled by interference while listening to your favorite station on that new world band portable shortwave radio? I am certain your answer is "yes!" Two shortwave stations using the same frequency can cause significant "co-channel interference" problems. In addition, splatter and heterodynes usually diminish the pleasure of SWL'ing.

An outdoor antenna that exhibits some directivity may eliminate the problem. But doesn't that defeat the purpose of having a portable shortwave receiver? What's the answer to this dilemma? Palomar Engineers believes they have the answer with their Model PA-420 "Channel Cleaner™" antenna. Let's look at this antenna that uses a new reception principle.

Some Background Info

The problem of co-channel interference has always existed, but is especially apparent with small portable shortwave radios sporting only a telescoping whip antenna. Dr. O. G. "Mike" Villard, Jr. of SRI International of Menlo Park, CA has developed small loop antenna principles for the reduction of this problem. One of his designs, the CSWL (Compact Spaced Whip Loop) offers a significant reduction of co-channel, as well as other forms of interference. The CSWL design creates a single fan-shaped null which shades the radio's built-in whip antenna from interfering signals. The Model PA-420 "Channel Cleaner™" is manufactured under an agreement with SRI International.

Installation And Use

Designed expressly for the small battery-powered all-band portable radio, the "Channel Cleaner™" consists of two pieces: a small control console which includes a platform for the radio, and the loop antenna which plugs into the control console. Installation couldn't be easier: simply sit your radio on the platform and extend the whip parallel with the loop. That's it!

Three factors affect the performance of the system. The adjustment of the "Q" and "Tune" controls on the control console, and the loop orientation. With practice, you can

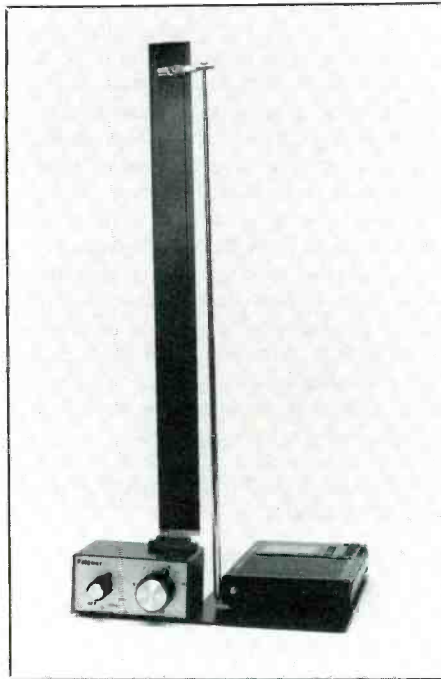

easily null an interfering sky-wave signal by approximately 20 dB. Adjustment of the two controls is quite critical and frequency sensitive. Also, it helps to place the entire assembly, "Channel Cleaner™" and the radio, on a small turntable. By rotating the entire assembly, nulls can more easily be achieved. The unit is effective on sky-wave as well as ground-wave signals. Typically, I found that even greater rejection nulls can be achieved on ground-wave signals.

Summary

The Palomar Engineers' Model PA-420 "Channel Cleaner™" antenna is a welcome addition to the listening shack. It's truly effective in reducing co-channel and other forms of interference for those of us with portable shortwave radios. The price of the unit is \$79.95, plus \$4.00 shipping/handling in the U.S. and Canada.

Please contact Palomar Engineers directly at Box 455, Escondido, CA 92033, (619) 747-3343 for more information.

Reviewed by Don Allen, N9ALK

HAM RADIO IS FUN!

It's even more fun for beginners now that they can operate voice and link computers just as soon as they obtain their Novice class license. You can talk to hams all over the world when conditions permit, then switch to a repeater for local coverage, perhaps using a transceiver in your car or handheld unit.

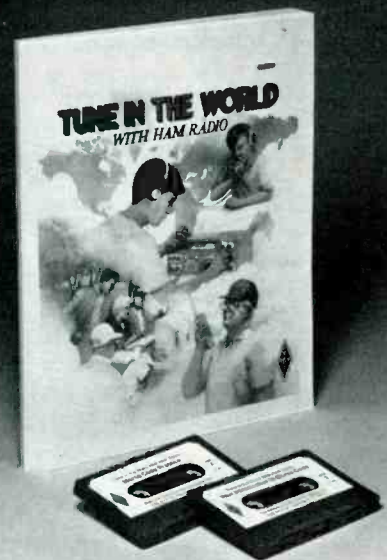

Your passport to ham radio adventure is TUNE-IN THE WORLD WITH HAM RADIO. The book tells what you need to know in order to pass your Novice exam. Two cassettes teach the code quickly and easily.

Enclosed is my check or money order for \$19.00 plus \$3.50 for shipping and handling or charge my

() VISA () MasterCard () Am. Express

Signature _____

Acct. No. _____

Good from _____ Expires _____

Name _____

Address _____

City _____ State _____ Zip _____

_____ PC

THE AMERICAN RADIO RELAY LEAGUE
225 MAIN ST.
NEWINGTON, CT 06111

CIRCLE 57 ON READER SERVICE CARD

Videos On Tap

Although not "books," we felt that videos should be given mention here in *Books You'll Like*. Two came in that you'll want to know about.

Glass Airwaves: The History of Vacuum-Tube FM Stereo Tuners is an interesting look at some early receiving devices dating from the 1950's and 1960's. Great old sets like the McIntosh MR-71 and MR-110, the Scott 310D and 30, the Dynaco FM-3, and the legendary Marantz 10B. These pure-tube tuners represented the zenith of the art of hi-fi design in this country twenty to forty years ago.

In this VHS video, you get a close look at the interiors, clearly showing the construction quality that gave American-built hi-fi products such commanding world respect during that era.

There is a soundtrack that contains music, but no narration. Information is conveyed on separate title screens. The makers felt that they didn't want the human voice to interfere with the "visual feast" of what is being seen. If we could only convince *M-TV* of this weird concept, we might silence all of the screaming while simultaneously getting the first opportunity to figure out the lyrics by reading them on title screens. In this particular tape, however, we think a voice-over narration would have been more informative and interesting than the read-along panels.

Glass Airwaves can be obtained in some stereo shops, and can also be ordered at \$29 from Corax Productions, 8635 W. Sahara Ave., Suite 534, Las Vegas, NV 89117.

Radio New York International is a new VHS format documentary produced by the RNI staff. Running about an hour and a quarter, the tape is a revealing compilation of material relating to the famous (or infamous, if you prefer) floating offshore broadcasting station located aboard the good ship *Sarah*. Two brief broadcasting stints in 1986 and 1987 got RNI dubbed as a "pirate" station and raided by the FCC.

There are tours of the ship, with heavy emphasis on the RNI equipment used to transmit on mediumwave, shortwave, FM, and even longwave. The tours are personally conducted by RNI's Al Weiner. You'll see a compilation of many clips of local and national TV news stories about the station, including interviews with and statements by the RNI staff and the FCC.

Then there's an incredible video taken by the FCC itself when they raided the station in 1987. Al Weiner was able to obtain a copy from the government only through the Freedom of Information Act, although he claims that they cut out certain parts before

turning it over to him. Still, what they released made me think the raid was a complete fiasco, black eye for the U.S. Coast Guard, and an eerie page in the FCC's history. The scenes of the raid and a few of the federal agents jokingly posing for their own video cameras during the raid were beyond belief and leave the viewer to come to some personal conclusions about many aspects of the raid and the way it was handled.

There are several other parts of the video, too, like the *Sarah* passing beneath bridges while enroute from Boston to New York. The ship's 104-ft. transmitting tower didn't look like it was going to clear those bridges without getting clipped. Shots taken of the *Sarah* when the sea was angry make it clear that she wasn't on a pleasure cruise.

Of course, the rusty, old, *Sarah* isn't quite *The Love Boat* by any stretch of the imagination. And, this video, itself, is also little rough when compared to a slick professional studio production. Yet, it is no less than an engrossing, compelling, and totally fascinating first-hand view of as curious an incident in American broadcasting history as has come along in a very long time.

The video of *Radio New York International* is available at \$29.95 from RNI, Monticello, ME 04760.

Big Topic, Big Book

The Encyclopedia of American Intelligence and Espionage, by G. J. A. O'Toole, is a gigantic 539-page book containing more than 700 entries telling of virtually every facet of its topic between the 18th Century and the present.

It's got coverage of the people, organizations, and incidents that have made history in (and behind) the headlines. For instance, the listing for Radio Free Europe gives its history, links to the intelligence community,

as well as the names of the movers and shakers who got RFE started and made it work. The RFE story was well-told and, from what I had already known about the station, appears to be both on the level and rather complete in its telling of the basics. Naturally, the entire RFE story would fill a couple of books.

There are entries relating to communications intelligence during the Civil War, to code breaking, to wiretapping, the NSA, and many other topics far too numerous to list here. There are also about 150 illustrations in this large (8-1/2 by 11 inch) hard-cover book.

We found it to be a well-researched and excellently prepared one-volume reference source on the subject of intelligence and espionage under the aegis of Uncle Sam.

The Encyclopedia of American Intelligence and Espionage is a \$50 book. It's from Facts on File, 460 Park Ave. South, New York, NY 10016. It may be available from many bookstores.

Calling All Adventurers, Armchair and Otherwise

Who among us hasn't dreamed of what it would be like to get in on the ground floor of a new country, just in time to open up that broadcasting station and give out radio licenses to all of our friends? Issue stamps, coins, currency? Read my lips— it can be done! The mouse does roar.

You may not realize it, but new mini and micro nations are constantly being formed with varying degrees of success. It's an unusual approach to adding new countries to the DXCC rolls, and you'll be surprised to learn that there are places for DX'peditions that would cause veteran DX hounds to foam at the mouth, if only someone would get the ARRL to add them to the glory roll.

The 2nd Edition of Erwin Strauss' book *How To Start Your Own Country* is an illustrated 174-page book that tells everything you'd want to know (why, where, how, etc.) about (recent) past and present micro or mini nations, and how you can get one going.

Contents include case histories of dozens of successful (and failed) "new country" projects, most of them since 1960. You'll get their case histories, and what went right or wrong. The true inside stories of actual, exotic little-known micro nations like Sealand, Oceanus, Hutt River Province, Spratly, Minerva, the Free Territory of Ely-Chaitlin, and many similar apparent sovereign states. These are histories and personalities you won't find in very many other serious reference sources.

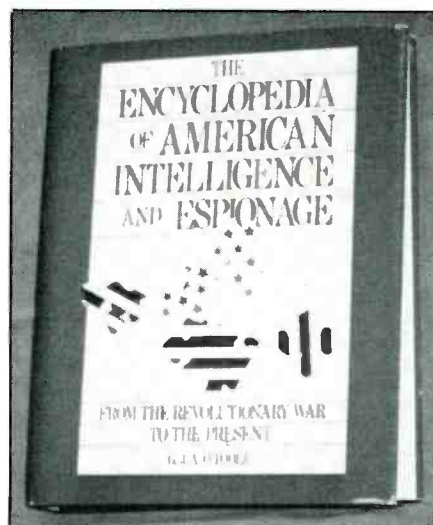

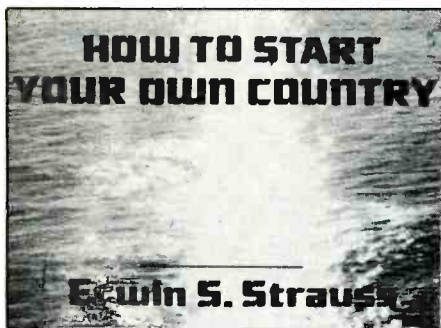

The book provides five workable approaches to starting a new nation, and tells about the single greatest obstacle facing a new country. That obstacle is obtaining sovereignty, although he offers three alternatives. He discusses diplomacy and national defense problems, internal organization, raising funds, recruitment of settlers, dealing with world superpowers, advantages (and disadvantages) of new nations. In fact, the author thinks that this may be a rather opportune time in world history to start up your own mini nation.

Illustrated with dozens of rare photos of these nations, their flags, coins, paper money, crests, passports, official documents, and maps, *How To Start Your Own Country* is the stuff from which dreams are made. That it's all true, makes it quite amazing. This is a "must have" book for every geography buff, DX chaser, and trivia maven.

There's a lengthy access chapter with names and addresses of current "new countries," as well as recommended information sources such as organizations and publications for the person interested in keeping abreast of any new nations that are on the horizon. We were pleased to see that *Popular Communications* was specifically mentioned and recommended.

How To Start Your Own Country is \$8.95, plus \$1 postage, from CRB Research Books, Inc., P.O. Box 56, Commack, NY 11725. Residents of New York State, add 68 cents sales tax.

But Will The Programs Improve?

You may not realize it, but there are about fifteen different companies (worldwide) toiling away to perfect a new technology that will cause a megabuck revolution in every TV-related field from broadcasting equipment to receiver sales and servicing. It will mean a revision of most of the rules that have been in effect for more than fifty years.

That new technology is High Definition Television (HDTV), a method of transmitting flawless audio, plus a crystal clear video

image that will be more breathtaking than the difference between black/white TV and the existing color TV technology. A demo that I saw recently of one of the HDTV systems being developed was so realistic that it almost looked like it was in 3-D.

Still, there are no free lunches. Unless most of the developing systems are willing to compromise some of their inherent quality by narrowing down their bandwidth requirements, HDTV systems are going to be very frequency hungry. Wondering where HDTV frequencies are going to come from has made many frequency users nervous. This is only one of many questions being raised as this new giant looms just ahead. Soon, each of the various HDTV systems will be banging on the FCC's door and demanding that it be selected as the national standard, and that it be allocated spectrum.

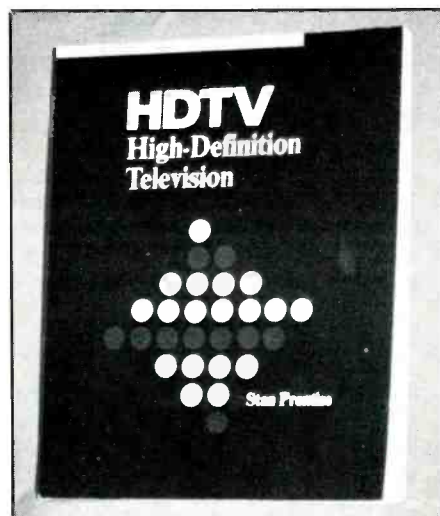

Questions will arise about compatibility with existing TV receivers and VCR's. Others will surely complain that the quality of programming is so banal that HDTV isn't going to make it any better and is, therefore, merely a waste of spectrum. Will existing TV sets be able to be upgraded to pick up HDTV?

In the 232-page illustrated book *HDTV*, by Stan Prentiss, you get an up-to-date and in-depth look at the various systems being developed, along with their advantages and disadvantages. Prentiss explains industry standards around the world that are thwarting HDTV, plus FCC and congressional hurdles in the USA. You'll learn about alternatives being proposed for HDTV, and about many of the problems that will have to be faced before any HDTV system can be fully implemented and successful. I mean, let's face it, your local TV repair shop is going to have to shell out big money for fancy new equipment, and the service tech is go-

ing to have to go back to school, in order to fix your HDTV receiver. This book is well-done and recommended.

HDTV, by Stan Prentiss, is a \$16.95 book (No. 3272) from TAB Books, Blue Ridge Summit, PA 17294-0850.

In Addition . . .

We received a well-done 16-page publication called the *Toronto Scanner Directory*, by Phillip Boucher. It's basically a computer printout listed by location, cross-listed according to frequency. It covers mainly public service frequencies in and around the metro Toronto (Ontario) area. Information regarding usage for each listing is also provided, which adds a dimension of usefulness to the directory. Some worthwhile explanatory text is also provided. We think Phillip did quite a fine job.

The *Toronto Scanner Directory* is \$ 6, by check or money order within Canada. Americans are requested to send money orders. Order it from Joe Skyfoot Word and Music Creations, 245 Lakeshore Drive, #303, Etobicoke, Ontario, Canada M8V 2A8.

Jo Gunn Enterprises

- CB Antennas
- Mobile Antennas

- 10 Meter Antennas
- Coax

Local - Groundwave - DX
Combination Antenna
JG-4 STAR



UPS SHIPPABLE



Specifications:
Type: Horz. & Vert.
Polarization Twin Feed
Gain: 15.5 DB
Front to Back Ratio: 45 DB True
Side Rejection: 45-50 DB True
Back Rejection: 45 DB True
Weight: 34 Pounds
Length: 12 Feet
SWR: 1.1
Horz. to Vert. Separation: 20-25 DB
Wind Survival: 100 MPH
Power Multiplication: 50X
Audio Gain: 20 DB
Wind Load: 3.7

JGAR - HILLBILLY



UPS SHIPPABLE

Specifications:
(Frequency Range 26,000-29,500)
Gain: Horizontal - 5.25 DB
Vertical - 4.75 DB
Multiplication Factors:
Horizontal - 17 Times
Vertical - 15 Times
Horz. to Vert. Separation: 20-25 DB
Power Rating: 2000 CW, 4000 PEP
Height: 11 Feet
Weight: 10 Pounds
Materials: Anodized 6063 T-6 Aircraft Aluminum Tubing
Requires 2 Separate Coaxial Cables for Hook-up

Call or send \$2.00 for Complete Catalog and Pricing of Antennas.



Route 1 - Box 32C, Hwy. 82
Ethelsville, AL 35461
(205) 658-2229
Hours: 10 am - 6 pm (CST)
Monday - Friday

DEALER INQUIRIES, PLEASE CALL

The GRE America Super Amplifier

Handheld scanners don't always produce the same reception results as desk-top (base station) models. Base stations often use a gain antenna mounted on a roof, thus giving them an advantage over handheld scanners in pulling in those weaker signals from mobile stations, handheld transceivers, and even distant or low power base stations. A handheld scanner is usually operated with its antenna at ground level, and no matter how good that antenna might be, it can't hope to match the performance of a roof-mounted antenna designed to provide signal gain.

Enter on the scene the Super Amplifier, a handy and compact aid specifically designed for enhancing the performance (signal pickup) of handheld scanners. The Super Amplifier is the same physical size as GRE America's popular Super Converter II, which is about equal to two or three rolls of mints. It doesn't require any internal connections, tools, or technical knowledge to add it to a handheld scanner. It hooks up in seconds to all handheld scanning receivers having a BNC type antenna connector. You simply plug in the Super Amplifier between the handheld scanner's antenna and antenna connector. That's all there is to the hookup!

It requires a 9 volt battery (not included) to operate. Well, that installation calls for a small screwdriver. Battery life is 24-hours of continuous operation. Or, if you're operating from one fixed location, you can use your own 9 VDC power adapter. A switch on the Super Amplifier lets you turn it on when it's needed, and shut it off when it's not. With the unit switched off, signals are bypassed through the Super Amplifier and the scanner returns to normal operation with no measurable signal loss.

When the Super Amplifier is switched on, a red LED lights and the unit goes to work boosting the level of all incoming signals between 100 MHz and 1,000 MHz (1 GHz). How much it boosts signals is up to you, since there's a small control knob on the Super Amplifier that allows adjustment of the amplification level. This knob allows for varying the gain from 0 to 20 dB, so that it can be precision tuned for best reception of a specific frequency or signal.

Note that each 3 dB of gain offers an approximate doubling of signal power. A transmitter putting out 3.5 watts, when boosted with 3 dB of amplification, will be

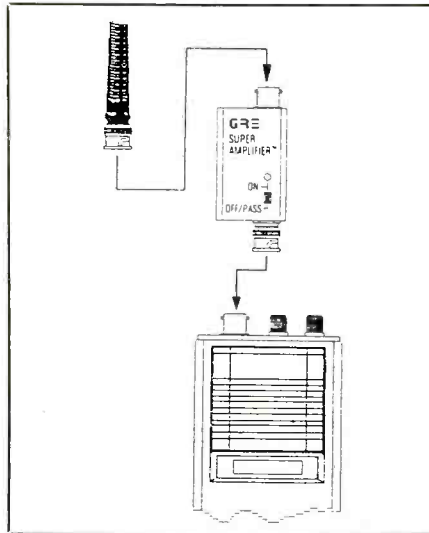

The installation only requires inserting the Super Amplifier between the scanner and its existing antenna. It's intended for use with scanners having BNC-type antenna connectors.

received as if it were a 7 watt transmitter (OK, 6.97 watts if you want to split hairs). If the amplification is cranked up to 8 dB, it will come in as if it were a 22 watt transmitter. An amplification factor of 10 dB makes it come in as if it were a 35 watt transmitter. So, even if your handheld has (as they say) *bad ears*, amplification of weaker incoming signals should offer definite help in what you're picking up.

Of course, signal boosting is something that can be overdone at times. If you use a cup to pour water into a narrow-necked bottle, you accomplish less by trying to fill the bottle with a bucket. The neck of the bottle can't handle all that's being thrust at it, and it becomes overloaded; water goes all over the place. Similarly, signals that are strong enough to be received well without amplification usually don't need or want this type of help, which is why the Super Amplifier has a gain control and, ultimately, a switch that shuts it off. Too much amplification of a particular signal or band can cause a scanner to overload. This results in reception of spurious (out of band) signals, noises, and other phenomena that are as annoying as they are counterproductive to monitoring.

The 20 dB maximum gain that the Super Amplifier offers is a lot of amplification, so

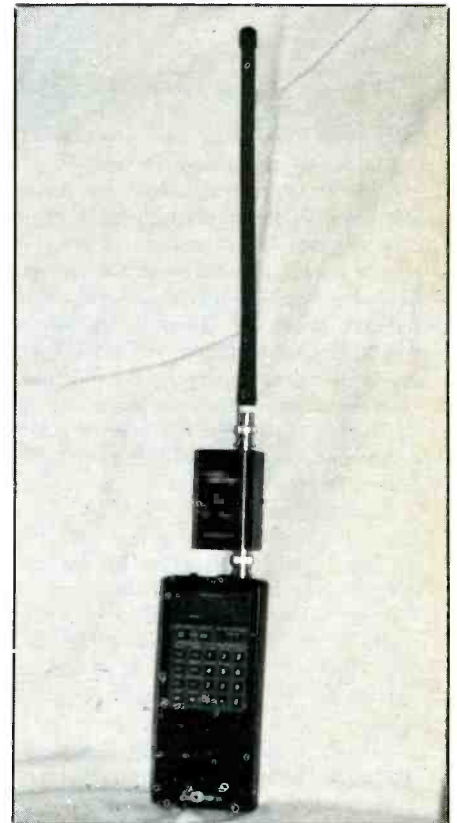

A Super Amplifier is small, so it doesn't take away from the compactness of a handheld scanner.

chances are, it probably won't be necessary to run it full blast (at maximum gain) on your handheld. We found that, in normal operation below 174 MHz, we needed to turn on the Super Amplifier only when reception was poor, or else when we couldn't hear anything on frequencies we knew to be active. Most of the time, we only had to run the gain control up to about a quarter to half way.

Reception above 406 MHz (and especially in the 800 MHz band) was significantly improved on our handheld with the Super Amplifier in constant operation, although we liked the gain adjusted a little higher in the UHF bands than during operation below 174 MHz.

Although the Super Amplifier was primarily designed for use with a handheld scanner, we wanted to see what it might do when hooked up to a base station operating

at a disadvantage. So, we tried the Super Amplifier on a desktop scanner using an indoor-mounted magnetic cellular (800 MHz band) mobile antenna. We found that the Super Amplifier in continuous operation at that installation provided improved local reception in the 150 to 174 MHz band, good reception in the 406 to 512 MHz band, and offered excellent reception in the 800 MHz band. No signal overload was noted in this test, and the Super Amplifier was exceptionally quiet.

This is a simple and easy-to-use accessory for handheld scanners. It's quite a hot little amplifier that, when used properly, worked well and permitted reception of signals that would have otherwise been missed. As such, it is a recommended and welcome aid to the convenience, enjoyment and excitement of monitoring with a handheld scanning receiver. We have a friend who does professional electronics surveillance and security work. He advises that the Super Amplifier has made his handheld a lot more useful in the various applications he has for a portable scanner.

The Super Amplifier comes with instructions, also a 120-day limited warranty from the factory against defects. It is sold nationally over the counter and by mail order through dealers carrying GRE America products. The MSRP is \$59.95. The manufacturer is GRE America, Inc., 425 Harbor Blvd., Belmont, CA 94002.

Reviewed by Rick Maslau, KNY2GL

NEW PRODUCTS

REVIEW OF NEW AND INTERESTING PRODUCTS



Message Recorder

Digitech Concepts announces its DR-3 Digital Message recorder/announcer. It's a fully digital voice recorder that instantly plays back or cancels any message loaded into three different memory storage areas. It can also automatically key your transmitter. Auxiliary outputs are provided for recording from your radio, tape machine, or other device. It is versatile and can be used in many different ways by SWL's, scanner users, CB'ers, hams, and commercial stations.

Other features include a speaker (with volume control), mike mute during playback, four user-selectable record times, auto message repeat with variable delay time, and separate output level adjust to match the DR-3 to your transmitter. This is factory assembled and tested.

The MSRP is \$159.95. For more information, contact Digitech Concepts, 200 West Main, Roberts, WI 54023, or circle 101 on our Readers' Service.



Strong Signals From Desktop Worldband Antenna

Greatly improved short-wave signals from an indoor antenna are now possible with the ANTENNA PLUS-2, announced today by Electron Processing, Inc. Using just a 20-foot piece of wire (supplied), the ANTENNA PLUS-2 brings in signals like much larger antennas. Reception is "peaked" for short-wave frequencies and is further enhanced by a special filter that eliminates interference caused by local FM/TV/VHF/UHF transmitters. Strong signals are assured by the unit's 15-22 dB internal amplifier. Receivers 0.3-30 MHz (10-1000 meter bands).

Quick and easy to install with adapting cables available for most receivers (not included). Compact size, rugged construction, and unobtrusive styling allow this antenna to bring in the most distant station without creating an eyesore.

The ANTENNA PLUS-2 is available with

choices of BNC, Phono, SO239 (UHF), and F connectors for connection to virtually any type of receiver. The antenna is powered by standard 115 VAC. A version with a built-in antenna splitter and second output jack are also available.

Pricing starts at \$89.95 for the standard model and \$109.95 for the dual output model with quantity discounts available. For a limited time we are offering a special introductory price of \$79.95 for the standard model. For additional information, contact Electron Processing, Inc. at PO Box 68, Cedar, MI 49621, call (616) 228-7020, or circle 102 on our Readers' Service.



Slimline Phone With Cellular Styling

Soundesign introduced a slimline phone with cellular styling. The two-piece telephone lends a hi-tech look to any home or office.

Attractively styled and ergonomically designed, Model 7345 is characterized by a combination of high performance and affordability. It features a lighted, 12-digit rubber keypad located on top of the handset for convenient dialing, day or night. An adjustable electronic ringer lets you raise or lower the ring volume, and both the keypad and LED visually signal incoming calls. Suggested retail for Model 7345 is \$39.95.

The handset has a fourteen-number memory, including four one-touch memory numbers, each with a 16-digit storage capacity. Other handy time savers include automatic last numbered redial with push button redial key. A push button voice volume control switch makes hearing easier in noisy rooms.

The new phone from Soundesign boasts a non-mar matte finish. Its table or wall mountable design makes it ideal for bedroom, kitchen or home office environments. Available in ivory or black, Model 7345 is hearing aid compatible and tone/pulse switchable.

The new slimline phone with cellular styling has been tested by GTE for durability to environmental stresses and design quality. Backed by a one-year limited warranty, the phone is FCC registered. It measures 2 3/4 inches wide by 3 inches high by 9 1/4 inches deep and is available for delivery today.

For more information, contact Soundesign, 400 Plaza Two, Jersey City, NJ 07311-3962.

YOU AIN'T HEARD NOTHIN...YET!

Since 1967, CRB Research has been the world's leading publisher and supplier of unique hobby and professional books and information including:

- Scanner Frequency Guides
- Shortwave Frequency Guides
- Military/Federal Communications
- Broadcast Station Registries
- Undercover Communications
- Survival Communications
- Covert Operations
- Electronic Espionage
- Surveillance
- Monitoring
- Cryptography & Codes
- Bugging
- Wiretapping
- Communications Antennas
- Electronics & Projects
- Computer Technology
- & Other Related Topics!

Ask For Big Free Catalog!

CRB RESEARCH

P.O. Box 56 Commack, NY 11725

CIRCLE 60 ON READER SERVICE CARD
THE MONITORING MAGAZINE

Scanning Tricks Of The Trade

Receive Scanner Signals Where No Signal Has Gone Before, Passive Repeaters, Radiating Coax, And Other Exotic Devices

BY PATRICK M. GRIFFITH

Over the years I have seen and used some unusual techniques both professionally and in my scanning hobby to receive signals in 'impossible' locations.

Some of these techniques may be so simple or obvious that they are frequently overlooked. Others are little known outside of the professional communications industry.

Three of these "tricks of the trade" are of particular interest to the scanner hobbyist. They are the passive repeater, radiating coax, and the passive reflector. In addition to being generally inexpensive, all of these are rather easy to construct and use once their theory is understood. These techniques and devices can be used separately,

or in combination, to bring you signals you were never able to hear before.

The Passive Repeater

The passive repeater is a system that, as the name implies, repeats a signal from one location to another without the use of active electronic devices. In it's simplest form the

This pole mounted VHF antenna located at the west portal of the Moffat Railroad Tunnel at Winter Park, Colorado allows trains within the tunnel to communicate with other radios outside the tunnel by acting as a passive repeater.

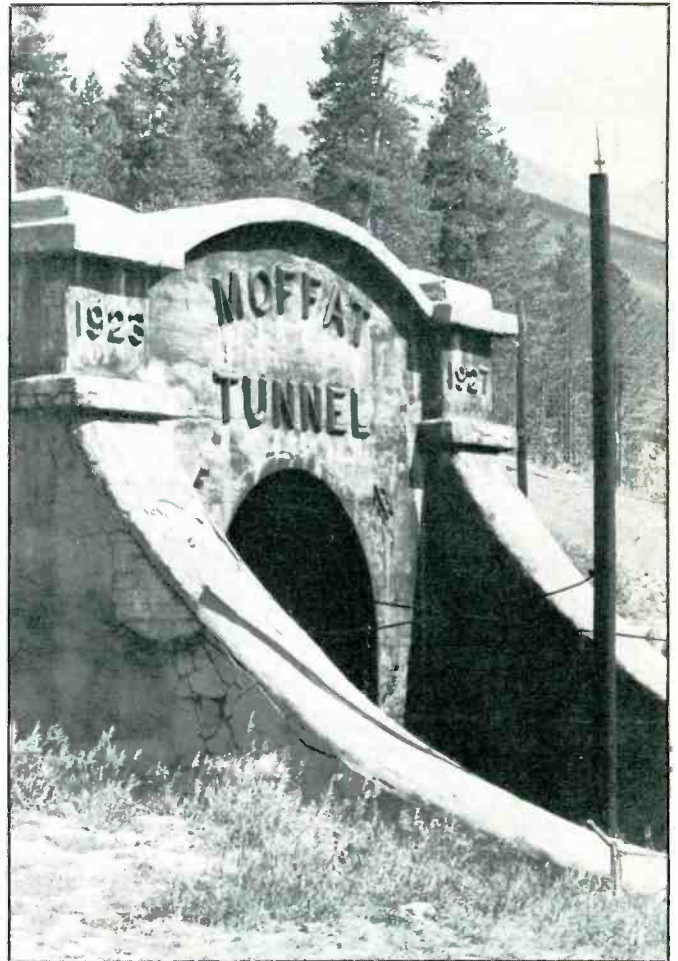
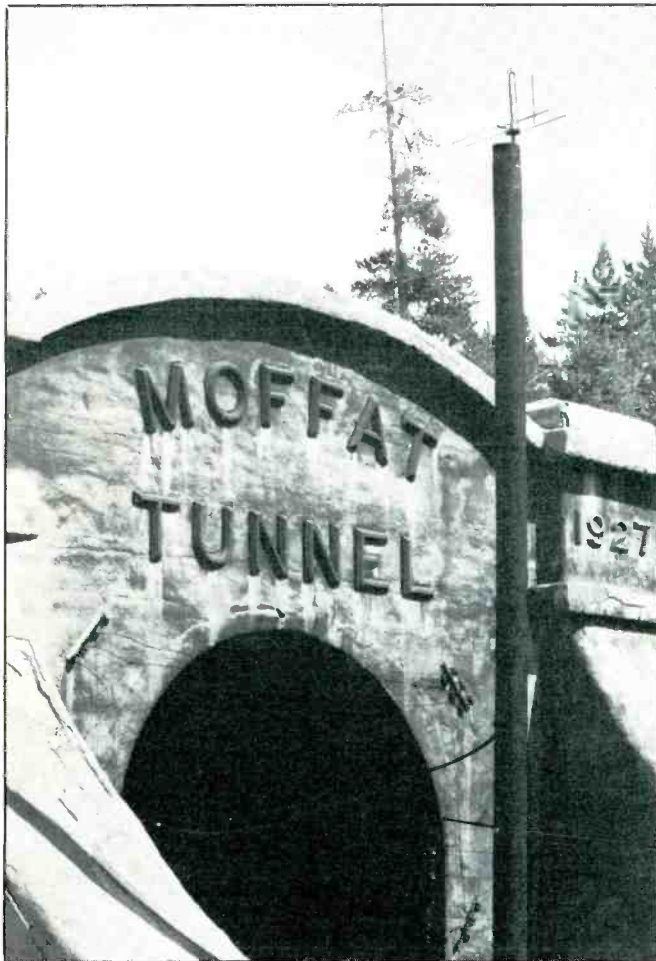

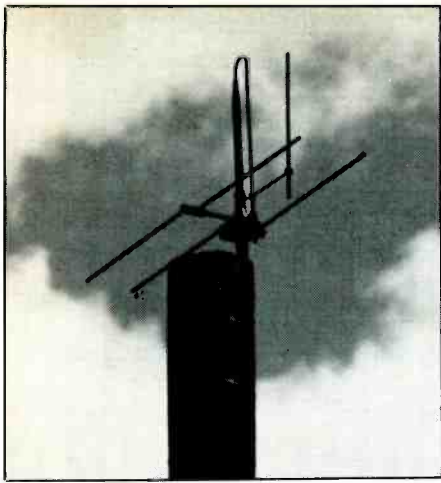

Close-up view of the antenna shown in photos 1A and 1B.

passive repeater consists of three main sections: the primary antenna, the coaxial cable, and the secondary antenna.

The primary antenna is placed in a location where good signal strength is available at the desired operating frequency. This antenna might be omnidirectional or it might

be directional and aimed at a distant city or transmitter site.

The secondary antenna is placed in the location where the signal is needed such as a house or business. The two antennas are then connected together by low loss coaxial cable.

This type system is useful in a situation such as a house that's covered with metal siding in that the secondary antenna will radiate within the house all signals picked up by the primary antenna outside. Of course, the signal will suffer some loss from the coax cable so extremely low loss cable should be used. This system is also bi-directional meaning that it will work in reverse to radiate signals out of building as well (see Diagram 1)

This system is often used professionally to allow radio communications into and out of tunnels, buildings, subways, mines, and so on that would normally be inaccessible to normal radio systems.

Radiating Coax

A variation of this system uses "radiating coax." Radiating coax is coaxial cable that has most of the electrical properties of regu-

lar coax cable, but is designed to "lose" some of the signal along its length. In effect, the coax cable becomes a long antenna.

This can be useful where the signal must be brought into long spans of area such as a barn, a subway, a building, or throughout a house. This system is essentially similar to the passive repeater with the section of coax within the area where the signal is needed being replaced with a length of radiating coax. In order to maintain proper impedance on the coax cable, the interior end must be terminated in either a secondary antenna or a 50 ohm resistor between the center and outer conductors. In such a system, the signal would be radiated all along the length of the radiating coax, rather than in one spot.

In both of these systems you will get the best results if the antenna are tuned to the frequency or band of interest. However, you will find that these systems are basically very broadband and will deliver signals in many frequency bands simultaneously.

You may also want to experiment with electronics such as wideband amplifiers in the line between the antenna. Commercially made amplifiers such as those designed to increase television or scanner signals work

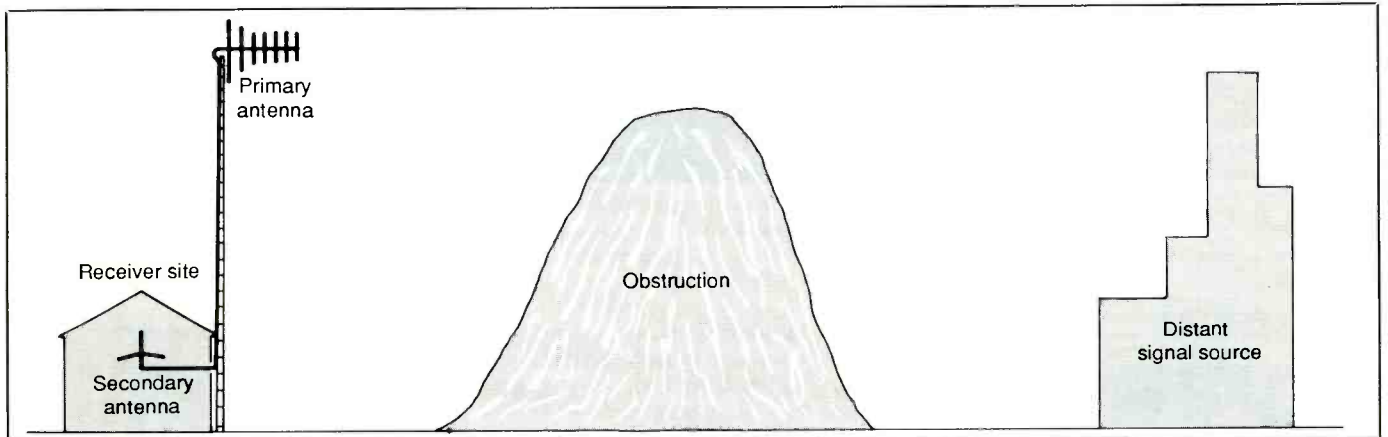
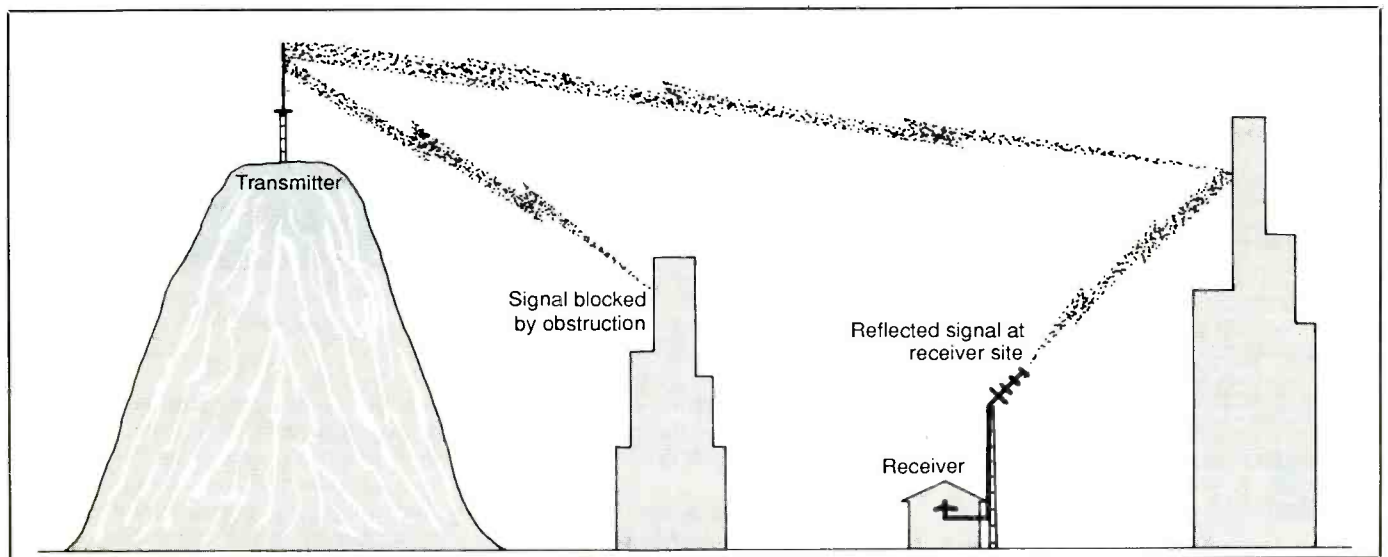

Diagram 1. ▲

Diagram 2. ▼



SUPERCHARGE YOUR RECEIVER!



ANTENNA PLUS

Finally hear those rare stations you've been reading about! Make your receiver spring to life! Big antenna performance from a tabletop box. Models for ALL BANDS, SCANNER or SHORTWAVE. Brings in the weakest signals with an internal amplifier! Choice of BNC, UHF, PHONO, F connectors. (please specify)
 ANTENNA PLUS-1 0.5-1300MHz "All Bands" (for wide coverage receive)
 ANTENNA PLUS-2 0.5-30MHz "Short Wave" (peaked for SWL's)
 ANTENNA PLUS-3 30-200MHz "Scanner" (peaked for VHF-UHF)
SPECIAL INTRODUCTORY PRICE \$79.95! (reg \$89.95)

SUPER VAK-TENNA Only \$149.⁹⁵



Pull in the weak ones with this amplified SHORT-WAVE and SCANNER antenna. Compact and easy to mount with a 15-22DB amplifier built in. Mounts with SUCTION CUPS! Receives 0.5-800MHz like a large outdoor antenna. Also available, MAST MOUNTED version SUPER-VAK-TENNA-MM \$149.95!

Only \$34.⁹⁵

SUCTION CUP MOUNT VAK-TENNA!

IDEAL FOR APARTMENTS, OFFICES OR RV'S
 Mount to your window for the BEST SCANNER coverage! Cups hold for months! Great reception in apartments. Landlords love it! Telescopes to 79" folds to 12". 30-500MHz Choice of BNC, PL259, F or Motorola connector. (specify when ordering)

TAPE SAVER

TS-1 \$59.95

Eliminates dead time on your scanner tapes! Listen to an entire nights scanning while driving to work! Interfaces scanner to your tape recorder for ACTION ONLY recording.



SIGNAL INTENSIFIERS

Make your antenna come to life!

RFP-40 1-1300 MHz! 15 DB GAIN! \$69.95



STRONGER SIGNALS for scanners, shortwave, AM-FM-TV, cable and more. 115VAC pwr. Choice of BNC, SO239 (PL259 mate) and F connectors. Battery or DC powered, remote mounted versions available. Some priced from \$34.95!

CB INTENSIFIER

Only \$49.⁹⁵

Improve your CB's range! The RFTK boosts received signals by 13db! Internal T/R relay. 12VDC pwr. (AC pwr add \$10)



SSB Version \$64.95

MARINE-VHF version \$99.95

INTERFERENCE FILTERS & ACCESSORIES

SCANNER FILTER HPF-1 (passes above 45 MHz) \$8.95, SHORT-WAVE FILTER LPF-1 (passes below 50 MHz) \$19.95, ANTENNA SWITCH AS-3 3 position \$14.95, VARIABLE ATTENUATOR VA-20 \$12.95

SEND FOR FREE SPECIFICATIONS!

NEW SCANNER ANTENNA!

Scanner Stick rugged outdoor antenna. Intro Price \$29.95! Covers 30-1000MHz. 35" long and fully assembled. SO239/UHF Conn.

Continous US shipping/handling \$4. AK, HI, PR, Canada \$7
 NY and MI residents add local sales tax.



ELECTRON PROCESSING, INC.
 P.O. BOX 68
 CEDAR, MI 49621
 616-228-7020

SATISFACTION GUARANTEED!

Offer any product (except software) from EPI and if not satisfied return it within 15 days for a full refund (less shipping/handling)

CIRCLE 62 ON READER SERVICE CARD

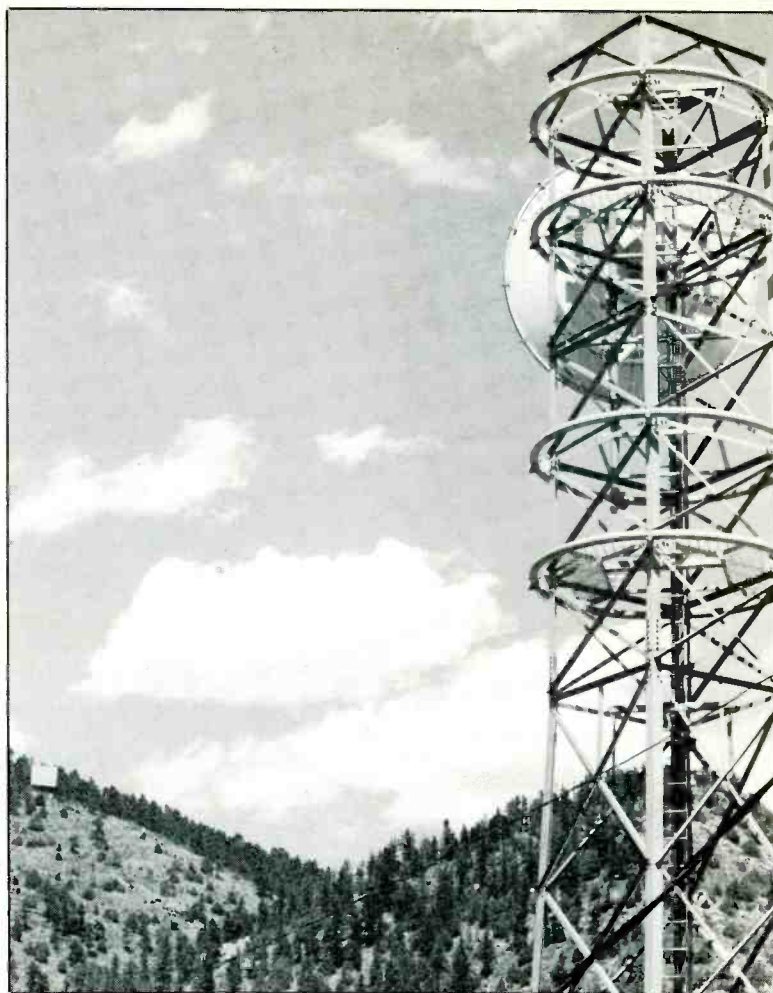

This telephone company microwave link located in Idaho Springs, Colorado used a "billboard" style passive reflector to bounce signals in and out of a valley. (note the reflector on the hillside to the lower left of the dish).

very well to these applications. If you roll your own amp, you must be careful not to reradiate too much signal or you may get a visit from the FCC checking to see why you are operating an illegal transmitter that is re-broadcasting nearly every frequency known to man.

Passive Reflector

Another type of operation that may improve your reception is the use of "passive reflectors." A passive reflector can be anything from a billboard sign to a hi-rise office building. Passive reflectors are commonly used in the microwave bands where radio signals behave much like light beams, but also work reasonably well in the VHF and UHF frequency bands.

I have found that in some cases I can receive a signal better by using a directional antenna aimed away from the transmitter and receiving a reflection of the signal (see diagram 2). Photo 2 shows a professional passive reflector in use at a telephone company installation.

While you might, at first, be skeptical of the capabilities of such unusual devices, keep in mind that all of these techniques



Closeup view of the "billboard" style reflector shown in photo 3.

have been used by the pros for many years to solve their unusual reception problems. Don't be afraid to experiment. And remember, just a few years ago, even the experts scoffed at the idea of glass mount antennas. Now they are in use everywhere. Sometimes the unusual method is the best. **PC**

November Book Buys



ANTENNAS

BEVERAGE ANTENNA HANDBOOK by Victor Mizek, W1WCR

Mizek delves deep into the secrets of the single wire Beverage and SWA (Steerable Wave Antenna) with helpful hints and tips on how to maximize performance based upon wire size, height above ground, overall length and impedance matching. Transformer design information for both termination and feedline matching is completely revised. ©1987 80 pages 2nd Edition.

Softbound \$14.95

VM-BAH

YAGI ANTENNA DESIGN by Dr. James Lawson, W2PV

W2PV was known world-wide as one of the most knowledgeable experts on antenna design and optimization. Loop antennas, The effects of ground, Stacking, Practical design and Practical Amateur Yagi antennas. Every Ham should get a copy for their bookshelf. ©1986 1st edition.

Hardbound \$14.95

AR-YD

THE AMATEUR RADIO VERTICAL HANDBOOK by Cpt. Paul H. Lee, USN (Ret.), N6PL

Based upon the author's years of work with a number of different vertical antenna designs, you'll get plenty of theory and design information along with a number of practical construction ideas. Included are designs for simple 1/4 and 5/8-wave antennas, as well as broadband and multi-element directional antennas. ©1984, 2nd edition.

Softbound \$9.95

CQ-VAH

W1FB's ANTENNA NOTEBOOK by Doug DeMaw, W1FB

Antennas have been one of DeMaw's passions in Amateur Radio. He has worked with countless designs of all shapes and configurations. This fully illustrated book give you how-to instructions on a number of different wire and vertical antennas. Also includes information on radial systems, tuners, balun and impedance transformers. ©1987 120 pages.

Softbound \$7.95

AR-AN

LOW BAND DX'ING by John Devoldere ON4UN 2nd Edition

Based upon years of practical on-the-air experience, learn the secrets of how ON4UN has been so successful on the low bands. Extensive coverage is given to transmit and receive antennas. Dipoles, inverted V's, slopers, phased arrays and Beverages. Also covered: propagation, transmitters, receivers, operating, software and an extensive Low Band bibliography.

Softbound \$9.95

AR-UN

EASY-UP ANTENNAS for Radio Listeners and Hams by Ed Noll W3FQJ

This book covers basic do-it-yourself antennas for SWL's, AM and FM BCB'ers, present and prospective Hams and scanner listeners. Includes dipoles, verticals, beams, long wires, and several special types and configurations. Also has time saving look-up dimension tables, constants and other helpful hints for antenna design. 1st edition 164 pages ©1988.

Softbound \$16.95

22495

NOVICE ANTENNA NOTEBOOK by Doug DeMaw W1FB

Novices have long wondered what is the best all around antenna for them to install. Up until now, this was a difficult question to answer. Aimed at the newly licensed Ham, DeMaw writes for the non-engineer in clear concise language with emphasis on easy-to-build antennas. Readers will learn how antennas operate and what governs performance. Also great reading for all levels of Amateur interest. 1st Edition ©1988.

Softbound \$7.95

AR-NAN

ANTENNAS by John Kraus, W8JK

Kraus' classic antenna book has been extensively revised and up-dated to reflect the latest state-of-the-art in antenna design and theory. Includes over 1,000 illustrations and nearly 600 worked examples and problem solutions. Chapters cover basic concepts, print sources and point source arrays, dipoles, helices, broadband and frequency independent antennas, special applications and tons more of information. 2nd edition 917 pages ©1988.

Hardbound \$59.95

MH-35422

ARRL ANTENNA BOOK by Jerry Hall, K1TD, 15th Edition

The 15th edition of this antenna classic represents over two years of hard work by editor K1TD. It's doubled in size too--from over 300 to over 700 pages big! 950 figures and charts cover just about every subject imaginable. Some of the highlights are: Chapters on Loop antennas, multi-band antennas, low frequency antennas, portable antennas, VHF and UHF systems, coupling the antenna to the transmitter and the antenna, plus p-l-e-n-t-y more. 15th edition 900+ pages ©1988.

Softbound \$17.95

AR-AM

ANTENNA IMPEDANCE MATCHING by ARRL

One of the most comprehensive books ever written on the use of Smith charts in solving impedance matching problems. 224 pages full of helpful information and solutions to tricky matching problems. ©1989.

Hardbound \$14.95

AR-IMP

ARRL ANTENNA COMPENDIUM by ARRL Staff

QST gets far more antenna articles than it can publish. This collection is taken from the best submissions and represents a wide range of subjects -- from quads and loops to general information -- this book has it! ©1985 1st Edition.

Softbound \$9.95

AR-AC

ANTENNA COMPENDIUM Vol. 2

includes MS-DOS program listings

Antennas are the #1 topic of interest among amateurs. ARRL annually receives far more antenna articles than it can use in QST. So, they decided to publish them in THE ANTENNA COMPENDIUM. These never before published articles run the range from simple, easy-to-construct antennas to sophisticated designs. Six program listings are included. You can also get the programs on a MS-DOS disk for an additional charge. ©1989 1st edition 208 pages.

Softbound Book Only \$11.95

Disk Only \$9.95

Book & Disk \$17.95

AR-AC2

FAR-AC2 (MS-DDS)

AR-FAC2 BUY 'EM BOTH SPECIAL

by W6SAI & W2LX

- RP-WA WIRE ANTENNA HANDBOOK - Wire antennas for all installations \$11.95
- RP-CQ ALL ABOUT CUBICAL QUAD ANTENNAS - The "quad" book \$ 9.95
- RP-VA ALL ABOUT VERTICAL ANTENNAS - Everything you want to know \$10.95
- RP-AH THE RADIO AMATEUR ANTENNA HANDBOOK - Complete guide to antennas \$11.95

HAM RADIO BOOKSTORE *Software Orders - Don't forget to tell us which computer you have*
CATALOG #M90
GREENVILLE, NH 03048

Now a division of CQ Communications, Inc.

Orders 603-878-1441

(8 am to 5 pm EDST)

FAX - 24 Hr. Hot Line 603-878-1951

SAVE TIME & MONEY

SHOP BY MAIL

OR CALL TODAY!



1990 EDITIONS

1990 RADIO AMATEUR CALLBOOKS

NORTH AMERICAN EDITION

Fully updated and edited to include all the latest FCC and foreign government call signs and addresses for Hams in North America. Includes plenty of handy operating aids such as time charts, QSL bureau addresses, census information and much more. Calls from snowy Canada to tropical Panama. Now is the time to buy a new Callbook when you'll get the most use out of your investment. ©1989

CB-US90

Softbound \$27.95

INTERNATIONAL EDITION

QSLs are a very important part of our hobby. All sorts of awards, including the coveted DXCC, require confirmation of contact before the award can be issued. Of special interest, addresses are being added daily for Hams in the USSR and other countries. While by no means complete, it's a start and will be of tremendous help in getting QSLs. Handy operating aids round out this super book value. ©1989

CB-F90

Softbound \$29.95

SPECIAL - BUY 'EM BOTH

CB-USF90 Reg. \$57.90 Only \$49.95 SAVE \$7.95

THE 1990 ARRL HANDBOOK

Revised and updated with the latest in Amateur technology, now is the time to order your very own copy of the world famous ARRL HANDBOOK. In addition to being the definitive reference volume for your Ham shack, there are plenty of projects for every interest in Amateur Radio -- from antennas for every application to the latest state-of-the-art projects -- you'll find it all in the 1990 HANDBOOK. Over 1100 pages ©1989.

AR-H890

Hardbound \$22.95



NEW BOOKS



1990-91 ARRL REPEATER DIRECTORY

Bigger and better! Over 14,000 listings including 1400 digipeaters -- every Ham should have a copy of this book in their car or shack. Handy resource book has listings by frequency and location. Invaluable aid while travelling. ©1990.

AR-RD90

Softbound \$9.95

AR-2RD90 (Buy 2 & Save)

\$9.95

MICROWAVE HANDBOOK - Components and Operating Techniques, Vol. 1

edited by M.W. Dixon, G3PFR

The microwave region has experienced an explosion in interest in the last few years. This new RSGB book contains simple and easy-to-understand theory explanations, projects and practical designs that have been tested and de-bugged. Includes: operating techniques, system analysis and propagation, antennas, transmission lines and microwave semiconductors and tubes. Great reference book! ©1989.

RS-MHB

Softbound \$34.95

RADIO AMATEUR CALLBOOK SUPPLEMENT

both NA and DX listings

Includes all the latest calls and address changes for hams around the world. Invaluable aid to getting coveted QSLs from rare DX stations. This is the only way to be fully up-to-date. Over 300 pages ©1990.

CB-SUP90

Softbound \$9.95



NEW SOFTWARE



MFJ EASY-DX Program and Packet interface (MS-DOS computer)

Here's a unique tool that organizes your DXCC quest into a simple easy-to-use format. Enter a call. Easy-DX gives you azimuth and sunrise-sunset time. It also tells you whether or not you need the contact for a new country, band or mode. Packet radio users get a built-in terminal program designed to make the most of Pavillion Software's Packet Cluster™ system or any other packet node. When connected, Easy-DX alerts you when a country you need is spotted. Comes on two 5.25" disks. Hard drive recommended. Latest version will be shipped.

FMFJ-EDX (MS-DDS)

\$39.95

PLEASE ENCLOSE \$3.75 FOR SHIPPING AND HANDLING

World Band Listening With A Portable

Part 2: Tuning Tips And Antenna

World band portable radios are often operated where signal levels are limited; such as, indoors, at ground level, in apartments and in other shielded locations surrounded by buildings or the metallic support system of high-rise apartments and condos. The performance is acceptable. Most do well with their built-in loop and their telescoping rod antenna, especially outdoors, and in areas clear of shielding and interference.

Results can be improved indoors, if need be, with the use of an indoor antenna. If you have space for a simple outdoor antenna, you have it made. However, a long and high gain antenna can mean trouble with some portables because they are overloaded easily by too strong a signal, causing a distorted output or lowering the receivers sensitivity to weaker signals.

This second part of the coverage of world band portables describes a good indoor antenna; how to tune the portable for best results, and some information on accessory items that can aid in improving the reception of very weak stations.

Effective indoor antennas can be made from lengths of audio cable and attached phono plugs, Fig. 1 top. Such cable is flexible, small in diameter, and can be hidden along the baseboard, under carpet, or wherever it is convenient to position the antenna wire. A convenient length for a 31 meter dipole is 24 feet on a leg. You can purchase a made-up 24 foot length of audio cable with a phono plug attached to one end (Radio Shack 42-2450 and other outlets). At the other end of the two-wire cable are two lugs. At this end, slowly separate the two wires of the cable up to the phono plug, Fig. 1, bottom. When you do so, each side forms one 240 foot length of a dipole. Overall length is about 48 feet, Fig. 2.

The phono plug is inserted into the antenna terminal of the Sangean 803A. Be certain to change over the antenna switch at the rear of the receiver from INT to EXT whenever you use an external antenna. Drop the antenna legs to the floor and extend them out in opposite directions along the floor as best you can. It need not be in a straight line, but keep the two ends separated as far as possible.

The antenna does well on 31M which is an advantage because it is used in Europe and countries in other parts of the world to direct English language programs toward North America in the evenings during the

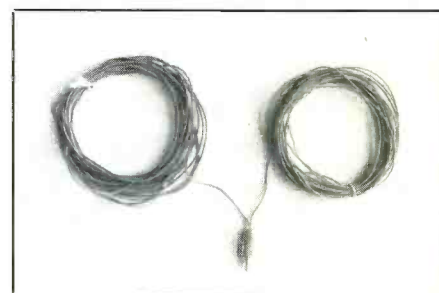
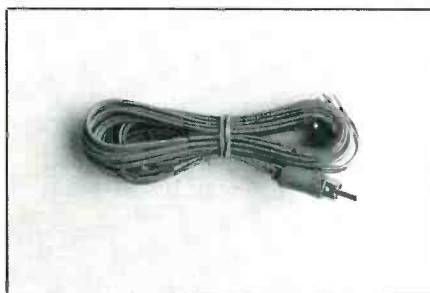

Fig. 1. (A) Length of audio cable (B) converted to 31M indoor dipole

prime-time period of 6 pm to 11 pm. The 31M band is good for these listening hours. Strong prime-time signals are also received on the 25, 41, and 49 meter bands, and can be picked up well with the antenna.

You can use the memory positions as you like. I like to place my most frequently listened to stations in memory and key them in during the evening prime-time. Typically, they would be BBC and Canada because of their many quality programs directed to the USA. During the evening, Canada also relays an English language program from Japan. I have a slot for VOA to listen to some of their programs. I like a number of the Radio Netherlands shows and usually have 6020 set aside for them. Also, Spain on 9630 is a permanent favorite with me. The USSR has several hours of English programming.

The above takes up six of my nine memory positions. Many of the European stations have one-half or one hour English programs such as: Switzerland, Sweden, Austria, West Germany, Czechoslovakia, Hungary, Greece, Romania, etc. These I can store in the three remaining memories according to the programs they carry on a particular evening. Several of the stations are near to each other in frequency and by plugging in the properly chosen memory frequencies you can quickly go from one to the other with the main frequency control. For example, you could choose one memory frequency at the low frequency end of the band, one at band center and the last at the high frequency end of the band. By switching in the proper memory frequency you will be able to tune to a particular frequency at that section of the band when it is necessary. You soon become accustomed to using the memory capability of your portable efficiently. It is a big

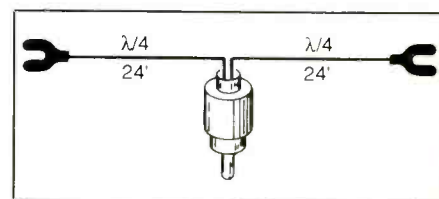

Fig. 2. 31 meter dipole made from audio cable

help in planning an evening of shortwave broadcast listening.

Tuning Tips

There is more to tuning in a shortwave station than just setting the frequency and volume controls. A shortwave listener should strive for the best readability with the least noise and interference. Three adjustments that can improve your listening quality are treble, bass, and RF gain controls along with the wide/narrow band frequency response switch, Fig. 3. Speech clarity is important when listening to news and all types of voice programs. Also, the DX'er, as he attempts to identify a weak signal and obtain the necessary QSL proof-of-reception, must become a tuning expert. The devoted music listener must pay attention to audio frequency response and obtain the best bandwidth he can without objectionable noise at the low and high frequency ends of the audio bandpass. Adjacent channel interference is also a factor in limiting clarity and audio response.

The initial step to take when tuning in a favorite program is to set your portable to the frequency which usually gives you the best signal. However, don't forget the sta-

tion's alternate frequencies. On a given night, or even during the course of the program, one frequency may improve. I often set-up two or three of the station's frequencies in memory, then I can switch among them quickly if interference or fading becomes a problem on the frequency being used.

Clarity and audio response are also influenced greatly by the wideband switch position. Increase your treble response for good listening up to the point where high frequency noise becomes unsatisfactory. Back off to the point of best listening. Do the same with the bass control, especially if you like good bass for music listening. However, low frequency line TV cable noises may be present at times and you will have to back off.

If the wideband setting of the bandwidth switch is not tenable, switch over to narrow. Readjust the treble and bass controls. Clarity can usually be improved by setting the frequency 1000 hertz above or below the assigned station frequency. If the assigned value of the station is 15125, try 15126 and 15124 to find the better one. Readjust the treble control for the most readable listening.

The RF gain control is usually set to maximum. However, when receiving a strong signal you can often make the reproduction more realistic, especially music, by cutting back on the RF gain. The volume control is then set for the most pleasant listening level. Also, don't forget your headset as a way to

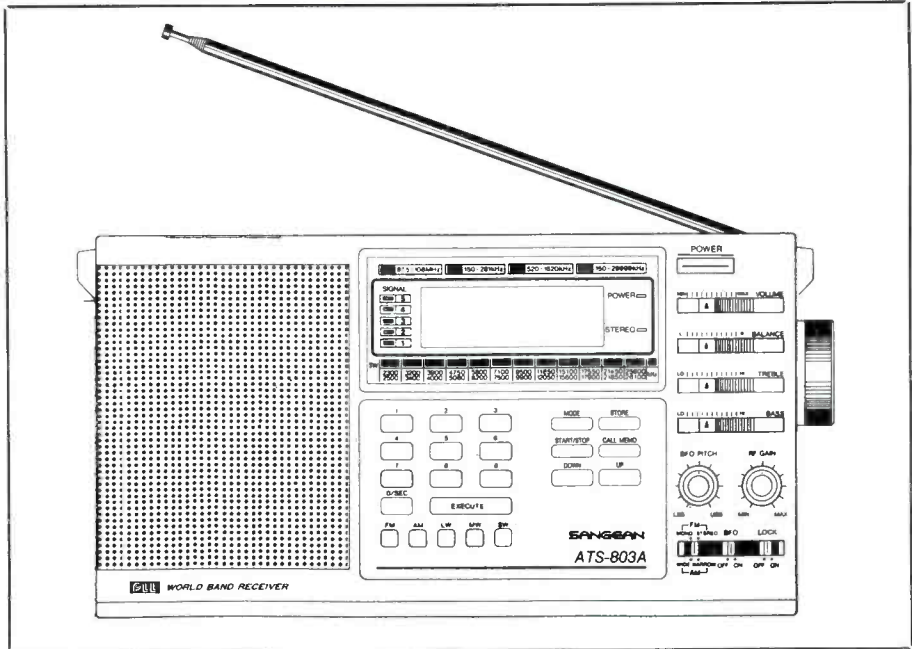

Fig. 3. Front panel plan showing operating controls and switches

listen more intently and better enjoy sound reproduction. You can adjust your volume level to your liking and other members of the family are not disturbed if they are not radio listening fans.

Accessory Items

A typical set-up that can be used in a

poor indoor location to improve performance for the avid world band and AM/FM broadcast listener or DXer can include a tuned pre-amplifier, such as the MFJ-1020A, Fig. 4, which covers a frequency range from 300 kHz to 30 MHz. Be careful you do not overload the portable and harm

(Continued on page 42)

ICOM's Dual Band Handhelds

ICOM's IC-24AT and IC-32AT call you to action with the most feature packed, power packed dual band handhelds available. Whether you prefer the convenience of a mini-handheld or the grasp of a full-size handheld, ICOM has the dual-bander fit for you.

The IC-24AT mini-handheld and the IC-32AT give you full operation on the 2-meter and 440 MHz amateur bands. Outstanding Performance!

POWER PACKED HANDHELDS. The IC-24AT provides up to 5 watts on 2-meters and 440 MHz with a 12V battery while the IC-32AT is 5½ watts on 2-meters and 5 watts on 440 MHz.

PLENTY OF MEMORIES. Store any frequency, Tx offset and subaudible tone in any memory. Total flexibility to meet your needs.

PROGRAMMABLE SCANNING. Both units scan band and memories plus offer easy memory lockout and instant memory recall.

PRIORITY WATCH. Monitor the call channel, a memory channel or all memory channels every five seconds while operating!

ADDITIONAL FEATURES INCLUDE: Battery saver, all subaudible tones, multi-function LCD readout, dial selectability and DTMF



pad for memory channel auto-patching. The compact lightweight IC-24AT also features a 24 hour clock with timer, and an autodialer. Access to multi-digit phone numbers at the touch of a button.

ACCESSORIES: The IC-24AT uses accessories from the "S" Series handhelds while the IC-32AT is compatible with all IC-2AT/02AT accessories. An optional UT-40 beeper silently monitors a busy channel for your calls. When the preprogrammed subaudible tone is received, the unit beeps and the LCD flashes. The dual is over, ICOM's IC-24AT mini-dual bander and IC-32AT full-size dual bander give you maximum performance in the package best suited for your needs. Check your local ICOM dealer for the finest dual banders available today. The ICOM IC-24AT and IC-32AT.

ICOM First in Communications

ICOM America, Inc. 2380-116th Avenue N.E., Bellevue, WA 98004
Customer Service Hotline (206) 454-7619
 3150 Premier Drive, Suite 126, Irving, TX 75063
 1777 Phoenix Parkway, Suite 201, Atlanta, GA 30349
 ICOM Canada, A Division of ICOM America, Inc., 3071 - #5 Road, Unit 9, Richmond, B.C. V6X 2T4 Canada
 All stated specifications subject to change without notice or obligation. All ICOM radios significantly exceed FCC regulations limiting spurious emissions. 24AT/1289.

POP'COMM's World Band Tuning Tips

NOVEMBER, 1990

This Pop'Comm feature is designed to help you hear more shortwave stations. Each month this handy, pull-out guide will show you when and where to tune to hear a wide variety of local and international broadcasters.

Not all of the listings are for transmissions in English, nor are most beamed to North America. Keep in mind that stations make frequent changes in their broadcast times and frequencies. Changes in propagation conditions may also make certain broadcasts difficult or impossible to receive at times. Your own receiving location and equipment also have a bearing on what stations you are able to hear.

All times are UTC.

| Freq. | Station/Country | UTC | Notes | Freq. | Station/Country | UTC | Notes |
|-------|-------------------------------|-------|------------------|-------|----------------------------|---------|------------------|
| 2360 | Radio Maya, Guatemala | 0200 | Maya | 5010 | R. Garoua, Cameroon | 0430 | FF, sign on |
| 2390 | R. Huayacacotla, Mexico | 0100 | SS | 5025 | R. Rebelde, Cuba | eves | SS |
| 2450 | R. Western Highlands, PNG | 1200 | EE/Pidgin | 5047 | RTT, Togo | 0525 | sign on, FF |
| 2485 | ABC Katherine, Australia | 1145 | EE | 5055 | RFO, Fr. Guina | 0830 | FF |
| 3205 | R. Ribeiro Preto, Brazil | 0800 | PP | 5567 | R. Nueva Vida, Colombia | 0145 | SS |
| 3215 | RRI Menado, Indonesia | 1200 | II | 5875 | BBC, England | 0400 | SS |
| 3220 | HCJB, Ecuador | 0200 | Quechua | 5910 | BRT, Belgium | 2215 | |
| 3225 | R. Occidente, Venezuela | 0100 | SS to 0400 close | 5945 | R. Austria Int'l | 2230 | |
| 3240 | TWR Swaziland | 0300 | vernacular | 5950 | VOFC via WFYR | eves | |
| 3245 | R. Gulf, Papua New Guinea | 1200 | EE/pidgin | 5954 | R. Casino, Costa Rica | 1045 | SS |
| 3260 | R. Madang, PNG | 1200 | EE/pidgin | 5955 | Voz de Centauros, Colombia | 0400 | SS |
| 3270 | R. Namibia | 0300 | | 5960 | R. Japan via Canada | 0100 | |
| 3290 | R. Tayabamba, Peru | 0400 | SS | 5975 | BBC via Antigua | 0430 | |
| 3316 | SLBS, Sierra Leone | 0600 | sign on | 5982 | AWR, Guatemala | 0130 | SS |
| 3320 | SABC, S. Africa | 0300 | Afrikaans | 5995 | R. Australia | 0900 | |
| 3325 | R. Liberal, Brazil | 0830 | PP | 6000 | R. Nicaragua | eves | SS/EE |
| 3330 | CHU, Canada | 24hrs | time signals | 6005 | CFCX, Canada | 0800 | |
| 3366 | GBC, Ghana | 0530 | sign on | 6015 | R. Austria Int'l | 0500 | via Canada |
| 3370 | R. Tezulutlan, Guatemala | 0200 | Indian | 6020 | R. Netherlands | 0030 | |
| 3380 | R. Chortis, Guatemala | 0230 | SS | 6035 | Voice of America | 0600 | via Liberia |
| 3395 | R. Zaracay, Ecuador | 0100 | SS | 6060 | RAE, Argentina | 0100 | SS |
| 3400 | R. Ed. 6 de Agosto, Brazil | 0300 | PP | 6075 | Caracol Bogota, Colombia | 0500 | SS |
| 3447 | RRI Pontianak, Indonesia | 1230 | II | 6090 | R. Luxembourg | 2300 | GG |
| 3925 | R. Tanpa, Japan | 0900 | JJ | 6100 | R. Yugoslavia | 2200 | |
| 3927 | Capital R., Transki, S. Af. | 0300 | EE | 6115 | RBI, E. Germany | 0430 | GG |
| 3940 | PBS, Hubel, China | 1130 | CC | 6120 | R. Japan | 1000 | EE via Canada |
| 3960 | R. Liberty, W. Germany | 0530 | RR | 6135 | KUSW, Utah | 1000 | |
| 4000 | R. Bafoussam, Cameroon | 0430 | sign on | 6135 | Swiss R. Int'l | 0130 | |
| 4238 | R. Inca de los Baños, Peru | 0230 | SS | 6140 | ABC, Australia | 0900 | |
| 4330 | V of the Strait, China | 1200 | CC | 6150 | Caracol Neiva, Colombia | 0500 | SS |
| 4485 | Petravplovsk R., USSR | 0200 | RR | 6165 | R. Netherlands | 0030 | |
| 4635 | Dushanbe R., USSR | 0030 | RR | 6174 | R. Twantinsuyo, Peru | 0930 | SS |
| 4719 | RRI Ujung Pandang, Indonesia | 1230 | II | 6180 | Voz de Guatemala | 1000 | SS, irregular |
| 4725 | V of Myanmar, Burma | 1145 | Burmese | 6195 | BBC | 0200 | |
| 4755 | R. Ed. Rural, Brazil | 0830 | PP | 6248 | Vatican Radio | 0500 | Latin |
| 4760 | ELWA, Liberia | 0600 | sign on | 6304 | R. Acari, Peru | 0200 | SS |
| 4770 | R. Nigeria, Kaduna | 0430 | sign on | 6305 | Voz del CID | 0600 | SS |
| 4785 | Baku Radio, USSR | 0200 | RR | 6500 | PBS Qinghai, China | 1200 | |
| 4790 | R. Atlantida, Peru | 0300 | SS | 6540 | R. Pyongyang, N. Korea | 1115 | JJ |
| 4800 | R. Buenos Nuevas, Guatemala | 0230 | Mam | 6570 | Myanmar Defence Forces, | | |
| 4805 | Rdf. Amazonas, Brazil | 0230 | PP | Burma | 1200 | Burmese | |
| 4815 | R. Guatapuri, Colombia | 0400 | SS, irregular | 6790 | CPBC, China | 1130 | |
| 4830 | R. Tachira, Venezuela | eves | SS | 6900 | Turkish Met. Radio | 0500 | TT |
| 4845 | ORTM, Mauritania | 0630 | FF, sign on | 7110 | V of Ethiopia | 0300 | Amharic, sign on |
| 4850 | CRTV, Cameroon | 0430 | FF, sign on | 7115 | R. Moscow | eves | |
| 4870 | ORTB, Benin | 0500 | FF, sign on | 7124 | RTV Guinea, Guinea | 0600 | FF, sign on |
| 4875 | V of Jinling, China | 1200 | CC | 7135 | R. Polonia, Poland | 0130 | Polish |
| 4880 | R. Five, S. Africa | 0300 | EE | 7170 | RFO New Caledonia | 0800 | FF |
| 4890 | R. Centinela del Sur, Ecuador | 0200 | SS | 7215 | R. Yugoslavia | 2330 | |
| 4895 | V de Rio Arauca, Colombia | 0300 | SS | 7230 | R. RSA, S. Africa | 0400 | Afrikaans |
| 4915 | GBC, Ghana | 0600 | EE | 7255 | V of Nigeria | 0500 | EE, sign on |
| 4926 | R. Nacional, Eq. Guinea | 0500 | SS | 7270 | R. Polonia, Poland | 0130 | Polish |
| 4940 | R. Abidjan, Iv. Coast | 0600 | FF, sign on | 7275 | R. Korea, S. Korea | 1100 | |
| 4945 | Caracol Neiva, Colombia | eves | SS | 7300 | R. Tirana, Albania | 0100 | |
| 4980 | Ecos del Torbes, Venezuela | 0330 | SS | 7315 | WRHI, Indiana | eves | |

| Freq. | Station/Country | UTC | Notes | Freq. | Station/Country | UTC | Notes |
|-------|------------------------------|------|--------------------|-------|----------------------------|------|-----------------------|
| 7340 | Voz del CID | 0100 | SS | 11870 | Lao National Radio | 1100 | via USSR |
| 7345 | KNLS, Alaska | 1200 | RR | 11880 | Spanish National Radio | 0000 | EE/SS |
| 7430 | V of Greece | eves | GG/EE | 11885 | R. Five, S. Africa | 0525 | sign on, EE |
| 9022 | VIORI, Iran | 1945 | | 11905 | R. Universo, Brazil | 0900 | PP |
| 9280 | WYFR, Florida | 1215 | CC, via Taiwan | 11910 | R. Budapest, Hungary | 0130 | |
| 9325 | R. Pyongyang, N. Korea | 1300 | | 11920 | R. Abidjan, Iv. Coast | 2230 | FF, irregular |
| 9360 | Spanish National Radio | 0200 | SS | 11930 | Trans World R., Bonaire | 0300 | |
| 9395 | V. of Greece | 0100 | GG/EE | 11955 | R. Canada Int'l | 1300 | |
| 9400 | R. Iran | 0200 | Farsi, clandestine | 11960 | HCJB, Ecuador | 0200 | SS |
| 9410 | BBC | 0200 | | 11965 | V of the UAE | 1600 | AA |
| 9435 | Kol Israel | 0100 | PP/SS | 11980 | AWR, Guam | 1100 | CC/JJ |
| 9445 | V of Turkey | 0200 | TT | 12005 | RTT Tunisia | 2300 | AA |
| 9475 | R. Cairo, Egypt | 0200 | EE | 12025 | R. Ulan Bator, Mongolia | 1200 | EE |
| 9480 | R. Tirana, Albania | 0400 | FF | 12050 | R. Cairo, Egypt | 2200 | AA |
| 9505 | R. Record, Brazil | 1000 | PP | 12085 | R. Damascus, Syria | 2110 | EE |
| 9510 | R. Romania Int'l | 0100 | | 13610 | R. Kuwait | 1900 | EE/AA |
| 9515 | BBC | 1100 | via Canada | 13660 | RFPI, Costa Rica | 1930 | |
| 9530 | KHBI, Salpan | 1400 | | 13720 | AWR, Guam | 1200 | |
| 9535 | RCI, Canada | 0100 | | 13770 | R. Netherlands | 1430 | |
| 9535 | Trans World Radio, Bonaire | 0300 | | 15010 | V of Vietnam | 1130 | |
| 9540 | R. Nacional, Venezuela | 1100 | SS | 15060 | BSKSA, Saudi Arabia | 1800 | AA |
| 9545 | Deutsche Welle, W. Germany | 0300 | | 15084 | VOIRI, Iran | 1700 | Farst |
| 9550 | Radio Havana, Cuba | 0000 | SS | 15090 | Vatican Radio | 1500 | |
| 9555 | La Hora Exacta, Mexico | 1200 | SS | 15100 | R. Beijing, China | 0100 | SS |
| 9560 | R. Jordan | 1400 | | 15105 | R. Yugoslavia | 0000 | EE |
| 9560 | V of Ethiopia | 1500 | | 15115 | HCJB, Ecuador | 1400 | EE |
| 9565 | R. Denmark | 0330 | Danish, via Norway | 15130 | R. Beijing, China | 0000 | via Mali |
| 9565 | R. Universo, Brazil | 0930 | PP | 15130 | R. Peace & Progress, USSR | 1330 | EE |
| 9575 | RAI, Italy | 0100 | | 15140 | R. Nacional, Chile | 1700 | SS |
| 9580 | Africa No. One, Gabon | 2200 | | 15150 | R. Canada Int'l | 2100 | FF/EE |
| 9580 | Radio Australia | 1200 | | 15165 | R. Denmark | 1230 | Danish, via Norway |
| 9590 | R. Netherlands | 0330 | via Bonaire | 15185 | WINB, Pennsylvania | 2100 | |
| 9600 | R. Portugal | 0130 | PP | 15190 | RTVC, Congo | days | FF |
| 9605 | Vatican Radio | 0030 | | 15195 | R. Bangladesh | 1200 | |
| 9610 | R. Peace & Progress, USSR | 2130 | | 15120 | R. Japan | 2200 | JJ via Gabon |
| 9615 | KGEI, California | 0330 | SS | 15220 | R. Budapest, Hungary | 1500 | |
| 9618 | R. Mozambique | 0400 | PP | 15230 | HCJB, Ecuador | 0030 | |
| 9620 | R. Yugoslavia | 2300 | | 15250 | R. Portugal | 2000 | |
| 9630 | R. Baghdad, Iraq | 0300 | AA | 15260 | BBC | 1500 | via Canada |
| 9640 | Ecos del Torbes, Venezuela | 0900 | SS | 15280 | KGEI, California | 2300 | SS |
| 9655 | HCJB, Ecuador | 0200 | RR | 15295 | V of Malaysia | 1200 | |
| 9670 | Adventist World Radio Europe | 0600 | | 15300 | R. Japan | 1200 | |
| 9675 | R. Cairo, Egypt | 0200 | | 15310 | R. Baghdad, Iraq | 2130 | AA |
| 9695 | Rio Mar, Brazil | 0900 | PP | 15315 | R. Netherlands | 0030 | via Bonaire |
| 9700 | R. Sofia, Bulgaria | 0400 | | 15330 | RTM Morocco | 2030 | AA |
| 9715 | R. Havana, Cuba | 0200 | | 15335 | All India Radio | 1330 | |
| 9715 | R. Baghdad, Iraq | 0300 | AA | 15345 | RAE, Argentina | 1300 | SS |
| 9725 | AWR, Guatemala | 0200 | EE/SS | 15350 | R. Japan | 0200 | JJ/SS, via Fr. Guiana |
| 9730 | R. Berlin Int'l | 1045 | | 15375 | KFBS, Saipan | 1200 | |
| 9735 | R. Nacional, Paraguay | 0030 | SS | 15400 | R. Finland Int'l | 1300 | Finnish |
| 9750 | R. Korea, S. Korea | 1200 | KK/EE | 15415 | LJB, Libya | 2200 | AA |
| 9770 | R. Australia | 1400 | | 15420 | WRNO, Louisiana | 1900 | |
| 9770 | R. Beijing, China | 0000 | via Mali | 15460 | R. France Int'l | 1600 | |
| 9790 | R. France Int'l | eves | FF/EE | 15475 | Africa No. One, Gabon | 1800 | FF |
| 9805 | R. Cairo, Egypt | 0330 | AA | 15495 | R. Kuwait | 2000 | AA |
| 9835 | R. Budapest, Hungary | 0130 | | 15540 | RTBF, Belgium | 1600 | FF |
| 9870 | R. Austria Int'l | eves | | 15560 | R. Netherlands | 1530 | |
| 9895 | R. Netherlands | 0030 | | 15575 | R. Korea, S. Korea | 1400 | EE |
| 9910 | All India Radio | 1630 | | 15580 | KUSW, Utah | 2200 | |
| 9925 | BRT, Belgium | 0330 | | 15615 | Kol Israel | 2200 | HH |
| 9977 | R. Pyongyang, N. Korea | 1200 | | 15630 | V of Greece | 1500 | Greek |
| 11375 | CPBS, China | 0945 | | 15690 | WWCR, Tennessee | 0030 | |
| 11550 | RTT Tunisia | 0430 | AA | 17550 | BRT, Belgium | 1230 | |
| 11580 | WYFR, Florida | 0400 | | 17580 | R. Afghanistan | 1630 | AA, via USSR |
| 11630 | R. Peace & Progress, USSR | 1630 | | 17595 | R. Cairo, Egypt | 1230 | |
| 11645 | V of Greece | 0000 | | 17610 | RTT Tunisia | 1600 | AA |
| 11660 | RTBF, Belgium | 0330 | FF | 17630 | Africa No. One, Gabon | 1500 | FF |
| 11670 | R. France Int'l | 0000 | | 17645 | V of UAE | 1400 | AA |
| 11685 | R. Beijing, China | 0000 | CC | 17680 | R. New Zealand Int'l | 0430 | |
| 11700 | R. Peace & Progress, USSR | 0000 | SS | 17705 | R. Norway Int'l | 2200 | NN |
| 11705 | R. Sweden | 0200 | | 17715 | R. Beijing, China | 0000 | via Mali |
| 11710 | RAE, Argentina | 0200 | EE | 17715 | Spanish National Radio | 2300 | SS |
| 11715 | R. Beijing, China | 0000 | EE, via Mali | 17730 | R. Baghdad, Iraq | 1300 | AA |
| 11720 | R. Sofia, Bulgaria | 0300 | | 17740 | R. Sweden | 1200 | Swedish |
| 11735 | R. Norway | 0300 | NN | 17775 | KVOH, California | 0100 | SS |
| 11745 | Radiobras, Brazil | 0200 | EE | 17815 | R. Cultura, Brazil | 0100 | PP |
| 11750 | R. Finland | 0300 | Finnish | 17825 | Qatar Broadcasting Service | 2100 | AA |
| 11760 | R. Cook Islands | 0700 | | 17865 | R. Nacional Colombia | 2200 | SS, USB, irregular |
| 11785 | R. Tashkent, Uzbek SSR | 1200 | EE | 17880 | R. Sweden | 1430 | Swedish |
| 11790 | UAE Radio, UAE | 1500 | AA/EE | 21455 | R. Liberty, W. Germany | 1400 | |
| 11805 | R. Globo, Brazil | 0900 | PP | 21550 | R. Finland | 1430 | |
| 11815 | R. Japan | 1400 | EE | 21605 | UAE Radio, UAE | 1600 | AA |
| 11830 | Trans World Radio, Guam | 1330 | | 21695 | Swiss R. Int'l | 1400 | |
| 11840 | R. Portugal | 0100 | PP | 21745 | Kol Israel | 1300 | |
| 11845 | R. Canada Int'l | 0030 | SS/EE | 25645 | RTBF, Belgium | 1600 | |
| 11865 | V of Germany, W. Germany | 0100 | | | | | |

YOU AIN'T HEARD NOTHIN'..YET!

Since 1967, CRB Research has been the world's leading publisher and supplier of unique hobby and professional books and information including:

- Scanner Frequency Guides
- Shortwave Frequency Guides
- Military/Federal Communications
- Broadcast Station Registries
- Undercover Communications
- Survival Communications
- Covert Operations
- Electronic Espionage
- Surveillance
- Monitoring
- Cryptography & Codes
- Bugging
- Wiretapping
- Communications Antennas
- Electronics & Projects
- Computer Technology
- & Other Related Topics!

Ask For Big Free Catalog!

CRB RESEARCH

P.O. Box 56 Commack, NY 11725

CIRCLE 71 ON READER SERVICE CARD

You Should Know (from page 39)



Fig. 4. Portable radio with tunable pre-amplifier and MW loop antenna. All can be battery powered

your reception with more interference rather than less by setting the preamplifier gain control too high. Portable receivers can often introduce intermodulation distortion when too strong a signal is supplied. The pre-amplifier in my poor location does very well on weak daytime signals operating on the higher-frequency shortwave broadcast band. The same applies during the late evening hours. However, during the prime-time listening hours the pre-amplifier is sel-

dom necessary.

In most locations, except the very poorest, a good portable can stand on its own. The two accessories are not really needed. Remember though that a very simple antenna connected to the external input will provide better results than the telescoping rod. The antenna described can be packed in your baggage during your travels for use when needed. The AM/FM/SW portable is the new thing.

PC

ART-1

ART-1: A complete interface system for send and receive on CW, RTTY (Baudot & ASCII) and AMTOR, for use with the Commodore 64/128 computer. Operating program on disk included. **\$199.00**

AIR-1: A complete interface system for send and receive on CW, RTTY (Baudot & ASCII) and AMTOR, for use with Commodore VIC-20. Operating program in ROM.

\$99.95

AIR-1

SWL

SWL: A receive only cartridge for CW, RTTY (Baudot & ASCII) for use with Commodore 64/128. Operating program in ROM. **\$69.95**

\$69.95

AIRDISK: An AIR-1 type operating program for use with your interface hardware. Both VIC-20 and C64/128 programs on one disk. **\$39.95**

AIRDISK

AIR-ROM: Cartridge version of AIRDISK for C64/128 only. **\$59.95**

\$59.95

MORSE COACH

MORSE COACH: A complete teaching and testing program for learning the Morse code in a cartridge. For C64 or C128. **\$49.95**
VEC SPECIAL \$39.95

\$49.95

\$39.95

G AND G ELECTRONICS
OF MARYLAND

8524 DAKOTA DRIVE, GAITHERSBURG, MD 20877

(301) 258-7373



CIRCLE 65 ON READER SERVICE CARD

POPULAR COMMUNICATIONS

76 NORTH BROADWAY
HICKSVILLE, NEW YORK 11801

FREE READER SERVICE CARD

ENTER MONTH AND YEAR OF THIS ISSUE:

| | | | | | | | | | | | |
|-------|--|--|--|--|--|------|--|--|--|--|--|
| Month | | | | | | Year | | | | | |
|-------|--|--|--|--|--|------|--|--|--|--|--|

(REQUESTS CANNOT BE PROCESSED WITHOUT DATES)

| | | | | | | | | | | | |
|-----|-----|-----|-----|-----|-----|-----|-----|-----|-----|-----|-----|
| 1 | 2 | 3 | 4 | 5 | 6 | 7 | 8 | 9 | 10 | 11 | 12 |
| 13 | 14 | 15 | 16 | 17 | 18 | 19 | 20 | 21 | 22 | 23 | 24 |
| 25 | 26 | 27 | 28 | 29 | 30 | 31 | 32 | 33 | 34 | 34 | 36 |
| 37 | 38 | 39 | 40 | 41 | 42 | 43 | 44 | 45 | 46 | 47 | 48 |
| 49 | 50 | 51 | 52 | 53 | 54 | 55 | 56 | 57 | 58 | 59 | 60 |
| 61 | 62 | 63 | 64 | 65 | 66 | 67 | 68 | 69 | 70 | 71 | 72 |
| 73 | 74 | 75 | 76 | 77 | 78 | 79 | 80 | 81 | 82 | 83 | 84 |
| 85 | 86 | 87 | 88 | 89 | 90 | 91 | 92 | 93 | 94 | 95 | 96 |
| 97 | 98 | 99 | 100 | 101 | 102 | 103 | 104 | 105 | 106 | 107 | 108 |
| 109 | 110 | 111 | 112 | 113 | 114 | 115 | 116 | 117 | 118 | 119 | 120 |
| 121 | 122 | 123 | 124 | 125 | 126 | 127 | 128 | 129 | 130 | 131 | 132 |
| 133 | 134 | 135 | 136 | 137 | 138 | 139 | 140 | 141 | 142 | 143 | 144 |
| 145 | 146 | 147 | 148 | 149 | 150 | 151 | 152 | 153 | 154 | 155 | 156 |
| 157 | 158 | 159 | 160 | 161 | 162 | 163 | 164 | 165 | 166 | 167 | 168 |
| 169 | 170 | 171 | 172 | 173 | 174 | 175 | 176 | 177 | 178 | 179 | 180 |

Did you purchase this issue of Popular Communications from either a newsstand or magazine store? **Yes** **No**

Name _____

Company Name _____

Address _____

City _____ State _____ Zip _____

BROADCAST DX'ING

BY ROGER STERCKX, KVT1JH

DX, NEWS AND VIEWS OF AM AND FM BROADCASTING

Low Power FM'er: In all of the months we have been asking readers of this column to submit broadcasting station bumper stickers, we have never gotten one from a 10 watt station. But that's what was represented on the orange/black sticker from KWDM, 88.9 MHz, of West Des Moines, IA. The sticker was sent in by Keith M. Mehl, Registered Monitor KIA0CF, of Des Moines, who tells us that the station is operated by the students of Valley High School.

Notes From A Daytimer: Our June column offered some comments on AM daytimers and their plight. Those remarks brought in a letter from Joe Cuhaj, Program Director at daytimer WBCA (1100 Hz, 10 kW), Bay Minette, AL. Joe, who is also an avid SW and MW DX'er, writes that he wishes all of WBCA's listeners could read our explanation of the whys and wherefores of daytime AM operation since many people are confused by it all.

Joe observes that when we wrote that being restricted to operating only from sunrise to sunset being "a problem" was an understatement. Local listeners don't understand why stations are required to do this. In fall, they want to hear their local high school football games. They also want to hear local news and programming at hours when their hometown AM stations aren't permitted to operate.

He notes that a few months ago, it was Primary day in Alabama. Bay Minette and Baldwin County are part of the Mobile radio market, and listeners in those two counties were interested in news of their city and county candidates. They had to look elsewhere for this information, or wait until the next morning.

Sponsors are also in a quandary about why they are unable to reach their local markets via AM radio during the appealing drive-time hours.

Joe makes the point that, as a DX'er, he enjoys turning on his radio and hearing

those 50 kW stations in California, Illinois, and Missouri. On the other hand, he understands that the majority of people aren't DX'ers. When they wake up in the morning to go to work, they would much prefer turning on their local AM station's frequency and hearing local news, weather, and programming, than hearing something relevant to listeners a thousand or more miles away.

He observes that there is a strange contradiction here. Broadcasters are granted licenses to provide service to their respective communities, yet the ability to provide that service to the extent that many broadcasters would like to do so, is severely limited. Thank you, Joe, for your thoughts on this.

Flip Side Of The Coin: "Why all the lament for AM daytime stations?" That's what Ira E. New, Jr., writes from Valdosta, GA. He asks that we remember the struggles that the first few FM stations went through. They endured their band being shifted from 44 MHz to 88 MHz, then they had to convince listeners that it was a good idea to purchase a special receiver to hear these broadcasts. Ira says he doesn't recall any tears being shed for some of the FM broadcasters that went bust in those early days.

Ira feels that FM is more suited to local coverage than is AM, while AM is fine for wide area broadcasting. He would like to see the daytimers removed from the AM clear channels, with the daytimers scattered across the band and no more "graveyard" channels like 1230 and 1240 kHz.

Another DX'ing Broadcaster: Roy Hafeli, of Mission, BC, writes to say that he's a DX'er (also into aviation, collecting radio station stickers, and model railroading) who works at station CFVR (850 kHz, 10 kW), Abbotsford, BC.

Roy is on the air from 5:30 to 6:30 a.m. (local time) with an agricultural program, then again from 9 a.m. to 1 p.m. (local) with his regular shift (a music program).

AM Call Letter Changes Requested

| Present | Seeking | |
|---------|---------|---------------|
| WOPA | WXET | Chicago, IL |
| WSUZ | WPLX | Palatka, FL |
| WXLF | WYRS | Rock Hill, SC |

FM Call Letter Changes Requested

| Present | Seeking | |
|---------|---------|--------------|
| KRNJ | KHMX | Houston, TX |
| KMIO | KMYK | Espanola, NM |
| KTNR | KKCR | Kenedy, TX |
| WVMA | WXAS | Oak Hill, WV |

Request Withdrawn For Call Letter Change

| Present | Wanted | |
|---------|--------|------------|
| KAVS | KHXT | Mojave, CA |

Changed AM Call Letters

| New | Former | |
|------|--------|-----------------|
| KACY | KINF | Lafayette, CA |
| KCUB | KIIM | Tucson, AZ |
| KCWR | KUZZ | Bakersfield, CA |
| KFQC | KBQC | Davenport, IA |
| KLAO | KESY | Omaha, NE |
| KLYC | KCYX | Clinton, OK |
| KSPA | KOWA | Escondido, CA |
| KXOW | KIXT | Hot Springs, AR |
| WGSB | WGLH | Mebane, NC |
| WJEH | WGTR | Gallipolis, OH |
| WKKE | WNCR | St. Pauls, NC |
| WKXM | WXDX | Winfield, AL |
| WOKD | WAPG | Arcadia, FL |
| WRBM | WKIE | Richmond, VA |

Changed FM Call Letters

| New | Former | |
|---------|----------|-------------------|
| KCUB-FM | KCUB | Stephenville |
| KESE | KJEM-FM | Seligman, MO |
| KLAA | KISY | Tioga, LA |
| KSGO | KYBS | Tracey, CA |
| KSWR | KKCC-FM | Clinton, OK |
| KWHN-FM | KL VU-FM | Haynesville, LA |
| KYQQ | KWKL | Arkansas City, KS |
| WBBE | WZRQ | Columbia City, IN |
| WDLY | WSEV-FM | Gatlinburg, IN |
| WEGZ | WBWA | Washburn, WI |
| WOKD-FM | WOKD | Arcadia, FL |
| WMXL | WFOU | Margate City, NJ |
| WPKR | WGGQ | Wauplin, WI |
| WQQQ | WJAZ | Stamford, CT |
| WTZR | WOFM | Moyock, NC |
| WWGZ | WDEY-FM | Lapeer, MI |
| WXKR | WOSE | Clinton, OH |
| WZKS | WXLN | Louisville, KY |

New FM Call Letters Assigned

| | |
|------|-------------------|
| KCAC | Camden, AR |
| KCUA | Coalville, UT |
| KXPQ | Sacramento, CA |
| WMXQ | Lynchburg, VA |
| WFDL | Lomira, WI |
| WRHQ | Richmond Hill, CA |



One of our readers has a couple of programs on CFVR.

Applications For AM Facility Changes

| | | |
|------|---------------|----------------------------------|
| KFXE | Camdenton, MO | 1520 kHz Increase to 10 kW/5 kW. |
| KIEV | Glendale, CA | 870 kHz Increase days to 15 kW. |
| WULA | Eufala, AL | 1240 kHz Drop to 600 watts days. |

AM Facility Changes Approved

| | | |
|------|----------------|-------------------------------------|
| KSDP | Sand Point, AK | 840 kHz Switch to 830 kHz. |
| WLVG | Cambridge, MA | 740 kHz Move to Needham, 2.5 kW. |

Applications For FM Frequency Changes

| | | |
|---------|------------------|------------------------|
| KLUA | Kailua-Kona, HI | 93.5 MHz To 93.9 MHz |
| KRCD-FM | Chubbock, ID | 98.3 MHz To 98.5 MHz |
| KRGK | Carthage, MO | 104.9 MHz To 95.1 MHz |
| KSPI-FM | Stillwater, OK | 93.9 MHz To 93.7 MHz |
| KXCI | Tucson, AZ | 91.7 MHz To 91.3 MHz |
| KYPG | Girard, KS | 101.1 MHz To 99.1 MHz |
| KZZQ | Mirando City, TX | 100.9 MHz To 100.5 MHz |
| WBWC | Berea, OH | 88.3 MHz To 91.5 MHz |
| WHOD-FM | Jackson, AL | 104.9 MHz To 94.5 MHz |
| WPBX | Southampton, NY | 91.3 MHz To 88.3 MHz |
| WRJO | Eagle River, WI | 94.3 MHz To 94.5 MHz |

FM Frequency Changes Approved

| | | |
|------|-----------------|------------------------|
| KEWB | Anderson, CA | 94.3 MHz To 94.7 MHz |
| KQLV | Sheridan, AR | 102.3 MHz To 102.9 MHz |
| KRIJ | Paradise, CA | 92.7 MHz To 103.8 MHz |
| WCOZ | Paris, KY | 96.7 MHz To 96.9 MHz |
| TFCS | New Britain, CT | 97.9 MHz To 107.7 MHz |



This WNGC bumper sticker was sent in by Ira New, Jr., of Georgia.

CFVR operates on a 24-hour sked from studios at 2722 Allwood Street, Abbotsford, BC. The station's music programming runs towards Adult Contemporary, 1960's through the present.

Keeping Track? For those who count noses, in the USA there are presently 10,717 AM/FM broadcasters. This breaks down to 4,979 AM's, 4,308 commercial FM's, and 1,430 in the category of FM educational (schools, colleges, religious, etc.). Add to this, 1,849 FM translators and boosters.

There are 4,955 VHF/UHF TV stations, plus 704 low power VHF/UHF TV stations.

ZAP! The FCC conditionally renewed the license of WAVW-FM, Vero Beach, FL, and also notified the licensee of an apparent liability for forfeiture in the amount of \$10,000. These steps came as a result of the FCC's claim that the station had "failed to

take meaningful and regular steps to recruit and hire qualified minorities . . ."

TV station KOCR, Cedar Rapids, IA, was ordered to forfeit \$20,000 for "repeated and willful" violation of FCC rules by operating the station from an unauthorized location.

The station contended that it was only through oversight that the necessary FCC formalities seeking consent were not gone through when the licensee decided to put the station up at a different location than the FCC had approved. The licensee said that the facilities had been completed for five months and the station had begun operation when it was realized that the necessary paperwork had not been filed, and the revised permit and license received from the FCC.

KOCR said that the amount the FCC wanted would create a financial hardship



June 1, 1990

Mr. Kevin McDougald
165 Chalmers Avenue
Winnipeg, Manitoba
R2L 0S7

Dear Mr. McDougald:

I received your recent letter regarding your reception of Channel 5 way up there in Winnipeg.

You're absolutely correct as to what we carried during that 10:21-10:31pm block of time.

I added some station promotion material to further "verify" your discovery. I'm glad to know our signal is that strong.

Sincerely,

Mark Binda

Mark Binda
Program Director

Channel Five Television Company • 474 James Robertson Parkway • Nashville, Tennessee 37219 • (615) 244-5000

A Division of HMC Communications, Inc.

• A CBS AFFILIATE

A TV veri letter received last summer from Channel 5, Nashville, TN. It was received by Kevin McDougald, Winnipeg, Manitoba. Nice going, Kevin!

that would take away from the station's ability to provide service. The FCC denied the plea and pressed for the full amount.

The FCC rescinded a letter of admonition it had sent to FM station WXVU, operated by Xavier University, Cincinnati, OH. The station had been criticized by the FCC because the agency had received complaints that the station "had aired advertisements of promotional material inappropriate for broadcast on a noncommercial station." WXVU defended its actions, explaining that five of the six were not promotional and that, in any event, they were all well within the established standards for such material. As for the one other announcement, WXVU said that shortly after it aired, it was removed from availability for further broadcast because it didn't appear to be in compliance with FCC criteria. Furthermore, stricter review standards were instituted at that time to avoid the possibility of a recurrence. WXVU noted that it was an isolated incident and that steps had been taken to prevent the problem from taking place in the future.

The FCC said that it took these things into account, realizing that noncommercial stations sometimes have difficulty in distinguishing which announcements should and shouldn't be aired per FCC regulations. The agency still seemed to have a few doubts as to how really suitable the announcements were, but apparently didn't feel that it was serious enough to let the letter of admonition remain in the station's license file.

Applications For New FM Stations

| | |
|--------------------|-----------|
| AR Camden | 89.5 MHz |
| AR Mena | 96.3 MHz |
| CA Baker | 101.5 MHz |
| CA Bayside | 91.5 MHz |
| CA Chico | 88.1 MHz |
| CA Lompoc | 104.9 MHz |
| FL Palatka | 91.9 MHz |
| FL Panama City | 89.1 MHz |
| GA Bolingbrook | 102.2 MHz |
| GA Warner Robins | 102.5 MHz |
| GA Zebulon | 92.5 MHz |
| ID Island Park | 106.5 MHz |
| ID Preston | 96.7 MHz |
| IL Princeville | 98.9 MHz |
| IL Seneca | 95.7 MHz |
| IL Streator | 106.1 MHz |
| IN Syracuse | 103.5 MHz |
| KY Stomping Ground | 99.1 MHz |
| ME Bar Harbor | 107.7 MHz |
| MI Beulah | 92.1 MHz |
| MI Bridgeman | 97.5 MHz |
| MI Manistee | 107.9 MHz |
| MI Stephenson | 102.3 MHz |
| MN Winona | 101.1 MHz |
| NE Sargent | 92.1 MHz |
| NJ Atlantic City | 89.7 MHz |
| NJ Vineland | 91.3 MHz |
| NY Chateaugay | 94.7 MHz |
| NY Conklin | 100.5 MHz |
| NY Endwell | 107.5 MHz |
| NY Nyack | 89.9 MHz |
| NY Ridge | 88.3 MHz |
| NY Southampton | 89.9 MHz |
| NY Southport | 99.5 MHz |
| OK Edmond | 97.7 MHz |
| PA Beaver Springs | 106.1 MHz |
| PA Murrysville | 88.1 MHz |
| PA Port Matilda | 107.9 MHz |
| SD Huron | 105.1 MHz |
| SD Rapid City | 98.7 MHz |
| TN Coalmont | 104.7 MHz |
| TN Dresden | 95.1 MHz |
| TN Madisonville | 99.5 MHz |
| TX Centerville | 103.1 MHz |
| TX Dublin | 104.9 MHz |
| TX Jacksboro | 104.9 MHz |
| VA So. Boston | 95.3 MHz |
| WI Altoona | 98.1 MHz |
| WI Lake Geneva | 96.1 MHz |
| WI Whitewater | 106.5 MHz |

Permits Granted For New FM Stations

| | |
|-------------|------------------|
| FL Palm Bay | 88.5 MHz, 1 kW |
| WA Wapato | 89.5 MHz, 15 kW |
| WY Burns | 101.9 MHz, 50 kW |

Both Sides Now — Well, Soon: Chances are that very soon, American manufacturers and importers of FM stereo receivers will be required to have their equipment also receive AM stereo. The manufacturers are against being forced into this position. Should this law become enacted, the FCC will undoubtedly require all AM broadcasters to install stereo equipment.

This column looks forward to AM/FM station photos and bumper stickers, news clippings, opinions, recent QSL's, and chit-chat.

POPULAR COMMUNICATIONS Order Back Issues of COMMUNICATIONS

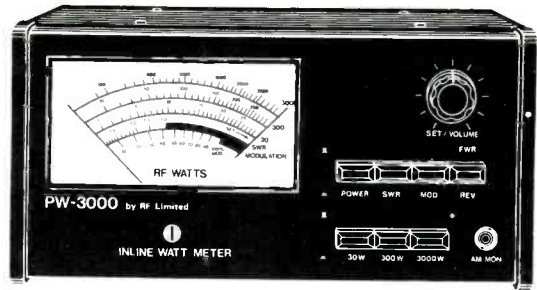

PW-3000/PW-3000 B/L INLINE WATTMETER

- 1.5 MHz Frequency Range
- Extra Large Meter Movement
- Extremely High Resolution scales, highest resolution in its price class
- Three selectable scales: 0-30, 0-300, 0-3000 watts
- Peak-reading, measures the peak envelope power (PEP) of an HF SSB or AM transmitter
- Check 4 transmission functions to ensure your station is operating properly RF output, antenna VSWR, percent modulation, and AM audio quality
- Designed for continuous use inline operation
- Optional meter back lighting (PW-3000/BL)

Introducing the Super Penetrator Mobile Ultra-Wideband 10 & 11 Meter Antenna

Featuring the widest band pass of any antenna on the market today. Our exclusive "Quad-Angular" helical coil has more surface area for highest possible gain and lowest static build-up resulting in quieter operations.

- Frequency range: 25-30 MHz
- VSWR: 1.3 MHz with a standing wave of 1.5 to or less
- Power Rating: 2.5 KW
- 2 shaft lengths available: 16 or 25 inches
- Mounting: 3/8 x 24 standard "stud" type
- Materials: machined from highest quality solid brass and stainless steel

Send for free catalogue and Smith chart.

Manufactured in Japan by Diamond
"The technology leader in antenna design"



Exclusively for
RF Limited

P.O. Box 1124
Issaquah, Washington 98027
Telephone (206) 392-0399
Telex 329 473 BURGESS SEA
Fax (206) 302-8413

CIRCLE 64 ON READER SERVICE CARD

COMMUNICATIONS CONFIDENTIAL

YOUR GUIDE TO SHORTWAVE "UTILITY" STATIONS

To all who supplied articles and information on the OTH Radar, many thanks. The material was most appreciated.

For those who like to follow DEA/Customs communications, interesting background material is to be found in "Turf Wars in the Federal Bureaucracy" which appeared in the 10 April, 1989, *NEWSWEEK*. Also, in the February, 1990, *POPULAR MECHANICS* in an article titled "High-Tech Drugbusters." Our thanks to Clay Gibbs, GA for drawing our attention to these articles. Clay also provided some of the data shown in Table 1 which lists frequencies in use for joint operations of DEA, Customs and Coast Guard units. Other details were from an anonymous contributor.

Larry McMahan, GA forwarded a news item which described a plan by scientists to study and pinpoint the source of radio waves coming from the planet Jupiter. Larry mentioned he recalled seeing somewhere that the frequency of these radio waves was around 20 MHz.

From R. C. Watts, KY we received a couple of items extracted from the Civil Air Patrol News. The first indicated the CAP celebrated 42 years as the official Air Force Auxiliary in May 1990. There are now 52 wings and approximately 2,000k subordinate units. The CAP provides a network of some 32,000 radios in support of local, regional and national emergency agencies, both military and civilian.

The second CAP item dealt with the changeover of the South Carolina Wing

"Kiddie Car" call sign to its new call sign of "Crescent."

A European monitor signing as Mr. Anonymous reported hearing US Military communications on 4815 kHz where two OM operators, apparently US Army types, were swapping jokes and playing 'rap' music over the air from their Walkmans. IDs were JDI1 and JDI2. Later, JDI3 was heard warning the men to use proper radio procedures. Also observed on the same evening was a SAC broadcast where the operator had a fit of laughing while announcing the coded groups and he had to keep turning off his mike while he collapsed laughing.

The mailbag contained an unsigned letter which described a very strange transmission. This activity was heard on 5211 kHz at 0430 UTC. WGY912 (FEMA Special Facility, Berryville, VA) was working "DOWNTOWN" (not identified). During the contact an unidentified individual requested a phone patch with first one, then another, telephone number and both numbers turned out to be Board of Education numbers in Berkeley County, WV????

James L. Scott, PA wrote "I began my listening hobby 31 years ago when I built an Allied/Knight kit at the age of 12. My interest at that young age also led me to a lifetime career as an electronics service technician. About 12 years ago I also became a ham operator and presently hold an advanced class license. Listening equipment includes a NRD 424, two Hammarlund HQ-170s, Icom 735, Regency 10, Uniden BC 145XL

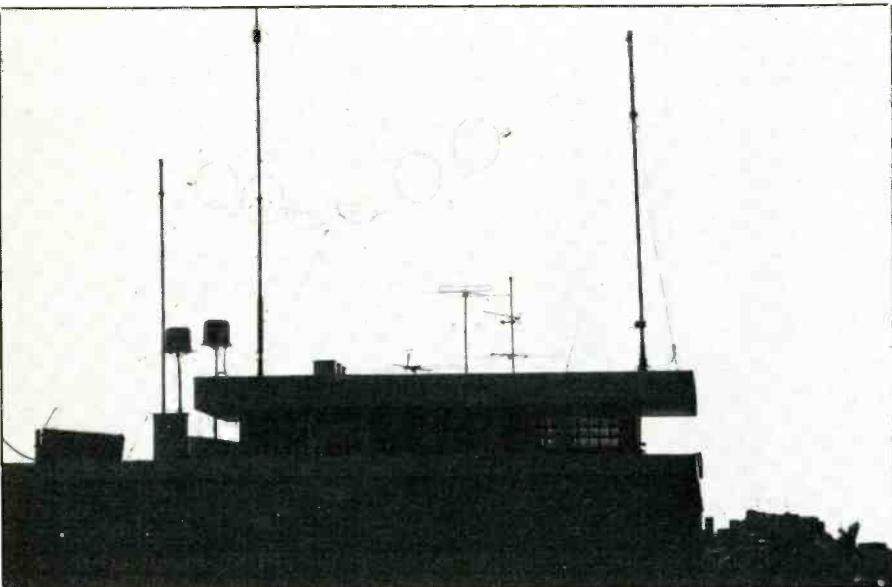

Antennas at Soviet Embassy, Stockholm, Sweden. Photo courtesy of Desmond Bell, Australia.

TABLE 1

| kHz | Identifier |
|------------|--------------------|
| 4500 | Zulu Alpha |
| 5277 | Alpha |
| 5571 | Yankee Bravo |
| 5841 | Bravo |
| 7527 | Zulu Bravo (1) |
| 7657 | Foxtrot |
| 8912 | Yankee Charlie (2) |
| 10242 | Tango Alpha (3) |
| 11073.5 | ? |
| 11076 | Echo |
| 11288 | Yankee Delta |
| 11494 | Victor Foxtrot (4) |
| 13312 | Yankee Echo |
| 13907 | ? (5) |
| 14686 | Papa |
| 15867 | Zulu Echo |
| 18171 | Sierra India |
| 18594 | Victor Charlie (7) |
| 18666 | Hotel |
| 19131 | ? |
| 20890 | ? (8) |
| 23214 | ? |
| 23402.5 | Romeo |
| 25350 | ? |

NOTE: Numbers in parens indicate freqs in trunked channel system.

and BC 800 XLT scanners. Antennas include long wire, Alpha Delta sloper, vertical, scanner and three element beam. (See photo of station)

TABLE 2

Homeports Of Large Harbor Tugs

Charleston, SC

| | |
|---------|--------------|
| YTB 792 | Antigo |
| YTB 804 | Ahoskie |
| YTB 802 | Cheraw |
| YTB 799 | Natchitoches |

Norfolk, VA

| | |
|---------|------------|
| YTB 825 | Wathena |
| YTB 770 | Dahlonega |
| YTB 790 | Menominee |
| YTB 766 | Wapakoneta |
| YTB 810 | Anoka |
| YTB 791 | Marinette |

Little Creek, VA

| | |
|---------|-----------|
| YTB 824 | Santaquin |
|---------|-----------|

Portsmouth Naval Shipyard, NH

| | |
|---------|--------|
| YTB 771 | Keokuk |
|---------|--------|

From Andy Gordon, CT we received a listing of the various homeports of some of the East Coast tugs. See Table 2.

233: Beacon PDR, Ottawa, OH at 00040. (Hill, MI)
236: Beacon 4L, Chatham, Ontario, Canada at 0051. (Hill, MI)

242: Beacon UL, Montreal, PQ, Canada at 0350. (Grubbs, NY)

272: Beacon YQA, Muskoka, Ontario, Canada at 0345. (Grubbs, NY)

282: Beacon LRO, Lathrop (Sharpe AAF), CA at 2300. (McCabe, CA)

306: Beacon H, Southeast Shoal LS (in Lake Erie near Point Pelee, Ontario, Canada at 2140. (Hill, MI)

314: Beacon F, Farallon Islands, CA at 2300. (McCabe, CA)

325: Beacon BO, Bodega Head, CA at 2300. (McCabe, CA)

335: Beacon K, Waterloo, Ontario, Canada at 2122. (Hill, MI)

344: Beacon CL, Cleveland (Hopkins AP), OH at 0445 w/OM-EE in background w/wx. (Warrington, OH)

360: Beacon AK, Akron (Fulton AP), OH at 0134. (Warrington, OH)

385: Beacon EVO, East Liverpool, OH at 0139. (Warrington, OH)

400: Beacon SLW, Wooster, OH at 0142. (Warrington, OH)

408: Beacon HBD, Youngtown, OH at 0942. (Warrington, OH)

420: VFN, Montreal, PQ, Canada in CW w/wx bcst at 0013. (Grubbs, NY)

1660: Experimental station at 0325 in AM w/announcement: "KA2XXB, Beltsville, Maryland, the experimental skywave suppression station operated by the National Association of Broadcasters." (Galasso, NJ)

4585: Blue Flight 800 in USB wkg Middle East 4 (CAP Shaw AFB, SC) re flight wx conditions during air search for missing aircraft at 1815. Plane wreckage finally found SW of Fredericks, VA. (McAtee, WV)

4596: AFF1T and AFF1AY in LSB running MARS net. AFF1T cld AIR & closed net at 0226. (Warrington, OH)

4780: Golden Pirate in LSB at 1249 w/roll call of Indiana Emergency Net. Contacted various cities in the state. (Willmer, MI)

4855: Liberty Star in USB at 0415 wkg Cape Radio and Variety 1 (Range Safety Officer) re target being in impact area (assume of solid rocket boosters) prior to Shuttle Atlantis QSY'd to 4520 kHz. (Willmer, MI)

5047: YL/EE at 2300 w/248 rptd 3x then 1-0 count. At 2310 ten tones, count 80 & into 3/2F grps. Rptd at 2317, end at 2325. (Eager, NY)

5180: USCGC Tampa (WMEC 902) in USB at 0310 wkg DOD Cape re having helicopter on board. Provide updates on sea state conditions. USS Saratoga in contact w/DOD Cape re helicopters ready for support. Saratoga also wkd Alert 3 and 4. King 1 also up for support of launch of Shuttle Atlantis. Stns later QSY'd 5810 kHz. (Willmer, MI)

6200: USS Miami, SSN755 clg USCG Comsta Miami at 0100. (Gordon, CT)

6506: NMN, USCG Comsta Portsmouth, VA wkg vessel Cecilia Degagnes (VCPG) in USB at 0249. (Hill, MI)

6574: OM/EE in USB at 0215 w/3+2F grps. (Hill, MI)

6607: NY Radio in LSB w/wx at 0617. (Warrington, OH)

6627: Unid stn in CW at 0215 w/callup of T88 (088) rptd then into 5F grps. Zero cut as ltr T. (Hill, MI)

6675: Three outbanders in so-called 45M band from Ireland and England during 2200-2225. At 2220 YL/EE popped up w/32831 on this Czech nbr freq. At 2225 into 5F grps. Outbanders had no clue what it was but one said he might copy the numbers for a lottery. Other said signal was "60dB over" and the outbanders then QSY'd to 6663 kHz. (Mason, England)

6800: K5IL, 7Q4R, MQ28, 1L5G, V2U5, and 2A9P in USB w/rdo checks at 1435. (Willmer, MI)

6830: Helicopter Nighthawk 919 in contact w/Cartwheel in USB at 1357. Nighthawk 919 indicates on the ground at 1410. (J.M., KY)

7375: YL/GG w/1-0 count and 192 from 200-2010. This freq also being used by R. Beijing to USSR. Was parallel w/other best freq of 9465 kHz. USB mode. (Mason, England)

7404: YL/GG in USB at 0036 w/5F grps each grp read twice. (Grubbs, NY)

7485: NESEA (Naval Electronics Systems Engineering Activity) Test Control at Pautuxant River NAS, MD wkg Charleston Test Contrl at 1630, then QSY'd to 9950 kHz. NESEA was testing their HF emitters. (Gordon, CT)

7532: YL/GG rptng Victor Bravo in USB w/electronic tones 1030-35. Then msgs in 5F grps for 088 and 415. (Mason, England)

7662.5: USMC station Recon 1 Alpha, Recon 2 Alpha, Comical, Corvette, and C.O.S. hrd in USB at 1319. (J.M., KY)

7680: YL/EE in AM at 0234 w/6959 & 2520 rptd while OM/Czech doing a long string of nbrs w/single word at end at 0235, then off air. Meanwhile YL continues. At 0239 YL stops and carrier off. On earlier date, hrd 5F grps in EE at same time as SS grps. (Fernandez, MA)

7845: Sounded like fishing boat net at 0115. ID's were 26KC, 8E2M, 88OE, Popeye, and Big Daddy. Lots of foul language. (Sprau, FL)

7939.5: Homestead wx, Eglin wx, MacDill wx and Charleston wx in LSB net at 1248. Stns also operating in RTTY mode on 7937.3 kHz. Other wx stns occasionally hrd her in USB. (J.M., KY)

8052: T7R w/5L grps in CW at 1257. Anything new on these stns w/digital transmissions between CW grps. (J.M., KY) No additional info as yet. (Ed.)

8420: YL/EE in AM w/callups of 824 and 675. At 0233 grp count of 103 rptd twice and into 5F grps. (Willmer, MI)

8777.8: Many LFL calls in USB net w/what sounds like a USN training exercise in radio operation. Hrd 0455. (Fernandez, MA)

8780.8: Electronic musical tones. "5 tones-pause-4 tones" rptd 4x in ten secs, w/AM carrier on only for duration on 4th sequence. Sent each 30 secs from 2350 until off at 0005. (Grubbs, NY)

Abbreviations Used For Intercepts

| | |
|-----|------------------------------------|
| AM | Amplitude Modulation mode |
| BC | Broadcast |
| CW | Morse Code mode |
| EE | English |
| GG | German |
| ID | Identifier/led/location |
| LSB | Lower Sideband mode |
| OM | Male operator |
| PP | Portuguese |
| SS | Spanish |
| trc | Traffic |
| USB | Upper Sideband mode |
| w/ | with |
| wx | Weather report/forecast |
| YL | Female operator |
| 4F | 4-figure coded groups (i.e. 5739) |
| 5F | 5-figure coded groups |
| 5L | 5-letter coded groups (i.e. IGRXJ) |

8868: Unid CW stns 6A6, 9A2, 8Q5, and 6MO. Prob French Navy, w/FF plaintext NAVCOMEX drill msgs during 0420-0450. (McMahan, GA)

8912: Domination in USB at 0045 clg Omaha 55 for approx 20 mins w/o success. Few times call was answered by a warbling sound. (Riaz, NJ)

8957: Shannon, Ireland Volmet in USB at 0531 w/wx observations at terminals around UK and Europe. (Fernandez, MA)

8967: "Flight 562" wkg unid stn & requested wx for Rota, Spain. In USB at 0327. (Hill, MI)

8968: YL/GG here every Sunday at 1000. Rptng 033 x3, 53101, 84. At 1005 five tones & into FG grps. AM mode. (Mason, England)

8993: Howard AFB, Panama wkg 67956 w/wx at 0448. (Moon, S. Africa)

9006: A/c 3816 clg Trenton Military, Canada w/rdo check. A/c Pilot reported problem on-board which after consultation w/ground was suspected of probably being a defective micro-switch. USB at 0025. (Riaz, NJ)

9023: Okie SAM wkg Tango Uniform in USB at 2239. Went into scrambled comms. (Rome, LA) Egg White (an AWACS) in contact w/Log Road re intercept of 2 Bear Ds about 300 miles east of Jacksonville, FL. Fighter flights hrd during monitoring included Filch, Legit, and Energetic. One Bear penetrated MADEZ (Military Air Defense Identification Zone) and was intercepted. Hrd at 1559. (Willmer, MI)

9028: Papa Zero Xray wkg Charlie Tango Papa w/ coded tlc. (British accents) in USB at 0130. (Hill, MI)

9122.5: WUE3 Alpha, US Army COE, Pittsburgh, PA, WUE4 Alpha, COE, Huntington, WV, WUE5 Alpha, COE, Louisville, KY, and WUE6 Alpha, COE, Nashville, TN grd during exercise at 1239 in USB. Also some activity on 6785 kHz. Alpha designators may mean these are remote or mobile units. 9122.5 kHz may be COE channel 8 and 6785 kHz channel 5. (J.M., KY)

9140: YL/EE in AM at 0240 w/5F grps, each grp rptd 2x. (Fernandez, MA)

9238.5: Flint 451, a/c enroute to location of Almightly, Guantanamo Bay Naval Air Station, Cuba, notifying Panther of position & ETA. USB at 0128 on Anti-Smuggler channel XE. (McMahan, GA)

RADIO FREQUENCIES
AUDIO FREQUENCIES
TIME INTERVALS
MUSICAL PITCH
TIME SIGNALS
RADIO PROPAGATION FORECASTS

NATIONAL BUREAU OF STANDARDS
BOULDER LABORATORIES
STANDARD RADIO TRANSMITTING STATIONS
Corrections to one part in ten billion published monthly



THANK YOU FOR YOUR REPORT ON RECEPTION OF

_____ Mc
Frequencies

_____ Station
Station

_____ Date
Date

NATIONAL BUREAU OF STANDARDS
BOULDER LABORATORIES
RADIO STANDARDS DIVISION
BOULDER, COLORADO

RADIO FREQUENCIES
AUDIO FREQUENCIES
TIME INTERVALS
MUSICAL PITCH
TIME SIGNALS
RADIO PROPAGATION FORECASTS

NATIONAL BUREAU OF STANDARDS
BOULDER LABORATORIES
STANDARD RADIO TRANSMITTING STATIONS
Corrections to one part in ten billion published monthly

THANK YOU FOR YOUR REPORT ON RECEPTION OF

15 _____ Mc
Frequencies

WWVH _____ July 17, 1961
Station Date

NATIONAL BUREAU OF STANDARDS
BOULDER LABORATORIES
RADIO STANDARDS DIVISION
BOULDER, COLORADO

Two 1961 QSLs from the collection of Owen Williamson. Sent in by Rita Williamson, TX.

9251: YL/EE w/5F grps following "Lincoln Poacher" tune. Also on 7887 kHz. 9251 was affected by warble jammer, evening sked used 1700-2100. Also now using 14487 kHz in mornings/afternoon 1200-1500. USB mode. (Mason, England)

10075: A/c W-1926 wkg Houston LDOC in USB at 0042 re phone call to be placed. A/c located 100 miles south of Cairo. (Hill, MI)

10125: YL/EE w/Charlie India Oscar Two at 0248. (Moon, S. Africa)

10132: YL/SS w/5F in progress at 0112, ending 0117. (Eager, NY)

10135: YL/GG w/1-0 count and 843 1900-1905. This was also simulcast on 11685 and 11273 kHz. After ten tones Gruppen 198 and into 4F grps. (Mason, England)

10449.8: YWX calls CW for approx 10 mins in CW and indicates has ftc for all. At 1031 commences w/mgs. Typical heading: NW NR CQ 11 CK 117 PP BT and into 5L grps. This prob Venezuelan Navy bcst. (Ed.)

10655: YL/GG w/1-0 count and 373 1800-1810. Was parallel w/11685 kHz which also being used by R. Beijing. (Mason, England)

10970: YL/EE in AM at 0506 w/5F grps, mixing w/AFRTS 1 kHz down and occasional USAF OTHR-B bursts. YL ended w/00000 at 0510. (Fernandez, MA)

11179: MAC 60148 (a/c)/Eagle Command Post via phone patch thru Letterman in USB at 0450 re flight data & mention of 76 passengers on board. Reported thunder storm activity while enroute to Hickham AFB, HI. (Fernandez, MA)

11191: Hershey, Joint Air Reconnaissance Center. Key West, FL in contact w/stns Bill Poster 1, Blue Star, Gunbarrel, Alpha and Herty Gerty, in USB at 1239. (J.M., KY)

11215: YL/GG in AM at 0222 w/3+2F grps. (Fernandez, MA)

11234: Zero Gold Uniform/Gibraltar in USB at 0307. These were RAF units w/tactical comms. (Fernandez, MA)

11246: Colombian Air Force 12018 wkg MacDill AFB w/pp to Andrews AFB Base Operations at 1550. CAF 12018 advised Andrews this was VIP flight from Bogota & Andrews was alternate landing site if bad wx developed at their primary destination. (McAteem, WV)

11288: Slingshot/Ranch House in USB 1800-1900 discussing radar tracks and suspect a/c not squawking in Caribbean. Also comms re private a/c island hopping and unloading cargo in Bermuda area. (Fernandez, MA)

11315: Ghostman trying w/o success to raise Homestead at 1638 in USB. (J.M., KY)

11321: SLHFB "W" hrd in CW at 1301. (Margolis, IL)

11474: KKN44, US DOS, Monrovia, Liberia in CW at 0117 wkg unid stn KRZ62 w/sig check plus Z sigs. (McMahan, GA)

11494: Two OM/EE in USB at 0250 discussing interdicting a drug operation. Much detailed info given in clear as scrambler inoperative. (Rome, LA)

12687: OFJ32, Helsinki, Finland in CW at 1635 w/QSX mkr. (Margolis, IL)

12691: GXH, USN stn in Thurso, Scotland w/NOTAMS in CW at 1649. (Margolis, IL)

12740: ZLB, Awarua, New Zealand w/Freq sked in CW at 1357. (Koechig, MI)

12788: JFA, Matsudo Fisheries, Japan w/CQ mkr in CW at 1830. (Margolis, IL)

12876: URL, Sevastopol, USSR w/CQ-QSX mkr in CW at 2229. (Margolis, IL)

13144: WOM, Miami, FL in USB at 2238 w/pp for m/v Song of Norway. (Rome, LA)

13201: MAC267 in USB at 1550 clg "Any Station or any Aircraft" for rdo check but no response. (Rome, LA)

13282: Honolulu Volmet w/wx in USB at 0400. Oakland Volmet w/wx in USB at 0405. (Hill, MI)

13434: YL/SS in AM at 0207 w/5F grps. (Fernandez, MA)

13457: FAA stns KCP 63, Longmont, CO and WHX 20, Seattle, WA in USB at 2306. KCP 63 to KDM 47, Forth Worth, TX testing ASCII at 150 and 300 baud. Also tested Morse code Hrd at 2058. (Willmer, MI)

14295: WA3NAN signing on for retransmission of shuttle audio from Goddard Space Center, Greenbelt, MD. ID'd a few times as "Hubble Control System." Gave explanation of the structure of the control system and Mission 31 highlights. USB at 1406. (Rome, LA)

14350.1: Mother Goose wkg Sea Wold at 0212 reporting that conditions not good. Try again tmw at 0900. Mother Goose was there next day but conditions still bad. Casper answered Mother Goose w/strong sig & willing relay to Sea Wolf but latter wants try again in one hour. Later short info exchange between Mother Goose and Sea World who now copying each other. Drug smugglers?? (Grubbs, NY)

14430: OM/SS & YL/SS in comms in USB at 1358. This could be XFIG, Hermasillo, Mexico, which has circuit on this freq to Mexico City. (Margolis, IL)

14645.5: SPW, Warsaw, Poland w/CW ID loop at 0135. (Koechig, MI)



SWL/Ham station of James L. Scott, PA.

16031.3: AJE, Coughton AFB w/LSB bcst of game between Cubs & Pirates at 0145. (Koechig, MI)

16170: Express to Sky Train in USB at 2110 w/"Platinum Mercury drill." Message was "Little sheep upon the grass stay 80 feet from my..." Was unable copy last part of msg. Oprs had British accent. (Willmer, MI)

16311.3: CQ DE COR, Havana, Cuba w/mkr in CW at 1200. (Margolis, IL)

16985.2: CTP, Lisbon, Portugal NATO w/QSX mkr in CW at 1748. (Koechig, MI)

17430: YL/GG rptng Hotel Kilo in USB w/electronic tones from 1600-05. Then msgs in 5F for 393 and 621. (Mason, England)

17555: YL/SS in AM at 0040 w/5F grps. (Watts, KY)

17922: London LDOC, England wkg a/c whose flight plans included flyover of London & Amsterdam to Copenhagen. USB at 1529. (Margolis, IL)

17925: American Air 1180 wkg New York re death on board & requested ambulance meet plane on arrival. Hrd at 2111. (Moon, S. Africa)

17996.5: Magic 51 Tactical Director in contact w/Magic Control re inoperable radar. Only able use IFF. Questioned value of sortie w/o radar. USB at 1522. (Willmer, MI)

18035: YL/SS in AM at 1917 w/5F grps. (Willmer, MI)

18535: MKD, RAF, Akrotiri, Cyprus in LSB at 1507. OM talking to YL on this phone circuit to London. (Margolis, IL)

18710: Wellington, New Zealand in USB at 0015 begins sked w/mkr rptng "This is a test transmission to adjust services, etc" Voice announcement foll by 7 dual tone sets. At 0030 Wellington calls Pitcairn Island and gives freqs he listens on. Hrd 18407 and 23160 kHz. Pitcairn sends wx, then telegrams, then pp. This is regular sked & hrd only on their Monday-Fridays. (McMahan, GA)

18988: Echo Juliet (OM in SS) dictates msg slowly to 2nd OM/SS on 18987.7 kHz. USB mode. 2nd opr was from LOL, Buenos Aires, Naval Radio, Argentina. (Margolis, IL)

20390: Agar 91 in USB at 2221 via Cape Radio to Riot Control arranging crew transport to arrival at March AFB. (Willmer, MI)

23254: French Air Force stn w/phonetic msg in USB at 1045. Hrd mention of Fort de France. (J.M., KY)

23287: USN ASW unit on Atlantic/Caribbean HICOM freq. USB at 1940 w/flash precedence msg concerning having lost visual contact w/unid SSN foll by losing sonar contact due to deep sinker. 5XR gave position in the clear & said they still searching to re-establish contact. Also gave last known heading and speed of SSN, then requested QSL from I80, which not obtained after several attempts. (McMahan, GA)

23551.5: CXQ343, Montevideo Naval Radio, Uruguay hrd on USBj at 1442 w/Charlie Uno in mil. comms in dpx. "Captain: and Commandante" often mentioned. This is an IANTN freq assigned to Montevideo. At 1447 a voice mirror w/YL-SS was rptd during when Charlie Uno was not xmtng. (Margolis, IL)

25350: Omaha 56 clg Slingshot to advise his position & ETA at Homestead AFB, FL. Hrd in USB at 2156. Could not hear Slingshot this freq but did hear Omaha 56 continue to detail his approach into the airfield using IFR, as it was a rainy day in Southern FL, giving his ETA as being 4 mins away. (McMahan, GA)



SUBSCRIBE NOW & SAVE!



CODE SCANNER ADVANCED MULTI-MODE DECODER Two Line, 32 Character LCD Display



Copies Morse, Baudot and ASCII Codes from your Radio! Automatic Morse Code tracking: 3-70 WPM. Built-in Code practice oscillator for hand key with readout to display. Built-in speaker. Advanced Analog and Digital filtering with AGC. Special practice mode to learn Morse characters. Compact size: 3 1/2" x 5 3/4". Operates from 12 VDC or 120 VAC adapter provided. Easy hook-up to Radio speaker or headphone jack. Made in U.S.A.

Call or write for FREE brochure or order Factory Direct.

CODE SCANNER Model CSCAN \$ 189.00

Add \$5.00 shipping for continental U.S. Send check, money order, VISA or MasterCard.

Microcraft

Corporation Telephone: (414) 241-8144
P.O. Box 513Q, Thiensville, Wisconsin 53092

CIRCLE 56 ON READER SERVICE CARD

TELEPHONES ENROUTE

BY TOM KNEITEL, K2AES

WHAT'S HAPPENING WITH CELLULAR, MARINE & MOBILE PHONES

Several times in the past we have mentioned the development of personal communications services (PCN) alternate to cellular phones, inasmuch as numerous other technologies are now on the horizon in North America and around the world.

While this sounds like a bonanza for the public, there are many considerations that have to be addressed as soon as possible. That's why the FCC is now investigating the various PCN systems in order to ascertain which of these services appear to be most needed by the public (and which merely duplicate other emerging services, and which are unfeasible). The FCC also wants to find out how much spectrum space these various services will be demanding, and in what part of the spectrum. They want to begin thinking about technical standards, operating regulations and general policy procedures.

While a choice of different PCN's available for various applications is a plus, all possible systems can't be approved and put into use or else there will be a clutter of too many PCN's. At some point there needs to be a sorting out, based upon established parameters. According to Roger Newell, who publishes a PCN industry journal called *Microcell Report* (170 Broadway, New York, NY 10038), the U.S. is already lagging behind other industrialized countries that have several types of PCN's in operation.

As has been noted here previously, the PCN to watch closest right now looks to be something called Cellular Telephone II (CT2), which is sort of a marriage between cellular and cordless telephone technologies. It is simple and inexpensive, and can be put into operation with only forty channel pairs and a bunch of short-range cells. The subscribers' units are intended only for placing outgoing calls.

A variation on this system is known as CT2-Plus and offers more elaborate services, including signaling individual subscribers.

Canada is testing CT2 in some areas on 864 to 866 MHz and 944 to 946 MHz. Testing areas at various times include Toronto, Montreal, Vancouver, Ottawa, and Calgary.

Meanwhile, other PCN's are also evolving. The American Mobile Satellite Corp. (AMSC) has hammered out an understanding with Motorola to explore jointly the potential of Motorola's proposed Iridium satellite communications system.

This system proposes to place a network of 77 small satellites in a low-earth geosynchronous orbit that will allow portable personal communications between mobile users anywhere in the world.

AMSC was licensed by the FCC a year and a half ago to launch and operate the mobile satellite system for the entire U.S.



Picture this new Ford cellular on the console of your Lincoln Continental.

(and territories), and 200 miles of coastal waters. AMSC is now beginning to provide mobile data services via leased capacity on an existing satellite. Full voice and high-speed data services are scheduled to begin with the launch of AMSC's first satellite in 1993. AMSC is located at 1233 20th Street N.W., Suite 301, Washington, DC 20036.

Ford Shifts Into Gear

Ford Motor Company announced the Ford Cellular System, now available for the Lincoln Town Car, Continental, and Mark VII. This system includes a factory-installed full-feature (Ford brand) cellular phone as well as participation in a national carrier air-time network.

Any cellular phone owner can subscribe to the Ford National Carrier Network, it's not exclusive to Ford cellular phone customers. However, a person purchasing a Lincoln with a factory-installed cellular will find that the unit has been activated by the car dealer and will be ready for immediate use upon taking delivery of the vehicle.

The Ford Cellular System is comprised of major carriers throughout the country. If a member moves to a new area, a visit to any Lincoln dealership in that area will quickly accomplish the assignment of a new local cellular number with no inconvenience or wasted time for the subscriber.

New subscribers get a free 60-day Custom Calling package. Depending upon local participating carriers, this might include one or more of the following: call waiting,

conferencing, call forwarding, mobile messaging, and detailed billing. Some of the companies participating in the Ford Cellular System include American Cellular, Ameritech, Bell Atlantic, BellSouth, GTE Mobilnet, NYNEX, SNET, United States Cellu-

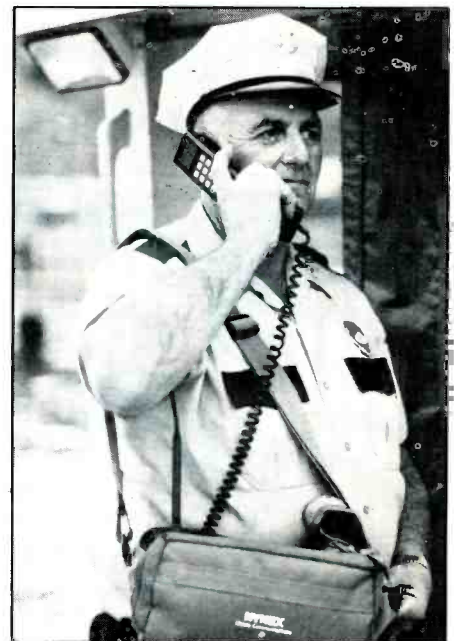

Piermont, NY, Fire Chief Don Cocker finds cellulars offer unique benefits over standard fire radio systems for certain important applications.

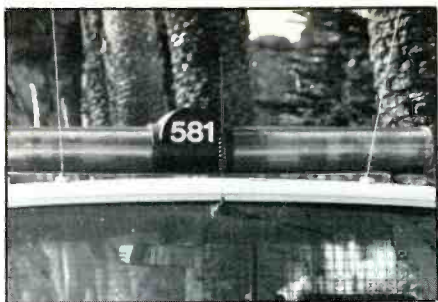

A police patrol car in Pacific Grove, CA. There's a cellular antenna sprouting from the center-top of the rear window. Many public safety agencies now employ cellulars as an adjunct to their regular VHF/UHF communications systems. (Snapped by David Palmer, CA.)

lar, and US WEST. More information on the Ford Cellular System is available by calling toll-free number (800) 367-3013.

The factory-installed cellular in Lincoln cars features speed dialing; 100 memory locations and 24-digit capacity; 1-digit recall; last number recall; 24-digit display recall; electronic lock; electronic volume control; and call-in-progress protection so that calls don't hang up off when the ignition is turned off. The unit offers hands-free operation, a mute-button, and a feature that automatically shuts off the unit's audio when calls are in the process of being placed or received.

Should any problem arise with the cellular unit, any Lincoln dealership, in conjunction with affiliated service providers, will arrange for servicing and the loan of a temporary replacement unit. A class act, all the way!

Also A Hard Worker

Let's not forget that all cellulars don't cruise around in the luxury of Lincoln cars. Some roll up their sleeves and go to work every day with folks wearing hard-hats, uniforms, jeans, and bib overalls.

For example, Piermont, NY, Volunteer Emergency Services now use cellulars during fire rescues and other emergencies. Before the firefighters enter a burning building, they want to know its type and construction, or of it contains hazardous materials. Without this information, anyone in a burning building runs the risk of being contaminated, or injured during a collapse.

In the past, the firefighters relied on their low-band radio system to contact the base for this information. This wasn't always effective. Reception was affected by distant stations coming through on skip, or the channel was busy with traffic from other agencies in neighboring communities. And, all conversations had to be relayed through the dispatcher, which added time and sometimes reduced the accuracy or completeness of the information given. Once, in fact, such an information loss resulted in

more than a dozen firemen being hospitalized for contact with a hazardous substance.

Thanks to the NYNEC Cellular Center, Piermont received a donation of two cellulars for emergency use by the Volunteer Emergency Services. Only two weeks later, thirteen people were trapped in a blazing two-story apartment building. The new cellular capability allowed Fire Chief Don Cocker to directly contact the county fire coordinator and fire investigator. He was able to rapidly determine the details of the building's construction.

With this information, he could calculate the path and extent of the fire and safely direct his crews through the building. The firemen acted quickly, and the 13 people trapped people were rescued with nothing worse than mild smoke inhalation, and the building itself escaped with a minimum of structural damage from holes poked in the walls and ceilings.

Highway Patrol Taking Cellular Calls For Safety

Working in cooperation with Mothers Against Drunk Driving (MADD), the Minnesota State Highway Patrol has suggested to cellular subscribers of US WEST that the can call 9-1-1 on their cellulars in order to speak directly with a state highway patrol dispatcher. They hope that US WEST subscribers will make this (free) call to report the locations (plate numbers, vehicle descriptions,

Over 75,000 active amateurs in over 125 countries throughout the world read and enjoy a different kind of ham magazine every month. They read CQ.

It's more than just a magazine. It's an institution.

SUBSCRIBE TODAY!



CQ The Radio Amateur's Journal
76 N. Broadway, Hicksville, NY 11801

Please send me CQ for Life 3 Years 2 Years 1 Year
 New Renewal Start with _____ issue
 1 year - 12 issues \$22.95
 Save \$12.45
 2 years - 24 issues \$43.00
 Save \$27.80
 3 years - 36 issues \$63.00
 Save \$43.20

Name _____ Call _____
 Street _____
 City _____ State _____ Zip _____

Charge My Order To: Payment Enclosed \$ _____
 MasterCard My account number is: _____
 VISA



THE SKY'S NO LONGER THE LIMIT

Airfone® **GTE**

In-flight Telephone Service

Card Number:

1101 550 9368 1001

TERRY HUNTER

Valid Thru: 12 31 90

GTE Airfone Inc. now offers special rates to holders of one of their new credit cards for their in-flight telephone service.

speed, and direction of travel) of vehicles apparently being operated by drunk drivers.

Signs of drunk driving include the vehicle being operated at night with the headlights off, erratic braking, weaving out of lane boundaries, and moving as slow as 10 m.p.h., according to the agency. Colonel Kevin Kittridge, Chief of the MHP, pointed out that the agency isn't asking people to become vigilantes, they just want to be alerted to impaired driving since it is a sign that the driver needs help. In fact, erratic vehicle operation may also be caused by a person having a heart attack, a stroke, a diabetic problem, temporary mental confusion, or any number of other conditions requiring immediate medical attention that can be summoned by the MHP.

For more information on this program, contact Bruce Amundson, US WEST, at (206) 562-5740.

News of Rail and Air Phones

GTE Railfone Inc., which operates the cellular service aboard several Amtrak passenger train routes, tells me that persons having AT&T Calling Cards can now use them aboard the Metroliner (Washington to New York City), and also the San Diegan (Los Angeles to San Diego).

About 4,500 calls per week are placed from these two trains, and the ability to use the AT&T cards will make the service even more accessible to travelers.

GTE Airfone Inc., serving many airliners with domestic air/ground telephone service has some new things on tap, too. A new program provides special prices for users of its Airfone on-flight telephone service. The GTE Airfone Business Card program will allow passengers to pay a service fee, and then pay reduced per-minute rates.

Two subscription options are available for domestic calls. One is to pay a per-minute fee of 30 cents and a charge of \$399 for each six months of service. Alternately, there is a per-minute fee of 50 cents and \$50 per month. Current regular rates are \$2 per minute, plus a \$2 set-up fee per call for domestic calls (includes Alaska, Hawaii, Puerto Rico, Virgin Islands, and Canada).

For more information on obtaining a GTE Airfone Business Card, contact GTE Air-

fone Inc., P.O. Box 1420, Downers Grove, IL 60515-8837.

Gorbyoski!

The first public mobile telephone network has been opened in Moscow, covering the metropolitan area, Sheremetjevo Airport, and primary connecting highways. By the start of 1991, coverage will have been expanded to a full 50-km radius around Moscow.

This was a joint venture of the Moscow Telephone Network (MGTS) and the huge Finnish-based international cellular manufacturer, Nokia. Called the AMT mobile net-

work, the new system serves international firms and embassies located in Moscow and now has about 1,000 subscribers. Features include the ability to make direct calls to any phone in the world.

Plans include the availability of personal paging in the Moscow area starting next year, kicking off with 10,000 subscribers.

Our column is interested in hearing from readers with cellular and personal questions, suggestions, stories, thoughts, opinions, and whatever. We also like to hear from manufacturers with information on new products, and also from cellular service providers regarding their facilities and services.

PC



World's Most Powerful CB and Amateur Mobile Antenna*

**Lockheed Corp. Test Shows
Wilson 1000 CB Antenna Has
58% More Gain Than The
K40 Antenna (on channel 40).**

In tests conducted by Lockheed Corporation, one of the world's largest Aerospace Companies, at their Rye Canyon Laboratory and Antenna Test Range, the Wilson 1000 was found to have 58% more power gain than the K40 Electronics Company, K40 CB Antenna. This means that the Wilson 1000 gives you 58% more gain on both transmit and receive. Now you can instantly increase your operating range by using a Wilson 1000.

**Guaranteed To Transmit and Receive
Farther Than Any Other Mobile
CB Antenna or Your Money Back**
New Design**

The Wilson 1000 higher gain performance is a result of new design developments that bring you the most powerful CB base loaded antenna available.

Why Wilson 1000 Performs Better

Many CB antennas lose more than 50% of the power put into them. The power is wasted as heat loss in the plastic inside the coil form and not radiated as radio waves.

We have designed a new coil form which suspends the coil in air and still retains the rigidity needed for support. This new design eliminates 95% of the dielectric losses. We feel that this new design is so unique that we have filed a patent application on it.

In addition, we use 10 Ga. silver plated wire to reduce resistive losses to a minimum.

In order to handle higher power for amateur use, we used the more efficient direct coupling method of matching, rather than the lossy capacitor coupling. With this method the Wilson 1000 will handle 3000 watts of power.

The Best You Can Buy

So far you have read about why the Wilson 1000 performs better, but it is also one of the most rugged antennas you can buy. It is made from high impact thermoplastics with ultraviolet protection. The threaded body mount and coil threads are stainless steel; the whip is tapered 177 ph. stainless steel. All of these reasons are why it is the best CB antenna on the market today, and we guarantee to you that it will outperform any CB antenna (K40, Formula 1, you name it) or your money back!

*Inductively base loaded antennas
**Call for details.

Lockheed - California Company

A Division of Lockheed Corporation
Burbank, California 91520

Aug. 21, 1987

Wilson Antenna Company Inc.
3 Sunset Way Unit A-10
Green Valley Commerce Center
Henderson, Nevada 89015

Subject: Comparative Gain Testing of Citizen's Band Antennas
Ref: Rye Canyon Antenna Lab File #670529

We have completed relative gain measurements of your model 1000 antenna using the K-40 antenna as the reference. The test was conducted with the antennas mounted on a 16' ground plane with a separation of greater than 300' between the transmit and test antennas. The antennas were tuned by the standard VSWR method. The results of the test are tabulated below:

| FREQUENCY (MHZ) | RELATIVE GAIN (dB) | RELATIVE POWER GAIN (%) |
|-----------------|--------------------|-------------------------|
| 26.965 | 1.30 | 35 |
| 27.015 | 1.30 | 35 |
| 27.065 | 1.45 | 40 |
| 27.115 | 1.60 | 45 |
| 27.165 | 1.50 | 41 |
| 27.215 | 1.60 | 45 |
| 27.265 | 1.75 | 50 |
| 27.315 | 1.95 | 57 |
| 27.365 | 2.00 | 58 |
| 27.405 | 2.00 | 58 |

**58%
MORE
POWER GAIN
THAN THE
K40**

CALL TODAY
TOLL FREE: 1-800-541-6116
FOR YOUR NEAREST DEALER
Wilson 1000
Available in Black or White

Roof Top Mount **59⁹⁵**
Trunk Lip Mount **69⁹⁵**
Magnetic Mount **79⁹⁵**
Wilson 1000 Trucker **59⁹⁵**
DEALERS Exclusive dealer areas still open

Wilson
ANTENNA INC.
1181 GRIER DR., STE. A
LAS VEGAS, NV 89119

CIRCLE 43 ON READER SERVICE CARD

Shuttle Amateur Radio Experiment

There are two Shuttle Amateur Radio Experiments (SAREX) scheduled for 1990. STS-35 (Columbia) was scheduled for launch in June. It will carry Dr. Ron Parise, WA4SIR, a payload specialist. He will be operating on 2 meter Amateur Radio frequencies in voice and data (Packet) mode. The second mission, STS-37 (Atlantis) will carry Lt. Col. Ken Cameron, KA5AWP. He will conduct experiments in voice, Packet, slow scan and fast scan TV.

Packet operations will be continuous for 12 hours each day from the Shuttle. The Packet station will be in the Robot mode and operate automatically. It will be able to work up to 9 Packet stations simultaneously. The Robot beacon will send a QRZ every two minutes. The primary Packet frequencies will be 145.550 MHz downlink and 144.950 MHz uplink (a standard 600 kHz repeater split). Packet operation will be in AFSK/FM at 1200 BPS. Just like standard terrestrial VHF Packet. You will connect to the shuttle the same way you would any other Packet station using Ron's call, WA4SIR. Voice and TV operation will depend upon the astronauts work load and sleep schedule.

The orbital track of both missions will have an inclination of 28.5 degrees. This will put the US out of range (with the exception of the far S.E. portion of the country) during most of the operational periods.

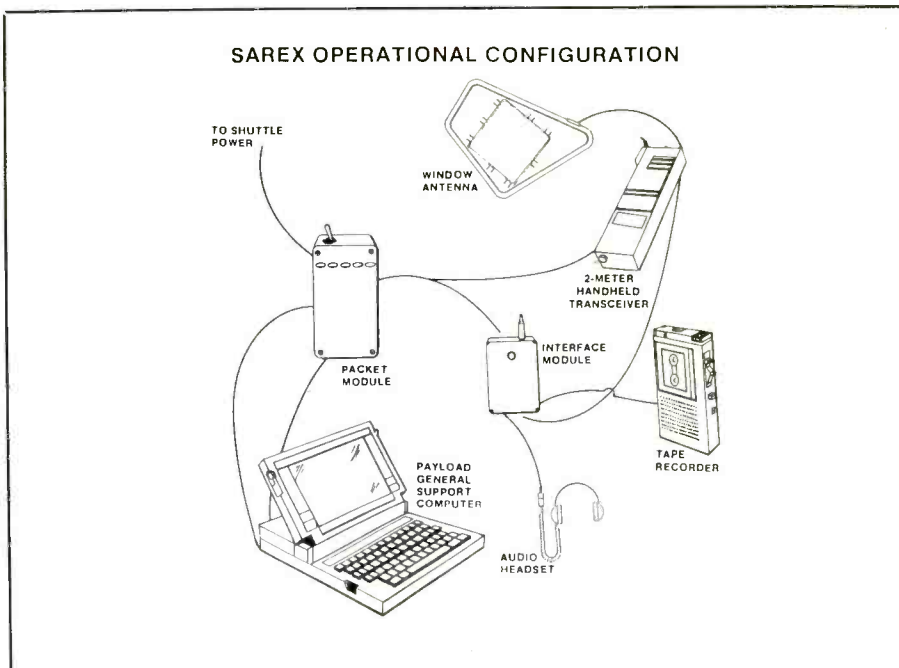

Equipment configuration for STS-35

AMSAT-NA plans to establish an H.F. ground station network to relay Shuttle communications. Stations are being set up in Africa, South America, Mexico and Ja-

pan. These stations will be under the management of W5RRR at Johnson Space Center in Houston. Shuttle communications will be carried by WA3NAN of God-



SAREX H.F. Frequencies

| | | |
|-----------|--------|----------------------------|
| 3.850 MHz | W5RRR | Johnson Space Center |
| 3.860 | WA3NAN | Goddard Spaceflight Center |
| 7.185 | WA3NAN | Goddard |
| 7.227 | W5RRR | Johnson |
| 14.280 | W5RRR | Johnson |
| 14.295 | WA3NAN | Goddard |
| 21.380 | W5RRR | Johnson |
| 28.400 | W5RRR | Johnson |
| 28.645 | WA3NAN | Goddard |

STS-35 Columbia Sarex Frequencies

| | Shuttle Transmit Frequency | Accompanying Shuttle Receive Frequencies |
|---------|----------------------------|--|
| Group 1 | 145.55 MHz | 144.95 MHz |
| | 145.55 | 144.91 |
| | 145.55 | 144.97 |
| Group 2 | 145.51 | 144.91 |
| | 145.51 | 144.93 |
| | 145.51 | 144.99 |
| Group 3 | 145.59 | 144.99 |
| | 145.59 | 144.95 |
| Group 4 | 145.55 | 144.95 |
| | 145.55 | 144.70 |
| | 145.55 | 144.75 |
| | 145.55 | 144.80 |
| | 145.55 | 144.85 |

Note: The 145.55/144.95 combination is in both Groups 1 and 4 because alternate uplink frequencies from Group 1 would be used over North and South America while those from Group 4 would be used generally in parts of the world.

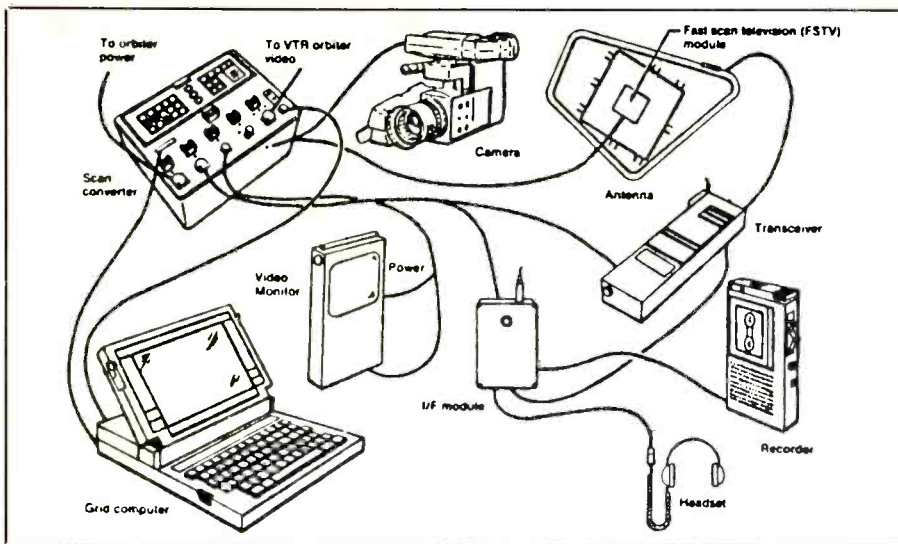

Equipment configuration for STS-37

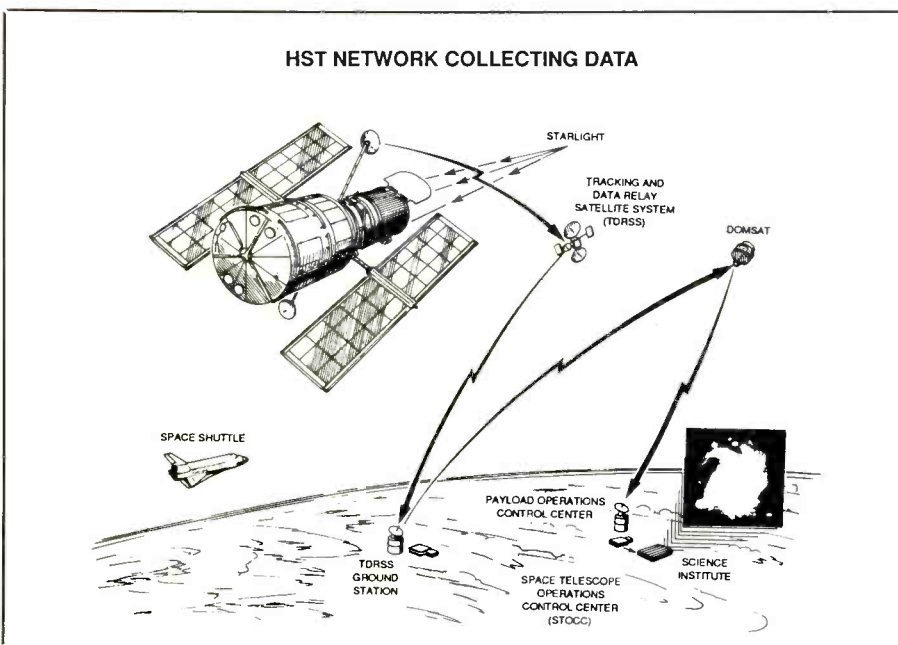
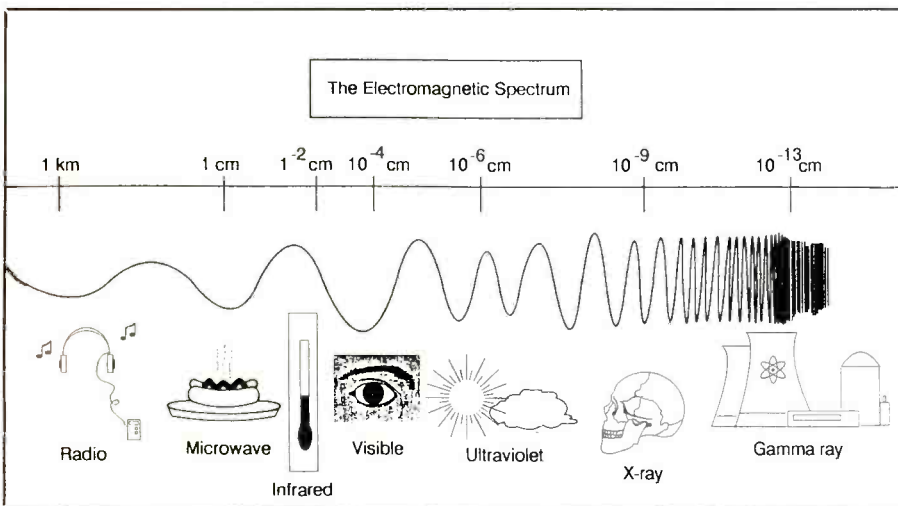

standard Spaceflight Center and W6VIO at the Jet Propulsion Laboratory in California. The Network will carry NASA mission commentary and radio transmissions, bulletins etc. The station will be broadcasting in the 75, 40, 20, 25 and 10 meter bands. The entire network is a complex one. It will require a combination of Amateur and Commercial satellites, H.F. radio and other commercial telecommunications facilities to provide this 'Live' coverage of the mission. In addition, a teleconference is planned to feed many Amateur repeaters throughout the US. This segment of the network will give easy access to schools and clubs for which several educational activities are planned. A short post-flight video will also be available to participants.

The Shuttle program has been on hold for several weeks now, due to a serious fuel leak problem. According to NASA officials, it is hoped that at least two shuttle launches can take place before the end of the year. The two missions with priority are; STS-38, a secret DOD mission, and STS-41, which will carry Ulysses. The Ulysses spacecraft will study the Sun and Solar winds. It has a small window and needs to be launched in late October. This will likely push the flight of STS-35 into late 1990 and STS-37 into 1991.

NASA Notes

The Hubble telescope (HST) will be the first user of the TDRSS satellite system to simultaneously require use of both multiple access (DAMA) and S-band single access. This service will be provided for 85 minutes during each orbit of Hubble. Up to 12,000 commands are transmitted in realtime to Hubble each day to maintain operation. Hubble will downlink over 3 billion bits of information through TDRSS daily.

Two multiple access communications satellites (MACSATs) were launched by the Navy recently from Vandenberg AFB. MACSAT was a DARPA (Defense Advanced Research Projects Agency) program. The two satellites will provide global store-and-forward (Packet) message relay capability at UHF frequencies for a variety of DOD users during its first year of testing.

The Roentgen satellite (Rosat) is a joint military research project. It's mission is to locate, more precisely, sources of X-ray emissions in both spiral and elliptical galaxies.

Technology 2000 will be held at the Washington D.C. Hilton on November 27 and 28. It will feature speakers and exhibitors from NASA and their contractors. They will address both prior and potential spinoffs of NASA research. For more information call (212) 490-3999.

NASA select TV broadcasts a wide range of interesting space programs, including coverage of Shuttle missions. It's carried on Satcom F-2R, transponder 13, C-band located at 72 degrees west, frequency 3960.0 MHz, vertical polarization, audio is monaural on 6.8 MHz.

See you next month.

PC

THE EXCITING WORLD OF RADIOTELETYPE MONITORING

People worldwide have been astounded for more than a year by events in Eastern Europe that have overturned old political systems for dynamic new ones. These events, along with other similar ones in the Middle East and Africa, may have some effect on your future RTTY monitoring, if they haven't already.

East and West Germany plan to unite politically in 1991 after merging economically and monetarily this past July. There is already talk about Berlin becoming the capital of the unified Germany as it had been from 1871 to 1945. Bonn, meanwhile, temporarily would keep the government offices because of the huge cost involved if the offices were to be moved to Berlin all at the same time.

This political unification would shut down East German diplomatic missions abroad. Gone would be all the stations using the Y7B through Y7L series of call signs, such as Y7L36 in Havana, Cuba, that had been monitored by RTTY buffs worldwide for many years. KNY37 in Washington, DC, would be shut down. The "Y7A" and "Y7K" stations from the foreign affairs ministry in Berlin, will be history.

Gazing into my crystal ball, I see the All-gemeiner Deutscher Nachrichtendienst (ADN) news agency in Berlin still transmitting RTTY news over HF Radio. But will the International Telecommunications Union allow ADN to keep its "Y2V" series of call signs? Will a unified Germany still have title to call signs beginning with Y2 through Y9, so that the maritime coastal station at Ruegen will remain Y5M? Only time will tell.

In the Middle East, pro-Western North Yemen and socialist South Yemen merged last May to become the Republic of Yemen, with ties to the West. San'a, the capital of North Yemen, became the capital of the new republic, while Aden, the capital of South Yemen, became the economic capital.

Prior to the merger, North Yemen used the 4W series of call signs and South Yemen had the 70 series. How will the ITU allocate the call signs now to the Yemen Republic? Will "70C," still be Khormaksar Aero? This station, as many RTTY hobbyists will tell you, had a peculiarity of sending its call sign as "70C," substituting a zero, for some strange reason, for the letter O.

This column will continue using the current series of call signs issued to the two formerly separated Yemen states until we are informed of the issuance by the ITU of new call signs.

In Africa, anti-government forces in Liberia last June captured the Firestone Tire and Rubber Company plantation, that country's biggest employer, at Harbel, about 30 miles east of Monrovia, the capital.

A KULUGYMINISZTERIUM CSUTORTOKON AZ MTI-HEZ KOZLEMENYT JUTTATOTT EL, AMELYBEN MELY AGGODALMAT FEJEZI KI A KOZEL-KELETI HELYZET UJABB HIRTELEN ROMLASA MIATT. MINDENKITOL ONMERSEKLETET SURGET, MERT MEGGYOZODESE SZERINT MINDEN MODON ELEJET KELL VENNI AZ INDULATOR TERJEDESENEK. EBBEN IGEN NAGY A MEGSZALLO HADSEREG FELELOSSEGE.

A MAGYAR KULUGYMINISZTERIUM EGYELORE NEM KAPOTT HIVATALOS ERTESITEST AZZAL KAPCSOLATBAN, HOGY A SVAJCI KORMANY A VIZUMKENYSZER ELTORLESET TERVEZI A KET ORSZAG KOZOTT. A TARCA ILLETEKESE UGYANAKKOR KOZOLTE: A KOVETKEZO HONAPBAN MINDEN BIZONNYAL SOR KERUL DANIAVAL ES SPANYOLORSZAGGAL A VIZUMKENYSZER TELJES ELTORLESERE.

A MAGYAR SZOCIALISTA PART A HET VEGEN TARTANDO KONGRESSZUSAN EGYERTELMUVE KIVANJA TENNI, HOGY SZOCIALDEMOKRATA JELLEGU, A SZOCIALDEMOKRACIA ERTEKEIT VALLO ES MEGVALOSITO SZOCIALISTA PART. NEM FOLYTATOJA, POLITIKAILAG NEM OROKOSE AZOKNAK A PARTOKNAK, AMELYEK AZ UTOBBI EVTIZEDEKBEK MEGUKAT KOMMUNISTANAK NEVEZTEK, VAGY ANNAK VALLOTTAK - HANGOZTATTAK AZ MSZP VEZETOI A KONGRESSZUST MEGELOZO SAJTOTAJEKOZTATOJUKON.

V E G E

WWW
HGX51 DE HGX21

V
VEEGE, NINCS TOEBB. SZABO UR NAGYON KOESZOENI GALAMBOR URNAK A KOEZREMUEKOEDEEST. UEDV,
MAASOM NINCS, BUCSUZOM JO PIHENEEST, JO WEEK END-ET UEDV.
MINDENKINEK S A HEETFOEI VISZLAAT AWS BY BY ""

End of a news transmission in Hungarian sent by HGX21, MFA, Budapest, Hungary, to HGX51. The call signs of both stations are given at the end of the transmission, before the sign-off which used the English expression "weekend." (This was logged on a Friday. Monitored on 13872.5 kHz at 1507 UTC, 425/100R. None of the standard references have a location for HGX51. Does any reader know it? If so, please inform us.

Veteran RTTY hobbyists have viewed telex traffic in the ARQ mode for many years between the plantation and company headquarters in Akron, Ohio. The primary frequencies were 15780 kHz and 15940 kHz.

When this column was being compiled, the plantation remained in operation. Only the dependents of non-Liberian employees

had been evacuated. For the employees themselves, it was business as usual, but Akron kept in constant communication with them. The 125,000 acre plantation employs 8,500 Liberians.

Now to the loggings section, in which all of this month's listings are from notebook of this column's editor.

NHUNO CUOC HOI DAM THAN RONGNDE BINH TH ONG HOA QUAN TE OIUBAC KI HA NONBM
CAC NGUON THAO TIN NOI E
I U MN O RUNG QUOC LDNO NGHIEM
HO
NH A CO MAT O HA NOI MOT STNLAY DE CHIAN BI CHO NHUYEN THAM
NUATU DON IN.
THAI LAN U VIET NAM WC AFP LCVBANG COC 31-5) OOT QUAN CHUC
N
ANA& HON P NGU D
N TH
I LAN OI B
T G
IVI DANH CA
XBATTHROI PHAH TRONG LANH HAI MN HOM NAYON DA DUOC T
E VOI
GIA DI
QUAN C UC N
Y CHO BIET 2510, & 7 DAN THAI TAN NGAY 30- DA TOI
SANOAYTRONAB CHIDONAMUABBYCZAZ30
CUA K ONG TUC THAI LAN CON 251 NGU DAN KHAC SE TRO VE THEI LAN
VAO NGAY HOM NAY.

Part of a news broadcast in Vietnamese sent by VNA, Hanoi, Vietnam, on 13655.5 kHz at 1510 UTC, 425/50R.

IDs of these two stas?

14960: RFLI, French Navy, Fort de France, Martinique, w/"controle de voie," ARQ-E3 425/192 at 1655.

15664.4: AFA2ER, A USAF MARS sta., chatting w another MARS sta at 1415, 350/45R.

15838.5: VER, Canadian Military, Ottawa, ON, w/encryption, TDM2 425/95-B at 1538.

16000: CNM69 1X, MAP, Rabat, Morocco, w/nx in FF, 425/50R at 1147.

16015: MFA, Sofia, Bulgari, w/tfc in Bulgarian, 75N at 1309.

16031.4: RBI75, PTT, Moscow, USSR, w/tfc to Kabul, Afghanistan, TDM2 425/96-B at 1152.

16032.8: RBI75, PTT, Moscow, USSR, on a diff circuit to Kabul, idling 1208 to past 1258, TDM2 425/96.

16056: NNN0TOH, a USN MARS sta, w relay of MARSgrams to NNN0THZ at 1616, Packet 1030/300. MARSgrams were from the crew of the USS Belleau Wood, and were previously relayed to the mainland several days earlier by NNN0NWH, Pearl Harbor, HI (see my logging at 20579 7).

16107.5: HBD20, MFA, Berne, Switzerland, w a 5L msg, ARQ, 1340-1402.

16117: 6VK317, PANA, Dakar, Senegal, w/nx in EE, 425/50R at 1236.

16250: RME22, Tass, Moscow, USSR, w/nx in Armenian at 1229, 425/50R.

16260: REM57, Tass, Moscow, w/nx in FF, 50R at 1318.

16300: RMD59, APN, Moscow, w/nx in PP, 425/100R at 1117.

16302: DFZG, MFA, Belgrade, Yugoslavia, w/RYRY at 1431, 425/75N, foll at 1435 w 3F grps & crypto after XYXYXY. Was // 18055.

16305: FJDG, Diego Garcia Meteo, Brit. Indian Ocean Terr., w/coded wx obs + msgs + CQ's, 1201-1245, 850/50R.

16326: Un-ID w/5L msgs, 1507-1523, 425/100R. Possibly Cuban diplo because I have logged CLP12, Embacuba Panama, in near this freq., 16326.8, at 425/100N.

16334: TAD, MFA, Ankara, Turkey, w/nx in Turk, 1535-1539, 850/75R.

16343: YZ14, Tanjug, Blegrade, Yugoslavia, w/nx in EE, 425/50R at 1322.

16387: XVN43, VNA, Hanoi, Vietnam, w/RYRY at 1208, foll by nx in FF at 1210, 425/50R.

16403: Y2V57, ADN, Berlin, GDR, w/nx in AA at 1852, 425/50N.

16955: UDH, Riga R., Latvia, w an ARQ phasing sig at 2042 + "UDH scan auto" marker in CW.

17443: BZG48, Xinhua, Beijing, China, w/nx in FF, 425/50R at 1138.

17510: RFD53, Tass, Moscow, USSR, w/nx in FF at 1150, 425/50R.

17513: AGA, Hickam AFB, HI, w/aero wx, 850/75N at 1400.

18042: DFZG, MFA, Belgrade, Yugoslavia, w/crypto after ZPZPZP, 425/75N at 1621. Moved up 1 kHz at 1657, sendt RY's w/o ID, then another crypto msg after ZPZPZP. Off the air at 1659.

18125: RND70, Tass, Moscow, w/nx in EE, 425/50R at 1150.

18160: RTB25, Tass, Moscow, w/nx in FF at 1156, 425/50R.

18242: ZRO4, Pretoria Meteo, RSA, w/coded wx at 1338, 425/75N.

18295: SDU9, STA, Stockholm, Sweden, w/a svc msg to Ho Chi Minh Ville, Vietnam, TDM2 425/96A at 1430, & w/tfc on channel B at 1450.

18376: RPFN, Monsanto Navrad, Portugal, w/foxes, counting & RYRY to RPTI, 850/75R at 1526.

18385: RRQ20, Tass, Moscow, USSR, w/nx in EE, 425/50R at 1657.

18634: CLP1, MFA, Havana, Cuba, w/valjiaminrex ttc to Embacuba Guyana, 425/100N at 1323.

18502: RFFA, Defense Ministry, Paris, France, w/"non protege" msgs in FF at 2148, TDM2 850/96-B; and w/"de Provence" + "controle de voie" on channel A at 2210.

18645: Un-ID w/just one 5L msg from 1343-1404, 500/75N. S/off w CFM GP 17 TKS GB SU.

18776-18777.7: MKK, RAF, London, England, w/foxes, counting, and RYIs on 6 FDM channels, 170/50N&R at 1544.

18966.5: RFHJ, French Navy, Papeete, Tahiti,

w/"controle de voie," ARQ-E3 425/96, at 1446 & 2132.

18993.5: SPW, Warsaw R., Poland, wkg an unid sta in ARQ at 1451.

19090.5: CLP1, MFA, Havana, Cuba, w/crypto after ZZZZZ to Zambia at 2205, and to Angola at 2230, 425/50N.

19618: YBU, GDR Embassy, Havana, Cuba, w/RYRY + "YBU" ID, 1828-1830, 550/75N, foll by 10 5L msgs until 1843.

20179.5: RFFA, Defense Ministry, Paris, France, w "non protege" ttc in FF at 1816, ARQ-E3 425/100.

20220: CLP1, MFA, Havana, Cuba, w/a congratulatory letter in SS & EE to Tanzania, 425/50N at 1957.

20325: MFA, Sofia, Bulgaria, w 5F msgs for its embassy at Buenos Aires, Argentina; a telegram in Bulgarian for Caracas, Venezuela; and a list of issued visas for Lima, Peru. Was 425/75N at 1956.

20381: CAK, Santiago Aero, Chile-aero wx & plaintext wx in SS, 850/50N at 2317.

20402: YWMI, Mairacaibo Navrad, Venezuela, w/unclassified ttc in SS to LOL, 850/75N at 2332.

20420: Y2V20, ADN, Berlin, GDR, w/nx in EE at 1535, 50/425N.

20556: RFGW, possibly MFA, Paris, France, w/5F msgs & ttc in FF to "U3H," 1444-1503, 144/FEC-A. The RFGW routing indicator has been used not only w Paris, but with other French stas outside France, usually in Africa, w the tag "milfrance." I believe, therefore, that RFGW collectively refers to the defense ministry offices at MFA, Paris, and its embassies.

20579.7: NNN0NWH, USN MARS, Pearl Harbor, w/MARSgrams from the crew of USS Belleau Wood (LHA 3), an amphibious assault ship, 170/75R at 2351.

20621: OMZ, MFA, Prague, Czechoslovakia, w/nx in Czech, 425/100N at 1442.

20715: Defense Ministry, Paris, France, w/"non protege" msgs in FF & 5L msgs, ARQ-E3 850/48, at 1556.

20734: Un-ID ending ARQ xmsn at 2254 w "urgent for rblac please fax a leila lima" & the remaining few wds garbled. The UN is listed on this freq. for ARQ xmsns.

21863.5: N. Korean Embassy, Havana, Cuba, w/5F msgs & nx in KK, 1000/50N at 1812.

22457: PWZ33, Rio de Janeiro Navrad, Brazil, w/ttc in PP at 2044, 50/850R; & w/Teste The quick brown fox . . . SGSG, RYRY, & 10 count, 2227. . .

22487: WLO, Mobile R., AL, w/a ttc list in FEC at 2230.

22566: WLO, Mobile, w/telex to PGDY, ship N. Madras, ARQ at 1751.

22571.5: WCC, Chatham R., MA, w/a ttc list in FEC at 2244.

22588: WLO, Mobile, wkg ships in ARQ mode at 1801.

22589: WLO, Mobile, w/high seas wx forecast in FEC at 1746.

22766: Un-ID using Packet 1030/300 at 2252. QRM gets increasingly louder at this time and covers the sig.

22904.5: DMK, MFA, Bonn, FRG, w/a brief msg in GG to an un-ID sta., ARQ-E 170/96, at 1738.

23355: Cuban Embassy, Kampala, Uganda, w/cables in 5F grps, 500/75N at 1907. To CW at 1919.

23373: Un-ID sta w s/off in II at 1457, ARQ-E 170/96.

23697.6: DFX69H6, PIAB, Bonn, FRG, w/nx in GG, FEC-A 425/96 at 1612.

23716: RFLI, French Navy, Fort de France, Martinique, w/METAR + non protege ttc in FF + "controle de voie," ARQ-E3 425/96 at 1457.

25222.5: WLO, Mobile R., AL, w/FEC phasing sig + CW ID at 1615.

25344: ZRQ8, Cape Town Navrad, RSA, uses tact. ID of S12SN in many msgs, 170/75R at 1442. Msgs included NAWS fm "BWZZ" to "RIF5"; ZRH 2/4/5/6/7 07201 S12SN RYRY. . . ZRH 2/4/5/6/7 07201 S12SN SGSG . . . ; 5L msgs, &, at 1530, nx in Afrikaans, foll by more 5L msgs.

25417.5: FRG Embassy, Buenos Aires, Argentina w "guten tag aus Buenos Aires" (good day from Buenos Aires) s/on to MFA, Bonn, w/ARQ-E 170/96 at 1655.

25421.5: FRG Embassy, Brasilia, Brazil, w "guten tag aus Bras." S/on to MFA, Bonn, ARQ-E 170/96 at 1430, foll by "teleks" ttc at 1435.



MetroWest announces . . .

Double Time for your Bearcat 100 XLT and 200 XLT Scanners

Run TWICE as long between charges with the New MetroWest Pro Pack 1200!

- 1200 ma-hr pack has Double the capacity of the original Bearcat pack.
- Perfect fit, style and color match to scanner. Only 0.2" Thicker than BC Pack. Fits into factory case.
- Recharges with your Bearcat module
- Guaranteed to double your run time
- 30 day trial and 1 Year performance guarantee
- Fully USA Made

MetroWest Only \$59 (plus \$4 S&H)
 822 N. Spring LaGrange Park, IL 60525
 (708) 354-2124 Mastercard and VISA accepted

CIRCLE 52 ON READER SERVICE CARD

FREE SAMPLE COPY!

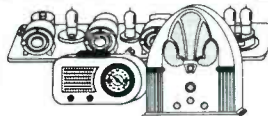

ANTIQUE RADIO CLASSIFIED

Antique Radio's Largest-Circulation Monthly Magazine

Articles - Classifieds - Ads for Parts & Services
Also: Early TV, Ham Equip., Books, Telegraph, 40's & 50's Radios & more...

Free 20-word ad each month. Don't miss out!

Free Sample. 6-Month Trial - \$13.
1-Year: \$24 (\$36 by 1st Class). Foreign - Write.
A.R.C., P.O. Box 802-T6, Carlisle, MA 01741

CIRCLE 51 ON READER SERVICE CARD

ICOM™ R7000 Sweeping 1300 Channels/Min.

DELTACOMM™ 1.04 gives you a custom interface and optimized software that will not just control but will maximize the potential of your R7000. Spectrum log at speeds in excess of 1300 channels/min. while automatically generating a histogram of frequency/activity. Advanced priority channel monitoring and program control, by channel, of remote tape recorders during scanning. Here are a few (there are many more) examples of the advanced features DELTACOMM has to offer:

- Birdie log during frequency search automatically characterizes your R7000, then locks out those frequencies.
- Auto histogram and scan file creation during spectrum log.
- Scan file channel lock-out feature allows scanning around channels without removing that frequency from database.
- Resume scan and maximum monitor values unique on each channel scanned.
- Each frequency within a scan file has an area (40 characters wide) for channel information.
- Auto frequency detection and storage during search and spectrum log.
- User friendly installation program reduces need for DOS knowledge.
- Full support of serial ports COM1-COM4
- On-screen HELP reduces need to refer to user manual.
- REQUIREMENTS: MS-DOS microcomputer with minimum 512k memory. DELTACOMM's performance is proportional to baud rate setting, style of display card and type of computer used.



\$299 Incl. Ext. Interface & Components for Cabling.
 Check, MO, VISA or MASTER
 Accepted + \$4 for S&H
 (WI Res. Add 5% Sales Tax)



DELTA RESEARCH
 PO Box 13677 • Wauwatosa, WI 53213
 FAX or Phone Weekdays (414) 353-4567

CIRCLE 53 ON READER SERVICE CARD

GETTING STARTED AS A RADIO AMATEUR

Waiting For Your Ticket

Every new ham faces the same problem: You've studied long and hard and you've just passed your Novice or Technician test. The first obstacle on the road to radio enjoyment is behind you and you feel like a million bucks. Now you're passing time waiting for the mailman to arrive with your sought-after license.

Until that piece of paper arrives, you're technically not a ham; but there are things you can do to lessen the frustration of playing the waiting game and ensure your first QSO will be all that you've imagined. The time between passing your test and the arrival of your license can be one of the most profitable times of your Amateur Radio career. Use the time wisely. Prepare your shack—and yourself!

Don't Stop Learning

Keep studying. All the work you put in preparing for your Novice or Tech test is only the beginning of a lifelong process of radio education. Obtain the study materials for your next license class and get to work! You'll go from SWL to Extra Class in a hurry if you get in the upgrade habit early.

Get to know the hams in your area. Tell them who you are and describe your situation. Visit as many local hams as you can. Chances are they'll be happy to have you over and enjoy the opportunity to welcome you to the local radio scene. A great way to meet new hams is to join a local radio club. If you'd like information on the clubs in your area, drop me a line at the address given at the end of the column. I'll be happy to send you a list of clubs in your area. Talking with other operators provides some "real-life" information to augment what you've learned from the study guides. Besides, it's never too early to make new radio friends!

Get Your Shack Ready

Before you buy a rig, there are a couple of things you should do: (1) Prepare your operating position and (2) Put up an antenna.

Getting your shack ready is important: Timely assessment of power sources, available space and possible antenna locations can make radio more enjoyable later.

Although it's difficult to offer specific advice, a few observations are in order. The shack and antenna location should be considered a single problem. It does little good to erect an antenna in a place where it's difficult or nearly impossible to run the feed line to your shack. On the other hand, if your antenna's too close to your shack, you may have RF feedback problems. This is called

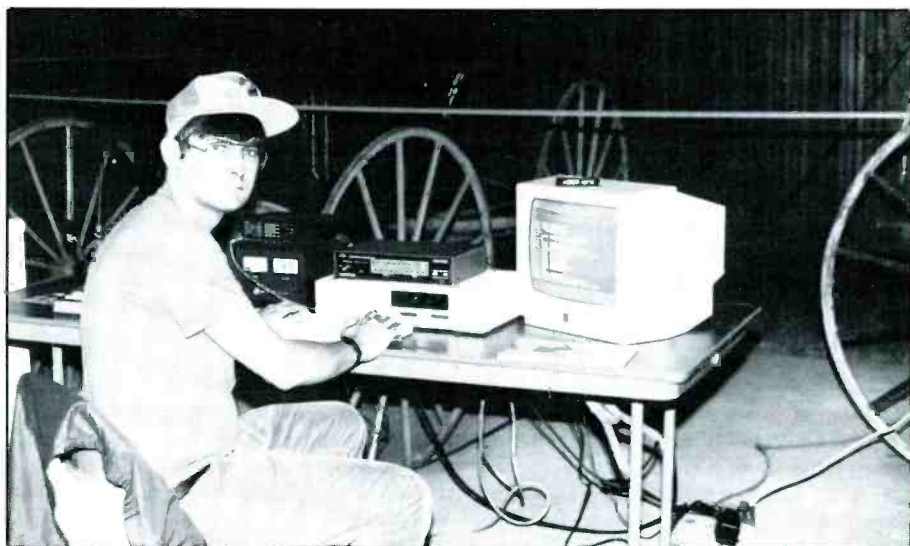

Andrew D. Schmidt, N2FTR, operates the packet station at the Poughkeepsie Amateur Radio Club's special-event operation at the Young-Morse Historic Site, or Locust Grove. Samuel F.B. Morse, inventor of the telegraph, among other things, lived in the house from 1847 to 1872. More than 200 people toured PARC the setup, which was in the 19th century carriage house.

having a "hot" shack—and you should avoid it!

Ideally, your shack should be at ground level or even in the basement—if the humidity can be adequately controlled(!)—because of easy access to a good earth ground. If you must set up your shack on the second or third floor, don't despair. A simple counterpoise (detailed in the August Ham Column) will get you on the air. Your shack should have a window to the outside world to facilitate the routing of feed lines and ground leads.

Your Operating Position

Even if you haven't obtained a rig yet, it's a good idea to consider the desk or table that will hold all of the radio gear and accessories you'll be accumulating. At a minimum, your station will probably include a transceiver, a microphone, a key or keyer, a logbook, headphones and several publications. Not only must your desk hold all of this stuff (and probably more), you've got to have room to "spread out" while operating. Because you'll be spending a fair amount of time there, don't forget good lighting and a comfortable chair. A swivel chair is best, if available.

Which Antenna?

Although a detailed discussion of the pros and cons of various antennas is beyond the scope of this column, a few comments are

appropriate. You may want to consider putting up some kind of multiband antenna. Statistically, Novices and Techs upgrade quickly, so as long as you're going to the trouble to put up an antenna in the first place, you might as well be prepared for future operating bands and modes right away.

Commercially made multiband antennas are advertised in *QST* and other ham magazines. You can make your own multiband antenna, however, if you have simple soldering skills and a few tools.

All of the materials are found at your local hardware store.

An excellent source of information on building simple (single and multiband) antennas is Doug DeMaw's *Novice Antenna Notebook*, available from the ARRL.

I hope I've given you a few ideas that will make waiting for your ticket to arrive a little more bearable. It can be a nerve-wracking time. Be thankful that Novice and Tech tickets are generally processed a little faster than they were ten years ago!

If you have a problem (as we all do at times), don't be afraid to ask for help. Most hams will agree—there's no better way to pay back the hobby than to help a new ham. Have fun!

Send your ideas, photos, suggestions and requests for club information to me at ARRL, Department PCN, 225 Main Street, Newington, CT 06111. See you on the bands.

PC

WHAT'S HAPPENING: INTERNATIONAL SHORTWAVE BROADCASTING BANDS

Back in days long gone, circa the mid-1950s, one could tune in broadcasts from Radio Brazzaville, in what was then French Equatorial Africa, about as easily and clearly as the signals we used to get from Radio RSA. And in English, yet. In the decades since, though, Brazzaville has become a more difficult catch due, to no small degree, to the tendency of the station to be inactive as much as it is active. So it was good news when the station ended another long period of inactivity and returned to the air, apparently with fresh transmitters. Look for RTV Congolaise—IDing (in French) as the Voice of the Revolution—3265, signing on at 0357. Perhaps an even better opportunity to hear it is on 15190 where it is active for much of our daylight period. We don't know what their QSL policy is like these days. Reception reports should be sent to Radiodiffusion Television Congolaise, B.P. 2241, Brazzaville, People's Republic of the Congo.

Construction of the Voice of America relay in Israel has been placed on a two year hold by the Israeli government while more

environmental studies are carried out. A few months back we told you about the complaints of environmentalists, nearby residents and even the military over the potential ill effects of that much RF in the area—even the very presence of the towers. Now Tel Aviv has decided it wants to know more about the effect such high-powered waves would have on the migratory birds which move through the area. The US has already spent \$40 million on the relay. The facility will also be used by Radio Free Europe/Radio Liberty. Stay tuned.

Meanwhile, budget crunches and declining world tensions have tensions rising within both the VOA and RFE/RL which are competing for as much of the funding pie as they can get. One governmental study group has already recommended that planning get underway now for the eventual closedown of Radio Free Europe and the transfer of those facilities to the Voice of America. RFE/RL will maintain its current budget next year, but the VOA's will be cut by \$2 million. More recommendations on the future of the governments's internation-



This vintage National HRO-60 receiver is in use in the shack of Helio Soares of Sao Paulo, Brazil.

al broadcasting efforts are still to come.

Radio Netherlands Media Network reports that there's been another delay in getting the Spanish National Radio's Costa Rica relay station on the air. In fact, construction hasn't even begun. The transmitter site has been deemed unsuitable, so another spot has to be found. The station will

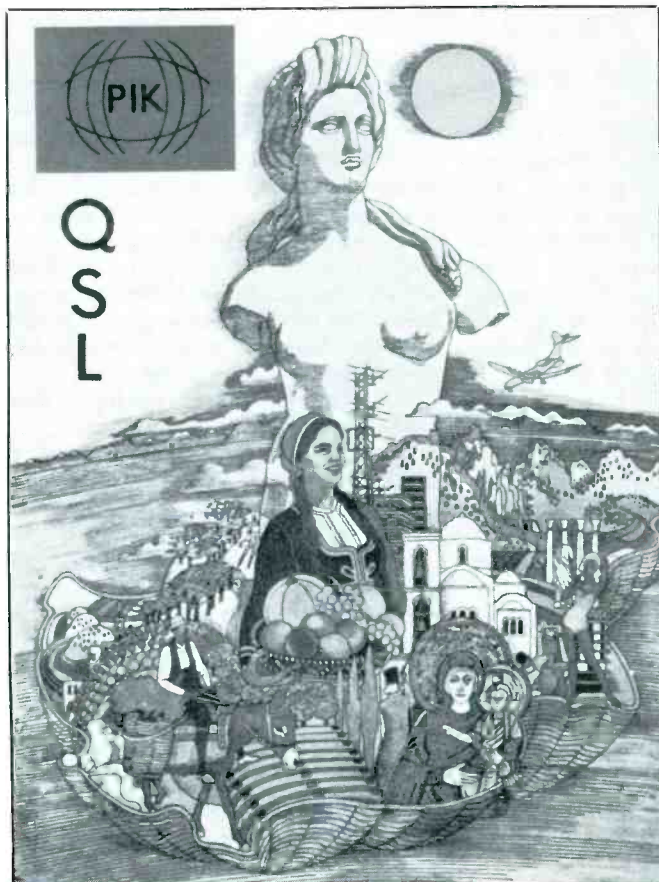

The Cyprus Broadcasting Corporation has a weekend only short-wave broadcast to Great Britain. Here's their QSL, courtesy of Aris Giannarelis of Greece.

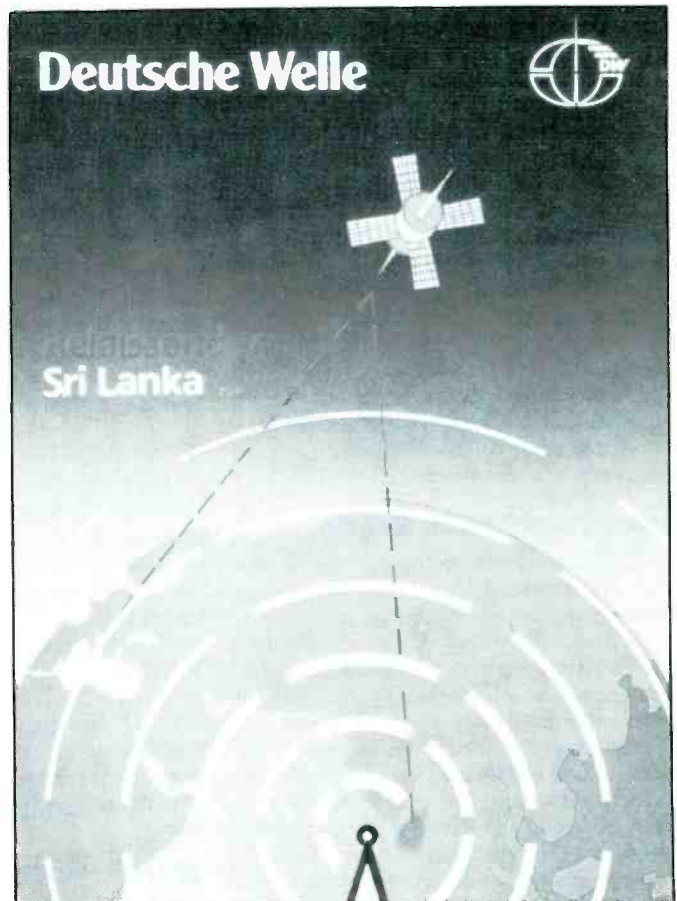

A special DW QSL covering reception of the Sri Lanka relay. (Thanks to William Walbesser, Ravenna, NY)



Utah! The World Is Welcome Here!

Here's the new and very attractive full color QSL card of KUSW Worldwide in Salt Lake City. (Thanks: Richard Contone, NY)

use a trio of 100 kw transmitters, which are already in Costa Rica.

More relay news: The transmitters of Radiobras in Brazil are probably being used as a Radio Beijing relay by now. The Radiobras units are to give Radio Beijing better coverage of Central and South America.

Radio Japan expects to have its Sri Lankan relay on the air early next year. Radio Japan will use the two-300 kw transmitters for ten hours per day. The facility will actually be a part of the Sri Lanka Broadcasting Corporation which will use it to improve reception of its own overseas broadcasts—and, if it works, that will be most welcome here.

Both of the Yemen stations, the former Radio San'a in the former Yemen Arab Republic and the former Democratic Yemen Broadcasting Service in Aden are now ID'ing as Republic of Yemen Radio, after the unification of the two countries. Best bets for reception are 9780 (actually closer to 9779) at 0300 sign on for the San'a transmitter. Check the former Democratic Yemen Broadcasting Service (Aden), also at 0300 on 7190. Reception of these two is far more an occasional thing than it is a daily affair! All programs are in Amharic.

WWCR in Nashville has a new mailing address, according to a QSL card received by Bob Fults, also in Tennessee. Mail to WWCR should now be sent to 4647 Old Hydes Ferry Pike, Nashville, TN 37218.

SURVEY. If you do any listening on the tropical bands you should get a copy of the new, 18th (1990) edition of the DSWCI Tropical Bands Survey. This is a very complete list of stations active between 2000 and 5900 MHz, listed by frequency with notes on times, languages, services and operating powers. You can get a copy via air-mail for nine International Reply Coupons.

Order from the Danish Shortwave Clubs International, c/o Bent Nielsen, Betty Nansens Alle 49, I tv., DK-2000 Fredericksberg, Denmark.

The *Mailbag* contains a letter from Robert Contone in Howard Beach, New York who wonders why European broadcasters only broadcast to North America in the evening. That's because most of them can only budget an hour or two a day for North America so they want to make that count by broadcasting when the potential audience is at its largest—in the evening when most people are at home rather than at work.

Kevin Story in Midland, Texas says he's recently added ten new countries, which puts him at the 99 mark. Good going, Kevin, and we'll wager you've hit 100 by now. Kevin says he's having QSL problems with Tunisia and Jordan. Both have a poor QSL'ing history, Kevin, and about all you can do is to be patient and keep trying.

Mike Perry in Beeville, Texas is puzzled over his loggings of an area medium-wave station—KIBL-1490—on 2980. That's their second harmonic, Mike!

Canadian time station CHU now gives the time in UTC/GMT instead of EST, notes Don Hallenbeck of Pittsfield, Maine. We don't know why or when this change was made, Don.

Don wonders about his current inability to hear WRNO in New Orleans on 7355 where he usually finds it in the local evenings. The most recent schedule has them there from 0000-0300, Don. You might also check 6185, 13720 and 15420 which are scheduled for use at other hours. The station is very much alive so perhaps its just some strange propagation preventing reception. As for seeing only one listing of WRNO in a recent *Listening Post*, we are getting away from carrying a long list of US station log-

gings and generally include only those which aren't so often reported or are somehow unusual.

Speaking of logs, remember we look for yours here each month. Please make them by country, leave room to cut them up, and include your last name and state abbreviations after each item.

We also welcome anything else you'd care to contribute—spare QSL cards for use as illustrations, schedules and other information from stations, news clippings and your comments and questions. And—photos of you and your shack—or just your shack if you're shy! We look forward to hearing from you as often as possible!

Here are this month's logs. All times are UTC and language is in English unless otherwise indicated.

Alaska: KNLS at 0805 on 11715 with "The Swingin' Years." (Story, TX)

Albania: Radio Tirana, 9500 at 0247 with man and woman with tourist phrases in English and Albanian. (Eager, NY) 11835 at 0800 with news. (Giannarelis, Greece)

Algeria: RTV Algerienne, 9535 at 0722 with news in FF, music. (Moser, PA)

Antigua: Deutsche Welle relay, 6040 at 0135 with "German by Radio." (Moser, PA)

BBC relay on 5875 at 0036 with religious program. (Moser, PA)

Ascension Island: BBC relay, 11750 at 0039. (Moser, PA) 17860 at 1705 with news, 17880 with sports at 1738, 21470 with religion at 1727. (Giannarelis, Greece)

Australia: Radio Australia, 9580 at 1233. (Olson, ND) 11800 at 1508, 15240 at 0805 and 21825 at 1004, the latter in JJ. (Giannarelis, Greece)

Austria: Radio Austria International, 9870//9875//13730 at 0138 with feature on economics. (Moser, PA) 0130 on 13730. (Pellicciari, CT) 21490 at 1532. (Carson, OK)

Bangladesh: Radio Bangladesh, 15195, very weak with talks at 1240. (Story, TX)

Belgium: BRT, 9925 in Dutch at 2218. (Moser, PA) 2330 in EE. (Pellicciari, CT) 13675 in DD at 1721 and 1004 in DD at 21810. (Giannarelis, Greece)

RTBF with IS at 0956 on 25645. (Giannarelis, Greece)

Botswana: Radio Botswana, 7255 at 0350 with IS. (Moser, PA)

Brazil: Radiobras, 11745 at 0227 with Latin music. (Moser, PA) Radio Bandeirantes, with ID by man in PP at 2338 on 11925. (Moser, PA)

Bulgaria: Radio Sofia, 11660 at 1836 with music. (Giannarelis, Greece) 15290 at 0355 with music. (Moser, PA) 15330 at 2130 with ID. (Eager, NY)

Burkina Faso: Radio Burkina, 4815 at 0531 with African music. (Moser, PA)

Cameroon: CRTV Yaounde, 7205 at 0540 with discussion about Cameroon settlements. (Story, TX)

Canada: CFRX relay CFRV, 6070 at 1240 with commercials, sports, ID. (Northrup, MD)

RCI: 9535 at 0232. (Olson, ND) 15260 at 1756 sign on. (Moser, PA) 17820 at 1804. (Carson, OK)

China: Radio Beijing, 15100 (via Mali, editor) at 0034 with chimes, history. Tentative log. (Moser, PA)

Chile: Radio Nacional de Chile, 15140 at 1737 with SS, music. (Moser, PA)

Costa Rica: Radio For Peace International, 21566 at 2235 in EE/FF with UN program "Scope," then "Caribbean Echoes" and into FF. (Carson, OK)

Adventist World Radio on 9725 at 1130 with ID, address and "Your Story Hour." (Moser, PA)

Cuba: Radio Havana Cuba, 11705 at 2249, via USSR relay. (Giannarelis, Greece)

Radio Solida, 9465 at 1235 in SS, ID. (Northrup, MO) (What is this? editor.)

Cyprus: Cyprus Broadcasting Corp on 7205//9650 at 2218 with play in Greek. Via BBC relay. (Giannarelis, Greece)

BBC relay, 11955 at 0234. (Moser, PA) 21470 at 1024. (Giannarelis, Greece)

High Performance 800MHZ



- Enjoy the best possible reception
- Hear signals other antennas miss
- Astounding performance outside
- Hear 10 times more signals when mounted directly on scanner

Only **\$19.95**

- Free shipping (Continental USA)
- Money back guarantee

MAX System™

GROUND PLANE ANTENNAS

CK-MO-MC-VISA Accepted (MA add 5% sales tax)

Send payment to: Cellular Security Group,
4 Gerring Rd., Gloucester, MA 01930
Or charge by phone: (508) 281-8892

CIRCLE 48 ON READER SERVICE CARD

World Probe

\$29.95 World Band Scanner Antenna

- Cuts Noise • Improves Reception • Indoors or Out •
- Works with all World Band Portables and Scanners •
- Sleek 6-ft Probe with Integral 25-ft Low-Loss Shielded Feedline •
- Fully Insulated and Weather Sealed • Decorator White Design •

AntennasWest Box 50062-P **FREE** Storage Pouch
801 373 8425 Provo, UT 84605 & Universal Connector Kit

Or call 800-926-7373

CIRCLE 5 ON READER SERVICE CARD

FREE CATALOG!

1-800-648-7938

JERROLD HAMLIN OAK ETC

CABLE TV DESCRAMBLERS

- Special Dealer Prices!
- Compare our Low Retail Prices!
- Guaranteed Prices & Warranties!
- Orders Shipped Immediately!

REPUBLIC CABLE PRODUCTS, INC.
4080 Paradise Rd., #15, Dept. 112
Las Vegas, NV 89109
For all other information (702) 362-9026

CIRCLE 49 ON READER SERVICE CARD

CB RADIO OWNERS!

We specialize in a wide variety of technical information, parts and services for CB radios. 10-Meter and FM conversion kits, repair books, plans, high-performance accessories. Thousands of satisfied customers since 1976! Catalog \$2.

CBC INTERNATIONAL
P.O. BOX 31500PC, PHOENIX, AZ 85046

ENGINEER'S TRADE SECRETS OF RADIO

by J.R. Cunningham

- How to build AM broadcast transmitters
- Info on AM broadcast antennas
- Homemade mica RF capacitors
- Winding your own coils
- AM modulation techniques
- Handbook for the broadcast engineer, ham, citizen's band operator, etc.

\$29.95 Postpaid
C.O.D. Orders Accepted

Medicine Man CB
P.O. Box 37
Clarksville, AR 72830
(501) 754-2076



CIRCLE 50 ON READER SERVICE CARD

Czechoslovakia: Radio Prague International, 5930 at 0300 with news. (Eager, NY) Here and //7345 at 0400. (Carson, OK)

Denmark: Radio Denmark (via Norway, editor) 21705 with EE ID 1630, 1830, 1930, 2130. (Vaage, CA) 25730 at 1732 with news in DD. (Giannarelis, Greece)

Djibouti: Radio TV Djibouti, 4780 at 0307-0315 in AA or Somali. Severe QRM. (Perry, TX)

East Germany: Radio Berlin International, 11785 at 0309 and on 11890 at 0345. (Carson, OK) 11890 at 0144 sign on with "Another Day in Paradise." (Moser, PA) 13610 at 1717 in AA, 13690 in AA at 1722. (Giannarelis, Greece.)

Ecuador: HCJB, 11740 at 1144. (Moser, PA) 15155 at 0251. (Olson, ND) 15270 at 0802 and 17790 at 2155. (Giannarelis, Greece)

Egypt: Radio Cairo, 9475 at 0200 with news, music. (Pellicciari, CT) 17690 with AA songs at 1711. (Giannarelis, Greece)

England: BBC, (via Cyprus?) 9740 at 1440. (Perry, TX) 9915 at 0130 with "Waveguide" program and in PP to Brazil at 2230 sign on at 11820. (Carson, OK) 11955 at 0258. (Olson, ND) 12095 at 2330. (Pellicciari, CT)

Finland: Radio Finland International, 11755 at 2304 in Finnish with economic news. (Moser, PA) 15400 at 1301 with "Northern Report" and mailbag. (Carson, OK) 21550 at 1302 with news. (Giannarelis, Greece)

France: Radio France International, 9790 at 0320 with news. (Moser, PA) 11995 with t-shirt contest, music. (Cousins, TX) 15330 at 0100 in FF. (Eager, NY) 25820 at 1003 with news in FF. (Giannarelis, Greece)

French Guiana: RFI relay, 9800 at 0321 with news. (Moser, PA)

Gabon: Africa Number One, 17630 at 0731 with news in FF. (Moser, PA)

Ghana: GBC, 4915 at 0600 with sign on and news. (Perry, TX) 6130 at 0732 with western music. (Moser, PA)

Greece: Voice of Greece, 11645 at 2223 with Greek music. (Moser, PA)

Radio Station Macedonia 9425, via VOA facility, at 1856 with news in Greek. Also 1728 in Greek on 9935/11595. (Giannarelis, Greece)

Guam: Adventist World Radio, 13720 at 1539 with songs. (Giannarelis, Greece)

Trans World Radio, KTWR, 11805 at 0951 with announcements and religious program. (Moser, PA)

Guatemala: Radio Cultural/TGNA on 3300 at 0300 with EE religious program. (Perry, TX)

Radio Buenos Nuevas, 4799 in SS with ID at 0330. (Perry, TX)

Hawaii: WWVH time station, 15000 at 0331 with announcements by woman. (Moser, PA)

Honduras: Radio Luz y Vida, 3250v in SS with music 0336. (Perry, TX)

HRVC, 4820 at 0315 with SS and music. (Moser, PA)

Hungary: Radio Budapest, 9835 at 0128 with DX program. (Carson, OK) 11910 at 0030 sign on. (Moser, PA)

Iceland: ISBS on 13855 at 2306 with talk in Icelandic. (Moser, PA)

India: All India Radio, 9520 at 2212 with commentary, 10330 at 1530 with news, 15265 at 2215 with commentary, 21735 at 1011 with news. (Giannarelis, Greece)

Iraq: Radio Baghdad, 13660 at 1720 with Arabic songs. (Giannarelis, Greece) 2100. (Moser, PA)

Israel: Kol Israel, 9435 at 0028 with IS. (Moser, PA) 21745 at 1004 with news, 21760 at 1010 in Hebrew. (Giannarelis, Greece)

Italy: RAI, 9575 at 0100 with male announcer speaking very clearly. YL and FF service at 0120. (Pellicciari, CT)

Japan: Radio Japan, 5960 (via Canada) at 0137. (Carson, OK) 9785 at 1235 with interview in JJ, no ID. (Northrup, MO) 11835 (via Gabon) at 2307. (Olson, ND) 11865 at 1546 in General Service. (Carson, OK) 15210 in JJ at 2230, 21700 at 1525 with JJ lesson, both via Gabon. (Giannarelis, Greece)

Jordan: Radio Jordan, 9560 at 1520 with pops. (Giannarelis, Greece)

Kuwait: Radio Kuwait, 11675 at 1930 in EE with woman announcer. (Story, TX) 1900 in EE on 13610. (Pellicciari, CT) 21675 in AA at 1017. (Giannarelis, Greece)

Liberia: Voice of America relay, 15600 at 1804 with news. (Moser, PA) 17870 with news at 1835. (Giannarelis, Greece)

| Abbreviation Used in Listening Post | |
|-------------------------------------|-------------------------------------|
| AA | Arabic |
| BC | Broadcasting |
| CC | Chinese |
| EE | English |
| FF | French |
| GG | German |
| ID | Identification |
| IS | Interval Signal |
| JJ | Japanese |
| mx | Music |
| NA | North America |
| nx | News |
| OM | Male |
| pgm | Program |
| PP | Portuguese |
| RR | Russian |
| rx | Religion/ious |
| SA | South America/n |
| SS | Spanish |
| UTC | Coordinated Universal Time (ex-GMT) |
| v | Frequency varies |
| w/ | With |
| WX | Weather |
| YL | Female |
| // | Parallel frequencies |

Lithuania: Radio Vilnius, 11790 at 2202, 15180 at 2220 and 15455 at 2201. (Carson, OK)

Luxembourg: Radio Luxembourg, 6090 at 2316 with pops. (Moser, PA)

Madagascar: Radio Netherlands relay, 15560 at 1848. (Moser, PA)

Mali: RTV Mali on 4835 at 0736 with music and FF. (Moser, PA)

Malta: Voice of the Mediterranean, 9765 at 0600 with "Theme For Living." (Pellicciari, CT) 0620 with music and ID. (Perry, TX) Deutsche Welle relay, tentative, 9565 at 0137. (Moser, PA)

Mexico: Radio Educacion, 6185 in SS with ID, 0308-0315. (Perry, TX)

Radio Mil: 6010, 24 hours in SS with music, news and commercials. (Reyes, Mexico)

Radio UNAM: (National Autonomous University of Mexico) 9600 at 1730 in Spanish with music, news. (Reyes, Mexico)

Monaco: Trans World Radio, 9480 at 0658 with religious programs, woman with ID. (Moser, PA) 9495 in RR at 1730, 11655 at 0855. (Giannarelis, Greece)

Mongolia: Radio Ulan Bator, 12015 at 1205 with news and political commentary. (Story, TX)

Morocco: RTVM, Tangier, 15335 at 2022 with AA and Mideast music. (Moser, PA)

Voice of America relay, Tangier, 15205 at 1731. (Giannarelis, Greece)

Netherlands: Radio Netherlands, 15560 at 2040 with Happy Station. (Moser, PA) 13700 in DD at 1723, 17575 (via Madaqascar) at 1130. (Giannarelis, Greece)

Netherlands Antilles: Radio Netherlands Bonaire relay, 9590 at 0352. (Carson, OK) 15560 at 0036 with request for reports on this new Bonaire frequency. (Moser, PA)

Trans World Radio, Bonaire, 11815//15345 at 1143. (Moser, PA) 11930 at 0330 with DX program. (Carson, OK)

New Zealand: Radio New Zealand International, 9855 at 0715 with music, recipes, radio collecting, letters. (Moser, PA) 17680 at 0600 with news, program for Tonga. (Carson, OK)

Nigeria: Voice of Nigeria, 7255 at 0500 with ID, music, news. (Perry, TX)

Radio Nigeria Channel 1, 4990 at 1850 with talk. (Giannarelis, Greece)

North Korea: Radio Pyongyang, 6560 at 1235, very weak with oriental music, no ID. (Northrup, MO) 9325//9977 with news. (Giannarelis, Greece) 11735 at 1100 with anthem, sign on, ID, news. (Moser, PA)

Northern Marianas: KHBI (Christian Science network, editor) 9530 at 1045 with announcements. (Moser, PA) 13625 at 1738, 17555 at 1900. (Giannarelis, Greece)

Norway: Radio Norway, 15165 at 1205 with IS, ID in EE and NN announcement about broadcast hours being curtailed due to a dispute. (Moser, PA) 21705 with EE IDs at 1600, 1800, 1900, 2100 in NN. (Vaage, CA)

Pakistan: Radio Pakistan, 21530 at 1600 with news, 21595 at 1020 in Indonesian. (Giannarelis, Greece)

Paraguay: Radio Nacional, 9735 at 2236 with music, man in SS. (Moser, PA)

Radio New York International via WWCR

You remember RNI, that famous shipboard shortwaver that created such a ruckus on the bands a few years ago? *They're back!* Listen for them every Sunday night over the shortwave facilities of WWCR, Nashville, on 7520 kHz. The schedule announced is four hours of free-form broadcasting from Allan, Randy, and the rest of the gang, beginning at 9 PM Eastern. The program is taking live call-ins from listeners. Be sure to tell them you're a *POP'COMM* reader.

RNI's studios are in New York, and the programs are being fed via landline to WWCR. WWCR, with its powerful rhombic antenna, has a signal that's heard throughout the world. We hope that this will be a successful opportunity for RNI!

Philippines: VOA relay, 9770 at 2204 with news, 15305//17820 at 2237 with news. (Giannarelis, Greece) 15155//15425 at 1147 with big band music. (Moser, PA)

Poland: Radio Polonia, 7270 (in Polish? editor) at 2326. (Moser, PA)

Portugal: Radio Portugal, 9600 at 0230 with "Welcome to Portugal" program. (Pellicciari, CT) 11840 at 0249. (Carson, OK) 21495 with songs at 1731. (Giannarelis, Greece)

Deutsche Welle relay, tentative, 11905 at 0429. (Carson, OK) (Sines relay facility, editor)

Romania: Radio Romania International, 9570 at 0201 with news. (Moser, PA) 11940 at 0400. (Pellicciari, CT) 17860 at 1735 with news. (Giannarelis, Greece)

Rwanda: DW relay 7225 at 0412 with news. (Moser, PA) 9735 at 1500 with news. (Giannarelis, Greece)

Saudi Arabia: BSKSA, 9705 at 1724 with drama, 21665 at 1018 in AA. (Giannarelis, Greece)

Swaziland: Trans World Radio, 9520 at 1712 with religious talk. (Giannarelis, Greece)

Seychelles: BBC relay, 15420 at 1002 with news. (Moser, PA) FEBA Radio, 15330 at 1503 with songs. (Giannarelis, Greece)

Singapore: Radio Singapore, 11940 at 1100 with news and market reports. (Story, TX)

BBC relay, 9740 at 1503 with news. (Giannarelis, Greece) 11750 at 0959 with time signal, ID, news. (Moser, PA)

Solomon Islands: SIBC on 9545 at 0735 with woman, news, ID. (Moser, PA)

South Africa: Radio RSA, 7270 at 0423 with EE ID and into PP. (Carson, OK) 17765 at 1842. (Giannarelis, Greece)

South Korea: Radio Korea, 9750 at 1215 news, "Seoul Calling." (Carson, OK) 9870 at 1724 with news. (Giannarelis, Greece)

Spain: Spanish National Radio, 9630 at 0500. (Pellicciari, CT) 11880 at 0300 with time signal, news. (Eager, NY) 21595 in SS at 1019. (Giannarelis, Greece)

Sweden: Radio Sweden, 9655 with news at 2100 and in FF at 1015 on 2160. (Giannarelis, Greece)

Switzerland: Red Cross Broadcasting Service, via SRI facilities on 9885 at 0310 with "Worldwide Activities." New QSL cards. (Pellicciari, CT)

Swiss Radio International: 6135 at 0226. (Moser, PA) 9885 at 0400. (Pellicciari, CT) 21695 at 1014. (Giannarelis, Greece)

Syria: Radio Damascus, 12085 at 2042 in AA. (Moser, PA)

Tahiti: Radio Tahiti, 11826//115171 at 0654 in language. (Moser, PA)

Taiwan: Voice of Free China, via WYFR, 5985 at 0301. (Carson, OK) 9680 at 0347. (Olson, ND) 21720 at 2200. (Giannarelis, Greece)

Turkey: Voice of Turkey, 9455 at 2315. (Moser, PA) 0156 with music, time signal 0200 and YL with TT ID. (Eager, NY)

United Arab Emirates: UAE Radio, Dubai, 15400 at 0330. (Pellicciari, CT)

Voice of the AUE: Abu Dhabi, 11985//13605 at 2201. (Moser, PA) 13605 in AA at 1615, 21515 in AA at 1022. (Giannarelis, Greece)

United States: Radio Marti, 9525 at 0217 with drama in SS. (Moser, PA)

WINB, Red Lion, PA, 15185 at 2230 with ID, easy listening music. (Carson, OK)

USSR: Radio Station Peace and Progress, 9810 at 1230 with drama in EE, no ID. (Northrup, MO)

Radio Moscow, 11710 at 0129. (Moser, PA) 11750 at 0303. (Olson, ND) 11840 at 1500, 11900//11995 at 1600, 17570 at 0521, 17605 at 0513, 17660 at 0458 and 21690 at 2238. (Carson, OK) 15585 at 0600. (Pellicciari, CT)

Vatican: Vatican Radio, 9645//11750 at 0221 in SS. (Moser, PA) 15105 at 2216 and 21650 at 1732. (Giannarelis, Greece)

Venezuela: Ecos del Torbes, tentative, 0315-0320 on 4980. (Perry, TX)

Vietnam: Voice of Vietnam, 15010 at 1013 with many mentions of Vietnam. (Moser, PA)

West Germany: Deutsche Welle, 6145 with German by Radio at 0136. (Moser, PA) 9670 (via Antigua) at 0500, 21510 at 1700. (Carson, OK) 21680 at 1016 in GG and 25740 at 1108 in GG. (Giannarelis, Greece)

Yugoslavia: Radio Yugoslavia, 11735 at 0001 with news, comment. (Carson, OK) 0027 with interview. (Moser, PA) 25795 at 1225 with folk music. (Giannarelis, Greece)

Muchos Gracias to the following reporters:
Aris Giannarelis, Athens, Greece; Mike Perry, Beeville, TX; William Moser, New Cumberland, PA; Kevin Story, Midland, TX; John Spencer Carson, Jr., Norman, OK; Miguel Angel Reyes, Morelia, Mexico; George Eager, New York, NY; Steve Pellicciari, Norwalk, CT; Bjorn Vaage, Granada Hills, CA; Rick Cousins, Friendswood, TX; David Olson, Watford City, ND and Mark A. Northrup, Gladstone, MO. **PC**

For 25 years, our people have endured long hours and tough working conditions for no pay.



And 9 out of 10 would do it again.

TO FIND OUT WHY
call

(316) 263-2100

or write

REACT INTERNATIONAL, INC.
242 Cleveland
Wichita, KS 67214

Base Loading – Good For Tall Vehicles

Your communications emergency vehicle probably looks like a porcupine. I can always tell the most dedicated emergency communicator—this is the radio operator that has the most antennas protruding above the roof line.

And that's important—"above the roof line." Many times you will spot a radio amateur or a GMRS radio operator with the antenna mounted down low, a necessary option to clear low-hanging obstructions. This makes sense when parking in underground garages, or scooting under big tree branches just inches above the roof line. But side-mounting antennas has its problems.

For one thing, a mobile side-mounted antenna may develop high SWR because of its proximity to the nearby metal. This is a common problem when the radio amateur mounts a high frequency, mobile, center-loaded whip off the chrome bumper. Much of the transmitted energy is wasted as high SWR because of the nearby metal from the trunk lid.

On-glass antennas have their merits. If you mount them up high, and tune them

carefully, they are good performers. A new glass antenna that covers dual-bands, 2 meters and 450 MHz, has just been announced by Mobile Mark (312-671-6690). It's expensive—about \$75—but is the first I have seen of the dual-band, on-the-glass style.

On the VHF and UHF bands, there are countless single-band, dual-band, and tri-band antennas to choose from. Some antennas have been around a long time—like Larsen, Antenna Specialists, Maxrad, Metz, and a host of other domestic VHF/UHF antenna specialists.

Relatively new to the VHF/UHF scene are imported antennas, available from RF Parts (800-854-1925) called Diamond Antennas, and the fine line of multi-band whips from Comet Antenna Company (NCG), Anaheim, California (714-630-4541). These companies compete for the same market, and you should call them for a catalog to see how many bands these relatively short antennas will pick up.

And for 10-meter and 11-meter operation, it's important to run a whip antenna that is as close to a natural quarter wave-

length as possible, in the center of your roof. This means a giant 9-foot whip for the ultimate in good signal radiation and weak signal capture. But a 9-footer on your roof is usually impractical.

Most 10-meter and 11-meter antennas are base-loaded with a very tall stinger. Generally, the taller the stinger, the better the performance. Antenna giants like, RF and Wilson (800-541-6116) has offered a loaded 10-meter antenna that offers exceptional signal performance, yet is short enough to fit nicely on a trunk lip.

With the recently imported-from-Europe line of ham radio 10-meter, and CB radio 11-meter; base-loaded whips have been receiving rave reviews. The line is called "President," a very familiar name in CB radio and accessory 15 years ago. It's now resurrected, and is offered by Extra Com from Glendale, California (818-244-7000). These base-loaded whips are imported from Spain from the American subsidiary of Europe's number one company in radio communications, CSI. And what makes these European imported antennas so dif-

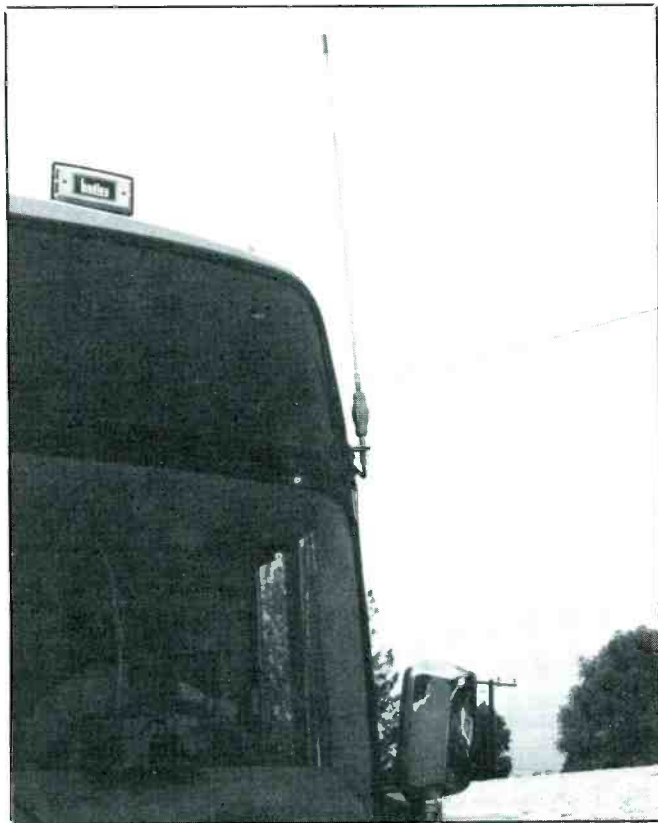

Helical loaded whips only work well when elevated to roof level. This whip is mounted too low on the emergency communication vehicle.

The base-loaded President antenna does not require the silly 90° spikes. (Courtesy C.P. King)

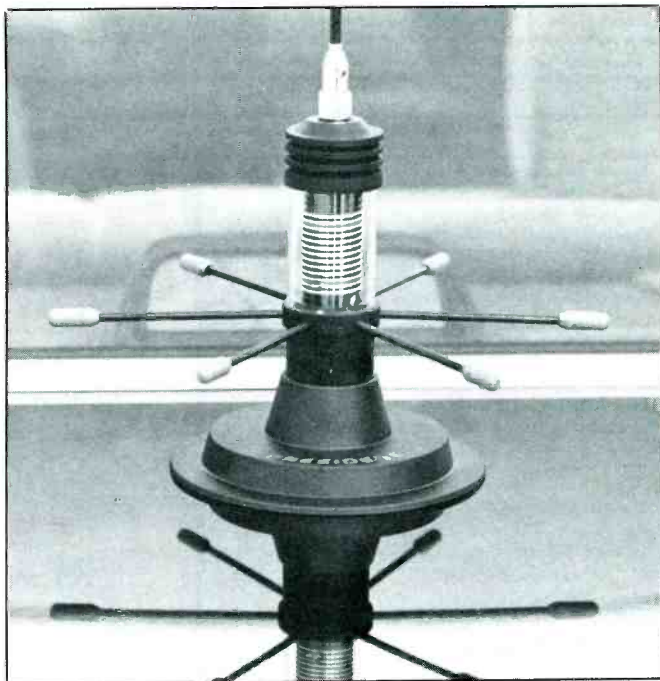

ferent is their loading characteristics—a hefty base-load, combined with a 7-wire, copper-braid-wound, graphite rod for center-loading. The graphite composite stingers offer low wind resistance, and also serve to top-load the antenna system.

Top-loading tends to reduce the take-off angle, and increase groundwave coverage close to the horizon.

The best 10-meter and 11-meter performance was achieved by using the Extra Com “Interceptor-ITC7000” graphite antenna. The whip is 54 inches long, and the base-loading coil ran cool as a clam with 100 watts of 10-meter output into it for several minutes. The coil uses heavy-gauge, silver-plated wire in a transparent chamber.

Attached to the coil chamber are 6 perpendicular miniature ground planes that extend out from the base. After playing with them for several minutes, it was apparent these are strictly add-on gadgets for cosmetics from CB’ers that want to look like they really have something different. For emergency communicators, I suggest you take them off, and only consider using them when you may have to mount your antenna on a piece of metal that doesn’t offer much counterpoise.

We tested the antenna on its heavy magnet, and it offered enough performance to give us both 10-meter as well as 11-meter capabilities with minimum SWR.

Another outstanding performer was the GX-9000 system that featured a 78-inch, stainless-steel whip mounted on top of an 8-gauge, silver coil displayed in the transparent chamber. The coil was large enough to offer us combined 10-meter and 11-meter performance without needing to adjust the big whip. We mounted the 9000 on a mirror mount, and the supplied 12 feet of cable gave us ample room to hook it up to our transceivers, and achieve about the same range as a regular 96-inch unloaded whip.

Yes, there are Citizens Band antennas dramatically shorter than 70 inches. Extra Com offers a 44-inch antenna, a 54-inch antenna, and a little flexible 23-inch graphite whip that offered fair performance. But the longer the whip for 10 meters and 11 meters, the better the signal output. There is no magical way that an emergency communicator can get out better with a shorter antenna than a longer one approaching a natural one-quarter wavelength. And, if you must use a short whip, try to get it up as high as possible on your emergency vehicle for added signal strength.

So this winter don’t be surprised to see some new CB/10-meter type antennas appear on the shelves of your local 2-way radio dealer. It’s tough to beat the outstanding performance of a K40 or a Wilson that have been around for a long, long time, but it’s also interesting to try a new European imported series of whips that are truly great performers for simultaneous 10-meter and 11-meter use without having to go up and adjust the whip. **PC**

HOW I GOT STARTED

POP’COMM invites readers to submit, in not more than about 125 words (give or take), how they got started in the communications hobby. Each month, we’ll accept them (preferably) typewritten, or otherwise easily legible. If you have a photo of yourself taken recently, or when you got started, please include it with your story. We can’t return or acknowledge material, whether or not it is used. Your story need be submitted only once, we’ll keep it on file and consider it

but it was the only way we could hear war news, and my first receiver was a crystal set (I still have the original crystal holder). It wasn’t much of a receiver. Usually it picked up only one station, and those times when it received two stations, they came in at the same time.

“After the war, I joined a local radio club and built my first battery powered receive one-tube regenerative receiver. Later, I added a one-tube amplifier. It wasn’t bad,



for future issues. All submissions become the property of *Popular Communications*.

Each month, the person whose story we use will receive a 1-year gift subscription (or subscription extension if already a subscriber) to *Popular Communications*.

Entries will be judged taking into consideration if the story is interesting, amusing, or unusual. We reserve the right to make any necessary editorial changes to improve style or grammar.

Address all entries to: How I Got Started, *Popular Communications*, 76 North Broadway, Hicksville, NY 11801.

Our Winner For November

The winning entry for November was sent to us by Milivoj Rudan, who lives in Stoney Creek, Ontario. He told us:

“My interest in radio got started while I was living in Yugoslavia, during WWII. Ra-

but it was hard to tune, and it had problems with hand capacitance.

“The next step upwards in equipment was a German army receiver that I got in a surplus store. It worked fine until the day something went wrong in my homemade power supply. The damage it caused to the tubes and other components ended my serious listening for a while. Eventually, I got a *Deutscher Kleinemfänger* receiver made by Siemens.

“Twenty years ago, I emigrated to Canada. That’s when I bought my first communications receiver, a Realistic DX-160. Still, I was saving for something more sophisticated. Presently, my main communications receiver is a Yaesu FRG-7700, and I also have a Realistic PRO-2021 scanner, plus various other receivers and accessories.

“It’s a long way from a crystal set in Europe during WWII, but I have never lost my interest in tuning in the world.” **PC**

27 MHz COMMUNICATIONS ACTIVITIES

Are you one of the readers who have, over the months, written to ask why the low-power handheld transceivers operate on 49 MHz instead of on 27 MHz where the two types of units could be conveniently mixed into the same CB communications systems?

Time was when low-power handhelds were manufactured to operate on 27 MHz (usually CB Channel 14), and 49 MHz operations didn't exist. That was in the 1960's and early 1970's. It was a good arrangement and it worked out fine. The low-powered units didn't need licenses and operated under FCC Part 15, while CB units operated under FCC Part 19, and later FCC Part 95, required individual station licenses.

At some point, the FCC decided that, because CB stations were licensed, it wasn't within the Part 95 rules for them to be permitted to communicate with unlicensed units. In my opinion, this was strictly a moot or technical problem within the structure of the FCC regulations, for there weren't any actual problems with the two types of stations mixed together. In fact, there were several benefits.

The FCC felt that it was necessary to maintain its position that licensed stations shouldn't communicate with unlicensed units. This, in order to encourage operators to license their CB stations, and to discourage them from contacting those who didn't bother obtaining licenses for their CB equipment.

The result was that the Part 15 low-powered stations, which had been allowed on 27 MHz for years, were relocated to a new band that was created for them at 49 MHz. CB'ers were angry since it was seen as being arbitrary and unfair. Furthermore, it didn't have any direct bearing on forcing delinquent Part 95 operators to get the necessary CB licenses. All it accomplished, insofar as the public was concerned, was to take away the compatibility of the two similar communications systems.

Now that CB licenses are history, it's time to get the ball rolling on allowing inexpensive low-powered handheld Part 15 transceivers back on 27 MHz. This need be on only two or three selected channels, while still keeping their existing 49 MHz allocation intact.

Low-powered handhelds mix especially well with regular CB equipment during outdoor activities such as camping, hunting, fishing, boating, scouting, and many kinds of sports.

What do you think about this? Let us know.

Venezuela Calling

Good letter arrived from *Alpha Centauri Base*, in Venezuela. You may have heard

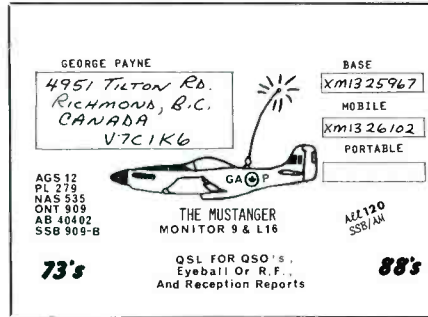

George, SSB Network member SSB-909-B, of Richmond, BC sent along this attractive QSL from his station.



Alas, the low-powered and unlicensed transceiver was bounced off of 27 MHz and sent to 49 MHz. Why not let them back on 27 MHz now?

him during band openings, David has a really good signal throughout North America.

In many cases, it is impractical to open the appliance and install bypass capacitors across AC wires inside the appliance housing. Several plug-in filters, however, are available for the purpose. These units are inserted into the wall outlet and provide their own outlet for the appliance plug. Selecting one of the major types depends on the degree of noise suppression required.

For light-duty applications, the simple one-capacitor filter may prove satisfactory. Next is the two-capacitor type, which generally has a ground lead. In severe cases of noise interference, the more complex coil-capacitor, or "all wave," type might be indicated. Usually a heavier-current appliance grinds out more noise and requires the additional filtering provided by the coils. Be certain, however, that the filter's current rating (6 amperes in some cases) is at least the same or (preferably) higher than the appliance it is filtering.

Check out catalogs from Radio Shack or other electronics suppliers for these filters. When you get the right one for the job, it should perform well. However, it really needs to be used at the location where the appliance plugs into its power source. It's not going to do much good connected to the power plug of your CB rig. That is to say, if the buzzing is coming from some appliance beyond your household and control (such as from a neighbor's house, or from an unknown source), you're probably out of luck.

Double Talk?

It's often convenient to hear incoming calls at some distance from the CB rig. The set may be in the basement or kitchen, and calls missed when the operator is in the living room, garage, yard, or shop. Extending the audio output of the CB rig can be done by the system shown in the diagram. This is

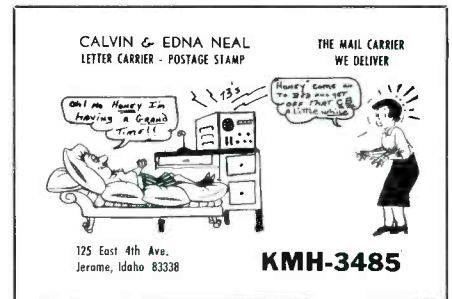

Cal and Edna, of Idaho, are known on the channels as "Letter Carrier" and "Postage Stamp." They submitted this QSL. Where's yours?



Put an eyeball on this deluxe station in Venezuela. It ID's as "Alpha Centauri Base," and the operator is Dave. He's one of our readers. Dave is active in many areas of communications.

a second speaker wired in parallel with the original speaker in the set. An external volume control permits adjusting loudness of the extra speaker.

The arrangement described here beats simply plugging in a speaker to the CB rig's "EXT SPKR" jack. When you do that, you cut off the set's internal speaker, and you

SALUDOS DE «ALFA CENTAURO»

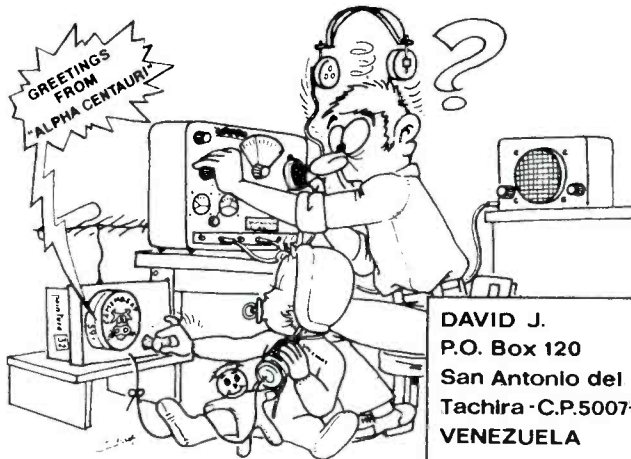

DAVID J.
P.O. Box 120
San Antonio del
Tachira - C.P.5007-A
VENEZUELA

The station QSL from Dave, in Venezuela. He'd like to swap QSL's with you.

have no ability to locally adjust the volume of the remotd speaker.

The audio signal is picked up directly at the terminals of the internal speaker. A pair of wires is brought out of the set and fitted with a socket. This allows the external speaker line to be easily disconnected if necessary, or for the selection of various external speakers placed at different locations.

The line may be run to the speaker using ordinary lamp cord (No. 18 wire) if you have some handy. Distances of up to 50 feet should cause little loss in sound volume. There will, however, be a slight drop in sound level at the CB transceiver's own speaker. But this can usually be compensated for by simply running the set's volume at a slightly increased level. The external speaker should be similar in type and size to the one already in the transceiver and have the same impedance (usually 3.2 ohms).

First, the good news: he thinks this column is excellent and he looks forward to receiving his issue each month. The bad news is that David complains that the column is only a fraction of the length it should be, al-

though he also enjoys reading the other parts of the magazine, too.

David's main squawk is with rudeness on the frequencies, such as people trying to kick DX stations off a frequency when they're attempting to establish contact with another station. Like many other operators, David's been cussed out in various languages by operators who resent skip signals pouring in on them from around the world while they're trying to have a local chat.

David suggests that some operators apparently don't fully understand that signals which propagate around the world on 27 MHz are not under the control of the operators whose voices are being heard. When an operator in Venezuela is having a conversation with someone in the Bahamas, he isn't deliberately trying to mess up a QSO in Dallas or Atlanta. But it's a big world, and there are a lot of operators squeezed on to a relatively few number of channels. Interference is bound to happen each time there is a skip opening, he says, and a little courtesy goes a long way. We agree!

Those who enjoy swapping QSL cards are

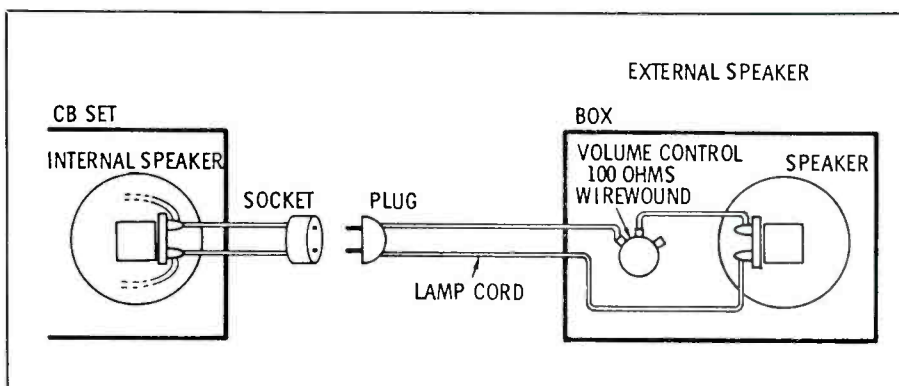

Simple layout for adding an extra loud-speaker.

Improve Your World Image



PC HF FACSIMILE 4.0 \$99

A complete facsimile reception system for the IBM PC or Compatible. Receives up to 16 intensity levels.

Includes:
Demodulator 80 Page Manual
Software Tutorial Cassette
Frequency List Interpretation Guide

Features:
Print on Epson, or HP Laser Jet
Disk Save, Zooming, Image processing
Unattended Image Capture and much more

PC GOES/WEFAX \$250

Designed to receive images directly from U.S. and Soviet meteorological satellites. Includes all of the above feature plus a complete orbital tracking system and resolution of up to 256 gray levels.

Software Systems Consulting

150 Avenida Cabrillo, "C", San Clemente, CA 92672
(714)-498-5784

CIRCLE 55 ON READER SERVICE CARD

SE SIGNAL ENGINEERING's High Performance CB Antennas

SUPERHAWK
\$114.95

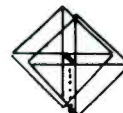

Goldenrod 45 Mobile Antenna



SPYDER A
\$35.95

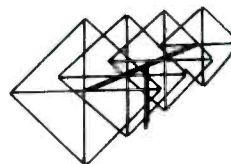

WHITE LIGHTNING
\$199.95

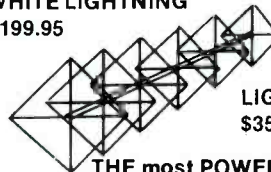

LIGHTNING 6
\$359.95

THE most POWERFUL
CB base in the world today!

All SE PATENTED rotary beams are true quads and OUTPERFORM their counter parts (quad/yagi types). SE's patented SFS matching system makes SE QUADS the most technologically advanced antennas in the world today.

If your dealer doesn't have SIGNAL ENGINEERING, write or call for full specs. DEALER inquiries invited.

SIGNAL ENGINEERING

2624 Fayette Drive, Mountain View, CA 94040
(415) 948-3833

invited to exchange cards with *Alpha Centauri Base*, as he has an attractive card and is into card swapping in a big way. His address is: David J., P.O. Box 120, San Antonio del Tachira C.P. 5007-A, Venezuela.

Canadian Licenses

Although we have mentioned it before, the amount of mail arriving here asking for information about the status of CB licenses in Canada makes it apparent that the word hasn't yet sufficiently gotten around. That word is that Canadian CB'ers no longer need to obtain or renew licenses for CB operation, although the regulations governing CB operations (and penalties for violations) remain in full force.

That information was confirmed in a note from Ron McCracken, of Canadian REACT. Ron says that existing CB Canadian CB call signs are still valid, but no new ones will be issued. He also reminds CB'ers on the road in Canada that CB Channel 9 is monitored

by REACT volunteers who are anxious to be of service if there's a problem along the way.

In order to get the best use of REACT's services in Canada, Canadian CB'ers are invited to obtain a copy of the free booklet "Getting Help by CB Radio." To get a copy, send a self-addressed, stamped (39 cents in Canadian stamps), business size return envelope to: REACT, Box 942, Sutton, Ontario, L0E 1R0.

Cut That Noise

A frequently heard complaint is that of noise in the receiver section of the CB rig caused by nearby use of appliances. No doubt about it, a number of appliances found in the home can be prolific generators of radio noise and can wipe out CB reception. The source is usually simple to identify since the noise occurs only when the appliance is in operation. Some typical offenders include: vacuum cleaners, hair dryers, mixers, electric razors, sewing machines, fans,

office machines, air conditioners, and oil burners.

In this simple hookup, both speakers produce sound simultaneously. Also, the maximum volume level at the distant speaker can't exceed the level set at the transceiver. The control on the external speaker can only decrease the loudest sound provided by the regular control.

No-Name Blues

More than a few readers have written to say that they had heard so much about the increased signal coverage of single-sideband (SSB) mode, that they made it a point to let their next new rig be one that offered a combination of AM and SSB modes. After spending the extra pesos for the equipment, they were less than thrilled when they switched up to the channels favored by SSB operators (36 to 40), announced their respective handles, and shouted for a *break*.

They report that the response was not what had been expected. Either their calls went ignored or else were met with varying amounts of hostility from the sidebanders on the frequencies.

So, for the benefit of those who are wondering what happened, let's remind potential and new single-sideband operators that the operating traditions and methods on these frequencies are not only very different than what takes place on the AM-channels, but AM-type operating procedures, lingo, 10-Codes, and handles, are totally unwelcome on channels used by sideband operators.

Asking for a "break" or saying "breaker" or "breaker breaker" could get you ignored in a big way, as could using a CB handle to identify yourself or your station. And forget the 10-Code, radio checks, time checks, talk of goodbuddies and all of the rest of the buzzwords you may have gotten used to while operating on AM.

Sidebanders generally identify their stations by the use of numbers issued by groups and organizations with which they are affiliated. Without a number from a known source, an operator may be regarded like a visitor from Saturn.

For those seeking numbers and information on proper operating techniques and procedures, my suggestion is to affiliate with the SSB Network. This is the world's largest and oldest (1964) continuously active national organization for sideband operators. There is a small one-time affiliation fee (which gets you a set of numbers and plenty of operating information), and then you're affiliated for life (there are no yearly dues).

Get more information: furnish a self-addressed, stamped, return envelope (business size) to: SSB Network, P.O. Box 908, Smithtown, N.Y. 11787.

As for us, we're out of here for now, but we'll be back. We want to hear from you with your CB shack photos, QSL's (your own and DX), thoughts, questions, ideas, newspaper clippings, and other things related to 27 MHz communications. **PC**

ASSOCIATED RADIO
8012 CONSER BOX 4327
OVERLAND PARK, KANSAS 66204

SHORT WAVE AMATEUR RADIO

CALL FOR YOUR LISTENING NEEDS

CALL 913-381-5900
FAX 913-648-3020

New and reconditioned equipment.
BUY—SELL—TRADE—SERVICE



Send \$3.00 for our current catalog and wholesale sheet.

Add New Enjoyment To Your SW Receiver with the *MICRODEC™ Decoder

MODE Selects, CW, RTTY, ASCII

POWER/VOLUME CONTROL

ALPHANUMERIC 5X7 DOT MATRIX 8 SEGMENT LED DISPLAY



SOMERSET ELECTRONICS, INC.

SIGNAL STRENGTH INDICATOR LED

DISPLAY INTENSITY CONTROLS SEVEN LEVELS OF INTENSITY

BATTERY CHARGE LED

\$199

LIST PRICE \$229.95

MICRODEC™ decodes MORSE, RTTY, and ASCII to ALPHANUMERIC CHARACTERS

- Automatically tracks MORSE code speeds from 5 to 70 WPM
- Decodes 60, 67, 75, 100 wpm RTTY and 110, 330 BAUD ASCII.
- Standard ASCII port to interface with your computer.
- Internal practice code oscillator.
- Standard cockpit green display. (red & yellow optional)
- Power switch/Volume control/Internal speaker

- Completely portable with optional NICAD rechargeable batteries mounted internally. — \$29.95 (List \$49.95)
- Ultra compact and lightweight (1.5H X 5.08W x 5.25L)
- Optional display color: \$15.00 (List \$30.00) (red or yellow)
- Operates on DC voltages between 9 VDC and 15 VDC (AC/DC adapter provided at no cost).

SHIPPING AND HANDLING: Continental United States add \$8.50 for UPS ground. Florida residents add 6% sales tax. Other types of Express shipments and foreign destinations will be quoted on request.

METHODS OF PAYMENT: MasterCard, VISA, Money Orders, Certified Checks, and Personal Checks. (Please allow two weeks for personal checks to clear.) QUANTITY DISCOUNT FOR HAM/SWL CLUBS. Dealer Inquiries Welcome.

SOMERSET ELECTRONICS, INC.
1290 HIGHWAY A1A, SATELLITE BEACH, FL 32937 • ORDER & FAX: (407) 773-8097

CIRCLE 44 ON READER SERVICE CARD

WASHINGTON PULSE

FCC ACTIONS AFFECTING COMMUNICATIONS

FCC Denies Requests For Reconsideration Of Order Reorganizing And Deregulating The Amateur Radio Service

The Commission denied three requests for reconsideration of various aspects of its May 31, 1989, *Report and Order* which reorganized the amateur service rules and codified existing policies.

First, the Radio-Television News Directors Association, *et al.*, (RTNDA), requested a change in the rule prohibiting amateur stations from providing communications facilities to support broadcasting operations, except when common carrier facilities and broadcast remote pickup links have been disrupted and life or property is in immediate danger. Specifically, it requested that the immediate safety of life or property provision in the rule be expanded to include information relating to any important news event, or in the alternative, that the immediacy factor be eliminated.

Second, David Popkin asked that various rules adopted by the Commission in the proceeding be amended including changes to reflect contemporary United States Postal Service terminology and licensing procedures. He also suggested certain language changes in the interest of clarifying the rules. Third, Karl Pagel requested that the Commission's rules be amended to show that as of January 1, 1990, the amateur service is the primary user of the 1.25 meter band.

With respect to RTNDA's request, the Commission said it was not persuaded that it should adopt either RTNDA's substitute rule or eliminate the immediacy factor from the current rule. The Commission believes that the prohibition against use of amateur stations for commercial purposes, including broadcasting, must be retained if the amateur service frequencies are to remain free of commercial and broadcasting exploitation.

Concerning Popkin's request, the Commission said, in some instances, he had failed to present persuasive arguments for adopting his suggestions. Moreover, Popkin's suggestion to permit the manual retransmission of time signals and weather information involves a substantive change that is beyond the scope of this proceeding. The Commission did, however, in accordance with Popkin's request, conform its rules to reflect contemporary postal terminology concerning a post office box, rural delivery service numbers, or general delivery.

With respect to frequency sharing of the 1.25 meter band between the amateur service and the Government radiolocation service, the Commission stated that Pagel's re-

quest was premature because elimination of amateur use of the 1.25 meter band will not be implemented in the amateur service rules until the current land mobile proceeding concerning the band is completed.

Aviation Services Rules Provide New Type Of Aeronautical Station

At the request of the Federal Aviation Administration (FAA), the Commission amended its Aviation Service rules to permit non-Government entities to install remote communications outlet stations (RCOs) at small airports without a control tower.

RCOs are comprised of transmitters and receivers owned and maintained by non-government entities such as municipal airport authorities. They are connected via land line to nearby FAA control towers or other control facilities.

In its request, the FAA stated that RCOs would enhance safety and improve the overall efficiency of aircraft operations in the vicinity of large airports with control towers. The Commission, in amending its rules, concluded that the public interest would be served by providing local government entities and private airport operators with a new class of aeronautical radio station that would make additional air traffic information available to the segment of the aviation community using uncontrolled airports close to larger controlled airports.

Indefinite Use Of Currently Installed Aircraft Radios

The Commission proposed amending its Aviation Service rules to allow currently installed aircraft radios with 50 ppm (parts per million) frequency tolerance to be continued to be used indefinitely.

This action was requested by the Aircraft Owners and Pilots Association, the Experimental Aircraft Association, the General Aviation Manufacturers Association and the Helicopters Association International.

A new standard of allowing a maximum 30 ppm for these radios becomes effective January 1, 1992.

In an order released May 22, 1984, the Commission amended the rules to conform Part 87 (Aviation Services) to the Final Acts of the 1979 Geneva WARC. Among other things, aircraft radio stations operating in the frequency band 100 MHz to 470 MHz were required to meet a frequency tolerance standard of 30 ppm. The original date for implementation of this in the FCC rules was 1985. It was later extended to 1990 and, at present, is 1992. After this date all aircraft transmitters operating in this band

and not meeting the 30 ppm frequency tolerance must be modified or replaced.

The petitioners asked the Commission to exclude all currently installed VHF aircraft radios from the 30 ppm frequency tolerance requirement. In support of its petition, the petitioners estimated that as many as 93,000 radios would be affected.

They noted that these radios are installed in small, single-engine, piston-powered aircraft which are primarily operated in relatively remote areas of the United States where they would not interfere with other U.S. or foreign radios employing the 30 ppm tolerance. They argued that the cost of modifying these radios would frequently exceed the radio's market value.

The Commission noted that a 50 ppm frequency tolerance is associated with older radios, radios that are designed to transmit and receive on channels spaced every 50 kHz (360 channels). Radios designed to transmit and receive on 100 kHz spaced channels (180 channels) generally are even older and meet a frequency tolerance of 100 ppm. A 30 ppm frequency tolerance is generally associated with radios that are designed to operate on 25 kHz spaced channels (720 channels). Thus, the Commission noted, the real issue here is the cost to the general aviation community of modifying or replacing radios with a 50 ppm frequency tolerance versus the FCC's and FAA's efforts to implement 25 kHz channelization nationwide.

It is possible for 50 kHz and 25 kHz equipment to operate in the same environment. Further, there are still areas of the country where 25 kHz equipment has not been implemented at ground stations and no definite FAA cut-off date has been established to implement 25 kHz in these areas. The Commission said that, while it strongly supports 25 kHz channelization nationwide, if there are no interference complaints or a definitive FAA implementation date, it probably would not be necessary to obsolete the use of previously installed 50 kHz equipment. As the FAA implements 25 kHz ground stations on a broader basis, the individual flying habits of aircraft operators will dictate when older radios have to be replaced. Those using the FAA's services will have to switch voluntarily to the newer radios or risk air traffic delays. Conversely, aircraft operators with no need for communications on 25 kHz spaced channels will be able to use previously installed 50 kHz channelled equipment indefinitely.

This proposal is consistent with international radio regulations. These regulations do not, however, permit aircraft radios with 100 kHz channel spacing to continue to operate with the 50 ppm frequency tolerance.

Therefore, the Commission did not propose to permit the continued use of aircraft radios with 100 kHz channel spacing.

Partial Reconsideration Of Rules To Permit Business Radio Use Of Certain Channels In The 150 MHz Band

The Commission granted, in part, requests for reconsideration of various aspects of the July 13, 1989, *Report and Order* (R&O) amending its rules to permit business radio use of certain channels in the 150 MHz band.

The petitioners, the National Association of Business and Educational Radio, Inc. (NABER), International Taxicab Association, Inc. (ITA), and the Forest Industries Telecommunications (FIT), requested that the Commission: 1) create additional offset channels in the 150 MHz band; 2) permit increased power on two additional Business Radio paging frequencies, 3) discontinue use of the 1950 Census for assigning certain frequencies shared between the Business and Taxicab Radio Service; 5) specify five different Business Radio paging frequencies in Puerto Rico and the Virgin Islands; 6) limit the transmitter power on the newly designated offset frequencies utilized by the Business Radio Service to 110 watts; and 7) per-

mit two-frequency operation on the new Business Radio Service frequencies that are adjacent to Taxicab Radio Service frequencies.

The Commission denied the petitioners requests with respect to creating additional offset channels in the 150 MHz band. It also declined to discontinue using the list of designated Standard Metropolitan Areas (SMAs) derived from the 1950 Census data in assigning certain shared frequencies in the 150 MHz band.

With respect to the other matters requested by the petitioners, the Commission found that the public interest would be served by modifying the rules adopted in the R&O. Specifically, the Commission: 1) designated different 150 MHz offset channels than those specified in the R&O for use by Taxicab Radio Service licensees outside the current list of SMAs; 2) designated different 150 MHz offset channels than originally specified for paging only operations in Puerto Rico and the Virgin Islands; 3) established a maximum transmitter outpower of 110 watts for Business Radio Service licensees operating on specified channels; 4) permitted increased power on an additional 150 MHz frequency currently designated for paging; and 5) changed the designated use of the four 157 MHz frequencies assigned to the Business Radio Service to mobile only use.

Inquiry Begun On New Personal Communications Services

The Commission began a broad inquiry into the development and implementation of new personal communications services (PCS), such as advanced cordless telephones and portable radio systems for personal use.

The Commission is looking for information that will enable it to develop regulatory policies concerning the possible implementation of such services.

Generally, the Notice of Inquiry asks for information to determine:

- Which new PCS services are needed;
- Where in the spectrum should they be located;
- How much spectrum should be allocated to them;
- Whether and how the services should be regulated; and
- What technical standards should be adopted.

More particularly, the Notice discusses two petitions for rulemaking, one from Cellular 21, Inc., and another from PCN America, Inc., that propose establishment of particular types of PCS.

PCS encompasses a broad range of radio communications services that free individuals from the constraints of wireline public

POPULAR COMMUNICATIONS

Here's what you've been looking for — an all new hard-hitting monthly magazine which gives a unique insider's view of what's really going on in the world of communications. POP' COMM is your primary source of information — bigger and better than any communications magazine, with exciting coverage of scanners, shortwave broadcast & utility stations, spy stations, pirate and clandestine broadcasters, RTTY monitoring, survivalist communications systems, FCC news, wiretapping and bugging, voice scrambling/unscrambling, surveillance/undercover communications, satellite & cable TV, sophisticated telephones, & more. What you've been looking for all along! Take advantage of substantial savings over the newsstand price by subscribing now. Don't miss out on even one single issue of POPULAR COMMUNICATIONS — order your subscription now.

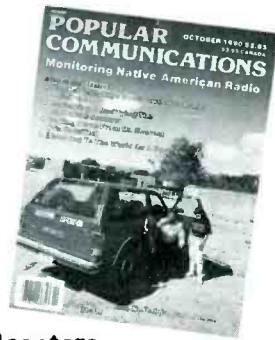

Twelve Issues
\$19.95

POPULAR COMMUNICATIONS

76 N. Broadway, Hicksville, NY 11801

Yes! POPULAR COMMUNICATIONS is just the magazine I've been looking for. Start sending it to me now! I understand that I may cancel at any time for any reason, and receive a full refund on my unused subscription.

Paid by: Check Money Order MasterCard VISA

My account number is:

| | | | | | |
|--|--|--|--|--|--|
| | | | | | |
|--|--|--|--|--|--|

Name _____

Street _____

City _____

State _____

Zip _____

- 1 year - 12 issues \$19.95
- 2 years - 24 issues \$38.00
- 3 years - 36 issues \$57.00

Canada/Mexico—one year \$22.00 US, two years \$42.00 US, three years \$63.00 US; Foreign—one year \$24.00 US, two years \$46.00 US, three years \$69.00 US, Foreign Air Mail—one year \$77.00 US, two years \$152.00 US, three years \$228.00 US

switched telephone network and enable them to communicate when they are away from their home or office telephone. Basic forms of PCS include the current cordless telephone, which enables individuals to receive or initiate communications in or near their home or office, and paging services, which notify individuals that someone is attempting to communicate with them. Car telephones represent a more advanced form of PCS. Car telephone service has been in operation for over 20 years, but was available only to a limited number of users until the mid-1980s when cellular radio service began to be offered in most of the major U.S. cities. Since then its growth has been very rapid and is expected to continue into the 1990s with the continued increased use of handheld portable telephones, as opposed to car-installed telephones. Portable telephones enable the users to call or be called at any time they are within a cellular system.

As the public has become more aware of PCS and their benefits, demand has begun to appear for even more advanced forms of PCS. The PCS being developed today have significant improvements over those currently available. The most significant feature of the next generation of these services appears to be a movement towards person-to-person, instead of station-to-station, communications.

Existing PCS require that users have a different telephone instrument for home, office and car, each with a separate number. Advancements in PCS technology have made lightweight, portable telephones more feasible. Thus, future PCS are expected to permit individuals to use the same device in several different environments. Therefore, a person could be reached at any location by dialing a single telephone number. Moreover, future systems are expected to have greater capacity, thus reducing blocking, and the digitization of future communications which will make them more difficult to intercept and, therefore, more private.

The Commission noted that global interest in new PCS has been developing over the last few years, arising, in part, from some countries' desire to introduce competition with existing cellular service and to provide their citizens with new and better services. The United Kingdom has been especially active in the area of PCS and has allocated spectrum for an advanced digital cordless telephone technology, referred to as CT-2.

The Europeans have also expressed substantial interest in personal communications networks (PCNs). While no precise definition of PCNs exists, in general, the current prevailing view is that PCNs will be cordless radiotelephone networks based on digital and microcell technologies. They will be self-contained, but will have the capability of accessing the public switched telephone network. The Commission noted that the

1992 WARC may possibly consider providing a world wide allocation for PCS in the 1700 MHz to 2300 MHz band.

The Commission said the apparent market demand for PCS, the new technological developments, and the growing world interest in these services has also stimulated interest in the U.S. Several entrepreneurs have approached the Commission in recent months seeking authorizations and rule changes related to development of domestic PCS. In particular, the Commission has received several requests for experimental authorizations to develop equipment and to conduct market studies to assist in the implementation of CT-2 and PCN-type studies.

In addition, the Commission has received two petitions for rulemaking from Cellular 21 and PCN America, a subsidiary of Millicom, Inc., requesting that it commence rulemaking proceedings to allocate spectrum for PCS services. The Commission has asked for comments on the details of these two proposals.

Cellular 21 requested that the Commission allocate the 940-941 MHz band for a second generation cordless telephone, CT-2, that includes a public access service such as the British telepoint services. It contended that CT-2 has technical advantages over today's first generation cordless telephones. It said these "older-style" cordless phones are subject to eavesdropping and interference. Cellular 21 proposed that the Com-

mission channelize the band into nine 100 kHz channels with a 50 kHz guardband at each end and limit both the base stations and mobile stations (handset) to 10 milliwatts of power. It asked that the FCC adopt the CAI signalling protocol that the United Kingdom has adopted for its CT-2 operations and asked that as CT-2 use increases, the 941-944 MHz band be made available for its use and the current users of this band be relocated to other bands.

PCN America asked the Commission to allocate 100 MHz from the 1850-1990 MHz band for PCNs. This band is currently allocated to the Private Operational-Fixed Microwave Service. Under this proposal, PCNs would be digital cordless telephone radionetworks with extensive service areas built on microcell technology. These networks would use inexpensive, pocket-sized terminals, intelligent networks, smart cards that can be read electronically to provide information about the user for billing purposes, and advanced signalling protocols. They would be essentially self-contained, although some interconnection to the telephone network would be built-in. They would provide integrated services including voice, data and image delivery. PCN America argued that PCNs can provide these services in a way that makes efficient use of the radio spectrum. It proposed that PCNs use spread spectrum techniques to allow sharing the spectrum with existing users. **PC**

Order Back Issues of **POPULAR COMMUNICATIONS**

Secret Frequencies

The Remote Computer Scanning System™



Turn those hours of manually searching for secret frequencies over to RCSS™. The RCSS™ significantly enhances the ICOM™ R7000 receiver capabilities by providing automated PC control over receiver scanning & memory functions.

Features

- Automatic detection and storage of active frequencies & other info while scanning.
- User specified Tuning Steps from 10-100 MHz.
- Scan Mode, Class of Service, or Type of Unit.
- Scanning resumes upon loss of carrier.
- Memory capacity: 1,000 frequencies.
- Monitor half-duplex communications.
- Mouse/Keyboard driven graphic user interface.

SYSTEMS & SOFTWARE INTERNATIONAL LTD.

4639 Timber Ridge Drive, Dumfries, VA, 22026-1059 USA
(703) 680-3559, Fax: (703) 878-1460. RCSS™ is available for both IBM compatible & Macintosh computers.



PICKS UP A WHISPER 50 FEET AWAY!

The model WAT-50 miniature FM transmitter uses a 4-stage circuit NOT to be confused with a simple wireless microphone. Simply snap the unit on top of a 9V battery and you can hear every sound in an entire house up to 1 mile away! Use with any FM radio. Tunes to any frequency from 70mhz - 130mhz. Easy to assemble kit includes all parts and instructions. Only 29.98 tax incl.



The WIRELESS TELEPHONE TRANSMITTER model WTT-20 is only about the size of a dime, yet transmits both sides of a telephone conversation to any FM radio with crystal clarity. Completely automatic. Uses power from the telephone line itself - never needs a battery! Up to ¼ mile range. Tunes from 70mhz - 130mhz. Easy to assemble kit includes all parts and instructions. Only \$29.98 tax incl.

Call or send **MO, VISA, MC** for immediate delivery. Single kit orders include \$1.50 S&H. **FREE SHIPPING** on orders of 2 or more. All orders shipped by **U.S. Mail**. **COD add \$4.00. Personal checks allow 21 days.**

DECO INDUSTRIES
BOX 607, BEDFORD HILLS, NY 10507
914-232-3878

CIRCLE 41 ON READER SERVICE CARD

CIRCLE 42 ON READER SERVICE CARD

FOCUS ON FREE RADIO BROADCASTING

CHGO, which a number of readers have reported over the past months, was busted by the FCC back on April 8. The station was run by on John L. Rosengarten of Chicago who was fined \$1,000 for illegally operating on 7415.

Josh Wilkes in Kentucky logged the first broadcast of the **Voice of Bono** on 0244 on 7413. Josh says the format was comedy recordings and fake commercials. He got a quick QSL, signed by Gary Daniels. (The address is PO Box 6527, Baltimore, MD 21219). Josh's QSL was designated number five. Mark Morgan in Ohio got QSL number seven for his reception of the premier broadcast. Mark says his letter from the station indicates the Bono broadcasts are actually being relayed by a different pirate. Tim Johnson of Illinois sends a copy of the letter he got which notes that Bono is "the family dog." Daniels says holiday weekends are the most likely times the station will be active.

The **Cheap Radio Thrills Network**, was heard by Kristin Kaye in New York at 0315-0400 on 7415 with some technical problems and mentions of broadcasting from the Albuquerque Fairgrounds. Gave phone numbers (1-800-555-5555, 213-555-5757 and 997-3251). Also noted were contacts with Jolly Roger Radio, WKZP and Tube Radio, as well as jamming from Hello Radio. The station was also heard by Tim

Johnson, ID'ing as the Cheap Comedy Thrills Network and telling listeners to write to *Pop'Comm*.

Mark Morgan heard WHBH on 7415 lower sideband at 2254-2335 with music and comedy.

WYNN was noted by William H. Taylor in Pennsylvania using 7400.5 at 1445. ID'd as "This is WYNN broadcasting from . . . you can write to us at . . ." but, Bill says, nothing was aired in these gaps. Played country music and featured a woman announcer so he wonders if this might really have been the all-female WYMN.

Hope Radio had a flurry of activity. David Grubbs in New York had them on 7398 at 0140 and then with a repeat of that broadcast on 7389.8 at 1918 the next day. Then, a few days later, they were on 7393.5 at 0119 "begging for reception reports" and seeking criticism of their programs. David noted the appearance of an open carrier on 7413.3 seven minutes after Hope closed. The carrier was the same strength and there was an apparently unintentional three seconds of Hope's program on 7413.3. This carrier went off at 0159 and at 0203 another carrier, equal in strength to the earlier one, came on and **Radio Clandestine** signed on. So David wonders if the two are using the same facility. Jeff Foster also heard Hope Radio in Michigan at 0140 on 7395 and 7400 at 0210.

Jeff found R F. Burns and **Radio Clandestine** at 0203 on 7415. Tim Johnson had this on 7395.7 with rock at 0302, being interrupted by someone repeating "get off the band while you can, man. Get off the band while you can . . ."

Tim heard **One Voice Radio** at 0200 on 7415. Jeff Foster got this one on the same frequency at 2321-2341 and 1950-2007 with "Joe" the announcer reading about rheumatitis, corn oil, cholesterol and the life of your toothbrush.

Another Tim Johnson logging was **Tube Radio**, which Tim heard at 0404 on 7409 giving the Baltimore address and making remarks like "I am the earth, the planet you call home." Foster also had them at 0035-0125 with poor audio and squeals. Hard to copy, says Jeff, but he did hear them give an address of PO Box 1226, New York, NY 10159, though Jeff's not sure if that is for QSLs. Jeff says they closed with the same Zeppelin instrumental used by Hope Radio.

The Voice of Intoxication was heard by Foster on 7412 at 0105-0135 with rock. The announcer said he'd respond to reports sent to "the usual publications." This may be the one Tim Johnson heard as the Voice of Gratification at 0103 on 7411.5.

Outlaw X was heard by Foster on 7414.6 at 0240 with just listener letters. Later there was a roundtable discussion with the Revolutionary Voice of Plainsville, US-

VOICE OF BONO
750 QSL

TO: Joshua Wilkes

This will confirm your reception of VOICE OF BONO:

DATE: 27 May 1990

TIME: 0244-0306

FREQ: 7413 kHz

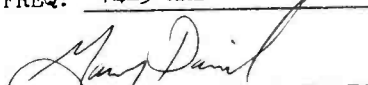
 Gary Daniels
 On-Air Operations



Bono
 Wonder Dog & Guiding Light

QSL # 5

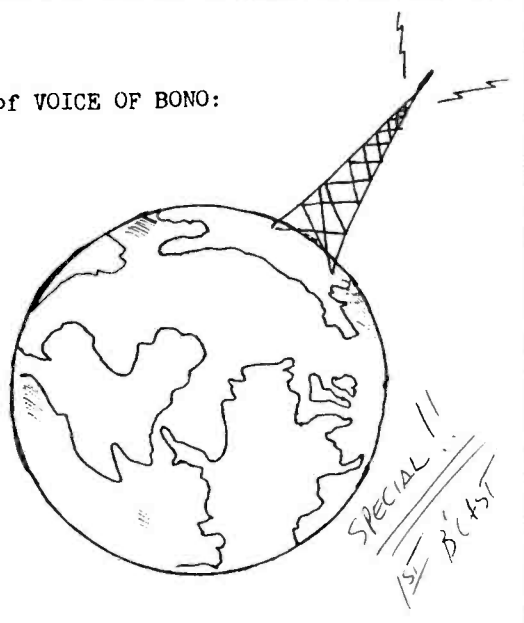

Joshua Wilkes, Mark Morgan and Tim Johnson all caught the first broadcast of the Voice of Bono and all got quick QSLs.



STANDARD FEATURES

- **FULL FUNCTION:** Direct and prescaled Frequency, Periods (or averages), Time Intervals (or averages), Frequency Ratios.
- **WIDE FREQUENCY RANGE:** 10 Hz to 2.4 GHz, useful 1 Hz to 3 GHz
- **HIGH RESOLUTION:** 1 sec gate time displays 1 Hz in 200 MHz.
- **HIGH ACCURACY:** TCXO ± 1 ppm standard
- 16 element signal strength meter
- 10 digit LCD readout
- NBS traceable calibration

ONLY **\$579**

OEI's model UTC 8030 is a full-featured Universal Counter-Timer with a Frequency Finder built in a unique bench/portable enclosure. The Frequency Finder's 10 mV antenna sensitivity and NiCad batteries provide true off-the-air measurements at maximum distance from any transmitter up to 3 GHz.



OPTOELECTRONICS, INC.

5821 NE 14TH AVENUE
FORT LAUDERDALE, FL 33334
FLORIDA PHONE (305) 771-2050

CIRCLE 58 ON READER SERVICE CARD

MORE THAN JUST A FREQUENCY COUNTER

OPTIONS

- TCXO 80 \$125
High precision ± 0.1 ppm sealed 10 MHz 20°-40°C temp controlled xtal oscillator
- NICAD 80 \$75
Internal rechargeable NiCad battery pack for >2 hours field use without recharging
- BL 80 \$40
Display backlight for nighttime use

ASK ABOUT
USEFUL ACCESSORIES

1-800-327-5912
FAX (305) 771-2052

One and the Voice of Draino. Outlaw X gave its general location as central Virginia. Johnson reports **WKZP** (K-ZAP) at 0105 on 7415 with rock and comedy.

Tim also had **WLIS** (We Love Interval Signals) with—interval signals—at 0405 on 7408.

Radio Free Massachusetts was heard by Foster at 0220-0245 with a repeat at 0415 on 7400. Played jazz and other music and what Jeff termed "the ultimate pirate anthem—We Want the Airwaves" by the Ramones. Gave the Blue Ridge address.

Mark Morgan found **WRFI** (Radio Free Intelligence) on 7415 at 2254-2335, in contact with WHBH.

He also heard **Radio Free Willy** on 7415 at 0251 with comedy and mentions of the "Soft Balls Radio Network."

Another Morgan log was **Secret Society Radio** on 7410 at 2251-2309 with music to abrupt closing. Gave the Baltimore address for QSLs.

Mark also had a log of **KNBS** on 7412 between 2320-2352 two nights running. Also the **Voice of the Obnoxious** on 6413 at 0217-0256 with music and comedy.

That's it for this month. Pirate activity continues high, despite brisk FCC actions, so there's plenty out there to hear and I hope you'll pass the results along to me here in the Pirate's Den. Let's hear from station operators, too!

PC

CQ Amateur Radio Buyer's Guide

You can buy with confidence when you have all the facts. The 1991 Equipment Buyer's Guide gives you in-depth coverage of HF/VHF/UHF rigs and accessories. All the information is here in one handy, concise directory with descriptions, technical specifications, model numbers, retail prices and photographs. How do you get a ham license? What's the latest on the code-free license? What equipment do you really need to work the satellites? Should you buy a computer for your shack? How do you add computer control to your rig? You can buy with confidence when you have all the facts. Order the 1991 Equipment Buyer's Guide today!

You'll need the Antenna Buyer's Guide to squeeze every last dB out of your antenna dollars. Make sure you get the best possible antenna system for the best price! HF and VHF/UHF, directional and omnidirectional, vertical and horizontal, mobile and portable—they are all covered in depth. Tuners, cables, wattmeters and more! You'll find detailed charts, specifications, photos and retail prices. Advice on getting the proper tower and antenna permits from a leading authority on PRB-1. Step-by-step guide to putting up your first beam! The bands are hotter than ever right now. You can't afford to wait.

ORDER YOUR BUYER'S GUIDES TODAY!

Don't miss the most valuable buying guides in the Amateur Radio field!

YES, please send me _____ copies at \$4.95 each:

- EQUIPMENT BUYER'S GUIDE
- ANTENNA BUYER'S GUIDE

Name _____ Call _____

Address _____

City _____ State _____ Zip _____

Send only \$4.95 each today. Foreign: \$6. U.S. funds. Check Money Order

MasterCard VISA Amex Card No. _____ Expires _____

Signature _____ (required on all charge orders)

Mail to: CQ Communications, Inc., 76 North Broadway, Hicksville, NY 11801/FAX: 516-681-2926



SCANNING VHF/UHF

BY CHUCK GYSI, N2DUP

MONITORING THE 30 TO 900 MHz "ACTION" BANDS

Winter time is almost here in many areas of the country. Now is the time to line up those lists of frequencies that bring good cold-weather monitoring. Make sure you have lists of local snowplowing frequencies, as well as ski resort frequencies if you live near such a mountain.

David Doan of Orlando, Florida, sends in a clipping that Florida now allows the legal use of scanners by news agencies in that state. While the practice has long been done, it wasn't until this law was signed that the usage became legal. The bill applies to any recognized newspaper or news publication that covers news full time.

Kevin R. Kellerman of Warren, Ohio, says that because of the amount of activity in his area on 155.595 MHz, police in Warren, Ohio, have switched to 151.220 MHz. That points up to an interesting note. Police, fire and local governments in many areas of the United States have been abandoning overcrowded VHF frequencies assigned strictly for their purposes for forestry conservation channels that may be unused or underused. These 151 and 159 MHz channels may be dead right now in your area, but don't be surprised to find police and fire activity on these channels in the near future if the available channels in your area become overloaded. Agencies other than forestry conservation departments can obtain these channels simply by filing an interservice coordination request when they seek their FCC license and prove there is a shortage of available frequencies in their own radio service. The applicant must also show that the forestry conservation channel being sought is not in use for actual forestry or environmental operations in their area.

Moreover, Kevin says that those still using 155.595 in his area are: Trumbull County, Liberty Township, Niles City and Girard City police. In addition, he reports Youngstown Municipal Airport on 119.750 and heard some Morse code on 114.400 (which probably is a VOR frequency in your area) whose signal planes use for navigation purposes. Kevin monitors with a Realistic PRO-2005 scanner and listens to shortwave with a Sangean ATS803A receiver. Kevin also inquires about the N2DUP after my name. Yes, that's my amateur radio call sign. The number in the call sign indicates what area of the country the ham lives in when the call sign was issued. In my case, the "2" indicates the call sign was issued when I was living in the region consisting of New York or New Jersey. However, hams can keep their call signs when they move to other areas of the country. For instance, even though I now live in an area of the Midwest where other hams have zeros in their



Everything is within reach at this listening post belonging to Registered Monitor KFL4DN, Richard Sprau of Lake City, Florida. Scanners include a Realistic PRO-2004 and PRO-2021. The lava light apparently is to soothe those frustrating monitoring sessions!

call signs, I am able to keep my old call sign. I could have requested a new call sign, however.

Michael D. Riggan, Registered Monitor, KAR5BP, of Little Rock, Arkansas, passes along a tip. He says that to improve reception of the 800 MHz band on his Realistic PRO-2004 scanner, he installed a 75-ohm attenuator (Radio Shack part No. 15-578) between the antenna cable and the antenna jack on the scanner. After installation, he adjusted the attenuator for best possible reception and found that the minimum set-

ting was best for him. He said that this device improved his 800 MHz reception 90 percent and there is no difference in signal quality on the other bands.

Timothy B. Mitchell of Lubbock, Texas, says he has seen mention in *POP'COMM* of Registered Monitoring Station "licenses" and wants to know how to obtain the distinctive ID. First of all, they aren't "licenses" and don't purport to give any authority to transmit. However, it does give you a distinctive ID that will readily identify you to other communications enthusiasts and stations that you are a serious monitor. For instance, my own official Registered Monitoring station ID is KPA3CA. That means my call was issued when I was living in Pennsylvania (PA), which is in the third (3) call district as far as ham call signs are assigned. Registration is only \$5, and you get a good looking parchment certificate. If you want a Registered Station ID, they're issued by CRB Research Books, Inc., PO Box 56, Commack, NY 11725. They've been issuing them since 1970.

Russell T. Bell of Kearneysville, West Virginia, wants to know why it is impossible to purchase, or get a diagram and parts list for a voice speech descrambler for scanner use when all kinds of descramblers are sold for satellite receivers and cable TV. One of the main reasons scanner descramblers no longer are sold on the open market is that the Electronic Communications Privacy Act of 1986 made it illegal to buy, sell or own a descrambler unless one was a law enforcement agency that had a need to monitor its own scrambled communications. Several firms used to sell these descramblers before



LABRADOR

VO1MON

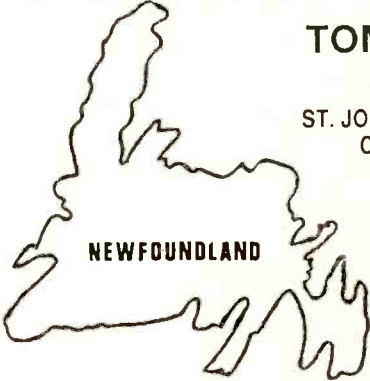

NEWFOUNDLAND

TOM WICKHAM

9 FEILD STREET
ST. JOHN'S, NEWFOUNDLAND
CANADA A1C 4J3

(709) 579-3129

73's**88's**

Station card sent out by Registered Monitor VO1-MON-10, Tom Wickham, of Newfoundland, Canada. Why not send us your card?



This good-looking certificate comes with a Registered Monitor ID. (Sample courtesy CRB Research Books, Inc.)

the ECPA took effect, however, rather than incur the wrath of government agents knocking on their doors, they obviously have discontinued making such models. Descrambling voice inversion scrambling isn't too hard if you know what you are doing. Basically, the high pitches become low and the low pitches become high pitches. However, you really don't want to violate the ECPA do you? And nobody ever eavesdrops on cellular phone calls either, right?

Ed O'Connell of Irvington, New Jersey, checks in to say that the police department in his town is now using the new 800 MHz band that has been opened to public safety agencies across the United States. The new band consists of channels spaced 12.5 kilohertz apart in the 866-869 MHz band, which previously was unused. Each region of the country, basically on a metropolitan or statewide basis, has been charged with drawing up plans to utilize the new band in their regions. The northern New Jersey-New York metropolitan area was one of the first regional plans approved by the Federal Communications Commission, and the Irvington Police Department in New Jersey did not waste any time in moving to the new band from their old VHF low band channels of 45.10 and 45.74. The department is using 866.125 for routine dispatch and 868.6875 for ambulances and the volunteer rescue squad. One of the conditions of getting these new 800 MHz channels is that the licensees must surrender their licenses for lower frequencies, thus it is likely Irvington will lose its two low band channels once their switch to the new band is complete. This will open up these two low band channels for some other type of operation in their area by another local government.

Ed also asks about the five nationwide mutual aid channels that Irvington has licensed themselves on. These five channels

are: 866.0125, 866.5125, 867.0125, 867.5125 and 868.0125. All these channels are exactly a half-MegaHertz apart. The mobile inputs, if used through a repeater, are 45 MHz lower than the listed frequency; however, talkaround (simplex) is allowed on the mutual aid channels. Unless an agency places a repeater, base station or control station on the air, it is allowed to operate on these new mutual aid channels without license as long as only mobiles or handheld radios are used. In fact, if an agency already operates on the older 851-866 MHz band, it also can include the new mutual aid channels in its radios if they will accommodate the new band, without worrying about FCC type acceptance to operate in the new band. The key here is to get as many agencies as possible to operate on these five new nationwide public safety mutual aid channels. Once this band really starts coming into use, you may hear all types of communications, especially surveillance, on these five mutual aid channels. And don't forget to check the channels 45 MHz lower, too!

While we're on the subject of Irvington police in New Jersey, which is a suburb of Newark, New Jersey, here is a list of car numbers used on their new 800 MHz system if you care to tune in: 100s, unmarked cars (special crimes and tactics); 201-205, patrol cars; 206-209, unmarked cars (not currently used); 211-214, sergeants; 220, lieutenant or captain; 223-224, traffic cars; 230s, detectives; 250s, rescue squad; 260s, police reserves; 280s, tow trucks. Thanks, Ed, for a report on one of the nation's first users of this new 800 MHz band.

What are you hearing on your scanner? We welcome your frequency lists, listening post photos and questions. Write to: Chuck Gysi, N2DUP, Scanning VHF/UHF, Popular Communications, 76 North Broadway, Hicksville, NY 11801-2909. **PC**

CHANNEL CLEANER™

- New reception principle.
- Reduce interference 15-30 dB.
- For small portable radios.

Bugged by interference? Two stations on one frequency and you can't understand either one? Splatter? Heterodynes?

Channel Cleaner™ solves these problems. Simply place your radio on Channel Cleaner's platform. Tune Channel Cleaner™ and rotate it to null out the interference.

Channel Cleaner™ makes a directional radio frequency shadow that shades your radio's antenna from the interference. Reception in all other directions is normal.

Experience this exciting new development. Order your Channel Cleaner™ today.

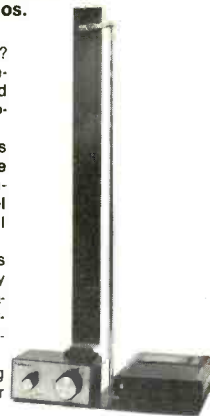

Model PA-420 Channel Cleaner™ \$79.95 + \$4 shipping/handling in U.S. & Canada. California residents add sales tax.



Send for FREE catalog that shows our complete line of antennas, preamplifiers, and filters.

PALOMAR ENGINEERS

BOX 455, ESCONDIDO, CA 92033
Phone: (619) 747-3343

GILFER — first in Shortwave



JRC NRD-525 "No. 1 receiver outside the commercial/military bracket... way ahead of the competition... outstanding in all modes... a best buy." — R. Lichte. CPU control, 0.15-30MHz, computer interface, 200 memories, PBT, blanker, notch, scan/sweep, clock. DATONG FL-3 AUDIO FILTER (atop NRD 525) Automatic, tunable 12 pole filtering makes weak sigs audible, removes noise, heterodynes; dual notch plus hi/lo pass filters.

VISIT GILFER'S STORE

Easy to find, accessible from New York City. Take Garden State Parkway (NE portion of N.J.), Exit 172. Gilfer is in the center of Park Ridge, opposite the Borough Hall. Store hours: M-F 10am-5pm, Sat. 10am-3pm.



Order operators: 1-800-GILFER-1
(1-800-445-3371) NJ 201/391-7887

GILFER SHORTWAVE
52 Park Ave. • Park Ridge, NJ 07656

CIRCLE 59 ON READER SERVICE CARD

Beaming In (from page 6)

to actually operate, I can still at least peak tune, using nothing more than a smoke detector as an output meter. But this machine was definitely a piece of work unto itself.

Still, in a grotesque way, *Ming* looked very impressive. Folks showing up and witnessing this foreboding contrivance with its deranged whirring, winking, blinking, beeping, burping, and chirping were fully aware that it was impatiently awaiting my instructions. They feared the havoc I might wreak with the machine should I experience even a fleeting moment of crankiness.

The truth was, however, that months later, I was still spooked by *Ming*. Each time I dared to touch the keyboard, I felt in imminent danger of electrocution. Moreover, I always suspected that I was only a few keystrokes away from sucking every last volt, amp, watt, ohm, henry, joule, and coulomb out of all power mains from Key West to the Yukon.

Yet, I was certain that if ever I could gain the upper hand, I'd ultimately find many uses for *Ming*, and would be able to accomplish them without a lot of time wasted by triple checking every command in the operating manuals. As for making good impressions, I was patiently waiting to show the gruesome contraption to one of my daughters who was then away at college studying engineering. She frequently said how useful it would be to have a really good computer.

When she showed up for Thanksgiving, I cautiously displayed *Ming*. I didn't mention that only the brave or foolhardy would dare to stand within twenty feet of it without a sprig of wolfsbane, a wooden stake, silver bullets, and a necklace of garlic. But she was ambivalent, doubting that in its existing state it could run the *Fortran* programs she needed. She thought it was probably little more than a—uh . . . glorified toy.

OK, so maybe it wasn't all things to all people. Sadly, however, after more than a year of forcing myself to pick at the computer on a regular basis, I still couldn't generate any enthusiasm. I did, however, manage to reduce the language barrier from the equivalent of learning Albanian to learning, let's say, maybe Farsi or Nepalese.

Eventually, I tapered off on my efforts to become its master, or even its friend. Several years passed without any attempts on my part to communicate with *Ming*.

Finally, I decided to sell it to a friend who had coveted *Ming* right from day one. I got rid of it despite the uneasy feeling I had that someday the demon computer would manage to find me again and retaliate. *Ming* and his new master later achieved places of honor in the Hackers' Hall of Fame by virtue of the indignant and outraged coverage they received in the national media that described their sinister escapades. But that's another story. Rest assured, *Ming* lives!

I've kept the doddering *Atari 800*, just for

posterity. Sure, it's a candidate for a museum, but it works and I'm captivated by its dignified simplicity. It can gracefully run several simple but useful programs, all at its own courtly, slow pace. It's an elegant and trusted friend. And, unlike others I could name, never once has it given me reason to suspect that, out of sheer orneriness, it was plotting to reach out and grab my sleeve or necktie in order to drag me screaming into its disk drive.

Much of my subsequent writing has been done on an IBM dedicated word processor that stores information on 3.5 inch diskettes. I've been comfortable with the machine, I'm used to working with it, and it has served my needs well. But, about three years ago, our company decided to make PC compatibles the office standard. Ever since then, the front office has been trying to palm off one of these clones on me.

Since compatibles use a disk operating system that's totally new to me, I checked out Jack Nimersheim's book, *The First Book of MS-DOS* (Sams) to get some idea of what was ahead. Jack wrote, "Mastering DOS is no walk in the park. At times, in fact, DOS seems more like an electronic obstacle course, one designed to try your mental patience and test your intellectual endurance." Trade in my schlemiel-proof word processor for one of these? No way, Jose! Thanks, but no thanks. I wasn't about to willingly patronize any more homeless computers that spoke exotic alien languages.

The typesetting people at *POP'COMM* prefer to deal with 5.25 inch floppies. The editorial staffs of the other magazines published by our company now work with compatibles and floppies. The diskettes used by my word processor have never been of value to anyone else in the company, although everybody agrees that they make excellent coasters for cold soda cans.

For years, the production people here have rather good-naturedly endured my various work idiosyncrasies, and the diskettes certainly haven't been the worst of them. It just meant that everything I put on diskettes had to be entered into a computer by *POP'COMM's* Associate Editor, Jeanine, in order for it to be of use to personnel who needed to deal with the material. The end of everybody's patience with me and my diskettes, though, came not long ago when our company acquired two more monthly publications, *Electronic Servicing & Technology*; also *Ham Radio* magazine, which has been combined with our existing *CQ* magazine.

At that point, with four monthly magazines, several annuals, and a lot of other things going on, the production department's strong feeling was that the time had finally come for me to get into sync with the rest of the team. Once more, I was invited to go peaceably into the 1990's with no more of this diskette nonsense. It was put to me pleasantly, but this time in the form of an offer I had the distinct feeling I probably shouldn't try to refuse.

To the accompaniment of cheers from those colleagues who deal with my manuscripts, a computer was unceremoniously slid off onto my desk one morning. While wondering what button to push or switch to flip first, it occurred to me that this could well be the lunatic *Ming's* long-awaited payback. I braced myself in expectation of the monitor zapping out a fiery orange tongue of high energy protons.

Jeanine came to my rescue, providing a hastily scribbled pictorial diagram with large red arrows showing where the on/off switch was; where the floppy goes; how to open and close files; and how to store information. I was in charge. It was a cinch!

Things have gone surprisingly well. After only five months of working with my new friend, last week I managed to inadvertently lean my elbow somewhere or other on the keyboard and accidentally delete a 159K file the company had loaded on the hard drive for me to work with. I don't have the slightest inkling as to what the data was. Neither do I know how I accomplished this, nor did I report its loss to the company. Still, it took place in only a split second, and that was better than ten minutes quicker than I was ever able to do anything with *Ming*, even intentionally. I took this as a good sign.

It's sitting on my desk next to some of the mail that continues to flow in from all of the good folks seeking my insights into computer matters. By the way, I've grown to love computerbabble, and now generously sprinkle it throughout my letters and conversations—ROM, XT, 80206, MB, RS-232, block, surge, virus, crash, GIGO, and the like. When I toss around these terms, I find that they have a magical soothing and reassuring effect upon those who seek my counsel. Using these terms also makes *me* feel better about all of this. I'm certain that the effect will be enhanced if and when I get some general idea of what this double-talk means.

Yesterday my daughter called. No longer an engineering student, she's now a plant engineer at a nuclear power facility. When I told her about my new computer, she said that, compared to the mainframe computer in her office, mine was "very compact." I'm not certain if that was an actual compliment, but it was unquestionably better than being accused of having a computer that's a glorified toy.

If you want to know how to VGA your mouse, or are having trouble with a packet in your RAM, just ask me. Hundreds of good people have come to regard me as an authority, so I suppose I must really be one. I graciously accept the honor. What's my opinion against the world? Therefore, I'll have lots of answers—but first, I want to straighten out that poor, confused dentist about using his computer.

Then, what the heck, I'll quietly drop in at the company's Lost and Found office. Maybe if they rummage around in that big carton of old sneakers, umbrellas, and eyeglasses, they'll find that 159K data file I lost. **PC**

COMMUNICATIONS SHOP

Advertising Rates: SCAN members and POP'COMM subscribers are entitled to one FREE 30-word, non-commercial classified ad per year. Enclose subscription name label with ad copy. For those people not in the previously mentioned groups, non-commercial ads are 30 cents per word, including abbreviations and addresses; minimum charge \$6.00 per issue. Ads from firms offering commercial products or services are \$1.00 per word; minimum charge \$20.00 per issue. Boldface words are \$1.20 each (specify which words). Leading key words set in all caps at no additional charge. All ads must be prepaid in full at time of insertion; a 5% discount is offered for prepaid 6 time insertions. All ads must be typewritten double spaced.

Approval: All ad copy is subject to Publisher's approval and may be modified to eliminate references to equipment and practices which are either illegal or otherwise not within the spirit or coverage scope of the magazine.

Closing Date: The 10th day in the third month preceding date of publication. Because the advertisers and equipment contained in Communications Shop have not been investigated, the Publisher of Popular Communications cannot vouch for the merchandise listed therein. Direct all correspondence and ad copy to: PC Communications Shop, 76 N. Broadway, Hicksville, NY 11801.

NEW! AIR-SCAN 5TH EDITION by Tom Kneitel. Complete guide to aero comms. Now in gigantic 192-page large-size format containing 60,000 + listings, including 2-30 MHz HF, 118 to 174 MHz VHF, 406 to 512 MHz UHF, and 800 MHz listings. Covers civil, military, private, and unlisted landing areas, heliports, and seaplane bases. Control towers, ground, approach/departure, FSS, unicoms, multicomms, crop dusters, air-ambulances, federal ops, traffic 'copters, aviation business, airline enroute, airport security/fire, etc. throughout USA. All Canadian mil, civilian airports and seaplane bases listed, plus lots more, including how-to text on aero monitoring. Most comprehensive aero frequency guide ever compiled. Only \$14.95 + \$2 postage to USA/Canada/APO/FPO. NY State residents add \$1.13 sales tax. From: CRB Research Books, Inc., P.O. Box 56, Commack, NY 11725, or ask your favorite communications dealer.

SCANNER MODIFICATION HANDBOOK by Bill Cheek ("Doctor Rigormortis"). New 160-page book. More than 20 performance improvement modifications. Simple step-by-step instructions, many photos. Primarily PRO-2004 & PRO-2005, some for PRO-34, BC-200/205XLT, BC-750XLT, BC-750XLT. Restore blocked out bands, speed up scanning rate, disable "beep," increase number of channels, improve squelch action, add an S-meter, interface with shortwave receivers, etc. Make the PRO-2004 & 2005 into a 6,400 channel scanner; put 3,200 channels into the PRO-34! Plus, cellular frequency charts, antenna info & mods, inside info on frequency management, operating hints, emergency power supplies, scanners & the law, lots more! Just issued, latest info. Only \$17.95, plus \$2 postage to addresses in USA/Canada. Residents of NY State add \$1.35 tax. CRB Research Books, P.O. Box 56, Commack, NY 11725.

COMMODORE 64 HAM PROGRAMS—8 disk sides over 200 Ham programs—\$16.95. 25¢ stamp gets unusual software catalog of Utilities, Games, Adult and British Disks. Home-Spun Software, Box 1064-PC, Estero, FL 33928.

WANTED FOR MUSEUM: Pre-1980 microcomputers and journals. David Larsen, KK4WW, Blacksburg Group, (703) 763-3311/231-7961.

WANTED: Goodwill donation of IBM-PC, packet TNC, technical books or transceivers for the Soviet Amateur Radio emergency radio service. David Larsen, International Amateur Radio Network, KK4WW, (703) 763-3311/231-6478.

WANTED: Old Ship Medium Frequency Radiotelegraph Equipment - Radiomarine or Mackay transmitters, receivers, or entire console. Write to PO Box 8802, Mandeville, LA 70470-8802.

CONVERT your own tape recorder to extended long playing. Save on tapes. Plans \$3.00. **Recorder control** turns on-off tape recorder automatically, records all telephone conversations. Plans \$3.00. Both complete easy to follow instructions for \$5.00. Delta House, 67 Linden, Natchez, MS 39120.

NEW! 7th Edition: Top Secret Registry of Government Radio Frequencies, by Tom Kneitel. Grown to gigantic 240-pages! 1000's of new listings, frequencies, stations for all scanner owners, nationwide. Includes: FBI, DEA, Customs, Secret Service, FCC, Immigration, Border Patrol, U.S. Attorney, ATF, Treasury, Fed. Prisons, U.S. Marshal, CIA, Postal Service, NSA, NORAD, USAF, USN, Army, USMC, FAA, NASA, DOE, NRC, FEMA, Dept. Agriculture, National Parks, USCG, EPA, DOT, V.A., UHF aero (225 to 400 MHz) listings, bugs & surveillance freqs, agents' lingo, codes, many more agencies, lots more info! Expanded Canadian listings. Only \$19.95, plus \$2 postage to N. American addresses. NY State residents add \$1.50 sales tax. Order now from CRB Research Books, P.O. Box 56, Commack, NY 11725. Dealer Inquiries Invited.

RADIO NEW YORK INTERNATIONAL official off the air recording of our first broadcast from the good ship Sarah. \$15.00 gets you a 60 minute cassette, plus an official letter and certificate from the RNI staff. Also available: RNI video (VHS) with tour of ship, news footage, the FCC boarding, and more. Only \$29.95. Radio New York International, Monticello, ME 04760.

FEDERAL FREQUENCIES the newest, most complete listing available yet. Law enforcement, military, defense, justice, treasury, plus much much more. T.V.—satellite—telephones—paging and other freqs. 224 pages! \$24.95 plus 2.00 p&h to: ART-SCI, dept. RKY, P.O. Box 1848, Burbank, CA 91507. (818) 843-4080. MC, VISA, AMEX, DISCOVER. CA residents add 6.75% sales tax.

TRAVEL HIGH INCOME! Radio officers needed for shipboard employment. Must have FCC Second Class Radio-Telegraph license and background in electronics. Approximately \$7000.00 per month to start after 6 month training. Call or write: Rae Echols, W7FFF. American Radio Association, 5700 Hammonds Ferry Rd., Linthicum Heights, MD 21090, 301-850-5379.

SCANNER MODIFICATION HANDBOOK, TOP SECRET #7, AIR SCAN #5. Plus many books by CRB, TAB, ARRL and others. We take phone orders and VISA/MASTERCARD. FREE catalog. DOYLE COMMUNICATIONS-PC, Route 8, Box 18, Lake Pleasant, N.Y. 12108 (518) 548-5515.

DESCRAMBLERS: OAK M35B, \$39.95. Also Jerrold, Zenith, Scientific Atlanta, etc. Guaranteed. Cable Plus, 14417 Chase #481-K Panorama City, CA 91402. 1-800-822-9955.

USE YOUR FREE INFORMATION CARD

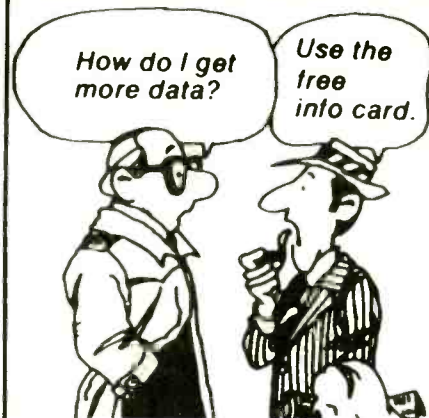

Free Product Information

Readers can obtain free information on products advertised, as well as for some editorially mentioned products. Simply circle the appropriate number printed below an advertisement onto the PC "Free Information Service" card bound into this issue. After filling in your name and address, just mail the postpaid card. Your request will be forwarded directly to the advertiser with a mailing label prepared by our reader-service department.

CABLE TV CONVERTERS
Why Pay A High Monthly Fee? Save \$100's A Year

- All Jerrold, Oak, Ham-Iln, Zenith, Scientific Atlanta, and more.
- 60 Day Money Back Guarantee
- Shipment within 24 hours
- WE WILL BEAT ANYONE'S PRICE No Illinois Orders Accepted

Electronic Engineering
P.O. Box 337, Barrington, IL 60011
Free catalog 1-800-542-9425 Information 1-708-540-1106

JRC NRD-525 HF Receiver

- Receive 90 kHz to 34 MHz V/UHF With Optional CMK-165 Converter
- 200 Memory Channels
- AM, FM, U/LSB, RTTY, FAX
- Multi Scan Feature

CALL TODAY!

ICOM IC-R9000
THE FINE ART OF LISTENING

- Continuous, All-Mode Receiver Covers 100 kHz to 2 GHz
- 1,000 Memories
- Advanced CRT Display
- Direct Digital Synthesizer System

CALL FOR ALL DETAILS!

ICOM IC-R71A
SUPERIOR PERFORMANCE RECEIVER

- USB, LSB, AM, RTTY and Optional FM
- Covers .1 to 30 MHz
- 32 Memory Channels
- Multi Scanning Functions
- Keyboard Frequency Entry

CALL TODAY!

KENWOOD R-5000
HIGH PERFORMANCE RECEIVER

- Covers 100 kHz to 30 MHz
- 100 Memories
- Keyboard or Main Dial Station Selection
- Programmable Scanning

CALL TODAY FOR DETAILS!

Amateur and SWL Accessories



HAMTRONICS, INC.

M, T, W (9-6)
Th, F (9-8)
Sat (9-3)

4033 Brownsville Road, Trevose, PA 19047
For Service & Info (215) 357-1400 For Orders (800) 426-2820 FAX 215-355-8958

NextDay Reception Reports

Two-Color Printing
Rainbow Cardstock
100 200 300
\$19.95 \$24.95 \$29.95

Specify • Receiver
• Antenna
• Your 40-Word
Personal Message

5 Star Reception Reports and QSL: Program
New York City, New York

• Command Attention • Send Clear Reports • Speed Replies • Save Time •

Box 50062-P • Provo, UT 84605 • **AntennasWest**
Circle: 800-926-7373
Hotline: 800-926-7373

CIRCLE 5 ON READER SERVICE CARD

*****PRESENTING*****
**CABLE TV
DESCRAMBLERS**
*****STARRING*****
JERROLD, HAMLIN, OAK
AND OTHER FAMOUS MANUFACTURERS

- FINEST WARRANTY PROGRAM AVAILABLE
- LOWEST RETAIL/WHOLESALE PRICES IN U.S.
- ORDERS SHIPPED FROM STOCK WITHIN 24 HOURS

FOR FREE CATALOG ONLY 1-800-345-8927
FOR ALL INFORMATION 1-818-709-9937

PACIFIC CABLE CO., INC.
7325 1/2 RESEDA BLVD., DEPT. 1156
RESEDA, CA 91335

HEAR ALL THE ACTION!

FED/AERO/RR/SW FREQ DIRS
SCANNER/HAM RADIO MODIFICATIONS,
TOP SECRET 7, AIR SCAN 5,
100+ BOOKS—BY CRB, ARRL, TAB, MORE.
800 MHZ CONVERTERS; ANTENNAS

Visa/MC/COD
NEW, larger CATALOG \$1 refunded w/order.
Doyle Communications-DPC, Route 8, Box 18,
Lake Pleasant, NY 12108. (518) 548-5515. 10AM-9PM

THE RADIO COLLECTION

1991 Passport to World Band Radio
\$13.95 includes US Shipping - save \$6.00

Free Catalog Available with an SASE
PO Box 149, Briarcliff Manor, NY 10510
Where Radio is Fun Again!

SHORTWAVE RECEIVERS. HAM RADIOS.
ANTENNAS, SCANNERS. Business Radios.
ICOM, YAesu, KENWOOD, SONY,
MOTOROLA.

... our 40th Year ... Worldwide shipping.
Sales ... Service. Large Showroom. Open 7 days.

Barry Electronics Corp.
WORLD WIDE AMATEUR RADIO SINCE 1950
Your one source for all Radio Equipment!

212-925-7000 or Fax 212-925-7001
512 Broadway, NYC, NY 10012

CIRCLE 68 ON READER SERVICE CARD

DX Helper II

Macintosh Software W7HR

MUF Map • MUF Plot
Gray Line • Great Circle
Prefix, Zone, Oblast
WWW Alert • CW Drill

\$49.95 Info
ppd \$1

AntennasWest

Box 50062-P, Provo, UT 84605

1-800-926-7373 See band openings on the map before they happen!

CIRCLE 5 ON READER SERVICE CARD

CW? NO PROBLEM. You can increase your speed, no matter how many times you've failed before. **Results guaranteed** when you follow the instructions. PASS Publishing's **CW Mental-Block Buster** program helps you **explode mental blocks** that hold you back. Based on 40 years of research, the **CW Mental-Block Buster** uses guided meditation, dynamic visualizations, and powerful affirmations to blast through mental blocks. **You can do code!** That means new bands, more contacts, more fun! (This is not a CW practice tape.) The **CW Mental-Block Buster** audio cassette and practice booklet are only \$24.95 ppd. in the US (NY residents add \$1.87 sales tax). (Quantity discounts available for classes.) PASS Publishing, P.O. Box 570, Stony Brook, NY 11780.

MORSE code got you down? Why let a mental block stand between you and upgrading? Use PASS Publishing's **CW Mental-Block Buster** to **blast through those barriers**. Just follow the instructions for 30 days—**Results Guaranteed!** Based on 40 years of research, the **CW Mental-Block Buster** uses guided meditation, dynamic visualizations, and powerful affirmations to blast through mental blocks. **You can do code!** That means new bands, more contacts, more fun! (This is not a CW practice tape.) The **CW Mental-Block Buster** audio cassette and practice booklet are only \$24.95 ppd. in the US (NY residents add \$1.87 sales tax). (Quantity discounts available for classes.) PASS Publishing, P.O. Box 570, Stony Brook, NY 11780.

TUNE In On Telephone Calls. Tom Kneitel's new 160-page book. Everything you need to know to effectively use a scanner and communications receiver to eavesdrop on private telephone calls from homes, offices, cars, ships, aircraft, trains. Explanatory text, photos, extensive listings section covers USA/Canada on HF, VHF, UHF, and above; thousands of locations, frequency assignments. Explains equipment, best techniques, laws regarding monitoring cellular, cordless, ship/shore, high seas, Air Force 1, airliners. 1-way paging, more. Only \$12.95 plus \$2 postage to USA/Canada/APO/FPO from CRB Research. Box 56, Commack, NY 11725. NY residents add sales tax. Dealer inquiries invited.

WOW! UNDERSTANDING & REPAIRING CB RADIOS by Lou Franklin. **Giant 380-page technical book** picks up where the "SCREWDRIVER EXPERTS" GUIDE leaves off. Includes circuit descriptions and troubleshooting guide for virtually all CB radios: 23 and 40-channel, crystal and PLL, solid-state and tube, AM, FM, SSB, CW, American, British and export models. Covers test equipment, transistor basics, synthesizers, receivers, transmitters, power supplies, T/R switching, antennas, interference, parts and accessory sources. Over 350 illustrations plus huge subject index. Moneyback Guaranteed Only \$29.95 plus \$3.50 U.S. & Canadian Air Mail, VISA/MC accepted. Free catalog of unique CB books, plans, and modification kits with order. Catalog only, \$2. **CB CITY INTERNATIONAL, BOX 31500PC, Phoenix, AZ 85046. Thousands of satisfied customers since 1976.**

PRO-2004/5/6 OWNERS: Search-and-Store finds elusive frequencies automatically. Internal no-holes installation—Keyboard control—retain present functions. Wired—tested—postpaid: Ten channel \$24.95—Selectable to 255 channels \$44.95. US checks or MO. Key Research, POB 846P, Cary, NC 27512-0846.

SCANNER MODIFICATION HANDBOOK, FERRELL'S CONFIDENTIAL FREQUENCY LIST, AIR SCAN. Plus many other books by CRB. SAM'S, TAB, ARRL and others, many at reduced prices. We take phone orders and VISA/MASTERCARD. FREE Catalog. **DOYLE COMMUNICATIONS-PC, Route 8, Box 18, Lake Pleasant, NY 12108 (518) 548-5515.**

TOMCAT'S BIG CB HANDBOOK, by Tom Kneitel. Just published, 221 large pages, fully illustrated. Complete guide to worldwide AM, SSB, Freeband, 27 MHz operations. Everything they never told you (legal & otherwise) from world's leading CB authority. Only \$13.95 (plus \$2 postage to North America) from CRB Research Books, Inc., P.O. Box 56, Commack, NY 11725. (NYS residents add sales tax). Dealer inquiries invited.

SURVEILLANCE-COUNTERMEASURES! Transmitters, detectors, phone security, night vision, stunguns, secret devices, restricted books. **MORE! GUARANTEED LOWEST PRICES!** **HUGE CATALOG \$5.00 (REFUNDABLE)** Protector, P.O. Box 520294-D, Salt Lake City, UT 84152.

WANTED: Any information on direct manufacturers or wholesalers of export CB equipment (no middlemen, please). Huge demand from my overseas travels. Thanks! John Lee, 99 Broadway, Apt 505, Elmwood Park, NJ 07407.

AERO Freqs for your area. Send SASE and your area for a price quote. D. Grote, PO Box, 244 Bristol, IL 60512.

WANTED: Avengers TV Series with Cathy Gale. Also new Avengers episodes. Have all 83 original Peel/King shows. VHS only. Jeff Hollis, Rt. 4, PO Box 261, Martinsburg, W. VA 25401.

PRO-2004/5/6/34, BC760XLT/200XLT kits. Reviewed - July Monitoring Times, LED S'Meter \$69.95, SASE for more information. KESCOMM, PO BOX 5212, Jacksonville, AR 72076.

SCANNERS: Realistic PRO-2003, mint w/service manual. Bearcat BC300 (intermittent memory prob.) otherwise A-1. Both for \$160. (314) 357-4621, L.M., Box 76, Parma, MO 63879.

TEN channel scanner for sale. Mint condition - asking \$35.00 or best offer. Send all requests to Frank Speth, 24 Garland Ave., Pittsfield, MA 01201-2724.

BLIND, disabled, shut-in writer seeks donations of shortwave radio—Sony, Grundig, Kenwood (or any other), wp, typewriter, pc or fax. Please help. Call Richard Jastrow at (213) 938-5347. Or write 5909 W. 6th St., Los Angeles, CA 90036.

FOR SALE: Zenith (Wavemagnet) Trans-Oceanic; Manufactured May 13, 1963 or 69. Best offer. Gary (609) 448-2706 (leave message).

FOR SALE: PRO-2005. Modified for Cellular \$175. EXCELLENT condition. Box/Manual. (401) 568-2152 after 6 PM.

BEST PRICES: CB RADIOS and ACCESSORIES, Radar Detectors, Scanners. Free list. CRS Communications, 1692 Central Park Ave., Yonkers, NY 10710.

SONY ICF 2002: Radio and all original accessories in mint condition - \$160.00 - includes shipping and ins. Thomas Merchant, *5 Savannah Ln, Chico, CA 95926. (916) 893-8558.

SCANNERS: Bearcat 140 in box with warranty - \$80. Also Regency R4030 in box. Covers all bands including 800 MHz handheld - \$200. Radio shack tunable receiver - \$50. Joe Magnano, 12 Cone Road, East Hampton, CT 06424. Phone (203) 267-4355.

SELLING COLLINS S-LINE: 32S-3 transmitter, 75S-3 receiver, 516F-2 power supply, 312B 4 station control, manuals, extra tubes, \$875. All checked by technician. Mike Decerbo, (203) 261-4221.

FOR SALE: KENWOOD R-2000 Communications Receiver and SWR Interface for Commodore C-64/128. With manuals. \$350.00. Call (304) 733-2272 or write Ernie Morrison, PO Box 161, Salt Rock, WV 25559.

BACK ISSUE SELL-OUT. PopComm 71 issues from 1984. Monitoring Times 58 issues from 1985. Both sets \$150 + S/H. N6KKA (916) 345-0773.

AMAZING DEVICE STOPS EAVESDROPPERS! Locks out extension, autostarts. Easy, quick fix. Plans \$20.00. Parts \$10.00 - \$3.00 S/H. **FREE** gift with order. SpyTex, PO Box 1258PC2, Austin, Texas 78718-1258.

KEEP IT SECRET: Low-Cost Electronic Countermeasures to Defeat Taps and Bugs—The first hands-on, how-to electronic countersurveillance videotop that teaches you how to stop others from spying on you. And you don't need a degree in electronics or trendy, high-tech equipment! Protect your home, office and personal life! Color, approx. 90 min., VHS. Send \$73.45 ppd to CEP Incorporated, PO Box 865-OPC, Boulder, Colorado 80306, (303) 443-2294.

SCANNER MONITORS WANTED in the following counties: Albany GA., Macon GA., Dade FL., Broward FL., Palm Beach FL., and the State of Vermont. **MAKE MONEY WITH YOUR HOBBY.** Call Bob Marshall 1-800-831-1331.

AR-1000 with cellular \$455, BC-200XLT w/cellular \$269, BC-760XLT w/cellular \$289, TS-2 w/cellular \$299, cellular converters, CB radios, ham gear, much more! Huge used gear list .25. New 1990 picture catalog \$100. Same day COD shipping, and we take trades! Galaxy, Box 1202, Akron, Ohio 44309 (216) 376-2402 9-5 EST.

EXECUTIVE PROTECTION. Countermeasure, Detection, Surveillance. **Books—**Private Investigations, Security, Disguise, Undercover, and more! **CATALOG \$1.00 REFUNDABLE.** NSC, 4450 Van Nuys Blvd. 588PC, Sherman Oaks, CA 91403.

UNDERGROUND FREQUENCY GUIDE by Harry Helms! New second edition tells where/how to hear spy numbers, Cuban military, Soviet spaceships, smugglers, the Mossad, more! Exclusive details on where mystery stations are/who operates them! Available from leading communications dealers or order direct \$10.95 plus \$2.00 shipping USA/Canada from HighText Publications, 7128 Miramar #15, San Diego, CA 92121 (CA add 85¢ sales tax).

MID-CANADA'S LEADING DISTRIBUTOR of CB's, scanners, radar detectors and accessories. Discounted prices. Uniden, Cobra, Wilson, President, etc. Visa accepted. **COMTELCO ELECTRONICS,** PO Box 1551, Winnipeg, Manitoba, Canada, R3C 2Z4 1-204-488-4257.

SCRAMBLING NEWS. This month's feature article is "So You Want To Sell Descramblers." This insider report gives all the ins and outs and lists true wholesale sources. \$19.95/yr. Sample \$3. **The Pay TV and Satellite Descrambling** series. Each volume is totally different and contains build-your-own, turn-ons, bypasses, etc. for most systems. Volume 1, 1989 edition and 1990 edition - \$14.95 each. Wireless Cable Handbook - \$9.95. Build Satellite Systems Under \$600 - \$12.95. Any 3/\$29 or 5/\$42. New catalog - \$1. **SCRAMBLING NEWS,** 1552 Hertel Ave, Buffalo, NY 14216. CODs are OK. (716) 874-2088.

225-400 MC RECEIVERS Tunable, Government Reconditioned. Satcom Antennas 240-270 MC Military Helical Type. New (419) 726-2249

77 YEAR-OLD disabled, on Soc. Sec. limited income. Unable to get out of house - Serious illness. Only enjoyment - Scanner Radio. Would like to have ICOM IC-R-7000 or Realistic 2005 Model scanner. Either donated or will pay small cash and mailing costs. Contact: Harold Ungar 21095 Gary Dr. #306, Hayward, CA 94546. (415) 531-3325.

SELL. Rare complete 74 years QST collection from issue one. Minimum offer \$3,000. K6IR, 16904 George Washington, Rockville, Maryland 20853-1128. (301) 774-7709.

ICOM IC-R1 Communications Receiver - Handheld portable scanner. Wideband frequency coverage: 100 kHz to 1300 MHz continuous coverage. Signal strength indicator. 100 memories. 10 banks of search frequencies. FM, Narrow FM and AM modes. Selectable channel separation: 0.5, 5, 8, 9, 10, 12.5, 15, 20, 25, 30, 50 kHz. Clock and power on/off timers. Built-in NiCd battery. Many other features. Uses same accessories as other ICOM handhelds. Includes AC adapter/charger, antenna, carrying strap, and belt clip. Dimensions 1.9"W x 1.4"D, weight 9.9 oz. New with warranty. \$450. (703) 222-7554.

ANTIQU radios, tubes, wiring diagrams, & literature. Send 2 stamps to VRS(PC) PO Box 541, Goffstown, NH 03045 for large list.

SWL SLOPER covers AM broadcast through 13 meter bands. 60" long. \$53.95 ppd. Jr. SWL Sloper covers 90 through 13 meter bands, 40" long \$43.95 ppd., VGE, Box 21305, S. Euclid, Ohio 44121.

SCANNER FREQUENCY SEARCH SERVICE Hear all there is to hear! SASE to: Heald, 6886P Jefferson Street, North Branch, MI 48461.

PAN-COM INTL CATALOG Over 350 Kits, Plans, Books about licensed/unlicensed AM/FM broadcasting, Ham/CB/SW/DX amplifiers, 1750M transmitters, Surveillance devices, Computers/Software, Science Projects, MORE. \$1.00 refundable. Box 130-P11, Paradise, CA 95967.

MOTOROLA PAGERS ENVOY TONE ONLY 35.340 MHZ AND TONE VOICE WITH CHARGER NEEDS BATTERY 152.240MHZ \$75 EACH. JOHN POLASHENSKI, PO BOX 11, FRELAND, PA 18224.

PRO2004 OWNERS 400 CHANNELS/30 CPS SCAN RATE KIT \$35.00 INSTALLED \$55.00 LESTER JERNIGAN, P.O. Box 5212, Jacksonville, AR 72076.

SCANNER FREQUENCY SEARCH SERVICE. Hear all there is to hear! SASE to: Heald, 6886P Jefferson Street, North Branch, MI 48461.

TELEVISION SETS made before 1946 wanted for substantial cash. Especially interested in "mirror-in-the-lid" and spinning disc sets. Finder's fee paid for leads. Arnold Chase, 9 Rushleigh Road. West Hartford, CT 06117 (203) 521-5280.

BUGGED? COUNTERMEASURE SWEEPS. Telephones, Offices, Watercraft, Aircraft. Confidentiality Assured. Write or call for a free eavesdrop brochure and estimate. Central States Investigations, 1007 West Jefferson Street, Suite 160, Springfield, IL 62702-4835. AC/217 525-9499.

CABLE TV CONVERTERS. Scientific Atlanta, Jerrold, Oak, Zenith, Hamlin. Many others. "New" MTS Stereo Add-On. Visa, M/C & Amex 1-800-826-7623. B&B Inc., P.O. Box 21-327, St. Paul, MN 55121.

RADIO New York International official off the air recording of our first broadcast live from the good ship Sarah. \$15.00 gets you a 60 minute cassette, plus an official letter and certificate from the RNI staff. RNI, Monticello, Maine 04760.

BUGGED? WIRETAPPED? Find out fast! Factory direct countermeasures equipment catalog \$1. Capri Electronics, Box 589W, Bayfield, CO 81122.

PRIVACY PROBLEM - NEED INFORMATION? New Electronics Surveillance, Debugging, Protection Catalog \$5.00 Kits - Assembled. TECHNOLOGY SERVICES, 829G GINETTE, GRENA, LA 70056

WANTED - PRO2004's in non-working condition. Wanted for parts will pay reasonable price. Must have all internal parts. Send description and price wanted to Lester Jernigan, P.O. Box 5212, Jacksonville, AR 72026.

INTERESTED in FM CB radio? For more information send SASE business envelope plus \$3 to GMRS. 107 West Caldwell, Phoenix, AZ 85041.

HURRY! Get in the **WORLDWIDE CB DIRECTORY** Correspond with CB'ers all over the world. For free info rush a (#10) SASE to: **WORLDWIDE CB DIRECTORY, P.O. BOX 19786, Dept. C, New Orleans, LA 70119.**

THE NEW YORK MONITOR NEWSLETTER—a monthly Newsletter that provides CB'ers with the latest up-to-the-minute Technical information—Radio Repair and Modification—Phase Lock Loop (PLL) Circuit/Expander—**2 YEAR COURSE IN ELECTRONIC COMMUNICATION** and much more!! \$24 per year mail to **LORD/WYATT COMMUNICATIONS, P.O. Box 030128PCD, Brooklyn, NY 11203-0001.**

AM/FM/TV BROADCAST BAND AIRCHECKS of metropolitan New York, N.J. & CT. area stations. Caught a NY station in the dead of night? Verify your logs with top-quality airchecks. Send your requirements for a free price quote to: AirResponse, 553 E. Fulton St., Long Beach, NY 11561-2416.

SURVEILLANCE - Audio/Video Equipment - Debugging. Industrial or private. 500 Item Catalog \$7.00. Security Systems 3017E. Hudson New Orleans LA 70131.

AR-1000 HANDHELD 6-1,300 MHz \$455. BC-200 XLT with cellular \$269. BC-760 XLT with cellular \$289. TS-2 with cellular \$299. used gear, trades, shortwave, CB, ham gear, much more! 1990 picture catalog and used gear inventory \$1.25—Galaxy, Box 1202, Akron, Ohio 44309 (216) 376-2402, 9-5 EST.

LEARN VCR Cleaning, Repair. Huge Profits! Secrets Revealed! No Experience Necessary. Better than Viejo at 1/7 the cost. 400+ page book, with 704 illustrations, \$24.95, postpaid. Worthington Publishing, 6907-202J Halifax River Drive, Tampa, FL 33617, or call (813) 988-5751 for C.O.D., Visa, or MC. Money-back guarantee.

DISCOUNT BOOKS, SCANNERS, ANTENNAS: We have radio books and frequency books by TAB, SAM's, ARRL, CRB, McGraw Hill and others, many at discount prices. FREE catalog. DOYLE COMMUNICATIONS, Route 8, Box 18, Lake Pleasant, NY 12108 (518) 548-5515.

WANTED: Someone who would like to donate a used twenty channel programmable scanner to a bedridden gentleman. Willing to pay all shipping charges. Call collect anytime (304) 232-3563.

ONE TOLL-PHONE CALL COULD EARN YOU \$500. We are a nationwide market leader in the fire/water restoration business and we are looking for people across the country, **LIKE YOU**, to join our team. If you are interested in learning more about our **FIRE SPOTTERS NETWORK**, please apply to J. Winn, P.O. Box 1888, South San Francisco, CA 94083-1888.

LOOKING for individuals to record radio stations in major metropolitan cities. Will pay!! Call 919-489-2164 or write PO Box 51554, Durham, NC 27717.

LOOP ANTENNAS! Interceptor Electronics offers a variety of shielded loop antennas for low frequency and AM broadcast DXing. 3FT outdoor loop and amplifier \$169.95. 1FT desktop loop \$149.95. 1FT hand-held loop \$159.95. More! Shipping extra. Check or money order. Interceptor Electronics Inc., Route 1, Box 439, Round Hill, VA 22141, (703) 338-4905.

SECRET NEW INVENTION STOPS EAVESDROPPERS! Easy to build. Stops extensions and most autostarts. Plans \$20.00. Parts \$10.00 \$3.00 S&H. **FREE** gift with order. Spy-Tex. PO Box 1258PC1, Austin, Texas, 78718-1258.

PAY TV AND SATELLITE DESCRAMBLING 1990 edition. Best edition yet. Check out the world of video descrambling. Turn-ons, descrambling circuits, cable countermeasures, pirate counter-counter measures. **ONLY \$14.95** Also. Scrambling News monthly \$19.95/yr. Catalog \$1 or call (716) 874-2088. COD's OK. **SCRAMBLING NEWS, 15552Q Hertel Ave., Buffalo, NY 14216.**

TOUCH TONE DECODER displays dialed numbers on cordless, cellular. Connects directly to scanner. Information for SASE. W.E.B., PO Box 2771-P, Spring Valley, CA 92077.

CW Lite is the **easiest** Morse code training method in the world, bar none! And it is the **fastest**, too. Just close your eyes and relax. This powerful **hypnosis cassette tape** does the rest. **Subliminals** speed you along! Only \$14.95 ppd in US (NY residents add \$1.12 tax). Order today! **PASS Publishing**, Box 570, Stony Brook, NY 11790.

SURVEILLANCE-DETECTION EQUIPMENT, TRANSMITTERS, DEBUGGING, SECURITY ITEMS, TELEPHONE LOGGING RECORDERS. \$5.00 CATALOG. EAVESDROPPING DETECTION EQUIPMENT. P.O. BOX 1087, WILLIAMS-VILLE, NY 14231.

TOUCH TONE DECODER DISPLAYS DIALED NUMBERS ON CORDLESS, CELLULAR, CONNECTS EASILY TO SCANNER. INFORMATION FOR SASE. W.E.B., P.O. B. 2771, SPRING VALLEY, CA 92077.

FOR SALE: ICOM R-7000, remote control, GTI Electronics Pan-adaptor, BK-Precision Model 2120 Oscilloscope, Grove Power Antenna III Preamp, Grove SP-100 Radio Speaker, Grove Scanner Beam Antenna, ICOM AH-7000 Disccone Antenna, Radio Shack Antenna Rotator, AOR-900 Handheld Scanner, Leather Case, Magnetic Mobile Antenna, Frequency Books, All manuals. Call Jim (404) 535-2509.

Advertiser's Index

| | |
|-------------------------------|--------------|
| AMC Sales, Inc. | 29 |
| ARRL | 28 |
| Ace Communications, IN | 80, Cov. III |
| Antenna Supermarket | 13 |
| Antennas West | 62, 78 |
| Antique Radio Classified | 58 |
| Associated Radio | 68 |
| Barry Electronics | 77 |
| CBC International | 62 |
| CQ Bookshop | 37 |
| CQ Buyer's Guide | 73 |
| CRB Research | 33, 42 |
| Cellular Security Group | 62 |
| Communications Electronics | 19 |
| DECO | 71 |
| Datacom International | 7 |
| Delta Research | 58 |
| Doyle Communications | 78 |
| Electron Processing | 36 |
| Electronic Engineering | 78 |
| Electronic Equipment Bank | 4, 5 |
| G & G Electronics | 42 |
| GRE America, Inc. | 21 |
| Gilfer Shortwave | 75 |
| Hamtronics, Inc. | 77 |
| ICOM | 39, Cov. II |
| JoGunn Ent. | 31 |
| Kenwood U.S.A. Corp. | Cov. IV |
| MFJ Enterprises, Inc. | 17 |
| Medicine Man | 62 |
| Metrowest | 58 |
| Microcraft Corporation | 48 |
| Monitoring Times | 28 |
| Moonbeam Press | 78 |
| OEI OPToelectronics | I, 73 |
| Pacific Cable Co. | 78 |
| Palomar Engineers | 73 |
| RF Limited | 45 |
| Radio Shack | 11 |
| React International | 63 |
| Republic Cable Products, Inc. | 62 |
| Scanner World, USA | 8 |
| Signal Engineering | 67 |
| Software Systems Consulting | 13, 67 |
| Somerset Electronics | 68 |
| Systems & Software | 71 |
| Tiare Publications | 79 |
| Universal SW Radio | 3 |
| Wilson Antennas, Inc. | 51 |

Readers can obtain free information on products advertised by the above companies, as well as for some editorially mentioned products. Simply circle the appropriate number printed below an advertisement onto the card bound into this issue.

Coast Guard Radio - A Guide to Using and Monitoring US Coast Guard Communications

Frequencies, calls, addresses,
more.

\$12.95 + \$2 s/h (\$3 foreign)

Catalog \$1, free w/order - Visa/MC

Tiare Publications
PO Box 493P
Lake Geneva WI 53147



AOR Scanners.

Great Performance. Great Service. Great Value.

Free Freight
 25-Day Money-Back Guarantee
 Toll-Free Service and Support
 No Credit Card Surcharge
 One Year Warranty



AR1000 **\$499**

1000 Channels. 8-600MHz, 805-1300MHz

Standard Features:

- Extremely compact size.
- Continuous coverage (except UHF TV 600-805)
- Antenna attenuator switch, 10db.
- Manual tuning knob.
- Earphone jack, 3.5mm.
- AM, FM and wide band FM tuning modes.
- Backlighted LCD display.
- 10 Scan Banks, 10 Search Banks.
- Selectable Priority Channel.
- Delay, Hold Features.
- Selectable Search Increments, 5-955KHz.
- Permanent memory backup.
- 4 AA Ni Cad batteries included.
- AC adaptor/charger.
- Carry Case.
- Cigarette Lighter Charger.
- Belt Clip.
- Earphone.

Options:

- External Speaker. Mobile Mount. MS190 \$19.50
- Extended Warranty. 2/3 yrs \$45/\$55

Specifications:

- Coverage: 8-600, 805,1300MHz
- Sensitivity: .35uV NFM, 1.0uV WFM, 1.0AM
- Speed: 20 ch/sec. scan. 40 ch/sec. search
- IF: 561.225, 58.075, 455KHz or 10.7MHz
- Increments: 5 to 955KHz selectable/ 5 or 12.5 steps.
- Audio: .4 Watts
- Power: Input 9 - 13.8 V. DC
- Antenna: BNC
- Display: LCD
- Dimensions: 6 7/8H x 1 3/4D x 2 1/2W. 12oz wt.

AR950 **\$239**



100 Channels. Low, Air, High, UHF & 800MHz.

Standard Features:

- Extremely compact size.
- Unrestricted 800MHz coverage.
- 100 channels permanent memory.
- Earphone Jack & Attenuator.
- Delay, Hold features.
- Channel 1 Priority.
- 5 Scan Banks, 5 Search Banks.
- Telescopic and Flexible Antennas w/ BNC connector.
- AC & DC Power cords w/ mtng hardware.
- One Year Limited Warranty.

Options:

- Base type antenna 25 to 1000MHz w 50'coax. AS300 \$59.95
- Mag Mnt Mobile Antenna. 15' coax. MA100 \$25.00
- Cigarette Lighter power adaptor. CP100 \$4.00
- External Speaker with mobile mount. MS100 \$19.50
- Extended Warranty. 2/3 yrs \$40/\$55

Specifications:

- Coverage: 27-54, 108-174, 406-512, 830-950MHz
- Sensitivity: .4uV Lo,Hi. .8uV Air. .5uV UHF. 1.0uV 800
- Scan Speed: 15 ch/sec.
- IF: 21.4MHz, 455KHz
- Increments: 10,12.5,25,30
- Audio: 1W
- Power: 12.8VDC, 200MA
- Antenna: BNC
- Display: LCD w/backlight
- Dimensions: 2 1/4H x 5 5/8W x 6 1/2D. 14oz wt.

We offer 100's of communications products.

AR2515

\$695



2016 Channels. 5-1500 MHz.

Standard Features:

- Extremely compact size.
- Continuous coverage.
- 2016 channels permanent memory.
- AM, FM wide and narrow modes.
- Signal strength meter & Tuning Knob.
- Bank 1 Priority.
- 62 Scan Banks, 16 Search Banks.
- Telescopic antenna w/ BNC connector for >25MHz.
- AC & DC Power.
- One Year Limited Warranty.

Options:

| | | |
|------------------------------------|--------|-----------|
| RS232 cable to DB25 connector. | BW-1. | \$24.95 |
| RS232 cable & software for MS DOS. | EG-1. | \$39.95 |
| BFO for SSB listening. | BFO-1. | \$159.00 |
| Base type antenna | | |
| 25 to 1000MHz w 50' coax. | AS300 | \$59.95 |
| Mag Mnt Mobile Antenna. 15' coax. | MA100 | \$25.00 |
| Cigarette Lighter power adaptor. | CP100 | \$4.00 |
| External Speaker | | |
| with mobile mount. | MS100 | \$19.50 |
| Extended Warranty. 2/3 yrs | | \$30/\$45 |
| Mobile Mtng Bracket. | MM1 | \$14.90 |
| Cigarette Lighter power adaptor. | CP100 | \$4.00 |

Specifications:

Coverage: 5 - 1500MHz
 Sensitivity: .35uV NFM, 1.0uV WFM,
 1.0uV AM >3.0uV SW AM
 Scan Speed: <=36 ch/sec.
 IF: 750MHz, 45.03MHz, 5.5MHz, 455MHz.
 Increments: 5,12.5,25KHz
 Audio: 1W
 Power: 12VDC, 200MA
 Antenna: BNC
 Display: LCD, backlighted
 Dimensions: 3 1/7H x 7 7/8D x 5 2/5W. 2lb 10oz wt.

AR3000

\$995



400 Channels. 100KHz to 2036MHz.

Standard Features:

- Extremely compact size.
- Continuous coverage
- Attenuation Programmable by Channel.
- Manual tuning knob.
- Tuning increments down to 50Hz.
- AM, FM, wide band FM, LSB, USB, CW modes.
- Backlighted LCD display.
- 4 Scan and Search Banks, Lockout in Search.
- 4 Priority Channels.
- RS232 control through DB25 connector.
- Delay, Hold Features.
- 15 band pass filters, GaAsFET RF amp.
- Sleep and Alarm Features.
- AC adaptor/charger. DC power cord.
- Telescopic Antenna.

Options:

| | | |
|--|-------|----------|
| Earphone. | EP200 | \$2.00 |
| External Speaker. Mobile Mount. | MS190 | \$19.50 |
| Extended Warranty. 2/3 yrs. | | \$65/75 |
| Mobile Mounting Bracket. | MM1 | \$14.90 |
| RS232 Control Package | SCS3 | \$295.00 |
| (software & cable) offers spectrum display and database. | | |

Specifications:

Coverage: 100KHz - 2036MHz
 Sensitivity: .35uV NFM, 1.0uV WFM,
 1.0AM/SSB/CW
 Speed: 20 ch/sec. scan. 20ch/sec. search
 IF: 736.23, (352.23) (198.63) 45.0275, 455KHz
 Increments: 50Hz and greater
 Selectivity: 2.4Khz/-6db (SSB) 12KHz/-6db
 (NFM/AM)
 Audio: 1.2 Watts at 4 ohms
 Power: Input 13.8 V. DC 500mA
 Antenna: BNC
 Display: LCD
 Dimensions: 3 1/7H x 5 2/5W x 7 7/8D Wt. 2lb 10oz.

To Order Call 1-800-445-7717

In All 50 States and Canada. 24 Hours a Day. Fax Orders: 1-800-448-1084, 24 Hours a Day.
ACE Communications Monitor Division 10707 E. 106th Street, Indianapolis, IN 46256
 Int'l Voice# 317-842-7115. Int'l Fax# 317-849-8794.

Service and Support Lines: Mon-Fri 9a.m. to 9p.m., Saturday 10-4. EST
 MasterCard, Visa, American Express, Checks, Approved P.O.'s. & C.O.D. (add 5.00)
Prices and specifications subject to change.

KENWOOD

Hear it All!



R-5000
R-2000
High performance receivers

Scan the world bands with Kenwood's R-5000, R-2000 and RZ-1. Listen in on foreign music, news, and commentary. Monitor local police, fire, and other public safety services, as well as the Marine channels, and the many other services.

(The VHF converter options must be used in the R-5000 and R-2000.)

R-5000

The R-5000 is a high performance, top-of-the-line receiver, with 100 memory channels, and direct keyboard or main dial tuning—makes station selection

super easy! Other useful features include programmable scanning, large, built-in speaker, 110 volt AC or 12 volt DC operation (with optional DCK-2 cable), VHF capability (108-174 MHz) with the VC-20 option, dual 24-hour clocks with timer, and even voice frequency readout with the VS-1 option.

R-2000

The R-2000 is a full band, all mode receiver with 10 memory channels and many deluxe features such as programmable scanning, dual 24-hour clocks with timer, all-mode squelch and noise blankers, a large, front-mounted speaker, 110 volt AC or 12 volt DC operation (with the DCK-1 cable kit) and 118-174 MHz VHF capability with VC-10 option.

Optional Accessories

R-2000:

- VC-10 VHF converter
- DCK-1 DC cable kit for 12 volt DC use.

R-5000:

- VC-20 VHF converter
- VS-1 Voice module
- DCK-2 for 12 volt DC operation
- YK-88A-1 AM filter
- YK-88SN SSB filter
- YK-88C CW filter
- MB-430 Mounting bracket.

Other Accessories:

- SP-430 External speaker
- SP-41 Compact mobile speaker
- SP-50B Mobile speaker
- HS-5 Deluxe headphones
- HS-6 Lightweight headphones

KENWOOD U.S.A. CORPORATION
COMMUNICATIONS & TEST EQUIPMENT GROUP
P.O. BOX 22745, 2201 E. Dominguez Street
Long Beach, CA 90801-5745
KENWOOD ELECTRONICS CANADA INC.
P.O. BOX 1075, 959 Gana Court
Mississauga, Ontario, Canada L4T 4C2

RZ-1 Wide-band scanning receiver



The RZ-1 wide-band, scanning receiver covers 500 kHz-905 MHz, in AM, and narrow or wideband FM. The automatic mode selection function makes listening

easier. One hundred memory channels with message and band marker, direct keyboard or VFO frequency entry, and versatile scanning functions, such as memory channel and band scan, with four types of scan stop. The RZ-1 is a 12 volt DC operated, compact unit, with built-in speaker, front-mounted phones jack, switchable AGC, squelch for narrow FM, illuminated keys, and a "beeper" to confirm keyboard operation.

Optional Accessory

- PG-2N Extra DC cable

Specifications, features, and prices are subject to change without notice or obligation

KENWOOD

...pacesetter in Amateur Radio
CIRCLE NO. 10 ON FREE INFORMATION CARD