

TRANSISTORIZED INTERFLEX RECEIVER

AUGUST 1955

RADIO - ELECTRONICS

TELEVISION • SERVICING • HIGH FIDELITY

HUGO GERNSBACK, Editor

In this issue:

How a Color TV
Matrix Works

•
Build a TV Stand
With Bass-Reflex
Speaker Enclosure

•
Service Problems
Solved With
a Straightedge

•
Thermistors



35¢
U. S. and
CANADA

Antenna Beams TV Sig
(See page 4)

ELTON J V 3-57
% PAUL S BOLLARO
434 EULTON ST
ELIZABETH 1 N J

TRAVELING LIGHT

BUT WITH A COMPLETE pocket-sized LABORATORY

ON HAND for his service needs in the Triplett

Model 666R pocket size VOM

TRAVELING LIGHT, too, on expense

Model 666R is only \$26.50 dealer net

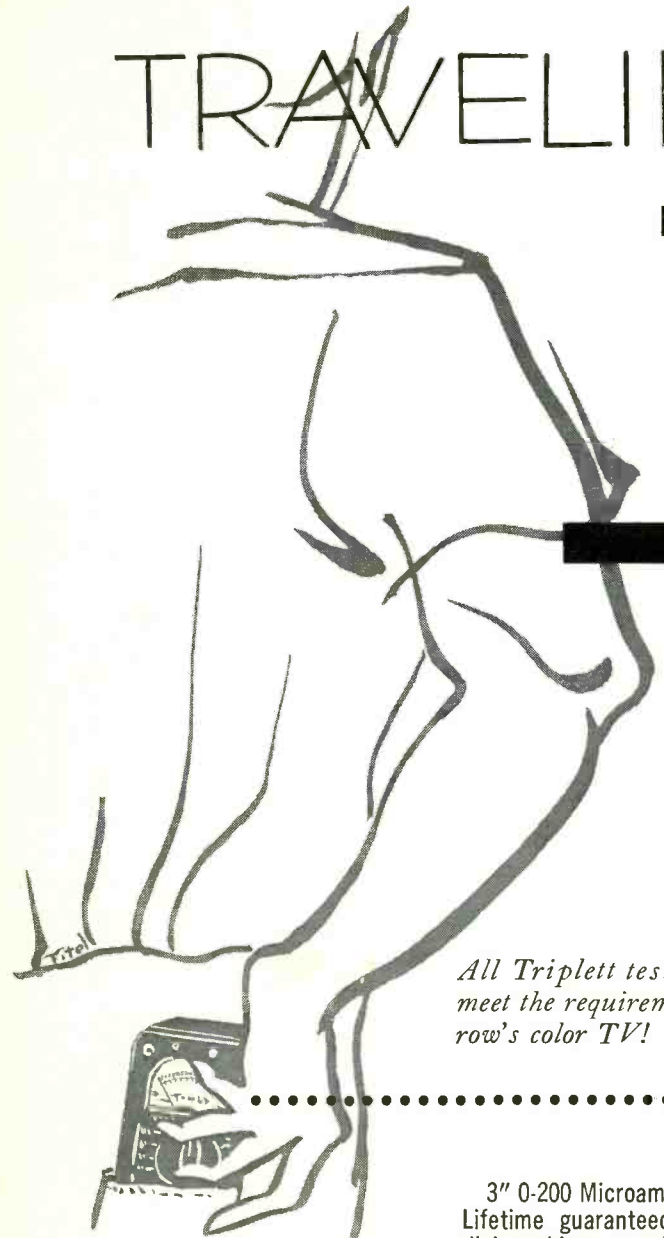

All Triplett test instruments meet the requirements of tomorrow's color TV!

Enclosed selector switch of molded construction keeps dirt out. Retains contact alignment permanently. A Triplett design representing the culmination of a quarter-century of switch making experience. Unit construction—All resistors, shunts, rectifier and batteries housed in a molded base integral with the switch. Eliminates chance for shorts. Direct connections. No cabling.

Precision film or wire-wound resistors, mounted in their own separate compartment—assures greater accuracy. Four connectors at top of case, controls, knobs and instrument are all flush mounted with the panel.

3" 0-200 Microammeter, RED • DOT Lifetime guaranteed. Red and black dial markings on white. Easy to read scale.

Precalibrated rectifier unit. Batteries—self-contained, snap-in types, easily replaced.

- RANGES**
 D.C. VOLTS: 0-10-50-250-1000-5000, at 1000 Ohms/Volt.
 A.C. VOLTS: 0-10-50-250-1000-5000, at 1000 Ohms/Volt.
 D.C. MA: 0-10-100, at 250 M.V.
 D.C. AMP.: 0-1, at 250 M.V.
 OHMS: 0-3000-300,000 (20-2000 center scale).
 MEGOHMS: 0-3 (20,000 Ohms center scale).

(Compensated Ohmmeter circuit.)
Also available—Model 666-HH Pocket V O M, Dealer Net \$24.50.

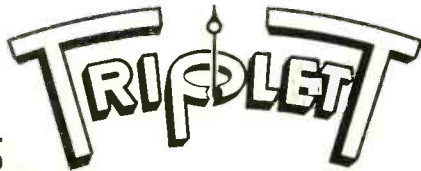
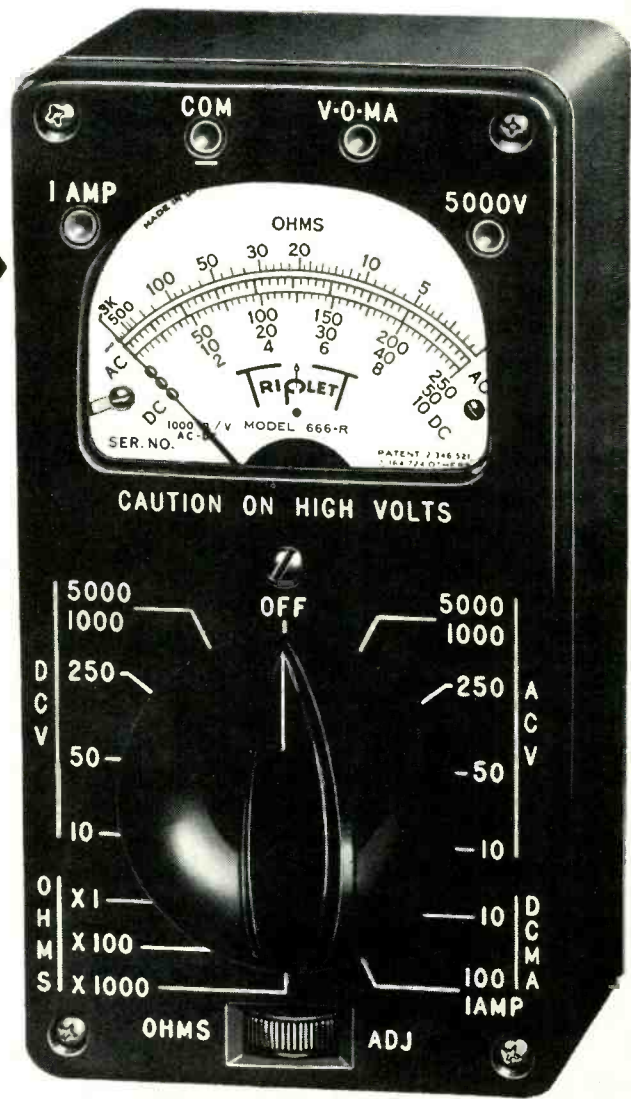

TRIPLETT ELECTRICAL INSTRUMENT CO.
Bluffton, Ohio

Dim.: 3 1/16 x 5 7/8 x 2 9/16



You Build THIS TRANSMITTER
with Parts I Send



I WILL TRAIN YOU FOR YOUR FCC LICENSE

LEARN COMMUNICATIONS by Practicing at Home in Spare Time

Use parts I send for Actual Experience

My Training Leads to Jobs Like These

BROADCASTING: Chief Technician, Chief Operator, Power Monitor, Remote Control Operator. **SHIP AND HARBOR RADIO:** Chief Operator, Radio-telephone Operator. **GOVERNMENT RADIO:** Operator in Army, Navy, Coast Guard, Forestry Service Dispatcher. **POLICE RADIO:** Transmitter Operator, Service Technician. **AVIATION RADIO:** Plane Radio Operator, Airport Transmitter Operator. **TELEVISION:** Pickup Operator, Voice Transmitter Operator, TV Technician.



The Communicator Course I offer you is backed by NRI's 40 year record of training men at home. My well-illustrated lessons give you the basic principles you must have to assure success. My skillfully developed kits "bring to life" what you learn from my lessons, give you practical experience on circuits common to BOTH Radio and Television. You build the low-power Broadcasting Transmitter shown above (at left). You put this station "on the air," and conduct procedures required of Broadcasting Station operators. My book shows other valuable equipment you build and keep.

mitter Operators, Remote Control Operators, Service and Maintenance Technicians, etc. Mail Coupon. Find out, without obligation, what I offer. NRI training can assure you more of the better things of life; can help you qualify for high pay and promotion when times are good, enjoy greater security when jobs are scarce. Progressive, ambitious men consider Radio-Television an outstanding field for their life's work. My 64-page book, "How to Be a Success in Radio-Television," gives important facts about America's fast growing industry, shows what my graduates are doing and earning. You see equipment you practice with at home. Also, you get actual sample lesson, see how easy it is to learn at home. I send both FREE.



J. E. SMITH
PRESIDENT,
National Radio Institute
For 40 years, the leader in training men at home.

I TRAINED THESE MEN AT HOME



"I have progressed very rapidly. My present position is Television Studio Supervisor with KEDD Television, Wichita."—Elmer Frelwadt, 3026 Stadium, Wichita, Kansas.



"I did not know a thing about Radio before I enrolled for your training. Now I have a job as Studio Engineer at Radio Station KMDJ."—Bill Delzell, Central City, Nebr.

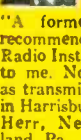

"A former employer recommended National Radio Institute training to me. Now employed as transmitter operator in Harrisburg."—Albert Herr, New Cumberland, Pa.

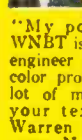

"My position with WNET is video control engineer on the RCA color project. I owe a lot of my success to your textbooks."—Warren Deem, Malverne, N. Y.



"Am with WCOB. Happy with my job. NRI course can't be beat. Passed exam for 1st class Radio-telephone license with no trouble."—Jesse W. Parker, Meridian, Miss.

AVAILABLE TO VETERANS UNDER G. I. BILLS

Television's Rapid Growth Making Good Jobs, Prosperity

Radio is bigger than ever with over 3000 Broadcasting Stations on the air making good jobs for Chief Operators, Recording and Remote Control Operators, Power Monitors, Technicians, etc. Now there's Television, too. About 200 TV Stations are on the air with many more being built, construction of hundreds of additional stations authorized, and new TV Station applications being filed every month. Think of the demand this is creating from coast to coast for Pickup and Voice Trans-

Get Facts Now—Mail Coupon

You don't have to leave home or give up your job to take NRI courses. Many of my graduates make more than the total cost of my training in a few weeks. Mail coupon now. J. E. SMITH, President, National Radio Institute, Dept. 5HF, Washington 9, D. C. OUR 40th YEAR.

I Also Have a Course in Radio-TV SERVICING

If you prefer a career in Radio-Television Servicing, I'll train you at home for it. Course includes many kits of parts. My book shows that many make \$10, \$15 a week EXTRA fixing sets while training.

Send for FREE 64 Pg. Book

Mr. J. E. SMITH, President, Dept. 5 HF
National Radio Institute, Washington 9, D. C.
Mail me 64-page Book FREE. (No salesman will call. Please write plainly.)

Name..... Age.....
Address.....
City..... Zone..... State.....

VETS write in date of discharge

RADIO - ELECTRONICS

Formerly RADIO CRAFT • Incorporating SHORT WAVE CRAFT • TELEVISION NEWS • RADIO & TELEVISION*

Hugo Gernsback
Editor and Publisher
M. Harvey Gernsback
Editorial Director
Fred Shunaman
Managing Editor
Robert F. Scott
WZPWG, Technical Editor
Jerome Kass
Associate Editor
I. Queen
Editorial Associate
Matthew Mandl
Television Consultant
Angie Pascale
Editorial Production
Wm. Lyon McLaughlin
Tech. Illustration Director
Sol Ehrlich
Art Director

Lee Robinson
General Manager
John J. Lamson
Sales Manager
G. Aliquo
Circulation Manager
Adam J. Smith
Director, Newsstand Sales
Robert Fallath
Promotion Manager

GERNSBACK PUBLICATIONS, INC.

Executive, Editorial and Advertising Offices, 25 West Broadway, New York 7, N. Y. Telephone REctor 2-8630.

Hugo Gernsback
Chairman of the Board
M. Harvey Gernsback
President
G. Aliquo
Secretary

ON THE COVER:

(Story on page 39) The newly completed 60-foot parabolic antenna at Holmdel, N. J., which will be used by Bell Laboratories in tests of Beyond-horizon transmission.

Color original by Dan Rubin



AUGUST 1955

Vol. XXVI, No. 8

Editorial (Page 31)

Transistor Progress.....by Hugo Gernsback 31

Television (Pages 32-41)

How a Matrix Works.....by Robert G. Middleton 32

Series-String Tubes in New TV Sets..... 34

Television—it's a Cinch: (Seventeenth Conversation, second half: Impedances and reflections; fantastic variety of antennas; reflectors and directors—the radio telescope.....by E. Aisberg 36

Antenna Beams TV Signals 188 Miles (Cover Feature)..... 39

TV Service Clinic.....Conducted by Jerry Kass 40

Audio—High-Fidelity (Pages 42-49)

Bass-Reflex TV Stand.....by Walt Wheelock 42

Circuit Features of High-Fidelity Power Amplifiers, by Robert F. Scott 44

For Golden Ears Only: The Rebel V Corner Horn; Electro-Voice Ultra-Linear ceramic cartridge; new records review.....by Monitor 47

Technical Reports (Pages 50-52)

What's New in Commercial Killers, Tape Applications and Transistorized Receivers.....by Sol Heller 50

Radio (Pages 53-62)

Communication on Secondary Waves.....by Joseph Braunbeck 53

Transistorized Interflex Receiver.....by Dr. William H. Grace, Jr. 54

Solving Service Problems with a Straightedge.....by H. P. Manly 56

Really Wireless Wireless.....by Ralph W. Hallows 58

Flexible Radio Control System.....by Richard H. Dorf 60

Test Instruments (Pages 68-82)

New Multimeters and V.T.V.M.'s.....by Robert F. Scott 68

Build This CRT Tester and Rejuvenator.....by James V. Cavaseno 74

Home-Built Grid Dip Meter.....by T. W. Dresser 79

Understanding Your Sweep Generator, Part I—Sweep generator output voltage and the zero-volt reference line.....by Robert G. Middleton 81

Electronics (Pages 86-98)

Applying Ultrasonics.....by S. M. Milanowski 86

Power Transistors are Here.....by Rufus P. Turner 90

Thermistors and Their Applications.....by Sherman H. Hubelbank 94

DEPARTMENTS

Books 121 Question Box 106

Business 117 Radio Month 6

Correspondence 14 Radio-Electronics Circuits 104

New Devices 99 Technical Literature 119

New Tubes and Transistors 102 Technicians' News 111

Patents 112 Technotes 109

People 116 Try This One 114

Average Paid Circulation over 175,000

RADIO-ELECTRONICS, August, 1955, Vol. XXVI, No. 8. Published monthly at Mt. Morris, Ill. by Gernsback Publications, Inc. Second-class mail privileges authorized at Mt. Morris, Ill. Copyright 1955 by Gernsback Publications, Inc. Text and illustrations must not be reproduced without permission of copyright owners.

SUBSCRIPTIONS: Address correspondence to Radio-Electronics, Subscription Dept., 404 N. Wesley Ave., Mt. Morris, Ill., or 25 West Broadway, New York 7, N. Y. When ordering a change please furnish an address stencil impression from a recent wrapper. Allow one month for change of address.

SUBSCRIPTION RATES: U. S., U. S. possessions and Canada, \$3.50 for one year; \$6.00 for two years; \$8.00 for three years; single copies 35c. All other countries \$4.50 a year; \$8.00 for two years; \$11.00 for three years.

BRANCH ADVERTISING OFFICES: Chicago: 7522 North Sheridan Road, Tel. ROGers Park 4-8000. Los Angeles: Ralph W. Harker and Associates, 682 Market St., Tel. GARfield 1-2481. FOREIGN AGENTS: Great Britain: Atlas Publishing and Distributing Co., Ltd., London E.C. 4. Australia: McGill's Agency, Melbourne. France: Brentano's, Paris 2e. Belgium: Agence et Messageries de la Presse, Brussels. Holland: Trilectron, Heemstede. Greece: International Book & News Agency, Athens. So. Africa: Central News Agency Ltd., Johannesburg. Capetown, Natal. Universal Book Agency, Johannesburg. Middle East: Steimatzy Middle East Agency, Jerusalem. India: Broadway News Centre, Dadar, Bombay #14. Pakistan: Paradise Book Stall, Karachi 3. POSTMASTER: If undeliverable send form 3578 to: RADIO-ELECTRONICS, 25 West Broadway, New York 7, N. Y. *Trademark registered U. S. Patent Office.



National Schools brings you a new dimension in training for TELEVISION-RADIO-ELECTRONICS

YOU CAN LEARN BY HOME STUDY, IF—

- you are ambitious to increase your earning power.
- you want to broaden your knowledge and skill.
- you choose the school with the most complete training and service.

50 Years of Successful Training

National Schools has been training men for success since 1905. Our graduates are located around the globe, in good-paying jobs in servicing, installation and manufacturing... in public and private industry, or in their own businesses. All this experience and background are your assurance of success.

What This New Dimension in Home Study Means to You

As a National Schools student, with Shop Method Home Training, you master *all phases* of the industry—TV, Radio, Electronics—theory and practice. You learn HOW and WHY, in one complete course at one low tuition.

Because National Schools' world headquarters are in Los Angeles—"capital city" of TV-Radio-Electronics—our staff is in close touch with industry. Our lessons and manuals are constantly revised to keep you up-to-the-minute on latest developments. We show you how to make spare time earnings as you learn, and we give you free placement assistance upon graduation. National Schools is approved for G. I. Training. Both Resident and Home Study courses are offered. If you are of draft age, our training helps you achieve specialized ratings and higher pay grades.

This *new dimension* enables us to train you as you should be trained at home, regardless of your age or previous education.

Your Course Includes Valuable Units

We send you important equipment, including a commercial, pro-

fessional Multitester... plus parts to build Receivers, Oscillators, Signal Generator, Continuity Checker, other units, and Short Wave and Standard Broadcast Superhet Receiver.

Mail Coupon for Complete Information

Get these two free books about this new dimension in Home Training. A comprehensive, illustrated fact-book and a sample National Schools lesson. No obligation, so mail coupon today.

NATIONAL SCHOOLS
TECHNICAL TRADE TRAINING SINCE 1905
Los Angeles 37, Calif. • Chicago: 323 W. Polk St.
In Canada: 811 W. Hastings St., Vancouver, B.C.



MAIL NOW TO OFFICE NEAREST YOU!

(mail in envelope or paste on postal card)

NATIONAL SCHOOLS, Dept. RG-85
4000 S. FIGUEROA STREET OR 323 W. POLK STREET
LOS ANGELES 37, CALIF., CHICAGO 7, ILL.

Rush FREE BOOK, "Your Future in Radio-TV-Electronics," and FREE LESSON. No obligation, no salesman will call.

NAME _____ BIRTHDAY _____ 19 _____

ADDRESS _____

CITY _____ ZONE _____ STATE _____

Check if interested ONLY in Resident Training at Los Angeles.
VETERANS: Give date of discharge _____

Movie Screen Brightness
for Your TV Picture

TUNG-SOL

Magic
Mirror

**Aluminized
PICTURE TUBE**



Yes, you can have a sharper, clearer TV picture . . . a picture with all the depth and detail you enjoy on the movie screen.

The Tung-Sol "Magic-Mirror" Aluminized Picture Tube gives you deeper blacks, more brilliant highlights and in-between tones that will make your picture fairly come alive. So treat yourself to new TV viewing pleasure with a Tung-Sol "Magic-Mirror" Aluminized Picture Tube.

The finest TV sets are factory-equipped with receiving and picture tubes made by Tung-Sol — one of America's leading electron tube manufacturers.

TUNG-SOL ELECTRIC INC., Newark 4, N. J.

Sales Offices: Atlanta, Chicago, Columbus, Culver City (Los Angeles), Dallas, Denver, Detroit, Montreal (Canada), Newark, Seattle.

TUNG-SOL

*Automotive
and Electronic
Products*



the
**Radio
month**



ONE MILLION PEOPLE view television with the aid of community antenna systems, according to Milton Shapp of Jerrold Electronics Corp., one of the largest makers of community antenna television systems. The statement was made in connection with the filing of a proposition by Jerrold at the FCC hearing on pay-as-you-see television.

Shapp stated to a New York press conference that the audience served by coaxial cable formed a natural opportunity for tests of the "tolllevision" system. There would be no need to scramble the broadcasts, he said, and the paid programs could be added as an extra service to persons already connected to the cable. Switching and metering systems could be simple and cheap. And, if the experiment were a success, wired television could be considered as a possible permanent solution to the pay-as-you-see controversy — one that would leave the public in full possession of the present TV channels, yet would offer a medium for those who wished to offer programs for a price.

SIGNAL CORPS MUSEUM of the United States Army has been dedicated in memory of the late Maj. Edwin H. Armstrong, pioneer in the development of radio. A plaque designating the museum "Armstrong Hall" was unveiled. Referring to Armstrong as "one of the greatest inventors of our times," General O'Connell, Chief Signal Officer, stated that "his genius was exceeded only by his love and devotion to country."

The museum — at Fort Monmouth,

N. J. — will make it possible for the Signal Corps, which celebrated its 95th anniversary on June 21, to preserve and record the Corps' traditions and achievements from the days of signal flags and telegraph to the present era of radar and microwaves. Some of the equipment housed in the museum is shown in the photo.

TRANSOCEANIC PHONE CABLE making voice transmission across the Atlantic possible for the first time, will be in operation in 1956. Laying the cable began June 22. Amplifiers of unique design, quality and structure, installed at regular intervals along the line, make the hitherto impossible feat of transmitting voice over a trans-Atlantic cable feasible.

The historic operation which will extend two submarine cables 2,250 miles between Newfoundland and Scotland is a joint undertaking of AT&T, the British Post Office and Canadian Overseas Telecommunication Corp. The telephone cable will be extended an additional 300 miles westward from Newfoundland to

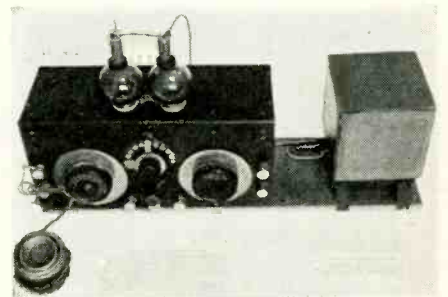

Two items in the Edwin Armstrong collection. Above—Prototype of the superhet. Below—a transmitter of interfering signals for jamming enemy transmissions.

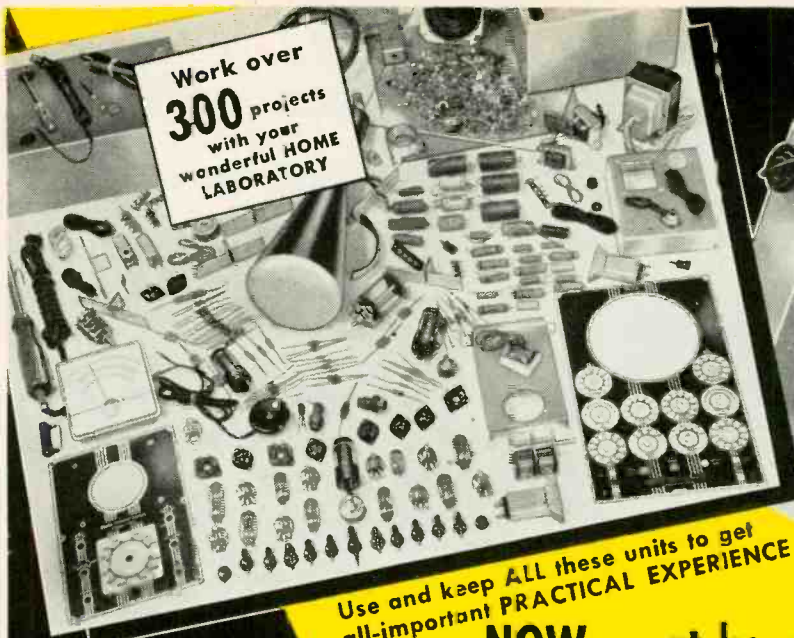

Work over
300 projects
with your
wonderful HOME
LABORATORY



21 INCH
Build and keep D.T.I.'s NEW
2 Unit TV Set—ideal for cus-
tom installation. (D.T.I. also
offers home training with-
out the TV set.)

Use and keep ALL these units to get
all-important PRACTICAL EXPERIENCE

NOW... at home... get D.T.I.'s
amazingly effective **NEW** training in
TELEVISION

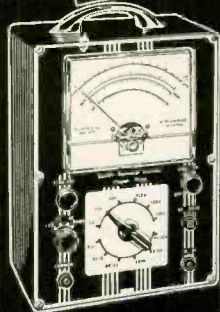

NEW!
Build and keep
D. T. I.'s new
VACUUM TUBE
VOLTMETER...
one of the most
useful of all test
instruments.



5 INCH
"SCOPE"

ABOVE: Also build
and keep this quality
Oscilloscope—almost
a "must" for Televi-
sion servicing.



Exclusive HOME MOVIES
help you grasp
important points
**FASTER...
EASIER...
BETTER.**
A tremendous
advantage!

Remarkable **NEW Styrene**
ELECTRO-LAB*

Insert pictorial diagram on transparent styrene base. (See insert.) Mount parts to follow pattern—using handy "snap in" fasteners. Eliminates wiring errors. Tops for speedy circuit changes... for providing maximum circuit experience in minimum time. Build and operate scores of interesting projects — such as the electronic circuit shown below.

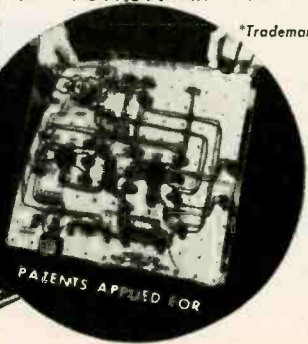

*Trademark

PATENTS APPLIED FOR

THOUSANDS OF SUCCESSFUL GRADUATES

WHY has D.T.I. become one of the largest training organizations of its kind? Because it provides EVERY MAJOR HOME TRAINING AID to help make the subject EASIER to learn... EASIER to remember—the kind of training so helpful for REAL PROGRESS. Students get thorough, up-to-date, practical training that TAKES ADVANTAGE of new and improved training developments. Study the ADVANTAGES shown on this page. Think what they can mean to YOU... to YOUR FUTURE! Or come to D.T.I.'s big Training Laboratories in Chicago. MAIL COUPON TODAY for complete facts—including valuable publication, "89 Ways to Earn Money in Television-Radio-Electronics." Also, valuable information for men subject to MILITARY SERVICE.

"One of America's Foremost Television Training Centers"

DeVRY
Technical Institute
CHICAGO 41, ILLINOIS
Formerly DeFOREST'S TRAINING, INC.

MAIL COUPON TODAY

DeVRY TECHNICAL INSTITUTE
4141 Belmont Ave., Chicago 41, Ill. Dept. RE-8-L

I would like complete facts including "89 Ways to Earn Money in Television-Radio-Electronics."

Name _____ Age _____
Street _____ Apt. _____
City _____ Zone _____ State _____
1 D.T.I.'s training is available in Canada.



Nova Scotia, and from there signals will be sent to the United States over a 575-mile radio relay system.

The first of the cables will cross the ocean by the end of summer. The second cable, to be placed some 20 miles away from the first, will be laid in the summer of 1956.

Each of the trans-Atlantic cables will be laid in three segments: two heavily armored shore ends reaching 500 miles off Newfoundland and 200 miles off Scotland, and a long center section of lighter design. Each cable will contain 52 intermediate repeaters (amplifiers) spaced 40 miles apart. The deep-sea repeater uses three vacuum tubes and some 60 other electrical components. It is housed in a flexible copper tube about 8 feet long and 1 3/4 inches in diameter. Power is supplied from the shore, about 2,200 volts at 0.225 ampere being required from each end. The cable system will handle 36 conversations simultaneously.

FLASH TUNING demonstrated by Zenith, uses a pistol-grip flashlight to permit the TV viewer to turn the set on or off, change channels or cut out the sound during long-winded commercials. Receivers using the Flash-Matic system have four photoelectric cells, one at each corner of the picture tube.

A beam shining in the lower left-

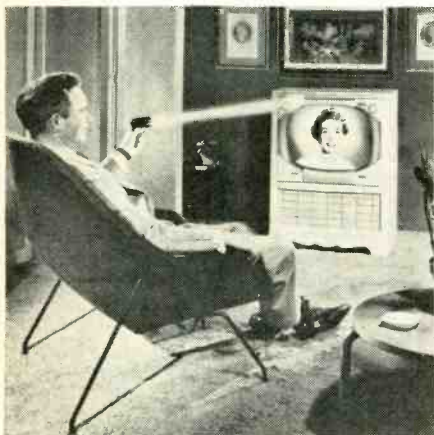

hand corner turns the set on or off. Channels are switched through the upper two cells: the one on the left turns channels counterclockwise, the other changes channels clockwise. The lower left-hand cell cuts out the audio—a second flash brings it back.

The photoelectric cells controlling channel selection operate a single motor. Channels are tuned in sequence. If the light is projected on either cell for more than an instant, several channels will be covered.

THE HUGO GERNSBACK AWARD, a scholarship given annually to an engineering student who has demonstrated potentialities of scientific leadership in the field of electronics, was awarded this year to Arvin Grabel, New York City. The scholarship is established at New York University for students who have completed their junior

year in the College of Engineering. It provides \$1,000 annually toward the student's tuition costs.

Mr. Grabel—selected for the scholarship by a committee appointed by the university—qualified for the committee's consideration with a general scholastic average of 85.1% on a scale which has a possible maximum of 95%.



ARVIN GRABEL

Last year's recipient of the scholarship, Lawrence Wechsler, received this year the degree of Bachelor of Electrical Engineering, *summa cum laude*, with a cumulative average of 95%, the ultimate. He is now continuing his studies toward a master's degree.

The Gernsback scholarship is the outgrowth of an award made to Hugo Gernsback in 1953, in recognition of his 50 years' service to the electronic industry. At that time he suggested expressing his appreciation of the honor by establishing a scholarship for the purpose of furthering education of engineering students who have demonstrated outstanding ability in radio-electronics.

SIX NEW TV STATIONS have gone on the air since our last report:

KLIX-TV	Twin Falls, Idaho.....	11
KLFY-TV	Lafayette, La.....	10
KOTA-TV	Rapid City, S.D.....	3
KCOR-TV	San Antonio, Tex.....	41
WTOV-TV	Norfolk, Va.....	27
WFRV-TV	Green Bay, Wis.....	5

Three stations have gone off the air:

WQXI-TV	Atlanta, Ga.....	36
WOKA	Macon, Ga.....	47
	(formerly WNEK-TV)	
WJTV	Jackson, Miss.....	25
	(formerly WSLI-TV)	

WDEL-TV's new call letters are WPFH, Wilmington, Del., channel 12.

The following are corrections of the June TV station list:

WILS-TV, Lansing, Mich., channel 54 is now WTOM-TV. WDXI-TV is on channel 7 in Jackson, Tenn., not in Texas. WTVE, Elmira, N. Y., channel 24, is off the air. KWK is KWK-TV, St. Louis, Mo., channel 4. KROC is KROC-TV, Rochester, Minn., channel 10.

want COLOR TV KNOW-HOW?

get this new book

"Color Television for the Service Technician"



another
great book
by Albert C. W.
Saunders

Here is Saunders at his best, employing his vast teaching experience to prepare the Service Technician for practical Color TV servicing. The entire subject is treated in easy-to-understand language, supported by a wealth of clear illustrations. Major emphasis is placed on Color Receiver installation and servicing. Here are the fact-packed chapters:

CHAPT. 1. Colorimetry: Discussion of color, hue, saturation, purity, brightness, color matching, color terminology.

CHAPT. 2. Color TV: Origin and content of the color signal; transmission; the color TV transmitter and camera; the luminance signal.

CHAPT. 3. Color Carrier: The chrominance signal, bandwidth, modulation, color sync signals; obtaining I and Q signals; transmission of luminance, chrominance and sync signals.

CHAPT. 4. Color Signal Analysis: The Color Signal; formation of Y, I and Q signals; scalar and vector quantities; doubly-balanced modulators.

CHAPT. 5. Tricolor Picture Tube: Types of color picture tubes; how they operate, construction and characteristics.

CHAPT. 6. Color Receivers: Descriptions of current color circuits; convergence adjustments and procedures; installation adjustments for specific models.

Prepare for Color TV with the help of this practical, valuable book. 116 pages. Fully illustrated. 8 1/2 x 11".

ORDER SC-1 \$2.50
Only

ORDER
TODAY!

HOWARD W. SAMS & CO., INC.

Order from your Parts Jabber today, or write to Howard W. Sams & Co., Inc., 2205 E. 46th St., Indianapolis 5, Ind.

My (check) (money order) for \$..... enclosed. Send copy(ies) of "Color TV for the Service Technician" (SC-1, \$2.50).

Name.....

Address.....

City..... Zone..... State.....
(outside U.S.A. priced slightly higher)

MAY WE SEND YOU THIS NEW 12" HIGH-FIDELITY LONG-PLAYING 33 1/3 RPM RECORD OF

"SCHEHERAZADE" and "CAPRICCIO ESPAGNOLE"

By Rimsky-Korsakov

Also available on 7-inch 45 rpm Extended Play Records

TO INTRODUCE YOU TO THIS BRAND-NEW SERIES OF LOW-COST HIGH-FIDELITY RECORDINGS

for only

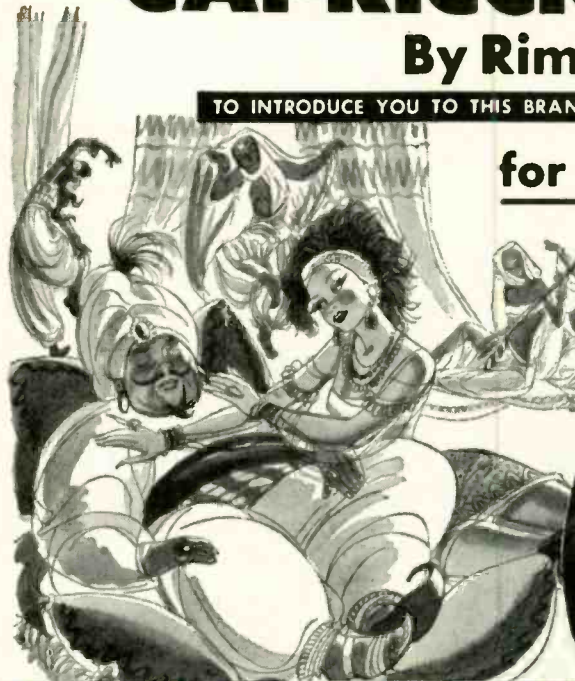
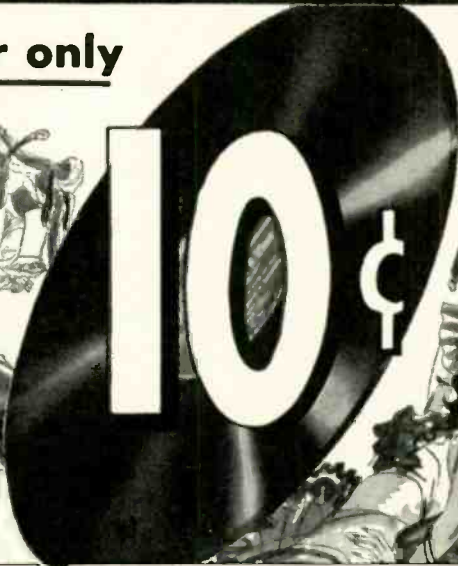

She Beguiled Him for 1001 Nights—To Save Her Head!

Remember the story of the "Arabian Nights"... how the Sultana Scheherazade saved her life by spinning wondrous tales of far-off places and fantastic adventures. That's the story that inspired Rimsky-Korsakov's most colorful score! Completed in 1888, *Scheherazade* is just as popular today as it was then. And little wonder—for there is nothing quite like it in the entire symphonic literature. No matter how often you've heard it before, you're sure to thrill to this tremendously exciting new performance under the baton of the internationally-famous conductor, Max Schoenherr!

A Fantasy on Spanish Themes

Rimsky-Korsakov loved to travel, and wherever he went he noted down the folk songs he heard—melodies, themes, dance tunes he would later use in his compositions. The *Capriccio Espagnole* was the result of a trip to Spain... and is based on several Spanish themes—a lively dance in two-four time; a wild gypsy song; a plaintive folksong; and as a stunning finale, a fiery Fandango!



An Exciting New Way for Your Entire Family to Learn to Enjoy Truly Great Music—and to Own the Best-Loved Symphonies, Concertos, Operas, Musical Comedies—AT AN UNUSUALLY LOW COST!

Yes! For only 10¢ you may have this brand-new, pure vinyl, high-fidelity 12" long-playing 33 1/3 r.p.m. record—containing both Rimsky-Korsakov's "Scheherazade" AND his "Capriccio Espagnole"—both works complete! We make this offer to acquaint you with the new planned program called MUSIC TREASURES OF THE WORLD.

Under this program you can now enjoy in your own home a complete recorded library of the world's great music... beautifully recorded on the latest high-fidelity electronic equipment, with the full range of sound (30-15,000 cycles per second)... yours for much less than the price you would normally expect to pay! High-fidelity recordings like these usually sell at retail for as much as \$5.95 each—but because assured distribution to members eliminates the usual expense of unsold records—and because of the development of mass production high-fidelity record pressing equipment—we are able to offer these 12" long-playing high-fidelity records to our members for only \$2.98 each!

WHAT DOES THIS MUSIC PROGRAM INCLUDE?

Music Treasures of the World makes available to you and your children the best-loved works of all the greatest composers, both serious and light—Bach, Beethoven, Brahms, Mozart, Tchaikovsky, Gershwin, etc. And these selections are thrilling brand-new performances, played by internationally famous philharmonic symphony orchestras under the batons of such eminent conductors as

Walter Hendl, Hans Swarowsky, Dean Dixon, Kurt Graunke, Felix Prohaska, William Strickland, etc.—brilliantly recorded especially for these new long-playing records!

YOU LEARN TO UNDERSTAND GREAT MUSIC

By accepting this introductory offer now, you will also be automatically enrolled in our fascinating Music Appreciation Course—*absolutely free!* Each month you will receive—FREE—a new issue of our Course to help you understand the fine points of music and enable you to listen to all music as do the critics and composers themselves!

HOW THIS UNIQUE MUSIC PROGRAM WORKS

Your purchase of the record offered above for 10¢ does not obligate you to buy any additional Music Treasures records—*ever!* However, we will be happy to extend to you the courtesy of an Associate Membership. Each month, as an Associate Member, you will be offered a new 12" long-playing 33 1/3 r.p.m. record at the special member's price of only \$2.98 each (plus a few cents for U. S. tax and shipping). If you do not wish to purchase any particular record, you need merely return the form provided for that purpose.

Remember—whether or not you decide to purchase any additional records from Music Treasures of the World, the introductory record is yours to keep—for only 10¢! And you will still receive, each month, a new issue of our Music Appreciation Course, FREE. So send 10¢ now—while you can still get BOTH of the Musical Treasures listed above.

FREE Music Appreciation Course

Each month you will receive a treatise in some important phase of How to Appreciate Music. Prepared by Joseph Machlis, Associate Professor of Music, Queens College of the City of New York—this course will help your entire family love and understand music. And each monthly issue is yours, *absolutely free*, until you cancel—whether or not you purchase any additional records!



MUSIC TREASURES OF THE WORLD, Dept. 245 RE-8
100 Sixth Ave., New York 13, N. Y.

BOTH FOR ONLY 10¢
Rimsky-Korsakov's "Scheherazade" AND "Capriccio Espagnole"

Here is my 10¢ as payment in full for the 12" long-playing record described above—plus the first treatise of your Music Appreciation Course—which I may keep whether or not I purchase any additional records. Each month, as an Associate Member I will receive advance notice of the new record release, which I may purchase at the special member's price of only \$2.98 per record, plus a few cents for U. S. tax and shipping. However, I may decline to accept any or all records offered me and I may cancel membership any time. It is further understood that I will receive the Music Appreciation Course—one lesson each month—*absolutely free!* All my records are to be 33 1/3 r.p.m. unless I specify 45 r.p.m. below.

Check here if you want the introductory offer above on four 45 r.p.m. Extended Play records. Future selections will be on four 45 r.p.m. Extended Play records—for \$3.50.
Membership limited to one person over 21 in any household

Name

Address

City..... Zone..... State.....

IN CANADA: 1184 Castlefield Ave., Toronto 10, Ont.

IT'S NEW
IT'S POWERFUL

IT'S EFFICIENT
IT'S COMPACT

IT'S STREAMLINED
and IT'S PATENTED, TOO!

TRIO[®]
Zephyr

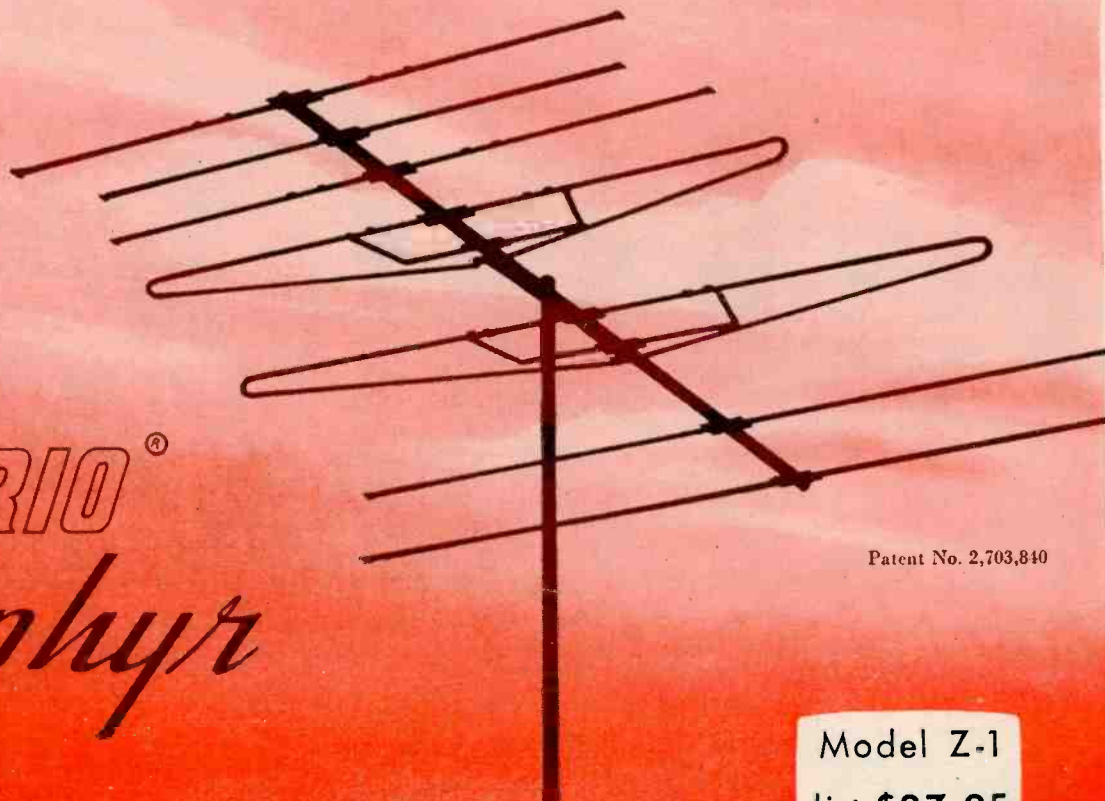

Patent No. 2,703,840

Model Z-1
list \$27.95

Uses Trio's
Internationally
Famous Insta-lok
Clamps



Millions of Insta-loks used! Tested and proven
to be the best, both here and abroad.

Superior Performance Fast Assembly Trio's recognized top quality construction

The Trio Zephyr gives top performance on all VHF channels with its revolutionary "Wing Dipole"—three half-wave elements in phase combined with an integrated director element makes each dipole a unidirectional antenna on the high channels.

The two driven elements are self-resonant to a different frequency and the elements are so spaced and so connected with respect to each other that during operation of the array on any one of the frequencies for which an element is resonant all of the elements are energized as active, or driven elements and at the same time each element is also operative as a parasitic element with respect to each of the other elements.

Single bay out-performs bulky stacked arrays but may be stacked in exceptional fringe areas.



TRIO Manufacturing Company
GRIGGSVILLE, ILLINOIS

COPYRIGHT 1955—TRIO MANUFACTURING COMPANY

EXPORT SALES DIV., SCHEEL INTERNATIONAL INC., 4237 N. Lincoln Ave., Chicago, U.S.A. Cable Address: HARSHEEL

FREE

MONEY MAKING
FCC
 Commercial Radio Operator
LICENSE
 INFORMATION

TELLS HOW -

WE GUARANTEE

TO TRAIN AND COACH YOU AT HOME IN SPARE TIME UNTIL YOU GET

YOUR FCC LICENSE

If you have had any practical experience—Amateur, Army, Navy, radio, repair, or experimenting.

HERE IS YOUR GUARANTEE

If you fail to pass your Commercial License exam after completing our course, we guarantee to continue your training, without additional cost of any kind, until you successfully obtain your Commercial license.

TV Engineering

INCLUDED IN OUR TRAINING AND COACHING

TELLS HOW -

OUR AMAZINGLY EFFECTIVE JOB-FINDING SERVICE HELPS CIRE STUDENTS GET BETTER JOBS. HERE ARE JUST A FEW RECENT EXAMPLES OF JOB-FINDING RESULTS:

CIVIL SERVICE

"Thanks to your course I obtained my 2nd phone license, and am now employed by Civil Service at Great Lakes Naval Training Station as an Equipment Specialist."

Kenneth R. Leiser, Fair Oaks, Mid. Del., McHenry, Ill.

STATE POLICE

"I have obtained my 1st class ticket (thanks to your school) and since receiving same I have held good jobs at all times. I am now Chief, Radio Operator with the Kentucky State Police."

Edwin Healy, 264 E. 3rd St., London, Ky.

BROADCASTING

"I wish to thank your Job Finding Service for the help in securing for me the position of transmitter operator here at WCAE, in Pittsburgh."

Walter Koschik, 1442 Ridge Ave., N. Braddock, Pa.

AIRLINES

"Due to your Job-Finding Service, I have been getting many offers from all over the country, and I have taken a job with Capital Airlines in Chicago, as a Radio Mechanic."

Harry Clare, 4537 S. Drexel Blvd., Chicago, Ill.

TELLS HOW -

EMPLOYERS MAKE JOB OFFERS LIKE THESE TO OUR GRADUATES EVERY MONTH!

Letter from nationally-known Airlines: "Radio Operators and Radio Mechanics are needed for our company. Periodic wage increase with opportunity for advancement. Both positions include many company benefits such as paid vacations, free flight mileage allowance and group insurance."

Letter from nationally-known manufacturer: "We have a very great need at the present time for radio-electronics technicians and would appreciate any helpful suggestions that you may be able to offer."

These are just a few of the examples of the job offers that come to our office periodically. Some licensed radioman filled each of these jobs; it might have been you!

Ours is the only home study course which supplies FCC-type examinations with all lessons and final test.

An Approved Member



ACT NOW!

Get ALL 3 FREE

Your FCC Ticket is recognized by employers as proof of your technical ability.

HERE'S PROOF FCC LICENSES ARE OFTEN SECURED IN A FEW HOURS OF STUDY WITH OUR COACHING AT HOME IN SPARE TIME:

Name and Address	License	Time
Harry G. Frame, Box 429, Charlestown, W. Va.	2nd Class	13 Weeks
Charles Ellis, Box 449, Charles City, Iowa	1st Class	28 Weeks
Omar Bibbs, 1320 E. 27th St., Kansas City, Mo.	1st Class	34 Weeks
Kenneth Rue, Dresser, Wisconsin	2nd Class	20 Weeks
B. L. Jordan, Seattle, Washington	1st Class	20 Weeks

CARL E. SMITH, E.E. Consulting Engineering, President

CLEVELAND INSTITUTE OF RADIO ELECTRONICS
 Desk RE-79, 4900 Euclid Bldg., Cleveland 3, Ohio



MAIL COUPON NOW!

Cleveland Institute of Radio Electronics
 Desk RE-79—4900 Euclid Bldg.,
 Cleveland 3, Ohio
 (Address to Desk No. to avoid delay)

I want to know how I can get my FCC Ticket in a minimum of time. Send me your FREE booklet, "How to Pass FCC License Examinations" (does not cover exams for Amateur License), as well as a sample FCC-type lesson and the amazing new booklet, "Money-Making FCC License information." Be sure to tell me about your Television Engineering Course.

Name.....

Address.....

City..... Zone..... State.....

FOR PROMPT RESULTS, SEND AIR MAIL
 Special tuition rates to members of the U. S. Armed Forces

Your best buy!

...for new installations

...for replacement needs!

...the fastest mounting, best performing aerial on the market

RADIART
Spee-Dee
AUTO AERIAL
MODEL 8BE

Here is the outstanding, NEW auto aerial and it has everything! Handsome in appearance... outstanding in performance... and a new design that is a snappy one-two-three installation WITHOUT EVEN LOOKING UNDER THE FENDER!

Here are a few of the features:

- ★ Speedy, one-man installation
- ★ 30° mast adjustment
- ★ Fits all body and fender contours
- ★ 57½" length extended - 18-8 stainless steel
- ★ Extra long, full 42" polyethylene lead-in

1. After dis-assembling, insert the lead and lower section through fender hole and guide the split ring through the fender hole—then draw up tight against fender.

2. Then lower rubber mat insulator and lock nut into position.

3. Just tighten assembly... plug lead-in into radio.

FEATURING EASY 1-2-3 INSTALLATION

SUBSIDIARY OF



THE RADIART CORPORATION
CLEVELAND 13, O.

TV Antennas - Auto Aerials - Vibrators - Rotors - Power Supplies

AS A DEMONSTRATION...

Will you accept without charge ANY ONE of these high-fidelity
MUSIC~APPRECIATION RECORDS

 <p>Richard Strauss' TILL EULENSPIEGEL'S MERRY PRANKS Smetana's THE MOLDAU (ON ONE 12" DISC) George Szell, conducting The Music Appreciation Symphony Orchestra</p>	 <p>Prokofiev's CLASSICAL SYMPHONY Britten's THE YOUNG PERSON'S GUIDE TO THE ORCHESTRA (ON ONE 12" DISC) Alfred Wallenstein, conducting The Music Appreciation Symphony Orchestra</p>
 <p>Wagner's OVERTURES TO TANNHÄUSER and DIE MEISTERSINGER (ON ONE 12" DISC) Norman Del Mar, conducting The London Symphony Orchestra</p>	 <p>Haydn's SYMPHONY NO. 102 IN B FLAT MAJOR Fritz Stiedry, conducting The Music Appreciation Symphony Orchestra</p>
 <p>J.S. Bach's SUITE FOR ORCHESTRA NO. 3 IN D MAJOR George Szell, conducting The Music Appreciation Symphony Orchestra</p>	 <p>Schumann's PIANO CONCERTO IN A MINOR Thomas Scherman, conducting The Little Orchestra Eileen Flissler, Pianist</p>
 <p>Mendelssohn's VIOLIN CONCERTO IN E MINOR Alexander Smallens, conducting Stadium Concerts Symphony Orchestra • Fredell Lack, Violinist</p>	 <p>Beethoven's SYMPHONY NO. 5 IN C MINOR Norman Del Mar, conducting The London Symphony Orchestra</p>

TO HELP YOU UNDERSTAND MUSIC BETTER AND ENJOY IT MORE

SPONSORED BY THE BOOK-OF-THE-MONTH CLUB, this new idea is designed for those who enjoy good music but who are aware, too often, that they do not listen to it with complete understanding and appreciation. There is no doubt about the reason: most of us are not primed about *what to listen for*. MUSIC-APPRECIATION RECORDS meet this need—for a fuller understanding of music—

better than any means ever devised. This form of self-education can be as thorough as the Music Appreciation courses given in many universities.

YOU SUBSCRIBE BUT TAKE ONLY THE RECORDS YOU WANT... A new MUSIC-APPRECIATION RECORD will be issued—for subscribers only—every month. The announcement about each forthcoming record will be written by the noted composer and music commentator Deems Taylor. After reading this descriptive essay you may take the record or not. *You are not obligated to take any specified number of records.* And you may stop at any time!

TWO TYPES OF RECORDS AVAILABLE ... All MUSIC-APPRECIATION RECORDS are high-fidelity, long-playing records of the highest quality—33 1/3 R.P.M. on Vinylite. They are of two kinds: first, a

so-called Standard Record—a *twelve-inch* disc—which presents the performance on one side, the analysis on the other. This is sold at \$3.60, to subscribers only. The other is an Analysis-Only Record—a *ten-inch* disc—priced at \$2.40. The latter is made available each month for any subscriber who may already have a satisfactory long-playing record of the work being presented. (A small charge is added to the prices above to cover postage and handling.)

TRY A ONE-MONTH SUBSCRIPTION—WITH NO OBLIGATION TO CONTINUE... Why not make a simple trial, to see if these records are as pleasurable and as enlightening as you may anticipate? The record you choose will be sent to you at once—at *no charge*. You may end the subscription immediately after hearing this record, or you may cancel any time thereafter.



ON ONE SIDE there is a full performance of a great musical work. The records feature orchestras and soloists of recognized distinction in this country and abroad. You listen to this performance first, or afterward, as you desire, and then ...



ON THE OTHER SIDE is an illuminating analysis of the music, with the themes and other main features of the work played separately with running explanatory comment, so that you can learn *what to listen for* in order to appreciate the work fully.

PLEASE RETURN ONLY IF YOU HAVE A 33 1/3 R. P. M. RECORD PLAYER

MUSIC-APPRECIATION RECORDS R39-8
 c/o Book-of-the-Month Club, Inc.
 345 Hudson Street, New York 14, N. Y.

Please send me at once, without charge, the MUSIC-APPRECIATION RECORD checked at the right and enter my name in a Trial Subscription to MUSIC-APPRECIATION RECORDS, under the conditions stated above. It is understood that, as a subscriber, I am not obligated to buy any specified number of records, but may take only those I want. Also, I may cancel my subscription after hearing this first record, or any time thereafter at my pleasure, but the introductory record is free in any case.

- AS MY FREE DEMONSTRATION RECORD PLEASE SEND ME
- | | |
|--|---|
| <input type="checkbox"/> Strauss' Till Eulenspiegel & Smetana's The Moldau | <input type="checkbox"/> Prokofiev's Symphony and Britten's Guide |
| <input type="checkbox"/> Wagner's Overtures | <input type="checkbox"/> Haydn's Symphony |
| <input type="checkbox"/> Bach's Suite | <input type="checkbox"/> Schumann's Concerto |
| <input type="checkbox"/> Mendelssohn's Concerto | <input type="checkbox"/> Beethoven's Symphony |

Mr. _____
 Mrs. _____
 Miss _____
 (Please Print)

ADDRESS _____

CITY _____ ZONE _____ STATE _____

MAR 37

The NEW American Beauty

Bantams

**ELECTRIC
SOLDERING
IRONS WORTH
"Crowing"
ABOUT!**



Cat. No. 3120 $\frac{3}{16}$ " Tip Diameter 30 Watts



Cat. No. 3120-SCP $\frac{3}{16}$ " Tip Diameter 30 Watts

Not just another "bantam"—but a true American Beauty "Bantam" backed by the most famous name in electric soldering for over 60 years.

American Beauty "Bantams" feature:

- Indestructible stainless steel casing that insures against undue loss of heat and keeps handle cool.
- Highest quality nickel-chromium heating element with genuine mica insulation.
- Tapered spool nose for maximum visibility and projection-free casing to assure easy access to hard-to-get-at places.
- Available in $\frac{1}{8}$ " and $\frac{3}{16}$ " tip diameters with either pencil type handle or standard handle and with long or short casing. Diamond point tip is standard—chisel type if specified.

For the finest quality in ALL TYPES of Electric Soldering Irons—Check with American Beauty first.

AMERICAN ELECTRICAL HEATER COMPANY



DETROIT 2, MICHIGAN

148-H

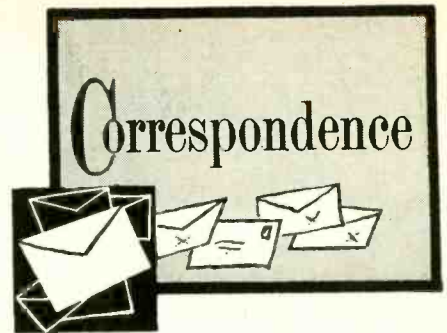

Correspondence

HORN ANTENNA

Dear Editor:

I would like to correct several erroneous impressions given by the article "Horn Antenna Construction" in your April issue.

The antenna, as described by Mr. O'Leary, is not a true horn. A true horn would have four sides and its interior surface would guide the r.f. wave to a pickup element located at the vertex. At v.h.f. its size would make it completely impractical.

The antenna described in the article is actually a fat conical dipole on the low v.h.f. band, as Mr. O'Leary suspects, and a V antenna on the high band. A much more practical version of this design is embodied in the driven element of Channel Master's *Super Fan*, introduced in 1949, and other fan type antennas made commercially since then.

The gain predicted by the referenced article in *Electronics* for a typical design rises from 1.5 db on channel 2 to 14.5 db on channel 13 over an isotropic source. Subtracting 2.16 db, the gain of a tuned dipole over an isotropic source, we get a predicted theoretical gain of -0.5 to 1 db on low-band v.h.f. and 11- to 12-db gain on high-band v.h.f. This theoretical gain is poor on the low band and only fair on the high band, compared to today's high-gain antennas.

Mr. O'Leary's model is somewhat larger than the model referred to above. But it hardly seems worth while when one considers its bulk and wind-loading, compared to one of today's streamlined broad-band Yagis.

The referenced article by Mr. Morgan contains no *measured* gain data—only predicted theoretical values. When this article was published in October, 1951, Channel Master constructed a model and measured its gain. The predicted gain was not sustained.

JULIUS GREEN

PROJECT ENGINEER

Channel Master Corp.
Ellenville, N. Y.

INDEPENDENT TECHNICIANS

Dear Editor:

In the Dallas-Ft. Worth area there are probably hundreds of part-time independent radio and TV technicians. This segment of the service industry is large enough to be recognized by parts distributors who give us equal rights with the large and the small shops. Most of us work in industries related to electronics and have an excellent apti-

Learn to Service TV Sets— any make or model—Quickly

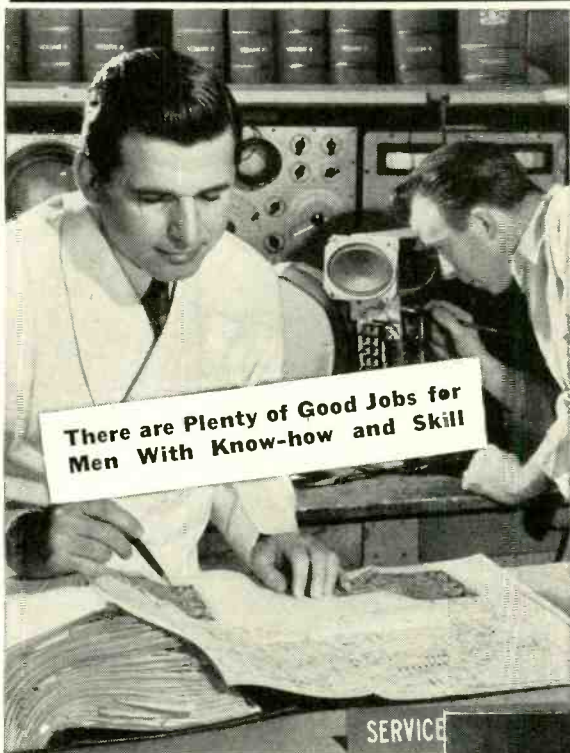

There are Plenty of Good Jobs for Men With Know-how and Skill

New ALL PRACTICE Method trains you at home to become a Professional TV Serviceman

You learn the time saving techniques, methods used by top TV Servicemen

This is 100% learn-by-doing, practical training. NRI supplies all necessary equipment, all tubes, including a 17-inch picture tube; and comprehensive manuals covering a thoroughly planned program of practice. You learn how experts diagnose TV receiver defects quickly. You easily learn the causes of defects—audio and video—and how to fix them accurately.

You get actual experience aligning TV receivers, isolating complaints from scope patterns, eliminating interference, using germanium crystals to rectify the TV picture signal, adjusting the ion trap and hundreds of other valuable Professional techniques.

17" Picture Tube, Components for a TV Receiver, Scope, Signal Generator, HF Probe—all included in introductory price under \$200—Easy Terms

If you want to go places in TV servicing, you will act quickly to find out what you get, what you practice, what you learn and how NRI's new course in Professional Television Servicing will help you advance through better technical knowledge and training. See pictures of equipment supplied, read what you practice in book offered FREE to ambitious men with some knowledge of Radio or TV fundamentals. Find out about this ALL PRACTICE Professional TV Servicing Course now.

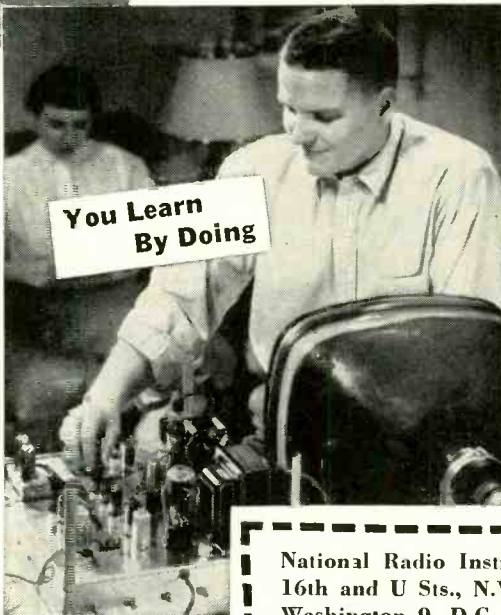

You Learn By Doing

UHF and COLOR Create Growing Opportunities

To cash in on the present UHF and the coming COLOR TV boom you'll need the kind of knowledge and experience NRI's Course gives. You'll get practice installing front-end channel selector strips in modern UHF-VHF receivers. You learn UHF servicing problems and their solution. Mail the coupon now. Discover how NRI's new course in PROFESSIONAL TELEVISION SERVICING meets the needs of the man who wants to get ahead in TV Servicing.

Not for Beginners

If you have some knowledge of Radio-TV fundamentals, or have had some Radio Shop experience or some Radio school training, this course IS FOR YOU. Mail coupon today.

Address National Radio Institute, Dept. 5HFT, 16th and U Sts., N. W., Washington 9, D. C.

MAIL NOW

COUPON BRINGS IMPORTANT BOOK FREE



Get this book and judge for yourself how this course will further your ambition to reach the top in TV Servicing or help to build a more secure business of your own in TV. Many of tomorrow's top TV Servicemen . . . men who can service any make, any model, UHF, VHF or Color TV . . . will be graduates of this training. Mail the coupon now. There is no obligation.

National Radio Institute, Dept. 5HFT, 16th and U Sts., N.W. Washington 9, D.C.

Please send my FREE copy of "How to Reach the Top in TV Servicing." I understand no salesman will call.

Name..... Age.....

Address.....

City..... Zone..... State.....

Approved Member National Home Study Council

From nursery phonographs . . . to hi-fidelity units

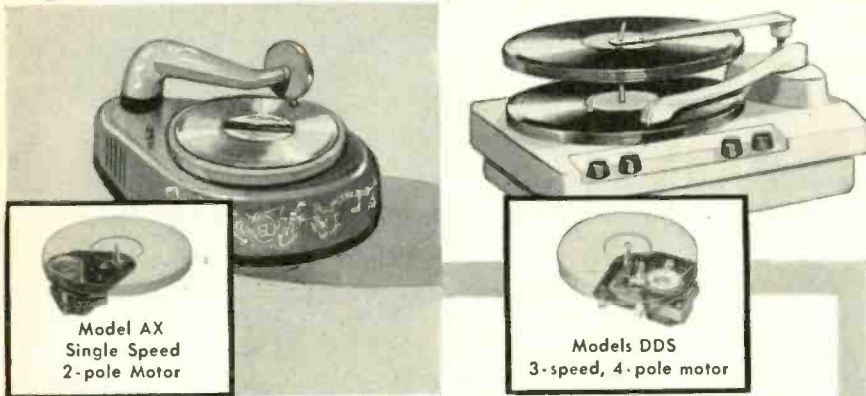

Model AX
Single Speed
2-pole Motor

Models DDS
3-speed, 4-pole motor

... ONLY **GI** Makes a Phonomotor for EVERY Application!..

World's only complete line . . . one convenient source for every phonomotor need — that's GI! No matter what the application: portables . . . Hi-Fi (2 and 4 pole motors) . . . combinations . . . record changers . . . tape and disc recorders . . . GI has the right motor for the job. First choice of leading original equipment manufacturers, first choice for replacement, GI motors through the years have won a reputation for quality and dependability that is unsurpassed anywhere.

Write today for a complete catalog giving descriptions and specifications of phonomotors in the famous GI "Smooth Power" line.



Model DR
2-speed,
4-pole motor



Model LC
Single-speed,
2-pole motor



Model RM4
Single speed,
4-pole motor



Model D-10 — 4-pole,
shaded pole AC
Induction type for tape,
wire or disc recorders.



THE GENERAL INDUSTRIES Co.

DEPARTMENT GE • ELYRIA, OHIO

OVER 97,000 TECHNICIANS HAVE LEARNED
HOW TO GET THE MOST OUT OF
BASIC TEST EQUIPMENT

for AM
FM-TV

'Servicing by Signal Substitution'

A BEST SELLER FOR OVER 13 YEARS!
(NEW, UP-TO-DATE, 14th EDITION)

The Modern, Simplified, Dynamic Approach to
all Receiver Adjustment & Alignment Problems

- ★ Nothing complicated to learn
- ★ No extra equipment to purchase
- ★ Universal . . . non-obsolete
- ★ Employs only Basic Test Instruments

Ask for "S.S.S." at your local Radio
Parts jobber or remit 40¢ in small
stamps or coin directly to factory.

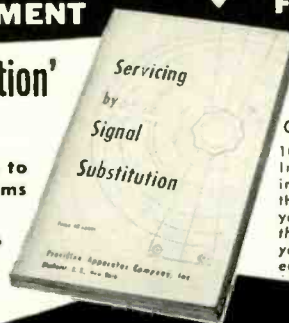

ONLY 40¢

103 pages.
Invaluable
information
that will help
you redouble
the value of
your basic test
equipment.

PRECISION APPARATUS COMPANY, INC.
70-31 84th STREET, GLENDALE 27, L. I., N. Y.

CORRESPONDENCE (Continued)

tude for service work. To call this group a bunch of "cellar fly-by-nights" is misrepresentation.

A frequent charge leveled at us is that we work too cheap. This seems to really upset some of the boys who write letters to your magazine. Do we work too cheaply—or too honestly? We do not advertise or make any service calls for \$1.95 but usually charge \$4 or \$5 per call.

It is no longer a secret to the set owner that more than 90% of TV service calls involve tubes. Why not be honest with the customer—replace the defective tube, charge him list price for it and \$4 or \$5 for the service call?

Some of the large authorized franchised service dealers are just as dishonest as smaller shops. I have seen numerous cases of outright fraud. Typical are the \$30 and \$38 estimates made to a neighbor's friend by two separate "reputable" service companies for the replacement of his tuner. It seems he was having trouble tuning his receiver. I was called to look at the set and found that the only thing wrong was that the string was off the fine-tuning shaft.

So, we had better reconsider the position of the independent or part-time technician.

(NAME WITHHELD)

Dallas, Tex.

ONE GRIPE TOO MANY

Dear Editor:

"Just a few gripes" by technician Anton Feldman in your January correspondence column are well taken except the third paragraph which starts, "When making repairs in the home, what customer will pay you for your years of experience and ability in troubleshooting and rapid diagnosis, when the defective component costs 18 cents?"

I believe it entirely fair to say that the technician is fully paid if he charges 18 cents plus his regular house-call service charge, just as an auto service man whose shrewd diagnosis forestalls serious damage to a costly motor receives only a fee for his time and material spent and a doctor whose timely advice may prevent invalidism or death for which charges only for an office visit, and the same as . . . well, these comparisons should clarify the point.

I think a TV and radio technician gets his rewards when the public finds out that he knows his onions and is satisfied to bill for material and time spent, and he sees the demand for his expert service grow and multiply.

F. H. SCHOEN

St. Paul, Minn.

A.F.C. OUTPUT POLARITY

Dear Editor:

The a.f.c. circuit described in the article "Adding A.F.C. to Your FM Tuner" (November, 1954) is the simplest yet and very satisfying if the discriminator happens to develop a positive voltage with a rise in frequency and a negative voltage with a de-

RADIO-ELECTRONICS

NEW
at
ALLIED

KNIGHT Low-Cost Test Instrument Kits

Lab Precision Quality...Easiest-to-Assemble Money-Saving Instruments

The greatest value anywhere for your test instrument dollar! Here's more for your money in accuracy, dependability, versatility and professional styling. Here's the last word in easy-to-build convenience. Instruction manuals are a marvel of simplicity for quick assembly without guesswork. You need only a screwdriver, soldering iron and pliers—and you're ready to build these top-quality instruments!

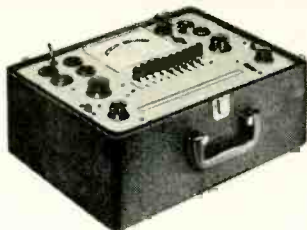

New Knight Tube Tester Kit

Expertly engineered, low-cost tube tester. Tests 4, 5, 6 and 7-pin large, regular and miniature types, octals, loctals, 9-pin miniatures, pilot lamps. Tests cover new 600 ma. series-string types. Checks for emission, shorts, open elements,

heater continuity. 4 1/2" meter with "Good-Replace" scale. Fast-operating roll chart. Universal socket pin selectors to test tubes with new base arrangements. Blank socket for future use. Choice of 14 fil. voltages from .75 to 117 v. Includes all parts, dark green metal case, gray panel, wire, solder. 9 x 4 x 10". For 110-120 v., 50-60 cy. AC. 14 lbs. 83 FX 143. Knight Tube Tester Kit. Only \$29.75 83 FX 142. As above but in fabrikoid covered portable case, 6 1/2 x 14 1/2 x 10 1/2". Shpg. wt., 15 lbs. Only \$34.75 83 F 141. TV Picture Tube Testing Adapter. Only \$3.75

New Knight Signal Tracer Kit



Ideal for visual and audible signal tracing of RF, IF, video and audio circuits—at less than the cost of an audio signal tracer alone. Highest usable gain: "magic eye" with calibrated attenuators permits stage by stage gain measurements. 4" PM speaker. With RF probe for checking all stages; includes audio probe tip. Noise test provision.

Built-in wattmeter calibrated 25 to 1000 watts. With gray and green metal case (7 x 10 x 5"), all parts, tubes, probes, precut leads, solder. For 105-125 v., 50-60 cy. AC. 13 lbs. 83 F 135. Knight Signal Tracer Kit. Only \$24.50

New Knight VOM Kit



Quality 20,000 ohm/volt VOM with 4 1/2" meter; ± 2% full scale accuracy; 1% multipliers; single switch selects: 6 DC ranges—0.2-5-10-50-250-1000-5000 at 20,00 ohms/volt; 6 AC ranges—0.25-10-50-250-1000-5000 at 5000 ohms/volt; 3 resistance ranges—0-2000-200,000 ohms and 0-200 meg. 4 DC current ranges—0-10-100 ma. and 0-1-10 amps. Complete with bakelite case (6 3/4 x 5 1/4 x 3 3/4"), all parts, 4' test leads, batteries, wire and solder.

83 F 140. Knight VOM Kit. Only \$26.50

New Knight RF Signal Generator Kit

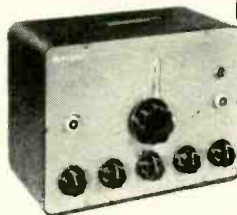

Provides modulated or unmodulated RF output on long wave, broadcast, short wave, FM and TV frequencies. Ideal for use with VTVM for aligning RF and IF sections of radio and TV sets; use with sweep generator as TV marker generator. Delivers audio output for troubleshooting all

audio stages. RF output: 160 kc to 110 mc on fundamentals; useful harmonic output to 220 mc; modulated at 400 cycles; with jack permitting modulation by external generator. Rated RF output 100,000 mv or greater. Max. audio output, 10 volts. Complete with green metal case (7 x 10 x 5") and gray panel, tubes, all parts, pre-wound coils, wire and solder. For 110-120 v., 50-60 cy. AC. 10 lbs. 83 F 145. Knight RF Signal Generator Kit. Only \$19.75

New Knight Audio Generator Kit



Ideal audio frequency source for checking audio circuits and speaker response; fine for Hi-Fi testing. Frequency range: 20 cps to 1 mc in 5 ranges. Output voltage: 10 volts to high imp., ± 1 db to 200 kc. Generator imp., 600 ohms. Less than .25% distortion from 100 cps through the audible

range; less than 1% when driving 600 ohm load at maximum output. Continuously variable step-attenuated output. Complete with green and gray metal case (8 1/2 x 11 x 7 1/2"), all parts, tubes, precut leads and solder. 17 lbs. 83 FX 137. Knight Audio Generator Kit. Only \$31.50

Send 10¢

GET THE PROOF OF KNIGHT QUALITY

Send for complete construction manuals

See for yourself the exceptional quality and super-value represented in Knight Test Instrument Kits. See why KNIGHT offers you more for your money in dependability, precision quality and versatility.

- 38 K 165. Knight Tube Tester Kit Construction Manual.
 - 38 K 170. Knight Signal Tracer Kit Construction Manual.
 - 38 K 168. Knight VOM Kit Construction Manual.
 - 38 K 166. Knight Signal Generator Kit Manual.
 - 38 K 169. Knight Audio Generator Kit Manual.
- Order any of the above construction manuals. Each only 10c

FREE Supplement No. 148

Send for our latest 56-Page Supplement featuring new releases and special values. Make your selections at ALLIED from the world's largest stocks of tubes, parts, test instruments, Hi-Fi audio equipment, Amateur gear, industrial components—everything in electronics at lowest prices.

ALLIED RADIO

ALLIED RADIO CORP., Dept. 2-H-5
100 N. Western Ave., Chicago 80, Ill.

Send FREE Supplement No. 148
 Ship the following KNIGHT Kits _____

Send construction manuals covering the following kits: _____
Amount Enclosed \$ _____

Name _____
Address _____
City _____ Zone _____ State _____

Apply Your Electronics Experience

ENGINEERS AND
PHYSICISTS WITH
ELECTRONICS TRAINING
ARE NEEDED TO
CONDUCT CLASSROOM
AND LABORATORY
PROGRAMS ON ADVANCED
SYSTEMS WORK IN THE
FIELDS OF RADAR FIRE
CONTROL, ELECTRONIC
COMPUTERS, GUIDED
MISSILES.

The proper functioning of the complex airborne radar and computer equipment produced by Hughes requires well-trained maintenance crews in the field.

At Hughes Research and Development Laboratories in Southern California engineers assigned to this program are members of the Technical Staff. As training engineers they instruct in equipment maintenance and operation for both military personnel and field engineers.

Prior to assignment, engineers participate in a technical training program to become familiar with latest Hughes equipment. After-hours graduate courses under Company sponsorship are available at nearby universities.

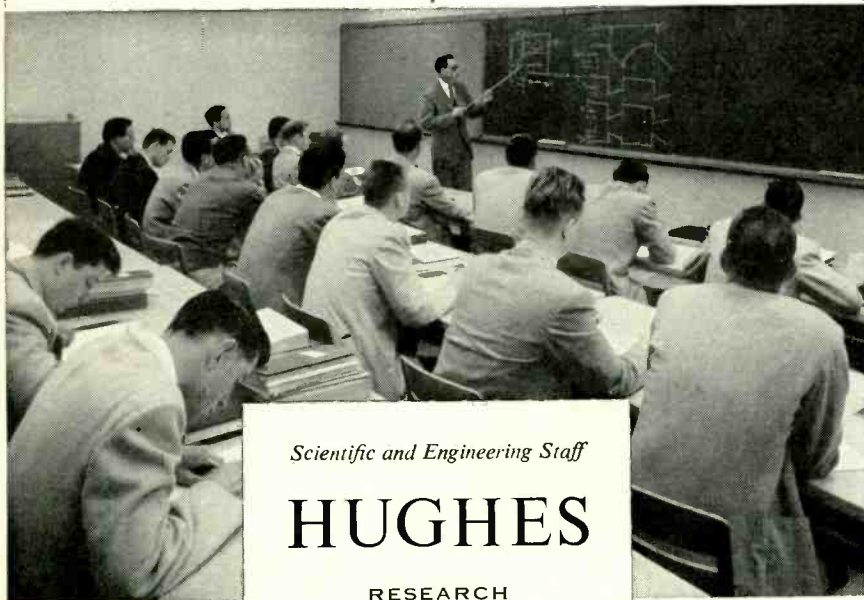

Scientific and Engineering Staff

HUGHES

RESEARCH
AND DEVELOPMENT
LABORATORIES

Culver City, Los Angeles County, California

CORRESPONDENCE

(Continued)

crease in frequency. I quote "Elmer's law" from *ELECTRONICS* of several years ago: "If you're measuring a d.c. voltage, the initial arrangement of the voltmeter leads will be wrongly polarized."

All textbooks state that, as frequency increases, the voltage goes positive; as frequency decreases, the voltage goes negative. Most people assume the audio lead does just that. It is well to use a v.t.v.m. on the discriminator output lead and observe the voltage as the local oscillator is increased in frequency. This can be done by tuning the dial up-scale while tuned to a signal. Stromberg-Carlson sets of 1946 do *not* have a positive voltage for an increase in frequency.

All that need be changed are the leads from the discriminator secondary winding and the plates of the diode. Change the plate leads and the a.f.c. works, otherwise it is impossible to tune. There may be other sets where it is mechanically easier to interchange the leads from the cathodes.

This is not a criticism, but an addition, because some readers may have unjustly condemned this circuit because of incomplete knowledge of the discriminator.

M. WM. GLENN, JR.
Canandaigua, N. Y.

PROGRESSIVE EDUCATION

Dear Editor:

I have been following the controversy between the editors of *RADIO-ELECTRONICS* and Mr. Holm on technical writing. The point missed by both parties is that "progressive education" has finally reared its ugly head in the field of elementary radio and electronics education. If you don't believe it, just go into radio trade school subject-study requirements that were considered a minimum necessity for the turning out of even a lowly radio repairman 10 to 15 years ago.

At that time, a radio repairman graduating from a technical high school or trade school was required to have mastered the fundamentals of mechanical drawing and schematic reading, general electrical science, radio applications of algebra and trigonometry and, of course, his regular trade work. It took two years' training to turn out a repairman. You had to be good in those days!

The editors of *RADIO-ELECTRONICS* may consider the mastery of radio and mathematical fundamentals something to be ignored nowadays. What was called "elementary" 10 to 15 years ago is now considered "advanced." But looking around today at the lower quality of a mass-production crop of boom-produced radio-TV service technicians via "progressive education," it still is apparent to me that there isn't any substitute for the mastery of basic math and circuit fundamentals which develops an orderly system of analysis in troubleshooting.

MR. J. PERKINSON, JR.
Miami, Fla. END

SERVICE DEALERS:

ask your



Tube Distributor for these wonderful sales helps...

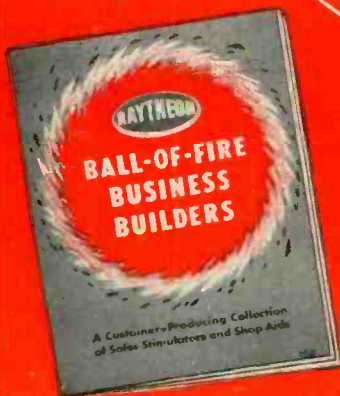

Tube and Tool Carrying Cases
Two sizes — hold both tubes and repair tools



Cardboard Cutout Trucks
With your name — give them to the children



Aluminum Snap-Out-Form Pocket Case
Protects forms, looks businesslike



Triplicate Invoice Sets
Provides 3 copies of each bill



14-Point Check-Up Card
Hang on set to show adjustments made



Drop Cloth
To show customers you care



Illuminated Outdoor Sign
A real traffic stopper



Go-Getter
Picks up small parts where hands can't reach



Window Streamer
Sells check-up service



Window Displays
To sell your service to passersby



You ain't seen nuthin', until you see the sensational collection of sales and shop aids in the new Raytheon BALL-OF-FIRE BUSINESS BUILDERS booklet. Pictured are a few of the new additions to Raytheon's already famous collection of tried and tested promotion items. For years, Service Dealers from coast-to-coast have been relying on Raytheon sales aids to help them get more than their share of business, using Raytheon Shop Aids to help them work more efficiently, and effectively.

Many items are free, the rest are 'way below normal cost. Ask your Raytheon Tube Distributor for a free copy of the new Raytheon Booklet or write to Department F, Raytheon Manufacturing Company, Receiving and Cathode Ray Tube Operations, Newton 58, Mass.



RAYTHEON MANUFACTURING COMPANY

Receiving and Cathode Ray Tube Operations

Newton, Mass. • Chicago • Atlanta, Ga. • Los Angeles, Calif.

Raytheon makes all these:

Receiving and Picture Tubes • Reliable Subminiature and Miniature Tubes
Semiconductor Diodes and Transistors • Nucleonic Tubes • Microwave Tubes



Excellence in Electronics.

**GOODBYE
TO SYNC
PROBLEMS**



**HYCON MODEL 622
5" OSCILLOSCOPE**

Now, Hycon brings you a really *new* oscilloscope, particularly adapted to random signals or low duty cycle pulses. Its unique *automatic triggered sweep* reduces adjustments, makes synchronization positive, protects phosphors in the absence of signal.

See and operate the new Model 622 at your local electronic parts jobber.

THE NEW 622 OFFERS...

- preset TV sweep frequencies
- 6 mc (± 3 db) vertical bandpass
- 5" flat face CRT... undistorted edge to edge
- illuminated graticule with dimmer
- electronically regulated power supplies
- unusually light weight and
- **AUTOMATIC TRIGGERED SWEEP**

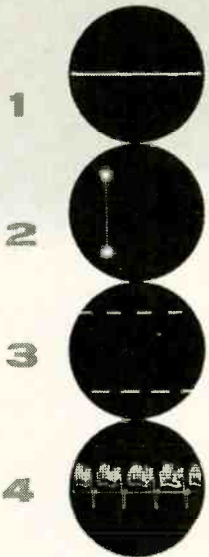

1 No signal... a stable sweep condition provides reference trace

2 Signal on Y-axis... monostable sweep mode automatically assumed

3 Triggered sweep (square-wave input) obtained by simply turning sync-level control

4 Typical TV signal (off-air pickup by receiver) across full CRT screen. Can be expanded across X-axis if desired.

BASIC SPECIFICATIONS

VERTICAL AMPLIFIER

Frequency Response: 6 cps to 6 mc ± 3 db; down less than 0.5 db @ 4 mc
Sensitivity: 10 mv rms (28 mv peak-to-peak) per inch
Input Impedance: 1 megohm, 40 mmf (± 2 mmf) over entire attenuator range

Ranges...

- a. 10 cps to 300 kc
 - b. Preset H & V television @ 7875 and 30 cps
 - c. 60 cps, variable phase line
- Type... automatic triggered or straight triggered (by switching)

HORIZONTAL AMPLIFIER

Frequency Response: 1.5 cps to 500 kc ± 3 db
Sensitivity: 75 mv rms (210 mv peak-to-peak) per inch
Input impedance: 100k, 25 mmf

SYNCHRONIZATION

Internal, external, positive, negative or AC line

CALIBRATION

Internal 60 cps square-wave .05 volts peak-to-peak $\pm 3\%$

POWER REQUIREMENTS

115 volts, 60 cycles, 175 watts

SWEEP CHARACTERISTICS

Usable writing speed... 0.03 sec/in to .3 μ sec/in

SIZE... WEIGHT

13 $\frac{5}{8}$ " x 10 $\frac{1}{2}$ " x 18 $\frac{3}{4}$ "... 32 lbs.

HYCON also brings you these test instruments... ready for color TV servicing



Model 617
3" Oscilloscope

High deflection sensitivity (.01 v/in rms); 4.5 mc vertical bandpass ± 1 db; internal 5% calibrating voltage. Flat face 3" CRT for usable trace edge to edge.



Model 614
VTVM

Has 21 ranges (28 with peak-to-peak scales); 6 $\frac{1}{2}$ " meter; 3% accuracy on DC and ohms, 5% on AC; response with auxiliary probe to 250 mc. Test probes stow inside case, ready to use.



Model 615
DIGITAL
VTVM

Reads out in numerical form... no interpolation, no reading wrong scale. Has 12 ranges; 1% accuracy DC and ohms, 2% on AC. You CAN'T read this meter incorrectly.

Hycon Mfg. Company

2961 East Colorado Street • Pasadena 8, California

"Where accuracy counts"

ORDNANCE • ELECTRONIC TEST INSTRUMENTS • AERIAL CAMERAS • GO NO-GO MISSILE TEST SYSTEMS • AERIAL SURVEYS • BASIC ELECTRONIC RESEARCH • ELECTRONIC SYSTEMS

KINGS of the TV FRONTIER!

Unmatched for power and performance!

This extraordinary fringe-area powerhouse is still the most sensitive all-channel antenna made today—bar none! The SUPER RAINBOW's many "years-ahead" engineering features include the triple-powered Tri-Pole, separate high and low band operation, 100% aluminum construction, and "Snap-Lock" pre-assembly. Also in great demand . . .

The RAINBOW, Model No. 330.

Model No.
331

SUPER RAINBOW

Extra elements, extra performance!

There may be antennas that resemble our TRAILBLAZER, but none can top its blazing performance. The TRAILBLAZER features extra High and Low Band directors, and full-wave directors on the High Band. It installs faster than any similar antenna, and—it's all aluminum! Especially recommended for areas with front-to-back interference problems, particularly on the Low Band. Count the elements . . . then compare the prices!

Model No.
335

TRAILBLAZER

Advanced design — and "Super-Sembled"

Look to the LANCERS for Channel Master "extras": extra elements and extra gain — at no extra cost. Completely "Super-Sembled." The SUPER LANCER gives 1½ db more gain on both the Low Band and the High Band than similar types. The LANCER, Model No. 333, has an extra director that provides 1½ db more Low Band gain. Count the elements . . . then compare the prices!

Model No.
334

SUPER LANCER

CHANNEL MASTER[®]

All-Channel Yagis

Unrivalled for power, popularity and price!

Servicemen everywhere are discovering an entirely new answer to the problem of multi-channel fringe-area reception: Channel Master all-channel yagis. These are the antennas that have what it takes to bring top TV performance to the most distant, isolated locations. And, they're ready for color, too!

Today's leading all-channel yagis are designed — and improved — in the Channel Master Antenna Development Laboratories. Isn't it logical to use Channel Master's famous engineering skill to solve your reception problems?



CHANNEL MASTER CORP. ELLENVILLE, N. Y.
The World's Largest Manufacturer of TV Antennas and Accessories

Copyright 1955, Channel Master Corp.

© Trade Mark Reg. U. S. Pat. Off.

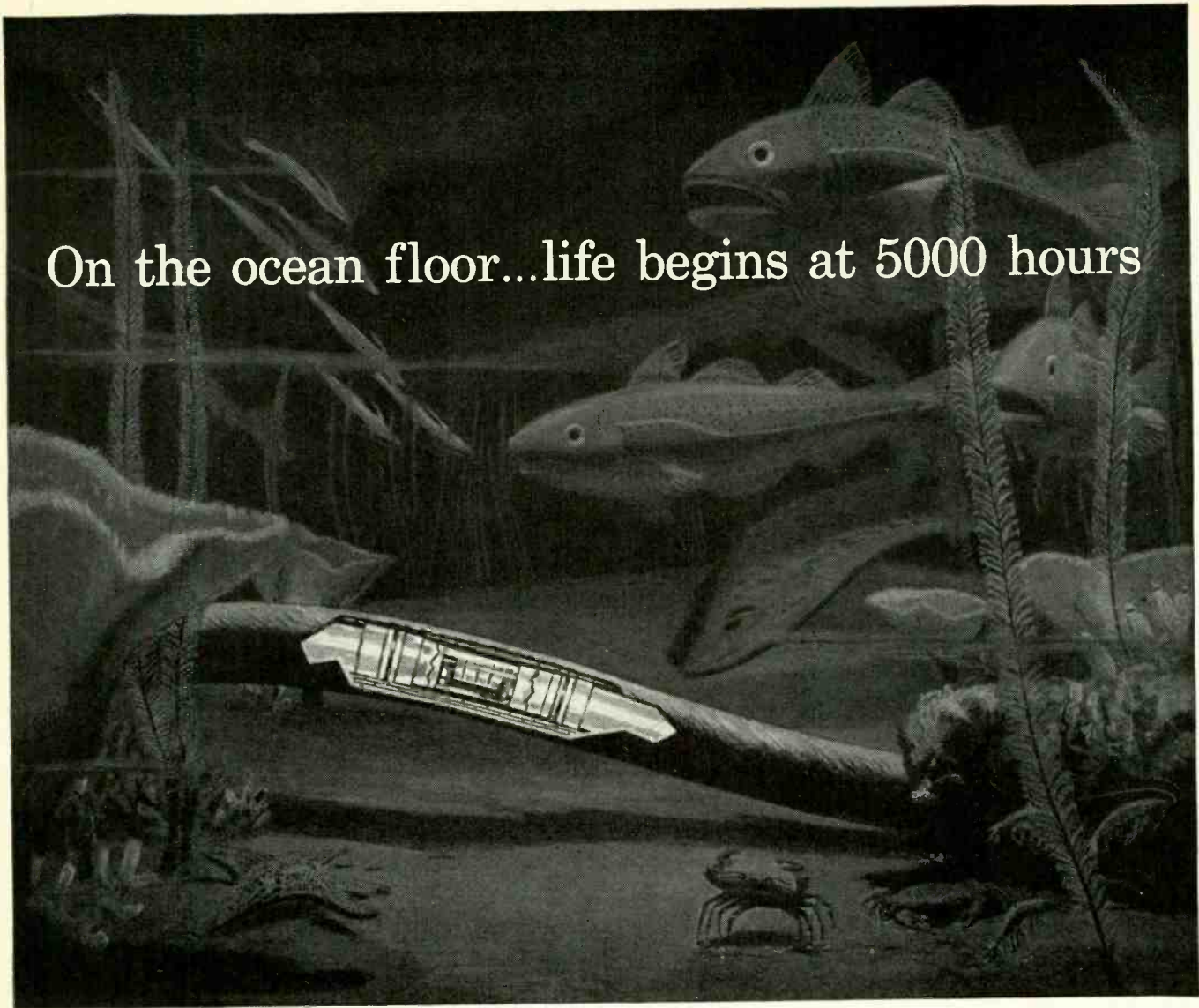

On the ocean floor...life begins at 5000 hours

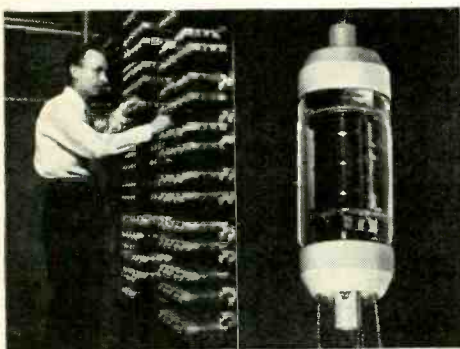

Electron tubes (right) for the Transatlantic Telephone Cable between Newfoundland and the British Isles are being handmade at Bell Laboratories. Life test bank is shown left. The cable system, which can carry 36 simultaneous conversations, is a joint enterprise of the American Telephone and Telegraph Company, the British Post Office and the Canadian Overseas Telecommunications Corporation.

When the world's first transoceanic telephone cable is laid across the Atlantic it will contain hundreds of electron tubes needed to amplify voices. Deep on the ocean floor these tubes must keep on working, year after year, far beyond reach of ordinary repair services.

Bell Telephone Laboratories scientists have developed a tube of unique endurance. Before a tube is even considered for use in the cable it is operated for 5000 hours under full voltage—more than the entire life of many tubes.

But survival alone is not enough. During the test each tube is exhaustively studied for behavior that may foreshadow trouble years later. Tubes that show even a hint of weakness are discarded. For the good ones, a life of many years can be safely predicted.

Bell Telephone Laboratories scientists began their quest for this ocean-floor tube many years ago. Now it is ready—another example of the foresightedness in research that helps keep the Bell Telephone System the world's best.

BELL TELEPHONE LABORATORIES

*Improving telephone service for America provides careers
for creative men in scientific and technical fields*



RADIO-ELECTRONICS



KEEP YOUR PRESENT JOB AND TRAIN TO BE A TELEVISION TECHNICIAN

Step Into a Higher Paying Position Without Giving Up Your Present Income



L. C. Lane, B.S., M.A. President, Radio-Television Training Association. Executive Director, Pierce School of Radio & Television.

I'll train you at HOME in your SPARE TIME

If you're now working as a Radio Technician, Maintenance Man, or Operator you can keep your job while studying one of my two NEW and UP-TO-THE-MINUTE Courses — FM and Television Technician Course — TV Cameraman and Studio Technician Course.

These Courses — especially prepared for home study—will prepare you for top-paying jobs in the ever-expanding radio-television-electronics industry.

EXPERT FM-TV TECHNICAL TRAINING

My FM-TV Technician Course lets you take full advantage of your previous experience — either civilian or Armed Forces. YOU CAN SAVE MONTHS OF TIME. My FM-TV Technician Course completes your training by providing a thorough background in Frequency Modulation and Television Theory and Practice.



You "Learn by Doing", working with parts and equipment I send you. Six large kits of FM and TV parts are given to you as part of the course. You build and keep a professional GIANT SCREEN TV RECEIVER complete with big picture tube (designed and engineered to take any size up to 21-inch).

Upon completion of your training, you may, if you desire — take two weeks of shop training at my associate resident school in New York City AT NO EXTRA COST!

PRACTICAL TV CAMERAMAN & STUDIO COURSE

My TV Cameraman and Studio Course is designed to train TV Studio Technicians and TV Cameramen, urgently needed today by Television Broadcasting Stations throughout the nation. New TV Stations are now mushrooming throughout the country. Men who can work as Audio Technicians, TV Cameramen, Microphone Boom Operators, Monitor Operators, Turntable Operators, Control Room Technicians can write their own tickets.



I will train you for an exciting high pay job as the man behind the TV camera. Work with TV stars in TV studios or "on location" at remote pick-ups.

Available if you want it . . . one week of actual work with studio equipment and TV Cameras at my associate resident school in New York City.

This course is a MUST for those who wish to increase their technical knowledge of television operations.

TRAINING FOR BEGINNERS

My Radio-FM-Television Technician Course is especially prepared for men with no previous experience or training. I have trained hundreds of men for successful careers in radio-television-electronics. Many of them had only a grammar school education and no previous experience whatsoever in the field.

Two weeks of intensive shop practice at my associate resident school is also included with this Course.

Radio **T**elevision **T**raining **A**ssociation

52 EAST 19th STREET • NEW YORK 3, N. Y.

Licensed by the State of New York • Approved for Veteran Training
AUGUST, 1955

FREE FCC COACHING COURSE

Important for BETTER PAY JOBS requiring FCC License. You get this training AT HOME and AT NO EXTRA COST. Top TV jobs go to FCC-licensed technicians.

VETERANS!

My School fully approved to train veterans under new Korean G.I. Bill. Write discharge date on coupon.

EARN WHILE YOU LEARN

Almost from the very start you can earn extra money while learning, repairing Radio-TV sets for friends and neighbors. Many of my students earn up to \$25 a week . . . pay for their entire training from spare time earnings . . . start their own profitable service business.

YOU GET THESE FOUR FREE!

MAIL THIS COUPON TODAY!
no salesman will call!

Mr. Leonard C. Lane, President Dept. R-8
RADIO-TELEVISION TRAINING ASSOCIATION
52 East 19th Street, New York 3, N. Y.

Dear Mr. Lane: Mail me your NEW FREE BOOK, FREE SAMPLE LESSON, and FREE aids that will show me how I can make BIG MONEY IN TELEVISION. I understand I am under no obligation and no salesman will call.
(PLEASE PRINT PLAINLY)

Name _____ Age _____

Address _____

City _____ Zone _____ State _____

I AM INTERESTED IN:
 Radio-FM-TV Technician Course
 FM-TV Technician Course
 TV Cameraman & Studio Technician Course

VETERANS!

Write discharge date _____



everyone's Looking for

"STAMINIZED"* CAPACITORS!

*"Staminized" is Astron's name for the special, extra-rugged construction of *all* their capacitors.. it's why smart service technicians are installing more and more fabulous Astron Blue·Point® molded plastic paper tubulars... their unsurpassed reliability builds consumer satisfaction and repeat business. Install dependable Blue·Points with absolute confidence, their exclusive bonded shell and seal form an impenetrable shield against heat and moisture damage.

You'll find Blue·Points are being used by leading set manufacturers because... a new solid thermosetting impregnant insures high capacitance stability over the entire operating range of -40°C to $+85^{\circ}\text{C}$... continuous 85°C operation *without derating*.

Each Astron Blue·Point is clearly marked for fast identification... individually tested and guaranteed to prevent call-backs!

There's a dependable Astron replacement capacitor for superior performance in *every* radio and TV servicing requirement... send for Astron Replacement Capacitor Catalog AC-4D today!



ASTRON

C O R P O R A T I O N

255 GRANT AVENUE, E. NEWARK, N. J.



Export Division: Rocke International Corp., 13 East 40th St., N. Y., N. Y. In Canada: Charles W. Pinton, 6 Alcina Ave., Toronto 10, Ontario

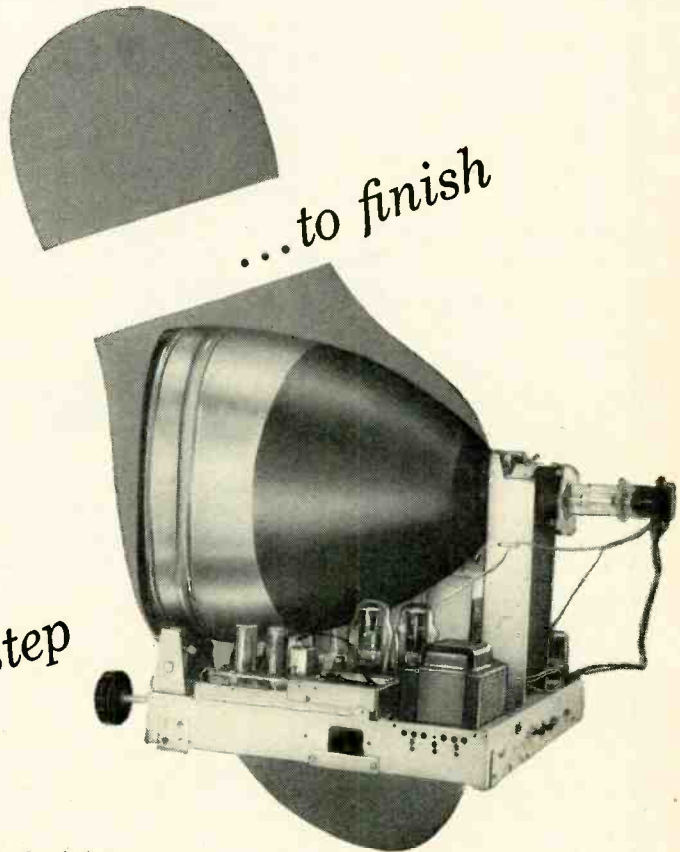

...and step by step

Become a top-notch television service technician

Now . . . RCA INSTITUTES offers modern TV KIT with Comprehensive Television Servicing Course

START to build with a TV Kit developed by one of America's foremost radio-tv schools—RCA Institutes. LEARN with simple step-by-step instruction how to build a modern, large-screen receiver. TEST each stage, as you build, and see how it works. Learn how "trouble-shooting" is applied. FINISH your Home Study Course ready and able to service all make and model sets!

Easy-to-follow instructions are planned and prepared for you through the efforts of RCA Institutes' instructors, engineers at RCA Laboratories, and training specialists of the RCA Service Company.

The RCA Institutes' TV Kit utilizes up-to-date circuits including:

- *Synchro-Guide horizontal automatic frequency control circuit.*
- *Horizontal magnetic reaction scanning.*
- *Latest deflection circuits.*
- *FM sound discriminator.*
- *High-gain, low-noise cascode tuner.*

Join the many thousands who have been successfully trained by RCA Institutes for a good job (or business of their own) in television servicing.

BASIC KNOWLEDGE OF RADIO NECESSARY
NO NEED FOR PREVIOUS TV TRAINING

FREE BOOKLET! MAIL COUPON NOW.

RCA INSTITUTES, INC., Home Study Dept. EK-8-55
350 West Fourth Street, New York 14, N. Y.

With no obligation on my part, please send me a copy of your booklet on the TV Servicing Home Study Course and Kit. I understand no salesman will call.

Name: _____ (Please print)

Address: _____

City: _____ Zone: _____ State: _____



RCA INSTITUTES, INC.
A SERVICE OF RADIO CORPORATION of AMERICA
350 WEST FOURTH STREET, NEW YORK 14, N. Y.

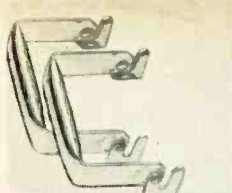

G-C TV CHASSIS SERVICE HANDLES
Safer; sets are easy to carry.
No. 9023 NET \$1.95



G-C PRINT-KOTE SILICONE Resin Spray
Protection for printed circuits.
No. 14-6 NET \$2.17



G-C WEATHER-PROOF SPEAKER CONE DOPE
For drive-in theaters, etc.
No. 9080-8 NET \$0.90



G-C NON-TOXIC ELECTRO-TET Cleaner
Non-flammable, safe, fast drying.
No. 10-G NET \$3.60

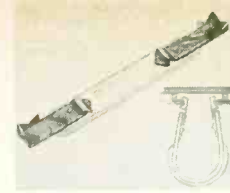

G-C LOW LOSS TV LINE KLIP
One-piece plastic; no springs.
No. 9055 NET \$0.15

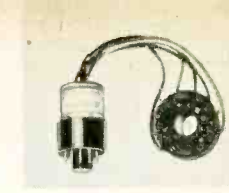

G-C TV PICTURE TUBE BOOSTER
Brightens picture tubes.
No. 8910 NET \$1.59



G-C DUAL SHEET METAL PUNCH
Two punches: 7/8" & 1 1/2".
No. 9260 NET \$3.50

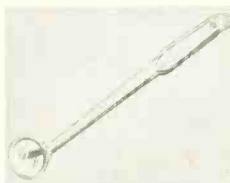

G-C ALL-PLASTIC INSPECTION MIRROR
No danger of shock, shorting.
No. 5090-P NET \$0.36



G-C TEST SOCKET ADAPTER KIT
Contains 4 G-C socket adapters.
No. 9250 NET \$6.75

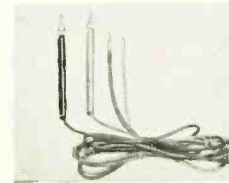

G-C ECONOMY TEST LEADS
Tenite 5" prods, 50" leads.
No. 9190 NET \$0.60



G-C SILVER PRINT
Printed circuit touch-up; pure silver. 1/2 Troy oz.
No. 21-1 NET \$2.37



G-C PRINT-KOTE SOLDER
Low melting; non-corrosive flux.
No. 9131 NET \$0.45



G-C 2-WAY HEX RATCHET BOX WRENCHES
Two sizes: 1/4" x 3/8", 3/8" x 3/8".
No. 9234 NET \$1.95
9235 2.10

GENERAL



CEMENT

Ask For These
RADIO-TV SERVICE AIDS

... at Your Jobber



G-C STANDARD "NO-STRETCH" DIAL CORD
Diameter .028; 25' spool.
No. 88-25 NET \$0.90



G-C PRINT-KOTE SOLDERING FLUX
Liquid flux for printed circuits.
No. 12-2 NET \$0.45

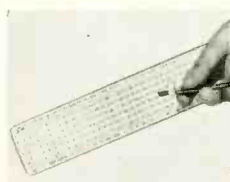

G-C WIRE MARKERS
Self-sticking; pre-cut; 3 strips.
No. 9229 NET \$0.75

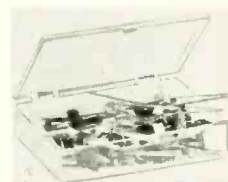

G-C POINTER ASSORTMENT
Includes radial and slide types.
No. 9120 NET \$0.99



G-C TERMINAL STRIP ASSORTMENT
Box of various types.
No. 9129 NET \$0.99



G-C SAFETY SCREWDRIVER
Insulated for hot circuit use.
No. 9209 NET \$0.75



G-C VM 33-1/3 PHONO DRIVE
Replacement set for VM changers.
No. 25-E NET \$0.30

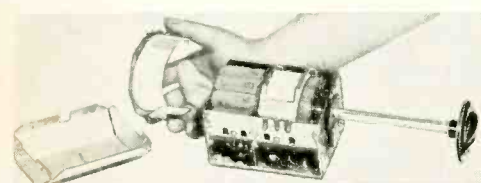

G-C TV TUNER KLEEN-O-MATIC
Cleans, shields Standard coil tuners. Easy to install.
No. 9221 NET \$1.50

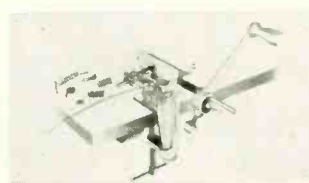

G-C SPEEDEX SPRING WINDER
Make any type spring fast.
No. 5209 NET \$14.95

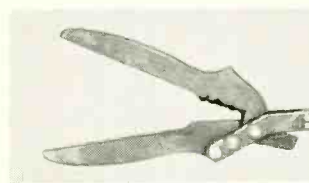

G-C 300-OHM LINE TOOL
Slot, strip, cut twin leads; crimp lugs.
No. 9220 NET \$3.95

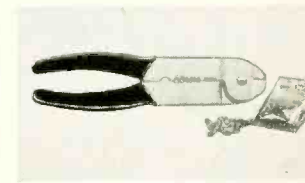

G-C SOLDERLESS TERMINAL REPAIR KIT
Fastener tool and terminals.
No. 8176 NET \$3.95

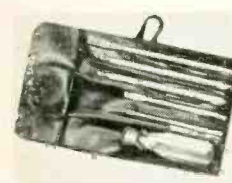

G-C 6-PC. SCREWDRIVER KIT
Fitted case and complete set.
No. 8615 NET \$1.17

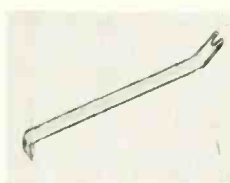

G-C PRY-UP TUBE LIFTER
Protects fingers and tubes.
No. 9213 NET \$0.15



G-C 6-PC. HEX NUT DRIVER KIT
Case with sockets 1/16" to 1/4".
No. 9206 NET \$2.40

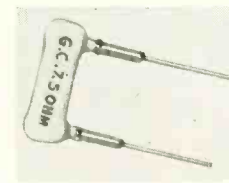

G-C 7.5-OHM FUSE RESISTOR
Replacement for series-wired set.
No. 9207 NET \$0.33

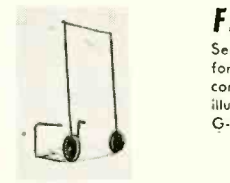

G-C TV "PICTO-VUE" RACK & TRUCK
Easy to use; includes mirror.
No. 9205 NET \$14.95

FREE!
Send postcard for your complete illustrated G-C Catalog

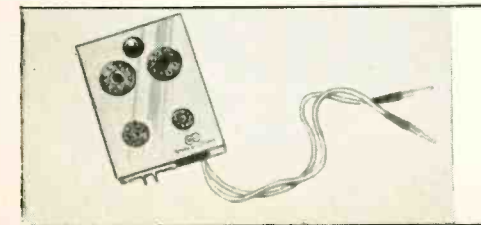

G-C TUBE-CHECKER

Easy-to-use series filament tube checker and continuity tester requires no tube warm-up. Simply plug tube in and get immediate check.

No. 9270 NET \$3.95



GENERAL CEMENT MFG. CO.

910 TAYLOR AVENUE • ROCKFORD, ILLINOIS

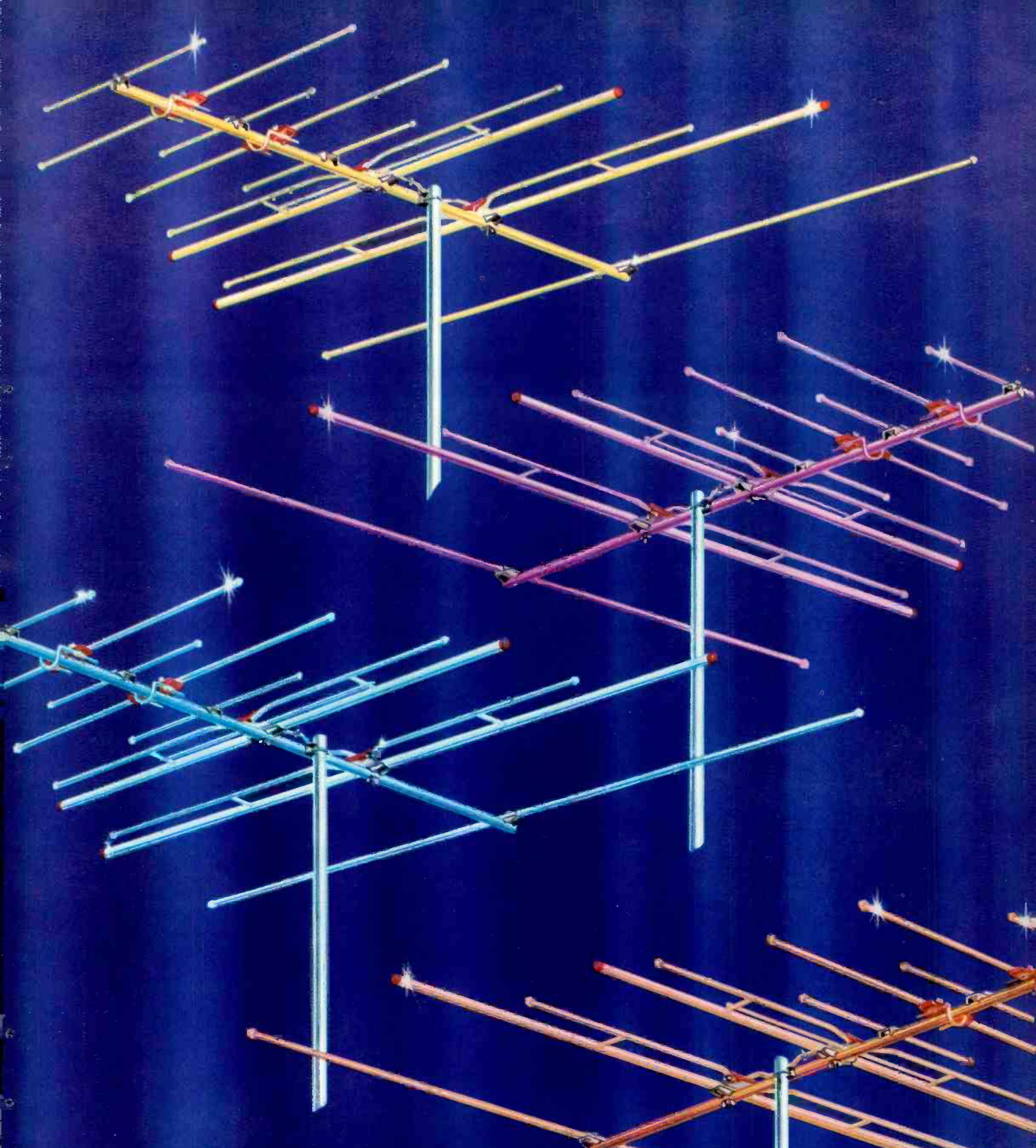

Originals by Winegard

WINEGARD INTERCEPTOR

world's finest TV antenna

now available in **COLOR**



**Now! Antennas
So Beautiful—
Display Them
with the
Sets you Sell!**

EYE APPEAL, DURABILITY, TOP PERFORMANCE

Here's a real merchandising story your customers will understand. Never has any antenna given you so much to talk about. Of course you have known for some time of the many superior advantages of the famous Winegard INTERCEPTORS. Thousands of satisfied customers, the world over, have acclaimed the INTERCEPTOR for its amazing performance. But here's a merchandising story your customers can understand completely . . . a story of —eye appeal, of durability and superb performance . . . a story of a protective coating that will keep the INTERCEP-

TOR as trigger-sensitive, as engineering-ly perfect as the day it left the factory.

You'll be proud to display several Winegard color INTERCEPTORS in your finest show rooms where their shimmering, metallic, jewel-like color tones will catch the eye of your customers . . . creating a replacement market for people who would ordinarily be satisfied with the same old, obsolete antenna they now have. Remember, an obsolete antenna or one that will deteriorate rapidly, will make even the finest set you sell unsatisfactory.



**Like
Colorful Metal
Drinking
Tumblers**

Anodized in 5 two-tone shimmering metallic colors. Anodizing provides a permanent protective coating against corrosive agents such as salt air, soot, dust, dampness and natural gases. Locks in practically forever all the matchless performance engineered into the Interceptor to insure perfect reception for years to come.

AN ENTIRELY NEW CONCEPT IN TV ANTENNA MERCHANDISING!



WINEGARD
INTERCEPTOR ANTENNAS

With Lumalite Color Metallic Coating
And Exclusive Electro-Lens Focusing

3000 Scotten Blvd., Burlington, Iowa

Get this FREE Booklet Today!

LOADED WITH CAREER-BUILDING FACTS — IT CAN LEAD YOU TO A BIGGER JOB, BETTER PAY, SECURITY AND SUCCESS IN RADIO — TV — ELECTRONICS

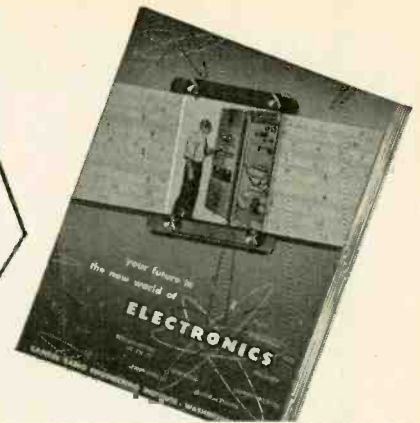

"YOUR FUTURE IN THE NEW WORLD OF ELECTRONICS"— contains a proved plan for your successful career in:

- ★ BROADCASTING
- ★ MANUFACTURING
- ★ SERVICING
- ★ ARMY, NAVY, AIR FORCE, COAST GUARD ELECTRONICS
- ★ TELEVISION
- ★ COMMUNICATIONS
- ★ AERONAUTICAL ELECTRONICS

A PROVED CAREER-PREPARATION PLAN THAT WORKS!

This free book has brought success home to thousands of men just like you! They are now enjoying responsible jobs, good pay and the good things of life. So can you! In less time than you think! We tell you how you can carve out a bigger better-paying job. Our proved career-preparation plan works because it was written by authorities who know exactly what the varied electronic industries want, need and expect from you!

ELECTRONICS' FUTURE CAN BE YOUR FUTURE

You can't keep up with the tremendous changes in the electronic industries. What's predicted for next year becomes outdated in a few months! All phases of the electronic industries are experiencing phenomenal growth. There are thousands of career openings, big ones. Industry can't find enough trained manpower to fill them—in manufacturing, testing, servicing, broadcasting and telecasting.

TAKE TV FOR EXAMPLE!

Four hundred and six stations are on the air! Many more are building or in

the plans stage; 32,859,915 sets are in use. Color TV is just starting to really come alive! This same phenomenal growth picture is repeated in every phase of business employing electronics—crime prevention, aeronautics, fire-fighting, communications, to name but a few. CREI has the plan to keep you moving upward, to help you assume your rightful place!

CREI GRADS ARE IN DEMAND!

The big companies know CREI men have what it takes! CREI grads are at work in America's biggest corporations, in positions ranging from technicians to engineers to top management. Companies such as United Air Lines, Canadian Broadcasting Corporation, Trans-Canada Airlines, Sears-Roe-

THOUSANDS LIKE YOU HAVE SUCCEEDED WITH CREI'S PLAN! "CREI TRAINING IS BEST"



"I chose CREI training upon recommendation of two top engineers. Before I had completed the course I became transmitter chief of a 5 KW station. I am now employed as a technician at a 100 KW TV station, and in spare time have a good TV sales and service business. Anyone interested in his electronic future should have CREI training." —Archie D. Patton, San Antonio, Texas

"I know of no case in which a man who applied himself and completed the CREI course failed to better himself through promotion and increase in salary." —Wendell L. Fraser, San Diego, Calif.

"CREI has raised me to professional status as a radioman. Thanks to your instructors who always gave me needed help." —Victor Mentzer, Wilmington, Del.

"I have been in radio and electronics for 24 years. I fully recommend CREI as the best school I have seen." —L. McManus, Montreal, Canada

CAPITOL RADIO ENGINEERING INSTITUTE

Accredited Technical Institute Curricula
Founded in 1927.
3224 — 16th Street, N.W.
Washington 10, D.C.

CREI also offers resident instruction: at the same high technical level, day or night, in Washington, D.C. New classes start frequently during the year. If this type of instruction meets your requirements, check the coupon for Residence School catalog. Qualified residence graduates may earn the degree of Associate in Applied Science.

INFORMATION FOR VETERANS

If you were discharged after June 27, 1950—let the new G.I. Bill of Rights help you obtain resident instruction. Check the coupon for full information.

MAIL THIS COUPON Today!

CAPITOL RADIO ENGINEERING INSTITUTE

Dept. 148B, 3224 16th St., N. W., Washington 10, D. C.
Please send me your course outline and FREE Illustrated Booklet "Your Future in the New World of Electronics" . . . describing opportunities and CREI home study courses in Practical Electronics Engineering.

- CHECK FIELD OF GREATEST INTEREST
- Practical Radio Engineering
 - Broadcast Radio Engineering (AM, FM, TV)
 - Practical Television Engineering
 - Aeronautical Electronics Engineering C

Name

Street

City..... Zone..... State.....

CHECK: Home Study Residence School Veteran

To help us answer your request intelligently, please give the following information:

EMPLOYED BY.....

TYPE OF PRESENT WORK.....

SCHOOL BACKGROUND.....

RADIO ELECTRONIC EXPERIENCE.....

IN WHAT BRANCH OF ELECTRONICS ARE YOU MOST INTERESTED?.....

STROMBERG-CARLSON®

Specifies



TEST INSTRUMENTS

38 KITS — 42 Wired Instruments

COLOR
and Monochrome TV set testing with *speed,*
accuracy, and *economy* . . .

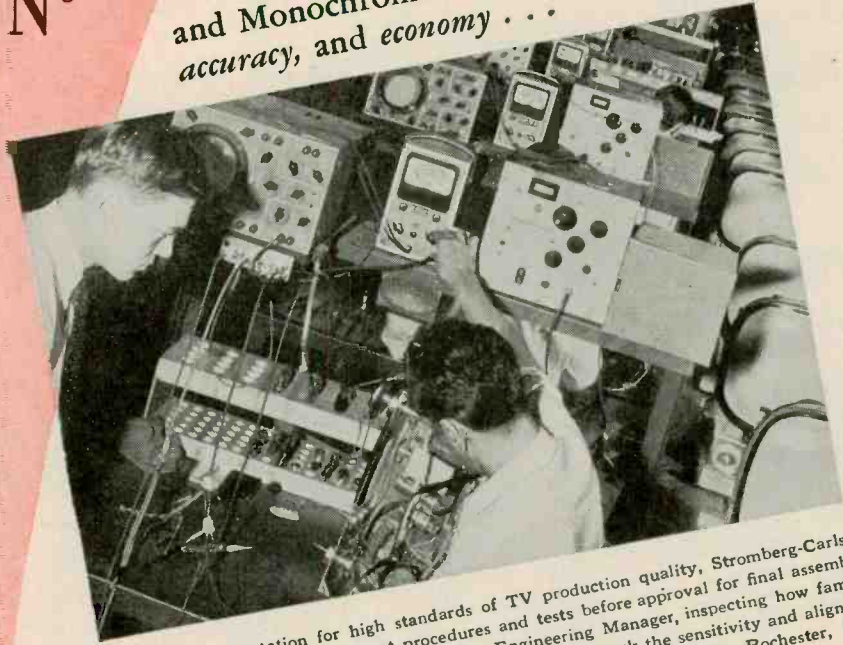

To maintain its reputation for high standards of TV production quality, Stromberg-Carlson subjects its TV receivers to stringent procedures and tests before approval for final assembly. Photo shows Harold P. Field, Test Equipment Engineering Manager, inspecting how famous EICO #221 VTVMs, at all vital TV Alignment Positions, check the sensitivity and align the IF amplifiers of all Color and Monochrome sets—at Stromberg-Carlson's Rochester, New York plant.



NEW #232 Peak-to-Peak VTVM with DUAL-PURPOSE AC/DC UNI-PROBE (pat. pend.)
KIT \$29.95
WIRED \$49.95



VACUUM TUBE VOLTMMETER #221
KIT \$25.95
WIRED \$39.95
DELUXE VTVM (with 7 1/2" METER) #214 KIT \$34.95
WIRED \$54.95

5" PUSH-PULL OSCILLOSCOPE #425
KIT \$44.95
WIRED \$79.95



NEW #470 7" PUSH-PULL OSCILLOSCOPE
KIT \$79.95
WIRED \$129.50



NEW! GEIGER COUNTER #803
KIT \$19.95 Wired \$29.95
Super-sensitive: detects .05 mr/hr & ore having even .01% uranium. With radioactive sample. (Less 2-67 1/2 v. & 2-1 1/2 v. batteries)



NEW! SENSATIONAL! Wide Band 5" SCOPE #460
KIT \$79.95 Wired \$129.50
DC to 5 mc, flat to 4.5 mc. Vert. sens.: 25 mv/in. Push-pull thruout.



NEW! WORLD'S BEST GENERATOR BUY! RF SIG. GEN. #324
KIT \$26.95 Wired \$39.95
Covers whole range of 150 kc—435 mc. Freq. accuracy: ± 1.5%. 6:1 vernier tuning knob & excellent spread.



TUBE TESTER #625
KIT \$34.95
WIRED \$49.95



NEW! BATTERY TESTER #584 KIT \$9.95 Wired \$12.95

Write for FREE Catalog C-8



NEW #944 FLYBACK TRANSFORMER & YOKE TESTER
KIT \$23.95
WIRED \$34.95



MULTI-SIGNAL TRACER #145
KIT \$19.95
WIRED \$28.95



1,000 Ohms/Volt MULTIMETER #536
KIT \$12.90
WIRED \$14.90

RF SIGNAL GENERATOR #320
KIT \$19.95 WIRED \$29.95

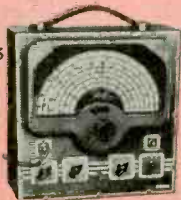

DELUXE RF SIGNAL GENERATOR #315
KIT \$39.95
WIRED \$59.95



6V & 12V BATTERY ELIMINATOR & CHARGER #1050
KIT \$29.95
WIRED \$38.95



RC BRIDGE & R-C-L COMPARATOR #950B
KIT \$19.95
WIRED \$29.95



20,000 Ohms/Volt MULTIMETER #565
KIT \$24.95
WIRED \$29.95



TV/FM SWEEP GENERATOR #360
KIT \$34.95
WIRED \$49.95



A PROBE FOR EVERY PURPOSE
KIT—WIRED \$2.75 and up

SMC-4.5 MC CRYSTAL \$3.95 ea.

©55



ELECTRONIC INSTRUMENT CO., Inc.
84 Withers Street • Brooklyn 11, N. Y.

Prices 5% higher on West Coast

TRANSISTOR PROGRESS

No longer experimental, transistors now compete with radio tubes . . .

THE transistor has now completed its seventh year and its experimental stage has been largely concluded. While improvements will be made for generations to come, certain types of transistors have now arrived commercially. They are turned out routinely as a mass product by a number of factories.

Originally, all transistors were handmade and the cost was exceedingly high. The first available transistors sold for about \$35 apiece. With present improvements and mass production, the price of some types has dropped every year. Transistors can now be bought by experimenters for as little as \$2.50. One company is selling one type to manufacturers in wholesale quantities for only 75c each. However, it should be noted that these low-price units are not all-purpose designs, but are mainly suitable for audio-frequency and low radio-frequency use by experimenters and the servicing fraternity who wish to experiment with transistors, thus getting used to their peculiarities.

The reason why one company is selling some transistors at such a low price is that they are rejects and will not have the relatively narrow tolerances the commercial types require.

This brings up the point of the average life of the transistor. Nothing certain is known about this for the simple reason that sufficient time has not elapsed to judge the average transistor's life. It is known, for instance, that the average life of a vacuum tube runs around 5,000 hours. Western Electric Company recently gave an estimate of 770,000 hours—88 years—of life for a transistor. This may be termed an educated guess, and the chances are that as time goes on even this long life will be exceeded.

If one can buy a fairly good transistor today for 75c (in quantities), what will the price of the average transistor be in the future?

In our February, 1953, issue, the writer predicted that in the future the price of transistors would be lower than that of vacuum tubes. In view of the low cost already reached, it may be assumed that a 50c transistor (at retail) will surely come about in the not-too-distant future. The price may go even lower as better automation-produced transistors are realized in years to come.

What the lowest price will be eventually is any man's guess. Radio tubes at one time cost as much as \$14 apiece retail during the broadcast boom in the early 1920's. They are sold to manufacturers today in quantity from a low of 33c. Inasmuch as the transistor is not as complicated an item as the vacuum tube, needing no glass-blowing, no vacuum, no cathode, no filament and few of the complex stages of manufacture that vacuum tubes require, it can be seen that transistors in the future will probably sell at extremely low prices.

At present, most transistors contain the important semi-

conductor germanium. Of 18 transistor manufacturers 17 use germanium, whereas one pioneer uses silicon. It seems quite certain that in the future many other semiconductors — perhaps combinations of semiconductors — will be used. As the industry is still in its infancy, it is certain that vast changes will be made to increase the efficiency of transistors in many directions.

While it is true that today's transistors do not compete with all vacuum tubes, the time will come when transistors will supplant nearly all modern vacuum tubes. Already transistors are getting into the power field. Though at present they handle only comparatively modest power, there is no reason why in the future there will not be power types of every conceivable kind.

One of the difficulties with transistors is that — although mass-produced — they are not all uniform by any means. The price remains high, not due to any great cost in manufacturing, but rather because of the present high percentage of rejects. This is due principally to the microscopic contacts. Because of these it is impossible to turn out a uniform product at the current stage of the art. Rejects in many factories still run very high, and as these rejects cannot be used they are discarded. Sometimes the rejects run as high as 50% of the entire output.

Another difficulty is that testing transistors takes as much time and effort as making them. However, these troubles will be overcome once the industry learns to eliminate such bottlenecks. It seems certain that in the end refined electronic methods will do much to boost transistor output.

As transistors are now readily available and will be more easily available — and at lower cost — in the immediate future, we would strongly recommend that service technicians, experimenters and all others interested in electronics begin working in earnest with transistors. *We can see an experimenter's and how-to-make-it boom in the near future.* It will be particularly the rising generation, interested in electronics, who will go in earnest into electronics via transistors. There is hardly any circuit that cannot be easily arranged in breadboard fashion by using transistors. We can see countless experimenters assembling vest-pocket radio sets, miniradios, simple burglar alarms, homemade hearing aids, garage door openers and dozens of other new devices which can be made at reasonable cost.

But it is particularly the servicing industry which should take up this work now so that technicians can familiarize themselves with the working and general characteristics of transistors. Not a month passes that new transistor radios, audio amplifiers and other appliances are not announced. Soon the service technician must maintain these new radio-electronic devices. The sooner he becomes experienced in transistor work, the better it will be for his future. There is no time to be lost now.

—H.G.

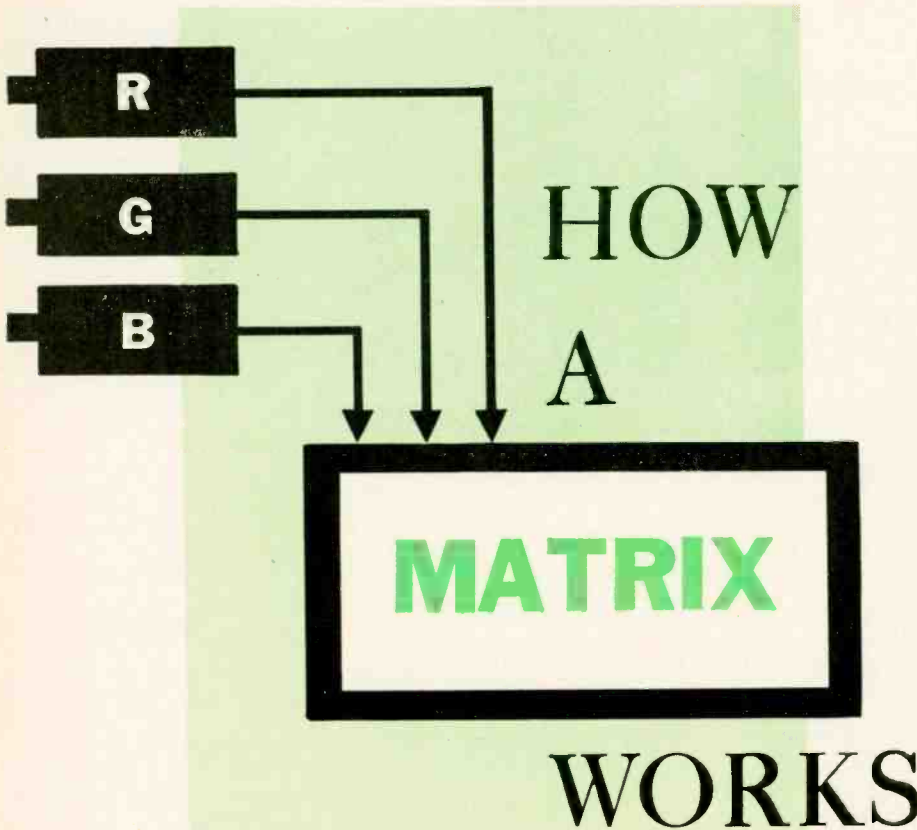

Explaining the operation of this key color TV circuit

By ROBERT G. MIDDLETON*

A MATRIX is a very simple device, and its operation can be easily understood if a person goes at it right. Consider the R-Y B-Y matrix system (Fig. 1) which makes extensive use of the color picture tube as a matrix.

It is helpful to get some basic principles fixed in mind at the outset:

1. A saturated red hue appears on the screen when the red gun alone functions. A saturated blue hue appears

*Chief field engineer, Simpson Electric Co.

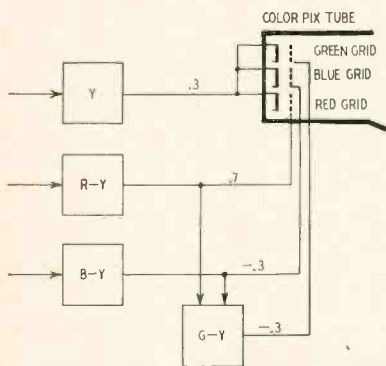

Fig. 1—A simple matrix arrangement. The cathode and grid signal voltages on color tube reproduce saturated red.

on the screen when the blue gun alone functions. A saturated green hue appears on the screen when the green gun alone functions.

2. When a red signal is being processed, output from the R-Y detector is applied to the red grid; output from the B-Y detector is applied to the blue grid and output from the G-Y matrix to the green grid. The signal applied to the blue grid is cancelled out by the Y signal on the cathode, and the signal applied to the

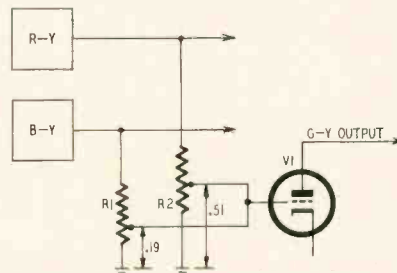

Fig. 2—Layout of the G-Y matrix.

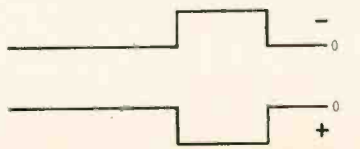

Fig. 3—Positive and negative signals.

green grid is cancelled out by the Y signal on the cathode. The signal on the red grid will not be cancelled, and the red grid alone functions.

3. When a pink signal is being processed, output from the R-Y detector is applied to the red grid; output from the B-Y detector to the blue grid and output from the G-Y matrix to the green grid. The signal applied to the blue grid is partially cancelled out by the Y signal of the cathode, and the signal applied to the green grid is partially cancelled out by the Y signal on the cathode. Now, there is some output coming from the blue and green guns, in addition to output from the red gun. Since red plus green plus blue equals white, the red is now mixed with white, and pink appears.
4. NOTE CAREFULLY: If we turn on the color killer switch, only Y remains at the cathodes (Fig. 1); there is no output to the red, green and blue grids. Now the cathodes are driving the red, blue and green guns (in balanced fashion) and a 30% gray is seen on the screen of the color picture tube instead of a saturated red. This is compatibility.

So this, then, is why the color TV transmitter separates the Y component from the complete color signal and transmits the signal in such a manner that the Y signal can be used separately or in combination with the chrominance signal. It is the Y signal which is "seen" by the black-and-white TV receiver, and it is the Y signal which dilutes a red signal to produce a pink signal at the color TV receiver by partial cancellation of the signals on the blue and green grids.

How G-Y is produced From R-Y and B-Y

Fig. 1 shows that the outputs from the R-Y and B-Y detectors are applied to the G-Y matrix as well as to the grids of the color picture tube. The principle of the G-Y matrix is shown in Fig. 2. Resistor attenuators R1 and R2 apply 0.51(R-Y) to the grid of V1, and 0.19(B-Y) to the grid of V1. The function of V1 is to make the signal negative instead of positive. In passing through a stage of amplification, a positive-going signal is converted to a negative-going signal. In other words, R1, R2 and V1 perform the operation:

$$[-0.51(R-Y)] - [-0.19(B-Y)] = G-Y$$

The matrix is sometimes called an adder, because it performs a simple addition (in this case, subtraction). The signals being added or subtracted in the matrix circuits are demodulated signals having a relatively low frequency. On a scope, the R-Y and B-Y and G-Y signals look like square waves of various durations and heights and polarities. Fig. 3 shows the typical appearance of these voltages.

Composition of the color signal

Since compatibility is a major consideration in transmission of the color TV signal, the black-and-white signal must contain all of the *brightness* information, and the color signal must contain all the *hue* and *saturation* information. Three independent modulations are impressed upon the complete color signal. These modulations are required upon the following basis:

1. A color is specified by the three characteristics of *brightness*, *hue* and *saturation*.
2. The *brightness* component of the color is the same signal as is transmitted in black-and-white programming.
3. *Hue* and *saturation* information is contained in the *color* signal, transmitted on the color subcarrier. (See Fig. 4.)

What is the nature of this color signal? First, it is a derived signal; i.e., it is the complete color signal (brightness, hue, saturation) from which the brightness component has been subtracted. The color-specifying part of the signal is thus called a *color-difference* signal. When the brightness signal is added to the color-difference signal, we will have the complete color signal. The brightness signal appears in the color TV receiver circuits as the conventional video amplifier signal, while the color-difference signal (containing hue and saturation information) appears in the form of three lower-frequency video signals. These various signals are added in simple matrix arrangements.

Now, let us have a somewhat closer look at a red signal as it is being processed in the matrix section of the color TV receiver. A saturated red signal has the following composition, as transmitted:

$$\begin{aligned}
 Y &= 0.3 \\
 R - Y &= 0.7 \\
 B - Y &= -0.3
 \end{aligned}$$

The Y signal is applied directly to the cathode of the color picture tube, as seen in Fig. 1. The R - Y signal of 0.7 is applied to the grid of the red gun. The B - Y signal of -0.3 is applied to the grid of the blue gun. The green matrix operates to form a G - Y signal equal to -0.3 from the R - Y and B - Y signals, and this -0.3(G - Y) signal is applied to the green gun, as shown in Fig. 1. The R - Y signal and the Y signal are both positive and add to 100% (fully saturated red). But the B - Y signal has an opposite polarity to the Y signal and cancels so that there is no output from the blue gun. Likewise, the G - Y signal has an opposite polarity to the Y signal and cancels so that there is no output from the green gun. Only the red gun is in operation and a saturated red hue appears on the screen of the color picture tube.

Now, if it is desired to transmit a

pink hue, the composition of the transmitted signal is different, such as: $Y = 0.65, R - Y = 0.35, B - Y = -0.15$. In such case, the G - Y matrix will operate to produce $G - Y = -0.15$. It is plain that the red gun will put out 100% energy, but now the blue gun is putting out 50% energy and so is the green gun. Hence, the red is diluted with white, since white is equal to red plus green plus blue; the resultant hue is in the pink range.

Matrices aren't so tough after all, are they?

But maybe you ask some specialized questions: such as: "If a pure red object is scanned at the color TV transmitter, no signal reaches the green or blue camera tubes. At what point is the -Y signal picked up? At what

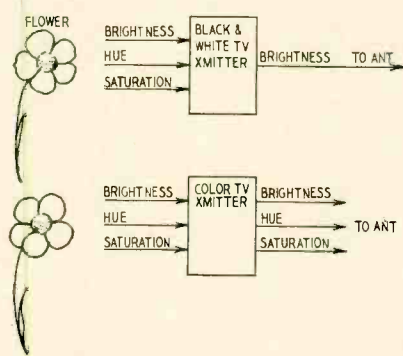

Fig. 4—Arrangement shows basic difference in monochrome and color TV systems.

point is the +Y signal picked up?" Well, let's take a look at Fig. 5, which shows the arrangement of an R - Y B - Y transmitter.

The output from the red camera drives the matrix, which responds by applying -Y to the R - Y and B - Y mixers, and +Y to the complete color-signal mixer. The mixers and modulators will generate a complete color signal comprising red = $0.3Y + 0.7(R - Y) - 0.3(B - Y)$. Note carefully that the output from the red camera is simply a certain voltage. When this voltage is applied to the matrix, a certain voltage must come out and this output voltage is termed the Y signal—it is a voltage proportional to the brightness of red, and it is the only voltage which is processed when the signal is received on a black-and-white receiver. When the Y voltage goes through a 180° phase shifter, we obtain -Y. And when we mix red with -Y, we get R - Y. It's that simple!

When the output from the phase shifter is applied to the input of the R - Y mixer, a certain voltage must come out, and when the output from the red camera is mixed with the output from the phase shifter in this R - Y mixer, the output must be R - Y. The output from the phase shifter is also applied to the B - Y mixer and, since the blue camera tube has no output for a red scene, the B - Y signal results only from the application of the -Y

voltage, which has a value of -30% when there is no output from the blue camera and 100% output from the red camera through the matrix and phase shifter.

You may object again that if the Y signal in the color tube *cancels* brightness, as pointed out above, how can we say that the *color* signal dilutes (desaturates) it? Answer: If we want a black-and-white picture, we turn off the color channel, and we see only the Y signal, which is still being applied to the cathode. This Y signal is driving the red, green and blue guns, in ratios which produce black-and-white. Now, if we want a color picture, we turn on the color channel and apply 70% R - Y

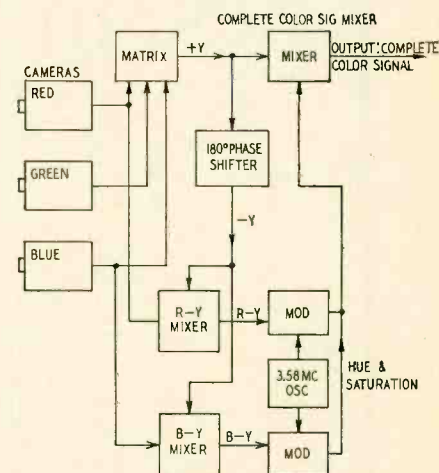

Fig. 5—The block diagram shows arrangement of R - Y B - Y transmitter.

to the red grid, -30% B - Y to the blue grid and -30% G - Y to the green grid. The signals on the red grid and cathode add, producing 100% output from the red gun (a saturated red); the signals on the blue grid and cathode cancel to zero; the signals on the green grid and cathode cancel to zero.

A further query I have heard is: "I am told that the output of the G - Y gun is -51% that of R - Y, added to -19% that of the B - Y. Thus, if at a certain moment the R - Y signal is 1 volt, the G - Y is -0.7 volt. But this ratio must be true whether a red, green or blue signal goes onto the picture tube. One can see that by increasing the red signal he might increase the red and green at the expense of blue or the blue and green at the expense of red, but never to get—say—a saturated green, with no output from red and blue."

Answer: The understanding of this situation follows from the foregoing points. It is helpful to recognize that G - Y is not transmitted as such (Fig. 1), but is *implicit* in R - Y and B - Y. The G - Y matrix *always* mixes -0.51 R - Y with -0.19 B - Y, no matter what color is being transmitted, and recovers the G - Y signal for any color. For example, the G - Y signal for a saturated green is 41%, for a saturated yellow -11%, for a saturated blue +11%. END

To reduce heater burnouts, trend in TV receiver design is toward controlled warmup time in heater circuitry

Series-String Tubes in New TV Sets

FOR the last eight or nine years TV designers have used series-string heaters and transformerless B supplies to reduce weight, size and cost of receivers. Many of these sets suffered frequent heater burnouts caused by power surges while the tubes were warming up. Research has proved that this trouble is caused by differences in the rates of resistance change in the heaters of the various tubes as current flows through them.

Some tubes reached operating temperature seconds before others and greatly disturbed the voltage distribution in the series string. While the slow-heating tubes were warming up, the voltage across the heaters of the relatively quick-heating tubes sometimes soared to 50% above normal and tubes burned out frequently. Set designers gave considerable attention to the arrangement of tubes in series strings and often recommended specific brands as replacements.

In a given type of tube, warmup time may vary from one brand to another because of the differences in heater construction. (See "Series Heater Strings for TV Receivers," *Electronics*, August, 1954.)

To minimize voltage surges and to simplify tube replacements in series-connected strings, tube manufacturers have developed a new series of types designed especially for 600-ma series-

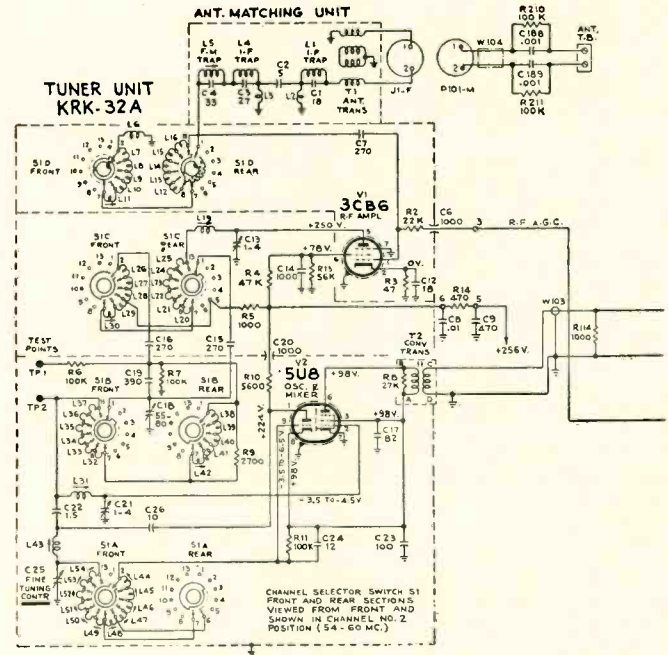

Complete schematic diagram of the RCA model 21-S-500R. Every heater in the circuit is connected in a series arrangement featuring controlled warm-up time.

Type	Heater Volts	Prototype	Heater volts, amps
2AF4	2.35	6AF4	6.3 — 0.225
3AL5	3.15	6AL5	6.3 — 0.3
3AU6	3.15	6AU6	6.3 — 0.3
3AV6	3.15	6AV6	6.3 — 0.3
3BC5	3.15	6BC5	6.3 — 0.3
3BE6	3.15	6BE6	6.3 — 0.3
3BN6	3.15	6BN6	6.3 — 0.3
3BY6	3.15	6BY6	6.3 — 0.3
3CB6	3.15	6CB6	6.3 — 0.3
3CF6	3.15	6CF6	6.3 — 0.3
3CS6	3.15	6CS6	6.3 — 0.3
4BQ7-A	4.2	6BQ7-A	6.3 — 0.4
4BZ7	4.2	6BZ7	6.3 — 0.4
5AM8	4.7	6AM8	6.3 — 0.45
5AN8	4.7	6AN8	6.3 — 0.45
5AQ5	4.7	6AQ5	6.3 — 0.45
5AS8	4.7	6AS8	6.3 — 0.45
5AT8	4.7	6AT8	6.3 — 0.45
5AV8	4.7		
5BK7-A	4.7	6BK7-A	6.3 — 0.45
5J6	4.7	6J6	6.3 — 0.45
5T8	4.7	6T8	6.3 — 0.45
5U8	4.7	6U8	6.3 — 0.45
5V6	4.7	6V6	6.3 — 0.45
5X8	4.7	6X8	6.3 — 0.45
6AU7*	3.15	12AU7*	6.3 — 0.3
6AU8	6.3		
6AW8	6.3		
6AX7*	3.15	12AX7*	6.3 — 0.3
6BA8	6.3		
6BZ6	6.3		
6S4-A	6.3	6S4	6.3 — 0.3
6SN7-GTB	6.3	6SN7-GTA	6.3 — 0.6
7AU7*	3.5		
12AV5-GA	12.6	6AV5-GA	6.3 — 1.2
12AX4-GTA	12.6	12AX4-GT	12.6 — 0.6
12B4-A*	6.3	12B4*	6.3 — 0.6
12BH7-A*	6.3	12BH7*	6.3 — 0.6
12BK5	12.6	6BK5	6.3 — 1.2
12BQ6-GA	12.6	6BQ6-GA	6.3 — 1.2
12BQ6-GTB	12.6	6BQ6-GT	6.3 — 1.2
12BY7-A*	6.3	12BY7*	6.3 — 0.6
12L6	12.6	25L6-GT	25 — 0.3
12W6-GT	12.6	6W6-GT	6.3 — 1.2
19AU4	18.9	6AU4	6.3 — 1.8
25CD6-GA	25	25CD6-G	25 — 0.6

*Operated with heater sections in parallel.

string circuits. These new types have heaters whose thermal characteristics are carefully controlled during manufacture. All electrical characteristics except those of the heater are identical to the prototype. Heater voltage is altered where necessary so the power consumed by the 600-ma heater is the same as in the older prototype.

For example, the 6BE6 draws 300 ma at 6.3 volts and its series-string equivalent, the 3BE6, draws 600 ma at 3.15 volts. Similarly, the 25L6 draws 300 ma at 25 volts while the 12L6, its series-string counterpart, draws 600 ma at 12.6 volts.

Generally, the new series-string tubes are identified by the prefix nu-

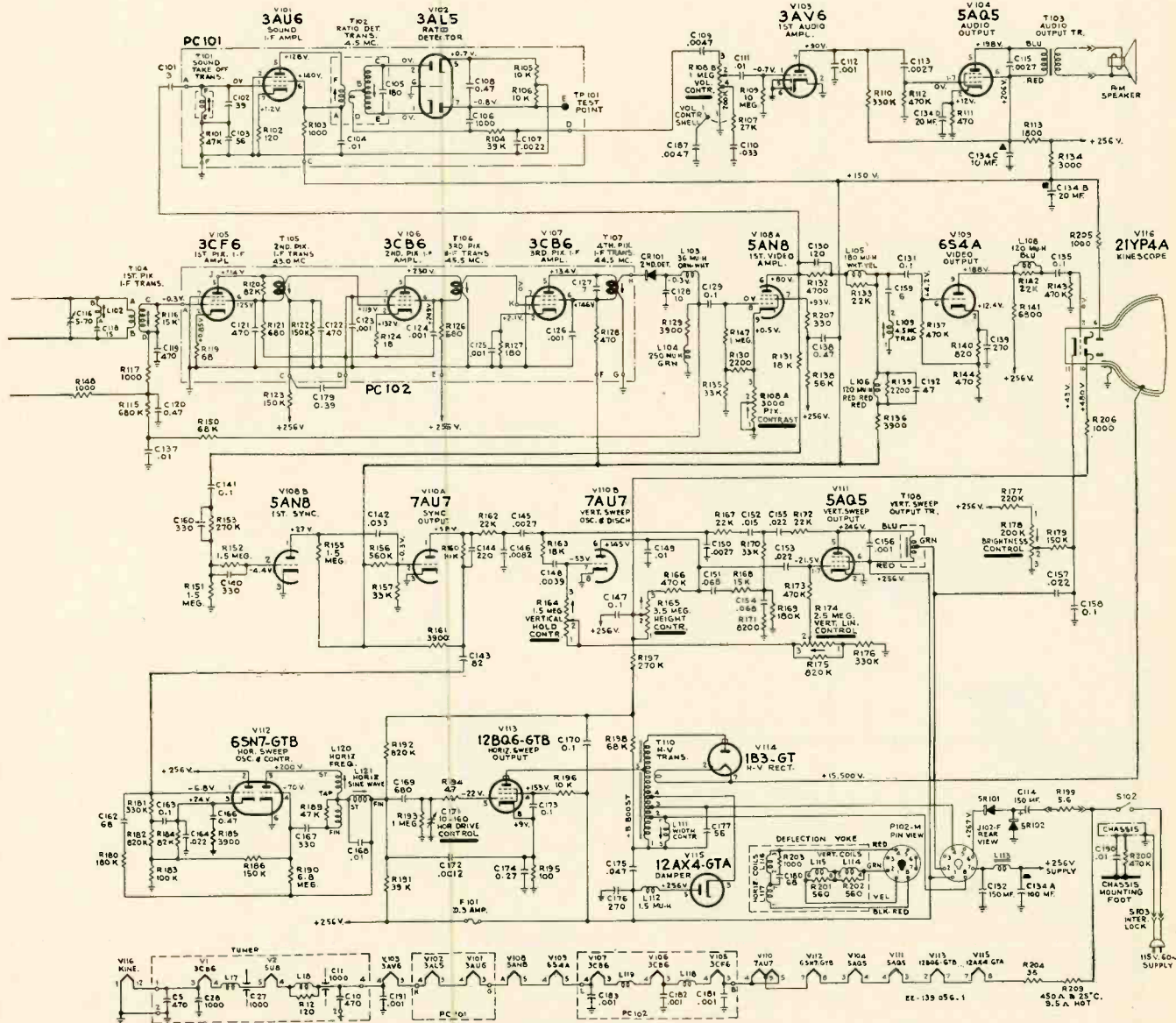

merals 2, 3, 4 and 5, which indicate the approximate heater voltage. The rest of the type number is the same as the prototype. The 6AU7 and 6AX7 (600-ma equivalents of the 12AU7 and 12AX7) operate at 3.15 volts when the heater sections are paralleled for 600-ma operation. Series-string types with 600-ma prototypes are designated with suffixes A and B. The table lists the more common series-string types with their prototypes.

The circuit of the RCA 21-S-500R illustrates a practical application of the 600-ma series-string tubes. All tubes draw the same current so there is no need for series-parallel connections and shunting resistors as used in many

earlier models. The picture tube, the r.f. amplifier, mixer-oscillator, first a.f. amplifier, ratio detector and sound i.f. amplifier are on the grounded end of the string to minimize troubles caused by high heater-cathode potentials and leakage.

This receiver is a 21-inch v.h.f. model featuring intercarrier sound with a ratio detector, horizontal a.f.c., stabilized vertical hold and horizontal (in the v.h.f.-u.h.f. unit) adjustable r.f. and i.f. sensitivity. Its all-channel v.h.f.-u.h.f. equivalent, the 21-S-500RU, uses the same basic circuit with a different (KRK-33) tuner having a 4BQ7-A cascode r.f. amplifier, a 5X8 triode-pentode as oscillator-mixer and a 2AF4 or

2AF4-A tube as a u.h.f. oscillator.

The tuner output is link-coupled to a three-stage composite i.f. system. A germanium-diode video detector supplies a.g.c. for the r.f. and first i.f. amplifiers and feeds the video and 4.5-mc beat to the 5AN8 first video amplifier stage. Sync and sound i.f. signals are taken off the plate circuit of the 5AN8. The video output stage is a 6S4-A. The horizontal and vertical deflection circuits and the high-voltage supply are conventional. The grid-leak bias on the 12BQ6-GTB (in the 21-S-500RU) is tapped off and applied to the a.g.c. line through the AGC CONTROL. The amount of fixed bias applied to the a.g.c. line varies the set's sensitivity. END

TELEVISION . . . it's a cinch

By E. AISBERG

From the original "La Télévision? . . . Mais c'est très simple!" Translated from the French by Fred Shunaman. All North American rights reserved. No extract may be printed without the permission of RADIO-ELECTRONICS and the author.

Seventeenth conversation, second half: Impedances and reflections; fantastic variety of antennas; reflectors and directors—the radio telescope

Reflections on reflections

WILL—So it's all a matter of matching impedances again?

KEN—Even more than you think. On the u.h.f. bands in particular, the lead-in is extremely important and its task a very delicate one. And it's especially important to avoid reflections due to poor matching.

WILL—Reflections?

KEN—If the lead is not properly matched to the antenna at one end and to the antenna circuit of the receiver at the other, it's likely that only a part of the signal will get into the receiver. The rest of it will be reflected back to the antenna, which will send it back to the receiver again. The receiver will only take part of that reflected signal, and so on.

WILL—The signal goes round and round, eh? And it finally gets into the set in several deliveries, instead of all at once. So what are the practical consequences of this piecemeal pickup?

KEN—You've seen the consequences—multiple images on the screen. The main image, representing the heaviest delivery of energy to the receiver, appears farthest left and is followed by a number of successively lighter and fainter ghosts.

WILL—I've gotten an effect something like that by moving a photograph slowly under a small fluorescent lamp.

KEN—The effect might be cute as a parlor trick, but in television we've got to get rid of it at all costs. So it's necessary to make sure the impedance of the lead-in is equal to both the center impedance of the antenna and the impedance of the receiver input circuit.

WILL—I've run into this "impedance" thing before, but I never could figure out how a piece of line could have the same impedance whether it's 5 or 50 feet long!

KEN—I could answer you very elegantly by telling you about "distributed constants" but that probably wouldn't help you very much. It's probably better to say that all antennas have resistance, inductance and capacitance, and their resultant causes the antenna to have a certain impedance. In a dipole, the impedance near the center of the antenna is about 72 ohms. The lead-in also has L, C and R distributed along its length, and these also result in a certain impedance. Now notice that, as you lengthen the line, the increased capacitance tends to reduce the impedance, while the increased inductance and resistance tend to increase it. Thus you have a balance, and the *characteristic impedance* of a given type of line remains the same for any length and over a wide range of frequencies. And the antenna input circuit of the receiver has a certain impedance, too.

WILL—If I get all this straight, it's necessary to have a lead-in with an impedance of 72 ohms to match the antenna, and the impedance of the receiver antenna circuit has to be 72 ohms, too?

KEN—You've got it all right! But you'll find that many—in fact, most—antennas don't have a 72-ohm impedance. The folded dipole and most of the more elaborate types have an impedance of near 300 ohms. That's the impedance of ribbon line. A 72-ohm line is coaxial (though you have a lot of higher-impedance coaxial, too). Practically all receivers have a 300-ohm input, though at least one big manufacturer confined himself to 72-ohm input sets for a long time.

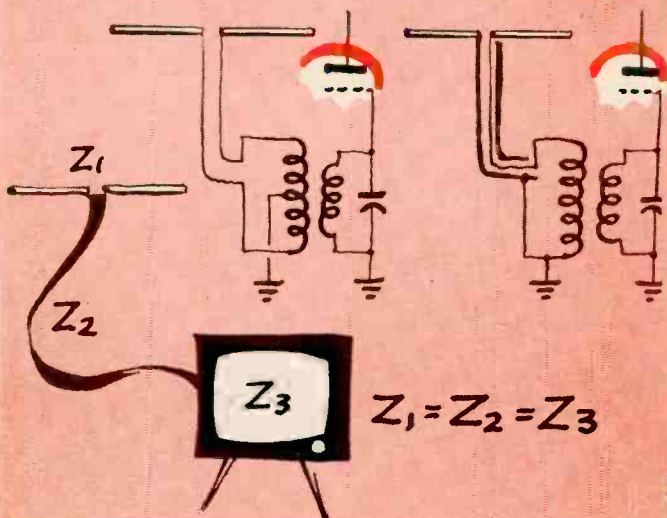
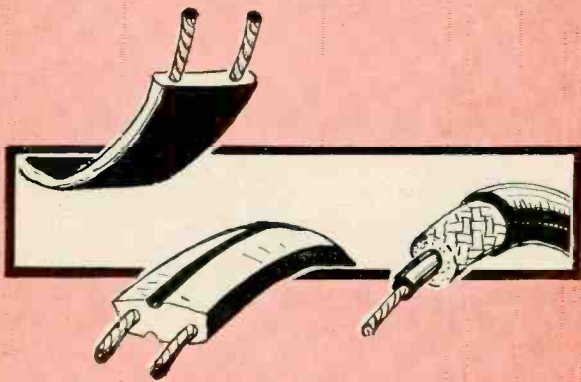
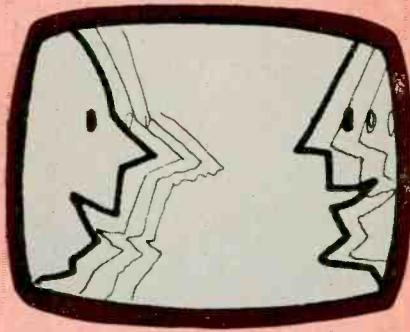

WILL—But how about these indoor antennas? Do you really have to have an outside job, up on the roof?

KEN—If you're in a really good location, a short distance from the transmitter, an indoor antenna may work well. Otherwise, a roof antenna is almost a necessity.

WILL—But we've been talking about tuned antennas. Those living-room dipoles certainly aren't big enough to resonate on the lower v.h.f. band?

KEN—Some of them have special methods of tuning which make them electrically longer than they look. For instance, the common rabbit-ears type depends on interaction between the two arms to some extent. Other antennas have a loading coil in the middle, and still others have hairpin loops that give the same effect. Then some have switches which put inductance and capacitance units in series or parallel with the antenna.

WILL—And what do you do if you have a 300-ohm antenna and one of those 72-ohm sets you've been talking about? Can you use an impedance-matching transformer?

KEN—You most certainly can, and do. Of course, you can use the old straight dipole with a 72-ohm lead-in, and there are various types of arrays with low impedance.

WILL—But why do we see such a fantastic variety of antennas on the roofs? The fact there are so many kinds seems to me to prove that none of them are near perfect.

KEN—The ideal is always just out of reach, in the TV antenna field as in most others. But there are many antennas that get a very good picture when used under the proper circumstances and where you don't have bad trouble with reflected images—ghosts.

Ghostly history

WILL—I can't see why the TV screens should be haunted like lonely houses . . .

KEN—All you need is a little reflection, Will, and you'll get it. You know that conducting materials are able to reflect radio-TV waves?

WILL—Yes, or we wouldn't have radar. Of course, radar uses microwaves. But v.h.f. waves are reflected by the ionosphere—at least when we get TV dx.

KEN—And I think you understand that v.h.f. and u.h.f. waves are reflected, not only by metallic objects, but also by surfaces that have a dielectric constant sharply different from that of the medium in which they have been traveling. Thus you can get reflections off a mountain—even one of poorly conducting rock—or off a building, though in most cases you will find the steel frame responsible. If you have enough reflections, your antenna may capture a half-dozen transmissions besides the one direct from the transmitter. And, of course, a signal that has arrived at the antenna after a reflection (or maybe two or three) has traveled farther than the one direct from the transmitter.

WILL—Let's see if I can follow this—it's practically the same thing as fading. When the waves follow paths of different lengths, they don't arrive at the antenna at the same time and in the same phase. If the reflected wave arrives out of phase, the signal is weakened. If it arrives in phase with the main signal, the two reinforce each other, and everything is O.K.

KEN—Not in this case, Will! Even though the waves arrive in phase, the difference in time shows up on the screen as a second image—a ghost—positioned to the right of the main image in exact proportion to the difference in time of the wave travel.

WILL—Then I suppose if you measure the distance between the live image and the ghost, you can calculate the difference in the length of the signal paths?

KEN—Nothing easier! For example, if your picture is 16 inches wide, the spot travels almost exactly 3 inches in 10 microseconds. So, if your ghost is exactly 0.2 inch to the right of the image, it arrived two-thirds of a microsecond after it. And, since radio waves travel about 300 meters per microsecond, the path of the ghost image must have been 200 meters longer than the direct wave. You could probably pick out the object that caused the reflection with the help of a map showing all prominent objects. You



TELEVISION

can even get a device called a *Microstick** that you can put on the screen to measure the distance directly in micro-seconds.

WILL—And if the reflecting object is a gas tank or metal tower, I suppose there's nothing for it but to use dynamite?

KEN—They have criminal laws covering that type of ghost elimination, Will. But you can often get the same result by using a highly directional antenna that discriminates against signals other than those coming directly from the transmitting antenna. Then reflected signals from the side or back are too weak to appear on the screen.

Mirrors on the rooftops

WILL—I understand directional transmitting antennas. They use reflectors and transmit the waves in a beam much like the light beam projected by the parabolic mirror of a searchlight.

KEN—A good many things in nature work both ways, Will. Take your parabolic mirror for example. You can use it to receive rays from the sun, with such effect that a piece of iron placed in the focus of the parabola can be melted as if it were in a furnace!

WILL—So, any directional antenna used for transmission will work just as well for reception? And all we have to do is use an antenna with a large number of wires to form a parabolic mirror, and we have no ghosts.

KEN—The idea works well, but it's a little expensive. They use something like it on u.h.f. though—the corner reflector. And you can make a parabolic-cylindrical mirror with four or five wires that will give fair results. Usually,

*Copyright RCA.

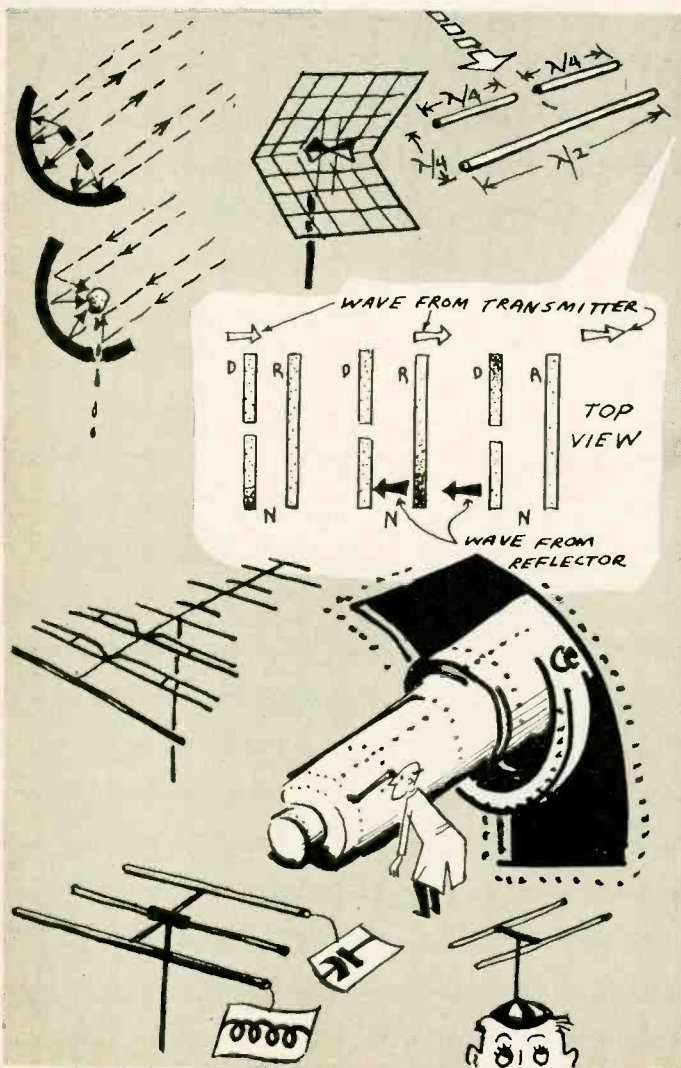

you just put a single reflector—a wire 5% or so longer than the antenna—behind the dipole. The distance may be between 0.15 and 0.5 wavelength, depending on whether you want greatest sensitivity in a forward direction, greatest rejection from the rear, what impedance is desired and a few other things that vary simultaneously with change in spacing.

WILL—I can't follow you, Ken. But let's get back to our reflector. I can see that four or five wires could give you something vaguely like a parabola. But one!

KEN—How about doing a little thinking? You can easily see that the reflector, like the dipole itself, picks up signals that cause currents to flow in it. And these currents set up waves that are sent to the dipole and reinforce the currents flowing there.

WILL—Yeah—I suppose so. But let's draw a diagram. I'll never get it otherwise. Now, suppose a wave arrives at the dipole and drives the electrons toward the south end. It reaches the reflector a quarter-wave later—because they're spaced a quarter-wavelength apart. There it also drives the electrons toward the south end. According to the laws of induction—which always work in contradictions—this displacement of electrons will set up a field that would cause electrons to move in the *opposite* direction—from south to north. This wave reaches the dipole a quarter wave later. Then it chases the electrons from south to north, in the opposite direction from that the first wave did! Do you call that reinforcement? That's cancellation!

KEN—Your mathematics are perfect, but your results are 100% wrong. You just forgot that between the time the first wave passed the dipole and the reflected wave reached it, time passed—a period of one alternation, or one half-wave, to be exact. And during that time the next alternation of the original signal reached the dipole. It was exactly opposite in phase to the previous alternation, and . . .

WILL—. . . also drove the electrons from the south to the north end. I see it all now! Now I see how a reflector can increase the pickup of a dipole. And I see also why it makes the antenna more directive. It wouldn't have any effect on signals arriving from the sides.

KEN—Now you can see how the antenna with a single reflector, whether a straight or folded dipole, a conical (often with the reflector disguised as another conical) or some related type, is the most common of all antennas.

How about a director?

WILL—What a pity we don't have a lens—an objective—as well as a reflector, as we do in optics. Then we could turn a real electronic telescope on our signals!

KEN—Your craze for far-fetched analogies will get you in wrong sometime, Will. But this time you've fallen right into a good example. The objective—call it a director—does exist. In microwaves we even have two kinds of lenses which work by refracting the rays just like optical lenses. The *director* is an element a trifle shorter than the dipole and is put ahead of instead of behind it. It is used together with a reflector to increase the directivity and sensitivity. You can have an antenna with more than one director and reflector. This type is called a Yagi, after the Japanese physicist Hidetsugu Yagi, who invented it.

WILL—But—except for a little difference in length—the director is the twin brother of the reflector. Why is its action exactly opposite?

KEN—That "little difference," as Marconi once pointed out, "is precisely the difference that makes it work!" The reflector is *longer* than the dipole and acts like an inductor. But the *shorter* director has a capacitive characteristic, so it has a very different action on the phase of the waves it radiates. You can make up another of your diagrams and figure it out, if you like. But before you do, note down that the dimensions of these *parasitic* elements are critical, that their presence cuts down the impedance of the dipole and that the impedance decreases as the elements are spaced closer together.

WILL—O.K., Ken. And now—if you don't mind—I think my mental antenna has been overloaded—I can't receive any more!

TO BE CONTINUED

Antenna Beams TV Signals 188 Miles

RELIABLE communication over distances far beyond those previously thought possible at TV and higher frequencies has been demonstrated in a series of experiments that began in 1950 and are still continuing.

The 60-foot antenna on our front cover is a new tool for research in this field. A similar antenna of half the size at the same site has been used to transmit TV signals from its location in Holmdel, N. J., to the Round Hill research station of the Massachusetts Institute of Technology near New Bedford, Mass. The distance is 188 miles. Longer distances have been covered in other experiments with television and pulse signals.

This type of transmission is important, not to the TV dx'er or fringe listener, but rather to the engineer seeking to supplement his microwave (and coaxial) relay routes. Highly directional antennas (like the one on our cover) and greater power are required. The antenna—60 feet in diameter—concentrates the 10 kilowatts which plans call for feeding into a narrow beam. The width depends on the radio frequency, being about $2\frac{1}{2}^\circ$ at 400 mc and $\frac{1}{4}^\circ$ at 4,000. This is 20,000 times the power and 30 times the antenna area used in the present microwave relay stations, which are placed in sight of each other, averaging about 30 miles apart.

The high power and the high-gain antennas are the secret of the long-distance transmissions. The effect appears to be relatively independent of frequency, antenna height and weather. Frequencies near 4,000 mc and as low as those in the lower v.h.f. band have been used. The signals are not dependent on ionospheric bending or reflection, and the effects of the terrain they pass over are not clearly understood.

The form of transmission has been likened by one scientist to that of a searchlight whose light may still be seen because of scattering by particles

in the atmosphere, even though it is behind a hill. Former theories underestimated the amount of that "glow" at points distant from the transmitter. Experiments indicate that signals are received 100 miles away at about 55 db lower intensity than would theoretically be the case if the line between the two stations could be straight. At 300 miles away the signal strength is 85 db below the so-called "free-space" level. But calculated on the basis used for estimating the range of standard TV stations—assuming a smooth spherical earth—the signals should be nearly 700 db lower!

The figure shows a large number of cases of reception of signals in the band between 300 and 4,000 mc. Those in the u.h.f. band (300–3,000 mc) are indicated by dots. The s.h.f. (super-high-frequency) signals between 3,000 and 4,000 mc are marked with crosses.

Tests between Holmdel and Round Hill have been made at u.h.f., at one time the frequency of 460 mc being

used. Television signals on 535 mc were also sent from the NBC experimental TV station at Bridgeport, Conn., prior to its dismantling several years ago. Pulse signals were transmitted at 3,700 mc. The difficulty of getting high power output at super-high frequencies has caused most of the experiments with television signals to be made in the lower part of the u.h.f. band, where sufficient power can be produced.

Reason for the long-distance transmissions has not been explained. The earliest theory was that the waves were scattered by atmospheric turbulence, much as the glow of the hidden searchlight is seen because its light is scattered by particles in the air. But high-gain antennas and tight beams would not be as valuable under such conditions as they seem to be in actual practice—the beams would broaden out. So the door is still open for a theory that will explain the phenomenon better. END

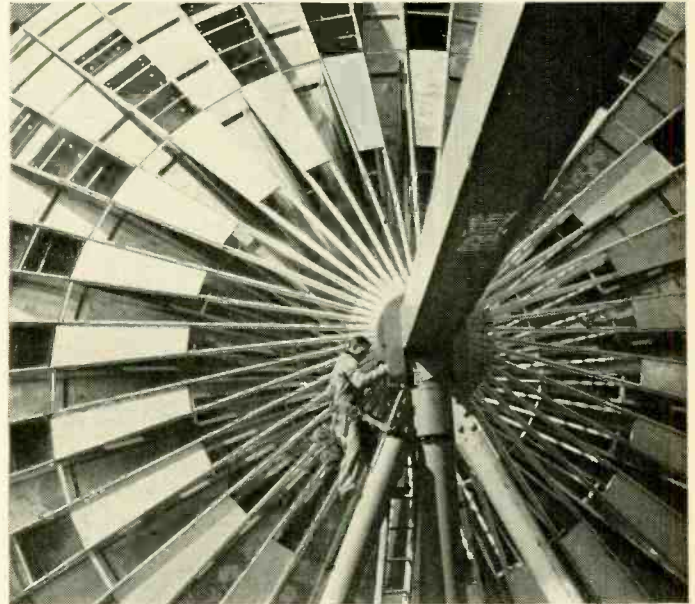

Rear center portion. The large beam is a counterweight.

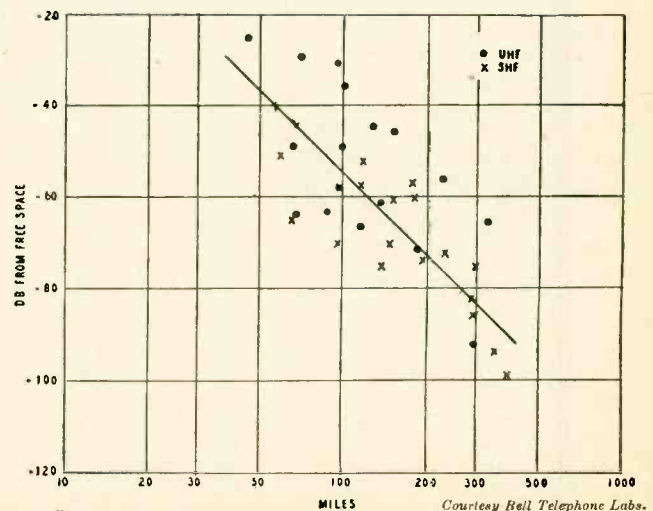

Median signal levels taken at frequencies from 300 to 4,000 mc.

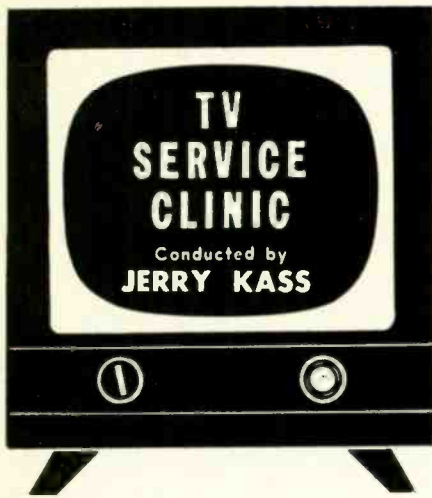

SCARCELY a week goes by without one or more readers requesting information on retrace elimination circuits. It would be a simple matter to show one or two circuits adequate for most situations. However, should these circuits fail to eliminate retrace lines the technician may be at a loss as to what his next step should be. Thus, before seeking a solution, let's examine the problem.

Like most other vacuum tubes, the picture tube operates with a bias voltage applied between its control grid and cathode. This fixed d.c. bias determines the *average* brightness of the picture. The *instantaneous* brightness is determined by the a.c. video signal that varies around the bias or operating point. The brightness control is generally a potentiometer connected between B plus and ground, with the center arm connected either to the cathode or grid.

Since the bias is the d.c. voltage between grid and cathode, applying a positive voltage to the cathode produces exactly the same effect as applying a negative voltage to the grid. And, when grid and cathode are positive with respect to ground, a greater positive voltage on the cathode also produces a negative bias. In either case the grid is made negative with respect to cathode.

In the transmitted signal all video information is contained between zero and 75% of the maximum amplitude of the signal. The 75% level is called the pedestal or blanking level. Above this point, an area called blacker-than-black, are the various synchronizing pulses. Since these pulses initiate the retrace of the sweep generators, it is necessary to black out the screen during this period.

Fig. 1-a shows a normal condition where the bias voltage is properly set. The entire a.c. video signal is used to produce fluctuations in picture tube brightness. At the blanking level, and during retrace, the beam current is cut off. Fig. 1-b shows a tube operating with excessive bias. Since the blanking level is beyond cutoff, portions of the video signal extending to the black

level will also be cut off, causing a loss of shadow detail and a generally dark picture.

Fig. 1-c shows a condition of insufficient bias. Here the blanking level falls short of cutoff. The black portions of the video signal being far from cutoff give the picture a very bright, washed-out appearance. Since the picture tube is not cut off during retrace, retrace lines are visible.

Not all cases of retrace lines are the result of misadjusted contrast or brightness controls. In extreme fringe areas the appearance of snow can often be appreciably reduced by decreasing the contrast setting and increasing the brightness. Unfortunately, the price for this is generally visible vertical retrace lines. Furthermore, it is normal to see these lines during camera changes and stations breaks.

Retrace elimination

The basic plan for removing these lines is to apply a sharp positive or negative pulse—depending upon whether it is applied to the cathode or grid of the picture tube—from the vertical sweep circuit. To avoid disturbing the characteristics of the video amplifier output circuit, it is usually a good idea to feed retrace elimination signals to the picture tube element that is not coupled to the video amplifier. The pulse will act in conjunction with the received blanking pulse to drive the picture tube deep into cutoff.

A very simple retrace elimination circuit is shown in Fig. 2. From a conventional blocking oscillator circuit connect a .05- μ f capacitor as shown by the dotted lines. If the circuit does not contain a large-value resistor between brightness control and grid, insert a 330,000-ohm unit as shown. This will help isolate the vertical pulse from the B plus line.

During the vertical retrace period a large negative pulse is developed across R and fed to the control grid of the picture tube, driving it deep into cutoff and eliminating the annoying retrace lines. In some circuits of this type, C is grounded and it is necessary to reverse the positions of C and R.

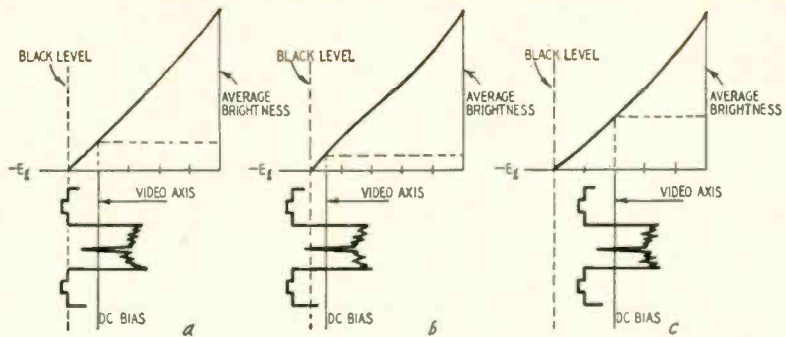

Fig. 1—Brightness versus grid bias—*a* is normal bias, *b* bias too high and *c* shows operation with too little bias.

Should a positive pulse be necessary for cathode application, the method shown in Fig. 3 can be used with the same values of resistance and capacitance. However, in this instance the vertical pulse is taken from the plate circuit of the vertical output tube. Actually, the pulse may be taken from the vertical deflection coils. When an autotransformer is used for coupling between the vertical output circuit and the deflection yoke, there is no polarity change from the positive pulse on the plate of the vertical output tube to the high side of the deflection coils. Should a standard transformer having an isolated secondary be used, pulse polarity will depend on the manner in which the deflection coils and secondary are connected.

Next month we will discuss the matter further, including some commercial circuits, as well as the matter of circuit adjustments.

Arcing to chassis

In a Magnavox receiver, 250 chassis, severe interference on the screen was accompanied with what sounded like arcing. This occurred only for the first few minutes after the set was turned on and would not reappear as long as the set remained on. I found that the arcing was taking place between the high-voltage compartment cover and the high-voltage transformer at the spot where the plate lead of the 1B3-GT leaves the transformer.

Using some high-voltage dope stopped the arcing. However, I would like to know the best method of reducing the high voltage or moving the transformer so that the trouble will not appear again and cause a callback.—M. D., Fort Wayne, Ind.

The reason for the arcing during the first few minutes of operation is that at this time the receiver is not fully warmed up and all operating voltages are high. As the tubes reach their normal operating temperature they load down the circuits and the voltages fall off somewhat. This difference could often mean the difference between arcing and no arcing.

This is not an uncommon occurrence

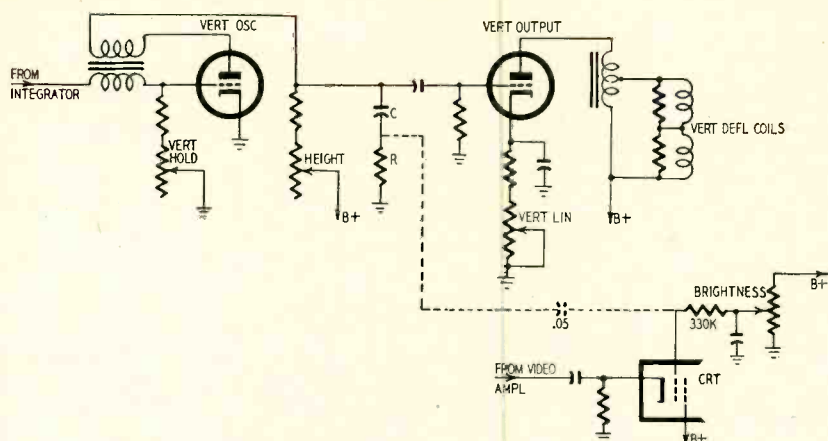

Fig. 2—Retrace blanking pulse taken from resistor in discharge circuit.

and I do not advise lowering the high voltage or moving the flyback transformer. Lowering the voltage would affect both the width and brightness. Moving the transformer means drilling new mounting holes and should be done only when everything else fails. What you have done is good, and a heavy coating should solve the problem. The only thing I would like to add is that you should place a piece of vinylite or high-voltage tape on the cover at the point where the 1B3-GT plate lead comes off the transformer.

Trailing whites

A model CT-89 Capehart receiver on the bench has a condition that I first diagnosed as smear. All peaking coils and load resistors in the video amplifier stages were checked and any suspicious parts replaced. However, this did not change the smearing condition. Closer examination revealed that what appeared as smear was actually a case of trailing whites with an overall appearance of ringing. What components are most likely at fault?—S. E., Joliet, Ill.

You did not state whether this trouble occurred on one or all channels. If only one channel is involved, check the operation of its local oscillator circuit. Compare all oscillator voltages with those on a properly operating channel. If you have a sweep generator and scope, check response of the defective channel against the manufacturer's curves or against response of properly operating channels. If you come up with a badly distorted waveshape, check the tuner for spurious oscillations.

If the trailing whites appear on all channels, check the value of the 4,700-ohm detector load resistor. Also check the 10- μ f detector bypass capacitor for leakage. If this does not clear up the trouble, carefully align the i.f. stages. As a final test, check every component in the video detector circuit.

Picture streaks

A Stromberg-Carlson model 622 is in the shop with the complaint that it offers no protection against noise, par-

ticularly ignition noise. At the customer's home, located near a garage and a heavily traveled road, I noticed that the ignition noises appeared as very long streaks instead of the usual small dots. I have checked for defective components in the r.f. and i.f. circuits but can find nothing out of order. A response curve of the video i.f. follows the manufacturer's recommendations very closely. I would appreciate some advice on this.—R. M., Detroit, Mich.

From your description of the symptoms, there is probably a defect in the a.g.c. delay network of this receiver. Try various settings of the a.g.c. potentiometer. If this does not help, check every resistor in the a.g.c. network and replace any units that are off value by more than 10%. In addition, connect a r.f. choke between the input terminal and the a.g.c. terminal on the printed i.f. strip. A small choke, about 2 μ h, should do the trick.

Certain noise pulses charge the capacitor at the grid of the first i.f. tube, causing the long streaks. The choke reduces the R-C time constant, discharging the capacitor more rapidly, eliminating the streaks and leaving only dots. The choke does not short out the i.f. signal because its r.f. impedance is very high.

Vertical instability

A Motorola chassis TS-531 has a very persistent case of vertical roll. I have checked the vertical oscillator and output tube and the sync clipper. All capacitors and resistors in these circuits have been checked. The horizontal circuits are extremely stable. In addition, I have checked all voltages in these stages against the schematic, and everything seems to shape up. Can you give me any hints on what else to look for?—A. M., Youngstown, Ohio.

Make a very thorough check of the a.g.c. circuit, checking all values and voltages against your schematic. Use your scope and look for any possible local interference generated within the set. This could be triggering the vertical oscillator, which does not have

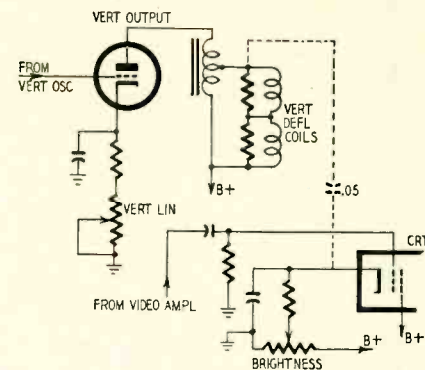

Fig. 3—Auxiliary blanking pulse taken from end of vertical deflection coil.

the a.f.c. protection of the horizontal circuits.

If you have the manufacturer's schematic, you have sync pulse patterns shown. Check these carefully for possible sync clipping. Also, observe the B supply line for excessive ripple. If you think it is too high, check all filter capacitors servicing this line. Also check the filter components in the bootstrap circuit. Finally, check all components in the video detector circuit.

Vertical hold control

Recently a set came in—a Crosley chassis 426—with an open vertical hold control. I replaced the hold control with an exact replacement. But I cannot get the picture to stop rolling, and picture height is reduced. Every voltage and resistance measurement indicates normal circuitry. I would appreciate some ideas on the trouble.—M. B., St. Paul, Minn.

If vertical roll was the only complaint and you found an open hold control, the probability is great that this was the only circuit defect—especially since upon replacement you then found everything else in order. The 426 chassis is of the Super V series in which this component has been the subject of much confusion, despite numerous field bulletins by Crosley.

These controls are made in two ways. In both cases the resistance specs are identical. However, in some controls made for early production models, the 350,000-ohm stop is reached at the extreme clockwise rotation of the control shaft. In later controls this stop is reached at the extreme counterclockwise position. When installing a new control, make sure the fixed resistance is in the circuit at all times.

Connect the center tap to the ground lead. Then measure the minimum resistance between each of the other terminals and ground. One of these readings will be zero ohms, and the other approximately 350,000 ohms. Connect the second lead to the terminal where the 350,000-ohm reading is obtained. This done, you should obtain normal operation. END

Bass- Reflex TV Stand

*Dual-function enclosure
supports TV set and
improves audio fidelity*

By WALT WHEELOCK

SO you have just bought a new 21-inch table-top television set? After all, with color just around the corner, why get a big console set now? Or perhaps there was not enough

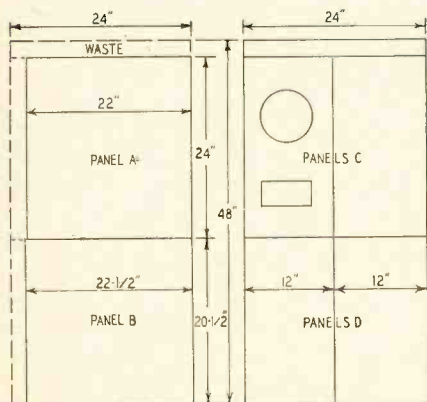
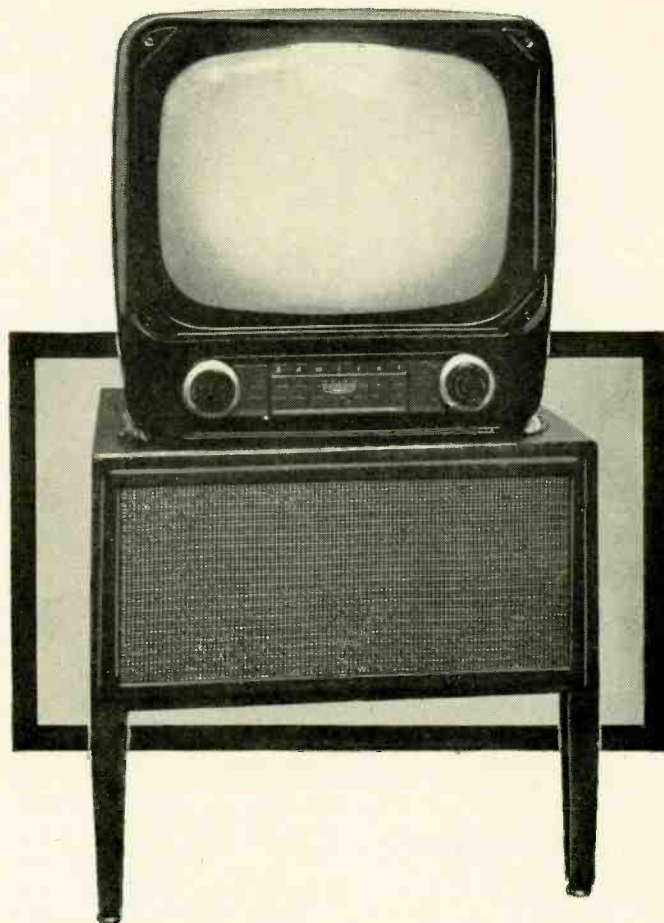

Fig. 1—Patterns for bass-reflex enclosure. Location of port is not critical.



The completed bass-reflex TV stand.

room for the larger set, or maybe \$198.95 was all the budget would stand? And the sound from this unit sounds much like that from the old a.c.-d.c. squawk-box? A quick investigation shows that it has the same 5-inch speaker and the same 1/2-inch stack in the output transformer. Still worse, the speaker is mounted on the side of the case, near the open end. Due to this poor baffling, the sound waves cancel at the middle frequencies and the higher frequencies are lost attempting to get around the corner. (There are no low-frequency tones to lose.)

There are three types of acceptable speaker enclosures, the infinite baffle, the various horn types and the bass-reflex systems. Of these the bass reflex is the simplest to construct and provides most satisfactory response for a limited space. Recently R-J, Magnavox and Permoflux have produced commercial systems using 8-inch speakers in enclosures with less than 2 cubic feet of total enclosure. Yet these reproduce sound far superior to any coming from a standard table-top television set.

This bass-reflex enclosure, designed to occupy the space beneath the TV set (see photo), serves as a stand for the set as well as supplying adequate baffling for the speaker. This plan provides 3 cubic feet of *net* space within the cabinet. While its shape is different than that of most bass-reflex cabinets, acoustic tests shows that the *volume* is

the controlling factor in this type of enclosure rather than the shape used to obtain this volume. Of course, the size of the port and the sound-absorbing material used are also factors.

Many of us, handy with a soldering iron or electronic circuits, find that woodworking is another game. The "do-it-yourself" shops are now stocking 3/4-inch plywood in 24 x 48-inch sheets. This cabinet is constructed from two of these smaller-sized panels. These same shops also stock screw-on wooden and iron legs. The plan is simplified so that the basic panels may be cut with five setups on a table saw or with an ordinary handsaw. By careful measuring it is possible to cut these panels from the sheets without even using a square, and the cabinet will be self-squaring when glued together.

The next step is to get an 8- or 10-inch speaker. Since this enclosure does not aim at the super hi-fi of the multiple-speaker room-sized systems, a speaker in the \$10-\$20 class such as the Permoflux 8T-8, Jensen P8R or Quam 8A10X will provide good sound from our television programs.

Follow the cuts indicated in Fig. 1, or have a woodworking shop make them. Cut out the speaker opening, 7 inches for an 8-inch or 9 inches for a 10-inch speaker. The size of the port depends on the cone resonant frequency and the volume of the enclosure. The optimum opening for our baffle for various cone

AUDIO—HIGH FIDELITY

into place. Mount the speaker on the front panel with 8-32 flathead machine screws.

When the speaker assembly is completed, the port may be tuned exactly by varying its area. The necessary test equipment for this includes a v.t.v.m. or audio output meter and an audio-frequency generator. The general procedure is to find the speaker's free-air resonance point and then vary the port opening (by sliding a small piece of plyboard over it) for equal peaks on each side of it. For details on this procedure, see "Tuning Speaker Enclosures," May, 1955, page 134.

The cabinet should now be sanded and all joints filled. After the filler has set, go over the surface again, sanding and filling until even the smallest cracks are smooth. The final appearance will depend on how well this part of the job is done.

When you are satisfied with the surfaces, the stand may be enameled or covered with leatherette, tapestry or grass cloth. Decorator's colors may be used with iron legs, black enamel with natural-finished wooden legs, or the leatherette or cloth surfaces with either type—any combination that strikes the fancy of the lady of the house. If sufficient equipment and skill are available, the stand may be constructed of cabinet-grade hardwood, then stained and varnished—but this requires mitered joints rather than the more simple butt joints used.

Finally the legs are screwed to the bottom and the front covered with grille cloth. Luminite or an equivalent should be used, rather than ordinary cloth, to avoid muffing the higher tones.

Now wire the speaker to the set's output transformer. Ordinary zip-cord is suitable for this. If the original speaker was a field type, leave the two B supply wires connected to the old speaker, as this serves as a filter choke on the power supply.

The photograph of the completed bass-reflex TV stand shows how this simple design will blend with that of the usual table-top television set. A few minutes of listening and you will realize that you are hearing music with a much fuller range of tones than has ever been produced by your set. END

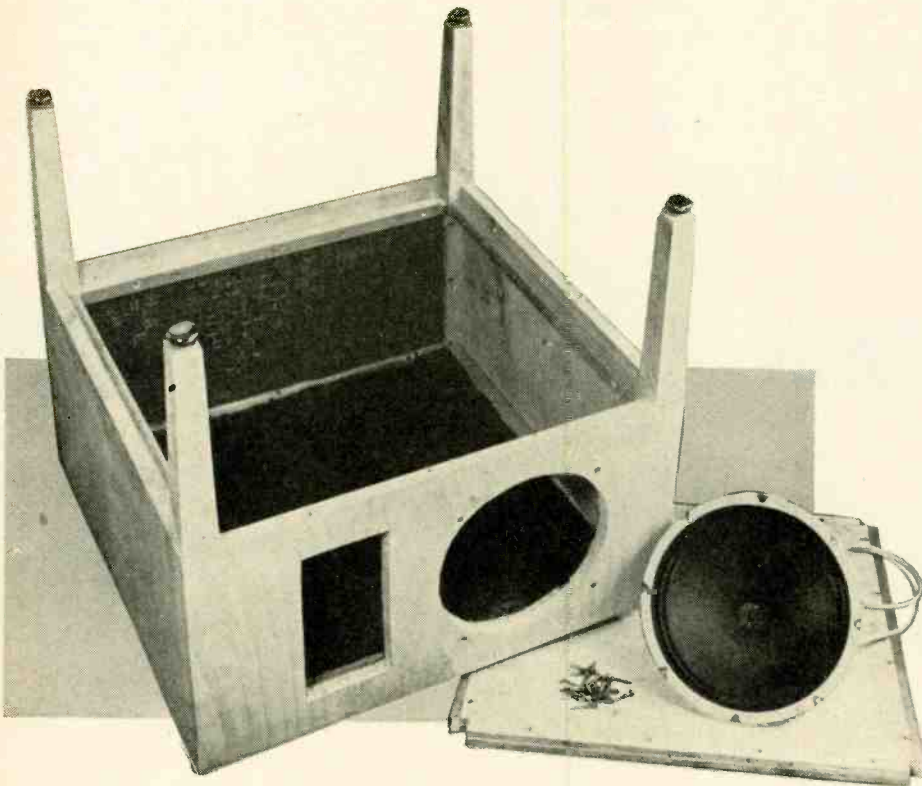

The enclosure before final assembly.

resonant frequencies is in the order of:

Frequency (Cycles)	Area (Square inches)	Dimensions (Inches)
60	16	3 x 5 1/2
70	30	4 x 7 1/2
80	50	5 x 10
90	80	8 x 10
100	100	10 x 10

Resonant frequencies are given in the specifications of all good speakers. For example, that of the Permoflex 8T-8 is 70 cycles. This port is cut as shown in the diagram. Exact position is not critical—most enclosures have it in roughly the same position as that shown in the photo above.

Assemble the cabinet, using glue blocks and plenty of wood screws, as shown in Fig. 2. (CAUTION, the bottom panel is screwed, not glued, into place, to allow access to the speaker.

Note that it is pushed in and screwed to the battens.) The top, back and one

MATERIAL		
Panel	No.	Size
A	1	24" x 22" x 3/4"
B	1	22 1/2" x 20 1/2" x 3/4"
C	2	24" x 12" x 3/4"
D	2	20 1/2" x 12" x 3/4"
Blocks	12	3/4 x 3/4 cut to size
Screws	88	= 6 x 1 1/4" FH Wood
Bolts	4	8-32 x 1 1/2" FH Machine
Legs	4	8" (or as desired)

side are lined with *Kimsul*, cotton batting or rug padding. Tack this firmly

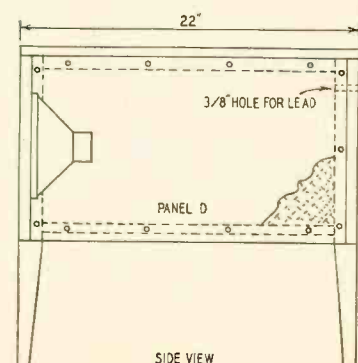
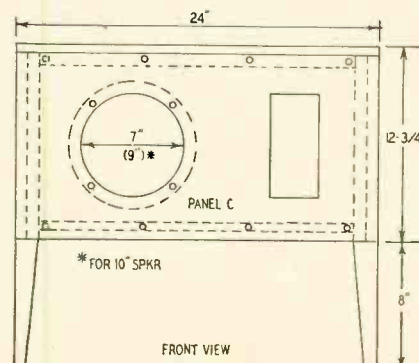
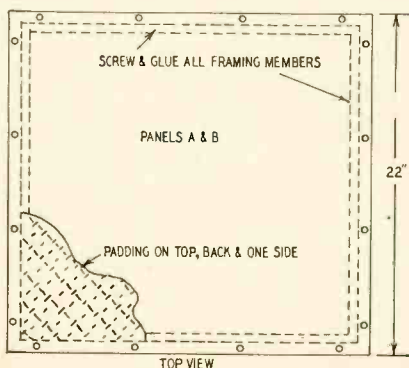

Fig. 2—The assembled cabinet. Either a 7- or 9-inch speaker may be used.

Circuit Features of High-Fidelity POWER AMPLIFIERS

First of several articles describing recent circuit developments designed to overcome effects of leakage reactance in output transformers: the basic McIntosh unity-coupled output circuit

By ROBERT F. SCOTT

TECHNICAL EDITOR

A MODERN high-fidelity power amplifier must be designed for minimum distortion, high peak power output for wide dynamic range, high efficiency for economical operation and high power sensitivity to develop the desired output with comparatively low driving voltages. Push-pull operation is universally used to cancel even-harmonic distortion. Class AB_1 - or AB_2 -operated beam-power output tubes are used for efficiency and power sensitivity. A class- AB_1 amplifier is biased and driven so plate current flows for considerably more than 180° and somewhat less than 360° of the input cycle. Class- AB_2 amplifiers are biased as for class- AB_1 operation but are driven harder so the grid goes positive for a small part of the input cycle. In both cases the tubes are alternately driven to cutoff during a small part of the input cycle.

The output transformer of a high-fidelity amplifier must have a large heavy core and a great number of primary turns for good low-frequency reproduction. The shunt capacitance of the primary must be low for good performance at frequencies above about 3 kc. Unfortunately, shunt capacitance increases rapidly as the number of primary turns is increased so high-frequency response falls off. Thus, any effort to increase the range at the low end results in a reduction in response at the high end.

Negative feedback is frequently used to flatten and increase the frequency response. But when the feedback volt-

age is taken from the secondary winding of the output transformer—as in most amplifiers—the amount of feedback is limited by the amount of phase shift caused by capacitive reactance of the load and flux leakage and distributed capacitance of the windings. One method of increasing the transformer

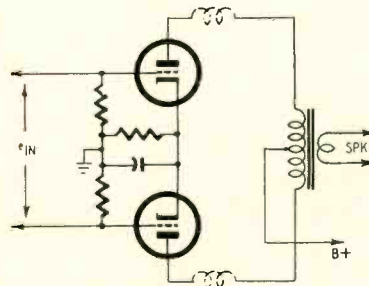

Fig. 1—A basic push-pull circuit showing the equivalent leakage inductance.

bandwidth while holding phase shift to tolerable levels is to use a very large core that permits good low-frequency output with comparatively few turns on the primary. Such transformers are seldom practical from an engineering or economic standpoint.

Leakage inductance and reactance

In a transformer of conventional design not all the lines of force produced by current in one half of the primary cut the turns in the other half. The flux lines not coupled to the other half of the coil produce a counter-e.m.f.—like that of self-induction—in the coil

producing them. In transformers this stray inductive effect is called *leakage inductance*.

Leakage inductance has the same effect as a separate inductor in series with each half of the coil and its plate. Fig. 1 shows a basic push-pull circuit with leakage inductance shown in dashed lines. This is the direct result of insufficient coupling between the halves of the primary winding.

At frequencies above 2 or 3 kc (depending on the transformer) the output waveform is distorted by a notch (Fig. 2) caused by sharp changes in total plate current as one tube is driven to cutoff. The abrupt change in plate current causes the leakage inductance to induce a counter-e.m.f. that produces this notch in the output waveform. In other words, when the tube cuts off, the leakage inductance generates a current that flows in the same direction

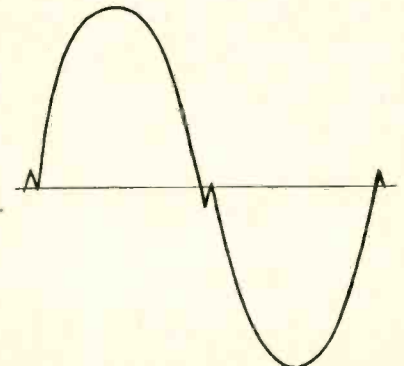

Fig. 2—Distorted output waveform.

AUDIO—HIGH FIDELITY

one wire—the coupling between the coils is unusually close and leakage reactance (the reactance of leakage inductance) is greatly reduced. (Fig. 4-b). This type of construction makes it possible to wind a transformer in which the leakage reactance is 1/200,000 of the primary inductive reactance or less. Leakage reactance should be at least 1/80,000 of the primary inductive reactance in a class-AB or -B output transformer for full output between 20 and 20,000 cycles with distortion not exceeding 1%.

The circuit in Fig. 4-b is impractical because separate d.c. supplies are needed for each tube and a special driving or input transformer is needed. The

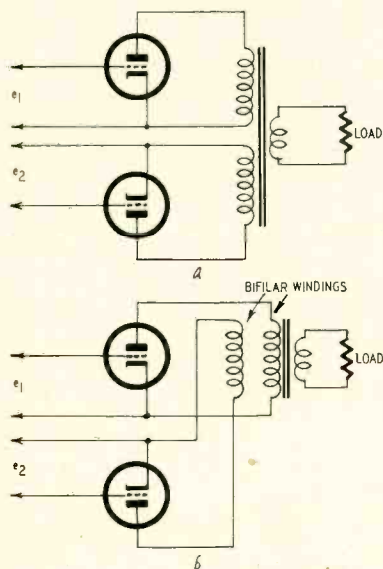

Fig. 4-a—Ordinary primary winding.
Fig. 4-b—A bifilar-wound primary.

next step in the development of the unity-coupled circuit was to change the connections so one of the identical windings is in the cathode circuit and the other in the plate circuit. Each winding was then tapped at the center as in Fig. 5.

Each tube now operates as a split-load phase inverter with the power output developed equally in the plate and cathode coils. When the input signal makes the grid of V1 more positive, current flows upward from ground to the cathode of V1 and then from its plate through the lower half of the plate winding to B plus. V2 operates in the same manner using the lower half of the cathode winding and the upper half of the plate winding. Since the plate and cathode coils are identical and bifilar-wound with a coupling factor approaching unity, leakage reactance is effectively eliminated and each tube appears to operate through the full primary.

The secondary winding sees the two primaries as a single winding so the effective turns ratio can be halved and plate-to-plate impedance reduced to one-quarter the optimum value for the same tubes operating in a conventional push-pull circuit. With the impedance

reduced to one-quarter (to 1,000 ohms if we assume 4,000 ohms plate-to-plate in a conventional circuit) the effect of distributed capacitance of the windings is reduced by the same factor and the high-frequency response of the transformer is increased correspondingly. The internal impedance of the output stage is further reduced to one-third the original value (333 ohms) by the 12-db feedback developed in the split-load circuit.

Pentodes should operate with a constant d.c. potential between cathode and screen to prevent degeneration unless screen-cathode feedback is actually desired, as in the Bell 2200 and Bogen DB20 (see "High-Quality Circuits," RADIO-ELECTRONICS, September, 1953). In the unity-coupled circuit the cathode is above ground for a.c. signal voltages so a.c. and d.c. potentials on the cathode and screen are held constant with respect to each other by connecting the screen of one tube to the plate of the other. In this way, the a.c. voltage on the screen is equal to and in phase with that on the cathode. Both elements rise and fall equally with signal voltage and the instantaneous voltage difference is always constant.

The amplifier circuit

The amplifier in Fig. 3 delivers 30 watts with a frequency response flat within ± 0.1 db from 20 to 30,000 cycles and within ± 0.5 db from 15 to 50,000 cycles. At 15 watts output, response is flat within ± 1 db from 10 cycles to 100 kc. Harmonic distortion is less than 0.33% at 30 watts output between

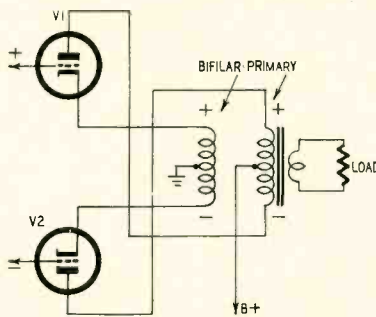

Fig. 5—Developing unity coupling between halves of the primary winding.

20 and 20,000 cycles. Intermodulation distortion is less than 0.5% when peak power output is below 60 watts for any frequency between 20 and 20,000 cycles. Phase shift is only 3° at 20 cycles and 9° at 20 kc. Damping factor is 12 or better at the 4-, 8-, and 16-ohm outputs and 16 at the 600-ohm terminals.

The 1614's in the unity-coupled output stage approach class-B operation at rated output so a 12AX7 push-pull cathode follower is used to provide the low-impedance source required for driving the grids. The 1614 grids are direct-coupled to the driver cathodes. The output tubes require a large signal voltage on the grids because of the degeneration in the cathode circuit. Each driver plate is direct-coupled to

the plate of the opposite output tube. This has the effect of doubling the driver tubes' plate voltage.

The cathode-follower drivers require a grid excitation voltage equal to that of the 1614's plus an additional voltage to compensate for the cathode followers' gain of less than one. This signal voltage—about 132 on each grid—is supplied by the 12BH7 voltage amplifier through R-C coupling to the 12AX7 grids.

The 12BH7 plate load resistors are supplied from the ends of the plate winding of the output transformer where current flow is in phase with the 12BH7 plate current. Thus, half the plate winding is in series with the 12BH7 load resistor and the voltages across the transformer and resistor are series aiding. This ingenious arrangement greatly increases the 12BH7 a.c. plate load impedance and stage gain while the d.c. load is only 12,000 ohms.

The positive feedback from the plates of the 1614's to the plates of the 12BH7's raises the effective output generator impedance to around 500 ohms so the ratio of generator impedance to output impedance is about equal to that of a well-designed triode output stage.

The 12BH7 grids are excited in push-pull by a 12AU7 cathode-coupled phase inverter. The input stage is half of a 12AX7 direct-coupled to the input grid of the 12AU7 to minimize low-frequency phase shift. Negative feedback is taken from a separate secondary on the output transformer and fed to the cathode circuit of the input stage.

Using the separate feedback winding greatly increases the stability of the amplifier. When feedback is taken from a load winding, a load with capacitive reactance will increase the phase shift within the output transformer and feedback may become positive at high frequencies. This effect is minimized with the separate feedback winding.

The MC-30 has separate B plus and bias supplies. The output stage operates class AB so large filter capacitors are used for adequate decoupling and low output impedance at all audio frequencies. Good regulation is maintained by using a 5U4-G rectifier and low-resistance power transformer and filter circuit. Fixed bias for the output stage is supplied by a half-wave selenium rectifier with a capacitor input R-C filter.

The amplifier delivers full output with a 0.5-volt a.c. input. Output loads of 4, 8 and 16 ohms are supplied from a low-impedance secondary on the output transformer. A 600-ohm balanced line may be fed from taps on the cathode winding of the bifilar primary.

In subsequent articles we will discuss the development and operation of the output circuits in the National *Horizon* series, the Electro-Voice *Cyclotron* and Stephens OTL (output-transformerless) amplifiers. END

FOR GOLDEN EARS ONLY

*The Rebel V corner horn;
Electro-Voice Ultra-Linear
ceramic cartridge; new
records review*

By MONITOR

THE Klipsch horn has won wide popularity both in its original front-loaded form and the smaller, simpler and cheaper back-loaded one. Especially interesting to those with small budgets have been the unfinished horns offered by Cabinart at low cost. It was inevitable that eventually a very small version of the Klipsch corner horn would be offered, and Cabinart has come up with a model for 12-inch speakers which I suppose is as small as a horn can be and still have any point. The Rebel V is only 20 inches high and 15 inches wide on the front baffle. In a corner it will occupy a space about 18 inches along each wall and only about 15 inches deep. It can be mounted—with a hanger provided for that purpose—at the junction of the wall and ceiling where it takes up no otherwise usable space. Cabinart makes no extravagant claims for this enclosure. I used it with an RCA LS12 speaker and found it very pleasant and satisfying.

Nobody in his right senses would expect a horn this small to do the job larger horns and elaborate combinations of speakers can do in very large enclosures—and we concede it won't. The Rebel V appears to be designed for a cutoff of about 60 cycles. Down to that point it is about as good as the speaker will permit it to be and that means about as good as any horn.

Its response does not stop at 60 cycles. There is some fundamental response below that which can be accentuated with bass boost in the amplifier. But on the whole one can say that its useful range is from around 50 cycles up. That means that the

realistic rendering of the deep bass, which makes the finest systems so awesomely pleasant to hear, is not within its capabilities, no matter how good the speaker. Cancellation of front and back waves occurs even with a speaker capable of going down to 30 cycles.

However, I have repeatedly pointed out that, though a good deal of realism is lost when the final two octaves are not reproduced, there isn't a great deal of loss of musical quality. You'll hear everything the composer wrote though the effect may not be quite as overpowering as he intended, and what you hear will sound very good.

The Rebel V reproduces its range much more cleanly and faithfully than reflexed or resonated enclosures of small size. I noted no artificial resonances. One of the $\frac{3}{4}$ -inch plywood partitions is common to two portions of the folded air column but it is so small that its resonance, if any, falls into the mid-range where the front radiation is dominant, and is not noticeable (if it exists at all). There is a dip or two in the range between 80 and 200 cycles where the back wave is apparently in phase with the front wave, but this, too, is not noticeable when listening to music.

Organ music is reproduced with gratifyingly pleasing quality because the pedal tones of the organ are made with open pipes whose strong harmonics fall into the Rebel V's most efficient range. What pleased and surprised me most was the excellent reproduction of drums. Horns are normally not particularly good in reproducing drums; after all, drums are diaphragms and

horn reproduction might be expected to change their tonal quality—and usually does. But probably because of its front radiation, which is by diaphragm, the Rebel V does a good enough job that nobody need hesitate demonstrating and showing off percussion records with it. The deep dullness of big bass drums (as in Moussorgsky's *Pictures* or Milhaud's *Concerto for Percussion*) will be missing, as if the membrane on the drums had been tightened or smaller drums substituted, but the drums will all be good and loud and very nicely defined.

The string basses are excellent and will even send vibrations through the walls and floor like bigger horns. On direct comparison with a full-range

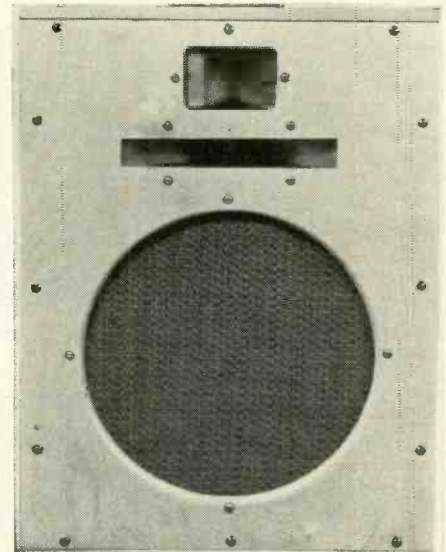

Rebel V—small version of the Klipsch.

AUDIO—HIGH FIDELITY

system they never seem to get below the lowest note of the cello, but you can readily distinguish them from the cello and they have no jukebox quality—are recognizably strings.

In other words, within its range the Rebel V is as good as the speaker used with it and suffers little in comparison with any other kind of system. Below its range it is certainly not inferior to other small speaker systems and superior to most in greater cleanness and freedom from noticeable artificial resonances. Because of this lack of resonances, the apparent definition and transient response of the speaker are improved. The sacrifice of the bottom octave and a half, just about inevitable in a small system, is a relatively small price to pay for its smallness and low price. I'm sure that those who use it with a good speaker in the \$25 class or better will be pleased with it—and it may well be more pleasing to neighbors in apartment houses than a \$500 horn capable of going all the way down.

The Rebel V comes in several models differing only in outside finish. I like the utility model (which comes with a handle and is rough and ready for just about any kind of treatment) for portable use in high-fidelity public-address systems. Incidentally, the Rebel V can be used without a corner although its efficiency below 100 cycles falls off greatly. The quality even then, however, is better than that of the case type or small reflexed enclosures generally used for portable PA systems.

Ultra-Linear ceramic cartridge

The Ultra-Linear, like the Titone I reviewed some months ago, uses a barium titanate element but with some significant differences in application. The Ultra-Linear is a single-needle cartridge available with either the microgroove or standard 3-mil needle. Two cartridges are therefore necessary for best fidelity on both new and old records. On the other hand, use of a fixed needle permits short, tight coupling of needle to element, thereby avoiding resonant effects.

Resonance is further minimized by damping the needle shaft as well as the element with viscous silicone. The success of these measures can be heard in rather surprising freedom from the resonant peaks previously associated with piezoelectric cartridges. The greatest departure from flatness is around the turnover point and even this is partly ascribable to the equalizer.

As I pointed out in my review of the Titone, the problem in applying the new ceramic cartridges is that of providing

proper equalization for modern recording curves. Literature accompanying the cartridges points out that equalization can be obtained by using a high resistance—3 to 10 megohms—in the grid circuit of the input tube. But changing to a high resistance may produce contact-potential biasing which may throw the stage into nonlinear operation.

Electro-Voice assures me that changing a 500,000-ohm resistor to 2 or 3 megohms is unlikely to produce bad effects. On the other hand, if the same stage is used as the input for a tuner, tape recorder or other high-level input, the increased grid resistance will produce excessive high-frequency losses. A simpler measure is to shunt the cartridge with a capacitance. The following gives E-V's recommendations for various grid resistor values. The db figure is the loss in gain produced by the shunting.

2 megohms	200 μf	3 db
1 megohm	800 μf	10 db
500,000 ohms	.002 μf	15.5 db
250,000 ohms	.0044 μf	21 db

Some amplifiers and control units use a cathode follower as the input tube for

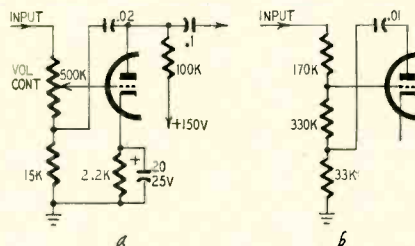

Fig. 1—Schematic diagrams show circuits for equalizing ceramic cartridges.

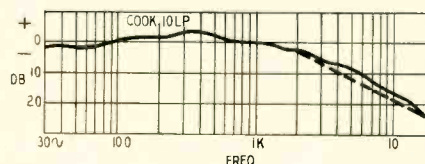

Fig. 2—Ultra-Linear cartridge response.

high-level inputs. In that case the high input resistance of the cathode follower should provide excellent equalization. But the typical amplifier or control unit uses a 500,000-ohm volume control in the high-level input. The problem is to provide adequate equalization in such an instance. Worrying about this the other day, I came upon an extremely simple solution. It consists simply of applying negative feedback around the input tube (Fig. 1-a). A single resistor and capacitor are the only parts necessary.

The curve of Fig. 2 was taken with this circuit with the volume control about two-thirds on. It shows the response to the Cook series 10LP test record. This is recorded with a flat treble, and since the Ultra-Linear (like all piezoelectric cartridges) has a sloping treble the curve also slopes beyond 1 kc. The significant thing about the

curve is the linearity beyond 2 kc. If you compare the curve with the dashed line, you will note that the maximum departure from flatness is a mere 3 db from 2,000 to 17,000 cycles. All modern recordings have pre-emphasis in the treble and the slope of the Ultra-Linear serves as a de-emphasis network.

When the volume control is turned lower, the bass is boosted; when it is turned higher, the bass is attenuated and the highs boosted. With other inputs, such as a radio or tape recorder, the circuit provides a loudness control boost of the bass which is pleasant with good hi-fi speaker systems. When the input stage has no volume control, the circuit of Fig. 1-b can be used and will provide a very similar curve but with less slope beyond 10 kc. I recommend the circuit highly; it seems to provide better quality than any other.

In this circuit the Ultra-Linear produces very gratifying listening. I doubt very much that the most golden ears could tell the difference in reproduction between it and that of most magnetics, assuming the magnetics are equalized to produce similar curves on both ends. The tests were made in a Garrard RC-90 changer. The measured distortion was about 50% higher than with the G-E cartridge, using both the Clarkstan IM record and the IM bands of the Cook series 10. However, the Ultra-Linear in the Garrard extends some 1/4 inch farther than the G-E and this results in a change in the tracking angle.

I have noted that very slight differences in tracking angle produce considerable increases in IM distortion and therefore judge that if the tracking were perfectly adjusted the IM distortion would be about on the same level as with the G-E which incidentally is better than any other cartridge I have tested in this respect.

So, here at last is a piezoelectric cartridge which qualifies in every respect for high-fidelity use. It *does* require equalization but can be equalized in several simple and inexpensive ways. When properly equalized it will compare favorably with all but the very finest and most expensive magnetic, ribbon or modulating cartridges.

Many audio enthusiasts will find it hard to believe that a piezoelectric cartridge can provide the splendid response of this unit. A trial of this one will convince them that this type has its place in the high-fidelity field.

New records review

Audiophile records are the hobby of an audiophile and represent an attempt to achieve the most complete faithfulness to the original without regard to conventions or competition and without special hi-fi effects. They were the first commercial pressings using microgroove spacing and a 1-mil needle at the 78-r.p.m. speed. This combination has a marked theoretical advantage in recording and playing back the very

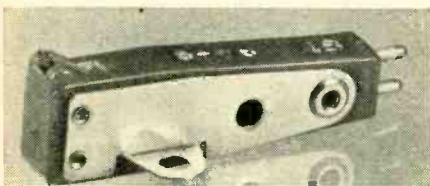

Electro-Voice Ultra-Linear cartridge.

high frequencies above 10,000 cycles. The 2.5-mil needle of the normal 78-r.p.m. system has difficulty tracing the high notes since it is larger than the cut of the chisel-shaped cutting needle. On the other hand 33 r.p.m. is too slow to provide enough room for the very rapid undulations of the frequencies above 10 kc, especially on the inner grooves of a disc.

Audiophile claims to cut frequencies up to 18 or 20 kc and the almost unique brilliance of the high end appears to testify to the truth of the claim. Aside from this, however, the review copies I received testify also to the meticulous care and pain taken in every step of the recording process. They are recorded with a modified AES curve—a crossover of 300 cycles and a slope of 10 db at 10 kc. But they are so remarkably low in distortion that they can be played back with a flat treble equalizer and the boost thus provided produces a spectacular brilliance at normal listening levels with equipment which itself contributes little or no distortion.

With one exception, none of the Audiophile records reviewed had any special hi-fi effects. Their virtue is entirely in faithfulness, realism and presence which are unsurpassed and only occasionally approached by 33-r.p.m. discs. In fact, it is the very next thing to the faithfulness of the finest 15-i.p.s. master tapes.

They do, however, offer an excellent measure of system distortion; if you hear any distortion, you can safely ascribe almost all of it to your own equipment. I rather doubt that the most critically golden ear could discern the distortion on the records themselves.

The catalog is largely devoted to jazz of the Chicago and New Orleans schools and all the discs are about equally good in quality, with the later numbers having a slight edge. They are available from many radio parts distributors, as well as record shops, at \$5.95. Catalogs are obtainable from Audiophile Records, Inc., Saukville, Wis.

Dixieland Jazz
Harry Blons and Band

Audiophile AP-1

This was recorded in 1950 and it is a shock to note that even the best of today's 33 r.p.m.'s have a good distance to go before they can equal the realism of this original Audiophile—if indeed, they ever can at the slower speed.

Syncopated Chamber Music
Red Nichols and Band

Audiophile AP-7

For anyone with memories of the 'Twenties it is a really extraordinary experience to hear Red Nichols as big and real as life itself. If your father did his dancing and romancing in the jazz age, this would be a present that will bring back everything but the bathtub gin.

BACH: Toccata and Fugue in D Minor
Prelude and Fugue in E Minor

Robert Noehren, solo organ

Audiophile AP-9

The bass of this is not as good or as spectacular as that on the Aeolian-Skinner records, possibly because the organ itself had a limited pedal organ, but the highs are better.

Echoes of the Thunderstorm
Crazy Quilt

Audiophile AP-20 (33 r.p.m.)

Acceding to the demand for something resembling the quality of the above 78-r.p.m. discs, Audiophile has issued a small catalog of 33-r.p.m. discs. Of these this is not only the most spectacular but possibly the demonstration record to end demonstrations. (This might be literally true if you play the *Thunderstorm* at too high a level, for the thunderbursts might well rupture speakers.)

Side A is a recording of a thunderstorm of really frightening realism—provided you have a system that can take it and dish it out down to at least 30 cycles and won't block or go into oscillation when excited by what may well be the highest transients ever put in a groove.

Side B offers some other unique material. The buzz-saw in band 1 is not too difficult; but the hammering of a rather amateur carpenter in band 2 can be real enough to call for aspirin. It will sound fairly good on anything, but on a superb system the dullness of the blows is possibly the best available test of transient response. Anything short of absolute verisimilitude is the fault of the speakers or amplifier.

Band 3 is an extremely realistic reproduction of a faucet filling a bucket with water—but be sure to announce this fact before you play it, to spare embarrassment, especially in mixed company. The next three bands are percussion bands with superb transient response and the final two are brilliantly clean and bright music boxes. All of this will be gratifying on any system which doesn't go into oscillation, motorboating or breathing. In A-B comparisons it winnows the merely fine from the superb systems like an overfed dog winnowing the hunks of meat from the stale potatoes in a stew.

Encore
Chicago Symphony Woodwind
Quintet

Audiophile AP-17 (33 r.p.m.)

Audiophile apologizes for the 33-r.p.m. discs in its catalog and lists them as grade B, but this is one of the most realistic renderings of a small woodwind group short of the original live sound itself. I know of nothing better for demonstrating the realism, naturalness or presence of hi-fi systems. And it is especially good for this because the selections are all old favorites such as the *March of the Little Tin Soldiers*, *Entrance of the Little Fauns*, *Gollivog's Cukewalk*, etc. If you play it with "flat" treble, you will hear an unusual type of intermodulation when the wind of the players rides the melody.

Note: Records below are 12-inch LP and play back with RIAA curve unless otherwise indicated.

BARTOK: Music for Strings, Percussion and Celesta
MILHAUD: Concerto for Percussion and Small Orchestra
CHAVEZ: Toccata for Percussion
Capitol P-8299

On the jacket Capitol says: "High-fidelity enthusiasts will find it unusually rewarding." This is one of the most unlikely understatements I have seen for some time. As a matter of fact, it's as good a demonstration and test record as there is on the market.

The *Toccata for Percussion* is rich in percussion effects. The Milhaud has the most tuneful music and a tremendous drum. The Bartok has the fewest percussion effects but contributes some very fine, sharp, edgy strings in choirs, a good string bass very well contrasted with the drums especially in the second movement, a sharp piano and a very dull highly damped drum, plus tympani played with varying pitch. A record every audiophile should enjoy highly though I'm not sure that even this musical disguise of the percussives will endear it to the rest of the family.

STRAVINSKY: History of a Soldier
Emanuel Vardi conducting Instrumental Ensemble
Vox PL-8990

Here is one of the very few 33-r.p.m. discs which approaches the 78-r.p.m. Audiophiles in presence and realism. A sort of fairy story set to music, a large part is voice narration and dia-

logue but there is some notable music and sound including a beautiful double bass, trumpet and flute and some excellent percussives, particularly one of the very best big but dull drums on records. The overall sound has a real-life stage liveness. This seems to me the best record in the Vox catalog and one of the best of the year in any catalog.

HOVHANES: Incidental Music for "The Flowering Peach"
Suite: Is there Survival
Orbit No. 1
Composer conducting small ensemble.

MGM E-3164

Extraordinary music and sound, very well recorded and with stunning high-fidelity quality, which needs fine systems to be heard at its best. The "Flowering Peach" is the Broadway play about Noah and the Ark and the music has some remarkable onomatopoeic moments. As music this is easier to take than the previous disc but I think it will please after very few hearings.

BACH: Concerto for Two Violins in D Minor
Concerto for Violin in A Minor
Concerto for Violin in E Major

Reinhold Barchet and Will Beh, violins
Pro Musica String Orchestra of Stuttgart
Vox PL-9150

GRIEG: String Quartet in G Major
RACHMANINOFF: String Quartet in G Minor

Guilet String Quartet
MGM E-3133

MENDELSSOHN: Trio No. 1 in D Minor
Trio No. 2 in C Minor

Trio de Bolzano
Vox PL-9160

RAVEL: Introduction and Allegro
For Harp, Flute, Clarinet and Strings
DEBUSSY: Dances, Sacred and Profane
Harp and Strings

SCHOENBERG: Transfigured Night
String Quartet
Capitol P-8304

Chamber music, well recorded and well played back, is likely to sound more real and alive with most systems than orchestral works. This is because it is easier to imagine a small group in one's living room and because they are usually recorded close up and achieve an intimacy and immediacy which are impossible with large orchestras. I have chosen the above from current chamber works as good examples of this "presence." The two-violin Bach concerto is one of the most melodic pieces in the classical literature. The Grieg and Rachmaninoff quartets are romantically pleasant to take and the four instruments are sharply defined. The same is true of the trios for piano, fiddle and cello. The Capitol offers the most varied fare and the widest assortment of test and demonstration effects, and this is possibly the easiest of all Schoenberg works to take.

END
Names and addresses of manufacturers of any items mentioned in this column may be obtained by writing Monitor. RADIO ELECTRONICS, 25 West Broadway, New York 7, N.Y.

NEW FRENCH TV STAMP



France recently issued a special television stamp in the denomination of 15 francs. This particular stamp is approximately 1½" wide. It shows typical French TV antennas, as well as the TV antenna on the Eiffel Tower. The waves around the Eiffel Tower are printed in light blue.



The Vocatrol—adapter socket is at left.

What's new in... Commercial Killers, Tape Applications and Transistorized Receivers

By SOL HELLER

WHILE some commercials are better than the program on which they occur, many are quite objectionable. Who hasn't sometimes wished for a gadget that would eliminate the sales spiels during some jam or long-hair music session? The Vocatrol Corp. of Cambridge, Mass., is putting out such a device, and an ingenious little circuit it is.

Vocatrol, as the gadget is called, "listens" sympathetically to music; when speech comes on, however, Vocatrol cuts off the radio or TV set. How such a differentiation between speech and music is possible is extremely interesting:

Both music and speech sounds go through rapid increases and decreases in level. In speech, however, the level

drops more rapidly than in music and deep drops occur more frequently. This significant difference is electronically exploited in the Vocatrol. The average rapid drops in level of speech sounds, incidentally, show a decrease rate of about 400 db per second; a total amplitude drop of roughly 20 db and a duration of about 50 milliseconds. A block diagram of the circuitry used is shown in Fig. 1, the schematic in Fig. 2.

The input signal is taken from the audio stage in a TV set or radio by an adapter socket (see photo) into which one of the receiver's audio tubes is placed (Fig. 3). This input signal is monitored by Vocatrol. During speech, a negative d.c. voltage is fed back to the grid of an audio amplifier (the same tube which connects to its circuit through the Vocatrol adapter). The

input signal is not affected by the negative d.c. voltage fed back to the audio amplifier during speech, and Vocatrol's monitoring function thus remains unimpaired.

A bandpass filter in the grid and plate circuits of V1 passes the vowel sounds in speech but rejects hum and sibilant sounds (such as "s"). These sounds tend to reduce the amplitude of rapid level drops which is undesirable, since such a reduction blurs the difference between music and speech, as seen by Vocatrol.

The audio control is amplified in V1 and rectified in V2-a, a level detector. This stage produces a d.c. voltage proportional to, and a measure of, the input signal level. Unless the signals were converted to d.c. in this way, Vocatrol would be unable to distinguish

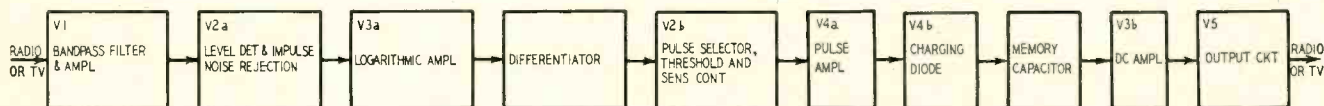

Fig. 1—Block diagram shows sequence of circuits contained in the Vocatrol. Each unit plays an important function.

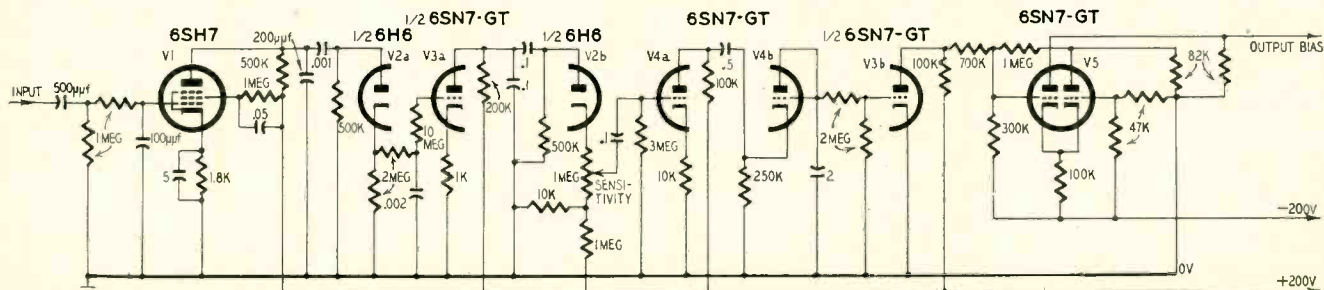
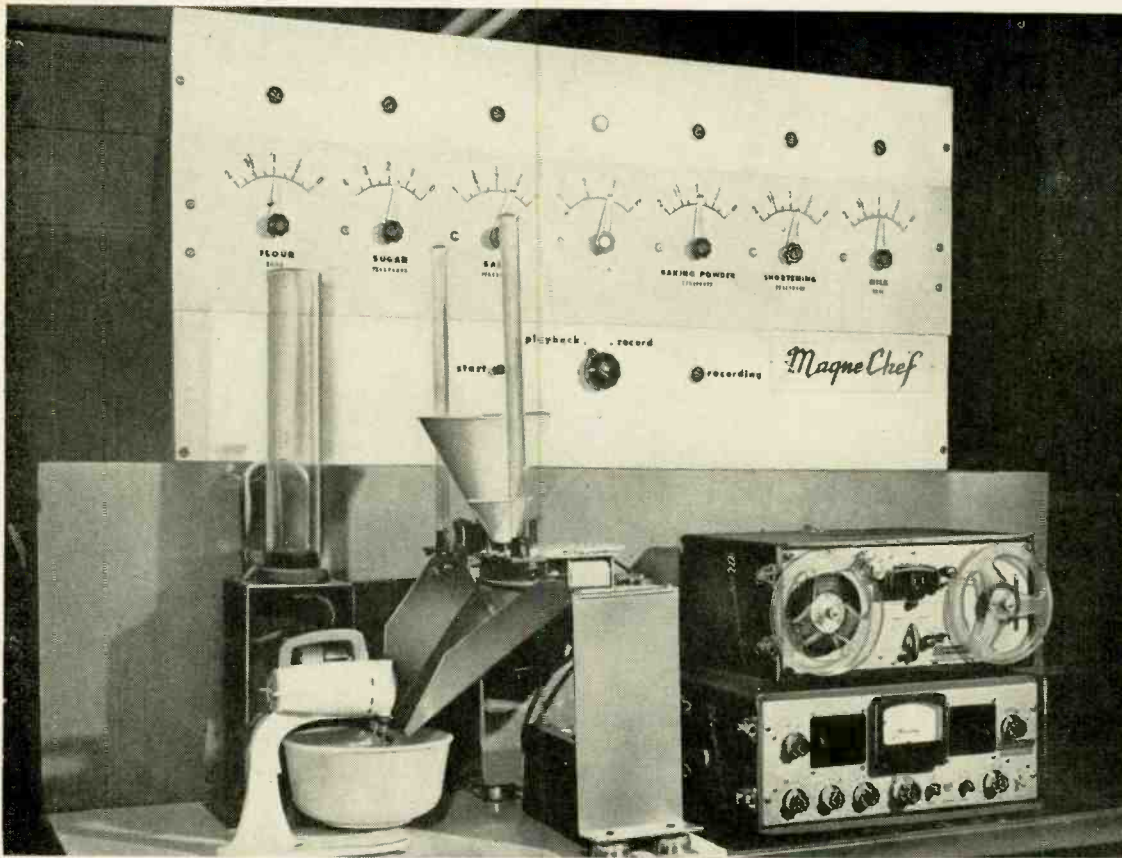

Fig. 2—Schematic of the Vocatrol, an automatic music-speech discriminator. The values of all components are shown.



The MagneChef cake-making apparatus. Control board adjusts amount of each cake ingredient to be used.

between speech and music, since the basis of comparison used is the d.c. level of each.

The filter in the output circuit of V2-a rejects impulse noise—the most prevalent type of radio static. Such noise must be rejected to prevent it from affecting the d.c. level relationships of speech and music signals. The time constant of the filter is such that the V2-a output correctly follows the rapid drops in speech, but does not respond to the noise.

Logarithmic amplifier V3-a produces a constant voltage per decibel of signal-level change, regardless of the sound

level at which the signal change occurs. This stage prevents shifts in program sound levels from affecting the differences between music and speech. A 24-db drop in signal produces twice as much output voltage in this stage as a 12-db drop, although the corresponding input signals differ in amplitude by only 25%.

The time constant of the differentiator circuit feeding the plate of V2-b is such that the average rapid changes in the level of speech sounds are not attenuated. Slow audio changes—such as the gradual amplitude reductions characteristic of music—are, however, greatly attenuated.

Rapid level drops in signal at the input of V2-b produce positive pulses at the V2-b output. Rapid level increases produce negative pulses at the output. Vocatrol is not interested in rapid level increases, because music and speech do not differ sufficiently with respect to this characteristic to permit its exploitation—the negative pulses are therefore rejected. Small-amplitude pulses of either polarity are rejected as well. The reason for this is rapid level drops (as well as increases) of small amplitude occur in music. If these were not filtered out, Vocatrol might sometimes interpret music as speech and cut it off. Only pulses large enough to overcome the threshold bias of V2-b are permitted to get through this circuit.

There are certain kinds of program material—patter songs with a faint orchestra accompaniment, for instance—which may be classified as either

speech or music by different listeners. Acceptance or rejection of such borderline material is permitted by adjustment of a sensitivity control in V2-b.

The control is on the front panel. Three settings are provided: NORM, LO and HIGH. At the NORM setting, practically all kinds of music will be accepted, while most announcers will not. A LO setting may be needed when very choppy popular music is tuned in. HIGH is appropriate for announcers who slur their words. Interestingly enough, most “singing commercials” are recognized as speech and cut off in the NORM position.

The output of pulse amplifier V4-a connects through diode V4-b to a 2- μ f memory capacitor which charges quickly through the low impedance of the diode—it discharges slowly through two large resistors. The charge across the capacitor at any instant depends on the frequency and amplitude of the pulses that have been applied to it during the previous few seconds.

When speech signals arrive at the input of the Vocatrol, an appreciable voltage is developed across the memory capacitor. This voltage is amplified by V3-b and transferred to multivibrator stage V5. The multivibrator, inoperative when no—or insufficient input—signal is applied to it, is triggered by the voltage transferred from V3-b to its input grid. A negative voltage is developed across one of the multivibrator's plate resistors during its operation. This voltage is fed as a bias to an audio amplifier in the radio or TV set and cuts this tube off.

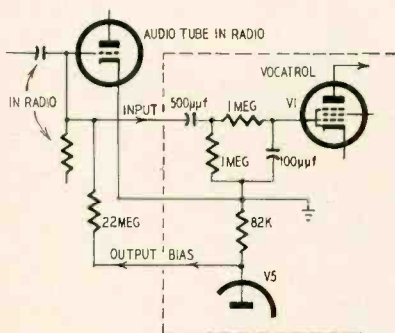

Fig. 3—Vocatrol connection to receiver.

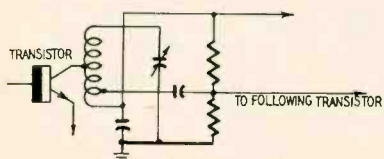

Fig. 4—Interstage coupling network in transistorized receiver i.f. stage.

TECHNICAL REPORTS

Sometimes Vocatrol is fooled momentarily by an announcer who mumbles or pauses too long between sentences (an infrequent occurrence, since commercial time is so costly). In such cases, speech may come through for an instant, but is cut off almost immediately.

Tape recorder bakes cake

Magnecord engineers recently demonstrated that a cake can be made by an automation process using a tape recorder as the "cook." Magnecord has disavowed any intention of displacing the housewife; its only purpose, according to the company, is to show that automation can be applied to almost any industrial operation. The same techniques used in the *MagneChef* cake-making operation are being perfected for various industrial and scientific applications.

The *MagneChef* is a very simple machine compared with some automation units. It consists, basically, of a standard PT63 recorder and amplifier. The unit connects, through electronic relays, to containers or tubes filled with various cake ingredients and to a conventional household electric mixer (see photo). Indicator devices on a large control board permit the amounts of each ingredient to be suitably varied. Lights above the indicators show which phase of the cake-baking operation is taking place.

The operator simply has to get a recipe and select (on the indicator board) the amounts of flour, baking powder, eggs and other ingredients required. He then starts the machine recording. When the recorder has made a tape of this data, the operator plays back the tape. Correct amounts of the various ingredients now automatically pass into the mixing bowl, in the proper sequence, and the mixer is turned on. When everything has been properly mixed and blended, the mixer shuts off. The cake is now ready to enter the oven. The whole process takes approximately 3 minutes.

Maybe it'll soon be time to revise an old song title to: "If I'd known you were coming, I'd have taped a cake."

Transistorized radio circuits

Transistorized broadcast radios are already on the market. What differences in receiver design are to be expected in them?

First, why is transistorization winning favor? A few of the advantages are: decrease in receiver size and weight, more efficient battery operation (of portable sets), greater assurance of troublefree operation (transistors have an indefinitely long life).

The block diagram of a transistorized radio is not basically different from that of a conventional broadcast receiver. There are, however, important circuit differences; these are necessary to exploit the advantages and counteract the limitations of transistors.

One mixed blessing is that the tran-

sistor is a low-impedance device. It therefore draws power from the signal source (unlike a class-A vacuum-tube amplifier). This power is amplified by the transistor and applied to its load, which may be another transistor.

Power losses must be minimized, particularly in r.f. and i.f. stages, since the gain of transistors in this frequency range is appreciably lower than that of tubes. One means of minimizing such power losses in i.f. stages is to keep the coupling impedance low. The output impedance of an i.f. stage, and the input impedance of the one following it, must therefore be made low enough to damp the impedance of the coupling network between them—power losses in this network are thus reduced.

Selectivity is also reduced by such damping, since the coupling circuits are tuned. To make up for this tendency toward reduced selectivity, the Q of the coupling circuits (unloaded) must be made very high so that a moderately high Q will be retained in these circuits even when they are loaded down. Miniaturized high-quality ferrite type coils will probably be used to attain such high Q 's.

The lower gain of transistors in comparison to tubes necessitates a greater number of them. Single instead of double-tuned coupling circuits will probably be used since the greater number of tuned coupling circuits will provide as much selectivity as the smaller number of double-tuned units do in a tube type set.

Transistors are usually connected to a tap on the tuned circuit (Fig. 4) rather than across the entire tank. Higher Q 's can be obtained more economically in the tuned circuits by this technique. Furthermore, changes in transistor characteristics are not as apt to affect the tuning when such a

connection is made. This technique provides impedance matching—vital in a power amplification system of the transistor type.

Transistor detectors offer marked advantages over vacuum-tube diode detectors. For one thing, fairly linear detection can be obtained at lower signal inputs. This means that less amplification need be used before the detector. Since transistors can produce higher gain in audio stages than they can in r.f. or i.f. circuits, the number of transistors required in the receiver is reduced. The fact that a transistor detector provides considerable gain and thus functions as a first audio stage as well as a second detector also contributes to the reduction.

Stages in a transistorized receiver require relatively low supply voltages. A 3-volt supply will be sufficient for all except the power amplifier and the driver stage preceding it—6 volts may be required here. Series-connected 1.5-volt cells are capable of supplying these voltages. The very low current drain of transistors—1 ma or less, mostly less—permits the use of conventional, inexpensive batteries. Very low operating costs—an important point in portable sets especially—thus become possible.

A notable stride was taken recently with the announcement by Philco and RCA of the transistorized automobile radio receiver. That this was bound to come was inevitable since the transistor lends itself so readily to a car with its limited power supply and space. Furthermore, the rapid increase in the development of power transistors provides the finishing touch to a complete line of these units for normal broadcast reception. Each new advance in transistor design should provide new and interesting circuits. END

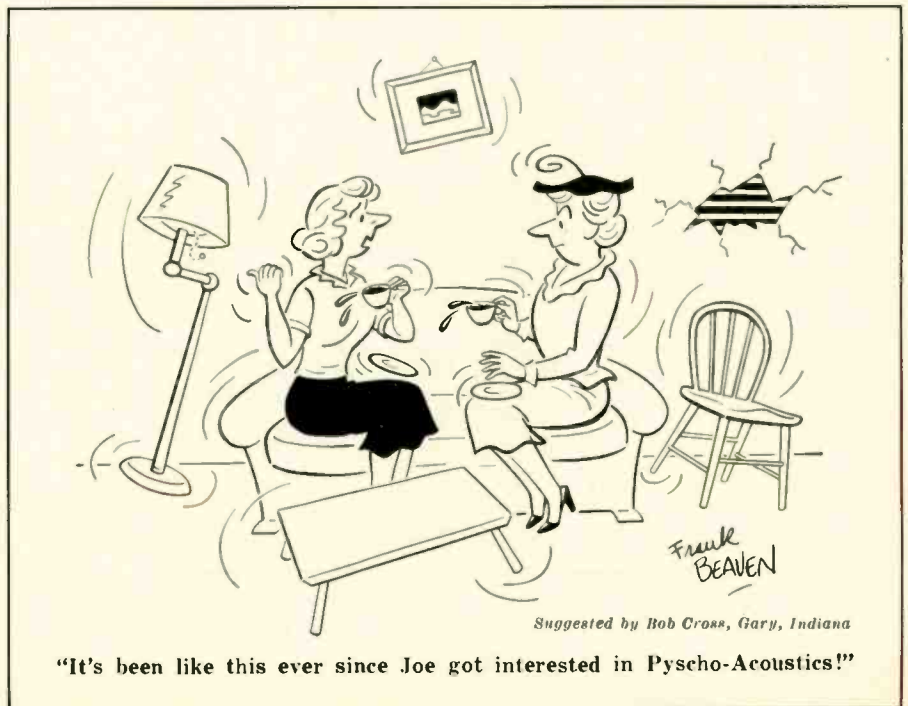

By JOSEPH BRAUNBECK

Communication on

SECONDARY WAVES SECONDARY WAVES

NOT much attention is generally paid to the fact that every antenna reradiates part of the high-frequency energy it absorbs from the field of the transmitter. This same principle enables us to see things illuminated by light. If the object is not black, it reradiates a part of the light it gets by illumination. Re-radiation on a certain frequency becomes much stronger if you connect a resonant circuit to the antenna. Though similar effects were heard in the days of crystal sets and one-tubers, it is not well known that it is possible to modulate the secondary radiation of any antenna by connecting it to one of the circuits described here. So without using an oscillator you can use secondary transmissions to send signals up to 60 feet. This is sufficient for experiments or for electronic baby-sitting.

The principle of any secondary-wave modulator is shown in Fig. 1. A resonant circuit (L-C) is connected to the antenna. An antenna wire several yards long is sufficient, but longer antennas of any form give better results. The resonant circuit consists of any broadcast coil and a normal 365- or 500- μf variable capacitor tuned to the station whose carrier you want to modulate. Signal strength of the station is not very important. Of course, a strong station gives strong secondary waves, but it also blankets your reradiated signal a short distance from your antenna.

Fig. 1 shows two switches connected in the resonant circuit. The amplitude of the reradiated carrier may be reduced either by shorting the variable capacitor with S1 or by disconnecting the ground with S2. Opening and closing one of the switches at a rate of, say, 500 times per second would result in a tone being heard in any nearby receiver tuned to the same station. As the mechanical operation of one of the switches would be difficult, it is advisable to substitute an electronic device.

Fig. 2 shows a circuit for single-tone modulation of the reradiated carrier. A small neon lamp takes the place of S1. Any low-voltage type without built-in resistance will do. Together with C2 and R the neon tube forms a relaxation oscillator. As the internal a.c.-resistance

of a fired neon lamp is very low, the resonant circuit is shorted every time the tube fires. In the moments the tube is dark, there is no short for the r.f. voltage. Though this simple circuit is very convenient for studying the distance at which the modulated secondary wave can be heard, it will not be satisfactory for giving single tone signals. As can be seen from the next circuits, it is very simple to modulate the secondary wave with phone.

In Fig. 3 the simplest possible phone modulator for secondary waves is shown. A carbon microphone takes the place of S2 in Fig. 1. Everything picked up by the microphone will be heard in any nearby receiver. You can add your commentary to broadcast transmissions or use the unit as an office intercom. If you install the modulator by baby's bed and tune it to your favorite station, you will hear if baby screams as you listen to broadcasts. Of course there is no hi-fi reproduction with a carbon microphone. If better quality is wanted, the circuit of Fig. 4 may be used. It is essentially a crystal set. If you have one already, you may use it. Modulation is based on the fact that the input impedance of a rectifier circuit varies when a voltage source is connected to the output. The audio voltage generated by the sound-powered microphone affects the input impedance of the crystal set and, therefore, the amplitude of the secondary wave. Instead of a sound-powered mike a single 2,000-ohm headset will do. You may also connect an electromagnetic pickup to the modulator to mix the broadcast program with your own background music.

If it is desired to work on other bands (for example, the shortwave or v.h.f. amateur bands), it is necessary only to alter the resonant circuits of the modulators described above. For experiments on v.h.f. it will be possible to use special circuits as shown in Figs. 5 and 6. The reradiating antenna is a folded half-wave dipole made from 300-ohm transmission line.

The carbon mike is connected at the middle. At higher frequencies the circuit of Fig. 6 gives better results because of its lower capacitance. At very short wavelengths results largely depend on the location of the secondary radiator. With a modulator like that in

Fig. 6, good results were obtained in the 144- and 220-meter amateur bands, using standard ham gear for receiver and transmitter.

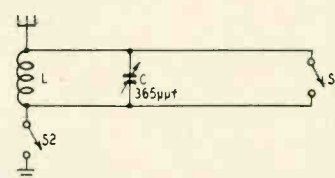

Fig. 1—Basic reradiating antenna.

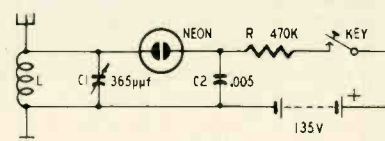

Fig. 2—Circuit for tone modulation.

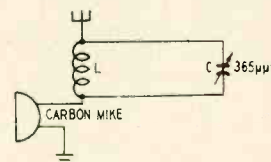

Fig. 3—Carbon mike replaces switch.

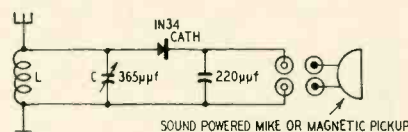

Fig. 4—A radiotelephone modulator.

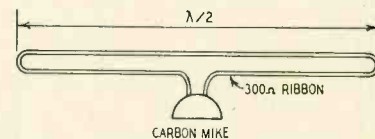

Fig. 5—Modulator for v.h.f. bands.

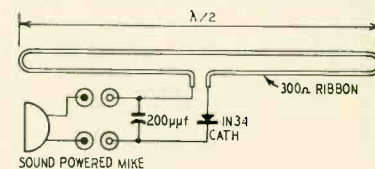

Fig. 6—Another v.h.f. modulator.

The receiver antenna should be rather short for good reception of secondary waves. Using the directional selectivity of ferrite rods or dipoles, it is often possible to suppress the original carrier and thus increase the range of the secondary transmitter.

END



Author shown with the transistorized circuit.

TRANSISTORIZED INTERFLEX RECEIVER

A 1955 version of a unique circuit popularized 30 years ago

By DR. WILLIAM H. GRACE, JR.

SOME readers of RADIO-ELECTRONICS will remember the famous and popular *Interflex* circuit devised by Mr. Hugo Gernsback in 1925. Many thousands of experimenters built sets with this unique circuit in that early period of radio history. For those who have forgotten the circuit or who were not in radio at that time, the following is a brief resume of its opera-

tion taken from Mr. Gernsback's original description:

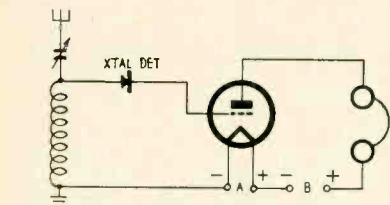

Fig. 1—The original Interflex circuit.

tion taken from Mr. Gernsback's original description:

"Fig. 1 shows how the crystal detector is *directly* connected into the grid of a tube. The circuit is not of the reflex type, nor is there regeneration in any form. The crystal in the grid circuit acts as a detector, while the vacuum tube acts as an amplifier. The amplification obtained is from 10 to 20, and may be greater in some cases. In other words, by using a crystal detector, the addition of the tube will give real amplification. The circuit is remarkable in that there is no distortion and reception of the signal is clearer than when the tube is used alone."

It may be interesting to "historians" among the readers to note that it was also from this same circuit that Mr. Gernsback developed his successful one-tube loudspeaker circuit, the *Megadyne*,

at a later date. It may also be of interest to note that the *Interflex*—in a slightly modified form—is used in modern TV video detector-amplifier circuits. Recalling the excellent results obtained from the *Interflex* years ago, I decided to see if this system could be adapted to a transistor in place of a tube. A breadboard layout was assembled (see photo) and the results were extremely satisfactory both as to clarity and volume. This transistor adaptation, using no r.f. amplification, has limitations for dx reception. But its performance on local stations from the suburban New York area left little to be desired. A volume control was needed to prevent blocking or clipping in the transistor. On about half of the 20-odd stations received, the volume control

The circuitry, however, is seldom such that a transistor can be substituted for a tube. It is practical to assemble circuits with transistors analogous to those commonly used with tubes. Fortunately, substituting a junction transistor of the correct type for the tube in the *Interflex* circuit is a simple matter. Both the RR115 junction transistor and the germanium diode (a 1N64) used in this circuit are Radio Receptor Co. products. These elements are reasonably priced and work well as a team. Other crystal diodes and triodes may work nicely but those mentioned seemed particularly suited to this circuit. Of course, the diode performs the rectification and the transistor the amplification. As with the old tube circuit, fidelity and volume appear to be superior to that obtained when the transistor is used alone as a rectifier-amplifier.

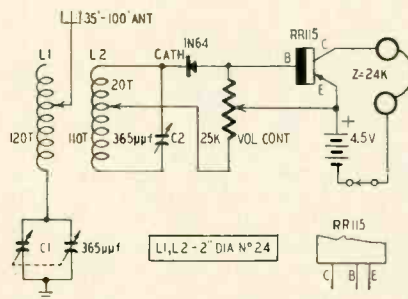
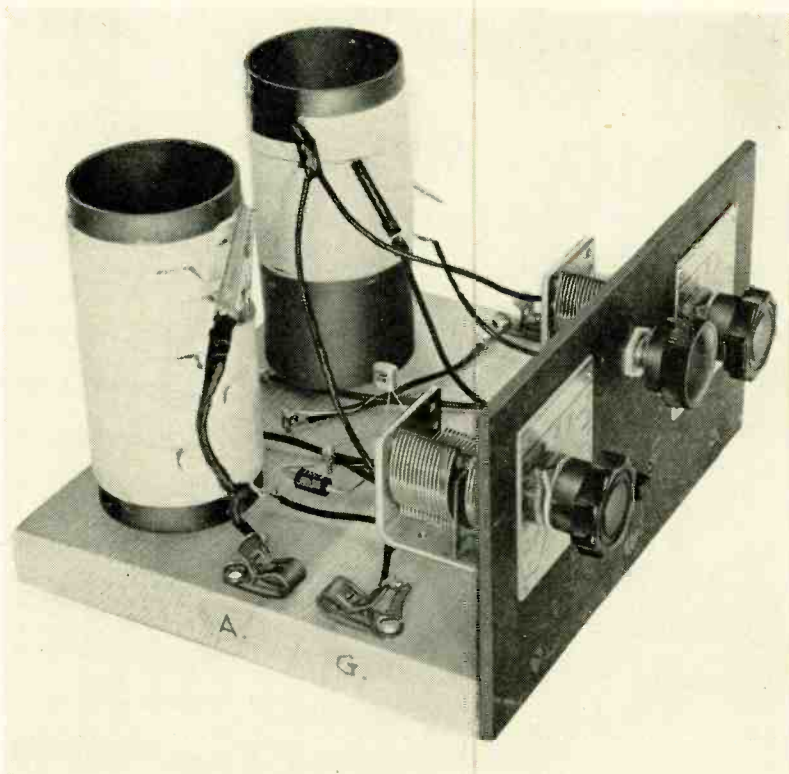

Fig. 2—Diagram of Interflex receiver.

had to be used to reduce the headphone level for comfortable listening.

Transistors may be compared to vacuum tubes, in an electronic sense, if it is remembered that the base corresponds to the grid, the emitter to the cathode and the collector to the plate.

Fig. 2 shows the circuit. The diode is connected exactly as in the original *Interflex*, but goes directly to the base of the transistor rather than to the grid of the tube. The emitter is tapped into inductance L2 at about 20 turns from the top. A few more turns will increase the strength of the signal but will broaden the tuning somewhat; a few less turns will lessen volume while increasing selectivity. This is fundamental engineering—the idea is to secure a fair impedance match. With this *Interflex* system, no large base series-capacitance is required as is usually found in conventional audio circuits following a diode. No bias resistor is used in this arrangement. The selectivity of the receiver can, of course, be controlled by altering the mutual coupling between L1 and L2. In general, these coils, mounted parallel to each other, may



The transistorized Interflex receiver.

of the tapped portion of the single-layer coil for a favorable impedance match.

Experiment with more or fewer turns for best results. However, the constructor should first lay out the circuit with single-layer coils, breadboard fashion, until performance is correct. This arrangement often saves much time and disappointment. Then, after the bugs are removed, the receiver may be housed in any manner desired.

Tuning the receiver (Fig. 2) is simple. Capacitor C1 resonates the antenna-ground circuit, C2 tunes the secondary. Many local broadcast stations should be heard with headphone-volume of such degree that the volume control will be found necessary to reduce it to the point of comfort. Quality should be excellent with unusual clarity, a characteristic of the circuit. The wide range of audio frequencies received makes listening a real pleasure. There should be no hiss or hum and little transistor noise to mar or interrupt the reception of voice or music.

The output side of any transistor circuit is generally the high-impedance side and, naturally, to secure the best efficiency, it should be fed into a high-impedance load—in this case the phones. This is the reason why fairly high-impedance magnetic phones will work best. Low-impedance phones should not be used unless a suitable matching transformer is provided. It is not necessary to use a long antenna to obtain good headphone volume, but at least 35 to 60 feet of flat top should be used if possible. Readers who have an antenna about 80 to 100 feet long will find the volume proportionately louder and will very likely get satisfactory dx results.

Having had some amount of experience with other transistor receivers, I found this circuit outperformed by a wide margin any similar circuit for clarity and volume on local stations. Numerous stations showed sufficient volume to be enjoyable on an old magnetic speaker without a second stage

Parts for Interflex receiver

- 1—25,000-ohm potentiometer; 1—2-gang variable capacitor, 365 μf; 1—variable capacitor, 365 μf;
- 1—diode (Radio Receptor 1N64 or equivalent); 1—transistor (Radio Receptor RR115 or equivalent);
- 3—1.5-volt penlight cells; 2—coil forms, 2-inch diameter, 5-6 inches long; 1—s.p.s.t. switch; 6—Fahnstock clips; 1/2 pound cotton- or enamel-covered No. 24 copper wire; 25 feet hookup wire; 1—breadboard; 1—alligator clip; 1—front panel; 3—knobs.

easily be shifted closer or farther apart to suit the selectivity required at the location of the builder. It was found that a 6-inch separation between coil centers gave very selective results and separated locals with no cross-talk to speak of.

Fig. 3 shows two circuits with single-dial tuning arrangements which worked fairly well though not as flexible or selective as the tuned-primary-tuned-secondary arrangement in Fig. 2. However, either of these single-dial versions will give about equal volume and will work well on antennas about 40 to 60 feet long. An interesting way to get good pickup from a short antenna of around 30 feet is to insert a ferrite coil, waterproofed by tape wrappings about at the midpoint of the antenna's length or just connected in series with

the antenna at the point where the lead-in is taken off. This trick requires some experiment to determine the best place to connect, but often results in a much better signal when you are forced to use a very short antenna for reception.

For experimenters not too familiar with transistors, it must be emphasized that battery polarity is *most important*. While the RR115 is a rugged specimen, metal encased against humidity, it will be damaged or ruined if the battery is incorrectly connected. A simple way of remembering how either p-n-p or n-p-n transistors are to be connected is to note the middle letter (p or n) then always connect the collector to the symbol indicated (if the middle letter is n, the negative side of the battery goes to the collector; if p, the positive side). This rule applies to either junction or point-contact types of transistors. Remembering it may save you the expense of purchasing new transistors.

Construction and operation

Because of the simplicity of the circuit and the assembly in general, no detailed description of construction is required. The builder may assemble the few parts needed either breadboard style or packaged in a small cabinet. For compactness, ferrite coils may be substituted for the single-layer inductances, in which case the ferrite coil used as the secondary will require about 35 or 40 turns of fine enamel wire wound over the outer cardboard shell. This winding is connected to the diode and to the emitter and takes the place

of audio amplification. If a following stage of push-pull transistor audio is added, the performance is almost hard to believe for so simple an electronic circuit.

If after building this single-transistor receiver, any readers are interested in the details of a push-pull stage designed for this set, the author will be pleased to describe it in a future article. Just let our editor know your wishes. Happy listening! END

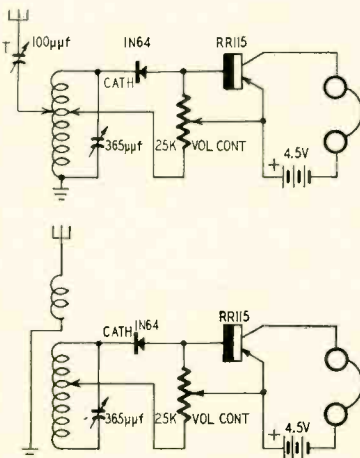

Fig. 3—Single-dial tuning arrangement

Solving Service Problems with a STRAIGHTEDGE

By H. P. MANLY

QUESTION: Why should anyone use two resistors connected together when a single unit would provide the same resistance?

Answers: Maybe the single unit isn't on hand. If it is on hand, the wattage rating may be too low for the power to be dissipated or the voltage rating may be less than the potential difference to be applied. It might be a matter of tolerances; you can match 10 or 20% resistors for 1% or better.

A similar question might be asked about using two capacitors connected together, and answers would be the same—except that seldom are we concerned with capacitor power dissipation when servicing receivers.

So long as two or more resistors are connected *in series* it takes but a moment to figure out the sum, because series resistances add together for the total resistance. They subtract when one or more resistors are removed from the series string.

Everything is equally simple so long as any number of capacitors are connected *in parallel*. Paralleled capacitances add together for total capacitance, and it is a matter of simple subtraction when one or more units are removed.

But series resistors and parallel capacitors are the solutions for only half the problems that arise. These series resistors or parallel capacitors are perfect when you need more resistance or more capacitance than in any one unit on hand. But they are useless when there is to be less resistance or less capacitance than in any one available unit. Then we must resort to parallel resistors or series capacitors.

The book says, "The combined value of resistors in parallel or capacitors in series is equal to the reciprocal of the sum of the reciprocals of the individual unit values." Probably you struggled with this one in school.

The rule is correct, no doubt of that, but try it on some problem like this: You need 15 μmf and have no capacitor of that value. But you do have several 47- μmf units and a few of various other values. What can you connect in series with 47 μmf to obtain 15 μmf ? Or maybe you want 210 ohms when the stock drawer yields only a half-dozen 1,000-ohm resistors and various smaller values, but not 210 ohms. What to connect in parallel with 1,000 ohms to provide 210 ohms, that's the question.

Fortunately, there are simpler rules than the one about reciprocals. Here is the first one: The combined value of

two resistors in parallel or of two capacitors in series is equal to their product divided by their sum. Calling the separate units A and B, the rule becomes

$$\frac{A \times B}{A + B} = \text{combined value}$$

This rule or formula is all right when you want the combined value of two units whose separate values are known. But it won't help with the problem of what to connect in series with 47 μmf to obtain 15 μmf . For such problems there is a different rule, equally simple. It is this:

A resistance to be connected in parallel or a capacitance in series with a known value to obtain a desired value is equal to the product of the known and desired values divided by their difference, not their sum. Calling the known (on hand) value A and the desired value Y the rule becomes

$$\frac{A \times Y}{A - Y} = \text{value of unit to be added}$$

Let's go back to the capacitors, where the known or on-hand value is 47 μmf and the desired value is 15 μmf . Here they are in the formula:

$$\frac{47 \times 15}{47 - 15} = \frac{705}{32} = 22.03 \mu\text{mf (in series)}$$

Thus we learn that a 22- μmf capacitor in series with a 47- μmf unit will give very close to 15 μmf —actually about 14.98 μmf , close enough for all practical purposes.

The resistor problem works out this way.

$$\frac{1,000 \times 210}{1,000 - 210} = \frac{210,000}{790} = 266 \text{ ohms (in parallel)}$$

If you can find a 270-ohm resistor (close enough to 266 ohms for practical purposes) and connect it in parallel with 1,000 ohms, the combination will provide 212.5 ohms. This is only a little more than 1% from the desired 210 ohms.

Using the straightedge

Even though the arithmetic is simple, it takes time. Few of us feel like covering a sheet of paper with figures while checking various combinations of what we have and what we want.

The accompanying alignment chart or nomograph will solve any one of these problems in a few seconds, and all you need is a straightedge such as a

ruler or a folded piece of paper to lay across the scales. The chart works for resistances in parallel and for capacitances in series. You may read scale numbers as ohms or megohms of resistance or as microfarads or micro-microfarads of capacitance—provided you read the same unit on all scales and throughout each problem.

The chart is in two sections, each consisting of three numbered scales. The two outer scales of either section apply to two resistances in parallel or two capacitances in series. The center scale gives combined parallel resistance or series capacitance.

Numbers on the outer scales of the left-hand section run from 5 to 200 and on the right-hand section from 100 to 4,000. However, the scales may be used for values any amount less than 5 or greater than 4,000, simply by multiplying or dividing with the same number all the values on all three scales being used for a problem.

As an example, dividing all scale values of the left-hand section of the chart by 10 would make the range 0.5 to 20 on the outer scales and 0.26 to 10 on the center scale, in any units. Multiplying all scale values on the right-hand section by 100 would make the outer scale range 10,000 to 400,000 and the center scale 5,000 to 200,000, in any units of resistance or capacitance.

For practice, place a straightedge at 24 and at 8 on the outer scales of the left-hand section of the chart. The straightedge crosses the center scale at 6. This answers any of several questions:

What is the capacitance of 24 μmf and 8 μmf (or of 24 μf and 8 μf) in series?

What capacitance in series with 24 μmf will provide 6 μmf ?

What is the resistance of 24 ohms (or megohms) in parallel with 8 ohms (or megohms)?

What resistance in parallel with 24 ohms will provide 6 ohms?

If you keep the straightedge at 6 on the center scale while moving one end down and the other up on the two outer scales, it becomes possible to read an almost unlimited number of combinations which will provide 6 units of capacitance or resistance.

Next, place the straightedge at 140 and at 500 on the outer scales of the right-hand section of the chart. The straightedge crosses the center scale close to 110. Dividing all these values by 10 would change them to 14, 50 and 11. Check these smaller values directly on the left-hand section of the chart.

The chart graduations have accuracy

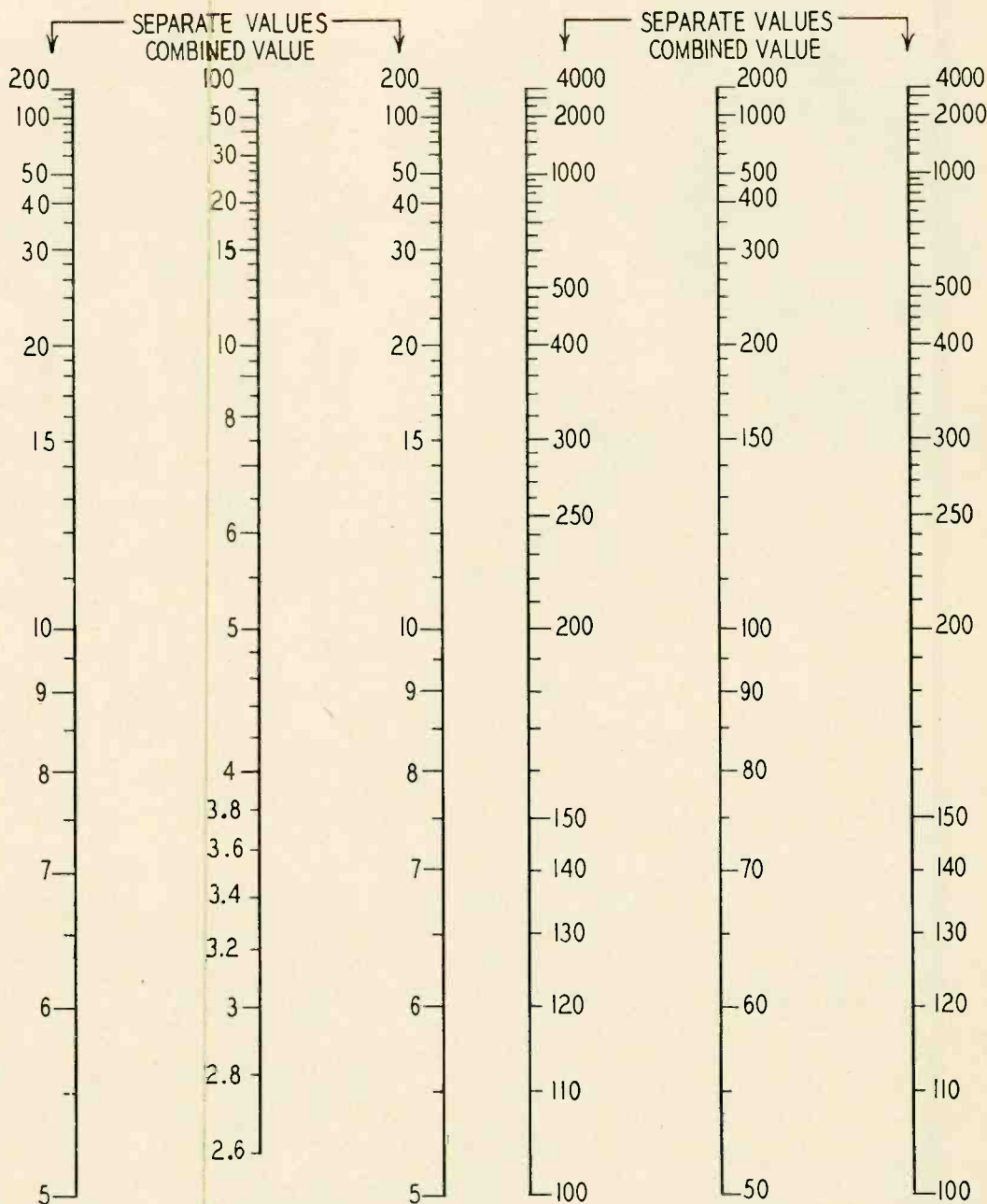

Nomograph for finding total value of resistors in parallel and capacitors in series—can also be used for determining inductance.

to spare for all ordinary service problems. Accuracy of your results depends on how carefully you place the straight-edge, and on how well you read values intermediate (interpolate) between graduations.

Three or more resistors or capacitors

The alignment chart applies to two resistors in parallel or to two capacitors in series. In the rare event that you have to work with three units proceed thus:

1. Begin with any two of the unit values and find their combined value in the manner explained.

2. Consider the combined value obtained as a single unit. Use it on one outer scale. On the other scale use the third value of resistance or capacitance. Read the combined value of the three units on the center scale.

Here is an example: Three parallel resistances are 600, 240 and 400 ohms.

Commence with 600 ohms and 240 ohms, for which the chart shows combined resistance of about 171 ohms. Use this 171 ohms on one outer scale and the remaining 400 ohms on the other outer scale. The chart will show the effective resistance of the three units in parallel is very close to 120 ohms.

Were a fourth resistance in parallel with the first three or a fourth capacitance in series with the others, determine the combined value of any three units as just explained. Use this combined value on one outer scale and the fourth value on the other outer scale to determine the combined value of all four units. There is no limit to the number of parallel resistances or series capacitances whose combined value may be found in this manner.

Inductances and reactances

We are not yet through with uses for the alignment chart. Parallel induct-

ances obey the same rules as parallel resistances. Therefore, the chart will give the combined inductance of any number of parallel inductances, if you avoid the effects of magnetic coupling between units. For parallel inductances read scale numbers as henries, millihenries or microhenries, sticking to the same unit for all three scales. All three scales may be multiplied or divided by any number to extend their range.

Since the alignment chart applies to parallel resistances, which are measured in ohms, it will work with any other parallel electrical oppositions measured in ohms. This makes it possible to determine combined values of parallel inductive reactances or capacitive reactances, because all of these are measured in ohms or in megohms.

In the same manner as used for finding the combined resistance of three resistors in parallel, the capacitance of three series capacitors is found. END

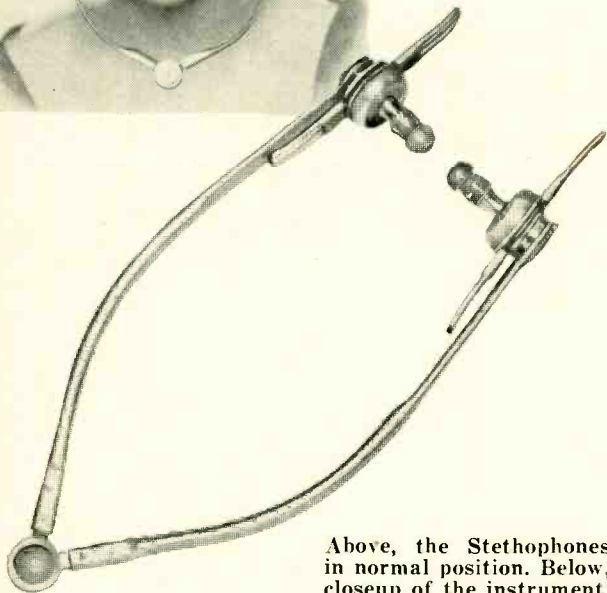

Above, the Stethophones in normal position. Below, closeup of the instrument.

Really Wireless WIRELESS

Having the appearance of a stethoscope, nonelectrical earphones provide radio and phono listening

By RALPH W. HALLOWS

AN ingenious system invented by V. A. Foot for the reception of radio or of the output of an audio amplifier has recently been installed in some British hospitals and in the front benches of the House of Commons (England). It is likely also to be widely used in places such as clubs, where some want to listen to radio while others desire to talk, read or play cards in peace and quiet; for only those wearing the light and comfortable earpieces (see photos) can hear the sounds that they reproduce.

The system is known as the Stethophone. The name is self-explanatory after a glance at the photos, which show the wishbone-shaped earphones: they recall the best known of all the doctors' appliances, the stethoscope.

There are no wires attached to the earphones or attaching them to anything. Each set of phones is a completely separate unit with no external connections.

Around the walls of the living room, club room or hospital ward runs a loop of wire which—when energized by the output of an audio amplifier—creates a magnetic field that varies with the modulation. The way in which the amplifier is connected to the loop is shown in Fig. 1. The 10-ohm potentiometer controls the overall intensity

of the magnetic field so as to give the best reception over the whole area served by the loop.

It has been found preferable to use two loops in parallel, one about 5 feet and the other about 3 or 3½ feet from the ground. This gives the most even distribution of the field and assures equally good reception whether the wearer of the phones is lying down, sitting or standing. Ordinary double cotton-covered wire of about No. 18 gauge may be used. But the Magnetic Broadcasting Co., London, England, which makes the Stethophone, has brought out a more convenient and more easily installed material for the loops. This consists of a wire of suitable gauge embedded in transparent tape, which is simply pressed on the wall.

Fig. 2 shows the details of one earphone. The horned pole pieces, made of laminations of high-permeability material, are so designed as to concentrate the flux from the surrounding field. There is a small air gap between them and the circular armature attached to the phosphor bronze diaphragm. The field does not induce any electric current in the earpiece, whose operation is entirely magnetic. The rotatable permanent magnet provides the necessary permanent polarization.

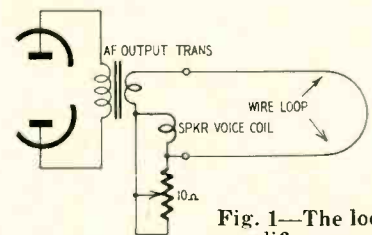

Fig. 1—The loop-amplifier connection.

If you look carefully at the photographs, you will see that at the base of the cap of each earpiece there is a knurled disc. This is attached to the permanent magnets, enabling them to be moved and providing a volume control. There is, in fact, a separate volume control for each ear, which makes the apparatus particularly useful to those whose hearing is better in one ear.

The horns of the pole pieces are so arranged that they always set themselves vertically, even when the wearer is lying down. This of course is necessary in the case of bedridden patients in a hospital.

The earpieces contain nothing whatever which can be injured by heat or moisture—a feature which appeals most strongly to hospital authorities. They can be boiled, sterilized or otherwise disinfected by any of the approved methods.

One of the most surprising points about the Stethophone is the low price of the earphone sets. Those without volume controls sell at about \$6 and those with controls at a little under \$9. A matching transformer suitable for supplying a loop from domestic receivers sells at about \$1.70. As there

AID TO INVENTORS URGED

is nothing whatever to go wrong with a Stethophone its life should be long and maintenance costs virtually nothing.

In the United States the Stethophone is distributed by the Fenton Company under the name of Induct-O-Phone. It is claimed that the output of a 10-watt amplifier fed into an aluminum or copper wire loop encircling a building gives perfect reception for an area of 1,000 square feet.

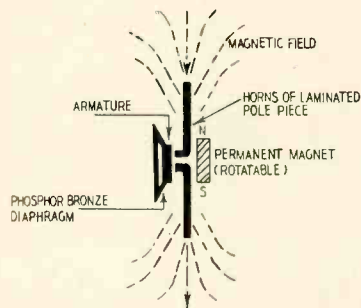

Fig. 2—Details of the magnetic earphone.

To get a louder output, it is advisable to match the output of the loop with the output of the amplifier. A small autotransformer can be purchased or made as follows:

Wind 70 turns of No. 20 cotton-covered magnet wire, with four tap-

SIZE - AWG	OHMS
14	2.25
12	1.588
10	0.999
8	0.628

ping points. (Use any small I or E section of laminated core.) The start of the coil is tapping point 1, the 40th turn is tapping point 2, the 55th turn is tapping point 3 and the 70th turn (end of coil) is point 4.

TAPS	Voice Coil Impedance				
	3 ohms	4 ohms	6 ohms	8 ohms	16 ohms
1 and 3	1.8	2.5	3.7	4.9	9.9
1 and 2	1.0	1.3	2.0	2.6	5.2
2 and 4	0.55	0.75	1.1	1.5	3.0
3 and 4	0.15	0.20	0.3	0.4	0.75

To match the output with the loop, connect the output terminals of the amplifier to tapping points 1 and 4 of the autotransformer. Calculate the impedance of the loop as follows: multiply the length of the loop with the resistance shown in Table I and divide by 1,000.

Table II locates which output of the autotransformer is closest to the impedance of the loop. Connect the loop to the proper tapping points on the output transformer. END

It is a truism that the tremendous economic development of the United States has been in large measure due to progress in invention, and our excellent patent system has been one of the chief incentives to and protectors of invention. Yet even with such encouragement and protection, the inventor's lot has not always been an easy one.

In many cases a patent has expired before the inventor could make any use of it. Persons like the late Nikola Tesla were often so far in advance of the rest of humanity that their patents ran out before the rest of the world had progressed far enough to make use of them. Tesla had patents on radio-guided submarines before 1900, for example. In other cases, broader and more basic patents may prevent a patent from taking effect until it has only a few years to run.

One of the most unfortunate of all situations is that in which war or civil emergency makes it impossible to utilize a patent either because the inventor is on active duty in the armed services or the patent is taken over by the Government because of its importance in national defense or war-created restrictions on materials make it impossible for the inventor to manufacture his product.

There would seem that there should be a means of restitution to the inventor for such losses. Since a patent is a contract between the inventor and the Government, it would be easy for the Government to extend the life of the patent for a period equal to that lost. *This has been proposed in bill H.R. 2128, now before Congress.*

It has been argued in opposition to such a bill that patentees were not the only ones who suffered loss through war or emergency situations. Many manufacturers whose business did not depend on patents were unable to manufacture their products. For example, it is pointed out, a man might have leased a piece of ground for 17 years (the lifetime of a patent) and gone to considerable expense in erecting a building on it and going into manufacture or trade. Then due to war shortages he may have had to shut down his factory, shop, filling station or whatever enterprise he may have initiated.

Such arguments overlook one important fact—that a patent is a contract between the country and the individual inventor in which the inventor is performing certain services for the nation in return for a Government guarantee that no other person can take unfair advantage of these acts for a given period of time. In short, the inventor reveals the workings of his art in sufficient detail that another skilled in the art can follow them. In return for such service, which makes it possible for the whole related art to make further prog-

ress, the inventor is granted the exclusive right to his invention for a period of 17 years, at the end of which time this property of his is dedicated to the nation and becomes the property of the public.

The manufacturer or gas-station operator has not performed any unique service to the public for the privilege of operating his property for his sole advantage. Neither will that property be dedicated to the public after a certain period. Furthermore, there are elements of convertibility in many businesses which cannot possibly exist in a patent, which by its very nature is limited to one thing.

Other objections have referred to possible resulting confusion. However, when a similar law was passed to protect veterans of the Korean war, the Patent Office was not overwhelmed with a flood of applications for extension. Although the United States has granted an enormous number of patents, only those issued during the last 17 years are valid. Of these, probably a majority are inactive; of the active ones, only a small number are eligible for extension due to the three causes listed above.

Cost has been given as another argument against the proposed action. H.R. 2128 provides, however, for fees that would cover all expenses to which the Patent Office might be put.

It is to the interests of all whose livelihood depends on uninterrupted progress in invention to support a plan which will stimulate invention and give assurance to inventors that the fruit of their efforts will not—by cause of war or civil emergency—be taken over by the public without recompense. RADIO-ELECTRONICS favors H.R. 2128 strongly and urges its readers to communicate with their Congressmen, asking them to support the bill to the utmost.

The proposed legislation is entirely fair and reasonable, and long overdue. It will provide to creative thinkers the necessary protection and security that should be theirs and relieve them of any anxiety as to wasted efforts. END

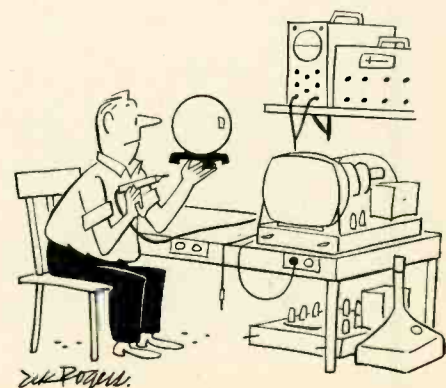

FLEXIBLE RADIO CONTROL SYSTEM

*Compact model boat
operates on 6 meters*

Part I—The transmitter circuit

LIKE to think (perhaps as a matter of self-defense) that there is a little of the boy still remaining in us grown men who like to design or build electronic gadgets. The fascination of making some piece of apparatus is very much like that of taking apart the clocks we ruined as children or the way we used to rig up fantastic systems of strings to open and close windows without getting out of bed.

It is just this type of satisfaction that has prompted the thought that I would design a radio-controlled model motorboat. The idea of standing on the shore of a lake or pond holding a little black box (it turned out a little *gray* box) and using switches to tell a boat rolling and pitching on the waters where to go and how—with no visible connection between box and boat—somehow appeals to the imagination. It brings home anew the idea that radio is not very far removed from the magicians' arts, and gives the individual who can build and operate such a system a sense of power and delight.

Radio control systems are far from new. They are used by the Army for flying anti-aircraft target planes, as well as by many groups for other purposes. In fact, every well-equipped hobby shop sells radio control systems over the counter; they operate on the Citizens band and don't require any legal formalities beyond filling a questionnaire. But they are expensive. Even the simplest are more expensive than the rather flexible system described here.

The usual "store-boughten" system includes a transmitter with a button which turns it on momentarily. The receiver is a superregenerative job with a single plate-circuit relay. When the transmitter is energized, the relay closes momentarily and operates an escapement mechanism obtaining power from a wound-up rubber band. The escapement turns the rudder to one of three positions—extreme right, extreme left or center. The rudder positions must be taken in turn. If the sequence is right-center-left, then to move the rudder from center to right you must push the button twice, bringing it first to left, then to right. There are no intermediate rudder positions and no control of the drive motor.

*Electronics consultant, New York.

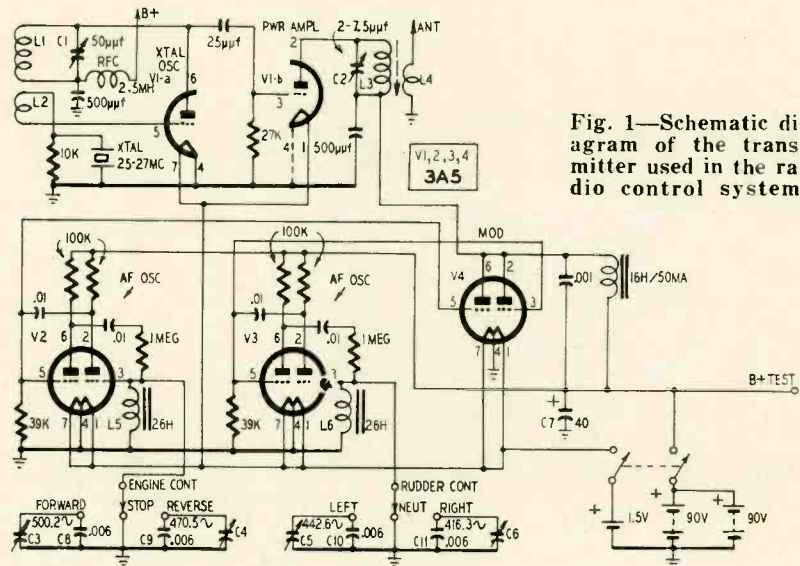

Fig. 1—Schematic diagram of the transmitter used in the radio control system.

A system like that is satisfactory for those who can't build their own, but it gives very little real control. It seemed essential to have control of all rudder positions plus the ability to start, stop and reverse the drive motor at will. The boat (see photo) has all these facilities. As a result it can execute the most intricate maneuvers, all depending on the skill of the shoreside operator.

It can weave its way through all sorts of traffic on a model-boat pond. It can come in for a landing at a pier or go alongside another boat, steering accurately into position and stopping short by reversing its engine.

The system which makes this possible need not be used on a boat—it can be used in a miniature truck for dry-land operation or anywhere else where remote control is desired. It is not new and nothing original is claimed for it other than organization of parts.

The first item is the transmitter (see photos). It operates on the 6-meter ham band and sends out r.f. modulated by any one or two of four available tone frequencies. There is one tone for forward, a second for reverse, a third for right rudder and a fourth for left. They are selected by the two lever switches seen on top of the transmitter. Note well that the transmitter operates on an amateur band, so an amateur transmitting license is needed.

The foremost lever has right, left and center positions, corresponding to desired rudder movement. It is spring-loaded so that it returns to center posi-

tion when the rudder has been adjusted as desired. The rear switch is positive acting and moves forward, center and back for drive motor control. The controls are independent so that the rudder can be controlled at the same time the drive motor is in operation.

The first step was to build the boat itself since none of the receiving equipment can be built until the mounting space can be seen. This particular boat is a model of a Harco 40-foot deluxe cabin cruiser. It was built from a kit (No. B-10M) put out by Sterling Models, Philadelphia, bought in a hobby shop in New York.

Those whose primary interest is electronics may sigh at the idea of having to do this kind of construction, but will be fascinated once they start. The precored wood pieces are easily broken out of the balsa and mahogany sheets. No copying of templates is required, so all the pieces fit accurately. But at the same time, enough originality and care is required to make this job a barrel of fun and a very pleasant few hours of something different—especially for those who, like myself, make a living from electronics and then use it for a hobby too.

Instructions in the kit are excellent, but you can't do a slapdash job and expect it to work and look right. All joints must be tight because the radio equipment is heavy and the boat will take in water if they are not. Paints are available especially for this kind of work and the color scheme can be any-

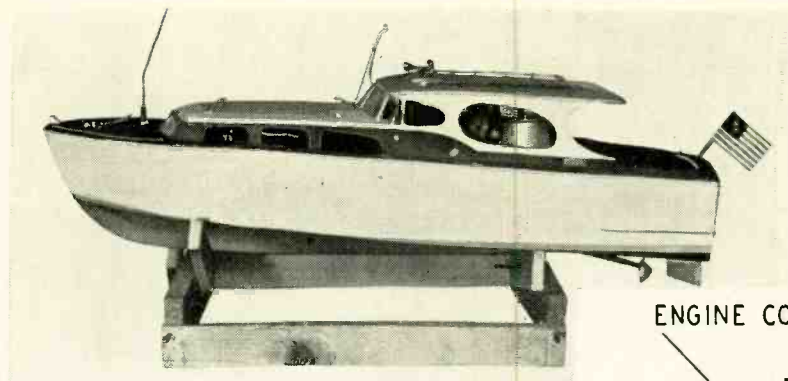

Left—Complete boat with cabin and antenna in place. Relays can be seen through window.

thing you like. The boat-building part of the work can be extra satisfaction, incidentally, for people who, like the writer, enjoy real boats but find it impractical to own one. The model is built just like a full-size job.

The transmitter circuit

The next item on the agenda was the transmitter, since it is necessary to check the receiving equipment. Fig. 1 is the complete transmitter schematic. Four 3A5's are used. Crystal oscillator V1-a is an overtone type using a 25.179-mc crystal. Coils L1 and L2 (Fig. 2) are wound on a 1/2-inch form and the distance between them adjusted for good reliable operation when C1 is tuned. As in all oscillators of this kind, tuning C1 will produce oscillation suddenly at a certain point. Further turning will reduce amplitude and then suddenly oscillation will stop. The capacitor should be adjusted for a point just a shade beyond where oscillation suddenly begins and is maximum. A grid dip meter is very helpful in adjusting the coils and the oscillator, and a receiver covering the 50-mc band is helpful, too.

Power amplifier V1-b operates as a doubler. Very little power is available, but very little is needed. While a slug-tuned form was used for L3-L4, it was hard to get a good, sharp output peak on the receiver or grid dip meter by adjusting the core. Making C2 variable gave much better results.

The antenna is an automobile whip sold for the broadcast band. About 60 inches long when extended, it has two mounting insulators. When bought, the upper insulator held the contact. This was changed to the lower insulator so that the contact screw comes into the transmitter box right next to the L4 winding. This can be seen in Fig. 2, a photo of the interior of the transmitter seen from the antenna side of the box.

Audio oscillators V2 and V3 are built very much like ordinary Wien-bridge R-C oscillators. The frequency-determining elements, however, are L5 and L6 plus the capacitance across these inductors. Class-A L-C oscillators like this, with no d.c. going through the inductor, are among the most stable, yet simplest, types. Stability is necessary because of the narrow resonance range of the reed relays in the boat.

Below—The remote control system transmitter.

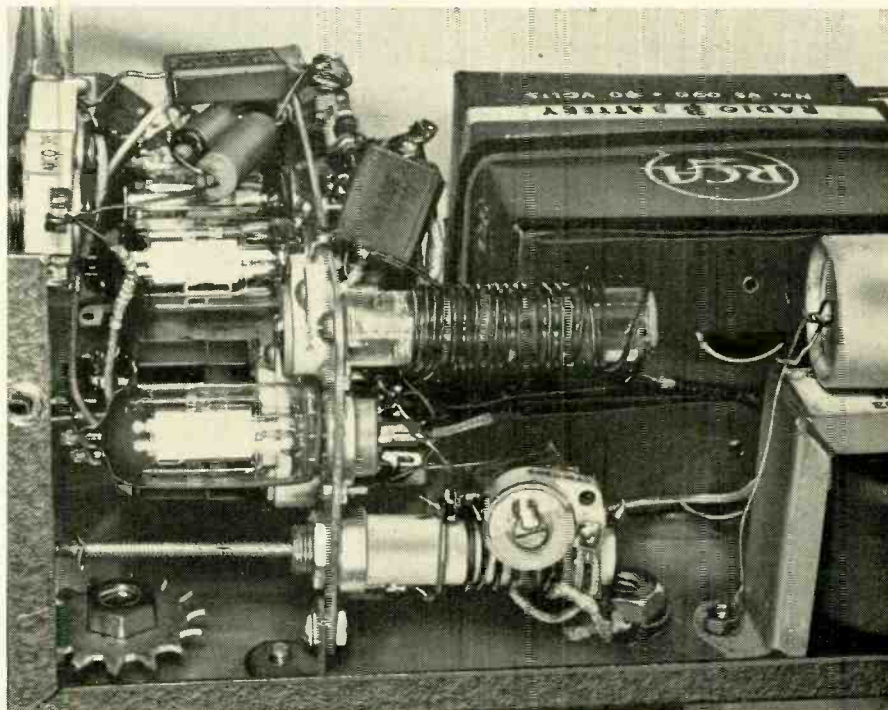
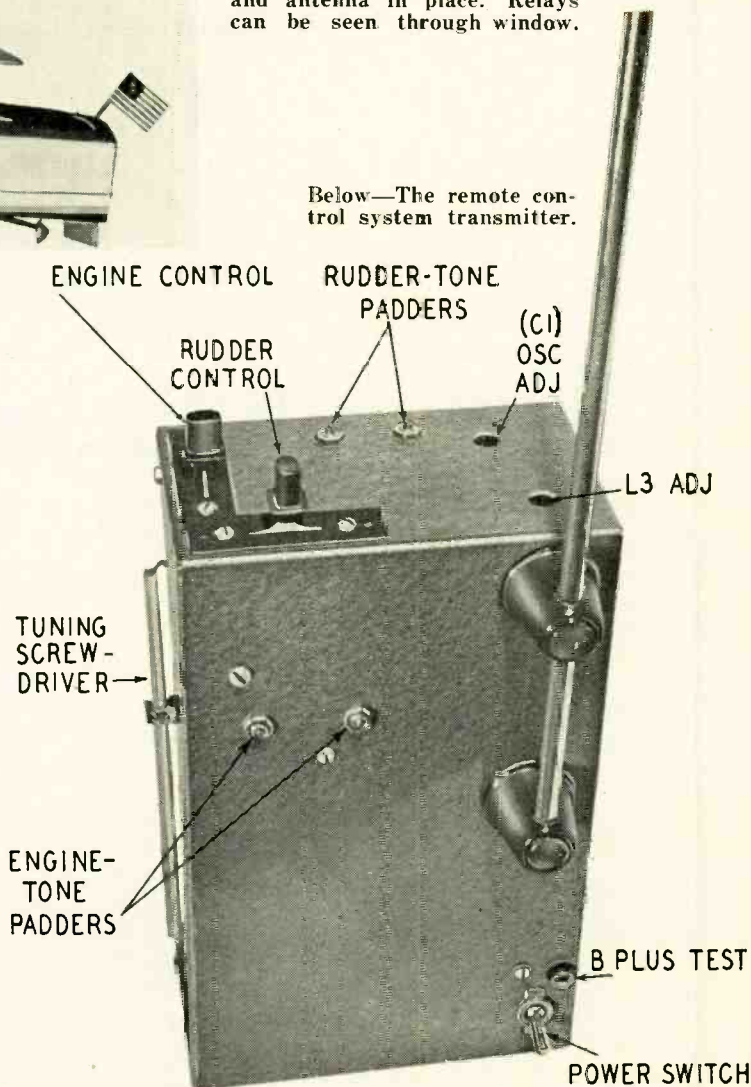

Fig. 2—Internal view. Oscillator coil is above and final coil below.

RADIO

The inductors are very small, cylindrical units obtained on the surplus market. Some readers are unlikely to find their exact type, but others can be used. The inductance value need not be that shown in Fig. 1, as long as the values used and a practical capacitor value can resonate them between 400 and 500 cycles. The two control switches ground the oscillators when no tones are wanted and switch in alternate capacitance values to give the proper frequencies to energize the desired resonant relays.

V4 is a Heising type used for simplicity even though 100% undistorted modulation is impossible. The values given for the oscillators limit modulation to a workable level.

The A battery is 1.5 volts and a pair of 90-volt B batteries are placed in parallel for greater capacity and greater voltage stability to help keep the audio oscillators on frequency. Capacitors C3, C4, C5 and C6 are pressure type .003- μ f trimmers across the tuning capacitors for each tone. Their tuning screws can be seen on the top and front of the transmitter. They are used to fine-set tone frequencies and to adjust for B voltage changes and are set after the receiver is working.

Transmitter construction

The transmitter is built inside a 6 x 3½ x 10-inch Bud Minibox. This box comes apart very conveniently in two sections rather than having just a removable cover. The part with the flanges is used for mounting the parts (Fig. 3). The transmitter proper is built on a sheet of aluminum 2¾ x 5 inches and mounted with small angle brackets to the front wall of the box. The control

Parts for transmitter

Resistors: 1—10,000, 1—27,000, 2—39,000, 4—100,000, 2—1 megohm, ½ watt.

Capacitors: 1—25 μ f, 2—500 μ f, mica; 1—.001 μ f, 4—.006 μ f (approximately, adjust value for tones), 4—.01 μ f, 200 volts; 1—40 μ f, 200 volts, electrolytic; 1—2.75 μ f, ceramic trimmer; 1—5.50 μ f, ceramic trimmer; 4—.003 μ f, compression type padder.

Inductors: L1—18 turns of No. 18 enameled wire on ½-inch form, 1¼ inches long; L2—3 turns of No. 18 enameled wire on ground end of L1 (adjust separation for best performance); L3—8 turns of No. 16 enameled wire on Millen 69046 slug-tuned form; L4—3 turns of hookup or No. 16 enameled wire, over ground end of L3; L5, L6—chokes, 26 h; L7—choke, 16 h @ 50 ma, 580 ohms.

Miscellaneous: 1—crystal, quartz, overtone type for 25-27 mc (25,179 mc); 1—1.5-volt battery (Burgess 4F or equivalent); 2—90-volt batteries (RCA VS090 or equivalent); 1—phone-tip jack, insulated; 1—2-pole 3-position switch (1 pole used), positive action, shorting (Centralab 1452 or equivalent); 1—2-pole 3-position switch (1 pole used), spring return, shorting (Centralab 1453 or equivalent); 1—d.p.s.t. toggle switch; 4—3A5 tubes; 1—automobile antenna, approximately 60 inches, cowl type; 4—7-pin miniature tube sockets; 1—socket for crystal; 1—metal plate for chassis, 2¾ x 5 inches; 1—6 x 3½ x 10-inch box (Bud Minibox CU-2110 or equivalent).

Boat kit: model of Harco 40-foot deluxe cabin cruiser (No. B-10 M), by Sterling Models, Philadelphia.

switches are mounted on the top. Fig. 4 shows how the capacitors for tuning are mounted on the drive motor switch and a ground leg on the chassis. The padders mounted to the top are for the rudder switch.

The batteries are placed in the main box below the chassis and strapped in

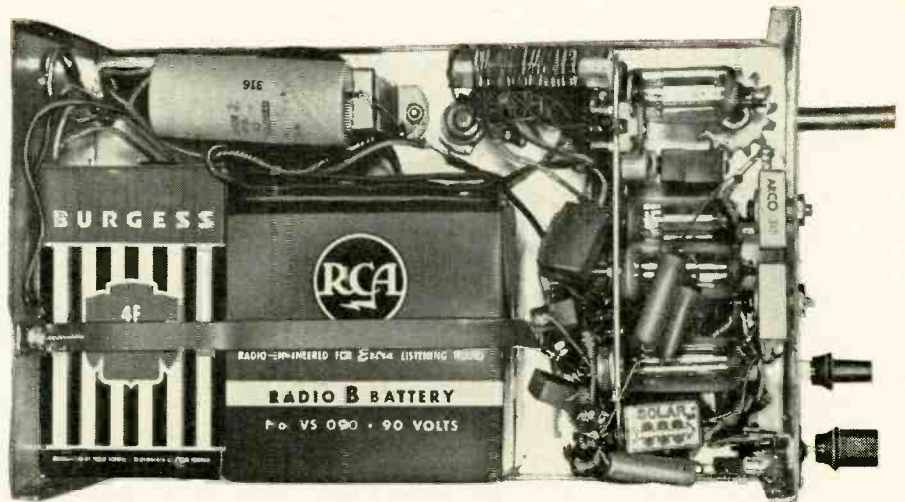
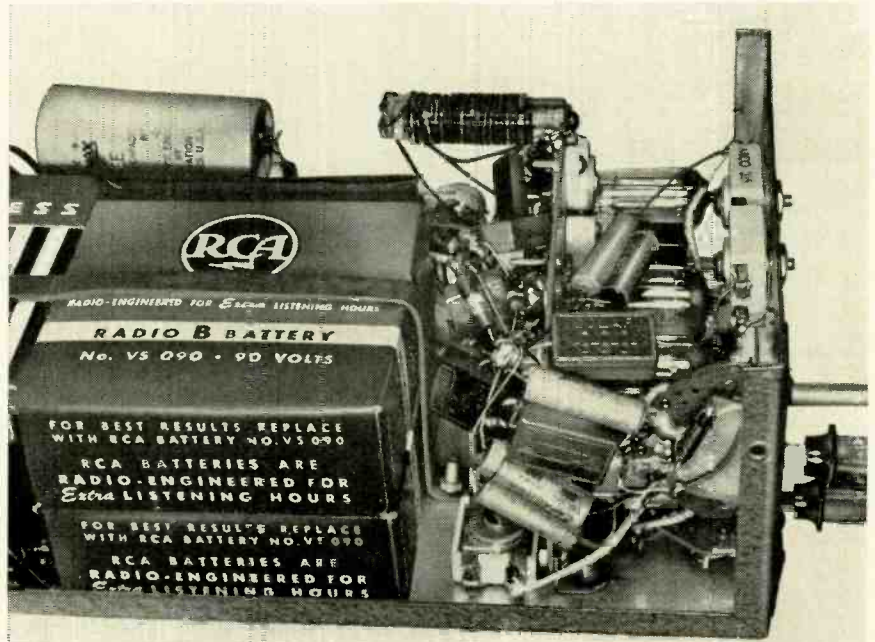

Fig. 3—View of transmitter rear. Components are on small metal plate.

Fig. 4, below—Closeup view shows engine switch and tone-tuning capacitors.



place with a bent strip of steel screwed to the box at both ends of the battery space. The modulation choke is also directly on the box to the left of the batteries in Fig. 3. Filter capacitor C7 is atop the choke. The power switch and test jack are near the bottom.

The transmitter is admittedly compact. However, the electrons find room enough to move around, and so will you if you are careful to plan adequately. You should be able to do a better job than I did, since some changes had to be made after mechanical arrangements were set. The final result shown in Fig. 1 can now be built straightforwardly, except that the tone-frequency capacitors C8, C9, C10 and C11 must wait.

A good way to select these capacitors is to connect the resonant relays in the receiver in series across the 4-ohm winding of a receiver output transformer. Turn on the transmitter, tune the receiver to it and, assuming the batteries are new, set the audio padders to almost full capacitance, without tightening

them. A capacitor decade is helpful, though miscellaneous values substituted with clips for C8 through C11 can be used. Substitute values around .006 μ f until the padders can be adjusted through a peak of audible sound from the relays. This audible peak is the center resonance point. Reduce the receiver output so the sound is rather small and completely inaudible when the tone is not near the peak.

To tell which relay is working, simply touch them with the fingers; the working one will show obvious vibration. The sockets for these relays are dual-crystal units made by Cinch (No. 2K4). The relays are Frahm's, made by James G. Biddle Co., Philadelphia 7, Pa. They must be obtained directly from the manufacturer. Other resonant relays exist and probably almost any are satisfactory, though impedances may be different.

Next month, the receiver and the mechanical portion of the equipment will be discussed. TO BE CONTINUED



Heathkit PRINTED CIRCUIT 5" COLOR TV Oscilloscope Kit

MODEL
O-10
\$69⁵⁰
Shpg. Wt. 27 lbs.

The technical specifications for this fine instrument speak for themselves. Vertical channel sensitivity is 0.025 volts RMS/inch at 1 Kc. Vertical frequency response is essentially flat to 5 Mc, and down only 1.5 db at 3.58 Mc. Ideal for Color TV work!

Extended sweep generator range is from 20 cps to 500 Kc in five steps, far beyond the range normally encountered at this price level.

Other features are: plastic-molded capacitors for coupling and by-pass—preformed and cabled wiring harness—Z axis input for intensity modulation—peak-to-peak voltage calibrating source built-in—retrace blanking amplifier—regulated power supply—high insulation printed circuit boards—step attenuated and frequency compensated vertical input circuit—push-pull horizontal and vertical amplifiers—excellent sync. characteristics—sharp, hairline focusing—uses 5U1 CRT—extremely attractive physical appearance.

An essential instrument for professional Laboratory, or for servicing monochrome or color TV.

Heathkit PRINTED CIRCUIT 3" OSCILLOSCOPE KIT



This light, portable 3" oscilloscope is just the ticket for the ham, for service calls, or as an "extra" scope in the shop, or lab. D. and weighs only 11 lbs.
Employs printed circuit board for improved circuit performance. Vertical amplifiers flat within +3 db from 2 cps to 200 Kc. Vertical sensitivity 0.25 volts RMS/inch peak-to-peak, and sweep generator operates from 20 cps to 100,000 cps. B.F. connection to deflection plates.

MODEL OL-1
\$29⁵⁰
Shpg. Wt. 14 lbs.

Heathkit PRINTED CIRCUIT 5" OSCILLOSCOPE KIT



This full-size 5" Oscilloscope incorporates many outstanding features. Vertical channel flat within +3 db. 2 cps to 200 Kc. with 0.09 volts RMS/ inch peak-to-peak sensitivity at 1 Kc. Sweep operation from 20 cps to 100,000 cps. Built-in peak-to-peak voltage calibration—3 step frequency compensated input attenuator—frequency compensated control—push-pull deflection amplifiers. Printed circuits for reliable performance and reduced construction time.

MODEL OM-1
\$49⁵⁰
Shpg. Wt. 26 lbs.



Heathkit PRINTED CIRCUIT VACUUM TUBE VOLTMETER KIT

MODEL V-7
\$24⁵⁰

Shpg. Wt. 7 lbs.

This VTVM has set a new standard for accuracy and reliability in kit-form electronic instruments. Features modern, time-saving printed circuits, and functional arrangement of controls and scales. Includes new peak-to-peak scale for FM and TV work.

Measures AC (RMS) and DC voltage at 0-1.5, 5, 15, 50, 150, 500, and 1500; peak-to-peak AC voltage at 0-4, 14, 40, 140, 400, 1400, and 4000; center-scale resistance readings of 10, 100, 1000, 10,000, 100 K, 1 meg., and 10 meg. DB scale provided also. Zero-center operation within range of front panel controls. Polarity reversal switch—200 μ a 4 1/2 meter-transformer power supply—11 megohm input impedance—1% precision resistors—high quality components used throughout.

Heathkit VOLTAGE CALIBRATOR KIT

Once calibrated, this instrument provides a known peak-to-peak voltage standard for comparison with unknown voltage values on an oscilloscope. Panel calibrated directly—no involved calculations required. Operates within a voltage range of .01 to 100 volts peak-to-peak.



MODEL VC-2
\$11⁵⁰

Shpg. Wt. 4 lbs



Heathkit 20,000 ohms/volt MULTIMETER KIT

MODEL MM-1
\$29⁵⁰

Shpg. Wt. 6 lbs.

Features comprehensive range coverage. 20,000 Ω /V D.C. and 5000 Ω /V A.C. Ranges: 0-1.5, 5, 50, 150, 500, 1500, and 5000 V. direct current from 0 to 150 μ a, 15 a. in 5 steps. Center-scale resistance of 15, 1500 and 150,000 ohms, and db from -10 to +65.

Uses 1% precision resistors—50 μ a. meter—molded bakelite case.

Heathkit DIRECT-READING CAPACITY METER KIT



MODEL CM-1
\$29⁵⁰

Shpg. Wt. 7 lbs.

Extremely valuable where speed and convenience are essential. Quality control work, production line checking, etc. Reads capacity directly on meter scale, from 0-100 mmfd, 1000 mmfd, .01 mfd, and .1 mfd. Residual capacity less than 1 mmfd. Not susceptible to hand capacity.



Heathkit A. C. VACUUM TUBE VOLTMETER KIT

MODEL AV-2
\$29⁵⁰

Shpg. Wt. 5 lbs.

Measures AC voltage only, from 10 cps to 50 Kc. Covers the range from 1 millivolt to 300 volts in 10 steps at high impedance input. Incorporates full 10 ranges of db scale from -52 db to +52 db. Essential in the audio laboratory or for audio enthusiasts and experimenters. Provides sensitivity essential for low level audio measurements.

Heathkit ELECTRONIC SWITCH KIT



MODEL S-2
\$23⁵⁰

Shpg. Wt. 11 lbs.

This device will electronically switch between 2 input signals to produce both signals alternately at the output. Used in conjunction with an oscilloscope, it will permit the observation of 2 signals simultaneously. Provides switching rates from 10 cps to 200 cps.

HEATH Company

A SUBSIDIARY OF DAYSTROM INC.
BENTON HARBOR 20, MICHIGAN

Heathkit TUBE CHECKER KIT



MODEL TC-2
\$29⁵⁰
Shpg. Wt. 12 lbs.

Because of its low price this fine tube tester is available, not only to the service shop and laboratory, but to part-time servicemen, experimenters, and radio amateurs, as well. Will test all tubes commonly encountered in radio and TV service work. Simple "GOOD-BAD" scale on the 4 1/2" meter. Tests for open, short, and quality on the basis of total emission. Includes illuminated roll chart. Fourteen different filament voltage values available. Separate lever switch for each tube element.

Model TC-2P is the same electrically as TC-2, except that it is housed in a beautiful two-toned portable carrying case. Only \$34.50. Shpg. Wt. 15 lbs.

Portable carrying case available separately for Model TC-2, or older model TC-1. Cab. No. 91-8, \$7.50. Shpg. Wt. 7 lbs.
CRT Test Adapter, Model 355 for use with the TC-2, \$4.50. Shpg. Wt. 1 lb.

SELECT YOUR NEXT HEATHKIT FROM

Heathkit TV ALIGNMENT GENERATOR KIT

Here is the complete R.F. signal source for FM and TV alignment, (both monochrome and color). Provides output on fundamentals from 3.6 Mc to 220 Mc in four bands, with harmonic output usable up through the UHF channels. Electronic sweep circuit eliminates mechanical gadgets and accompanying noise, hum, and vibration. Continuously variable sweep up to 0-42 Mc, depending on base frequency.

Variable marker (19-60 Mc on fundamentals) and crystal marker (4.5 Mc and multiples thereof) generators built-in. Crystal included with kit. Provision for external marker if desired.

Packed with outstanding features. 50 ohm output impedance—exceptionally good linearity—effective AGC action—plenty of R.F. output. An essential instrument for the up-to-date service shop.



\$49⁵⁰

MODEL TS-4
Shpg. Wt. 16 lbs.



Shpg. Wt. 8 lbs.

MODEL SG-8
\$19⁵⁰

Heathkit SIGNAL GENERATOR KIT

This is one of our most popular kits, and is "serviceman engineered" to fulfill the signal source requirements of the radio serviceman and experimenter.

Covers 160 Kc to 110 Mc on fundamentals (5 bands), with output in excess of 100,000 microvolts. Calibrated harmonics extend usefulness up to 220 Mc. Choice of unmodulated R.F. output, 400 cps modulated R.F. output, or 400 cps audio output. Step-type and continuously variable output attenuation controls.

Coils are prewound, and construction manual is complete. Calibration unnecessary for service applications.

Model RS-1

Heathkit RESISTANCE SUBSTITUTION BOX KIT



Provides switch selection of 36 RTMA 1 watt standard 10% resistors, ranging from 15 ohms to 10 megohms. Numerous applications in radio and TV work.

\$5⁵⁰
Shpg. Wt. 2 lbs.

Heathkit CONDENSER SUBSTITUTION BOX KIT

Very popular companion to Heathkit RS-1. Individual selection of 18 RTMA standard condenser values from .0001 mfd to .22 mfd. Aluminum panel, bakelite case, and includes 18" flexible leads with alligator clips.

Model CS-1
\$5⁵⁰
Shpg. Wt. 2 lbs.



Model DR-1

Heathkit DECADE RESISTANCE KIT



Twenty 1% precision resistors provide resistance from 1-99,999 ohms in 1 ohm steps. Indispensable around service shop, laboratory, ham shack, or home workshop.

\$19⁵⁰
Shpg. Wt. 4 lbs.

Heathkit DECADE CONDENSER KIT

Provides capacity values from 100 mmf to 0.111 mfd in steps of 100 mmfs. +1% precision silver-mica condensers used. High quality ceramic wafer switches for reduced leakage.



Shpg. Wt. 3 lbs.

\$16⁵⁰

Heathkit CONDENSER CHECKER KIT



Measures capacity in four ranges from .00001 to 1000 mfd. Power factor control is provided for indication of electrolytic condenser efficiency. Tests capacitors under actual load conditions. Checks resistance from 100 ohms to 5 megohms. Direct reading scales for all tests. No calculation necessary.

Model C-3
\$19⁵⁰
Shpg. Wt. 7 lbs.



Model T-3

Heathkit VISUAL-AURAL SIGNAL TRACER KIT

\$23⁵⁰

Shpg. Wt. 9 lbs.

This signal tracer features a high-gain R.F. channel and probe to permit signal tracing from the receiver antenna input through the R.F. and I.F. stages. Separate low gain channel for audio circuits. Both visual and aural indication by means of speaker and electron beam "eye" tube.

Also noise locator circuit, wattmeter, and terminals for "patching" output transformer or speaker into external circuit.

Heathkit LABORATORY GENERATOR KIT



Here is a signal generator for use where high accuracy and metered performance are essential. Covers 150 Kc to 30 Mc on fundamentals in 5 bands. 400 cps modulation variable from 0 to 50%. R.F. output at 50 Ω from 100,000 to 1 μ v. Meter reads R.F. output in μ v. or modulation percentage. Fixed-step and variable output.

\$39⁵⁰
Shpg. Wt. 16 lbs.



Model M-1

Heathkit HANDITESTER KIT

\$14⁵⁰

Shpg. Wt. 3 lbs.

The M-1 is literally pocket size to fit in your coat pocket, tool-box, glove compartment, or desk drawer. Measures A.C. or D.C. v. in 5 steps from a full scale minimum of 0-10 v. to a maximum of 0-5000 v. Measures direct current at 0-10 Ma and 0-100 Ma, and provides ohmmeter ranges of 0-3000 and 0-300,000 ohms. Sensitivity of 1,000 ohms/v. 1% precision divider resistors employed.

HEATH Company

A SUBSIDIARY OF DAYSTROM INC.
BENTON HARBOR 20, MICHIGAN

THESE HIGH QUALITY INSTRUMENTS

Heathkit HARMONIC DISTORTION METER KIT



MODEL HD-1
\$49.50
 Shpg. Wt. 13 lbs

Performs the functions of more elaborate and much more expensive audio distortion testing devices and yet is simple to operate and inexpensive to own. Used with a sine wave generator, it will check the harmonic distortion output of audio amplifiers under a variety of conditions. Essential in audio design work.

The HD-1 reads harmonic distortion directly on the meter as a percentage of the original signal input. It operates from 20 to 20,000 cps in 3 ranges, and incorporates a VTVM circuit for initial reference settings and final harmonic distortion readings. VTVM ranges are 0-1, 3, 10, and 30 volts full scale. 1% precision voltage divider resistors used. Distortion meter scales are 0-1, 3, 10, 30 and 100% full scale. Having a high input impedance the HD-1 requires only .3 volt input for distortion tests.

Heathkit AUDIO GENERATOR KIT

This basic audio reference generator deserves a place in your Laboratory. Complete frequency coverage is afforded from 20 cps to 1 Mc in 5 ranges, and output is constant within ± 1 db from 20 cps to 400 Kc, down only 3 db at 600 Kc., and 8 db at 1 Mc. An extremely good sine wave is produced, with a distortion percentage below 0.4% from 100 cps through the audible range.

Plenty of audio output for all applications; up to 10 v. under no load conditions. Output controllable with a continuously variable or step-type attenuator with settings of 1 μ v, 100 μ v, 1 v, and 10 v. Cathode follower output.



MODEL AG-8
\$29.50
 Shpg. Wt. 11 lbs.



Heathkit VARIABLE VOLTAGE POWER SUPPLY KIT

Model PS-3
\$35.50
 Shpg. Wt. 17 lbs.

Provides regulated DC output for B+, and 6.3 v. AC at 4 amps. for filaments. Output variable from 0 to 500 v. DC at no load, linear from 0-10 ma at 450 vdc and 0-130 ma at 200 vdc! Essential for circuit design and development. Voltage or current read on $4\frac{1}{2}$ " meter.



Heathkit "Q" METER KIT

Model QM-1
\$44.50
 Shpg. Wt. 14 lbs.

Will measure Q of condensers, RF resistance and distributed capacity of coils, etc. Uses $4\frac{1}{2}$ " 50 μ a meter for direct indication. Will test at 150 Kc to 18 Mc in 4 ranges. Measures capacity from 40 mmf to 450 mmf within ± 3 mmf. Useful for checking wave traps, chokes, peaking coils. Indispensable for coil winding and determining unknown condenser values.

Heathkit AUDIO ANALYZER KIT



MODEL AA-1
\$59.50
 Shpg. Wt. 13 lbs.

The AA-1 consists of an audio wattmeter, an AC VTVM, and a complete IM analyzer, all in one compact unit. It offers a tremendous saving over the price of these instruments purchased separately.

Use the VTVM to measure noise, frequency response, output gain, power supply ripple, etc. Use the wattmeter for measurement of power output. Internal loads provided for 4, 8, 16, or 600 ohms. VTVM also calibrated for DBM units so db gain or loss can be noted quickly.

High or low impedance IM measurements can be made. High (6 Kc) and low (60 cps) frequency generators built-in. Only 4 meter scales are employed, and one of these is in color so that results are easily read on the scale. Full scale VTVM ranges are .01 to 300 volts in 10 steps, full scale wattmeter ranges are .15 mw to 150 w in 7 steps. IM analyzer scales are 1%, 3%, 10%, 30% and 100%.

Heathkit AUDIO OSCILLATOR KIT



MODEL AO-1
\$24.50
 Shpg. Wt. 10 lbs.

(SINE WAVE - SQUARE WAVE)

Features sine or square wave coverage from 20 to 20,000 cps in 3 ranges. An instrument specifically designed to completely fulfill the needs of the serviceman and high fidelity enthusiast. Offers high-level output across the entire frequency range, low distortion and low impedance output. Uses a thermistor in the second amplifier stage to maintain essentially flat output through the entire frequency range. Produces good, clean square waves with a rise time of only 2 microseconds.

Heathkit IMPEDANCE BRIDGE KIT



Model IB-2
\$59.50
 Shpg. Wt. 12 lbs.

Measures resistance, capacitance, inductance, dissipation factors of condensers, and the storage factor of inductance. Employs 2-section CRL dial. D, Q and DQ functions are combined in one control. $\frac{1}{2}$ % resistors and capacitors used in critical circuits. 100-0-100 microammeter for null indications. 1000 cycle oscillator, 4 tube detector-amplifier, and power supply built-in.

Heathkit 6-12 VOLT BATTERY ELIMINATOR KIT



Model BE-4
\$31.50
 Shpg. Wt. 17 lbs.

Furnishes 6 or 12 volt output for the new 12 v. car radios in addition to 6 v. models. Two continuously variable output voltage ranges; 0-8 v. DC at 10 A. continuously or 15 A. intermittent, 0-16 v. DC at 5 A. continuously or 7.5 A. intermittent. Output voltage is clean and well filtered by two 10,000 mfd condensers. Panel meters read voltage and current output.

Heathkit BROADCAST BAND RECEIVER KIT



MODEL BR-2
\$17.50
 (Less Cabinet)
 Shpg. Wt. 10 lbs.

Build your own receiver with confidence. Complete instruction book anticipates your every question.

Features transformer-type power supply, high-gain miniature tubes, built-in antenna, planetary tuning from 550 Kc to 1600 Kc, $5\frac{1}{2}$ " speaker. Also adaptable for use as AM tuner or phono amplifier.

CABINET: Fabric covered plywood cabinet available, complete with aluminum panel and re-inforced speaker grille. Part No. 91-9, Shpg. Wt. 5 lbs., \$4.50

HEATH Company

A SUBSIDIARY OF DAYSTROM INC.

BENTON HARBOR 20, MICHIGAN

New

Heathkit DX-100 PHONE AND CW TRANSMITTER KIT



MODEL DX-100

\$189⁵⁰

Shpg. Wt. 120 lbs.

Shipped motor freight unless otherwise requested. \$50.00 deposit required for C.O.D. orders.

This one compact package contains complete transmitter, with built-in VFO, modulator, and power supplies. Provides phone or CW operation—VFO or crystal excitation—and band-switching from 160 meters through 10 meters. R.F. power output 100—125 watts phone, 120—140 CW. Parallel 6146's modulated by push-pull 1625's. Pi network interstage and output coupling for reduced harmonic output. Will match non-reactive antennas between 50 ohms and 600 ohms. TVI suppressed with extensive shielding and filtering. Rugged metal cabinet has inter-locking seams.

The high-quality transmitter is packed with desirable features not expected at this price level. Copper plated chassis—potted trans-

formers—wide spaced tuning capacitors—ceramic insulation—illuminated VFO dial and meter face—remote control socket—preformed wiring harness—concentric control shafts—high quality, well rated components used throughout. Overall dimensions 20 $\frac{1}{8}$ " wide x 13 $\frac{3}{4}$ " high x 16" deep.

Supplied complete with all components, tubes, cabinet and detailed construction Manual. (Less crystals.) Don't be deceived by the low price! This is a top-quality transmitter designed to give you years of reliable service and dependable performance.



MODEL AT-1

\$29⁵⁰

Shpg. Wt. 15 lbs.

Heathkit AMATEUR TRANSMITTER KIT

Enjoy the trouble-free operation of commercially designed equipment while still benefiting from the economies and personal satisfaction of "building it yourself."

This CW Transmitter is complete with its own power supply, and covers 80, 40, 20, 15, 11 and 10 meters. Single knob bandswitching eliminates coil changing. Panel meter indicates grid or plate current for the final. Crystal operation, or can be excited by external VFO. Crystal not included in kit. Incorporates features one would not expect in this price range, such as key-click filter, line-quality components throughout. Instruction Book simplifies assembly. Uses 6AG7 oscillator, 6L6 final and 5U4G rectifier. Up to 35 watts plate power input.



Model GD-1B

\$19⁵⁰

Shpg. Wt. 4 lbs.

Heathkit GRID DIP METER KIT

This is an extremely valuable tool for Hams, Engineers or Servicemen. Covering from 2 Mc to 250 Mc, it uses 500 μ a meter for indication. Kit includes prewound coils and rack. Will accomplish literally hundreds of jobs on all types of equipment.

Heathkit ANTENNA IMPEDANCE METER KIT

Use in conjunction with a signal source for measuring antenna impedance, line matching purposes, etc. Will double, also, as a phone monitor or relative field strength indicator.

100 μ a meter employed. Covers the range from 0 to 600 ohms. An instrument of many uses for the amateur.



Model AM-1

\$14⁵⁰

Shpg. Wt. 2 lbs.

Heathkit VFO KIT



MODEL VF-1

\$19⁵⁰

Shpg. Wt. 7 lbs.

Weigh the cost of this kit against the cost of crystals—and consider the convenience and flexibility of VFO operation. This is one of the most outstanding kits we have ever offered for the radio amateur.

Covers 160—80—40—20—15—11 and 10 meters with three basic oscillator frequencies. Illuminated and precalibrated dial scale clearly indicates frequency on all bands and provides more than two feet of dial calibration. Reflects quality design in the use of ceramic coil forms and tuning capacitor insulation, and copper plated chassis. Simply plugs into crystal socket of any modern transmitter to provide coverage of the bands from 160 meters through 10 meters. Uses 6AU6 Clapp oscillator, and OA2 voltage regulator for stability. May be powered from plug on Heathkit Model AT-1 Transmitter, or supplied with power from most transmitters.



Model AC-1

\$14⁵⁰

Shpg. Wt. 4 lbs.

Heathkit ANTENNA COUPLER KIT

Poor matching allows valuable communications energy to be lost. The Model AC-1 will match your low power transmitter to an end-fed long wire antenna. Also attenuates signals above 36 Mc, reducing TVI. 52ohm coaxial input—power up to 75 watts—10 through 80 meters.

Heathkit COMMUNICATIONS RECEIVER KIT

Covers 550 Kc to 35 Mc in 4 bands. Features electrical bandspread—separate R.F. and A.F. gain controls—noise limiter—AGC—BFO—phone jack—5 $\frac{1}{2}$ " PM speaker. CABINET: Fabric covered plywood cabinet. Part No. 91-10. Shpg. Wt. 5 lbs. \$4.50



Model AR-2

\$25⁵⁰

Shpg. Wt. 12 lbs. (Less Cabinet)

HEATH Company

A SUBSIDIARY OF DAYSTROM INC.
BENTON HARBOR 20, MICHIGAN

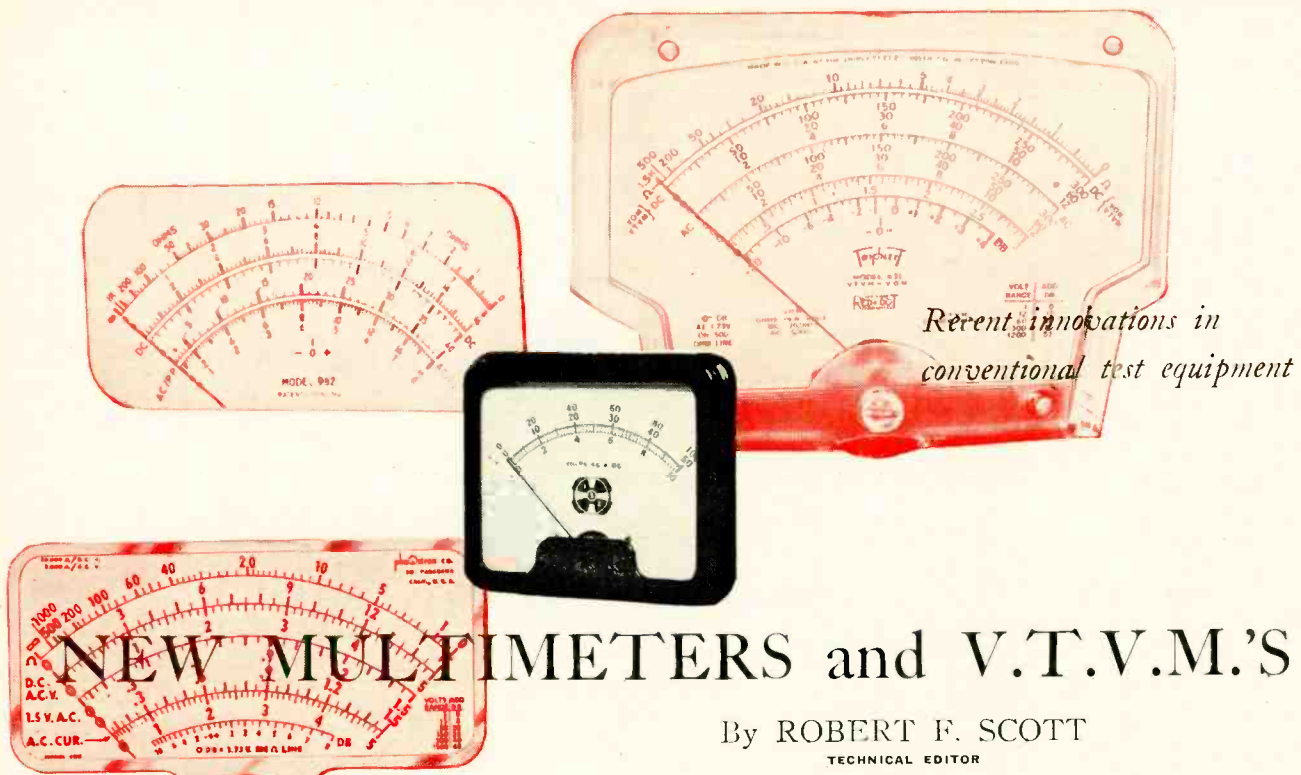

NEW MULTIMETERS and V.T.V.M.'S

By ROBERT F. SCOTT
TECHNICAL EDITOR

MANY new and different types of radio and electronic test equipment were introduced and displayed at the recent IRE show in New York. With the exception of a few displays designed solely as "eye catchers," few instruments attracted more attention than the various multimeters and v.t.v.m.'s.

Some firms exhibited conventional design and circuitry with such features as magnetically shielded metal cases (Phaotron Co.) while others demonstrated designs offering automatic range selection (Bergen Laboratories), expanded scales (Beekman Instruments and American Scientific Development Co.), a combination volt-ohm-milliammeter and v.t.v.m. (Triplett), a battery-operated v.t.v.m. with 32 ranges and exceptionally long battery life (Weston) and several digital volt and volt-ohmmeters with various types of "read-out" indicators.

A multimeter, combination multimeter and v.t.v.m., and two v.t.v.m.'s are described in this article. Others will be described when sufficient material is available from the manufacturers.

The Phaotron multimeter

As the photo (page 70) shows, the Phaotron 555 a.c.-d.c. multimeter is the "new look" in this type of instrument. It is enclosed in a 6½ x 4¾ x 2½-inch shatterproof nonmagnetic metal case that protects it against inaccuracies that often occur when conventional nonshielded plastic-cased instruments are used in strong magnetic fields.

Voltages—a.c. at 2,000 ohms per volt and d.c. at 20,000 ohms per volt—are measured in 7 ranges: 0-1.5, 5, 15, 50, 150, 500 and 0-1,500. The 11 full-

scale d.c. ranges are: 50, 150 and 500 μ a, 1.5, 5, 15, 50, 150, 500 and 1,500 ma, and 15 amps. The 8 a.c. ranges are: 1.5, 5, 15, 50, 150, 500 and 1,500 ma, and 15 amperes. A.c. output is measured from -10 to +50 db in 6 ranges. Zero db equals 1.73 volts across 500 ohms. Resistances from 0.25 ohm to 10 megohms are measured in 4 ranges with full-scale readings of 1,000 and 100,000 ohms, 1 and 10 megohms and half-scale values of 20, 2,000, 20,000 and 200,000 ohms, respectively.

During a period of approximately three months we used and compared the model 555 with three similar multimeters of competitive makes in applications that varied from TV and radio servicing to troubleshooting an automobile lighting system. Its overall performance was all that could be expected of any instrument of this type. The 555's weight is about average but its leather over-the-shoulder camera type carrying case makes it seem lighter and it is definitely more convenient to carry along with other instruments or equipment. The longest scale—4¾ inches—is approximately 1¼ inches longer than those of bulkier instruments and the scale markings are larger and more legible. However, the extremely thin laboratory type pointer makes the instrument more difficult to read than others from some angles or when the light is not just right. A slightly broader pointer would probably increase the ease with which the 555 can be read under some conditions.

On the instrument tested the ZERO OHMS control is so sensitive that it was difficult to bring the pointer to zero quickly without overshooting on both sides. This did not occur on models

demonstrated at the show. Company engineers stated that this trouble had been corrected early in production by using a different resistance taper.

The complete circuit of the model 555 is shown in Fig. 1. The meter has a 45- μ a movement with a resistance of 2,000 ohms. When the selector switch is set to the d.c. voltage or 50- μ a current ranges, the movement is shunted by 18,000 ohms to reduce its sensitivity to 50 μ a.

Fig. 2 is the circuit used for current measurements. Switching has been simplified. A tapped shunt is used on all except the 15-amp ranges. The 15-amp shunt is calibrated with a resistance of approximately .024 ohm. All other resistors are 1% units. Alternating-current ranges begin at 1.5 ma and continue through 15 amps full scale. A full-wave instrument rectifier and compensating resistors R1, R26 and R28 are used for a.c. measurements. Output (decibels) and a.c. and d.c. voltages are measured with the basic circuit in Fig. 3.

In the DC position of the function switch an 18,000-ohm resistor (R31) is shunted across the meter to reduce its sensitivity to 50 μ a for 20,000-ohms-per-volt measurements. On a.c. the resistance in the voltage divider used as the range selector is reduced and the meter and rectifier are shunted by 10,000 ohms and an adjustable 600-ohm resistor to drop the sensitivity to 2,000 ohms per volt. When the function switch is set to OUTPUT, the circuit is the same as for AC except for the 0.1- μ f blocking capacitor that is switched in series with the negative input terminal.

The basic circuit for resistance meas-

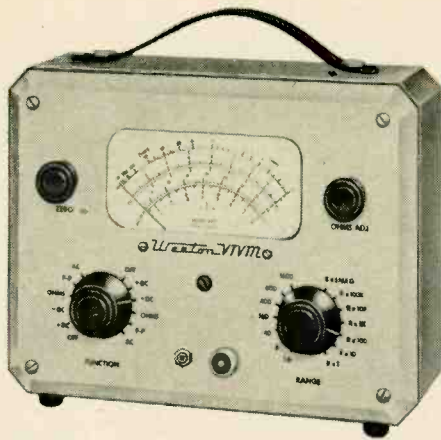

The Weston vacuum-tube voltmeter 982.

Measurements is shown in Fig. 4. In all ranges the resistance being measured is in series with a battery voltage across a section of the current shunt across the meter. The 1.5-volt cell is used on

the $R \times 1$, $R \times 100$ and $R \times 1,000$ ranges. A 15-volt battery is inserted in series with the 1.5-volt cell and the unknown resistance on the $R \times 10,000$ range.

Throwing the function switch to TRANSIT removes the meter from the multimeter circuit and shunts it to protect its movement against damage during storage and transportation.

Weston model 982

The new Weston model 982 is a completely portable battery-operated v.t.v.m. designed especially to meet the needs of the modern radio and electronic technician. Built around a CK-548DX low-drain hearing-aid type tube, the instrument features etched-circuit wiring and switching; extremely long battery life; d.c., a.c. and peak-to-peak voltage measurements as low as 1.6 volts full-scale and resistance measurements as high as 1,000 megohms. Input

resistance is 10 megohms for d.c., 2.83 megohms for a.c. and 1 megohm for peak-to-peak measurements.

Fig. 5 is the complete circuit of the 982. A bridge analogy is shown in Fig. 6. The battery voltages are equal in the two adjacent arms of the bridge. Thus the circuit can be balanced and the meter current reduced to zero by adjusting R18 so its resistance and the plate-filament resistance of the tube equal R19. Now, any voltage applied to the input of the bridge (the grid) will change the effective tube resistance so the circuit is unbalanced and the meter deflects.

The indicating circuit may also be considered as a cathode follower with the meter in the filament return as in Fig. 7. The circuit is connected so plate current through the meter is bucked out by current from a section of the tapped battery by adjusting the ZERO control. The input resistance is constant at 10 megohms. All or a portion of the voltage to be measured (depending on the range) is applied to the grid of the cathode follower. When the voltage is positive on the grid, the tube's internal resistance drops and the plate current exceeds the bucking current and the meter reads upscale. The 33-megohm resistor and .01- μ f capacitor prevent stray electrostatic charges from reaching the grid.

A novel arrangement is used for a.c. and peak-to-peak voltage measurements. The peak-to-peak circuit is in Fig. 8. This circuit is used for all voltages to 1,600 with frequencies from 20 to 2,000 cycles and voltages to 160 at 20 cycles to 300 kc. A low-capacitance 10-to-1 probe (Fig. 5) is used when low circuit loading is important or when peak-to-peak voltages above 160 have frequency components above 4 kc. The adapter raises the input impedance to 10 megohms shunted by 15 μ f.

The input divider consists of R3 through R12 and capacitors C2, C3, C4 and C10. The resistors serve as voltage dividers for all voltages below 2 kc and the capacitors are voltage dividers for frequencies above 2 kc on the 8- and 40-volt ranges.

The a.c. signal applied to the grid of the cathode follower modulates the plate current and causes an amplified a.c. voltage to appear in the cathode circuit. This voltage is rectified by the CK-740 germanium diodes to develop a d.c. voltage equal to the peak-to-peak a.c. voltage. This d.c. voltage is applied to the grid of the tube to unbalance the d.c. bridge and produce a reading on the meter.

When the instrument is used on the AC setting (Fig. 5), a 1.83-megohm resistor (R15) is inserted in series with the applied voltage to increase the input resistance to 2.83 megohms and decrease the instrument's sensitivity to give correct r.m.s. readings.

A series type ohmmeter is used for resistance measurements. A 1.5-volt cell is inserted in series with the unknown resistance and a portion of the

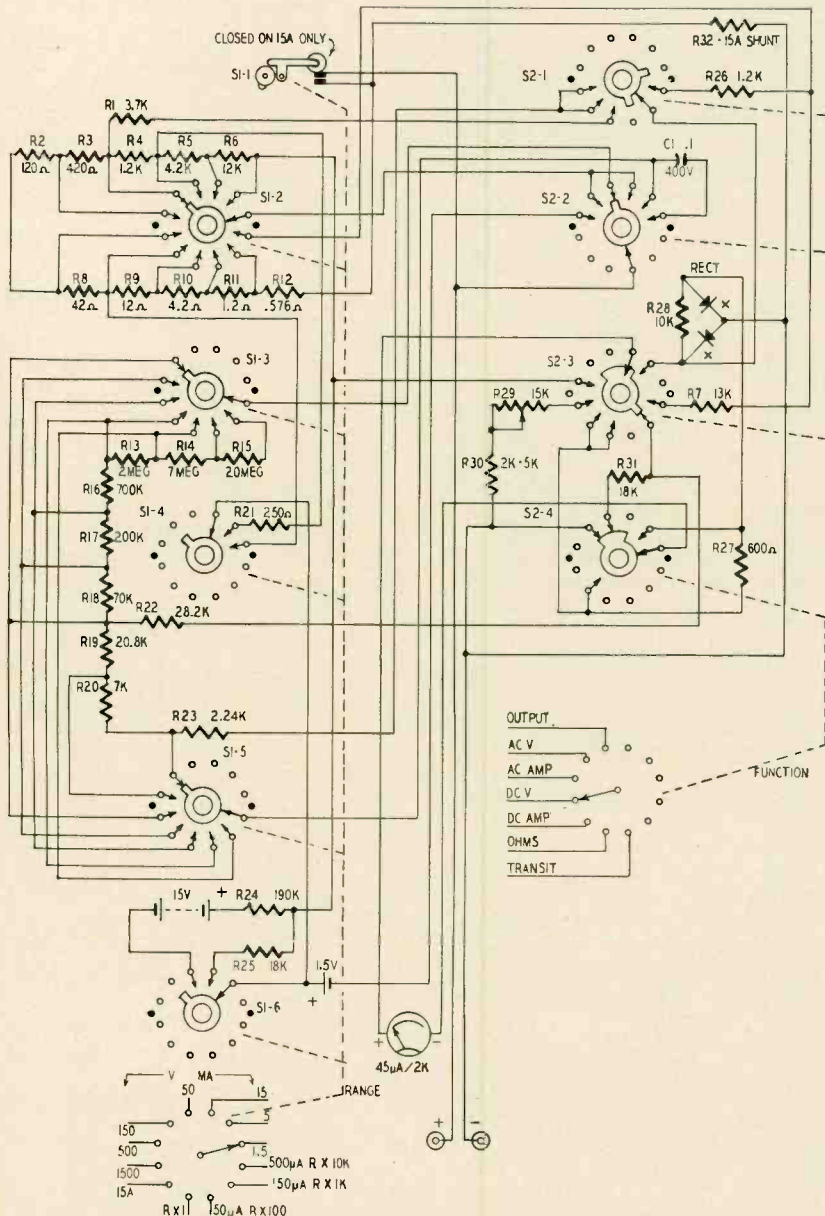
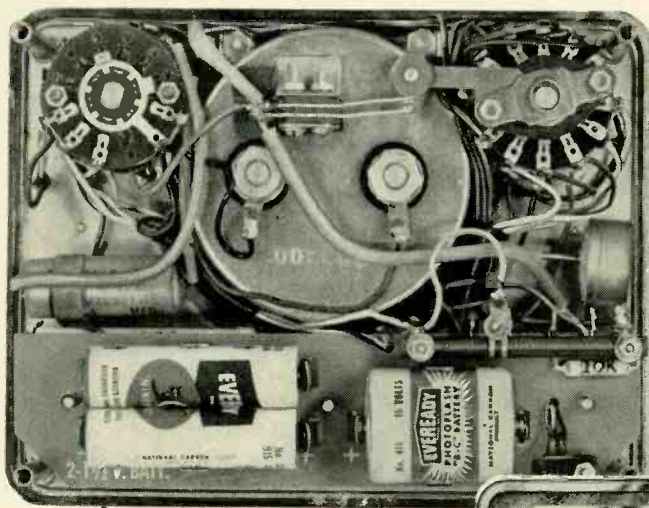
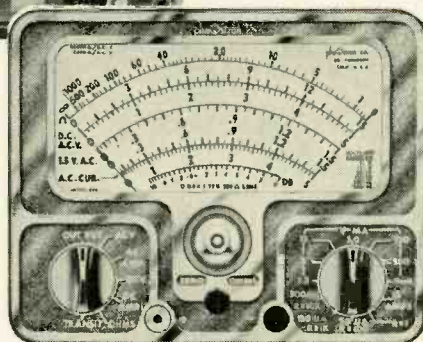

Fig. 1—Schematic diagram of the Phaostron model 555 a.c.-d.c. multimeter.

TEST INSTRUMENTS



An internal view of the Phaostron.



The Phaostron a.c.-d.c. multimeter.

input resistance divider consisting of R1 through R14. The v.t.v.m. measures the voltage across a known section of the resistance divider and indicates the value of the unknown resistor on the ohms scale.

The ZERO control compensates for variations in the B voltage and adjusts the pointer to the left-hand zero. The OHMS ADJ control compensates for voltage variations in the 1.5-volt ohmmeter cell and lines up the pointer with zero on

the ohms scale when the test leads are shorted together.

The filament of the CK-548DX draws only 10 ma—about one-sixth the current of a small flashlight bulb—so the standard type D flashlight cell used in the filament circuit will last three to six months when used normally for eight hours per day. The drain on the 45-volt B battery is so low that its useful life—approximately one year—is determined mainly by temperature and humidity which affect shelf-life.

As the batteries age their internal resistance gradually increases to a point where the meter cannot be zeroed. The internal 45-volt battery can be checked by setting the FUNCTION switch to +DC and the RANGE selector to 40 volts with the shielded test lead on the 45-volt terminal of the battery. The meter reads 22.5 volts for a new battery but the instrument operates normally until the reading drops to about 19, after which the B battery should be replaced.

Batteries are replaced by removing four screws from the back panel. Components are easily replaced by removing four screws on the front panel. The defective part should be clipped out of the circuit leaving as much pigtail as possible attached to the etched plate.

The Triplett v.t.v.m.—v.o.m.

The model 631 Triplett is a combination volt-ohm-milliammeter and a d.c. vacuum-tube voltmeter. The v.t.v.m. is battery-operated and measures 1.2, 6, 30 and 120 volts full scale, with an input impedance of 11 megohms. The multimeter section measures voltages in full-scale ranges of 3, 12, 60, 300 and

1,200 at 20,000 ohms per volt on d.c. and 5,000 ohms per volt on a.c. Direct-current ranges are 60 μ a, 1.5, 12, 120 and 1,200 ma, and 12 amps. Resistance is measured in four ranges with full-scale deflections of 1,500, 15,000 ohms and 1.5 and 150 megohms. A.c. output in decibels is measured in six ranges covering from -20 to +56 db. Zero db is 1.73 volts across 500 ohms (.006 watt).

Accessory high-voltage probes (for the multimeter circuit) are available for increasing the range to 12,000, 30,000 and 60,000 volts d.c. and to 12,000 and 30,000 volts a.c. External current shunts are available for 1.2, 30, 60 and 120 amps d.c.

The circuit of the 631 is shown in Fig. 9. The multimeter circuit is conventional and similar to that of the

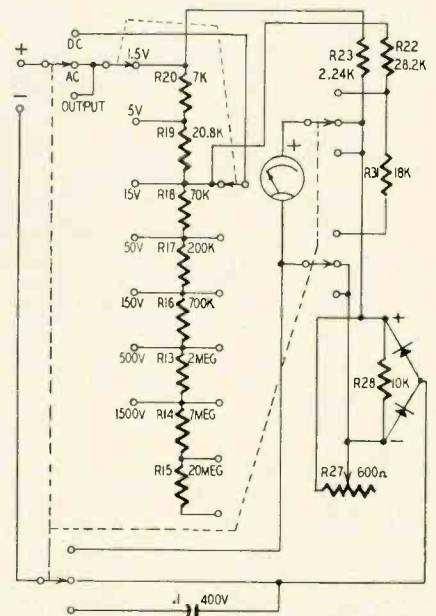

Fig. 3—Model 555 circuit for measuring a.c. and d.c. volts, and decibels.

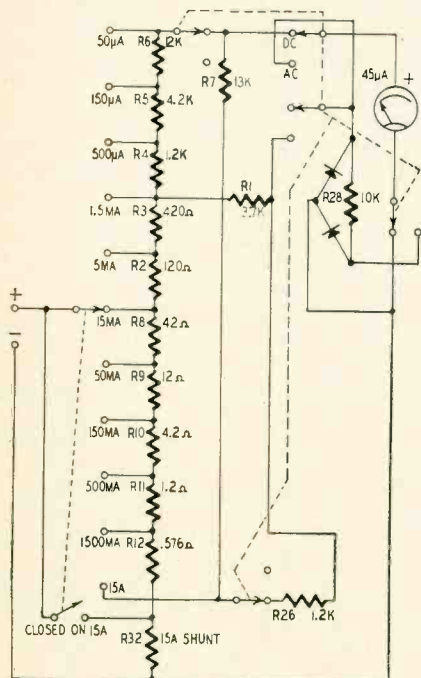

Fig. 2—Circuit for current measurements.

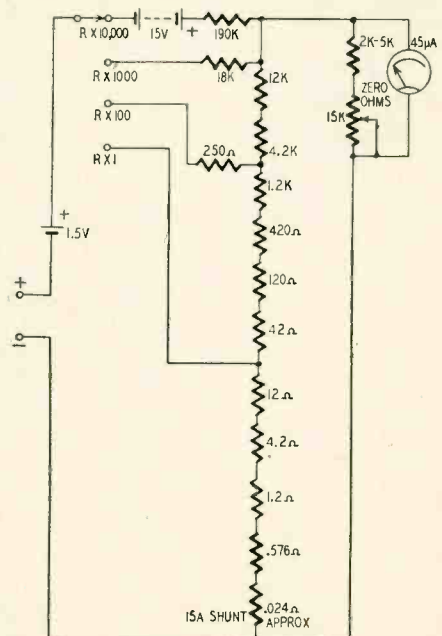

Fig. 4—Circuit measures resistance.

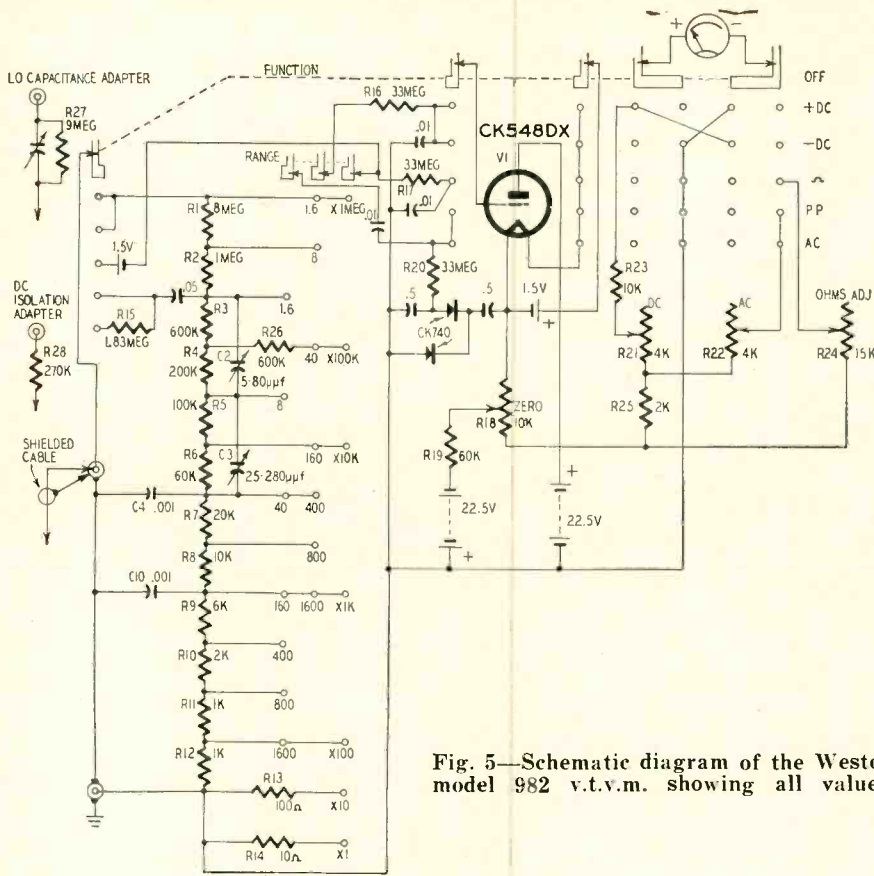

Fig. 5—Schematic diagram of the Weston model 982 v.t.v.m. showing all values.

Phaotron 555. The v.t.v.m. circuit (Fig. 10) is similar to that used in the Weston v.t.v.m. just described. The meter is between the center tap on the B battery and the filament return of the tube. The ZERO ADJ control balances out the initial plate current flowing through the meter by adjusting the amount of bucking current fed backward through

the meter by the batteries. The .01- μ f capacitor prevents a.c., r.f. and electrostatic voltages from reaching the grid, causing inaccuracies.

The battery can be checked without being removed from the instrument. The 1.5-volt cell is O.K. as long as the $R \times 1$ range of the multimeter can be zeroed. The plate battery is checked by turning on the v.t.v.m. and passing the TEST B PLUS button. The meter should read between 21 and 24 volts on the 30-volt v.t.v.m. scale.

The VM-30 Deca-Meter

For maximum accuracy when measuring voltages on a v.t.v.m. or multimeter we try to select a range where the voltage reading falls in the center or about two-thirds of full-scale deflection. But this is not always possible. Very often we wish to measure as accurately as possible a voltage of say 255 volts. This would be difficult with many meters that have 250 volts as one range and 1,000 or 1,500 as the next one up. Measurements on the 250-volt range of our hypothetical meter can be read quite closely because one division on the scale is usually 5 volts or less. On the 1,500-volt range each division is 20 volts and the indication falls down into the most inaccurate part of the scale.

This difficulty does not exist with an expanded-scale decade type meter such as the model VM-30 v.t.v.m. made by American Scientific Development Co. This instrument features a total of 30 voltage ranges in 10-, 50- and 100-volt

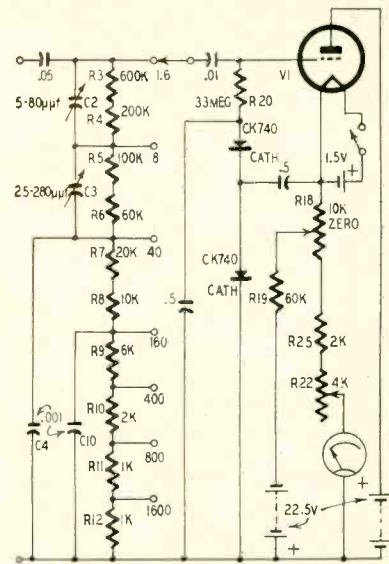

Fig. 8—Circuit measures peak-to-peak volts.

steps. D.c. voltages to 1,000, and a.c. to 300, can be read. Input impedance is constant at 11 megohms on d.c. and is approximately 1 megohm at 60 cycles. Response is substantially flat up to 4.5 mc. Above this, the accuracy depends on the inductance and capacitance of the test leads.

Fig. 11 is the circuit of the VM-30. With the RANGE selector set to A (10 volts) the full-scale deflection is 10 volts and the voltage read on the meter is added to the voltage selected on the A range of the DECADE SELECTOR. Any 10-volt section of voltages up to 100 can be spread over the entire meter scale. Thus, if the meter reads 6 volts when the DECADE SELECTOR is set to 70, this indicates that the voltage applied to the meter is 70 plus 6, or 76. If the meter reads 10 under this setup, the voltage is 80. Any voltage equal to or less than that indicated on the DECADE SELECTOR will read zero on the meter.

The circuit is a modification of a triode slideback voltmeter. However, instead of adjusting a bucking bias on the grid to give a predetermined reading on a plate current meter, the de-

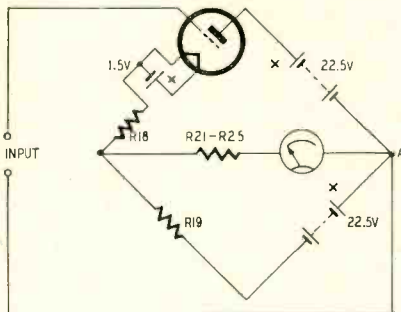

Fig. 6—Bridge analogy of the 982.

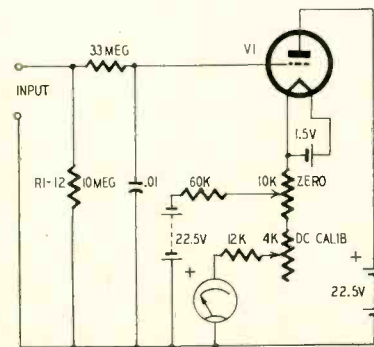

Fig. 7—982 cathode follower circuit.



The Tripplett model 631 v.t.v.m. v.o.m.

P. R. MALLORY & CO. INC.
MALLORY
APPROVED PRECISION PRODUCTS

P. R. MALLORY & CO. INC.
MALLORY
APPROVED PRECISION PRODUCTS

P. R. MALLORY & CO. INC.
MALLORY
APPROVED PRECISION PRODUCTS

Exact Duplicate DUAL CONTROLS available TWO ways

DO you prefer ready-to-use dual controls? Or would you like a small stock of control sections, switches and shafts that you can assemble quickly for the combination you need?

Either way, with Mallory, you can be sure of duplicating the exact electrical characteristics of the controls in practically any popular TV set.

Either way, with Mallory, you can equal or exceed the performance of the original equipment control. You can count on accurate resistance values, smooth tapers, quiet operation and long life.

Either way, with Mallory, you can be sure the job is right the first time... without profit-cutting "come backs."

Either way, your Mallory distributor has what you need. Call him today!

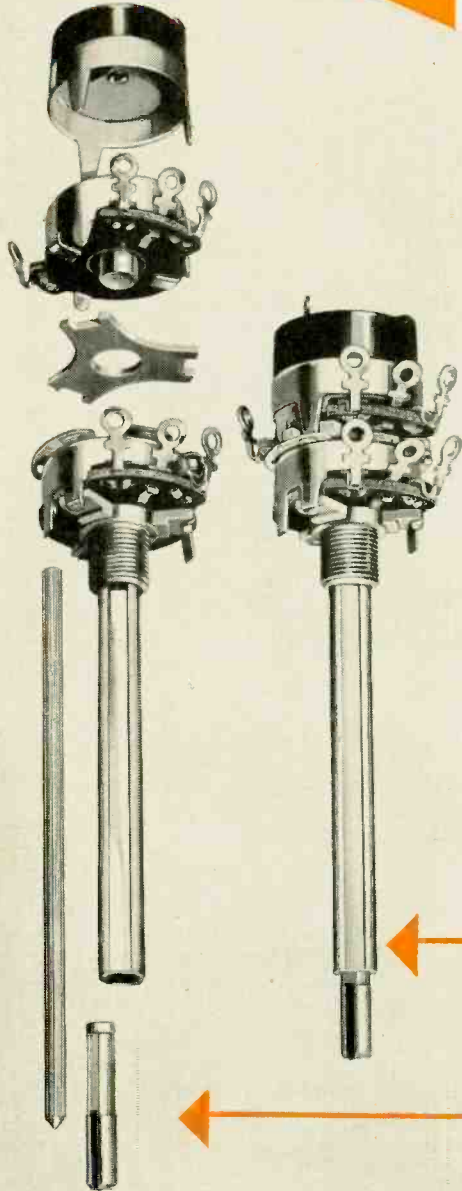

Exact duplicate, ready-to-use, dual control... factory-made with all the resistance values, tapers, taps, switches and shaft lengths needed for most of the popular TV sets.

Exact duplicate, dual control kits. With a small stock of factory-assembled control sections, you can make 10,000 different combinations. No soldering or special tools required. Assembly takes less than five minutes.

APPROVED PRECISION PRODUCTS

APPROVED PRECISION PRODUCTS

P. R. MALLORY & CO. INC.
MALLORY

CAPACITORS • CONTROLS • VIBRATORS • SWITCHES • RESISTORS
RECTIFIERS • POWER SUPPLIES • FILTERS • MERCURY BATTERIES

APPROVED PRECISION PRODUCTS

P. R. MALLORY & CO. Inc., INDIANAPOLIS 6, INDIANA

P. R. MALLORY & CO. INC.
MALLORY
APPROVED PRECISION PRODUCTS

P. R. MALLORY & CO. INC.
MALLORY
APPROVED PRECISION PRODUCTS

P. R. MALLORY & CO. INC.
MALLORY
APPROVED PRECISION PRODUCTS

Build This CRT TESTER and REJUVENATOR

Inexpensive instrument reactivates picture tubes and indicates operating condition

By JAMES V. CAVASENO

WITH the prospect of color television staring them in the face many people will not want to spend a lot of money to repair old monochrome sets—especially when it comes to buying a new picture tube. Knowing that there is money to be made if I can give the customer a picture good enough to watch, I started reading up on construction and operation of picture tubes. I found a number of causes for their failure. Chief among them is the trouble known as “cathode growth” which in time causes the tube to give a dim picture. If this is allowed to go on, the growth will eventually short the cathode and grid so there will be no picture at all. The rejuvenator in this article will make any picture tube whose dimness is caused by this condition as good as new.

The parts required to build this unit (Fig. 1) are few and inexpensive. The total cost of mine was about \$7, and I have used it lots of times to rejuvenate tubes at an average of \$5 a tube. It has seldom failed me. I now tell the customer he owes me nothing if it doesn't work; that's how sure of it I have become. I have even stopped selling picture tubes until I have tried to rejuvenate the old one. That way I make nearly the same profit—everyone nowadays wants a big discount—and I don't have to worry about the one-year warranty.

I used a cigar box to house my tester, and later installed it in the metal box shown here. The meter used (surplus and costing \$1.50) is a 0–20 ma, and I designed the circuit around it. If a different type meter is used, the value of R1 may have to be changed to get a convenient reading on it. About half-scale is O.K. If the needle moves only a little, it will be hard to tell the difference between a good tube and a bad one. It is not practical to try to use a meter which requires more than 50 ma for full-scale deflection since the reading will be hard to make out. A smaller one will be much better, but R1 will have to be made accordingly larger. R2 should not be changed.

After assembling the unit, calibrate it

as follows: Set it up for test position and plug in a new tube. Adjust the pointer knob on R3 until you read about 6.5 volts across the filaments of the tube. Mark the position of the knob and the position of the meter needle at this point. This gives you your calibration. When testing a tube, set the knob to this same position and, if the tube is good, the meter will read the same as before. If the meter reads less, the tube under test is weak and should be rejuvenated. With the tube plugged in, rotate the S1 to REJUVENTATE, and turn control R3 for full voltage on the filaments. It is necessary to leave it for only a few seconds, after which the tube should read good. Even a tube that gives almost no reading may be restored

so that it will work satisfactorily. This tester doesn't show any switching for a short test.

If a short exists between filament and cathode (a common condition), there

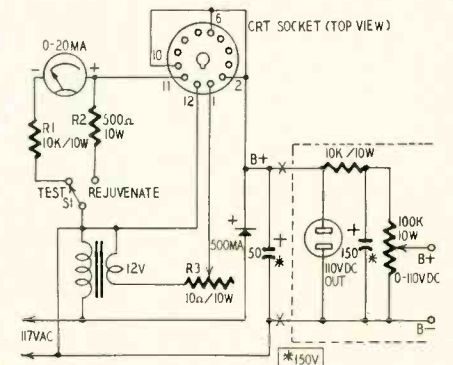
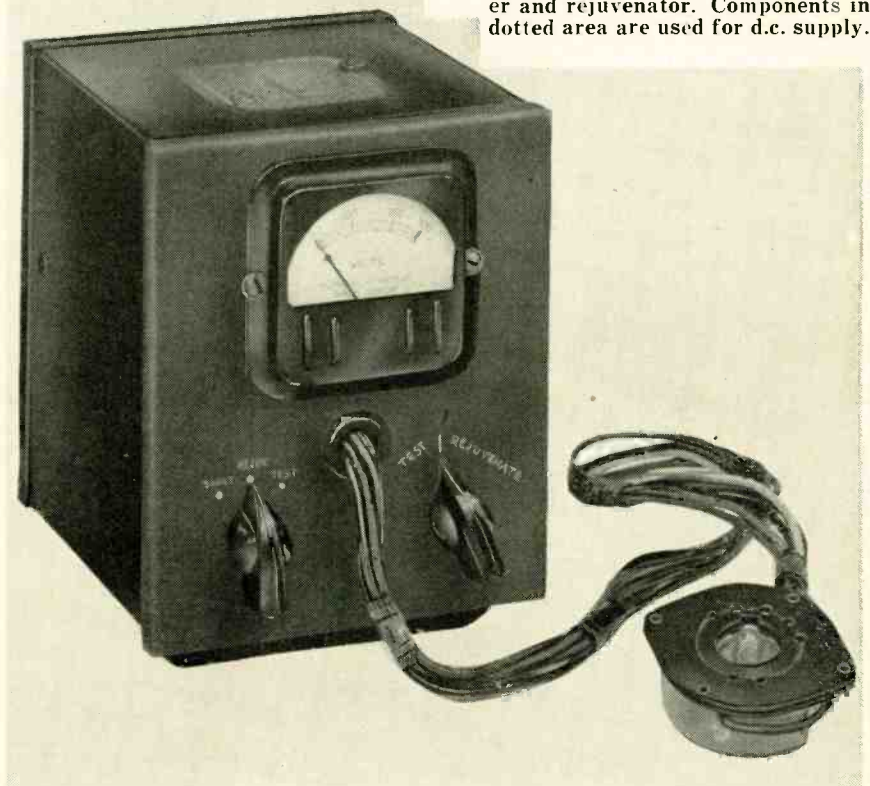

Fig. 1—The cathode-ray tube checker and rejuvenator. Components in dotted area are used for d.c. supply.



Front view of the rejuvenator checker.

YOU MUST PLEASE
women
YOUR CUSTOMERS
IF YOU WANT
TO MAKE YOUR
BUSINESS GROW

It's a woman you have to please in 76.9% of your service calls.

You'll please more women when you use tubes with the Good Housekeeping Guaranty Seal . . . CBS tubes.



CBS tubes are advertised and merchandized to millions of women in national magazines . . . and on Arthur Godfrey's Talent Scouts over nationwide TV and Radio networks.

More and more women will have greater confidence in you and your service when you use tubes with the Good Housekeeping Seal . . . tubes with the respected name — CBS.

Ask your distributor for
CBS tubes



CBS-HYTRON

Danvers, Massachusetts

A DIVISION OF

COLUMBIA BROADCASTING SYSTEM, INC.

a HIT in
High Fidelity
with
COLLINS
AUDIO PRODUCTS CO.
'PRE-FAB' TUNERS

Collins Audio Products Co. is in no way affiliated with Collins Radio Co.

Each Collins Tuner Kit is complete with punched chassis, tubes, power transformer, power supply, components, hardware, dial assembly, tuning eye, knobs, wire, etc., as well as the completed sub-assemblies: FM tuning units, AM tuning units, IF amplifiers, etc. All sub-assemblies wired, tested and aligned at the factory make Collins Pre-Fab Kits easy to assemble even without technical knowledge. The end result is a fine, high quality, high fidelity instrument at often less than half the cost—because you helped make it AND BOUGHT IT DIRECT FROM THE FACTORY.

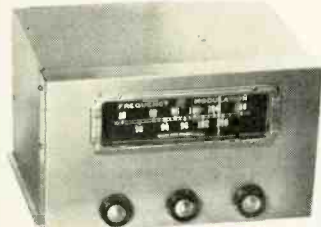

NEW FM TUNER KIT

New decorative gold front. New cascade front end—3 mv sensitivity. IF amplifier mounted, wired and tested in the chassis. You mount completed RF tuning unit and power supply. 11 tubes, 20 to 20,000 cycle response. A.F.C. and switch. Size: 12½" x 9½" x 7" high. Shipping weight: 15 pounds. Manual supplied. Gold screen cover available at \$3.50 extra. PRICE: **\$59.50**



NEW FM-AM TUNER KIT

New, decorative gold front like FM tuner above. New cascade front end on FM—3 mv sensitivity. 15 tubes. Comprises chassis, power supply parts, AM unit, FM unit, IF amplifier, all wired and tested, ready for mounting in chassis. A.F.C. with switch. Kits include all parts and hardware. Size: 14" x 12" x 7½" high. Shipping weight: 19 pounds. Manual supplied. **\$82.50** Gold screen cover available at \$3.75 extra. PRICE:

FMF-3B Tuning Unit with Cascade
 Permability tuned, 3 tubes, A.F.C., 3 microvolts sensitivity. May be used with any 10.7 MC IF amplifier such as our IF-6. **\$19.50**
 2 pounds.

AM-4 Tuning Unit
 3-gang tuning condenser. Unit covers 530 to 1600 KC. Completely wired and tested with tubes. 4 tubes. Chassis plate measures: 4" x 7¾". 2½ pounds. **\$24.50**

IF-6 Amplifier
 6 tubes, 10.7 MC. Low distortion, high gain. 3 pounds. **\$21.50**

MAIL COUPON TODAY!

To: Collins Audio Products Co., Inc.
 P. O. Box 368 RE-8
 Westfield, N. J.
 Tel. Westfield 2-1390

- FM Tuner Kit FM-AM Tuner Kit
 FMF-3B Tuning Unit IF-6 Amplifier
 AM-4 Tuning Unit COVER

Name
 Address
 City State
 Amount for Kit \$
 See weights, add shipping cost \$
 Total amount enclosed \$
 Check Money Order

WHEN YOU THINK OF TUNERS,
THINK OF
COLLINS AUDIO PRODUCTS

TEST INSTRUMENTS

will be no reading on the meter. In this case—as in any case where there is no indication on the meter—the tube is no good. If a tube is shorted, this unit will not help much, but the short may sometimes be eliminated by arcing the high voltage from a TV set across the shorted elements for a few seconds. This is done by grounding one of the shorted elements and connecting the high voltage to the other.

The other components in the unit are standard. The switch is a s.p.d.t. toggle type, control R3 is a 10-ohm 10-watt rheostat, and finally the transformer is a stepdown 117 to 12 volts. This may be an 8-volt heavy-duty bell transformer, in which case potentiometer R3 may also be eliminated since all it does is cut down the voltage to a safe value for the tube being tested. The 12-volt type is preferable—it works much better. If one wants to simplify further, the selenium rectifier and filter capacitor may also be omitted by letting the tube do the rectifying. This is done by connecting a jumper in place of the rectifier. In this case resistors R1 and R2 will have to be reduced in value because the circuit will now draw less current.

Parts list for tester-rejuvenator

Resistors: 1—500, 1—10,000, 1—100,000, 1—500,000, all 10 watts; 1—10,000 ohms, 1—500,000 ohms, 10-watt potentiometers or variable resistors.

Capacitors: 2—50 µf, 150 volts, electrolytic.

Miscellaneous: 1—meter, 0-20 ma, or see text; 1—transformer: primary, 117 volts, secondary, 12 volts (or see text); 1—selenium rectifier, 500-ma type; 1—receptacle for d.c. output; wire, hardware, etc.

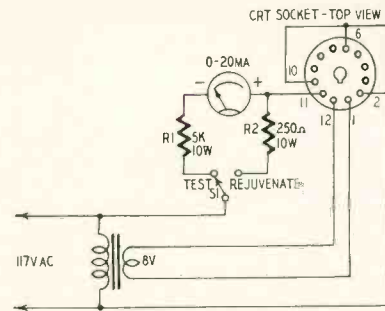
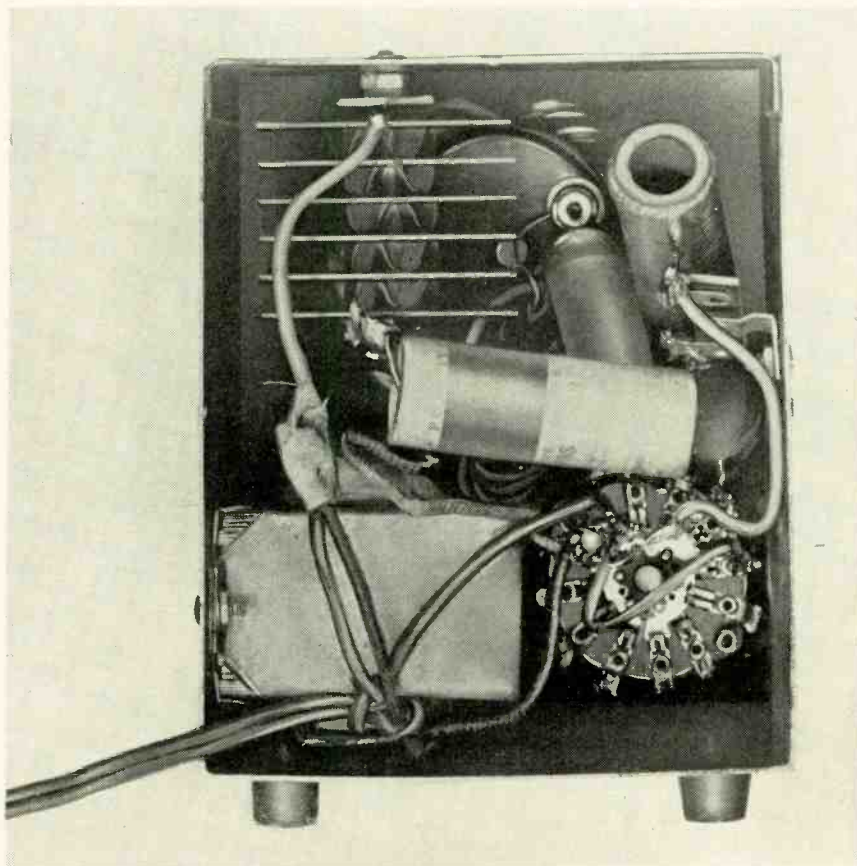

Fig. 2—Simplified form of the checker.

Fig. 2 shows the simpler diagram. The better circuit is that in Fig. 1.

The unit is useful for other purposes. I have installed an outlet in mine and use it to test small d.c. appliances such as a record player with an inverter in it for d.c. use; sometimes I get a radio which plays only on d.c. The current drain of these is small and does not overload the tester. I have also added another 10,000-ohm resistor and another capacitor to filter the d.c. further, and a 100,000-ohm pot across the d.c. From the center tap of this pot and ground, I can get any value of d.c. voltage I may need up to about 110. This is handy when I align sets and need 3 or 4 volts on the a.g.c. bus.

I don't claim this is the best tester and rejuvenator in the world, but for the average service shop it is all that's needed. It will tell instantly if a trouble is in the picture tube or in the set. Also it will make many discarded pix tubes good enough for shop use. END



Inside view of the completed instrument.

Superior's new
Model TV-11

TUBE TESTER



SPECIFICATIONS:

- ★ Tests all tubes, including 4, 5, 6, 7, Octal, Lock-in, Peanut, Bantam, Hearing Aid, Thyatron, Miniatures, Sub-miniatures, Novals, Sub-minars, Proximity fuse types, etc.
- ★ Uses the new self-cleaning Lever Action Switches for individual element testing. Because all elements are numbered according to pin-number in the RMA base numbering system, the user can instantly identify which element is under test. Tubes having tapped filaments and tubes with filaments terminating in more than one pin are truly tested with the Model TV-11 as any of the pins may be placed in the neutral position when necessary.
- ★ The Model TV-11 does not use any combination type sockets. Instead individual sockets are used for each type of tube. Thus it is impossible to damage a tube by inserting it in the wrong socket.
- ★ Free-moving built-in roll chart provides complete data for all tubes.
- ★ Newly designed Line Voltage Control compensates for variation of any Line Voltage between 105 Volts and 130 Volts.
- ★ NOISE TEST: Phono-jack on front panel for plugging in either phones or external amplifier will detect microphonic tubes or noise due to faulty elements and loose internal connections.
- ★ EXTRA SERVICE — The Model TV-11 may be used as an extremely sensitive Condenser Leakage Checker. A relaxation type oscillator incorporated in this model will detect leakages even when the frequency is one per minute.

The model TV-11 operates on 105-130 Volt 60 Cycles A.C.
Comes housed in a beautiful hand-rubbed oak cabinet
complete with portable cover

\$47⁵⁰
NET

Superior's New
Model TV-40

C.R.T. TUBE TESTER



A complete picture tube tester for little more than the price of a "make-shift" adapter!!

The Model TV-40 is absolutely complete! Self-contained, including built-in power supply, it tests picture tubes in the only practical way to efficiently test such tubes; that is by the use of a separate instrument which is designed exclusively to test the ever increasing number of picture tubes!

EASY TO USE:

Simply insert line cord into any 110 volt A.C. outlet, then attach tester socket to tube base (Ion trap need not be on tube). Throw switch up for quality test...read direct on Good-Bad scale. Throw switch down for all leakage tests.

Tests all magnetically deflected tubes...in the set...out of the set... in the carton!!

SPECIFICATIONS:

- Tests all magnetically deflected picture tubes from 7 inch to 30 inch types.
- Tests for quality by the well established emission method. All readings on "Good-Bad" scale.
- Tests for inter-element shorts and leakages up to 5 megohms.
- Test for open elements.

Model TV-40 C.R.T. Tube Tester comes absolutely complete—nothing else to buy. Housed in round cornered, molded bakelite case. Only

\$15⁸⁵
NET

SHIPPED ON APPROVAL
NO MONEY WITH ORDER - NO C.O.D.

We invite you to try before you buy any of the models described on this and the following page. If after a 10 day trial you are completely satisfied and decide to keep the Tester, you need send us only the down payment and agree to pay the balance due at the monthly indicated rate. (See other side for time-payment schedule details.)

**NO INTEREST
OR FINANCE
CHARGES ADDED!**

If not completely satisfied, you are privileged to return the Tester to us, cancelling any further obligation.

**SEE OTHER
SIDE**

CUT OUT AND MAIL TODAY!

BUSINESS REPLY CARD

No Postage Stamp Necessary if Mailed in the United States

POSTAGE WILL BE PAID BY—

MOSS ELECTRONIC DIST. CO., INC.

3849 TENTH AVENUE

NEW YORK 34, N. Y.

FIRST CLASS
Permit No. 61430
New York, N. Y.

Superior's new
Model 670-A

SUPER METER

A COMBINATION VOLT-OHM MILLIAMMETER PLUS CAPACITY REACTANCE
INDUCTANCE AND DECIBEL MEASUREMENTS



SPECIFICATIONS:

D.C. VOLTS: 0 to 7.5/15/75/150/750/1,500/7,500 Volts
A.C. VOLTS: 0 to 15/30/150/300/1,500/3,000 Volts
OUTPUT VOLTS: 0 to 15/30/150/300/1,500/3,000 Volts
D.C. CURRENT: 0 to 1.5/15/150 Ma. 0 to 1.5/15 Amperes
RESISTANCE: 0 to 1,000/100,000 Ohms 0 to 10 Meg-ohms
CAPACITY: .001 to Mfd. 1 to 50 Mfd. (GOOD-BAD scale for checking quality of electrolytics)
REACTANCE: 50 to 2,500 Ohms 2,500 Ohms to 2.5 Meg-ohms
INDUCTANCE: .15 to 7 Henrie: 7 to 7,000 Henries
DECIBELS: -6 to +18 +14 to +38 +34 to +58

ADDED FEATURE:

Built-in ISOLATION TRANSFORMER reduces possibility of burning out meter through misuse.

The Model 670-A comes housed in a rugged crackle-finished steel cabinet complete with test leads and operating instructions.

\$28⁴⁰ NET

The New Model TV-50

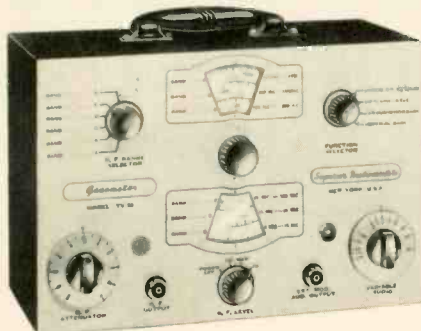

GENOMETER

A versatile all-inclusive GENERATOR which provides ALL the outputs for servicing:
A.M. Radio • F.M. Radio • Amplifiers • Black and White TV • Color TV

7 Signal Generators in One!

- ✓ R. F. Signal Generator for A.M.
- ✓ R. F. Signal Generator for F.M.
- ✓ Audio Frequency Generator
- ✓ Bar Generator
- ✓ Cross Hatch Generator
- ✓ Color Dot Pattern Generator
- ✓ Marker Generator

R. F. SIGNAL GENERATOR: The Model TV-50 Genometer provides complete coverage for A.M. and F.M. alignment. Generates Radio Frequencies from 100 Kilocycles to 60 Megacycles on fundamentals and from 60 Megacycles to 180 Megacycles on powerful harmonics.

CROSS HATCH GENERATOR: The Model TV-50 Genometer will project a cross-hatch pattern on any TV picture tube. The pattern will consist of non-shifting, horizontal and vertical lines interlaced to provide a stable cross-hatch effect.

VARIABLE AUDIO FREQUENCY GENERATOR: In addition to a fixed 400 cycle sinewave audio, the Model TV-50 Genometer provides a variable 300 cycle to 20,000 cycle peaked wave audio signal.

DOT PATTERN GENERATOR (FOR COLOR TV) Although you will be able to use most of your regular standard equipment for servicing Color TV, the one addition which is a "must" is a Dot Pattern Generator. The Dot Pattern projected on any color TV Receiver tube by the Model TV-50 will enable you to adjust for proper color convergence.

BAR GENERATOR: The Model TV-50 projects an actual Bar Pattern on any TV Receiver Screen. Pattern will consist of 4 to 16 horizontal bars or 7 to 20 vertical bars.

MARKER GENERATOR: The Model TV-50 includes all the most frequently needed marker points. The following markers are provided: 189 Kc., 262.5 Kc., 456 Kc., 600 Kc., 1000 Kc., 1400 Kc., 1600 Kc., 2000 Kc., 2500 Kc., 3579 Kc., 4.5 Mc., 5 Mc., 10.7 Mc., (3579 Kc. is the color burst frequency.)

THE MODEL TV-50 comes absolutely complete with shielded leads and operating instructions.

\$47⁵⁰ NET

**SHIPPED ON APPROVAL
 NO MONEY WITH ORDER - NO C.O.D.**

MOSS ELECTRONIC DISTRIBUTING CO., INC.
 Dept. D-146, 3849 Tenth Avenue, New York 34, N. Y.

Please send me the units checked. I agree to pay down payment within 10 days and to pay the monthly balance as shown. It is understood there will be no finance, interest or any other charges, provided I send my monthly payments when due. It is further understood that should I fail to make payments when due, the full unpaid balance shall become immediately due and payable.

- Model TV-11 . . . Total Price \$47.50 \$11.50 within 10 days. Balance \$6.00 monthly for 6 months.
- Model TV-40 . . . Total Price \$15.85 \$3.85 within 10 days. Balance \$4.00 monthly for 3 months.
- Model 670-A . . . Total Price \$28.40 \$7.40 within 10 days. Balance \$3.50 monthly for 6 months.
- Model TV-50 . . . Total Price \$47.50 \$11.50 within 10 days. Balance \$6.00 monthly for 6 months.

Name _____
 Address _____
 City _____ Zone _____ State _____

We invite you to try before you buy any of the models described on this and the preceding page. If after a 10 day trial you are completely satisfied and decide to keep the Tester, you need send us only the down payment and agree to pay the balance due at the monthly indicated rate.

**NO INTEREST
 OR FINANCE
 CHARGES ADDED!**

If not completely satisfied, you are privileged to return the Tester to us, cancelling any further obligation.

**SEE OTHER
 SIDE**

CUT OUT AND MAIL TODAY!

Home-Built GRID DIP METER

By T. W. DRESSER

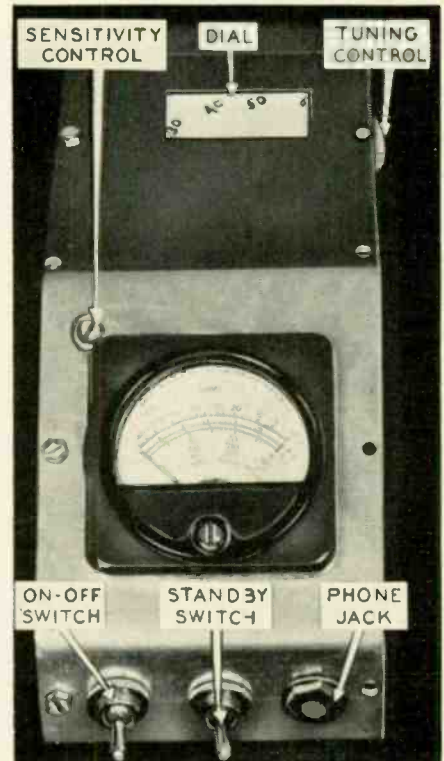
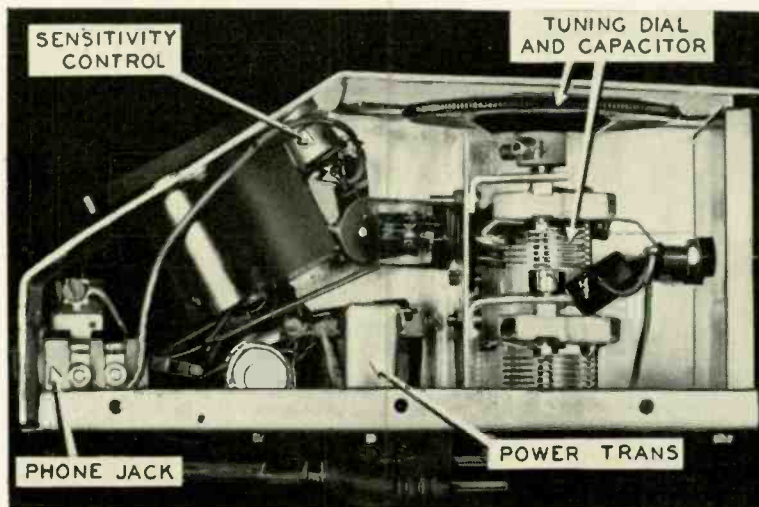

Above is a front view of the meter, and at left a side view, showing how parts are laid out in the instrument.

It is mighty strange that the grid dip meter, the principles of which are as old as radio, should be regarded by many amateurs and technicians as an instrument which may be O.K. in the lab but not of much use in the shop. Yet, no instrument is of more practical help to the radio man. Simple and reasonably inexpensive to build, it requires no maintenance or adjustment other than the changing of a tube on rare occasions. With a good grid dip meter a technician can just about sling his signal generator and multimeter into the nearest creek and not particularly miss them. And if he is a TV technician, a grid dip meter is invaluable. For the fellow who can't afford a signal generator and has always lined up his home-built rigs on a signal from the nearest broadcast station—well, this is where he comes into his own!

Most grid dip meters are a combination low-power oscillator and absorption type wavemeter and can, therefore, be

used to check both energized and de-energized circuits. Used as an oscillator a grid dip meter can determine pretty accurately the resonant frequency of tuned circuits, locate parasitic frequencies and tune, approximately, transmitter stages with the power off. It can also be used to peak i.f. transformers, traps and filters in receivers. And, together with an audio oscillator, it will help considerably in locating troubles in TV receivers and in alignment.

With the oscillator plate supply switched off and the instrument used as an absorption type wavemeter, it will indicate the frequency of radiated signals, check spurious radiations and—with a pair of phones plugged into the socket—serve as a quality monitor on AM transmissions. For sheer versatility and all around usefulness it is hard to beat.

Several conventional circuits can be used in building such a meter. Two of

them are shown in Figs. 1, 2. The unit in Fig. 1 is extremely good, having a sensitive meter movement of 200–500 microamperes and a stable and reliable oscillator which insures accurate dial readings. However, the components used in the circuit make it expensive to build. A much simpler version and one that is considerably cheaper to build is shown in Fig. 2.

A robust plate current meter takes the place of the grid meter used in Fig. 1 and the circuit is reduced to bare essentials without sacrificing anything in the way of efficiency. There is no rectifier for the B voltage—the tube acts as its own rectifier. Very little can go wrong with it and the cost is low, the most expensive item possibly being the meter. It can be used with a.c. or d.c. supplies and a .001- μ f capacitor isolates the supply line from the chassis. Nevertheless it would be a good safe policy to make the case of Bakelite or some other insulating mate-

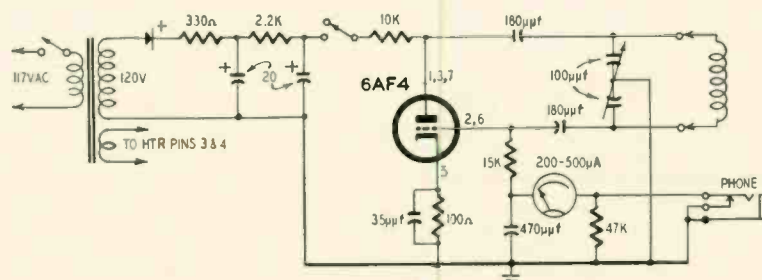

Fig. 1.—Schematic of the sensitive grid dip meter. Complete coil data at right.

TABLE I—Coil Data—Figs. 1, 5

Frequency (mc)	Turns	Gauge
1.7–4.5	170 ¹	36
2.9–7.5	85 ¹	36
6.4–16	31 ¹	26
13–32	18 ¹	21
25–60	7.5 ²	16
60–150	1 3/4 ³	16

¹ closewound
² spaced wire diameter
³ spaced twice wire diameter
 Use 3/8-inch polystyrene forms
 (All wire enamel-insulated)

TEST INSTRUMENTS

Parts for Fig. 1 grid dip meter

Resistors: 1—100, 1—330, 1—2,200, 1—10,000, 1—15,000, 1—47,000 ohms, 1/2 watt.

Capacitors: 1—35 μf , 2—180 μf , 1—470 μf , 2—20 μf , 200 volts; 2—100 μf , variable, ganged.

Miscellaneous: 1—transformer, 117-120 volts @ 15 ma, 6.3 volts @ 500 ma; 1—selenium rectifier; 1—6AF4 and socket; 1—0-200 microammeter; 1—s.p.s.t. switch; 1—phone jack; socket for coil forms.

Parts for Fig. 2 grid dip meter

Resistors: 1—3,300, 1—100,000, 1—1 megohm, 1/2 watt.

Capacitors: 1—50 μf , 1—.001 μf , 1—2.5 μf (see text); 1—120 μf , variable.

Miscellaneous: 1—plate current meter; 1—3A4 and socket, 1—s.p.s.t. switch; socket for coil forms.

Parts for Fig. 3 grid dip meter

3—47,000-ohm resistors; 1—35- μf , 2—16- μf , 200-volt capacitors. 1—40- μf variable capacitor; 1—6J5 and socket; 1—0-1 milliammeter; 1—choke, 6 h, 500 ohms. 1—selenium rectifier; 1 transformer (see text); socket for coil forms.

Parts for Fig. 5 grid dip meter

Resistors: 1—180, 1—1,000, 2—10,000, 1—33,000, 1—100,000 ohms, 1/2 watt; 1—100,000-ohm potentiometer (miniature).

Capacitors: 2—180 μf , 1—16 μf , 200 volts; 2—100 μf , variable, ganged.

Miscellaneous: 1—0-1 milliammeter; 1—phone jack; 1—9002 and socket; 1—selenium rectifier; 1—transformer, 117-120 volts, 6.3 volts @ 500 ma; socket for coil forms.

rial just to make doubly sure of safety. You can get plenty of meters but you only have one life!

Apart from the meter and the tube, a 3A4 (or 3Q4, 3S4, 3V4), the remaining few parts will probably be found in the junkbox. The 2.5- μf capacitor should be either mica or paper and at least 350 working volts. The .001- μf capacitor to chassis *must* be a 600-volt mica unit. The coil data for this circuit is given in Table II. An a.c. version of this grid dip meter can be made by using an isolating transformer with a winding for the heater supply.

Another simple arrangement, and one that is not costly to build, is shown in Fig. 3. The coil data and form sizes are given in Table III. The supply transformer must necessarily be small due to the size of the case (Fig. 4).

TABLE II—Coil Data for Fig. 2

Frequency (mc)	Turns	Gauge	Form (inches)
1.5-3	80 ¹	28	1
3-6	50 ¹	28	1
6-12	26 ²	21	3/4
12-24	13 ²	21	3/4
24-48	6 ²	21	3/4

¹ closewound
² spaced wire diameter
(All wire enamel-insulated)

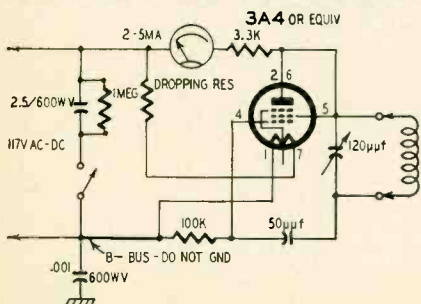

Fig. 2—Simple a.c.-d.c. grid dip meter.

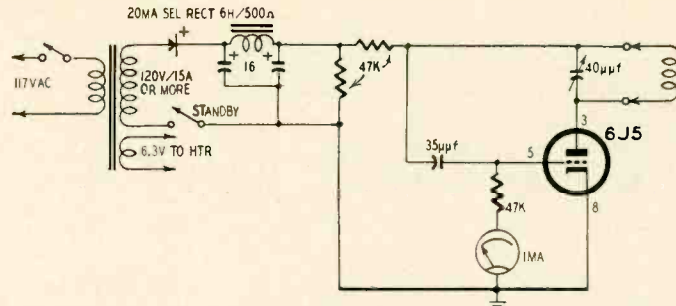

Fig. 3—Schematic diagram of another simple, inexpensive grid dip meter.

TABLE III—Coil Data for Fig. 3

Frequency (mc)	Turns	Gauge
0.44-0.48	165	36
3.4-5.7	47	26
5.2-9.5	23	19
9-17	14	16
15-29	8	16
26-50	4	14
40-80	2	14
70-155	1	12
110-250	0.5	1/8-inch bare copper strip

All coils closewound on 1/8-inch form, preferably polystyrene.
(All wire enamel-insulated)

It is a half-wave type delivering 120 volts at 15 ma or more.

The case, like that of all except the a.c.-d.c. version, is bent from aluminum to the measurements in Fig. 4 and the parts are laid out as in the photos. The back panel of the case into which the coils plug is made from a 3-inch square of Plexiglas, fastened to the case by small countersunk screws. These fit into threaded holes in the edge of the 1/4-inch material drilled to take two banana sockets.

Probably the most awkward job with any of these meters is that of calibrating the dial. For this purpose a signal generator is almost a necessity. The original dial was marked in 200-kc steps. If no signal generator is available the job could be done by picking up the oscillator's signals at various points on an all-wave receiver (and at intermediate points if possible) and interpolating the remainder of the markings.

Still another circuit is shown in Fig. 5. This is the one I prefer. It is reasonable in price and free from the risks of the a.c.-d.c. version. It is robust, covers a wide range, is sensitive and easy to build. The layout of this

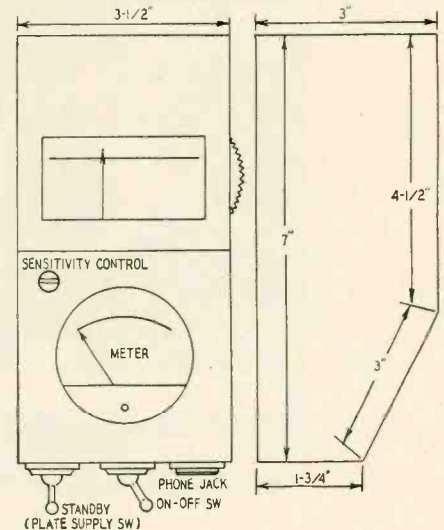

Fig. 4—Layout of instrument chassis.

meter closely follows that of the others except that there is no smoothing choke and a split-stator tuning capacitor is used instead of a single-gang type. Coil data is in Table I.

Most commercial grid dip meters use a geared drive with the dial forming part of the drive. This is difficult to make up, but the one used in these meters is just as efficient and as smooth in operation. It uses an epicyclic unit and the edge of the dial, protruding slightly through the case side and operated by the thumb holding the meter (thus leaving the other hand free), forms the actual driving mechanism. The original dial was cut from a 1/8 inch thick sheet of Bakelite, but any reasonably hard insulating material will do just as well.

All components should be of the miniature type as space is strictly limited inside the unit and there is none to spare for large transformers or electrolytics.

END

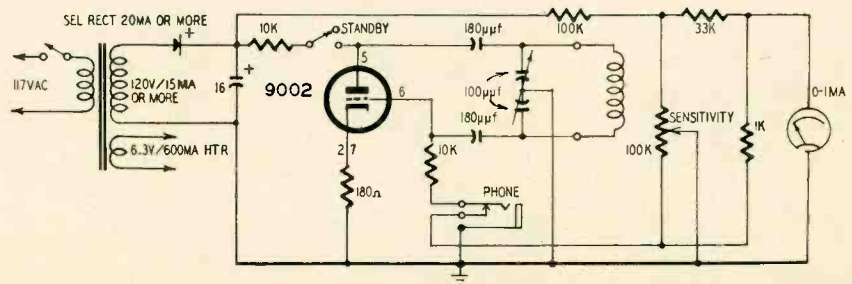

Fig. 5—Schematic of the author's preference—simple and very sensitive.

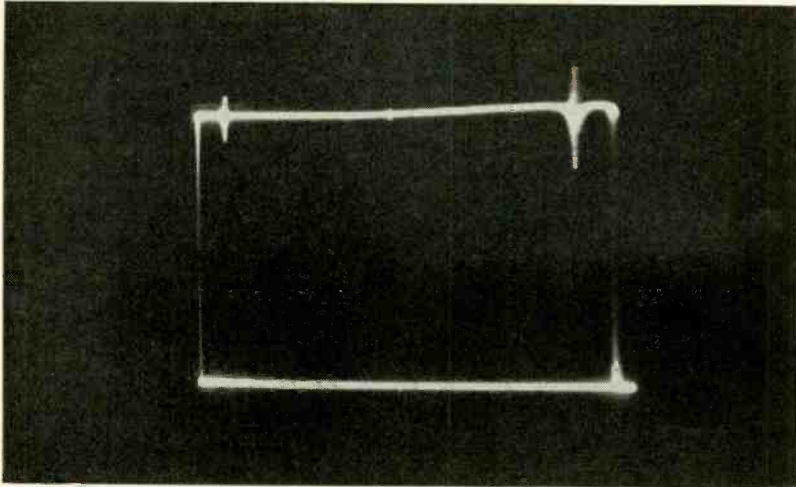

Fig. 1—Pattern shows a flat output. Pip at left is a spurious marker.

UNDERSTANDING YOUR SWEEP GENERATOR

Part I—Sweep generator output voltage and the zero-volt reference line

By ROBERT G. MIDDLETON*

SEVERAL additional technical considerations must be accorded the *sweep generator*, over and above those accorded the familiar *signal generator*. Briefly, these are:

1. A sweep generator must provide constant output over a band of frequencies. This requirement does not apply to a signal generator.

2. A sweep generator must maintain this uniform output at any setting of the attenuator.

3. The uniformity of output over a given band of frequencies must remain independent of conditions of test, such as imposed by connection of auxiliary cables to a marker generator or to a scope sweep circuit.

4. The freedom from amplitude variation must be unaffected by the frequency band under test; i.e., unaffected by the setting of the sweep width control.

The meaning of *constant output* is illustrated in Fig. 1, the type of pattern obtained when the test setup used is arranged as shown in Fig. 2.

Several important considerations should be carefully observed in this test. The rectangular type of pattern is obtained by use of the *blanking function* in the sweep generator. This blanking function provides a zero-volt reference line, without which it will be difficult to determine the percentage of departure from constant output. The zero-volt reference line is seen as the lower horizontal line in Fig. 1.

The swept output from the generator is shown as the upper horizontal line in Fig. 1. Since the output variation is within 1 db over the swept band, the output is considered to be satisfactorily constant. In the example shown in Fig. 1, the sweep width of the generator is set to 5 mc. (The output from a sweep generator will always *appear* to be flatter at small sweep widths; the im-

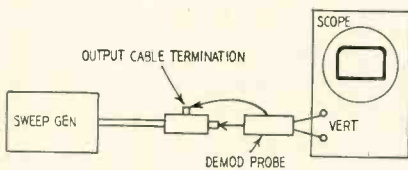

Fig. 2—The test setup used to obtain the sweep pattern shown in Fig. 1.

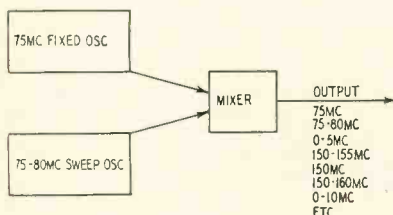

Fig. 3—Partial list of frequencies available at output of generator.

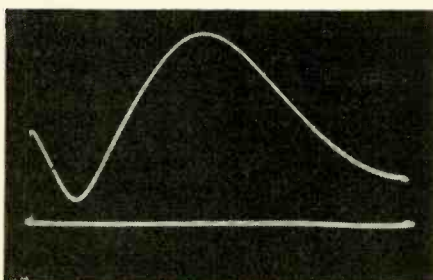

Fig. 4—Distortion in the sweep generator output voltage. This is often caused by poorly bonded shielding.

* Chief field engineer, Simpson Electric Co.

TEST INSTRUMENTS

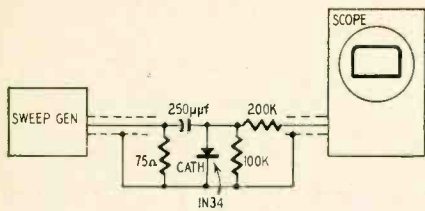

Fig. 5—Circuit used to check linearity of the output of a sweep generator.

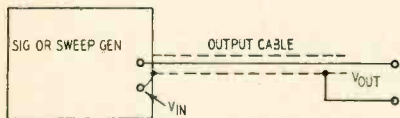

Fig. 6—An unterminated output cable. Only when cable represents half-wavelength will voltage out equal voltage in.

portant question for the technician concerns the flatness over the sweep width to be used in testing TV receiver circuits.) In video-frequency tests, the sweep width will commonly be 5 mc; in i.f. tests, 6 to 8 mc; in r.f. tests, 10 to 15 mc.

Inspection of Fig. 1 shows that spurious markers appearing in the swept output from the generator may present a problem. The beginner is often puzzled by their appearance. However, when it is realized that the frequency under test is actually being derived as a beat frequency, as indicated in Fig. 3 for a typical situation, the possibility of cross-beats and spurious marker generation becomes understandable. The arrangement of Fig. 3 leads also to various requirements in practical test work, to be discussed in detail later.

If the swept output from the generator is not flat, the pattern appears typically as shown in Fig. 4. This lack of flatness is a serious consideration in practical test work because the technician will misadjust the receiver circuits in compensating for the nonuniform generator characteristic. However, when making such a flatness check, the demodulator probe must be properly arranged so that the generator is not falsely blamed for a nonuniform probe characteristic. For example, the demodulator probe in Fig. 2 can be arranged as shown in Fig. 5. Success in realizing a flat probe characteristic results from the use of short leads.

Beginners sometimes make the mistake of using a ground lead several inches long between the probe and the generator output-cable termination. This length of ground lead may be inconsequential at several megacycles, but at higher frequencies, such as 100 or 200 mc, may impair the flatness of the probe response seriously. A good rule to follow is to utilize the pigtails of the components themselves as connecting

leads, keeping them short as possible.

Proper termination of the generator output cable is absolutely essential to maintain a flat generator characteristic. This is apparent in Fig. 6—an open-ended output cable must operate as a resonant stub and develop varying terminal voltages at various frequencies. In a signal generator which provides only one output frequency at a time, this matter is of little concern, as the technician can merely advance the attenuator setting if necessary when the operating frequency is changed. But in a sweep generator, the output cable *must* be flattened by terminating the cable in its own characteristic impedance.

The majority of service sweep generators uses output cables with a characteristic impedance of approximately 75 ohms. Of course, wirewound resistors should be avoided and only composition units used for cable termination. As noted in the probe construction discussion, leads must also be kept to minimum length in terminating the output cable. It is best to connect the terminating resistor as close to the exposed end of the cable as is mechanically practical. Again, this precaution can be neglected at low frequencies but is a serious consideration at higher frequencies.

Fig. 7 shows that when the flatness-check pattern is displayed on an a.c. scope, the resting position of the scope beam (when no input voltage is applied) cuts exactly midway through the pattern. But when the flatness-check pattern is displayed on a d.c. scope, the resting position of the scope beam coincides with the zero-volt reference line in the pattern. There is a very definite reason for this difference. The resting position of the beam in an a.c. scope always indicates the average value of a waveform, and this average value is a.c. voltage zero. But the resting position of the beam in a d.c. scope indicates the

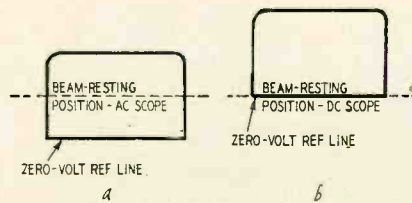

Fig. 7—The zero-volt resting position as it appears in a.c. and d.c. scopes.

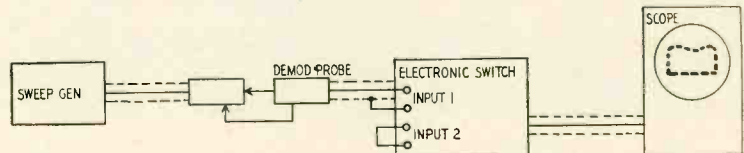

Fig. 8—Electronic switch indicates zero-volt reference line on a.c. scope.

zero-volt level of the complete waveform (including the d.c. voltage present). It is plain that the zero-volt reference level of the sweep generator indicates the zero-volt level of the complete waveform. In other words, the zero-volt reference-line function of a sweep generator can be considered a form of d.c. restorer.

It may be asked why the output from the demodulator probe has a d.c. component as well as an a.c. one. This is because the probe is a detector. The d.c. component is equal to the peak voltage of the sweep output and the a.c. component to the amount of variation in the swept trace. Flatness can be measured only by reproducing the complete output voltage from the demodulator probe and, as has been seen, this can be done by using the zero-volt reference-line facility of the sweep generator. But another significant possibility is also apparent from Fig. 7-a: if the sweep generator does not provide a zero-volt reference-line facility, a d.c. scope will provide the required function.

If the technician does not have a zero-volt reference-line function in his sweep generator and does not have a d.c. scope available, it is still possible to measure the generator output flatness. An electronic switch can be used between the probe output and the vertical input terminals of the scope, as shown in Fig. 8. In this method, the zero-volt reference line (d.c. restoration) is applied outside the generator instead of inside. The first pair of input terminals to the electronic switch receives the output voltage from the demodulator probe, while the second pair of terminals to the electronic switch is shorted, so that the scope is indicating zero voltage half the time and the probe output the other half. Two dotted lines appear on the scope screen, as indicated in Fig. 8, to show the swept trace and also the zero-volt reference level.

TO BE CONTINUED

SETTING THE PACE . . .

in **ALL-CHANNEL**
fringe antennas!



SUPER SUN BEAM
Model SB662

The new, super-sharp yagi utilizing the unique Tri-King dipole together with completely insulated parasitic directors and reflectors! Actually two antennas in one for peak high and low band reception.



Clear Beam's **5** peak performers solve all fringe problems* . . .

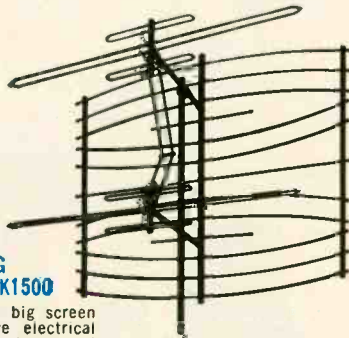

TRI-KING
Model TK1500

Highest gain of the big screen antennas! Half wave electrical spacing. Eliminates ghosts and co-channel interference. Full radar screen - wind tunnel tested!

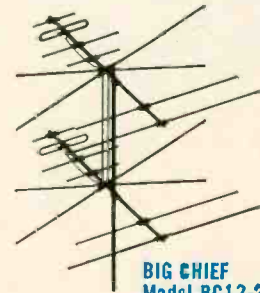

BIG CHIEF
Model BC12-2

An advanced conical Yagi with element diameters varied for precision tuning, matched sensitivity and peak performance on high and low band!

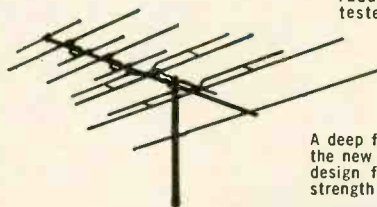

SKY SWEEP
Model MYS80

A deep fringe yagi incorporating the new magnetic "Focal-Sharp" design for concentrating signal strength!

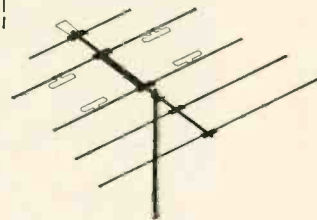

HUNTER Model MYH50

New wave trap principle gives extremely high gain, sharp directivity, in-phase tuning on all channels. New, flat design for low wind resistance!

*Spectrum-tested for balanced color reception!

affiliated with
TEMPO TV products



CLEAR ANTENNA CORP.
BEAM Canoga Park, Calif. • Chicago, Ill.

Warehouses in Seattle, Portland, San Francisco, Honolulu, Dallas, Kansas City, Chicago, Detroit, Baltimore

NOW!

PHILCO®



MODEL 7100

PHILCO TUBES
IMPROVE THE
PERFORMANCE OF
ANY TV OR
RADIO RECEIVER

PHILCO
UNIVERSAL
Color Bar and Dot Bar
GENERATOR

Puts You in the Color Service Business with One Instrument!

A COMBINED COLOR-BAR AND DOT-BAR GENERATOR PLUS A DYNAMIC WHITE BALANCE TEST

From Philco laboratories comes one compact generator with all Color Bar and Dot Bar Generator features—a new versatile instrument that meets all color service requirements . . . on the bench or in the field! Used in conjunction with present monochrome test equipment, the Philco Model 7100 Universal Color Generator fully equips the service man to completely trouble-shoot circuits associated with color reproduction and make accurate convergence adjustments . . . in any color receiver made. The full-screen 10 bar color pattern was developed to provide rapid, accurate servicing. See the Philco Universal Color Bar and Dot Bar Generator at your Philco distributor's.

Look at These Special PHILCO Features!

1. Signals for checking and setup of: Static and Dynamic Convergence; Dynamic White Balance, Frequency of Color Oscillator; Phase of Demodulators; Matrix Circuits; Color and black and white linearity.
2. Four crystals control picture and sound carriers.
3. Two additional crystals control internally generated color signals and horizontal sync pulses.
4. Fully regulated Power supply.
5. Visual markers simplify identification of color bars.

SAVE UP TO \$130.00

By buying PHILCO, you save up to \$130.00 over other equivalent types of equipment that give you the same service functions. This compact Philco Color Bar and Dot Bar Generator gives you the features of *two* generators . . . at a much lower cost!

COMPLETE PRICE ONLY

\$269.50

Compare Value! Performance! Features!

PHILCO CORPORATION *Accessory Division*
"A" & Allegheny Avenue, Philadelphia 34, Pa.



APPLYING

ULTRASONICS

Ultrasound is finding its way into numerous medical and industrial processes

By S. M. MILANOWSKI

SOME time may pass before you can walk into any dentist's office and get your cavities reamed with an ultrasonic drill. But such work is already being done. And according to almost everyone who can possibly be regarded as an authority on the subject, it's just about the nicest thing that has happened to dental patients since Painless Parker developed the easy-payment plan.

Why? Because a dentist using an ultrasonic tool can drill your teeth without hurting you—and, in most cases, without first shooting a paralyzing dose of Novocaine into your gums.

The electronic device that has made ultrasonic dentistry a reality is the Cavitron. It was originally developed by Cavitron Equipment Corporation of Long Island City, N. Y., to facilitate the machining of extremely hard and brittle materials like diamond, quartz, germanium and glass.

Ultrasonic machining, a new process with many unexplored potentialities, has a large number of practical applications. However, if researchers at such institutions as Columbia University's School of Dental and Oral Surgery aren't sadly mistaken, ultrasonic dentistry is of great importance to the general public.

The Cavitron's basic circuit (Fig. 1) is functionally the same as the circuit

in a radio transmitter. Its purpose is to convert 115-volt 60-cycle, single-phase current into about 1.4 kw of input power for a magnetostrictive transducer.

Fundamentally, the magnetostrictive transducer is a coil with a ferromagnetic core (see Fig. 2). When the coil is energized with radio-frequency current, the core expands and contracts so as to produce an ultrasonic beam with a frequency in the neighborhood of 29 kc.

A flexible metal conductor transmits the ultrasound to a drill which looks much like a conventional dental instrument. This causes a cutting tool (see photo) on the output end of the drill to move back and forth with a reciprocal stroke whose amplitude is about 1/1,000 inch.

The cutting tools (see photo) do not have to be sharp like a conventional instrument, because they cut by driving fine abrasive particles (aluminum oxide in water) against the decayed walls of a cavity—much the same as a toothbrush causes the abrasive particles in toothpaste to remove food particles when you brush your teeth. This cutting action is relatively painless because the cutting tool is not in constant contact with a tooth and because no appreciable amount of heat is generated.

Even if the cutting tool slipped and came in contact with a patient's flesh,

no special pain would be felt and no serious damage would be done because ultrasonic cutting action is ineffective against soft materials.

According to Dr. Carl R. Oman, Professor of Dentistry at Columbia University, any dentist capable of using a conventional drill with reasonable competence can learn ultrasonic dentistry in a matter of minutes.

Ultrasonics in industry

Cavitrons used by machinists have transducers mounted on slide columns so that the transducers can be moved up or down like the chuck on a drill press. Their cutting tools are brazed or soldered to special toolholders, directly attached to the lower ends of the transducers.

Weights and counterweights on each transducer slide column enable a machinist to feed his cutting tool into a workpiece with nothing more than the force of gravity, and cutting is done as the tool comes in contact with particles in an abrasive solution which is usually pumped into the work area via a pair of flexible metal tubes (see photo).

Most of the cutting tools are made of relatively soft grades of steel. This type of steel is highly resistant to the sort of abrasive action that enables a Cavitron to machine extremely hard materials. The tools may have any of numerous configurations. For example:

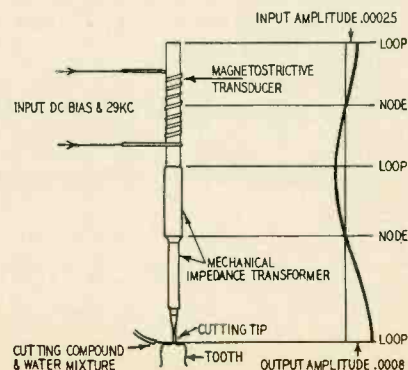
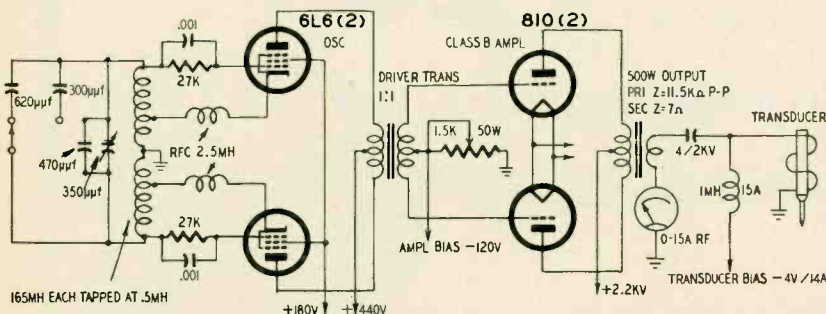

Fig. 1—Above, schematic of an industrial Cavitron ultrasonic generator. Fig. 2—Right, Cavitron transducer—basically, a coil with ferromagnetic core.



QUIET QUIET QUIET QUIET

XLR is the designation of Cannon's all new audio cord connector... the most modern addition to the long line of distinguished Cannon Connectors featured on all top-quality microphones. It's really quiet, too!

New resilient insulator and special zed-construction of socket contact assembly protects against disagreeable mechanical interference... noise problems encountered with many other type connectors when their cables are moved, pulled or subjected to shock.

Features streamline design, bright nickel finish, integral cable clamp, neoprene cable relief, and the time-tested Latch-Lock that Cannon pioneered on the first audio connectors. Available with three 15-amp. or four 10-amp. contacts. Available in panel receptacle type, providing same continuous characteristics.

Available from distributors everywhere, or from the factory in production quantities.

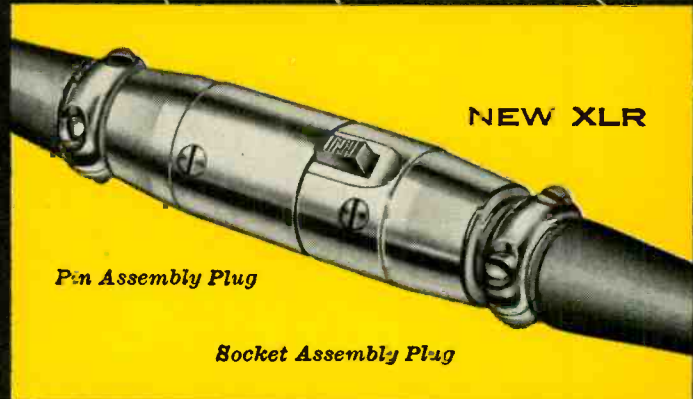

NEW XLR

Pin Assembly Plug

Socket Assembly Plug

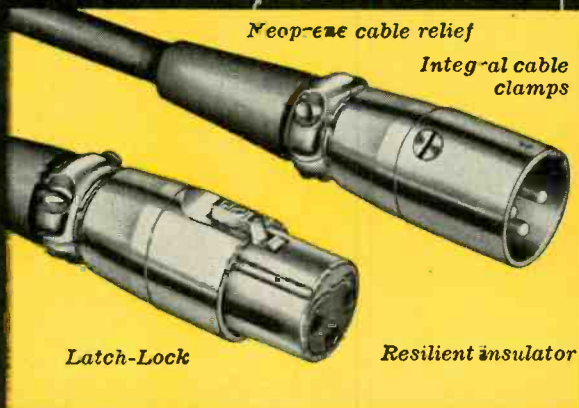

Neoprene cable relief

Integral cable clamps

Latch-Lock

Resilient insulator

first in connectors

CANNON PLUGS

CANNON ELECTRIC COMPANY
3209 Humboldt St.,
Los Angeles 31, California

Please refer to Dept. 144

Factories in Los Angeles; East Haven; Toronto, Canada; London, England. Representatives in all principal cities. Distributors everywhere.

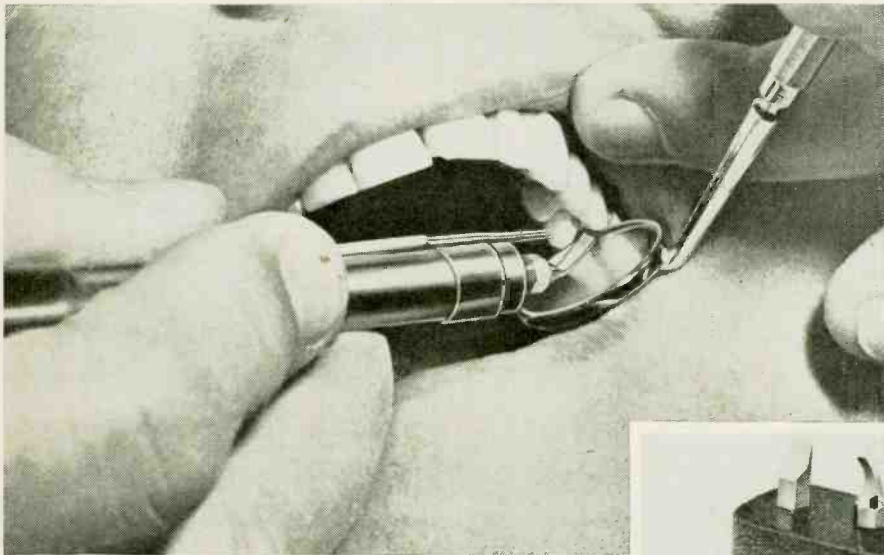

A dental Cavitron transducer.

1. The needle from a hypodermic syringe may be used as a cutting tool in machining small-diameter holes.

2. A standard steel screw may be used as a cutting tool in threading holes, if a workpiece is properly rotated.

3. A tool made by assembling thin steel strips, so that they resemble the compartments in an egg crate, has been used in gang-cutting germanium parts for transistors with unprecedented speed and accuracy.

4. Tools resembling metal coins have been used to emboss figures, letters and other details in glass surfaces. (An ordinary 10-cent piece can be brazed to the face of a toolholder for use as an ultrasonic embossing die!)

5. Bent steel rods may be used as cutting tools in drilling curved holes (the output of a Cavitron tends to follow the configuration of a cutting tool).

Samples of work done by the Cavitron process are shown in the photo. The time required to complete an ultrasonic machining operation depends not so much on the size of a cutting tool or the area being machined as on the hardness of a workpiece. For instance, a cutting tool capable of producing a 1/4-inch square hole will penetrate a 3/16-inch layer of Carballoy in 21 minutes and a 3/16-inch layer of glass in only 7 minutes because glass is three times as hard as Carballoy.

The largest cuts thus far made with a Cavitron covered 3 square inches; the smallest were .0001-inch diameter holes.

Some noise can be heard when a Cavitron is operating; but that is a byproduct, analogous to the background hum of a radio receiver, not ultrasound. Such noise is useful because it enables a machinist to tune his equipment by ear as well as by instruments.

A Cavitron is tuned to vary its output frequencies in accordance with the acoustical properties of different materials. This, of course, makes it possible to machine any given workpiece with maximum efficiency. END

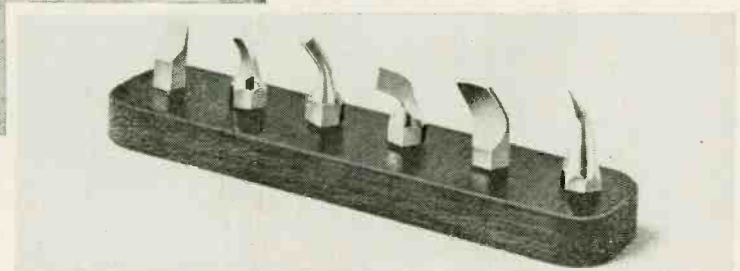

Dental Cavitron cutting heads

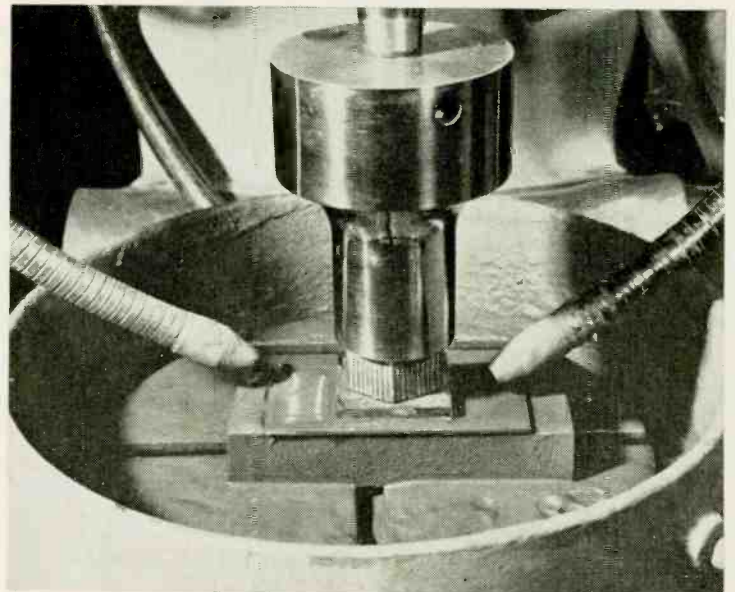

The Cavitron's work area. Flexible tubes carry abrasives to the work.

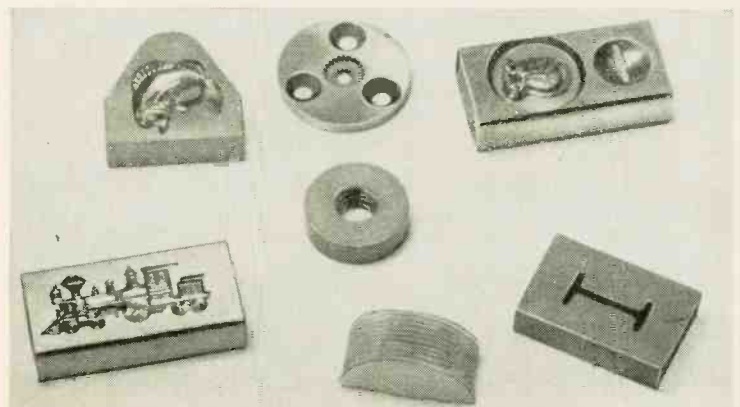

Samples of work performed with ultrasonic Cavitron on hard materials.

WHAT'S YOUR SERVICE PROBLEM?

FM Radios • Amplifiers and Tuners • Auto Radios • Record Changers

PHOTOFACT HELPS YOU SOLVE IT FASTER, EASIER, BETTER, MORE PROFITABLY!

THE WORLD'S FINEST SERVICE DATA

PHOTOFACT Service Data is the *only* service information based upon first-hand examination of the actual production-run receivers and equipment. It is authentic, uniform data developed through actual study and analysis by service engineers in the Howard W. Sams Laboratories. PHOTOFACT is the *only data* prepared from the practical point of view of the Service Technician.

Thousands of Service Technicians use PHOTOFACT daily for time-saving, profit-boosting service operations. If you've never used PHOTOFACT, you've never realized your full earning power—you've never given such complete customer satisfaction. So get the proof for yourself. Try PHOTOFACT—use it on any job. Your Parts Distributor has the Folder Sets you need for any of the 17,000 TV and radio receivers, changers, recorders, etc., covered in PHOTOFACT. Once you use this great service, we know you'll want the complete PHOTOFACT Library.



THESE GREAT FEATURES ARE EXCLUSIVE IN PHOTOFACT—THEY HELP YOU EARN MORE DAILY, HELP INSURE CUSTOMER SATISFACTION

FULL SCHEMATIC COVERAGE

1. Famous "Standard Notation" uniform symbols are used in every schematic.
2. The same standard, uniform layout is used for each schematic.
3. Diagrams are clear, large, easy to read, easy to handle.

4. Wave forms are shown right on the TV schematics for quick analysis by 'scope.

5. Voltages appear on the schematics for speedy voltage analysis.

6. Transformer lead color-coding is indicated on the schematic.

7. Transformer winding resistances appear on the schematic.

8. Schematics are keyed to photos and parts lists.

FULL PHOTOGRAPHIC COVERAGE

9. Exclusive photo coverage of all chassis views is provided for each receiver.

10. All parts are numbered and keyed to the schematic and parts lists.

11. Photo coverage provides quicker parts identifications and location.

ALIGNMENT INSTRUCTIONS

12. Complete, detailed alignment data is standard and uniformly presented in all Folders.

13. Alignment frequencies are shown on radio photos adjacent to adjustment number—adjustments are keyed to schematic and photos.

TUBE PLACEMENT CHARTS

14. Top and bottom views are shown. Top view is positioned as chassis would be viewed from back of cabinet.

15. Blank pin or locating key on each tube is shown on placement chart.

16. Tube charts include fuse location for quick service reference.

TUBE FAILURE CHECK CHARTS

17. Shows common trouble symptoms and indicates tubes generally responsible for such troubles.

18. Series filament strings are schematically presented for quick reference.

COMPLETE PARTS LISTS

19. A complete and detailed parts list is given for each receiver.

20. Proper replacement parts are listed, together with installation notes where required.

21. All parts are keyed to the photos and schematics for quick reference.

FIELD SERVICE NOTES

22. Each Folder includes time-saving tips for servicing in the customer's home.

23. Valuable hints are given for quick access to pertinent adjustments.

24. Tips on safety glass removal and cleaning.

TROUBLE-SHOOTING AIDS

25. Includes advice for localizing commonly recurring troubles.

26. Gives useful description of any new or unusual circuits employed in the receiver.

27. Includes hints and advice for each specific chassis.

OUTSTANDING GENERAL FEATURES

28. Each and every PHOTOFACT Folder, regardless of receiver manufacturer, is presented in a standard, uniform layout.

29. PHOTOFACT is a *current* service—you don't have to wait a year or longer for the data you need. PHOTOFACT keeps right up with receiver production.

30. PHOTOFACT gives you *complete* coverage on TV, Radio, Amplifiers, Tuners, Phonos, Changers.

31. PHOTOFACT maintains an inquiry service bureau for the benefit of its customers.

ONLY \$25 DOWN

Puts a Photofact Service Data Library in Your Shop. Ask Your Photofact Distributor—He Has the Full Easy-Pay Details.

FREE PHOTOFACT CUMULATIVE INDEX



Send for it! Your guide to virtually any model ever to come into your shop; helps you locate the proper PHOTOFACT Folder you need to solve any service problem on any model. Once you have the make and chassis number, it takes just 60 seconds to find the applicable PHOTOFACT Folder. Send coupon now for your FREE copy of the valuable Cumulative Index to all PHOTOFACT Folders.

HOWARD W. SAMS & CO., INC.

Howard W. Sams & Co., Inc., Dept. 2-H-5
2205 E. 46th St., Indianapolis 5, Ind.

Send FREE Photofact Cumulative Index.

Name.....

Address.....

City..... Zone... State.....

HELPS YOU EARN MORE DAILY

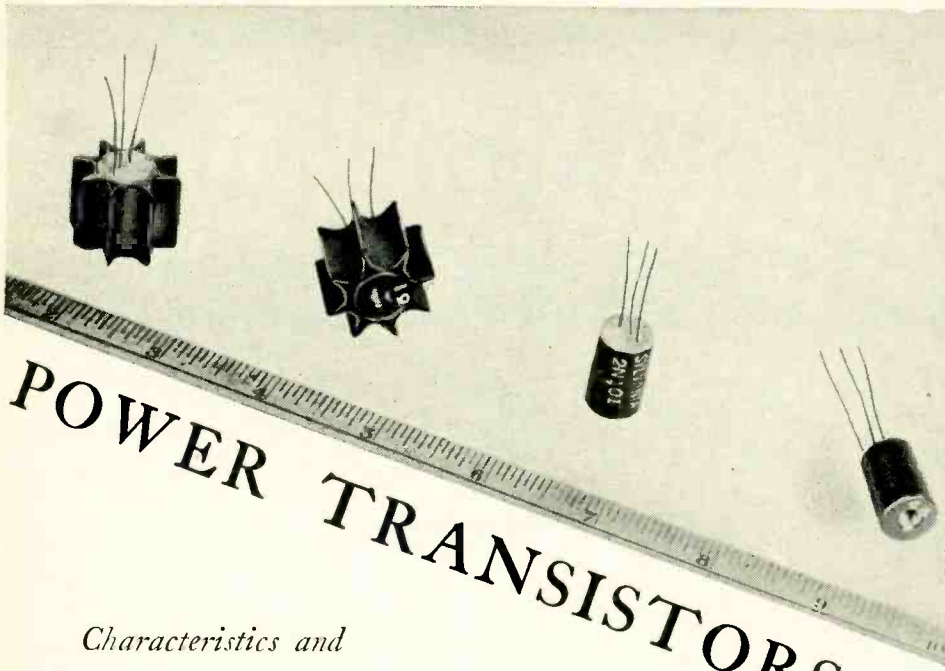

A family of power transistors. Shown from left to right are the Sylvania types 2N68, 2N95, 2N101 and 2N102.

POWER TRANSISTORS ARE HERE

Characteristics and applications of the new heavy-duty units

By RUFUS P. TURNER

TO many minds the greatest failing of the transistor has been its very low power output. Except in hearing aids, personal radio receivers and some test instruments, the conventional output of a few milliwatts has been insufficient for widespread application. Today, however, low power no longer is a deterrent to progress in transistorizing audio-frequency amplifiers, servomechanisms and sundry control devices. The power transistor has emerged from the laboratory stage.

Presently, there is available a variety of units providing up to 10 watts output at frequencies up to 10 kc and slightly beyond. The strictly laboratory units now are providing 60-watt operation! Operating at low voltages, power transistors bring closer the day of car radios and portable PA systems in which the highest d.c. potential is 6 volts (see the Radio Month, July, page 6).

It is the purpose of this article to acquaint the experimenter, technician and applications engineer with these new transistors, their salient electrical characteristics and sources of supply.

The power transistor table lists units now offered commercially and answers the question always asked first by the practical man: "What is the operating voltage, power output and power gain?" The mass of other data, too voluminous to be printed on these pages, may be obtained from the technical literature for the particular transistor of interest to the reader. Such additional data include input and output impedances, physical

size, operating currents, maximum operating frequency, distortion, maximum operating temperature, etc.

From the table, it is seen that the power transistors are of the germanium p-n-p type, except the Sylvania 2N95 and 2N102 and the Texas Instruments X-2 which are germanium n-p-n units. Texas Instruments X-15 is the lone silicon n-p-n representative. The Sylvania pairs 2N68 and 2N95, 2N101 and 2N102 are complements of each other which make possible high-power

single-ended push-pull and often completely transformerless, complementary symmetry circuits. Not all of these transistors were available to the retail purchaser at the time of writing, but there is little doubt that in time all of them will be on the general market.

Even the casual reader of transistor literature realizes that there is a multitude of operating conditions for transistor amplifiers. To keep the table listings to a minimum, we have selected for presentation the condition giving

POWER TRANSISTOR TABLE

Manufacturer and Number	Type	Collector Voltage (d.c.)	Maximum Power Output (Watts)		Power Gain (db)	Manufacturer and Number	Type	Collector Voltage (d.c.)	Maximum Power Output (Watts)		Power Gain (db)	
			single-ended class A	push-pull class B					single-ended class A	push-pull class B		
Hydro-Aire	JP-1	p-n-p	-22.5	0.4 (CB)	15	Sylvania con'l	2N101	p-n-p	-12	0.6 (CE)	23	
		p-n-p	-14	2.5 (CE)	10			p-n-p	-12		5.0 (CE)	15
	H-1	p-n-p	-28		10 (CE)		10	2N102	n-p-n	12	0.6 (CE)	23
		p-n-p	-14	2.5 (CE)	20		n-p-n		12		5.0 (CE)	15
Minneapolis-Honeywell	H-2	p-n-p	-28		10 (CE)	20	X-2	n-p-n	22.5		0.5 (CE)	22.7
		p-n-p	-14	1.0 (CE)	17	Texas Instruments X-15		n-p-n silicon	35		1.0 (CE)	14
	H-3	p-n-p	-28		4.0 (CE)		17	Transistor Products X-78	p-n-p	-45	1.3 (CE)	2.0 (CE)
		p-n-p	-14	1.0 (CE)	20	X-108	p-n-p		-45	1.3 (CE)	2.0 (CE)	36
H-4	p-n-p	-28		4.0 (CE)	20		2N83	p-n-p	-30	0.9 (CE)		30
	p-n-p	-14	2.5 (CE)	12.5	Transitron	p-n-p		-30		15 (CC)	7	
2N57	p-n-p	-28		10 (CE)		12.5	2N84	p-n-p	-20	0.4 (CE)		32
	p-n-p	-12	0.6 (CE)	23	2N71	p-n-p		-20		10 (CC)	7	
Sylvania	2N68	p-n-p	-12			5.0 (CE)	15	Westinghouse	p-n-p	-22.5	0.4 (CE)	25
		p-n-p	12	0.6 (CE)	23	-40				2.0 (CE)	10	
2N95	n-p-n			5.0 (CE)	15							

CB, common-base circuit; CC, common-collector circuit; CE, common-emitter circuit.

*New!
Revolutionary!*



- ★ The GENERAL has a closely spaced screen (7 inches) to minimize pick up off the rear. With more and more stations coming on the air, on the same channel, this is a major problem of today and tomorrow.
- ★ The GENERAL is completely pre-assembled. By simply tightening three wing nuts, the antenna is ready to mount.
- ★ The GENERAL is light in weight with low wind resistance. Not only easy to put up, but easy to KEEP up.
- ★ The GENERAL is packed in a small carton. This makes the antenna more economical to ship, store, and handle.
- ★ The GENERAL sells for less than comparable products. This gives YOU a better mark up and faster moving merchandise.

**Some Exclusive Territories Available
To Aggressive Jobbers.**

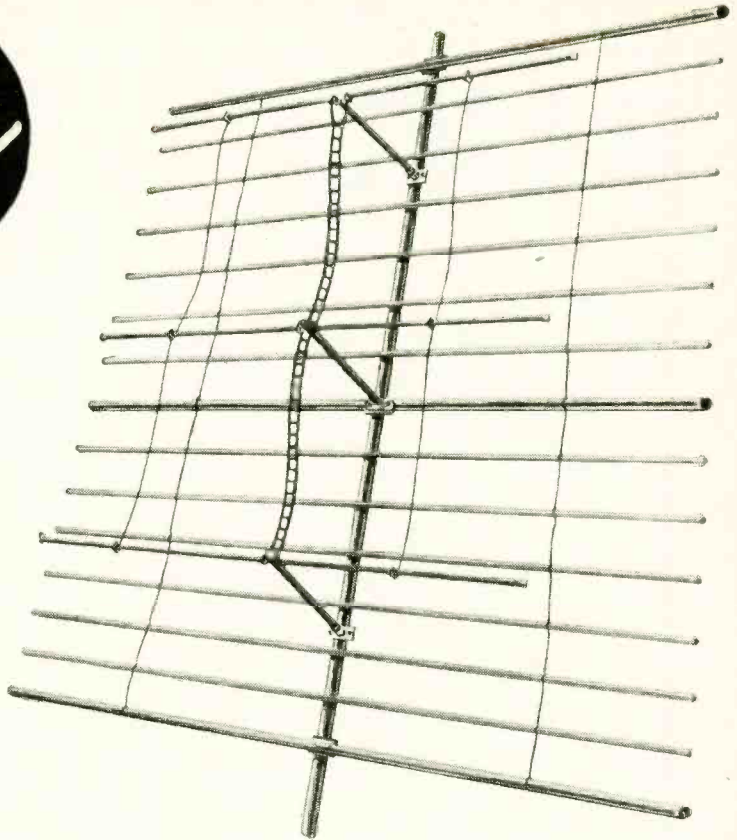

★ The GENERAL is low enough in price to use in the most competitive market and is recommended for all locations.

The GENERAL combines 6 dipoles in a phased collinear array for super gain on channels 7 to 13 and features an interpolated dipole arrangement on channels 2 through 6 for a small physical size, high gain array on these channels. The GENERAL has peak gains of over 15 D.B. and is recommended for use in the most difficult reception areas.

LIST PRICE 24.95

World's Finest TV Antennas and Towers

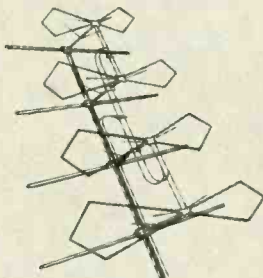

WAYCO, Inc., manufactures a complete line of antennas and towers, priced from \$1.98 list, up. Write for free literature.

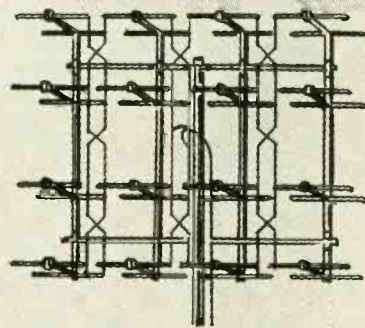

SUPER FRINGE MASTER. Unconditionally guaranteed to out-perform all other UHF antennas or your money refunded. Available in 16 or 32 element arrays. Completely assembled or knocked down.

P. O. Box 115
Phone 7-2981

WAYCO, Inc.

WAYNESBORO
TENNESSEE

Announcing the first

BASIC

books ever to be published
on Synchros and Servos!

"BASIC SYNCHROS AND SERVOMECHANISMS"

by Van Valkenburgh, Nooger & Neville, Inc.

A NEW 2-VOLUME "PICTURE BOOK" SERIES DERIVED FROM THE U.S. NAVY'S TRAINING PROGRAM!

Synchro and servomechanisms are vital elements in the successful performance of very many devices employed by all branches of industry and the Armed Forces. They aim the guns on ships, planes, and ground artillery—in general are used in many ways to produce and control rotary motion at a distance, with a degree of accuracy and rapidity far superior to that possible manually.

Now, for the very first time, there will appear purely basic books which teach the fundamentals of synchro and servomechanisms without recourse to complicated mathematics. Written to be understood even by those without college educations, these books furnish a clear background in the functioning of these systems. They deal with the subject on a step-by-step basis: Every page has at least one big, clear illustration (of the most exciting and informative type) to make understanding easier. Every page deals with one individual phase of the subject. These new books (like the earlier series on Basic Electricity and Basic Electronics described below) are derived from the U.S. Navy's Common-Core Training Program. They have been tried and tested.

"Basic Synchros and Servomechanisms" will be published as a 2-volume set in late August, 1955. The books will be paper bound, 6" x 9", and will total approximately 270 pages containing more than 300 illustrations.

2-VOL. SET ONLY \$5.50

LEARN BASIC ELECTRICITY AND BASIC ELECTRONICS THE EASY PICTURE BOOK WAY!

"BASIC ELECTRICITY" "BASIC ELECTRONICS"

by Van Valkenburgh, Nooger & Neville, Inc.

The fabulous Picture Book training courses derived from the Navy's Basic Electricity-Electronics training program! Over 1,700 big clear pictures to guide you every step of the way! 25,000 Navy students have successfully mastered the fundamentals of these vital subjects in record time . . . and now YOU can do the same! Imagine—a complete idea on every page—at least one big drawing on that same page to illustrate and explain it—review pages at the end of every section to highlight the subjects just covered. There's never been an easier, better way to learn basic electricity and electronics!

"BASIC ELECTRICITY" 5-vol. set only \$9

"BASIC ELECTRONICS" 5-vol. set only \$9

ORDER TODAY!

Rider books are sold by electronics parts jobbers and book stores throughout the country. If YOUR dealer doesn't have them, mail this coupon to us!

JOHN F. RIDER PUBLISHER, INC.
Dept. RE-8, 480 Canal St., N.Y. 13, N.Y.

Enclosed is \$..... Send me:

Basic Synchros & Servomechanism 2-vol. set \$5.50

Basic Electricity 5-vol. set \$9.00

Basic Electronics 5-vol. set \$9.00

Add state & city sales tax where applicable.
In Canada, prices approx. 5% more

Name

Address

City & State

ELECTRONICS

maximum power output for each transistor. To illustrate the table's usefulness, consider the Minneapolis-Honeywell type H-2. If a pair of these units is to be operated in a class-B output stage, we find from the table that the collector d.c. supply voltage must be -28 and that 10 watts output may be obtained in a common-emitter circuit. Since the power gain is shown as 20 db (that is, 100 times), one-hundredth of 10 watts or 100 milliwatts driving power will be required.

There is, in the field, some apathy toward the use of power transistors as class-A amplifiers. One reason for this is the considerably higher efficiency obtainable from class B. Another reason is the high steady d.c. collector current required in class-A operation. Nevertheless, at the higher class-A output power levels, the transistor still appears to be ahead of a tube of the same capability when its freedom from

levels, the transistor must be mounted in close contact with a metallic mass (heat sink or dissipator) which will remove heat generated by normal operation. In some instances, a satisfactory heat sink is obtained when the transistor is bolted to the chassis, provided the chassis has sufficient area and thickness. However, the cooling structure of most power transistors is connected internally to one of the electrodes, usually the collector, and push-pull transistors accordingly cannot be mounted without at least a thin mica insulator between their shells and chassis, otherwise their collectors would be short-circuited by the chassis.

The diagram shows a typical class-B power-transistor output amplifier stage. Resistor R1 and the battery voltage are selected for a total no-signal collector current of 1 ma. Heavily bypassed emitter stabilization resistors are required if collector current shows

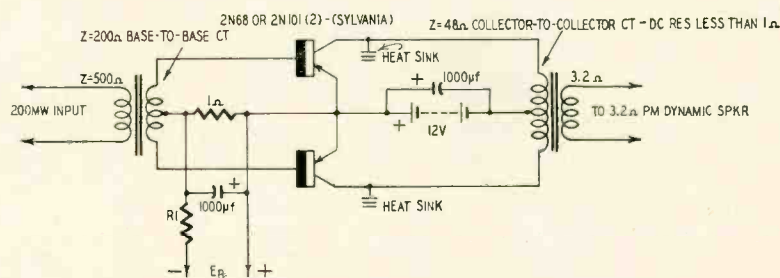

A power-transistor output amplifier.

filament current is considered.

It would seem entirely feasible to use a 1/2-ampere 6-volt transistor audio stage in a car radio where ordinarily the vibrator type power supply it replaces takes from 5 to 10 amperes. Certainly the power transistor should not be operated class A at those power output levels that can be attained easily by less expensive, conventional, small transistors in class B with better power supply economy.

An attractive feature of the power transistor is its low d.c. voltage requirement. However, it is as true of power transistors as of other matters that one does not receive something for nothing. High current is the price paid for this low voltage. The high direct currents of the power transistor impose rather severe requirements on the design of the coupling transformers and on that of the power supply. While on this subject, it should be mentioned that standard, catalogued transformers are unsatisfactory at the low-impedance and high-current levels met in the power transistor. At present, both input and output transformers must either be obtained on special order or built by the user.

Another practical consideration worth noting is the requirement for heat removal from the power transistor. Transistor manufacturers' specifications differ widely with respect to the maximum power which can be dissipated safely in free air. At higher

a tendency toward "runaway." A typical heat sink would consist of a 25-square-inch chassis, 1/16 inch thick. The maximum-signal current of this stage is 550 ma and maximum power output is 5 watts.

POWER TRANSISTOR MANUFACTURERS

HYDRO-AIRE, INC., 3000 Winona Ave., Burbank, Calif.

MINNEAPOLIS-HONEYWELL REGULATOR CO., Transistor Div., 2733 4 Ave. So., Minneapolis 5, Minn.

SYLVANIA ELECTRIC PRODUCTS, INC., Electronics Div., 100 Sylvan Road, Woburn, Mass.

TEXAS INSTRUMENTS, INC., 6000 Lemmon Ave., Dallas 9, Tex.

TRANSISTOR PRODUCTS, INC., 241 Crescent St., Waltham 54, Mass.

TRANSITRON ELECTRONIC CORP., 403 Main St., Melrose 76, Mass.

WESTINGHOUSE ELECTRIC CORP., Electronic Tube Div., Elmira, N. Y.

The commercial availability of power transistors will open many new avenues of application and can be expected to extend the horizons of equipment transistorization. Some possible applications that come readily to mind are intercoms, metal locators, portable PA systems, motor drive and switching circuits, electronic musical instrument amplifiers, low-frequency electromedical equipment and power converters.

Thus, the transistor, originally stereotyped as a tiny low-power device, has come into its own as a unit of considerable power-handling capabilities. END

WIRE FOR EVERY ELECTRONIC PRODUCT

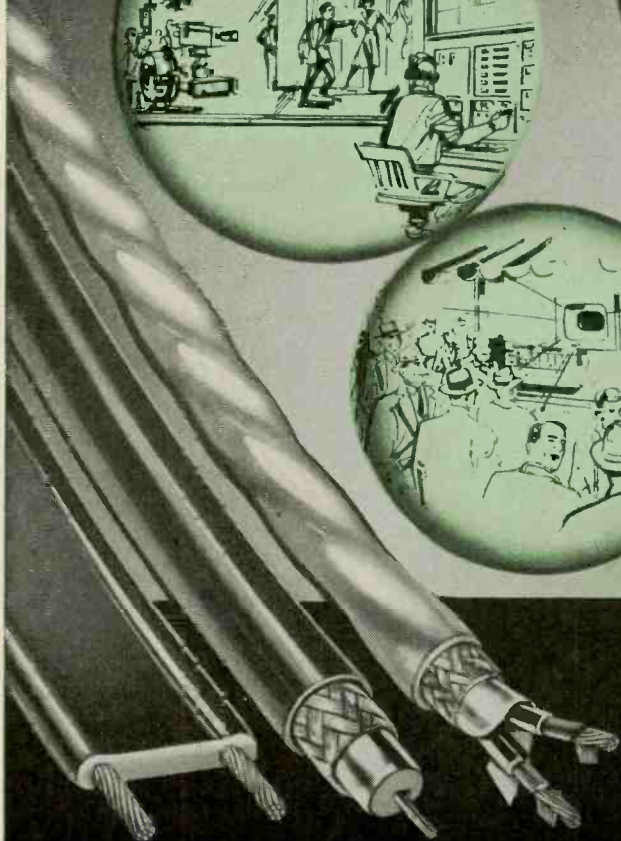
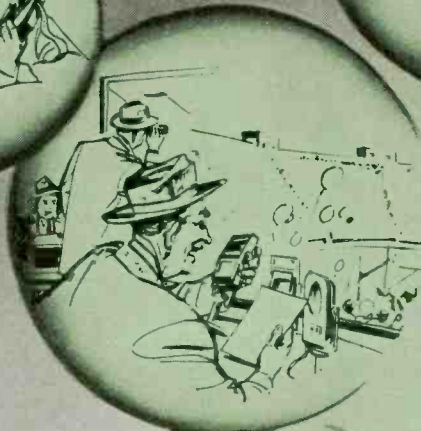
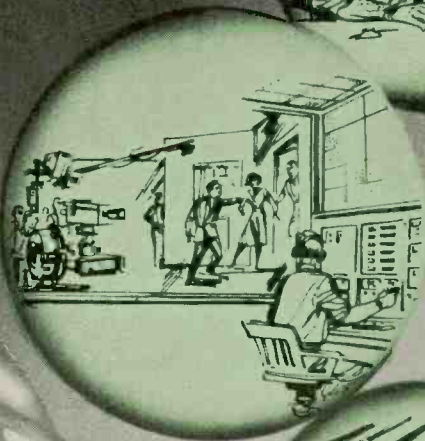
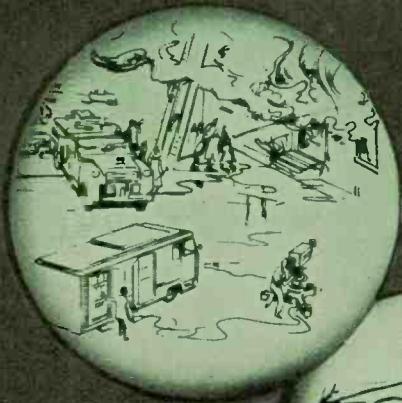

Belden

WIREMAKER FOR INDUSTRY
SINCE 1902

BELDEN MANUFACTURING CO. - CHICAGO

3-8

THERMISTORS

... and their applications

Characteristics and circuits of an important lesser-known semiconductor

By SHERMAN H. HUBELBANK*

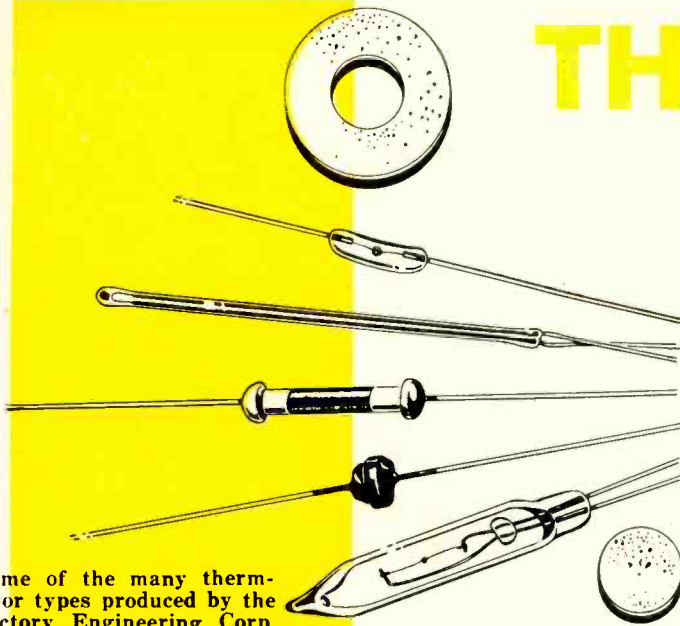

Some of the many thermistor types produced by the Victory Engineering Corp.

SEMICONDUCTORS are beginning to play an important role in the field of electronics, with transistors the best known. Another semiconductor, developed a number of years before transistors, is beginning to be used in many new applications. This semiconductor is the thermistor. It can perform many special functions in electronic circuits, either alone or with vacuum tubes or transistors.

The *thermistor* is a *thermally sensitive resistor*, made from a semiconductor that has a high negative temperature coefficient of resistance. Its decrease in resistance as the temperature rises and increase as the temperature falls, in addition to its nonlinear resistance characteristic, make the thermistor useful in many applications. These include volume limiters, compressors and expanders, automatic gain regulators, temperature control and temperature measurements. One manufacturer of this device, Victory Engineering Corp., of Union, N. J., lists 82 different applications of the thermistor in various industries.

Basically, the thermistor is a stable ceramiclike structure consisting mostly of metallic oxides. These oxides are mixed in the proportion required to provide the specific resistance and temperature coefficients desired for the particular design specification. After appropriate binders are added, they are formed into suitable shapes such as beads, rods and discs and then sintered into a strong compact mass.

The bead type thermistor is usually either enclosed in glass or mounted in gas-filled bulbs with wire leads for electrical connections. This type is extremely sensitive to small differential temperatures and responds rapidly to very small amounts of power. Long, narrow round rods with pigtail wire leads wrapped around the ends are representative of the rod type of

thermistor. Electrically they have moderate power dissipation and high resistance. Disc thermistors look like washers, with the flat surfaces allowing a pressure type of contact. They have a low resistance and can handle high power.

Electrical characteristics

The thermistor is a semiconductor which has both nonlinear and negative resistance. Its electrical conductivity at or near room temperature is much less than that of most metals, but much greater than that of most insulators.

A typical voltage vs. current plot of a thermistor is shown in Fig. 1. As the

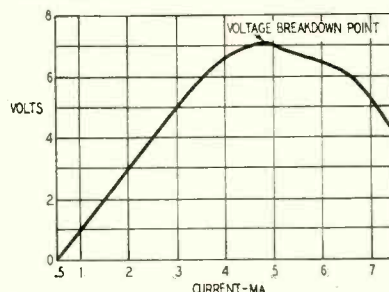

Fig. 1—A typical thermistor curve.

current through the thermistor is increased, the voltage across it begins to rise in accordance with Ohm's law. As the current is further increased the slope of the curve decreases nonlinearly till it flattens out. At this *breakdown voltage point*, the voltage developed across the thermistor is at a maximum. As the current is further increased the voltage *decreases* and the curve exhibits a typical negative resistance characteristic caused by the heating of the thermistor with the increase in current.

In discussing the various applications of thermistors, all references to their changing resistance values are made with the assumption that the thermistor is operating *beyond* the breakdown voltage point. This point of operation determines the effective working range

of the thermistor. If a circuit were operating below this point it would not be necessary to use a thermistor.

The curve shown in Fig. 1 represents a typical static characteristic curve, where the power supplied to a thermistor is equal to the power dissipated by it and the temperature remains constant.

Thermal characteristics

Fig. 2 is a plot of resistance vs. temperature for a typical rod thermistor. In general, the resistance of a thermistor decreases as the temperature increases and in many cases doubles with every 20° C decrease in temperature. An interesting property is that the aging rate of a thermistor decreases with use at elevated temperatures, hence it becomes better the longer it is used.

There are three major methods of producing temperature changes in

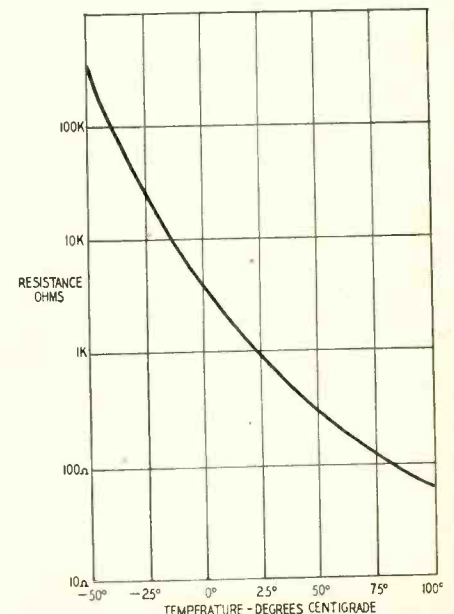
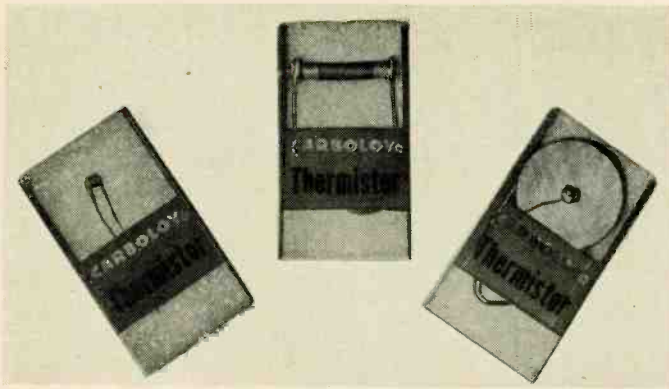

Fig. 2—Resistance-temperature curve.



Thermistors produced by G-E. These units are typical of the assortment of sizes and shapes available.

thermistors. In the first the resistance is controlled by the ambient temperature. This is based on the condition that the power dissipated in the thermistor is negligible with regard to self-heating. As a result, the temperature of the thermistor is the same as the ambient temperature. This allows it to measure variations in the ambient, since its resistance is a function of the ambient temperature.

The second or electrically heated method allows the electric current in a circuit to pass directly through the thermistor. This heats the device, changing the impedance of the circuit. The power dissipation in the thermistor heats the unit above its surrounding temperature, causing the resistance of the thermistor to be a function of the power dissipated in it.

The third or physical method is similar to the first except that the thermistor is heated above its ambient temperature by an external heating coil. As a result the resistance of the thermistor becomes a function of the heat generated in the heating coil.

Since resistance change in a thermistor does not occur immediately as the current passing through it is varied, it is important to consider the dynamic characteristic plot. This curve (Fig. 3) is a plot of load voltage vs. time in seconds. At zero time its resistance is high. A major portion of the voltage appears across the thermistor and a small amount across the load resistor. But as time increases, so does the temperature. The thermistor resistance decreases, causing more voltage to be applied to the load than across the thermistor. The final amount of voltage applied to the load is limited by the circuit resistance and the point at

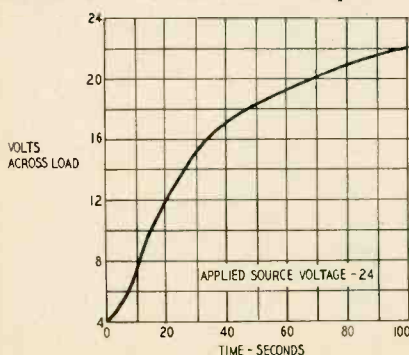

Fig. 3—A dynamic thermistor curve.

which the thermistor resistance stops changing.

It is possible to vary the time delay from a few milliseconds to several minutes by proper circuit design. The thermal mass of the thermistor element determines the time it takes for the temperature change to cause a change in resistance. The smaller the element, the more rapidly the resistance will change with current changes.

Applications

A typical voltage regulation circuit is shown in Fig. 4. The output may be maintained independent of the input variations by placing a conventional resistor R2 in series with thermistor R1. When the input voltage increases, current flow will increase through the series combination. This will cause a decrease in the resistance of the thermistor, resulting in a voltage decrease across it which allows the output voltage to remain essentially constant. The value of R2 is chosen in conjunction with the value of the thermistor resistance. Another consideration in the selection of the resistance of the thermistor and resistor is that due to the thermistor's nonlinearity. It will have smaller variations in voltage drop than the fluctuations occurring in the supply voltage.

Figs. 5, 6 show applications of thermistors in conventional volume-limiter circuits. The function of a volume limiter is to prevent the sound level from exceeding a predetermined level.

The bridge type limiter shown in Fig. 5 is a network of thermistors and conventional resistors arranged as a Wheatstone bridge. When the input level is low, the thermistors are cold and their resistance is high. This unbalances the bridge, and the output will be high. When the input level is high, the thermistors are heated by the high current and their resistance is low. This causes the bridge to approach a balance, lowering the output. As a result, the output remains nearly constant regardless of increases in the input. Since the bridge is never perfectly balanced, some output will always be obtained for any amount of input.

In Fig. 6 a shunt type volume limiter is shown. This circuit acts as a limiter because the primary impedance of the transformer is dependent upon that of

the secondary. When the secondary impedance is high—as when the thermistor is cold—the primary passes very little current. When the secondary impedance drops, due to the thermistor's heating with the increased current as a result of a high input level, the primary shunts more current across the line. Thus large volume changes are limited without producing appreciable waveform distortion.

The circuit shown in Fig. 7 is that of a transistor-thermistor volume-limiter amplifier. It consists basically of two thermistors and one transistor. The transistor operates as a grounded-emitter type. As the input signal increases, the resistance of each thermistor decreases, causing the circuit to approach balance. Since the bridge network is of the null type, the input signal to the transistor decreases.

At the same time, the secondary impedance of the transformer changes in value due to the thermistors' change in resistance. This creates a mismatch between the secondary and primary of the transformer and the input to the transistor. This lowers the efficiency of the circuit; not all the available signal is allowed to pass. These two actions together complete the limiting action. By proper design of components it can be determined at what level the signal will pass and at what level it will cut off.

When the signal decreases, the thermistors increase in resistance and the circuit approaches a better match, which in turn increases the efficiency of the circuit and permits a greater signal output. Resistor R1 acts as part of the matching network for the transistor input. The transistor amplifier circuit is designed to allow a constant volume output under predetermined conditions.

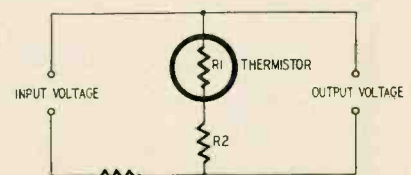

Fig. 4—Typical voltage regulator.

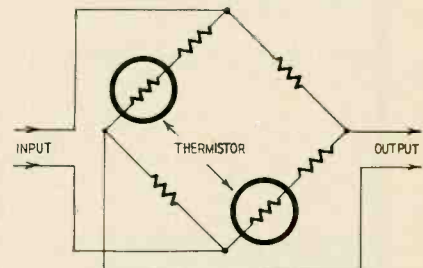

Fig. 5—Bridge type volume limiter.

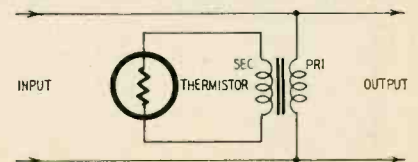

Fig. 6—Shunt type volume limiter.

COMPLETE TRAINING FOR BETTER RADIO-TV SERVICE JOBS



Let these two great new Ghirardi training books teach you to handle all types of AM, FM and TV service jobs by approved professional methods—and watch your efficiency and earnings soar!

Completely modern, profusely illustrated and written so you can easily understand every word, these books pave the way to fast, accurate service on any type of home radio-TV electronic equipment ever made. Each book is brand new. Each contains the latest data on the latest methods and equipment—NOT a rehash of old, out-of-date material. Each is co-authored by A. A. Ghirardi whose famous RADIO PHYSICS COURSE and MODERN RADIO SERVICE were, for 20 years, more widely used for military, school and home study training than any other books of their type!

THE NEW Ghirardi

RADIO-TV SERVICE LIBRARY

Almost 1500 pages and over 800 clear illustrations show step-by-step how to handle every phase of modern troubleshooting and servicing.

1—Radio and Television Receiver TROUBLESHOOTING & REPAIR

A complete guide to profitable professional methods. For the novice, it is a comprehensive training course. For the experienced serviceman, it is a quick way to "brush up" on specific jobs, to develop improved techniques or to find fast answers to puzzling service problems. Includes invaluable "step-by-step" service charts. 820 pages, 417 illus., price \$6.75 separately.

2—Radio and Television Receiver CIRCUITRY AND OPERATION

This 669-page volume is the ideal guide for servicemen who realize it pays to know what really makes modern radio-TV receivers "tick" and why. Gives a complete understanding of basic circuits and circuit variations; how to recognize them at a glance; how to eliminate guesswork and useless testing in servicing them. 417 illus. Price separately \$6.50.

New low price . . . You Save \$1.25!

If broken into lesson form and sent to you as a "course," you'd regard these two great books as a bargain at \$50 or more! Together, they form a complete modern servicing library to help you work faster, more efficiently and more profitably.

Under this offer you buy them both for only \$12.00. You save \$1.25 on the price of the two books—and have the privilege of paying in easy installments while you use them.

10-DAY FREE TRIAL

Dept. RE-85, RINEHART & CO., Inc.
232 Madison Ave., New York 16, N. Y.

Send books below for 10-day FREE EXAMINATION. In 10 days, I will either remit price (plus postage) or return books postpaid and owe you nothing.

Radio & TV Receiver TROUBLESHOOTING & REPAIR (Price \$6.75 separately)

Radio & TV Receiver CIRCUITRY & OPERATION (Price \$6.50 separately)

Check here for MONEY-SAVING COMBINATION OFFER . . . Save \$1.25. Send

both of above big books at special price of only \$12.00 for the two. (Regular price \$13.25 . . . you save \$1.25.) Payable at rate of \$3 (plus postage) after 10 days if you decide to keep books and \$3 a month for 3 months until \$12 has been paid.

Name

Address

City, Zone, State

Outside U.S.A.—\$7.25 for TROUBLESHOOTING & REPAIR; \$7.00 for CIRCUITRY & OPERATION; \$13.00 for both books. Cash with order, but money refunded if you return books in 10 days.

ELECTRONICS

Two thermistors are used in Fig. 8, one as a reference and the other as an indicator. The circuit is a basic type easily adapted to indicate variations in the pressure of any type of chamber whether it is filled with a gas or fluid.

Both thermistors are directly heated and operate on the linear portion of their curves. Since the thermistors will reach a state of equilibrium when they dissipate heat at the same rate at which they absorb it, the circuit may be balanced by applying sufficient current to heat them above the reference temperature. This method enables the indicating device to be controlled by the ambient temperature.

With the indicating thermistor placed in an environment with a different temperature coefficient than the environment of the reference thermistor, the device may be calibrated to read the pressure variations. This may be done because the two media in which the thermistors are placed have different coefficients of temperature. As a result, each dissipates heat at a different rate. Variations in pressure cause variations in the rate of heat dissipation and consequently variations in resistance.

A remote thermometer or refrigerator thermostat application is shown in Fig. 9. This circuit consists of a thyatron with a.c. on its plate and

d.c. grid bias supplied through a rectifier tube. In addition, an a.c. signal is superimposed on the grid of the thyatron from the thermistor. The potentiometer adjusts the grid bias and so controls the tripping temperature of the unit.

By biasing the thyatron sufficiently below cutoff, neither the positive half-cycles of the a.c. applied from the input to the anode nor those of the thermistor will fire the thyatron at temperatures above the regulating temperature. As the temperature increases, the resistance of the thermistor decreases, changing the bias of the thyatron and driving it further into cutoff.

As the temperature decreases, the tube will fire at a specific temperature and operate the relay, opening the controlled device. This occurs because the grid bias is a function of the setting of the potentiometer and the resistance of the thermistor. Since the thermistor resistance varies with temperature changes, the control unit was designed to allow the relay to operate when the temperature falls to a specific value. This causes the combined resistance of the thermistor at this temperature and the fixed value of the potentiometer to fire the thyatron, operating the relay and shutting off the refrigerator motor.

A high-frequency power-measuring

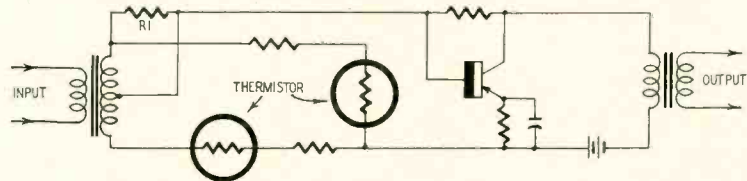

Fig. 7—Schematic diagram of a thermistor-transistor volume-limiter amplifier.

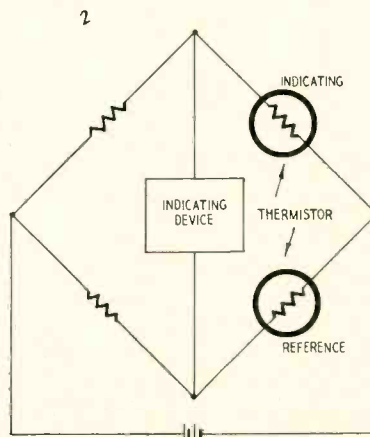

Fig. 8—Pressure-measuring circuit.

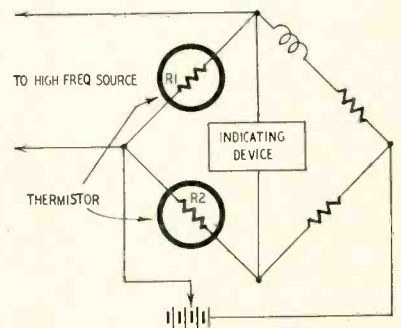

Fig. 10—Schematic diagram of a high-frequency power-measuring circuit.

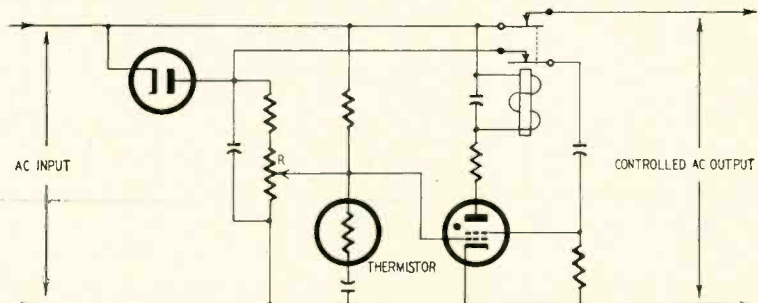

Fig. 9—Schematic of a thermistor thermostat using a thyatron and diode.

THE #630 TV RECEIVER remains unmatched for quality and performance ••• RCA designed and developed this set quality-wise *not* price-wise ••• The original 10" set retailed at \$375.00 ••• Subsequent TV sets serve to prove the sacrifice of quality for price ••• what better proof can there be of its superiority than the fact that it is the choice of TV engineers and TV technicians! Herewith we offer you—YOUR BEST BUYS IN TV!—All you pay is the price shown ••• Excise taxes have already been paid by us.

Brooks **LIFE-SIZE TV INSTRUCTIONS** for building any #630 TV Receiver from the original 10" to the latest 27" **\$1.25** postpaid

HINTS FOR BETTER PERFORMANCE 50¢ on your #630 TV receiver..... postpaid

Brooks **CASCADE MANUAL**, how to install Cascade Tuner in any make TV Set. **25¢** postpaid

90° TV CONVERSION MANUAL, how to convert any TV SET to 24", 27", etc. **50¢** postpaid

70° TV CONVERSION MANUAL, how to convert any TV SET to 17", 21", etc. **50¢** postpaid

A.G.C. STEP-BY-STEP INSTRUCTIONS, how to add A.G.C. to any make TV Receiver **25¢** postpaid

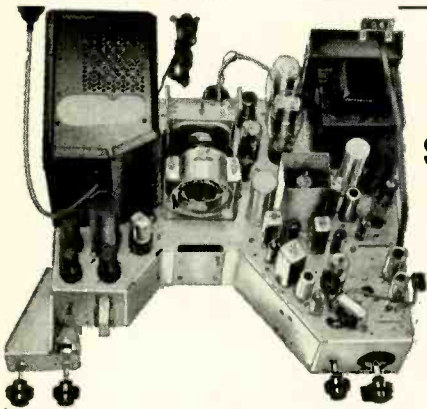

Build your own
Super De Luxe 31-TUBE #630 TV CHASSIS

#630 SUPER DE LUXE 31-TUBE TV KIT
Engineered in strict adherence to the genuine RCA #630 plus added features ••• OPERATES 16" to 21" PICTURE TUBES ••• CASCADE TUNER ••• COSINE YOKE ••• LARGER POWER TRANSFORMER ••• KEYED AGC ••• 12" SPEAKER ••• CONDENSERS and RESISTORS at rated capacities and tolerances. You receive a COMPLETE SET OF PARTS AND TUBES. Everything needed is included, (less CRT and wire.) You will enjoy building it with "LIFE-SIZE easy to follow step-by-step ASSEMBLING INSTRUCTIONS" included with each KIT.
slashed to **\$99.99**
Same KIT for 27" and ALL 90° CRT's **\$110.39**

CUSTOM-BUILT CABINETS FACTORY TO YOU

3 LEADING STYLES in genuine mahogany or walnut (blond 10% extra) • Ready drilled for any #630 TV chassis and cutout for any 16", 17", 19", 20" or 21" picture tube at no extras in price • Also supplied with undrilled knob panel for any other TV set • EVERYTHING NECESSARY for an easy perfect chassis and CRT assembly is included • Each cabinet is delivered complete as pictured with mask, safety glass, mounting brackets, backboard, backup, hardware and assembling instructions • Each cabinet is shipped in an air cushioned carton from FACTORY to YOU!

The **VOGUE** Most Popular Table Model **H-25", W-26", D-22"** **\$35.91**

The **MANHATTAN** Style, Quality, Price **H-41", W-25", D-23"** **\$53.43**

The **MAYFAIR** Exclusively modern, with an elegance of simplicity in styling. **H-41", W-26", D-25"** **\$73.26**

VOGUE also available for 24" or 27" picture tube **H-31", W-27" D-23"** **\$59.54**

MANHATTAN for 24" or 27" CRT **\$79.22**
H-46", W-30", D-24"

Special this month Mayfair in mahog., walnut or blond, only **\$73.26**

#630 SUPER DE LUXE TV CHASSIS
LICENSED UNDER RCA PATENTS
COMPLETE READY TO PLUG IN AND PLAY—Similar in characteristics and features to the 70° TV KIT above • Manufactured especially for us by nationally known manufacturers • No efforts or expense have been spared in workmanship or materials, to make this #630 SUPER DE LUXE TV CHASSIS the best obtainable. Customers report reception better than 200 miles. Each set is factory aligned and air-tested • All parts carry the RMA three month guarantee • Our mass volume of business on this CHASSIS (numbering thousands of pleased customers) now makes it possible for us to reduce the price, (less CRT.)
slashed to **\$142.27**

NATIONALLY KNOWN BRAND PICTURE TUBES
BRAND NEW in Factory Sealed Cartons—With a Full Year Guarantee
17" #17BP4A \$22.66 | **21" #21EP4B Aluminized \$32.21** | **24" 90° #24CP4A Aluminized \$48.99** | **27" 90° #27EP4A Aluminized \$74.31**

Modernize a #630 or any TV Set with a **STANDARD CASCADE TUNER**
For better all around performance
Complete with tubes and Brooks CASCADE MANUAL with step-by-step instructions and all extra parts needed. **\$15.97**

PULSE KEYED AGC KIT
Finest, most accurate and the easiest Kit to install in any make TV RECEIVER including the #630. Improves performance and insures a steady Picture on all channels.
COMPLETE SET OF PARTS \$2.99
Including 6AU6 tube & Instructions

We Also Sell The Complete Line of **TECH-MASTER #630 TV CHASSIS**. Catalog mailed on request.

#630 TV BASIC PARTS KITS
PUNCHED & DRILLED CHASSIS PAN BRACKET & SHIELD KIT (18 items)
VIDEO & I.F. KIT (19 items)
POWER TRANSFORMER #201T6
VERTICAL OUTPUT TRANSFORMER
VERTICAL BLOCKING TRANSFORMER
FLYBACK TRANSFORMER #211T5
FOCUS COIL, 470 ohms #202D2
COSINE DEFLECTION YOKE 70°
All for only **\$29.97** Incl. #630 INSTRUCTIONS

#630 Parts in COMPLETE SETS

TV WIRE & SOLDER KIT, for any Set.....	\$.98
630-KIT, screws, nuts, rivets, washers, etc.....	1.69
TERMINAL STRIP KIT, set of 30.....	.69
VIDEO AND I.F. KIT, 19 items.....	4.99
VARIABLE CONTROL KIT, 9 controls.....	3.97
CARBON RESISTOR KIT, 107 resistors.....	4.98
WIREWOUND RESISTOR KIT, 4 resistors.....	1.76
BRACKET AND SHIELD KIT, 18 items.....	6.44
ELECTROLYTIC CONDENSER KIT, 6 cond.....	4.96
TUBULAR CONDENSER KIT, 38 condensers.....	3.63
CERAMIC CONDENSER KIT, 28 condensers.....	1.98
MICA CONDENSER KIT, 11 condensers.....	.97

NEW 70° CONVERSION KIT ANY MAKE TV RECEIVER
including the #630 can now be converted to operate the 21" or any 70° Picture Tube.
COMPLETE SET OF ESSENTIAL PARTS
including the latest TODD 70° COSINE DEFLECTION YOKE & FLYBACK TRANSFORMER and easy to follow Step-By-Step Instructions & Diagrams.
List price \$29.50 Your price.... **\$12.17**

UNIVERSAL Picture Tube MOUNTING BRACKETS
Fits All 12 1/2" to 21" picture tubes
Complete — Including band that holds picture tube
\$4.97

PARTS For #630 TV SETS

PUNCHED CHASSIS PAN, cadmium plated.....	\$3.96
COMPLETE SET OF KNOBS, incl. decals.....	.99
POWER TRANSFORMER, 295ma. 201T6.....	9.16
VERTICAL OUTPUT TRANS. 204T2.....	2.24
VERTICAL BLOCKING TRANS. 208T2.....	.98
TV FLYBACK TRANS. 211T5.....	2.97
TV FLYBACK TRANS, with AGC, 211T5.....	4.94
FOCUS COIL, 470 ohms, 202D2.....	2.93
DEFLECTION YOKE, Cosine 70°.....	3.45
TV 90° DEFLECTION YOKE.....	5.98
TV FLYBACK TRANS., for 90°.....	4.42
SYNCHROLOC TRANSFORMER 208T8.....	.98
FILTER CHOKE, 62 ohms.....	1.15
WIDTH CONTROL COIL, keyed AGC.....	.52
ION TRAP BEAM BENDER, single 203D1.....	.52

CONVERT your TV SET to 27"
or ANY 90° PICTURE TUBE!
UNIVERSAL 90° CONVERSION KIT
COMPLETE SET OF ESSENTIAL PARTS
Including the latest TODD 90° COSINE DEFLECTION YOKE & FLYBACK TRANSFORMER and easy to follow Step-By-Step Instructions & Diagrams.
List price.....\$39.75 Your price.... **\$15.98**

BROOKS RADIO & TV CORP., 84 Vesey St., Dept. A, New York 7, N. Y. TELEPHONE COrrland 7-2359

Don't Gamble

WITH

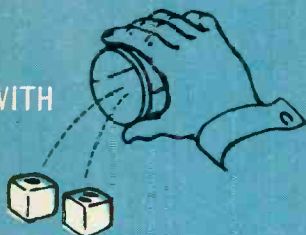

Your Profits



be **SURE** with **AMPHENOL**

As a dealer you may be gambling with present profits and with future business growth—and for only 30¢! 30¢ is the price difference between quality AMPHENOL Twin-Lead and any low-priced, inferior twin-lead in an average 50 feet installation.

Here are the figures:

AMPHENOL 14-056 Twin-Lead, dealer net..	\$16.25 M Ft.*
Low-priced twin-lead, approximate dealer net	10.00 M Ft.
Difference per foot006¢
Difference per 50 feet installation.....	.30¢

Here are a dealer's gains with AMPHENOL:

1. Every foot of AMPHENOL Twin-Lead is unconditionally guaranteed for quality and best performance.
2. Finest materials: virgin polyethylene, top-grade copper conductors.

Here are a dealer's losses with inferior, low-priced twin-leads:

1. Poor raw material, including reclaimed polyethylene, means that a dealer may have to go back two or three times on an installation to replace lead-in which has pulled apart, or has snapped conductors, or has suffered material deterioration. No profits there!
2. Customer criticism causing loss of valuable word of mouth advertising and business reputation. No profits there!

Be sure, don't gamble. Install with genuine AMPHENOL Twin-Lead.

* In 5000 foot quantities



It will be to your advantage to check the reasons for the difference in twin-lead prices. Obtain the free booklet "Don't Gamble with Your Profits" and the Vest Pocket Guide to Twin-Leads from your AMPHENOL Distributor.

see your authorized AMPHENOL Distributor! . . .
AMERICAN PHENOLIC CORPORATION

ELECTRONICS

circuit is shown in Fig. 10. Thermistor R1 is the power-absorbing thermistor, R2 the environmental temperature-compensating thermistor. Mounted in the waveguide, R1 acts as the terminating resistance. The thermistors are biased to a selected operating resistance, one which matches the impedance of the waveguide in the absence of the power to be measured. When power is applied from the high-frequency source, R1 increases in temperature and decreases in resistance. This causes the bridge to become unbalanced and the indicating device to record the difference in power before and after the application of the high-frequency energy. Compensating thermistor R2 holds the circuit independent of the effect of temperature change on the measuring thermistor characteristics.

The major advantage of this type of bolometer over a conventional one which uses a platinum element as the sensitive resistor is that the uncertainty caused by temperature fluctuating in or around the waveguide is removed. By proper selection of thermistors and the biasing current, the indicating device can use a vacuum tube grid input directly without any impedance-matching elements.

An interesting and a potentially important household application is the Westinghouse *Electronic Eye* heat-control device in the new electric ranges. This permits cooking without the burning of food. It consists of a thermistor embedded in a silicone rubber paste, used to dissipate maximum heat. The thermistor is placed in contact with the pan and controls the operation of the electric range at specific predetermined temperatures.

In designing thermistor application circuits it is necessary to know the cold resistance of the thermistor, the maximum steady-state voltage which can be developed across the thermistor at the specified temperature, the current required to develop the maximum voltage and the maximum continuous current through the thermistor. In addition, it is important to know the voltage developed across the thermistor, the resistance and the power dissipation at the maximum continuous current.

The author wishes to extend his thanks to Richard Schaefer and George Quayle for their helpful suggestions in the preparation of the material included in this article. END

References

- J. A. Becker, C. B. Green, and G. L. Pearson, "Properties and Uses of Thermistors—Thermally Sensitive Resistors," *Electrical Engineering*, November, 1946.
- Carboloy Thermistor Manual TH-13, Carboloy Department of General Electric.
- K. P. Dowell, "Thermistors as Components Open Product Design Horizons," *Electrical Manufacturing*, August, 1948.
- "Nonlinear Resistors," *The Aerovox Research Worker*, October-November, 1953.
- G. L. Pearson, "Thermistors, Their Characteristics and Uses," *Bell Laboratories Record*, December, 1940.
- William Shockley, "Electrons and Holes in Semiconductors," D. Van Nostrand Co., Inc.
- Albert H. Taylor, "Thermistor Thermostats," *Electronics*, July, 1950.
- "VECO Data Book—Thermistors," Victory Engineering Corp., Union, N. J.

new Devices



TV ANTENNAS, Tescon model C-1 Constellation, C-2 Super-Constellation. High-gain broadband, all-channel v.h.f. in-line Yagi types for deep-fringe reception. Diamond phasing loops multiply director element functions. Broadband T-matched

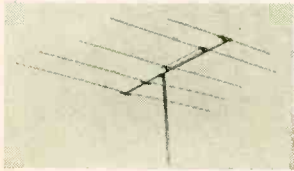

driven elements for low- and high-band v.h.f., high front-to-back ratio with negligible side response on all channels. Stacking harnesses available for emphasis on low or high channel response or all-v.h.f. performance.—Tescon, T-V Products Co., Springfield Gardens, N. Y.

CRYSTAL MICROPHONE, Capps model CR BB, acoustically amplifies frequencies between 40 and 150 cycles up to 12 db. Band selection by control knob on microphone. Bass can be set to compensate for deficiencies of recording and PA systems. Frequency response, 30-12,000 cycles; output, -52 db.

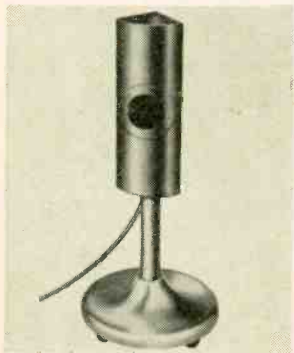

—Frank L. Capps & Co., Inc., 20 Addison Pl., Valley Stream, N. Y.

FOUR NEW UNITS, Hallicrafters HT-31 linear amplifier, SX-100 deluxe receiver, R-46B speaker, HT-30 transmitter-exciter. HT-31: full-band power amplifier covering 80 to 10 meters; power input, 500-510 watts; power output, 330 peak effective on 80 with slightly less on 10 meters; drive power, 10 watts on lowest frequency. Uses two 811-A zero-bias triodes in parallel. HT-30 (shown in photo): power output SSB peak effective of 35 watts; built-in v.f.o. with



dial calibrated directly in kc; bandswitching for 80, 40, 20, 10 meters; 64:8:1 ratio gear drive system. SX-100: 100-ke. quartz-crystal calibrator mounted in vacuum. T-notch filter increases selectivity, eliminates heterodynes. Antenna trimmer for all type antennas.—Hallicrafters Co., 4401 W. Fifth Ave., Chicago 24, Ill.

MICROPHONE, Electro-Voice model 664 variable D cardioid dynamic unit. Cardioid polar pattern at all frequencies; high front-to-back discrimination and wide-range response; pop-proof filter minimizes wind and breath blasts. Response



from 60 to 13,000 cycles; output level 55 db; 150 ohms and high impedance; impedance changed by moving one connection in connector. 18-foot cable with MC4M connector.—Electro-Voice, Inc., Buchanan, Mich.

TURN TABLE, Rek-O-Kut model L-37 Rondine Jr., 12-inch unit handles 33 1/2- and 78-r.p.m. records. Model L-34 (recently introduced) operates at 33 1/2 and 45 r.p.m. Both models identi-



BUILD 15 RADIO

CIRCUITS AT HOME ONLY
With the New Improved
1955 Progressive Radio

\$19⁹⁵
Complete

"EDU-KIT"

NOW INCLUDES
RECEIVER,
TRANSMITTER,
CODE OSCILLATOR,
SIGNAL TRACER
CIRCUITS



- ATTRACTIVELY GIFT PACKED
- FREE SOLDERING IRON
- NO ADDITIONAL PARTS NEEDED
- EXCELLENT BACKGROUND FOR TV
- 30 DAY MONEY-BACK GUARANTEE
- SCHOOL INQUIRIES INVITED
- ABSOLUTELY NO KNOWLEDGE OF RADIO NECESSARY

WHAT THE PROGRESSIVE RADIO "EDU-KIT" OFFERS YOU

Our Kit is designed to provide a fundamental background in radio, with the basic facts of Radio Theory and Construction Practice expressed simply and clearly. You will gain a knowledge of basic Radio Principles involved in Radio Reception, Radio Transmission and Audio Amplification.

You will learn how to identify Radio Symbols and Diagrams; how to build radios, using regular radio circuit schematics; how to mount various radio parts; how to wire and solder in a professional manner. You will learn proper chassis layout. You will learn how to service and trouble-shoot radios. You will learn code. You will receive training for F.C.C. Novice License. You will learn High Fidelity.

In brief, you will receive a practical basic education in Radio, worth many times the small price you pay.

THE KIT FOR EVERYONE

The Progressive Radio "Edu-Kit" was specifically prepared for any person who has a desire to learn Radio. The Kit has been used successfully by young and old in all parts of the world. It is not necessary that you have even the slightest background in science or radio.

The Progressive Radio "Edu-Kit" is used by many Radio Schools and Clubs in this country and abroad. It is used by Armed Forces Personnel and Veterans throughout the world.

The Progressive Radio "Edu-Kit" requires no instructor. All instructions are included. All parts are individually boxed, and identified by name, illustration and diagram. Every step involved in building these sets is carefully explained.

PROGRESSIVE TEACHING METHOD

The Progressive Radio "Edu-Kit" comes complete with instructions. These instructions are arranged in a clear, simple and progressive manner. The theory of Radio Transmission, Radio Reception, Audio Amplification and servicing by Signal Tracing is clearly explained. Every part is identified by illustration and diagram. You will learn the function and theory of every part used.

The Progressive Radio "Edu-Kit" uses the principle of "Learn by Doing". Therefore you will build radio circuits, perform jobs, and conduct experiments to illustrate the principles which you learn. These circuits are designed in a modern manner, according to the best principles of present-day educational practice. You begin by building a simple radio. The next set that you build is slightly more advanced. Gradually, in a progressive manner, you will find yourself constructing still more advanced multi-tube radio sets, and doing work like a professional Radio Technician. Altogether you will build Receiver, Transmitter, Code Oscillator and Signal Tracer Circuits—15 in all. These sets operate on 105-125 V. AC-DC. For use in Foreign Countries having 210-250 Volt Source, an Adaptor for 210-250 V. AC-DC operation is available.

THE PROGRESSIVE RADIO "EDU-KIT" IS COMPLETE

You will receive every part necessary to build 15 different radio circuits. Our "Edu-Kit" contains tubes, tube sockets, variable, electrolytic, and paper condensers, resistors, tie strips, coils, hardware, tubing, etc. No solder or wire included.

Every part that you need is included. These parts are individually packaged, so that you can easily identify every item. A soldering iron is included, as well as an Electrical and Radio Tester. Complete, easy-to-follow instructions are provided. All parts are guaranteed, brand new, carefully selected and matched.

In addition, the "Edu-Kit" now contains lessons for servicing with the Progressive Signal Tracer, F.C.C. instructions, quizzes, High Fidelity instructions.

TROUBLE-SHOOTING LESSONS

Trouble-shooting and servicing are included. You will be taught to recognize and repair troubles. You will build and learn to operate a professional Signal Tracer. You receive an Electrical and Radio Tester, and learn to use it for radio repairs. While you are learning in this practical way, you will be able to do many a repair job for your neighbors and friends, and charge fees which will far exceed the cost of the "Edu-Kit". Here is your opportunity to learn radio quickly and easily, and have others pay for it.

FREE EXTRAS

ELECTRICAL & RADIO TESTER ● ELECTRIC SOLDERING IRON
TV BOOK ● QUIZZES ● FREE CONSULTATION SERVICE ● HI-FI GUIDE

Progressive "Edu-Kits" Inc., 497 Union Ave., Brooklyn 11, N.Y.

MAIL TODAY—Order shipped same day received.

30-Day Money-Back Guarantee. Include ALL FREE EXTRAS

- Send "Edu-Kit" Postpaid. I enclose full payment of \$19.95 (U.S.A. only).
- Send "Edu-Kit" Postpaid. I enclose full payment of \$26.95 (Outside U.S.A.).
- 210-250 V. Foreign Line Voltage Adapter for "Edu-Kit"—\$2.50.
- Send "Edu-Kit" C.O.D. I will pay \$19.95 plus postage (U.S.A. only).
- I wish additional information describing "Edu-Kit". No Obligation.
- Send me FREE Radio-TV Servicing Literature. No Obligation.

Name.....

Address.....

PROGRESSIVE "EDU-KITS" INC.

497 UNION AVE., RM. 107-G, PROGRESSIVE BLDG., BROOKLYN 11, N.Y.

NEW DEVICES

cal in mechanical design and performance. Mechanical filtering eliminates acoustical coupling between motor and turntable. Permanently affixed strobe disc for instantaneous speed checking. Cork-neoprene mat material prevents record slippage.—**Rek-O-Kut Co.**, 38-01 Queens Blvd., Long Island City 1, N. Y.

SUBSTITUTION BOX. *Electronic Measurements Corp.* model 900, in wired and kit forms. 36 RETMA resistor values from 15 ohms to 10 megohms, 18 RETMA capacitance values from .001 to 0.22 μ f. 10% accuracy. Determines resistance and capacitance values in R-C time circuits as well as charred

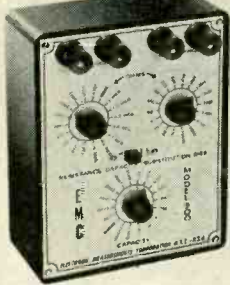

or unmarked resistors and capacitors.—**Electronic Measurements Corp.**, 280 Lafayette St., New York 12, N. Y.

DISTORTION METER. *Heath HD-1* harmonic-distortion meter kit. Used with audio sine-wave generator, checks harmonic distortion at output of audio

amplifiers. Frequency range:



20-20,000 cycles in 3 ranges. V.t.v.m. circuit for initial reference settings and final harmonic-distortion readings. High input impedance. Requires only 0.3-volt input signal for distortion tests. Uses 0A2, 6X4, 5879, 12AT7, 12AX7, 12BY7. 8 1/2 x 13 x 8 inches.—**Heath Co.**, Benton Harbor 20, Mich.

1 1/2-INCH PANEL METERS. *Phaestron*, 4 types, in magnetically shielded unbreakable metal housings. Front zero adjustments; 2% accuracy insured. *Custom chrome:* rectangular, black die-cast bezel highlighted by chrome trim; *Custom Chrome Illuminated:* same as above but



with 5,000-hour self-contained lamps for illuminating scales; 1/2-inch *Custom:* all black rectangular bezel (colors available for industrial users); 1/2-inch *Custom Illuminated:* same as above with 5,000-hour self-contained lamps.—**Phaestron Co.**, 151 Pasadena Ave., So. Pasadena, Calif.

5-INCH OSCILLOSCOPE. *RCA WO-91A.* Dual-band response with 4.5-mc response in wide-band position. Vertical amplifier has voltage-calibrated frequency-compensated 3-to-1 step attenuator. Built-in calibration for peak-to-peak voltage measurements; vertical polarity reversal switch for upright or inverted trace display;

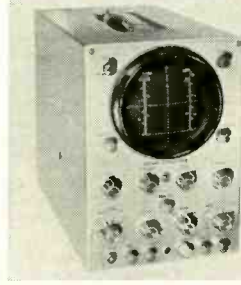

one-piece probe with built-in switch for low-capacitance or direct operation; preset vertical and horizontal sweep positions; plus-or-minus internal sync selector; shielded vertical input connector; shielded cable; positive-lock internal sync. Slip-on signal-tracing demodulator probe as accessory.—**Ra-**

(Continued)
dio Corporation of America, Tube Division, Harrison, N. J.
WHITE DOT GENERATOR. *Win-tronix model 160,* compatible for black-and-white or color TV. Large and small white dots for color receiver convergence; vertical and horizontal bars for sweep circuit alignment. Internally generated vertical sync pulses and locked-to-line frequency give stable operation. R.f. carrier output and external modulation provisions.—**Winston Electronics, Inc.**, 4312 Main St., Philadelphia 27, Pa.



CAPACITOR. *Astron ET* miniature electrolytic for limited-space applications such as portable television sets, hearing aids, miniature radios, tape recorders, etc. Adaptable to automatic chassis assembly. Wide range of values, stable high-

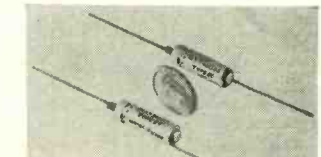

gain etch process, low leakage current, low-resistance terminal tab connection.—**Astron**

LIFETIME GUARANTEED TUBES

BRAND NEW PICTURE TUBES

● RCA Licensed ● One Year Unconditional Guarantee

TYPE	PRICE	TYPE	PRICE
10BP4	\$11.90	17BP4	\$20.63
12LP4	\$14.38	19AP4	\$24.81
14BP4	\$16.86	21AP4	\$28.79
16RP4	\$19.38	21EP4	\$28.79
16LP4	\$19.38	24AP4	\$42.50

● Picture Tubes shipped F.O.B. Harrison, N. J.

LOOK WHAT YOU GET FREE!

FREE BONUS BOX
With Every \$25 Order

- 1 RCA Cheater Cord
- 10 Assorted resistors
- 10 Assorted 2-Color "blank" tube cartons
- 1 6BQ6GT tube
- 1 6AU6 tube
- 1 6CB6 tube

FREE CLOCK RADIO

With Every \$125 Purchase Within 30 Days
Wakemaster clock radio with famous Sessions clock movement wakes you to music or alarm. May be purchased outright from MAJOR BRAND for \$17.95. In ivory or rust.

FREE GIFT CERTIFICATE*

worth \$5 toward the purchase of any of our merchandise on future orders will be sent with any order of \$50 or more.

*Free Gift Certificate cannot be used to obtain another certificate unless order is \$55 or more.

WE PAY ALL POSTAGE on orders shipped in USA, Territories and APO's. Send only purchase price of merchandise. Please include approximate postage on foreign shipments. All orders subject to prior sale. 25c Handling Charge on Orders under \$5. Quantity users Write For Special Discounts.

Write For FREE Tube List—Order Blank—and FREE Sample Tube Carton. We want Y-O-U On Our Mailing List!

NEW INDOOR ANTENNA

Both U H F and V H F. Brings better reception than most outdoor antennas. Use on top of TV.

List Price \$9.95

YOUR PRICE

Lots of 3
\$3.29
\$3.99 each

THIS AD IS WORTH M-O-N-E-Y

Clip out this ad and attach it to your order. Three 6SN7GT's will be shipped FREE with any order of \$10 or more.

- Top Branded Tubes and Our Own MAJOR BRAND Label
- Each Tube Individually Boxed and Guaranteed for Life
- Over a Half Million Tubes Always in Stock
- Immediate Shipment
- Free Postage On All Orders With Full Remittance

Here's How LIFETIME GUARANTEED TUBES

- SAVES YOU PLENTY!
- There are fewer "call backs"
- There are no "out of date" tubes
- "Peak Performance" testing in our fully equipped Testing Department before shipment guarantees quality

024	43	5AW4	75	6B17GT	75	6X4	34	12SK7	45
1A4P	33	5J6	63	6BN6	58	6X5	34	12SN7GT	56
1A7GT	43	5T4	69	6B06GT	78	6X8	73	12SQ7	37
183GT	65	5U4G	43	6B07	78	6Y6G	55	12SR7	45
1C5GT	41	5UB	74	6B75G	58	7A4	45	12V6GT	45
1D5GP	43	5V4G	50	6B7Z	88	7AS	53	12X4	37
1E7GT	41	5Y3	31	6C4	37	7A6	45	14A7	42
1G6GT	41	5Y4G	36	6C5	35	7A7	43	14B6	38
1H4C	43	5Z3	41	6C6	49	7A8	45	14C7	50
1H5GT	47	6A7	57	6C6GG	1.15	7B5	39	19B6GG	1.15
1J6GT	47	6A8	45	6D6	48	7B6	42	19T8	65
1L4	45	6A8A	43	6E5	44	7B7	41	24A	39
1L6	55	6AC7	67	6F5	44	7B8	39	25AV5GT	78
1LA4	57	6AF4	79	6F6	38	7C4	39	25B06GT	78
1LA6	47	6AG5	50	6G6	40	7C5	42	25L6GT	47
1LR4	57	6AG7	69	6M6	38	7C6	43	25W4GT	43
1LCS	49	6AM6	69	6J4	1.79	7C7	45	25Z5	37
1LC6	47	6AJ5	70	6J5	39	7E5	45	25Z6	37
1LD5	57	6AK5	54	6J6	47	7E6	45	25Z7	25
1LE3	57	6AL5	39	6J7	43	7E7	70	35A5	46
1LG5	57	6AQ5	46	6J8G	85	7F7	59	35B5	50
1LH4	64	6AR5	46	6K6GT	37	7F8	70	35CS	50
1LMS	47	6AS5	48	6K7	59	7G7	75	35L6GT	47
1N5GT	50	6AS6	1.70	6K8	65	7H7	50	35W4	34
1R5	50	6AS7G	2.15	6L5	68	7J7	75	35Y4	34
1S5	42	6AT6	65	6N7	60	7L7	75	35Z5GT	34
1T4	50	6AU4GT	65	6N7	60	7N7	50	37	29
1U5	47	6AU5GT	59	6Q7	40	7Z6	66	50A5	46
1V2	65	6AV5GT	65	6SA7	45	12A7G	63	50B5	50
1X2	61	6AV6	39	6SC7	48	12A27	61	50C5	50
1Y4	55	6AX4GT	60	6ST7	41	12AUG	53	50L6GT	43
2A5	57	6AX5GT	57	6SM7	43	12AU7	53	50L6GT	43
2A7	55	6B4G	52	6S7	43	12AV6	35	75	42
2V4	51	6B6	69	6SK7	45	12AV7	67	76	42
3A5	50	6BA6	47	6SL7GT	55	12AX4GT	58	77	38
3AL5	45	6BA7	58	6SN7GT	55	12AX7	58	77	38
3AU5	46	6BC5	47	6SQ7	39	12B4	68	78	38
3BC5	54	6BC7	80	6T8	42	12B6	46	80	34
3BN6	70	6BE6	45	6S57	41	12B6E	48	80	34
3CB6	52	6BF5	40	6T4	95	12B6E	46	84	624
3C4	46	6BF6	50	6T8	60	12B7	60	117GT	1.09
3Q5GT	57	6BG6G	1.15	6U8	75	12B7V	65	117N7GT	1.09
3S4	47	6BH6	50	6V3	80	12BZ7	61	117P7GT	1.09
3V4	47	6B6	67	6V6GT	46	12C06	35	117Z3	35
4BQ7	89	6BK5	68	6W4GT	39	12SA7	45	117Z6GT	63
4BZ7	95	6BK7	76	6W6GT	53	12S7	45	117Z6GT	63

Write Dept. E-RE

MAJOR BRAND TUBE CO.
Romano Bldg. ESsex 4-1106 Harrison, N. J.

NEW DEVICES

Corp., 255 Grant Ave., East Newark, N. J.

SOLDERING IRONS, American Beauty Bantam. Stainless steel, projection-free casing minimizes heat loss; keeps handle cool. Mica-insulated, nickel-

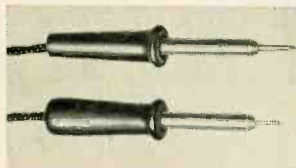

chromium heating element; tapered spool nose. In 1/8- and 3/8-inch tip diameters with either pencil type or standard handle, long or short casing. Diamond point tip; chisel type supplied if specified.—American Electrical Heater Co., 6110 Cass Ave., Detroit 2, Mich.

ROTOR, Cornell-Dubilier and Radiart model TR-4 (meter control dial cabinet version of TR-2) has accurate directional indication, for all compass points. Uses 4-wire cable. Load capacity 150 pounds; 12 heavy-duty ball bearings in two 6 1/2-inch ball bearing races. Streamlined weatherproof design; re-

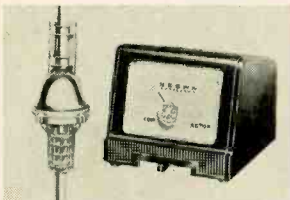

inforced die-cast housing; heavy-duty precision gears; reversible clamps for 7/8-2-inch masts; mechanical brake released magnetically; heavy-duty motor that reverses instantly; 3 heavy-duty guy wire lugs.—Cornell-Dubilier Electric Corp., South Plainfield, N. J.; Radiart Corp., 3455 Vega Ave., Cleveland 13, Ohio.

SHEET METAL PUNCH, General Cement, punches tube socket and capacitor holes (1/8 and 1 5/32 inches) easily and quick-

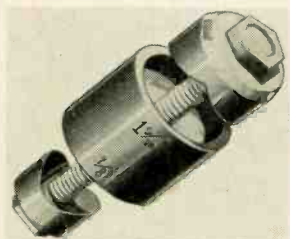

ly. Takes metal up to 3/32 inch thick without burrs.—General Cement Mfg. Co., 919 Taylor Ave., Rockford, Ill.

GERMANIUM POWER RECTIFIERS, International Rectifier Corp. Diffused junction units for

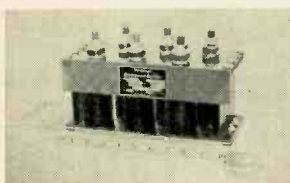

All specifications given on these pages are from manufacturers' data.

(Continued)

voltage ranges from 10 volts to 100 kv, 10 to 100,000 amperes, by connecting junctions and assemblies in series or parallel. Natural convection, forced convection or liquid-cooled. Fan-cooled germanium unit shown rated at 750 amperes, 40 volts output, in 3-phase half-wave circuit.—International Rectifier Corp., El Segundo, Calif.

TUBE BRIGHTENER, Perma-Power Golden C-Brite model C201, combines functions of C-Brite parallel and series picture-

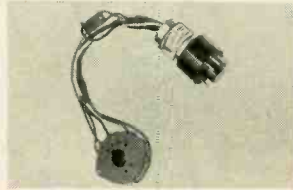

tube brighteners. Adaptable to either parallel or series-string filament circuits by self-contained reversible plug. For both electrostatic and magnetic focus tubes.—Perma-Power Co., 4727 N. Damen Ave., Chicago 25, Ill.

BLUE JACKET RESISTORS, Sprague, in 174 types: 3, 5, 10 watts, from 1 to 50,000 ohms. Tolerance to 50 ohms ±10%; over 50 ohms, ±5%. For point-



to-point, terminal-board and printed-chassis wiring. Axial lead design gives secure mounting. Vitreous enamel coating.—Sprague Products Co., 81 Marshall St., North Adams, Mass.

NUT DRIVERS, Vaco, color-keyed: black shafts 3/8-inch hex sockets; red, 1/4 inch; yellow, 5/16 inch; green, 11/32 inch; blue, 3/8 inch; brown, 1/2 inch; orange, 1/2 inch. Shafts hollow entire length, insulated from Comfordome handle to tip.

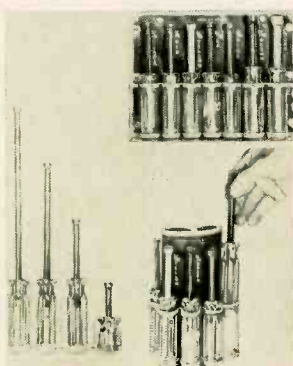

Lengths: stubby, 1 1/2 inches out of handle; regular, 3 inches; long, 5 1/2 inches; extra long, 8 1/4 inches.

K-7—service technician's kit—plastic holder hangs, folds, stands. Transparent plastic slots marked for size and color hold 7 nut drivers.—Vaco Products Co., 317 E. Ontario St., Chicago 11, Ill.

RCA INSTITUTES

COLOR TV

HOME STUDY COURSE

trains you in the "why" and "how" of Color TV Servicing

Study Color Television Servicing from the very source of the latest, up-to-the-minute Color TV developments. Train under the direction of men who are experts in this field. Take advantage of the big future in Color TV through RCA Institutes' Home Study Course, which covers all phases of Color Servicing. It is a practical down-to-earth course in basic color theory as well as how-to-do-it TV servicing techniques.

This color television course was planned and developed through the efforts of instructors of RCA Institutes, engineers of RCA Laboratories and training specialists of RCA Service Company. You get the benefit of years of RCA research and development in color television.

Because of its highly specialized nature, this course is offered only to those already experienced in radio-television servicing. Color TV Servicing will open the door to the big opportunity you've always hoped for. Find out how easy it is to cash in on Color TV.



SEND FOR FREE BOOKLET
NO SALESMEN WILL CALL

RCA INSTITUTES, INC.
A SERVICE OF RADIO CORPORATION OF AMERICA
350 WEST FOURTH STREET, NEW YORK 14, N.Y.



DEPT. RE-8-55

Without obligation on my part, please send me a copy of your booklet on the Home Study Course in Color TV Servicing.

NAME _____

ADDRESS _____

CITY _____ ZONE _____ STATE _____



We're still telling
the
world about

Telechiefs

because Sangamo
Telechief Capacitors
still outperform all
other paper tubulars



What do we mean when we say Sangamo Telechief Capacitors outperform all other molded paper tubulars?

Simply this: When it comes to moisture resistance... optimum operation in high temperatures... when it comes to holding rated capacity under all conditions, the Sangamo Telechief wins hands down.

Tests by major manufacturers and branches of the Armed Services—not our tests—have proven that Telechiefs outlive

all other molded tubular capacitors... that they have a final insulation resistance 10 to 15 times greater than any other paper tubular because they're molded in HUMIDITITE... the remarkable plastic molding compound developed by Sangamo.

HERE IS TRULY EXTRA VALUE AT NO EXTRA COST! Best of all, Telechief, the biggest value in molded paper tubulars, is available to you at the price of an ordinary capacitor.

SC55-9



SANGAMO ELECTRIC COMPANY
MARION, ILLINOIS

new
Tubes & Transistors

6CM7

A medium-mu dual-triode of the nine-pin miniature type, the 6CM7 contains two dissimilar units in one envelope. It is intended especially for use as a vertical deflection oscillator and vertical deflection amplifier in television receivers. Announced by RCA, this tube is designed with a 600-ma heater having a controlled warmup time for use in sets with series-heater strings.

Triode 1 is designed for use as a conventional blocking oscillator in vertical deflection circuits. It has a maximum d.c. plate voltage rating of 500, a maximum average plate current rating of 20 ma and a maximum plate dissipation rating of 1.25 watts.

Triode 2 of the 6CM7 is a high permeance unit designed especially for use as a vertical deflection amplifier. Its structure permits cool operation of the grid, minimizing grid emission. This triode has a maximum d.c. plate voltage rating of 500, a maximum peak positive-pulse plate voltage rating of 2,200 and a maximum plate dissipation rating of 5 watts. These features enable this triode, in suitable circuits, to deflect fully picture tubes having deflection angles up to 90° and operating at second-anode voltages up to 20,000.

Each triode of the 6CM7 has a separate cathode with individual base pins

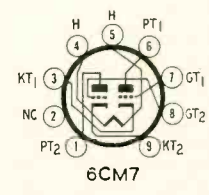

(see base diagram) to permit greater flexibility in circuit connections.

2N77, 2N105

RCA has announced two alloy-junction transistors, the 2N77 and 2N105, of the germanium p-n-p type designed especially for low-power, audio-frequency amplifier service such as in hearing-aid applications. Both units are hermetically sealed. The 2N77 is approximately 1/4 inch in diameter and 3/8 inch in length; the 2N105 approximately 1/8 inch in diameter and 1/4 inch in length. The transistors feature low base-lead resistance to minimize ohmic losses, improve frequency response and insure high input-circuit efficiency.

The 2N77 in a common-emitter circuit has a collector-to-base-connection current-amplification ratio of 55; a matched-impedance, low-frequency

NEW TUBES AND TRANSISTORS (Continued)

power gain of 44 db; a collector-to-emitter alpha frequency cutoff of 700 kc and a low noise factor of 6.5 db average. The collector dissipation, depending on circuit conditions, can be as high as 35 milliwatts. The figure of merit for high-frequency performance is 1.7 mc.

The 2N105 in a common-emitter circuit has a collector-to-base-connection current-amplification ratio of 55; a matched-impedance, low-frequency power gain of 42 db; a collector-to-emitter alpha frequency cutoff of 750 kc; a maximum cutoff collector current of only $-5 \mu\text{amp}$ and an exceptionally low noise factor of 4.5 db average. The collector dissipation, depending on circuit conditions, can be as high as 35 milliwatts. The figure of merit for high-frequency performance is 2.5 mc.

2N109

Another RCA transistor announcement concerns the 2N109, an alloy-junction unit of the p-n-p type designed especially for use in class-B push-pull power output stages of battery-operated portable radio receivers and audio amplifiers operating at power levels of approximately 100 milliwatts.

Intended especially for use in large-signal applications, such as class-B audio service, and as a high-gain class-A driver, the 2N109 permits the design of amplifiers requiring high power sensitivity, low distortion, high power efficiency and low battery drain.

The 2N109 features extreme stability, excellent uniformity of characteristics, low alpha falloff with increase in emitter currents to reduce distortion and a low cutoff collector current to improve circuit efficiency and reduce idling currents. In a common-emitter type circuit, the 2N109 has a large-signal base-connection-to-collector d.c. current amplification ratio (approximately linear to 30 ma) of 70 and a power gain (for two transistors in a

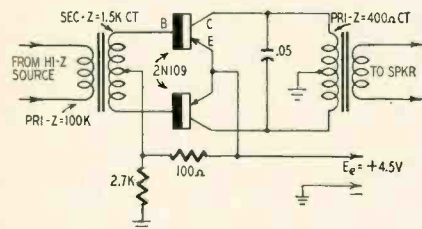

class-B push-pull audio circuit) of 30 db.

The schematic diagram shows a typical class-B push-pull audio amplifier using the 2N109. Typical values for this circuit are as follows: (collector values) d.c. supply voltage, 4.5; peak current (per transistor), -40 ma ; d.c. current (at 75-mw output, per transistor), 13 ma; zero-signal current (per transistor), -2 ma ; load impedance (per collector), 100 ohms; signal-source impedance (per base connection), 375 ohms. The base-connection-to-emitter bias voltage is -0.17 , the power gain 30 db, the useful power output 75 milliwatts. **END**

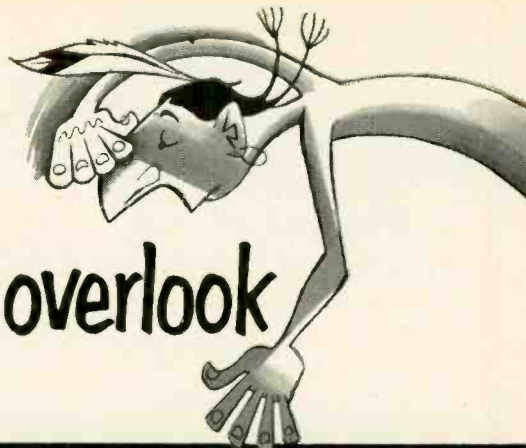

..but don't overlook

SANGAMO REPLACEMENT ELECTROLYTIC CAPACITORS



SANGAMO Type MT "Chieftains." Specially designed for television and other electronic applications where operation at 85°C is required... hermetically sealed in round aluminum containers... small size makes them good for mounting in limited space... they fit anywhere and can be mounted in almost any position.



SANGAMO Type PL "Warrior." These twist-tab electrolytics are used as original equipment by all major manufacturers... they are exact replacements... assure long life and dependable performance at 85°C and under conditions of high surge voltages and extreme ripple currents.



SANGAMO Type CS "Tomahawk." These electrolytic capacitors are contained in wax-filled cardboard tubes with insulated flexible leads approximately 8 inches in length extending from both ends of the unit. Each unit is supplied with a mounting strap to facilitate mounting to the chassis.

SC55-10

SANGAMO ELECTRIC COMPANY
MARION, ILLINOIS





Gigantic SAVINGS on TUBES and Parts!

• Same Day Service • Full Year Guarantee
 • All Tubes Individually Boxed • 400 Types Always In Stock • For Quality, Performance, Dependability.

Type	Price	Type	Price	Type	Price
0Z4M	.65	6AU4GT	.68	7F8	.79
1A2X2	.62	6AU6	.46	7H7	.59
1B3GT	.73	6AU7	.61	7J7	.79
1LA4	.59	6AV5GT	.83	7K7	.69
1LA6	.69	6AV6	.54	7L7	.61
1LC5	.59	6AX4GT	.65	7Q7	.66
1LC6	.79	6AX7	.64	7S7	.71
1LE3	.59	6BA6	.49	7Y4	.69
1LG5	.69	6BC5	.52	12A74	.60
1LH4	.69	6BC7	.82	12AL5	.37
1LNS	.59	6BE6	.51	12A05	.52
1RS	.59	6CG6	1.25	12AT7	.60
1S5	.51	6BH6	.53	12AT7	.72
1U4	.57	6BJ6	.49	12AU6	.46
1U5	.57	6BK5	.80	12AU6	.60
1X2A	.68	6BK7	.80	12AV6	.39
2AF4	.96	6BL7GT	.91	12AV7	.73
3A3	.80	6BN6	.74	12AX4	.67
3AL5	.42	6BQ6GT	.98	12AX7	.63
3AU6	.46	6B07	.90	12B4	.60
3BC5	.54	6BZ7	.90	12BA6	.49
3BN6	.74	6C4	.40	12B6	.51
3CB6	.54	6CB6	.54	12BF6	.54
3Q4	.59	6CD6	1.11	12BH7	.63
3Q5GT	.69	6CF6	.64	12BQ6GT	.99
3S4	.58	6CS6	.51	12BY7	.65
3V4	.58	6HG6T	.41	12BZ7	.65
4BQ7	.90	6J5GT	.48	12CR6	.51
4BZ7	.96	6L6	.64	12L6	.61
5AM8	.75	6K6GT	.45	12SA7GT	.65
5AN8	.78	6L6	.84	12SJ7M	.65
5AT8	.75	6Q7	.45	12SK7GT	.63
5AW4	.59	6S4	.48	12SL7GT	.57
5J6	.64	6SA7GT	.55	12SN7GT	.59
5T4	.79	6SH7GT	.49	12SQ7GT	.56
5T8	.81	6SJ7GT	.50	12SX7	.46
5U4G	.55	6SK7GT	.53	12X4	.38
5U8	.78	6SL7GT	.67	14A7	.63
5V4	.74	6SN7GT	.59	14B2	.63
5V6	.50	6SQ7GT	.46	14R7	.79
5X8	.75	6T4	.99	19AU4	.76
5Y3GT	.37	6T8	.80	19B66	1.39
6AB4	.46	6UB	.78	19T8	.69
6AC7M	.86	6V6GT	.50	25AV5GT	.83
6AD7	.69	6V7GT	.86	6V8	.98
6AF4	.90	6W4GT	.57	25CD6	1.44
6AC5	.56	6W6GT	.57	25L6GT	.51
6AC7M	.69	6X4	.37	35B5	.52
6AM4	.67	6X5GT	.37	35C5	.51
6AM6	.73	6X8	.75	35L6GT	.51
6AK5	.96	7A5	.59	35W4	.47
6AK6	.59	7A6	.69	35V4	.54
6ALS	.42	7A7	.69	35Z3	.59
6AM8	.78	7A8	.68	35Z5GT	.47
6AN4	.95	7AC7	.69	50A5	.55
6AN8	.78	7B7	.49	50B5	.52
6AQ5	.50	7C5	.69	50C5	.51
6AQ6	.46	7C6	.59	50L6GT	.51
6AQ7	.70	7C7	.59	80	.43
6AR5	.45	7E7	.59	11Z23	.45
6AS5	.40	7F7	.59	11Z26	.82
6AS6	1.49				
6AT6	.41				

TERRIFIC VALUE!!

8 TUBE CAR RADIO



Made for Hudson cars. Can be installed in dash or under dash of most cars. Separate P.M. speaker. Automatic push buttons. Tone control. Push-Pull 6AQ5 output.

- In original Factory Cartons.
- Contains 2 6AQ5, 2 6BD6, 1 6BE6, 6C4, 6AV6, 6X4, 6 volt cars.
- Complete with knobs, mounting brackets, condensers, fuse, etc.
- \$85 seller.

\$29⁹⁵

Lots of 3 \$27.95



FULL LINE OF DYNAMIC SPEAKERS

5" to 12" Famous Make 89c each
 Asst. of 10 79c each
 Available 1700 or 2500 ohms.

WRITE Dept. RE-8 for FREE Tube and Parts Catalog Listing Over 400 Tube Types.

Export Inquiries Invited!

TERMS: 25% deposit must accompany all orders—balance COD. All shipments FOB Irvington warehouse.

ORDERS UNDER \$5.00—50c HANDLING CHARGE.

PLEASE: Send full remittance. Allow for postage and save COD charges. Unused money refunded.

Subject to prior sale.

Rad-Tel TUBE CO.

115 COIT ST., IRVINGTON II, N. J.

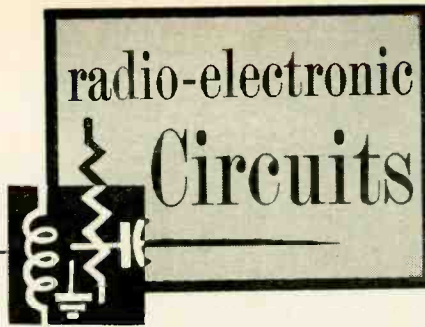

T-R RELAY FOR HAMS

Amateur handbooks and magazines have described a number of different break-in systems designed for instantaneous changeover from transmit to receive operation of high-speed CW stations. Most of these require a separate receiving antenna, a bias supply for blocking the receiver and a high-speed relay for shorting the receiver's antenna terminals while transmitting.

mission line from the receiver's antenna input terminals. V2 and the other relay components are in a shielded box on the rear of the receiver close to the antenna terminal.

The author stated that the system has worked perfectly on a 10-watt rig but some modifications may be needed for rigs running about 50 watts or more. He recommends the following:

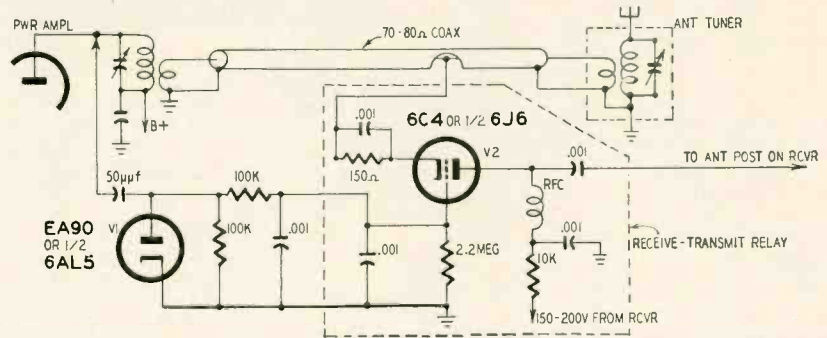

An unusual approach to the problem is described by G3GNY in *The Short Wave Magazine*. The circuit of his T-R (transmit-receive) relay is shown.

The relay consists of a grounded-grid amplifier V2 and a half-wave rectifier V1. The amplifier cathode is connected to a coaxial line between the transmitter output and the antenna tuning unit. V1 is connected to the final amplifier plate to rectify a portion of the r.f. output and develop a high negative bias on the grid of V2.

When the transmitter is off, V2 acts as a low-noise amplifier that develops a signal voltage across the r.f. choke in its plate circuit and applies it to the receiver's antenna terminal. This circuit provides some useful gain on the lower amateur bands. Above about 14 mc the performance of the amplifier and the signal-to-noise and image ratios can be improved by inserting a tuned circuit between the r.f. choke and V2's plate. The 150-ohm cathode resistor provides normal operating bias.

When the transmitter is keyed, V1 rectifies the r.f. signal and cuts off V2. The grounded grid shields the trans-

The 50- μ f capacitor connected to the plate of V1 should have a voltage rating at least four times the d.c. voltage on the final amplifier plate. It should be tapped down on the tank coil if the final plate voltage exceeds about 500.

When operating on 14 mc or above, try r.f. chokes in the heater leads for improved performance.

The lead from the relay chassis to the transmitter must be considerably shorter than a quarter-wavelength at the operating frequency to minimize losses due to mismatch when the transmitter is not operating.

The keying system should completely cut off all stages contained in the transmitter.

(Amateurs wishing to adapt this system to high-power rigs might try eliminating V1 and obtaining blocking bias for V2 from a tap on a grid leak in a buffer, doubler or the final stage. Shield the receiver as completely as possible—treat it like a rig with a bad case of TVI—to prevent r.f. from entering except through the antenna terminals.—Editor)

SIMPLE REFLEX RECEIVER

Designing high-performance receivers with a minimum number of tubes seems to be a hobby of many European experimenters and engineers if the number of reflex receivers described in their publications is a criterion. The reflex receiver shown is an adaptation of one

described in *Radio Bulletin* (Antwerp, Belgium). The original circuit used an EL41 tube, a CG6/E crystal diode and a switch and capacitor arrangement for tuning. The circuit has been modified for American crystal and tube types and to provide continuous tuning.

The antenna is connected to the control grid of the tube through an un-tuned circuit. The incoming r.f. signal is amplified by the pentode and fed to the detector through the primary of a

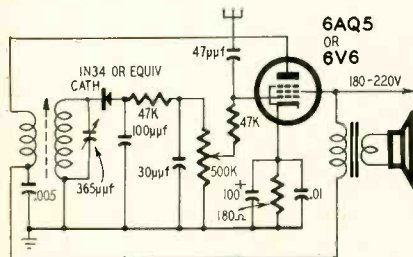

broadcast type r.f. transformer. After detection the a.f. signal is fed to the control grid of the tube and is taken off the screen grid through an output transformer. No specifications being available on the output transformer, we recommend a multimatch type connected for best performance.

PUSH-PULL CASCODE BOOSTER

This push-pull cascode booster is reprinted from *Radio Magazin* (Munich). The circuit uses a pair of PCC84 dual-triode tubes. American low-noise dual triodes such as the 6BK7-A and 6BQ7-A can probably be substituted. At 200 mc the input resistance of a single triode section of a PCC84 is around

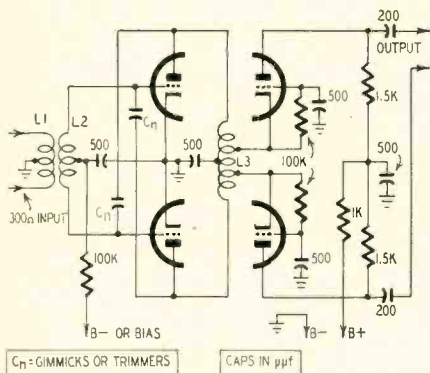

5,000 ohms and is about 10,000 ohms in the push-pull circuit.

Coils are wound with No. 18 silver-plated wire on forms approximately 1/4 inch in diameter. L2 is seven turns center-tapped. L1 is two turns wound over the center of L2 and tapped at the center. L3 is six turns tapped at the center and approximately 3/4 turn from each end. The end taps can best be set with a noise generator or by adjusting for minimum noise and maximum signal. Coils for other frequencies can be wound by the cut-and-try process, using a grid-dip oscillator to check the tuning range.

As in standard cascode arrangements, the plates of the input triodes drive the cathode circuits of the output triodes through L3. The output of the push-pull circuit is taken through the two 200-µf capacitors in the plate circuit. END

Simpson...the most Complete Line of VOM's

Select the one that fits your needs!

MODEL

260
world's most popular!

Over half a million Model 260's have been sold to date! 20,000 Ohms per volt. You'll find it wherever quick, accurate, electrical checks are needed. It's so handy, so dependable, so sensibly priced! Ask your jobber. Price, including Adjust-A-Vue Handle, only ... **\$38.95**

Carrying Cases from **\$6.75**



MODEL **262**

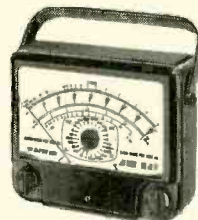

the new VOM with a 7" meter

20,000 Ohms per volt DC and 5,000 Ohms per volt AC sensitivity ... 33 ranges ... compact 7" case with Adjust-A-Vue Handle ... **\$59.50**

Carrying Case ... **\$ 9.95**

MODEL **269**

100,000 Ohms per volt!

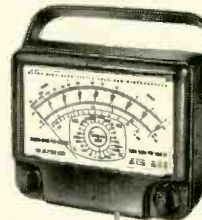

Most sensitive VOM

available! A Volt-Ohm-Microammeter with a big 7" meter in a compact 7" case... 33 ranges... Adjust-A-Vue Handle ... **\$88.00** price complete...

Carrying Case ... **\$ 9.95**

NEW!

- ▶ **MIDGETESTER** Model 355—New shirt-pocket size Volt-Ohmmeter **\$29.95**
- MODEL 240**—Small VOM; 14 ranges; up to 3000 volts AC or DC **\$26.35**
- MODEL 230**—Small VOM; 12 ranges; up to 1000 volts AC or DC **\$24.95**
- ROTO RANGER** Model 221-25 Separate meters at turn of a switch **\$75.00**
- LABORATORY STANDARD**—For instrument calibration. Price on application.

Simpson ELECTRIC COMPANY

World's Largest Manufacturer of Electronic Test Equipment

5203 W. Kinzie St., Chicago 44, Ill. • ESTebrook 9-1121
In Canada: Bach-Simpson, Ltd., London, Ontario



**NEW! THE ONLY
COMPLETE BOOK ON
TELECASTING!**
covers every phase

"Principles & Practices of
**TELECASTING
OPERATIONS"**

by **HAROLD E. ENNES**

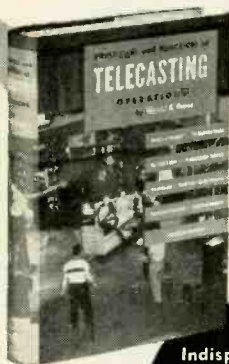

**600 PAGES
OF PRACTICAL
INFORMATION
for everyone
interested in
TELECASTING**

top reference
on Telecasting

Indispensable to the
Engineer, Production Man,
Director, Technician, and
to all Students of
the Video-Audio Art

CONTENTS:

A Partial List of Authoritative Chapters:

Basic Telecasting Equipment; The TV Camera; The TV Control Room; Fundamentals of TV Studio Lighting and Equipment; Network Program Relay Systems; TV Operational and Maintenance Practices; Technical Production of TV Shows; Field Equipment and Microwave Relays; Analysis of Video and Audio Transmitting Plants; Technical Definitions — PLUS HUNDREDS OF OTHER SUBJECTS

Here, in one complete, easy-to-understand volume is the whole fascinating story of Telecasting operations. Whether you are a Chief Engineer, Production Director or Technical Director; if you are now working in or planning to work in TV, or if you are simply interested in Telecasting, this book is *meant* for you. Here is practical, useful information that makes you familiar with the equipment and techniques used in Telecasting, tells you *everything*—answers all your questions about TV production and transmission. If you work or are interested in Telecasting, you'll want this vast wealth of reliable information—you'll want this book in your library. Order your copy today!

600 Pages, 450 Illustrations
6" x 9"
Hard Covers **\$7.95**

**ORDER
TODAY!**

Order from your electronic parts distributor or bookstore, or write direct to Howard W. Sams & Co., Inc. 2205 E. 46th St., Indianapolis 5, Ind.

My (check) (money order) for \$..... enclosed. Send the following:..... copy(ies) of "Telecasting Operations" (\$7.95 per copy).

Name.....

Address.....

City.....State.....

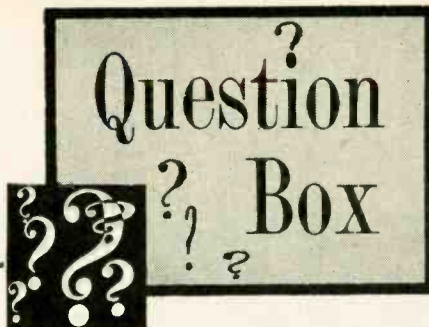

MULTISTATION INTERCOM

Please show how the quick-heating intercom in the Question Box of the November, 1954, issue can be modified to use several remote stations.—A. V. B., Los Angeles, Calif.

Here is a simplified diagram of the intercom as modified for several remotes. The switches on the remote stations are d.p.d.t. pushbuttons or lever or rotary types with a spring-return position. One section connects

the remote, initiating the call to the input of the amplifier at the master station. The other section operates the relay to supply power to the master if it is turned off.

The station selector switch should have one more position than there are remote stations planned for the system. This switch should be returned to **STANDBY** whenever the system is not in use so any one of the remotes can call

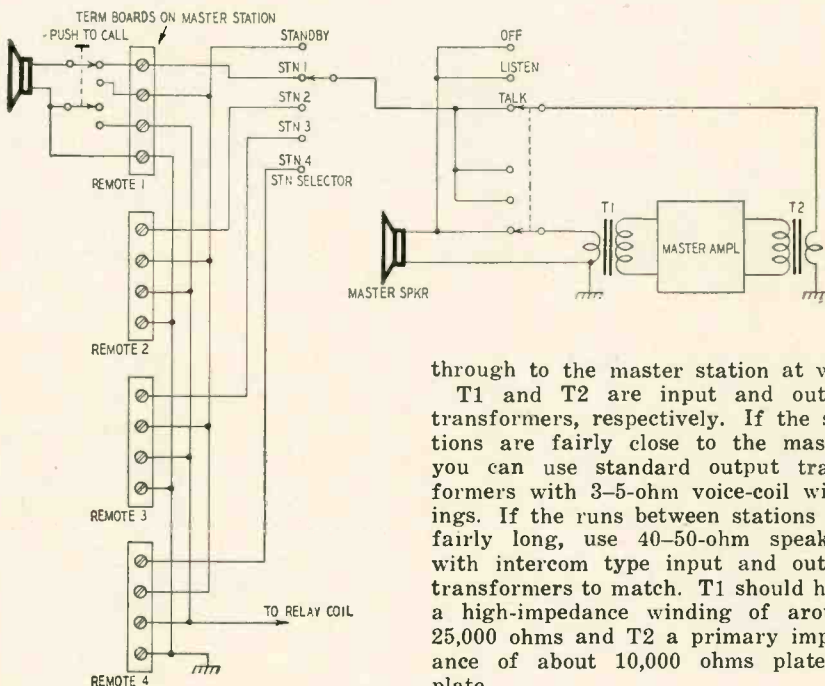

through to the master station at will.

T1 and T2 are input and output transformers, respectively. If the stations are fairly close to the master, you can use standard output transformers with 3-5-ohm voice-coil windings. If the runs between stations are fairly long, use 40-50-ohm speakers with intercom type input and output transformers to match. T1 should have a high-impedance winding of around 25,000 ohms and T2 a primary impedance of about 10,000 ohms plate-to-plate.

HIGH VOLTAGE FOR C-R TUBE

I have noticed that in oscilloscopes the high-voltage supply develops a negative voltage while a positive high-voltage supply is used in TV sets with electrostatically deflected C-R tubes. Why the difference in polarity for different applications?—H. O. M., Bronx, N. Y.

The selection of power-supply polarity for electrostatically deflected tubes is mainly a matter of designer's choice. Each system has its particular advantages and disadvantages. A positive polarity (grounded negative) is used when the cathode is grounded; negative polarity (positive ground) is used when the second anode is at or close to ground potential.

To minimize beam defocusing in a scope or TV set, the deflection plates

should be held at or close to the voltage on the second anode. If a positive supply is used, the second anode and deflection plates may be several thousand volts above ground and special high-voltage coupling capacitors must be used between the deflection amplifiers and deflection plates. If the amplifiers are designed to handle comparatively low frequencies, the coupling capacitors may be as large as 0.25 μ f. High-voltage capacitors above about .006 μ f are expensive, bulky and often difficult to obtain. Direct coupling between amplifier and deflection plates is not practical when the supply has a grounded negative because of the difference in the d.c. voltages on the amplifier and deflection plates. (Of course, this does not apply when the supply is split to

deliver both positive and negative voltages.) A grounded-negative supply in a TV receiver permits the use of direct coupling between the video output tube and the cathode or grid of the C-R tube because it is easy to design a circuit where these elements operate at the same d.c. voltages.

A grounded-positive supply simplifies the design and construction of direct-coupled deflection amplifiers because the deflection plates are easily operated at the same d.c. voltage that appears on the plates of the amplifiers. With resistance coupling this type of supply permits the use of inexpensive low-voltage coupling capacitors.

Unfortunately, a grounded-positive supply places the grid and cathode at the extreme negative end of a voltage divider network. This places a high voltage on the focus and brightness controls and between cathode and

heater. The controls must be well insulated to prevent breakdown to chassis and to minimize shock hazard.

To eliminate heater-to-cathode breakdown, one side of the heater is usually connected to the cathode either directly or through a large resistor. This now places the full high voltage on the heater of the C-R tube so a special transmitting type filament transformer with high-voltage insulation is required for this tube.

An additional disadvantage of the negative supply is that the beam is more susceptible to brightness modulation by stray signal voltages because of the high resistance between grid and ground. This is a disadvantage in scopes that have intensity-modulation circuits. In a TV set, this would prevent the use of direct coupling between the C-R tube grid or cathode and the video output stage.

VARIABLE VOLTAGE SUPPLY

Please print the circuit of a variable-voltage transmitter power supply that will handle up to 400 ma. I want to be able to reduce the voltage on the final stage without using heavy drop-

proper selection of power transformer and thyatron rectifier tubes. The output voltage is adjusted by varying the phase of the a.c. signal applied to the rectifier grids.

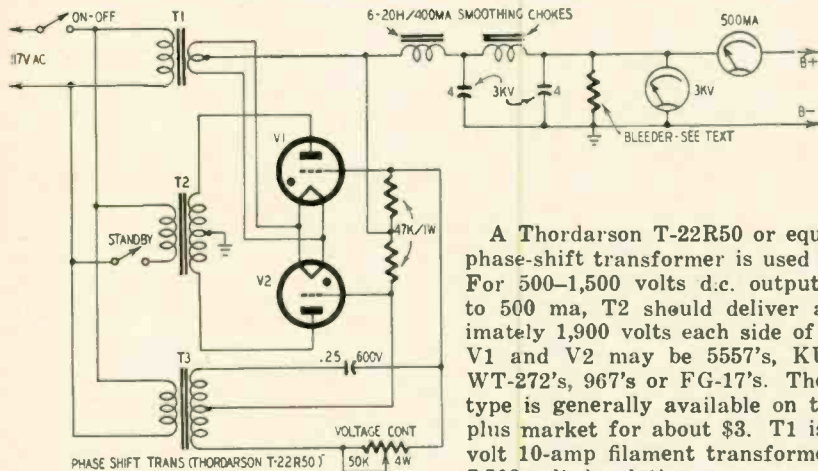

ping resistors or expensive variable-voltage transformers such as a Variac.—L. McC., New York, N. Y.

You have not specified the range desired but we assume that you want at least 1,500 volts. You can use this circuit (from a Thordarson catalog) to supply up to 2,500 volts with the

A Thordarson T-22R50 or equivalent phase-shift transformer is used for T3. For 500-1,500 volts d.c. output at up to 500 ma, T2 should deliver approximately 1,900 volts each side of center. V1 and V2 may be 5557's, KU-627's, WT-272's, 967's or FG-17's. The latter type is generally available on the surplus market for about \$3. T1 is a 2.5-volt 10-amp filament transformer with 7,500-volt insulation.

For 1,500 to 2,500 volts output use a 6,000-volt center-tapped transformer for T2, a 5-volt 15-amp unit for T1 and 873's for V1 and V2. The bleeder resistor should be around 50,000 ohms and 100 watts for the 1,500-volt supply and 75,000 ohms at 200 watts for the 2,500-volt circuit.

TRANSMISSION LINE MATCHING PROBLEMS

I have a 6,500-foot TV transmission line connecting a four-bay all-channel conical to my receiver. The line is No. 12 copper-clad steel wire spaced 6 inches apart for an impedance of 600 ohms. The matching sections at the ends are 82-foot lengths of No. 12 spaced 1 1/2 inches apart. This works well on some channels but not on others. I believe there may be a mismatch between the line and the antenna and receiver. Please tell me the correct lengths for

the matching sections.—W. P. B., Dobbins, Calif.

A transmission-line impedance-matching section is effective only at the frequencies at which it is an odd number of quarter-wavelengths long. There will be a severe mismatch on some channels. You can eliminate the mismatch by using a tapered line section. Space the wires of your present matching section 6 inches apart at the 600-ohm end and 1/2 inch apart at the 300-ohm end.

END



YOU'LL BE "QUICK ON THE DRAW"

with this new TOOL HOLSTER

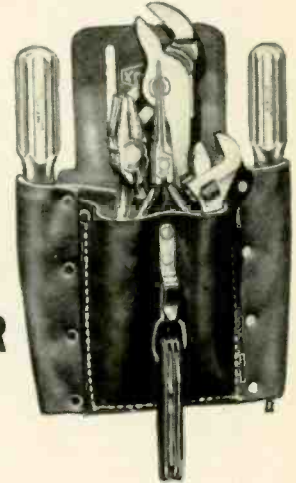

- Safely holds up to 7 tools for quick use wherever you go!
- 5 pliable leather pockets—solid Russet Saddle leather back!
- Knife snap—knife attached or removed in one fast motion
- Stitched with sturdy hot wax thread, locked with steel rivets.

XCELITE No. 150 List \$4.75
(without tools)

Ask your XCELITE supplier about this new holster—and some first-class "weapons" to carry in it!

XCELITE, INCORPORATED
(formerly Park Metalware Co., Inc.)
Dept. J
Orchard Park, New York



YOU OWE IT TO YOURSELF!

If you buy Radio & TV Receiving and Special Purpose Tubes — for replacement — for repair — for PROFIT — you owe it to yourself to send today for our FREE complete listing — top quality tubes — individually boxed — guaranteed for ONE YEAR, at seasonally LOW PRICES!

ELECTRON TUBE CORP OF AMERICA
580 Broadway, New York 12, N. Y., Worth 6-2091

\$3.00 FOR CARTOON IDEAS
RADIO-ELECTRONICS prints several radio cartoons every month. Readers are invited to contribute humorous radio ideas which can be used in cartoon form. It is not necessary that you draw a sketch, unless you wish.
Address
RADIO-CARTOONS, RADIO-ELECTRONICS
25 West Broadway, New York 7, N.Y.

how to use probes for better servicing

This brand new Gernsback Library Book—the biggest we have ever published, tells you how to use probes for better servicing with today's complex test instruments.

PROBES is the most complete book on the subject. Written by a probe manufacturer and a teacher-engineer, it pools their knowledge and the actual experience of service technicians, to tell you how probes are designed, what the various types can or can not do, and when, where and how to use each type. Construction details on building your own, if you so desire. And for the first time in any book, details on a transistorized model.

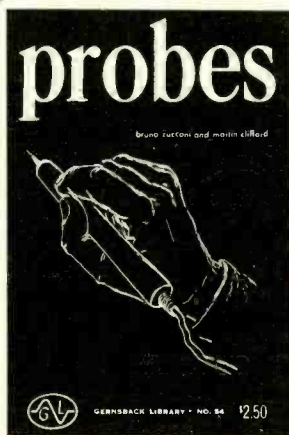

PROBES. By Bruno Zucconi and Martin Clifford. Gernsback Library Book No. 54. 224 Pages. Over 200 illustrations. Paper cover. **\$2.50**

Some of the things you'll learn from this book

Crystal demodulator probes • Classifications and advantages • Working with crystal probes • Signal tracing • Alignment • Testing video amplifiers • Voltage-doubler probes—advantages and limitations

• Peak-to-peak probe • Color TV testing • Balanced probes • TV boosters • Low-capacitance probes • Design and construction of probes • Effect on meter • Isolation and direct calibration • Spe-

cialized probes • Audio tracer • Hum probe • Transistor probe • Chromatic probe • Probe circuits • Vacuum-tube probes • Signal tracer for AM, FM, TV • Television wave-

GET YOUR COPY AT YOUR PARTS DISTRIBUTOR

HARD COVER EDITION NOW AVAILABLE

A limited quantity of PROBES in a deluxe, handsomely bound gold leaf stamped hard-cover edition is now available by mail order only. \$4.00 postpaid. Please use coupon below.

mail this coupon today

GERNSBACK PUBLICATIONS, Inc.
DEPT. 85
25 West Broadway
New York 7, N.Y.

Gentlemen:

- Please send me postpaid a copy of the deluxe, hard-cover edition of PROBES. My remittance of \$4.00 is enclosed.
- Send me full details on how I can save money on technical books with the new Gernsback Library Club Plan.

NAME..... PLEASE PRINT
STREET.....
CITY..... ZONE..... STATE.....



SAVE MONEY ON THIS NEW BOOK CLUB PLAN

Now—a practical, thrifty way for you to get the latest and best books on every phase of servicing—just as they roll off the press! Each book is a big, handsomely bound hard-cover volume which regularly sells for \$4.00 and up. But club members can get them for as little as \$2.98 each—a saving of over 25%! Memberships open now! Keep up with the latest servicing methods and techniques. Take advantage of this unique club plan now. Send in the attached coupon for full details.

Publishers of
RADIO-ELECTRONICS

OPPORTUNITY ADLETS

Rates—45c per word (including name, address and initials). Minimum ad 10 words. Cash must accompany all ads except those placed by accredited agencies. Discount, 10% for 12 consecutive issues. Misleading or objectionable ads not accepted. Copy for Oct. issue must reach us before Aug. 15, 1955.

Radio-Electronics

25 W. Broadway, New York 7, N. Y.

HIGH-FIDELITY SPEAKERS REPAIRED. Amprite Speaker Service, 70 Vesey St., New York 7, N.Y.

BUY SURPLUS radios, receivers & electronic equipment direct from Government. Bulletin \$1.00. Box 1842A, Hartford 1, Conn.

SPEAKER RECONING: Guaranteed workmanship. C&M Recone Co., 255 Tiosa St., Trenton 9, N.J.

GEIGER COUNTER KITS \$34.50. Geiger Counter & Scintillator Diagrams Catalog Free. R. F. Chambers, 13833 San Antonio Dr., Norwalk, Calif.

ALL Types TV tuners serviced within 36 hours. For information write DAN'S TV Laboratory, 2 West 183d St., N.Y. 53, N.Y.

DIAGRAMS FOR REPAIRING RADIOS \$1.00. Television \$2.00. Give Make, Model. Diagram Service. Box 672-RE, Hartford 1, Conn.

FIDELITY UNLIMITED: AUTHORIZED DISTRIBUTORS of HIGH-FIDELITY COMPONENTS. SHIPMENTS PREPAID and INSURED. SPECIALS: NEW COLLARO RC-54 with Mounting Board, 45 spindle, dual Blank Heads, \$38.75. Accessories: RPX-650, dual saphires \$6.50. Diamond and sapphire Stylus, \$10.75. WRITE US YOUR HI-FI REQUIREMENTS. FREE AUDIO GUIDE. COMPLETE STOCK. FIDELITY UNLIMITED, 63-03 39th Ave., WOODSIDE 77, N.Y. Dept. RE.

TUBES—TV, RADIO, TRANSMITTING, AND SPECIAL PURPOSE TYPES BOUGHT, SOLD AND EXCHANGED. Send details to B. N. Gensier W2LN1, 512 Broadway, N.Y. 12, N.Y.

ALL MAKES OF ELECTRICAL INSTRUMENTS AND TESTING equipment repaired. Write for free catalogue on new and used instruments at a savings. Hazelton Instrument Co., 128 Liberty Street, New York, N. Y.

WANTED: AN/APR-4, other "APR", "TS", "IE", "ARC-1", "ARC-3", "ART-13", "BC-348", etc. Microwave Equipment. Everything Surplus. Special tubes. The Manuals. Lab Quality Equipment. Meters. Fast Action. Fair Treatment. Top Dollar! Littell, Fairhills Box 26, Dayton 9, Ohio.

COINT without numbers. Logic Mirror-wise. 4 pages. Send 25c. W. J. Mallory, 616 N. 34th St., Omaha 3, Neb.

MATHEMATICS SERVICE. problems, calculations. Electronics, mathematics. Reasonable rates. Mathematics Service, Box 6671, Orlando, Florida.

SPEAKER RECONING. low prices. Michigan Speaker Reconing Service, 930 Metropolis, Marine City, Michigan.

DIAGRAMS: Professional Model Timers, Counters, Intercoms, Organs, etc. \$1.00 each. List free. Parks, 101 S.E. 57th, Portland 15, Oregon.

RADAR, SONAR, LORAN, etc. by correspondence course. See our ad in School Directory. Progressive Electronics Institute.

POWER TRANSFORMERS REBUILT—all makes, TV-Radio or Special. Red Arrow Radio, 924 Metropolis, Marine City, Michigan.

QUALITY GEIGER COUNTERS at unbelievably low prices. Write for illustrated literature, Dept. 4, Electronics Division, Roberts Manufacturing Co., Cleburne, Tex.

25-50% DISCOUNT, guaranteed. Factory Fresh LP records; 69c and up; pre-recorded tapes. Send 20c for catalogue. SOUTHWEST RECORDS, 4710 Caroline, Houston 4, Texas.

FREE TRANSISTOR Code practice oscillator kit. See our ad in this issue—or write TRANS-AURE ELECTRONICS, INC., 149 Broadway, Dept. R, New York 6, N.Y.

16" III FI ELECTRICAL Transcriptions Catalog 10c. Transcriptions, 166 Barkley, Clifton, N.J.

\$200 WEEKLY CLEANING Venetian Blinds. Free book. Burt, 2434RX, Wichita 13, Kansas.

TV TRADE-IN SETS. Philco, R.C.A., Emerson, others. List available. 10"—\$17, 12" to 17"—\$20 up. Washtek Service Co., Dept. E, 956 Southern Blvd., Bronx, N.Y.

TV FM ANTENNAS. ALL TYPES INCLUDING UHF. Mounts, accessories. Lowest prices. Wholesale Supply Co., Lunenburg 2, Mass.

TAPE RECORDERS, ACCESSORIES, BEST BUYS. Boynton Studio, 10 E. Pennsylvania, Tuckahoe, N.Y.

Technotes



BOOSTER TROUBLES

Failure of the Standard Coil booster to operate on the high v.h.f. channels can usually be corrected by replacing the 6AK5 tube.

The Regency boosters can be souped up by making the following changes: Change the two input capacitors (usually 47 to 56 μf) to a lower value. Make the change on the antenna input end first, with booster and TV set operating. Try values of about 40, 30, 20 and 10 μf for clearest picture. Then do the same on the output end of the booster. I found 10- μf units provide a great increase in gain. This change also applies to the Masco Sky Chief.

On the Turner booster, using a single 12AT7, performance can be considerably improved by replacing the cathode resistor (100 ohms) with a 50-ohm unit. This modification did not result in any increase in noise.—*W. S. Ross*

HORIZONTAL PULL ON 630

When this effect occurs during a closeup along with a white smear down the left side of the picture, the defect is usually due to a bad synchrolock transformer having shorted turns. Replacing this transformer will cure the trouble. In some cases lowering the bias on the 6SK7 sync amplifier will compensate for the defect temporarily.—*Wayne Miller*

TELETONE 282

Insufficient vertical sweep has been traced to an open 1.5-megohm plate resistor. Check the 6SN7-GT vertical output tube for possible low emission.—*Marty Britt*

5Z4 SUBSTITUTION

To improve and prolong receiver performance in sets using a 5Z4 as a low-voltage rectifier, replace this tube with a 5V4-G. A direct substitution can be made and the new tube has a higher current rating.—*Ross Harris*

G-E UHF-101

Failure of this converter has been traced to two causes. The first was defective selenium rectifiers in the power supply circuit. Voltage measurements in this circuit can be tricky and often give false readings. Replacement of both rectifiers cleared up the trouble in several cases.

The second was an increase in value of the resistor in the power supply circuit. It is rated at 3,000 ohms—replace it with a 2,000-ohm unit of higher wattage.—*E. M. Breckenridge*

NEW INVENTION

Eliminates ROOF ANTENNAS

IN METROPOLITAN AREAS

"Rembrandt" Indoor TV Antenna
Guarantees **BEST POSSIBLE PICTURE or YOUR MONEY BACK**

Now — at last — an indoor antenna that outperforms or — at the very least — equals any roof antenna or master antenna system in the metropolitan area!

BASED ON RADAR

Up to ten times more powerful than all other indoor antennas, the "REMBRANDT" is based on a radical, new principle. It couples radar loops with resonant di-poles. This automatically brings in the clearest, sharpest, strongest signal on every channel — both in color and black-white. And in practically all locations the 9 position orientation switch completely eliminates ghosts. But don't take our word for it. The proof is in the picture. Make a side-by-side test of the "REMBRANDT" with any other indoor or outdoor antenna, regardless of cost. Compare its performance in your home, on your set. You and you alone be the judge.

MONEY BACK GUARANTEED



So positive are we of the results, we make you this bonafide money back guarantee: the "REMBRANDT" must give you a better picture than any other antenna. If not, return it to your dealer and get your full purchase price refunded. No questions asked.

Completely
ELIMINATES ALL GHOSTS PRACTICALLY EVERYWHERE
WRITE WIRE PHONE FOR THE NAME OF YOUR NEAREST DISTRIBUTOR
DISTRIBUTOR INQUIRIES INVITED

UP TO
10
TIMES MORE
Powerful
THAN ALL OTHER INDOOR ANTENNAS
EBONY OR MAHAGONY
\$14.95
COMPLETE
GOLD FINISH
\$5.00 EXTRA

Protected under one or more of SIX U.S. PATENTS:
2,585,670; 2,609,530; 2,625,655; 2,644,091; 2,661,423; 2,552,816.

ALL CHANNEL ANTENNA CORP.

47-39 49th STREET, WOODSIDE 77, N. Y.

EXETER 2-1336

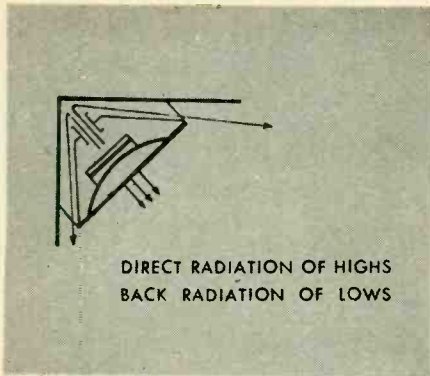

8" or 12" speakers

THE
Rebel* 5

A KLIPSCH CORNER FOLDED HORN OF MINUTE PROPORTIONS!

An amazing 20' high, the Rebel 5 design involves a cavity (capacitance); a slot (inertance) and a corner horn to provide back loading for a direct radiator speaker. The middle and extreme high ranges are preferably reproduced with corresponding horns and the resulting 3-way speaker system can be squeezed into the tiny space.

Reduction in size of speaker structure sacrifices one or more of the following: the maximum wavelength the system can produce; the smoothness of response (reduction of size invariably produces peaks in the bass range); introduction of distortion because of extreme diaphragm excursion if the enclosure is too small (this is usually associated with peaked response). All Rebels necessarily violate these principles. The trick in retaining a high level of quality typical of Rebel design is to coordinate the design of the low-pass filter with the short length of horn exterior to the housing and to introduce an effective cut-off of gradual slope such that the output, instead of becoming highly distorted in the extreme bass range, merely attenuates without presenting frequency doubling and resultant intermodulation of high frequencies.

* Trade Mark

Dimensions: 21" H, 16 5/8" W, 14" D.

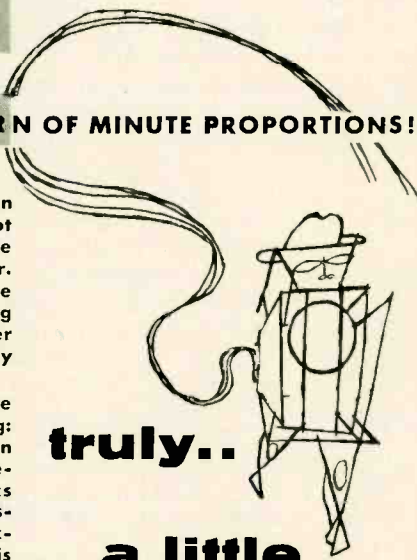

**truly..
a little
monster**

— based upon the same
corner horn principles
as the Klipschorn ■

KR-5-U Utility	KR-5	KR-5-Portable
Unfinished \$33.00	\$48.00	Leatherette \$48.00

all prices slightly higher west and south

■ Paul Klipsch's article "SMALL CORNER HORNS" is an editorial feature of RADIO/ELECTRONICS, July issue. Write for our "R/E reprint".



75 North 11th Street Brooklyn, N. Y.

ADMIRAL 19P1

Intermittent picture and sound or a complete loss of picture and sound, giving symptoms of a short, in most cases have been traced to a defective 6BZ7 cascode r.f. amplifier tube. The tube will usually check perfect in a tube tester, showing no signs of shorted elements.

In cases of no picture or sound, observe the plate of the 6BZ7. If the tube is at fault, one of the plates will usually glow red hot and may become gassy, drawing excessive current. If a tube change doesn't help, check the 800- μ f capacitor connected from pin 7 to ground. Also check the value of all resistors in the circuit. —G. P. Oberto

SENTINEL 400

No picture on this model has been corrected by replacing the 0.1- μ f capacitor (screen bypass) on the 6Y6 high-voltage oscillator. Also replace the 33,000-ohm screen grid resistor and check the tube for possible damage due to component failure.—George R. Anglado.

RASTER DISPLACED TO RIGHT

In a Bendix model 3051 the left-hand side of the picture tube was unlit. This condition could not be eliminated by the centering adjustment. It was established that the unlit section was due to improper centering rather than a smaller-than-normal raster.

The centering action is controlled in part by a selenium rectifier which furnishes a bucking current to move the entire raster to the left. The selenium rectifier had aged and did not supply enough current through the deflection coils to buck the boosted B plus flowing through the yoke coils. Thus, the raster was greatly displaced to the right. The 65-ma unit was replaced with a larger rectifier so that aging would be less severe. (Aging of the original unit may have been hastened by running it too close to the full-load point.) Replacement restored normal centering action. —J. A. McRoberts

C-R TUBE SOCKET REPAIR

I have found in many cases that the filament wires of C-R tubes break or loosen due to heat. In addition, loose sockets or a poor soldering job strain the wires.

This can usually be corrected by using a hacksaw blade with fine teeth. Cut into pins 1 and 12 about 1/8 inch from the tube socket. Slant the picture tube forward and with a hot iron flow solder into the opening made by the saw. In cutting the socket pins, be sure not to cut the wires inside the hollow pins.

This will fix even a broken wire in the picture-tube socket pin as it fills the complete pin with solder. Just putting a hot iron to the socket pin only resolders the lead to the tip of the pin and in many cases fails to do even that. —E. F. Sharp

END

Technicians' News

NATESA CONVENTION

The 1955 summer convention of the National Alliance of Television & Electronic Service Associations is being held Aug. 19-21, at the Morrison Hotel, Chicago. Complete details of the convention had not been worked out at the time of writing, but it is understood that the procedure will in general parallel that of last year, with slight modifications due to the larger number of delegates expected.

L. I. OPENS SERIES

The Long Island (N. Y.) Radio & Television Guild started a series of lectures on servicing black-and-white TV receivers at its May meeting. The series is being handled by Ralph Raynor.

Opening speaker of the evening was Fred Shunaman, managing editor of RADIO-ELECTRONICS, who spoke on "Publicity, the Technician's Greatest Weapon."

Besides the two talks the meeting also discussed latest reports on progress of the distributor shopping program and the encouraging cooperation the guild has been receiving from manufacturers in its campaign to promote ethical selling practices in the distributor field.

UNITY PROPOSED

The Federation of Radio Servicemen's Associations of Pennsylvania (FRSAP) resolved unanimously to support a meeting to explore the possibilities of unity within the electronic service profession. The meeting was proposed for Pittsburgh and would include delegates from NATESA, NETSDA and unaffiliated organizations. The groups not affiliated with the two larger national organizations has been put at about 50 in a recent release from NATESA, though the possibility is that the number is greater rather than smaller.

LANCASTER CARDS

The Northern Lancaster County Electronics Servicemens Association (Pa.) calls our attention to the following errors in a "Technicians News" item in the June issue:

The identification cards were not issued by the association, as stated, but by the George D. Barbey Co., Inc., to whom all credit for the system is due, and who had in fact put it in effect before the association was formed. At the present time, the Barbey Co. is the only distributor that has a suitable card system in effect in the area, according to the association secretary.

NEW NATESA MEMBERS

The National Alliance of Television and Electronic Service Associations announces that seven new groups have affiliated with the organization. They are:

Radio and Television Technicians Guild, Gadsden, Ala.

Associated Radio and TV Service Shops, Borger, Tex.

Long Island Electronic Technicians Association, Inc. (LIETA), Oceanside, N. Y.

Radio-Television Service Association of Western Minnesota.

Middle Tennessee Television Technicians Association, Nashville, Tenn.

Radio and Electronic Technicians Association, New Orleans, La.

Syracuse Television Technicians Association, Syracuse, N. Y. END

Get This Valuable Book

Just for Examining COYNE'S New 5-Volume Set

FREE



Applied Practical Radio-Television



Yes, you get this big, brand new book, "150 Radio-Television Picture Patterns and Diagrams Explained", absolutely FREE! Just off the press! Gives complete 11x22" Schematic Diagrams on leading models Radio and Television Sets. Easy-to-read, large 8½x11" pages, with full instructions on how to read and use the diagrams. A "must" in every Radio and Television service-man's repair kit. You get this valuable book as a FREE Gift for asking to see Coyne's great new 6-book set, "Applied Practical Radio-Television"!

ON 7 DAY FREE TRIAL!

At Last! Money-Making "Know-How" on Transistors, Color TV and Servicing

Coyne's great new 6-volume set gives you all the answers to servicing problems—quickly! For basic "know-how" that is easy to understand, you'll find everything you want in volumes 1 to 5 which contain over 5000 practical facts and data. They cover every step from principles to installing, servicing, trouble-shooting and aligning all types of radio and TV sets. So up-to-date it includes COLOR TV and UHF, adapters, converters. Also covers latest data on TRANSISTORS.

Extra! 900-Page Television Cyclopeda Included

And then, for speedy on-the-job use, you get volume 6—the famous Coyne TELEVISION CYCLOPEDIA. It answers today's television problems on servicing, alignment, installation and others. In easy-to-find ABC order, cross indexed. Use this 6 volume TV-RADIO LIBRARY free for 7 days; get the valuable Servicing Book ABSOLUTELY FREE!

SEND NO MONEY! Just mail coupon for 6-volume set on 7 days free trial. We'll include book of 150 TV-Radio Patterns & Diagrams. If you keep the set, pay \$2 in 7 days and \$2 per month until \$22.50 plus postage is paid. (Cash price \$20.95). Or you can return the library at our expense in 7 days and owe nothing. **YOU BE THE JUDGE.** Either way, the book of TV-Radio Patterns is yours FREE to keep! Offer is limited. Act NOW!

FREE BOOK—FREE TRIAL COUPON!

Educational Book Publishing Division

COYNE ELECTRICAL SCHOOL, Dept. 85-T1
500 S. Paulina St., Chicago 12, Ill.

YES! Send 6-volume "Applied Practical Radio-Television" for 7 days FREE TRIAL per your offer. Include TV-Radio Patterns & Diagram Book FREE.

Name Age

Address

City Zone State

Where Employed

() Check here if you want library sent COD. You pay postman \$20.95 plus COD postage on delivery. 7-day money-back guarantee.

Educational Book Publishing Division
COYNE ELECTRICAL SCHOOL
500 S. Paulina St., Dept. 85-T1, Chicago 12, Ill.

ARKAY LABORATORY TESTED KITS AUGUST SPECIALS

SINGLE CHASSIS HIGH FIDELITY MODEL A-12 AMPLIFIER KIT



This 12 watt amplifier contains pre-amplifier, main amplifier and power supply on one chassis. Flat within ± 1 db from 20 to 20,000 cps. Push-pull output with 5 separate inputs . . . all controls from a master control switch on front panel. Separate controls for bass and treble each offering maximum db boost and cut.

Specifications:

Frequency response— ± 1 db at 20 to 20,000 cps. • Power output—12 watts • Total Harmonic Distortion—1% (@3 db below rated output) • Tone Controls—(Bass @ 30 cps) 15 db boost, 15 db cut . . . (treble @ 15 kc) 15 db boost, 20 db cut • Tubes—6ac7 magnetic phono pre-amplifier and input amplifier; 6SL7 voltage amplifier, tone control amplifier and phase inverter; 6V6 push-pull pentode power amplifier; 5Y3 rectifier • Power Requirements—110 to 125 volts, 50 to 60 cycles

\$22.95

21" TV KIT — ARKAY MODEL 14T21



This 21" television receiver features vertical chassis construction using series string heater type tubes in a push-pull transformerless operation. Contains turret type tuner (completely wired and tested). This kit is an unusual value. Designed for top performance it handles even fringe area reception without difficulty. It is completely tested and is assembled easily. It features the very latest circuit and tubes.

Specifications:

Picture tube—21Y4 • Side controls—on-off switch and volume control, contrast, horizontal hold, vertical hold, channel selector, and fine tuning • Rear controls—Brightness, height, vertical linearity, AM rejection, sound sensitivity, horizontal frequency • Video I.F. carrier—45.75 mc • Sound I.F. carrier—41.25 mc • C.R.T. High voltage—14 KV • Loudspeaker—5" 3.2 ohm @ 400 cycles • Focus—Electrostatic • Deflection—Electromagnetic

\$79.50

ARKAY KIT MODEL AM-FM



This unit, suitable for table, shelf or cabinet mounting in custom home installations, features a grounded amplifier circuit, with low noise FM front end, automatic frequency control. Its unusual performance allows pin point high selectivity tuning with a Foster-Seeley discriminator.

Specifications:

Sensitivity—FM 5uv for 30uv quieting; AM, 25uv • Selectivity—FM 200 kc band with 6bv down; AM, AMC band with 6bv down • Frequency range—FM, at 88 to 108 meg mc; AM, 530 to 1650 kc • Image Rejection—30 db minimum • Distortion—less than 1% at rated output • Frequency response—FM, ± 5 db 20-20,000 cps; AM ± 3 db 20-5,000 cps • Hum level—65 db • Tubes—(2) 12AT7, (1) 6BE6, (2) 6AR6, (1) 6BA6, (1) 6AL5, selenium rectifier.

\$24.95

Arkay Model FM-6, same specifications as above, FM only

\$18.95

OTHER PRODUCTS IN THE ARKAY LINE OF KITS

- Radios • Testing Equipment • Phonographs
- Experimenters Equipment • Battery Chargers
- Audio Amplifiers • Geiger Counters

Visit your local distributor for these wonderful kits and write today for the special FREE Radio Kits, Catalogue and list of dealers. Your copy will be sent by return mail with no obligation. Write to . . .

Radio Kits Inc., Dept. R-8

120 Cedar Street New York, N. Y.

Gentlemen:
Please send your new FREE catalogue to me.
Name _____
Address _____
City _____ Zone _____ State _____

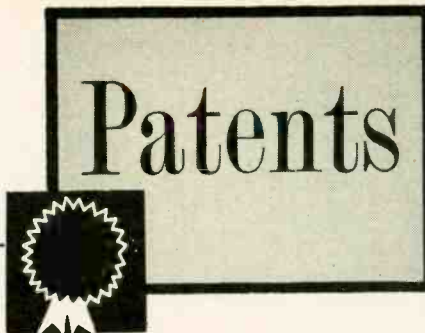

SQUELCH

Patent No. 2,704,324

Samuel L. Broadhead, Jr., Cedar Rapids, Iowa. (Assigned to Collins Radio Co., Cedar Rapids, Iowa)

This squelch circuit disables an audio amplifier either when no signal is tuned in or when the noise-to-signal ratio is too high.

The detected current flows to ground and develops a negative potential at point P. Two components are present here: d.c. proportional to the carrier of the signal, and a.c. representing modulated energy. Noise develops the same cur-

sufficient negative bias voltage to block it.

When a weak signal rides in on a strong noise background, the negative d.c. (at P) is nearly zero due to the weak carrier. Considerable a.c. component (due to noise) passes through C and is rectified by a diode. This d.c. is a positive voltage which passes through filter 2. It overcomes the weak negative voltage

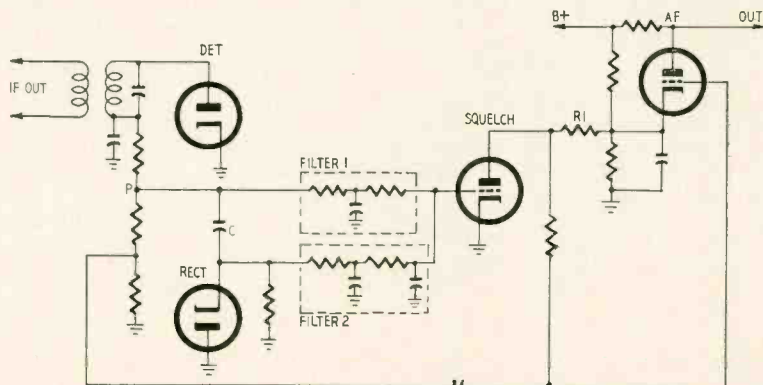

rent as a greatly overmodulated signal. In other words, noise provides much a.c. with little d.c.

Without a signal, the d.c. is zero at point P. The squelch tube is without bias so it conducts heavily. Current through R1—one end of which is connected to the cathode and the other indirectly to the grid of the a.f. tube—generates

through filter 1. Again the squelch tube conducts heavily and the audio channel is silenced.

When the incoming signal is strong enough to be understood, the detector output has a greater d.c. component than a.c. Under this condition the squelch tube is blocked and the audio operates normally.

IMPACT TRANSDUCER

Patent No. 2,691,159

Jerome D. Heibel, Erie, Pa. (Assigned to Erie Resistor Corp., Erie, Pa.)

This piezoelectric device converts mechanical energy to a flash of light. It comprises a barium titanate disc between metallic electrodes (Fig. 1). An edge band, painted with metallic ink or paint, permits charges that might accumulate on the electrodes to leak off. The disc (like other ceramics) has a high dielectric constant and is capable of holding a charge for a long time.

In Fig. 2, with the switch closed, the neon



Fig. 1

lamp flashes each time the transducer is pounded with the hammer.

To prevent damage to the ceramic, heavy metal covers are soldered to the electrodes. Note that

the painted band is shown here as R. Without this component, random shocks might excite the device and store up a voltage. Thus the neon lamp would flash as soon as the switch was

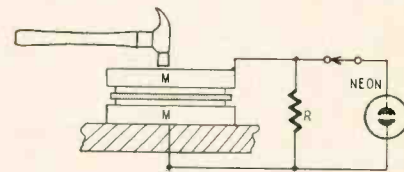

Fig. 2

closed, even though no blow were struck at that instant. Resistor R wipes off all previous voltages.

HURRICANE PLOTTER

Patent No. 2,698,431

Leo S. Bielinski, Mingus, Tex.

To plot the course of a hurricane or typhoon over water, specially equipped planes may follow the storm and take weather data. This is hazardous and costly. Here is an invention which does away with all this. A self-controlled miniature sailboat is launched to ride in "the eye" or center of the storm while transmitting weather data. Weather stations use direction finders to

"fix" the course of the sailboat (and the storm).

Important features of the vessel are shown in the diagram. The boat is dropped by parachute near the storm. As it descends, a captive balloon is released, its cable being a radio antenna. The sail steers and drives the boat. A ventilating tube provides air below decks where a transmitter and storage battery are located.

When the vessel reaches the surface of the water, the transmitter is switched on automatically. Its signal blows up small explosive charges within the parachute cable sleeves to release the parachute. Thereafter, the sail steers

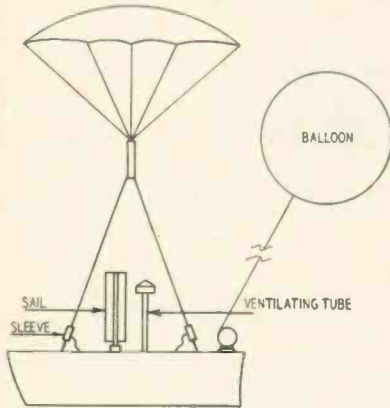

the boat. These storms are accompanied by high winds which whirl counterclockwise. The sail is set to steer the boat slightly to the left, thus driving it toward the storm center.

Vital weather data such as barometric pressure may be transmitted by the sailboat.

RADAR TRAFFIC CONTROL
Patent No. 2,702,342

Nathaniel I. Korman, Merchantsville, N. J. (Assigned to Radio Corp. of America)

This traffic control is especially applicable where traffic is heavy and congested as in subway and municipal transit. Block signals ordinarily keep trains well-spaced regardless of their speed. This radar system takes into account the speed of a train as well as its distance behind another. Naturally slow-moving trains can be safely bunched more closely than those moving at high speeds.

Each train transmits radar pulses along a transmission line placed between the rails. A reflector is carried under each train a quarter-wavelength behind the radar antenna. The reflector does two things: reflects radar energy so that waves are transmitted in the forward direction only; reflects waves from the train behind for maximum echo and minimum interference with other signals.

A radar echo reflected from the train ahead generates a voltage in accordance with the dis-

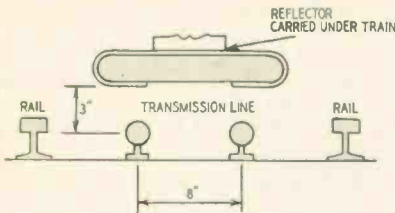

tance between trains. A second voltage is provided by the speedometer and computer. The computer determines (by prearranged design) the minimum safe distance for any given speed. If the radar echo is too strong for that speed, it indicates that the trains are too close for safety. The comparison circuit then operates a relay that may apply brakes automatically or sound a warning whistle. If the radar voltage is well within the critical limit for the given speed, a "go ahead" or "full speed" signal may be indicated for the engineer.

The diagram shows details of a typical radar setup. The transmission line is shown between the rails. The lines are spaced 8 inches. The metal reflector—about 30 inches long—is carried under the train 3 inches above the lines. These dimensions are for a radar frequency of about 100 mc.

The radar control has two important advantages. It speeds service with safety. Weather conditions cannot affect it since the "go" and "stop" signals can be flashed to the engineer right in his cab. **END**

The Sensational

Granco

"Music Hall"
FM TUNER



Model T-160

Compares Favorably With High Priced Tuners!

AMAZING VALUE... **\$34⁹⁵*** in walnut

For those who already have audio and speaker facilities either separately or in a radio, TV or phonograph. High sensitivity, exclusive Granco NO DRIFT coaxial-tuning and built-in antenna. Housed in beautiful plastic cabinet.

TWO MORE SENSATIONAL "Music Hall" VALUES

● The GRANCO FM RADIO-Model 610 in the same compact cabinet has exclusive Granco coaxial-tuning for DRIFT-FREE performance. A real quality radio with superb tone, sensitivity and selectivity. AC-DC. Only \$29.95* in ebony.

● The GRANCO FM-AM RADIO-Model 720 has all the fine FM features of Model 610 plus fine AM reception. Two built-in (AM and FM) antennae. Terrific value. \$39.95* in ebony.

Both available in decorator colors at slightly higher prices.

*Prices slightly higher in West and South.

For name of your nearest dealer, write: **GRANCO PRODUCTS INC.**
36-07 20th Avenue, Long Island City 5, N. Y.

ASK TO SEE IT!

AUDEL'S AUTO MECHANICS GUIDE

Every Mechanic needs AUDEL'S AUTO GUIDE. Saves Time & Money. Highly Endorsed. Covers Whole Subject. 1. Principles. 2. Construction. 3. Ignition. 4. Service. 5. Repairs. Handy Size. Easily Understood. New Fluid Drive. Hydraulic Shift & Diesel Engines fully covered. Over 1700 pages—1540 Illustrations showing Inside Views of Modern Cars, Trucks & Buses with instructions for Service Jobs. Ask to see it on 7 days Free Trial. Mail Order Today. \$4. Complete. If O. K. Pay Only \$1. a Month until paid. **AUDEL, Publishers, 49 W. 23rd St., New York 10, N. Y.**

800 PAGES
500 ILLUS.

HOW TO FIX



- ELECTRIC RANGES
- TOASTERS
- IRONERS
- ROASTERS
- DRYERS
- BROILERS
- VACUUMS
- HEATERS
- WIRING
- MOTORS
- WASHERS
- CASSEROLES
- OIL BURNERS
- PERCOLATORS
- FOOD MIXERS
- REFRIGERATORS
- ALSO MANY OTHER GAS AND ELECTRIC APPLIANCES

A Shop Companion & Ready Reference for Electric & Gas Home Appliance Servicemen, Mechanics & Dealers covers Servicing & Repairs. Tells How to Locate Troubles, How to take Appliances Apart, How to Repair, How to Assemble & Connect. Gives testing methods, wiring diagrams & complete service data. Answers Your Questions. **EASY TO READ**

\$4 COMPLETE - PAY \$1 A MO. TO GET THIS ASSISTANCE FOR YOURSELF SIMPLY FILL IN AND MAIL COUPON TODAY.

.....
AUDEL, Publishers, 49 WEST 23rd ST., New York 10, N. Y.
Mail AUDEL'S HOME APPLIANCE SERVICE GUIDE, (\$4) for free examination. If O.K. I will send you \$1 in 7 days; then remit \$1 monthly until \$4 is paid. Otherwise, I will return book promptly.

Name.....
Address.....
Occupation.....
Employed by.....

LEARN TV

the practical way..

17", 21" and 27"

BUILD the New TRANSVISION TV KIT

ONLY **\$15⁰⁰** gets you started*

*THIS MODEST INVESTMENT gets you started on a most fascinating project — assembling the new "E" type Transvision TV Kit in easy stages. For \$15 you get PACKAGE #1 (standard first package for all new "E" kits). This package gives you the BASIC CHASSIS and required first-stage TV COMPONENTS, with complete instructions. When ready, you order the next stage (pkg. #2), etc.

- PROFIT 3 WAYS:**
- 1 Learn TV
 - 2 Save up to 50%
 - 3 Prepare for COLOR TV

FREE CATALOG

Shows 8 Great TV Kits:
EXCLUSIVE: Only Transvision TV Kits are adaptable to UHF. Ideal for FRINGE AREAS. No Previous Technical Knowledge required. Write now!

NEW ROCHELLE, N. Y.

MAIL THIS COUPON TODAY —
TRANSVISION, INC., NEW ROCHELLE, N. Y. Dept. e-8

I'm enclosing \$_____ deposit. Send standard kit PACKAGE #1, with all Instruction Material. Balance C.O.D.

Send FREE copy of your new TV Kit Catalog.

Name.....
Address.....
City..... State.....

NEW! ATLAS CJ-30 COBRA-JECTOR

INDESTRUCTIBLE FIBER-GLASS
ALL WEATHER
WIDE ANGLE DISPERSION

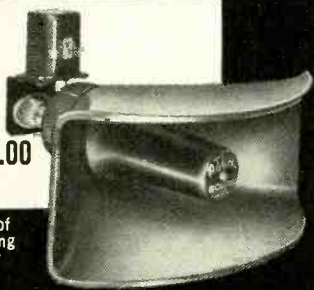

List \$40.00
NET \$24.00

Complete with Driver.

Weatherproof Line Matching Transformer as shown, Net \$5.10.

New versatile all-purpose projector—excellent for paging & talk-back, intercom, marine, and industrial voice & music systems. Penetrating articulation assures wide angle intelligible coverage even under adverse sound conditions. "ALNICC-V-PLUS" magnetic assembly. Double-sealed against all weather. Omni-directional mounting bracket. Quick, easy installation. An amazing "power package"—Specify the CJ-30 for the "tough" jobs!

Input Power (continuous).....15 watts
Input Impedance.....8 ohms
Response250-9000 cps
Dispersion120° x 60°
Dimensions:Opening, 14" x 6"
Overall Length, 14"



WRITE FOR COMPLETE CATALOG
ATLAS SOUND CORP.

1443 — 39 St., Bklyn. 18, N. Y.

In Canada: Atlas Radio Corp., Ltd., Toronto, Ont.

STEEL ANTENNA TOWERS

*need no
GUY WIRES*

Improve radio and TV reception. Easy to erect . . . self-supporting 3 post towers . . . last a lifetime. Built of galvanized steel sections—no guy wires necessary—safe and resistant to high wind.

Available in heights of 33, 47, 60, 73, 87, and 100 feet.

TERRITORIES OPEN FOR
JOBBER - DEALER FRANCHISE

Write for dimensions, structural details, prices, discounts, and available territorial assignments.

AERMOTOR COMPANY

Dept. 7008, 2500 Roosevelt Rd., Chicago 8, Ill.
BUILDERS OF STEEL TOWERS SINCE 1888



PANEL-MOUNTING MICROPHONE

Here is a simple way to mount a small microphone, such as the Turner 81 or the Shure 777 Slim-X, directly on the panel of your transmitter or amplifier. The ball-and-socket joint allows

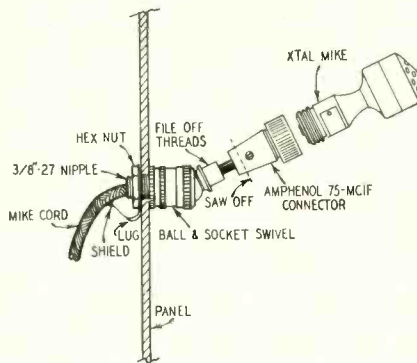

the mike to be adjusted to the desired angle and then locked in that position.

Bore a $\frac{3}{8}$ -inch diameter hole through the panel and mount an electrical ball-and-socket swivel by means of a short

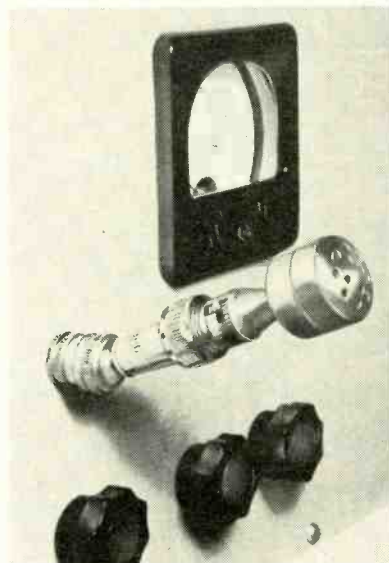

length of $\frac{1}{8}$ -27 nipple and a hexagon nut to fit. File off the $\frac{1}{8}$ -27 male threads on the neck of the swivel, remove the cord-protecting spring from an Amphenol 75-MC1F (or 75-MC1M for some mikes) cable connector, and push the neck of the swivel into the end of the connector, as shown. Run a little solder around the edges to hold the two parts together securely or saw a little off the end of the connector so that its set-screw will contact the neck

EDLIE SUMMER SAVINGS



Automatic GARAGE DOOR OPENER

Just a touch of your finger opens and closes your heavy garage door. Operates by remote control. Modern garage doors are either one-piece tilt-up or sectional roll-up, up to 18 ft. wide. This new, remarkable perma-power garage door opener will operate these doors when equipped with horizontal roller track and a $2\frac{1}{2}$ " ceiling clearance. Motorizes your garage door! Ideal for the woman driver—she no longer has to flog, push and pull heavy garage doors.

Model G101: Complete system incl. motor mechanism, radio transmitter & receiver for 6 v. system, antennas, mounting hardware, wiring & wall switch. Special! Complete.....\$145.90
Model 300A: Motor mechanism only \$ 99.95
Model RC101: Remote control radio only Includes transmitter & receiver 57.50
Model RC101T: Remote control transmitter only 22.90
Adapter cord: Adapts transmitter for 12 v. auto systems 1.79

AMPLIFIER CHASSIS & COVER



\$10. value for \$1.65. Adaptable for the construction of a 10 or 12 Watt amplifier. Chassis & cover is made of #18 gauge steel (about 1/16" thick) and finished in a glossy battleship grey. Chassis has 4 standard socket holes, a $1\frac{1}{2}$ " x $2\frac{3}{4}$ " transformer cutout, plus numerous $\frac{3}{8}$ " diameter holes for component mountings. Front of chassis has control holes. Overall size: $9\frac{5}{8}$ " x $5\frac{1}{4}$ " x 3". Two angle brackets are welded to either end of chassis to which cover ($9\frac{5}{8}$ " x 5 " x 4 ") is attached. Cover Limited Supply \$1.65 as chassis.



Metal Cabinet & Chassis Assembly Special Buy!

Consists of 4 parts, easily to assemble to form a rugged cabinet & chassis for power supply or amplifier, etc. Made of sturdy #20 gauge steel finished in baked black crackle.

Chassis size: 13 " x 7 " x $2\frac{1}{2}$ " with 6 socket holes & numerous $\frac{3}{8}$ " dia. holes for component mounting. Cover (13 " x 7 " x $6\frac{3}{8}$ ") with perforations for air cooling. Front plate: $8\frac{3}{4}$ " x 7 ". Bottom plate: 13 " x 7 ". Over- Now! \$1.85 all size: 13 " x 7 " x $8\frac{3}{4}$ ".



Big Savings 3-Speed AUTOMATIC RECORD CHANGER

Limited quantity! Famous make automatic changer plays all 3 speeds (33 $\frac{1}{3}$, 45 & 78 RPM) and all size records (7", 10" & 12"), intermixes records of same speed. Automatic shut off after last record. 1955 model Reduced \$22.50 to

TERMS: All misc shipped FOB New York City. prices subject to change without notice. Include 20% deposit for COD's.

EDLIE Electronics

154 Greenwich Street
New York 6, New York

DI 9-3143

WRITE TODAY FOR NEW FREE CATALOG!

of the swivel. The mike cable connects to the connector in the usual manner except that the shield on the cable goes to a lug under the hex nut on the rear of the panel. The mike can now be screwed into the 75-MC1F and adjusted to any desired angle. It takes but a few seconds to remove it when you want to use it elsewhere.—*Arthur Trauffer*

SIMPLE CHASSIS

Recently I needed a small chassis for a preamplifier. I had a flat metal plate of about the right size so I could have bent two sides down in a vise or drilled holes and put on angle brackets to give me the depth of a regular chassis. Then it occurred to me that all I need do was to take a pair of gas pliers and bend down the four corners. By doing this I had the chassis ready in a few seconds.—*Herbert H. Lenk*

SHOP KINK

To prevent hammers from slipping from the hands of our service technicians and possibly damaging equipment on the bench or appliances or furniture in the customer's home, we drill a few small holes crosswise through the handle near the end. The holes provide a vacuum-like grip and minimize slippage.—*Harvey Muller*

MINIATURE SOCKETS

Installing or replacing miniature retainer-ring type tube sockets irritates most technicians and constructors. The usual method of using a screwdriver often results in a broken ring or chipped socket.

The job can be simplified by starting the ring with the fingers and then using a 5/8-inch socket from a wrench set or a short length of tubing to apply even pressure all around the ring. A few taps of a mallet lock the tube socket firmly in place.—*Robert E. Riddle*

WINDOW DISPLAYS

Too often the cost of props like manikins, clothes, flowers, etc., to dress our windows for a holiday or seasonal merchandising or service display has deterred us from the sales or service promotion we had in mind. However, we've now arranged with neighboring dealers to loan us the props we need. In return, an 8 x 10-inch card in the window announces: "Clothes courtesy of" etc.

By thus giving the lenders credit, they make extra sales and gain new customers, as when once some male and female manikins were loaned us by a clothing store to make up a window display showing a happy family gathered around a television receiver. The display sold three suits off one manikin's back!

The props enable us to change our windows to represent any sales or service theme and, while they are borrowed, the ways of combining them to deliver our service message are our own!—*Henry Josephs*

END

**OVER 1/2 MILLION
WELLER SOLDERING GUNS**
*have been bought by
radio and TV servicemen*

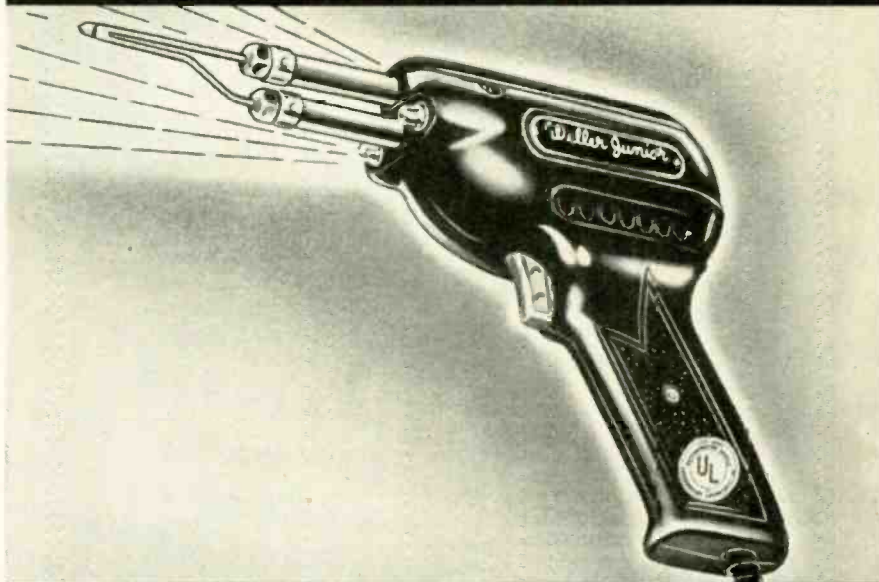

Weller... first to design and patent a soldering gun

Weller... first in performance and features

Weller... first in value — models as low as \$7.95

Weller ask your distributor for a demonstration
ELECTRIC CORP. 822 Packer Street
Easton, Pa.

NEW TV BUSINESS

NO CALLBACKS
HEAVY SALARIES \$100 in
TRUCKS TO KEEP The Mail
Will Bring Complete Booklet
TELECOM, Box 926, Los Gatos, Cal.

**ENJOY 3 COLOR TELEVISION
FILTER SCREEN NOW**
Changes dull eye-straining black and white pictures into beautiful color tones. Seconds to attach. No tools used. Helps eliminate glare and snow in fringe areas. Order direct. Send \$1 for screen size up to 16", \$1.25 size 17", \$1.50 size 20", \$2 size 21", \$2.50 size 24", \$3 size 27". We pay postage except on C.O.D. orders. Satisfaction guaranteed. Inquiries from dealers also welcomed.
Zingc Electronics, Johnstown 13, New York

EASY TO LEARN CODE

It is easy to learn or increase speed with an Instructograph Code Teacher. Affords the quickest and most practical method yet developed. For beginners or advanced students. Available tapes from beginner's alphabet to typical messages on all subjects. Speed range 5 to 40 WPM. Always ready—no QRM.



ENDORSED BY THOUSANDS!
The Instructograph Code Teacher literally takes the place of an operator-instructor and enables anyone to learn and master code without further assistance. Thousands of successful operators have "acquired the code" with the Instructograph System. Write today for convenient rental and purchase plans.

INSTRUCTOGRAPH COMPANY
4701 Sheridan Rd., Dept. RC, Chicago 40, Ill.



REPAIR AUTO RADIOS *quickly, easily with* **STANCOR** EXACT REPLACEMENT AUTO VIBRATOR TRANSFORMERS

You can increase your auto radio repair profits by reducing installation time with STANCOR exact replacement vibrator transformers. Like STANCOR flybacks, STANCOR auto vibrator transformers are faithful duplicates of the originals they are designed to replace.

New STANCOR Auto Radio Transformer Replacement Guide, the most complete ever published. This valuable book lists accurate replacement data for over 540 car radios, built or used by over 40 manufacturers. Both vibrator powers and audio outputs are included. It's available FREE from your CHICAGO STANDARD distributor.

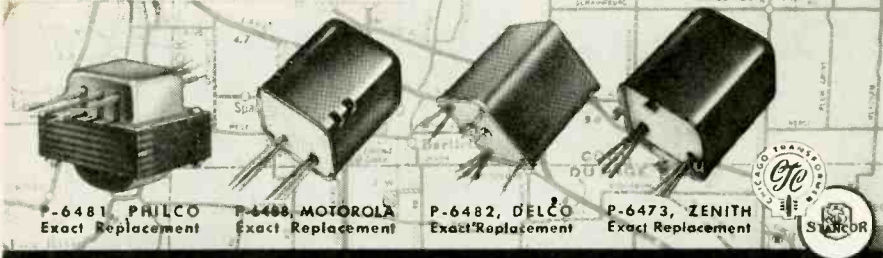

CHICAGO STANDARD TRANSFORMER CORPORATION
3592 ELSTON AVENUE • CHICAGO 18, ILLINOIS
Export Sales: Roburn Agencies, Inc., 431 Greenwich St., New York 13, N.Y.

ELECTRONIC ENGINEERS

Would you prefer to work in NEW YORK CITY?

We have career opportunities for electronic engineers with pulse circuit or digital computer experience.

If you are qualified, phone or write our Personnel Dept. to arrange to discuss salary and working conditions as well as meet our engineers, who will tell you about the work, the plans and the company.

LEWYT MFG. CORP.
60 BROADWAY, BROOKLYN, N.Y.
EVERGREEN 8-9600

USED RECORDING TAPE (PLASTIC BASE)

ATTENTION: Radio Stations, electronic calculators, industrial users: We have the new 1 1/2 or 2 mil mylar "sound-plate" "lifetime" or "P.E." tapes and we will buy or exchange your present 1 mil mylar or plastic tapes.

1.79	for 7" — 1200 foot
.93	for 5" — 600 foot
.53	for 4" — 300 foot
.27	for 3" — 150 foot

★ ★ ★ ★ ★ ★ ★ ★ ★ ★ ★ ★ ★ ★ ★ ★

USED "MYLAR" TAPE (1 Mil)

900 ft. (5" reel)	... 1.69
1800 ft. (7" reel)	... 2.99

New empty plastic reels in boxes for easy labeling. 3" 10c; 4" 22c; 5" 24c; 7" Professional reel (2 1/4" hub) 29c ea. 10 1/2" Aluminum Reel \$2.21. EMPTY BOXES: 3" 3c; 4" 5c; 5" 7c ea.

Send for new Price List. "Tape Recording" magazine and back issues available. Please Include Sufficient Postage

COMMISSIONED ELECTRONICS CO.
2503 Champlain St. N.W. Washington 9, D.C.

People



A. L. Milk
in Washington, D. C.

Arthur L. Milk was elected a vice president of Sylvania Electric Products. He will continue as head of the company's Government Relations Department with headquarters

Gramer Yarbrough was appointed sales manager of American Microphone Co., Pasadena, Calif., which is now a subsidiary of Elgin National Watch Co. Yarbrough has been with American for



G. Yarbrough
the past 26 years.



M. P. Fieldman joined Perma-Power Co., Chicago as a vice president. He was formerly general manager of Hall-dorson Transformer Corp. In his new position, he will launch Perma-Power's sales campaign on its new radio-controlled garage-door opener.

M. P. Fieldman joined Perma-Power Co., Chicago as a vice president. He was formerly general manager of Hall-dorson Transformer Corp. In his new position, he will launch Perma-Power's sales campaign on its new radio-controlled garage-door opener.

Richard P. Axten joined Raytheon Manufacturing Co., Waltham, Mass., as director of public relations. He was formerly with Alexander Smith Inc. Jack



R. P. Axten

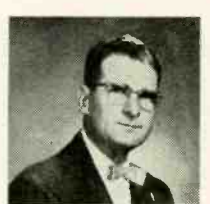

J. L. Hobby

L. Hobby, who joined Raytheon four years ago as staff assistant for public relations, was appointed to the post of manager of publicity and institutional advertising, reporting to Axten.

Personnel Notes
... W. P. Ready joined Wallace's Telematics, Jamaica Plain, Mass., as general sales manager. Formerly general sales manager of National Co., he was more recently a sales representative. END



Merchandising and Promotion
 General Cement Manufacturing Co.,
 Rockford, Ill., introduced a new self-



service power spray product display for its distributors. The rack features 25 products and colors in pressurized spray cans.

Electro-Voice Inc., Buchanan, Mich., is sponsoring a "Weekend with High Fidelity" contest. In a mailing to its distributors, the company explained details of the contest and described the various promotional aids it is making available to support it.

Erie Resister Corp., Erie, Pa., de-

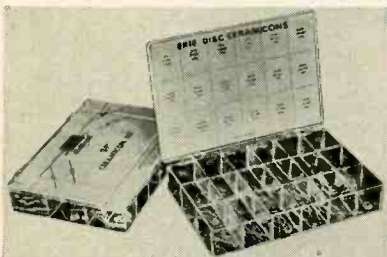

signed two new kits for its disc and GP tubular ceramicons.

Winegard Co., Burlington, Iowa, introduced its new *Pixie* TV antenna line with a "Pixie Buck" promotion for distributors and service technicians. The company also designed a new flyer for its *Interceptor* and *Super-Interceptor* antennas.

Cornell-Dubilier, South Plainfield, N. J., announced a new *Cerami-server*

WIN-TRONIX

Makes Sweep and Sync Circuit Trouble-Shooting Easy! **LOW-COST DYNAMIC SWEEP CIRCUIT ANALYZER**

for
 Black-and-White TV
 and color too!
 only

\$59⁹⁵ dealer net



Model 820

TWO
 INSTRUMENTS
 IN ONE

1. Horizontal and vertical sawtooth-square wave and sync pulse generator.
2. Complete compatible flyback and yoke tester.

ISOLATE SWEEP/SYNC TROUBLES RAPIDLY IN FIVE EASY STEPS!!!

1. VERTICAL TROUBLESHOOTING
 Inject 60 cps on vertical output grid from "vertical grid drive" jack.



2. HORIZONTAL TROUBLESHOOTING
 Inject 15,734 cps on horizontal output grid from "horizontal grid drive" jack.



3. HORIZONTAL TROUBLESHOOTING
 Drive horizontal output xfmr directly from "xfmr drive" jack.



4. COMPONENT TESTING
 Test flyback transformer and deflection yoke in receiver with Model 820.

5. SYNC CIRCUIT TROUBLESHOOTING
 Inject vertical and horizontal sync pulses, stage by stage, in sync amplifiers, with accessory probes.

SPECIFICATIONS

Signal Outputs
 15,734 cps sawtooth and pulse adjustable.
 15,734 square wave adjustable.
 60 cps sawtooth locked to line.
 Overload indicator for safety and test.
 Oscillating neon indicator with D.C. amplifier for flyback/yoke test.
 Calibrated for color and black-and-white.
 Test leads supplied.
 Operates on 105-125 VAC.

OTHER WIN-TRONIX LOW-COST TV TEST INSTRUMENTS— Buy Now for Bl. & Wh. Service—be ready for color!

WHITE DOT—Linearity Generator
 Model 160
\$79.95

RAINBOW GENERATOR
 Model 150
 Patent Pending **\$49.95**

COMPATIBLE FIELD STRENGTH METER
 Model 330
\$129.95

FLYBACK AND YOKE TESTER
 Model 810
\$29.95

• Compatible advanced design prevents obsolescence!
 • Low cost with high quality!
 • Portability!
 • Standard warranty on all instruments!

SEE YOUR PARTS JOBBER!
 WRITE FOR FREE LITERATURE!

COMPATIBLE CRYSTAL CALIBRATOR
 Model 120
\$59.95

WINSTON ELECTRONICS, INC.

RE-855 4312 Main St., Philadelphia 27, Pa.

!! A WHALE OF A BUY !!
"Jumbo Radio-Electronics Parts Kit"



Loaded with inventory odds & ends of new and surplus stocks. TO SAVE YOU \$\$\$... 17 LBS. CHOCK-FULL OF: SWITCHES, CONTROLS, RESISTORS, CONDENSERS, ER. WIRE, PHOTOFACETS, SPEAKER ACCESSORIES, COILS, KNOBS, PLUS DOZENS OF OTHER ITEMS (Shpg. wt. 20 lbs.)

ALL FOR \$3.95

MIDGET CRYSTAL MIKE	Hi-impedance, hi-gain (134 O.D. x 1/4") Rubber shock mtid. Less housing	\$1.29
TV-RADIO BUILDERS LIBRARY	for Students, Servicers, Hams, Schematics & diagrams including Photofacts. Kit of 25 assorted	.98
MOULDED PLASTIC CONDENSERS	50 mini to 2 mfd. 200-600V. 50 asstd	\$1.98 100 asstd 2.98
EXPERIMENTAL TUBES	Filament tested. Kit of 40 asstd. receiving types	1.98
ALNICO MAGNETS	Powerful Bar. Block. "U", Rod, etc. types. Kit of 10 assorted	1.98
WIRE-WOUND RESISTORS	5 to 25 watt. including tapered. Kit of 12 asstd.	.98
ROTARY SELECTOR SWITCHES	including multi-deck & ceramic. Kit of 6 assorted	1.75

Min. Order \$3.00... 20% deposit required. Please add sufficient postage—excess refunded.

LEOTONE RADIO CORP.
 67 Dey Street
 New York 7, N. Y.

TRANSISTOR Personal Portable Radio Kit
BATTERIES LAST 10,000 HOURS
 COMPLETE... Nothing else to buy
 SIMPLIFIED... A child can assemble it
 Screwdriver only tool needed

TRANSISTOR, diode, earphones, batteries, tuning capacitor, antenna, attractive carrying case, etc., included. Complete instructions.

FREE TRANSISTOR code practice oscillator kit with each TRANSISTOR radio only \$9.95—check or money order 10-day Money-Back Guarantee.

TRANS-AIRE ELECTRONICS INC.
 149 Broadway, Dept. R New York 6, N. Y.

LEARN

Television-Radio Electricity

REFRIGERATION-ELECTRONICS

IN THE GREAT SHOPS OF COYNE

TRAIN QUICKLY! OLDEST, BEST EQUIPPED SCHOOL of ITS KIND in U.S.

Come to the Great Shops of Coyne in Chicago. Get practical training in opportunity fields—TELEVISION—RADIO—ELECTRICITY—ELECTRONICS. Prepare now for a better job and a real future.

Approved for Veterans

Finance Plan—Enroll now, pay most of tuition later. If you need part-time work to help out with living expenses we'll help you get it. Advanced education or previous experience not needed.

FREE BOOK Clip coupon for Big Free Illustrated Book. No obligation and No Salesman Will Call. Act NOW.

B. W. Cooke, President

COYNE ELECTRICAL SCHOOL
 A TECHNICAL TRADE INSTITUTE OPERATED NOT FOR PROFIT
 Established 1899
 500 S. Paulina, Chicago

**ELECTRICITY ★ TELEVISION
 RADIO ★ REFRIGERATION ★ ELECTRONICS**

B. W. COOKE, Pres.

COYNE Electrical School
 500 S. Paulina St., Chicago 12, Ill. Dept. C5-81H

Send FREE BOOK and full details on:

TELEVISION-RADIO ELECTRICITY

NAME.....

ADDRESS.....

CITY..... STATE.....

BUSINESS

(Continued)



merchandise cabinet for distributors and dealers. It contains an assortment of 87 types of capacitors.

Channel Master Corp., Ellenville, N. Y., extended its TV Installation Clinic program for technicians to the Hawaiian Islands through the cooperation of its Honolulu distributor, Radio-Wholesale & Supply Co.

International Rectifier Corp., El Segundo, Calif., is marketing its B2M Sun Battery on a display card on which



the battery is mounted in a protective transparent plastic bubble.

RETMA announced the winners in the Radio Listening Contest which it sponsored in cooperation with Boys Life Magazine and the ARRL. Over 450 prizes, including 75 Gernsback Library Books, were awarded by manufacturers in the electronics industry.

University Loudspeakers, Inc., White Plains, N. Y., reports success with its Progressive Speaker Expansion sales plan by which high-fidelity fans may acquire their hi-fi systems in successive steps.

Tele-Matic Industries, Brooklyn, N. Y., developed a new point-of-sale display for its TV service extensions.

Calendar of Events

Electronics and Automatic Production Symposium Aug. 22-23, Sheraton Palace, San Francisco, Calif.

Western Electronics Show and Convention, Aug. 24-26, Civic Auditorium, San Francisco, Calif. (RADIO-ELECTRONICS will exhibit in Booth 1208.)

British National Radio Show, Aug. 24-Sept. 3, Earls Court, London, England.

10th Annual Instrument Conference and Exhibit, Sept. 12-16, Shrine Exposition Hall and Auditorium, Los Angeles, Calif.

RETMA Symposium on Automation, Sept. 26-27, Irvine Auditorium, University of Pennsylvania, Philadelphia, Pa.

High Fidelity Show, Sept. 30-Oct. 2, Palmer House, Chicago. (RADIO-ELECTRONICS will exhibit in Room 746.)

Production and Sales

RETMA reported output of 2,771,426 TV sets for the first four months of 1955 compared with 1,904,718 for the like period in 1954. For the first four months of 1955 4,739,919 radio sets were produced as against 3,326,800 in the 1954 period.

RETMA reported sales of 2,355,740 TV sets and 1,609,182 radios, exclusive of automobile sets, for the first four months of 1955. This compares with 2,145,147 TV sets and 1,487,247 radios for the 1954 period. The association reported the sale of 3,427,805 TV picture tubes and 152,762,273 receiving tubes for the first four months of 1955. Both figures were substantially ahead of the same period last year.

Show Notes

The Audio Engineers Society will hold its 1955 Convention in New York, Oct. 12-15 in conjunction with the Audio Fair which will run Oct. 13-16.

The 1955 Radio Fall Meeting will be held Oct. 17-19 in Syracuse, N. Y., under the sponsorship of RETMA and IRE.

RADIO-ELECTRONICS invites visitors at the Western Electronics Show and Convention in San Francisco, Aug. 24-26, to visit its display in Booth 1208.

An Atomic Exposition will be held Dec. 10-16 in Cleveland.

Astron Corp., East Newark, N. J., has embarked on a new expansion program, according to its president, Otto Paschkes. Financing for the program has already been arranged and the initial step, the addition of 20,000 square feet of new manufacturing space at present quarters, is already under way.

The IRE signed a lease for all four exhibit floors at the New York Coliseum, which is under construction, for its 1956 Radio Engineering Show March 19-22. The committee also arranged for space at the Kingsbridge Armory and Kingsbridge Palace in the event that the Coliseum is not completed in time.

New Plants and Expansions

Technical Appliance Corp. is constructing a fourth addition to its plant in Sherburne, N. Y.

Sylvania Electric Products has arranged to increase by 50% the size of its electronics laboratory under construction at Waltham, Mass. The new building will house the Missile Systems Laboratory and Engineers Laboratories.

RCA opened a new five-building administration and engineering center for RCA consumer products and the RCA Service Co. at Cherry Hill, a suburb of Camden, N. J.

Raytheon Manufacturing Co., Waltham, Mass., will purchase the plant in Lowell, Mass., leased in 1952. END

technical Literature



DRY CELLS

National Bureau of Standards Circular 559 (6th edition) on Specification for Dry Cells and Batteries supersedes Circular 466. Together with information on older types, it gives data on flat cells and new alkaline primary mercury cells and air depolarized cells in miniature size that have been developed as replacements for other types of dry cells used in hearing-aid instruments, etc.

Government Printing Office, Washington 25, D. C., 25 cents.

MILLER CATALOGS

Catalog No. 55A lists Miller all-wave r.f. coils, receiver coil kits, radio interference filters and wave traps, oscillator coils, r.f. chokes, TV components and adjustable coils, etc.

No. 56 is a general catalog listing nearly 1,000 different replacement items. Among them are: miniature r.f. coils, broadcast-band coils, FM-v.h.f. components, etc.

No. 156, TV Technician's Coil Replacement Guide, gives replacement data for adjustable ion traps, video peaking coils, picture and sound i.f. transformers, antenna-matching coils, adjustable linearity and width controls, horizontal oscillator coils, etc.

J. W. Miller Co., 5917 S. Main St., Los Angeles 3, Calif.

Any or all of these catalogs, bulletins, or periodicals are available to you on request direct to the manufacturers, whose addresses are listed at the end of each item. Use your letterhead—do not use postcards. To facilitate identification, mention the issue and page of RADIO-ELECTRONICS on which the item appears.

UNLESS OTHERWISE STATED, ALL ITEMS ARE GRATIS. ALL LITERATURE OFFERS ARE VOID AFTER SIX MONTHS.

HAM EQUIPMENT

A revised edition of the 4-page folder *Headlines for Hams* covers 45 popular RCA amateur type oscillators, amplifiers, frequency multipliers, voltage regulators, thyratrons, rectifiers, oscillograph types for test equipment and camera tubes for use in amateur telecasting. It also contains a tube line-up chart for amateur transmitters; operating conditions for class-C amplifier and oscillator, modulator and frequency-multiplier service; single-sideband tube data and the latest ham ratings on popular receiving-tube types.

Commercial Engineering, Tube Div., Radio Corporation of America, Harrison, N. J., or local RCA tube distributor.

INTRODUCING Stanley's Sensational Coupon Premium Offer!

For every dollar you spend for parts or tubes you'll receive a coupon redeemable for FREE gifts! These gifts include electrical appliances, etc. Use them or sell them over the counter.

SAVE UP TO 90% OFF LIST PRICES ON PARTS and TUBES

PARTS SPECIALS

Picture Tube **BRIGHTENER** \$1.29 ea. **\$1.19** Lots of 3

4" PM SPEAKER With Matching Output Transformer. Alnico 5 magnet. Output transformer matches 50L6, etc. **\$1.57**

21" TV SET TABLE MODEL Reg. \$149.95 **\$115.00**

AC-DC SUPERHET JEWEL 5-TUBE RADIO Terrific buy! Special Stanley price! Reg. list \$14.95 **\$12.95!**

Send for free premium catalogue... but better yet place your order with Stanley NOW. Start collecting these valuable coupons!

Unconditionally Guaranteed! CONDENSERS Molded Tubulars: .001 MFD—600 V 10c ea.

Lots of 10. 8c ea. .01 MFD—600 V 12c ea.

Lots of 10. 10c ea. All sizes available at lowest prices!

70" COSINE YOKES Popular TV deflection yoke. New cosine type for anti-anastigmatic focusing. Complete with leads. **\$2.99** ea. List \$10.30!

CERAMICON KIT Assortment of 50 ceramic condensers. Popular sizes. List price \$10. **\$1.99** Lots of 5 **\$1.89** ea.

TUBE SPECIALS!

TILL SEPT. 1

1A7GT 1T5GT
1U4 3Q4
3S4 6AQ5
6AV6 7E5

50A5

39¢ EACH

Special Purpose Transmitting and Cathode Ray TUBES

TYPE	PRICE	TYPE	PRICE	TYPE	PRICE	TYPE	PRICE
02A	.45	6AL7GT	.70	6SA7GT	.50	12SH7	.47
1B3GT	.75	6AS5	.50	6S7	.50	12SJ7GT	.50
1L1	.55	6AS6	2.00	6S8GT	.43	12SK7	.50
1L6	.60	6AS7G	2.25	6SH7	.45	12SL7GT	.89
1LA4	.66	6AT6	.40	6SI7GT	.45	12SN7GT	.60
1LB1	.66	6AUSGT	.70	6SK7	.50	12SQ7GT	.44
1LC6	.66	6AU6	.46	6SL7GT	.70	14A5	.59
1LD5	.66	6AV5GT	.85	6SN7GT	.60	14A7	.45
1LE3	.66	6AX5GT	.59	6S87GT	.44	14B6	.40
1LG5	.66	6B4G	.80	6V8GT	.48	14Q7	.52
1LH4	.66	6BA6	.49	6W4GT	.40	19BG6G	1.18
1LN5	.49	6BC5	.55	6W6	.60	19J6	.66
1NSGT	.55	6BE6	.50	6W6GT	.56	19T8	.70
1R4	.66	6BG6G	1.18	6X4	.35	25A7GT	1.50
1R5	.67	6BH6	.61	6X5	.39	25AV5GT	.80
1S4	.65	6BJ6	.49	6X3GT	.35	25B6G	.98
1S5	.65	6BK5	.70	6X8	.75	25B6G	.88
1T1	.65	6BK7A	.78	6Y6G	.63	25B6GT	.90
1U5	.50	6BN6	.59	7A4-XXL	.47	25Y5	.45
1V	.57	6BL7GT	.77	7A5	.55	25Z5	.38
1X2A	.79	6BQ6GT	.88	7A6	.47	25Z6GT	.42
2D21	1.00	6BQ7A	.83	7A7	.46	35A5	.48
2V3G	.80	6BZ7	.90	7A8	.46	35A5	.48
2X2A	1.03	6BY5G	.60	7B5	.41	35B5	.52
3D6	.45	6C4	.39	7B7	.43	35C5	.51
3LF4	.80	6C5	.36	7B8	.47	35L6GT	.48
3Q4	.62	6C6	.50	7C4	.40	35W4	.39
3Q5GT	.63	6CB6	.55	7C5	.44	35Y4	.40
3V4	.65	6CD6G	1.18	7C6	.45	35Z3	.41
5T4	.70	6D6	.50	7F8	.70	35Z5GT	.39
5U4G	.49	6E5	.46	7Y4	.35	50B5	.52
5V4G	.71	6F6	.40	12A7	.46	50C5	.51
5Y3GT	.39	6H6GT	.40	12A77	.68	50L6	.48
5Y4G	.43	6J4	2.00	12A6	.46	50L6GT	.45
5Z3	.47	6J5GT	.43	12A7	.60	75	.44
5Z4	.54	6J6	.49	12A6	.46	77	.39
6A7	.59	6J7	.45	12A7	.70	78	.39
6A8	.59	6K7	.40	12A77	.90	80	.35
6A8A	.48	6K6GT	.39	12BA6	.48	83V	.60
6AF4	.80	6L7	.44	12B1	.70	117L7GT	2.00
6A6S	.56	6N7	.61	12BE6	.50	117N7GT	2.00
6AH6	.80	6Q7	.45	12BH7	.70	117P7GT	2.03
6AK5	.80	6S4	.48	12BY7	.68	117Z3	.67
6AL5	.44	6S7G	.47	12SA7	.52	117Z6GT	.65

FREE with each \$25 or more order! S-Pc. Sylvania Repair Kit. Value \$4.95. Includes: flashlight head, Philips screwdriver, flat head screwdriver, alignment tool, polystyrene case.

FREE with EVERY order regardless of size! Combination kit of resistors, condensers, volume control and line cords—retail value \$2.95.

Our tubes come from such surplus sources as govt agencies, receiver mfgs., etc. Most are new, balance from govt and other equipment.

Open Account To Rated Firms

TERMS: 25% deposit required on all orders, balance C.O.D. Orders under \$5.00, \$1 Service charge. Postage paid in USA on all orders accompanied by full remittance. All unused money refunded with order.

SEND FOR PARTS and TUBE LISTING

Dept. RE-8 Gregory 1-2498

Stanley ELECTRONICS CORP.

935 MAIN AVENUE - PASSAIC, N. J.

"There's nothing wrong with you, doctor, that a new JENSEN NEEDLE won't fix up."

Picture Tube Booster Scoop!

95¢

New Life for Old Pic Tubes

Full socket, 6 leads. For electrostatic or electromagnetic parallel circuits. Order Marvelite A-5. (Lots of 6...75c ea.)

Full Range Recording TAPE

Model FR-7 1200 ft. reel Plastic base **\$1.95** Per reel

Reproduces full range sound in flawless fidelity. Top quality, guaranteed. Lots of 6 or more \$1.79 each.

ALNICO V PM SPEAKERS

Your Choice **98¢**

4" square (1 1/2" deep)
5" round (1 3/4" deep)

HAMS!

Mobile Antenna Bargain!

New. Hvy. duty Signal Corps whip antenna. For fixed or mobile use. 82" ext., 12" collapsed. Complete with bracket. **\$195**

Sizzling Summer SPECIALS!

Tub. Electrolytic Condensers

MT-0225 25mfd-25V **33c**
Lots of 10 30c ea.

MT-1520 20mfd-150V **39c**
Lots of 10 35c ea.

MT-1550 50mfd-150V **45c**
Lots of 10 39c ea.

MTD-1520 20-20mfd-150V **55c**
Lots of 10 50c ea.

MTD-301 to 30mfd-150V **59c**
Lots of 10 55c ea.

MT-4508 8mfd-450V **45c**
Lots of 10 39c ea.

MT-4516 16mfd-450V **53c**
Lots of 10 49c ea.

MT-4520 20mfd-450V **55c**
Lots of 10 50c ea.

MT-4530 30mfd-450V **69c**
Lots of 10 63c ea.

Write for FREE FY1 Bulletin 231

WHOLESALE RADIO PARTS CO., Inc.

311 W. Baltimore St. • Baltimore 1, Md.

the
complete
line!



**Cornell-Dubilier
Communication
Vibrators**

Based on
Rigid U. S. Government
Engineering Specifications



These Eight Types Offer Complete
Replacement for ORIGINAL Com-
munications Equipment:

old	new
5515	5715
5518	5718
—	5721
—	5722
5605	5805
5620	5820
5621	5821
5622	5822

NOW... Cornell-Dubilier makes
available to commercial users
of communications equipment a new
line of vibrators based upon the
experience of producing over two
million similar units to the
exacting requirements of U.S.
Signal Corps specifications.



CONSISTENTLY DEPENDABLE
CORNELL-DUBILIER
SOUTH PLAINFIELD, NEW JERSEY

ROTORS · CAPACITORS · VIBRATORS · ANTENNAS · CONVERTERS

TELEVISION

Big demand for graduates

B.S. DEGREE IN 27 MONTHS in Electronic Engineering including Radio and TV—VHF, UHF, AM and FM. Students use over \$100,000 worth of equipment including 2 large commercial type transmitters in new TV lab. Intense specialized course includes strong basis in mathematics, science and advanced design.

Hundreds of young men each year are earning engineering degrees in this recognized institution. Start any quarter. Many earn a major part of expense in this industrial center. Low tuition. Competent instruction. Thorough, intense, practical program. Also **B.S. DEGREE IN 27 MO.** in Aeronautical, Chemical, Civil, Electrical and Mechanical Engineering. G.I. Gov't approved. Enter Sept., Dec., March, June. Free catalog. **ENROLL NOW.**

INDIANA TECHNICAL COLLEGE
1785 E. Washington Blvd., Fort Wayne 2, Indiana



TRANSISTOR RADIO !!!

World's smallest and lowest priced transistor set. Perfect for baseball fans, office workers, children. Polystyrene plastic case smaller than cigarette pack, carry in shirt pocket or purse. Tunes all stations. Operates one month on two pen cells. Plays indoors, outdoors, at beach, on boats. Ideal emergency portable for Civil Defense stations. Assemble quickly. Complete with battery, less earset—\$12.00. Special imported hearing aid earset—\$4.00. Single headphone—\$2.00 Postpaid. Cash, Check or Money Order. Eastern Audio Research, Box 64, Little Neck 63, New York.

Watch for the
September Issue of
RADIO-ELECTRONICS
on Sale August 25

TECHNICAL LITERATURE (Continued)

RETMA BOOKLET

Things You Should Know About the Purchase and Servicing of Television Sets (revised and enlarged third edition) was prepared by RETMA's Service Committee in cooperation with the Radio-Television Committee of the Association of Better Business Bureaus.

It outlines basic information concerning television receivers as an aid to consumers in making a satisfactory purchase and obtaining proper service when necessary. It covers such items as antennas, interference, service and service contracts, and types of service contractors. A section on u.h.f. and v.h.f. TV reception is included for general information.

Single copies from *Radio-Electronics-Television Manufacturers Association*, 777 14th St., N. W., Washington 5, D. C.

ELECTROMAGNETIC COMPONENTS

Electromagnetic components for TV and radio applications are described and illustrated in *Catalog No. 21*. Among the equipment described are ion traps, centering devices, speakers, flybacks, TV focusing magnets, field-neutralizing assemblies, purity rings, blue-beam benders and Barkhausen oscillation eliminators.

Heppner Mfg. Co., Round Lake, Ill.

TV ALIGNMENT EQUIPMENT

Hickok's 8-page booklet on TV alignment equipment contains reprinted articles on the use of the model 691 marker adder, 690 marker generator in TV alignment and conversion of the model 650 video generator to the color-compatible model 650C.

Hickok Electrical Instrument Co., 10531 Dupont Ave., Cleveland 8, Ohio.

CAPACITOR CROSS-INDEX

Form UPX155, a comprehensive twist-prong type capacitor cross-index and price list of recommended replacements for four leading brands, lists 1,000 different types for quick interchangeability, along with stock numbers and approximate prices of Cornell-Dubilier equivalents.

Cornell-Dubilier Electric Corp., S. Plainfield, N. J., or Cornell-Dubilier distributors.

TRANSFORMERS

Triad's *Catalog TR-55* lists 685 items, 79 of which are new to the line, among them: a series of subminiature audio transformers; several additions to the line of high-fidelity output transformers, power components, Geofomers, replacement power audio and dry-disc rectifier transformers and television replacement items covering numerous applications.

TV Replacement Guide TV-155 shows Triad items recommended for replacement in over 5,800 models of television receivers.

Triad Transformer Corp., 4055 Redwood Ave., Venice, Calif. **END**

Books



TRANSISTORS: THEORY AND APPLICATIONS, by Abraham Coblenz and Harry L. Owens. McGraw-Hill Book Co., Inc., 332 W. 42d St., New York, N. Y. 6 x 9 inches, 313 pages. \$6.

A book, in simple language, for the engineer, technician and student, it begins with a glimpse into quantum mechanics, then follows with the characteristics of point contacts and junctions. One large chapter is devoted to the cascading of transistors. All nine possible forms are studied in detail. Equations for in and out impedance, gain and output power are derived. These results are summarized at the end.

Math is limited largely to one chapter, where general circuit equations are derived. This section (and other places where equations are given) may be omitted without much loss to the reader. However, the derivations are given in great detail and by gradual steps, so that anyone with slight knowledge of algebra who wants to get the "know-how" can follow them.

Other points of interest: A chapter on switching circuits, notes on manufacturing techniques of various types of transistors, description of new transistors not yet generally available (including analog, unipolar, coaxial types).—IQ

INTRODUCTION TO PHYSICS, by Frank M. Durbin. Prentice-Hall, Inc., 70 5th Ave., New York, N. Y. 6 x 9 inches, 780 pages. \$9.

This is a very interesting, informative, and modern outline of physics. The first part describes principles and applications of mechanics, heat, sound, electricity and light. The second deals with atomic physics. Well illustrated and easy to understand, each chapter has an introduction, summary and problems (with answers at the end of the book). A few sample problems are also worked out in the text.

Part 2 starts with a description of electrons and tubes. The following chapters describe atomic particles and nuclear reactions, including those of the H-bomb. The treatment is non-mathematical, but important formulas and charts are included.

The author drops into philosophy on page 551. He fears that modern theories have grown so complex that "the human mind may have met its master" and soon only "mental giants" will be able to cope with them. Apparently he overlooks the fact that

NEW IMPROVED



Senco Filament CHECKER

NOW ONLY \$2.75

DEALER NET With Leads \$2.95

MORE VERSATILE LOWER COST

COMpletely NEW

- Automatically checks ALL TUBES including localts and pix tube.
- Continuity and voltage tester—no switches, merely plug in test leads.

Ask your Jobber to see the New Senco Checker.

SERVICE INSTRUMENTS CO. ADDISON, ILLINOIS
"ADDISON INDUSTRIAL DISTRICT"

10 JAZZ CLASSICS \$1

Long-Play (33 $\frac{1}{3}$ RPM) Hi-Fidelity

A Treasury of Jazz

FEATURING
Charlie Parker
Teddy Wilson
Coleman Hawkins
Eddie Condon
Dizzy Gillespie
Jack Teagarden
Pee Wee Russell
Erroll Garner
Sidney Bechet
Art Tatum

And Dozens of Other "Greats"!

Not \$1 each—
But \$1 for All Ten

Now get ALL TEN of these "all-time great" jazz masterpieces for only \$1, no strings attached. Dazzling recorded performances of Jelly Roll Blues, Honeysuckle Rose, Basin Street Blues, Relaxin' at Camarillo plus 6 other famous jazz classics played by the best Bands, soloists and Combos ever assembled.

Hear for yourself the artistry, the amazing high fidelity of Jazztone Society recordings. With the 10 jazz classics you also obtain a valuable Trial Membership in the Jazztone Society with full privileges—and no obligation ever to buy another record unless you wish!

But you must hurry. Mail the coupon with \$1.00 now! Supply of sample Jazz Classics is limited, and offer may soon be withdrawn.

The Jazztone Society, Inc. Dept. REL-8
43 West 61st Street, New York 23, N. Y.

Enclosed is \$1 in full payment for the recordings of 10 jazz classics listed. Enroll me as a trial member. Privileges: No purchase obligation ever! Advance notice of releases. 5 day free trial on any discs. I may reject records before or after receipt, may cancel membership at any time. For future 1 p. full 12" discs I keep, I'll pay only \$2.75 each plus a few cents shipping and excise tax... saving 40% off usual retail price!

Name.....
Address.....
City..... State.....
Canada address: 105 Bond St., Toronto 2, Ont.

6-VOLT BATTERY SOLDERING IRON AND WELDER

U.S. Army release. Brand New—Never Used. Fully Guaranteed. This soldering iron can be used to solder or weld when connected to any six-volt storage battery. Uses approximately 200 to 300 watts. The high intensity arc created between the metal to be soldered and the carbon electrode (carbons supplied free with iron) can be used to heat tin or aluminum solder. Suitable also for light brazing and spot welding. Arc can be used

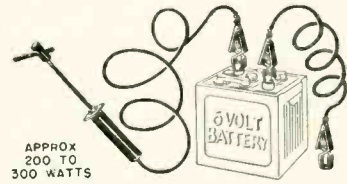

for melting metals, cutting holes and soldering seams in chassis. Also useful for analyzing metals and minerals.

Battery soldering iron outfit includes 2 carbons, 3 heavy duty spring clips, 2 pieces 5 ft. heavy duty wire cable. (Battery not included.) Ideal for use where current is not available.

Ship wt. 4 lbs. **\$1.95**

ITEM NO. 126
UNUSUAL BUY.....(P.P. & Hdg. Chgs. 50c)

VARIABLE SPEED UNIVERSAL MOTOR



FOR 110 VOLTS, A.C. OR D.C. Used, but in excellent condition. Special lever control permits variable speeds up to 3000 r.p.m. 1/4" shaft extends from both sides of motor. Measures 7 1/2 x 3 3/4" diam. overall Shp. Wt. 6 3/4 lbs.

ITEM NO. 127
Your Price..... **\$2.45**
P.P. & Hdg. Chgs. 75c



WATT HOUR METER

Leading makes—reconditioned. Ideal for trailer parks. 100-110 volts, 60 cycles, 2-wire A.C. 5 amp. Heavy metal case 8 1/2" x 6 1/4" x 5". Easy to install. Ship. wt. 14 lbs.

ITEM NO. 33 **\$4.50**
(P.P. & Hdg. Chgs. \$1.25)

AMAZING BLACK LIGHT



250-watt ultra-violet light source. Makes fluorescent articles glow in the dark. Fits any lamp socket. For experimenting, entertaining, unusual lighting effects.

Ship. wt. 2 lbs.

ITEM NO. 87 **\$2.45**
(P.P. & Hdg. Chgs. 35c)



BLAK-RAY SELF-FILTERING ULTRA-VIOLET LAMP

BLAK-RAY 4-watt lamp, model X-4, with U-V tube. Lamp has a wave-length of 3654 to 4000 angstrom units. Some of the substances made to fluoresce are certain woods, oils, minerals, milkstone, cloth, paints, plastics, waxes, drugs, crayons, etc. Self-filtering and harmless.

Equipped with aluminum reflector. 110 volt 50-60 cycle A.C. 2000 to 3000 hours of service. Approved by Underwriters has a built-in transformer.

ITEM NO. 125 **\$16.75**
(Shp. Chgs. 80c)

POWERFUL ALL PURPOSE MOTOR

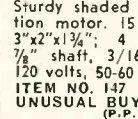

Sturdy shaded pole A.C. induction motor. 15 watts, 3000 rpm. 3" x 2 1/4" x 1 3/4"; 4 mounting studs; 7/8" shaft, 3/16" diameter; 110-120 volts, 50-60 cycles. A.C. only.

ITEM NO. 147
UNUSUAL BUY **\$2.45**
(P.P. & Hdg. Chgs. 35c)

250 POWER TELESCOPE LENS KIT



Make your own high powered 6 ft. telescope! Kit contains 2" diam., 75" focal length, ground and polished objective lens and necessary eye pieces. Magnifies 50x to 250x. Full instructions.

ITEM NO. 123 **\$2.95**
(Shp. Chgs. 10c)

HUDSON SPECIALTIES CO.
25 West Broadway, Dept. RE-85
New York 7, N. Y.

I am enclosing full remittance for items circled below. (Be sure to include shipping charges.)

OR, my deposit of \$..... SHIP balance C.O.D.

MINIMUM C.O.D. ORDER \$5.00.

C.O.D. ORDERS ACCEPTED ONLY WITH 20% DEPOSIT. INCLUDE SHIPPING CHARGES.

87 147 33 152 126 123 125 127

Name.....
Please Print Clearly
Address.....
City..... Zone..... State.....

for function and beauty

TO THE EYE • TO THE EAR

**SHERWOOD
HIGH FIDELITY
S-1000 AMPLIFIER**

outstanding engineering provides: 20 watt ultra-linear output • push-button record equalization • 2729 low noise phono preamplifier • new "center-set" loudness control • rumble and scratch filters • speaker damping selector • tape recording provisions • 5 inputs



with cabinets to fit any decorating scheme. \$99.50 to \$109.50 complete.

Sherwood
ELECTRONIC LABORATORIES

Dept. 8E, 2802 W. CULLOM AVE. • CHICAGO 18, ILL.

**Radio Corporation
of America**

We have prepared a comprehensive analysis of this premier company in the electronics industry.

For copy, address Dept. E

**Carl M. Loeb,
Rhoades & Co.**

Members New York Stock Exchange
42 WALL STREET, NEW YORK 5, N.Y.
Offices and Correspondents in 90 Cities

throughout the ages it has been left for a few mental giants to develop new theories and simplify the old.

It takes time to digest a new theory, but eventually it becomes mere homework for schoolboys. The secret of progress lies in the ability of the human mind to simplify old methods and devise new ones. It is doubtful whether future scientists will need busier brains. Without a question, however, they will need faster computers, special mathematical symbols and processes. As now, it is likely that a few advanced students will understand advanced ideas and tools, and other people will be content merely to apply these principles. There are today many thousands of well-trained radio and TV technicians, but they don't need to understand Maxwell's laws, the basis of radio.—IQ

RADIO TROUBLESHOOTING GUIDEBOOK, Volume I, by John F. Rider and J. Richard Johnson. John F. Rider Publisher, Inc. 480 Canal St., New York 13, N. Y. 156 pages. \$2.40.

Divided into three parts—"Superheterodyne Receivers," "Fundamental Troubleshooting" and "Common Symptoms and Remedies"—the book discusses the theory and circuitry of conventional AM and FM receivers, introduces various troubleshooting methods and then describes causes of and remedies for such symptoms as undesired signals, weak signals, distortion, noise and dead receivers. END

A NEW ANGLE FOR P.A.

WIDE ANGLE DISPERSION



MODEL CIB MODEL CMIL

Never before has such P. A. quality and design been integrated as in the compact construction of the new University Model CIB and Model CMIL. Their unique design provides the user with the limitless benefits of • Wide Angle Dispersion • Uniform Response • High Efficiency • Sensitive Talk-Back. Better Articulation — crisp, clear speech reproduction penetrates the din and clatter of high noise level areas. Greater Economy — Inherent high conversion efficiency cuts down the need for expensive high powered amplifiers. Dependable . . . Weather-Resistant — whatever the P. A. application — whatever the weather, these speakers will meet the necessary technical or physical requirements.

DURABLE CONSTRUCTION

1. Wear-Resistant Bell — one piece mold of extra-thick gauge reinforced fibreglass/polyester resin.
2. Full length steel bead imbedded into the mold at the mouth of the bell.

UNIQUE ADJUSTABLE MOUNTING

3. Exclusive 'Positive-Lok' of specially serrated teeth on each side of bracket secures speaker position.
4. Convenient wing-nut operation permits adjustment for optimum coverage.

University LOUDSPEAKERS Inc.

80 South Kensico Avenue, White Plains, N. Y.



Radio Thirty-Five Years Ago
In Gernsback Publications

**HUGO GERNSBACK
Founder**

Modern Electrics	1908
Wireless Association of America	1908
Electrical Experimenter	1913
Radio News	1919
Science & Invention	1920
Television	1927
Radio-Craft	1929
Short-Wave Craft	1930
Television News	1931

Some of the larger libraries still have copies of ELECTRICAL EXPERIMENTER on file for interested readers.

- In August, 1921, Science and Invention (formerly Electrical Experimenter)**
- Telephone Amplifier Hurls Sound 4 Miles.
 - Building A Buried Treasure Finder, by Victor H. Todd.
 - Freak Phonographs, by H. Johnstone.
 - The Smallest Telephone.
 - Radio On Your Vacation, by J. L. Arthur.
 - Resonance Wave Coil Antennae, by J. O. Mauborgne, Major, S.C., and Guy Hill, Capt., S.C.

CORRECTION

The speaker enclosure in the left-hand column, page 74, of the July Issue was mistakenly called the Rebel V. It is the Rebel III. The Cabinart KR-5 in the center column is a portable version of the Rebel V.

We thank the author, Paul W. Klipsch, for this correction.

RADIO SCHOOL DIRECTORY

SENDING SPEED
CODE RECEIVING



Be a "key" man. Learn how to send and receive messages in code by telegraph and radio. Commerce needs thousands of men for jobs. Good pay, adventure, interesting work. Learn at home quickly through famous Candler System. Quality for Amateur or Commercial License. Write for FREE BOOK.
CANDLER SYSTEM CO.
Dept. 3-J, Box 928, Denver 1, Colo., U.S.A.

RADAR

Our school is now offering a correspondence course in Radar, Microwaves, and Loran. Get your FCC endorsement, high paying job in industry as a radar technician. Priced below expectations. Write

PROGRESSIVE ELECTRONICS INSTITUTE
P.O. Box 543 Akron 9, Ohio

Get Your F.C.C. LICENSE Quickly!

Guaranteed preparation, in a MINIMUM OF TIME, for F.C.C. commercial operator examinations. Our highly specialized training is available by correspondence, or in resident classes in

WASHINGTON, D.C. and HOLLYWOOD, CALIF.

Write for our free booklet with complete details.

GRANTHAM School of Electronics
Dept. 101-P, 737 11th Street N.W., Washington 1, D.C.

RCA INSTITUTES, INC.

A service of Radio Corporation of America
350 West 4th St., New York 14, N. Y.

OFFERS COURSES IN ALL TECHNICAL PHASES OF RADIO, TELEVISION, ELECTRONICS

Approved for Veterans
Write Dept. RE-55 for Catalog

RADIO-TV ELECTRONICS

CREI

CREI graduates in big demand. ECPD-Accredited Technical Institute Curricula. New classes start monthly. Free placement service for grads. Courses: Radio Engineering, Broadcast or TV Engineering; TV, FM, AM Servicing; resident studies leading to "Associate in Applied Science" degree. Write for free catalog. Approved for vets.

CAPITOL RADIO ENGINEERING INSTITUTE
Dept. RE, 3224 — 16th St., N.W., Washington 10, D.C.

GET INTO ELECTRONICS



You can enter this uncrowded, interesting field. Defense expansion, new developments demand trained specialists. Study all phases radio & electronics theory and practice: TV; FM; broadcasting; servicing; aviation, marine, police radio, 18-month course. Graduates in demand by major companies. H.S. or equivalent required. Begin Jan., March, June, Sept. Campus life. Write for catalog.

VALPARAISO TECHNICAL INSTITUTE
Dept. C Valparaiso, Ind.

MORE JOBS than graduates

Demand for our engineering graduates exceeds supply. Effective placement service. Study in this world-famed college established 1884. Quarters start September, January, March, June. Approved for Veterans.

Bach. Sc. degree in 27 months

Complete Radio Eng. course includes TV, UHF and FM. Also Mech., Civil, Elec., Chem., Aero. and Adm. Eng.; Bus. Adm., Acct. Small classes. Well-equipped labs. Modest costs. Prep. courses. Write **Jean McCarthy, Director of Admissions, for Catalog, View Book and "Your Career" Book.**

TRI-STATE COLLEGE
2485 College Avenue, Angola, Indiana

RADIO ENGINEERING DEGREE IN 27 MONTHS

Intensive, specialized course including strong basis in mathematics and electrical engineering, advanced radio theory and design, television. Modern lab. Low tuition. Self-help opportunities. Also B.S. degree in 27 months in Aeronautical, Chemical, Civil, Electrical, and Mechanical Engineering. G.I. Gov't approved. Enter September, December, March, June. Catalog.

INDIANA TECHNICAL COLLEGE
1585 E. Washington Blvd., Fort Wayne 2, Indiana

TV REPAIRMEN EARN TOP MONEY!



IN JUST 12 MONTHS, COMPLETE TV SERVICE TRAINING, INCLUDING COLOR TV. Streamlined course gives you all essentials for a good job as service technician. Graduates in great demand; jobs are plentiful in this growing field. Other electronic courses in radio operation and maintenance. Day or evening classes. Opportunity for employment in local industry. Approved for Korean veterans.

Write for Catalog 111 Today

INDIANAPOLIS ELECTRONIC SCHOOL
312 E. Washington, Indianapolis 4, Ind.

TELEVISION PREPARE FOR A GOOD JOB!

BROADCAST ENGINEER
ELECTRONICS
RADIO SERVICING

Television Servicing

(Approved for Veterans)
SEND FOR FREE LITERATURE
BALTIMORE TECHNICAL INSTITUTE
1425 EUTAW PLACE, BALTIMORE 17, MD.

EARN MORE MONEY— BE A PROFESSIONAL TELEVISION SERVICE TECHNICIAN



GET DOWN-TO-EARTH PRACTICAL TV TRAINING WITH WTI EXPERTS FOR THE TOP PAYING \$5,000-\$10,000 PER YEAR JOBS.

UHF—COLOR—VHF

Master the latest, up-to-the-minute TV and Color TV developments QUICKLY.

SEND FOR FREE BOOK TODAY!

WESTERN TV offers real experience on live equipment in our BIG SHOPS AND LABORATORIES in the shortest practical time under expert instructors. Graduates are in big demand because they have the "field experience" necessary for immediate "bench" or supervisory positions. You learn every phase of Radio and TV servicing (AM, FM, VHF, UHF). WTI men win fast promotion... can demand better pay... develop highly profitable businesses of their own with the latest and most PRACTICAL PERSONALIZED TRAINING BEHIND THEM. You concentrate all your time on being a PROFESSIONAL TV SERVICE TECHNICIAN — non-essential math and engineering theory omitted. YOU CAN EARN WHILE YOU LEARN. Special Finance Plan.

APPROVED FOR VETERANS. Find out how you can get into the TOP PAY GROUP — Send for this fact-packed book NOW!

WESTERN TELEVISION INSTITUTE

America's Leading Television Servicing School

NAME _____ AGE _____
ADDRESS _____
CITY _____ ZONE _____ STATE _____

Western Television Institute Dept. E-8-55
341 W. 18th St., Los Angeles 15, Calif.
Without obligation, please send FREE fully illustrated booklet. (No salesman will call.)

Become an ELECTRICAL ENGINEER

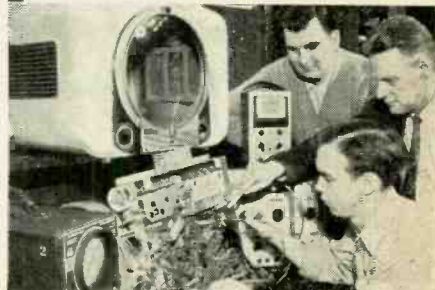

Major in Electronics or Power BS Degree in 36 months

Prepare now for a career as an electrical engineer or engineering technician — and take advantage of the many opportunities in these expanding fields.

You can save a year by optional year round study. Previous military, academic, or practical training may be evaluated for advanced credit.

Enter Radio and Television — courses 12 to 18 months

You can be a radio technician in 12 months. In an additional 6-months you can become a radio-television technician with Associate in Applied Science degree. Color television instruction is included in this program.

These technician courses may form the first third of the program leading to a degree in Electrical Engineering. Twenty-one subjects in electronics, electronic engineering and electronic design are included in these courses. Courses also offered: radio-television service (12 mos.); electrical service (6 mos.); general preparatory (3 mos.).

Terms — September, January, April, July

Faculty of specialists. 50,000 former students—annual enrollment from 48 states, 23 foreign countries. Non-profit institution. 52nd year. Courses approved for veterans. Residence courses only.

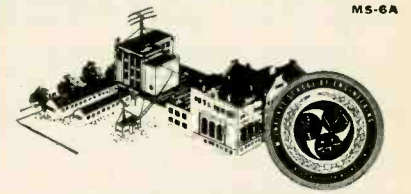

MILWAUKEE SCHOOL OF ENGINEERING

MILWAUKEE SCHOOL OF ENGINEERING
Dept. RE-855, 1025 N. Milwaukee Street
Milwaukee 1, Wisconsin
Send FREE illustrated booklets
 Career in Electrical Engineering,
 Career in Radio-Television.

I am interested in _____ (name of course)

Name _____ Age _____

Address _____

City _____ Zone _____ State _____

If veteran, indicate date of discharge _____

NOW COYNE TRAINS YOU IN SPARETIME AT HOME TELEVISION RADIO-ELECTRONICS

Only from famous COYNE do you get this modern up-to-the minute TV Home Training. Easy to follow instructions—fully illustrated with 2150 photos and diagrams. Not an old Radio Course with Television tacked on. Includes *UHF* and *COLOR TV*. Personal guidance by Coyne Staff. *Practical Job Guides* to help you EARN MONEY QUICKLY IN A TV-RADIO SALES AND SERVICE BUSINESS—part time or full time. COSTS MUCH LESS—pay only for training—no costly "put together kits".

SEND COUPON FOR FREE BOOK
 SEND COUPON BELOW for Free Book and full details including EASY PAYMENT PLAN. NO COST OR OBLIGATION—NO SALESMAN WILL CALL.



B. W. COOKE, Pres. **COYNE ELECTRICAL SCHOOL** FOUNDED 1899

A TECHNICAL TRADE INSTITUTE OPERATED NOT FOR PROFIT
 500 S. Paulina Dept. C5-HT4 Chicago 12, Illinois

COYNE ELECTRICAL SCHOOL
 Television Home Training Div.
 500 S. Paulina St., Chicago 12, Ill., Dept. C5-HT4

Send FREE BOOK and details of your Television Home Training offer.

Name _____
 Address _____
 City _____ State _____

TV TUNER REPAIRS
48-HOUR SERVICE
 Defective tuners rebuilt to factory standards. New tuner guarantee. Ship prepaid.

RADIO PRODUCTS CO.
 College Point 56 New York

We carry a full stock of Replacement Tuners for all makes of T.V.

STAN-BURN ED-ARKE

CATHODE RAY TUBE SPECIALS

ONE YEAR GUARANTEE

G.E.		STAN-BURN	
10BP4A	\$14.95	10BP4	\$10.20
10FP4A	21.10	12LP4	11.90
12KP4A	24.45	12LP4A	13.95
12LP4A	18.75	12QP4	11.90
12QP4A/B1014		12JP4	11.90
Dumont	25.10	12UP4A	14.50
12UP4B	34.25	14CP4	15.60
14CP4	22.50	15DP4	17.50
15DP4/B1014		16KP4	17.50
Dumont	26.75	16DP4 or A	17.50
16AP4A	34.25	16JP4 or A	17.50
16DP4A (N.U.)	25.25	16CP4 or A	17.50
16GP4 A or B	33.25	16FP4	17.50
16KP4/16RP4	24.20	16WP4	17.50
16KP4A (Aluminum)	28.35	16FP4	17.50
16JP4A (N.U.)	27.95	16AP4A	23.00
16LP4A	28.50	16EP4	19.00
16WP4A	27.50	16EP4A	23.50
16GP4B	33.95	16GP4 or A	21.00
17BP4A	27.50	17BP4	18.50
17BP4B	29.75	17CP4A	21.60
17CP4	29.95	17GP4B	22.60
17CP4B		19FP4	23.00
(Aluminum)	38.50	19FP4A	24.00
19AP4A	39.75	19AP4	23.90
20CP4	30.00	19AP4A	24.90
20LP4	37.50	20CP4	23.95
21AP4	39.75	21EP4	25.50
21EP4	31.80	21AP4	26.50
21EP4A	36.35	24AP4	49.00
24AP4A	89.75		

Prices Subject to Change Without Notice

AUTHORIZED DISTRIBUTORS for General Electric, Kenrad, Tunn-Sol, Hallicrafters, De Wald, Techni-master, Automatic and General Motors.

Only the 5 Top-Quality Brands of

STANDARD BRAND TUBES

AT SENSIBLE PRICES

Remember! Our Factory-Fresh TV Tube Stocks Do Not Require So-called Meter Testing.

- Individually boxed. • Only 1st quality.
- Latest Dating • Standard RTMA Guarantee
- No private label, electrical or mechanical rejects.
- No rebrands or rewashed "bargains."

FREE! Newest Handy-Order Form Lists Newest String-Series Types, etc. Newest Carbon Snap-Out Tube. Handy-Order Form, Lists, etc.

- Lists ALL Popular TV & Radio Types.
- Makes Mail-Order a Pleasure.
- All Tube Orders Over \$25.00 (with Remittance) Postpaid. Overnight Shipment.

SNOOPSCOPE TUBE . . . Supersensitive; converts invisible infra-red rays into a bright image . . . Seen in total darkness.

- Type CRI 143 or 147...Special. each **\$4.98**
- Infra-red filter for extremely sharp images each **\$1.02**
- HV-converter Kit—write for details . . . for snoopscopes, GM Kits, etc.

• **DIRECTION SELENIUM RECTIFIERS.** In stock and to order—48 hr. delivery . . . Write for catalog.

SPECIAL-PURPOSE TUBES

Write for our complete listing on XMTG, Industrial, Special-Purpose and Crystal Diodes. We stock over 2,000 types at excellent prices. Specialists in 5000/6000 Series.

TWO-COLORED TUBE CARTONS. with new Safety Partitions. Prevents Tube Breakage. This Super-Gloss Red and Black Carton is the Most Distinctive Box Available Today! Minimum: 100 any one size. Quantity prices on request. Boxes F.O.B., N.Y., N.Y.

SIZE EACH

Miniature. . . (6AU6, 6AL5, etc.) . . . \$1.01

GT. (6SN7, 6X4, etc.) . . . 1.95

LARGE GT. (1B3, 6BQ6GT, etc.)015

LARGE G. (5U4G, 6B6GG, etc.)02

NEW! Same tube cartons as above, but in glossy white . . . no printing . . . Same prices apply. Specify white.

BARRY ELECTRONICS CORP.
 512 Broadway N.Y. 12, N.Y.
 Phone: Walker 5-7000

NEW RCA SURPLUS
TV CAMERA only \$197.50

Labs, technicians, industries, hobbyists, medical—set up your own telecast system! It's a "mechanical eye" for factories, swim pools, penal and mental institutions, closed circuit TV—hundreds of other uses! Send for full details today!

Ask For New Free Catalogue!
HARJO SALES CO., Dept. RE-8
 503 N. Victory Blvd. Burbank, Calif.

PORTABLE RADIOS

JEWEL—Battery only. . . \$12.99 net
 Case for same. . . 1.50
 Batteries. . . 1.95

CABANA 3 way portable, 5 tube. . . \$16.75
 Batteries. . . 2.50

JEWEL 5 tube Super Het—Red, Ivory, Walnut and Ebony. . . 12.50
 with Clock—5 tube AC-DC Walnut. . . \$15.45

RECORD PLAYERS

Manual 3 speed record player—single needle. . . \$14.50
 Manual 3 speed with flip-over cartridge. . . \$16.95
 Automatic 3 speed with VM changer. . . \$37.50

PENTRON TAPE RECORDERS

Model CT7 . . . \$81.50
 Model TR4 . . . 119.00
 Model HT25 . . . 140.00
 (catalogs on request)

'55 FORD, PLYMOUTH, CHEV. Automatic Radio Manual. . . \$41.97
 Push Button. . . 45.47

630 ANNLEY 29 tube Chassis. . . \$115.00

TURNER AU phono cartridge—Universal replacement. . . \$1.59 ea. @ \$1.49 ea.

VM CHANGER—with tonette flip-over cartridge. BRAND NEW—Hi-Fi original cartons. . . \$21.49

We invite export inquiries and offers. Our export department will give special attention to expediting foreign orders at minimum commissions. We are authorized distributors for United Motors, all Delco and Gen. Motors Auto Radio parts in stock.

We also carry a complete line of popular makes of Radio Tubes at 50/10 discount. Also many other special purpose and transmitting types, and all electronic parts and equipment at lowest prices. Send us a list of your requirements for prompt quotations. Terms: 20% with order. Balance C.O.D. All prices F.O.B. NEW YORK Warehouse. Minimum order \$5.00. Write for our latest price list and Hi-Fi catalog to Dept. RE-8.

STAN-BURN RADIO and ELECTRONICS CO.
 1697 BROADWAY • NEW YORK 19, N.Y.

ADVERTISING INDEX

Radio-Electronics does not assume responsibility for any errors appearing in the index below.

Aeromotor Co.	114
All Channel Antenna Corp.	109
Allied Radio Corp.	17
American Electrical Heater Co.	14
American Phenolic Corp.	98
Arkay Radio Kits, Inc.	112
Astron Corp.	24
Atlas Sound Corp.	114
Audel Publishers	113
Barry Electronics	124
Belden Manufacturing Co.	93
Bell Telephone Labs.	22
Book-of-the-Month Club, Inc.	13
Brooks Radio & TV Corp.	97
CBS-Hytron	75
Cabinart	110
Cannon Electric Co.	87
Capitol Radio Engineering Institute	29
Channel Master Corp.	21
Chicago Standard Transformer Co.	116
Clear Beam Antenna Corp.	83
Cleveland Institute of Radio Electronics	11
Collins Audio Products	76
Commissioned Electronics	116
Cornell-Dubilier Electric Corp.	120
Coyne Electrical School	111, 118, 124
DeVry Technical Institute	7
Eastern Audio Research	120
Edlie Electronics	114
Electro-Voice, Inc.	Inside Back Cover
Electron Tube Corp. of America	107
Electronic Instrument Co. (EICO)	30
General Cement Manufacturing Co.	26
General Industries Co.	16
Granco Products	113
Harjo Sales Co.	124
Heath Co.	63-67
Hudson Specialties Co.	121
Hughes Research & Development Labs.	18
Hycon Manufacturing Co.	20
Indiana Technical College	120
Instructograph Co.	115
Jensen Industries	119
Jazztone Society, Inc.	121
Lafayette Radio	125
Leotone Radio Corp.	118
Levy Manufacturing Corp.	116
Loeb, Rhoades & Co.	122
Major Brand Tube Co.	100
Mallory, P. R. & Co.	73
Mess Electronics Distributing Co.	77, 78
Music Treasures of the World	9
National Radio Institute	3, 15
National Schools	5
Opportunity Adlets	108
Philco Corporation	84, 85
Precision Technics Co., Inc.	126
Progressive Edu-Kits, Inc.	99
RCA Institutes, Inc.	25, 101
RCA Tube Div. (Radio Corporation of America)	Back Cover
Rad-Tel Tube Co.	104
Radiart Corp.	12
Radio Products Co.	124
Radio-Television Training Association	23
Raytheon Manufacturing Co.	19
Rider, J. F., Publisher	92
Rinehart Books, Inc.	96
Sams, Howard W., & Co., Inc.	8, 89, 106
Sangamo Electric Co.	102, 103
Service Instruments Co.	113
Sherwood Electronics Labs.	122
Simpson Electric Co.	105
Stan-Burn Radio & Electronics	124
Stanley Electronics Corp.	119
Tab	126
Telecom	115
Trans-Aire Electronics, Inc.	118
Transvision, Inc.	113
Trio Manufacturing Co.	10
Triplet Electrical Instrument Co.	Inside Front Cover
Tung-Sol	6
University Loudspeakers	122
Wayco, Inc.	91
Weller Electric Co.	115
Wholesale Radio Parts Co.	119
Winegard Co.	27, 28
Winston Electronics, Inc.	117
Xcelite, Inc.	107
Zingo Electronics	115

LAFAYETTE'S SPECTACULAR MONEY SAVERS



HIGH SENSITIVITY AC-DC MULTITESTER 20,000 ohms per Volt

The new Lafayette High Sensitivity Multitester is a complete instrument (not a kit). Here is an instrument packed with every desirable feature found only in instruments costing twice as much. One of the most sensitive multitesters ever offered. 20,000 ohms per volt DC; 8,000 ohms AC, having a high sensitivity 45 microamps meter. Full scale AC-DC voltage ranges are 0-10V, 0-50V, 0-250V, 0-500V, 0-1,000V; DC current ranges 50 microamps, 2.5 ma, 25 ma, 250 ma. Resistance: 0-5K ohms, 0-50K ohms, 0-500K and 0-5 megohms. Decibel range: -20 +5 db; +5 +22 db (0 db -0.775V -600 ohms). Extreme versatility and accuracy. 1% precision resistors; 3" meter; beautiful plastic front, with metal bottom for ruggedness. Size: 3 3/4" x 5 3/4" x 2 3/4". Complete with batteries and leads. Shpg. Wt. 4 lbs.

19.95

RW-30G.....NET **19.95**
In lots of 3 **19.25**

NEW POCKET AC-DC VOM MULTITESTER 1,000 ohms per Volt

This instrument is one of the best buys that Lafayette has ever offered in a Wide Range AC-DC MULTITESTER. An ideal portable unit that meets the need for a compact, yet rugged test instrument. Has ease of operation usually found only in MORE EXPENSIVE INSTRUMENTS. Has 1000 ohms/volt sensitivity on both AC or DC. Uses full 3" rectangular meter with large easy to read scale. Uses 1% precision resistors, jeweled D'Arsonval microamp meter movement. Ranges: AC-DC and output volts 0-5, 0-25, 0-250, 0-1000V; DC current 0-1, 0-10, 0-100, MA; Resistance 0-10K and 0-100K ohms. In handsome sturdy bakelite case. Size: 4 3/4" x 3 3/4" x 1 3/4". Supplied Complete with test leads and batteries. A Must for every serviceman, shop, Laboratory or experimenter—and at Lafayette's Price you can afford to own one. Shpg. Wt. 2 1/2 lbs.

9.95



MODEL RW-27C—Complete In Lots of 3 **9.45**
Single, ea. **9.95**

WEBSTER • GARRARD • COLLARO 3-SPEED—HI-FI RECORD CHANGER

Now Lafayette makes it possible for you to save money on the three most popular makes of 3 speed Record changers.

WEBCOR Diskchanger: It's completely automatic, 33 1/3, 45 and 78 RPM, automatic shut off after last Record, balanced tone arm, etc. Size 13 3/4" x 12 x 8 1/4". Shpg. Wt. 16 lbs.

Stock No. PK-49—With Dual Turnover Cartridge..... **26.50**
Stock No. PK-46—With G.E. RPX 050 Triple Play Cartridge. **25.50**

COLLARO, THE WORLD'S FINEST 3 SPEED INTERMIX CHANGER: Collaro Model 3/532—3 speed Intermix changer designed and engineered to meet the most exacting requirements of the finest audio systems: While our stocks last. Shpg. Wt. 23 lbs. with G.E. RPX—050 Triple play cartridge.....Net **34.50**

With G.E. RPX—052A Triple play latest Golden Treasure cartridge with Diamond and Sapphire styli installed.....Net **44.95**

Collaro RC-54: Latest Collaro 3 speed Intermix less cartridge.....Net **47.77**

With G.E. RPX—050 Triple play cartridge.....Net **49.95**

With G.E. RPX—052A Triple play Golden Treasure cartridge with Diamond and Sapphire styli installed.....Net **59.95**

Garrard Model RC-80 3 speed Record changer less cartridge.....Net **48.51**

Model RC-80 with G.E. RPX—050 Triple play Cartridge.....Net **51.95**

Model RC-80 with G.E. RPX—052—A latest triple play Golden Treasure cartridge with Diamond and Sapphire styli installed.....Net **62.53**

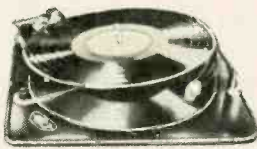

TRANSISTOR

455KC I.F. 1/2"x1/2"x3/4" H

This tiny I.F. is the same as used in the transistorized sets of the leading manufacturers. Ideal for building miniature equipment.

MS-126—Single, each..... **89c**
In lots of 10, each..... **79c**



TWO TRANSISTOR RADIO RECEIVER KIT

Essential parts, 1-loopstick, 2-gang variable condenser; 2-G.E. 2N107 Transistors, 1 Volume control, 1 Argonne transistor audio transformer, resistors condensers, Batteries and 1-Dynamic Ear phone.

KT-50..... **9.74**

TRANSISTOR CODE PRACTICE OSCILLATOR KIT

Build your own, Miniature size, code practice oscillator complete parts 1, G.E. 2N107—Transistor, 3-1/2 watt resistors, 1-Volume Control, 2-condensers; and Batteries, and instructions.....Net **2.49**
Telegraph Key..... **.89**
Dynamic ear phone..... **1.95**

RAYTHEON TRANSISTORS

CK-722—Singly, each..... **2.10**
—In lots of 10, each..... **1.95**
CK-721—Singly, each..... **2.40**
—In lots of 10, each..... **2.25**

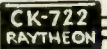

NEW GE TRANSISTOR TYPE 2N107

High Fidelity Amplifier Kit
10 WATT — BUILT-IN PREAMPLIFIER For G.E. Reluctance Cartridge
FREQUENCY RESPONSE: 20-20,000 CYCLES

Designed for installations where high quality reproduction is required. Separate tone controls for bass and treble. Inverse feedback circuit. Specifications: Power Output 10 watts or 32 db less than 3% distortion. Frequency Response: 20 to 20,000 cps ± 1 db. Tone Control: produces maximum bass boost of + 8 db at 100 cps. Treble Control produces maximum treble boost + 10 db at 10,000 cps. Hum: -70 db below rated output. Tube Complement: 1-6SC7, 1-6SL7, 2-6V6GT, 1-5Y3GT. Power Consumption 70 watts 110-120 volts 60 cycles. Shpg. Wt. 15 lbs. Complete with 3D diagrams and instructions.

KT-23—Complete with tubes.....Net **19.95**

RADIO CATALOG

FREE send for it GET LAFAYETTE'S NEW CATALOG PACKED WITH THE LARGEST SELECTION OF QUALITY ELECTRONICS EQUIPMENT AT BARGAIN PRICES.

Lafayette Radio
NEW YORK, N.Y. 100 Sixth Ave.
BRONX, N.Y. 542 E. Fordham Rd
NEWARK, N.J. 24 Central Ave.
PLAINFIELD, N.J. 139 West 2nd St.
BOSTON, MASS. 110 Federal St.

To Speed Shipment on Your Order Please Mention **DEPT. JH** Remit by Check or Money Order. Include sufficient money for Postage. We Refund unused amounts.

Lafayette Greatest Tape Buy Ever!

1200 FT. REEL
Genuine Plastic Base
RECORDING TAPE
Shpg. Wt. 14 oz.

LAFAYETTE made a terrific deal with one of the leading manufacturers of recording tape to supply us with their regular tape which sells for almost twice our price. **WE GUARANTEE ABSOLUTE SATISFACTION OR YOUR MONEY BACK.** The finest, professional-quality recording tape obtainable. Highest performance for thousands of playings. Red Oxide Base in a smooth, uniform coating; greater signal strength; with maximum fidelity; uniform frequency response from 40-15,000 cps.

In lots of 10 rolls **1.75 ea**

High Output Dynamic Microphone
List Price **\$47.00**
\$12.95

High quality Dynamic microphone exceptionally fine for Public address recording, etc. Flat response 60-10,000 cps. Impedance 40,000 ±15% at 1,000 cps. output level -55 db. Die cast metal case equipped with 6 ft. of shielded cable. Shpg. wt. 3 lbs.
PA-19—in lots of 3..... **12.45**
singly, ea. **12.95**

TOP QUALITY CRYSTAL MICROPHONE
COMPARE IT WITH ANY MIKE AT 2 to 3 TIMES THE PRICE

A quality crystal Microphone for PA systems, house recorders. Frequency response 30 to 10,000 cycles. Output level -52 db. Provides ample output for use with low gain amplifiers. Complete with 5 ft. of shielded cable. Shpg. wt. 3 1/2 lbs.
PA-24—in lots of 3..... **\$3.95**
singly, each..... **4.25**

LAPEL MICROPHONE
REGULAR \$16.00 VALUE!
FULL -55 db.
OUTPUT LEVEL!
IDEAL GENERAL PURPOSE MIKE!
2.95

Specially engineered crystal Microphone. Attaches to lapel. Only 1 5/8" in diameter. Exceptional frequency response. Output level -55 db. chrome plated case and clip for attaching to lapel. Includes 5 ft. of shielded cable. Shpg. wt. 1 lb.
PA-18..... **2.95**

PM SPEAKERS—FINE QUALITY ALNICO V MAGNET

4" P M—3.2 ohm SK-11..... **1.59**
5" P M—3.2 ohm SK-12..... **1.69**
6" P M—3.2 ohm SK-13..... **2.19**
6 x 9 P M—3.2 ohm SK-17..... **3.15**
12" P M—RCA—12 Watt—6.8 ohm ALNICO V Magnet..... **5.25**
6.8 ohm SK-40..... **5.25**
12" COAXIAL P M SPEAKER SK-22..... **9.75**

SONOTONE 9980-S

TURNOVER CERAMIC PHONO CARTRIDGE WITH DUAL SAPPHIRE NEEDLES
REPLACEMENT FOR COLUMBIA 360—VM—WEBSTER AND CRESCENT RECORD CHANGERS
SPECIFY STOCK NO. PK-40
In lots of 5, each... **3.50**
Singly, each... **3.98**



TAB

THAT'S A BUY

SENSATIONAL CRYSTAL OFFER!!
FT243 Crystals*



3525
3725
3925
4780
5235
6335
8013

ASS'TD 10 EA.
Singly ea. 5880
55¢

4190 5030 5485 5880
ESSENTIALLY EACH
SOLD SINGLY EACH 39¢ 26¢

*Listed in Kiloceles.

New Ham Band Crystals
Hi-Stability Power Oscillators. Newly Ground Individually Tested & Gd.
3500-4000 KC. \$2.25
7000-7400 KC. 8.00
OR ANY RANGE 3500-8000 KC. - 2 KC
"TAB" Bargains @ \$1.69 ea. for \$9.00

HI-FI SPEAKERS

Inbuilt network, 2 wires needed for HP & LP Response. Famous HI-FI Speaker Mfg. Co. Coaxial PM & 5" Tweeter 25 Watt/17500 cycles.
MODEL P25CO \$19.50
12" Coaxial PM & 3 1/2" Tweeter 12 Watt/45-15000 cyc.
Special \$12.75; 3 for \$35.
8" Coaxial PM & 2 1/2" Sw/Rw/70-15K Coaxial P8CO \$7.98; 2 for \$15
12" HI-FI PM 10w/45-14K. \$10; 2 for \$18
8" HI-FI PM 7w/45-14K. \$7.25; 2 for \$13

HI-FI Audio Components
Phono Carf. & N'dies Gtd.

RPX050* Dual .001A .003 \$6.98
RPX052* Gold Treas. \$19.75
RPX041* (S) .001 5.25
RPX040* (S) .003 5.25
RPX053* Hi-Fi Gold Treas. \$28.98
*GE Original Boxed S. S. Back Gtd.
RPJ010 Dual (S) .001 & .003 (GE) \$1.98
RPJ012 Dual (D) .001 & .003 "Tetrad" 18.99
RPJ013 Dual (DS) .001 & .003 "Tetrad" 19.99
RPJ003 or RPJ004 Sing D. "Tetrad" 9.99
RPJ001 or RPJ005 Sing S. (GE) 1.35
MG or 78 Single Diamond \$1.98; 4/ 7.50
MG and 78 Dual Sapphire \$1.98; 4/ 7.50
MG or 78 Single Diamond "Tetrad" 9.89
MG and 78 Dual Diamond "Tetrad" 20.89

HI-FI RECORDING TAPE

Finest, S, S, Back Gtd.
PRECISION COATED & SLIT.
Gtd Splice free. Quality Control. Constant Base. Gtd Constant Output. Freq. 7 1/2 IPS. 40-15K Oxide Wnd per 1 1/2". 72" reel; 1200 ft. per reel.
SOLD SINGLY \$1.80 Special \$1.58 ea.

"TAB" All Mdse. Sold On Money Back GUARANTEE

ALL NEW DUAL VOLTAGE PHONO CARTRIDGE

\$1.70 ea. LOTS OF 6
Replaces 127 Popular Make & Type Cartridges 95% of ALL 78 RPM'S

Externally mounted condenser slips off for output of 4 1/2 Volts. With condenser in place, voltage at output terminals is 2 Volts. Freq. response 6000 Cy. A terrific Deal for Servicemen. Write for Replacement Chart. Singly \$1.80 ea.

MIKE & HEADSET BARGAINS

Sound Pwr. Headset, Chest & Throat Mike Per pair \$29.98
230V Throat Mike Bobbie Button 200-600cps ± 2dB 30V. 6/33
Crystal Mike & Cable. \$1.88
Crystal Mike Cartridge. 2 \$1
P20 Headset Hi Imped only \$4.98
Navy Mike. Carbon. 98 ea. 3 for \$5
Slim Jim. Hi-Gain Dynamic Mike & Tilt Stand. All Purpose. 50 DB/80-7500 cps. Singly \$8.79 ea. 3 for \$24.49.

"TAB" DO-IT-YOURSELF TOOLS

Hi Quality Power Saws

Cummins 6 3/4" Maxswal (90° cut 2 1/4" 45° cut dress 2x4)
"TAB" Bargain Buy @ \$39.95
THOR 5" Power Saw (90° & 45° cut) Special \$22.50

NEW GENUINE "INCA" QUICKIE WRENCH

The 10 Way Wrench with 100 Uses!
Fits 95% of sizes from 1/8" to 1 1/2".
& Bolts 1/4" to 9/16". Precision Mfg. Gtd Rustproof. Brkproof. "TAB" Special. 79 ea. Lots of 10 @ \$6.

Thor Electric Speed Drills

200 J 1/4" Electric Speed Drill w/ Jacobs Chuck. 2400 RPM. 115 VAC only \$34.25
400J 1/2" Electric Speed Drill w/geared Chuck. 425 RPM/115 VAC. \$29.95

ORSA Wood Saws

Finest Swedish Sanvick Steel. Non-breakable. double action cutting edge. Closing out. Reg. \$12 to \$18 ea. Special Buy \$4 ea. 3 for \$10; 6 for \$18.

Money Back Guarantee (Cost of Mds. Only) \$5 Min. Order F.O.B. N.Y.C. Add Shpg. Charges or for C.O.D. 25% Dep. Tubes Gtd. via R-Exp. only. Prices subject to Change Without Notice. Phone Recorder 2-6245. CABLE: "TABPARTS"

STORAGE & DRY BATTERIES

A-Specialty 180 V Dry Battery \$1 ea. 6 for \$5
B-Burgess 1 1/2 V. 4 Cells 1C or 2D 11c ea. 48/\$2.75
C-HB4A/2V Storage Baty. Special \$2.25 ea. 6 for \$11
D-Gould 4V/16AH Storage Battery Only \$2 ea. 6 for \$8
E-Evredl 6V No. 1401 Hot Shot \$1 ea. 12 for \$8
F-6VNT6/BB24U. \$2 ea. 6 for \$10
G-6V/12AH Storage Baty. \$3 ea. 6 for \$24
H-2V/12AH/GE/Storage Baty \$4 ea. 6 for \$20

"GRAIN OF WHEAT" LAMPS

No. 323-3V Clear. 5/51
No. 323-3V Red. 5/51
Green "TAB" Buy @ 4 for \$1
"TAB" Special @ 4 for \$1
\$21G-28V & Shutter Red
Discout 100 Qty. 159¢
Qty's 1000 @ 30%.

CIRCUIT BREAKERS

Heinmann Mark Bkrs. Amps: 3, 5, 7, 9, 12, 30, 35, 40, 80, 180, 220 ea. \$1.98; 12/\$20.50
57 S 94 D. 12/30/35/40/80/180 Amps: 5, 10, 15, 20, 25 @ 98¢
Klixon Thermo Push Button Bkrs. Amps: 5, 10, 15, 30, 35. 89¢; 10/\$7.98

4MFD/1200VDC 10MFD/600VDC (or ass'td.)

LOTS OF 12... \$1.50 ea.
Sold Singly ea. \$1.79

1-222-A Signal Generator-Complete with Tubes "TAB" Special @ \$79.50
Microswitch Kit... 4 Ass'td \$1; 20 \$4
Planetary Drive... 5/1 & 1 to 1 \$2.49
Lamp Lamp. adjustable w/Bulb & Reflector... \$1.57 ea. 7 for \$10

TUBES!!

1st Quality • No Electrical or Mechanical Rejects
"TAB" TESTED & GUARANTEED

Individually Boxed • Hickok Mu Tested • WE WHOLESALE TO SERVICEMEN, DEALERS & INDUSTRY

0A2	74	2E5	92	688	64	6S7	56	12BE6	62
0A3	98	2V3	2.90	68A6	64	6S7	56	12BH7	69
0B3	1.36	2X2A	1.15	68C5	60	6S7	60	12C8	62
0C3	88	3B4	2.70	68E6	46	6S7	49	12D5	48
0D3	78	3B7	5.6	68G6	1.24	6T4	1.15	12K8	64
1A5CT	64	3Q5	6.8	68J6	68	6U5	78	12SA7	64
1A7GT	96	354	4.6	68K7A	1.11	6V7	64	12SH7	62
1AD4	72	4E5	7.9	68L6	1.19	6V6GT	56	12SL7	54
1AE4	3.75	4E7Z	1.55	68M6	5.2	7A7	38	12SK7	48
1AH4	1.07	5AX4	1.22	68Q6	96	6X4	42	12SL7	56
1B4	6.0	5Y4	1.54	6C4	38	6X5	46	12SN7	56
1B3	66	5R4GYW	1.4	6C5	56	7A4	2.7	12SR7	46
1C6	49	5T4	1.48	6C6	56	7A4	74	12Z3	89
1E5	69	5U4	1.46	6C8	82	7A5	74	12Z3	89
1E7	49	5X4G	1.78	6C8B	52	7A7	68	14A7	89
1E7	49	5X4G	1.78	6C8B	52	7A7	68	14A7	89
1G4GT	69	5Y3	3.6	6D6	1.08	7A8	68	14A7	89
1G5	69	5Y3	3.6	6D6	1.08	7A8	68	14A7	89
1G6GT	69	6A3	1.29	6E5	1.09	7B6	81	19T8	1.49
1H4C	49	6A5	2.98	6F5	91	7B8	82	24A4	92
1H5GT	72	6A1	3.81	6F5	64	7C4	62	25A6	1.79
1H6	69	6A7	1.09	6F8	68	7C7	54	25L6	62
1J6G	69	6AB7	1.09	6G6	92	7E6	54	25L6	62
1L4	49	6A6	4.2	6H6	52	7E7	72	25Y5	84
1L4A	1.01	6AB7	4.2	6H6	4.59	7E7	72	25Y5	84
1L8A	1.09	6AC5	1.19	6J5	4.2	7F8	1.18	26	79
1L8C	89	6AF6	5.8	6J6	48	7H7	72	28D7	1.29
1LDS	98	6AF6	5.8	6J6	48	7H7	72	28D7	1.29
1LE3	99	6AG5	5.0	6K6	49	757	1.29	35S1	69
1L6	1.0	6AG7	1.14	6K7	46	7V7	1.06	35A5	71
1L6	1.0	6AG7	1.14	6K7	46	7V7	1.06	35A5	71
1LPS	78	6AK5	6.2	6L6	98	7Y4	64	35C5	54
1R4	1.19	6AK6	7.4	6L7	80	10	49	35Y4	68
1R5	52	6AL7	1.22	6P7	80	2A6	48	35Z3	69
1S4	88	6A05	4.6	6Q7	81	12AH7	52	35Z5	46
1S4	42	6A5	3.4	6R5	7.44	12AL5	54	39A4	56
1T4	52	6AR6	2.74	6S4	48	12AT7	68	49	1.29
1T5	98	6AS6	1.75	6S7	1.30	12AT7	68	49	1.29
1T6	49	6A7	1.42	6S7	92	12AUG	44	50A5	54
1U5	48	6AT6	4.62	6SA7	92	12AUG	44	50A5	54
1V2	62	6AU6	4.6	6SC7	74	12AV6	38	50L6	60
1X2A	62	6A7	1.42	6S7	92	12AV6	38	50L6	60
2A4	2.37	6AV6	4.8	6SG7	42	12AY7	68	76	68
2A5	78	6AX4	8.1	6SM7	62	12BA6	52	77	68
2A6	1.49	6B5	1.12	6S7	82	12BA7	64	83V	1.22
2A7	89	6B7	9.1	6SL7	56	12BD6	65	117Z3	68

NEW HIGH CURRENT POWER SUPPLIES-ONE YEAR GTD

Variable 0-28VDC. Completely Built. Full Wave Selenium Rectifier. Transformer. Variable Volt. Meter. Switch. Terminal & Fuse. Housed In Heavy Duty Steel Cabinet. 115V/60Cy Input. And Phase to order. Specify Cont. Rating in W-Meters

110 or 220V±
Sik No
T28V5A 0-28 VDC at 5 Amp \$ 45
T28V5ACC 5 Amp (1% Ripple) 5.75
T28V12A 0-28 VDC at 12 Amp \$108
T28V12ACC 12 Amp (1% Ripple) \$145
T28V24A 0-28 VDC at 24 Amp \$65
T28V24ACC 24 Amp (1% Ripple) \$195
T28V50A 0-28 VDC at 50 Amp \$260
T28V50ACC 50 Amp (1% Ripple) \$430
T28V100A 0-28 VDC at 100 Amp \$469

New! Basic Supplies, 115 VAC In

B115P5A 115 VDCV at 5 Amp \$90.00
B115P10A 115 VDC at 10 Amp 190.00
B200P10A 220 VDC at 10 Amp \$83.00
B230P10A 230 VDC at 10 Amp \$83.00
Less Meters. † 115 or 230 VAC and 3 Phase

New Variable Voltage Xfms Superior-Gr-Staco-Utc

0-135V 1.25A \$ 7.99
0-135V 3A \$11.99
Cased 0-135V 7.5A \$11.99
Uncased 0-135V 7.5A \$17.25
Cased 0-270V 3A \$24.95
Uncased 0-270V 3A \$18.00
Cased 0-135V 15A \$41.98
Cased 0-270V 9A \$41.98
Sik or more 10% Disc.

New 110-115 VDC Power Supplies

For Fans, Shavers, Motors, Bells, Drills, Selenoids, Business Machines, Battery Chgrs., Machine Tools & Signal Systems.
up to 50W... \$4.95; up to 100W... \$7.95
up to 250W... \$12.95; up to 350W... \$14.95
up to 800W... \$28.95; up to 1100W... \$32.95

NEW! Quality Voltage REGULATOR

\$ \$ Popularly Priced \$ \$ ONLY \$16.98

LINE VOLTAGE STABILIZER Stabilizes line voltage without tubes or tubes. Operates regardless of Voltage and Freq. shift. Ideal for TV, Radio or Hi-Fi use. Insures full size strength, & sync of TV picture regardless of live voltage. Automatically operated equipment. TROUBLE FREE. QUIET. needs no adjustment. Input 100 to 300 watts. Input 100-125V/Output 115V plus or minus 3% 50-60 Cy.

Order Six and Take 10% Discount

NEW "TABTRON" SELENIUM BRIDGE RECTIFIERS

Dated ONE YEAR GUARANTEE

We info. Powers Rectifiers to your specs. From 1 Amp up to and above 1000 Amps. Giving Inst. Full Wave Bridge.

Curr.	18 1/4	36 28	54 42	130/100
Volts	Volts	Volts	Volts	Volts
1AMP	\$1.40	\$3.35	\$7.75	\$8.25
2AMP	2.10	2.95	5.35	10.00
3AMP	3.00	4.15	5.85	12.75
4AMP	3.70	7.15	12.35	14.00
6AMP	4.45	8.75	12.85	32.00
10AMP	6.50	12.50	19.50	41.35
12AMP	8.00	15.75	22.10	42.25
20AMP	13.05	25.05	37.25	78.50
24AMP	16.00	31.95	44.50	89.00
30AMP	19.75	38.65	50.00	100.00
36AMP	24.75	47.50	65.00	120.00
50AMP	29.50	54.35	97.35	174.00

New Rectifier Xfms

Primary 115V 60 Cyclic
5 Amp... \$8.65; 2 \$15.75
12 Amp... \$15.75; 2 \$29.95
24 Amp... \$35.75; 2 \$69.95
100 Amps... \$59.00; 2 \$112.00
100 Amp... \$108.00; 2 \$210.00
18 Volt, 2 Amps. \$1.98; 2 \$3.50
Secondary (Dual) 18-15-9-0-9-15-18 Volts
100 Ohm. 1.25 Ohm. 2.5 Ohm. 5 Ohm. 10 Ohm.
2xAmpl. Voltage 1/4 max. e Dual Pri 115 & 220V 60 cy. Tapped 36VCT

New Rectifier Chokes

CR6001 1AMP 0.1HY/67R 33¢
CR6002 2AMP 0.1HY/67R 33¢
CR6003 5AMP 0.07HY/67R 33¢
CR6004 12AMP 0.1HY/1R 33¢
CR6005 24A/0.04HY/0.025R/20 33¢

230 to 115V Autotransformers

For 220-240 V/50-60 cy in. To 110-120 v or step-up. 7 w/ Cord Plug & Receptacle.
TPA500/50W... \$2.55
TPA075/75W... \$3.85
TPA100/100W... \$4.00
TPA200/200W... \$5.75
TPA250/250W... \$6.75
TPA300/300W... \$7.25
TPA500/500W \$8.25; TPA750/750W \$11.75
Model TPA1000/1000W/1KW... \$16.95
Model TPA2000/2000W/2KW... \$34.00
\$1.00 Order. 10% Disc. Less C. & P

New Variable 0 to 6 & 12 Volt/12A

DC Power Supply

Battery E-type. Complete Charging, Model RR. Plater, Aircraft, Marine or any DC Rect. Extra Dry Duty Selenium Rectifier. 2 Meters V & A. Designed for Cont. Service & up to 20 Amps Intermittent overload.
7612V12AC... \$31.95

MICRO & MU SWITCHES

Switches
A-Mu Load Sw. \$1.98
3 1/2" DPNO & NC/15A
12/10 B Micro Sw. Pin Plunger \$1.98
SHDT/10A... 3 for \$2.98
Plunger SPDT/10A... 3 for \$2.98
Micro Sw. Plunger SPNO/10A... 3 for \$3.51
12/53 E Push Toggle APNO & H. DPST/12A... 3 for \$3.51
12/53 F Micro Sw. Roller SPNC/10A... 3 for \$3.51
12/53 G C.H. 3PPT/A/HP... 3 for \$3.51
12/53 H Micro Sw. Plunger Button SPNO/10A... 3 for \$3.51
Micro Sw. Cased Hvy duty arc sup. magnets Plunger SPNC/30A... 3 for \$6.54
Plunger Button SPNO/30A... 3 for \$6.54
12/53 K Switchette SPNO... 3 for \$15.53
Start & Stop Push button control... 3 for \$9.98
Kit & Ass'td. Parts @ \$3.00
Qty's 100 Add Night 20% Discount

PARTS CABINET

50 DRAW, HVY GAUGE STEEL, 34 1/2" H, 18W, 9" L. Draw 3W, 2 1/2" D. 65 lbs. Special Only \$35. Total 350 lbs. 100% W. 6 1/2" "TAB" @ \$1.69; 4 for \$6.00. Plastic Utility Boxes, Size 10 1/2 x 6 1/2 x 2 1/2". 100% W. 100% W. \$1.59 ea. Your Choice Any Seven @ \$10.

NEW! Super SENSITIVE Precision GEIGER COUNTER

Simple to use. Rugged, dependable. Excellent for prospecting, industrial, scientific & civil defense work. Dual simultaneous indications when approaching EVEN poor uranium deposits; flashing neon panel lamp & clicks from headhphone. 100% W. 100% W. Radioactive test sample. Less Batteries. Sturdy drawn aluminum case w/hammerlock finish. 115V. 100% W. Special AC only @ \$29.35. KIT @ \$19.95.

NEW 212W/SEC PHOTOFLASH AC & Dry Battery Kit

Includes four-525 MFD/450V Condensers. Total 212W Secs. Resistors, capacitors, rectifier, flash bulb, 100% W. Kodachrome flash gun, guide. \$40 Daylight Kodachrome. \$40 on Ektachrome. Less Batteries. "TAB" Special AC only @ \$44.98

106W/Sec Fotoflash Kit, AC or Bat

Includes two (2) 525 MFD/

you are invited by **Electro-Voice**[®]
to...

WIN!

1 "WEEK-END WITH HIGH FIDELITY!"



WIN!

2 LIFETIME OF HIGH FIDELITY MUSIC!

CONTEST STARTS AUGUST 1, 1955

As always, Electro-Voice is FIRST! Now E-V sponsors this unique and exciting contest, that you might hear (perhaps win) today's finest matched high fidelity sound systems. For a lifetime after this

glorious listening experience, you will judge music reproduction equipment by its ability to approach the perfection already achieved by E-V matched high fidelity components and loudspeaker systems!

WIN this "double-size" first PRIZE!

- 1** WEEK-END WITH HIGH FIDELITY ALL-EXPENSE-PAID week-end trip for two . . . from wherever you enter the contest to Electro-Voice—the Home of High Fidelity! See hi-fi equipment take form before your eyes! Take part in the assembly of your own wonderful prize, if you wish.
- 2** LIFETIME OF HIGH FIDELITY MUSIC with your own incomparable *Patri-cian* 4-way audio reproducer and the beautiful *Peerage* console complete with all equipment!

and LOOK...9 more PRIZES, wonderful to WIN!

3 Second Prizes . . . magnificent E-V 15TRX 15-in. three-way speakers!

3 Third Prizes . . . outstanding E-V 12TRX 12-in. three-way speakers!

3 Fourth Prizes . . . powerful E-V 12TRXB 12-in. three-way speakers!

WIN the incomparable *Patri-cian* 4-way audio reproducer! Choice of Korina Blonde or Mahogany cabinet, four speakers, three level controls and 4-way crossover!

WIN the beautiful *Peerage* console plus 30-watt amplifier, pre-amplifier, remote control and FM tuner and record changer or turntable of your choice!

**IT'S EASY!
HERE'S ALL YOU DO!**

Just two pleasant steps: (A) Hear E-V high fidelity demonstrated by your E-V Distributor. A truly thrilling experience awaits you! (B) Fill in and mail the official entry blank, provided by E-V Distributor. (Be sure the salesman signs your entry blank.) Contest closes at midnight, September 30, 1955.

ELECTRO-VOICE, INC., BUCHANAN, MICH.

Gentlemen: I want a chance to win a "Week-End with High Fidelity." Please send me the names of nearest participating E-V Distributors.

Name _____

Address _____

City _____ Zone _____ State _____

My nearest large trading center is _____

Electro-Voice

ELECTRO-VOICE, INC., BUCHANAN, MICHIGAN



BY POPULAR DEMAND!

... the new

... the improved

RCA "TREASURE CHEST"



LARGER—

holds more tubes!

STRONGER —

built to last longer!

MORE PROFESSIONAL LOOKING—

helps build your prestige!

Here it is—the *new, improved* RCA "Treasure Chest"! Use it to carry a full selection of receiving tubes with you on your service calls. Use it to carry small tools. Use it to display the world-famous brand name—RCA—and let it work for you to build your business by instilling customer confidence.

STARTING NOW . . . For each RCA Picture Tube, or every 25 RCA Receiving Tubes you purchase, your RCA Tube Distributor will give you one RCA "Treasure Note." Save 20 "Treasure Notes" and your RCA Tube Distributor will trade them for the *NEW* RCA "TREASURE CHEST." This rugged, custom-built tube-carrying case is *not for sale* anywhere, at any price!

*Here's more
treasure . . .
the RCA
"MULTICORD"!*



It's an all-in-one power cord with two popular types of "cheater" receptacles; a hard-rubber, 3-way power outlet for test equipment, soldering gun, etc.; and a clamp-on work light. A real time-saver for busy service technicians! It's yours **FREE** of extra cost for only 5 RCA "Treasure Notes."

These offers expire at midnight, August 31, 1955 so act promptly. Don't miss out . . . Order your RCA Picture Tubes and RCA Receiving Tubes and start collecting valuable "Treasure Notes" now!



RADIO CORPORATION of AMERICA
TUBE DIVISION

HARRISON, N. J.