

Radio-Electronics

TELEVISION • SERVICING • HIGH FIDELITY

HUGO GERNSBACK, Editor-in-chief

Directory of FM Multiplex Equipment

An up-to-the-minute listing of receivers and adapters. Features important characteristics and differences between the various units. See page 38.

Other Articles On FM Stereo

Horizontal Oscillator Drifting

The culprit in too many TV service callbacks. Wayne Lemons shows how to spot and cure drift troubles quickly. See page 50.

Build a Better Light Meter

An easily constructed unit so sensitive it will give accurate readings at light levels so low as to require 30-second exposures. Uses a cadmium sulphide cell. See page 43.

Test Equipment For Industry

Matt Mandl shows where industrial test apparatus is like radio—TV servicing gear, and where it differs. Also what new pieces of equipment the service technician will have to understand and use. See page 63.

New  FM Multiplex Receivers and Adapters



50c

V A L PRIDDY 6-62
BRANCH RD RT 1
VA W VA

TRIPLETT

ACTUAL SIZE

USES UNLIMITED:

- Field Engineers
- Application Engineers
- Electrical, Radio, TV, and Appliance Servicemen
- Electrical Contractors
- Factory Maintenance Men
- Electronic Technicians
- Home Owners, Hobbyists



MODEL 310

complete VOLT-OHM-MILLIAMMETER



World's Largest Selling POCKET SIZE V-O-M

FEATURES:

- 1 Hand size and lightweight, but with the features of a full-size V-O-M.
- 2 20,000 ohms per volt DC; 5,000 AC.
- 3 EXCLUSIVE SINGLE SELECTOR SWITCH speeds circuit and range settings. The first miniature V-O-M with this exclusive feature for quick, fool-proof selection of all ranges.

SELF-SHIELDED Bar-Ring instrument; permits checking in strong magnetic fields • Fitting interchangeable test prod tip into top of tester makes it the common probe, thereby freeing one hand • UNBREAKABLE plastic meter window • BANANA-TYPE JACKS—positive connection and long life.

■ Price—only \$37.50; leather case \$3.20.

Available For Immediate Delivery From Your Triplet Distributor's Stock



MODEL 100

The most comprehensive test set in the Triplet line is Model 100 V-O-M Clamp-On-Ammeter Kit, now available at distributors. The world's most versatile instrument—a complete accurate V-O-M plus a clamp-on-ammeter with which you can take measurements without stripping the wires. Handsome, triple-purpose carton holds and displays all the components: Model 310 miniaturized V-O-M, Model 10 Clamp-On-Ammeter, Model 101 Line Separator, No. 311 Extension leads, and a leather carrying case, which neatly accommodates all the components. Model 101 literally makes it possible to separate the two sides of the line when using Model 10. Extension leads permit use of Model 10 at a distance from the V-O-M. Complete Model 100 is only

\$64.50

THE TRIPPLETT ELECTRICAL INSTRUMENT COMPANY, BLUFFTON, OHIO

MANUFACTURERS OF PANEL AND PORTABLE INSTRUMENTS; ELECTRICAL AND ELECTRONIC TEST EQUIPMENT

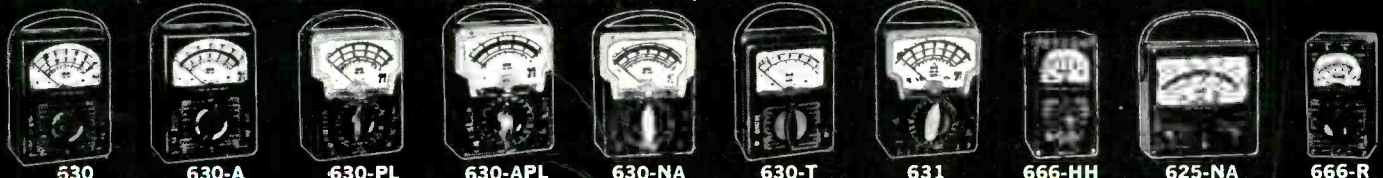

FOR EVERY PURPOSE—THE WORLD'S MOST COMPLETE LINE OF V-O-M'S

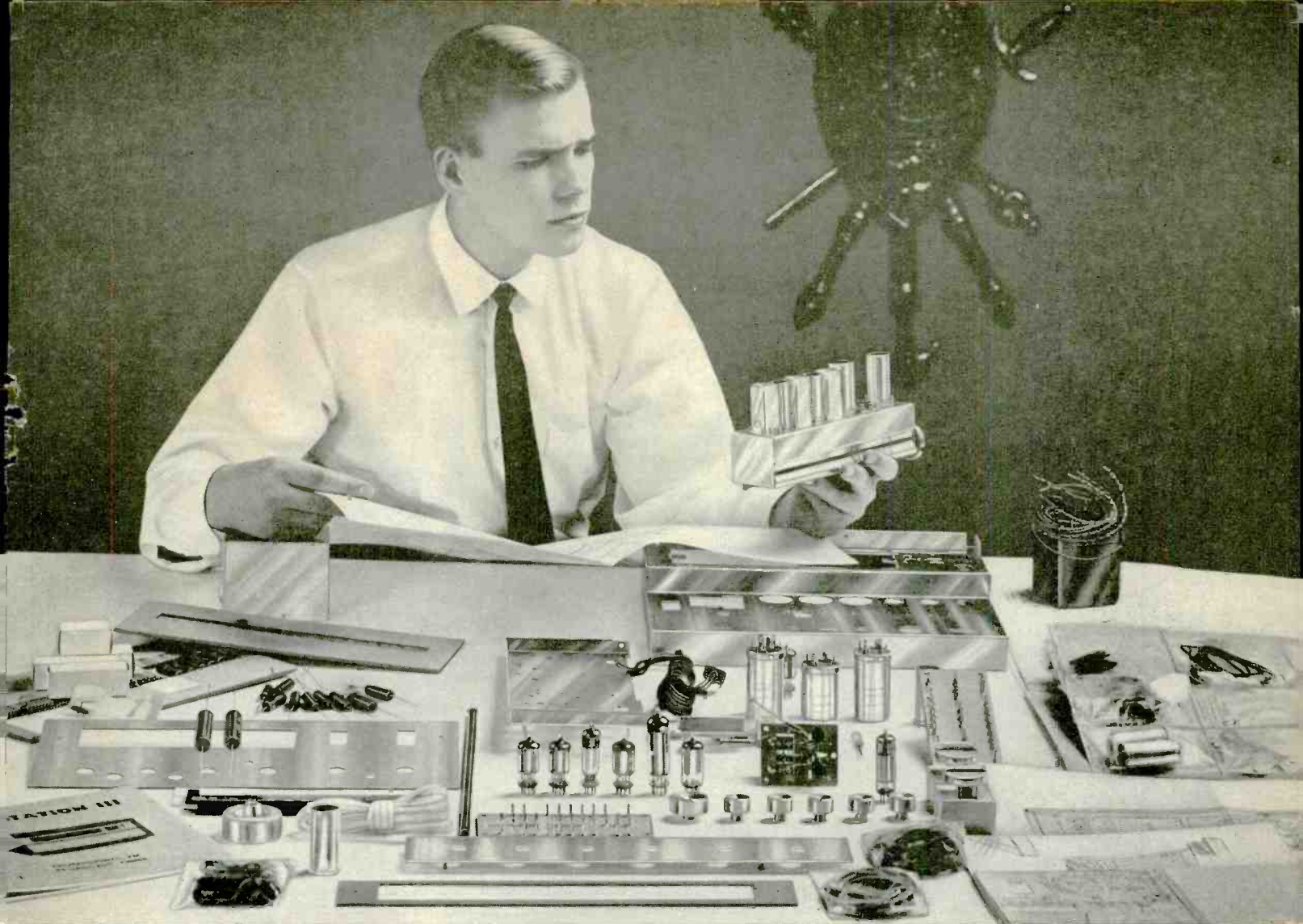

Can You Afford 15 Hours to Build The World's Best FM/Multiplex Tuner?

Fifteen hours. That's all it takes to build the world's best FM/Multiplex tuner.

Citation has the "specs" to back the claim but numbers alone can't tell the story. On its real measure, *the way it sounds*, Citation III is unsurpassed. And with good reason.

After years of intensive listening tests, Stew Hegeman, director of engineering of the Citation Kit Division, discovered that the performance of any instrument in the audible range is strongly influenced by its response in the non-audible range. Consistent with this basic design philosophy—the Citation III has a *frequency response three octaves above and below the normal range of hearing*. The result: unmeasurable distortion and the incomparable "Citation Sound."

The qualities that make Citation III the world's best FM tuner also make it the world's best FM/Multiplex tuner. The multiplex section has been engineered to provide wideband response, exceptional sensitivity and absolute oscillator stability. It mounts right on the chassis and the front panel accommodates the adapter controls.

What makes Citation III even *more* remarkable is that it can be built in 15 hours without reliance upon external equipment.

To meet the special requirements of Citation III, a new FM cartridge was developed which embodies every critical tuner element in one compact unit. It is completely assembled at the factory, totally shielded and perfectly aligned. With the cartridge as a standard and the two D'Arsonval tuning meters, the

problem of IF alignment and oscillator adjustment are eliminated.

Citation III is the *only* kit to employ military-type construction. Rigid terminal boards are provided for mounting components. Once mounted, components are suspended tightly between turret lugs. Lead length is sharply defined. Overall stability of the instrument is thus assured. Other special aids include packaging of small hardware in separate plastic envelopes and mounting of resistors and condensers on special component cards.

For complete information on all Citation kits, including reprints of independent laboratory test reports, write Dept. RE-10, Citation Kit Division, Harman-Kardon, Inc., Plainview, N. Y.

The Citation III FM tuner—kit, \$149.95; wired, \$229.95. The Citation III MA multiplex adapter—factory wired only, \$89.95. The Citation III X integrated multiplex tuner—factory wired, \$319.90. All prices slightly higher in the West.



Build the Very Best

CITATION KITS by

harman kardon

Formerly RADIO CRAFT — Incorporating SHORT WAVE CRAFT — TELEVISION NEWS — RADIO & TELEVISION*

editorial

- Hugo Gernsback **33** Extra-terrestrial TV
- stereo-high fidelity-audio**
- Larry Steckler **38** FM Stereo Component Directory
Guide to the new multiplex units
- Leonard Feldman **46** Convert to Stereo
How, when and where to use a multiplex adapter
- W. R. Williams **54** Build a Quality Stereo Preamp
This 4-tube unit is perfect for the do-it-yourselfer
- Norman H. Crowhurst **59** Does FM Stereo Follow Its Own Theory?
New light on how FM multiplex really works
- 62** Key to the Cover
- Joseph Marshall **73** Accurate Alignment of Hi-Fi FM Tuners
Use an FM generator and distortion analyzer
- 84** FM Stereo Is Not So Tough
Multiplex stereo presented pictorially
- Art Trauffer **85** Stereo Phones to Mono Phones
- George L. Augspurger **91** How to Place Your Stereo Speakers
There are two basic rules

what's new

- 53** Pictorial Reports of New Developments

electronics

- A. N. Glennon **34** How Sonar Works
Its uses in peace and war
- Charles E. Cohn **37** Checking Power Transformers
- Alen E. Gordon **43** Ultrasensitive Photographic Lightmeter
Build a simple meter that measures low light levels
- Ronald L. Ives **66** Add a Pilot Light to Variable Autotransformers
- 74** What's Your EQ? (Answers to September Puzzles on page 75)
- Ronald Wilensky **77** Electronic Repeating Switch
- A. K. Taylor **110** Transistor Bias Regulator
Use a diode

television

- Wayne Lemons **49** Line-of-Sight 136 Miles
- 50** Stop Horizontal Oscillator Drift
How to handle those tricky horizontal oscillator circuits
- Jack Darr **68** TV Service Clinic
Technician's tour of circuits affecting width
- Jack Darr **90** An Integrated Antenna
TV yagi has built-in booster amplifier
- 103** Service Prices for TV Repairs

industrial electronics

- Matthew Mandl **63** Industrial Test Equipment—Is It Different?
Not enough to keep the service technician from using it
- Ed Bukstein **78** Industrial Electronics Dictionary
From electron microscope to hard X-rays
- Tom Jaski **96** Unusual Relay Circuits
Fourth article of a series

test instruments

- Dave Stone **56** Rf Signal Generator Covers Marine Bands
R-E printed circuit speeds construction
- Wayne Lemons **75** Speedy Transistor Tester
Switchbox turns your ohmmeter into a transistor checker

radio

- Stanley Leinwoll **58** Short-wave Forecast for Sept. 15-Oct. 15
- Roy E. Pafenberg **76** Relay Service Note
- Harold Davis **86** Double CB Receiver Sensitivity
How to add an rf stage to Heathkit's GW-10 series transceivers
- Stanley Leinwoll **104** Sporadic-E Opens New Horizons
New technique of short-wave communications without the F-layer

the departments

- 133 Business and People
67 Corrections
24 Correspondence
138 New Books

- 135 New Literature
126 New Patents
114 New Products
124 New Tubes & Semiconductors

- 6 News Briefs
128 Noteworthy Circuits
111 Technicians' News

- 122 Technotes
130 Try This One
137 50 Years Ago

Over 50 Years of Electronic Publishing

EDITOR-IN-CHIEF AND PUBLISHER
Hugo Gernsback

EDITOR
M. Harvey Gernsback

MANAGING EDITOR
Fred Shunaman

TECHNICAL EDITOR
Robert F. Scott, W2PWG

ASSOCIATE EDITOR
Larry Steckler

EDITORIAL ASSOCIATE
I. Queen

SERVICE EDITOR
Jack Darr

ART DIRECTOR
Harry Schlack

TECH. ILLUSTRATION DIRECTOR
Wm. Lyon McLaughlin

ART ASSOCIATE
Fred Neinast

PRODUCTION MANAGER
Elizabeth Stalcup

DIRECTOR, ADVERTISING SALES
Lee Robinson

EASTERN SALES MANAGER
John J. Lamson

CIRCULATION MANAGER
G. Aliquo

DIRECTOR, NEWSSTAND SALES
Adam J. Smith

PROMOTION MANAGER
Robert Fallath

Average Paid Circulation
Over 157,000



—on the cover—

(Story on page 38)

The young lady is keeping company with some of the FM Stereo units listed in our directory. For a quick identification of the sets see page 62.

Color original
by Irving Kaufman

Gernsback Publications, Inc.

EXECUTIVE, EDITORIAL, ADVERTISING OFFICES

154 W. 14 St., New York 11, N.Y.
Telephone AL 5-775

CHAIRMAN OF THE BOARD
Hugo Gernsback

PRESIDENT

M. Harvey Gernsback

SECRETARY

G. Aliquo



Radio-Electronics is indexed in
Applied Science & Technology Index
(Formerly Industrial Arts Index)

*Trademark registered U. S. Pat. Office

GET YOUR ELECTRONICS-TV-RADIO HOME TRAINING FROM N.T.S. RESIDENT SCHOOL

BREAK THROUGH TO HIGHER PAY, GREATER JOB SECURITY

START NOW! Break through the Earning Barrier that stops "half-trained" men. N.T.S. "All-Phase" Training prepares you . . . at home in spare time . . . for a high-paying CAREER as a **MASTER TECHNICIAN** in Electronics — TV — Radio. One Master Course at One Low Tuition trains you for unlimited opportunities in All Phases: Servicing, Communications, Preparation for F.C.C. License, Broadcasting, Manufacturing, Automation, Radar and Micro-Waves, Missile and Rocket Projects.

A MORE REWARDING JOB . . . a secure future . . . a richer, fuller life can be yours! As an N.T.S. **MASTER TECHNICIAN** you can go straight to the top in industry . . . or open your own profitable business.

Over 1 City Block of Modern School Facilities, Laboratories and Shops Housing Over 1,000 Students.

50,000 Graduates — all over the World — since 1905

BETTER . . . MORE COMPLETE . . . LOWER COST . . . WITH NATIONAL SCHOOLS' SHOP-METHOD HOME TRAINING!

BETTER . . . Training that is proved and tested in N.T.S. Resident School shops and laboratories, by a School that is the **OLDEST and LARGEST** of its kind in the world.

MORE COMPLETE . . . You learn **ALL PHASES OF** Television — Radio — Electronics.

LOWER COST . . . Other schools make several courses out of the material in our **ONE MASTER COURSE . . .** and you pay more for less training than you get in our course at **ONE LOW TUITION!**

NATIONAL TECHNICAL SCHOOLS
WORLD-WIDE TRAINING SINCE 1905

THE SCHOOL BEHIND YOUR HOME-STUDY TRAINING

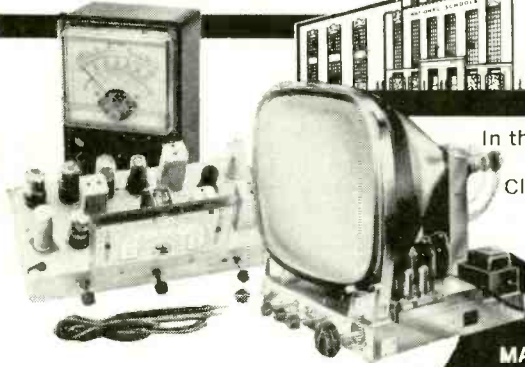

In these modern School Headquarters your Home Training is: Classroom-Developed, Lab-Studio Planned, Shop-Tested, Industry-Approved, Home Study-Designed.



TRAIN AT HOME IN YOUR SPARE TIME . . . AT YOUR OWN PACE!

19 BIG KITS YOURS TO KEEP

- Friendly Instruction and Guidance
- Graduate Advisory Service
- Unlimited Consultation
- Diploma Recognized by Industry
- **EVERYTHING YOU NEED FOR SUCCESS**

N.T.S. IS NOT JUST A MAILING ADDRESS ON A COUPON

N.T.S. is a real school . . . a world famous training center since 1905. Thousands of men from all over the world come to train in our shops, labs, studios and classrooms.

You learn quickly and easily the N.T.S. Shop-Tested way. You get lessons, manuals, job projects, personal consultation from instructors as you progress. You build a Short-Wave, Long-Wave Superhet Receiver plus a large screen TV set from the ground up with parts we send you at no additional cost. You also get a Professional Multitester for your practical job projects. The Multitester will become one of your most valuable instruments in spare time work while training, and afterwards too. Many students pay for their entire tuition with spare time work. You can, too . . . we show you how.

SEND FOR INFORMATION NOW . . . TODAY! IT COSTS YOU NOTHING TO INVESTIGATE

After you graduate you can open your own TV-Radio repair business or go into high paying jobs like these: Communications Technicians, Hi-Fi, Stereo and Sound Recording Specialists, TV-Radio Broadcasting Technician, Technician in Computers & Missiles, Electronics Field Technician, Specialist in Micro-Waves and Servomechanisms, Expert Trouble Shooter, All-Phase Master Technician, TV-Radio Sales, Service and Repair.

RESIDENT TRAINING AT LOS ANGELES
If you wish to take your Electronics-TV-Radio training in our famous Resident School in Los Angeles — the oldest and largest school of its kind in the world — write for special Resident School catalog and information, or check special box in coupon.

MAIL COUPON NOW FOR FREE BOOK & ACTUAL LESSON

No obligation. No salesman will call.



ACCREDITED MEMBER

NATIONAL TECHNICAL SCHOOLS

WORLD-WIDE TRAINING SINCE 1905

4000 SO. FIGUEROA ST., LOS ANGELES 37, CALIF., U. S. A.

NATIONAL TECHNICAL SCHOOLS
WORLD-WIDE TRAINING SINCE 1905

Mail Now To
National Technical Schools, Dept. RG-101
4000 S. Figueroa St., Los Angeles 37, Calif.
Please rush FREE Electronics - TV-Radio "Opportunity" Book and Actual Lesson.

Name _____ Age _____
Address _____
City _____ Zone _____ State _____

Check here if interested ONLY in Resident Training at Los Angeles.
VETERANS: Give date of discharge _____

RADIO-ELECTRONICS published monthly at Mt. Morris, Ill., by Gernsback Publications Inc. Second-class postage paid at Mt. Morris, Ill. Copyright © 1961, by Gernsback Publications Inc. All rights reserved under Universal, International and Pan-American Copyright Conventions. SUBSCRIPTION RATES: US and possessions, Canada; \$5 for 1, \$9 for 2, \$12 for 3 years. Pan-American countries: \$6 for 1, \$11 for 2, \$15 for 3 years. Other countries: \$6.50 for 1, \$12 for 2, \$16.50 for 3 years.

News Briefs

Now We Can Talk in Pulses

Phone users in the Newark-Passaic, N. J., area have unknowingly been taking part in a synthetic speech experiment—every time they pick up their phones. Instead of going out over the lines in original audio form, their words are broken down into the language of computers; the transmission is by *pulse code modulation*.

This is the first regular use of the system, which was developed by the Bell Laboratories and demonstrated some years ago (RADIO-ELECTRONICS, February 1948). It has been named T-1 by the phone company. The speaker's voice is "sampled," tiny bits being taken 8,000 times a second. The level of each sample is measured and given a number in binary code, 1, 2, 4, 8, etc. up to 128. At the receiving exchange the message is decoded and each binary number replaced by an audio pulse of the correct strength. The result is a reconstituted signal not distinguishable from the original in ordinary phone conversation.

Since a large number of pulse-coded conversations can be carried on the same pair of wires, the new system is expected to be particularly useful in large cities such as New York, where congestion below ground has often made it difficult to find room for additional telephone conduit.

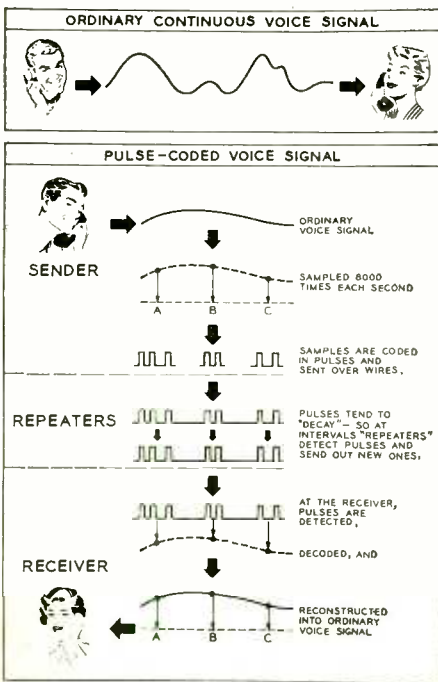

To install T-1, telephone companies will not have to dig up city streets. Instead, using existing cable, they can connect terminal equipment in telephone buildings at each end of the route, and repeater equipment in manholes or on poles along the way.

Another advantage is that each repeater station *reconstitutes* the signal instead of simply relaying it. If the message is distorted, but still intelligible, the relay station, instead of amplifying it with the distortion, sends out a perfectly formed new set of code pulses. Thus, as long as the pulses can all be interpreted correctly, the signals will be as clear after several repeaters (they are spaced about every mile along the transmission route) as after the first.

Pay TV for Little Rock

Midwest Video Corp. has been authorized by the Public Service Commission to set up a pay television system in Little Rock, Ark. Midwest is operating under franchise from International Telemeter, the company now operating a pay-TV setup in Etibicoke, Ontario. The system brings the program on a cable, and a coin box is used to collect the fees for each attraction.

Midwest Radio plans to begin operations in the southwest portion of the city, an area containing about 10,000 homes. No definite target date was announced. There is some opposition by the local theaters, and one spokesman suggested that the authorization may be appealed in the courts.

CHU Corrects Time

The time signals of the Dominion Observatory station at Ottawa, Canada, were advanced 50 milliseconds Aug. 1, reported Malcolm Thompson of the Observatory. This change was made to bring the signals exactly to Universal Time. Station MSF at Greenwich made the same change at the same time. CHU transmits continuously on 3.33, 7.335 and 14.67 mc.

The signals of CHU are widely used throughout the United States as well as Canada, and have become practically the standard at sports-car rallies, due to CHU's practice of announcing the time by voice every minute, instead of every 5 minutes as does WWV.

Ultrasonics Affects Health?

Workers exposed to intense ultra-

sonic waves and high-frequency noises show definite physical reactions, reports the Russian magazine *Hygiene and Sanitation*. The general effect, the article reports, is fatigue, irritability, headache, moderate loss of weight, decreased work output and frequently, reduction of blood pressure. Industries that use ultrasonic devices should provide periodic medical examination for their workers, the magazine advises.

Optical Maser New Light Source

Optical maser is being used as "an ideal light source for short-exposure, high-magnification photomicrography, and for shadowgraph and schlieren work," according to Bell Labs. The ruby-red spot, 10,000 times brighter over a given area than the sun, may make the optical maser as important to the photographer as to the communications engineer.

TV Set Shortage Coming?

Television receivers are selling faster than they are being manufactured, recently warned Frank Mansfield, EIA's top market researcher. If production does not come up, there may be an actual shortage of sets on the retail market in the late fall.

Mansfield estimates that at least 6,220,000 TV sets will be sold in 1961, a slight increase over 1960. Inventories are lower than they have been since 1954. So unless production is stepped up rapidly, there will not be enough sets on hand to meet the year-end demand.

New "Banana" Tube for Color

British Mullard has announced a type of tube using principles altogether different from the shadow mask, Lawrence or others now in development. The tube is a cylinder about 4 inches in diameter, with three equally spaced cylindrical rods running along its length. The screen

Advertising Representatives: Los Angeles: Harker-Husted-Coughlin, 408 1/2 South Alvarado St., Tel. DU'nkirk 7-2328. San Francisco: Harker-Husted-Coughlin, 444 Market St., Tel. GARfield 1-0151. Atlanta: J. Sidney Crane & Associates, 22 Elsie St. N.E., Tel. TRInity 2-0720. **United Kingdom:** Publishing & Distributing Co., Ltd., Mitre House, 177 Regent St., London, W. 1, England.
Foreign Agents: Great Britain: Atlas Publishing and Distributing Co., Ltd., 18 Bride Lane, London E.C. 4.
Subscription Service: Address form 3579 and correspondence to Radio-Electronics, Subscriber Service, 154 West 14th St., New York 11, N.Y. When requesting a change of address, please furnish an address label from a recent issue. Allow one month for change of address.

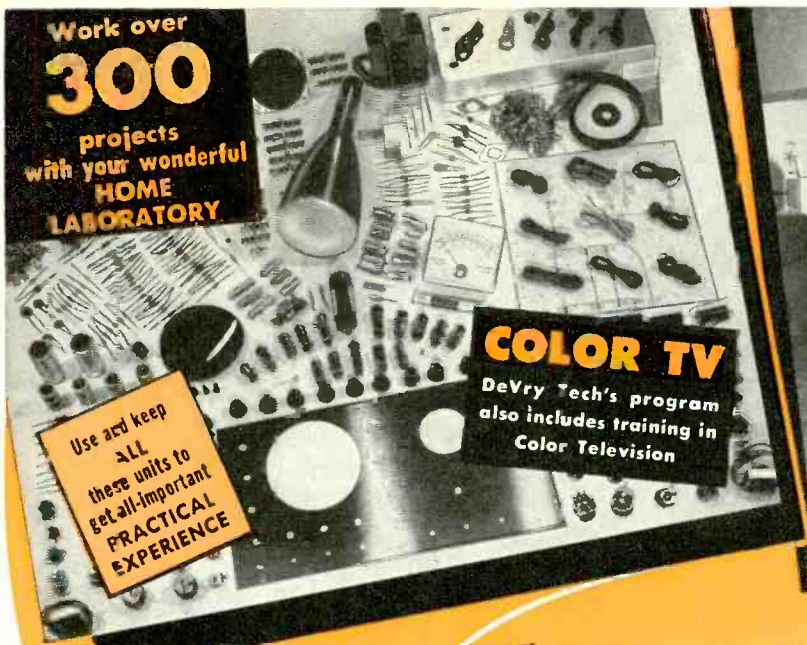

Work over
300
projects
with your wonderful
**HOME
LABORATORY**

Use and keep
ALL
these units to
get all-important
**PRACTICAL
EXPERIENCE**

COLOR TV
DeVry Tech's program
also includes training in
Color Television

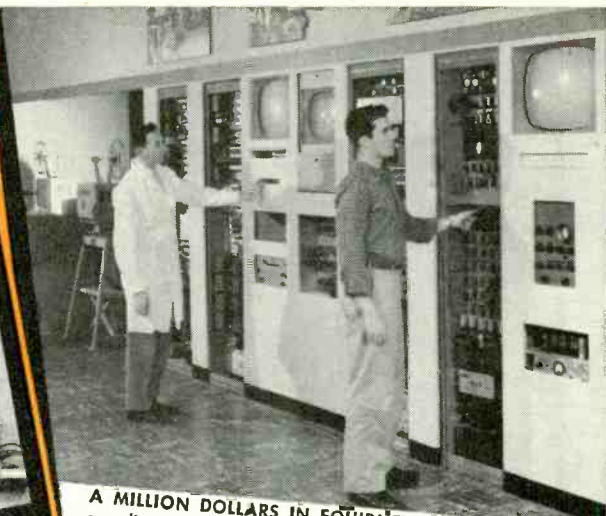

A MILLION DOLLARS IN EQUIPMENT! Instruments, tools, supplies are available for DeVry Tech students in our Chicago and Toronto Laboratories. Above is shown a Closed Circuit TV station in our Chicago Laboratories.



NEW!
NEW!
NEW!

Shown above is the valuable new combination oscilloscope and volt-meter which DeVry Tech men build during the new training program. But that's not all! New movies, new experimental projects—all prepare you thoroughly in this latest and greatest DeVry Tech training program.



Exclusive HOME MOVIES help you grasp important points **FASTER . . . EASIER . . . BETTER.** A tremendous advantage!

NOW...at home...get DeVry Tech's amazing effective training in

ELECTRONICS

RADIO-TELEVISION! Nothing else like it for providing real LABORATORY-TYPE training at home. Get the kind of thorough, practical experience YOU NEED for the kind of progress YOU WANT in today's tremendous field of Television, Radio and Electronics. Qualify yourself for real money . . . interesting work . . . a wonderfully promising future. And when you finish, DeVry Technical Institute's active Employment Service HELPS YOU GET STARTED! Or open your own profitable Television-Radio Service Business.

THOUSANDS OF SUCCESSFUL GRADUATES

Why has DeVry Technical Institute become one of the largest training organizations of its kind? Because it provides EVERY MAJOR HOME TRAINING AID to help make the subject EASIER to learn . . . EASIER to remember—the kind of training so helpful for REAL PROGRESS. Students get thorough, up-to-date, practical training that TAKES ADVANTAGE of new and improved training developments. Study the ADVANTAGES shown on this page. Think what they can mean to YOU . . . to YOUR FUTURE! Or come to DeVry Tech's modern Training Laboratories in Chicago or Toronto. MAIL COUPON TODAY for complete facts—including 2 valuable free booklets, "Pocket Guide to Real Earnings" and "Electronics in Space Travel". Also, valuable information for men subject to MILITARY SERVICE.

Accredited member of
National Home Study Council



**SEND FOR 2 FREE BOOKLETS
MAIL COUPON TODAY!**

DeVRY TECHNICAL INSTITUTE
4141 Belmont Avenue, Chicago 41, Ill., Dept. RE-TOR
Please give me your two free booklets, "Pocket Guide to Real Earnings" and "Electronics in Space Travel"; also include details on how to prepare for a career in Electronics. I am interested in the following opportunity fields (check one or more):

- | | |
|--|--|
| <input type="checkbox"/> Space & Missile Electronics | <input type="checkbox"/> Communications |
| <input type="checkbox"/> Television and Radio | <input type="checkbox"/> Computers |
| <input type="checkbox"/> Microwaves | <input type="checkbox"/> Broadcasting |
| <input type="checkbox"/> Radar | <input type="checkbox"/> Industrial Electronics |
| <input type="checkbox"/> Automation Electronics | <input type="checkbox"/> Special "Short Courses" |

Name _____ Age _____
Address _____ PLEASE PRINT Apt. _____
City _____ Zone _____ State _____

Check here if you face military service.
1001 Canadian residents: Write DeVry Tech of Canada, Ltd.,
970 Lawrence Avenue West, Toronto 19, Ontario

NEW! ALL NEW!

**Now Prepare For
SPACE AND MISSILE
Electronics At Home**



DeVry Tech now also makes available their highly effective SPACE and MISSILE ELECTRONICS Program. Now a man can train at home for a job in "outer space"—and not only "keep his feet on the ground": he can keep his present job while he is training. DeVry opens a wider range of job opportunities to a wider range of men 17-55.

**DeVRY TECHNICAL
INSTITUTE**
CHICAGO • TORONTO

Introducing the perfect mate for any TV/FM antenna

NEW TRANSISTOR

JERROLD® POWERMATE

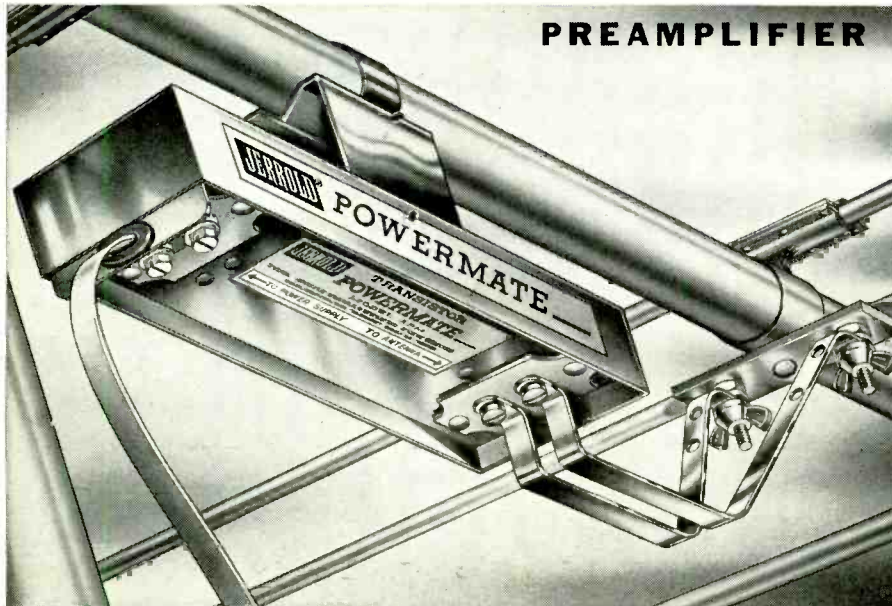

mounts on boom, mast, wall, window... offers highest gain, lowest noise figure

Here's the preamplifier for every TV antenna in your area, whether new or up for years! The exclusive universal bracket of the new JERROLD Transistor POWERMATE permits mounting directly on the antenna boom (for greatest boost before download losses) or at any other point—along the mast, on the wall or windowsill, behind the set—anywhere your best judgment dictates.

And look at this gain: An average of 13.9db at Channel 13 and 18.25db at Channel 2—by far the highest in the business! This remarkable gain gives any antenna system the lowest System Noise Figure obtainable—the key to better pictures.

See your distributor today, or write for special bulletin describing System Noise Figure.

Only \$39.95 list, complete with power supply

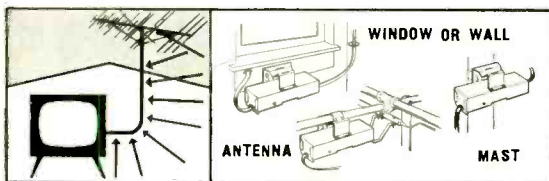

MOUNT IT AND FORGET IT

On the antenna or anywhere along the download, POWERMATE is up for good. Same 300-ohm lead that carries signal also carries 15 volts ac to POWERMATE. No tubes, no batteries to replace.

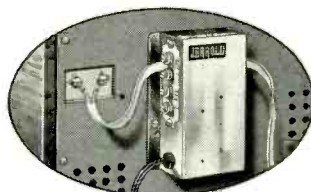

REMOTE A-C POWER SUPPLY

installs on or near receiver, draws less current than an electric clock. No polarity nuisance when attaching to lead, no danger of damaging the transistor.

JERROLD® ELECTRONICS CORPORATION
Distributor Sales Division, Dept. IDS-170
The Jerrold Building, Philadelphia 32, Pa.

Jerrold Electronics (Canada) Ltd., Toronto, Ontario
Export Representative: CBS International, New York 22, N.Y.

AMERICA'S LEADING MANUFACTURER OF TV-FM RECEPTION AIDS AND MASTER-ANTENNA-SYSTEM PRODUCTS

is simply a strip of phosphor ¼ inch wide and 16 inches long. It is composed of three color phosphors. The beam is "wobbled" to strike the desired phosphor at any point along its scan. The gun is mounted at one end of the tube and the beam projected parallel to the phosphor strip, being bent down to it by a "bowing magnet" that acts as the horizontal sweep. Vertical sweep is mechanical, by rotating the tube at about 1,000 rpm. Light from the phosphor strip is projected through cylindrical lenses to form the image on a mirror, from which it is viewed. Still in an early experimental stage, the tube is not far enough developed to make any predictions as to its ultimate feasibility possible.

Audio Surgical Instrument Combats Heart Block

An electronic depth probe makes it easy for the surgeon to locate vital heart tissue—the "bundle of His"—during open heart operations and thus oriented, work with the minimum likelihood of surgical heart block.

The probe, which uses tri-axial

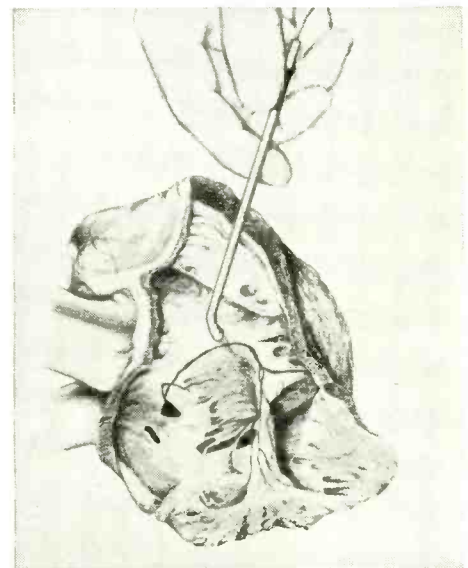

gold electrodes, is attached to a "tone box" which produces a buzz that varies according to the conductivity of the matter reached by the probe. When contact with the bundle of His is made, the pitch changes noticeably.

The instrument, manufactured by Medtronic Inc., of Minneapolis, uses a transistor circuit with rechargeable battery. It is called the Medtronic Conduction System Locator.

Gallium Arsenide Phototube Is Highly Sensitive

The Lansdale Div. of Philco reports a new gallium arsenide phototube that is one or two orders more sensitive than conventional photodiodes. It can also operate in daylight without sensitivity degrada-

how to get a Commercial FCC LICENSE

An FCC License, Or Your Money Back!

Completion of the Master Course (both Sections) will prepare you for a First Class Commercial Radio Telephone License with a Radar Endorsement. Should you fail to pass the FCC examination for this license after successfully completing the Master Course, you will receive a full refund of all tuition payments. This guarantee is valid for the entire period of your enrollment agreement.

FREE!

find out how . . .

1. You can get job security. Specialized education is the road to higher salary and important jobs in the growing field of electronics.
2. You can solve the problems that stump other technicians. Problems in electronics are becoming more complex. Your ability to solve problems will help you get ahead in your field.
3. You can handle new electronic devices. Every day, advances are being made in electronics. Only through education can you find out how to keep up with these developments and how to use the new devices.

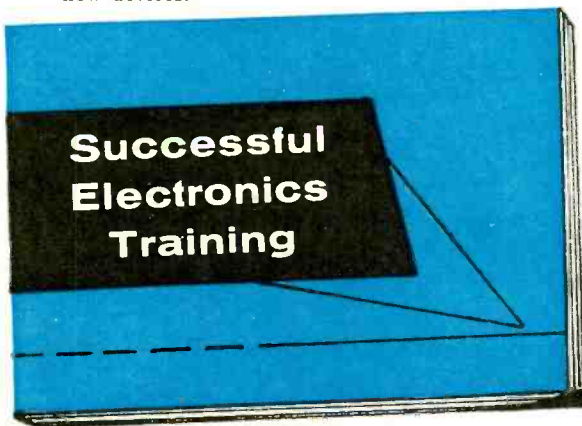

Increase Your Technical Knowledge

Get a government license plus an understanding of such electronic applications as computers . . . industrial electronics . . . radar . . . communications . . . and many more

CLEVELAND INSTITUTE OF ELECTRONICS
1776 E. 17th St. Desk RE58A Cleveland 14, Ohio

OCTOBER, 1961



good training
doesn't cost . . .
it pays!



Get All 3 Booklets and This Handy Pocket Electronics Data Guide Folder **Free**

Puts all the commonly used conversion factors, formulas, tables, and color codes at your fingertips. Yours absolutely free if you mail the coupon today. No further obligation.

Sorry—Not For Beginners

Please inquire only if you really want to get ahead and to add to what you have already learned in school, in the service, or on the job. Some previous schooling or experience in electronics, electricity, or related fields is necessary for success in Cleveland Institute programs.

Accredited by the National Home Study Council

Cleveland Institute of Electronics

Desk RE58A, 1776 E. 17th St., Cleveland 14, Ohio



Please send Free Career Information prepared to help me get ahead in Electronics. I have had training or experience in Electronics as indicated below.

- | | |
|---|---|
| <input type="checkbox"/> Military | <input type="checkbox"/> Broadcasting |
| <input type="checkbox"/> Radio-TV Servicing | <input type="checkbox"/> Home Experimenting |
| <input type="checkbox"/> Manufacturing | <input type="checkbox"/> Telephone Company |
| <input type="checkbox"/> Amateur Radio | <input type="checkbox"/> Other _____ |

In what kind of work are you now engaged?

In what branch of Electronics are you interested?

Name _____ Age _____

Address _____

City _____ Zone _____ State _____

RE58A

high-profit replacement twins

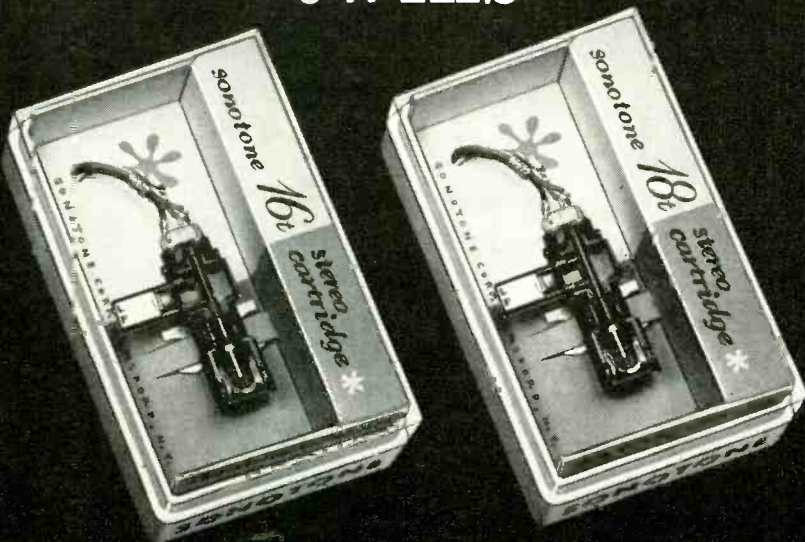

#1 choice of 16 leading high fidelity manufacturers

These 2 new Sonotone stereo cartridges are "original replacements" for the bulk of sets you service. They give brilliant, crisp highs...full lows. Satisfy the most critical audiophile's ear!

When you're all stocked up on Sonotone cartridges, good servicing is easy to do—and really brings in the profits.

The Sonotone 16T and 18T stereo cartridges are natural replacements. They are already being used as original equipment by America's leading phonograph manufacturers.

As for sets without Sonotone, replacement

with a Sonotone will make 2 out of 3 sound better. The specifications—especially the channel separation—would do anyone proud. The cartridges have no audible hum—never sound tinny.

There are Sonotones for every kind of set—from the simplest portable to the most extravagant stereo equipment. Stock Sonotone, and keep your customers happy...your profits high!

SPECIFICATIONS

Sonotone 16T
 Response.....flat ± 1 db from 20 to 10,000 cps,
 with smooth rolloff to 12,000 cps.
 Output Voltage... 0.5 volt
 Compliance..... 2.4×10^{-6} cm/dyne
 Tracking Force... 4-6 grams for professional arms,
 5-7 grams for changers.
 Mounting
 Dimensions... fits all standard mounting centers.

Sonotone 18T
 Response.....flat ± 1 db from 20 to 10,000 cps,
 with smooth rolloff to 12,000 cps.
 Output Voltage... 0.7 volt
 Compliance..... 1.5×10^{-6} cm/dyne
 Tracking Force... 6-8 grams for professional arms,
 7-9 grams for changers.
 Mounting
 Dimensions... fits all standard mounting centers.

Sonotone

© C ELECTRONIC APPLICATIONS DIVISION,
 O R DEPT. C2-101, ELMSFORD, N. Y.
 P. In Canada, contact Atlas Radio Corp., Ltd., Toronto

Leading Makers of Cartridges • Speakers • Tape Heads • Mikes • Electronic Tubes • Batteries

tion, unlike earlier units, and will work at temperatures approaching 120°C.

The new phototube works at the red end of the spectrum, operating on both visible and near-infrared light. It is designed to work between 0.4 and 0.9 micron, with a peak sensitivity at 0.85 micron. Applications for the new photodiode, according to Dr. Sutcliffe of the Lansdale Div., will include celestial body sensing, missile tracking, space vehicle guidance, and applications in the computer and inertial guidance fields. At its present price of \$100 each, its use will be confined to areas where cheaper and less sensitive phototubes will not work.

Quality Control Now Automated

Computers now not only direct machines but can look into the future and anticipate manufacturing mistakes or drifts toward tolerance limits before they happen. This is now being done on a production line that turns out resistors for Western Electric at Winston-Salem, N. C.

Military necessity—the need to turn out deposited-carbon resistors that would operate 200,000,000 hours without failure in the Nike-Zeus anti-missile missile system—sparked the program. A wholly new manufacturing philosophy emerged—a production procedure that omits final inspection, the costly process of sorting out and junking defective products.

First, the W-E engineers built a conventional automated line to make resistors under the control of a digital computer. Sensing devices were then installed at strategic stations along the line to detect trends in machine performance and tendencies on the part of the product to depart from specified values. Based on this information, supplied by the sensors, the computer continuously predicts future process trends and feeds correcting information to the automated line that heads off manufacturing errors before they occur. Hence, only good resistors are made.

FCC Moves on TV Allocations

Proposals for rules issued by the Federal Communications Commission would make several regions all-uhf and would drop in short-range vhf stations in a number of others. The FCC also proposes to continue to push for all-channel-set legislation, ease technical requirements for uhf TV transmitters, permit dual vhf-uhf operation by existing vhf stations, use uhf translators to fill in dead spots in a station's service area, and earmark certain uhf channels for educational TV.

The areas the FCC proposes to de-intermix and make all-uhf are Madison, Wis.; Champaign and Rockford, Ill.; Hartford, Conn.; Erie, Pa.; and Binghamton, N. Y.; Columbia, S. C., and Montgomery, Ala.



NRI—Oldest and Largest Radio Television School Now Offers NEW HOME STUDY TRAINING IN INDUSTRIAL ELECTRONICS & MILITARY ELECTRONICS



Special Training Equipment Included

Pick the field of your choice—and train at home with the leader—NRI. In addition to Industrial Electronics and FCC License training explained at the right, NRI offers comprehensive courses in Radio-TV Servicing and Radio-TV Communications. Except for the FCC course, all NRI courses include—at no extra cost—special training equipment for actual practice at home, building circuits and working experiments. Makes theory you learn come to life in an interesting, easy-to-grasp manner.

Multiplexing, FM Stereo Broadcasting Included

NRI training keeps up with the times. New, additional profit opportunities exist for the Technician who understands the latest technical advances. Course material now covers FM Stereo Broadcasting, tells you about Multiplexing equipment, other recent developments.

Learn More to Earn More

Act now. The catalog NRI sends you gives more facts about the field of your choice, shows equipment you get and keep. No obligation. Cost of NRI training is low. Monthly payments. 60-Day Trial Plan. Mail postage-free card today. NATIONAL RADIO INSTITUTE, Washington 16, D.C.

This is the age of Electronics. Rapidly expanding uses for Electronic Equipment in industry, business, the military demands more trained men. Prepare now for a career as an Electronic Technician to assure advancement or to profit from your hobby. NRI now offers a complete course in ELECTRONICS—Principles, Practices, Maintenance. Computers, telemetry, automation, avionics are changing our world, yet all employ the same basic principles . . . and that is what this NRI course stresses with illustrated lessons and special training equipment. Mail card below.

NEW HOME STUDY TRAINING FOR YOUR FCC LICENSE



An FCC Commercial License combined with NRI time-tested training can be the keys to a better future for you with higher pay, interesting work, more rapid advancement as the rewards. Prepare at home quickly for your FCC examinations through NRI's new, low-cost, special training. Like other NRI-trained men, you can be monitoring TV shows, radio broadcasts, operating shipboard and aviation radio, or holding down other important jobs. Get full details—mail the card below.

FOR MORE INFORMATION-TURN PAGE

Cut Out and Mail—No Stamp Needed



**NATIONAL RADIO INSTITUTE
WASHINGTON 16, D.C.**

Send me your Electronic, Radio-TV catalog without cost or obligation. I am interested in the course checked below: (No representative will call. Please PRINT.)

- | | |
|---|---|
| <input type="checkbox"/> INDUSTRIAL ELECTRONICS | <input type="checkbox"/> COMMUNICATIONS |
| <input type="checkbox"/> FCC LICENSE | <input type="checkbox"/> SERVICING |

WX

Name _____ Age _____

Address _____

City _____ Zone _____ State _____

ACCREDITED MEMBER NATIONAL HOME STUDY COUNCIL

**Send for
64-Page
CATALOG
FREE**

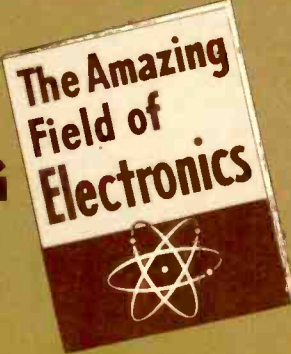

**ELECTRONICS NEEDS
4 TO 7
QUALIFIED TECHNICIANS**



FOR EVERY ENGINEER



Join The Thousands Who Trained For Advancement With NRI

Thousands of NRI graduates throughout the U. S. and Canada are proof that it is practical to train at home. NRI graduates are in every kind of Electronics work: inspectors, maintenance men, lab technicians, testers, broadcasting and mobile communications operators, Radio-TV service technicians, or in essential military and government posts. Catalog tells more about what NRI graduates do and earn. Mail postage free card.

Choose from 4 Courses

1 INDUSTRIAL ELECTRONICS
Learn Principles, Practices, Maintenance of Electronic equipment used today by business, industry, military, government. Covers computers, servos, telemetry, multiplexing, many other subjects.

2 FCC LICENSE
Every communications station must have one or more FCC-licensed operators. New NRI course is designed to prepare you for your First Class FCC exams. You learn quickly, training at home in your spare time.

3 COMMUNICATIONS
Training for men who want to operate and maintain radio and TV stations; police, marine, aviation, mobile radio, etc. Includes FM Stereo broadcasting. Course also prepares you for your FCC license exam.

4 SERVICING
Learn to service and maintain AM-FM Radios, TV sets, Stereo Hi-Fi, PA systems, etc. A profitable, interesting field for a spare-time or full-time business of your own.

SEE OTHER SIDE



"THE FINEST JOB I EVER HAD" is what Thomas Bilak, Jr., Cayuga, N. Y., says of his position with The G. E. Advanced Electronic Center at Cornell University. He writes, "Thanks to NRI, I have a job which I enjoy and which also pays well."



BUILDING ELECTRONIC CIRCUITS on specially-designed plug-in type chassis, is the work of Robert H. Laurens, Hammonton, N. J. He is an Electronic Technician working on the "Univac" computer. Laurens says, "My NRI training helped me to pass the test to obtain this position."



"I OWE MY SUCCESS TO NRI" says Cecil E. Wallace, Dallas, Texas. He holds a First Class FCC Radio-telephone License and works as a Recording Engineer with KRLD-TV.



MARINE RADIO OPERATOR is the job of E. P. Searcy, Jr., New Orleans, La. He works for Alcoa Steamship Company, has also worked as a TV transmitter engineer. He says, "I can recommend NRI training very highly."



FROM FACTORY LABORER TO HIS OWN BUSINESS that rang up sales of \$158,000 in one year. That's the success William F. Kline of Cincinnati, Ohio, has had since taking NRI training. "The course got me started on the road," he says.

FIRST CLASS
PERMIT
NO. 20-R
(Sec. 34.9, P.L.&R.)
Washington, D.C.

BUSINESS REPLY MAIL
NO POSTAGE STAMP NECESSARY IF MAILED IN THE UNITED STATES

POSTAGE WILL BE PAID BY



National Radio Institute
3939 Wisconsin Avenue
Washington 16, D.C.



NRI IS OLDEST—LARGEST SCHOOL OF ITS KIND

Training men to succeed by home study has been the National Radio Institute's only business for over 45 years. NRI is America's oldest and largest Electronics home-study school. Don't delay. Cut out and mail POSTAGE-FREE CARD.



MAIL POSTAGE-FREE CARD

The FCC also took three final actions, allotting channel 13 to Grand Rapids, Mich., channel 9 to Syracuse, and channel 9 to Rochester, N. Y.

Calendar of Events

- ISA Instrument Automation Conference and Exhibit**, Sept. 11-15, Los Angeles Memorial Sports Arena, Los Angeles.
- EIA Fall Conference**, Sept. 12-14, Biltmore Hotel, New York.
- IHFH High Fidelity Show**, Sept. 13-17, Trade Show Building, New York. Radio-Electronics will exhibit in Room 525.
- AIEE-IRE Engineering Management Conference**, Sept. 14-15, Roosevelt Hotel, New York N.Y.
- IRE Symposium on Engineering Writing and Speech**, Sept. 14-15, Bellevue-Stratford Hotel, Philadelphia, Pa.
- National Exhibition of Radio and TV**, set for Sept. 14-25, Parc Des Expositions, Paris, France.
- Instrument Society of America-AIEE-IRE Industrial Electronics Symposium**, Sept. 20-21, Bradford Hotel, Boston, Mass.
- IRE National Communications Symposium**, Oct. 2-4, Utica, N.Y.
- IRE Canadian Electronics Conference**, Oct. 2-4, Automotive Bldg., Exhibition Park, Toronto, Canada.
- IRE Annual Broadcast Symposium**, Oct. 6-7, Willard Hotel, Washington, D.C.
- IRE-AIEE National Electronics Conference**, Oct. 9-11, International Amphitheatre, Chicago.
- Audio Engineering Society Fall Convention and Technical Exhibit**, Oct. 9-13, Hotel New Yorker, New York.
- IRE National Symposium on Engineering Writing & Speech**, Oct. 16-17, Michigan State University, East Lansing, Mich.
- IRE Symposium on Electronics Engineering and Education**, Oct. 19-20, Greensboro Coliseum, Greensboro, N. C.
- IRE New York Conference on Electronic Reliability**, Oct. 20, New York University College of Engineering, New York.
- IRE East Coast Conference on Aerospace & Navigational Electronics**, Oct. 23-25, Lord Baltimore Hotel, Baltimore, Md.
- URSI-IRE Fall Meeting** Oct. 23-25, University of Texas, Austin, Tex.
- Armour Research Foundation 1961 Computer Application Symposium**, Oct. 25-26, Morrison Hotel, Chicago.
- IRE Electron Devices Meeting**, Oct. 26-28, Sheraton Park Hotel, Washington, D. C.
- ERA Mid-Atlantic Chapter Hi-Fidelity Show**, Oct. 27-29, Benjamin Franklin Hotel, Philadelphia, Pa.
- EIA-IRE Annual Radio Fall Meeting**, Oct. 30-Nov. 1, Hotel Syracuse, Syracuse, N. Y.
- IRE-AIEE Conference on Nonlinear Magnetics**, Nov. 6-8, Statler Hilton Hotel, Los Angeles.
- IRE Conference on Radio Interference Reduction and Electronic Compatibility**, Nov. 7-9, Illinois Institute of Technology, Chicago.
- AIEE-IRE Conference on Magnetism and Magnetic Materials**, Nov. 13-16, Hotel Westward Ho, Phoenix, Ariz.
- IRE Northeast Research and Engineering Meeting**, Nov. 14-16, Somerset Hotel & Commonwealth Armory, Boston.
- IRE Symposium on Electronic Systems Reliability**, Nov. 14, Linda Hall Library Auditorium, Kansas City, Mo.

Medical Electronic Progress Reported at Convention

Electronics is already playing an important part in practical medicine, delegates to the Fourth International Conference of Medical Electronics reported. The conference was held in New York, with Vladimir K. Zworykin presiding.

The use of computers was possibly the most impressive advance. Dozens were exhibited at the conference, some capable of analyzing and correlating data on as many as 800 symptoms and 100 diseases for the benefit of the doctor making a diagnosis.

(Continued on page 16)

for outstanding value . . .

Build Your Own superb Scott Stereo Components!

Have fun . . . save money . . . get the best! Now you can build your own world-famous Scott components . . . and you can make substantial savings compared to the costs of the nearest equivalent factory assembled units.

H. H. Scott kits feature the same engineering, same high performance, same features and parts as do the factory wired components. Tuners have exclusive Scott Wide-Band design with factory aligned silver-plated front ends. Amplifiers use H. H. Scott's superb conservatively rated transformers.

Scott kits are fun to build, too. The wires are pre-cut to exact length and pre-stripped. Instruction books are in full color to help you see exactly what you're doing. Mechanical parts are factory-riveted to the chassis.

For a genuine H. H. Scott system at a real saving, choose from these fine kits:

LT-110 FM Multiplex Stereo Tuner Pre-wired and aligned front end and multiplex sections; Wide-Band design; 2.2 uv sensitivity (IHFM); \$159.95*

LK-48 48-Watt Stereo Complete Amplifier Kit A truly superior amplifier with power enough to drive even the most inefficient speaker systems. Only \$119.95*

LK-72 72-Watt Stereo Complete Amplifier Kit Fabulous Scott features never before available in a kit: derived center channel controls; tape monitor; \$159.95*

LT-10 FM Tuner Kit Unique Ez-A-Line alignment system. Sensitivity 2.2 uv (IHFM). \$99.95*

LC-21 Stereo Pre-Amplifier Kit Exceptional versatility. 16 front panel controls; frequency response for optional laboratory applications 8 to 50,000 cps! \$99.95*

LK-150 150-Watt Stereo Power Amplifier Kit Conservative design, massive transformers unsurpassed performance. \$169.95*

*slightly higher West of Rockies.

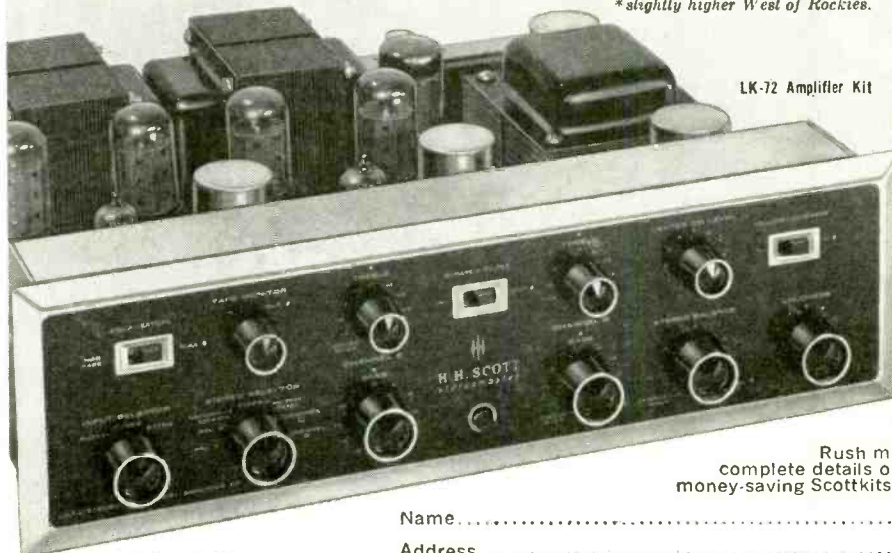

LK-72 Amplifier Kit

Rush me complete details on money-saving Scottkits.

Name.....
Address.....
City..... Zone..... State.....

H.H. SCOTT

H. H. Scott, Inc., Dept. 570-10
111 Powdermill Rd., Maynard, Mass.

Export: Morhan
Exporting Corp.,
458 Broadway, NYC

FREE!

Colorful and detailed 20-page "Guide to Custom Stereo" including complete technical information on Scottkits.

WATCH FOR

THESE

FEATURES

IN

Radio-Electronics

FUTURE

ISSUES

- Ionosphere—Invisible Radio Mirror
- Electronic Careers in the Navy
- Build a Kit or Build from Scratch?
- Get Full Value from Your Scope
- Industrial Infrared Radiometers
- Build an Audio Voltmeter-Wattmeter
- Automobile Interference Suppression
- Crossover Networks—a Practical Approach
- Make a Simple Reverberation Unit

SUBSCRIPTION RATES

1 year \$5 2 years \$9 3 years \$12

154 West 14th Street

New York 11, N.Y.

NOVEMBER ISSUE—On Sale Oct. 17

At Bell Telephone Laboratories, mathematician Sidney Darlington has contributed notably in developing the art of circuit analysis.

IT HAPPENS IN THE MIND...

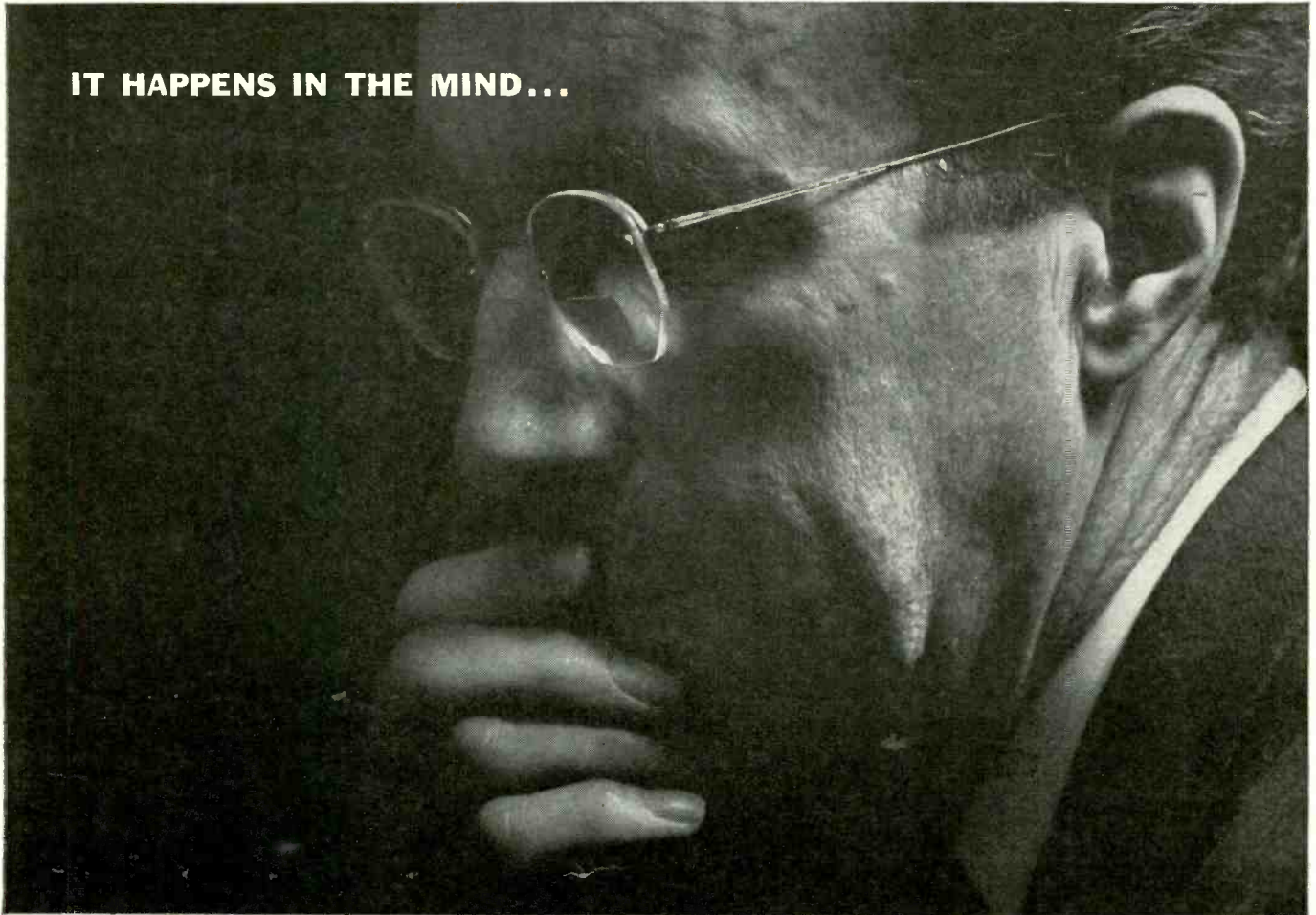

... It is essentially a thing of the mind for it works through concepts, symbols and relationships ... it helps man to analyze and synthesize the complex phenomena of the universe and himself ... it works in many ways to advance electrical communications:

IT IS CALLED MATHEMATICS

At Bell Telephone Laboratories mathematics works powerfully to solve problems involving complex data. For example, engineers must design and synthesize complex systems to process specific signals in precisely controlled ways. At the same time the technology provides a wide choice of circuits and components. Mathematical circuit analysis reveals the circuits which can do the job most efficiently and economically.

Intriguingly, too, the mathematical approach leads to basically new knowledge. For example, it led to the invention of the electric wave filter ... disclosed a kind of wave trans-

mission which may some day carry huge amounts of information in waveguide systems ... foretold the feasibility of modern quality control ... led to a scientific technique for determining how many circuits must be provided for good service without having costly equipment lie idle.

In the continuing creation of new devices, technologies and systems, Bell Laboratories utilizes whatever serves best—mathematical analysis, laboratory experimentation, simulation with electronic computers. Together they assure the economical advancement of all Bell System communications services.



BELL TELEPHONE LABORATORIES

WORLD CENTER OF COMMUNICATIONS RESEARCH AND DEVELOPMENT

The Same School That Originated The RTS BUSINESS PLAN

...NOW
Proudly
Presents...

A SPECIAL **COMPACT** COURSE COVERING ALL THREE PHASES OF **ELECTRONICS**

The Entire Course Is Made Up Of The Following:

- 35 LESSONS COVERING BASIC AND INTERMEDIATE ELECTRONICS
- 9 EQUIPMENT KITS COMPLETE WITH TUBES AND BATTERIES
- SOLDERING IRON
- 25 LESSONS COVERING THESE ADVANCED ELECTRONIC SUBJECTS:
 - Thyratron Tubes • Semiconductors • Electronic Symbols and Drawings • Voltage-Regulators • Electronic-Timers • Control Systems • X-Rays • Photoelectric Devices • Dielectric Heating • Geiger Counters • Pulse Circuitry • Clippers and Limiters • Multivibrators • Electronic Counters • Radar • Magnetic Amplifiers • Analog-Computers • DC Amplifiers • Digital Computers • Storage Systems • Input and Output Devices • Servomechanisms • Telemetry
- 60 EXAMINATIONS
- UNLIMITED CONSULTATION SERVICE
- KIT MANUALS
- DIPLOMA UPON GRADUATION

BASIC • INTERMEDIATE • ADVANCED
DESIGNED FOR THE BUSY MAN OF TODAY

This is MODERN training for the MODERN man. You'll find no "horse and buggy" methods here. Every page of this streamlined course is devoted to important Electronics principles and practical projects. You'll be amazed how fast you grasp Electronics the RTS way. RTS has combined modern THEORY and PRACTICE to make this the finest training program of its kind available!

SATISFIES NOVICE, TECHNICIAN OR HOBBYIST

Whether you're new to Electronics or an old "pro," chances are you'll find this to be the ideal course for you. The novice will appreciate the completeness of the training. It starts with the most basic considerations, covering each important point thoroughly; yet concisely. The technician will enjoy the practical review of fundamentals and profit from the 25 advanced subjects covered.

RTS GIVES YOU "TOP MILEAGE" FOR YOUR TRAINING DOLLAR

The price quoted below buys EVERYTHING — there are no extras to pay for. RTS has gone "all out" to give you the best training value in America. Why pay hundreds of dollars for training such as we offer when it's available for this LOW PRICE? If you can find a better training bargain... BUY IT!

CAN BE COMPLETED IN MONTHS INSTEAD OF YEARS

Some students will complete this course with "Jet-Like" speed but we allow up to two years if your circumstances require it. You study at your own rate. You are ENCOURAGED but not pushed. You'll find the lessons professionally written but easy to understand. LET US SEND YOU ONE OF THESE LESSONS ALONG WITH YOUR CAREER BOOKLET SO YOU CAN SEE FOR YOURSELF. NO OBLIGATION!

AND MUCH MORE...

RTS' Membership in The Association of Home Study Schools is your assurance of Reliability, Integrity and Quality of Training.



RTS ELECTRONICS DIVISION
815 E. ROSECRANS AVENUE
LOS ANGELES 59, CALIFORNIA

Est. 1922



L 201B

**COMPLETE COST...
INCLUDES ALL KITS,
TUBES, BATTERIES, ETC.
\$125.00***

**Rush
Coupon**

**NO
SALESMAN
WILL
CALL!**

* TERMS ALSO AVAILABLE
AS LITTLE AS

\$500 DOWN \$500 PER MONTH

**SAVE TIME — SEND
\$5.00 WITH COUPON**
YOUR FIRST LESSONS AND
KIT WILL BE RUSHED TO YOU
THE SAME DAY THEY ARE RECEIVED!

DON'T LOSE OUT — FIND OUT!

RTS ELECTRONICS DIVISION, Dept. RE101

815 E. ROSECRANS AVENUE LOS ANGELES 59, CALIFORNIA

Rush me full information by return mail. (Please Print)

Name _____ Age _____

Address _____

City _____ Zone _____ State _____

ENROLL ME NOW **SEND MORE FACTS**

KEEP A CONSTANT CHECK ON YOUR LINE VOLTAGE

ACTUAL
SIZE

with the New RCA WV-120A POWER LINE MONITOR

- **EXPANDED SCALE**
Scale is expanded from 100 to 140 volts for easy reading
 - **HIGH ACCURACY**
±2% at 120 volts; ±3% at 100 and 140 volts
 - **TRUE RMS READINGS**
Moving-vane type meter gives accurate RMS readings, even when line voltage is not pure sine wave
 - **FAST METER ACTION**
Reveals "bounces" and fluctuations in line voltage
 - **LARGE NUMERALS, LARGE POINTER, LARGE SCALE**
Provide easy readability from distance of ten feet or more
 - **CONVENIENT WALL MOUNTING**
Holes are provided in rear of case for wall mounting
 - **LOW PRICE—ONLY \$14.95***
Extremely low priced for a large-sized, expanded scale, RMS meter of such high accuracy
- See the RCA WV-120A at your Authorized RCA Distributor.
*User Price (Optional)

Electron Tube Div., Harrison, N. J.



The Most Trusted Name
in Electronics

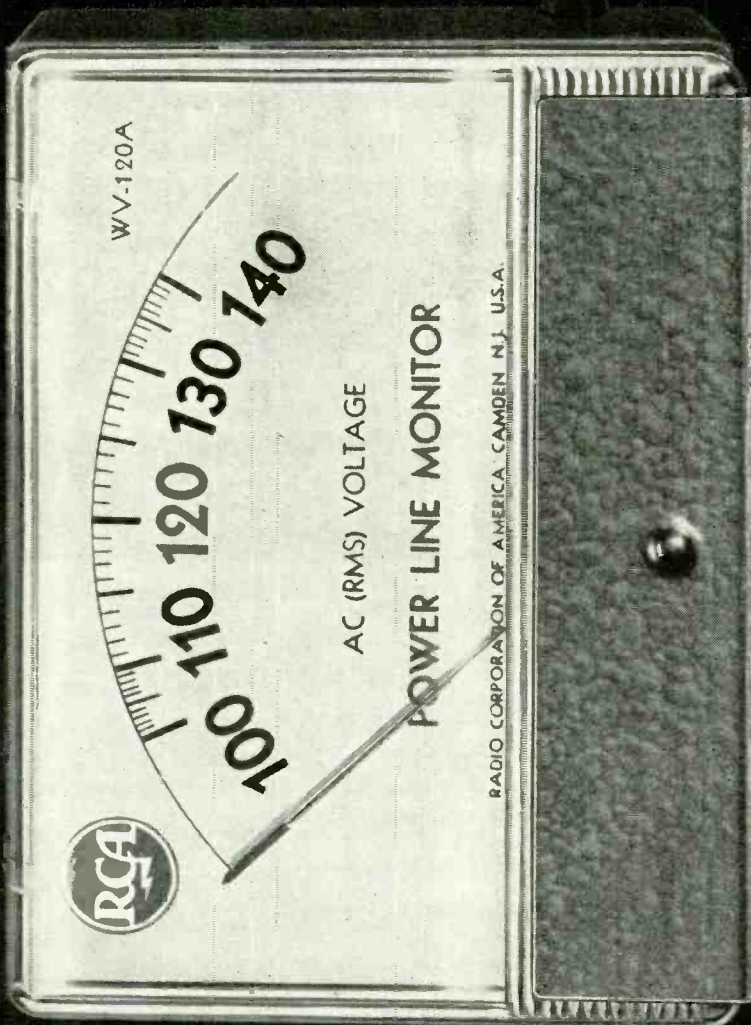

(Continued from page 13)

Other devices exhibited were new types of radio pills, which telemeter information from the stomach or intestinal tract when swallowed by the patient. Other devices included television cameras so small as to permit photographing surgical procedures formerly inaccessible to the camera, a continuous-recording electroencephalograph and monitoring devices that make it possible for a nurse at a single desk to observe continuously the temperature, pulse, respiration and bodily movements of a ward of a dozen patients.

Battery TV's Arrive

The 8-inch Japanese transistor battery portables reported in this and other magazines nearly a year ago were placed on sale in the New York market late in June. The sets are made by Sony, well known for its transistor radios, and are selling at \$249.95.

Silicon Rectifiers Replace Tube Types in Transmitters

Frank Marx, vice president in charge of engineering of the American Broadcasting Co. has announced that silicon rectifiers will replace tube rectifiers in all its owned and operated radio stations. Marx stated that 35% to 40% of the troubles that caused disruption of service have been due to mercury rectifier arc-backs, and that these are the largest single cause of serious transmitter troubles. The development of high-voltage semiconductor rectifiers, he says, offers a means of eliminating this source of transmitter trouble, and of "assuring our stations of continuous, dependable service."

TV City Guide for Tourists

An application filed with New York City authorities for a closed-circuit television system would provide TV information on New York's entertainment and shopping facilities to the guests in 200,000 hotel rooms.

The city guide programs, according to the backers of the proposal, Sterling Information Services, would be piped in on one of the vacant channels, and would be 1 hour long with 1 minute of commercials for each 5 minutes of noncommercial time. Existing ducts belonging to the telephone company would be used to transmit the programs.

Electronics Spots Hurricanes

Hurricanes this season are being kept under closer control than ever before, the Weather Bureau reports. Last year, the bureau states, hurricane Donna was kept under close watch by the new weather radar being tried out at Miami, Key West, Daytona Beach and Tampa. This year additional stations have been installed at Brownsville (Tex.), New Orleans, Charleston (S.C.), Washington and New York, while useful

MAKE MORE MONEY



TRAIN FOR ELECTRONICS . . .

In RESIDENT CLASSES

Grantham *resident* schools are located in four major cities—Hollywood, Seattle, Kansas City, and Washington, D. C. Regularly scheduled classes in F. C. C. license preparation are offered at all locations. New *day* classes begin every three months, and new *evening* classes begin four times a year. The day classes meet 5 days a week and prepare you for a first class F. C. C. license in 12 weeks. The evening classes meet 3 nights a week and prepare you for a first class license in 20 weeks. For more information about the Grantham resident schools, indicate in the coupon the city of your choice and then mail the coupon to the School's home office in Hollywood, Calif. Free details will be mailed to you promptly.

Through HOME STUDY

Grantham training is the easy way to learn more quickly—to prepare more thoroughly—for F. C. C. examinations. And your first class license is the quick, easy way to prove to your employer that you are worth more money.

This correspondence course is directed toward two major objectives—(1) to *teach* you a great deal about electronics, and (2) to prepare you to *pass* all of the F. C. C. examinations required for a first class commercial operator's license. We teach you step by step and have you practice with FCC-type tests which you send to the school for grading and comment. You prepare for your F. C. C. examinations under the watchful direction of an instructor who is especially qualified in this field.

GET your first class commercial F. C. C. LICENSE

To get ahead in electronics—first, you need the proper training; then, you need “proof” of your knowledge. Your first class commercial F. C. C. license is a “diploma” in communications electronics, awarded by the U. S. Government when you pass certain examinations. This diploma is recognized by employers. Grantham School of Electronics specializes in preparing you to *earn* this diploma.

Grantham training is offered in resident classes or by correspondence. Our free booklet gives complete details. If you are interested in preparing for your F. C. C. license, mail the coupon below to the School's home office at 1505 N. Western Ave., Hollywood 27, California—the address given in the coupon—and our free booklet will be mailed to you promptly. No charge—no obligation.

Get your First Class Commercial F.C.C. License by training at

GRANTHAM SCHOOL OF ELECTRONICS

HOLLYWOOD

SEATTLE

KANSAS CITY

WASHINGTON

Accredited by the National Home Study Council

This booklet **FREE!**

This free booklet gives details of our training and explains what an F. C. C. license can do for your future. Send for your copy today.

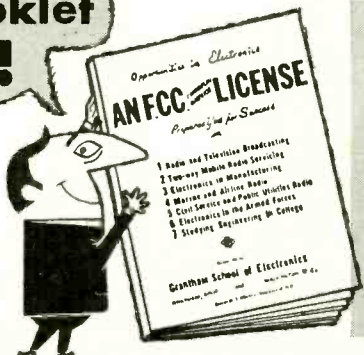

for **FREE** Booklet **CLIP COUPON** and mail in envelope or paste on postal card.

for **FREE** Booklet **CLIP COUPON** and mail in envelope or paste on postal card.



To: **GRANTHAM SCHOOL OF ELECTRONICS**
1505 N. Western Ave., Hollywood 27, Calif.

Please send me your free booklet telling how I can get my commercial F. C. C. license quickly. I understand there is no obligation and no salesman will call.

Name _____ Age _____

Address _____

City _____ State _____

I am interested in: Home Study, Kansas City classes, 14R
 Hollywood classes, Seattle classes, Washington classes

with **DYNAKIT**
you know
you have the **BEST!**

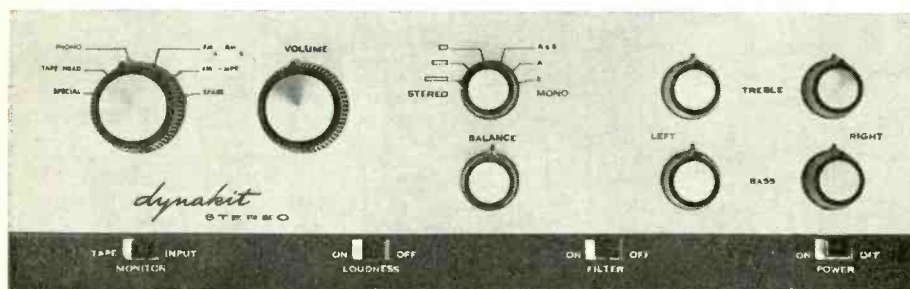

PAS-2 \$59.95 kit, \$99.95 assembled

The new Dynakit Stereophonic Preamplifier has *all* the quality features which you require for the finest high fidelity reproduction. This handsomely styled control unit is a model of classical quality and contemporary simplicity.

BEST IN EVERY WAY

In either kit or wired form, the new Dynakit Stereo Preamp represents both the finest quality and the finest value available. It utilizes the basic circuitry of the famous Dynakit monophonic preamplifier without compromise of quality. This circuit has the lowest possible distortion, an absolute minimum of hum and noise, superior transient response, and every other attribute which can contribute to natural, satisfying sound quality.

Dynakit's basic philosophy of simplicity of layout and control action, along with impeccable performance, is well exemplified in the design. Every useful function is incorporated, but the operation of the unit is not complex since the controls are arranged and identified in a functional manner. Operation of controls and switches is smooth, noise-free, and non-interacting. The unit is a pleasure to assemble, a pleasure to operate, and a pleasure to hear. It is not necessary to spend a lot of money to have the best sound available. Dynakit equipment has no compromises in quality. It is designed to be the finest and to be used by those who are not satisfied with less than the best. We suggest that you listen to it at your Hi Fi dealer, or write for our brochure which gives complete specifications on all Dynakit high fidelity components.

★ **Best Performance**

Frequency response within 1 db 10 cps to 40 kc. Distortion (either IM or harmonic) less than .05%. Response and distortion unaffected by settings of volume control. Undistorted square wave performance demonstrates outstandingly fine transient performance. Noise and hum inaudible at normal listening levels. High gain permits operation with lowest level cartridges. (1 millivolt input gives 1 volt output on RIAA input.)

★ **Finest Quality Components**

1% tolerance components used in critical equalization-determining circuits. Tone control components matched to provide **absolutely flat response** at center settings. Highest quality plastic molded capacitors, low noise resistors, conservatively operated electrolytics, plated chassis and hardware, all lead to long life with unchanging specifications. One year guarantee on all parts.

★ **Greater Flexibility**

7 stereo inputs (or 14 monophonic ones) provide for all present and future sources. "Special" input provides option for special equalization characteristics. Provision for tape head, tape playback amplifier, and monitoring tape recordings. **Independent** tone controls for each channel. Exclusive Dyna "Blend" switch to control stereo separation. Unique feedback scratch filter takes out the hash and leaves in the music. Rear panel ac outlets enable switching other components with preamp on-off switch. Self-powered (with dc heater supply) permits use with any amplifiers.

★ **Outstanding Appearance**

Choice of bone white or charcoal brown textured finish cover. Solid brass, etched front panel. Designed by Raoul Ibarquien, prominent industrial stylist. Requires only 13" by 3 3/4" panel space and can be readily mounted on any thickness of panel with convenient PM-3 auxiliary mounting kit.

★ **Easiest Assembly**

About 8 hour average assembly time—from one-third to one-fourth that of other kits. Assembly speeded by use of pre-assembled printed circuit boards plus ultra-simple and accessible layout of parts. Complete pictorial diagrams included plus step-by-step instructions so that no technical skill is required. Also available fully wire and individually tested.

radars will also be working on Nantucket and Cape Hatteras. The radar stations will probably receive some aid from weather satellites, which can observe and plot the path of a storm directly. Ordinary radio will also play its part, as weather planes close to the hurricane send back detailed reports.

Briefer Briefs

All capacitors and resistors made by Aerovox and sold through all industry markets are now covered by a 2-year warranty. The new policy, the company states, is the result of the increasing recognition of product reliability and dependability. No immediate increase in prices is seen as a result of the longer warranty.

Radio Corporation of America announces that its millionth nuvistor has been produced. The small-size, low-noise tube is used especially in TV tuners to improve signal-noise ratio in fringe areas. Nuvistors are now available in five types: two general-purpose industrial triodes, a general-purpose industrial sharp-cutoff tetrode, and two high-mu entertainment triodes.

Normal metals may act like superconductors at very low temperatures, according to scientists of the Arthur D. Little laboratories in Cambridge, Mass. Normal metals in thin film form, they find, can be made to act as superconductors by placing them in contact with a superconducting metal film at the proper temperature.

The FCC proposes to amend its Rules and Regulations so that the seal certifying that a television receiver complies with FCC radiation limits will be visible. The proposed rule provides that the seal shall be affixed to the back panel, shall be 1 x 3 inches in size and shall contrast with the color of the cabinet finish.

New transistorized image orthicon TV camera developed by Admiral for the Signal Corps is so sensitive that it is "capable of observing persons and objects from a distance of several hundred yards in virtually total darkness." The camera measures 5 x 10 x 30 inches and weighs 35 lb.

Sylvania has joined the ranks of the color TV producers, with a 21-inch set that will be available at a suggested list price of \$825.

New Canadian 1,300-mile microwave communications system stretches from Grand Prairie, Alta., to Mount Dave on the Yukon-Alaskan border. It vastly improves telephone and telegraph communications along the length of Canada's Alaska Highway, and forms a link in a high-quality communications system between the United States and Alaska. END

DYNACO, INC., 3916 POWELTON AVENUE, PHILA. 4, PA.
 CABLE ADDRESS: DYNACO, PHILA.

STOP AND SHOP

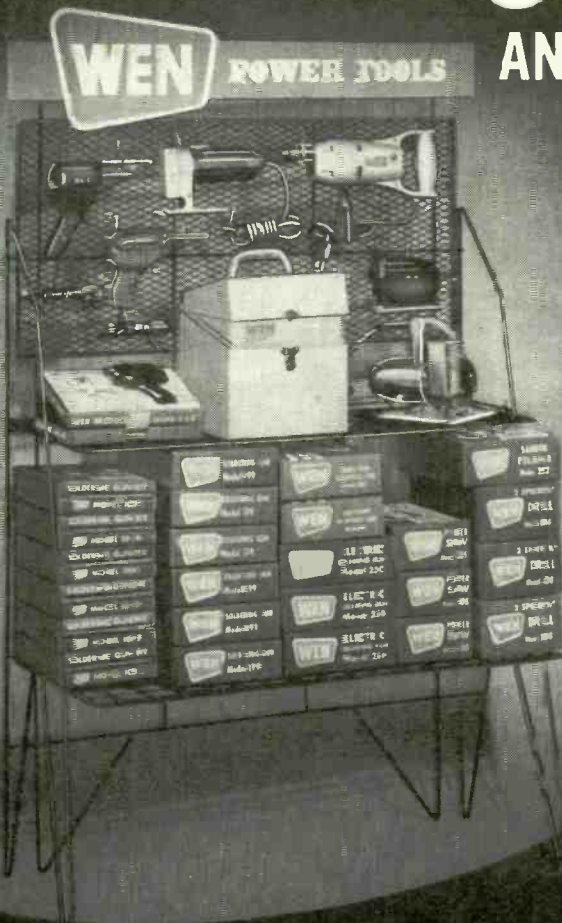

Look for this convenient display at your Electronic Parts Distributor (listed in the column at right). A full assortment of famous WEN power tools awaits your inspection. Step up to WEN quality—factory guaranteed to perform to professional standards.

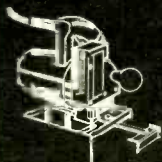

FAMOUS "ALL SAW"

Best selling power saw in the business! A souped-up UL "Industrially Rated" 1/2 HP saw—equal, great for 6" logs and delicate pattern work. Cuts virtually any material quickly cleanly. Complete with 7 blades rip guide, circle cutter. \$44.95.



UNIVERSAL SABRE SAW

Lightweight and extremely versatile! Easily cuts 2 x 4's and fine scrollwork in any shape. Cuts wood, steel, wallboard, plastic, leather—anything normally cut with any saw. Powerful J.L. Approved motor \$26.95.



2-SPEED DOUBLE-DUTY DRILL

No other drill like it! Big 3/8" geared chuck—2 speeds. Change from 1000 RPM (heavy duty) to 3000 RPM (delicate work) in seconds. 2 ball thrust bearings... oversize oilite bearings. Drill, polish, sand, grind, wire brush, mix pair—you name it. Most versatile tool in your workshop. \$29.95.



PROFESSIONAL SOLDER GUNS

The standard of the Electronic Industry for 10 years! No one—not even WEN—has been able to improve the WEN design. Quick heat, slim sturdy plastic housings. From feather-light 100 watts to 250 watt heavy duty Guns and kits \$5.95 to \$15.95.

WORLD'S FINEST SANDERS



Choose from 3 models—all straight-line fine-finish types... all with plenty of power. Perfect for re-finishing and new wood work. Never a scratch to mar a good surface. 14,400 strokes per minute by sanding surfaces to 20 sq. in. \$13.95 to \$19.95.

WEN PRODUCTS, INC.

3310 Northwest Highway, Chicago 3, Ill.

- ALA., Opelika, Southern Electronics Corp.
- CALIF., Buena Park, Ford Electronics
- Burbank, Electronic City, Inc.
- Downey, Master Electronic Supply, Inc.
- Hollywood, Hollywood Radio & Electronics, Inc.
- Yale Radio Electric Co.
- Inglewood, Acorn Radio & Electronics
- Long Beach, Larry Lynde
- Los Angeles, Hoffman Electronics-Parts Sales
- Figart's Radio Supply Co.
- Radio Products Sales, Inc.
- Shelley Radio Co., Inc.
- North Hollywood Arrow Sales, Inc.
- Hong Distributing Co.
- Oakland, Brill Audio Products
- Oxnard, Warsco Sales Co.
- Paramount, Elwyn W. Ley Co.
- Pasadena, Dow Radio, Inc.
- Riverside, Electronic Emporium Corp.
- Sacramento, Lombard's Electronics
- Radio Television Products, Co.
- San Carlos, Fortune Electronics
- San Diego, Southland Electronics Inc.
- San Francisco, Market Radio Supply Co.
- West Coast Radio & Electronics
- San Jose, Dealer Electronic Corp.
- Schad Electronic Supply, Inc.
- Santa Ana, Arrow Electronics, Inc.
- Seaside, Mat's Electronics Supply
- Temple City, G & M Wholesale Electronics
- Torrance, Torrance Electronics
- West Covina, West Covina Wholesale Electronics
- COLO., Denver, Fistell's Electronic Supply Co.
- Mountain States Electric Supply
- CONN., Hartford, Del Padre Supply of Hartford
- D.C., Washington, Electronic Wholesalers, Inc.
- FLA., Pensacola, Grice Electronics, Inc.
- Tallahassee, Peard Electronic Supply, Inc.
- GA., Atlanta, Southeastern Radio Parts Co.
- Macon, Peard Electronic Supply, Inc.
- ILL., Aurora, Nationwide—W. J. Electronics
- Berwyn, Nationwide—W. J. Electronics
- B. B. & W. Inc.
- Champaign, York Radio and Television
- Chicago, Allied Radio Corp.
- Arthur Nagel Inc.
- Bowman Electronic Supply Co.
- Nationwide—W. J. Electronics
- Phico Dist., Inc.
- Forest Park, Allied Radio Corp.
- Kankakee, York Radio and Television
- Oak Park, Melvin Electronics, Inc.
- Skokie, E & H Electrical Distributors
- Springfield, York Radio and Television
- Waukegan, Nationwide—W. J. Electronics
- IND., Evansville, Geo. C. Mettler Co.
- Gary, Allied Radio of Indiana
- Nationwide—W. J. Electronics
- Hammond, Tri-City Electric Co., Inc.
- Nationwide—W. J. Electronics
- Indianapolis, Graham Electronics Supply
- Radio Distributing Co.
- Van Sickle Radio Supply Co.
- IA., Fort Madison, York Radio and Television
- Sioux City, Duke's Radio Co.
- Molstad Distributing Co.
- Ottumwa, York Radio and Television
- LA., Baton Rouge, Davis Electronics Supplies
- Lafayette, Electro Technical Labs.
- Lake Charles, Wholesale Radio Equipment, Inc.
- New Orleans, Walther Bros. Co., Inc.
- Radio Parts Inc.
- Shreveport, Koelmay Sales Co., Inc.
- MASS., Lawrence, Alco Electronics
- MD., Baltimore, Revaco of Maryland, Inc.
- Silver Spring, Silver Spring Electronic Supply
- MICH., Detroit, Electronic Parts Co.
- MISS., Greenville, Delta Electronics Supplies, Inc.
- Pascagoula, Mays Electronics Supply
- MO., Hannibal, York Radio and Television
- Jefferson City, York Radio and Television
- Joplin, Russell Belden Electric Co.
- Kansas City, Walters Radio Supply, Inc.
- NEBR., Omaha, Omaha Electronics Co.
- N.H., Laconia, Laconia Electric Co.
- Nashua, Gate City Electric Co.
- N.Y., Albany, Seiden Sound, Inc.
- Binghamton, Stack Electronics, Inc.
- Bronx, W. Bergman Co., Inc.
- Buffalo, W. Bergman Co., Inc.
- Radio Equipment Corp.
- Hempstead, Standard Parts Corp.
- Rochester, Rochester Radio Supply Co.
- Syracuse, Morris Electronics of Syracuse, Inc.
- Utica, Associated Electronics Supply
- OHIO, Akron, The Sun Radio Co.
- Chillicothe, Buckeye Electronics Distributors, Inc.
- Columbus, Buckeye Electronics Distributors, Inc.
- Whitehead Radio Co.
- Coshocton, Wagner's Supply
- Dayton, Srepcu, Inc.
- Stotts-Friedman Co.
- East Liverpool, United Electronics, Inc.
- Lancaster, Buckeye Electronics Distributors, Inc.
- Lima, Hutch & Son
- Mansfield, Wholesaling, Inc.
- Toledo, Lifetime Electronics
- Mainline Dist., Inc.
- Warren Radio Co.
- Warren, Rem Electronics
- Youngstown, Armes Electronics
- Glen Electronics
- PA., Butler, E and E Supply, Inc.
- Erie, Warren Radio, Inc.
- Harrisburg, Radio Distributing Co.
- Philadelphia, Radio Electric Service Co.
- Pittsburgh, Lafayette Radio Electronics
- M. Left Parts Co.
- Radio Parts Co.
- Tarentum, Huston TV Parts
- Wayne, High Fidelity House
- TEXAS, Austin, Service Electronic Supply
- UTAH, Salt Lake City, Manwill Supply Co.
- VA., Portsmouth, Distributors, Inc.
- WASH., Seattle, F. B. Connelly Co.
- Seattle Radio Supply, Inc.
- W. VA., Beckley, Chemcity Electronic Dist., Inc.
- WIS., Appleton, Valley Radio Distributors
- Fond du Lac, Harris Radio Corp.
- Madison, Radio Distributors
- Satterfield Electronics, Inc.
- Manitowoc, Harris Radio Corp.
- Milwaukee, Allied Radio of Wisconsin
- Radio Parts Co.
- Electronic Enterprises, Inc.
- Portage, Satterfield Electronics, Inc.
- West Allis, Marsh Radio Supply
- Wisconsin Rapids, Satterfield Electronics, Inc.

Free

ALLIED

444-PAGE ELECTRONICS CATALOG

WORLD'S BIGGEST • MOST COMPLETE

*best buys
for 1962*

**EVERYTHING IN
ELECTRONICS
including exclusive
products & special
values available
only from
ALLIED**

**Send
for it
today!**

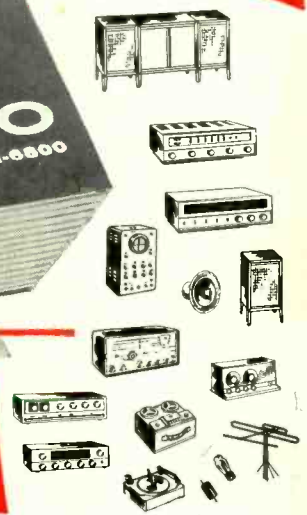
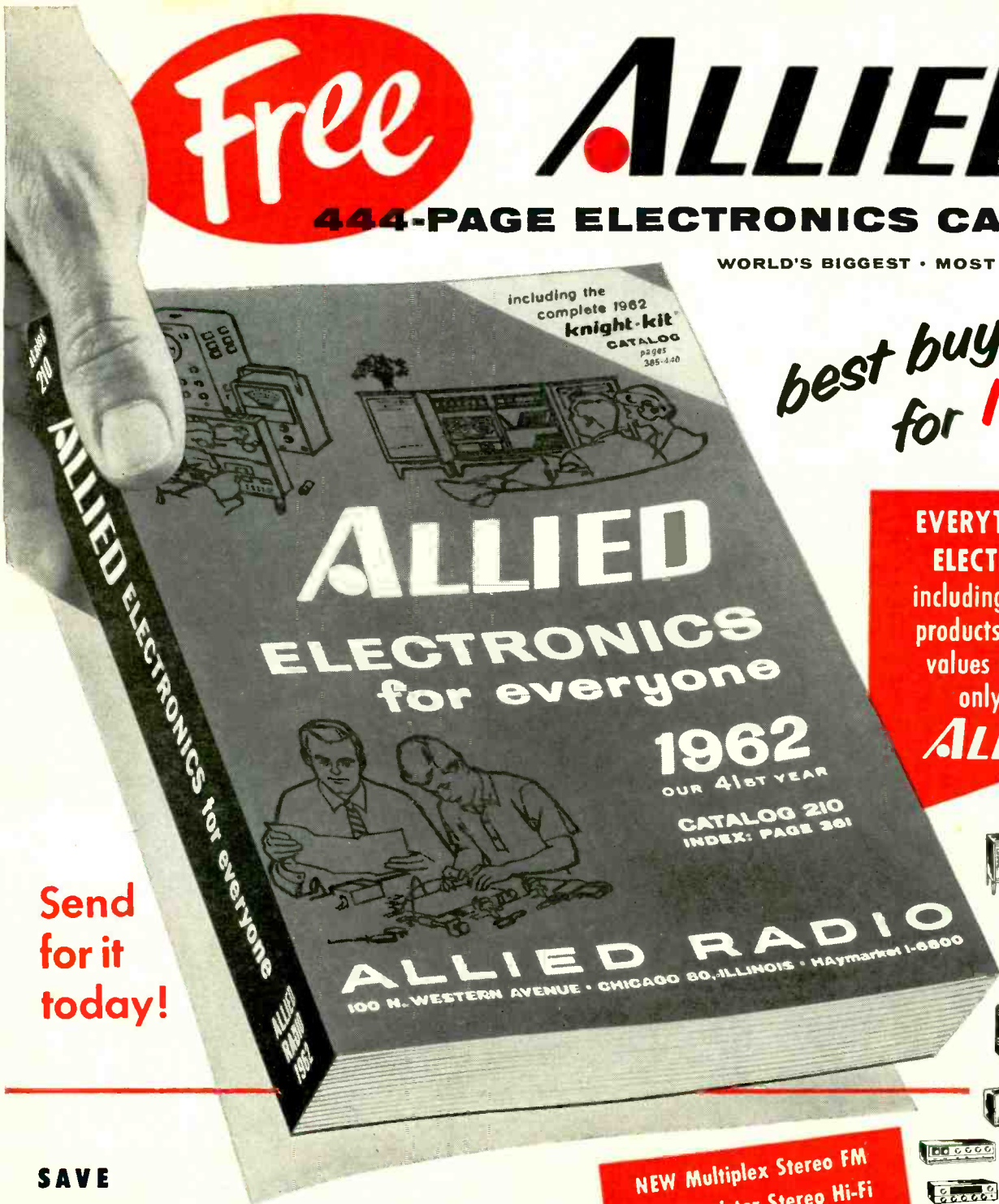

**SAVE
MOST
ON EVERYTHING IN ELECTRONICS**

- New Stereo Hi-Fi Systems—Everything in Hi-Fi Components
- New Multiplex Stereo FM • All-Transistor Stereo Hi-Fi
- Money-Saving Build-Your-Own KNIGHT-KITS® for Every Need
- Best Buys in Tape Recorders, Tape, and Supplies
- Citizens Band 2-Way Radios • Short-Wave Receivers
- Amateur Receivers, Transmitters, and Station Gear
- Latest Public Address Systems, Paging and Intercom Equipment
- TV Tubes, Antennas, Accessories • Batteries, Wire and Cable
- Test and Laboratory Instruments • Tools, Hardware
- Huge Listings of Parts, Tubes, Transistors, Technical Books

**NEW Multiplex Stereo FM
All-Transistor Stereo Hi-Fi**

exclusive money-saving KNIGHT® products
SAVE MOST on famous KNIGHT Stereo Hi-Fi — comparable to the best in quality, styling and performance, yet priced far lower. Select super-value KNIGHT components or complete systems (including latest Multiplex Stereo and All-Transistor hi-fi) and save most. KNIGHT products are acclaimed by all those who recognize integrity in design and manufacture and who appreciate value.

new

NO MONEY DOWN
on Allied's new Credit Fund Plan
Now—enjoy 50% more buying power—up to 24 months to pay—see our 1962 Catalog for simple details.

SEND FOR 444-PAGE CATALOG TODAY!

Satisfaction Guaranteed or Your Money Back

ALLIED

RADIO-ELECTRONICS



BIG PLUS!
in your 1962
ALLIED
CATALOG

includes complete catalog featuring over 90 exciting

knight-kits

A PRODUCT OF ALLIED RADIO

NEW for '62 and simply great!
available only from **ALLIED**

new
HI-FI KITS



All-In-One FM-AM Tuner-Amplifier Kit with latest built-in MULTIPLEX Stereo FM.....\$129.95



MULTIPLEX Self-Powered Adapter Kit, for Stereo FM reception.....\$19.95



Deluxe Stereo FM-AM Tuner Kit with latest built-in MULTIPLEX Stereo FM.....\$99.95



ALL-TRANSISTOR 50-Watt Stereo Amplifier Kit, less case.....\$79.95

new
HOBBYIST KITS



ALL-TRANSISTOR Wireless Intercom System Kit (2 units).....\$45.90



TRANSISTORIZED Electronic Tachometer Kit.....\$24.95



Amazing 100-In-1 Electronic Science Lab Kit.....\$29.95



ALL-TRANSISTOR 2-Band AM-Shortwave DX-er Radio Receiver Kit.....\$19.95

building a Knight-Kit is the most satisfying do-it-yourself experience in the world!

5 BIG REASONS WHY:

- **Convenience Designed**—makes you a kit-building expert—even the very first time!
- **Wonderful to Build**—you'll marvel at the sheer ease of assembly with the exclusive "show-how" manual guiding you like a good instructor.
- **You Own the Best**—you'll enjoy with pride a true custom-built product, professional in its engineering and performance.
- **You Save So Much**—because you buy direct from Allied at our money-saving volume prices—and because you do the easy assembly yourself.
- **Easiest to Buy**—NO MONEY DOWN on Allied's new Credit Fund Plan—easiest terms ever!

MONEY BACK GUARANTEE: Buy any Knight-Kit. Build it! Use it! You must be satisfied or you get your money back!

see more than 90 KNIGHT-KITS

- 21 HIGH-FIDELITY KITS
- 25 HOBBYIST KITS
- 31 INSTRUMENT KITS
- 14 AMATEUR & CITIZENS BAND KITS

KNIGHT-KITS are also available in Canada

RADIO

World's Largest
Electronic
Supply House

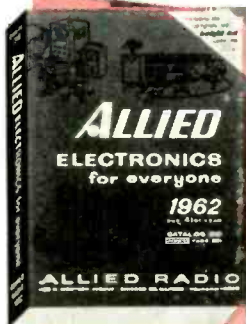

Send for it today!

new



Phone and CW 60-Watt Ham Transmitter Kit.....\$49.95



Mutual Conductance Tube Tester Kit.....\$99.50

- World's Largest Stocks • Lowest Money-Saving Prices
 - Fastest Shipment • Expert Help • Easiest-Pay Terms
 - Satisfaction Guaranteed or Your Money Back
- send for the world's biggest electronics catalog!

Free

ALLIED RADIO, Dept. 200-K1
100 N. Western Ave., Chicago 80, Ill.

Send FREE 1962 ALLIED 444-page Catalog

Name _____
PLEASE PRINT

Address _____

City _____ Zone _____ State _____

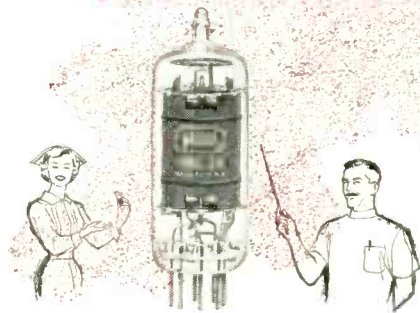
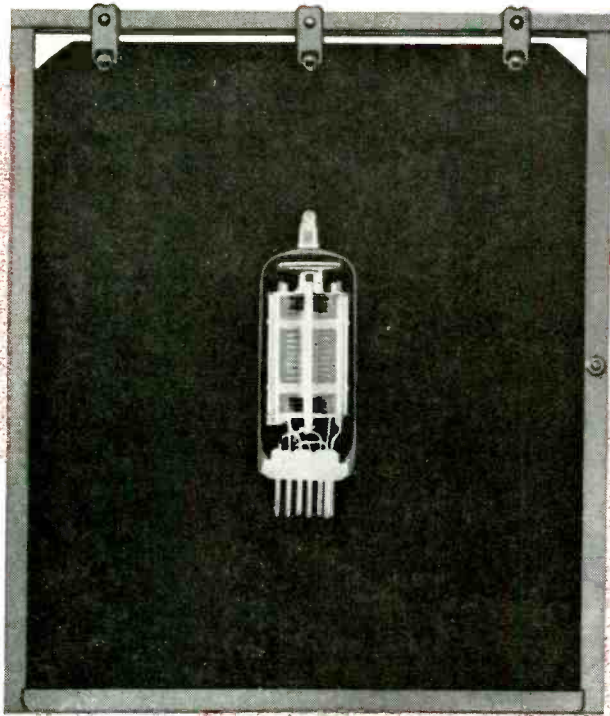

ABSENCE OF "GRID EMISSION" AND GAS DEMONSTRATES GOOD HEALTH OF TUNG-SOL IF AMPLIFIER TUBES

Radio and TV doctors know that IF amplifier tubes must be physically sound in order to enjoy a healthy long life. Because they operate in a high impedance circuit, internal cleanliness is vital to avoid gas distress. Grid emission, which displays identical symptoms, likewise must be carefully avoided. Tung-Sol's exacting engineering standards and rigid quality control in every step of manufacture assure vigorous long life. Tung-Sol IF amplifier tubes are made in a humidity-controlled, dust-free atmosphere. The operator's hands never touch

the cathode coating. Gas evacuation and metal heating are done with critical precision by means of the most advanced equipment. As a result, Tung-Sol IF amplifier tubes possess unusual stamina and help you to maintain enviable standards in your service business.

GOOD MEDICINE FOR PROFITS

One of the most highly recommended medicines for profits in radio and TV service business is the prescribing of tubes that are reliable. Cuts radio and TV set hospital visits. You can rely on Tung-Sol tubes.

HERE ARE SOME OF THE MORE POPULAR TUNG-SOL IF AMPLIFIERS:
 1U4; 6AG5; 3AU6; 4AU6; 6AU6A; 12AU6; 3BA6; 4BA6; 6BA6; 12BA6;
 3BC5; 4BC5; 6BC5; 6BH6; 6BJ6; 3CB6; 4CB6; 6CB6; 3BZ6; 4BZ6;
 6BZ6; 12BZ6; 3DK6; 4DK6; 6DK6; 12AC6; 12BL6; 12AF6; 12EK6; 12EZ6;
 18GD6A; 18FW6A



the first name to ask for when ordering



TUNG-SOL
 IF AMPLIFIER TUBES

TUNG-SOL ELECTRIC INC., NEWARK 4, N.J.

Correspondence



CORNER SPEAKERS BEST!

Dear Editor:

Corner placement of a sound reproducer results in the longest path before the first reflection, oblique angles of incidence, and an apparent increase in room size, compared to wall-located speakers. There is a common and widespread fallacy that corner placement excites more room modes or resonances. A study of the principle of mirror images shows that a corner speaker does exactly what a double-size wall speaker would do in a room twice as large.* This is true whether actuation is by open cone, horn, modulated air blast, electrostatic or ionized air. Corner placement results in the lowest measured peak-to-trough sound pressure ratios. It usually results in an octave extension of the bass range. It always reduces distortion by reducing the required diaphragm excursion for a given power and sound pressure output.

Whatever the actuating principle, the power levels and diaphragm excursions always have to be considered. For example, taking Frank Massa's 100 dynes per square centimeter as "necessary to secure realistic musical reproduction" and a room of 3,000-cubic-foot volume and 0.8-second reverberation time leads to the need for one acoustic watt of power. At low frequencies this requires moving large volumes of air. If modulation distortion limits air-sheet motion to 1/16 inch, a radiating area of about 20 square feet is required to radiate 1 acoustic watt at 32.7 cycles per second. This much area for the bass would result in severely anomalous polar or spatial radiation patterns at the middle and high frequencies. There still remains a desirable separation of spectrum, with large speakers radiating the long wavelengths and small ones radiating short wavelengths.

PAUL W. KLIPSCH

Klipsch & Assoc. Inc.
Hope, Ark.

ANTI-PLANE COLLISION

Dear Editor:

Your editorial "Anti-Plane-Collision Radar" in the March 1961 issue, is of interest. I believe that a few words on the Federal Aviation Agency program, and the difficulties inherent in collision prevention devices, will make a useful epilogue.

The development of positive collision avoidance devices was first undertaken

*Paul W. Klipsch, "Room Dimensions for Optimum Listening and the Half-Room Principle", *IRE Trans. Audio*, Vol. AU-6, No. 1, Jan.-Feb. 1958, pp. 14-15.

PHOTOFACT world's finest electronic service data now greater than ever!

with dozens of exclusive new features for fastest, easiest, more profitable servicing

OVER 50,000 LISTINGS: Only service data of its kind—prepared from analysis of the actual equipment. Complete, uniform, accurate. Over 21,000,000 PHOTOFACT Sets now in use! If you're not using PHOTOFACT, you're not realizing your full earning power. So get the proof—try PHOTOFACT on any job—see how much time you save, how much more you can earn daily! Your Parts Distributor has the PHOTOFACT Folder Sets you need. Have *all* the help you'll ever want for greater servicing success and bigger earnings!



EXCLUSIVE IN PHOTOFACT

FAMOUS "STANDARD NOTATION" SCHEMATICS

- Uniform symbols in each schematic; same circuit layout form each time

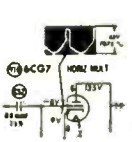

- Voltages at tube pins and test points
- Waveforms of appropriate points on TV schematics
- "CircuiTrace" identification numbers for printed circuits

- Schematic items keyed to chassis photos and parts lists
- Special capacitor and resistor ratings
- Coil and transformer color codes or terminal identification

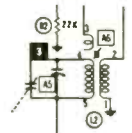

- Test points labeled
- Special currents shown (B+, horizontal output cathode, horizontal output screen)

- Alignment adjustments and test points labeled
- Tube functions shown
- Control and switch functions shown
- Switch sequence indicated
- Power supply "sources" shown
- Fuse ratings indicated
- Coil resistance over 1 ohm shown
- Coding of electrolytic capacitors shown

REPLACEMENT PARTS LISTS



- Lists standard, locally available replacement parts
- Includes notes for special installation or other considerations
- Includes ratings and/or measured values for assisting in selection of replacement parts
- All parts keyed to chassis photos and schematics for quick reference

TUBE PLACEMENT DIAGRAMS



- Shows tube types and functions; top and bottom views shown
- Includes filament connections on series string
- Indicates TV sound and sync paths
- Tube failure check charts included
- Shows blank pin or locating key on each tube
- Includes fuse locations and ratings.

ALIGNMENT INSTRUCTIONS



- Gives step-by-step easy-to-follow alignment data
- Procedure makes use of standard service-type equipment
- Alignment frequencies are shown on chassis photos near adjustment number—adjustments are keyed to schematic and photos

"CIRCUITRACE" FEATURE



- Invaluable printed board servicing aid—indicates points on board photo and schematic for quick, easy measurement of components, or test locations

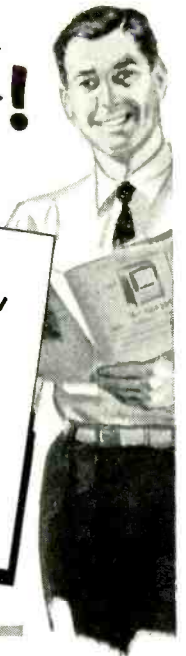

FULL PHOTO COVERAGE



- All chassis views are shown in actual photographs
- All parts are numbered and keyed to the schematic and parts lists
- Test and alignment points indicated

FIELD SERVICE NOTES

- Outlines procedure for "in the home" adjustments
- Gives hints on quick access to pertinent adjustments, safety glass removal, etc.

"BONUS" FEATURES

- Disassembly instructions
- Dial cord diagrams
- Record changer and tape recorder "exploded views" for easy mechanical parts replacement or service

"PLUS" ADVANTAGES

- ★ Citizens Band Radio coverage
- ★ Tube Test data—provides setting for testing new tubes
- ★ Color TV Course "Bonus" beginning in Set No. 541
- ★ Eligibility for membership in "PEET" with ownership of a PHOTOFACT Library

SEND FOR YOUR PHOTOFACT INDEX NOW!

FREE

ONLY \$10 DOWN puts the complete PHOTOFACT Library in your shop—and you have up to 30 months to pay. Right now—keep up with the industry—sign up for a Standing Order Subscription to PHOTOFACT! See your Sams distributor for full details on a Library or Standing Order purchase!

FREE VALUABLE PHOTOFACT INDEX

YOUR GUIDE TO OVER 50,000 TV, Radio, Electronic Listings! Send for it today! Your guide to virtually every model produced since 1946. Helps you locate the proper PHOTOFACT Folder you need to solve any service problem in any model. Send the coupon today for your **FREE** copy of the latest PHOTOFACT Index to the service data you need!

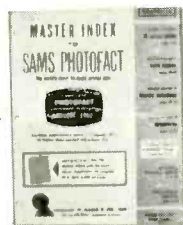

HOWARD W. SAMS & CO., INC.

Howard W. Sams & Co., Inc., Dept. 6-K1
1724 E. 38th St., Indianapolis 6, Ind.

- Send **FREE** Photofact Cumulative Index
- Send full information on: Easy Buy Plan Standing Order Subscription "Peet" Program

Shop Name _____

Attn: _____

Address _____

City _____ Zone _____ State _____

NOW... Master System Performance at a Home Booster Price!

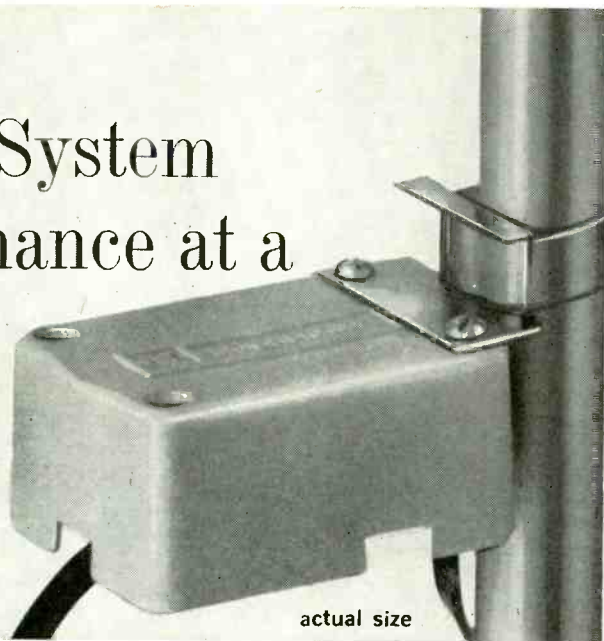

Blonder-Tongue signal master, AB-4

(new transistor, mast-mounted TV/FM 4-set booster)... \$29.95 list

- ✓ Transistor circuit provides lowest noise, maintenance free operation—no tubes to burn out or replace—no heat dissipation problems.
- ✓ Mast mounting takes advantage of best signal-to-noise ratio—minimizes snow. (Can also be mounted at any convenient point along the download.)
- ✓ World's smallest and lightest booster—no additional weight or wind resistance for mast to bear.
- ✓ Remote power supply at set uses 4 low-cost flashlight batteries for pure d.c.—eliminates AC power line, and components which may fail.
- ✓ Converts existing antenna into a powerful amplifier-distribution system—no need to invest in a new antenna.
- ✓ Eliminates costly installation of giant antenna arrays in most fringe areas.
- ✓ Provides improved FM reception (gain 12-15 db).
- ✓ Stripless 300-ohm terminals on booster and remote power supply for fast installation, positive contact.
- ✓ No separate balun needed—matches impedance of antennas and TV sets.

ALL THIS PLUS... 4 set coupler incorporated in remote control power supply distributes fully isolated amplified signals for brilliant reception on up to 4 TV or FM sets.

Improve TV and FM reception today. Add the new Blonder-Tongue AB-4. Sold thru distributors. For details write. Dept. RE-10.

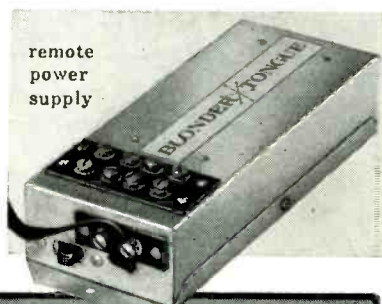

1 set
gain: up to 19 db,
channel 2
Up to 10.5 db,
channel 13

2 sets
gain: up to 14 db,
channel 2
Up to 6 db,
channel 13

3 sets
gain: up to 13 db,
channel 2
Up to 4 db,
channel 13

4 sets
gain: up to 10.5 db,
channel 2
Up to 2 db,
channel 13

Patent applied for

engineered and manufactured by

BLONDER-TONGUE

9 Alling St., Newark, N. J.

Canadian Div.: Benco Television Assoc., Toronto, Ont. Export: Morhan Export Corp., N. Y. 13, N. Y.
home TV accessories • UHF converters • master TV systems • closed circuit TV systems

in 1955. The firm requirement was established that only self-contained non-cooperative operation was acceptable. After several years' work by outstanding engineering organizations, it was determined that this requirement could not be met by state-of-the-art techniques.

The FAA program for developing collision-prevention devices started under the Airways Modernization Board in late 1958. The first technique tested was that of ground reflection ranging with altitude communicated, and the threat criteria of time to nearest approach. Flight tests were run in December 1960, using a completely instrumented but extremely developmental installation. Additional tests will be conducted within the next several months.

Other techniques under consideration for collision avoidance are in such early stages that little should be said of their potentiality. Infrared techniques for collision prevention, unlike some military applications, suffer from the very low radiant intensity of general aviation aircraft.

Very carefully controlled tests of non-cooperative systems were performed by the Navy Ordnance Test Station, China Lake, California, at the request of the Federal Aviation Agency. The possibility exists that a cooperative infrared proximity warning indicator (PWI) can be devised using a modified rotating light beacon, but infrared PWI will be strictly a good-weather device and useful only on planes flown under visual flight conditions. Preliminary tests of this equipment were conducted in June 1961.

The operational use of collision-avoidance systems in the Air Traffic Control System will require the solution of several difficult problems to insure that a pilot is not instructed or his aircraft maneuvered into a more hazardous position. It is for these reasons that it appears at this time that the most promising way of decreasing the likelihood of mid-air collisions is by making large improvements in the Air Traffic Control System.

N. E. HALABY

Administrator
Federal Aviation Agency
Washington 25, D. C.

MEDICINE AND ELECTRONICS

Dear Editor:

Medical electronics is gaining more and more attention. Your article "Electronics in the Psychology Lab" is another example of this. But I would like to comment on this article.

E.K.G. is the German abbreviation for Electrocardiogram. Our abbreviation is E.C.G. However, we often use the German abbreviation to avoid verbal confusion between E.E.G. and E.C.G.

The E.K.G. in Fig. 2 is upside down. I believe it is electromechanically produced rather than recorded from a human subject because of the triangular slow wave complexes that represent auricular depolarization and ventricular

NEW

TESTS All TV and Radio Tubes
—both old and new

TESTS the Nuvistors

TESTS the new 10-pin tubes

TESTS the new 12-pin Compactrons

TESTS voltage regulators, thyratrons,
auto radio hybrid tubes,
European hi-fi tubes, and
most industrial types.



Model 600
DYNA-QUIK

only \$69⁹⁵
NET

8½" x 11" x 4½"
Handsome, sturdy
leatherette-covered
carrying case

**NEW TUBE
INFORMATION
SERVICE**

available every 3
months for all B&K
Dyna-Quik Tube Testers



for the first time, a
B & K QUALITY
TUBE TESTER
at this
amazing low cost!

*Checks for all shorts, grid
emission, leakage, and gas*

*Checks each section of multi-
section tubes separately*

*Checks tube capability under
simulated load conditions*

*Rejects bad tubes
—not good tubes*

For the man who wants the performance and reliability of a B&K professional-quality tester at minimum cost . . . there's nothing like the new "600". No other tube tester in this price range is so complete and up-to-date. Tests the newest tube types, as well as the old. It's fast . . . it's accurate . . . it's easy to use. Quickly reveals tube condition. Saves customers. Sells more tube replacements. Stops call-backs. Steps up servicing profit . . . day after day. Pays for itself over and over again.

Exclusive adjustable grid emission test. Sensitivity to over 100 megohms. Phosphor bronze socket contacts. Complete tube listing in handy reference index. Extremely compact.

B & K MANUFACTURING CO.
1801 W. BELLE PLAINE AVE • CHICAGO 13, ILL.
Canada: Atlas Radio Corp., 50 Wingold, Toronto 19, Ont.
Export: Empire Exporters, 277 Broadway, New York 7, U.S.A.

Schober

captures
magnificent
pipe organ
tone
in a
tiny
electronic
tube

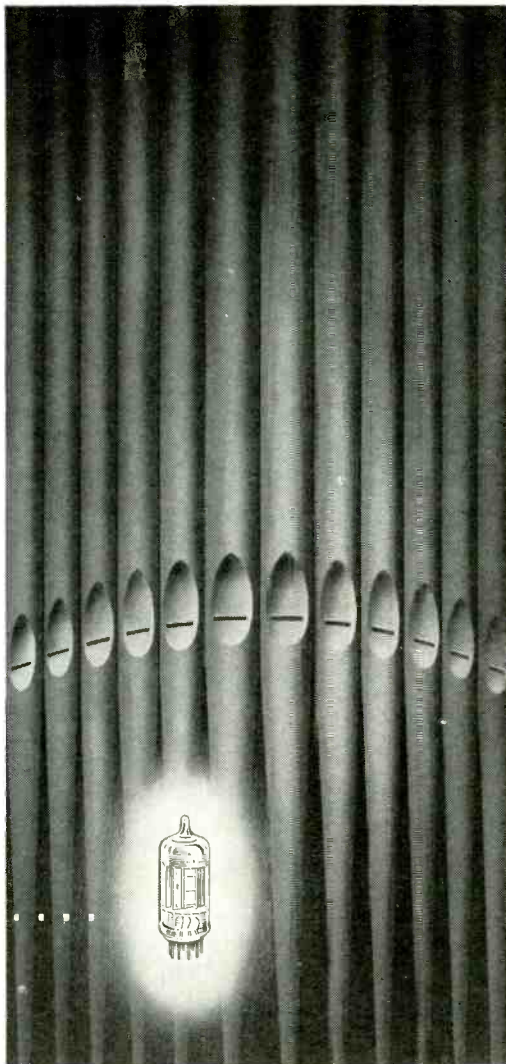

Here is magnificent Pipe Organ tone; tremendous tonal color range; two 61-note pipe-organ keyboards; hand-rubbed cabinetry in the finish of your choice. Taken together they comprise a superlative electronic instrument comparable to organs selling for \$2,500 to \$6,000.

Yet, when you assemble the Schober of your choice, you save more than half the normal cost and create a superb instrument to bring the delightful gift of music to your family.

Matched kits and printed circuitry make it possible.

Work requiring knowledge and experience is eliminated. All that remains is the pride and pleasure of watching a fine musical instrument take shape under your own hands. The Schober organ you assemble will equal or surpass any factory-built organ for quality, reliability and circuitry.

And the Schober Electronic Organ is so easy to play!

From the very first day even novices will transform simple tunes into deeply satisfying musical experiences — because unlike a piano whose tone dies away almost as soon as the keys are struck, organ tones continue to sing out as long as the key is held down. Then, by simply moving your right foot, you change the volume so that the sound becomes rich and alive.

The coupon brings you full details on how you can start building the Schober of your choice with an investment of as little as \$18.95. In addition, you may have an exciting 10" LP record demonstrating Schober's full range of tones and voices. The \$2 charge for the record is refunded when you order your starting kit. No salesman will call.

MAIL THIS COUPON TODAY



THE Schober Organ CORPORATION
Dept. RE-15 43 WEST 61ST STREET, NEW YORK 23, N.Y.

The Schober Organ Corp., Dept. RE-15
43 West 61st Street, New York 23, N.Y.

Please send me FREE full-color booklet and other literature on the Schober organ.

Please send me the Hi-Fi demonstration record. I enclose \$2 which is refundable when I order my first kit.

name _____

address _____

city _____ zone _____ state _____

repolarization. Human hearts and all animals that I know of give off rather round-shaped waves. This is with the exception of the ventricular depolarization wave which is tall and sharp as you have it pictured.

Your E.E.G. samples in Fig. 1 are excellent for getting across what you wanted to get across. May I suggest, though, that Fig. 1-c "c" is not a recording during an epileptic seizure, but more likely a recording during a subclinical epileptic discharge that probably reflects the patient's tendency toward seizures.

Thank you for this useful article and for many others.

JIM STEPHEN
E.E.G. Technician

Regina, Saskatchewan, Canada

[Thank you too for letting us know what you like in RADIO-ELECTRONICS. —Editor]

KEEP THEM COMING

Dear Editor:

Louis B. Henry has something on his side in his letter "I'd Buy A Kit" in the July Correspondence column. But when he says "such articles are quite useless except as purely and strictly reading material," I definitely disagree with him.

How about "Wind Your Own Ferrite-Core Antenna"? If I'd been using a transistor radio, I would have been winding and trying that one right away.

I look over all construction articles with interest. And when you build something entirely yourself, turn on the juice and she works—brother, you really live for a while!

So just keep those construction projects coming.

JOHN IALE

Eureka River, Alberta, Canada

I LIKE TO BUILD-IT-MYSELF

Dear Editor:

In your July correspondence column, construction projects were mentioned. Allow me to include myself among the many who buy RADIO-ELECTRONICS primarily for them alone! Should they disappear or be reduced in number, I would have no reason to continue reading R-E.

My only complaint is that some of your projects are too sophisticated, while others of more interest are too simple.

I have built, and no doubt will build more kits, but they are usually items of test equipment whose accuracy and calibration would be difficult for the home constructor. But by far the majority of the equipment I have is home-made, and some of it I think far superior to similar items available commercially.

HAROLD L. STEPHENS

Biloxi, Miss.

[The above two letters are typical of our readers. They like and respect kits but get something extra out of building a complete device from scratch, all by themselves.—Editor] END

RADIO SHACK Proudly Presents



29 Realistic KITS

**GREATEST VALUES
IN ELECTRONICS**
Look, perform like factory-wired
units at up to 42% less cost
Exclusive years-ahead designs

Radio Shack's whole new family of audio and test equipment kits employs the most advanced designs and engineering concepts known today! They meet the most exacting requirements in performance and appearance. They're easy and fun to build! Critical areas are pre-wired, factory-aligned. Even a novice can follow the simplified assembly manuals. And they're easy to own on No Money Down credit terms. Every kit backed by a money-back guarantee. We show here six kits newly introduced in our exciting 1962 Catalog.

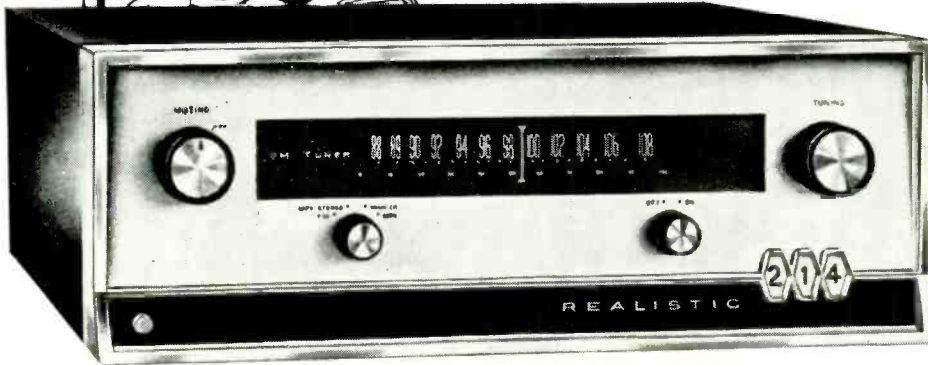

FM Stereo Multiplex Tuner Kit. Highest standards of excellence with deluxe built-in integral multiplex section. It features wide band circuitry for exceptional sensitivity; 2.2 μ V, drift-free selectivity. Frequency response 10-20,000 cps \pm 1 db. 3 I-F stages, 3 limiters. 11 tubes plus rectifier. Muting, tuning, function selector. Tape recorder output. 90LX092—\$149.95

Matching Units—unexcelled anywhere

50-Watt Stereo Amplifier Kit — the powerful, all-transistor HK-208. Unique 18-transistor circuit eliminates hum, noise, output transformers and heat. Absolutely flat —1 db 10-15,000 cps at full power. Truly a breakthrough in semi-conductor stereo design, the only amplifier of its kind in the world! 90LX093 — \$139.95



Radio Shack's 1962 Line of Kits Includes All These:

- Stereophonic Preamplifier Kit
- Stereo 140W Basic Amplifier Kit
- 40 Watt Stereo Amplifier Kit
- Complete Stereo System Kits
- Universal Multiplex Adapter Kit
- Hi-Fi 12 Watt Amplifier Kit
- FM Adapter Kit
- Stereo Balance Meter Kit
- Wireless Intercom Kits
- Deluxe Signal Generator Kit
- Deluxe VTVM Kit
- Standard VTVM Kit
- Ultra-Modern Tube Tester Kit
- 500W Variable AC Supply Kit
- VOM Kit with 4 1/2" Meter
- Signal Generator Kit
- AC VTVM Preamplifier Kit
- Electronic Photo Relay Kit
- "Novatherm" Thermometer Kit
- 5-Tube Teakwood Radio Kit
- 2-Transistor Home Radio Kit
- 6-Transistor Portable Radio Kit
- Transistor Experimental Lab Kit

See complete specifications of these fine kits in Free Catalog

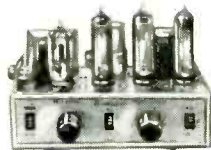

Stereo Amplifier Kit. Terrific value! Converts mono phono to stereo. Easy to build. 90LX079 — \$10.95



The HK204 — Quality FM Tuner Kit. Incredibly value! Simple assembly. 90LX070 — \$19.95



Dual Trace Oscilloscope Kit. Flat response from 10 cycles to 3 megacycles. 94LX072 — \$79.95



Tube Tester Kit. Superbly engineered — priced low. For octal, loctal, 9-7 pin tubes. 94L061 — \$15.95



Send today for **FREE** 1962 Catalog

Gentlemen:

Please send me your giant new 340-page Electronics Catalog of over 100,000 items and every supplement for one year—all FREE and POSTPAID.

Mail coupon to

RADIO SHACK Corp.
730 Commonwealth Avenue
Boston 17, Massachusetts

NAME _____

ADDRESS _____

CITY _____

ZONE _____

STATE _____

61K10D

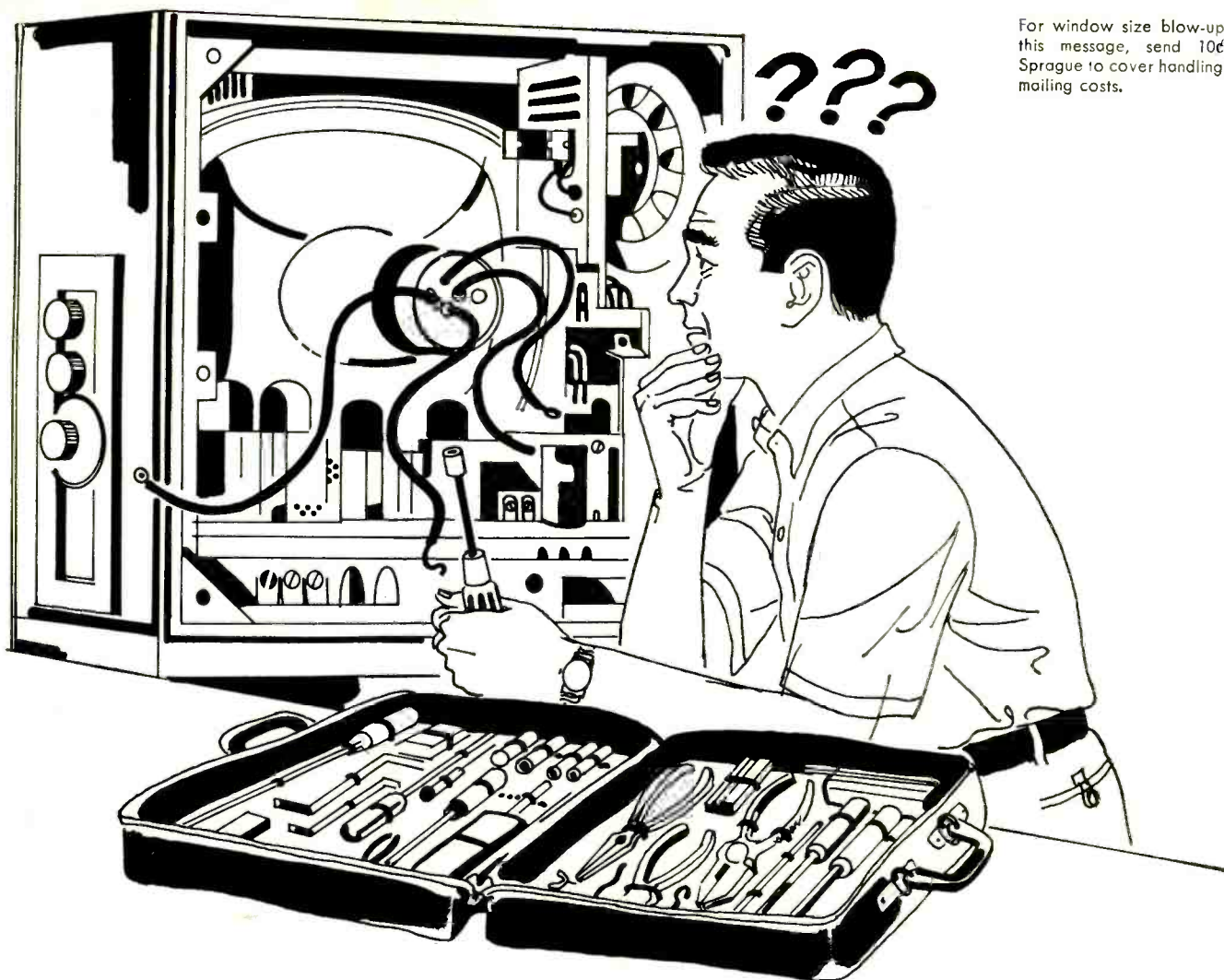

For window size blow-ups of this message, send 10¢ to Sprague to cover handling and mailing costs.

It takes MORE than TOOLS to be a TV Technician!

Just what IS the difference between the "screwdriver mechanic" and the expert TV-Radio Technician?

NOT expensive tools and test equipment—although they ARE essential.

TRAINING is the first big difference. The tinkerer guesses, but the expert technician KNOWS—because he spent years in the study of electronic theory and its application to television techniques.

EXPERIENCE is the next big difference. The professional TV specialist has repaired hundreds—perhaps thousands—of sets. He knows the complexities and the variations in circuits. He is familiar with the hundreds of parts which make up the "innards" of each type of TV. He can diagnose trouble and cure it quickly and safely.

PROGRESSIVENESS is another big difference. The expert TV Technician continually spends countless hours and hundreds of dollars on manuals, keeping up to date on new developments, new circuits, and new troubleshooting techniques. When trouble develops, he knows what to do about it.

Well-meaning, but poorly informed "screwdriver mechanics" and "do-it-yourself-ers," frequently unable to accurately diagnose TV trouble, often "butcher" a set to the point where it can be dangerous as well as expensive.

DON'T RISK YOUR SAFETY OR NEEDLESS EXTRA EXPENSE—CALL AN EXPERT TECHNICIAN AT THE FIRST SIGN OF TROUBLE! HIS FEE IS YOUR INVESTMENT IN SAFETY AND SATISFACTION.

THIS MESSAGE WAS PREPARED BY SPRAGUE PRODUCTS COMPANY,
DISTRIBUTORS' SUPPLY SUBSIDIARY OF SPRAGUE ELECTRIC COMPANY, NORTH ADAMS, MASSACHUSETTS FOR . . .

YOUR NEIGHBORHOOD TV-RADIO TECHNICIAN



UNCOMPROMISING ENGINEERING

BEST BUYS IN SERVICE INSTRUMENTS: everything from Scopes to Probes



DC-5 MC
5" Scope #460
Kit \$79.95
Wired \$129.50

Also Avail.—5" Push-Pull Scope #425
Kit \$44.95 Wired \$79.95



Peak-To-Peak
VTVM #232
& Uni-Probe®
Kit \$29.95
Wired \$49.95
VTVM #221
Kit \$25.95
Wired \$39.95

Pat. #2,790,051

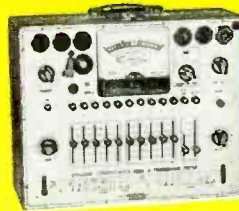

Dynamic Conductance
Tube & Transistor Tester #666
Kit \$69.95 Wired \$109.95
Complete with steel cover & handle



TV-FM Sweep Generator
& Marker #368
Kit \$69.95 Wired \$119.95

BEST BUYS FOR INDUSTRIAL TESTING: everything from Bridges to Supplies

NEW Metered
Variable Auto-
Transformer AC
Bench Supplies:
#1073 (3 amp.)
Kit \$35.95
Wired \$47.95
#1078 (7½ amp.)
Kit \$42.95
Wired \$54.95



NEW Extra-Low-
Ripple 6 &
12 Volt
Battery
Eliminator
& Charger #1064
Kit \$43.95
Wired \$52.95



NEW AC
Volt-Watt
Meter #260
Kit \$49.95
Wired \$79.95



1350 Combinations!
Series/Parallel R-C
Combination Box #1140
U.S. Pat. No. 2954518
Kit \$13.95 Wired \$19.95



BEST BUYS IN STEREO & MONO HI-FI: everything from Tape Decks to Speakers

Transistorized
Stereo/
Mono
4-Track
Tape
Deck
Wired
Model
RP100W
\$399.95
Semi-Kit
Model
RP100K
Electronics in Kit form \$299.95



An original, exclusive EICO product designed and manufactured in the U.S.A. (Patents Pending)



NEW FM-AM Stereo Tuner ST96
Kit \$89.95 Wired \$129.95 Inc. FET

NEW 70-Watt Integrated
Stereo Amplifier ST70
Kit \$94.95 Wired \$149.95



NEW 40-Watt Integrated
Stereo Amplifier ST40
Kit \$79.95 Wired \$129.95



Bookshelf Speaker System HFS1
Kit \$39.95 Wired \$47.95



BEST BUYS IN "HAM" GEAR: from Transmitters to Code Oscillators

NEW 60-Watt CW Transmitter #723
Kit \$49.95 Wired \$79.95



90-Watt CW Transmitter #720
U.S. Pat. No. D-184776
Kit \$79.95 Wired \$119.95



Universal Modulator Driver #730
Kit \$49.95 Wired \$79.95
Cover E-5 \$4.50



Grid Dip Meter #710
Kit \$29.95 Wired \$49.95



Over 2 MILLION EICO instruments in use. Compare EICO side-by-side critically with products selling for 2 or 3 times more. Buy your EICO right "off the shelf" from 1500 neighborhood dealers coast to coast, most of whom offer budget terms.

BEST BUYS IN CITIZENS TRANSCEIVERS AND TRANSISTOR RADIOS

Over 80 unique products to choose from!

*Including Posi-Lock Mounting Bracket

EICO, 3300 N. Blvd., L.I.C. 1, N.Y. c10

Send free 32-page catalog & Distributor's name.

Send Free Schematic of Model No.

Send new 36-page GUIDEBOOK TO HI-FI for which I enclose 25c for postage & handling.

Name _____

Address _____

City _____ Zone _____ State _____



NEW DeLuxe
Citizens Band Transceivers:
#770: 117 VAC—
Kit \$69.95 Wired \$99.95
#771: 117 VAC & 6 VDC,*
#772: 117 VAC & 12 VDC*—
Kit \$79.95 Wired \$109.95



Citizens Band Transceivers:
#760: 117 VAC—
Kit \$59.95 Wired \$89.95
#761: 117 VAC & 6 VDC,*
#762: 117 VAC & 12 VDC*—
Kit \$69.95 Wired \$99.95



Transistor Portable Radio RA6
Kit \$29.95 Wired \$49.95 Incl. FET

Listen to the EICO Hour, WABC-FM, N. Y. 95.5 MC, Mon.-Fri., 7:15-8 P.M.

Add 5% in the West © 1961 by EICO, 3300 N. Blvd., L. I. C. 1, N. Y.

Turn Page for more EICO Values

FM Multiplex Stereo broadcasting has arrived!

A top quality stereo tape recorder will permit you to build a stereo tape library of your favorite music at low cost. As your musical interests change, you may record the new music that interests you at no additional cost. See your EICO dealer now for a demonstration of the EICO RP-100.

dedicated to perfection



TRANSISTORIZED 4-TRACK STEREO TAPE DECK

MODEL RP-100W

Completely assembled, wired and tested. **\$399.95**

MODEL RP-100K

Semi-kit includes a completely assembled and tested transport, electronics in kit form. **\$299.95**

Perfected 4-track stereo/mono recording, 4 & 2 track playback. True high fidelity transistor electronics, individual for record & playback, plus separate record & playback heads permitting off-the-tape monitor. 2 recording level meters, mixing, mic & level controls, switched sound-on-sound recording. Electrodynamically braked supply & take-up reel motors; hysteresis synchronous capstan motor. Individual solenoids for pinch-roller & tape lifters. All-electric, interlocked push-button transport control & interlocked safety "record" pushbutton. Precision tape guidance & sweep loading — no pressure pads. No slurring or tape bounce problems. Digital turns counter. Vertical or horizontal mounting. Modular plug-in construction. An original, exclusive EICO product designed & manufactured in U. S. A. (patents pending).

NEW SUPERB SERIES.....

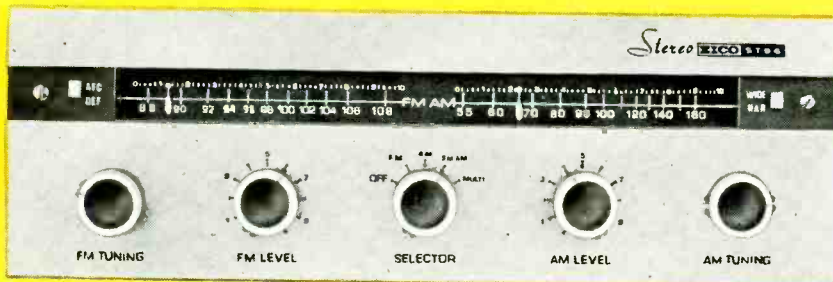

FM-AM STEREO TUNER ST96

Kit \$89.95 Includes Metal Cover and FET Wired \$129.95

FM and AM stereo tuners on one compact chassis. Easy-to-assemble: prewired, prealigned RF and IF stages for AM and FM. Exclusive precision prewired EYE-TRONIC® tuning on both AM and FM.

FM TUNER

Switched AFC (Automatic Frequency Control). Sensitivity: 1.5uv for 20db quieting. Frequency Response: 20-15,000 cps ±1db.

AM TUNER

Switched "wide" and "narrow" bandpass. High Q filter eliminates 10 kc whistle. Sensitivity: 3uv for 1.0V output at 20db S/N ratio. Frequency Response: 20-9,000 cps ("wide"); 20-4,500 cps ("narrow").

OF EICO STEREO.....

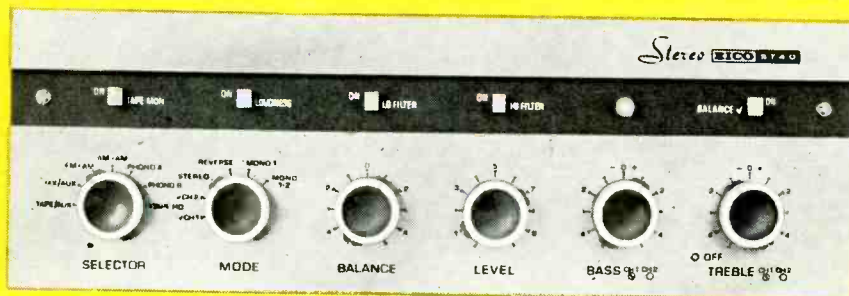

70-WATT INTEGRATED STEREO AMPLIFIER ST70

Kit \$94.95 Includes Metal Cover Wired \$149.95

40-WATT INTEGRATED STEREO AMPLIFIER ST40

Kit \$79.95 Includes Metal Cover Wired \$129.95

BOTH AMPLIFIERS: Complete stereo centers plus two excellent power amplifiers. Accept, control, and amplify signals from any stereo or mono source.

ST70: Cathode-coupled phase inverter circuitry preceded by a direct-coupled voltage amplifier. Harmonic Distortion: less than 1% from 25-20,000 cps within 1db of 70 watts. Frequency Response: ±½db 10-50,000 cps.

ST40: Highly stable Williamson-type power amplifiers. Harmonic Distortion: less than 1% from 40-20,000 cps within 1 db of 40 watts. Frequency Response: ±½db 12-25,000 cps.

Over 2 MILLION EICO Instruments in use. Most EICO Dealers offer budget terms. Add 5% in West.



FM MULTIPLEX ADAPTOR MX-99

Kit \$39.95 Wired \$64.95

An original EICO contribution to the art of FM Multiplex reception



The new EICO MX-99 Multiplex Adaptor incorporates the best features of both the matrixing and sampling techniques. It is free of phase-distorting filters and provides the required, or better-than-required, suppression of all spurious signals including SCA (67kc) background music carrier, re-inserted 38kc sub-carrier, 19kc pilot carrier and all harmonics thereof. This is very important for high quality tape recording, where spurious signals can beat against the tape recorder bias oscillator and result in audible spurious tones in a recording. This adaptor will synchronize with any usable output from the FM tuner and will demodulate, without significant distortion, tuner outputs as high as 7 volts peak-to-peak (2.5 volts RMS). The MX-99 is self-powered and provides entirely automatic stereo/mono operation. A separation of 35 db between channels is typical across the entire audio spectrum. Low impedance cathode follower outputs permit long lines. The MX-99 is designed for all EICO FM equipment (HFT-90, HFT-92, ST-96) and component quality, ratio detector FM equipment provided with a multiplex output.

C-10

EICO, 3300 N. Blvd., L. I. C. 1, N. Y.
 Send free 32-page catalog & dealer's name
 Send new 36-page Guidebook to Hi-Fi for which I enclose 25¢ for postage & handling.

Name
 Address
 City Zone State

Listen to the EICO Hour, WABC-FM, N. Y. 95.5 MC, Mon.-Fri., 7:15-8 P.M.

Export Dept., Roburn Agencies Inc., 431 Greenwich St., New York 13, N. Y.

© 1961 by EICO, 3300 N. Blvd., L. I. C. 1, N. Y.

EXTRA-TERRESTRIAL TV

... *The Great New Uses of TV Are About to Unfold* ...

PERHAPS the most important applications of television will be made during the next few decades. It would appear certain that these applications will not be on earth but outside our planet.

Already a number of such uses have been made, chiefly in weather satellites. Special TV cameras scan cloud covers, record the result on tape and, on command from earth, transmit the result to our meteorologists for analysis.

In a like manner, the Russians, on Oct. 18, 1959, for the first time in history scanned the far side of our natural satellite, using one of their rockets to circumnavigate the moon. The rocket then transmitted the pictures to Russia on command of their scientists, by radio impulses from earth.

In the January, 1951, issue of this magazine, the writer forecast a new weapon, the *Television Bomb*. A television camera, built into the nose of a bomb, could be dropped accurately despite rain, fog or night, on its target.* The TV bombardier would watch on his TV screen the exact progress of the falling bomb's flight. By radio control he could so manipulate the bomb that he could guide it exactly onto the target.

This was before the intercontinental ballistic missiles. The same principle can be used with them—it will take some of the present inaccuracy out of these long-distance missiles. If such missiles were equipped with television, advanced ground stations or special instrumented planes could follow the progress of the bomb-carrying ICBM via its TV transmitter. When the bomb reaches its apogee, hundreds of miles above the earth, it starts its descent. It may, however, be off target. The computers at the watching ground or air station would be able almost instantly to calculate the correct angle at which it should fall to hit the target. Then, via radio control, an *auxiliary lateral correcting rocket* would be fired from the falling missile. This will deviate its flight sufficiently to assure a bull's-eye hit on target.

In 1951, the author, in an illustrated article "Celestial Television,"† foresaw how the world could watch extra-terrestrial events. By means of TV cameras on board a space ship 15,000 miles distant from earth, TV watchers would see how our whole planet appears from space and also watch the breathtaking spectacle of our flaming sun (viewed through special filters) with its miraculous streaming corona, in a black sky, with millions of brilliant stars surrounding it.

Such unusual broadcasts are perfectly feasible even today. We need not wait for manned space vehicles. If the money is available, a satellite can be built now, carrying special remote-control TV camera broadcast equipment.

As this is being written, at Harvard-Smithsonian, two TV orbiting telescopes are being developed. Also under development is a lunar orbiter that should soon be ready for firing. It should be very dramatic because it will give large-scale pictures of the rugged lunar surface.

During the next 10 years it will also be possible to

solve one of the greatest astronomical puzzles that has vexed our scientists for generations.

We know next to nothing of our nearest planet in space, Venus. We have never even seen it. All we can see is its perpetual cloud cover—never its surface. Hence we do not know whether it is completely or partially covered with water, or whether it has any continents. Nor do we know the length of Venus' day, or whether it turns one side to the sun perpetually, as the moon does to our earth.

This irritating problem may be solved during this decade by the use of a special radio-controlled, unmanned, TV-equipped rocket. It would circumnavigate Venus in a continuous tight spiral, descending slowly into the planet's thick cloud-covered atmosphere, until it emerges below it, televising its daylight surface without interruption. The TV signals would then be sent earthward and be recorded there. During opposition of earth and Venus, the distance separating the two planets is some 25,000,000 miles. This means that it takes the signals 2 minutes and 18 seconds to reach us, since radio waves travel at the rate of 186,000 miles a second. What happens to the Venus TV rocket? The first ones may not be recovered—they probably will crash on Venus; later and better ones will return to earth intact. This would be more desirable, as they would also take TV tape records scanning the entire visible Venus panorama. This is a superior method to the 25,000,000-mile long-distance TV signals (of the pioneer rockets), which are also influenced adversely by outer space radio-astronomical disturbances. Incidentally, the idea of such a rocket is not new—it originated with the writer in 1953 in his illustrated article "Television Guided Space-ship."** In this article the rocket, however, circumnavigated the moon.

Television on our nearest neighbor in space will be an extensive chapter by itself. Many unmanned lunar rockets, long before man sets foot onto the moon, will be TV-equipped to better guide the rockets in televising their approach and viewing the moon's surface from several hundred miles up. It takes only 1.2 seconds for TV signals to reach the earth, thus in 2.4 seconds we can reach the rocket by radio before it makes its final descent. Therefore, radio manipulation of the rocket's auxiliary *retro-rockets* is quite feasible on the moon.

Unmanned lunar vehicles will be TV-equipped routinely for easier moon exploration and surveying. Later on, manned expeditions will carry TV cameras as a matter of course. The earth, as seen from the moon, 238,000 miles away, will make exciting TV programs, as will the sun. So will closeup views of the colossal lunar mountains, as well as the vast moon craters. Then will come TV spectacles of the moon's far side, as well as TV exploration of the titanic lunar caves—the inside of the many-billion-years-old airless, vacuum-immersed dead world.

—H.G.

*See also "The Radio-Controlled Television Plane" (bomb-dropping war plane), by H. Gernsback, *The Experimenter*, page 22, November, 1924.

†*Forecast 1952*, annual.

***Forecast 1954*, annual.

How sonar works

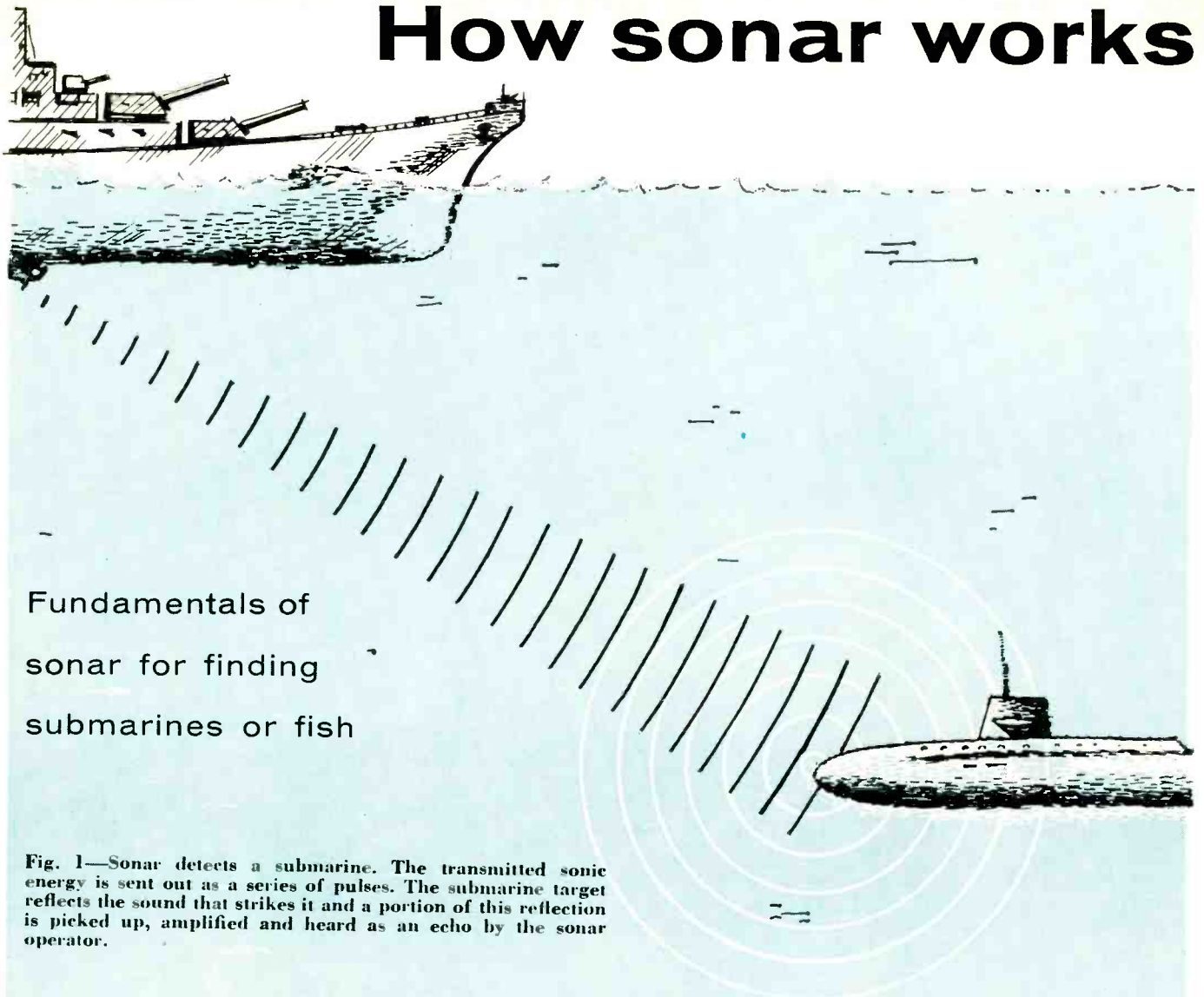

Fundamentals of sonar for finding submarines or fish

Fig. 1—Sonar detects a submarine. The transmitted sonic energy is sent out as a series of pulses. The submarine target reflects the sound that strikes it and a portion of this reflection is picked up, amplified and heard as an echo by the sonar operator.

By A. N. GLENNON

Sonars are electronic devices which use underwater sounds to locate submarines. They can also be used to find fish and chart the ocean bottom.

To detect submarines, sonars transmit a high-powered pulse of sound, called a *ping*, then listen for an echo. A submarine within detection range will return an audible echo. The sound of the echo depends on the frequency and pulse length of the ping, but is usually short and sharp with a metallic quality. The echo can also be made to show up as a bright spot on a PPI scope or as a deflection of an A-scope trace.

The Navy does not have exclusive use of sonars. They are used by merchant ships, fishing boats and yachts, too—not to look for submarines, but to tell how deep the water is or to find fish. Sonars built for these purposes are

often called echo sounders.

A modern echo-ranging sonar can spot a submarine several miles away, under good conditions. It is usually mounted on a destroyer, with the operator in a protected location within the hull, and transducer mounted near the forward end of the ship, underwater on the keel.

To detect a submarine, the sonar sends out a short pulse of sound, concentrated into a narrow conical beam (Fig. 1). The ping travels through the water, strikes the submarine and a small portion bounces back. This echo is picked up by the transducer, amplified and presented to the operator.

A sonar transducer converts electrical energy to acoustic energy the same way a radio loudspeaker does. Like a loudspeaker, it will also convert acoustic energy back into an electrical signal, so the same transducer can be used for both transmitting and receiving. Since an echo can be down 120 db or more from the outgoing ping, sonar trans-

ducers must have a wide dynamic range.

Echo-ranging sonar

The block diagram in Fig. 2 shows a typical echo-ranging sonar. There are five major assemblies: the operator's console, transmitter, transducer, amplifier and receiver.

The operator's console normally controls the outgoing power. A transmission pulse generated in the console triggers the transmitter's oscillator. At the same time, a keying pulse goes to the transmit-receive (T-R) switch in the amplifier, to disconnect the receiver for the duration of the ping. The transmitter pulse then proceeds through the T-R switch to the transducer.

A keying pulse also goes to the receiver. This helps protect the operator from reverberations, which are very strong for a second or two after each ping. The keying pulse reduces receiver gain, then lets it recover slowly as reverberations die away.

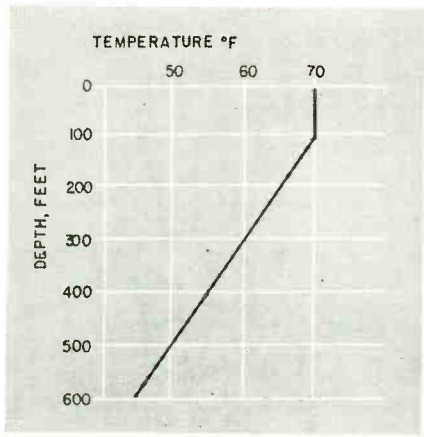

Fig. 4—Typical temperature-depth distribution for deep ocean areas.

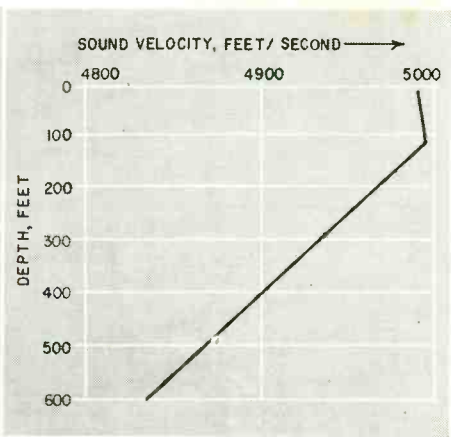

Fig. 5—Sound-velocity distribution arising from temperatures in Fig. 4.

refraction to handicap underwater communications or search.

In point-to-point transmissions, which includes echo ranging, refraction reduces the intensity of received sound by bending sound beams away from where they are aimed, toward regions of slower velocity. The effect is so common that straight-line paths for sound are almost nonexistent. The severity of refraction varies from day to day, and communication or detection ranges can vary from several hundred yards to several thousand yards because of bending.

In deep ocean areas, temperature varies considerably with depth. A fairly common temperature structure is shown in Fig. 4. Here, temperature is constant near the surface, then steadily decreases as depth increases. This structure causes velocity to vary as shown in Fig. 5.

Velocity characteristics of this sort distort a sonar beam as shown in Fig. 6. Because there is a low-velocity region near the surface as well as a deep one, the beam splits into two parts, one bending toward the surface while the other is bent severely downward. Under these conditions, a very deep submarine, or one at periscope depth, might be picked up at a range of over 4,000 yards, while one at 100 feet depth could escape detection until the range was about 2,000 yards. In the "shadow

Fig. 6—Sound-ray pattern generated by the velocity structure of Fig. 5. Part of the beam is bent upward, the rest downward, leaving shadow areas not scanned by sonar.

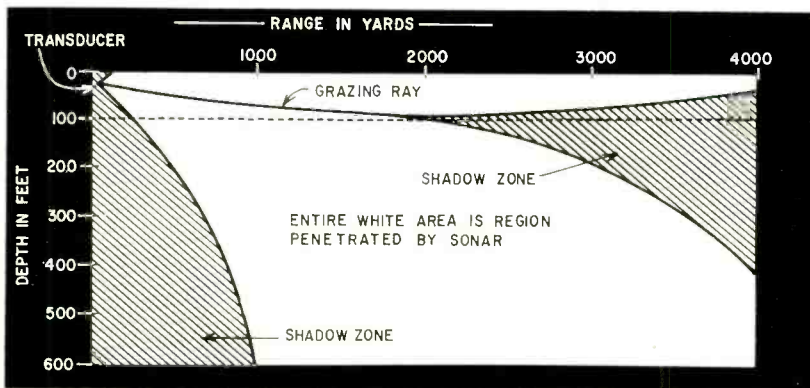

zones," almost the entire signal is lost by refraction. Although some sound will scatter into the zone, the amount is negligible.

As sound spreads out from its source, it gets weaker. The sound passing through a particular area in one place (Fig. 7) has to cover four times that area when it has gone twice as far from the source. This means a loss of 6 db each time the distance doubles. It is most severe near the source of the ping, amounting to 60 db in the first thousand yards but, as Fig. 8 shows, the effect decreases as distance increases.

Absorption loss is created by molecular effects. Part of it is due to friction, part to molecular excitation. It increases with increasing frequency, and at 10 kc is about 2 db per thousand yards.

Reverberations do not attenuate sound, but reduce the amount of useful echo by raising the background noise

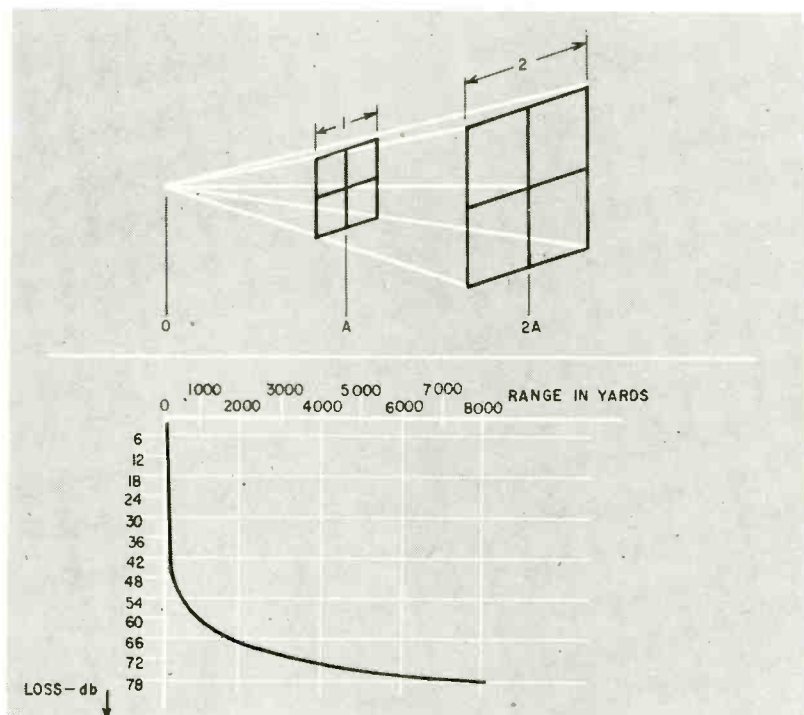

Fig. 7 (Top)—The effect of spreading. Sound which starts from source as O has spread to pass through an area 1-unit square at distance A. At distance 2A, the sound covers an area four times larger. Accompanying reduction in sound intensity is 6 db.

Fig. 8 (bottom)—Spreading loss. There is a 6-db loss each time distance traveled doubles.

level. They are caused by back-scattering of sound from the surface or bottom, or from minute particles in the water. The effect is most serious in the first few seconds after a ping. In tracking a close-in target, reverberations can be high enough to blank the echo out completely.

Acoustic echo ranging is a slow process. Sound travels about 1,600 yards a second in water, compared to 186,000 miles a second for rf energy in air. Since the ping has to make a round trip between transducer and target, sonar range is measured at a rate of 800 yards a second.

A time-base sweep is provided to measure range. Accuracy is difficult to obtain, because of the variations that always occur in sound velocity. Velocity

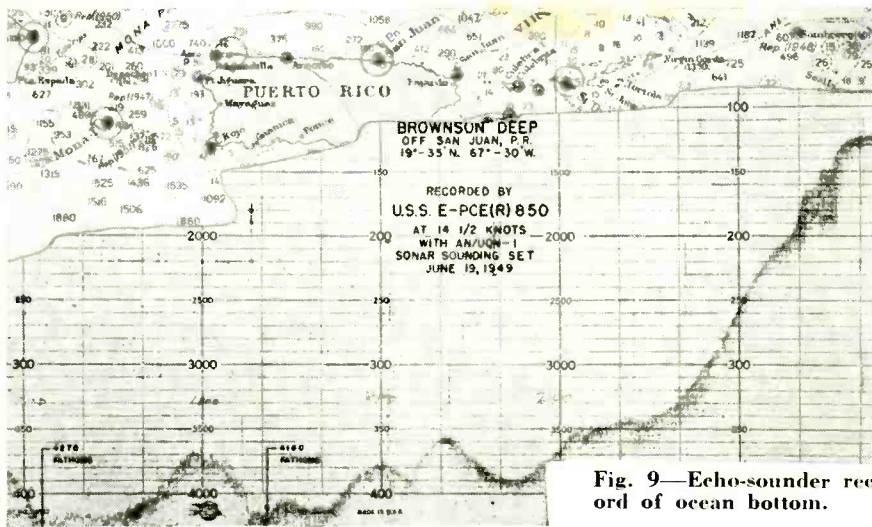

Fig. 9—Echo-sounder record of ocean bottom.

not only varies with depth, but also from place to place within the ocean, from day to day and throughout each day. This continuous variation makes it difficult to pick out one number to use as the velocity of sound. Sonar operators are forced to choose an aver-

by the factors that create so much trouble in submarine detection. Since the beams are aimed straight down, refraction is no problem. Spreading and attenuation are compensated for by the hugeness of the bottom as a target. Echo sounders, as a result, are

be bulkhead-mounted. It was developed for the Navy as the AN/UQN-1B echo sounder, and has now been released for civilian use. It presents a permanent record of depth information on sensitized paper (Fig. 9).

This sort of equipment is useful in ocean survey work, and is also a valuable tool for navigators. In a fog, for example, echo-sounder information can be used to pilot ships within sighting distance of shore or navigational markers.

Another small sonar is the Edo Fishscope. It does not give a permanent record, but provides an A-scope indication of water depth, and the depth of any fish that are within the beam. Fig. 10 shows a fishing boat about to receive echoes showing a school of fish just over the bottom. With this information, the fishermen can cast their nets where they know there are fish, and set the nets to the right depth to catch them. By using their Fishscope, they make more productive cruises.

The instrument has two scales for presentation of its information. One shows all the water directly beneath the

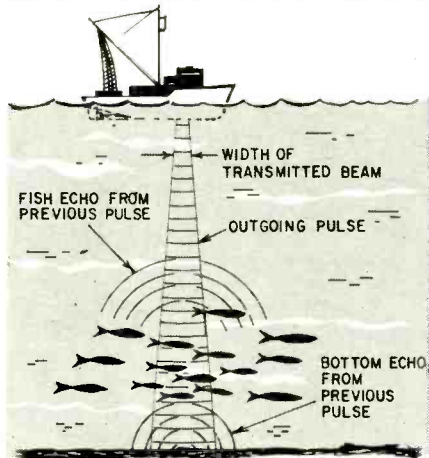

Fig. 10—Fishing boat locating fish with vertical-beamed sonar.

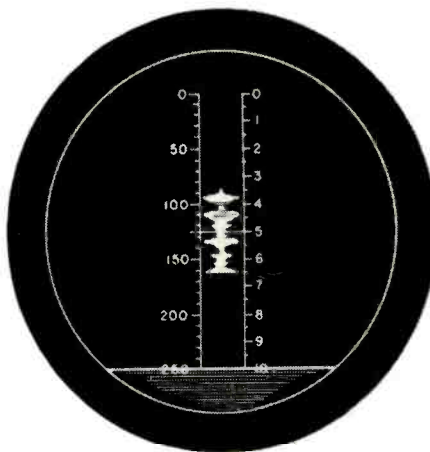
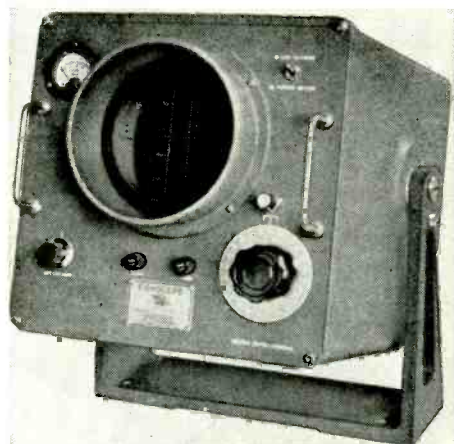
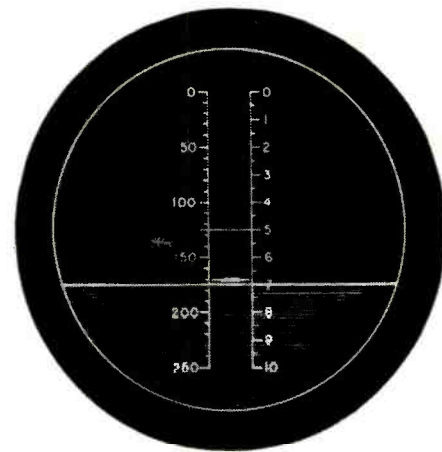

Fig. 11—Fish-finder scope pattern showing fish 5 fathoms above the bottom. Difference between patterns is result of using different scales.



EDO Corp.

Fishscope is compact unit used by commercial fisherman to locate fish.

age, based on the local velocity structure. With a properly chosen average set into the range unit, range errors due to velocity error will not be harmfully large.

Depth finders

Echo sounders aren't affected greatly

small and compact, and operate at low power. Even so, they must have all the components of a large sonar, or at least provide the same functions.

The echo sounder shown in the photo is completely contained, except for the transducer, in a small cabinet that can

boat, to a depth of 250 fathoms. The other scale, available at the flip of a switch, shows any selected 10-fathom sector of this water. In Fig. 11, the Fishscope is indicating a school of fish about 5 fathoms from the bottom, as it appears on each of the two scales. END

Checking power transformers

We often run into a power transformer whose proper lead connections are unknown. It is dangerous to wire up such a transformer and try it out as the manufacturer may use a nonstandard color code for his leads, and you might connect the power line to the wrong ones. (It cost me one blown fuse to discover that, on one transformer, the black leads went to the filament winding and not the primary.) An ohmmeter often cannot deliver useful information, especially on larger units where all windings have fairly low resistances.

Therefore, I recommend the following method for testing a new transformer:

Take a source of low ac voltage (say, 6.3 volts) and connect it to the leads you believe connect to the filament winding of the corresponding voltage. Then measure the ac voltages at the other leads and compare the readings with what you expect. If they coincide, then your assumed assignment of leads is correct. If not, try some other leads till you hit the right ones. With this method, a wrong guess can do no damage.—Charles E. Cohn

FM STEREO COMPONENT DIRECTORY

By **LARRY STECKLER**
ASSOCIATE EDITOR

FM STEREO HAS REALLY ARRIVED. THE SYSTEM HAS BEEN SELECTED and approved. Some FM stations are already transmitting stereo programs and others will soon follow. To receive these stereo broadcasts, FM stereo (multiplex) equipment is needed.

Hi-fi component manufacturers are bringing FM stereo receivers to the market as fast as possible. There are adapters for converting existing FM tuners. And there are all-new FM stereo tuners and receivers.

In an attempt to unravel some of the confusion, we queried all hi-fi manufacturers. We asked them about their existing and planned FM stereo gear. This directory is the result of these questions. It lists every hi-fi FM stereo adapter, tuner and receiver known at the time of writing.

Most of the units described are already on the market or will be by the time this article is published. Wherever possible, a photo of the unit is included with the capsule report on its specifications. In some cases photos are not yet available. Some manufacturers have only prototype units that are not suitable for illustration. But it is just a matter of time before they will be coming off the production line.

On the specification end, we have attempted to abbreviate the data now available, picking out the important facts. Where a specific bit of information is given in one listing and not in the next, it just wasn't available for that next unit.

A number of circuits are used in these adapters and tuners. These will be presented and discussed elsewhere. The Crosby schematic appears this month. Others will appear in future issues.

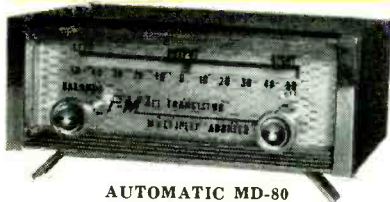

AUTOMATIC MD-80



ADMIRAL AMX100

ADMIRAL AMX100

Admiral Corp., 3800 Cortland St., Chicago 47, Ill.

FM Stereo Adapter

Self-powered unit is transistorized. For use with Admiral AM/FM tuners made during 1960, 1961 and 1962. Has gain of 1; frequency response, 20-20,000 cycles. 38-kc signal is suppressed 40 db. All controls are preset. Channel separation better than 26 db. 8-1/16 x 4 3/4 x 4 inches.

ALTEC-LANSING 359-A

Altec-Lansing Corp., 1515 S. Manchester Ave., Anaheim, Calif.

FM Stereo Adapter

Self-powered adapter for Altec 353A, 309A and 312A receivers and tuners. Adapter has 3-volt low-impedance output. It has no controls and is designed to be located out of sight behind the tuner chassis.

AUTOMATIC MD-80

Automatic Radio, 122 Brookline Ave., Boston 15, Mass.

FM Stereo Adapter

All-transistor FM stereo adapter for use with companion FM tuner. Operates off 9 volts from tuner or separate battery. On-off and balance controls.

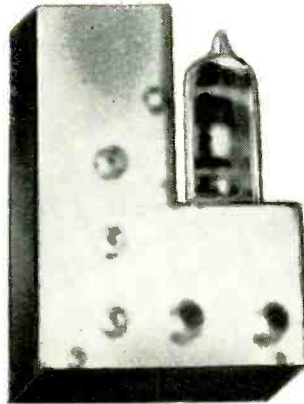

BELL MXA-1

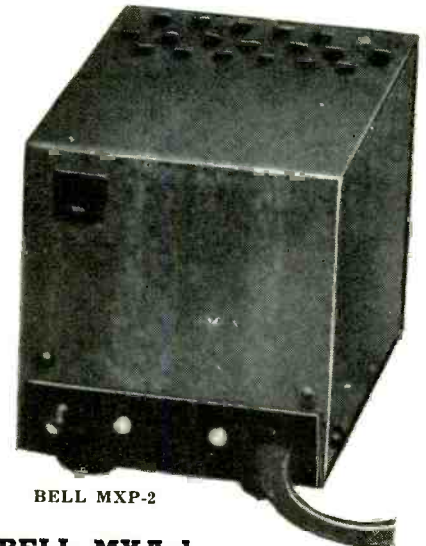

BELL MXP-2

BELL MXA-1

Bell Sound Div., 555 Marion Rd., Columbus 7, Ohio

FM Stereo Adapter

\$39.95

Piggyback unit uses three tubes and two diodes. Becomes integral part of Bell tuners. Can be used with other tuners with response to 53 kc. Adapter output 1 volt. High impedance. Response 20-15,000 cycles ± 3 db. Hum and noise 50 db down. 38-kc carrier and harmonics 60 db down. No controls. Channel separation, 30 db.

BELL MXP-2

FM Stereo Adapter

Self-powered version of the MXA-1. Designed for use with Bell tuners, it can also be used with other tuners that have high-frequency response to 53 kc and provision for a multiplex output jack. All other characteristics the same as the MXA-1.

BOGEN PX60

Bogen-Presto Co., PO Box 500, Paramus, N.J.

FM Stereo Adapter

\$69.50

Self-powered unit for Bogen tuners and other makes that have wide bandspread and good if linearity. Adapter output 1 volt, from low-impedance cathode follower. Response flat 50-15,000 cycles. Hum and noise 60 db down. Power, mono-stereo, stereo dimension, separation controls. 24-db channel separation. 9 x 4 1/2 x 4 1/2 inches.

BOGEN RP40A

Stereo Receiver \$399.95
 Complete AM/FM stereo, tuner, preamp and dual 22-watt amplifier, with built-in multiplex. Circuit of multiplex section has same general characteristics as the Bogen PX60 adapter. Channel separation better than 20 db. 16 x 6 x 13½ inches.

BOGEN RP200

Stereo Receiver \$299.95
 Complete AM/FM tuner, stereo preamp and dual 20-watt amplifiers. Channel separation for FM stereo better than 20 db. Multiplex section has same general characteristics as the Bogen PX-60 adapter. 16½ x 5½ x 14 inches.

BOGEN TP60

Stereo Tuner \$269.95
 Complete AM/FM tuner with built-in multiplex section. Channel separation better than 20 db. Multiplex circuitry has same general characteristics as the Bogen PX60 adapter. 16 x 6 x 9 inches.

BOGEN TP200

Stereo Tuner \$199.95
 Complete AM/FM tuner with built-in multiplex. Response 20-18,000 cycles ±0.5 db. 38-kc carrier and harmonics are suppressed. General multiplex characteristics same as Bogen PX60 adapter. 15 x 4¾ x 12½ inches.



BOGEN PX60

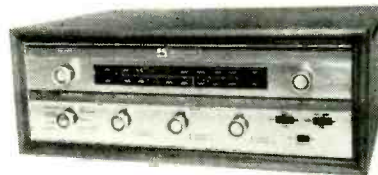

BOGEN RP200

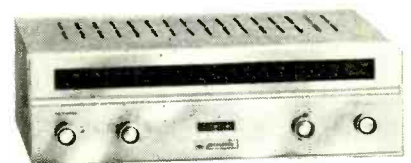

BOGEN TP200



BOGEN RP40A



CROSBY MX-101

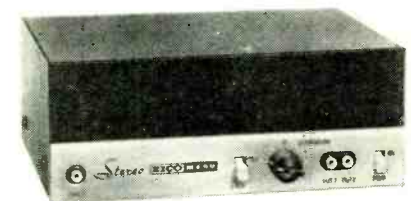

EICO MX99

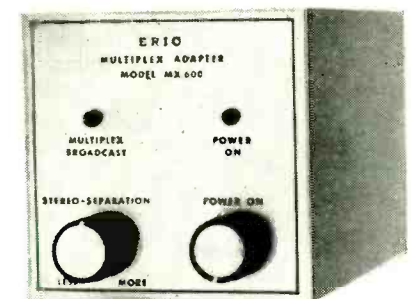

ERIC MX600-D

CROSBY MX-80

Crosby Electronics Inc., 135 Eileen Way, Syosset, N.Y.

FM Stereo Adapter \$49.95
 Adapter is specifically designed for R-80 AM/FM stereo receiver. Adapter powered by receiver. Receiver has stereo FM controls already mounted on front panel. Adapter has the same specifications as the MX-101 adapter. 6 x 4 x 4 inches.

CROSBY MX-101

Universal FM Stereo Adapter \$69.95
 Self-powered unit uses four tubes and two semiconductor diodes. Will work with almost any FM tuner that has a multiplex output. Dimension control varies separation with maximum of at least 20 db over the entire audio range of 30-15,000 db cycles. 5½ x 4¾ x 9 inches.

CROSBY 650MX

Stereo Receiver \$249.95
 Complete FM tuner, stereo preamp and dual 14-watt amplifiers. Built-in multiplex section has same general characteristics as MX-101 adapter.

DEWALD P-400

DeWald Radio Mfg., 35-15 37th Ave., Long Island City 1, N.Y.

FM Stereo Adapter \$47.95
 Self-powered FM stereo adapter for DeWald and other wide-band FM tuners. Output 3 volts. Response 50-15,000 cycles. Hum and noise 75 db down. On-off, stereo-mono switches; stereo blend control. 4½ x 9½ x 3½ inches.

DEWALD R-1103

Stereo Tuner
 FM tuner with built-in multiplex circuitry. Multiplex section has same general specifications as the DeWald P-400 adapter. Complete 13½ x 4¾ x 11½ inches.

DYNACO FMX-3

Dynaco Inc., 3912 Powelton Ave., Philadelphia 4, Pa.

FM Stereo Adapter \$29.95
 Stereo FM adapter designed to work only with the Dyna-tuner. Adapter output 1 volt. Response 20-15,000 cycles. Hum and noise 60 db down. Unit draws power from tuner. Separation control. Available November 1961.

EICO MX99

Electronic Instrument Co., 33-00 Northern Blvd., Long Island City 1, N.Y.

FM Stereo Adapter wired \$64.95
 kit \$39.95

Self-powered adapter for use with all Eico FM equipment and any other component FM tuners that use a ratio detector and have a multiplex output jack. Filters out 67-, 38- and 19-kc carriers. Indicator lamp lights when unit is receiving stereo program. 35-db separation between channels over entire audio range. 9½ x 6¾ x 3¾ inches.

ERIC MX600-D

Eric Engineering, 8270 Santa Monica Blvd., Los Angeles 46, Calif.

FM Stereo Adapter \$59.95
 Self-powered unit can be used with all Eric tuners and most other makes that have wide bandwidths. Indicator lights when FM stereo program is being received. Uses Compactron tubes. On-off, stereo separation controls. 4½ x 4½ x 8½ inches.



FISHER MPX-100



G-E MA-2G

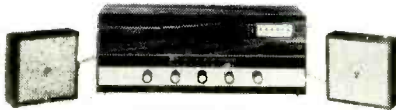

GRANCO 809



GROMMES 103GTA



GROMMES 101GTA



HARMAN-KARDON T300X



GROMMES 500

FISHER MPX-100

Fisher Radio Corp., 21-21 44th Dr., Long Island City 1, N.Y.

FM Stereo Adapter

Self-powered adapter for use with all Fisher FM tuners receivers and other tuners having ratio detectors and multiplex outputs. Stereo balance and selector switches. Stereo beacon lights to indicate stereo program is being received. 4 7/8 x 4 7/8 x 12 inches.

G-E MA-2G

General Electric, Electronics Park, Syracuse, N.Y.

FM Stereo Adapter

Unit is self-powered. Requires input of 1 to 1.5 volts rms corresponding to 75-kc deviation. Hum and noise 60 db down. Response 50-15,000 cycles ± 3 db. 10 x 2 1/4 x 3 inches.

GRANCO 809

Granco, 83-30 Kew Gardens Rd., Queens, N.Y.

Stereo Receiver

Complete stereo receiver (AM/FM tuners, stereo preamp, dual amplifiers) with built-in multiplex circuitry.

GROMMES 101GTA

Precision Electronics Inc., 9101 King St., Franklin Park, Ill.

Stereo Tuner

\$129.90

FM tuner with optional built-in multiplex circuitry. No stereo specifications available.

GROMMES 500

Stereo Receiver

\$339.90

FM/AM tuner, stereo preamp, dual 20-watt amplifiers. Has built-in multiplex as an option. No multiplex specifications available.

GROMMES 103GTA

Stereo Tuner

\$299.90

FM/AM tuner with optional built-in multiplex circuitry. No data available on multiplex section.

HARMAN-KARDON CITATION IIIMA

Harman-Kardon Inc., Ames Court, Plainview, N.Y.

FM Stereo Adapter

(wired) \$89.95

Mounts on and powered by Citation III FM tuner. New escutcheon for tuner allows for adapter controls. Tuner chassis already has holes for mounting controls. Wired unit available about Oct. 1. Kit version should be available before end of year.

HARMAN-KARDON MX500

FM Stereo Adapter

Plug-in adapter uses two tubes and two semiconductor diodes. For use with manufacturer's F500, ST360A, ST360 and ST350. 38-kc notch filter drops out 38-kc carrier to avoid interference with bias oscillator of a tape recorder when one is used.

HARMAN-KARDON MX600

FM Stereo Adapter

\$49.95

Snaps onto back of tuner and draws power from it. For use with TA230, TA224 and TA260 receivers. Consists of two-stage subcarrier main amplifier followed by a 19-kc synchronous oscillator. Output level 1.25 volts. Distortion less than 1%. Frequency response 15-15,000 cycles ± 1 db.

HARMAN-KARDON MX700

FM Stereo Adapter

Self-powered adapter for use with all Harman-Kardon tuners and receivers that have multiplex outputs. Same circuitry as the MX-600 with additional power supply.

HARMAN-KARDON T300X

Stereo Tuner

\$149.95

AM/FM tuner with a built-in multiplex section. Multiplex circuitry is same as in MX-600 snap-on adapter.

HEATHKIT AC-11, ACW-11

Heath Co., Benton Harbor, Mich.

FM Stereo Adapter

Kit \$32.50

Wired \$56.25

Self-powered adapter plugs into multiplex output jack of quality FM tuners. Three-tube circuit insures low distortion with simplified balanced-diode detector. Controlled signal matrixing for maximum channel separation. Frequency response 50-15,000 cycles. 3 3/8 x 3 1/2 x 9 7/8 inches.

KARG MX-4

Karg Laboratories Inc., 132 Ely Ave., S. Norwalk, Conn.

FM Stereo Adapter

\$64.50

Self-powered unit will work with tuners that have a 100% modulated output between approximately 0.2 and 1 volt.



KNIGHT KN-125M



KNIGHT KN-136M



KNIGHT KN-150M



KNIGHT KN-250M



KNIGHT KN-310M



HEATHKIT AC-11, ACW-11

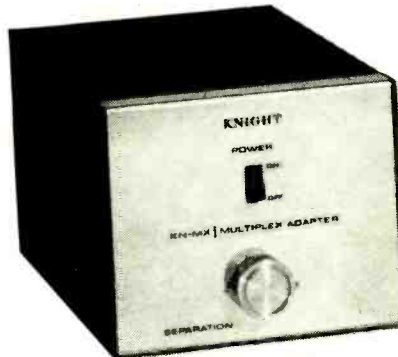

KNIGHT KN-MX

Adapter output 2 volts, impedance 10,000 ohms. Response 40-15,000 cycles ± 2 db. Hum and noise 55 db down. 38-kc signal and harmonics 40 db down. On-off and separation controls. Channel separation 28 db. 5 x 5 x 8 inches.

KNIGHT KN-MX

Allied Radio, 100 N. Western Ave., Chicago 80, Ill.

FM Stereo Adapter

\$39.95

Self-powered adapter will work with FM tuners that have wide-band if's and discriminator—to 250 kc. Audio output at least 0.4 volt at 30% modulation. Adapter output 2.5 volts. Frequency response 50-15,000 cycles. Hum and noise 50 db down. 38-kc signal and harmonics suppressed 20 db. Separation and power controls.

KNIGHT KN-125M

Stereo Tuner

\$179.95

FM/AM tuner with built-in multiplex circuitry for receiving stereo FM broadcasts. Characteristics of the multiplex section are similar to the Knight KN-MX adapter.

KNIGHT KN-136M

Stereo Tuner

\$119.95

FM/AM tuner has built-in multiplex circuitry with characteristics similar to the Knight KN-MX adapter.

KNIGHT KN-150M

Stereo Tuner

\$149.95

Tuner with built-in multiplex circuitry. Characteristics of multiplex section similar to Knight KN-MX adapter. Has indicator light to show when stereo program is being received.

KNIGHT KN-250M

Stereo Tuner

\$139.95

All-transistor FM tuner with built-in multiplex circuitry for receiving FM stereo broadcasts. Characteristics of the multiplex section are similar to the Knight KN-MX adapter.

KNIGHT KN-310M

Stereo Receiver

\$239.95

All-transistor unit has FM tuner, multiplex built-in, stereo preamp and dual 20-watt amplifiers. Characteristics of multiplex circuitry similar to Knight KN-MX adapter.



LAFAYETTE LA-215

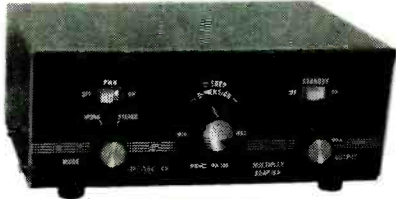

PACO MA-100



H. H. SCOTT 335

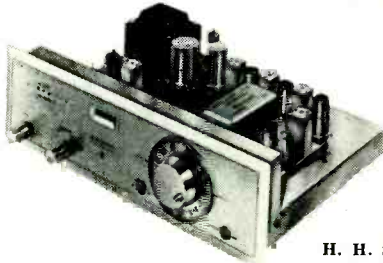

H. H. SCOTT 350



SHERWOOD S3MX



SHERWOOD S-3000 IV

LAFAYETTE LA-215

Lafayette Radio & Electronics, 165-08 Liberty Ave., Jamaica 33, N.Y.

FM Stereo Adapter

Self-powered unit will work with all tuners that deliver 0.7 volt at 100% modulation at their multiplex output. Adapter output 1 volt. Response, 20-20,000 cycles ± 1 db. 38-kc signal and harmonics suppressed 50 db. Function and separation controls. Channel separation better than 30 db.

PACO MA-100

Paco Electronics Co. Inc., 70-31 84th St., Glendale 27, N.Y.

FM Stereo Adapter

Self-powered adapter for Paco ST-45 and ST-25 tuners. Can also be used with many other wide-band tuners. Dimension and volume controls, mono-stereo switch. 19- and 38-kc signals are suppressed.

PILOT 100

Pilot Radio, Corp., 3706 36th St., Long Island City, N.Y.

FM Stereo Adapter

\$49.50

Self-powered adapter designed for Pilot receivers but will work with tuners that have wide-band circuits, 0.2-2 volts output at 100% modulation at their multiplex output. Adapter has 2-db gain, low-impedance output. FCC standards as to frequency response and channel separation. 5 x 3 x 12 inches.

PILOT 200

FM Stereo Adapter

\$79.50

Self-powered adapter works with wide-band tuners whose multiplex output is between 0.2 and 2 volts, with 100% modulation. Same general characteristics as the Pilot 100 but automatically switches in and out. FM stereo 19-kc pilot carrier turns adapter on. When 19-kc signal is absent, adapter goes off. 5 x 3 x 14 inches.

H. H. SCOTT 335

H. H. Scott Inc., 111 Powder Mill Rd., Maynard, Mass.

FM Stereo Adapter

\$99.95

Adapter is designed to work with Scott tuners. Output is 2 volts at 90% modulation. Frequency response 20-15,000 cycles ± 1 db. 38-kc carrier and its harmonics suppressed at least 50 db. Selector, noise filter, level and adapter in-out controls. Channel separation approximately 35 db. Separate outputs for tape recorder. Indicator lights when stereo program is received. 4 $\frac{1}{2}$ x 6 $\frac{1}{2}$ x 12 $\frac{1}{4}$ inches.

H. H. SCOTT 350

Stereo Tuner

\$199.95

FM tuner with built-in multiplex circuitry. Frequency response 20-15,000 cycles ± 1 db. Hum and noise 60 db down. 38-kc carrier and its harmonics suppressed at least 50 db. Stereo indicator lights when stereo program is being received. Channel separation 35 db or better. 4 $\frac{1}{2}$ x 15 x 10 inches.

SHERWOOD A3MX

Sherwood Electronic Labs., 4300 N. California Ave., Chicago 18, Ill.

FM Stereo Adapter

\$49.50

Plug-in unit is powered by tuner it is used with. Designed specifically for S2200 and S-30000III. Two-tube circuit is similar to S3MX but does not have hiss filter and 69-kc filter is in circuit at all times.

SHERWOOD S3MX

FM Stereo Adapter

\$69.50

Self-powered unit can be used with Sherwood FM tuners that have multiplex output and wide-band detector. Adapter circuitry uses four tubes plus rectifier. Hum and noise 60 db down. Output 2 volts with less than $\frac{1}{2}$ % distortion. Filter circuits remove 19-kc pilot carrier and 67-kc subchannel transmission. Frequency response 20-15,000 cycles ± 1 db. 5 $\frac{1}{2}$ x 10 $\frac{1}{2}$ x 4 inches.

SHERWOOD S-3000 IV

Stereo Tuner

\$160.00

Complete FM stereo tuner. Adapter circuitry has phase-locked synchronous oscillator to reinsert multiplex carrier. Filter circuits remove 19-kc pilot carrier and 67-kc subchannel transmission. Frequency response of adapter section is 20-15,000 cycles ± 1 db.

SHERWOOD S-8000

Stereo Receiver

\$299.50

Complete FM stereo tuner, preamp and amplifier. FM section has controlled frequency and phase response of the if amplifier, limiters and discriminator, flat to 75 kc, for minimum distortion and maximum separation of the multiplexed signal. Multiplex circuitry same as A3MX plug-in adapter. 16 $\frac{1}{4}$ x 14 x 4 $\frac{1}{2}$ inches. END

ULTRASENSITIVE PHOTOGRAPHIC LIGHTMETER

By ALEN E. GORDON

When taking indoor pictures or night shots, where there is a minimum of light, the average commercial light meter is useless. It just isn't sensitive enough to give a reading. But the home-made unit described here is so sensitive that it will give accurate readings for light levels that require exposures as long as 30 seconds. It is also designed to take light readings down the narrow tubes of microscopes and medical instruments. The secret is a cadmium sulphide photocell.

The man who takes indoor pictures or night photos without flashbulbs uses very sensitive film and fast lenses. For such work, most photographers use regular light meters with a booster cell. Even this booster is often inadequate because it simply does not have enough sensitivity to measure the small amounts of light available.

In my work I take pictures down the tubes of microscopes, bronchoscopes and other medical tools. No light meter was small enough to fit into a 1/2- to 1-inch diameter tube and read the light accurately. Most commercial units have photocells that are about 1 by 2 inches—much too large for a microscope. Furthermore, this work requires high sensitivity, and the amount of light varies tremendously with microscope diaphragm settings, slide thickness and depth of staining. The only way in the past was to set the exposure by trial and error.

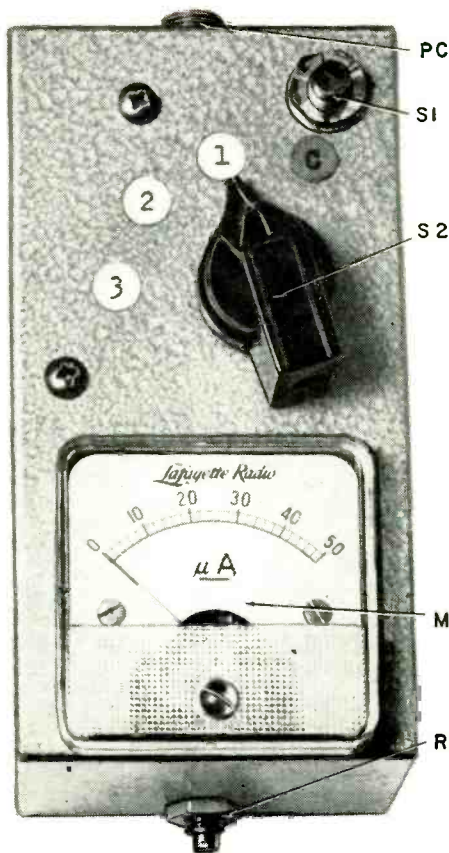

Finished unit. Push S1 for light reading.

This meter is an excellent tool for all these purposes. It can be hand-held and is small enough to fit in your pocket. Sensitivity is high—it will read the dimmest light in the corner of a room lit by ordinary lightbulbs. The photocell itself is as small as a pencil eraser and, when mounted, it can easily be inserted into a microscope barrel.

The circuit

The heart of the unit is a cadmium selenide photocell manufactured by Clairex. Use their model CL-4. It is mounted in a plastic case 1/4 inch in diameter and 1/2 inch long. The cell is not like the usual light-meter photocell—it does not generate electricity—but it is infinitely more sensitive. Its resistance varies as the amount of light hitting it changes, adjusting the amount of voltage that can be fed through it to produce a meter reading. This is a disadvantage of the unit, it needs batteries, and the probable reason why it is not used in commercial meters although the battery drain is low, never more than 5 ma.

The circuit (Fig. 1) shows what is basically an ohmmeter for measuring the resistance of the cell. With no light

The photographer's dream, it measures existing light for indoor or night photography

hitting it, the resistance is very high. This drops as increasing amounts of light strike the cell. A 22.5-volt hearing-aid battery powers the unit. The current is read on a miniature 50- μ a meter. A less sensitive meter or a lower battery voltage lowers the unit's sensitivity. The opposite is also true. If an even more sensitive meter were needed, you would have to go to high-voltage batteries. If portability could be sacrificed, a high-voltage power pack could be built or a vacuum-tube microammeter used.

The photocell is temperature-sensitive. A temperature change from 50° to 90°F causes a 5% change in the meter reading. For those who are mathematically inclined, the temperature coefficient of resistance at 25°C and 10 foot-candles is 0.25% per °C. However, this has not been a problem.

One thing that definitely has to be kept in mind is the spectral response (Fig. 2). Peak sensitivity is at 6,900 Å, which is the color red. In all ordinary scenes, this can be safely ignored. But, if the scene is pure blue and green with absolutely no color in the yellow-red range, decrease the exposure two or three stops to compensate for the lower meter sensitivity. As you can imagine, scenes composed of only blue and green light are extremely rare. In shooting many rolls of film at night along the streets of New York, I have never yet come across an overexposed shot because of this. Other Clairex photocells

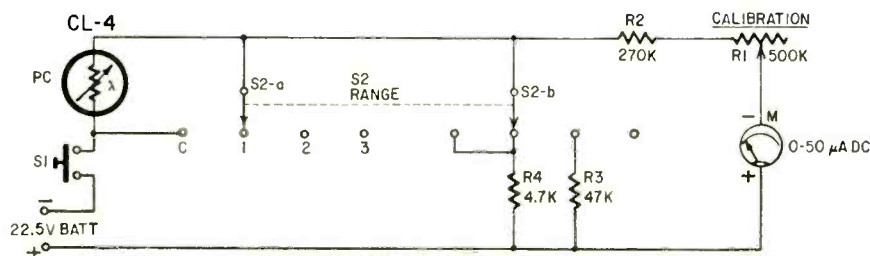

Fig. 1—Circuit of the sensitive light meter.

- R1—pot. 500,000 ohms, miniature
- R2—270,000 ohms, 1/2 watt
- R3—47,000 ohms, 1/2 watt
- R4—4,700 ohms, 1/2 watt
- BATT—22.5 volts (Eveready No. 505 or equivalent)
- M—0-50 μ a, dc (Lafayette TM-200 or equivalent)
- PC—Clairex CL-4
- S1—spsst normally open pushbutton
- S2—double-pole 4-position rotary
- Case, 1/2 x 2 x 4 inches
- Miscellaneous hardware

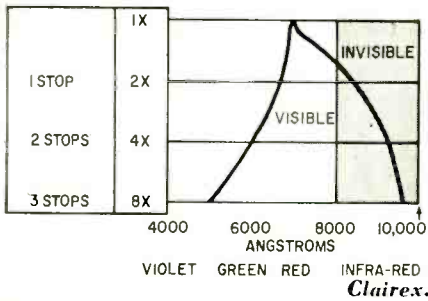

Fig. 2—Spectral response of the CL-4 photocell.

(high-impedance models unsuitable for a lightmeter) have peak responses in the blue-green spectrum. The high sensitivity of the CL-4 to infrared light makes this meter useful for infrared photography too.

Construction kinks

Mount the CL-4 photocell in an ordinary bushing for a 1/4-inch shaft. The exact way of mounting the cell depends on your needs. The farther back in the case the cell is, the narrower its angle of light acceptance. This is shown in Fig. 3. This phenomenon is useful if you are taking a picture of very light areas with heavy shadows. The ordinary meter has a wide acceptance angle and will read an average from this scene. The only way you could properly expose the film is to get up close and read the light in the bright as well as the dark areas and then determine your exposure accordingly. But what happens if this cannot be done, as in a picture of a valley with shadows in it? Simply use the principle of Fig. 3 to make a meter of very narrow light acceptance and measure both readings from the same spot. In my unit I mounted the photocell in the bushing as deep as I could get it.

The bushing can be extended with a piece of Bakelite tubing. Paint the inside of the bushing or Bakelite tube dull black to minimize reflections. Be sure that the plastic is really lightproof because the meter is extremely sensitive. You cannot even use your finger or palm to block out the light to demon-

strate that the meter will return to zero with no light. It will actually read the light coming through your finger, and you must use a piece of metal to block it off.

S1 is positioned so it is directly under the thumb. This spring-return switch is depressed to read the light or to calibrate. In this way no current flows unless S1 is on and you cannot run down the battery by forgetting to turn off the switch. The parts are laid out so S1 is under the thumb of a right-handed person, and everything has to be reversed for the left-handed. Position 1 on the meter is the least sensitive scale and position 3 the most sensitive. Position C is for adjusting the ohmmeter circuit for variations in battery voltage. At this setting the photocell is completely shorted out and resistor R4 is connected across the battery to measure the voltage with a 5-ma current drain. The meter is adjusted to full scale with R2, a miniature unit with a screwdriver shaft I adjust with my fingernail. This adjustment has to be made only rarely and the rheostat could be put inside the case.

Any 2-pole 4-position switch can be used for S2. The battery mounts in a standard aluminum bracket.

Calibration

Calibration is simple in principle but a little tricky to carry out. In principle, you hold the meter side by side with a meter of known accuracy, and compare readings. Point them toward and away from a steady light source—use a 100-watt lamp. For example: to get the figures shown on the calibration chart in Fig. 4, set the calibrated meter for an ASA film speed of 125 and an aperture of f/2. This way all you have to read is the shutter speed. With the two meters side by side read the speed reading off the calibrated meter. On my unit, when I got an exposure time of 1/125 second, my sensitive meter read 27 μ a on range 1. When the calibrated meter read 1/30 second, the sensitive meter read 14 μ a on range 1 and 41 μ a on range 2.

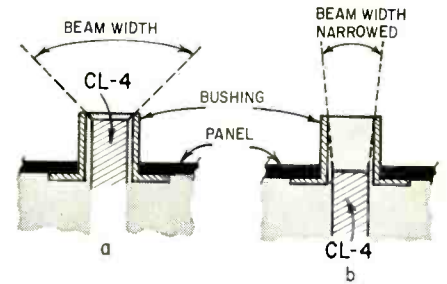

Fig. 3—How moving photocell back into tube narrows angle of accepted light.

The only problem comes when you reach the lower limits on the scale of the reference meter. Then you will need a neutral density filter of some known value. These filters cut down the amount of light by some known amount and do it consistently over the light spectrum. If you do not already own one, you can pick up a filter for about \$2.

Place the filter over the sensitive meter's photocell. Now when you point the two meters toward a light source, subtract the filter factor from the reading on the commercial meter. For example, if the filter has a 5-stop factor and the commercial meter read 1/30-second exposure at f/2 with an ASA film speed of 125, the reading on your sensitive meter (15 μ a on range 2 and 40 μ a on range 3) is equivalent to a 1/30-second exposure at a shutter opening 5 stops larger than f/2 (f/2, f/2.8, f/4, f/5.6, f/8, f/11). Or since the calibration chart assumes that the ASA stays at 125 and the aperture at f/2, shutter speed is slowed down five steps (1/30, 1/15, 1/8, 1/4, 1/2, 1 second). Do this step by step and you will get calibrated readings that are lower than any possible with the commercial unit.

Do not hold the new and the reference meters in your hand—small angular changes result in large meter-reading changes, and all errors will affect the weaker measurements. Hold the meters firmly on a desk top and make all readings carefully. After several practice runs you will get consistent readings and make a good calibration chart.

The calibration charts for my meter

Inside the hand-sized case.

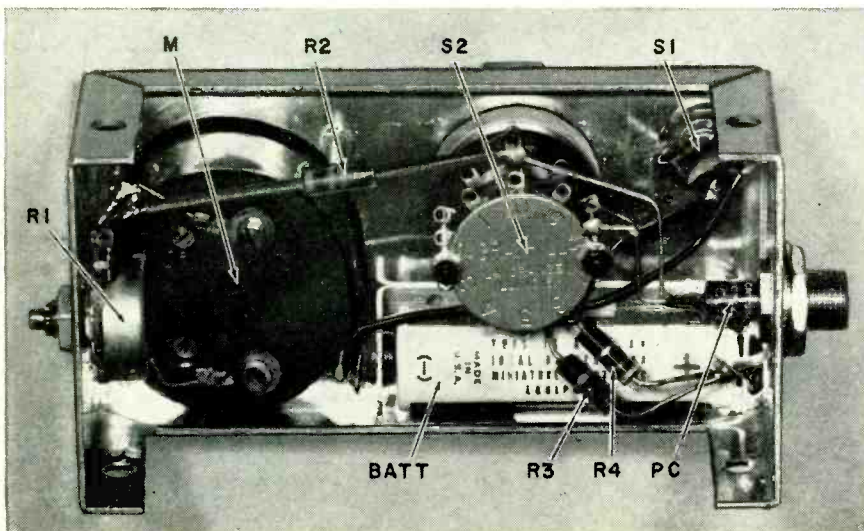

SPEED IN SECONDS	(ASA 125 Film At f/2)		
	METER READING RANGE		
	1	2	3
1/250	27		
1/125	23		
1/60	18	46	
1/30	14	41	
1/15	9	36	
1/8	5	31	
1/4		25	
1/2		21	46
1		15	40
2		10	34
4		4	27
8			21

Fig. 4—Basic calibration chart.

are shown in Figs. 4 and 5. Fig. 5 is plotted on 5-cycle semilogarithmic paper. The lower scale is the meter reading: 0-50 μ a. The left-hand scales are a little unusual. To understand them, you have to know something about the ASA system of rating film. In this system, which is the one used in the United States, the higher the ASA number the more sensitive the film. If you double the ASA number, you need only half the exposure time, all other things being equal.

Not knowing what type of film I was going to use, scale A was set up in "ASA-seconds at f/2." What this means is that your camera is set at f/2, then you read a figure "ASA-seconds." You read off the number, and divide by the ASA number of the film you are using. This gives the exposure time. Let us say you are using Kodachrome with an ASA rating of 10, and the meter reads 27 on the most sensitive scale (METER RANGE 3). For this, scale A at the left reads 500 ASA-seconds. (Follow 27 on the meter reading scale at the bottom of the chart until it intersects the proper METER RANGE scale. Then follow across to the left and read the answer on scale A.) Dividing this by the ASA number, 10, gives an exposure time of 50 seconds. With ASA 800 film, the exposure time is 500/800 or $\frac{1}{2}$ second (the closest shutter speed). With ASA 50 film it is 10 seconds. Scale A is a general scale you can use with any type of film new or old.

To save the work of dividing out the ASA number, I also made up scales to read the exposure time for my two favorite films. Scales B and C have the ASA number divided out so you can read off the exposure times directly. Scale B is labeled "ASA 50." This is the one I use when I shoot with Panatomic X film. Scale C is labeled "ASA 125," the rating of the fastest indoor color film available today, high-speed Ektachrome. You can make up scales like this one or one like Fig. 4. It is exactly the same thing as scale C. It is set up for ASA 125 film and f/2. I then read off the exposure time vs. the meter reading.

You can make up all sorts of scales for these charts. If your camera has a maximum opening of less than f/2, the scales can be altered. In the example above with Kodachrome, if the exposure at f/2 is 50 seconds, then at f/2.8 it is 100 seconds; at f/4, 200 seconds, etc. When you make up new scales, just cut out a strip of the logarithmic paper and write the exposure times on it. Slide it

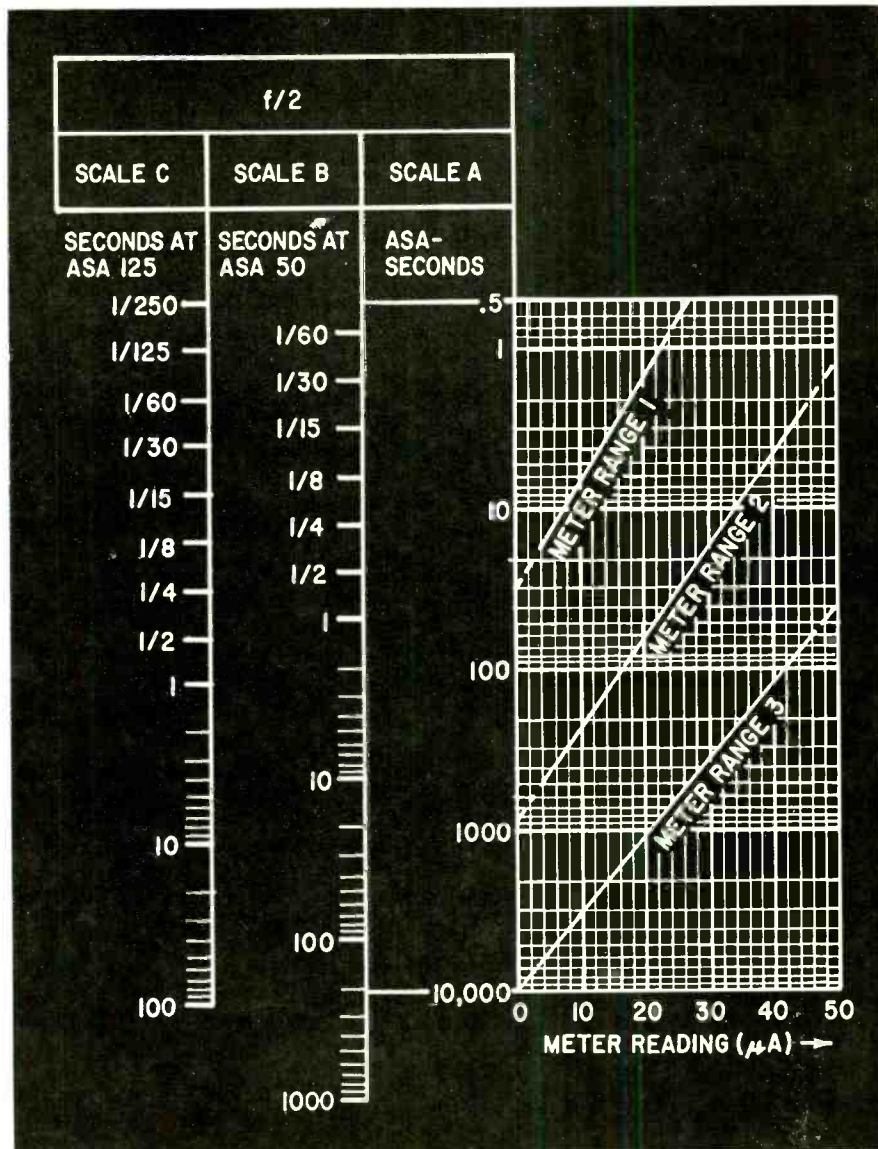

CONVERT TO STEREO

How, when and where multiplex adapters can be used

By **LEONARD FELDMAN***

SINCE APRIL 19, 1961, THE DAY OF THE FCC stereo multiplex decision, we have been literally deluged with inquiries concerning the problems of multiplex conversion of present-day tuners and FM receivers. Naturally, interest is extremely keen, for stereo via FM promises to provide the missing music source for stereo listening and stereo home recording.

Are all tuners convertible?

Virtually all FM tuners now in the hands of the public can be converted to stereo by adding a multiplex adapter. That does not mean that all tuners will work equally well after conversion. Many inexpensive tuners may, because of their simple ratio-detector type circuits, actually produce better stereo results than some of the more expensive tuners featuring the well known Foster-Seeley limiter high-impedance discriminator circuit, long considered the standard in FM detector design. Problems resulting from the particular tuner design will be dealt with later. For the moment, two degrees of "readiness for conversion" should be considered: tuners that already have a multiplex jack and tuners to which this jack must be added.

Tuners with multiplex jacks

Almost all tuners built in the last 5 years or so already have a multiplex jack. It is usually located at the rear of the chassis (or on the top of the chassis, adjacent to the ratio detector or discriminator transformer). If a circuit diagram of the particular tuner is not

available, trace the actual connection of the multiplex jack to determine whether it is wired to meet FCC-approved standards.

Fig. 1 shows a discriminator circuit that does have a multiplex jack. Nevertheless, if an adapter were connected to this jack, it would not work. You will note a 300- μf coupling capacitor in series with the MX (multiplex) jack. It was designed into this circuit at a time when it was universally assumed that two outputs would be required to feed a multiplex adapter—one from the MX jack, the other from the main tuner output. If such a technique had become standard, the MX jack would have provided only high-frequency subcarrier components to the adapter (easily passed by the 300- μf coupling capacitor). The main output would have passed normal main-channel audio-frequency components. In the FCC-approved system, all frequency components (low-frequency audio plus high-frequency subcarrier sideband components) must be fed to the adapter from the one multiplex jack. Therefore, if you find such a small blocking capacitor, wire a low-value resistor (200 to 300 ohms) across the capacitor or short it out completely.

Fig. 2 shows a ratio-detector type circuit. Here, too, a multiplex output jack has been provided and, since no coupling capacitor is shown, this particular circuit is ready for connection to a multiplex adapter.

Adding a multiplex jack

You can add a multiplex jack to an FM tuner in a few minutes. Locate the discriminator or ratio detector and examine its wiring. You will always find a series resistor, followed by a capacitor to ground whose product of values (in

ohms times farads) equals approximately .000075 (75 μsec). For example, a 75,000-ohm series resistor will be followed by a .001- μf capacitor to ground. (In practice, these circuits may have R-C products ranging from 50 to 100 μsec .) This combination of values is known as the "de-emphasis network" and rolls off or attenuates the high audio frequencies which have been pre-emphasized at the transmitter. (The resulting audio output, after de-emphasis, has flat frequency response from 30 to 15,000 cycles.)

The multiplex connection should be made *just ahead* of this de-emphasis network (at the end of the 75,000-ohm resistor *away* from the .001- μf capacitor, for example). In locating the de-emphasis network, do not be surprised if the product of the values of R and C is not exactly .000075. In Fig. 2, for example, the resistor is 68,000 ohms while the capacitor is .001 μf , giving an apparent de-emphasis characteristic of .000068. Actually, the manufacturer is depending upon stray capacitance of some of his wiring at this circuit point to contribute the missing μf . Then, too, certain European tuners and receivers are built to different standards, having a de-emphasis characteristic of .000050 or so.

If more than 6 inches of cable is required between the MX output circuit point and the input to the multiplex adapter, use only low-capacitance shielded cable such as RG-58/U or RG-59/U. Under no circumstances should the distance between tuner and adapter exceed 3 feet. If a phono jack is added to the chassis, use standard pin-type phono plugs at the ends of the cable that connects the tuner and adapter. Some adapter manufacturers provide a fixed

*Director of engineering, Crosby Electronics Inc., Syosset, N.Y.

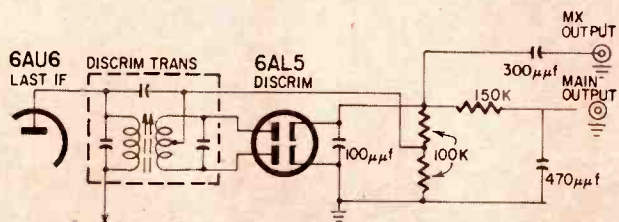

Fig. 1—Typical Foster-Seeley discriminator circuit.

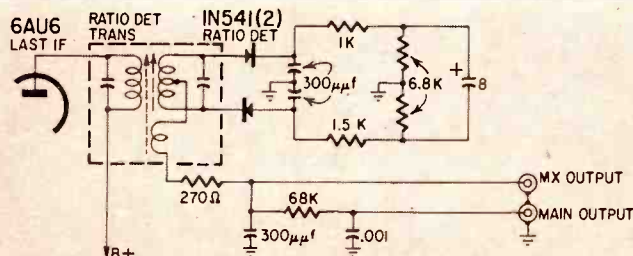

Fig. 2—Typical FM detector circuit ready to accommodate a multiplex adapter.

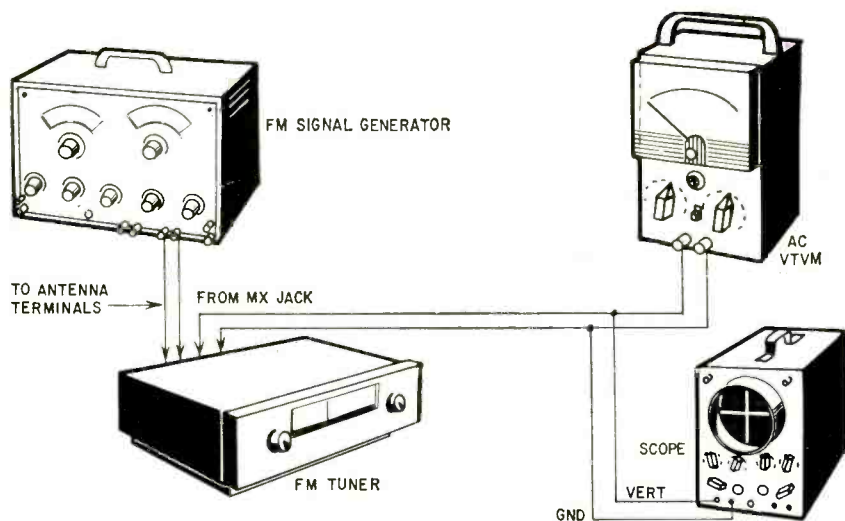

Fig. 3—Block diagram of setup used to determine available output voltage from tuner to be converted to stereo.

length of cable, right from the adapter, terminated in the proper pin plug. No extension cables should be added in these instances.

Tuner output vs adapter input

Adapter manufacturers, with few exceptions, are trying to make their units suitable for use with as many commercially available tuners and receivers as possible. Nevertheless, when one considers the number of tuners and receivers already on the market (over 17,000,000) and the number of variations in their design, it becomes apparent that you must be careful when trying to match a given tuner to a given adapter. The most important consideration is output voltage available from the tuner at its detector.

Many tuners have a stage of audio amplification following detecton, to provide high output. This is of no use whatever, since the adapter is connected ahead of any such amplification. To determine available output from a given tuner detector, set up your test equipment according to Fig. 3. Apply an FM signal at 100- μ v 75-kc deviation with 400-cycle modulation to the tuner. If your generator does not have an accurate attenuator, reduce signal strength to the lowest value available. Tune the tuner or receiver to the generator frequency and measure the audio output from the multiplex jack with an ac vtvm.

At this point it is a very good idea to observe the output of the tuner with an oscilloscope. If, at 75-kc deviation and 100- μ v rf input, distortion is seen (Fig. 4), you've got a pretty good indication that the tuner is badly out of alignment. If alignment does not improve the situation, the tuner is not likely to be suitable for multiplex stereo. Check the appearance of the output at even lower levels of rf signal input. Most tuners will start showing distortion of the kind shown in Fig. 4 as the signal strength is reduced, indicating reduced bandwidth at low signal levels.

While adequate bandwidth alone does

not insure perfect stereo results after conversion, lack of bandwidth is a sure sign of trouble ahead.

After determining the available output voltage, check the specifications of the adapter to be used. The important specification may appear as input voltage required from the tuner or as pilot-carrier amplitude required for proper operation. If the input voltage requirement is given, it is easy to check for adequate voltage. Where only pilot-carrier voltage required is stated, divide the tuner output voltage by 10 to determine if it is adequate. For example, let's say a tuner produces 1 volt out for 75-kc deviation, and the adapter to be used requires 65 mv of subcarrier pilot. Dividing the 1.0-volt tuner output by 10 yields 0.1 volt (or 100 mv), which is greater than the 65 mv required by the adapter. Thus, this tuner would feed enough voltage to the adapter to actuate its circuits properly.

Some wide-band tuners, while offering very good bandwidth (no distortion of the kind shown in Fig. 4, even at a few microvolts input), may not have enough audio voltage at their discriminator or ratio detector outputs. More elaborate adapters featuring extra stages of amplification have to be used with these tuners. Some manufacturers have indicated that their adapters are suitable only for their tuners, most of which have very low audio output at their MX jacks. Since these manufacturers have added gain to their adapters, there is a possibility that if these adapters were used with more conventional, high-output tuners, the high voltage available might overload this particular form of adapter. Thus, both the minimum and maximum voltage requirements of an adapter should be known.

Signal strength vs stereo reception

Unfortunately for some prospective stereo FM listeners now in fringe areas, the FCC, in choosing the approved system, was more concerned with the monophonic listeners than with the future stereo market. The

system chosen has the least degradation when a mono listener tunes in a stereo broadcast monophonically. Conversely, the system chosen has the most degradation in stereo listening of all the systems evaluated. Simply stated, this means that a barely usable mono signal strength will be unsatisfactory when stereo is broadcast on the same station. In fact, the signal-to-noise reduction can be as much as 13 to 20 db compared with mono broadcasts. Thus, a given tuner in a given installation which provided a 30-db signal to noise condition (minimum acceptable for serious listening) may have only a 10- to 17-db signal-to-noise ratio (definitely unusable) when stereo is broadcast. Another way of stating the same facts is: the range of a station is substantially reduced when it broadcasts stereo.

Antenna installations

Because of the stereo range problem, the antenna installation becomes extremely important. FM users have been spoiled and expect adequate reception using little more than a hank of wire hooked to one of the antenna terminals. This arrangement simply won't do for stereo. A good rule to follow is to pay as much attention to the antenna, its location, orientation and quality as you did in the early days of TV. The FCC, while acknowledging inferior reception range for stereo, has not authorized

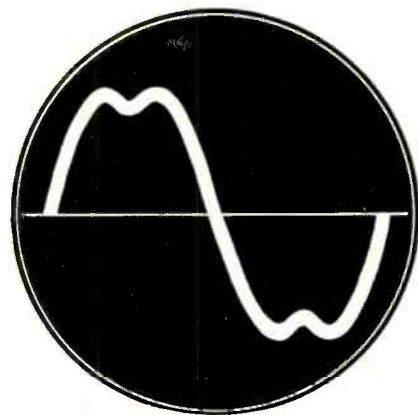

Fig. 4—Adapter output waveform from tuner having inadequate if or discriminator bandwidth for proper conversion to stereo.

increased transmitter power to compensate for the reduced service range. So your only solution is to increase the signal received at the tuner's antenna terminals. The mere substitution of an adequate antenna for the usual piece of wire often results in a signal improvement of 10 to 1—far more than the degradation brought about by stereo transmission.

Of course, if you already have a superior antenna installation, but the distance to the transmitter is so great as to make mono performance barely usable, don't even try a stereo conversion. The only solution in such instances is to buy a new and more sensitive tuner. Such extreme situations should

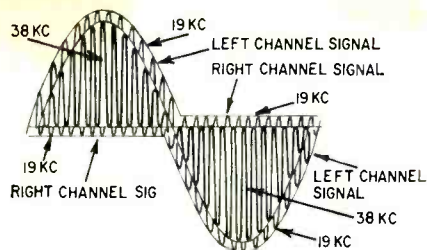

Fig. 5—Properly recovered composite signal (only left channel has program material) suitable for multiplex adapter input.

be few and far between, however, particularly in view of the mushrooming growth in the number of FM stations throughout the country.

Adapter output connections

In approaching the problem of connecting the adapter outputs to amplifier inputs, we are on more familiar ground. Here, two ordinary shielded phono type cables can be used. If the adapter has cathode-follower output circuits, lead length is not critical and may be as great as 200 feet. The adapter outputs should connect to a pair of high-level high-impedance inputs on the amplifier. Many recent stereo amplifiers have an MX position on the selector switch. Use the pair of inputs corresponding to this position of the selector switch. Actually, these inputs are similar to aux or tuner positions on earlier amplifiers and those positions may be used.

Once the adapter has been connected, the MX amplifier input is used for either stereo or monophonic FM listening. Either way, signal is fed to both speakers when the adapter is used. If the tuner is an AM-FM unit, and AM listening is desired, the regular main output connection from tuner to amplifier must be retained, and the selector switch will have to be set to the tuner position.

Adapter location

Some adapters have controls on their front panels, others do not. Obviously, those that feature controls such as special noise filters, separation controls and even balance controls should be installed so they are accessible during normal use. Adapters without front-panel controls can be installed inconspicuously so no front-panel cutout is required. All adapters, however, must be adjusted after being installed. This technique will be discussed shortly.

Problem tuners

As mentioned earlier some narrow-band high-impedance discriminator type sets may cause trouble when adapters are added. Formerly, the discriminator (and, for that matter, the if circuits) handled low-frequency audio (up to 15 kc), and were called upon to detect such signals faithfully. Now, in addition to recovering audio, the discriminator must detect audio plus an assortment of frequencies ranging from 19 to 53 kc. Not only must these frequencies be recovered with low distortion, but with faithful amplitude and

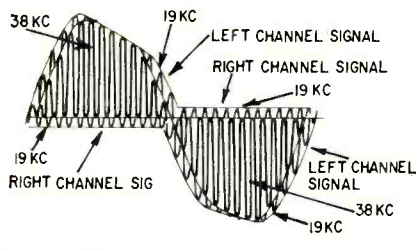

Fig. 6—This composite waveform shows signs of diode clipping. If such a signal is applied to any multiplex adapter, the output signal will have high audio distortion.

phase response as well. Lack of accurate phase response results in decreased stereo separation. (A left-only signal will produce some output from right channel, just like a lower-grade stereo cartridge.)

Improper amplitude response causes distortion in the output signal and usually decreases separation, particularly where high-frequency audio tones are involved. Distortion in the recovered composite waveform, however, will cause really serious distortion. Since these detectors have high output impedances, they are extremely susceptible to high-frequency rolloff because of the cable capacitance between discriminator and adapter as well as because of their own rf filter capacitor (100 μf in Fig. 1). This filter capacitor has an additional detrimental effect known as diode clipping.

Fig. 5 shows the composite waveform of a left-only or right-only signal as seen at the discriminator output

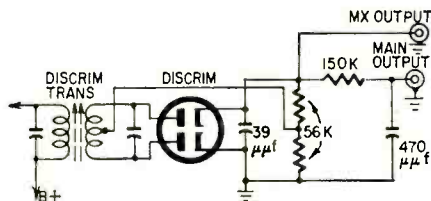

Fig. 8—Suggested modification of Foster-Sceley discriminator reduces its output impedance and minimizes effect of diode clipping (Fig. 1).

when a single tone is transmitted. Fig. 6 shows the same signal after having undergone severe diode clipping. Fig. 7 shows the same waveform reproduced by a set whose discriminator has insufficient bandwidth. Waveforms in Figs. 6 and 7 will result in severely distorted audio output from the adapter. There is nothing the adapter can do to correct these deficiencies—they are inherent in the tuner itself. The defect of Fig. 7 can to some extent be rectified in the tuner by rewiring the discriminator output, lowering the output impedance of the discriminator (and hence improving the frequency response of this circuit) by about 2 to 1. The changed values are shown in Fig. 8 and should be compared with the circuit of Fig. 1.

Adapter problems

It is far too early to attempt to predict what service problems will arise in adapters themselves, nor is this dis-

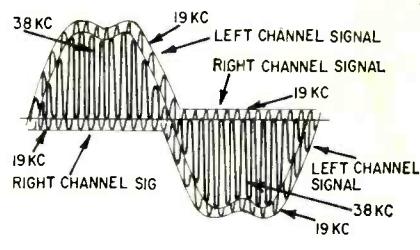

Fig. 7—Recovered waveform from a tuner that has inadequate bandwidth.

cussion intended as a circuit troubleshooting course for adapters. Certain adjustments, however, have already been found to be critical, and these will be mentioned (Fig. 9).

Separation

As you no doubt know by now, stereo programs are transmitted by one FM station by sending $L + R$ (the sum of both channels) in the usual manner. $L - R$ (the electrical difference between both channels) is transmitted via an ultrasonic subcarrier and its sidebands. Actually only the sidebands are transmitted—the subcarrier itself is suppressed. A low-amplitude 19-kc pilot signal is also transmitted so the subcarrier can be reinserted in proper phase relationship to the sidebands at the receiving end.

The separate L and R are recovered by performing the following electrical additions and subtractions: $(L + R) + (L - R) = 2L$ and $(L + R) - (L - R) = 2R$. It is obvious that exactly equal amounts of $L + R$ and $L - R$ must be added and subtracted to and from each other to recover a distinct L and a distinct R. If these $L + R$ and $L - R$ quantities are not recombined in proper proportion, the L signal will have some R mixed in and the R signal will contain some L—stereo separation will be reduced. The FCC requires that these two quantities be transmitted in correct proportion. There is no guarantee, however, that a given tuner will recover them in the same proportion. Usually, the $L - R$ information (contained in the frequencies from 23 to 53 kc) is attenuated compared with the $L + R$ information because of the poor high-frequency response of the detection circuit of most tuners.

This is even true to a certain degree in tuners using ratio detectors. Therefore, adapter manufacturers have incorporated a separation or $L + R$ control which varies the amount of $L + R$ with respect to a fixed amount of $L - R$ as it appears at the output of the tuner in the form of ultrasonic sidebands. The manufacturer can adjust this control only on the basis of $L + R$ being equal to $L - R$ (the FCC standards). Nearly always, this control will have to be adjusted after the adapter is hooked up, to get best stereo separation. This should be done during a stereo broadcast during which, it is hoped, the announcer will give listeners an opportunity to make this adjustment

stop horizontal oscillator drift

By WAYNE LEMONS

Get rid of that intermittent horizontal wobble, twisting and jumping

Perhaps no trouble is more annoying than a TV set that seems to perform perfectly, only to become intermittently inoperative after being thoroughly "cooked" in the shop and finally delivered to the customer's home. One such trouble is horizontal oscillator drift.

The drift (frequency change) may occur only after the set has been on for several hours. It may be slight, and re-setting the horizontal hold control may correct it temporarily. Sometimes the customer may have to reset the hold control only once during an entire evening.

Other times the fault may take the form of suddenly jumping out of horizontal sync at station breaks or when changing channels. It may go out only one frame (representing a 60-cycle horizontal oscillator change) or it may "take off," going out several frames and producing numerous horizontal lines on the screen.

Just about any type of horizontal oscillator must have a stability better than 0.4% if it is to perform properly. Actually, though, by its very nature, which requires that it be controllable, a horizontal oscillator cannot be too stable! This means that, to perform acceptably, it must be neither too tight (hard to control) nor too loose. A too-tight oscillator tends to take off on its own and pay very little attention to the control voltage. On the other hand, a too-loose oscillator responds well (generally) to control voltages, but may be easily upset by noise pulses and may bend and weave if sync is unstable.

The tightness or looseness of an oscillator is determined by the overall design of the circuit. In servicing, design factors usually need not concern us. Our job is to get the darn thing working again.

On occasion, though, we may run into a set that is short in the design department. If the set has a record of horizontal oscillator problems, some technicians

rebuild the entire circuit, using a layout they know is stable. If you should decide (in the heat of battle) to rebuild the horizontal oscillator, don't change oscillator types! For instance, don't replace a Synchronguide with a multivibrator unless you are prepared to modify the sync system too.

There are exceptions, of course. On an older Sylvania model, the one that used a special oscillator and sync input transformer (Fig. 1), we changed the circuit to a Synchronguide; we had to get a new transformer anyway and the Sylvania replacement was not readily available.

What causes drift?

There are probably just as many possibilities as there are components in the oscillator and sync sections of a particular receiver. Experience, however, has taught us that some are much more frequent offenders than others.

First, let's take the familiar and most widely used circuit—the multivibrator. This is simply an amplifier with the output fed back into the input, through cathode coupling, in the correct phase to sustain oscillations. A ringing coil

"tightens up" the circuit.

The size of resistor R1 in Fig. 2 plays an important role in just how "tight" the ringing coil makes the circuit. If the resistor is smaller, the ringing coil has more stabilizing effect and thus the oscillator becomes less responsive to sync control. It is our opinion that the correct size for this resistor is the one that will let the oscillator just work with the ringing coil shorted out. This is usually about 6,800 ohms.

A dc voltage developed by the phase detector controls the speed of the oscillator. The phase detector may be a dual diode tube but in recent years semiconductor diodes have been used by most manufacturers. The phase detectors measure the speed of the oscillator as compared to the sync input and develop either a positive or negative voltage, depending on this information. If something goes amiss in the phase detector circuit, such as a defective diode, the horizontal oscillator is sent an incorrect control voltage. Either a highly negative or a highly positive voltage on the oscillator control grid will stop the oscillator. Even if the voltage is not high enough to block the oscillator, it may

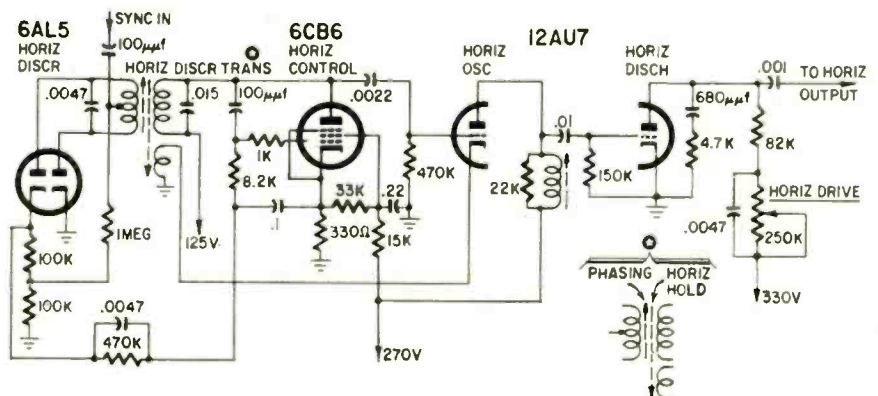

Fig. 1—This complex horizontal oscillator and control circuit can be replaced easily with a Synchronguide circuit. Use a 10-µf sync input capacitor.

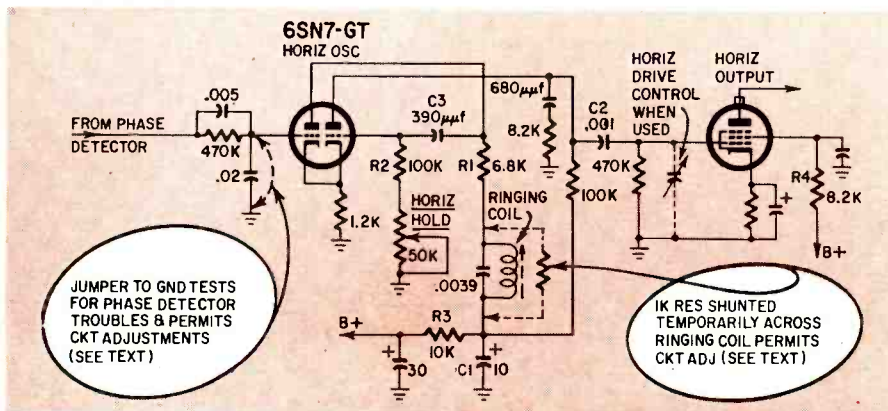

Fig. 2—Typical horizontal multivibrator with ringing coil for stability.

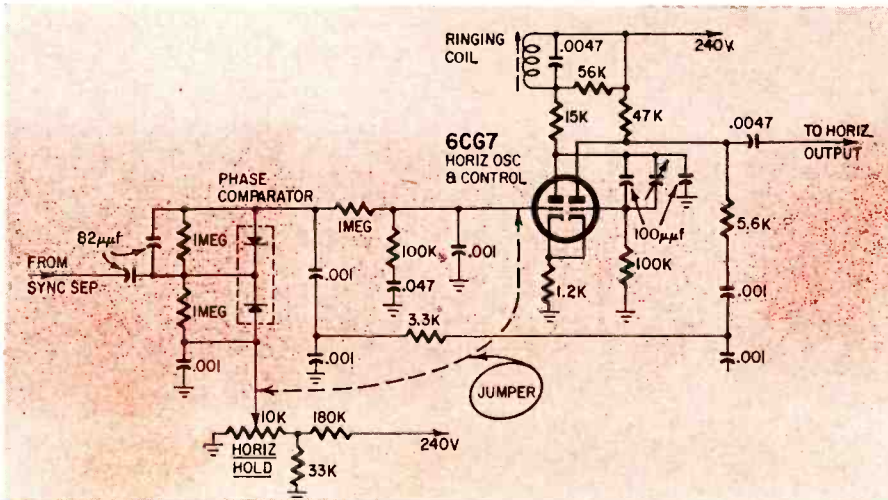

Fig. 3—Using jumper to disable sync where grid is not normally at zero voltage.

change the frequency so much that little or no high voltage is developed.

It follows, then, that a fault in the phase detector system can cause horizontal oscillator drift. A classic example of this occurred in G-E and Hotpoint portables a few years ago. Defective semiconductor diodes caused the raster to disappear when the set was tuned to a station, but the raster and high voltage returned when off channel.

Fortunately, it is usually simple to tell whether the trouble is in the oscillator or the phase detector stage by grounding the control grid with a jumper (Fig. 2). This completely eliminates the phase detector (and sync) as a source of trouble.

If you have severe oscillator drift, simply ground the control grid. The picture won't lock in, of course, but

you'll be able to tell if there is a recurrence of oscillator drift. If, after operating the set a while, you find very little change in the "floating" speed of the picture, you can reasonably assume that the oscillator is stable. If the picture goes way out of sync or the raster disappears when you remove the jumper, you know the trouble is in the sync circuit. This method works with all horizontal multivibrators that normally have zero bias on the sync input grid. For circuits like the one in late-model Emersons (Fig. 3), connect the grid back to the center arm on the horizontal hold control, since the grid normally operates about 6 volts positive.

Check for natural resonance

Shunt the ringing coil with a 1,000-ohm carbon resistor. High voltage

should remain and the picture should stay in sync. If the oscillator changes frequency drastically, you can be almost certain of an unstable oscillator. Why? Because the natural resonant frequency of the oscillator circuit (with the ringing coil out of the circuit) is not 15,750 cycles. This means that, even though you may be able to lock the picture by (mis)adjusting the ringing coil, there is continuous "warfare" inside the oscillator circuit. A sudden noise pulse, a loss of sync or a change in line voltage may let the circuit take off, and it will be impossible for the phase detector to recapture the oscillator.

To adjust a multivibrator

1. Remove sync by shorting the sync-controlled multivibrator grid.
2. Shunt the ringing coil temporarily with a 1,000-ohm resistor.
3. Adjust the horizontal hold control (not the ringing coil) until the picture floats by slowly.
4. Remove the 1,000-ohm shunt from the ringing coil.
5. Adjust the ringing coil until the picture floats by slowly. (Do not touch the hold control.)
6. Remove the sync short; the picture should lock in. If there is only a slight out-of-sync condition, adjust the hold control for a locked-in picture.
7. If the picture is far out when the sync short is removed, either the control grid does not normally operate at zero voltage or there is trouble in the phase detector circuit.

8. In sets without a resistance hold control, juggle values of either R2, C3 or both (Fig. 2) until the picture floats by with sync shorted and ringing coil shunted. A resistance-capacitance substitution box is ideal for this.

Defective components

The most common cause of drift other than misadjustment is electrolytic by-passes. C1 in Fig. 2 may partially open, causing the oscillator to become erratic or slow to stabilize. Many circuits do not use the 10,000-ohm decoupling resistor (R3) and rely on the B-plus electrolytic alone to bypass horizontal currents. It is very possible for a B-plus electrolytic to cause horizontal instability without producing any other apparent symptom.

In our experience, coupling capacitors and resistors give the least trouble, at least those in the oscillator circuit proper. C2, coupling the oscillator to the output tube, is a frequent offender, however. Slight leakage here affects the oscillator plate voltage as well as the loading. C3, used in older circuits, will cause instability if it partially opens, especially if the oscillator design is critical.

An instability condition that is hard to trace sometimes occurs if the screen resistor (R4) burns and changes to a low value. This in turn causes the output tube to "gas" and load the oscillator circuit.

The ringing-coil circuit can cause trouble but the shunt method of testing makes it easy to determine. The 1,000-

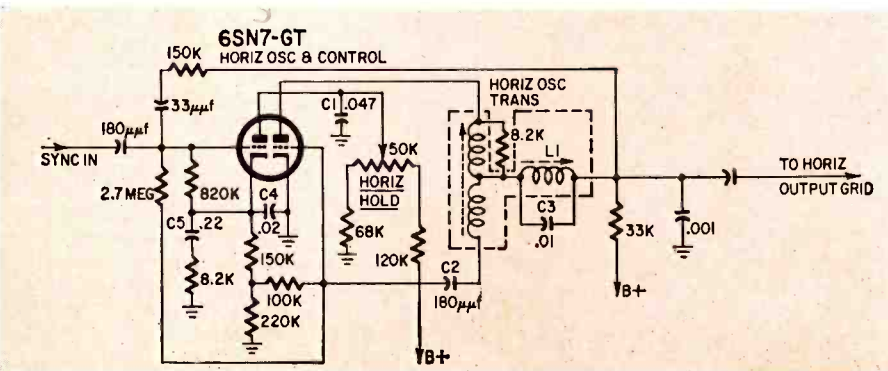

Fig. 4—Typical Synchronizer circuit.

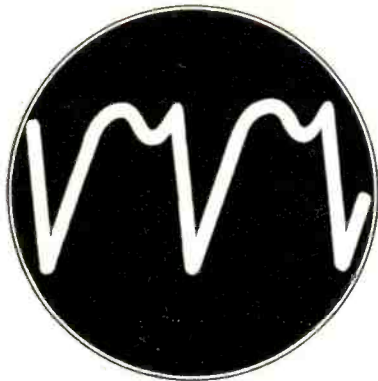

Fig. 5—Synchroguide waveform as seen on scope. Use a low-capacitance scope probe.

ohm shunt will eliminate the ringing coil as a factor in determining the oscillator frequency.

The Synchroguide

Drift in the Synchroguide is a little harder to isolate than in the multivibrator since the control circuit is tied with the oscillator so intimately. It is hard to separate them for testing.

Basically, the Synchroguide is a blocking oscillator with a stabilization circuit (L1-C3, Fig. 4). A second triode changes the oscillator speed in accordance with sync information.

A misadjusted stabilization circuit is the greatest cause of instability. It can be properly adjusted only with a scope and a low-capacitance probe. Fig. 5 shows the correct characteristic waveform with the picture locked in.

The Synchroguide is all high-impedance circuitry. Because of this, it is most susceptible to slight leakage in capacitors. Always check C1, C2, C3, C4 and C5 with a good leakage checker (one that puts 100 volts or more on the capacitor being tested). Any capacitor that shows even slight leakage should be replaced with exactly the same type. Do *not* replace any capacitors in this circuit with ceramic units unless you are sure of their characteristics!

The Sears Synchroguide is a little unusual (Fig. 6) in that bias for the control tube is taken from the output tube grid. The .005- μ f coupling capacitor is a frequent offender in this circuit. Slight leakage here will upset the oscillator control without affecting the high voltage. A horizontal jitter or "piecrust" effect is the usual result. This capacitor is part of a printed component pack but it may be pried loose and a paper .005- μ f unit substituted.

RCA Synchrophase

This circuit is a first cousin to the Synchroguide. This particular model (Fig. 7) uses diode phase detectors but other models use control circuits similar to the older Synchroguides.

A scope cannot be used to adjust the Synchrophase. Follow this procedure:

1. Turn the horizontal hold to extreme clockwise position.
2. Connect a jumper across the sine-wave coil.
3. Connect a jumper from grid to

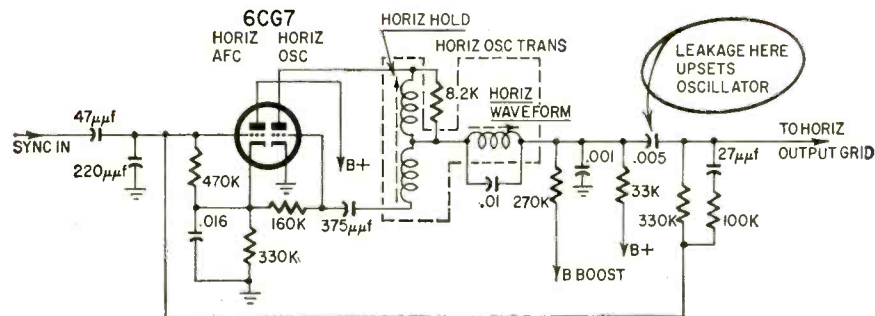

Fig. 6—Synchroguide circuit in Silvertone 528.50060. Leakage in circled capacitor can cause some unusual symptoms.

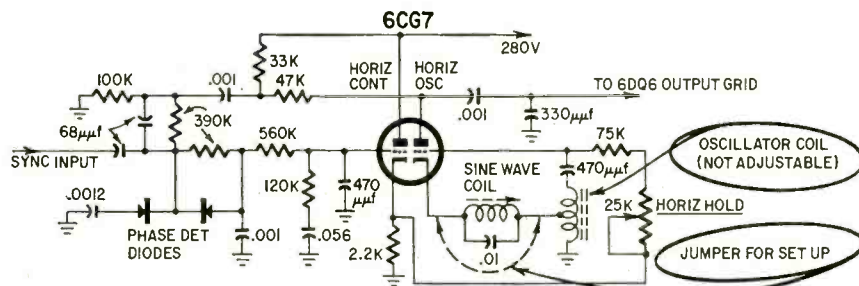

Fig. 7—Synchrophase circuit in RCA KCS-131 chassis.

ground of the sync amplifier tube (not the control tube).

4. Adjust the horizontal hold control until a picture floats by slowly.

5. Remove the jumper across the sine-wave coil and adjust the coil until the picture again floats by slowly.

6. Remove the sync short. The picture should lock in.

Because the Synchrophase is a new circuit, not much service information has been received from the field. Probably it will be subject to essentially the same faults as the Synchroguide.

Oscillator-drift check points

1. Check capacitors for leakage.
2. Check electrolytics for opens or

partial opens.

3. Check for unsoldered terminals. These sometimes escape detection for years.

4. If the set uses semiconductor diode phase detectors, check for good front-to-back ratio with an ohmmeter. Both diodes should have about the same ratio.

5. Make sure adjustments are correct.

6. Do not use ceramic capacitors for replacements unless you are absolutely sure of their characteristics.

7. Check tubes critically for gas content and heater-cathode leakage.

8. If the customer's complaint is slow drift, enclose the set in box and let it play for 2 hours before delivery to make sure you have found the trouble. END

Fiber Optics in New C-R Tube

Du Mont has announced a cathode-ray tube with a glass fiber faceplate. The faceplate of the 1 $\frac{1}{8}$ -inch tube is made up of more than 6,000,000 glass fibers, 10 microns in diameter. Light originating from any point on the phosphor layer inside the faceplate is carried down one or more of the glass rods without spreading or halo effects. Since the image is carried direct to the outer surface, all parallax is eliminated. The tube, which costs \$900, is expected to be used in such applications as flying-spot scanning, photographic printing, and coupling to fiber optical systems.

Fiber optics is also used in an image storage panel patented by Joseph T. McNaney, inventor of image display tubes. In this panel, each individual fiber is covered with a coating of selenium as a photoconductive medium. The inside surface is coated with a transparent conductive ma-

terial which makes contact with the photoconductive fibers. The outer surface has a coating of electroluminescent material, over which is a transparent conductive layer. The two conductive layers are connected across an ac supply in the manner of a conventional luminescent panel. A light image projected on the back of the panel produces a luminescent image on the front. Light feedback keeps the image displayed until the power is turned off.

Fiber optics is based on the principle that light entering a glass or other light-conducting rod at one end may be trapped and continue to the other end, even if the rod is curved or doubles back on itself. Thus the rod becomes a waveguide for light. Possible applications of fiber optics in electronics were discussed in Hugo Gernsback's editorial in the August, 1960, issue.

What's New

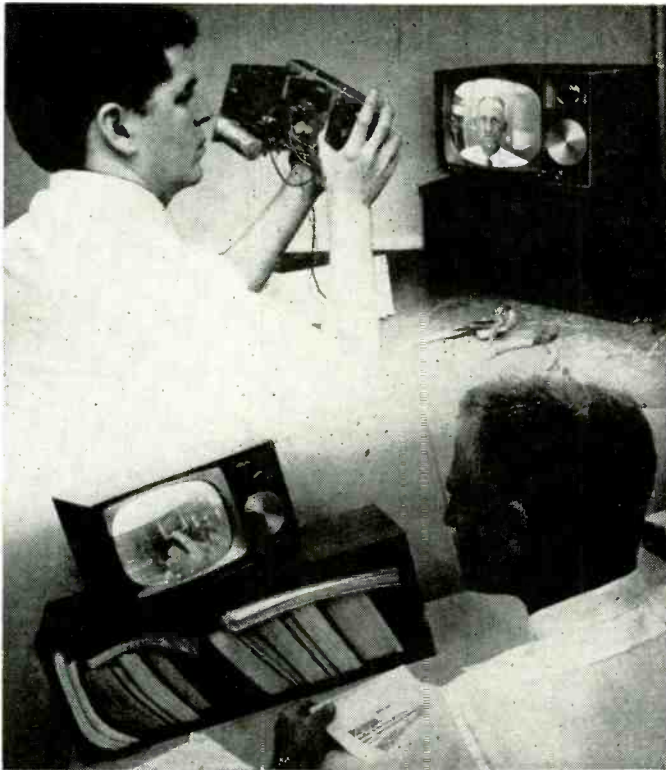

EXPERIMENTAL AUDIO-VISUAL communications system designed by Motorola may become the intercom of the future. Called *Visicom*, it uses only simple video-frequency circuitry. Possible uses would include door answerer, baby sitter, communication between executives in separate offices, teacher-student or supervisor-workman communication and similar applications. For door answering and baby watching, the unit could be simplified, with camera in one unit and monitor in another.



SPACE-AGE GAUGE directly measures atmosphere density in space. "Pressure" from 10^{-7} to 10^{-11} mm of mercury are within its range. Already tested in an Aerobee Hi rocket, these Westinghouse units are expected to be used to gather data at altitudes from 70 to 125 miles.

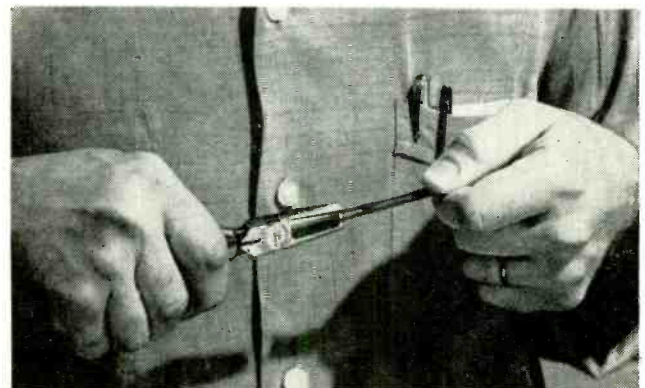

STRIPPING TWIN-LEAD, subject of more than one how-to-do-it hint or kink in service magazines, is now reduced to a science. These special pliers, made for the job, are placed between the leads, then all insulation removed neatly with one quick jerk. The new tool, made by Kraeuter & Co., can also be used as end-cutting pliers.

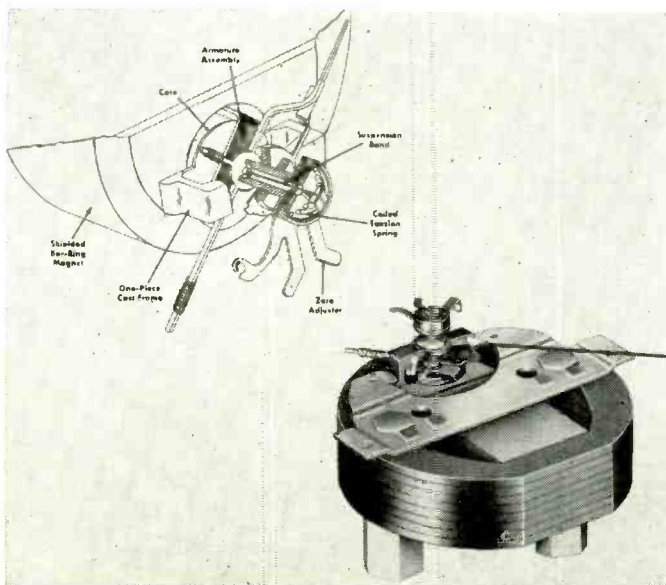

NEW IDEA IN METERS makes instruments shock-resistant, increases accuracy and all-round ruggedness. In the new Triplet Suspension panel instruments, the moving-coil and pointer assembly is supported on a thin, narrow band kept tightly suspended between special spring terminals. No pivots, jewels or hairsprings are needed. Torsion returns the pointer to zero, and the coil-spring terminals take up the shock if the meter is jarred or dropped.

BUILD

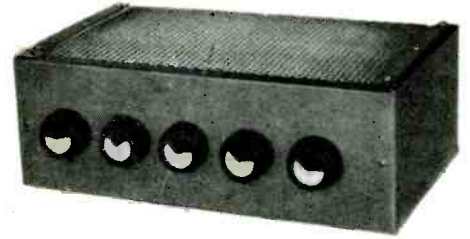

A QUALITY STEREO PREAMP

4-tube unit is easy to assemble

By W. R. WILLIAMS

Here is a sweet little stereo preamp that is well worth the time it takes to put it together. It uses standard parts yet has a dual loudness control of the type normally found only in monaural preamps. Other features are maximum bass and treble boost and a dc heater supply. Four 7025 tubes assure balanced output and require only 6 to 8 ma plate current that can be drawn from the 300-volt line in the main

amplifier. The unit measures only 12¼ x 7 x 4½ inches.

The basic circuit for this preamp was found in an article on preamp design by Norman Crowhurst which appeared in the May 1960 issue. I decided it was the basis of an inexpensive stereo preamp which would have characteristics found only in more costly commercial units. Tonal quality matches anything I have ever heard and, while I haven't run any sensitivity

measurements, Mr. Crowhurst's design calls for 2 volts out from a 1-millivolt input.

Features

RIAA equalization is used on the low-level inputs as it is the standard in the recording industry. A five-position two-pole FUNCTION switch provides for stereo, stereo reverse, FM one channel, FM with multiplex, or FM with AM. This switching meets all of my require-

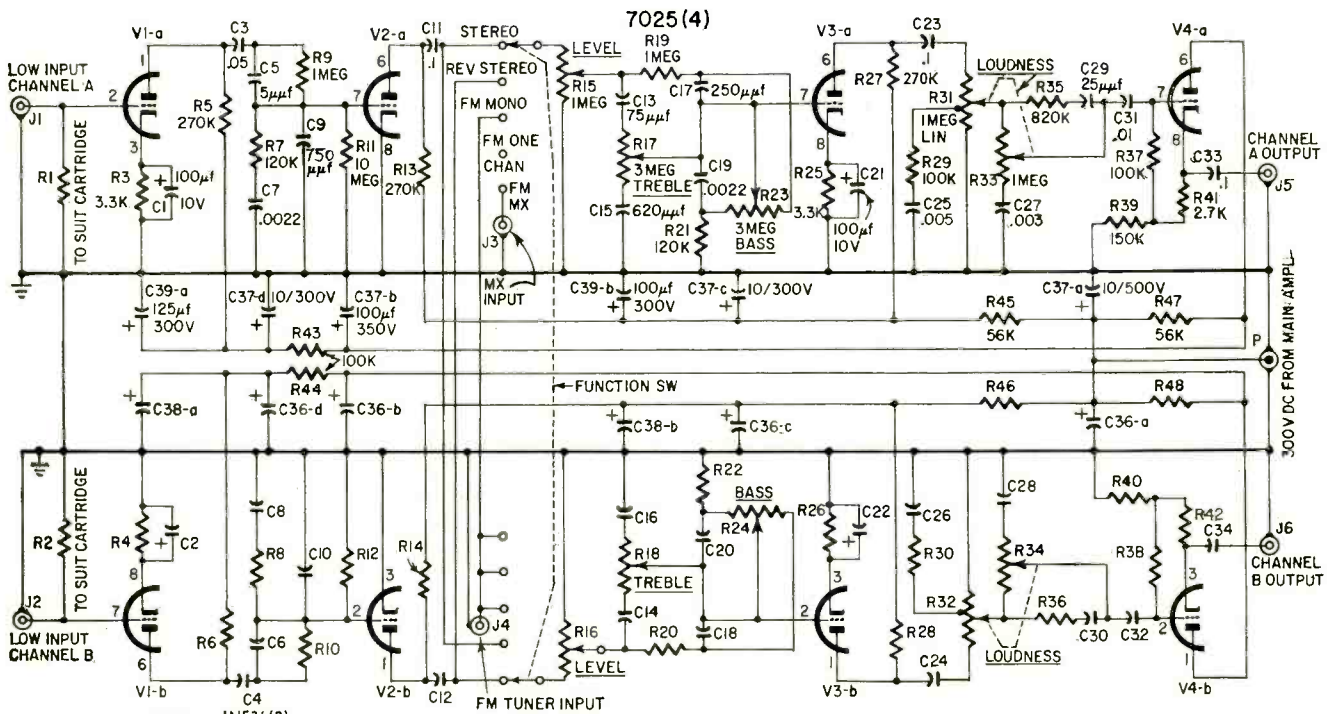
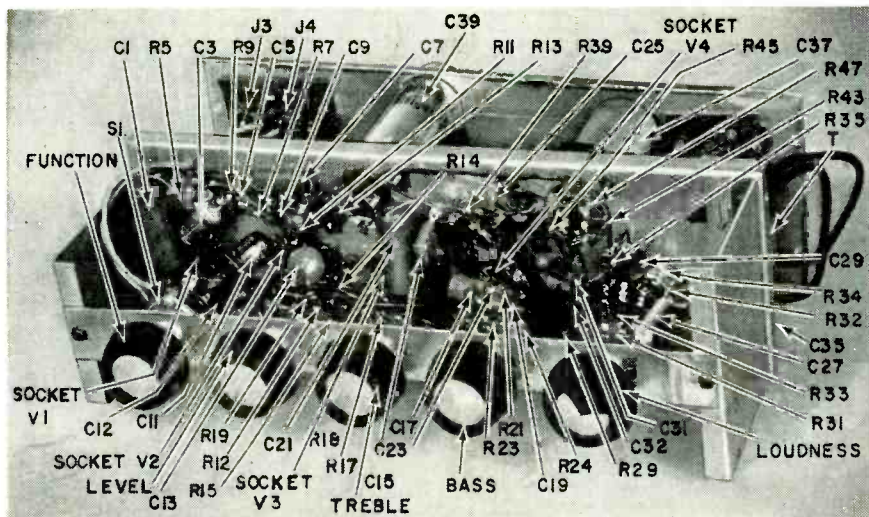

Fig. 1—Complete circuit of the preamp.

- R1, R2—value to suit cartridge
- R3, R4, R25, R26—3,300 ohms
- R5, R6, R13, R14, R27, R28—270,000 ohms, low noise, match to 1%
- R7, R8, R21, R22—120,000 ohms
- R9, R10, R19, R20—1 megohm
- R11, R12—10 megohms
- R15, R33—pot, 1 megohm, audio taper, Centralab type FI-52 front section (see text)
- R16, R34—pot, 1 megohm, audio taper, Centralab type R2-52 rear section
- R17, R23—pot, 3 megohms, audio taper, front section, Centralab FI-79
- R18, R24—pot, 3 megohms, audio taper, rear section, Centralab R2-79
- R29, R30, R37, R38, R43, R44—100,000 ohms
- R31—pot, 1 megohm, 500,000-ohm tap, linear taper, Centralab type B15/16 front control
- R32—pot, 1 megohm, 500,000-ohm tap, linear taper, Centralab type B15/16 rear control
- R35, R36—820,000 ohms
- R39, R40—150,000 ohms
- R41, R42—2,700 ohms
- R45, R46, R47, R48—56,000 ohms
- All resistors ½-watt 10% unless noted
- C1, C2, C21, C22—100 µf, 10 volts, electrolytic
- C3, C4—0.05 µf, tubular paper
- C5, C6—5 µf, ceramic
- C7, C8, C19, C20—0.022 µf, molded paper
- C9, C10—750 µf, ceramic
- C11, C12, C23, C24—0.1 µf, molded paper
- C13, C14—75 µf, disc ceramic
- C15, C16—620 µf, mica
- C17, C18—250 µf, tubular ceramic
- C25, C26—0.005 µf, disc ceramic
- C27, C28—0.003 µf, tubular ceramic
- C29, C30—25 µf, tubular ceramic
- C31, C32—0.1 µf, tubular ceramic
- C33, C34—0.1 µf (see text)
- C35—500 µf, 15 volts, electrolytic
- C36, C37—10-100-10-10 µf 500-350-300-300 volts electrolytic, can type
- C38, C39—125-100 µf, 300 volts, electrolytic, can type

- All capacitors 400 volts or better
- J1, J2, J3, J4, J5, J6—phono jacks
- P—male connector
- RECT 1, RECT 2—IN536
- S1—2-pole 5-position rotary switch
- T—filament transformer: primary, 117 volts; secondary, 25.2 volts, ct. 2.2 amperes (Triad F4IX)
- V1, V2, V3, V4—7025
- Chassis, 12 x 4 x ¾ inch, aluminum
- Side pieces, 2 — 4 x ¾ inches, aluminum
- Sockets, 9-pin miniature (4)
- Miscellaneous hardware



Parts arrangement inside the chassis.

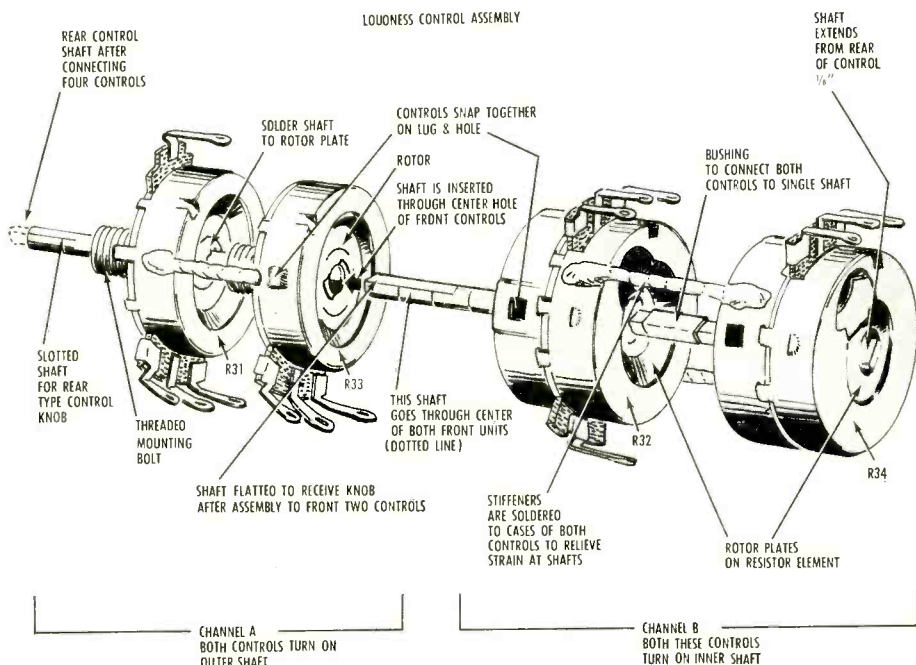

Fig. 2—Details of the loudness control assembly.

ments but could be changed if desired (Fig. 1).

Dc heater voltage was desired to reduce hum and, for this reason, heater voltage could not be taken from the power amplifier. A separate dc heater supply is therefore included. The BASS, TREBLE and LEVEL controls for each channel are independent and concentric, and give a wide variation in tonal response. The loudness control is a worth-while feature that eliminates the need for readjusting bass and treble controls whenever volume is adjusted.

Construction

The main wiring is done on a 12 x 4 x 3/8-inch chassis. Terminal strips make for neat component placement. The tube sockets are in the center of the chassis. Channel A is wired on one

side of them and channel B on the other. This arrangement makes wiring simple and assures maximum channel separation. When chassis wiring is completed, add the side pieces that support the control mounting strip. Dual concentric controls are used throughout. Position the terminals on the controls so they face in opposite directions (see loudness-control detail, Fig. 2) for maximum channel separation.

The loudness control cannot be purchased as a complete unit but is made from two sets of standard controls. (Fig. 2 shows complete construction details for assembling it.) The channel-A control is made by joining two front units together, soldering the shaft of one to the wiper disc of the second. Do not apply too much heat when doing this; you may damage the resistive ele-

ment and make it noisy. Solder two pieces of copper wire (approximately No. 9) from the case of the first control to the case of the second. This makes the unit rigid and takes all strain from the shaft connection.

The channel-B control is made from two rear controls. Since they have aluminum shafts, they are joined by filing one shaft flat on each side, then bending a piece of brass strip to form a bushing. The bushing is pushed over the shaft projection on the wiper disc of the other control. I used Centralab type B controls for these units because they have features that make joining possible. To complete the channel-B control, two more wire stiffeners are used. One word of caution: Make sure that you have full rotation of the front and rear controls before soldering. When the control for each channel is complete, snap the two together in the normal way, lugs in opposite directions.

In the preamp output circuit, capacitors C33 and C34 are suitable for amplifier input resistance of 250,000 ohms; 0.25- μ f capacitors should be used for input resistances of 100,000 ohms.

The preamp is extremely sensitive to hum, therefore follow all standard precautions to guard against it. Ground returns should be made to the same point

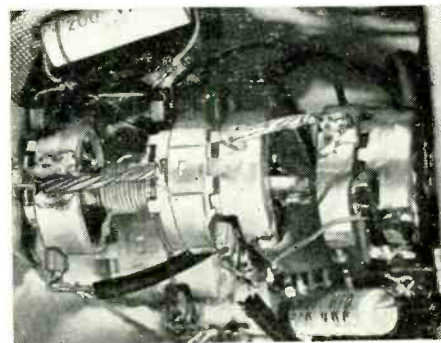

The loudness control mounted and wired.

for each stage. Connect the ground bus from stage to stage (a separate bus for each channel) continuously from input to output, and ground to the chassis at the input end. Notice that a large amount of filtering is used; this is necessary as there is little filtering in the power supply. Should a regulated well filtered supply be used, filtering could be reduced. Plate loading resistors are low-noise types, matched to within 1%. Elsewhere, standard carbon units are used.

The dc heater supply is built on the tube side of the chassis, using a 25-volt center-tapped transformer rated at 600 ma or more, and two silicon rectifiers. These rectifiers are small, inexpensive and preferable to selenium units because of their negligible voltage drop. Heaters are wired separately, connected to ground at the output end of the bus with the transformer center tap.

An aluminum cover completes the preamp and shields the unit from possible outside hum sources. END

By DAVE STONE



Portable Trans-Marine uses three transistors to cover a frequency range of 225 kc to 4.5 mc

RF SIGNAL GENERATOR COVERS MARINE BANDS

THE Trans-Marine transistorized rf signal generator produces tone-modulated or CW signals from 225 kc to 4.5 mc and is particularly useful for aligning and testing the rf and if stages of marine, auto, long-wave, broadcast and some short-wave receivers. The lightweight, compact, battery-powered set can be slipped into the service technician's toolbox and carried afloat for on-the-spot marine receiver repairs.

A modest battery drain of 2.5-ma provides a 2-volt output on the low ranges, dropping to a 0.1-volt level on the highest range, enough for the normal run of alignment problems in most receivers. The Trans-Marine is made with easily obtained parts and does not require any complicated or difficult construction techniques, but the end result is a useful test set that is ready for operation anytime, anywhere.

Circuit action

Rf transistor V1, a 2N1086, operates as a grounded-base, collector-to-emitter

feedback oscillator. Capacitors C1, C2, C3 and C4 form the variable elements of the feedback path between the collector and emitter. Oscillator frequency is controlled by variable capacitor C6 and coils L1 through L5.

The oscillator's output is taken across R1 and applied to V2's base. This transistor operates as a straight voltage amplifier. The amplified signal is then fed through C11, output LEVEL control R6, and C12 to the output jack.

The audio modulation is supplied by V3, a 2N35 transistor in a transformer-coupled feedback audio-oscillator circuit. The transformer provides a feedback path between collector and base, causing the circuit to oscillate at a frequency determined by the inductance of the collector winding and the stray capacitance of the transistor and transformer.

The resulting tone (approximately 1,000 cycles) is coupled through C13 to V2's base to modulate the signal pro-

duced by V1. S2 switches the audio oscillator on or off.

Construction hints

Inductances L1 through L5 and feedback capacitors C1 through C4 are all mounted on RANGE switch S1. The coil lugs are straightened and fastened across the upper-and lower-deck switch terminals, one terminal to each deck. The feedback capacitors are mounted between the deck terminals in the same manner.

T, S2, S3, R6, C6, J and the battery are mounted to the sides of the case. The remaining circuitry is fastened to

Speed construction time. Use a RADIO-ELECTRONICS printed-circuit board. Available for \$1.25 each, postpaid, from Detroit Electronic Corp., 13000 Capital Ave., Oak Park, Mich.

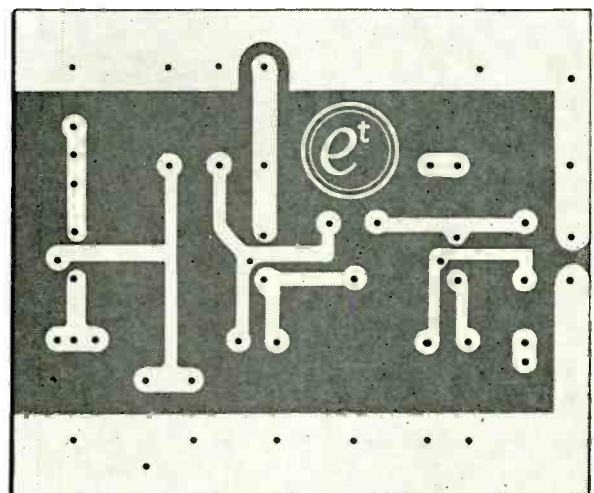
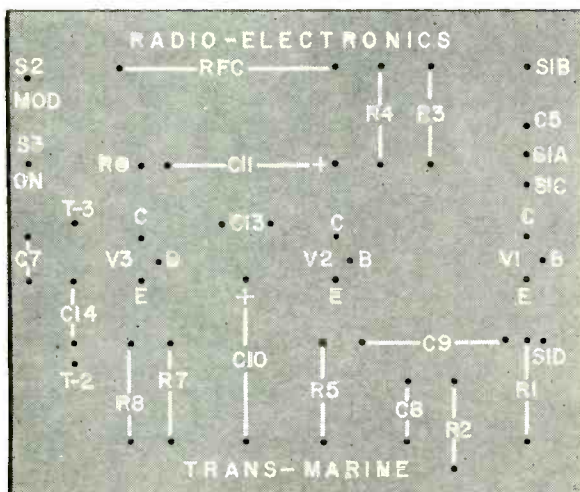

Details of the printed-circuit board for this unit. These figures are actual size.

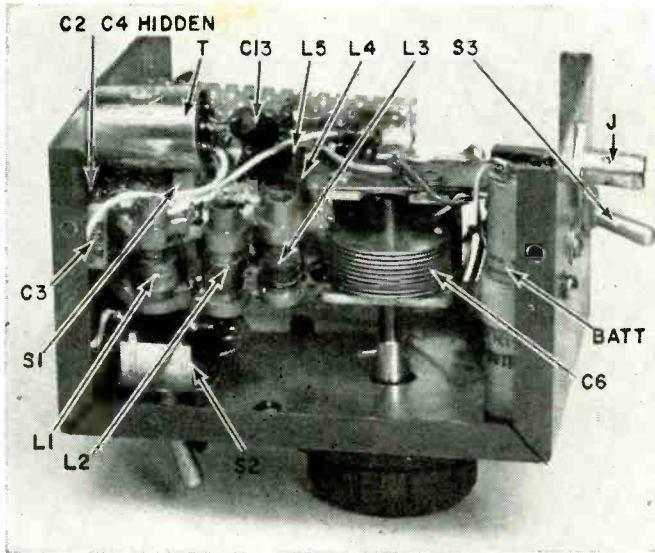

This view gives a detailed look at how the coils are mounted across the range switch.

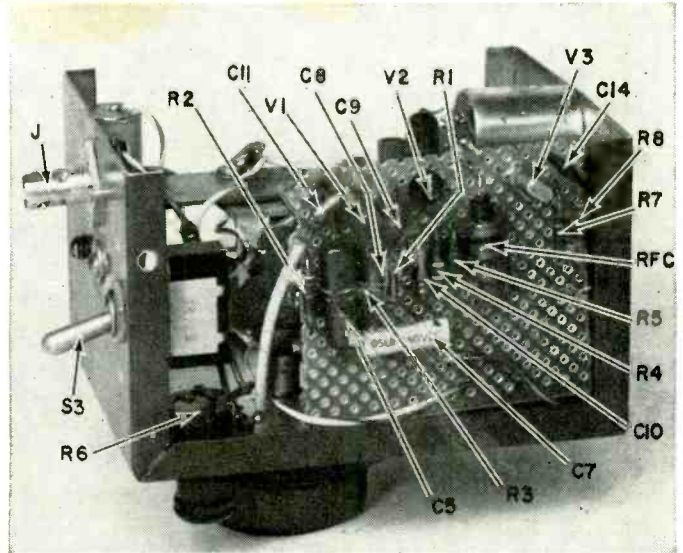

Parts layout on the perforated plastic chassis.

a 2½ x 3-inch perforated board and installed close to S1 and the tuning capacitor. Straightforward layout is used, and all leads are kept as short as possible. The 5 x 4 x 3-inch case doesn't allow much free space so careful layout is necessary if you want to keep the unit small.

Miniature parts are used wherever possible to keep the test set compact, but standard-size components can be used without ill effect. A mercury battery is used because of its relatively constant output during its life, but standard dry cells and a larger enclosure can be used if desired.

To help speed construction, RADIO-ELECTRONICS is making available a printed-circuit board for this signal generator. Of necessity, the coils are still mounted right on the switch—it's the most convenient method. But all other components mount on the board. If you use the printed-circuit board,

mount it in the same manner as the perforated board shown in the photos. Of course, don't forget to ground the ground foil to the cabinet. If you don't, the unit won't work and your output jack will be floating.

Calibration techniques remain the same. A smaller case was suggested but, unless you need a really tiny instrument, there is no advantage to this. In fact, many technicians prefer larger instruments for their shop. When it doesn't have to be portable, they like an instrument that won't get lost.

Calibration

After construction is complete, insert a millimeter in series with the positive battery lead and S3. Turn S2 to CW, throw S3 to ON and note the current reading. If it is appreciably higher than 2.5 ma, remove the power immediately and inspect the wiring for a wrong connection or defective transis-

tor. When the correct reading is obtained, turn S2 to MOD and again note the reading. If the audio oscillator circuit is correctly wired, the meter reading will increase only 0.5 ma.

It is easy to calibrate the generator's upper ranges with a good communications receiver. For the lower ranges you'll need a stable signal generator and oscilloscope since most communications receivers do not go below the broadcast band. If a low-frequency receiver can be borrowed, it will be a lot easier to use for calibration than a generator and scope.

Connect the Trans-Marine output to the receiver's antenna terminals and set the receiver's dial to about 4.5 mc. Place a numbered dial on C6's shaft and rotate C6 to its full-open minimum-capacitance position. Turn the RANGE switch to position 5, S2 to MOD and S3 to ON. Adjust L5's slug for a tone-modulated signal at the 4.5-mc setting of

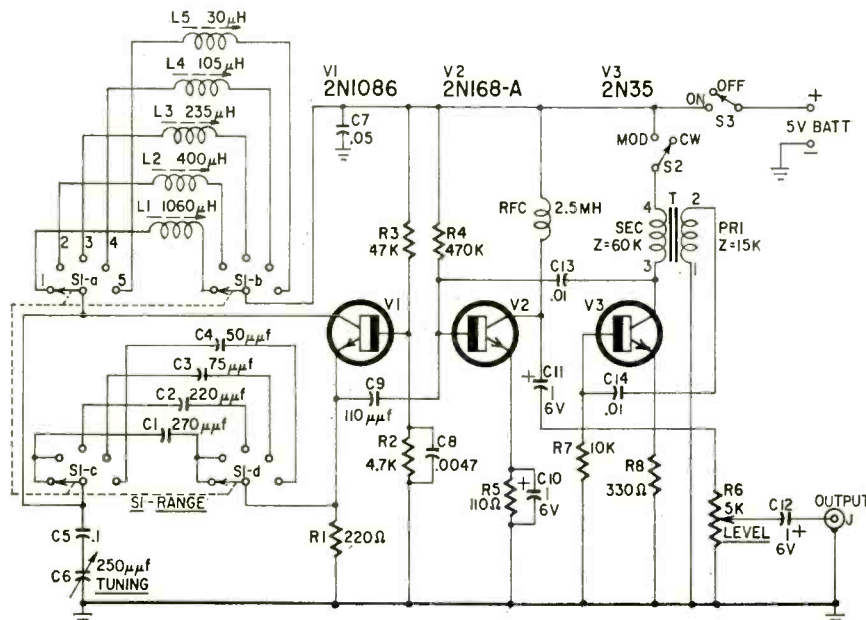

The generator circuit is simple, but effective.

- R1—220 ohms
- R2—4,700 ohms
- R3—47,000 ohms
- R4—470,000 ohms
- R5—110 ohms, 5%
- R6—pot, 5,000 ohms, linear

- R7—10,000 ohms
- R8—330 ohms
- All resistors ½-watt 10%, unless noted
- C1—270 μF, mica
- C2—220 μF, mica
- C3—75 μF, mica
- C4—50 μF, mica
- C5—0.1 μF, paper
- C6—250 μF, variable (capacitor used was cut down from a midget 2-gang unit to 9 stator and 11 rotor plates. However, you can use a Hammarlund MC-250-M or equivalent if you get a deeper case)
- C7—.05 μF, paper
- C8—.0047 μF, paper
- C9—110 μF, mica
- C10, C11, C12—1 μF, paper or 6-volt electrolytic
- C13, C14—.01 μF, paper or ceramic
- BATT—5 volts (2 Mallory TR-134R or equivalent in series)
- J—coaxial connector
- *L1—1060 μH (North Hills 1000-N or equivalent)
- *L2—400 μH (North Hills 1000-L or equivalent)
- *L3—235 μH (North Hills 1000-K or equivalent)
- *L4—105 μH (North Hills 1000-J or equivalent)
- *L5—30 μH (North Hills 1000-H or equivalent)
- RFC—2.5 mh
- S1—2 decks, 4 poles, 5 positions, rotary
- S2, S3—pspf toggle
- T—audio transformer: primary, 15,000 ohms; secondary, 60,000 ohms (UTC O-4 or equivalent)
- V1—2N1086 (G-E)
- V2—2N168-A (G-E)
- V3—2N35 (Sylvania)
- Case, 3 x 4 x 5 inches
- Miscellaneous hardware
- *Available from Harrison Radio, 225 Greenwich St., New York, N.Y., and Hudson-Terminal Radio, 212 Fulton St., New York, N.Y.

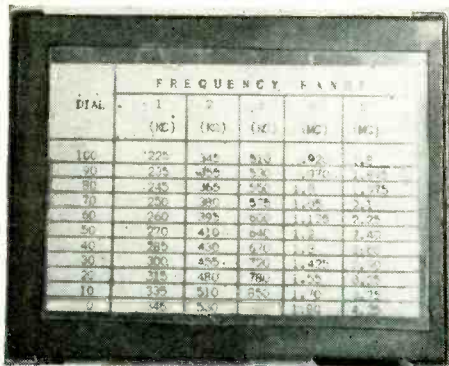

The author ended up with this scale of frequencies covered by his instrument.

the receiver. Rotate C6 toward the low-frequency or maximum-capacitance end and tabulate C6's dial markings with the frequencies indicated on the receiver.

When C6's fully closed position is reached, leave the receiver at this frequency, rotate S1 to position 4, turn C6 back to its full-open position and adjust L4's slug for a signal at the previous setting of the receiver dial. Continue the calibration toward the low-frequency end.

Follow this simple procedure until all ranges are calibrated. If the receiver you have doesn't go down far enough, calibrate with the receiver until you run out of the receiver's lowest frequency range, then use a stable signal generator and oscilloscope to finish the job with Lissajous figures.

Connect the calibrating signal generator's output to the scope's horizontal input and the test set's output to the vertical input, with S2 set to the CW position. When the two generator frequencies are equal, an ellipse will appear on the scope face. Continue the with the calibrating generator's frequency when an ellipse is obtained.

The Trans-Marine generator can be used in the same manner as any other standard signal generator. Connect it to the rf, mixer or if stage of any receiver for alignment or signal substituting. If it is to be connected to a test point which contains dc, like the plate of a mixer tube, insert a 0.1- μ f 400-volt capacitor between the output jack and test point. The modest investment in the construction of this handy unit will repay itself many times over with ease of aligning and testing marine, auto, portable and fixed receivers. END

PRINTED-CIRCUIT BUILDERS

The photos of the original instrument were shown, since assembly on the board is semi-automatic. R-E had a board made and tested the unit with it wired in place. There was no change in performance. All parts not mounted on the printed board are fastened to the case or mounted on the switches. Connect the arms of S1-a, b, c, d to S1A, B, C, D on the board with ordinary hookup wire. S3's ON terminal and S2's MOD terminal to go to S3 ON and S2 MOD on the board.

SHORT-WAVE FORECAST

Sept. 15-Oct. 15

By STANLEY LEINWOLL†

THE TREND TOWARD WINTER PROPAGATION CONDITIONS, CHARACTERIZED BY HIGHER usable frequencies during the daylight hours and lower usable nighttime frequencies, will continue.

During the latter part of September, a noticeable decrease in static levels and ionospheric absorption will result in a significant improvement in the 4-, 6-, and 7-mc broadcast bands during the evening hours. Conditions in these bands should be better for the next several months than they have been in 5 years.

Propagation conditions between the United States and Australia, Africa and South Asia improve considerably during equinox periods. This improvement will be general and should be noticeable in all bands.

The tables show the optimum broadcast band, in megacycles, for propagation of programs between the locations shown during the time periods indicated.

To use the tables, the listener selects the one most suitable for his location, reads down the left side to the region he wishes to hear, then follows the line to the right until he is under the appropriate time. (Time is given at the top of each table in 2-hour intervals from midnight to 10 pm, in your local standard time.) The figure thus obtained is the short-wave band (in megacycles) nearest to the optimum working frequency.

For example, a listener in the Central USA would be most likely to receive broadcasts in the 17-mc broadcast band from Western Europe at noon.

The tables are designed to serve primarily as a general guide, since day-to-day variations in receiving conditions can be large.

At certain hours, propagation over some of the paths given in the tables may be extremely difficult, or impossible. These are shown with an asterisk (*).

†Radio Frequency and Propagation Manager, RADIO FREE EUROPE

EASTERN US to:

	Mid	2	4	6	8	10	Noon	2	4	6	8	10
West Europe	7	7	7	15	17	17	17	17	17	11	9	9
East Europe	7*	7*	7*	11	15	15	17	15	11	9	7*	7*
Northern Latin America	11	11	9	15	15	15	15	15	15	15	15	11
Southern Latin America	15	11	11	11	15	15	15	15	15	15	15	15
Near East	7	7*	7*	11	15	17	17	17	15	11	9	9
North Africa	9	7	7	15	17	17	17	17	17	15	11	9
South & Central Africa	9	9	9*	17	21	21	21	21	17	15	11	9
Far East	9	7	7*	7*	11	11	9*	9*	11	15	11	9
Australia & New Zealand	11	11	9	9	9	7*	9*	21*	21	21	17	15

CENTRAL US to:

West Europe	7*	7*	7	11	15	17	17	17	11	9	7	7*
East Europe	7	7*	7*	11	15	15	11	11*	9*	9*	7	7
Northern Latin America	11	9	9	15	15	15	15	15	15	15	11	11
Southern Latin America	11	11	9	15	15	15	15	15	15	15	15	11
Near East	7*	7*	7*	11	15	15	15	11	11*	9*	9	9
North Africa	9	7	7*	15	17	17	17	17	11	11	9	9
South & Central Africa	9	7	9*	15	17	17	17	17	17	15	11	9
Far East	9	7	7*	6*	11	9*	9*	17	17	17	17	11
Australia & New Zealand	11	11	11	9	9	9*	21*	21	21	21	17	15

WESTERN US to:

West Europe	7	7*	7*	11	15	15	17	11	9*	9*	7	7
East Europe	9	7*	7*	11	15	11	11	9*	9*	7*	9	9
Northern Latin America	11	9	9	15	15	15	15	15	15	15	11	11
Southern Latin America	11	11	9	15	15	15	15	15	15	15	11	11
North Africa	7	7*	7*	11	15	15	17	11	11	9	9	9
South & Central Africa	9	7*	7*	17	17	17	21	17	15	9	7	9
Far East	9	7	7	7	11	9	11	17	17	17	17	11
South Asia	9	7	7*	7	11	15	15	11*	15	17	15	11
Australia & New Zealand	15	11	9	9	9	15*	21	21	21	21	21	17

DOES FM STEREO FOLLOW ITS OWN THEORY?

Some of the explanations are more complex than the circuit workings

By **NORMAN H. CROWHURST***

EVER SINCE THE ARTICLE IN THE JULY issue of RADIO-ELECTRONICS, we have been trying to get information about adapter circuits. Many manufacturers had released information on an adapter, with model number and photograph, with the usual claims of tested performance superior to anything else available. But when it came to giving technical information about how their circuit was different from the others, or supplying a schematic so we could see for ourselves what they had done, nothing was forthcoming. Several did invite us to go see.

These visits have been informative. The questions we asked uncovered so much that engineers did *not* know about the new system and how to work with it, that we started to find at least some of the answers. A week's intensive work, followed by further visits to other companies working on the problems, shows that our long background in audio design has paid off, when it comes to stereo multiplex: we suspect that we now know more about the theory and practice of stereo multiplex

*Audio Design Service.

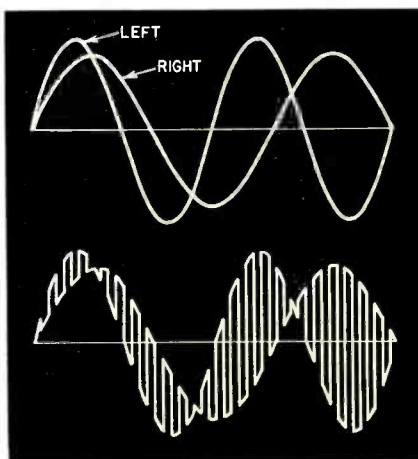

Fig. 1—How mathematical approach to time-division multiplex assumes the waveform is made: top shows the left and right waveforms superimposed; at bottom is theoretical composite stereo waveform (without pilot).

than anyone else in the industry.

Of course, a lot of people are making rapid progress. Many ideas for new circuits are in the works. Some of these will fulfill the dreams of their originators and some of them won't. But the biggest thing we found from this lightning investigation is a general misunderstanding about how the system works—or should work. This incorrect understanding of some aspects is hindering progress in solving the problems.

Basic concept

It's commonly known, from the very fact that the system was developed independently in two different ways by Zenith and G-E, that the same system can be analyzed from two different viewpoints. And it will work with correspondingly different circuitry. But there are points about each that have led many "up the garden path" unnecessarily.

We have had several arguments about the mathematics presented with the Zenith approach. The Zenith method works, there is no argument about that, but the math used to explain *how* it works can mislead the student.

The approach uses a switching concept: an electronic switch flips between left and right channels at a frequency of 38 kc. The mathematical analysis assumes this switching is instantaneous, like a square wave (Fig. 1). The circuit may in fact use this technique. But if it does, the modulation frequencies will include sidebands of 38 kc, sidebands of 114 kc, sidebands of 190 kc, and so on, just like any other 38-kc square wave.

The highest frequency that should be used to modulate the transmitter is 75 kc. So, regardless of the switching method used, all those sidebands of 114 kc, 190 kc and higher frequencies just have to be cleaned off with a low-pass filter.

If we show the sidebands corresponding to 38-kc modulation, square wave, of the transmitter, they look like Fig. 2. Compared with the FCC requirements, every harmonic up to the 29th is at too high a level, after the first. Then an SCA subcarrier of 67 kc may

have to be squeezed in too. In point of fact, the composite stereo, L + R with L - R suppressed-carrier modulated on 38 kc, is passed through a very-sharp-cutoff 54-kc low-pass filter, so everything but the simple 38-kc sidebands is cleaned off, for all intents and purposes.

If you have a 38-kc square wave, it isn't a very good square wave if you only have 38, 114 and 190 kc (Fig. 3). But if you take away the 114 and 190 kc, it doesn't even begin to look like a square wave. It's just a sine wave, pure and simple. To try and analyze it as an approximation to a square wave would be ridiculous. The approximation isn't rough—it's nonexistent. Yet that, in effect, is what the use of Fourier analysis in the Zenith math is trying to do.

Then you do the same on reception, with a similar "approximation". If that

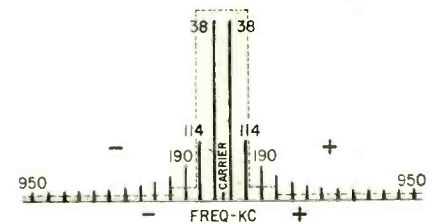

Fig. 2—Sidebands corresponding to 38-kc modulating square wave. Shaded area is permitted boundary level of the FCC; note how many sidebands exceed this level seriously.

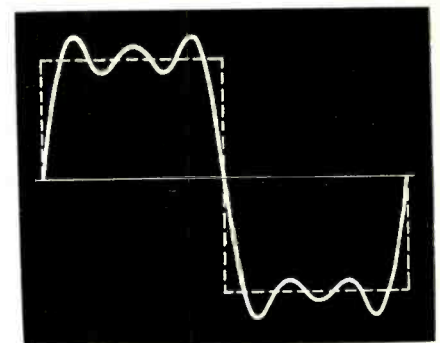
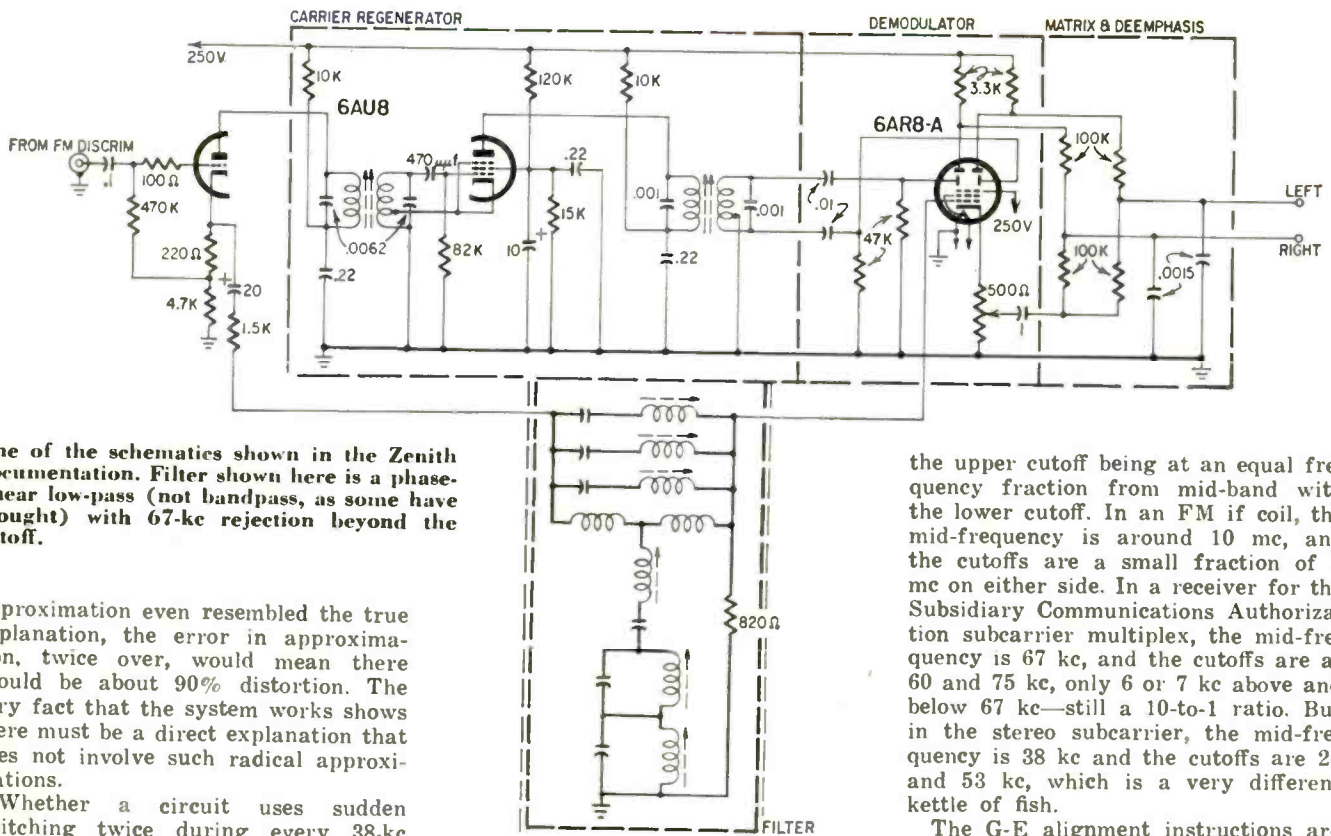

Fig. 3—Nearest approximation to a square wave possible with fundamental, third and fifth harmonics (38, 114 and 190 kc) is shown here; it is not a particularly close approximation.



One of the schematics shown in the Zenith documentation. Filter shown here is a phase-linear low-pass (not bandpass, as some have thought) with 67-ke rejection beyond the cutoff.

approximation even resembled the true explanation, the error in approximation, twice over, would mean there should be about 90% distortion. The very fact that the system works shows there must be a direct explanation that does not involve such radical approximations.

Whether a circuit uses sudden switching twice during every 38-ke cycle and filters off the harmonics, or whether a more direct arrangement samples left and right by a sinusoidal fluctuation at 38 ke from one to the other (Fig. 4), the latter is the kind of signal actually used to modulate the transmitter. We don't find that waveform at all hard to visualize. In fact it's easier to imagine and draw than trying to figure out what happens to the suddenly switched signal when all its harmonics are cleaned off.

Incidentally, this correction gets rid of the $2/\pi$ factor in the math that has been mentioned as having to be built into the reception circuit. If you have to build it into the adapter at all, it's only because you make it necessary by introducing the particular approximation that causes it—at the receiver—using a sudden switching circuit with low-pass filtering for demodulation, which some are doing.

Oddly enough, the math involving Fourier series is so complicated only an engineer pretends to understand it, while this more correct explanation is simple enough for a technician to understand from the waveform drawing of it. We would also emphasize that this criticism applies only to the Zenith theorization—their system definitely works.

Bandpass filters

That criticism concerned the Zenith approach. To keep things fair, this one concerns the G-E approach! Their original design uses a bandpass filter to separate subcarrier modulation from L + R. They prescribe "phase-linear" filters for this and the associated low-pass filter.

It was only when we tried to design a phase-linear bandpass filter to the

required specification that we found out there is no such animal—in this bandwidth. To "prove" that such a filter is possible, some have quoted the complicated Bode filter shown in the Zenith schematic (top of page). That is not a bandpass filter, but a low-pass type.

A phase-linear low-pass filter is no great problem. But a phase-linear high-pass cannot possibly exist, and a bandpass of this bandwidth is essentially a synthesis of the two. In a correctly designed low-pass filter, the phase delay, up to cutoff, is proportional to frequency (Fig. 5). If it's 30° at 5,000 cycles (5 ke), 60° at 10 ke, and 90° at 15 ke (all practical figures), it is phase-linear. The delay is 1/4 of a 15-ke cycle, 1/6 of a 10-ke cycle, or 1/12 of a 5-ke cycle, each of which means 16 2/3 microseconds, the same constant delay time.

But in a complementary high-pass filter, 90° phase advance (not delay in high pass) at 15 ke would correspond with 60° advance at 22.5 ke and 30° advance at 45 ke. These figures convert to time advances of 16.7, 7.4 and 3.3 microseconds, respectively. Nothing can be done, over a band this wide, to make the time-delay/advance characteristic anywhere near linear.

In relatively narrow bandwidth filters, where the response is due to the relative Q and coupling factor of tuned circuits, the overall response can be analyzed, to a close approximation, as analogous to a low-pass filter, where the cutoff frequency is equal to the deviation of either cutoff in the bandpass from mid-frequency (Fig. 6).

This close approximation depends on

the upper cutoff being at an equal frequency fraction from mid-band with the lower cutoff. In an FM if coil, the mid-frequency is around 10 mc, and the cutoffs are a small fraction of 1 mc on either side. In a receiver for the Subsidiary Communications Authorization subcarrier multiplex, the mid-frequency is 67 ke, and the cutoffs are at 60 and 75 ke, only 6 or 7 ke above and below 67 ke—still a 10-to-1 ratio. But in the stereo subcarrier, the mid-frequency is 38 ke and the cutoffs are 23 and 53 ke, which is a very different kettle of fish.

The G-E alignment instructions are a little bit of a giveaway to this fact. They say the subcarrier reinsertion phase should be adjusted for maximum stereo separation at the higher audio frequencies, and the matrix (dimension) adjustment should be used for separation at the lower stereo frequencies. Put in simple terms, what this means is this:

Having two variables, the subcarrier reinsertion phase and the dimension

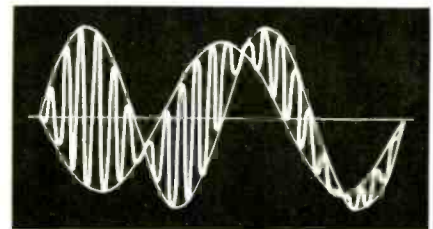

Fig. 4—Actual kind of waveform the system does use, based on left and right waveforms used in Fig. 1. Each time left and right waveforms cross, the 38-ke component goes through zero and reverses phase.

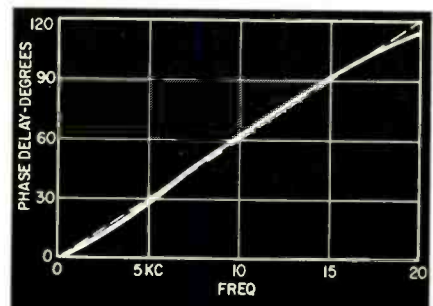

Fig. 5—Phase response of 15-ke low-pass filter to illustrate phase linearity. Dashed line represents theoretical ideal. Solid line is for a relatively simple practical circuit.

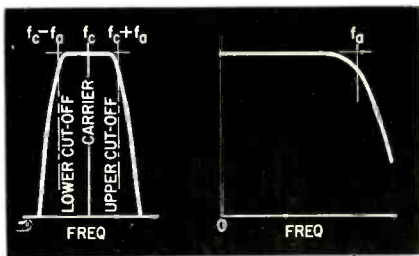

Fig. 6—Where band of bandpass filter is narrow, in terms of mid- or carrier frequency, it can be analyzed approximately in terms of an equivalent low-pass response (right).

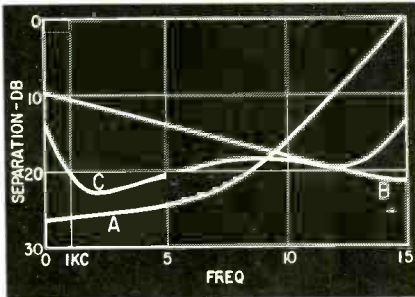

Fig. 7—Separation when a bandpass filter is used in L - R circuit. Curve A, with subcarrier phase and matrix adjusted for maximum separation at low audio frequencies; curve B, with both adjusted for maximum separation at highest audio frequencies; curve C, practical setting, with phase adjusted to get maximum separation at high frequencies and matrix adjustment for maximum separation at low frequencies.

control, means that separation can be made high at two frequencies by what is really a "crooked" adjustment. Suitable choice of these frequencies means the separation does not get too high in between or beyond them (Fig. 7). But the very method means separation cannot be very high anywhere.

Fortunately there is a fairly simple remedy. A phase-linear low-pass filter is no problem, so we can use this to separate the L + R component. It is easy to null out the L + R component from the subcarrier detection, merely by returning the detector load circuit to the output point of the low-pass filter (Fig. 8). In this way, the whole L - R demodulation circuit "floats" at L + R audio, and a bandpass filter is not needed. Time delay can be equalized between L + R and L - R very completely by matching the delay caused by the detector load to that caused by the low-pass filter (Fig. 9).

These are some of the things engineers have been finding out the hard way. What has hindered them, of course, has been the absence of any generator or test equipment to work with. The more successful manufacturers made their own rather than wait for a model to be made available by somebody else.

Other details

One misunderstanding encountered was that the G-E system provides

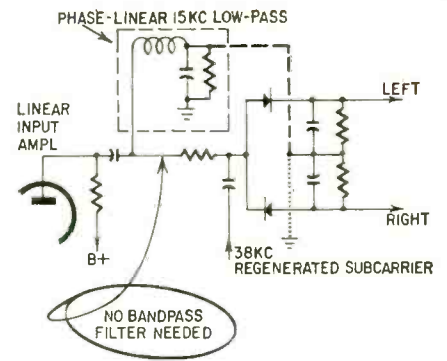

Fig. 8—Change in filter-circuit connection with matrix arrangement obviates need for bandpass filter. Instead of returning diode load circuits to ground (dotted line), the return is made to the low-pass filter output (dashed line).

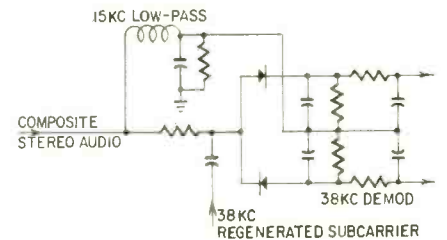
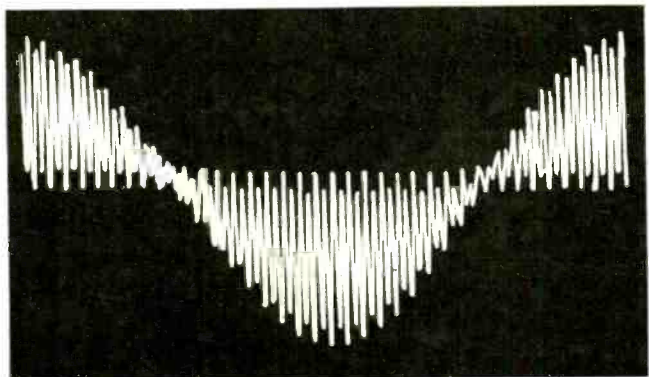
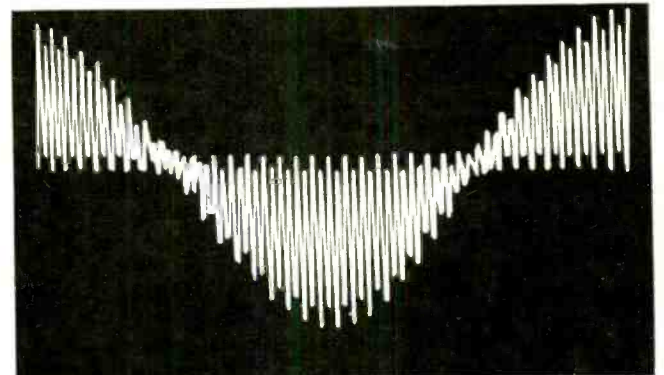

Fig. 9—Equalizing delay times is easy with this arrangement. The 15-kc low-pass and the 38-kc demodulator circuit loading are adjusted to have the same time delay.



LEFT ONLY
a



RIGHT ONLY
b

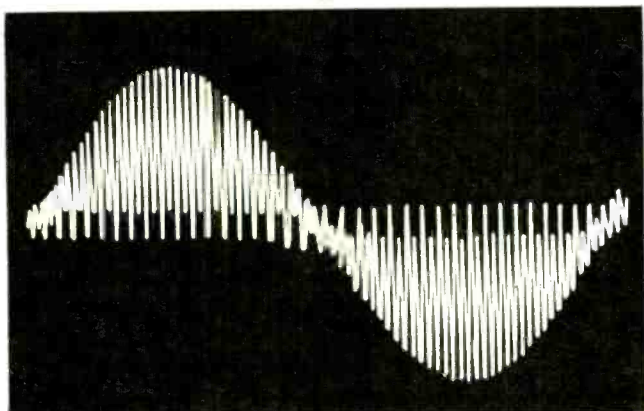

LEFT ONLY
c

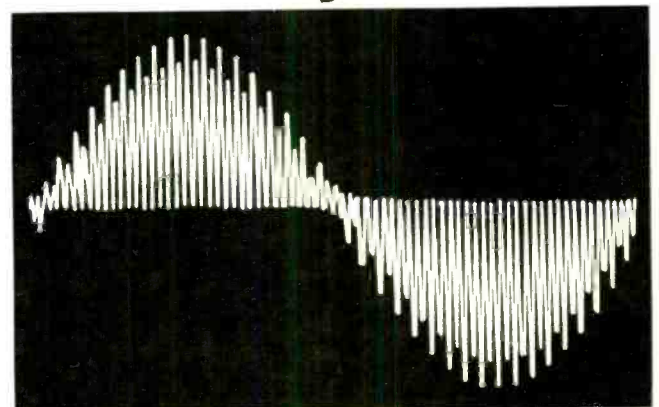

RIGHT ONLY
d

Fig. 10—Patterns published by Zenith for FCC issued standard can be used to phase pilot frequency. In a and in b, the double pilot frequency crosses 0 axis with modulated subcarrier. In c and in d, it is 90° out of phase with the subcarriers.

means for adjusting relative magnitudes of $L + R$ and $L - R$, thereby controlling separation, while the Zenith method of reception does not. When the foregoing misunderstandings are corrected, the picture changes.

Either circuit is capable of adjustment to secure maximum separation of left and right after either switching (Zenith) or dematrixing (G-E). The exact method will vary from circuit to circuit. To give anything like a complete rundown on this aspect, we'll have to wait until we have a more complete picture of the various circuits available. At this writing, few have been released for publication.

Another important feature about alignment, which depends on having a good generator of some sort, is being sure that the phase of the pilot carrier is right, relative to the suppressed-carrier modulated subcarrier. Stated like that it sounds like looking for the phase of something that isn't there, which would be a problem. It's only there when there is $L - R$ modulation.

If you check the phasing, by Lissajou pattern or any other method, at the output from the respective generator circuits, before mixing, there may be some error. This is due to differential phase shifts before you reach the output, which is the input to your adapter. The best place to check phase is where it matters, at the input to the adapter under test.

In their document of Oct. 28, 1960, Zenith showed different phasings of pilot frequency, with audio on only one channel (Fig. 10). The patterns for

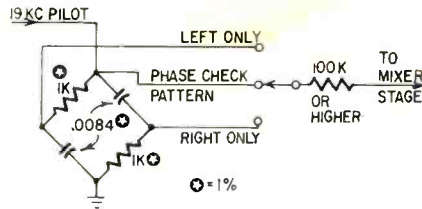

Fig. 11—Simple circuit that can be included in a service type generator to check pilot frequency phasing.

signal as prescribed by the FCC are those at *a* and *b*. The easiest to check phase is *d*. If the pilot signal circuit has a phase adjustment, followed by a low-impedance twin phase-shifting network to give 45° advance or delay from the center position (Fig. 11), the center position can be used to get an output pattern like Fig. 10-d by careful adjustment. The other two positions provide an input signal equivalent to left only and right only, for phase-alignment and separation checks on the receiver.

One adapter with a nice feature has already appeared, from Fisher. It has a "stereo beacon" which, as well as indicating when stereo is being transmitted by FM from the station to which the tuner is set, switches off the subcarrier demodulator when no pilot is present, and thus avoids unnecessary noise when receiving mono on the same system. It just parallels left and right when the transmission is monophonic.

A number of other interesting developments are going on, about which

we have unofficial news but not permission to say anything at this juncture. In fact, this whole project looks like about just the most flexible system ever to tickle an audio man's fancy.

Installing the new system will bring a few problems. Not all tuners will work well with an adapter, although they might be quite good monophonic tuners. The main difference (but this statement may oversimplify matters a little) is that for stereo the tuner must provide distortion-free reception of "audio" up to 75 kc, instead of just 15 kc, as previously.

Antenna installation becomes more important than before. Reflections that could cause ghosts on a TV screen may not be audible on monophonic FM reception in any way—distortion or frequency response. But on stereo multiplex, these ghosts can cause distortion, change in frequency response and interference with separation at different frequencies. So you need a good antenna installation that will virtually eliminate reflections, due either to excessive mismatch or multi-path reception.

Testing the same antenna for TV reception is not the answer, of course, because the TV program does not use either the same frequency or the same transmitting antenna location as the FM stereo. It's a job that has to be done with patient observation on actual FM stereo multiplex reception when transmissions are available.

The new system will undoubtedly have its "teething" problems all around. But "stay tuned"—we'll keep you posted on new developments. **END**

KEY TO THE COVER

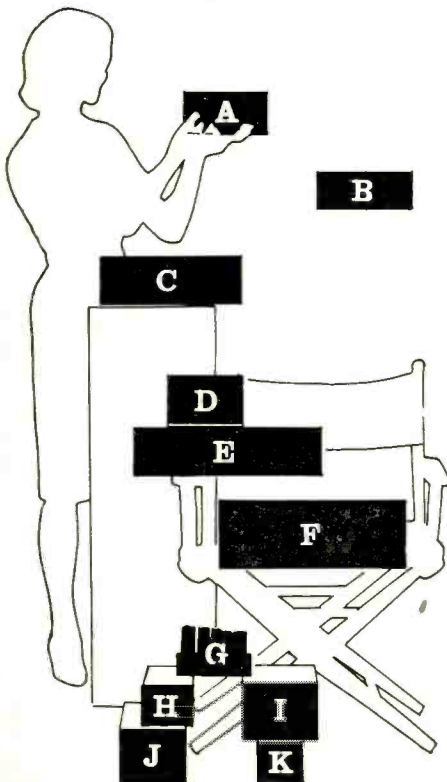

A lot of FM stereo gear is keeping the young lady on our cover rather busy. As she can't tell you which unit is which, we've prepared this little guide. Just pick out any item on the cover, match it to the diagram here and check the letter to identify it.

A—Paco	MA-100
B—Eico	MX99
C—Pilot	200
D—H. H. Scott	335
E—Sherwood	S-8000
F—Bogen	RP40A
G—Harman-Kardon	MX600
H—Bogen	PX60
I—Lafayette	LA-215
J—Crosby	MX-101
K—Heath	AC-11

Want to know more about these units? Check the directory starting on page 38.

REASSEMBLING SPRING-LOADED GEARS

By **CHARLES E. COHN**

Many dial mechanisms use spring-loaded gears to eliminate backlash. When reassembling such a mechanism after working on it, gear adjustment must be right. Note the relationship of the two spring-connected gears with no force on the springs. Then move the gears relative to each other, in the direction that compresses the springs, until the teeth of the two first coincide with the springs under force. Then mesh them with the other gear of the train. Moving the gears to compress the springs further than this increases the friction of the system and makes it harder to operate. This can be done, however, if the load carried by the gear train is high enough so that the light spring loading recommended here is not enough to take up the backlash. The lightest spring loading that will keep the two loaded gears from moving relative to each other under reversal of motion is the loading that should be used.

INDUSTRIAL TEST EQUIPMENT

Operation is basically the same, but precision is better than that of TV test instruments

IS IT DIFFERENT?

By MATTHEW MANDL

THE differences between industrial test equipment and TV service gear are those of refinements and modifications of basic voltmeters, ohmmeters, oscilloscopes and related units to adapt them to the more demanding requirements of industrial electronic gear and circuitry. Service technicians who know how to use their own equipment will have no difficulty using similar higher-level industrial equipment once the ranges, applications and variations are understood.

On occasion, a piece of equipment unrelated to the test equipment found in TV servicing will be encountered, such as the strip-chart recorder discussed later. When its basic principles are understood, however, the technician

An example of an industrial meter is the Metronix model 311, a panel-mounted ac unit. Its usefulness in industrial electronics, is due to its high input impedance and broad frequency range. These desirable factors were obtained by using a vtvm.

The input impedance of the model 311 is 5 megohms, paralleled by 25- μ f capacitance. The high input impedance is particularly useful when it is necessary to make voltage measurements without loading the circuit under test with the voltmeter circuit.

Ordinary voltmeters for industrial work are calibrated at 60 cycles, and their accuracy varies when signal voltages above or below the calibrated frequency are measured. But this meter's

tachometer transducer which is attached to probe leads as shown. It is used to measure the speed of motors, rotating machinery, conveyor belts and other motions. The speed is directly indicated on the specially calibrated meter dial.

The tachometer transducer is based on the dc generator principle. When an armature rotates in a magnetic field, the magnetic lines of force are cut and a voltage is induced in the output leads. In a tachometer, the generator assembly is very small so the unit is not excessively bulky.

When the shaft which protrudes from the tachometer housing is held on a motor shaft or other rotating device, the spinning armature in the tachometer generates a voltage output pro-

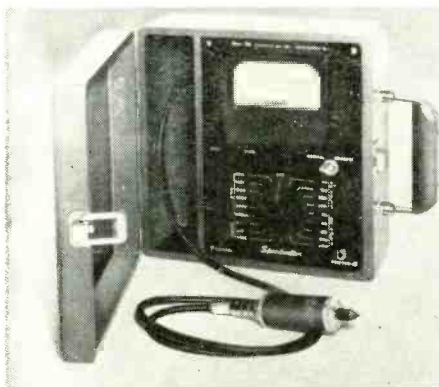

Servo-Tek Products Co Inc.

The Speedvolter with its tachometer probe measures rpm.

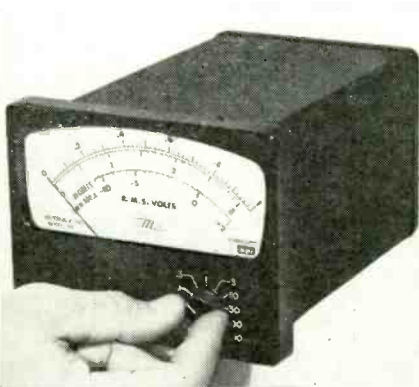

Metronix Inc.

Metronix model 311 is miniature industrial vtvm.

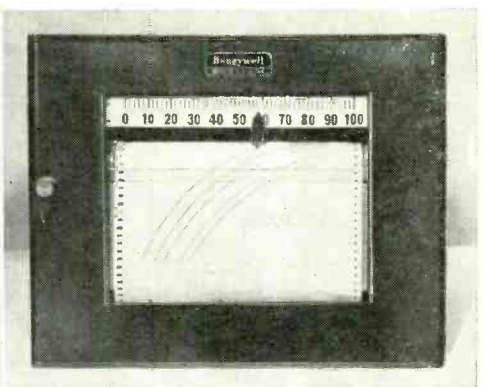

Minneapolis-Honeywell Regulator Co.

Typical strip recorder.

will have no trouble using it, particularly if he is proficient in handling ordinary meters, scopes and checking devices.

Vtvm's and vom's

The ordinary vtvm and vom are extensively employed in testing, servicing and maintaining industrial electronic equipment. There are, however, numerous occasions when more specialized types are used for tasks normally beyond the capabilities of the basic units. One such might be a miniature unit to meet a certain set of requirements, or it may have a greater input impedance and higher scale ranges. Others may interpret the signal voltage output from transducers and give a direct reading of the information sensed by them.

frequency range is from 20 cycles to 250 kilocycles. Accuracy is $\pm 2\%$ of full-scale deflection over the entire frequency range. Also, the instrument is comparatively unaffected by any line-voltage variations. A 10% change in line voltage will cause an error of no more than 1% of full-scale deflection. The full-scale sensitivity of the unit begins at 10 mv and goes up to 300 volts rms.

A volt-ohmmeter with a special speed-reading (tachometer) probe is the Servo-Tek Speedvolter. It is designed to meet industrial requirements for a quick and accurate means of measuring speed. Because of its voltage and resistance checking capabilities, it can also be used as a testing and servicing device.

The Speedvolter has an external ta-

chometer probe is attached to probe leads as shown. It is used to measure the speed of motors, rotating machinery, conveyor belts and other motions. The speed is directly indicated on the specially calibrated meter dial.

The tester, as mentioned earlier, is a voltmeter and ohmmeter as well as a tachometer. The selector switch chooses any of six speed ranges, from 0 to 300 rpm up to 0 to 12,000 rpm. For measuring linear speeds, the ranges are from 0 to 30 feet up to 0 to 12,000 feet per minute. The dc ranges are from 0 to 30 up to 0 to 600 volts. The basic meter movement is a 5,000-ohm-per-volt unit. The ac ranges are from the low scale of 0 to 30, up to 0 to 600 volts. The ohmmeter scale measures 1 to 200,000 ohms.

(Continued on page 66)

STEREO/HI-FI



New Deluxe Stereo Preamplifier
15 pushbutton-selected inputs; two sets of controls.
Kit AA-11, 19 lbs. . . . \$84.95



Low Cost AM/FM Tuner
Has multiplex output jack, two tuning "eyes", adjustable AFC.
Kit AJ-11, 19 lbs. . . . \$69.95



Hi-Fi Rated 14 watt Amplifier
Mono. amplifier and preamp. 3 inputs; Heath Ultra-Linear.[®]
Kit AA-161, 15 lbs. . . . \$33.54

HEATHKIT[®]

the only

GENERAL



Superhet. CB "Walkie-Talkie"
9 transistor crystal-controlled superhet. with RF stage; 1 uv sensitivity; squelch & noise limiter.
Kit GW-21, 3 lbs. . . . \$44.95



Short Wave Radio
4 bands, 550kc-30mc; lighted dial & meter; circuit board.
Kit GR-91, 9 lbs. . . . \$39.95



Telephone Amplifier
Hands-free phone calls; all-transistor; battery powered.
Kit GD-71, 2 lbs. . . . \$19.95

EDUCATIONAL



Two-Part Basic Radio Course
each with authoritative textbook and parts for receiver.
EK-2A & 2B, 6 lbs. ea. \$19.95



VTVM Applications Course
First of a series; includes textbook & experiment parts.
EF-1, 3 lbs. . . . \$8.95



Educational Analog Computer
Ideal for school or industry; 9 amplifiers, complete manual.
Kit EC-1, 43 lbs. . . . \$199.95

MARINE



3-Band RDF
10 transistor, 1 diode; covers Beacon, Consolan, Broadcast, Marine.
Kit MR-11, 12 lbs. . . . \$109.95



Low Cost Depth Sounder
All-transistor, battery power; depth 0-100'; transducer inc.
Kit MI-10, 9 lbs. . . . \$69.95



Power Converter
Converts 6 or 12 v. battery power to 117 VAC; switched; fused.
Kit MP-10, 7 lbs. . . . \$29.95

AMATEUR



7 Band VFO
Covers 80 thru 2 meters; vernier, regulated, isolated; xmtr powered.
Kit HG-10, 12 lbs. . . . \$34.95



50 watt CW Transmitter
80-10 meters; low pass filter; single switch station control.
Kit HX-11, 17 lbs. . . . \$43.50

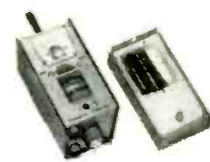

"Tunnel Dipper"
Exclusive tunnel-diode osc.; works like grid-dip; 2.7-270mc.
Kit HM-10, 3 lbs. . . . \$34.95

TEST & LAB.



AC VTVM
10 ranges, .01-300v.; response 10 cps-500kc; 10 megohm input.
Kit IM-21, 4 lbs. . . . \$33.95



General Purpose 3" Scope
Push-pull amps; sweep 20 to 100,000 cps; sensitivity .25v.
Kit IO-21, 14 lbs. . . . \$49.95



Deluxe Capacitor Checker
Direct reading; check all types completely, plus R and L.
Kit IT-11, 7 lbs. . . . \$29.95

▶ TOP VALUE

Value is a relative thing. In electronic kits it relates to quality of design, components, ease of assembly, performance and price. Heathkit is world-famous as the value standard.

▶ EASIEST TO ASSEMBLE

Millions of satisfied Heath customers attest to the superiority of Heathkit construction manuals . . . so easy to follow, so complete that we **guarantee** you can build any Heathkit!

▶ BEST QUALITY

Quality begins with design and continues through performance. Heathkit engineering reflects our greater experience and no-compromise quality components. Result: quality performance.

▶ LOW PRICES

The Heathkit goal: to produce the highest quality kits at the lowest possible prices. Our devotion to this goal keeps Heathkit the world leader . . . the name you can trust for value.



complete line of Electronic kits!

OVER 250 KITS FOR EVERY NEED!

▶ WORLD'S LARGEST MFR.

of electronic kits. Since 1927, Heath has been producing do-it-yourself equipment. Today, the Heathkit line includes over 250 different kits for your every need, interest and budget.

▶ NO DOWN PAYMENTS

It's easiest to buy Heathkit! No-money-down terms on your Heathkit order of \$25 to \$600! Take as long as 18 months to pay . . . reasonable carrying charges. Details in our '62 Catalog. These new, relaxed terms, coupled with our guarantee that you can build any Heathkit, are your assurance of complete satisfaction.

▶ NEW GUARANTEE

We guarantee you can build any Heathkit! This money-back Heathkit guarantee, unprecedented in the kit industry, is made possible by our millions of satisfied customers who have proved that building a Heathkit requires no special background, experience, skills or training! Now, regardless of your mechanical ability or experience, you too can enjoy the immense satisfaction of creating with your own hands an electronic product that performs like the factory built models . . . you too can enjoy the great savings of Heath "do-it-yourself" kits.

Money Back Guarantee

The Heath Company unconditionally guarantees that you can build any Heathkit product and that it will perform in accordance with our published specifications, by simply following and completing our check-by-step instructions, or your purchase price will be cheerfully refunded.

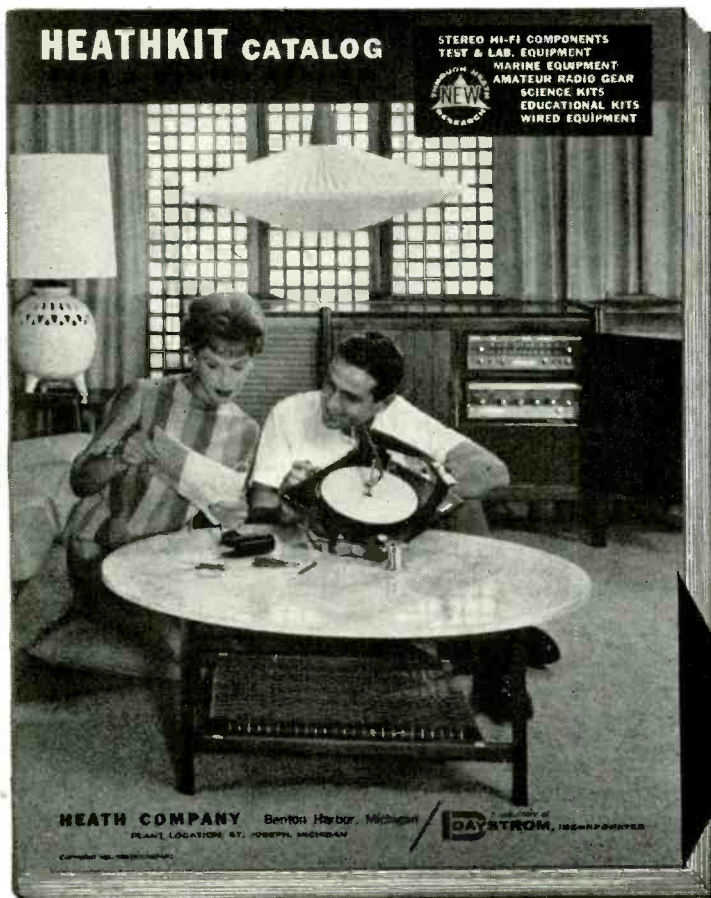

Send... FOR THIS NEW
100 PAGE CATALOG...
OVER 250 KITS

Free

1962 Heathkit Catalog. The world's biggest kit catalog . . . big new size, big photos, complete descriptions, specifications, schematics.

Details over 250 exclusive kits available only from Heath. We'll be glad to send your friends free copies too!



HEATH COMPANY

Benton Harbor 20, Michigan

Send FREE 1962 Heathkit 100 page Catalog

Name _____

Address _____

City _____ Zone _____ State _____

(Continued from page 63)

Oscilloscopes

As in radio and television servicing, the industrial oscilloscope is useful for visual observation of the signals in oscillators, amplifiers and other such circuits. It is also used for signal tracing in conjunction with a signal generator, and for measuring peak-to-peak voltages. Many industrial scopes are similar to the types used by the TV technician. In research and design laboratories, however, more complex ones are used. They have a greater degree of input voltage sensitivity and a much higher sweep range. The more expensive scopes also have signal amplifiers which reproduce faithfully the sharp rise and fall of square waves and pulses. (See "About These Super-scopes," *RADIO-ELECTRONICS*, March, 1961.)

A scope which is useful in industrial electronic applications is one which can display two input signals simultaneously. A typical instrument is the Hewlett-Packard model 122A. It has a 200-kc bandwidth which permits observation and measurement of the performance of electrical as well as mechanical equipment. It can be used as an ordinary scope with just a single trace, or, where two signal waveforms are to be compared, can provide two separate traces

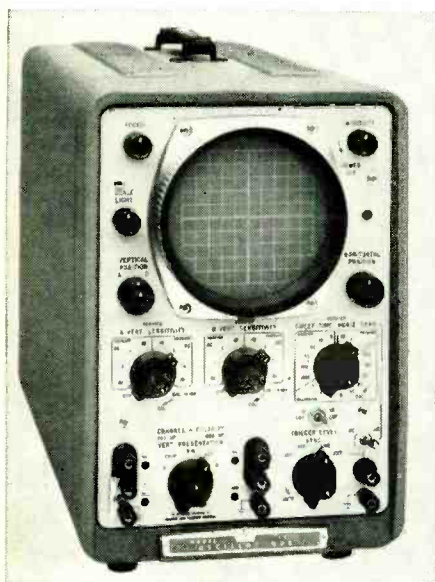

Hewlett Packard model 122A is a dual-trace scope.

just as though two scopes were used.

This unit has twin vertical sweep amplifiers which have direct-coupled circuitry so that very-low-frequency square waves may be used for test purposes. Ac coupling may also be used, to eliminate unwanted dc signals. The device is useful, for instance, in vibration studies in industrial electronic applications. In this application more rapid analysis is possible because both the driving source waveform for the vibration test as well as the actual vibration pattern can be seen at the same time and in relation to each other.

When two signals are viewed, they may be of different amplitudes because

there are separate attenuators for each of the two signals. Direct-reading calibrated sweeps are available. One knob selects any of 15 calibrated sweep ranges from 5 μ sec to 200 msec. The same concentric knob also selects the calibrated horizontal sensitivity. A feature of this scope is the sweep expander which aids observation and also speeds the analysis of transient signals by magnifying any 2-centimeter portions of the trace to 10 centimeters for easy viewing of the sectional details. This expander device may be used on any sweep range and increases the 5- μ sec sweep to 1 μ sec per centimeter.

Strip-chart recorder

Strip-chart recorders contain a roll of paper marked with graph lines. The roll is driven by a motor and glides under a recording pen or a recording stylus for graphing information. This type of recorder is useful because it will show variations in signals over extended time periods and can be used for keeping a permanent record of the variations of temperature, voltage, current, motor speed, and other such data.

Of particular interest is the Brown Instrument Co.'s ElectroniK Function Plotter. It is especially useful where it is necessary to indicate graphically one variable function with respect to another. Thus this strip-chart plotter is of value in industrial electronic applications such as the recording, plotting and graphing of variables in fabrication processes, construction applications, power distribution systems and chemical plants. Specifically, the device plots curves capable of indicating such information as relationship of speed vs torque, stress vs strain, temperature vs pressure, amplifier output vs amplifier input, fluid volume vs pressure and magnetizing force vs flux density. In the latter application, it is of significant usefulness in the plotting of hysteresis curves of magnetic materials.

The ElectroniK Function Plotter uses two measuring circuits, two balancing circuits and two amplifiers which regulate drive motors. The pen which traces the graph lines moves horizontally under control of one of the variables sensed by any one of various devices such as thermocouples, tachometer generators or other dc sources. As the recording pen travels horizontally across the calibrated scale chart, it indicates continuously magnitude of the variable and hence represents the X-axis on a rectangular coordinate plot. The second variable, representing the Y-axis on a graph, is mechanically linked to the chart drive mechanism to regulate the vertical movement of the chart. The result of these simultaneous operations is a continuous plot of Y as a function of X.

So far we have examined three categories of industrial test equipment. Next month we will continue by showing how hysteresis curves of magnetic materials are plotted with strip recorders and why we bother to do so. Also, typical industrial test procedures will be presented. **END**

Add a pilot light to variable autotransformers

By RONALD L. IVES

VARIABLE autotransformers such as the Variac, Varitran and Powerstat are widely used in electronic work to adjust and control line voltage. At many installations, a pilot lamp is used to indicate when the device is operating.

Conventional methods of connecting a pilot lamp to a variable autotransformer are shown in Fig. 1. Here (Fig. 1-a) a neon lamp with a series current-limiting resistor is connected across the primary. This is inexpensive and produces little heat but does not produce very much light. In Fig. 1-b, a filament pilot (such as a No. 44 lamp) is connected across the line with a suitable series dropping resistor. This produces adequate light for most purposes but emits considerable heat, 25 watts

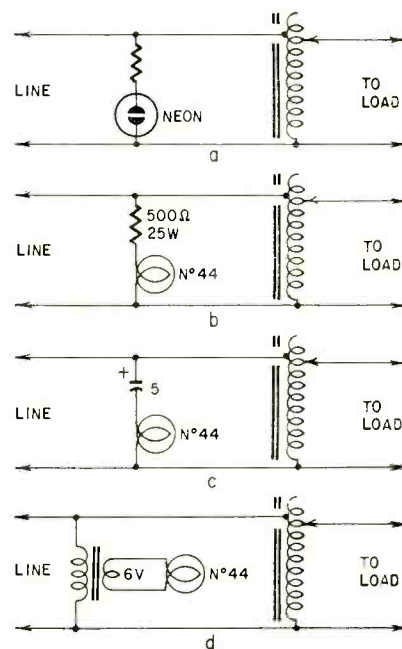

Fig. 1—Four standard methods of connecting a pilot lamp across a variable autotransformer.

being dissipated in the dropping resistor and only 1.5 watts in the lamp. In Fig. 1-c, a similar lamp is connected across the input in series with a large capacitor which limits the current to that required for the lamp filament. This method, although bulky and initially costly, operates stone cold. In Fig. 1-d, the pilot lamp is powered by a midget stepdown transformer. This is relatively inexpensive and compact.

By taking advantage of the properties of any standard variable autotransformer, most of the voltage reduction necessary for ordinary pilot-lamp operation can be handled by the transformer itself. Usually, the voltage across the two outer taps of a conventional variable autotransformer is about 20, with a 117-volt input (Fig. 2).

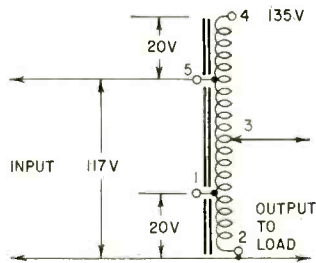

Fig. 2—There is about 20 volts across the top two taps of the transformer.

By using these taps, a low voltage for the pilot lamp is available, and most conventional lamps can be operated in series with a small resistor, to drop the voltage. Connections and constants for No. 44 lamp are shown in Fig. 3. The value of a dropping resistor for other lamps is easily computed by using Ohm's law.

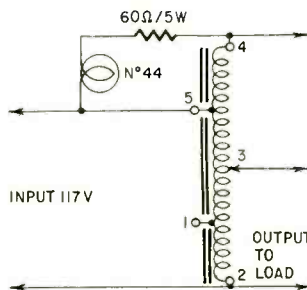

Fig. 3—Pilot lamp (No. 44) hooked up across the 20-volt taps.

Obviously, the same general principles can be applied to devices other than lamps. In some industrial installations, relays, tube filaments and crystal oven heaters could be so operated. However, don't forget that anything connected to the supply line and may be hot in relation to ground. **END**

CORRECTIONS

In the transceiver chart on page 53 of the September issue, the location of Karr Engineering Corp. was inadvertently listed as Englewood, Calif. The correct location is Palo Alto, Calif.

The electrocardiogram (EKG recording) in the article "Electronics in the Psychology Laboratory" (page 82, July issue) is upside down.

We thank Dr. Evan H. Ashby, Jr., of Remington, Va., for calling this to our attention.



A SOUND APPROACH to Commercial and Industrial Application... THE NEW COMMANDER SERIES BY HARMAN-KARDON

Flexible. Versatile. Dependable. That's the new Harman-Kardon Commander Series of amplifiers and systems for commercial and industrial sound use. They're ruggedly constructed for continuous duty. They include deluxe features at popular prices. They're designed and manufactured by Harman-Kardon—noted for the quality, reliability and superb performance standards of its high fidelity products, including the highly acclaimed Citation Kits. *In short:* the new Commander Series is built BY soundmen—FOR soundmen. Here are some of the exclusive features that make these the best instruments you can buy for the price. **MASTER VOLUME CONTROL:** Enables total amplifier output to be varied without disturbing other control settings. **MIXER CONTROL:** Convenient ONE KNOB control permits fading and blending of signal from two channels, in any desired amount. (*DA-35, DA-100*) **MULTIPLE INPUTS:** All at the rear—allow for an unusually high degree of installation and operational flexibility. **ANTI-FEEDBACK FILTER:** Equalizes frequencies most sensitive to generation of feedback "howl" without reducing articulation—thus achieving maximum power output under difficult acoustical conditions. (*DA-12*) **25 AND 70 VOLT OUTPUTS:** Provides two constant voltage systems—70 and the newer 25 volt balanced system—for optimum flexibility and economy in speaker installation. **LOCKING COVERS:** Unique feature on units in this price class—designed to prevent tampering or accidental change of precise control settings. **PLUS:** Magnetic Cartridge Input; Tape Recorder Output; Independent Power Switches; and many other deluxe features.

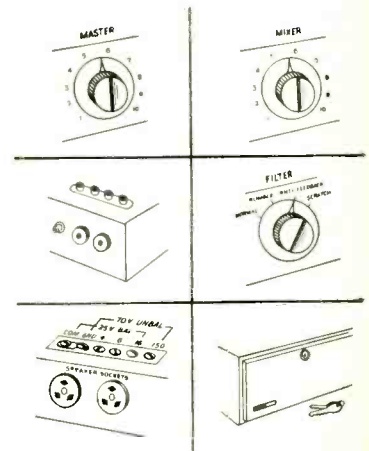

The Commander Series shown above includes the following: Model DA-12, 12 Watt PA Amplifier—\$75.00 List; Model DA-35, 35 Watt PA Amplifier—\$119.95 List; Model DA-100, 100 Watt PA Amplifier—\$187.50 List; Model DPR-7, Combination Mixer/Preamplifier—\$75.00 List; Model PT-1, Phonograph Top—\$37.50 List; Model LC-1 and LC-2, Locking Panel Covers: Model LC-1—\$8.50 List, Model LC-2—\$9.00 List.

For informative catalog on complete Commander Series write Desk 10F.

Commercial Sound Division



Harman-Kardon, Inc.
Plainview, N. Y.

TV Service Clinic

conducted by

JACK DARR, SERVICE EDITOR

This is your column in the magazine: the service is absolutely free; there is no charge for answering your questions, and your name and address will be kept confidential if you so wish. The main purpose is to help everyone working in electronics with their unusual problems. Send in your questions; each one gets an immediate personal answer. Later, the more interesting cases are published in the Clinic columns.

Due to the many peculiarities found in commercial TV circuits, you might find a different answer to a question than the one we give, even though the "conductor" of this column is himself a full-time professional TV technician. We would be interested to hear of such cases, as we feel that the more widespread knowledge of such peculiarities, the better off we'll all be! So, if you have an unusual service job, or one which is giving you trouble from an obscure cause, send in a question on it; we'll answer it promptly and to the best of our ability.

THERE ARE TIMES WHEN THE MAIL IN THIS department runs pretty heavy on width troubles. In our day-to-day servicing activities, we've found that the percentage of width troubles to other defects runs fairly high at times. So we thought that we'd run over some of the more common (and a few uncommon) causes of this defect. Let's take them one at a time.

Tubes

As with all other TV troubles, weak tubes cause most of the complaints. They get the most wear. So the first step in troubleshooting width complaints is to replace all tubes in the horizontal sweep circuits—oscillator, output, damper and high-voltage rectifier. Unless this is done, there's always the chance that an unsuspected bad tube is still in the set. (Might throw in the low-voltage rectifier while you're at it, just for luck.)

Frankly, the horizontal sweep and high-voltage sections of a TV set are

pretty rough to test, unless you have one of the specialized in-circuit testers, such as the unit designed by Wayne Lemons and described in the February 1961 issue of RADIO-ELECTRONICS. These make the task a lot easier, for you're able to read actual operating values of voltage and current. There are several professional test instruments built for the purpose: the Doss 250, B&K 1070 and Sencore SS105. I can't recommend them too highly.

You've changed the tubes, and the picture is still narrow. We're going to have to pull the chassis and take some measurements. While there are wide variations in voltages in other stages of a TV set, you'll find a lot of uniformity in horizontal output stages.

For example, the voltage on a 6BQ6 plate will be about the same in all sets (but don't measure it), and the screen voltage should be about 150. This is usually obtained through a dropping resistor to B-plus or boost. Check this resistor carefully. A previous tube may have shorted and burned the resistor, causing it to go off value. A change in screen voltage alters the operating constants of the tube severely. Some sets vary the screen voltage to adjust width. Check this variable resistor. It may be burned or dirty (Fig. 1).

Low screen voltage causes insufficient width. High screen voltage causes excessive plate current in the output stage and shortens the life of the output tube. As a quick average, almost all common horizontal output tubes in use today have screen voltages ranging from 100 to 157 (average, 150) except the 'BG6 series, which use from 250 to 300 volts on their screens.

The screen bypass capacitor can be the source of some obscure troubles. If it is open, the usual result is a loss of width or sometimes parasitic oscillations of various kinds. If it is leaky,

we get low screen voltage and loss of width. Average value of this capacitor is about 0.1 to 0.15 μ f, and it must never be rated at less than 600 volts.

While we're working around the screen circuit, let's take in a very obscure complaint that has caused lots of headaches among technicians. This is screen emission, or grid emission, in the horizontal output tube. When the tube develops this defect, the screen actually emits electrons. This, of course, plays hob with the normal sequence of events in the electron stream within the tube. The usual symptom is a gradual loss of width and brightness after the set has been on for a while. Sometimes it takes as long as 2 hours for the trouble to show up. We get pull-in from the sides, and in some cases, even a slight horizontal instability.

There is a good test for this (Fig. 2). Connect a vtvm to the grid of the output tube, set to a medium range (0-30 volts negative) and open the cathode of the tube while the set is running and thoroughly warmed up. If there is any reading at all after the initial reading has "soaked off" (the normal grid-bias reading from the grid current developed by the horizontal drive), either the tube has screen or grid emission or the coupling capacitor is leaky.

A sure test for coupling capacitors is easy. Just pull the tube out of the socket. If there is any reading, the capacitor must be leaking. Now you'll have a reading to begin with, as we said, but this should drop to zero in 5 seconds or so. If it doesn't, substitute a new tube, heat the set for an hour or so and repeat the test.

This width situation covers more ground than we expected. We'll stop here for now and continue next issue.

Tuner replacement

In the December 1959 issue of RADIO-ELECTRONICS you had an article on replacing a tuner. I have a similar problem and would like your help on it. I want to change a variable-capacitance tuner in a Philco 53-T-1883, replacing it with a turret tuner from a 51-T-1602 Philco. Is this possible without too much revamping? I am sure the original tuner is beyond repair.—C. R. D., Ashtabala, Ohio.

I think this will be possible without

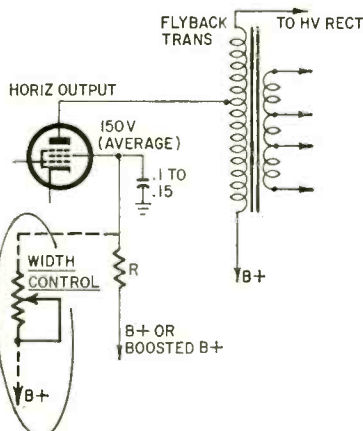

Fig. 1—Screen supply circuit in average TV set. Dashed lines show alternate circuit where a variable dropping resistor is used as the width control.

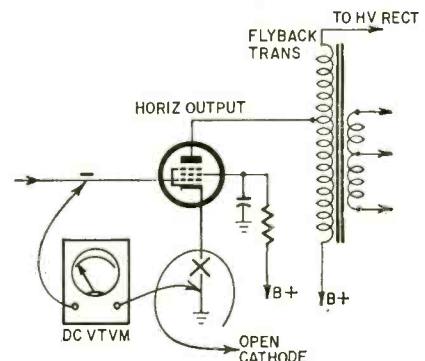

Fig. 2—To check for grid emission, open the cathode of the tube while the set is operating and measure voltage between grid and ground.

too much trouble. The 53-T-1883 uses the 44 rf chassis and the tuner mounts on the side. This should leave you plenty of room. Physical dimensions and mounting will be your worst problems.

Both tuners have the first video if transformer in the tuner chassis, so this should simplify your connections. This transformer is tuned to 23.6 mc on both tuners unless the alignment has been changed or tampered with.

There were several versions of the turret tuner in that series of Philco chassis. Some were built by Philco, others by Standard Coil. Some had only 8 channels, some 12. Electrically they are all close enough so that it will make no difference which one you have. After making all connections as per the schematic—B-plus, filament, agc, etc.—it would be a good idea to run a video if alignment curve on the whole set. If you don't have the necessary FM sweep-alignment equipment, wait until you can get a good clear test pattern, with sound, and very lightly touch up the alignment of the 23.6-mc adjustment on the tuner for best definition of the vertical wedge and best sound at the same time.

Retrace eliminator

Can you tell me how to hook up a vertical retrace eliminator in a Philco 52-T2140?—J. L., Wayne, W. Va.

This is fairly simple. To eliminate vertical retrace lines, we simply apply a pulse of voltage to either the cathode or grid of the crt to cut off the electron beam during vertical retrace time. To apply blanking to the cathode, we need positive-going pulses. To the grid negative-going pulses are used.

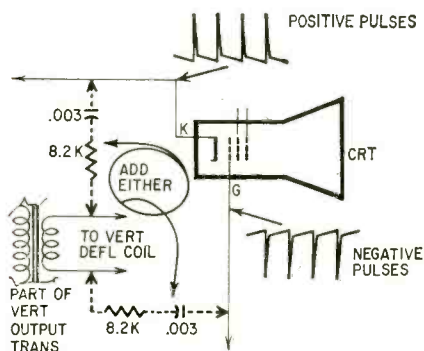

Fig. 3—A simple vertical retrace eliminator circuit.

Fig. 3 shows some typical circuits you can use. Incidentally, you can do a lot of cut-and-try here without hurting anything. You don't even have to check polarity on your pulses. Just hook up the R-C network to wherever you want it. If the retrace lines get worse, you've got the wrong polarity. You can pick up pulses almost anywhere in the vertical circuit except at the plate of the output tube.

Poor height

A Crosley 11-461WU has insufficient height. I checked voltages, and found only 25 volts on the plate of the vertical oscillator. All the resistances be-



MODEL 704 STEREO FM/AM RADIO with Automatic Frequency Control \$49.95* Also available as Model 604 FM Radio \$39.95*

MODEL SC-4 GRANCO FM STEREO COMPANION \$29.95* for use with Models 704 and 604

STEREO FM RADIO

Only Granco brings the magnificent new sound of stereophonic FM radio into your home—today! Fine Granco FM/AM radio with AFC... and matching speaker-amplifier Stereo Companion for total listening pleasure never before possible. Hear Granco stereophonic FM radio now—at fine dealers everywhere.

Write for free booklet "THE WONDERFUL WORLD OF STEREO FM"



GRANCO

America's Leading Specialist in Stereophonic FM

DIVISION • DUMONT EMERSON CORPORATION, Dept. RE • 680 FIFTH AVENUE, N.Y. 19

*Suggested list. Prices slightly higher in some areas.

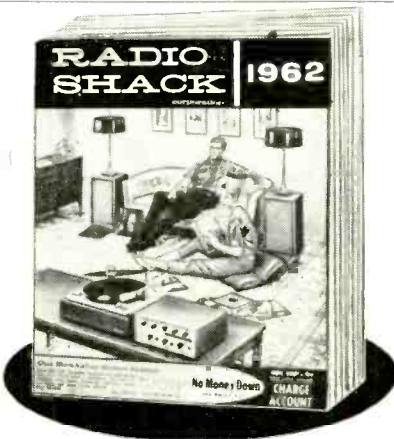

TYPICAL VALUES FROM OUR NEW 336-PAGE BOOK



REALISTIC 2-SPEED TAPE RECORDER—compare at \$99.95! The TR-170. 2 speeds: 3 3/4 and 7 1/2 ips; external speaker jack. 7" reel capacity. . . . \$54.95

"ELECTROSTAT-2" 2-way SPEAKER SYSTEM. Looks, sounds like a \$100 set! Hi-Fi stereo speaker for balanced tone. 4-element tweeter, 8" woofer. . . . \$54.95



REALISTIC STEREO AMPLIFIER KIT. First under \$20! Exclusive at Radio Shack. Easy to assemble—pre-mounted except resistors, capacitors. . . . \$10.95

RADIO SHACK Corp.

Boston 17, Massachusetts

Yours **FREE** for the asking
Radio Shack's 1962 Catalog
Biggest in our 38-year history!

Nationwide standard of excellence in
Electronics, Music, Communications

Radio Shack Corp. of Boston, Mass., is fortunately located in the educational, cultural, and scientific "hub" of America. Through the years we have become the "hub" for a rapidly expanding group which enjoys the fascination of electronics. Last year we filled over one million orders from our famous electronics catalogs. This year we have published the most complete catalog in our history to serve electronics devotees even better.

Our 1962 giant catalog brims with over 100,000 values like those shown at left. Stereo, Hi-Fi, Ham Radio, Test Equipment, Records, Tapes, Parts and Accessories, 30 pages of Kits—the biggest line of electronic equipment and parts in the world! Guaranteed to satisfy or money back. Easy to own. No Money Down credit terms.

When you send coupon, you get our giant catalog plus all other books for 1 year.

MAIL THIS COUPON TODAY

Radio Shack Corp. Dept. 61K10
730 Commonwealth Ave., Boston 17, Mass.

Please send me Radio Shack's famous electronics catalogs for 1 full year—all FREE and POSTPAID.

Name _____

Address _____

City & Zone _____

State _____

tween the plate and B-plus were normal. If I remove the tube from the socket, the voltage comes up. If I put a 100,000-ohm resistor between cathode and ground the plate voltage comes up to normal, but the oscillator doesn't work. The vertical amplifier in the same envelope is OK.—P. H., McKees Rocks, Pa.

Your loss of plate voltage is obviously caused by the tube drawing too much current. This accounts for the rise in voltage when the tube is removed. When you inserted the high resistance in the cathode circuit, you overrode the defective bias circuit, blocking the tube, and the plate current stopped flowing.

Check the grid voltage on the defective section. You will undoubtedly find it positive. Check two components: the coupling capacitor between the vertical oscillator grid and the integrator, and the vertical blocking transformer (for leakage between the windings). If the positive plate voltage is leaking between windings, it would drive the grid heavily positive. The tube would draw a very high plate current, giving you the symptoms you describe. To check it, disconnect the grid end of the transformer at the grid connection, and re-measure your grid voltage. It should drop to zero. If the transformer is leaking, the open end of the grid winding will show a high positive voltage.

No raster on strong stations

I am working on a Westinghouse V-2192. The complaint is no raster on strong stations and very dark raster on weaker channels. If I substitute an agc bias, I can get a picture. The voltages around the agc keyer tube are as shown in the sketch (Fig. 4). If I touch the grid of the first video if, the picture comes back.—J. H., Hudson, N. Y.

This is an agc blackout caused by overloading on the strong signal. This sounds awfully simple, but I've been caught on it myself at times. Check the shields on the video if stages. If one of them is missing, you may be getting regeneration or oscillation strong enough to cause this.

The voltages you show on the keyer tube are almost all wrong (Fig. 4). Notice that the plate and screen voltages are high. This indicates a lack of the proper grid bias. You show 80 volts here and it ought to be 60. The cathode reads 120 volts, leaving you with an actual grid-cathode voltage of -40. You're just not drawing the

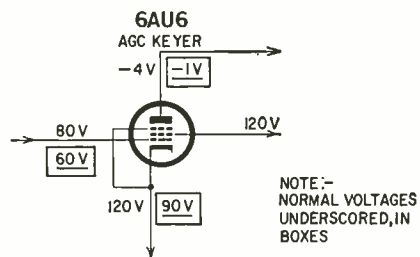

Fig. 4—Measured and correct voltages on 6AU6 agc keyer. Correct voltages are underscored, in boxes.

right amount of plate current in this stage.

The most likely cause of this trouble is either incorrect resistors in the supply circuit, or insufficient video signal applied to the control grid. Check this with a calibrated scope. There could be an open coupling capacitor or leakage in the supply circuit between grid and the signal takeoff point at the video amplifier. Also, don't overlook the possibility of open peaking chokes, etc., in the video amplifier stage or even a weak tube.

Chronic tube burnout

I am having trouble keeping tubes in the high-voltage section of a Syl- vania chassis 1-512-1-2. It is a 27-inch set and uses two 6BQ6's and two 1B3's. It has a voltage-doubler circuit and the tubes seem to get too much current, making them go bad every 3 or 4 months.—Q. E. C., Port Arthur, Tex.

Your difficulty is caused by just slightly low drive voltage on the 6BQ6's—this has occurred before in several sets. The cure is to raise the drive to normal. Check the horizontal oscillator tube and circuit and be sure that there is at least 18–20 volts dc, as measured on a vtvm, or about 150 volts peak-to-peak, as read on a scope. The short life of the 1B3's could also be traced back to the same fault. Excessive currents through the horizontal output tubes could raise the pulse voltage, overloading their filaments. Check the plate current of each of the 'BQ6's, after repairs have been completed. It should not be over 100 ma per tube.

One other possibility would be to replace the 6BQ6's with 6DQ6's. However, before doing anything drastic to the set, make a very careful check of the ac line voltage at the customer's home! It could be slightly high and would cause all of the symptoms described!

Hot linearity coil

I'm having trouble with a Hoffman 21 M115, chassis 196. The 6BQ6 screen grid resistor gets very hot. The linearity coil is dripping wax. The waveform at the 6BQ6 grid is 100 volts p-p, but it doesn't look right to me (Fig. 5). Voltages seem close to normal and the 6BQ6 is drawing 95 ma.—R. H., Collins, Miss.

There are two possibilities here. One, of course, is improper adjustment of the horizontal linearity coil. However, since you read 6BQ6 plate current as only 95 ma, you probably have the other one.

This is parasitic oscillation in the horizontal output stage, mostly in the screen circuit. It is the most likely cause of the ringing seen in the horizontal oscillator grid waveform. Put a resistor of about 100–150 ohms in series with the screen of the 6BQ6 and adjust the horizontal linearity coil for minimum plate current. Check the screen bypass capacitor (Fig. 6). Also, take a low-capacitance probe and check all of the B-plus supply circuits for traces of horizontal hash. If you find



Fig. 5—This waveform was on the grid of the horizontal output tube of a Hoffman 196. Note the excessive ringing.

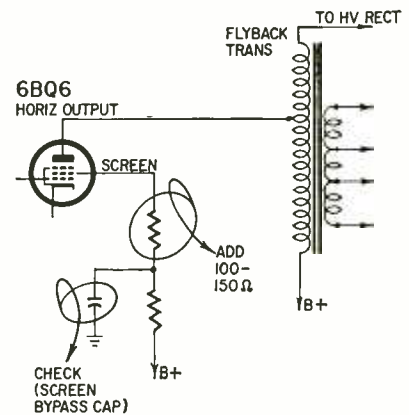

Fig. 6—Add a 100- to 150-ohm resistor in series with the screen grid to damp out parasitic oscillations. Also check screen bypass capacitor for leakage.

any, it is caused by insufficient filtering or bypassing. Bridge the electrolytics in and around that circuit and check up on your lead dress around the 6BQ6.

19- to 21-inch conversion

I have the problem of converting a Zenith 24H21 from a 19AP4-A to a 21-inch picture tube. Please tell me if this change can be made, and how.—S. T., Johnstown, Pa.

This will be a fairly simple conversion, with only mechanical changes required. The best choice of picture tube would be a 21EP4. If the present tube is being fully swept, you will have ample width. The 21EP4 is also economically priced. Don't forget to ground the outer coating when you install this tube.

Poor pix detail

The picture detail is poor in a Raytheon 17AY21. I've changed all the tubes in the video section without helping it. The scanning lines are sharp.—J. S., Rockford, S.D.

Sounds like your video if is badly out of alignment. This is the most common cause of loss of fine detail if the picture is focused properly.

Run a complete realignment of these stages. You might also check the series and shunt peaking chokes in the video and detector output circuits. If one of these is defective, it could cause the same trouble.

END

RCA training at home can be the smartest investment you ever made

Look what you get in the Course in Radio and Electronic Fundamentals

40 Fascinating THEORY LESSONS



Containing all the basic principles of radio and electronics in easy-to-understand form.

40 EXPERIMENT LESSONS

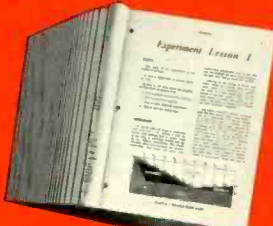

Each containing absorbing, practical experiments bound together in 20 books.

40 SERVICE PRACTICES



Full of practical, time-saving and money-saving servicing tips, bound into 20 books.

PLUS ALL THIS AT NO EXTRA COST...

15 KITS to build a Multimeter, AM Receiver and Signal Generator. Kits contain new parts for experiments, integrated so as to demonstrate what you learn in the lessons and to help you develop technical skills. Each kit is fun to put together!



MULTIMETER

A sensitive precision measuring instrument you build and use on the job. Big 4½" meter with 50 microamp meter movement. 20,000 ohms-per-volt sensitivity d-c, 6,667 a-c.



SIGNAL GENERATOR

A "must" for aligning and trouble-shooting receivers. Build it for your own use. 170 KC to 50 MC fundamental frequencies for all radio and TV work.



AM RECEIVER

Have the satisfaction of building your own radio receiver with this high-quality 6-tube superheterodyne set. Big 5" speaker, fine tone!

Practical work with the very first lesson! Pay-only-as-you-learn! No long-term contracts to sign! No monthly installment payments. Pay only for one study group at a time if and when you order it!

Stake out your future in electronics now! SEND FOR OUR FREE HOME STUDY CATALOG TODAY!

Just fill out this card and drop it in the mail—no postage needed. ▶

RCA INSTITUTES, INC.
A Service of Radio Corporation of America
350 West Fourth Street
New York 14, N. Y.



RCA INSTITUTES INC. Home Study School, Dept. RE-01

A Service of Radio Corporation of America
350 West Fourth Street, New York 14, N. Y.

Without obligation, rush me the FREE 64-page illustrated book describing your electronic training program (check one). No salesman will call.

Home Study Los Angeles Resident School New York Resident School

Name (Please Print)

Address

City Zone State

Veterans: Enter discharge date.....

CANADIANS—Take advantage of these same RCA courses at no additional cost. No postage, no customs, no delay. Enclose this card in envelope and mail to: RCA Victor Company, Ltd., 5581 Royalmount Ave., Montreal 9, Quebec.



The Most Trusted Name in Electronics

HOME STUDY SCHOOL

RESIDENT SCHOOLS



RCA TRAINING CAN BE THE SMARTEST INVESTMENT YOU EVER MAKE

With RCA Institutes Home Study training you set your own pace in keeping with your own ability, finances and time. You get prime quality equipment as a regular part of the course . . . and you never have to take apart one piece to build another. Perhaps most important, RCA's liberal Pay-As-You-Learn Plan is the most economical home study method *because you pay only for lessons as you order them . . . one study group at a time!* If you drop out at *any* time, for *any* reason, you do not owe RCA one penny! No other obligations! No installment payments required! Licensed by New York State Education Department.

Choose YOUR FUTURE from this list of courses:

- Radio and Electronic Fundamentals (see reverse side)
- Television Servicing
- Color Television
- Electronics for Automation
- Transistors

START YOUR CAREER IN ELECTRONICS NOW AT RCA INSTITUTES in Los Angeles-New York City

CHOOSE FROM THIS LIST . . .

	Course	Qualifications	Length of Course
A	Advanced Electronic Technology (T-3)	High School grad, with Algebra, Physics or Science	Day 2¼ yrs. Eve. 6¾ yrs. (N.Y.) 4½ yrs. (L.A.)
B	Television and General Electronics (V-7)	2 yrs. High School, with Algebra, Physics or Science	Day 1½ yrs. Eve. 4½ yrs. (N.Y.) 3 yrs. (L.A.)
C	Radio and Television Servicing (V-3)	2 yrs. High School, with Algebra, Physics or Science	Day 9 mos. Eve. 2¼ yrs. (N.Y.) 1½ yrs. (L.A.)
D	Transistors	Radio background	Eve. 3 mos.
E	Electronic Drafting (V-11 V-12)	2 yrs. High School, with Algebra, Physics or Science	Eve. Basic: 1 yr. Advanced: 2 yrs.
F	Color Television	Television background	Eve. 3 mos.
G	Radio Telegraph Operating (V-5)	2 yrs. High School, with Algebra, Physics or Science	Day 9 mos. Eve. 2¼ yrs. (N.Y.) 1½ yrs. (L.A.)
H	Computer Programming (C-1)	College Graduate or Industry sponsored	Eve. 24 weeks Sat 30 weeks
I	Technical Writing (V-10)	High School Graduate	Day 9 mos. (L.A.) Eve. 2¼ yrs. (L.A.) 3 mos. (N.Y.)
J	Automation Electronics (V-14)	Background in Radio Receivers and Transistors	Eve. 9 mos. (N.Y.) Sat. 44 weeks (N.Y.)
K	Digital Computers	Electronics background	Eve. 3 mos. (L.A.)
L	Preparatory Math & Physics (P-O)	1 yr. High School	Day 3 mos. or 6 mos.
M	Preparatory Mathematics (P-OA)	1 yr. High School	Eve. 3 mos.

FIRST CLASS
PERMIT NO.
10662
NEW YORK, N. Y.

BUSINESS REPLY MAIL

No Postage Stamp Necessary if mailed in U. S.

Postage will be paid by —

RCA INSTITUTES, INC., Dept., RE-01
350 West Fourth Street
New York 14, N. Y.



RCA Institutes is one of the largest technical institutes in the United States devoted exclusively to electronics. Co-educational Day and Evening classes. Free Placement Service. Applications now being accepted.



SEND FOR THIS FREE ILLUSTRATED BOOK TODAY. Fill in the other side of the postage-free card and check Resident School.

RCA INSTITUTES, INC. A Service of Radio Corporation of America
350 W. 4th St., N. Y. 14, N. Y. • 610 S. Main St., Los Angeles 14, Calif.



The Most Trusted Name in Electronics

Accurate alignment of Hi-Fi FM TUNERS

By JOSEPH MARSHALL

This time we use an FM generator and a distortion analyzer to do the job

LAST MONTH WE SAW HOW TO ALIGN FM tuners without using either a scope or a sweep generator. This month we will discuss another FM alignment procedure that uses instruments.

There is a method of alignment, not nearly as well known as the visual and vtm methods, which is both simpler and more effective. It calls for an FM generator covering the FM band and a distortion meter (or a 400-cycle null network and any ac meter capable of reading 400-cycle ac). It works equally well with any kind of detector, requires a minimum setup time, and the setup remains the same throughout the alignment process. Since its criterion of measurement is the lowest distortion, it also results in the highest fidelity.

Quite a few shops specializing in

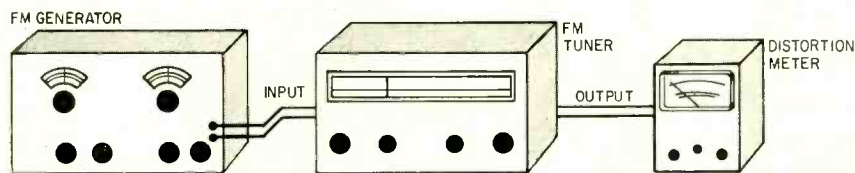

Fig. 1—A typical setup using sweep generator and distortion meter for FM tuner alignment.

hi-fi servicing own distortion meters, either IM or harmonic. Few shops own a good FM signal generator. The Measurements Corp. and Boonton Radio generators, which are ideal, unfortunately leave very little change out of a thousand-dollar bill. An occasional Measurements 78FM can be found on the surplus market for as little as \$100 and, if in good condition, is a real bargain. The procedure is very simple.

▶ Connect the harmonic-distortion meter to the tuner output and adjust the tuner volume control and the sensitivity of the distortion meter so that tuner noise produces a 0-db reading on the meter scale. Connect the FM generator to the tuner input and feed an unmodulated signal at either 90 or 106 mc into the tuner and adjust the generator output to produce a 20-db reduction in the reading on the distortion meter. Note, for reference, the input in microvolts. Retune the gen-

erator and tuner to 106 (or 90) mc and repeat. Compare the input with that at 90 mc. Note which position yields the highest sensitivity, and tune the generator and tuner carefully to this weak signal at either 90 or 106 mc, whichever is the more sensitive point.

▶ Modulate the generator with internal 400-cycle tone and adjust for 75-kc deviation. Adjust tuner volume control and meter sensitivity so audio output gives about a half-scale reading.

▶ Now adjust the primary slug of the detector transformer and the slugs of all if and limiter transformers for maximum output as read on the meter—this will coincide with maximum swing on tuner's tuning meter or indicator.

▶ Increase the generator output until

tuner tuning indicator is saturated. Null the distortion meter for the 400-cycle tone and take a distortion reading. Now adjust the detector transformer secondary for lowest distortion. You can safely sweep the entire range of the slug through the two or three peaks. One of them will have considerably lower distortion.

▶ Reduce generator output to the low input used in the first step and carefully adjust the tuner for minimum distortion on the distortion meter. Raise generator output again till the tuning indicator is saturated and re-adjust the detector secondary again for minimum distortion.

▶ Reduce generator output to the previous low value, reset the distortion meter to read the total audio output of tuner. Now adjust the tracking and peak the front-end trimmers.

You can check sensitivity at 90 and 106 mc by repeating the first step. You should have an improvement. If you

find that the difference in sensitivity at 90 and 106 mc is greater than 6 db, try to equalize the sensitivity by adjusting capacitive trimmers at the high end and coil inductances at the low end. Or, in a fringe area, adjust the sensitivity to favor desired weak stations.

You can also use an IM analyzer. Feed the tuner output to the analyzer input. Feed the composite signal from analyzer into the external modulation jack of the FM generator. You can meter this input to the voltage suggested in the generator manual. Or, more simply, you can set the deviation at 75 kc and then increase IM analyzer output until you hear or read appreciable distortion.

This method is so simple, foolproof and effective that it is to be hoped that someone will soon provide a reasonably priced FM generator—or better yet—a generator with a built-in nulling network and meter.

The outlined procedures will apply equally well to the mass-produced FM tuners and receivers that are found in hi-fi packages, table model receivers, etc. However, you are likely to run into gated-beam detectors. No component tuner I can recall uses a gated-beam detector though several use gated-beam limiters. The gated-beam detector combines the functions of limiting and detection and can be aligned as follows:

▶ Feed the tuner with a signal from an AM generator anywhere in the FM band or, if you want to go to the trouble, at the intermediate frequency.

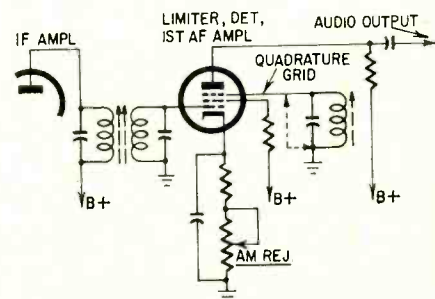

Fig. 2—The gated-beam detector. Alignment details are in the text.

WHAT'S YOUR EQ?

The EQ's are now the most popular department in the magazine. Our mail is reaching an all-time high! We just can't answer individual letters, but will continue to print the more interesting solutions (the ones the original authors never thought of!).

Here are a few more we hope our readers will find challenging. And if you can develop an original EQ that will stump our readers, send it to us. We pay \$10 and up for each one accepted. Write to EQ editor, RADIO-ELECTRONICS 154 West 14th St., New York 11, N.Y. Answers to September puzzles are on the opposite page.

An Electronic Ground?

This Zenith chassis 15Z31 came into the shop with what appeared to be a folded-over ground symbol. The shop technician took one look and pointed out the trouble, not by deduction, but because he had had the same trouble before. Could you have done as well? — *Wayne Lemons*

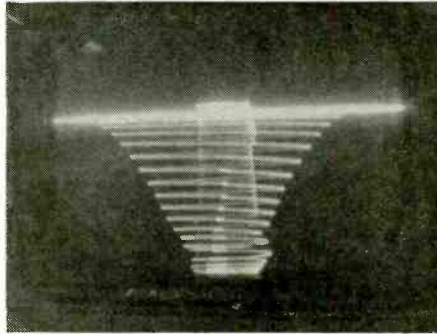

Simple Impedance Problem

At 1,000 cycles, what is the impedance of this circuit (to the nearest ohm) between points A and B, and what is its phase angle (to the nearest degree)? — *Charles Erwin Cohn*

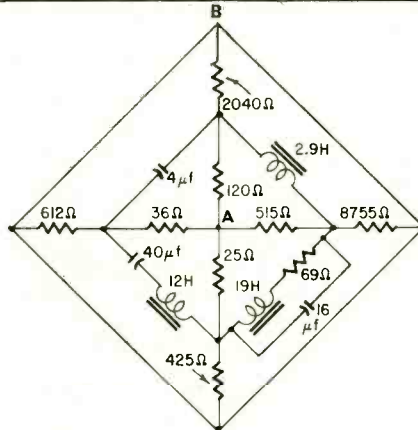

Electronic Photogram Puzzle

This novel, puzzle can provide many minutes of fun for the electronic technician and hobbyist. The object is to see how many of the radio-electronic components you can identify correctly in the photo-diagram. Watch out—a couple foreign (nonelectronic) parts are thrown in just to mislead you!

List your answers in the blank spaces and then check your answers next month.—*John A. Comstock*

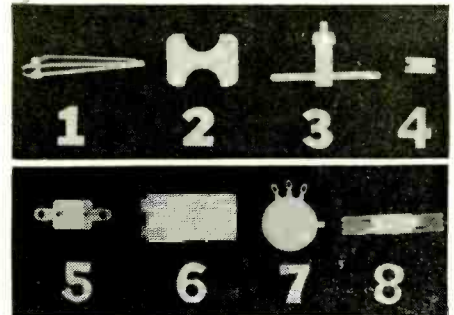

1. _____
2. _____
3. _____
4. _____
5. _____
6. _____
7. _____
8. _____

Accurate Alignment of Hi-Fi FM Tuners

(continued)

Carefully peak the signal and modulate at around 30%. Connect an audio output meter or the ac section of your vtvm to audio output of tuner.

► Ground the quadrature grid (see diagram). Turn up the volume control on the tuner and adjust generator output to produce a moderate reading on the meter. Check to see that the limiter is not limiting. If limiting shows up, reduce output.

► Tune the primary and secondary slugs of the detector transformer for maximum swing.

► Increase generator output until the

limiter is saturated (meter reading does not increase with increased input). Adjust the variable cathode resistor for minimum reading on the meter.

► Disconnect the generator and tune in an FM station of moderate strength. Unground the quadrature grid and tune quadrature coil for maximum audio output.

Peaking double-humped if

If you run into an older tuner with the double-humped response curve, you can still peak it easily by the method below. The double-humped response

may show up when you check the shape and symmetry of the if as detailed earlier. Or it may show up when you try to peak the if. Get a 1,000-ohm resistor and attach two small alligator clips to its leads. Keep the leads as short as possible but with enough flexibility to be conveniently used. Clip this loading resistor across the secondary of the if transformer when you are peaking the primary, and across the primary when peaking the secondary. You will find that you get a broad single peak and the idea is to adjust the trimmer or slug for the middle of this broad peak. END

SPEEDY TRANSISTOR TESTER

With this switchbox and an ohmmeter you can spot defective transistors and separate the p-n-p's from the n-p-n's

Front panel of the switchbox sports a selector switch, transistor socket and jacks for your ohmmeter probes.

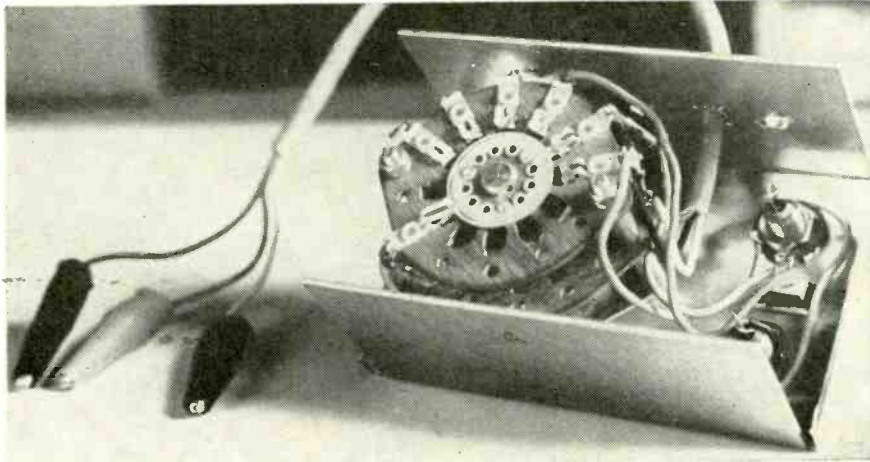
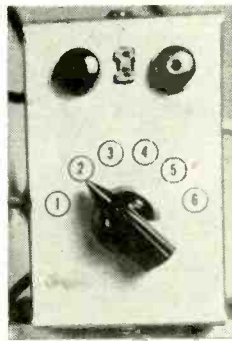

Inside the switchbox.

By WAYNE LEMONS

NEARLY ALL MANUFACTURERS RECOMMEND an ohmmeter test for transistors, especially for power types. It consists of placing test leads between the base and emitter, base and collector, collector and emitter, and then reversing the leads to check diode action. If you get a high-resistance reading in one direction and a low-resistance reading in the other between the base and emitter and the base and collector, and a high-resistance reading in both directions from collector to emitter, the transistor is considered good.

This does not check gain but, since transistor gain seldom changes, a gain test is virtually unnecessary for service work. Unfortunately, holding two test leads while fumbling with three transistor leads and trying to remember which is which and why, is no job for a man with only two hands and a one-track mind.

The little box shown here, used with your ohmmeter, decomplicates and defrustrates the process marvelously. A transistor socket is used for plug-in transistors, and the three clips for other types. It makes no difference whether the transistor tested is an n-p-n or p-n-p. Simply plug your ohmmeter into the jacks provided and rotate the tester switch from 1 to 6. You should get alternate low- and high-resistance (or high and low) readings in positions 1 to 4 and high-resistance readings on both 5 and 6. In other words, there will be two low-resistance and four high-resistance readings if the transistor is good. You can identify transistors as n-p-n or p-n-p by noting if the low-resistance reading occurs on position 1

or 2. This unit and the meter used with it gives a low-resistance reading on position 1 for n-p-n types and position 2 for p-n-p's. Other wiring arrangements or a different meter could reverse this. It's easy to find out—check a good transistor with known characteristics.

The R × 10 scale is used for most transistors but you may want to use the R × 1 scale for power types. The R × 10 scale is probably about right for most of the resistances encountered. Transistors will vary but you usually get 100 ohms or less in the forward direction to over 50,000 ohms in the reverse direction for small-signal types. Power types usually have less resistance in both forward and reverse directions. Different meter scales will alter the readings—for instance, you may get 20 ohms forward resistance on the R × 10 scale and only 10 ohms on the R × 1 scale. Ratio of front to back is more important than actual values. Ratios of 100 to 1 are desirable though sometimes not necessary. END

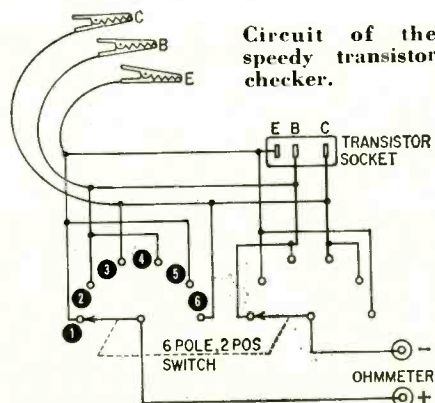

What's Your EQ September Solutions

Over the River

The solution shown is for 10 wires but it applies to any even number of wires greater than 4.—Start by tying wires into pairs except for four wires. Tie three of these together and leave one free. Label the pairs A-A, B-B, C-C; then label the set of three D-D-D. The remaining wire is then labeled 1. Move over to the other side. Find the free wire and label it 1. Find the pairs and label them 2-3, 4-5, 6-7; then label the set of three 8-9-10. Tie 1-2-10 together. Then tie the following wires into pairs 3-4, 5-6, 7-8; leave 9 free. Move back to the first side. Open all the wires that are tied together. Find the free wire and label it 9. Find the wires that are connected to No. 1. Label the D-wire 10 and the C-wire 2, then the other C-wire must be 3. Label it. Find the wire connected to No. 3 and label it 4. Since it is an A-wire, label the other A-wire 5. Find the wire connected to No. 5 and label it 6. Since it is a B-wire, label the other B-wire 7. Find the wire connected to No. 7 and label it 8. This completes wire identification.

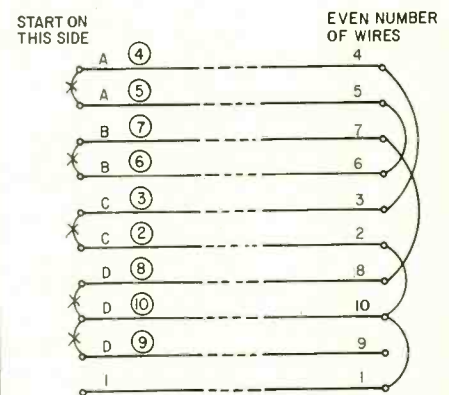

Automated Voting

Now everyone gets to vote. Three employees can outvote the boss—when they want to listen to the radio, that is. Wonder how this system works when Dick wants a raise?

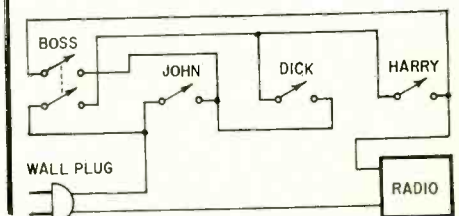



FOR ALL
BLACK & WHITE
PICTURE TUBES

2 volt / 4 volt / 6 volt / 8 volt
series or parallel
electrostatic or electromagnetic

Perma-Power

INTRODUCES THE

2-Brite

IF THE BASE
IS RIGHT
THE BOOST
IS RIGHT

7 POWER RATINGS

VOLTS	AMPS
2.34	.600
2.68	.450
4.70	.300
6.30	.300
6.30	.450
6.30	.600
8.40	.450

MODEL C202
for duodecal
base sets



MODEL C212
for 110°
button base
sets
(RCA type)



MODEL C222
for 110° shell
base sets
(Sylvania-
Dumont type)



A Britener with a slide switch for series or parallel wiring is nothing new—but those previously available could only be used on picture tubes with heater ratings of 6.3 volts, .600 amps. For all other heater ratings, a single-purpose auto-former has been necessary.

Now Perma-Power has developed a truly universal series/parallel Britener—one that can be used on ANY set without endangering the delicate filaments through too much boost. Only Perma-Power—the leader—offers you this convenience.

You can brighten any TV picture with Perma-Power's 2-Brite. If the base is right, the boost is right! You don't even have to take the time to consult a Britener Selector Guide. Just choose the right base style—and install with confidence.

List Price \$3.75

Perma-Power COMPANY

3100 N. ELSTON AVE. • CHICAGO 18, ILL.

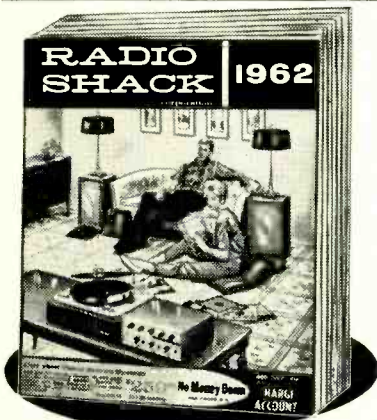

RADIO SHACK Corp.
Boston, Massachusetts

Send for your **FREE** personal copy of
RADIO SHACK'S 336-PAGE 1962 CATALOG
Nationwide standard of excellence in
Electronics, Music, Communications

Also receive all other issues for 1 year!

Our bigger, better catalogs offer the widest line of electronic parts and equipment in the world! Latest in Stereo, Hi-Fi, Ham Radio, Test Equipment, Pre-Recorded Tapes, Tape Recorders, Records, Component Parts—plus 30 pages of new fun-to-build kits. Every item is easy to own on new No Money Down Credit Terms. Every item is guaranteed to satisfy or your money back.

MAIL THIS COUPON TODAY

RADIO SHACK Corp. Dept. 61K10C
730 Commonwealth Ave., Boston 17, Massachusetts
Please send me Radio Shack's new 1962 Electronics Catalog and every new issue for the next 12 months—all FREE and POSTPAID.

Name _____
Address _____
City & Zone _____ State _____

Black Box Mixup

Almost too simple. The black box merely contains a nice, neat short circuit. The cells, of course, both have equal internal resistances through which the current, I , flows. When two cells are in series, the resistance as well as the voltage doubles, leaving current I essentially constant.

Series-Parallel Capacitors

This is a typical sample of the present-day right-angled drawing. (It can make any problem unnecessarily complicated.) Drawn in bridge form as shown here, it is easy to see that the 5- μ f capacitor has no effect on the cir-

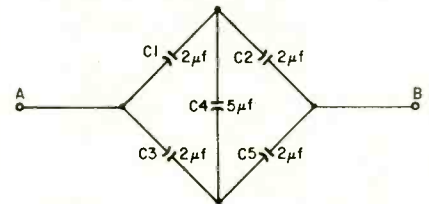

cuit, and that we have two parallel branches of two 2- μ f capacitors in series with each other. Capacitance of each branch: 1- μ f; total capacitance: 2- μ f. END

Relay Service Note

A relay that intermittently fails to operate when the proper signal is applied is exasperating. We ran into this twice—the escapement relay in two signal-seeking automobile radios failed to operate. In each instance the proper current was applied to the relay winding, mechanical action was free and the escapement released smoothly when operated manually.

We noted that when operated manually with current applied, an unusual amount of force was required to actuate the mechanism. Close inspection disclosed a small sliver of iron filing held in a horizontal position between the armature and the pole piece of the relay. Residual magnetism prevented its being moved in normal handling. When current was applied, the filing bridged the gap between the armature and the pole piece, preventing normal operation of the relay. We removed the filing with a piece of gummed tape to effect a permanent cure.—Roy E. Pafenberg

Electronic Repeating Switch

This simple repeating switch is useful for life testing, ornamental lighting, cycling display motors, cycling soldering irons to prevent overheating and numerous other applications. It acts as a spdt switch whose contact arm can be moved downward and held for 10 to 28 seconds and upward and held for 30 to 40 seconds.

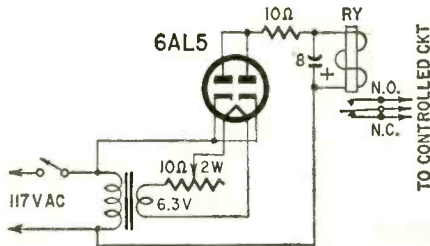

Fig. 1

The basic circuit is shown in Fig. 1. When the potentiometer is set for zero resistance, it takes about 5 seconds for the tube to warm up and conduct enough to pull in the relay. The time delay can be increased by increasing the resistance in series with the heater.

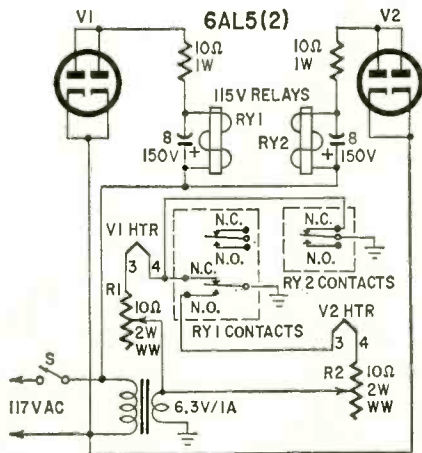
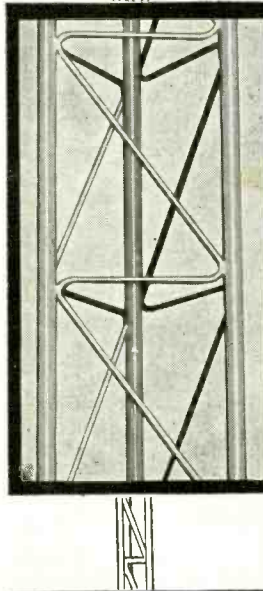
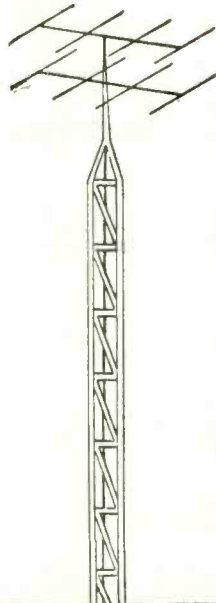

Fig. 2

With two of these delay circuits interconnected as in Fig. 2, we can vary the on and off times of the device being controlled or tested. When S is closed, heater voltage is applied to V1. After a warmup period (determined by the setting of R1) V1 conducts and RY1's normally closed contacts open up. V1 continues to receive heater voltage through RY2's normally closed contact.

When RY1 pulls in, it applies heater voltage to V2 through R2. When V2 reaches operating temperature, RY2 pulls in and opens V1's heater circuit, thus releasing RY1. This breaks V2's heater circuit and the cycle repeats.

Assuming that a lamp is connected to power through RY1's normally closed contacts, it goes off as soon as V1 warms up and comes on again when V2 reaches operating temperature. Off time is controlled by R2; on time by R1. R1's and R2's functions are reversed when the lamp or load is connected across RY1's normally open contacts.—Ronald Wilensky



THE MOST FAMOUS LINE OF TOWERS IN THE WORLD ARE ROHN!

Here are the features that make them the largest selling and most accepted tower for television, radio, industrial and communications uses:

- **ZIG-ZAG CONSTRUCTION**—proven zig-zag design means sturdiness and dependability that is truly outstanding. Tower sections are completely assembled and electric welded throughout for maximum strength and greater economy in erection.
- **HOT DIPPED GALVANIZED AFTER FABRICATION**—Entire tower sections are completely zinc coated after fabrication for the finest outer protection possible. Being galvanized after fabrication means no uncoated bolt holes, weld spots or seam to rust. All ROHN Towers last far longer and have less maintenance than competitive towers because of this feature.
- **HIGHEST QUALITY MATERIAL USED**—only highest quality laboratory-certified steel tubing is used (not pipe). Quality steel plus heavy gauges combine to give far greater strength than competitive towers.
- **COMPLETE LINE FOR WHATEVER YOUR NEEDS**—Fully self-supporting towers are available to 170 feet or lower; heavy duty guyed towers available up to 500 feet. Whatever your needs, check ROHN.
- **UNEXCELLED ENGINEERING**—all ROHN Towers are engineered to meet the most rigid requirements as outlined by all major communications equipment manufacturers and electronic industry associations.
- **UNIVERSAL ACCEPTANCE**—Hundreds of thousands of Rohn Towers are in use all over the world. They have withstood the "test of time"—the only true test as to the superiority of a tower. So why settle for less than the BEST? Insist on the largest selling tower in the world—ROHN.

For your needs and for all allied tower accessories, contact your local ROHN salesman or write direct for full information.

SEND THE HANDY COUPON INDICATING YOUR NEEDS

ROHN
Manufacturing
Company
BOX 2000
PEORIA, ILLINOIS

ROHN Manufacturing Company
Box 2000
Peoria, Illinois

Send me complete literature on the following ROHN Products:

- TV Towers Amateur Towers
 Communication Towers ROHN Accessories

Name

Firm

Address

City State

LEKTRON FIRST

66 EACH

LEKTRON KING KITS

NOT \$1.98
NOT \$1.00
FREE POSTAGE on \$10 orders

NEW KIT KING® KITS

FIRST TIME EVER IN LEKTRON'S HISTORY! BRAND NEW PARTS! ALL MADE IN U.S.A. \$5 to \$35 VALUES! LEKTRON EXCLUSIVE!

- 25 COILS, r.f. ant. osc. slug-tuned \$1.00 tool, 25 for 66¢
- 5 VOLUME CONTROLS, to 1/2-meg, submini too; ea. val. diff. 5 for 66¢
- 5 TRANSISTOR SOCKETS, low loss case; submini tubes, too; 5 for 66¢
- 30 TUBULAR CONDENSERS, 0.001 to .5 mf to 1600 WV, 30 for 66¢
- "HOOK-UP" WIRE SPECIAL, 150-ft. all types insulation, colors, 66¢
- TOGGLE TYPE SWITCHES: 31ST, DPDT, etc. 115VAC, 4 for 66¢
- 15 SILVER MICA's, condensers, 10% tool 15 dif. values, 15 for 66¢
- 30 CERAMIC CONDENSERS, discs, "dogbones" to .01 mf, 30 for 66¢
- 30 MICA CONDENSERS, incl. "silver" tool 15 dif. values, 30 for 66¢
- 3 PNP Transistors; "golden" value; factory over-runs, etc. 3 for 66¢
- 30 TERMINAL STRIPS, lug & screw types to 9 lugs, 30 for 66¢
- 3 500-MILL SILICON RECTIFIERS, tubular & "top hat" 3 for 66¢
- 15 CRYSTAL DIODES, germanium, unmarked, over-runs, 15 for 66¢
- 3 NPN TRANSISTORS; "golden" value; factory over-runs 3 for 66¢
- 10 POWER RESISTORS, 5 to 50 watts, 50-7500 ohms, 10 for 66¢
- 5 PR. RCA PHONO PLUG & JACK SETS, for amps, tuners 5 pr. 66¢
- 2 SUN CELLS; 5/8" sq., unmt. Generates volt. from sun 2 for 66¢
- 10 MOLDED CONDENSERS, (metal) 0.003 to .25 mfd, 10 for 66¢
- 30 CARBON RESISTORS, 1/2, 1, 2W, 1% & 5% tol., 30 for 66¢
- 30 CERAMIC CONDENSERS, discs tool To .01mf, 15 val. 30 for 66¢
- 15 STANDARD KNOBS, radio-TV hi-a, push, set screw, 15 for 66¢
- 25 PLUG & RECEPTACLES, audio, battery, hi-f, spkrs, etc. 25 for 66¢
- 5 ELECTROLYTICS, FPs, tubular, singles, to triples, to 450WV, 5 for 66¢

How to Order: Check (✓) blocks; send check, cash, or money order. Rated: 30 days.

POSTAGE CHART—Orders \$5-\$10 add 85¢; Orders \$2-\$5 add 55¢ MINIMUM ORDER—4 KITS

LEKTRON 241-245 EVERETT AVE. CHELSEA 50, MASS.

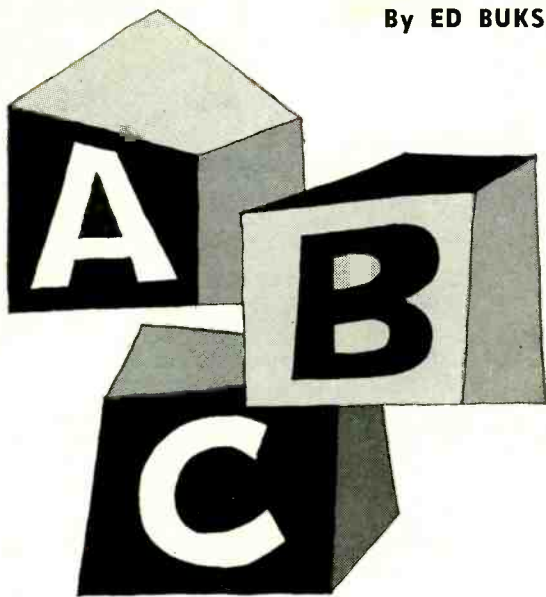

INDUSTRIAL ELECTRONIC DICTIONARY

From electron microscope to hard X-rays.

Electron microscope: Magnifying device using an electron beam instead of light as in a conventional microscope. The electron stream diverges and casts a shadow of the specimen on a fluorescent screen or a photographic plate. The electron microscope is capable of greater magnification and resolution than its optical counterpart.

Electrostatic precipitation: Method of controlling small particles of paint, dust, smoke, abrasives and other materials with electrical charges. The particles are charged by passing them through a set of wires or plates connected to a high-voltage power supply. The charged particles are then attracted to any object given an opposite charge. In electrostatic paint spraying, for example, the particles of paint are charged oppositely as compared to the object to be painted. In the manufacture of sandpaper, the abrasive particles are charged so that they fall with sharp points upward on the paper backing. Smoke and dust particles are attracted to a metal plate to remove them from chimney gases in industrial plants. This not only cuts down on fumes and smoke, but the recovered particles may be very valuable (in refining operations, for example).

Electrostatic storage welding: Same as

capacitive storage welding. A bank of previously charged capacitors is allowed to discharge through the primary of a welding transformer. The resulting current flow in the secondary produces enough heat to weld the metals.

Error detector: That portion of an automatic control system that determines when the regulated quantity has deviated beyond the limits of the dead zone. The error-detector circuit generally consists of a transducer for measuring the value of the quantity to be regulated, and a comparator circuit for comparing the measured value against a reference quantity. The difference (error) is then amplified and used to restore the regulated quantity to the desired value. The transducers used in error-detector circuits are variously referred to as sensing elements, pickup elements and data pickoffs. Typical examples are thermocouples (for temperature control), bellows-actuated potentiometer (for pressure control), moisture detectors (for humidity control), etc.

Feedback: Process of returning a portion of the output (or a signal proportional to output) to the input. In automatic control systems, the feedback is compared against a reference quantity and the difference (error sig-

nal) is applied as input. As a result of this input, the output changes in a direction that reduces the error to zero.

Firing angle: The electrical angle (of plate supply voltage) at which a gaseous tube ionizes. Thyratrons, ignitrons and other gas- or vapor-filled tubes are often operated with ac plate supplies. The tube may be made to fire (ionize) at a selected time during the positive half-cycle of plate supply voltage by adjusting the bias voltage (Fig. 12). If the bias of a thyatron is increased, for example, the plate voltage must reach a higher value before the gas can ionize. The tube, therefore, fires later in the positive half-cycle of plate supply voltage and the average current through the load is decreased. (See Amplitude-controlled rectifier.)

Flame-failure control: A circuit that automatically shuts off the fuel supply to a furnace if the pilot burner should accidentally go out. This keeps unignited fuel from accumulating in the furnace, avoiding its attendant hazards. Blue-sensitive phototubes are often used to sense the characteristic blue flame of the pilot burner.

Flip-flop circuit: Same as binary circuit. A distinction is sometimes made between the binary circuit and the flip-flop on the basis that the binary circuit has only one input terminal (feeding to both grids) and the flip-flop may have separate input terminals for the two grids. The simplest flip-flops use neon lamps.

Fluoroscope: An X-ray instrument in which the object to be examined is positioned between an X-ray tube and a fluorescent screen. The X-rays penetrate the object according to its density and then excite the fluorescent screen to produce a visible image. A system of mirrors and lead-glass shields permits the operator to view the image without exposing himself to direct radiation. Fluoroscopic examination is used industrially to inspect packaged foods for proper filling and to spot foreign particles, citrus fruits for internal texture and quality, and rubber tires for internal defects, etc.

Fluoroscopy: X-ray examination by viewing the image produced on a fluorescent screen (see Fluoroscope). This feature distinguishes fluoroscopy from *radiography*, a process of producing an X-ray image on a photographic film.

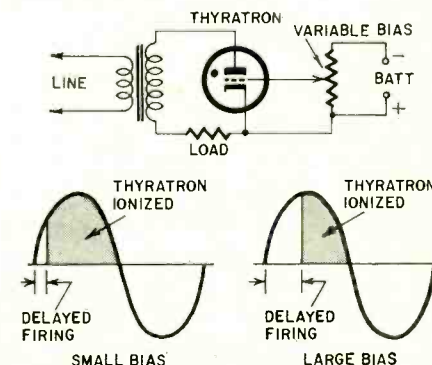

Fig. 12—Thyatron has this typical firing-angle diagram.

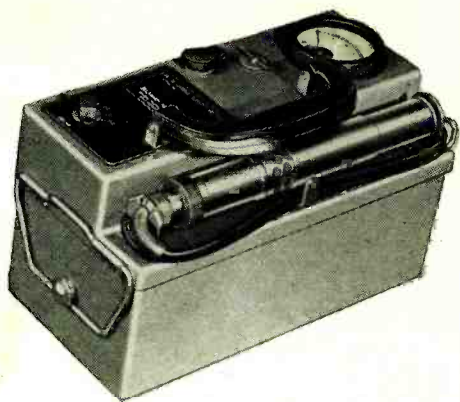

Fig. 13—A portable Geiger counter.

Gas amplification: A numerical rating indicating the greater sensitivity of a gas-filled phototube as compared to a vacuum phototube. A phototube having a gas amplification of 5, for example, will draw 5 times as much current as an otherwise equivalent vacuum phototube under equal conditions of illumination. Gas amplification is generally in the range of 3 to 10.

Gas detector: Photoelectric instrument used to monitor the concentration of harmful gases in the air. Many noxious gases absorb ultraviolet radiation. Therefore, the presence of these gases decreases the illumination received by a phototube from an ultraviolet source. The phototube controls a relay to sound an alarm when the gas concentration approaches a dangerous level.

Geiger counter: Instrument used for detecting and monitoring radioactivity. The Geiger tube is a cold-cathode, gas-filled diode operated with a plate supply voltage slightly less than that required to ionize the gas. Particles and radiation emitted from radioactive substances enter the tube and ionize the gas. The resulting pulses of plate current—one for each particle detected—are amplified and applied to a headset, neon lamp, counting rate meter or other indicating device.

Grid-controlled rectifier: Rectifier circuit employing thyratrons. Load current is varied by adjusting the bias of the thyratrons. Grid-controlled rectifiers are of two general types: amplitude-controlled and phase-controlled. The former uses a variable dc bias, and the latter a variable-phase ac bias (see Amplitude-controlled rectifier).

Hard X-rays: Highly penetrating X-rays as distinguished from soft X-rays, which are less penetrating. The degree of hardness (penetrating power) is determined by the amount of voltage applied to the X-ray tube: the greater the voltage, the harder the X-rays. Hard X-rays are used to inspect metal castings for internal cracks and air bubbles, for examining welded joints and for inspecting complex mechanical assemblies for proper location and positioning of internal components. Soft X-rays are used for inspecting low-density materials such as plastics, packaged foods, etc. TO BE CONTINUED

OCTOBER, 1961

NEXT MONTH

NOVEMBER—RADIO-ELECTRONICS

Joe Marshall's back with—

WHAT'S WITH HI-FI PICKUP ARMS?

The provocative Joe Marshall writes again in our November issue. This time he takes critical aim at some pickup problems and tells how the 1961 arms are trying to meet them. He's compiled a useful tabulation of pickup arms, features, characteristics and prices that makes an invaluable buying guide. Don't miss it in next month's issue.

Super R/C—

PRINTED CIRCUIT RADIO CONTROL SYSTEM

Here's a powerful and reliable radio control unit with muscles. It will control not only model boats and such—but even your lawnmower. Printed circuit boards are available to make construction even easier. See it in the November issue.

CRYSTAL CONTROLLED FREQUENCY DIVIDER

Looking for low frequencies? Insert this divider after the output of a 100-kc oscillator and get down as low as 2 kc. This neat and simple job uses three transistors. Read about it in the November issue.

New Way to Shoot Trouble—

SHOOT RADIO TROUBLES WITH A CHART

November *Radio-Electronics* gives you an effective, systematic graphic way to radio troubleshooting. It leads you through circuitry the quickest and surest way. This one is high priority for service technicians.

NOVEMBER ISSUE ON SALE

OCTOBER 17th

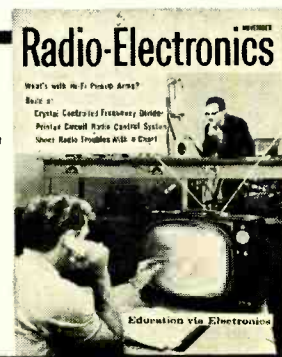

LAFAYETTE is America's Citizens Band Headquarters

Complete Portable Communications for Everyone



Ship to Shore



On the Farm



Construction Work

NO LICENSES, TESTS OR AGE LIMITS



HE-29A

PORTABLE—POCKET SIZE Only 6 7/8 x 3 1/4 x 1 5/8"

LAFAYETTE 9 TRANSISTOR CITIZENS BAND "WALKIE TALKIE"



Complete with Leather Carrying Case, Earphone, Antenna, Batteries, and Crystal

39.95
2 for **78.88**
NO MONEY DOWN

- Completely Wired—Ready to Operate
 - Fully Transistorized—9 Transistors plus 1 Diode
 - Uses Inexpensive Penlight Batteries
 - No License, Tests or Age Limits
 - Comes with Leather Carrying Case, Earphone, Antenna, Batteries and Crystals
- As simple and easy to use as the telephone—and twice as handy. Receives and transmits up to 1.5 miles under average conditions. Weighs only 18-oz. and slips into your pocket. Push-to-talk button operates built-in speaker as sensitive microphone.

LAFAYETTE HE-20A Deluxe CITIZENS BAND TRANSCEIVER

ONLY **109.50**
NO MONEY DOWN



Made in U.S.A.

Now With Added Deluxe Features—

- Pi-Network for Greater Power Output
 - Calibrated "S" Meter
 - 14 Tube Performance, 3 Diodes
 - Built-in 12 Volt Power Supply for Mobile Use
 - Complete with Matched Crystals for Channel 9
- A highly efficient 2-way communications system operating over a distance of up to 20 miles or more depending on terrain. Features

4 crystal-controlled transmit positions and 4 crystal-controlled receive positions. Tuneable superhet receiver covers all 23 assigned channels. Other highlights include dependable push-to-talk ceramic mike & relay, adjustable squelch control, automatic series gate noise limiter and illuminated dial.

LAFAYETTE HE-15A

Made in U.S.A.



SUPERHET

Citizens Band TRANSCIEVER

- Completely Wired—Not A Kit
- 5 Crystal-Controlled Transmitting Positions
- Tuneable Receiver Over Full 23 Channels
- High Output Ceramic Microphone
- Complete with Transmitting Crystal for Channel 9

A compact, precision transmitter and receiver covering up to a 20 mile or more radius, depending upon conditions. The HE-15A features an effective full-wave variable noise limiter, planetary vernier tuning, RF and microphone jack, on front panel. 12 tube performance from 4 dual-function tubes, 2 single-function tubes, 2 rectifiers.

- HE-19 Telescoping Whip Antenna Net 3.95
- HE-16 Power Supply for 12 Volts Net 10.95
- HE-18 Power Supply for 6 Volts Net 10.95

ONLY **59.50**
NO MONEY DOWN

NOT A KIT

LAFAYETTE All-in-One CITIZENS BAND MOBILE ANTENNA

6.95

HE-800WX

- Chrome Swivel Base
- Stainless Steel Spring
- 102 1/2" Stainless Steel Whip for Optimum 11-Meter Performance

Chrome swivel ball mount base designed for mounting on any surface. Stainless steel spring holds rod in properly adjusted position and prevents rod damage from shocks and blows. Stainless steel whip for maximum resiliency and strength.



NEW! LAFAYETTE RADIO FIELD INDICATOR

6.95

- Continuously Indicates Transmitter Output
 - Rugged 200 ua Meter Movement
 - Requires No Electricity, Batteries or Transmitter Connection
- Check the performance of marine, mobile or fixed transmitter. Features a 200 ua meter movement with variable sensitivity control. Earphones can be plugged in for an aural check of output. Antenna extends from 3 1/4" to 10 3/4". Magnet on bottom plate allows easy mounting on car dash or metal surfaces. Size, less antenna, 3 1/8"W, 2 1/4"H, 2"D.



TM-14

LAFAYETTE RADIO

SEND MAIL ORDER TO LAFAYETTE RADIO
111 JERICHO TURNPIKE
SYOSSET, LONG ISLAND, NEW YORK

PLEASE INCLUDE SHIPPING CHARGES WITH ORDER.

OTHER LOCATIONS	NEW YORK, N. Y. 100 6th Avenue	NEWARK, N. J. 24 Central Avenue	PARAMUS, N. J. 182 Route 17
JAMAICA, N. Y. 165-08 Liberty Avenue	BRONX, N. Y. 542 E. Fordham Rd.	BOSTON, MASS. 110 Federal Street	PLAINFIELD, N. J. 139 W. 2nd Street

FREE!

LAFAYETTE

**340 PAGE 1962
ELECTRONICS CATALOG**

"America's Hi-Fi & Electronics Shopping Center"

Yours free for the asking — the biggest, best and most comprehensive catalog in the 41-year history of Lafayette Radio. Audiophile, Experimenter, Hobbyist, Technician, Engineer, Student, Serviceman, Dealer — you'll find what you want in this latest Lafayette catalog.

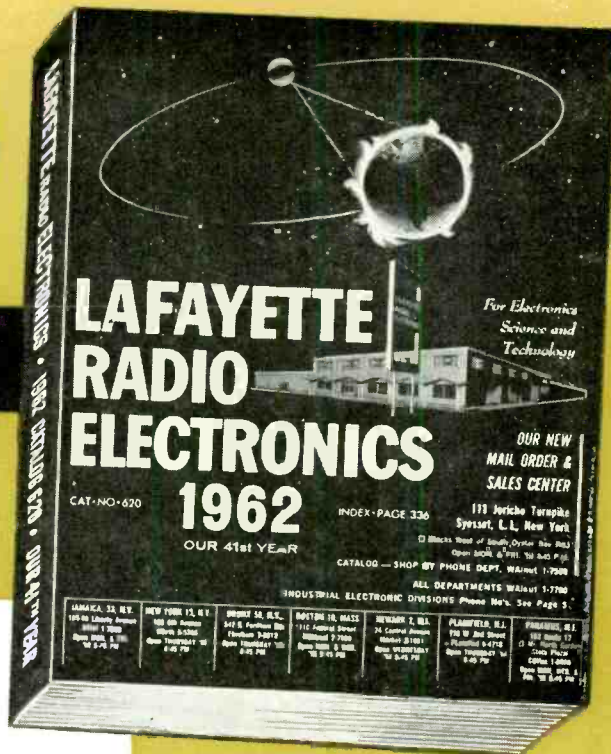

CATALOG # 620

LARGEST STOCK SELECTION. Stereophonic Hi-Fi equipment, Citizens Band, Ham and Amateur equipment, Radio & TV parts, Optics, Industrial Supplies, and much more, including all the favorite name brands.

LAFAYETTE EXCLUSIVES. Featured are the famous Lafayette Kits . . . dollar for dollar the best value for your money today. You'll also see hundreds of Lafayette specials . . . available only from Lafayette. And, as always, **SATISFACTION GUARANTEED OR MONEY REFUNDED.**

LOWEST PRICES. You'll save money too with Lafayette's low, low prices. The lowest prices are always in the Lafayette catalog.

24-HOUR SERVICE. Quick, courteous service is your guarantee at Lafayette. Most orders are fully processed within 24 hours after receipt in the mail Order Division.

NEW EASY-PAY PLAN.
Now, **NO MONEY DOWN . . .**
up to 24 months to pay.



**COMPLETELY WIRED,
FULL SIZE TUBE TESTER
TE-15.....19.95**



**10,000
OHMS-PER-VOLT
MULTITESTER
TE-10.....9.95**



**TRANSISTORIZED
PORTABLE TAPE RECORDER
RK-125.....29.95**

**SUPERHETERODYNE
COMMUNICATIONS RECEIVER
KT-200, Kit64.50
HE-10, Wired79.95**



**FM STEREO
MULTIPLEX TUNER
LT-700.....129.50**



**9-TRANSISTOR
CITIZENS BAND
"WALKIE TALKIE"
HE-29A each 39.95
2-for 78.88**

LAFAYETTE'S

**NEW MAIL ORDER HEADQUARTERS
111 JERICHO TURNPIKE
(2 Blocks West of South Oyster Bay Rd.)
SYOSSET, LONG ISLAND, NEW YORK**

**Watch for Opening
Fall, 1961**

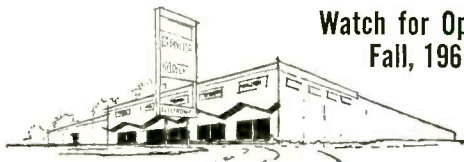

**LAFAYETTE RADIO, DEPT. J11-2
P.O. BOX 10, SYOSSET, L. I., N. Y.**

- Rush my **FREE Lafayette 1962 Catalog 620**
- Please send me # _____, shipping charges collect.
- I am enclosing \$ _____



340 PAGES

Name _____

Address _____

City _____ Zone _____ State _____

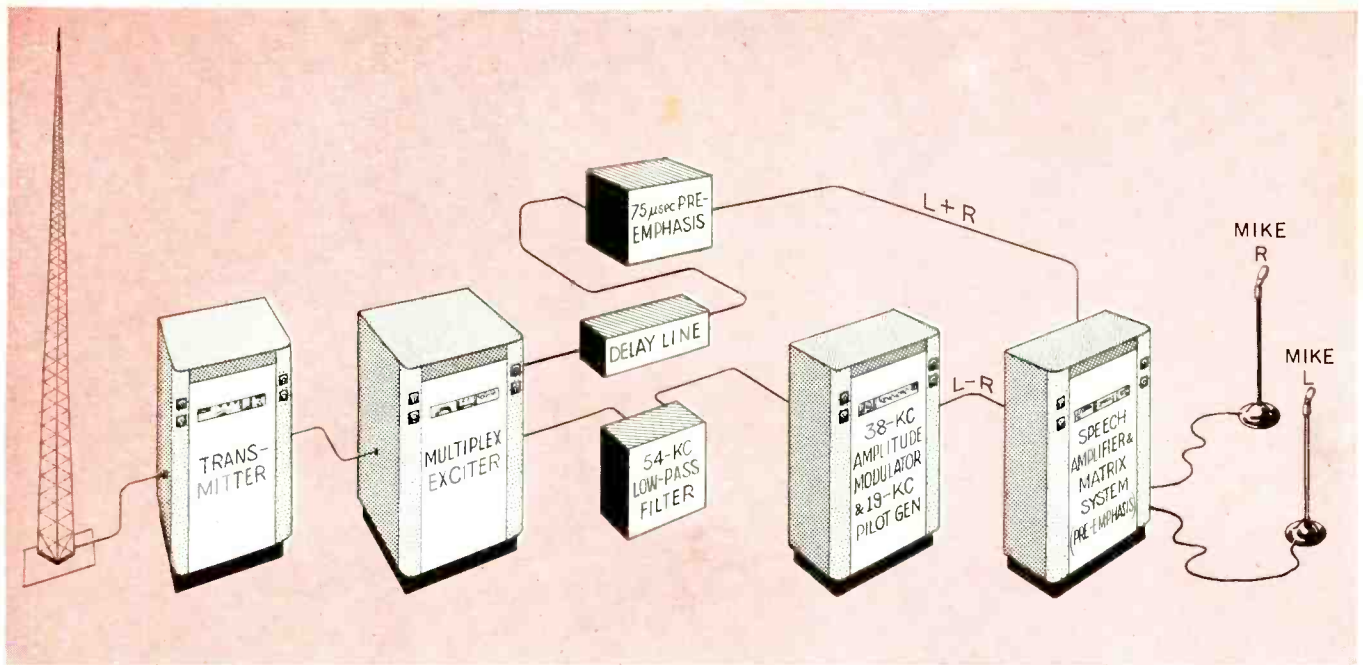

FM STEREO IS NOT SO TOUGH

STEREO FM TRANSMISSION AND RECEPTION is not as complex as some of the descriptions have made it look. The illustrations above shows what happens in stereo broadcasting.

The signal from the two microphones at the far right is amplified and then mixed by a pair of transformers to produce an in-phase (L + R) and an out-of-phase (L - R) component. Pre-emphasis is applied (shown for the L - R in the first rack—for the L + R in a separate unit) and the L + R signal delayed roughly 48 μsec to keep it in phase. The L - R signal then is used to modulate a 38-kc carrier (afterward suppressed). The equipment that produces the 38-kc carrier also originates the 19-kc signal that acts as a pilot in the receiver.

The 38-kc signal now goes through a 54-kc low-pass filter to remove any components that might interfere with the

67-kc SCA signal that will also be transmitted by many stations. Then it and the L + R signal modulate the rf in the multiplex exciter. The rf signal from the exciter is amplified in the FM transmitter.

Reception (lower illustration) is simpler. If the listener has a good FM tuner, he uses it with a multiplex adapter as shown. Or he may buy a new stereo FM tuner which has left- and right-channel outputs instead of a multiplex jack. In either case, the right and left outputs go to a two-channel stereo amplifier and to speakers as would the output from a stereo pickup or stereo tape.

There may be many complicated formulas and confusing distinctions to trouble the engineer in designing this equipment. The stereo signal knows nothing of these, and we can see that it makes its way through the apparatus in a pretty straightforward way. END

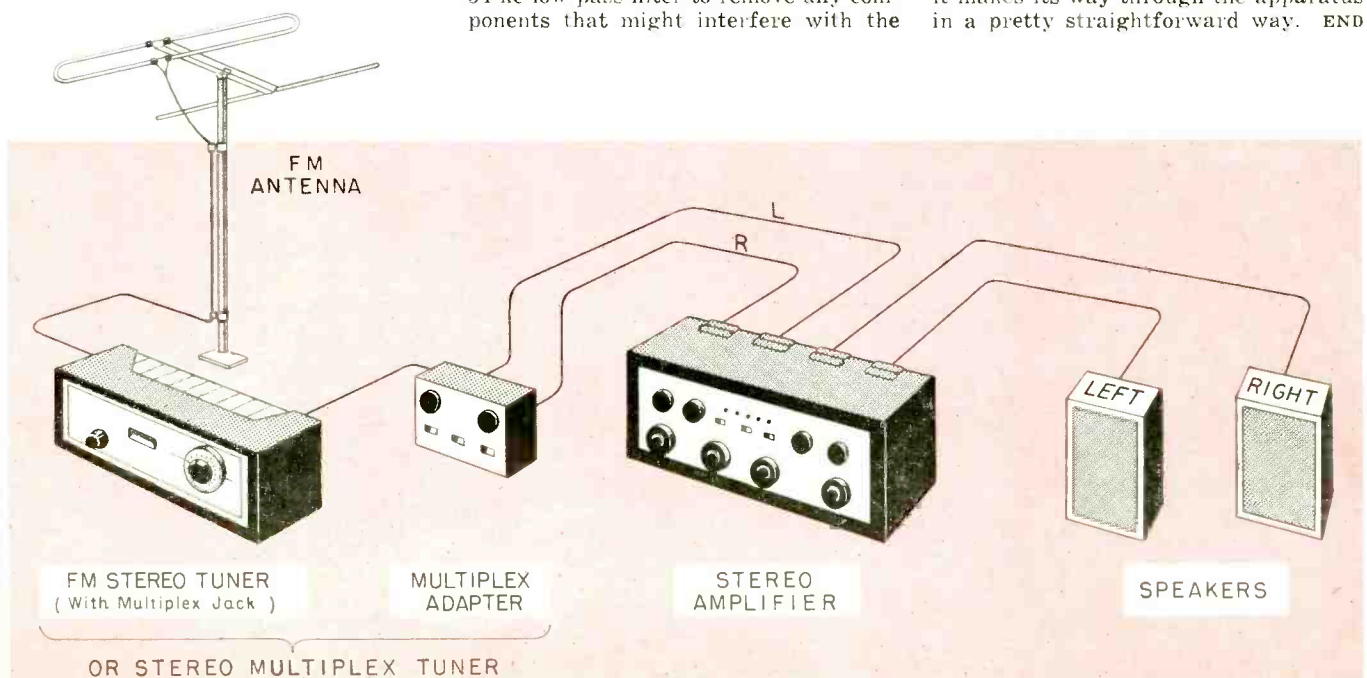

Stereo Phones to Mono Phones

JUDGING BY THE INCREASING NUMBER OF quality stereo phones around, the pleasure of listening to stereo with earphones is gaining in popularity. Some of these stereo phones are equipped with a three-conductor phone plug which is wired as in A in the diagram. When you want to plug the phones into a monaural jack for monaural listening, the hookup is wrong and you hear the signal in one phone only. The simple adapter described here converts the phones from stereo to monaural wiring without changes in the plug that comes with the phones. The adapter converts the stereo phones to monaural as in B in the diagram.

As shown in the illustrations, the adapter consists of a three-conductor phone jack and a standard phone plug mounted in a plastic pill container, wired as shown. I used a 1-inch-diameter plastic container cut to a length of 1½ inches. A plastic container is used to avoid shorts—if you use a metal container, mount either the jack or the plug with fiber shoulder washers to insulate either from the metal can. The phone plug is securely cemented into a hole in one end of the plastic case. —Art Trauffer

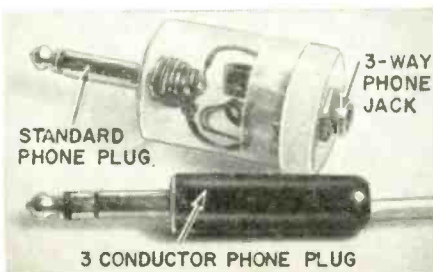
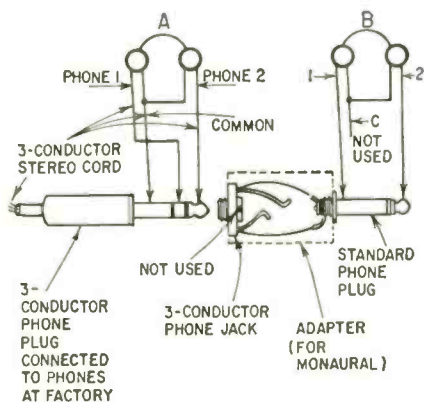

“I Teach MATH a Funny Way”

... says Dr. Aaron Bakst, distinguished mathematician and lecturer at New York University. And the N. Y. Times says of this method: “A rich dish, well-stocked with parlor tricks and ingenious problems . . . a new trend toward the humanization of mathematics.”

DR. BAKST'S “funny way to teach math” cuts out the learning and memorizing of rules and formulas. In 791 fascinating pages his book *Mathematics: Its Magic and Mastery* uses entertaining puzzles, games and tricks to simplify and

humanize math for the average person.

Even if you never finished high school math, you'll find this book easy to follow. It explains every basic step in mathematics; shows how to solve all sorts of problems, from adding up everyday bills to short-cut ways of operating giant electronic calculators. And even Einstein's theory of relativity is explained so simply that any layman can readily understand it.

PARTIAL CONTENTS of this 791-Page Book

Short Terms in Long Division
Fractions Without Denominators
The Game of 999
Properties of Numbers
Repeated-Digit Baffles
The Other Side of Zero
Secret Codes with Numbers
The Great Pyramid Mystery
Simple Calculating Devices
A Home-Made Abacus
Multiplication Made Painless
How to Remember that Phone Number
The Number Magician's Secret
Algebra Magic
Why the Rich Get Richer
Arithmetic Sequences for Rabbits
Logarithm Declares a Dividend
Streamlining Everyday Computations
How to Figure the Odds
Unsquaring the Square
The Triangle—
Man's Servant and Master
Measuring Heights with a Mirror
The Secret of the Sphinx
Trig Without Tables
Squashing the Rectangle
How to Wrap a Circle
Cutting Corners From a Triangle
The Shortest Route on Earth
Cork-screw Geometry
Mathematics on the Rifle Range

*Unsquaring the Square;
How to Figure the Odds;
The Great Pyramid Mystery;
The Game of 999*

These and scores of other intriguing solutions to problems (see partial table of contents at left) quickly give you a good grasp of advanced arithmetic, algebra, geometry and trigonometry.

You learn by *doing*, not by studying. And what you do is made so absorbing that you'll thoroughly enjoy each single “treasure hunt” episode with this gifted mathematician and writer.

Today's Stress on Math

In today's world of science, automation, engineering and automatic computing, a good knowledge of all phases of mathematics will help *anyone* to advance himself faster and farther. In fact, it is an absolute essential in many fields, for reaching the top positions.

Dr. Bakst's book assures that your new knowledge of math will be of *practical* value to you—because he applies its principles to home life, insurance, business, finance, scientific and managerial problems.

Examine it FREE for 10 days

There is no need to send any money now. The coupon will bring you this 791-page book for 10 days' free trial. If not convinced that it brings you an interesting and practical way to gain a knowledge of mathematics which will be of great value to you, return it and owe nothing. Otherwise you may keep it by sending us only \$1.50 down and the balance in easy payments. Mail the coupon NOW. D. Van Nostrand Company, Inc., Dept. 1810, 120 Alexander Street, Princeton,

A WHOLE LIBRARY IN ONE
GIANT 791-PAGE VOLUME

10-DAY FREE EXAMINATION COUPON

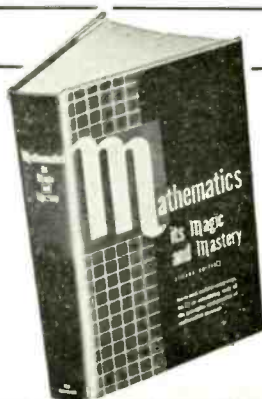

D. VAN NOSTRAND COMPANY, INC., DEPT. 1810
120 ALEXANDER STREET, PRINCETON, N. J.

Please send—for ten days' free examination—**MATHEMATICS: ITS MAGIC AND MASTERY** by Dr. Aaron Bakst. Within ten days I will either return the book or send you \$1.50 as first payment and only \$2.00 per month for the three months plus a small shipping cost (a total of \$7.50).

PRINT NAME

ADDRESS

CITY

ZONE

STATE

(SAVE: If you send \$7.50 with this coupon we will pay all shipping costs. Same return privilege; refund guaranteed.)

(In Canada: Address 25 Hollinger Road, Toronto 16. Price slightly higher.) For Foreign and A.P.O., send \$7.50 with order.

Double CB receiver sensitivity

Add a 1-tube rf stage to your Heathkit

By HAROLD DAVIS

Performance of the already good Heathkit Citizens-band GW-10A and GW-10D transceivers can be greatly improved by adding an rf stage to the receiving end.

The modification described here was designed by my good friend D. C. Nix. It can be made before or after completing the kit, but is probably easiest to handle during construction.

Adding an rf stage is not simple, but is well worth the effort. Looking at pictorial 6 in the construction manual (the necessary portion is duplicated in Fig. 1), swing terminal strip K around 180°. Then move the output transformer 1/2 inch to the left. You will have to drill new mounting holes 1/2 inch to the left of those now on the chassis.

Punch a 5/8-inch hole in the chassis between terminal strips K and L. Place a seven-pin miniature tube socket in this hole. Fasten one ear of the socket with the screw that holds terminal strip K. Use another screw and nut to fasten the other ear through the hole that originally held one side of the output transformer.

Now break off the right side of the bracket installed on the speaker. It was originally intended to hold the output transformer but is not used in this kit, and it interferes with the added rf stage.

The next step is the rf transformer. You'll have to wind it yourself. Several TV if transformers were tried but none were entirely satisfactory. Having access to a frequency meter and a GDO, it was no job at all to design one. I stripped the windings of a Meissner No. 163487 transformer, and in their place wound 15-turn coils of No. 26 enameled wire for both primary and secondary. Install a 12-μmf NPO disc capacitor across each winding.

Once the rf transformer is finished, remove antenna coil RA, cut a new hole for it just forward of terminal strip J, and mount it there. You'll have to move terminal strip J about 3/8 inch closer to the edge of the chassis. Install the rf coil where the antenna coil was originally located. Now you are ready to wire in the rf stage. Complete all wiring following the schematic in Fig. 2. You shouldn't have any trouble.

Once the circuit is wired you only have to tune the rf transformer and you're ready to go once again. Use the original slugs and peak the stage for greatest output. This can be done even without a signal generator. Just tune in a station on the desired band and peak the transformer.

This rf stage is fixed-tuned, and one might wonder about its efficiency. However, when we consider that all 23 CB channels are packed into an area only 0.715 mc wide, the stage won't be far off at either end. In addition, if it is peaked on the channel that is used most, efficiency is optimum.

If you want figures to back up the facts, here they are. On a direct side-by-side comparison with another make set that includes an rf stage, the modified Heathkit performed equally well. The specifications for the reference set stated that it had a sensitivity of 0.5 μv for a 10-db signal-to-noise ratio. Since the Heathkit specs read 1 μv, we can assume that receiver sensitivity has been doubled. Additional proof of improved performance came in a side-by-side test with an unmodified receiver. Signals that could not be read previously, were easily understood with the modified unit. END

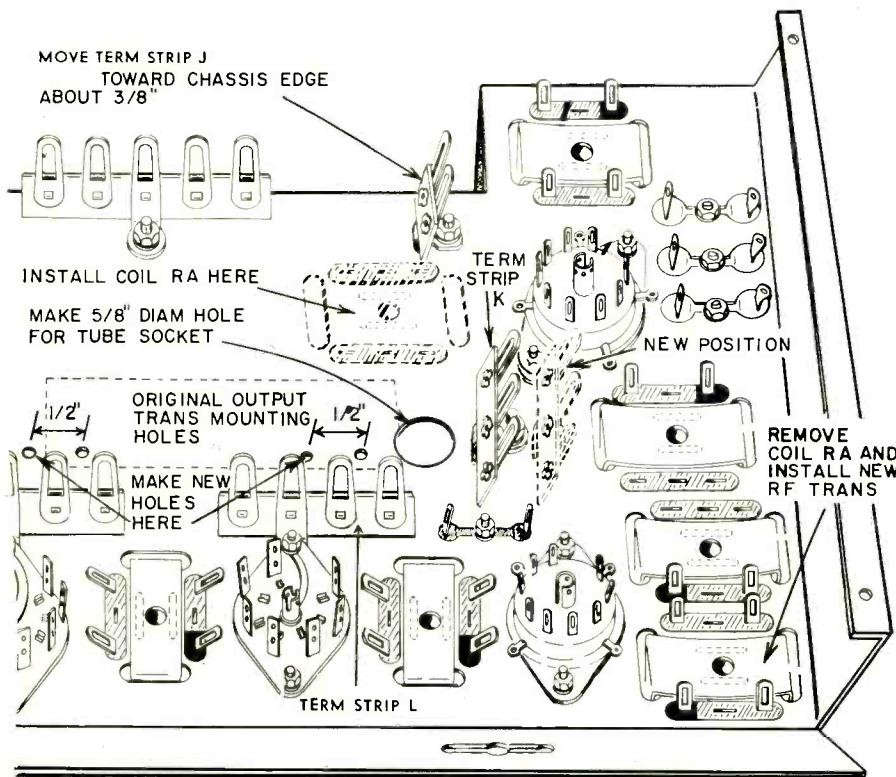

Fig. 1—Pictorial diagram shows necessary modifications.

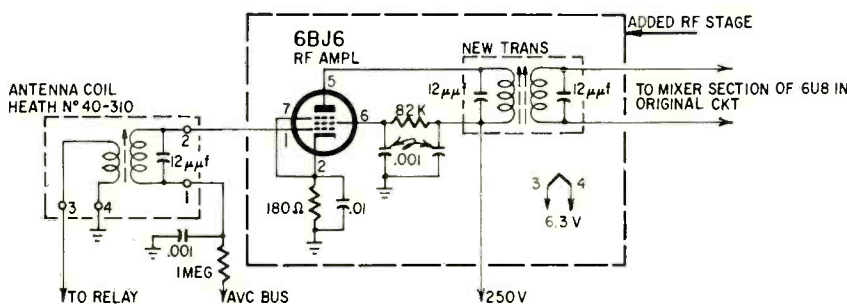
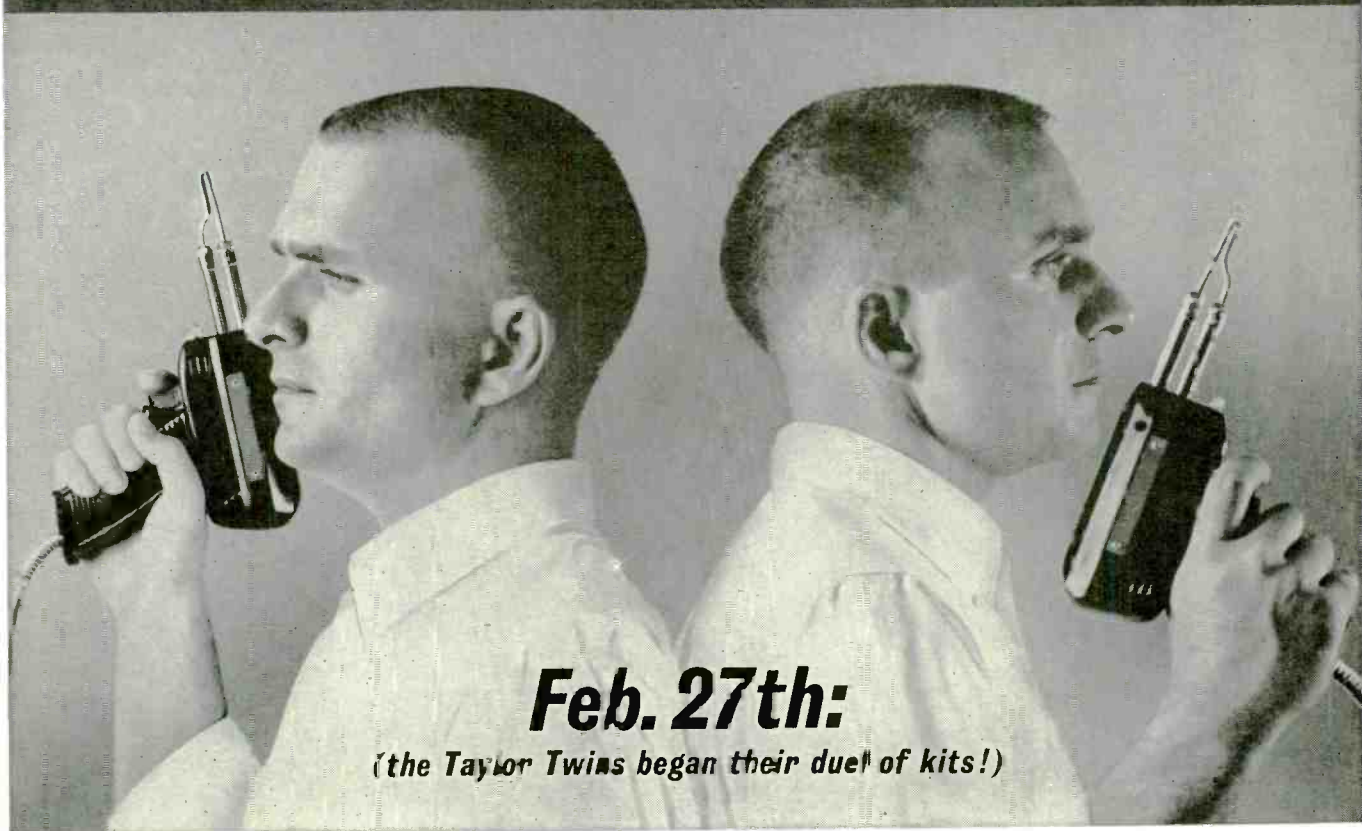

Fig. 2—Circuit of the rf stage inserted in the transceiver.



Feb. 5th:

(Paco ran this ad in The New York Times)



Feb. 27th:

(the Taylor Twins began their duel of kits!)

*Don and Larry Taylor, with twin backgrounds and skills, have competitively built kit after kit, Paco vs. other makes. In one test Don built the Paco, in the next Larry did. Net results: Paco kits proved faster, easier, and better in performance. **For a typical Twin-Test report turn the page.***

HERE ARE JUST A FEW OF
PACO'S NEWEST KITS:



V-70 VACUUM-TUBE VOLTMETER KIT: Employs balanced vacuum tube bridge circuit for all voltage and resistance measurements plus 3-way probe for accurate, rapid test. Includes: 7 DC voltmeter ranges, 7 AC voltmeter ranges (RMS) from 0 to 1500 volts, and 7 AC voltmeter ranges (peak to peak) from 0 to 4000 volts. Also 7 decibel ranges, -6 to +66 db and 7 electronic ohmmeter ranges from 0.2 ohms to 1000 megohms.
V-70 Kit with "Twin-Tested" operating assembly manual \$31.95 net
V-70W: Factory-wired \$49.95 net



C-25 IN-CIRCUIT CAPACITOR TESTER KIT: Reveals dried out, shorted, or open electrolytics—in the circuit—with Paco's exclusive Electrolytic Dial.
Simple Sequential Test: reveals open or shorted capacitors, even electrolytics.
Electrolytic Dial: indicates in-circuit capacity from 2 to 400 mfd; condenser is proved non-shorted and not open if capacity reading can be obtained.
Model C-25 Kit: with Paco-detailed operating assembly manual \$19.95 net
Model C-25W: Factory-wired \$29.95 net



SA-40 STEREO PREAMP-AMPLIFIER: Power: 20W (RMS) per channel, 40W total. Peak, 40W with 80W total. Response: 30 cps to 90 Kc, within 1.0 DB. Distortion: within 0.5% at 20W per channel. Includes: 14 inputs and 14 Panel Controls, black and gold case.
SA-40 Kit with enclosure, "Twin-Tested" operating assembly manual \$79.95 net
SA-40W: Factory-wired, ready to operate \$129.95 net
SA-50: Stereo Kit as above with different styling, 25w per channel TBA*



ST-25 FM TUNER: Sensitivity: 1.5 microvolts for 20 DB quieting. Harmonic Distortion: less than 1%. Includes: Dual Limiters, AFC and AFC Defeat, "Eye" type tuning indicator, Multiplex jack. Black and gold case or walnut enclosure at slight extra cost.
ST-25 Kit with fully-wired prealigned front end, "Twin-Tested" manual \$42.95 net
ST-25W: Factory-wired, ready to operate \$59.95 net
ST-26 Tuner-Amplifier Kit: Same as ST-25, with built-in amplifier \$54.95 net
ST-26W Tuner-Amplifier: Factory-wired, ready to operate \$69.95 net



DF-90 TRANSISTORIZED DEPTH FINDER KIT: Protect your boat against shoals and underwater hazards with this compact, easy-to-read depth finder. Locates hard-to-find schools of fish, too.
Fully Transistorized: 5 transistors, low battery drain for very long battery life.
Fast, Easy Readings: over-sized scale with 1-ft. calibrations from 0-120 ft.
DF-90 Kit: Complete with "Twin-Tested" assembly operating manual \$84.50 net
DF-90W: Factory-wired \$135.50 net



G-15 GRID DIP METER: Major Functions: 1-Variable Frequency Oscillator covering 400 Kc up to 250 Mc in 8 bands; 2-Absorption Wavemeter, 400 Kc to 250 Mc; 3-Modulation Indicator. Applications: antenna tuning, standing wave checks, neutralizing, TVI suppression, carrier monitoring, etc: RF signal source for visual alignment marking between 400 Kc and 250 Mc. Weighs only 3 lbs.
G-15 Kit: Complete with 8 plug-in coils, "Twin-Tested" manual \$31.95 net
G-15W: Factory-wired \$39.95 net

©1961, PACOTRONICS, INC. ALL PRICES INCL. F.E.T. *Price to be announced

"I built the Paco SA-40 Stereo Preamp Amplifier."

Larry Taylor, 8 Stevens Place, Huntington Station, N. Y. "It took me one-third less time to build the Paco kit than it took Don to make the almost identical preamp-amplifier by another kit maker. But it wasn't just the time; it was knowing you're using the right part, and that you understand the instructions completely. Paco parts are all pictured and labelled, the resistors are neatly mounted on cards for easy identification. And Paco's instruction book doesn't leave you guessing. The fold-out diagrams and drawings are always right beside the instructions, so you're not reading one part of the book and following a diagram in another part. Photographs in Paco's book show how each assembly should actually look. I enjoyed building Paco kits, because I wasn't wasting time or worrying."



"I built a competing Stereo Preamp Amplifier."

Don Taylor, 39 Cross Street, Smithtown, N. Y. "Neither Larry nor I are speed demons because we're very meticulous about wiring and soldering. So I was even more surprised when it took me 50% more time to finish my kit. My problem began when I tried to separate the parts. The resistors were in boxes, but not in any logical way: identical resistors often wound up in different boxes. The instruction book was clumsy to work from. It caused wasteful mistakes. Once I lost 20 to 25 minutes because I misread a tiny key letter that meant not to solder a certain connection. A lot of the fun of kit-building was lost when I had to spend time making up for shortcomings of the packaging and the instruction manual."



THE PACO KITS YOU WANT ARE AT THESE DISTRIBUTORS:

*Hi-Fidelity Equipment Only †Test Equipment Only

- ALABAMA**
Anniston Southeastern Radio Parts
Birmingham Forbes Distributing Co., Inc.†
Gadsden Southeastern Radio Parts
Mobile Emrich Radio Supply
Montgomery Southeastern Radio Parts
Selma Southeastern Radio Parts
- CALIFORNIA**
Bellflower Giant Electronics*
Berkeley Electronic Suppliers
Canoga Park Sandy's Electronic Supply†
Culver City Arrow Sales, Inc.†
Hayward Hayward Electronics†
Hollywood Hollywood Radio & Elec., Inc.†
Inglewood Arrow Sales, Inc.†
Long Beach R. C. & L. F. Hall, Inc.
Los Angeles L. A. Electronic Supply
Millbrae T. V. Radio Wholesaler†
Modesto Inland Electronic Suppliers†
Monterey Monterey Electronic Supply†
Mountainview Ray-Tel Industrial Co.
North Hollywood Arrow Sales, Inc.†
Honig Distributing Co.†
Palo Alto Peninsula Electronics Supply
Zack Electronics
Pasadena Arrow Sales, Inc.†
Dow Radio, Inc.
Reseda Dulco Sound Systems
Sacramento Lombards Electronics*
Salinas Peninsula Electronics Supply
San Diego Silvergate Radio Supply
San Francisco Market Radio Supply Co.
Zack Electronics
San Jose Electronic Center
Peninsula Electronics Supply
San Jose T. V. Supply
Schad Electronic Supply
United Radio & T. V.
San Mateo San Mateo Elec. Supply Co.
Santa Ana Arrow Sales, Inc.†
Stockton Dunlap Radio & Tele. Supply†
Sunnyvale Sunnyvale Electronics
Vallejo Electronics' Best Buy
Whittier Hi-Fi Haven*
- COLORADO**
Denver Electronic Parts Company
- CONNECTICUT**
Bridgeport Hatry Electronic Enterprises
Hartford Del Padre Supply of Hartford
Hatry Electronic Enterprises
Radio Shack Corporation
Signal Electronic Center
Seell Electronics
New Britain United Electronics
New Haven American Television, Inc.
Hatry Electronic Enterprises
Radio Shack Corporation
Norwich Aikens Electronic Supply Inc.
Stamford Radio Shack Corporation
Waterbury Hatry Electronic Enterprises
Parts Unlimited Stores
See your classified phone directory
- FLORIDA**
Daytona Beach Hammond Electr., Inc.
Jacksonville Hammond Electronics, Inc.
Kinkade Radio Supply
Peard Electronic Supply Co.†
Lakeland Hammond Electronics, Inc.
Melbourne Electr. Wholesalers, Inc.
Miami Electronic Equipment Co., Inc.
Electronic Wholesalers, Inc.
Herman Electronics
Orlando Hammond Electronics, Inc.
Tampa Hammond Electronics, Inc.
Kinkade Radio Supply
Thurrow Electronics
- GEORGIA**
Athens Southeastern Radio Parts
Atlanta Southeastern Radio Parts
Gainesville Southeastern Radio Parts
La Grange Southeastern Radio Parts
Rome Southeastern Radio Parts
Savannah Southeastern Radio Parts
- HAWAII**
Honolulu Precision Radio Ltd.
- ILLINOIS**
Champaign Electronic Parts Co.
Chicago Arthur Nagel Inc.
Irving Joseph, Inc.
U. S. Radio & T. V. Supplies
Jacksonville Baptist Electronic Supply†
Joliet Mainline Industrial Supply Co.,
- INDIANA**
Bloomington H. A. Williams Co.
Columbus H. A. Williams Co.
Evansville Hutch & Son, Inc.†
Ohio Valley Sound†
Indianapolis Graham Elec. Supply Inc.
Meunier Electronic Supply Co.
Van Sickle Radio Supply Co.
Lafayette Lafayette Radio Supply
Muncie Muncie Electronic Supply
Richmond H. A. Williams Co.
- KANSAS**
Kansas City Manhattan Radio & Equip.†
- KENTUCKY**
Lexington Radio Electronic Equip. Co.
Louisville P. I. Burks Co.
- LOUISIANA**
Baton Rouge Davis Electronic Supply†
Lake Charles Television Radio Supply†
New Orleans Crescent Radio & Sup. Inc.†
Epcor†
Southern Radio Supply†
Shreveport Koelemy Sales Co., Inc.†
- MARYLAND**
Baltimore Hi-Fi Shops*
Revacto of Maryland†
Hagerstown Zimmerman Wholesalers
Salisbury Standard Electronics Supply†
Towson Baynesville Electronics†
Wheaton Key Electronics
- MASSACHUSETTS**
Boston Lafayette Radio Electronics
Radio Shack Corporation
Braintree Radio Shack Corporation
Brockton Tee Vee Supply Co.
Brookline Radio Shack Corporation
Chelsea Lektron, Inc.
Holyoke Kathleen Smith Music Shop Inc.
Jamaica Plain Tee Vee Supply Co.
Lynn Land Electronics Supply Inc.†
Milford Tee Vee Supply Co.
Peabody Tee Vee Supply Co.
Springfield Del Padre Music Shop Inc.
Del Padre Supply of Springfield
- MICHIGAN**
Battle Creek Electronic Supply Corp.
Dearborn Hi-Fi Studios, Inc.*
Detroit Hi Fidelity Workshop*
Hi-Fi Studios, Inc.*
Radio Specialties Co.
Grand Rapids Burma Radio Supply
Grosse Pointe Hi Fidelity Workshop*
Kalamazoo Electronic Supply Corp.
Muskegon Western Elec. Supply Co.†
Pontiac Hi Fidelity Workshop*
Wyandotte Hi Fidelity Workshop*
Radio Specialties Co.
- MINNESOTA**
Minneapolis Ken Craft Hi-Fi*
St. Paul Electronic Market*
- MISSOURI**
Joplin Four State Radio Supply†
Kansas City McGee Radio Co.
Manhattan Radio & Equipment Inc.†
St. Louis Deltronics Distributing Co.†
Olive Electronic Supply
- MONTANA**
Billings Electronic Supply Co.†
- NEBRASKA**
Omaha Omaha Electronics Co.†
Scotts Bluff Tri State Electronics Inc.
- NEW HAMPSHIRE**
Concord Evans Radio
- NEW JERSEY**
Bergenfield Arcco T. V. Parts Corp.*
Hackensack EmSCO Electronics Inc.*
Morris Plains Park Electronic Corp.
Newark Terminal-Hudson
Lafayette Radio Electronics
North Bergen Arcco T. V. Parts Corp.*
Paramus Lafayette Radio Electronics
Passaic Ed's Electronics Inc.
Plainfield Lafayette Radio Electronics
Princeton Sun Radio & Electronics Co.
Springfield Disco Electronics, Inc.
Westwood Arcco T. V. Parts Corp.*
Parts Unlimited Stores
See your classified phone directory
- NEW MEXICO**
Albuquerque Electronic Parts Co.†
Yucca Wholesaler†
Los Alamos Valley Engineering Co.
- NEW YORK**
Albany Greylock Electronics†
Seiden Sound, Inc.†
Bayside Snyder Electronic Dists. Inc.*
Binghamton Stack Electronics†
Brooklyn Witmal Electronics*
Benray Electronic Distributors
Bronx Adamson Electronic Corp.*
Buffalo Radio Equipment Corp.†
Standard Electronics, Inc.†
East Northport Arena Electronics, Inc.†
Elmont Great Eastern Mills-Electronics*
Hempstead Newmark & Lewis*
Jamaica Harrison Radio Corp.
Lafayette Radio Electronics
Peerless Radio Dist. Inc.
Kingston Greylock Electronics†
Long Island City Electronics Supply Corp.
Middletown Artec Distributors Inc.†
Certified Electronics Inc.†
Mineola Arrow Electronics Inc.
New Hyde Park Dressner Audio Sales Co.*
New York City Adson Electronics
Arrow Electronics
Consolidated Radio Sales Inc.†
Dale Electronics Co.
Grand Central Radio
Harrison Radio Corp.
Hi Fidelity Center*
Lafayette Radio Electronics
Magic Vue Television Corp.*
Magna Electronics Co.
Sun Radio & Electronics Co.
Terminal-Hudson
Wilmar Distributors Corp.*
Zalytron Tube Corp.
Poughkeepsie Greylock Electronic†
Rochester Rochester Radio Supply Co.
Rome Rome Electronics, Inc.†
Schenectady Grimmers Elec. Parts Sup.
Syracuse L. Gordon Dist. Co.†
Syracuse Radio Supply Co.
Utica Grapac Electronics†
Parts Unlimited Stores
See your classified phone directory
- NORTH CAROLINA**
Concord Mac Victor Electr. Supply Inc.
(Continued on next page) →

BUILD A HI-FI MUSIC WALL! Don Brann's new book *How to Build a Hi-Fi Music Wall* gives you step-by-step instructions for building a decorator styled cabinet or an entire music wall. Send 50c and your name and address to: PACOTRONICS, INC., Dept. RE-10 70-31 84th Street, Glendale 27, New York.

PACO DISTRIBUTOR LIST (cont'd.)

- OHIO**
Columbus Whitehead Radio Co.*
Cincinnati United Radio, Inc.
Dayton Sreppo Inc.
Toledo Lifetime Electronics
Warren Radio Co.
Warren Valley Electronics*
Youngstown Armies Electronics
- OKLAHOMA**
Oklahoma City Dulaney's†
- PENNSYLVANIA**
Allentown A. A. Peters, Inc.
Charleroi Barno Radio Co.
Erie Mace Electronics
Harrisburg Electronic Wholesalers, Inc.
Radio Distributing Co.
McKeesport Barno Radio Co.
New Brighton Television Parts Co., Inc.
Pittsburgh House of Audio*
Marks Parts Co.†
Metropolitan Distributors, Inc.
Opus One*
Reading George D. Barbey Co.
State College Alvo Electronics Dist. Inc.*
Tarentum Huston TV Parts Co.
Wilkes-Barre General Radio & Elec. Co.
- RHODE ISLAND**
Providence Electronic Distributors, Inc.
Radio Shack Corporation
- SOUTH CAROLINA**
Columbia Hi-Fi Sound & Records Co.*
Southeastern Radio Parts
- SOUTH DAKOTA**
Rapid City Dakota Electronics
- TENNESSEE**
Chattanooga Curle Radio Supply
Columbia Randolph & Williams†
Knoxville Smith Electronics Supply Inc.†
Nashville Electra Distributing Co.*
Randolph & Ricet
- TEXAS**
Abilene R & R Electronics Co.
Amarillo R & R Electronics Co.
Austin Modern Electronics Co.
Service Electronic Supply
Bay City R. C. & L. F. Hall, Inc.
Baytown R. C. & L. F. Hall, Inc.
Beaumont R. C. & L. F. Hall, Inc.
Conroe R. C. & L. F. Hall, Inc.
Corpus Christi Modern Electronics Co.
Wicks Radio Equipment Co.†
Dallas All State Distributors, Inc.†
Grabtree's Wholesale Radio & TV†
Denison Denison Radio Supply
Freeport R. C. & L. F. Hall, Inc.
Galveston Electrotext
R. C. & L. F. Hall, Inc.
Houston Electrotext
Gilbert Co.
R. C. & L. F. Hall, Inc.
McAllen Rio Radio Supply Co.†
Midland R & R Electronics Co.
Odessa R & R Electronics Co.
Pasadena R. C. & L. F. Hall, Inc.
San Angelo R & R Electronics Co.
San Antonio Modern Electronics Co.
Radio TV Parts Co.†
Sherman Electrotext Supply Inc.
Texas City Electrotext
R. C. & L. F. Hall, Inc.
Wichita Falls R & R Electronics Co.
- UTAH**
Salt Lake City Moore Radio Supply†
- VIRGINIA**
Norfolk Southern Television Corp.†
Richmond Banner Electronics, Inc.†
Industrial Electronic Tube Corp.†
Roanoke Dixie Appliance Co.†
- WASHINGTON**
Seattle Empire Electronic Supply Inc.
Northgate Cameras*
Pacific Electronic Sales Co., Inc.
Radio Products Sales Co., Inc.
Spokane E. M. Johnson Co.
Tacoma Branham Hi-Fi*
Sound Center*
- WASHINGTON, D. C.**
Elec. Wholesalers, Inc.
Rucker Electronic Products Inc.
Arlington, Va., Key Electronics
Rucker Electronic Products Inc.
College Park, Md. Rucker Elec. Prod. Inc.
Silver Spring, Md. Kenyon Elec. Corp.†
Rucker Electronic Products Inc.
Silver Spring Electronic Supply
- WISCONSIN**
Milwaukee Acme Radio Supply
West Allis Hi-Fi Salon*
- WEST VIRGINIA**
Beckley Chemcity Electronic Dist. Inc.†
- EXPORT:**
Morhan Exporting Corp., New York, N. Y.
- CANADA:**
Atlas Radio Corp., Toronto, Ontario
- *Hi-Fidelity Equipment Only
†Test Equipment Only



For free illustrated PACO catalog write:
Paco Electronics, Dept. RE-10
70-31 84th Street, Glendale 27, N. Y.
A subsidiary of PACOTRONICS, INC.

An Integrated Antenna

Field-Test Report by our Service Editor, Jack Darr

I HAVE ALWAYS FAVORED ANTENNA BOOSTERS (mounted on the antenna itself). Now the Winegard Co. has come up with what looks to me like a logical step. The antenna booster is *designed as part of the antenna!* This new antenna is called the Powertron, and comes in several models. The P-44, which is the one we tested, is a 14-element all-channel Yagi, similar in design to the company's CL-4. The antenna booster uses a single ECC88/6DJ8 tube, and a gain of 14 db is claimed for the amplifier. (This seems a reasonable figure, to us. We were making some tests on signal propagation at the time, using another older antenna and a 4-tube antenna booster. Pictures received with the P-44 were equal to those from the more elaborate rig, and the signal strength on the field-strength meter showed only a very slight loss!)

Two other models add more directors to the basic P-44. The P-44X has 21 elements and the SP-44X no less than 30 elements.

More recently, the company has put out a trio of transistorized Powertrons: the P-55, a 14-element antenna; the P-55X with 21 elements, and the SP (Super-Power) 55X, a 30-element antenna. The transistor types were not available when I ran my test on the P-44.

Mechanical construction of this antenna is very sturdy, and, while this type is not *quite* as convenient as the "snapout" ones, there is very little real assembly work to do. We put it together at the top of a 40-foot tower without any trouble at all. Lead-in terminals on both booster and power supply are of the "no-strip" type.

The booster is designed as an integral part of the antenna: the tapered-T dipole is fed directly to the booster in-

call very good, and equaled any type of antenna so far tested here. This model shows the usual slightly wide frontal lobe common to all-channel Yagi configurations with only three directors—about 60-70°. The larger models will probably bring this down to a very narrow lobe, suitable for use under any condition of co-channel interference. At one time, we picked up three stations on channel 4, simply by rotating the antenna 360°! Each one was quite clear, and there was a minimum of venetian-blind interference.

In a deep-fringe location, front-to-back ratio is often more important than absolute gain. This antenna showed a very good FTB ratio. In fact, the first time we read it, we waited until we could check it for another 2 or 3 days so that we could be sure.

Incidentally, the P-44 does not show any signs of my pet hate in all-channel antennas: *pattern breakup* on the high bands! (An antenna develops three, four or even seven or eight individual lobes, none too usable.) On both high and low bands, the P-44 shows only a single lobe.

Color reception on this antenna was very good. One of the big headaches in color has been standing waves on the lead-in, especially with high-gain boosters. This one showed no trace of ringing or ghosts on any channel.

We used our regular stations for the test: channel 5, 85 miles away; channel 6, 95 miles; channels 4 and 11, 20 miles (all distances airline, of course), and even our favorite freak, channel 8 from 206 miles away! This last comes in regularly, and even snowfree once in a while! Reception was very good on all, despite some highly disturbed weather during most of the test. END

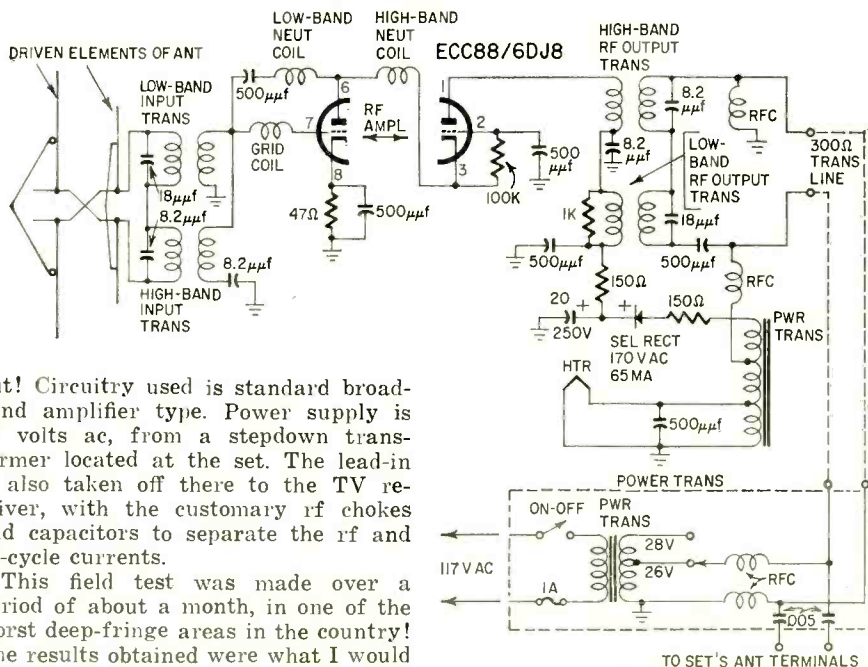

put! Circuitry used is standard broad-band amplifier type. Power supply is 24 volts ac, from a stepdown transformer located at the set. The lead-in is also taken off there to the TV receiver, with the customary rf chokes and capacitors to separate the rf and 60-cycle currents.

This field test was made over a period of about a month, in one of the worst deep-fringe areas in the country! The results obtained were what I would

HOW TO PLACE YOUR STEREO SPEAKERS

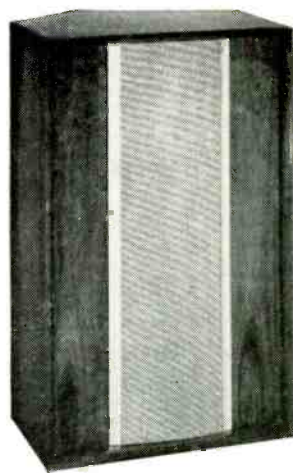

The Patrician by
Electro-Voice.

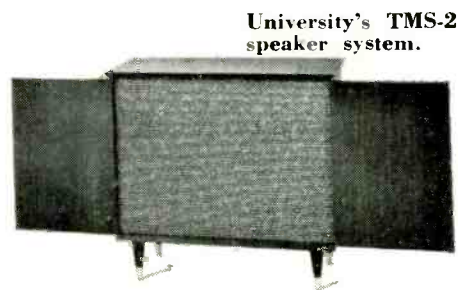

University's TMS-2
speaker system.

The inside story on how to select and use stereo speakers to get the most in listening pleasure

By **GEORGE L. AUGSPURGER**

THE ANNOUNCEMENT OF AN APPROVED system for broadcasting stereo sound on a single FM channel is already stimulating new interest in stereo reproduction. All the questions asked when disc stereo was first introduced commercially will be asked again. Those who were bored by discussions of stereo speaker placement 2 years ago are trying to find the answers to such questions now.

Fortunately, a lot of the initial confusion that surrounded the mysterious process of stereophonic reproduction has been cleared away. Notions about stereo loudspeakers, for example. Do you remember the profusion of systems, gadgets, formulas and recommendations into which the innocent audiophile was plunged when he investigated the possibility of converting his installation to stereo? There were 101 different methods of hooking up assorted speak-

ers, networks, pads and transformers. And each manufacturer had his own pet loudspeaker arrangement.

Today, while the choice of excellent speakers has never been greater, their selection is far easier. The majority of speaker manufacturers suggest a pair of identical speaker systems as the basic stereo ensemble. This is logical, since the two-channel stereo system we're using is exactly that—two separate but identical channels over which sound can be reproduced.

Basic stereo speaker rules

This brings us to a fundamental axiom: stereo requires two matched speaker systems properly oriented with respect to the listener. This is not quite as inflexible as it sounds, but it is the cornerstone, so to speak. All the fancy patented systems with their reflectors and mixers and directors are variations on this primary axiom. The two speaker systems required for stereo listening don't have to be any special type. They can be single speakers, multiple speakers, small speakers or big speakers.

As an interesting sidelight, a lot of people thought that the trend toward small "bookshelf" speaker systems resulted from the space requirements of stereo installations. But now, with a new wave of interest in stereo, just the opposite seems to be happening. Speaker manufacturers who had practically given up trying to promote their larger models find that audiophiles are once again choosing big boxes and corner horns. A number of outstanding new big speaker systems have been introduced in the last year, and the critical listener with an appetite for the best in sound has a variety of products from which to choose.

But whether they be small or large, modest or expensive, two matched speaker systems are a necessity for your stereo installation. However, there is a difference between *matched* speakers and *identical* speakers. Also, the reference to proper orientation needs further explanation.

The basic axiom for stereo speakers can be expanded to include two sub-rules. These are based on an accumulation of experience and represent pretty general agreement among speaker manufacturers, engineers and audio specialists.

- ▶ Use speakers that sound alike.
- ▶ Place the two speakers so the listener sees an angle of about 40° between them.

Use speakers that sound alike

You will get best possible stereo sound if you use identical speaker systems. The two systems can be installed in separate enclosures, or you may prefer one of the single-cabinet, or "integrated," stereo speaker systems.

Which is better? Answer: It depends.

Single-cabinet stereo speaker systems have a number of advantages. It is often easier to find a place for a single new piece of furniture than a pair of speaker enclosures. The integrated system may offer engineering features that cannot be duplicated with separate enclosures.

For example, University makes a deceptively small cabinet which incorporates deflector panels to bounce the sound off room walls and thus achieve a wide, somewhat diffuse sound source. Bozak made a system using similar deflector panels, but in reverse. Here the panels reflect the sound directly to the listening area. They can be adjusted to focus the sound toward the listener and give the desired amount of diffusion.

The JBL "gon" series (Paragon, Metregon, Minigon) turn the Bozak arrangement inside out and direct the sound from the two speakers inward, reflecting it from a curved panel which is the distinguishing feature of these models. The idea is to control the directional characteristics of the two sound sources so that properly balanced stereo can be appreciated over a larger listening area. The operation of these three types of integrated systems is shown in Fig. 1.

(Continued on page 94)

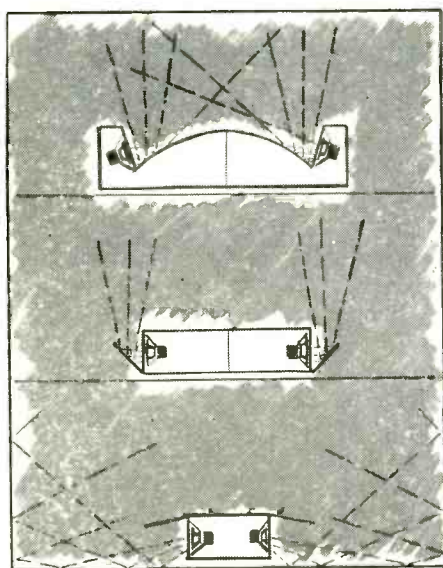
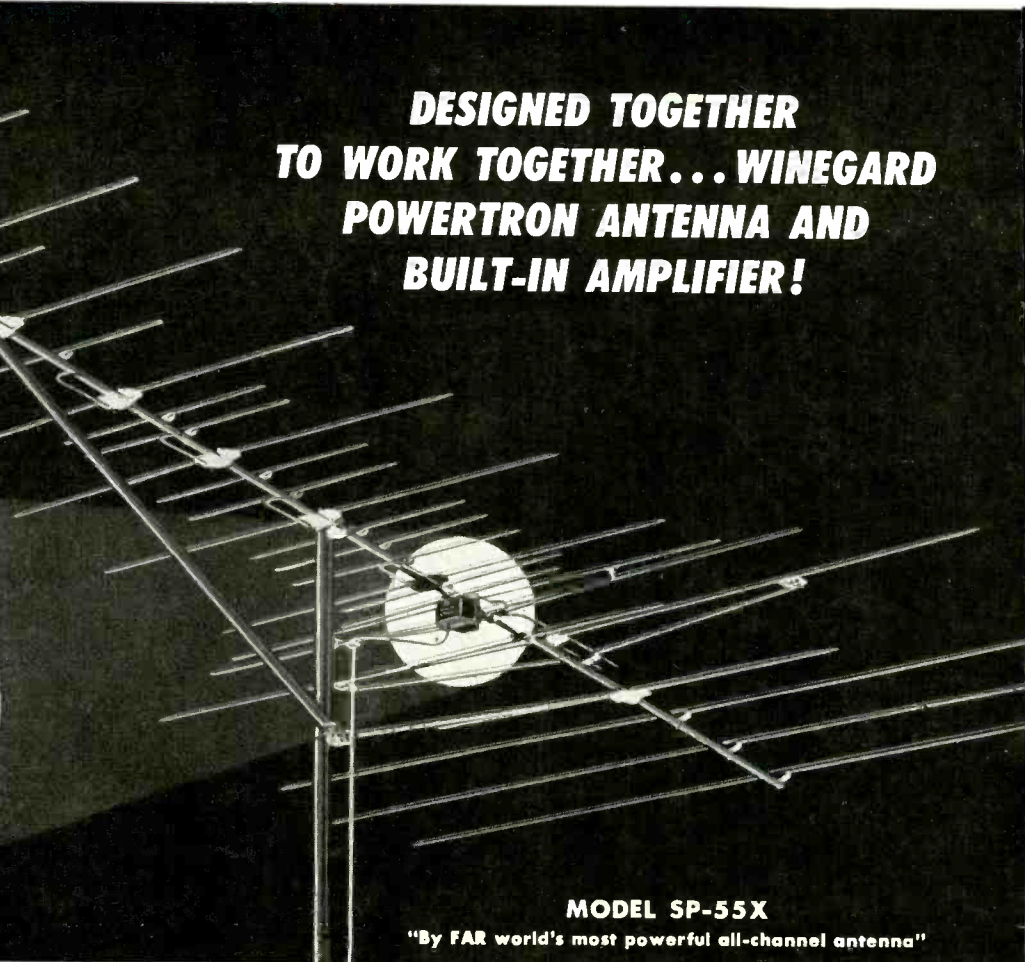
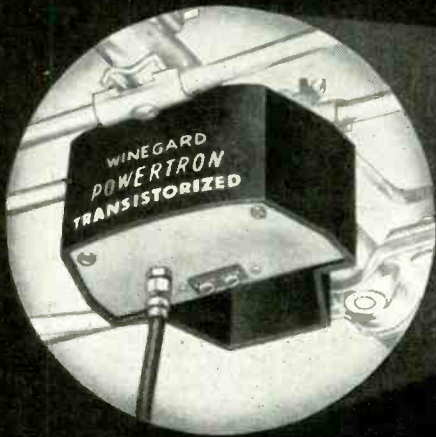

Fig. 1—Three types of integrated speaker systems and their sound radiation patterns. (Top) JBL Metregon, (center) Bozak Stereo Fantasy, (bottom) University TMS-2.

Why the WINEGARD ELECTRONIC MOST EFFECTIVE TV ANTENNA...

**DESIGNED TOGETHER
TO WORK TOGETHER... WINEGARD
POWERTRON ANTENNA AND
BUILT-IN AMPLIFIER!**





TRANSISTORIZED!





MODEL SP-55X

"By FAR world's most powerful all-channel antenna"

WHY? BECAUSE...

-  **IT CAPTURES MORE SIGNAL** than any other all-channel antenna ever made. Patented design, electro-lens director system, dual "TAPERED T" driven elements, 30 precision-tuned elements in all.
-  **IT'S THE ONLY TRUE ELECTRONIC ANTENNA.** Only the Winegard Powertron is built with the amplifier as part of the driven element—not an "add-on" attachment.
-  **IT ELIMINATES ALL SIGNAL LOSS** that normally occurs between the driven element and the amplifier due to transmission and coupling mis-match.
-  **IT BOOSTS WEAK SIGNALS UP OUT OF THE SNOW** far better than any other antenna or antenna-amplifier combination made.

 **FOR VIVID COLOR, HIGH DEFINITION BLACK AND WHITE AND LONG DISTANCE RECEPTION,** nothing can compare to the Super Powertron. Thousands have been installed all over the country and our files are full of testimonials from grateful TV viewers and Service-Technicians alike.

 **WINEGARD IS THE ONLY MANUFACTURER THAT MAKES BOTH ANTENNAS AND RF AMPLIFIERS.** Because of this you can feel confident of getting the very best. But don't take our word for it—let your eyes and ears and field strength meter tell the story.



MODEL P-55
Powertron — transistorized, 14 elements.



MODEL P-55X
Powertron with Pack — Transistorized, 21 elements.



MODEL SP-55X
Super Powertron — transistorized, 30 elements.

POWERTRON is by far WORLD'S

Not 60%...Not 70%...but over 95% efficient

OUTFEATURES — OUTPERFORMS ORDINARY ANTENNAS WITH "ADD-ON" TYPE SIGNAL BOOSTERS!

THIS IS BETTER —



Exclusive amplified "Tapered T" driven element for perfect match and lowest possible signal-to-noise ratio. Only Powertron has it.

THAN THIS —



Not an after-thought "add on" signal booster hung on an ordinary antenna — not an old fashioned mast mounted booster.

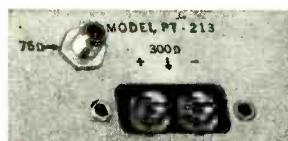

ONLY POWERTRON HAS BOTH 300 OHM TWIN LEAD OR 75 OHM COAX TERMINALS ON BUILT-IN AMPLIFIER.



ONLY POWERTRON GIVES YOU YOUR CHOICE OF TRANSISTORS OR TUBES (TUBE MODELS 300 OHM ONLY).

POWERTRON HAS COMPLETELY AC POWER SUPPLY



Transistorized Model has rectifier and filter in power supply — not in amplifier, where servicing is difficult. No batteries. Costs 27¢ to operate for full year. Battery types require \$5 to \$9 in batteries a year to operate continuously at maximum efficiency.

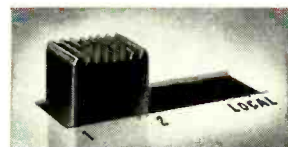

ONLY POWERTRON HAS RANGE CONTROL SWITCH TO PREVENT OVER-DRIVING TV SETS ON EXTRA STRONG CHANNELS.



ONLY POWERTRON HAS AC PLUG-IN OUTLET FOR TV SET BUILT INTO THE POWER SUPPLY.

POWERTRON IS 100% CORROSION-PROOFED — ANTENNA IS GOLD ANODIZED, ALL HARDWARE IRRIDIZED, AMPLIFIER HOUSING OF HIGH IMPACT PLASTIC.

ONLY THE POWERTRON CAN DO ALL THIS!

1. Powertron will drive up to 10 TV sets and each set will have a better picture than an ordinary antenna will deliver to one set.
2. Powertron will drive a TV signal through one-half mile of lead-in with signal to spare—permits you unprecedented flexibility for remote installations.
3. Powertron will virtually eliminate snow and interference even on an old TV set.
4. Powertron will deliver superlative color reception far better than a non-electronic antenna.
5. Powertron brings in stations beyond the reach of non-electronic antennas—delivers greatest reception distance.

OCTOBER, 1961

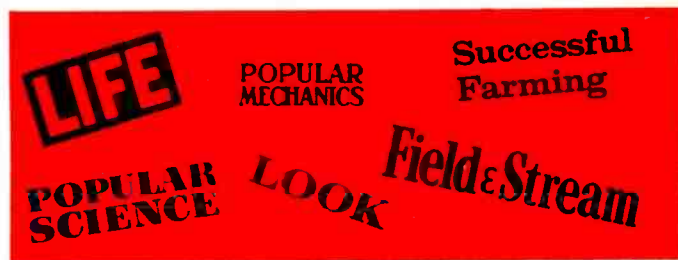

AND WINEGARD POWERTRON is the only antenna presold to your customers—nationally advertised in the biggest consumer advertising campaign yet! So stock up now—take advantage of the demand Winegard is building for you.

Write for free technical bulletins.



Winegard

ANTENNA SYSTEMS

Winegard Co., 3013-10 Kirkwood, Burlington, Iowa

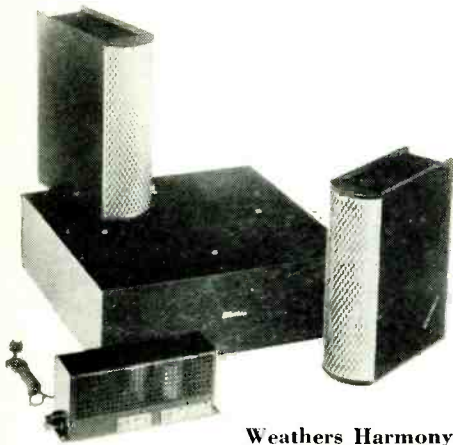

Weathers Harmony Trio SE-60A.

(Continued from page 91)

But an integrated system has its limitations. The University design, for example, can't operate sandwiched between two pieces of heavy overstuffed furniture. The Bozak and JBL models provide a stereo sound source whose width is limited by the size of the cabinet. This in turn establishes how far away you can sit and still enjoy the stereo effect.

A third factor is that most single-cabinet systems try to achieve a diffuse sound source. This satisfies the listener who is annoyed by the effect of two distinct sound sources, but those who like ping-pong stereo are disappointed. (One of the first multiplex demonstrations was a flop because the sound didn't jump back and forth between speakers—it wasn't "stereo".)

Two separate enclosures may not be able to match some of the features of the integrated systems, but they have the advantage that spacing can be adjusted to give best possible results in specific surroundings. Also, if you move or if the furniture is rearranged, the speakers can be relocated too.

If you can't use identical speakers, the next best thing is to use systems which have identical sound characteristics *except* in the low bass region. The sense of directionality is largely lost below 150 cycles or so, and this very low bass content is usually present on both channels of normal stereo material. True enough, some stereo recordings are made with most of the bass funneled through one channel, but you can use the "channel-reverse" switch on your stereo amplifier to feed the deepest bass to the speaker best able to reproduce it, no matter how the material was originally recorded.

Why would anyone want a combination like that? Because it may be the only practical way of utilizing a very large and expensive monophonic speaker system which you already own. An alternate solution is to use the same mid- and high-frequency transducers, together with a smaller woofer, all installed in a smaller enclosure. In either case, the speaker manufacturer will be happy to give you more explicit advice about the combination which will work best in the space you have available.

What about using speakers of different types or different brands? This is skating on thin ice, and I would want to hear the combination or else be awfully sure of results before much money was invested.

This is not to say it can't be done. Remember, the rule is that the speakers should *sound* alike, and surprising combinations sometimes yield acceptable stereo quality. Offhand, I know of a high-quality 8-inch speaker which has a characteristic sound very similar to that of one of the big corner-horn systems. It isn't identical to the big system of course, and it can't begin to duplicate its dynamic range, but so long as the volume control is kept to a reasonable setting the two together make a most pleasing stereo sound.

Two-speaker variations

Since symmetry is desirable, some people want to know if they can keep their present speaker system and flank it with two smaller units. This can be made to work, but it is usually not recommended. Since the side speakers carry most of the sound (and all of the stereo information) their limitations determine the quality of the whole system.

Another variation uses a single woofer in combination with two sets of mid- and high-frequency speakers. The University system already described uses a single woofer. The Weathers Harmony Trio system consists of two small speakers disguised to look a little like books, and a single unusual woofer hidden somewhere in the room.

However, most of the common-bass systems have been supplanted by pairs of compact speakers. Placement, wiring and balancing of the extra low-frequency reproducer are usually more trouble than the novelty is worth.

Speaker placement

Although important, the recom-

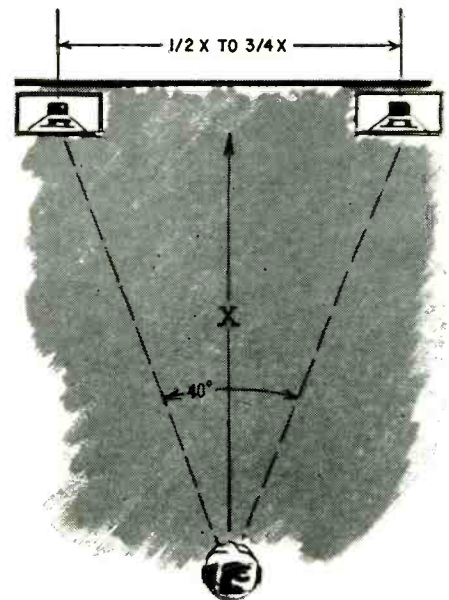

Fig. 2—The optimum listening angle puts the speakers 40° apart.

mended 40° angle needn't be taken literally. There is nothing critical about it. It is easier to remember that the speakers should be separated about half to three-quarters the distance from them to the listener (Fig. 2). The farther the listening area, the farther apart the speakers should be. If the listening area is about 12 feet from the wall where the speakers are to be set, they should be 6 to 9 feet apart. It is as simple as that.

But sometimes the arrangement of a particular room makes it impossible to locate two speakers for best results. Look at Fig. 3. A second speaker can be placed only at A or B. If it is set at A, the speakers are too close together. At B, they are too far apart.

The solution is to use position B for the second stereo speaker, and then set a third speaker at A. This "center-fill" speaker handles a mixture of both

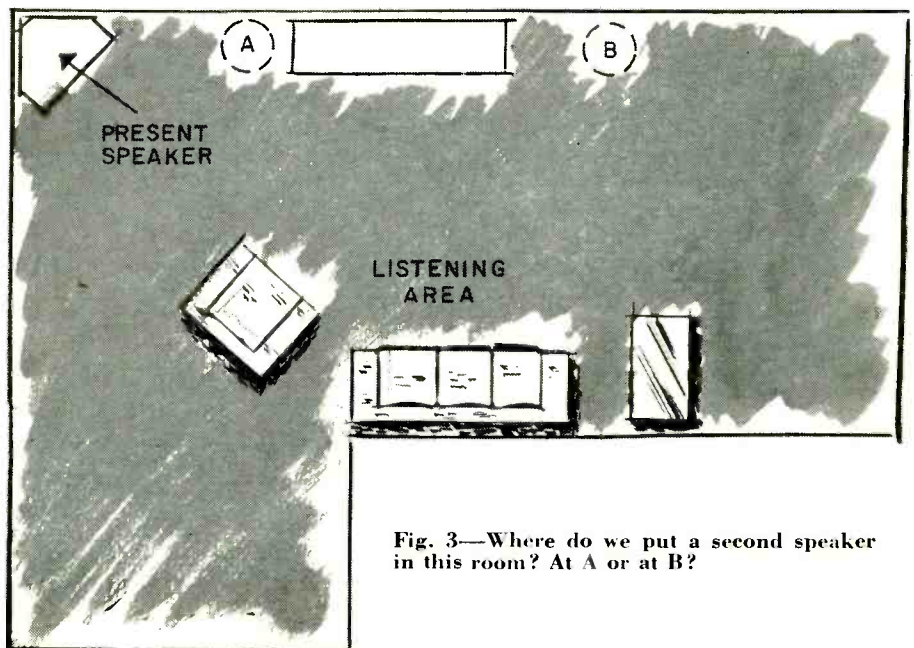

Fig. 3—Where do we put a second speaker in this room? At A or at B?

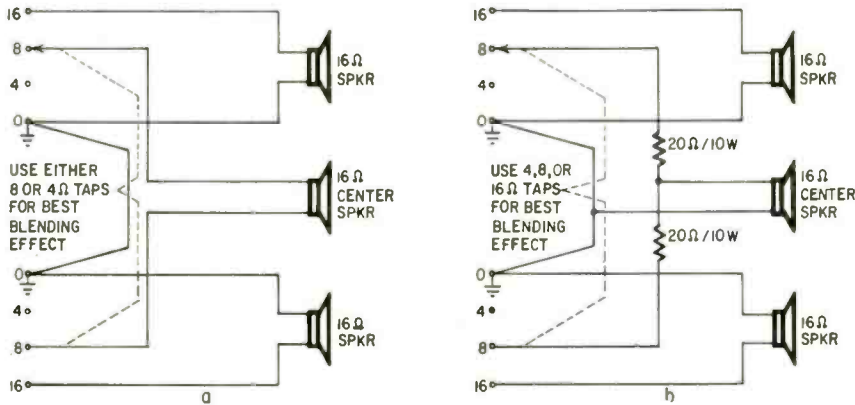

Fig. 4-a—Use this arrangement to feed the center speaker a difference signal. b—This arrangement feeds a sum signal to the center speaker.

stereo channels and effectively fills the "hole in the middle" which would otherwise result from wide speaker spacing.

Some people have the idea that such a three-speaker arrangement is three-channel stereo. This is not so. All commercial stereo program material is recorded on two channels, and no matter how many amplifiers and speakers you add, you still have two-channel stereo. A third speaker merely augments the sound from the basic pair of matched speaker systems.

The easiest way to hook up a third speaker is that suggested by Paul Klipsch and shown in Fig. 4-a. This circuit won't pump much bass through

the center speaker since it feeds a signal consisting of the difference between the two channels, but there is no reason why the two main speakers can't handle all the bass anyway.

If you are a stickler for engineering niceties, you may prefer to feed the sum of the two channels to the center speaker. You can use the circuit in Fig. 4-b, or you can provide a separate amplifier to drive the third speaker. Some stereo amplifiers have a jack for this purpose. The separate amplifier is the best method to use if you want to drive additional monophonic speakers at remote locations.

In working out speaker placement,

whether you use two or three, try to keep the listening area located symmetrically with respect to the speakers. One disadvantage of having only two channels of stereo information is that the effective listening area is fairly restricted. In general, the more directional the speakers used, the smaller the stereo listening area. The integrated stereo speaker systems which use reflecting surfaces to disperse the sound are generally better in this respect than two individual speaker systems.

It is a good idea to keep the speakers near ear level if possible. Stereo is more impressive than monophonic reproduction primarily because of the heightened sense of a live performance. Hearing a jazz combo crammed against the ceiling, or a coloratura soprano trilling from the bottom shelf in a bookcase tends to be unnerving.

And one last thing about placement. Only the very low audio frequencies flow around objects. The most important part of the sound spectrum tends to travel like light, in a direct path. Like light, it will be blocked by a solid object between the source and the listener. Again and again lengthy correspondence about a speaker system which was "obviously defective because it doesn't sound at all like it did in the dealer's showroom" finally turned up the fact that it was neatly hidden behind an overstuffed sofa! **END**

TV-RADIO Servicemen or Beginners...

Send for *Coyne's*
7-Volume Job-Training Set
on 7-Day **FREE TRIAL!**



The First
Practical
TV-RADIO-
ELECTRONICS
Shop
Library!

Answers ALL Servicing Problems QUICKLY...
Makes You Worth More On The Job!

Put money-making, time-saving TV-RADIO-ELECTRONICS know-how at your fingertips—examine Coyne's all-new 7-Volume TV-RADIO-ELECTRONICS Reference Set for 7 days at our expense! Shows you the way to easier TV-Radio repair—time saving, practical working knowledge that helps you get the BIG money! How to install, service and align ALL radio and TV sets, even color-TV, UHF, FM and transistorized equipment. New photo-instruction shows you what makes equipment "tick". No complicated math or theory—just practical facts you can put to use immediately right in the shop, or for ready reference at home. Over 3000 pages; 1200 diagrams; 10,000 facts!

SEND NO MONEY! Just mail coupon for 7-Volume TV-Radio Set on 7-Day FREE TRIAL! We'll include the FREE BOOK below. If you keep the set, pay only \$3 in 7 days and \$3 per month until \$27.25 plus postage is paid. Cash price only \$24.95. Or return set at our expense in 7 days and owe nothing. Either way, the FREE BOOK is yours to keep. Offer limited, so act NOW!

"LEARNED MORE FROM THEM THAN FROM 5 YEARS WORK!"

"Learned more from your first two volumes than from 5 years work."
—Guy Bliss, New York

"Swell set for either the serviceman or the beginner. Every service bench should have one."
—Melvin Masbruch, Iowa.

FREE DIAGRAM BOOK!

We'll send you this big book, "150 Radio-Television Picture Patterns and Diagrams Explained" ABSOLUTELY FREE just for examining Coyne's 7-Volume Shop Library on 7-Day FREE TRIAL! Shows how to cut servicing time by reading picture-patterns, plus schematic diagrams for many TV and radio sets. Yours FREE whether you keep the 7-Volume Set or not! Mail coupon TODAY!



Like Having An Electronics Expert Right At Your Side!

- VOL. 1—EVERYTHING ON TV-RADIO PRINCIPLES! 300 pages of practical explanations; hundreds of illustrations.
- VOL. 2—EVERYTHING ON TV-RADIO-FM RECEIVERS; 403 pages; fully illustrated.
- VOL. 3—EVERYTHING ON TV-RADIO CIRCUITS! 336 pages; hundreds of illustrations, circuit diagrams.
- VOL. 4—EVERYTHING ON SERVICING INSTRUMENTS! How they work, how to use them. 368 pages; illustrated.

- VOL. 5—EVERYTHING ON TV TROUBLESHOOTING! Covers all types of sets. 437 pages; illustrations, diagrams.
- VOL. 6—TV CYCLOPEDIA! Quick and concise answers to TV problems in alphabetical order, including UHF, Color TV and Transistors; 868 pages.
- VOL. 7—TRANSISTOR CIRCUIT HANDBOOK! Practical Reference covering Transistor Applications; over 200 Circuit Diagrams; 410 pages.

ALL 7 BOOKS HAVE BRIGHT, MODERN, VINYL CLOTH WASHABLE COVERS

FREE BOOK—FREE TRIAL COUPON!

Educational Book Publishing Division
COYNE ELECTRICAL SCHOOL

1455 W. Congress Parkway, Dept. A1-RE, Chicago 7, Illinois

Yes! Send me COYNE'S 7-Volume Applied Practical TV-RADIO-ELECTRONICS Set for 7-Days FREE TRIAL per your offer. Include "Patterns & Diagrams" book FREE!

Name _____ Age _____

Address _____

City _____ Zone _____ State _____

Check here if you want Set sent C.O.D. Coyne pays postage on C.O.D. and cash orders. 7-Day Money-Back Guarantee.

Coyne ELECTRICAL SCHOOL 1455 W. Congress Parkway Dept. A1-RE, Chicago 7, Illinois

Unusual Relay Circuits

Fourth of a series, this article discusses sophisticated circuits—alternators, pulse generators, counters and flip-flops

Besides their more familiar functions relays are used in many industrial applications calling for more sophisticated circuits. Among them are the special sequence circuits, selection and counting circuits, alternators, pulse generation and stretching, and special functions that are not in these categories.

One special circuit is the wavefront relay shown in Fig. 1. It energizes when ac is applied and the capacitor demands a heavy charging current. This current keeps the relay energized. But as the capacitor charges, the current drops and the relay opens. Now it cannot be energized again until the ac is removed and the charge on capacitor C leaks off through the resistor. Actual component values depend on the relay and how long it must be energized, but can easily be determined. The value of the capacitor, in excess of the minimum required to energize the relay, determines how long the relay remains energized.

Another interesting circuit is shown in Fig. 2. This is a time proportional relay. It is arranged so that the time the relay remains energized after the control voltage is removed depends on how long the voltage was on in the first place. The capacitor cannot charge rapidly because of the reversed diode. Only backward leakage in the diode charges the capacitor. If the control voltage remains on a long time, the capacitor can gain enough charge to hold the relay closed for a considerable time after the control voltage is re-

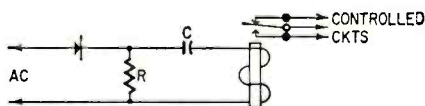

Fig. 1—Wavefront relay energized once each time ac is applied.

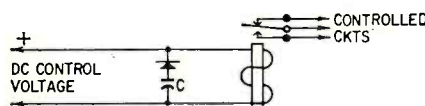

Fig. 2—Time-proportional relay holds in after control voltage is removed. Holding time is proportional to time voltage was applied.

moved. Again the actual values needed depend on the relay.

Fig. 3 is a useful circuit. It prevents accidental reversal of a dc supply. This is needed where devices would be damaged by such a reversal. In Fig. 3 the sensitive relay is not normally energized, since the voltage is blocked by the diode. But if the input polarity is reversed, the sensitive relay energizes rapidly and activates the heavy-duty relay which immediately opens the dc supply circuit. The contacts of the heavy-duty relay must carry the current normally drawn through them.

Many special circuits can be designed. But most industrial applications call for fairly well established functions that can be handled by the relays. For example, alternate circuits are frequently used in industry. Often several devices that can do the same job equally well are available, but one is kept on standby. However, a completely idle unit might deteriorate and provide no safety margin. To prevent this, an alternator circuit is used to operate both devices equally.

A typical example is a pumping station with two identical pumps. One is needed for intermittent pumping jobs, and the other is a standby. Or one is needed most of the time, the other only once in a while when the load is heavy. An alternator circuit can be used to assure even wear of the pumps. In the first case (Fig. 4), the pumps are started alternately and only one pump runs. In the second case pump 1 is started and both pumps run when demand is heavy (Fig. 5). Pump 2 will be started on the next run. Each time the float demands pumping a ratchet relay is activated. As shown, the ratchet relay remains on as long as the float contacts are closed.

Though shown for two pumps only, the circuits of Figs. 4 and 5 could be readily extended for three, four or more pumps. They could be arranged, not only to alternate which pump will be used, but also to provide a sequence of which pump will be used first, second, third etc.

The same kind of alternator or commutator function can be used with counting circuits, but these are more

complicated than the cam or ratchet type relay circuits.

The next useful function performed by relays is selection. Fig. 6 shows a simple system which can select one of 16 points with only four signals. However, as you can see, this circuit has the disadvantage that the first relay needs only one set of contacts and the last eight sets. Fig. 7 shows how this circuit can be rearranged to equalize the number of contacts. With an equal number of contacts, the relays will all operate at the same speed and with the same holding margin.

Selection often calls for pulse operation. We can operate a relay with one pulse and release it with the next, provided the pulses are matched to the operating speed of the relay. Fig. 8 shows how this can be done. In Fig. 8-a, the first positive pulse locks the relay, the second releases it. This circuit is sensitive to pulse length. In Fig. 8-b, a positive pulse locks the relay, a negative pulse unlocks it. The flip-flop in Fig. 13 (it is discussed later) is one means of producing alternate positive and negative pulses.

Another way to do the job is with two coils on the relay. One coil is used for energizing, the second for holding. Shorting the first coil will reduce holding power enough to let the relay drop out. Two winding coils are generally found only in telephone type relays.

Another item ostensibly available only in telephone relays but used extensively in circuits shown here is the make-before-break contact. To get this in an industrial type relay we adjust a normally closed and normally open contact to overlap.

Counting circuits can also handle selection, so let's look at some counting circuits and see how they operate. Out

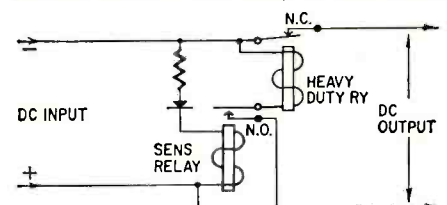
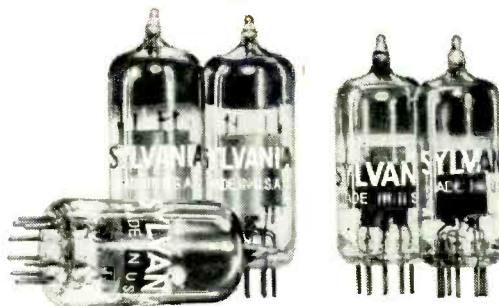

Fig. 3—Polarity sensitive circuit protects against reversal of dc supply.



18FW6 A
 18FX6 A
 18FY6 A
 32ET5 A
 36AM3 B

SYLVANIA BEATS THE HEAT

Familiar numbers, aren't they? But the "A" and "B" versions are brand-new . . . introduced by Sylvania to help you hold onto your home radio service profits.

The 100-mA heater concept, pioneered by Sylvania, offers "cool" operation in series-string connection. But "series-string," as you know, can be pretty hard on heaters at the instant of "turn-on"; can shorten tube life; can mean a callback. Now, Sylvania has incorporated significant controls on warm-up time of the heaters. Surge voltages on any one heater in this 5-tube complement are therefore minimized, expectant tube life is extended. Benefits to you? Obvious . . . high probability of mighty few callbacks due to *Sylvania tube* failure.

You too can beat the heat of profit-burning callbacks. Don't just order "tubes." Always order SYLVANIA TUBES. Electronic Tubes Division, Sylvania Electric Products Inc., 1740 Broadway, New York 19, N. Y.

New, improved 100-mA AC-DC tubes feature controlled heater warm-up time . . . increased heater life . . . defeat profit-burning callbacks!



SYLVANIA

SUBSIDIARY OF

GENERAL TELEPHONE & ELECTRONICS



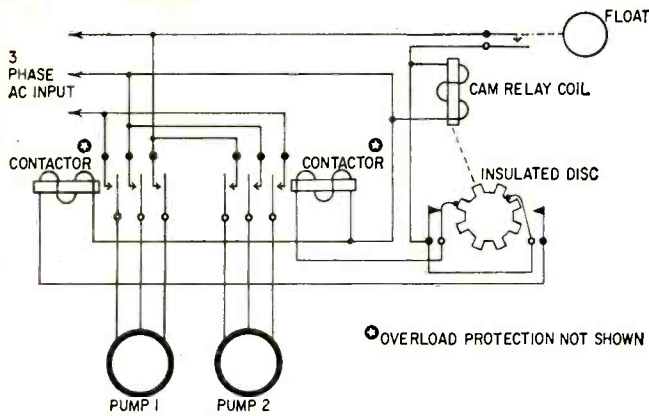

Fig. 4—Simple alternator circuit. Each time float closes pumping circuit, cam relay steps, alternating between pump 1 and pump 2.

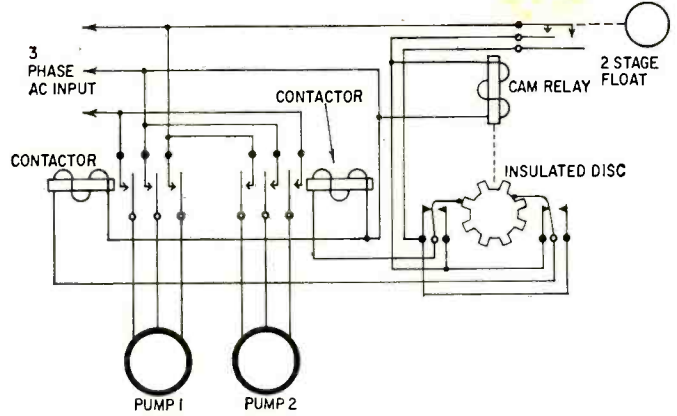

Fig. 5—With 2-stage float, this alternator determines which pump starts first. Each time float closes top contact, cam relay alternates contacts. When demand increases, closing second float contact, other pump starts.

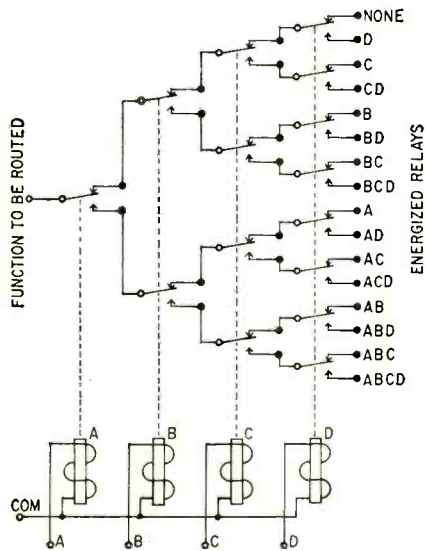

Fig. 6—Cascading relay contacts allows control of 16 points with only four signal inputs.

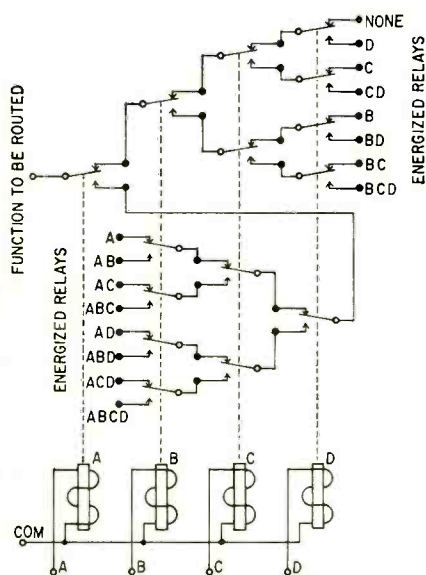

Fig. 7—Rearranged contacts can allow the same selection as in Fig. 6, but with more even distribution of relay contacts.

must have a simple circuit to generate a pulse each time we push a button. Fig. 9 shows such a circuit. The duration of the pulse is controlled by selecting a relay with a desired operating speed and adjusting the make-before-break contact fingers.

A simple bi-directional counting circuit is shown in Fig. 10. (Single-direction counting circuits are shown in Figs. 11 and 12.) In Fig. 10, two relays are used per step. Each time a pulse is fed into input 1, the circuit adds one step. Each time a pulse is fed into input 2, the circuit subtracts a step, no matter what the total circuit situation. The first pulse to arrive energizes RY1, which is then connected across the line in series with RY2. This connects the pulse line to RY3 and the next pulse energizes that relay and RY4 and so on. When all relays are locked and a pulse arrives at input 2, RY5 is virtually shorted and drops out, also dropping out RY6 and so on. Only three steps are shown, but there is no practical limit to how many steps can be used. Note that the circuit is ideal for counting a difference of incoming pulses from two sources.

A simple unidirectional pulse-operated counting chain is shown in Fig. 11-a. Each pulse adds an energized relay to the chain until all of them are on. Turning the relays off requires a momentary interruption of the supply. Fig. 11-b shows how the same operation requires two relays if the make-before-break contacts are not used.

Fig. 12 is a similar counting circuit, but here the relays are not locked together. Instead, each relay when energized turns off the previous relay. Again the pulses must be measured. This counting circuit is what is known as a round-and-round chain. It is so arranged that when RY4 is energized, RY1 is released and ready to be energized, and the cycle starts over again. In fact, with a steady voltage instead of pulses on the pulse line, the circuit would continue to cycle. The relay contacts shown at the bottom of the diagram can be used to generate pulses. Pulse duration depends on relay characteristics. With a slow relay in

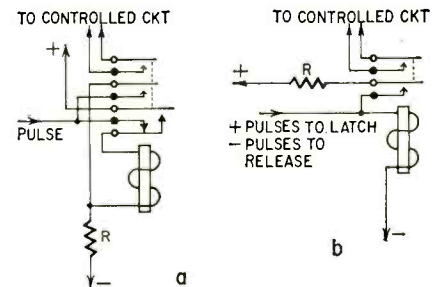

Fig. 8—These arrangements can replace 2-coil relay. a—first pulse locks relay. Next pulse releases it. Pulses must be measured. b—Positive pulse locks relay. Negative pulse unlocks it.

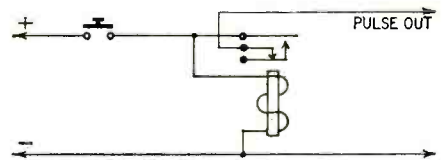

Fig. 9—Simple circuit produces a single pulse each time button is pressed.

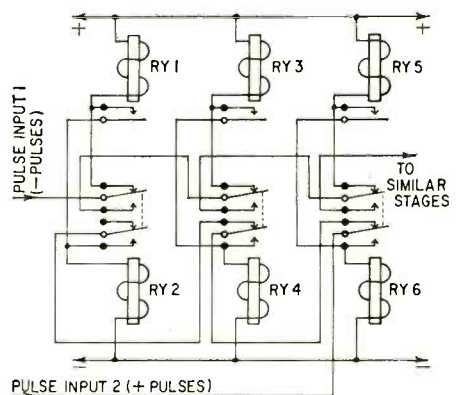
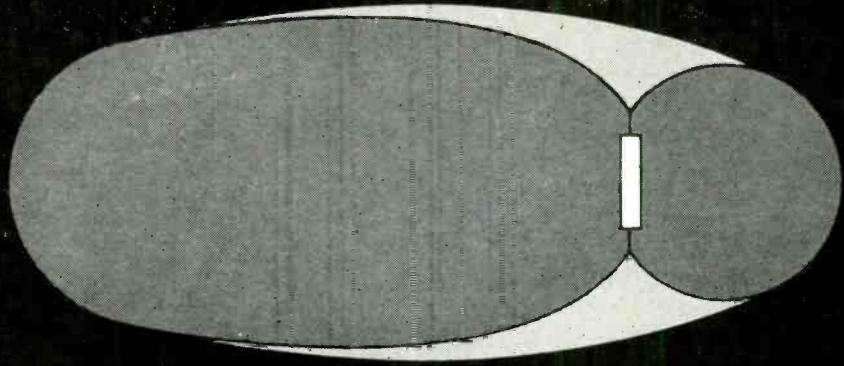

Fig. 10—Progressive lock and unlock circuit uses two relays per step.

the chain, for example, a kind of loping rhythm can be developed. This circuit is excellent for life-testing relays since they cycle as fast as they can operate, and an enormous number of relay operations can take place in a day. To make the chain longer than shown, RY4 is not returned through the normally closed contact on RY1, but in-

sound solution

new sound columns reduce acoustic feedback and reverberation to insignificant levels... offer the highest power-handling capacity and widest frequency response in the industry.



NEW UNIVERSITY UNILINE acoustically-tapered p.a./hi-fi sound columns

BUT FIRST THINGS FIRST. WHAT IS A SOUND COLUMN?

THEORY: Essentially, a sound column is an in-line radiator using multiple speakers, one above the other, to provide broad horizontal dispersion and narrow vertical dispersion. The shape of the beam is similar to that of a fan held horizontally, its apex representing the source of the sound. As a result of its restricted vertical dispersion pattern, the sound is placed **only where it is needed**, avoiding reflections from the ceiling and floor to reduce acoustic feedback and reverberation.

PRACTICE: Theoretically, all sound columns should perform with equal success—but they don't. What makes the difference? The degree of uniformity of the beam in the upper frequency range. In ordinary sound columns, the higher the frequency, the narrower the beam. Consequently, some means must be provided to reduce excessive high frequency beaming.

Only UNILINE offers **acoustic tapering**, the most perfect method yet devised for preventing uneven high frequency dispersion! UNILINE reduces acoustic feedback and reverberation to virtual **non-existence**, thus solving your difficult microphone and speaker placement problems. And only UNILINE offers power-handling capacity **up to 150 watts**... with frequency response ratings as wide as 35-17,000 cps! (Special voice frequency model available.)

For optimum dispersion at **all** frequencies, for uniform sound level within the beam, for music and speech, indoors and out... for **all** high reverberation areas... specifications and performance reveal that there is only one **best** line of sound columns—it is UNILINE.

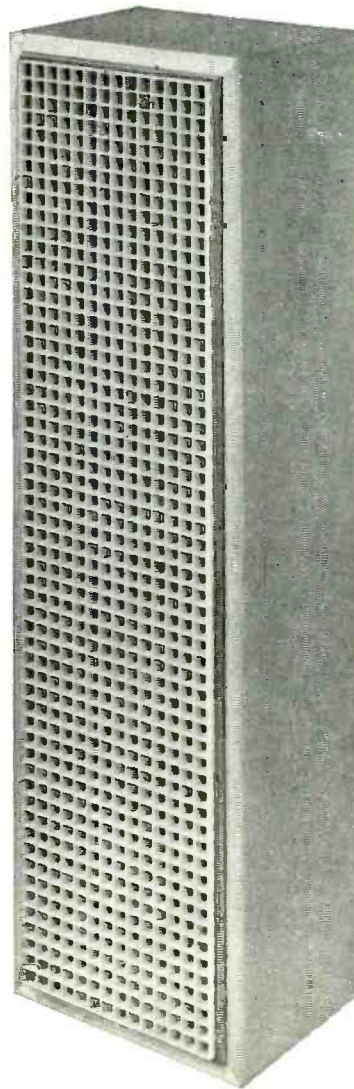

MODEL UCS-6—MUSIC & SPEECH

60" Column
(6 extended-range 8" speakers)
Frequency Range: 35-17,000 cps
Power Capacity: 150 watts IPM
Impedance: 16 ohms
Vertical Angle: 16°
Horizontal Angle: 120°
Dimensions: 58½" x 10" x 7"

MODEL CS0-6

Same as above, but completely weather-proof for outdoor installations.

MODEL CS-4—MUSIC & SPEECH

40" column
(4 extended-range 8" speakers)
Frequency Range: 45-17,000 cps
Power Capacity: 80 watts IPM
Impedance: 8 ohms
Vertical Angle: 22°
Horizontal Angle: 120°
Dimensions: 39¼" x 10" x 7"

MODEL CS-3—SPEECH

40" column
(Special, multi-design speakers for speech applications)
Frequency Range: 150-10,000 cps
Power Capacity: 40 watts
Impedance: 8 ohms
Vertical Angle: 22°
Horizontal Angle: 120°
Dimensions: 39" x 8" x 6"

SLATED FOR AUGUST DELIVERY!

For complete specifications on all four of the new UNILINE Models, contact your UNIVERSITY representative or write:
Desk J-10,
University Loudspeakers, Inc.,
80 S. Kensico Ave.,
White Plains, New York.



A Division of Ling-Temco Electronics, Inc.

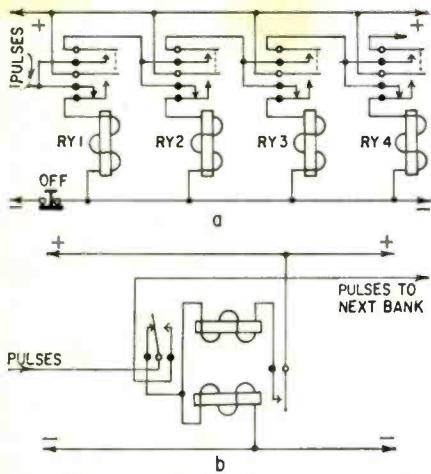

Fig. 11—*a*—Simple lock-up counting chain. *b*—Two relays are needed without make-before-break contacts.

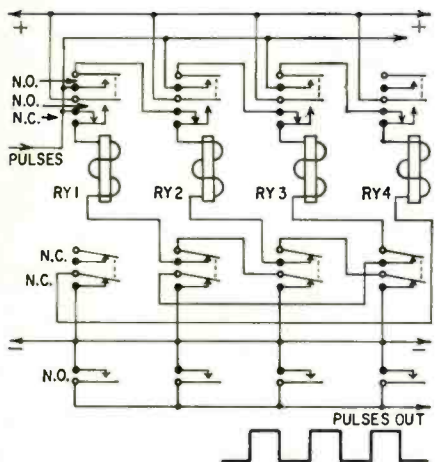

Fig. 12—Pulse lock-up-lock-down chain. Only one relay is energized at a time.

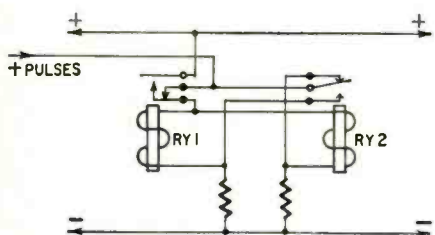

Fig. 13—Basic two relay flip-flop.

stead is connected as RY2 and 3 are.

Sequence control can be handled by counting chains when the pulses are derived from the operated devices in turn, as may be desirable when these devices can also be activated by other controls such as pressure switches, etc. The chain then prevents premature operation.

Selection can be handled by a counting chain since the device to be selected can be represented by a number of pulses equal to the position of its control relay in the chain. In such circuits, a slow-release relay is usually added. It disconnects the control voltage from the function by remaining energized as long as pulses come in. This prevents all devices from operating one after another as the proper one is selected.

A basic counting circuit not sensitive

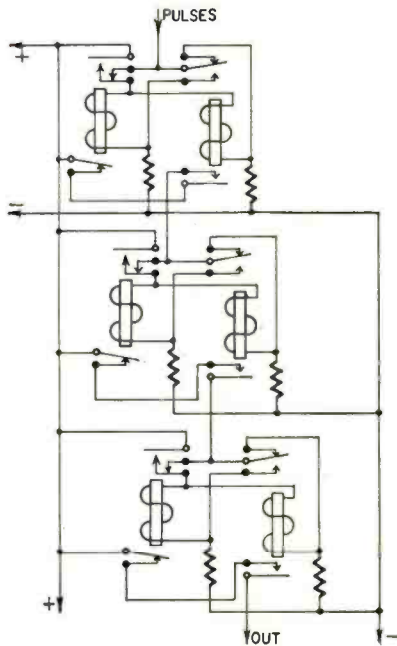

Fig. 14—Binary counter built from relay flip-flops.

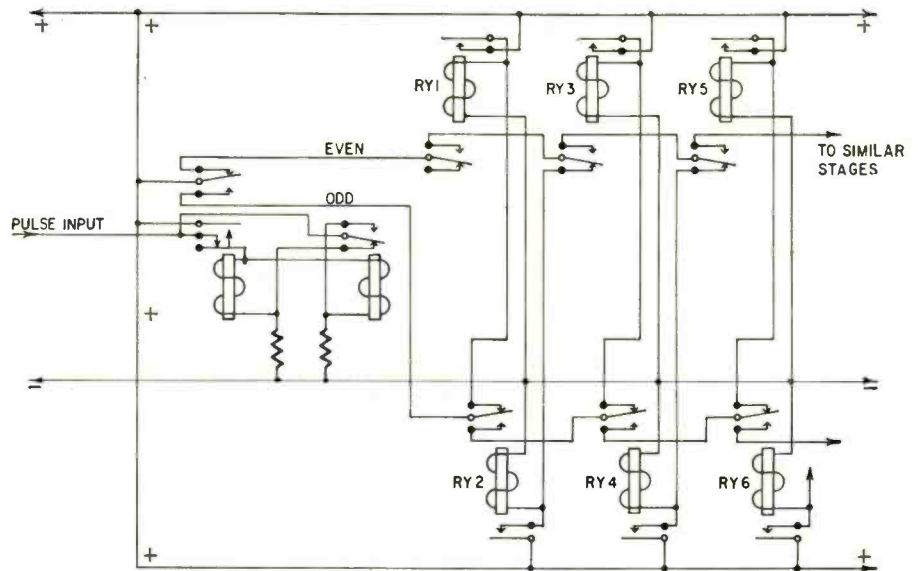

Fig. 15—Odds and evens counter uses flip-flop and one relay per stage.

to pulse length is the relay flip-flop shown in Fig. 13. The first pulse arriving energizes RY1 and through the make-before-break contact locks this relay. RY2 does not energize as it is shorted by the pulse. But as soon as the pulse stops, RY2, being parallel to RY1, energizes. When the second pulse starts, the two ends of RY1's coil see the same potential and this relay drops out. This transfers the holding circuit for RY2 back to the pulse line. When the second pulse stops, RY2 drops out. In two pulses the circuit is back to its original state. Note that with a spdt contact on one of the relays, an alternate positive or negative voltage could be provided for every pulse. Since it is a typical binary, the relay flip-flop can be used for binary counting when built into chains, as shown in Fig. 14.

This circuit can also be used as a frequency divider, each stage dividing the pulse frequency of the previous

one by two.

The flip-flop circuit can be used for other purposes. For example, in Fig. 15 it activates an odd-and-even counter which has one relay per count. Another practical use is in selecting loads. When connected as in Fig. 16, with a switch instead of a pulse circuit, four loads can be selected, depending on the position of the switch, since the relay position changes at the beginning and the end of each pulse.

There you have some of the counting, selecting, commutating and special circuits that can be built with relays. Many other circuits are possible, and the ones shown here were selected to give an overview of relay use in these functions. Early computers were built with relays but vacuum tubes soon replaced them, and now transistors are beginning to take over the computer trade. But, in industry, relays will be with us for a long time. They are basically economical, rugged and quite dependable, fairly easy to maintain and, with the usual conservatism in operation, familiar to industrial circuit

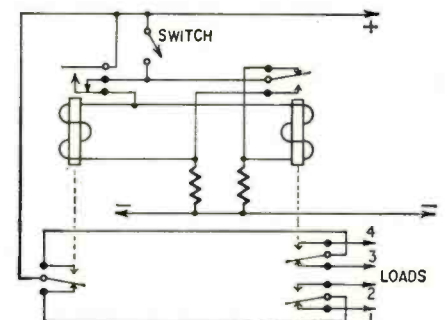

Fig. 16—How the same flip-flop circuit can be used with a switch instead of pulses to select one of four loads.

designers.

One class of relay has been ignored so far since it is a subject all by itself, the induction relay. In the next article in this series we will tell you how, why and where induction relays are used in industrial circuits. END

It's taking the country by storm



With thundering applause... here's what they say...

- "It is the best tube tester I have ever owned."
F. M., MONROE, LA., TV TECHNICIAN
- "It's a real asset to any serviceman." (35 years in servicing)
C. H. W., EAST PRAIRIE, MO., TV TECHNICIAN
- "This is the best checker I have ever used."
E. L. R., HASTINGS, MICH., TV TECHNICIAN
- "A must for every serviceman. A real Time Saver at a reasonable price."
W. P., ERIE, PA., TV TECHNICIAN
- "The most complete and reliable instrument I ever bought for this price."
H. P. R., QUEBEC, CANADA, TV TECHNICIAN
- "I already own one. This is my second Mighty Mite."
PHILCO DISTRIBUTOR, ST. LOUIS, MO.
- "Mighty Mite has paid for itself the first month."
W. C., UNIONTOWN, PA., TV REPAIR
- "I have found the Mighty Mite all that you say it is and more. It tests tubes that my other tester, costing twice as much, will not test."
L. K. E., W9PWQ, CHICAGO, HAM

Don't be misled... there's only one Mighty Mite!

MAGAZINE TEST LABS SAY...

PF Reporter, Nov., 1960, page 65...
"When putting the Model TC109 to work in the lab, I tried to 'trip up' the tester by throwing a few curves at it. Using my prized collection of rejected tubes that have mostly 'tough dog' defects, I proceeded with the tests given in the Sencore instructions." The results: The Mighty Mite found every trouble, even the toughest.

Les Deane

Electronics World, Jan., 1961, page 103...
"We checked two dozen tubes known to be defective. Many had been passed as 'good' by other testers. Each failed at least one of the three tests provided by the TC109. On the other hand, every new tube previously known to be in good condition checked good on the Mighty Mite."



In a nut shell... here's why the Mighty Mite finds them all. It checks tube grid circuits with the same high sensitivity as the indispensable Sencore LC3 Leakage Checker; yet it checks emission, leakage and shorts just like the big, expensive testers. That's why we call it the Mighty Mite... you can't miss!

ONLY 59⁵⁰
DEALER NET

Your Distributor

has them in stock



ALL PARTS MADE **SENCORE** IN AMERICA

SENCORE
ADDISON 3, ILLINOIS

Announcing...

NEW MIGHTY MITE II

Identical to TC109 Mighty Mite with addition of 4 sockets for testing compactrons, nuvistors, novars and 10 pin tubes.

Model TC114..... Dealer Net

67⁵⁰

"ONE DOLLAR" buys As much as \$15 worth—Everything Brand New and sold to you with a money back guarantee.

DEDUCT 10% ON ANY ORDER OF \$10 OR OVER—Plus a FREE SURPRISE PACKAGE

- | | | | |
|--|--|--|--|
| <ul style="list-style-type: none"> <input type="checkbox"/> 1-5" PM SPEAKER \$1
alnico \pm 5 magnet <input type="checkbox"/> 1-4" PM SPEAKER \$1
alnico \pm 5 magnet <input type="checkbox"/> 1-3" PM SPEAKER \$1
alnico \pm 5 magnet <input type="checkbox"/> 1-3 1/2" TWEETER \$1
SPEAKER for HI-FI <input type="checkbox"/> 3-AUDIO OUTPUT \$1
TRANS. 50L6 type <input type="checkbox"/> 2-AUDIO OUTPUT \$1
TRANS 50L6 pushpull <input type="checkbox"/> 3-AUDIO OUTPUT \$1
TRANS. 6K6 or 6V6 <input type="checkbox"/> 2-AUDIO OUTPUT \$1
TRANS. 6K6 push-pull <input type="checkbox"/> 3-AUDIO OUTPUT \$1
TRANS. 3Q4, 3Q5, 3S4 <input type="checkbox"/> 10-CHOKO TRANS. \$1
750, 1 hy, 100 ma <input type="checkbox"/> 5-SETS SPEAKER \$1
PLUGS wired <input type="checkbox"/> 3-I.F. COIL TRANS- \$1
FORMERS 456 kc <input type="checkbox"/> 2-I.F. COIL TRANS. \$1
G.E. \pm RTL143, 456kc <input type="checkbox"/> 3-I.F. COIL TRANS- \$1
FORMERS 10.7mc FM <input type="checkbox"/> 3-I.F. COIL TRANS- \$1
FORMERS 262kc (auto) <input type="checkbox"/> 4-OVAL LOOP AN- \$1
TENNAS ass't hi-gain <input type="checkbox"/> 3-LOOPSTICK ANT. \$1
latest type adjustable <input type="checkbox"/> 3-VARIABLE COND. \$1
super 420/162 mfd <input type="checkbox"/> 3-ASST. SIZES RA- \$1
DIO CHASSIS PANS <input type="checkbox"/> 3-SILICON RECTIFI- \$1
ERS 350 ma <input type="checkbox"/> 12-RADIO OSCILLA- \$1
TOR COILS 456 kc <input type="checkbox"/> 3-1/2 MEG. VOLUME \$1
CONTROLS w/switch <input type="checkbox"/> 5-1/2 MEG VOLUME \$1
CONTROLS less switch <input type="checkbox"/> 5-1 MEG VOLUME \$1
CONTROLS less switch <input type="checkbox"/> 5-50K VOLUME CON- \$1
TROLS less switch <input type="checkbox"/> 5-ASST. 4 WATT \$1
WIREW'D CONTROLS <input type="checkbox"/> 10-ASST. VOLUME \$1
CONTROLS less switch <input type="checkbox"/> 5-ASST. VOLUME \$1
CONTROLS w/switch <input type="checkbox"/> 100-VOLUME CON- \$1
TROL HEX NUTS <input type="checkbox"/> 10-SURE GRIP \$1
ALLIGATOR CLIPS <input type="checkbox"/> 1-GOLD GRILLE \$1
CLOTH 14x14 or 12x18 <input type="checkbox"/> 10-SETS PHONO \$1
PLUGS and PINJACKS <input type="checkbox"/> 2-\$2.50 SAPPHIRE \$1
NEEDLES 5000 plays <input type="checkbox"/> 20-ASST. PILOT \$1
LIGHTS popular types <input type="checkbox"/> 10-PILOT LT. SKTS. \$1
bayonet type, wired <input type="checkbox"/> 50-ASST. TERMINAL \$1
STRIPS 1, 2, 3, 4 lug <input type="checkbox"/> 35-ASST. RADIO \$1
KNOBS, screw, push-on <input type="checkbox"/> 100-ASSORTED \$1
KNOB SET-SCREWS <input type="checkbox"/> 25-ASS'TED RADIO \$1
DIAL POINTERS <input type="checkbox"/> 25-ASS'TED CLOCK \$1
RADIO KNOBS <input type="checkbox"/> 35-ASST. SOCKETS \$1
7 pin, 8 pin, 9 pin <input type="checkbox"/> 25-ASST. PRINTED \$1
CIRCUIT SOCKETS <input type="checkbox"/> 100'-FINEST NYLON \$1
DIAL CORD best size | <ul style="list-style-type: none"> <input type="checkbox"/> 100-ASST. 1/2 WATT \$1
RESISTORS some 5% <input type="checkbox"/> 70-ASST. 1 WATT \$1
RESISTORS some 5% <input type="checkbox"/> 35-ASST. 2 WATT \$1
RESISTORS some 5% <input type="checkbox"/> 50-ASSORTED \$1
FUSES popular sizes <input type="checkbox"/> 50-ASST. TUBULAR \$1
CONDENSERS <input type="checkbox"/> 20-TUBULAR CON- \$1
DENSERS .047-400v <input type="checkbox"/> 15-TUBULAR CON- \$1
DENSERS .47-400v <input type="checkbox"/> 25-TUBULAR CON- \$1
DENSERS .001-600v <input type="checkbox"/> 20-TUBULAR CON- \$1
DENSERS .005-600v <input type="checkbox"/> 20-TUBULAR CON- \$1
DENSERS .01-600v <input type="checkbox"/> 15-TUBULAR CON- \$1
DENSERS .1-600v <input type="checkbox"/> 15-TUBULAR CON- \$1
DENSERS .25-600v <input type="checkbox"/> 10-HV CONDENSERS \$1
.007-1600v <input type="checkbox"/> 3-ELECTROLYTIC \$1
COND. 50/30-150v <input type="checkbox"/> 2-ELECTROLYTIC \$1
COND. 80/80/20-150v <input type="checkbox"/> 10-ASST. RADIO \$1
ELECTROLYTIC COND. <input type="checkbox"/> 5-ASST. TV ELEC- \$1
TROLYTIC COND. <input type="checkbox"/> 2-ELECTROLYTIC \$1
COND. 40/40-450v <input type="checkbox"/> 4-ELECTROLYTIC \$1
COND. 10-450v <input type="checkbox"/> 3-ELECTROLYTIC \$1
COND. 16/16-450v <input type="checkbox"/> 3-ELECTROLYTIC \$1
COND. 30-450v <input type="checkbox"/> 3-ELECTROLYTIC \$1
COND. 80-450v <input type="checkbox"/> 30-FP CONDENSER \$1
MOUNTING WAFERS <input type="checkbox"/> 2-ELECTROLYTIC \$1
COND. 50/50-150v <input type="checkbox"/> 5-ELECTROLYTIC \$1
COND. 25-50v <input type="checkbox"/> 5-ELECTROLYTIC \$1
COND. 100-50v <input type="checkbox"/> 50-100K 1/2 WATT \$1
RESISTORS 10% <input type="checkbox"/> 50-220K 1/2 WATT \$1
RESISTORS 10% <input type="checkbox"/> 50-470K 1/2 WATT \$1
RESISTORS 10% <input type="checkbox"/> 50-2.2 MEG 1/2 W. \$1
RESISTORS 10% <input type="checkbox"/> 20-ASST. WIREW'D \$1
RES. 5, 10, 20 watt <input type="checkbox"/> 40-ASST. PRECISION \$1
RESISTORS 1% <input type="checkbox"/> 35-ASST. DISC CE- \$1
RAMICS best numbers <input type="checkbox"/> 35-DISC CERAMICS \$1
5000 mmf <input type="checkbox"/> 25-ASSORTED MICA \$1
TRIMMER COND. <input type="checkbox"/> 5-DIODE CRYSTALS \$1
2-1N21 1-1N64
1-1N60 1-1N82 <input type="checkbox"/> 4-DIODE CRYSTALS \$1
1-1N34 1-1N60
1-1N64 1-1N69 <input type="checkbox"/> 3-SELENIUM RECT. \$1
2-65ma & 1-75ma <input type="checkbox"/> 2-SELENIUM RECT. \$1
1-100ma & 1-250ma <input type="checkbox"/> 2-SELENIUM RECT. \$1
1-75ma & 1-350ma <input type="checkbox"/> 2-SELENIUM RECT. \$1
1-65ma & 1-450ma <input type="checkbox"/> 1-SELENIUM RECTI- \$1
FIER 500 ma | <ul style="list-style-type: none"> <input type="checkbox"/> 15-ASST. ROTARY \$1
SWITCHES \$15 worth <input type="checkbox"/> 3-TOGGLE SWITCH- \$1
ES spst, dpdt, etc. <input type="checkbox"/> 8-SLIDE SWITCHES \$1
spst, dpdt, etc. <input type="checkbox"/> 1-LB. SPOOL ROSIN \$1
CORE SOLDER 40/60 <input type="checkbox"/> 600-ASST. HDWARE \$1
screws, nuts, riv., etc. <input type="checkbox"/> 200-SELF TAPPING \$1
SCREWS #8 x 1/2" <input type="checkbox"/> 200-6/32 HEX NUTS \$1
& 200-6/32 BOLTS <input type="checkbox"/> 8-ASST. LUCITE \$1
CASES handy for parts <input type="checkbox"/> 10-6' ELECTRIC \$1
LINE CORDS w/plugs <input type="checkbox"/> 5-TV CHEATER \$1
CORDS w/both plugs <input type="checkbox"/> 4-50'SPOOLS HOOK- \$1
UP WIRE 4 colors <input type="checkbox"/> 25-INSULATED \$1
SHIELDED WIRE <input type="checkbox"/> 75-MINIATURE ZIP \$1
CORD 2 conductor <input type="checkbox"/> 32'TEST PROD. WIRE \$1
deluxe (red or black) <input type="checkbox"/> 50-STRIPS ASS'TED \$1
SPAGHETTI best sizes <input type="checkbox"/> 100-ASST. RUBBER \$1
GROMMETS best sizes <input type="checkbox"/> 50'-HI-VOLTAGE \$1
WIRE top quality <input type="checkbox"/> 50' ZIP CORD (2-cond) \$1
#18 brown or ivory <input type="checkbox"/> 200'-BUSS WIRE \$1
handiest size \pm 20 <input type="checkbox"/> 200'-HOOK-UP WIRE \$1
any color <input type="checkbox"/> 500-ASST. SOLDER- \$1
ING LUGS best sizes <input type="checkbox"/> 50-ASST. MICA CON- \$1
DENSERS some in 5% <input type="checkbox"/> 50-ASST. CERAMIC \$1
COND. some in 5% <input type="checkbox"/> 35-MICA COND. 20- \$1
5mmf & 15-25mmf <input type="checkbox"/> 35-MICA COND. 20- \$1
50mmf & 15-68mmf <input type="checkbox"/> 35-MICA COND. 20- \$1
100mmf, 15-270mmf <input type="checkbox"/> 35-MICA COND. 20- \$1
470mmf, 15-680mmf <input type="checkbox"/> 35-MICA COND. 20- \$1
820mmf 15-1000mmf <input type="checkbox"/> 35-MICA COND. 20- \$1
2200, 15-2400mmf <input type="checkbox"/> 35-MICA COND. 20- \$1
3300, 15-4700 mmf <input type="checkbox"/> 35-MICA COND. 20- \$1
6800, 15-10000mmf <input type="checkbox"/> 35-CERAMIC COND. \$1
20-5mmf, 15-10mmf <input type="checkbox"/> 35-CERAMIC COND. \$1
20-25mmf, 15-47 mmf <input type="checkbox"/> 35-CERAMIC COND. \$1
20-56mmf, 15-82mmf <input type="checkbox"/> 35-CERAMIC COND. \$1
20-100, 15-150 mmf <input type="checkbox"/> 35-CERAMIC COND. \$1
20-270, 15-470 mmf <input type="checkbox"/> 35-CERAMIC COND. \$1
20-1000, 15-1500mmf <input type="checkbox"/> 35-CERAMIC COND. \$1
20-2000, 15-5000mmf <input type="checkbox"/> 4-RCA 1U4 TUBES \$1
also serves as a 1T4 <input type="checkbox"/> 3-GENERAL ELEC. \$1
35W4 TUBES <input type="checkbox"/> TOP BRAND TUBES- \$1
1B3, 1X2B, OZ4, 5U4,
6SN7, 6CB6, 6U8, 6J6,
6V6, 6K6, 6X8, 6AX4,
6AC7, 12AT7, 12AU7/ea. | <ul style="list-style-type: none"> <input type="checkbox"/> \$15-'JACKPOT' \$1
TELEVISION PARTS <input type="checkbox"/> 1-70° FLYBACK \$1
TRANS. incl schematic <input type="checkbox"/> 1-90° FLYBACK \$1
TRANS. incl schematic <input type="checkbox"/> 3-\$11 TODD 60° \$1
DEFLECTION YOKES <input type="checkbox"/> 1-\$7 INDOOR TV \$1
ANT. hi-gain 3 sec. <input type="checkbox"/> 100'-TWIN LEAD-IN \$1
WIRE 300Q/heav. duty <input type="checkbox"/> 50'-FLAT 4-COND. \$1
WIRE many purposes <input type="checkbox"/> 20-ASST. TV KNOBS, \$1
ESCUTCHEONS, etc. <input type="checkbox"/> 15-ASST. STANDARD \$1
TUNER VHF STRIPS <input type="checkbox"/> 6-ASST. STANDARD \$1
TUNER UHF STRIPS <input type="checkbox"/> 25-ASST. PEAKING \$1
COILS popular types <input type="checkbox"/> 2-RCA SYNCHRO- \$1
GUIDE COILS #20SR1 <input type="checkbox"/> 1-RCA SYNCHROLOC \$1
COIL #20BT8 <input type="checkbox"/> 2-STANDARD AGC \$1
COILS 1R4AG <input type="checkbox"/> 2-RATIO DETECTOR \$1
COILS 4.5 mc <input type="checkbox"/> 2-RATIO DETECTOR \$1
COILS 10.7 mc <input type="checkbox"/> 2-TV SOUND I.F. \$1
COILS 4.5mc <input type="checkbox"/> 2-SOUND DISCRIMI- \$1
NATOR COILS 10.7mc <input type="checkbox"/> 1-TV VERTICAL OUT- \$1
PUT TRANSFORMER
10 to 1 ratio <input type="checkbox"/> 1-VERTICAL BLOCK. \$1
TRANS. standard <input type="checkbox"/> 4-TV ION TRAPS \$1
good for all TV's <input type="checkbox"/> 4-TV CENTERING \$1
RINGS for back of yoke <input type="checkbox"/> 15-ASST. TV COILS \$1
sync, peaking, width <input type="checkbox"/> 5-TV CRT. SOCKETS \$1
with 18" leads <input type="checkbox"/> 5-HI-VOLT. ANODE \$1
LEADS with 20" leads <input type="checkbox"/> 3-TV CARTWHEEL \$1
CONDENSERS 20 kv <input type="checkbox"/> 2-TV CARTWHEEL \$1
CONDENSERS 30kv <input type="checkbox"/> 3-HV RECTIFIER \$1
SOCKETS 1B3 mounted <input type="checkbox"/> 3-HV RECTIFIERS \$1
SOCKETS 1X2 mounted <input type="checkbox"/> 1-TV FOCALYZER \$1
adjusts any ohmage <input type="checkbox"/> 1-2 MEGOHM RESIS- \$1
TOR 20w for #630 <input type="checkbox"/> 1-SILICON RECTI- \$1
FIER 750 ma <input type="checkbox"/> 2-SILICON RECTIFI- \$1
ERS 500 ma <input type="checkbox"/> 3-TV ALIGNMENT \$1
TOOLS assortment #1 <input type="checkbox"/> 3-TV ALIGNMENT \$1
TOOLS assortment #2 <input type="checkbox"/> 3-TV ALIGNMENT \$1
TOOLS assortment #3 <input type="checkbox"/> 3-TV ALIGNMENT \$1
TOOLS assortment #4 <input type="checkbox"/> 3-TV ALIGNMENT \$1
TOOLS assortment #5 |
|--|--|--|--|

EACH ALIGNMENT TOOL is different & valued at over \$1

HANDY WAY TO ORDER—Simply pencil mark items wanted (X in square is sufficient), enclose with money order or check. You will receive a new copy of these offers for re-orders.

ON SMALL ORDERS—Include stamps for postage, excess refunded. Larger orders shipped express collect.

BROOKS RADIO & TV CORP., 84 Vesey St., New York 7, N. Y.

SERVICE PRICES FOR TV REPAIRS

This list of TV repair costs was published by the Television & Electronic Service Association of Wisconsin. Naturally, it is only a guide and prices will vary somewhat, depending on local conditions. Price lists used by service associations of other states will appear from time to time.

These suggested fees cover diagnosis of trouble, location, installation or repair of component or circuit including mechanical defects. Parts are additional. They are based upon a survey of operational expense of leading service companies, time studies and cost analysis of time required to accomplish the listed service operation on a wide variety of television receivers with operations performed by competent technicians.

Basic Service Fee—Tube Check—Cleaning	
Chassis—Remove and Replace—Set-up	\$ 4.00
1. Ac Input Circuit	7.25
2. Audio Circuit	15.45
3. Automatic-Frequency-Control System	18.90
4. Automatic-Gain-Control System	19.10
5. Control: Single Unit	6.75
Dual Unit	9.75
6. Damper Circuit	11.60
7. Deflection Yoke and Circuit	9.35
8. Filament Circuit	11.65
9. Focus Circuit	9.80
10. Horizontal Oscillator Circuit	17.85
11. Horizontal Output Circuit	14.55

90-Day Parts Guarantee

12. If Amplifier Circuit	13.75
13. Picture Tube: Replacement	9.50
14. Power Supply Circuit (High Voltage)	14.20
15. Power Supply Circuit (Low Voltage)	12.45
16. Power Transformer	10.45
17. Speaker	4.75
18. Selenium Rectifiers	12.25
19. Synchronizing Circuit: (Vert. or Horiz.)	17.60
20. Tuner: (Turret Type)	12.50
21. Tuner: (Wafer Type)	19.50
22. Tuner: Cleaning and Lubrication (Turret Type)	4.25
23. Tuner: Cleaning and Lubrication (Wafer type)	6.25
24. Tuner: Replacement or Removal	12.50
25. Vertical Oscillator Circuit	14.20
26. Vertical Output Circuit	12.20
27. Video Circuit	12.25
28. Retrace Blanking Circuit	8.10
29. Printed Circuits (Concealed Type)	Add \$8.50 to above price
30. Clean Picture Tube (Removal)	3.85

Alignment of Tuned Circuits

31. Video (Complete)	12.59
32. Sound (Complete)	8.75
33. Automatic Frequency Control Circuit	7.75
34. Sound Discriminator Circuits	4.25
35. Tuner: Local Oscillators only	2.00
36. Uhf Tuners	Hourly Rate
"Local Zone" Average Service Fee	7.00
Additional TV Shop Fee—per hour or portion thereof	8.40
Analysis and location of trouble when esti- mate is given and set is not repaired	\$10.00
IWP (In Warranty Parts Exchange Fee)	
50c per part—Minimum Fee	1.20
Storage after 30 days: per month or portion thereof	2.00

Prices Subject to Change Without Notice.
Rev. June 1, 1960

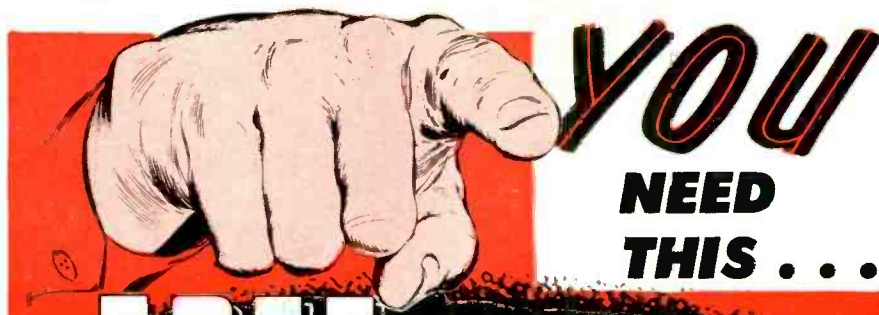

FREE GIANT ALL NEW 1962 BA CATALOG



SAVE UP TO
50% ON B-A
SELECTED
KITS

TOP VALUES
IN POWER
AND HAND
TOOLS

HI-FI AND
STEREO
SYSTEMS &
COMPONENTS

30 PAGES
OF BARGAINS
NOT IN ANY
OTHER CATALOG

**RUSH COUPON
TODAY!**

BURSTEIN-APPLEBEE CO. Dept. RE,
1012-14 McGee St., Kansas City 6, Mo.

Rush me New 1962 B-A Catalog No. 621

NAME _____

ADDRESS _____

CITY _____

STATE _____

MERCURY TV TUNER SERVICE

890-2 River Ave., Bronx 51, N.Y.

"Largest in the East"

VHF-UHF TUNERS

7 Months Warranty

Price Includes Labor & Minor Parts

TUBES & MAJOR PARTS
AT NET PRICES

ALL MAKES
ONE PRICE!

\$9.50

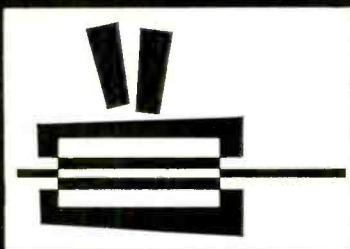

When Shipping Tuner: Include Tubes,
Shields and Damaged Parts.
Give Model Number and State Complaint

PACK WELL AND INSURE
24 HOURS ON POPULAR TYPES



SPORADIC-E OPENS NEW HORIZONS

New technique may provide many more high-frequency radio channels. Radio Free Europe tests are pointing the way

By **STANLEY LEINWOLL***

During the past several months Radio Free Europe schedules have included frequency assignments specifically selected to make use of sporadic-E propagation to reach RFE targets behind the Iron Curtain. These transmissions, initially undertaken on an experimental basis, are expected to have a significant impact on high-frequency communications for the next 5 to 10 years.

Although sporadic-E (E_s) propagation has been known for many years, this is the first time any international broadcast operation has used it in a regular schedule, with antennas specifically suited to exploit this mode of propagation.

This technique has made it possible to schedule frequencies well beyond those ordinarily considered the normal operating range. This effectively expands

available spectrum space, and provides a valuable tool in RFE's continuing effort to combat jamming.

Late last May, Radio Free Europe included a 15-mc frequency in its schedule of Hungarian broadcasts from Biblis, Germany. This was during daylight hours, when the normal maximum usable frequency over this path is of the order of 9 mc.

The maximum usable frequency (MUF) is the highest frequency that is reflected by the regular F-layers of the ionosphere at any given time over a particular circuit. It is generally the highest frequency assigned to a circuit over which some degree of reliability is required. Scheduling a frequency 75% above the MUF as we did in the Biblis tests would result in extremely poor effectiveness figures with satisfactory reception unlikely

more than 5% of the time.

Fig. 1 is an MUF curve for August, 1961. It shows how maximum usable frequency normally varies with time over the Biblis/Hungary path. The 15-mc signals from Biblis were propagated off the E-layer of the ionosphere, making use of a summertime anomaly occurring in the E-layer which is referred to as sporadic-E. While this anomaly has been known for some time, it is not well understood.

Fig. 2 shows the layers of the ionosphere. Most long-distance high-frequency communication takes place via F-layers, most ionospheric absorption in the D-layer.

sphere on a typical summer day. These layers, made up of ionized gases of differing densities, can return obliquely incident radio waves to earth, thus making long-distance high-frequency radio communication possible.

Sporadic-E occurs as clouds or patches of high ionization density which form for no apparent reason, exist for up to several hours at a time, then disappear just as mysteriously. Sporadic-E clouds reflect radio waves of considerably higher frequency than those reflected by the normal F-layers of the ionosphere.

In mid-latitudes, E_s is most prevalent during the summer months, occurring over 50% of the time at mid-day. Many

FIRST REPORT ON A NEW SHORT-WAVE TRANSMISSION TECHNIQUE

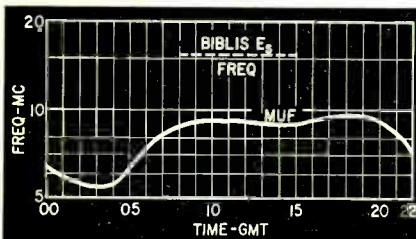

Fig. 1—Curve showing maximum usable frequency over the Biblis, Germany, to Hungary circuit for August, 1961. Radio Free Europe E_s frequency is shown by dashed line.

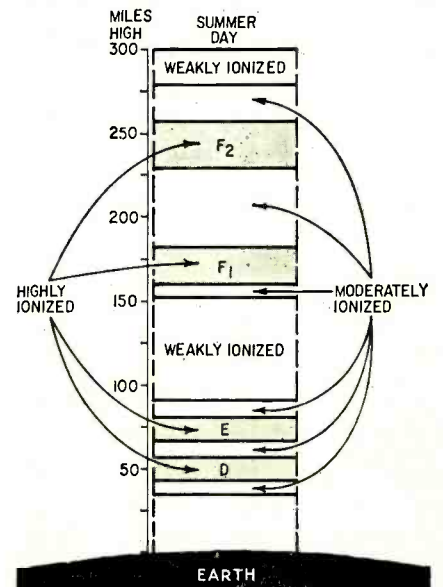

Fig. 2—Ionosphere layers on typical summer day. Most long-distance high-frequency communication takes place via F-layers, most ionospheric absorption in the D-layer.

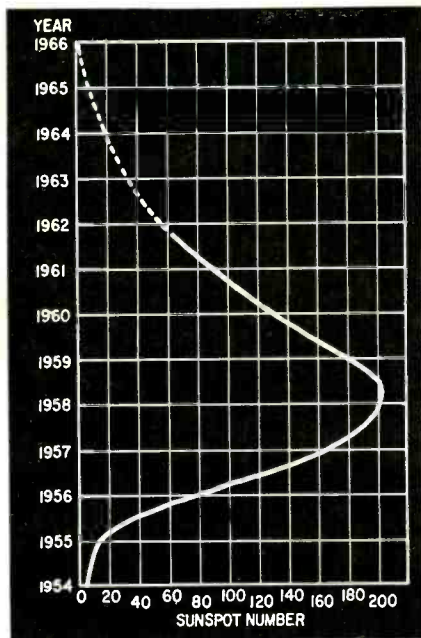

Fig. 3—Sunspot cycle from 1954 to now (solid line). Values to expected sunspot minimum in 1965 (dashed line).

scientists have agreed that sporadic-E is a very important effect, but up to now methods for taking its effects into account have been poor.

Sporadic-E is most evident during years of low sunspot activity. Since MUF's vary with sunspot number, E_s activity is most in evidence when MUF's are low. During years of high solar activity, MUF's are high, normally approaching the upper limit of the short-wave spectrum over many paths. At such times E_s effects are scarcely noticeable in the high-frequency bands.

Fig. 3 shows sunspot activity during the past 7 years. You can see that sunspot numbers have been declining steadily since 1958. The broken line is a projection of the sunspot cycle and indicates that, if the present trend continues, the cycle minimum will occur sometime in 1965. The decrease in sunspot number and the accompanying decrease in MUF will result in a corresponding decrease in the amount of propagationally useful high-frequency radio spectrum. In addition, world-wide demands for additional spectrum space in the high-frequency broadcast bands are expected to double in the coming decade.

The combination of decreasing spectrum space brought about by a decline in sunspot activity and increased demands for spectrum space resulting from an increase in short-wave broadcasts throughout the world has been of great concern to broadcasters, who anticipate that the amount of useful spectrum space will fall far short of what is needed.

About RFE tests

As part of an extensive program to determine what countermeasures can be taken to deal with the problem of the dwindling spectrum, RFE has undertaken a series of tests to find out whether consistent broadcast operation

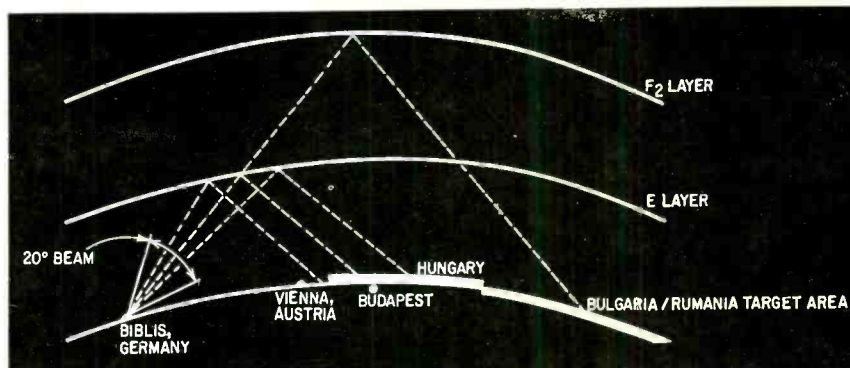

Fig. 4—How antenna designed to cover Rumania-Bulgaria via F₂-layer propagation was used to transmit signals to Hungary via reflection off the E-layer.

above the MUF is possible and practical. Fig. 4 shows how these tests are being conducted.

Since the E-layer of the ionosphere is considerably lower than the F-layers, an antenna with a relatively low radiation angle is required to bounce a signal off the E-layer.

RFE antennas are designed for normal F-layer propagation. Consequently, radiation angles for normal F-layer operation to targets in nearby Central Europe are relatively high. The problem of choosing a proper antenna was solved by scheduling broadcasts to Hungary on an antenna designed for beaming broadcasts to Rumania.

Fig. 4 shows that the vertical radiation angle of the Rumanian antenna is optimum for E-layer propagation of programs beamed to Hungary.

Results thus far have been excellent, with reception comparable to that ob-

available spectrum space at a time when additional channels are a valuable commodity.

Although E_s is observed about 50% of the days during the summer months, the RFE transmissions on 15-mc indicate that the signal is propagated considerably more than 50% of the time leading to the conclusion that, in addition to E_s, some other E-layer propagation mode is also a factor. It has been suggested that the phenomenon be referred to as anomalous E-layer propagation, rather than the misleading E_s.

In addition, using frequencies above the MUF has proved valuable in countering the effects of jamming.

Jamming is defined as the creation and transmission of various kinds of radio interference for the purpose of preventing normal reception of radio broadcasts. The Communists have been jamming Radio Free Europe broadcasts



Radio Free Europe operates this transmitting station in Biblis, Germany.

served on lower frequencies via normal F-layer propagation. At present, plans for incorporating regular E_s transmissions into our schedules are under way.

Although the E-layer of the ionosphere exists principally during daylight hours, E_s activity is observed around the clock during the summer. Tests are under way to determine whether nighttime E_s transmissions above the F-layer MUF are practical.

Irrespective of the results of these nighttime tests, the success of the daytime E_s tests is a significant step toward solving a serious problem for broadcasters. In effect, it expands the

since 1951.

Since most of the jamming transmitters in Central Europe are designed for relatively high-angle operation, we have found that jamming from the satellites during the E_s tests has been relatively ineffective, and that it has been necessary for jammers at more distant locations, principally the Soviet Union, to be called into operation.

In addition to putting an additional strain on the Communist jamming system, the strength of the delivered jamming signal is weaker than it would be were the transmitter located closer to the target areas.

END

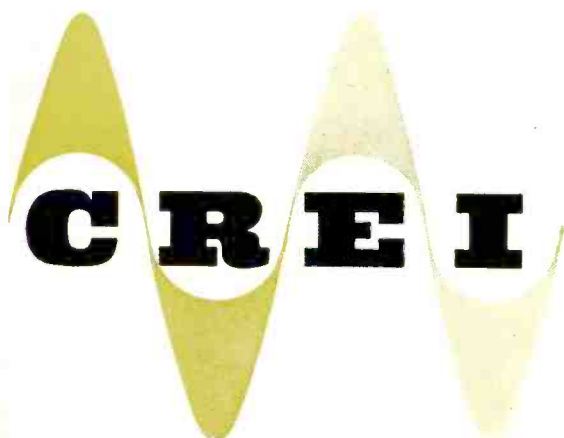

“a CREI home study program helped me increase my salary by a factor of four (4).”

“I am indeed grateful to CREI for my success. Since enrollment in a CREI Home Study Program in Electronic Engineering Technology, I have progressed from a Junior Technician to a recognized and licensed Senior Engineer. My present title is Field Support Manager and my salary has increased by a factor of four (4).”

*Mearl Martin, Jr., SENIOR ENGINEER
Field Support Manager, Tektronix, Inc.,
Portland, Ore.*

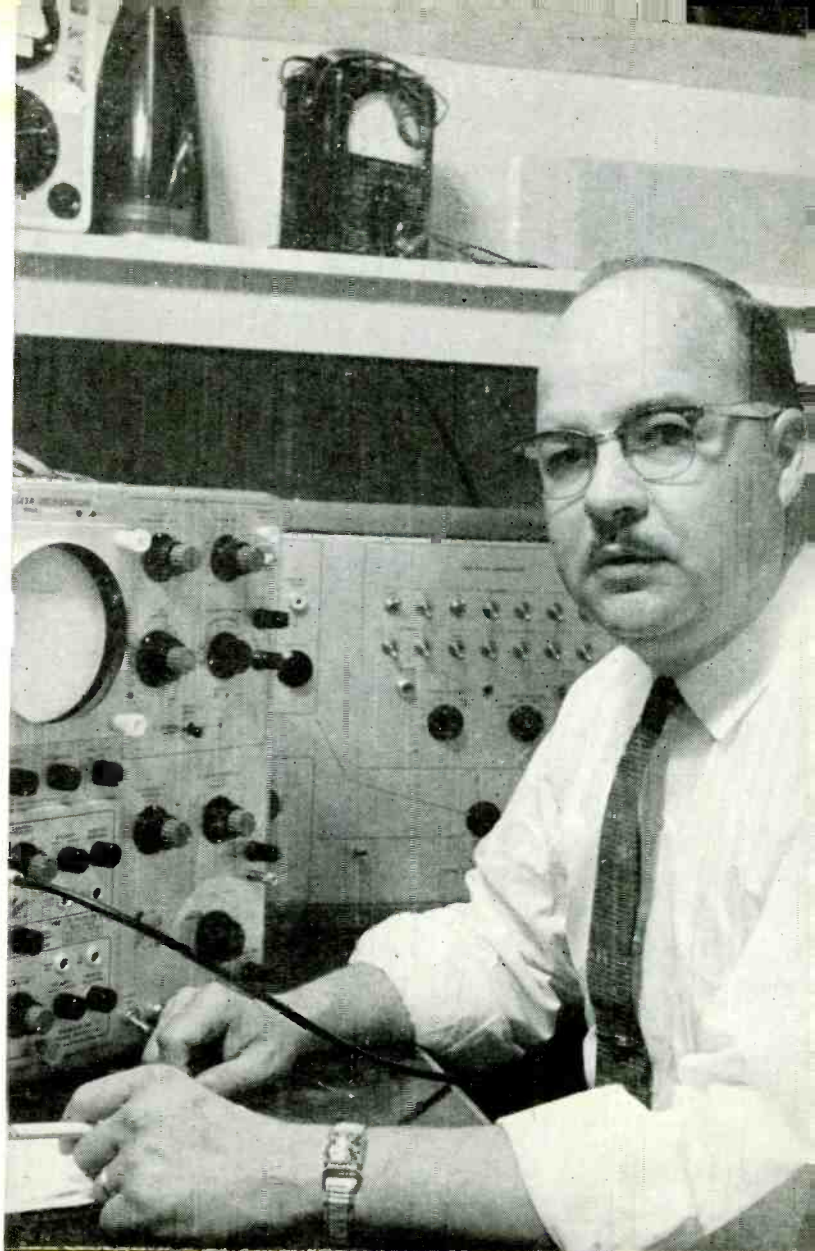

INCREASE YOUR EARNING POWER while you are on the job. Mearl Martin, Jr. made profitable use of his CREI-acquired knowledge in progressing from Junior technician to licensed Senior Engineer. His present position is Field Support Manager, Marketing Division of Tektronix, Inc.

INDUSTRY-RECOGNIZED CREI HOME STUDY PROGRAMS PREPARE YOU FOR INCREASED RESPONSIBILITIES AND HIGHER-PAYING POSITIONS IN ELECTRONICS.

THERE IS A CREI PROGRAM TO MEET YOUR NEED. Today thousands of advanced electronics personnel—engineering technicians, engineers, administrators, executives—attribute their present high salaries and positions to their home study of CREI Programs in Electronic Engineering Technology. Wherever you go—wherever thorough knowledge of electronic engineering technology is a prime requisite—you'll find CREI Home Study students and alumni welcomed.

TOP SCIENTISTS CONTRIBUTE TO COURSES. When you enroll in a CREI Home Study Program, you join more than 20,500 students presently working in almost every phase of electronics in all 50 states and most countries in the free world. You study courses to which a number of today's leading engineers and scientists have contributed. You are guided and assisted by CREI's staff of experienced instructors. How long it takes to complete your CREI Home Study Program depends on your on-the-job experience, the amount of time you devote to study and the program or programs you choose.

DEMAND FOR CREI-PREPARED MEN IS GREAT. It far exceeds the supply—has exceeded the supply for many years. Specifically designed to prepare you for responsible positions in electronics, CREI Home Study Programs include the latest advancements in



EMPLOYERS RECOGNIZE THE BENEFITS they receive when employees increase their knowledge through educational programs. Industry need for better educated men increases by the day. Here Mearl Martin discusses education with W. K. Dallas, V.P., Manager, Marketing Division, Tektronix, Inc.



ASSURE A BETTER FUTURE with a CREI Home Study Program. Living is better when you prepare yourself for—and get desired promotions. CREI alone has Mearl enjoys living in a comfortable home in Portland, Oregon. CREI Programs help you make living better wherever you are located.



GAIN NEW PROFESSIONAL STANDING. The CREI Home Study Programs help you form new associations with responsible members of your company. Above (L to R) is Mearl Martin with Robert Wruble, Group Manager and Rollie Smith, Field Training Manager at Tektronix, Inc.



YOUR WHOLE FAMILY BENEFITS from the success you can achieve from a CREI Home Study Program. They share in it. They enjoy it with you. It helps them realize and understand some of the values of a better education. Above Mearl Martin relaxes at home with his wife and his son and daughter.

electronics. We invite you to check the thoroughness and completeness of CREI Home Study Programs in the catalog provided on request. They include:

- INTRODUCTION TO ELECTRONIC ENGINEERING TECHNOLOGY
- ELECTRONIC ENGINEERING TECHNOLOGY • SPECIALIZED COMMUNICATIONS ENGINEERING TECHNOLOGY • SPECIALIZED AERONAUTICAL AND NAVIGATIONAL ENGINEERING TECHNOLOGY
- SPECIALIZED TELEVISION ENGINEERING TECHNOLOGY
- SPECIALIZED SERVOMECHANISMS AND COMPUTER ENGINEERING TECHNOLOGY • SPECIALIZED ENGINEERING MATHEMATICS
- AUTOMATION AND INDUSTRIAL ELECTRONIC ENGINEERING TECHNOLOGY • NUCLEAR ENGINEERING TECHNOLOGY

RATES HIGH WITH INDUSTRY. The high calibre of CREI Home Study Programs is attested to by America's biggest corporations, where CREI students and alumni attain positions ranging from engineering technicians to engineers to top officials. Such companies are National Broadcasting Company, Pan American Airways, Federal Electric Corporation, The Martin Company, Northwest Telephone Company, Mackay Radio, Florida Power and Light, and many others. These companies not only recognize CREI Home Study educational qualifications but often pay all or part of CREI tuition for their staff members.

ELECTRONICS HOME STUDY SPECIALISTS FOR 34 YEARS. CREI Home Study Programs are the product of 34 years of experience; CREI itself was among the first to have its curricula accredited by the Engineers' Council for Professional Develop-

ment. Each program is developed with the same painstaking skill and care that CREI put into its World War II electronics courses for the Army Signal Corps, its special radio courses for the Navy, and its post-war group training programs for leading aviation and electronics companies. For those who can attend in person, CREI maintains a Residence School in Washington, D. C., also offering ECPD accredited Technical Institute curricula.

REQUIREMENTS FOR ENROLLMENT. Pre-requisite is a high school education or equivalent plus electronics training and/or practical electronics experience. (Electronics experience and/or training not necessary for Residence School.) If you qualify, send for the latest CREI catalog at no cost. Veterans may apply under the G.I. Bill. If you're doubtful about your qualifications, let us check them for you. Use the coupon inserted between these pages or—if coupon has been removed—send qualifications to:



The Capitol Radio Engineering Institute
 ECPD Accredited Technical Institute Curricula • Founded 1927
 Dept. 1410 H, 3224 Sixteenth St., N.W.
 Washington 10, D.C.

Announcing the Ultimate IN FM TUNERS



THE FISHER FM-1000 FM-Multiplex Wide-Band Tuner Exclusive Stereo Beacon

The FISHER FMR-1 Broadcast Monitor and network relay tuner is now being made available to the audio connoisseur seeking the absolute ultimate — FM-1000. A magnificent, architectural-brass finish control panel sets off this beautiful instrument. It has the remarkably high sensitivity of 1.5 microvolts (IHFM) and its tunable front-end boasts four tuned circuits—for a degree of sensitivity, and image and spurious response rejection never before attained. An exceptional feature is STEREO BEACON, the Fisher invention that automatically lights a signal when the station is broadcasting in Multiplex and simultaneously switches the unit from monophonic to stereo operation. **\$419.50** Walnut (20-UW) and Mahogany (20-UM) Cabinets for the FM-1000 **\$24.95**

USE THIS COUPON FISHER RADIO CORPORATION LONG ISLAND CITY 1, N. Y.

Please rush FREE literature on the following:

- Specifications on FISHER FM-1000
- Complete Catalogues on FISHER equipment
- Illustrated Custom Stereo Installation Guide

Name _____

Address _____

City _____ State _____ RE10

TRANSISTOR BIAS REGULATOR

By A. K. TAYLOR

SHUNT VOLTAGE REGULATORS SUCH AS gas-filled regulator tubes and Zener diodes have a dynamic resistance (dE/dI) much lower than their static resistance (E/I), but are not available for very low voltages. For fractions of a volt, use a semiconductor diode or the surviving diode of a half-burnt-out transistor.

Fig. 1 shows the E-vs-I characteristics for three diodes, taken by varying a high resistance in series with the diode and plotting diode voltage against current. The voltage varies but little for currents over 5 ma. The slope of the flatter part of the curve, approximately $\Delta E/\Delta I$, corresponds to 10 ohms for the

high-perveance diode and 5 ohms for the other two.

This is the dynamic resistance which the load sees. The static resistance (E/I) which determines the necessary bleeder current is around 10 times as much. Bleeder current, which would have to be 40 ma to develop 0.4 volt across 10 ohms or 0.2 volt across 5 ohms, need be only 5 ma plus the maximum current drawn by the load. Diodes with still flatter characteristics and various voltage drops can probably be found among the innumerable types manufactured.

This represents a real saving in biasing class-B transistor amplifiers.

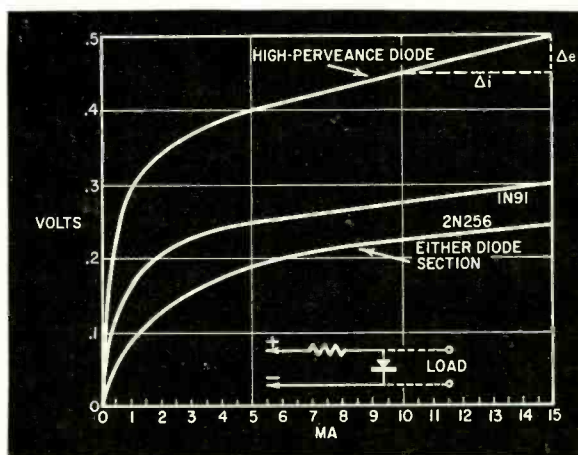

Fig. 1

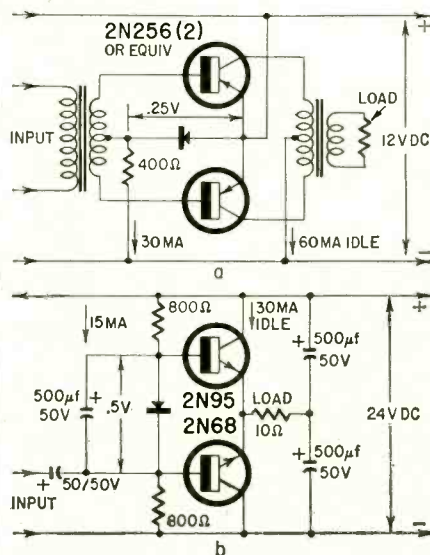

Fig. 2

The low-resistance bleeders ordinarily used not only waste batteries but can seriously load driver stages in transformerless circuits. Fig. 2 shows typical applications to transformer-coupled and complementary push-pull amplifiers. A diode-connected 2N256, or two in parallel, is most nearly right for Fig. 2-a, and the high-perveance diode or two of the others in series are right for the complementary circuit (Fig. 2-b).

Current distribution varies with individual transistors. With a typical complementary pair, the transistor bases draw 1 ma and the diode 14 ma when idle. With full signal and 10-ohm load, the transistors draw 10 ma, the diode draws 5 ma and the bias drops to 0.4 volt, which is still enough to prevent crossover distortion. The negative temperature coefficients of the diodes stabilize the idle current in either amplifier well enough so that with good heat sinks no other temperature stabilization is necessary. END

TECHNICIANS'

NEWS

ANOTHER LICENSING LAW DIES

Miami, Fla.—A proposed licensing law for Dade County was killed by the Metro Commission by a vote of 10 to 1. The commission stated that the law, which was backed by TESA-Miami, might "become an open door for the complete control of the industry by the wishes and desires of the few." The County Manager's office also reported that it would cost \$20,000 to administer such a law during the first year.

TRI-STATE COUNCIL NEWS

Gloucester, N. J.—The Allied Electronic Technicians Association elected Tony DeFranco, president, and Ray Dellinger, vice president. Joseph Papovich was re-elected secretary and Joseph Eberhardt, treasurer.

Trenton, N. J.—Bob Kroeson of the Trenton Chamber of Commerce was the guest speaker at a recent meeting of the Radio Servicemen's Association of Trenton. His topic was Business Malpractices, with the accent on TV.

MORE JOURNEYMAN TECHNICIANS

Santa Clara, Calif.—Ten radio-TV service technicians joined the ranks of California State journeyman technicians when they received state trade certificates at a ceremony sponsored by the Santa Clara Valley and Santa Cruz County Chapters of the California State Electronics Association. Five of the new journeymen also received the designation of Master Technician. They are first to receive this rating which was established by CSEA last year.

Those receiving the CSEA Master Technician certificates and State of California Journeyman certificates were Keiji Aochi, William G. Cleveland, Melvin Haury, Evrett A. Hunter and Oliver Sharrai.

Completing the apprenticeship course and receiving journeymen certificates were Alvin H. Bowers, Roderick A. Curry, Willis G. Jensen, Sandy Lunares and Joseph R. Twitchell.

POLICE GIVEN TALK

Seattle, Wash.—A TSA representative recently spoke before the weekly meeting of the Detective Division (Robbery-Burglary) of the Seattle Police Department on the means and methods of identifying electronic equipment. He cited the ease with which paper serial number tags can be removed, and the alternate methods of identification by hidden serial numbers and the serial numbers on replacement picture tubes which are a part of the service records

KNOWLEDGE

is better than guesswork...

and STANCOR takes the guesswork out of TRANSFORMER REPLACEMENTS

When you use Stancor exact replacements, you *know* that you have a transformer that duplicates in every way the original manufacturer's electrical and physical specifications.

What's more, you know in advance that you'll be able to use a Stancor unit, because Stancor offers virtually complete coverage on flybacks and yokes . . . and the Stancor TV Guide, the most detailed in the industry, gives you exact information on the right transformer to use.

Contact your Stancor distributor for information on how to get your copy of the Stancor TV Guide.

Take all the guesswork out of transformer replacements—always specify Stancor.

STANCOR

ELECTRONICS, INC.

formerly Chicago Standard Transformer Corporation • 3501 West Addison Street • Chicago 18, Illinois

TV PICTURE TUBES

All Aluminized Glass Types BUY DIRECT AND SAVE

• 12LP4—\$8.95 • 17BP4—\$9.95 • 21AL/ATP4—\$16.75
• 24DP4—\$24.50 • 27EP4—\$39.95

ALL TYPES AVAILABLE All Prices with old tube F.O.B. Chicago

These tubes are made from reprocessed glass. All materials including electron gun are brand new.

PICTURE TUBE OUTLET

2922 MILWAUKEE • Chicago 18

FREE . . . Write for complete Picture Tube list.

TAPE RECORDERS



HI-FI COMPONENTS SLEEP LEARN KITS

Unusual Values Free 1961 Catalog DRESSNER,

MERITAPE Low cost, high quality recording tape, in boxes or cans.

1523RE Jericho Tpke. New Hyde Park, N.Y.

HOW TO MAKE MONEY IN CITIZENS BAND RADIO

AUTHORITATIVE GUIDEBOOK ABOUT THE BOOM IN TWO-WAY MOBILE-RADIO! GIVES FACTS, FIGURES, PAY RATES. WRITE TODAY!

FREE

LAMPKIN LABORATORIES, INC. Dept. 26 BRADENTON, FLA.

FREE! CATALOG OF HI-FI, RADIO, TV PARTS & ACCESSORIES — yours for the asking!

Vidaire ELECTRONICS MFG. CORP. 365 BABYLON TPKE. — ROOSEVELT, N. Y.

news from hallicrafters



littlefone

CB-3 TRANSCEIVER

Only Hallicrafters offers 8-channel convenience and all these quality performance features.

The transmitter . . . output circuit matches 50 ohm antenna systems. Standardized CR23/U crystals (3rd overtone, series resonant) readily available. Output amplifier adjustable for max. legal input. 100% modulation on positive peaks. Series-tuned 2nd harmonic trap for excellent TV suppression.

The receiver . . . sensitivity less than 1.0 UV for 10 db. signal-to-noise ratio. Electronic squelch works on less than 6 db. signal strength change. 6 kc. selectivity. Image rej. 40 db. min. Audio output over 2 watts. Auto. noise limiter, series and shunt diodes.

\$149.50

citizens band

Before you choose from the countless brands of CB equipment available, consider this fact: Nowhere in the field of communications is a manufacturer's experience, integrity and record of achievement more critical to performance and reliability than in citizen's band. Hallicrafters has built more precision communications equipment than *all other CB manufacturers.*

the new ideas in communications are born at . . .



Chicago 24, Illinois

Export Sales: International Div.,
Raytheon Mfg. Co., Waltham, Mass.

Canada: Gould Sales Co.
Montreal, P.Q.

of most shops, and which appear on the customer's picture-tube warranty card. Also mentioned were ways of looking up the serial number from sales records, service records, etc. Captain Shaunessy expressed the department's appreciation for the information, and for the continued running of the stolen-set information in *TSA Service News*.

50% HAVE COLOR TV

Mulberry, Ind.—Is it true that this town has a color TV saturation of 50%? It's said that Charlie Maish, parts salesman for Associated Distributors, has an RCA color set and the other resident owns a black-and-white set.—*Hoosier Test Probe*

INDIANA ELECTION

Richmond, Ind.—The banquet room of the Rathskeller was the scene of the annual banquet and election of officers of RETA-Richmond. Following the feast W. F. Barnett was elected president; Robert Reed, vice president; Victor Ballman, secretary, and Charles H. Norman, treasurer.

AGAINST WARRANTY EXTENSION

Ephrata, Pa.—"We're against extending warranties" was the cry from delegates to the Federation of Television & Radio Service Associations of Pennsylvania at a recent meeting. This refers to extensions of warranties beyond 90 days for parts and labor and more than one year on picture tubes.

COLOR TV TRAINING

Philadelphia, Pa.—The Television Service Association of Delaware Valley will conduct a color TV service program. It is being handled with the cooperation of Raymond Rosen & Co., Inc., the local RCA distributor.

Raymond Rosen Inc. is making available to association members a color TV chassis and test equipment. The RCA Service Co. is contributing specially prepared material for the program and is providing Howard Spencer, administrator of technical training, as an instructor.

FTC GETS TSADV RECORDS

Philadelphia, Pa.—Herman Shore, president of the Television Service Association of Delaware Valley, has been ordered by a US District Court to identify TSADV records requested by the FTC. Until now, the association has refused to give any records to the FTC unless individual members were ordered to do so. This was done by the group following their lawyer's instructions not to turn over any records unless a subpoena were issued to individuals so they would be, in testifying, legally immune from possible future prosecution.

The FTC has not said why they wish to examine TSADV records but it appears that they may wish to look into an alleged boycott of certain parts distributors by members of the association.

Commenting on the court order, Mr. Sidney Black, the association's lawyer,

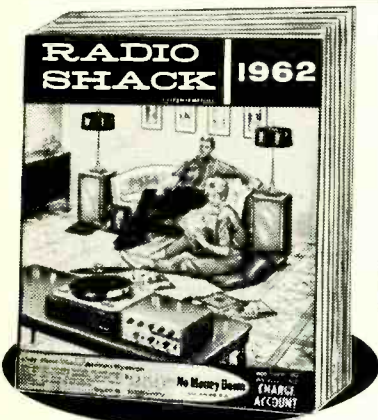

RADIO SHACK Corp.
Boston, Massachusetts

Send for your **FREE** personal copy of
RADIO SHACK'S 336-PAGE 1962 CATALOG

**Nationwide standard of excellence in
Electronics, Music, Communications**

Also receive all other issues for 1 year!

Our bigger, better catalogs offer the widest line of electronic parts and equipment in the world! Latest in Stereo, Hi-Fi, Ham Radio, Test Equipment, Pre-Recorded Tapes, Tape Recorders, Records, Component Parts—plus 30 pages of new fun-to-build kits. Every item is easy to own on new No Money Down Credit Terms. Every item is guaranteed to satisfy or your money back.

MAIL THIS COUPON TODAY

RADIO SHACK Corp. Dept. 61K10B
730 Commonwealth Ave., Boston 17, Massachusetts
Please send me Radio Shack's new 1962 Electronics Catalog and every new issue for the next 12 months—all FREE and POSTPAID.

Name _____

Address _____

City & Zone _____ State _____

said: "We have never tried to keep our records from the FTC. We simply objected to the subpoena being issued to the group and not an individual so that immunity against future possible prosecution would protect those who testify.

"We would like to bring the practice of certain distributors to the eyes of the FTC so that these problems could be solved. We feel it is impossible for the FTC to see all these accusations against distributors and not investigate distributor practices."

REPORT ON LICENSING

California—The following is a report on state Licensing Bill No. 265 that appeared in the *Modern Electronic Service Dealer* (Los Angeles, Calif.)

The licensing bill backed by CSEA (California State Electronics Association) has come to a halt. The bill as it now stands is in the Senate Business and Professions Committee and is scheduled for interim hearing.

Briefly, before the bill was submitted, it had 47 co-authors from the Assembly. During the next 5 months, the bill was amended six times as recommended by different departments within the state. The only change that affected the bill was made in the Governmental and Efficiency Committee hearing. It was to leave out certification of technicians for the time being. The bill then went to the Finance Committee and was stalemated because the state budget had not passed. Then the bill finally got to the floor of the assembly where it was passed by a vote of 58 to 6.

The bill next went to the Business and Professions Committee for their approval. From there it was supposed to go to the Finance Committee and then to the Senate floor in time to be passed this year. But the bill got tied up by the Business and Professions Committee who moved that it be sent to the Interim Committee for more study.

NATESA GETS NEW PRESIDENT

Chicago, Ill.—Ralph Woertendyke of Salina, Kan., was elected president of the National Alliance of Television & Electronic Service Associations. He succeeds A. A. Benoit, Jr. Other officers elected at the annual convention at the Pick-Congress hotel were John Stefanski, secretary general; Nelson Burns, treasurer; Irving J. Toner, eastern vice president; George Carlson, eastern secretary; T. R. Nabor, west central vice president; B. R. Moon, west central secretary; Pat Barr, west vice president; Les Quigley, western secretary. Frank Moch remains as executive director. His term still has a year to run.

WARRANTY EXTENDED

Chicago, Ill.—Westinghouse Electric has announced that they are including a 90-day labor warranty on all products made by the company's television-radio division.

A feature of the plan is a telephone service that gives customers the address

of the nearest independent authorized service company. All service work will be done by independent service dealers appointed by local distributors, Westinghouse states.

ELECTION RETURNS

Butte, Mont.—The Electronic Service Association of Butte has a new slate of officers: Pat Gordon, president; Harry Carroll, recording secretary; Kenneth Venner, treasurer. Outgoing president Raymond G. Tuszynski was elected corresponding secretary. Al Laurvick and Bjarne Johnson were voted trustees.

KARL W. HEINZMAN PASSES

Detroit, Mich. — The independent service industry lost one of its best leaders and sharpest minds with the passing of Karl W. Heinzman. His death followed two weeks in the Art Center Hospital, where he was recuperating from his second heart attack within the year. He was planning to return home when the fatal attack occurred.

CSEA CHAPTER NEWS

Burbank, Calif.—At the regular meeting of the Burbank-Glendale Chapter at Genio's Restaurant Robert Hahn spoke on servicing video amplifiers and remote controls. He is service manager for Philco, Los Angeles. Later, members discussed the state licensing bill.

San Diego, Calif.—Annual elections were the business of the day. The new directors are Clifford T. Coons, P. E. Fort, Howard Ellis, G. S. Lowell, Walt Meekins, Gene O'Brien and Earl Robbins. The new board then elected its officers for the coming year: president, Gene O'Brien; vice president, Howard Ellis; secretary-treasurer, G. S. Lowell. Guest speaker for the evening was Wm. A. Stone, regional manager of Simplified Tax Records Inc. He presented a tax preparation, record keeping and business management system for the small businessman.



"We've checked your credit references and you may charge any service required—up to a dollar."

NEW SAMS BOOKS

JUST OUT—THIRD EDITION OF THE FAMOUS HOWARD W. SAMS

Tube Substitution Handbook

Still Only \$1.50

- ★ Completely Updated and Fully Revised
- ★ Includes Over 800 New Substitutions



Latest edition of the book you'll find useful every day. Contains only DIRECT substitutions. Now includes 5,234 substitutions (808 more than in prior volume). Lists 2,759 substitutions for 1,687 receiving tube types. Shows 224 industrial and 602 European substitutes for American receiving types; 513 American for European receiving types; 465 picture tubes with 1,136 substitutes. Includes useful data on tube substitution. A "must" for every tube caddy and service bench. 96 pages; 5½ x 8½". Only \$1.50

New On Industrial Electronics!

Using the Oscilloscope In Industrial Electronics

by Middleton & Payne



Explains how to use scope to test industrial equipment such as thyatron controls, ignitrons and controls, saturable reactors and magnetic amplifiers, radar equipment, automotive ignition systems, transistorized controls. First 4 chapters cover basics: scope information capability, operating features, characteristics, general use in industrial electronics. Ten other chapters discuss waveform photography, lab applications, scope maintenance and calibration, etc. Includes handy scope specifications charts as well as numerous waveforms showing normal and abnormal operation. 256 pages, 5½ x 8½". Only \$4.95

Industrial Transistor & Semiconductor Handbook

by Robert B. Tomer



Now available—latest, most complete data on industrial semiconductors, their characteristics, circuit-design procedures, typical applications. First 4 chapters on semiconductor physics, general characteristics, circuit fundamentals, ratings and measurements. Other chapters discuss applications: diodes, industrial control, power converters, communications, unusual devices, thermoelectricity in solar-energy conversion. Special chapter discloses advanced semiconductor manufacturing techniques. Final chapter describes new developments, such as thin-film and integrated circuits, high-density packaging, microelements, etc. Appendix contains transistor parameter symbols and definitions, plus methods for determining thermal stability of transistor circuits. The up-to-the-minute book on semiconductors. 256 pages; 5½ x 8½". Only \$4.95

NEW! VOL. 9 SERVICING TRANSISTOR RADIOS!

Just out—covers 47 models produced in 1960. Complete PHOTOFACT® servicing data. 160 pages; 8½ x 11". Only \$2.95

HOWARD W. SAMS & CO., INC.

Order from your Sams Distributor today, or mail to Howard W. Sams & Co., Inc. Dept. K-21 1720 E. 38th St., Indianapolis 8, Ind.

- Send me the following books:
- Tube Substitution Handbook Vol. 3 (TUB-3)
 - Using the Scope in Industrial Electronics (OSM-1)
 - Indust. Transistor & Semicond. Handbook (TTT-1)
 - Servicing Transistor Radios (TSM-9)

\$.....enclosed. Send Free Book List

Name _____
 Address _____
 City _____ Zone _____ State _____
 IN CANADA: A. C. Simmonds & Sons, Ltd., Toronto 7
 (outside U.S.A. priced slightly higher)

new PRODUCTS



AM/FM STEREO TUNER, T300X. Built-in multiplex section. Sensitivity 0.95- μ v for 20-db

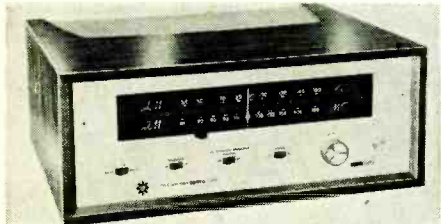

quieting. 3.2- μ v usable sensitivity (IHF standards). Distortion less than 0.1% at 100% modulation. Response 10-35,000 cycles \pm 1 db.—Harman-Kardon Inc., Ames Court, Plainview, N. Y.

FM STEREO ADAPTER, MX600D. For manufacturer's FM tuners and other makes having wide bandwidths. Stereo Announcer lights when

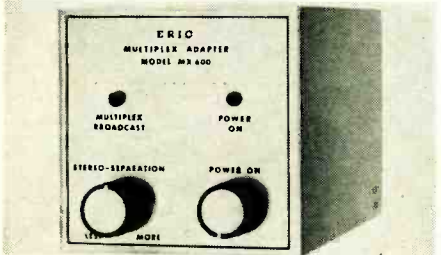

stereo program is being broadcast. Uses Compactron tubes.—Eric Electronics Corp., 1823 Colorado Ave., Santa Monica, Calif.

FM STEREO GENERATOR type 830. Provides composite stereo signal for modulating an FM generator. This produces a composite test signal which conforms to FCC stereo FM standards.



Audio oscillator and oscilloscope needed to complete test setup.—H. H. Scott Inc., Instrument Div., 111 Powder Mill Rd., Maynard, Mass.

PHASE COORDINATOR checks balance and phase relations of speaker output of stereo



system. Direct-reading meter clearly indicates correct setting.—Jesse M. Kohler Co., 1566 E. 91 St., Brooklyn 36, N. Y.

STEREO AMPLIFIER, model X-101-B. Combination stereo preamp, dual 26-watt amplifiers. Response, 20-20,000 cycles \pm 1 db. Harmonic distortion 0.5% at full output. IM distortion 0.8% at rated output. 6 pairs of inputs. High- and

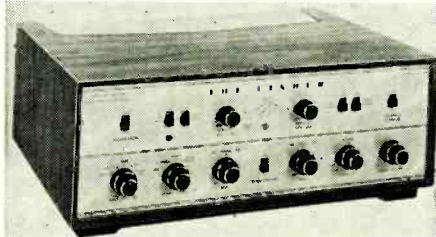

low-frequency filters. 4-, 8- and 16-ohm outputs. 19 front-panel controls.—Fisher Radio Corp., 21-21 44th Drive, Long Island City 1, N. Y.

STEREO RECEIVER, model 200-A. Dual 16-watt amplifiers, AM, FM tuners and transistorized stereo preamp. FM sensitivity 2 μ v for 20-db quieting. Scratch and rumble filters.



Frequency response 20-20,000 cycles. Channel separation better than 52 db.—Monarch Electronics International Inc., 7035 Laurel Canyon Blvd., No. Hollywood, Calif.

CB MIKE, B-213AC. Ceramic high-impedance unit. 50-8,000-cycle frequency response. Output



level -58 db. Push-to-talk dpst switch.—American Microphone Mfg. Co., 412 S. Wyman St., Rockford, Ill.

CB TRANSCEIVER, model 772. Superhet receiver has rf stage for high sensitivity. 4-position transmitter switch selects any of 4 crystal-

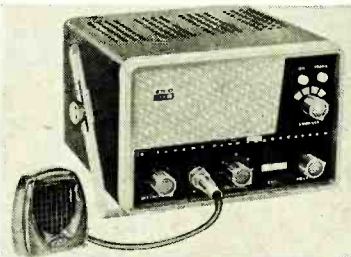

controlled channels. Kit or fully wired and tested. Transmitter crystal oscillator and rf final prewired, tuned and sealed at factory in kit version.—Electronic Instrument Co. Inc. (EICO), 33-00 Northern Blvd., Long Island City 1, N. Y.

COMMUNICATIONS RECEIVER, model HE-80. Covers 550-kc to 30-mc in four bands. Calibrated electrical bandspread for amateur bands.



Sensitivity, 1 μ v for 10-db signal-to-noise ratio. Selectivity 10 kc at -60 db. Speaker and headphone outputs. 7 x 15 x 10 in.—Lafayette Radio Electronics Corp., 165-08 Liberty Ave., Jamaica 33, N. Y.

COLLAPSIBLE CB ANTENNA, model CB-27. 60 inches extended, 27 inches collapsed. Etched tuning scales in top rod section. One for Citi-



zens band, other for amateur (28-30-mc) band. Mounts on front fender. Supplied with coax cable.—New-Tronics Div., 3455 Vega Ave., Cleveland 13, Ohio.

CB ANTENNAS, model GP-1 (illus.) ground-plane unit has 1-inch-diameter driven element



and drooping radials. **Model CBY3** is 3-element Yagi.—Clear Beam Antenna Corp., 21341 Roscoe Blvd., Canoga Park, Calif.

MOBILE ANTENNA clamps onto car window. No tools needed. No holes to drill. Bracket rubber-lined. Interchangeable antennas for CB,

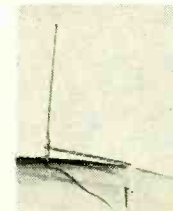

1 $\frac{1}{4}$ -, 2-, 6- and 10-meter amateur bands and 155-mc businessman's band.—Electrophone & Parts Corp., 530 Canal St., New York 13, N. Y.

CB MOBILE ANTENNA, Omni-Slot Boundary Antenna. Ring type design. Provides gain of

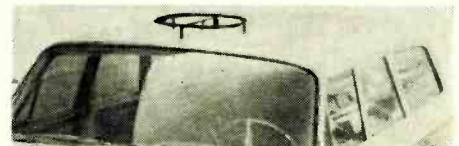

$\frac{1}{4}$ -wave whip. Only 2 inches high.—General Electromagnetics Corp., 11719 E. Washington Blvd., Whittier, Calif.

CB ANTENNA, model CBGP-5. Ground-plane

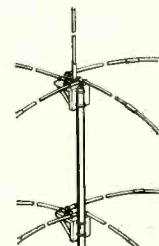

type. Aluminum elements are telescopic and made in two sections. Anodized cadmium-plated mounting brackets. Matches 52-ohm line.—Master Mobile Mounts Inc., 4125 W. Jefferson Blvd., Los Angeles 16, Calif.

CB BASE-STATION ANTENNA, Mark II Super Beacon. For 27-mc. 19 feet tall. Requires no ground radials or skirts. Precipitation static



suppressed by plastic overcoating on antenna. VSWR less than 1.5:1 over entire Citizens band. Matches 50-ohm coax.—Mark Mobile Inc., 5441 Fargo Ave., Skokie, Ill.

CONVERTER-AMPLIFIER, BT-70 Ampliverter for low-power translator areas which use uhf

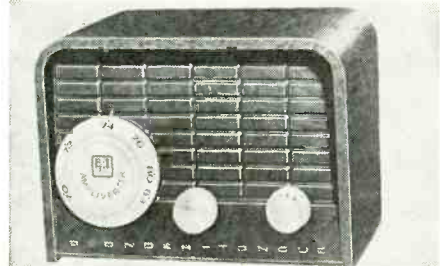

channels 70-83. Converts vhf channels 5 or 6 into any uhf channel between 70 and 83.—Blonder-Tongue Labs. Inc., 9 Alling St., Newark, N. J.

TRANSISTOR INTERCOM SYSTEMS, PA-265. 3-station system. Any station can be called from master without disturbing other remote. 3-transistor circuit operates off 3 size-C flashlight

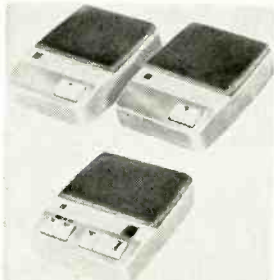

cells. 3¼-inch speakers. Each unit 1¼ x 5 x 6¾ in.—Lafayette Radio Electronics Corp., 165-08 Liberty Ave., Jamaica 33, N. Y.

VOICE CASE, complete PA system in 12 x 18-



inch attache case. Battery-powered. With lavalier mike and 25 feet of cord. Volume control in mike base.—Siegler Corp., 875 S. Arroyo Pkway., Pasadena, Calif.

THIN SPEAKERS, models 52C10 and 8C10PA (illus). Both use 10-ounce ceramic (barrium ferrite) magnets. Units are thin enough to

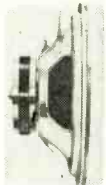

mount between standard wall studs.—Quam-Nichols Co., 234 E. Marquette Rd., Chicago 37, Ill.

SPEAKER SYSTEM, CR-1 Crescendo, 3-way



system uses 10-inch bi-axial transducer and 4-inch tweeter. Built-in crossover. Frequency response from 25 to 18,500 cycles. 24 x 12 x 12 in.—Mercury Electronics Corp., 111 Roosevelt Ave., Mineola, N. Y.

REMOTE SPEAKER, No grille, 8 x 10¼ x 6¾ in. Model SH-8 has random-width wood paneling design which replaces grille cloth. Tiny slots load 6 x 9 speaker. Blond, mahogany or



walnut.—Utah Radio & Electronic Corp., Huntington, Ind.

REPLACEMENT SPEAKERS for electronic organs. 12-inch units withstand sustained low-



frequency notes. Model OR12J-8, 8-ohm voice coil; OR12J-16, 16-ohm voice coil. Both handle 15 watts of peak audio.—Utah Radio & Electronic Corp., Huntington, Ind.

BULK TAPE ERASER, model HD-11. Handles

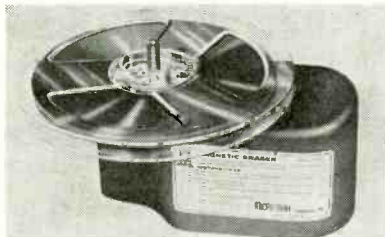

5- to 10½-inch reels. Erases all recorded material simultaneously.—Microtran Co. Inc., 145 E. Mineola Ave., Valley Stream, N. Y.

DYNAMIC MIKES, models 70 and 71. Response 50-18,000 cycles. Output level into high-impedance input 28 mv/10 dynes/cm². For tape re-

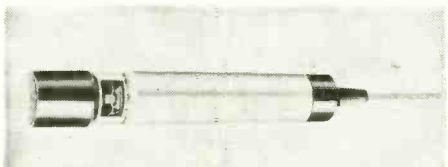

orders, ham rigs and PA installations.—University Loudspeakers Inc., 80 S. Kensico Ave., White Plains, N. Y.

CONVERSION KIT R-67 converts Roberts, Metzner, Akai and Terracorder tape recorders

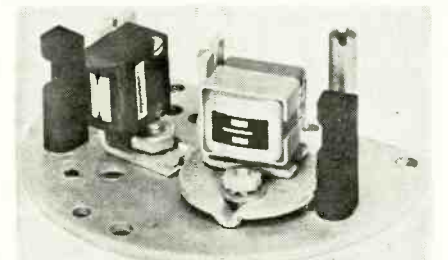

to 4-track stereo playback. Uses TLB-2 laminated core head that has 100 micro-inch gap.—Nortronics Co. Inc., 1015 S. 6th St., Minneapolis 4, Minn.

SOUND METER, model 450. Sound-level range: (Continued on page 120)





Olson

FREE

FREE

FREE

FREE

FREE

FREE

FREE

FREE

FREE

FREE

FREE

FREE

10 OLSON STORES
Plus
MAIL ORDER

Visit your local
Olson Stores at . . .

AKRON, OHIO
69 W. State Street

BUFFALO, N.Y.
711 Main Street

CHICAGO, ILL.
4101 N. Milwaukee Ave.

CHICAGO, ILL.
123 N. Western Ave.

CLEVELAND, OHIO
2020 Euclid Ave.

CLEVELAND, OHIO
6813 Pearl Road

COLUMBUS, OHIO
142 N. High Street

INGLEWOOD, CALIF.
4642 W. Century Blvd.

MILWAUKEE, WISC.
423 W. Michigan

PITTSBURGH, PENN.
5918 Penn Avenue

Fill in coupon for a FREE One Year Subscription to OLSON'S Fantastic Bargain Packed Catalog—Unheard of LOW, LOW WHOLE-SALE PRICES on Brand Name Speakers, Changers, Tubes, Tools, Hi-Fi's, Stereo Amps, Tuners and other Bargains.

MAIL TO: ■■■■■

OLSON ELECTRONICS
725 S. Forge Street
Akron 8, Ohio

NAME _____

ADDRESS _____

CITY _____ ZONE _____ STATE _____

EXAMINE ANY OF THESE TESTERS BEFORE YOU BUY!!

Yes, we offer to ship at our risk one or more of the testers described on these pages.

SUPERIOR'S NEW MODEL 770-A

VOLT-OHM MILLIAMMETER



FEATURES:

- Compact—measures 3 1/8" x 5 7/8" x 2 1/4".
- Uses "Full View" 2% accurate 850 Microampere D'Arsonval type meter
- Housed in round-cornered, molded case.

SPECIFICATIONS:

- 6 A.C. VOLTAGE RANGES: 0-15/30/150/300/1500/3000 Volts.
- 6 D.C. VOLTAGE RANGES: 0-7.5/15/75/150/750/1500 Volts.
- 2 RESISTANCE RANGES: 0-10,000 Ohms, 0-1 Megohm.
- 3 D.C. CURRENT RANGES: 0-15/150 Ma., 0-1.5 Amps.
- 3 DECIBEL RANGES: -6 db to +18 db, +14 db to +38 db, +34 db to +58 db.

The Model 770-A comes complete with test leads and operating instructions. Price is \$15.85. Terms: \$3.85 after 10 day trial then \$4.00 monthly for 3 months.

SUPERIOR'S NEW MODEL 79

SUPER-METER

WITH NEW 6" FULL VIEW METER

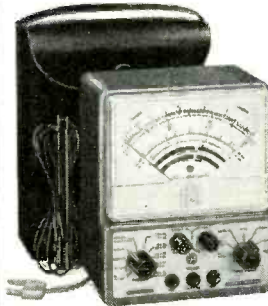

SPECIFICATIONS:

- D.C. VOLTS: 0 to 7.5/15/75/150/750/1,500.
- A.C. VOLTS: 0 to 15/30/150/300/1,500/3,000.
- D.C. CURRENT: 0 to 1.5/15/150 Ma. 0 to 1.5/15 Amperes.
- RESISTANCE: 0 to 1,000/100,000 Ohms. 0 to 10 Megohms.
- CAPACITY: .001 to 1 Mfd. 1 to 50 Mfd.
- REACTANCE: 50 to 2,500 Ohms, 2,500 Ohms to 2.5 Megohms.
- INDUCTANCE: .15 to 7 Henries, 7 to 7,000 Henries.
- DECIBELS: -6 to +18, +14 to +38, +34 to +58.

The following components are all tested for QUALITY at appropriate test potentials. Two separate BAD-GOOD scales on the meter are used for direct readings.

All Electrolytic Condensers from 1 MFD to 1000 MFD.
All Selenium Rectifiers. All Germanium Diodes.
All Silicon Rectifiers. All Silicon Diodes.

Model 79 comes complete with operating instructions, test leads and carrying case. Price is \$38.50. Terms: \$8.50 after 10 day trial then \$6.00 monthly for 5 months.

SUPERIOR'S NEW MODEL 77

VACUUM TUBE VOLTMETER

WITH NEW 6" FULL VIEW METER



Compare it to any peak-to-peak V.T.V.M. made by any other manufacturer at any price!

SPECIFICATIONS:

- DC VOLTS—0 to 3/15/75/150/300/750/1500 volts at 11 megohms input resistance.
- AC VOLTS (RMS)—0 to 3/15/75/150/300/750/1500 volts.
- AC VOLTS (Peak to Peak)—0 to 8/40/200/400/800/2000 volts.
- ELECTRONIC OHMMETER—0 to 1000 ohms/10,000 ohms/100,000 ohms/1 megohm/10 megohms/100 megohms/1,000 megohms.
- DECIBELS—10 db to +18 db, +10 db to +38 db, +30 db to +58 db. All based on 0 db = .006 watts (6 mw) into a 500 ohm line (1.73v).
- ZERO CENTER METER—For discriminator alignment with full scale range of 0 to 1.5/7.5/37.5/150/375/750 volts at 11 megohms input resistance.

Model 77 comes complete with operating instructions, probe and test leads and carrying case. Price is \$42.50. Terms: \$12.50 after 10 day trial then \$6.00 monthly for 5 months.

SUPERIOR'S NEW MODEL 80

20,000 OHMS PER VOLT ALLMETER



6 INCH FULL-VIEW METER provides large easy-to-read calibrations. No squinting or guessing when you use Model 80.

MIRRORED SCALE permits fine accurate measurements where fractional readings are important.

SPECIFICATIONS:

- 7 D.C. VOLTAGE RANGES: (At a sensitivity of 20,000 Ohms per Volt) 0 to 15/75/150/300/750/1500/7500 Volts.
- 6 A.C. VOLTAGE RANGES: (At a sensitivity of 5,000 Ohms per Volt) 0 to 15/75/150/300/750/1500 Volts.
- 3 RESISTANCE RANGES: 0 to 2,000/200,000 Ohms. 0-20 Megohms.
- 2 CAPACITY RANGES: .00025 Mfd. to .3 Mfd., .05 Mfd. to 30 Mfd.
- 5 D.C. CURRENT RANGES: 0-75 Microamperes, 0 to 7.5/75/750 Milli-amperes, 0 to 15 Amperes.
- 3 DECIBEL RANGES: -6 db to +18 db, +14 db to +38 db, +34 db to +58 db.

NOTE: The line cord is used only for capacity measurements. Resistance ranges operate on self-contained batteries.

Model 80 Allmeter comes complete with operating instructions, test leads and portable carrying case. Price is \$42.50. Terms: \$12.50 after 10 day trial then \$6.00 monthly for 5 months.

SUPERIOR'S NEW MODEL 70 UTILITY TESTER

FOR REPAIRING ALL ELECTRICAL APPLIANCES MOTORS ★ AUTOMOBILES

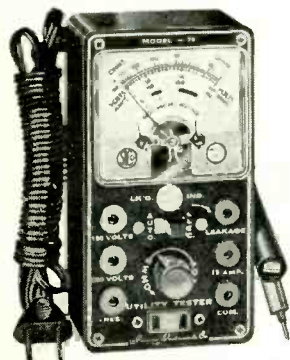

INCLUDED FREE

64 page condensed course in electricity. Profusely illustrated. Written in simple, easy-to-understand style.

As an electrical trouble shooter the Model 70:

- Will test Toasters, Irons, Broilers, Heating Pads, Clocks, Fans, Vacuum Cleaners, Refrigerators, Lamps, Fluorescents, Switches, Thermostats, etc.
- Measures A.C. and D.C. Voltages, A.C. and D.C. Current, Resistances, Leakage, etc.
- Incorporates a sensitive direct-reading resistance range which will measure all resistances commonly used in electrical appliances, motors, etc.
- Leakage detecting circuit will indicate continuity from zero ohms to 5 megohms (5,000,000 ohms).

As an Automotive Tester the Model 70 will test:

- Both 6 Volt and 12 Volt Storage Batteries
- Generators
- Starters
- Distributors
- Ignition Coils
- Regulators
- Relays
- Circuit Breakers
- Cigarette Lighters
- Stop Lights
- Condensers
- Directional Signal Systems
- All Lamps and Bulbs
- Fuses
- Heating Systems
- Horns
- Also will locate poor grounds, breaks in wiring, poor connections, etc.

Model 70 comes complete with 64 page book and test leads. Price is \$15.85. Terms: \$3.85 after 10 day trial then \$4.00 monthly for 3 months.

DID YOU EVER?

- ▶ Order merchandise by mail, including deposit or payment in full, then wait and write...wait and write?
- ▶ Purchase anything on time and sign a lengthy complex contract written in small difficult-to-read type?
- ▶ Purchase an item by mail or in a retail store then experience frustrating delay and red tape when you applied for a refund?

Obviously prompt shipment and attention to orders is an essential requirement in our business... We ship at our risk!

NO

CONTRACT TO SIGN

CO-MAKERS

EMPLOYER
NOTIFICATION

The simple order authorization included in this offer is all you sign. We ask only that you promise to pay for or return the goods we ship in good faith.

**EXAMINE ANY ITEM YOU SELECT
IN THE PRIVACY OF YOUR OWN HOME**

Then if completely satisfied pay on the interest-free terms plainly specified. When we say interest-free we mean not one penny added for "interest" for "finance" for "credit-checking" or for "carrying charges." The net price of each tester is plainly marked in our ads—that is all you pay except for parcel post or other transportation charges we may prepay.

SUPERIOR'S NEW MODEL 82A
MULTI-SOCKET TYPE

TUBE TESTER

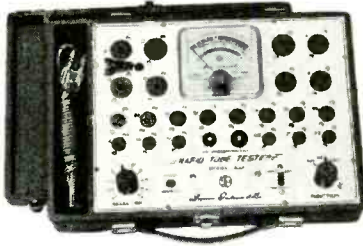

Model 82A comes housed in handsome, portable case. Price is \$36.50. Terms: \$6.50 after 10 day trial then \$6.00 monthly for 5 months.

SPECIFICATIONS:

- Tests over 1000 tube types.
- Tests OZ4 and other gas-filled tubes.
- Employs new 4" meter with sealed air-damping chamber resulting in accurate vibrationless readings.
- Use of 22 sockets permits testing all popular tube types and prevents possible obsolescence.
- Dual Scale meter permits testing of low current tubes.
- 7 and 9 pin straighteners mounted on panel.
- All sections of multi-element tubes tested simultaneously.
- Ultra-sensitive leakage test circuit will indicate leakage up to 5 megohms.

SUPERIOR'S NEW MODEL TW-11
STANDARD PROFESSIONAL

TUBE TESTER



The Model TW-11 comes housed in a handsome, portable, saddle-stitched Texon case. Price is \$47.50. Terms: \$11.50 after 10 day trial then \$6.00 monthly for 6 months.

- Uses the new self-cleaning Lever Action Switches for individual element testing. Because all elements are numbered according to pin-number in the RMA base numbering system, the user can instantly identify which element is under test.
- Free-moving built-in roll chart provides complete data for all tubes. All tube listings printed in large-easy-to-read type.
- **NOISE TEST:** Phono-jack on front panel for plugging in either phones or external amplifier will detect microphonic tubes or noise due to faulty elements and loose internal connections.
- **SEPARATE SCALE FOR LOW-CURRENT TUBES**—Previously, on emission type tube testers, it has been standard practice to use one scale for all tubes. As a result, the calibration for low-current types has been restricted to a small portion of the scale. The extra scale used here greatly simplifies testing of low-current types.

SUPERIOR'S NEW MODEL 83A

C.R.T. TESTER

Tests and Rejuvenates
ALL PICTURE TUBES

ALL BLACK AND WHITE TUBES
From 50 degree to 110 degree types—from 8" to 30" types.

ALL COLOR TUBES
Test ALL picture tubes—in the carton—out of the carton—in the set!



Model 83-A comes housed in handsome portable Saddle-stitched Texon case—complete with socket for all black and white tubes and all color tubes. Price is \$38.50. Terms: \$8.50 after 10 day trial then \$6.00 monthly for 5 months.

Model 83A provides separate filament operating voltages for the older 6.3 types and the newer 8.4 types. Model 83A properly tests the red, green and blue sections of color tubes individually—for each section of a color tube contains its own filament, plate, grid and cathode. Model 83A will detect tubes which are apparently good but require rejuvenation. Such tubes will provide a picture seemingly good but lacking in proper definition, contrast and focus.

Rejuvenation of picture tubes is not simply a matter of applying a high voltage to the filament. Such voltages improperly applied can strip the cathode of the oxide coating essential for proper emission. The Model 83A applies a selective low voltage uniformly to assure increased life with no danger of cathode damage.

SUPERIOR'S NEW MODEL 85

TRANS-CONDUCTANCE TYPE TUBE TESTER

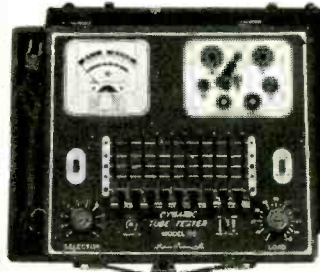

scientifically selected symbols speeded up the element switching step. As the tube becomes necessary and advantageous.

• **"FREE-POINT" LEVER TYPE ELEMENT SWITCH ASSEMBLY** marked according to RETMA basing, permits application of test voltages to any of the elements of a tube.

• **FIVE FIVE (5) YEAR CHART DATA SERVICE.** Revised up-to-date subsequent charts will be mailed to all Model 85 purchasers at no charge for a period of five years after date of purchase.

Model 85 comes complete, housed in a handsome portable cabinet with slip-on cover. Price is \$52.50. Terms: \$12.50 after 10 day trial then \$8.00 monthly for 5 months.

- Employs latest improved **TRANS-CONDUCTANCE** circuit. Test tubes under "dynamic" (simulated) operating conditions. An in-phase signal is impressed on the input section of a tube and the resultant plate current change is measured as a function of tube quality. This provides the most suitable method of simulating the manner in which tubes actually operate in radio, TV receivers, amplifiers and other circuits. Amplification factor, plate resistance and cathode emission are all correlated in one meter reading.
- **SYMBOL REFERENCES:** Model 85 employs time-saving symbols (°, +, ●, ▲, ■) in place of difficult-to-remember letters previously used. Repeated time-studies proved to us that use of these manufacturers increase the release of new tube types, this time-saving feature

SUPERIOR'S NEW MODEL TV-50A

GENOMETER 7 Signal Generators in One!

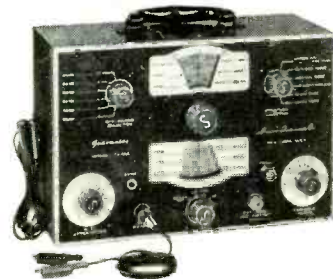

- ✓ R.F. Signal Generator for A.M.
- ✓ R.F. Signal Generator for F.M.
- ✓ Audio Frequency Generator
- ✓ Bar Generator
- ✓ Cross Hatch Generator
- ✓ Color Dot Pattern Generator
- ✓ Marker Generator

A versatile all-inclusive GENERATOR which provides ALL the outputs for servicing:

A.M. Radio • F.M. Radio • Amplifiers
• Black and White TV • Color TV

The Model TV-50A comes absolutely complete with shielded leads and operating instructions. Price is \$47.50. Terms: \$11.50 after 10 day trial then \$6.00 monthly for 6 months.

SUPERIOR'S NEW MODEL 88

TESTS ALL TRANSISTORS AND TRANSISTOR RADIOS



AS A TRANSISTOR RADIO TESTER

An R.F. Signal source, modulated by an audio tone is injected into the transistor receiver from the antenna through the R.F. stage, past the mixer into the I.F. Amplifier and detector stages and on to the audio amplifier. This injected signal is then followed and traced through the receiver by means of a built-in High Gain Transistorized Signal Tracer until the cause of trouble is located and pinpointed.

AS A TRANSISTOR TESTER

The Model 88 will test all transistors including NPN and PNP, silicon, germanium and the new gallium arsenide types, without referring to characteristic data sheets. The time-saving advantage of this technique is self-evident. A further benefit of this service is that it will enable you to test new transistors as they are released!

Model 88 comes housed in a handsome portable case. Complete with a set of Clip-on Cables for Transistor Testing; an R.F. Diode Probe for R.F. & I.F. Tracing; an Audio Probe for Amplifier Tracing and a Signal Injector Cable. Complete—nothing else to buy! Price is \$38.50. Terms: \$8.50 after 10 day trial then \$6.00 monthly for 5 months.

SEND POSTCARD TODAY

(NO POSTAGE
NECESSARY)

Try any of the instruments on this or the facing page for 10 days before you buy. If completely satisfied then send down payment and pay balance as indicated on coupon. No interest or Finance Charges Added! If not completely satisfied return unit to us, no explanation necessary.

MOSS ELECTRONIC, INC., DEPT D-908, 3849 TENTH AVENUE, NEW YORK 34, N.Y.

VALUE PACKED

**2 QUALITY TESTERS
FOR THE PRICE OF ONE**



A top performing TUBE TESTER and a complete VOM

- A trusty companion for a serviceman or maintenance man.
- A real money maker for a part time serviceman.
- Worth its weight in gold to the experimenter, student or kit builder.

The TC101 Tube Tester tests for emission under full load, for tube shorts and leakage up to 2 megohms between all tube elements. It will test every radio and TV tube you encounter (over 2,000) plus five star foreign imports and auto radio tubes. The VOM features a sensitive 1 Ma D'Arsonval movement with 0 to 12 volt range for testing auto electrical systems, 0 to 120 volt for fast testing of electrical appliances and 0 to 1200 volts for radio and TV testing. All ranges are either AC or DC. Resistance measurements up to 5 megohms.

Completely factory wired and tested. All-American made to insure top quality and performance.

MODEL TC101 only **\$39⁹⁵**

GOLD PRODUCTS, INC.,

500 S. Westgate Dr., Addison Illinois

- Send me TC101 Tube Tester and VOM.
 Check enclosed \$39.95. (Save Shpg. Charges)
 Send C.O.D.

Name _____

Street _____

City _____ Zone _____ State _____

Distributor's Name (If any) _____

★ Order Now! 10 Day Money Back Guarantee.

(Continued from page 115)

35 to -142 db. Response: 40 to 8,000 cycles. All-transistor. Rochelle salt diaphragm type mike. Direct-reading scale. 2 x 3 x 6 in. 2 lbs.—H. H. Scott Inc., 111 Powder Mill Rd., Maynard, Mass.

SHIELDED FLAT PLUG No. 228 (2-conductor) and No. 238 (3-conductor). ¼-inch finger, built-in cable clamp. For guitars, amplifiers, audio,



amateur and communications equipment.—Switchcraft Inc., 5555 N. Elston Ave., Chicago.

PANEL BUSHING, Panel-Juster. Adapts all of manufacturer's controls to accommodate all panels ¼-¾ inch thick. Adapter bushing screws



over bushing on control.—Clarostat Mfg. Co. Inc., Dover, N. H.

REPLACEMENT TRANSISTORS, kit 8JP contains 8 American-made transistors and diodes that replace more than 95% of semi-conductors

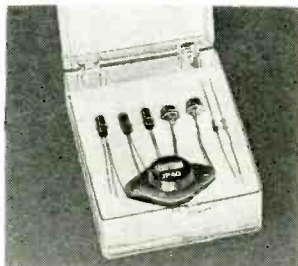

used in Japanese and other foreign radios.—Semiconics Corp., 370 Broadway, New York, N. Y.

REPLACEMENT TRANSFORMERS, A-2986

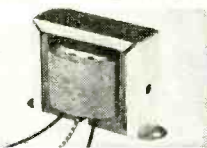

(illus) exact replacement for Admiral 79B43-18 vertical output auto-transformer. A-4081 replaces Packard-Bell 89460A; A-2988, Admiral 79B43-20 and 79C43-20; A-2984, Admiral 79B43-19—Merit Coil & Transformer Corp., Merit Plaza, Hollywood, Fla.

SWEEP GENERATOR / MARKER ADDER, model G-32. Sweep covers frequency range from 3-220 mc. Sweep width from 0 to 20 mc, continuously variable. Crystal-controlled marker oscilla-

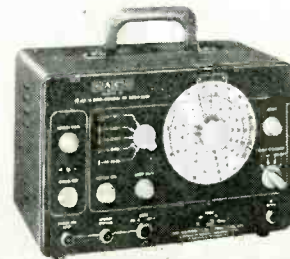

tor. 4.5-mc crystal supplied. Internal blanking eliminates retrace on scope.—Paco Electronics Co. Inc., 70-31 84th St., Glendale 27, N. Y.

TUBE TESTER, Dyna-Quik model 700. Dynamic mutual-conductance tube tester. Multiple sockets for rapid testing of most TV and radio tubes. Simplified switch section to check new tubes in Dyna-Quik emission circuit. Tests all tubes

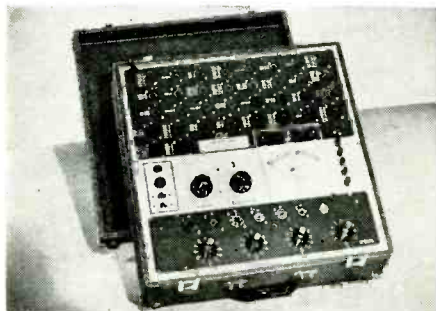

including nuvistors, 10- and 12-pin types. Provision for future new sockets. Checks for shorts, grid emission, leakage and gas. Makes life test.—B&K Mfg. Co., 1801 W. Belle Plaine Ave., Chicago 13, Ill.

IN-CIRCUIT TRANSISTOR TESTER, model 990. Checks all transistors in or out of circuit. When circuit impedance is more than 500 ohms, transistors are checked with maximum error of about 5%. Higher impedance lowers error. Checks for beta gain, shorts, and collector cur-



"Spotlight Specials"

Look for them at your
distributors and
SAVE!

Need some new drivers?
Doesn't everyone?

Well, right now is the time to get them and genuine VACO drivers at that! These are the drivers with the world's most comfortable handle with rugged blades of chrome vanadium steel—guaranteed not to break.

Every driver has a special, low "Spotlight Special" price—for a limited time only!

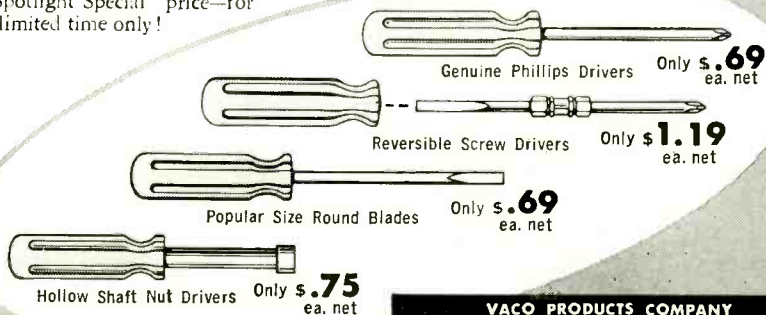

VACO PRODUCTS COMPANY
 317 East Ontario Street, Chicago 11, Ill.
 In Canada: Vaco-Lynn Products, Ltd. and Atlas Radio Corp

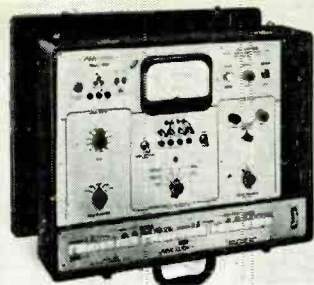

rent.—Precision Apparatus Co. Inc., 70-31 84th St., Glendale 27, N. Y.

WIDE-BAND SCOPE, model ES-150. Laboratory type instrument covers entire range between dc and 5 mc. Dc sensitivity 70 mv/in. Ac sensitivity 25 mv rms/in. Rise time better than .08 μ sec. Input impedance 1.5 megohms shunted by 23 μ f.



4-step frequency-compensated vertical input attenuator. Built-in voltage calibrator.—Precision Apparatus Co. Inc., 70-31 84th St., Glendale 27, N. Y.

TRANSISTOR TESTER model TR115. Improved version of earlier TRC4 transistor and diode tester. Checks for leakage, current gain (beta),

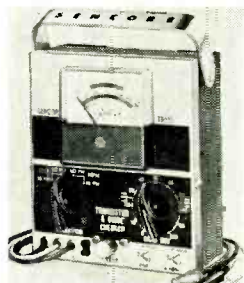

shorts and opens. Beta read direct or on good-bad scale.—Sencore, 426 S. Westgate Dr., Addison, Ill.

SERVICE CASE. Royalite plastic. 22 x 15 x 9 inches. 8 lbs. Space for tools and practical tube

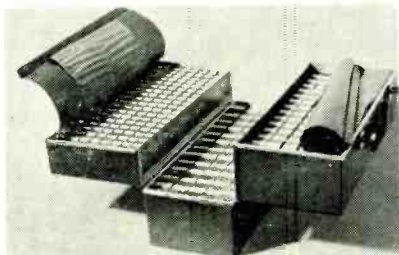

replacement inventory.—General Electric, Distributor Sales, Electronic Components Div., Owensboro, Ky.

RECHARGEABLE BATTERIES, sintered-plate

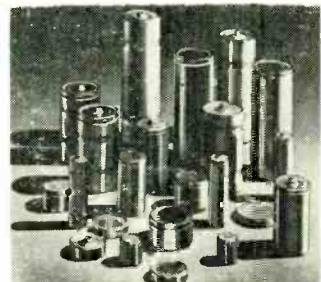

nickel-cadmium units. Made in a variety of sizes and voltages.—Sonotone Corp., Elmsford, N. Y.

All specifications from manufacturers' data.

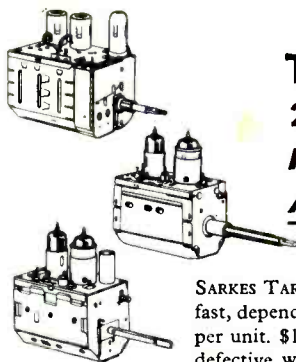

TUNERS REPAIRED \$8.50

24-Hour Service 6-Month Warranty

Repair Charge includes ALL Replacement Parts

SARKES TARZIAN, INC., pioneer in the Tuner Manufacturing business, offers fast, dependable, factory repair service on *all* makes and models. Cost—\$8.50 per unit. \$15 for UV combinations. Now offering 6-month warranty against defective workmanship and parts failure due to normal usage. Tuners repaired on approved, open accounts. Replacements available at low cost on tuners beyond practical repair.

Tarzian-made tuners easily identified by this stamping. When inquiring about service or replacements for other than Tarzian-made tuners, always give tube complement . . . shaft length . . . filament voltage . . . series or shunt heater . . . IF frequency, chassis identification. And, allow a little more time for service on these tuners. Use this address for fast, factory repair service:

SERVICE MANAGER • TUNER DIVISION DEPT. C



SARKES TARZIAN INC

east hillside drive
bloomington, indiana
edison 2-7251

Mfgs. of Tuners, Semiconductors, Air Trimmers, FM Radios, Audio Tape, and Broadcast Equipment

ASK ABOUT Group SUBSCRIPTION RATES to **RADIO-ELECTRONICS**

YOU SAVE MONEY!

RUSH US YOUR LIST OF HI-FI COMPONENTS FOR A SPECIAL QUOTATION

WRITE FOR FREE AUDIO DISCOUNT CATALOG A-15

New low prices on amplifiers, tuners, tape recorders, speakers, etc.

KEY ELECTRONICS CO.
120 LIBERTY ST.
NEW YORK 6, N.Y.

the **business-like approach**

to SERVICE CHARGES and RECORD KEEPING



For customer's prices on every replacement part, plus flat rate and hourly service charge data, regional and national. Dave Rice's OFFICIAL PRICING DIGEST, listing over 63,000 items. \$2.50.

▲ AVAILABLE FROM YOUR DISTRIBUTOR ▼

If you want to operate on a *professional* level, Dave Rice's OFFICIAL ORDER BOOKS give you triplicate forms for order, invoice, and office records . . . spaces for tubes, parts, serial numbers, labor and tax charges, signatures, etc. 75c per book, \$6.50 for dust-proof box of 10.



Dave Rice's

ELECTRONIC PUBLISHING COMPANY, INC.
133 N. JEFFERSON ST. • CHICAGO 6, ILL.

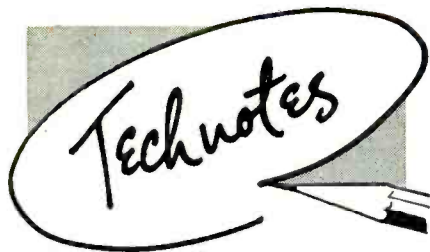

FORD 67MF

When bench-checking, be sure to observe proper polarity of the 12-volt input or the signal seeker won't seek and the reverse mechanism will fail to operate, resulting in the motor running with the dial pointer at the extreme left or right end. If the signal seeker fails to operate properly, and everything else fails, try several 12AU7 trigger tubes. This circuit is sometimes critical with apparently good 12AU7's.

Clean all mechanical parts of the seeker and lubricate with some light oil and graphite.—George P. Oberto

FLOATING SPEAKER TERMINALS

This could happen to you if you're not careful. A car drives in. You decide it needs a new speaker.

A new universal type is installed. The speaker lead is hooked up and the set turned on. Nothing happens. So you

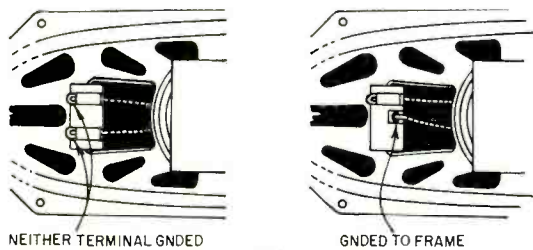

Fig.1

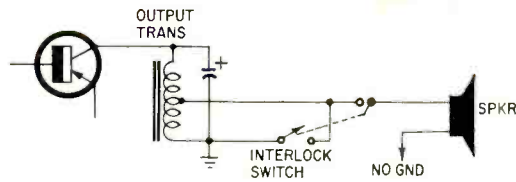

Fig.2

turn the volume control all the way up to make sure it is really dead. Later you find a blown transistor. Why?

The original speaker had one lug soldered to ground. The universal replacement had floating terminals—neither one was grounded (see Fig. 1). When the replacement was connected to the radio, the circuit was still open because the speaker and radio did not have a common ground (Fig. 2). The interlock switch which protects against no load opened when the new speaker was plugged in. This left the output transformer without a load and caused high audio voltage spikes to be built up across it when the volume control was turned up to a high level. This can ruin the output transistor or shorten its life drastically.—Delco Radio Testing Tips

TICKS ON TAPE

An intermittent ticking noise during tape playback may be caused by oxide deposits along a portion of the tape path. The most likely places for such deposits are around the heads, the capstan and the guides or pressure rollers.

Do not wipe the oxide away—it may only smear. Brush loose particles away. Alcohol is good for cleaning. Use it on a toothpick wrapped with cotton. Do not use pipe cleaners or other implements containing iron wire near the magnetic heads. Rub the cleaner away with a fresh piece of cotton on a toothpick or small wooden stick (or borrow a Q tip from your wife).—Lawrence Shaw

RCA CTC-5 COLOR SET

When adjusted for sharpest picture, focus would drift off after a few minutes, accompanied by loss of horizontal phase

FOR SHARPEST, CLEAREST VOICE TRANSMISSION WITH ANY CITIZENS BAND TRANSCEIVERS, SPECIFY THE TURNER 350C

Even the best citizens band equipment is no better than the microphone it uses. That's why more Turner 350C microphones are used as original equipment in CB than any other. That's why it will pay you to specify the Turner 350C when you buy CB equipment or replace your microphone.

■ The 350C is furnished with an 11' retracted (five foot extended) coiled cord. Hanger button and standard dash bracket are included for mobile rig mounting. Response: 80 to 7000 cps. Output: -54 db. Net price: \$10.08. ■ See Turner microphones at your electronic parts distributor or send coupon for complete information and the name of your nearest Turner distributor.



TURNER 254C FOR BASE STATION

Desk type ceramic mike operates by a touch bar on-off switch and lever lock on-off switch. Response: 80-7000 cps. Output: -54 db. Net price: \$14.10.

THE TURNER MICROPHONE COMPANY

925 17th Street NE,
Cedar Rapids, Iowa

Gentlemen:

send me further information on the 350C and 254C CB microphones and the name of my nearest Turner distributor.

NAME _____

ADDRESS _____

CITY _____

STATE _____

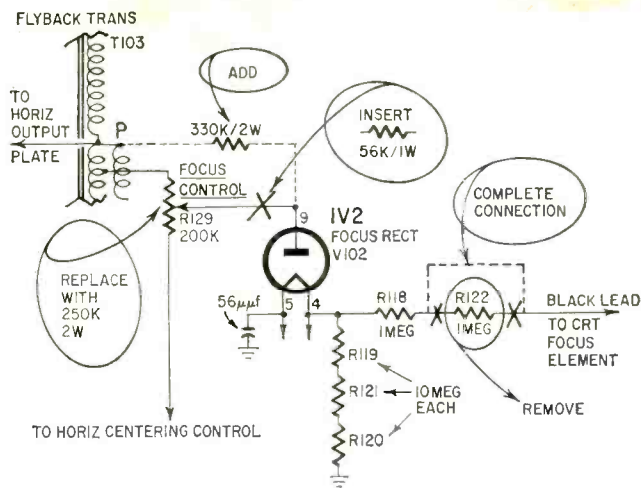

and vertical sync. Also, red and purple streaks appeared across the picture. As I removed the back of the set, I noted the distinctive odor of ozone. The focus control, located in the high-voltage cage, was warm to the touch. When it was removed and examined, the resistance element was found pitted and burned in several places.

I replaced the pot with a new 250,000-ohm 2-watt unit (RCA part 102150-C). When installing the new pot, it is necessary to clip the locating tab. To keep the control from turning when focus is adjusted, the nut holding the pot must be securely tightened. As the terminals of the new control cannot be inserted through the mounting board, I had to solder three 3-inch lengths of buss wire to the control terminals. The bus wire is then inserted through the mounting-board holes.

When installing this new pot, it is necessary to remove the lead from pin 9 of V102 to the center terminal of R129. In its place connect the 56,000-ohm 1-watt resistor supplied with the control. Insulate both resistor leads and position them away from any nearby parts.

WE BUY TECHNOTES

RADIO-ELECTRONICS wants Industrial Technotes. These should cover equipment (including closed-circuit television) actually used in industrial work, or technotes on counters, controls and other apparatus whose uses are largely industrial. Unillustrated Technotes pay \$5; circuit diagrams raise the price to \$9 and acceptable photos are worth \$7 each. Send your technotes from industry to Technotes Editor, RADIO-ELECTRONICS, 154 W. 14th St., New York 11, N. Y.

Once the new control is installed, you may find best focus is off toward one end or the other of the control setting. To get optimum focus near the center of the focus-control rotation, remove the black wire (kine focus lead) from R122 and reconnect to the junction of R118 and R122. Then remove R122, leaving terminal 2 on the terminal board 16 vacant. Next, take a 12-inch length of high-voltage wire (insulated for 10,000 volts) and connect terminal P of T103 (flyback transformer) to terminal 2 of terminal board 16. Lastly, connect a 330,000-ohm 2-watt resistor from terminal 2 of terminal board 16 to pin 9 of V102. Insulate both leads and dress away from any other parts.—*Michael L. Tortarriello*

RCA KCS-107-B

The ¼-amp B-plus fuse would blow at irregular intervals and damper tube failure was unusually high. Also, the horizontal output transformer was running a little hot. I inserted a 200-ohm 20-watt resistor ahead of the damper and bypassed it to ground with a 0.5-µf 600-volt capacitor.

Result—safe horizontal output transformer current, ample width and no more blown fuses. If you run into this problem, but don't have excessive current through the horizontal output transformer, all you need is the bypass capacitor. It will reduce ripple and prevent needless fuse failure.—*Charles Andrews*

END



New Volume III SURPLUS RADIO CONVERSION MANUAL

—gives new conversion data, instructions, and diagrams for putting surplus equipment to practical use.

Contents include:

701-A; AN/APN-1; AN/CRC-7; AN/URC-4; ARA; BC-442; 453-455; 456-459; 603; 696; 950; 1066; 1253; CBY-29125; 50083; 50141; 52208-11; 52232; 52302-09; FT-241A; MBF(COL-43065); MD-7/ARC-5; R-9/APN-4; R23-R28/ARC-5; RAT; RAV; RM-52(53); RT-19/ARC-4; SCR-274N; SCR-522; T-15/ARC-5 to T-23/ARC-5.

For list of contents of Vols. I and II, send stamped, addressed envelope. \$3.00 per volume

*Order from your favorite electronic parts distributor.

If he cannot supply, send us his name and your remittance, and we will supply; foreign, add 10%.

EDITORS and ENGINEERS, Ltd.

Summerland 5, California



Dealers: Electronic distributors order from us. Bookstores, libraries, newsdealers order from Baker & Taylor, Hillside, N. J. Export (exc. Canada), order from H. J. Snyder Co., 440 Park Ave. So., N.Y. 16.

ATLAS "Job Rated" P. A. SPEAKERS



There is an Atlas Speaker Ideally Suited for Every Job

All Atlas P. A. speakers are highly efficient, especially in the voice frequency range, providing the extra "punch" needed to override high level background noise. Most are 100% weatherproof; aluminum and diecast parts are treated with corrosion inhibitors, then finished in "stone hard" baked enamel. The CJ Cobra-Jector horns are constructed of nonresonant, indestructible fiberglass, and HU and TP speaker horns of aluminum, finished in gun-metal grey. The HU and TP speakers are particularly designed for efficient talkback operations. The peaked characteristics within the voice frequencies increase the sensitivity of these speakers as pickup devices.

All HU and CJ speakers are equipped with versatile "Versalock" . . . This rugged, reliable mounting bracket, completely adjustable both horizontally and vertically, provides positive locking in any position.

The DU-12 and DC-5, Atlas' renowned DeCor projectors, are styled to harmonize with any decor, modern or traditional. Send for free catalog to Dept. RE-10

Model	HU-12N	HU-15N	HU-24N	CJ-14N	CJ-30N	CJ-44	TP-15N	TP-24N	DU-12	DC-5
POWER*	7.5 w	25 w	25 w	7.5 w	25 w	60 w	25 w	25 w	7.5 w	6 w
IMPEDANCE**	8 ohm	8 ohm	8 ohm	8 ohm	8 ohm	16 ohms	8 ohm	8 ohm	8 ohm	8 ohm
FREQUENCY C.P.S.	350-10,000	250-10,000	200-10,000	400-10,000	250-10,000	150-9000	250-10,000	200-10,000	400-10,000	120-7000
LENGTH OVERALL	7 1/4 in.	8 3/4 in.	12 in.	8 in.	1 1/4 in.	23" x 13"	16 1/2 in.	23 in.	14 in.	14 in.
BELL DIAMETER	7 1/2 in.	9 3/4 in.	11 1/4 in.	9 1/2" x 5 1/2"	14" x 6"	19 in.	9 3/4 in.	11 1/4 in.	7 in.	7 in.
NET PRICE	\$16.20	\$20.10	\$22.35	\$18.00	\$24.60	\$43.50	\$31.20	\$34.50	\$19.80	\$13.20

*Input range limited to frequencies above horn cutoff **All models available in 45 ohms at slightly higher prices

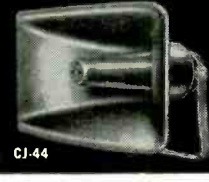

**ATLAS
SOUND CORP.**
1449 39th Street
Brooklyn 18, N. Y.
In Canada:
Atlas Radio Corp., Ltd.,
Toronto, Ontario

BUILD THE FINEST
Professional Quality
 CUSTOMIZED
TV KIT

On Easy "Pay As You Wire" Terms
 Only \$15 for the Starting Package!

The
"PROFESSIONAL"
 Series—designed for
 the perfectionist seeking
 the finest in TV performance.
 Easy to assemble. No technical
 knowledge required. An ideal
 "Learning" Kit with a Complete
 Course of Study is available.

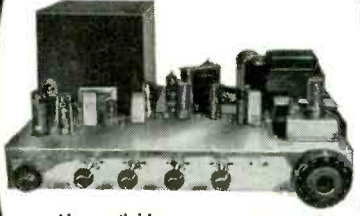

Also available:
**WIRED
 CHASSIS**
 for custom
 installations
 with a choice



of vertical or horizontal
 controls and the newest
 23", 24" or 27"
 CRT.



Beautiful Cabinets —
 designed to enhance sound quality and blend with
 modern decor. For TV or combination TV and Hi-Fi.

A few of the **Professional Quality Features:**
 Choice of push-pull 10-watt audio or output to
 your Hi-Fi system... D.C. restoration...
 Ultra-linear sweep circuits... Standard Coil
 Guided Grid Turret Tuner... Super-sensitiv-
 ity for fringe areas... Complete line of Acces-
 sories for Custom Installations.

Choice of 23", 24" or 27" CRT. Prices range
 from \$119 to \$199.

U.S. Armed Services and over 4000 schools and
 colleges have selected *Transvision* Receivers for
 educational television.

Interested in Electronics?

Learn the basic principles of elec-
 tronics from the Course available with the Kit.

ASSEMBLY MANUAL—\$2.00

See how easy it is to assemble the *Transvision*
 Kit. Cost of Manual refunded on purchase of Kit.



New Rochelle, N.Y.
 NE 6-6000

START NOW — MAIL THIS COUPON

- TRANSVISION Electronics, Inc., New Rochelle, N.Y. Dept. R.E.
 Send FREE 8-page Catalog... I enclose \$2 for Assembly
 Manual, refundable on purchase of Kit.
 I enclose \$15 for Starting Pkg. on pay-as-you-wire plan.
 (Complete Kits range from \$119 to \$199.)

Name _____
 Address _____
 City _____ Zone _____ State _____

NEW
TUBES and
**SEMI-
 CONDUCTORS**

THINGS WERE RELATIVELY QUIET THIS
 month. But even so, we came across a
 couple of high-speed switching transis-
 tors, another novar tube, and a twin-
 triode for TV vertical deflection cir-
 cuits.

5BC3

A full-wave vacuum rectifier of the
 novar type intended for use in the power
 supplies of television and radio receivers
 and high-fidelity audio equipment hav-

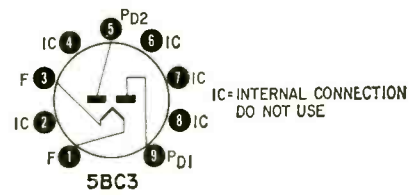

ing high current and voltage require-
 ments.

Typical operating characteristics of
 the RCA 5BC3 as a full-wave rectifier
 with a capacitor input filter are:

$V_{p,p}$ (supply rms)	600	900	1100
Filter input capacitor (μf)	40	40	40
Total effective plate supply impedance per plate (ohms)	21	67	97
V_{output} (dc at input to filter) at 300-ma load	290	-----	-----
275-ma load	-----	460	-----
162-ma load	-----	-----	630
150-ma load	335	-----	-----
137.5-ma load	-----	520	-----
81-ma load	-----	-----	680

2N779-A

A germanium micro-alloy diffused-
 base transistor specifically designed for
 very-high-speed switching applications.
 This p-n-p unit has been reliably used

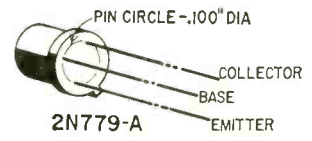

in circuits with speeds of more than
 20 mc.

Electrical characteristics of the
 Philco 2N779-A are:

I_{CBO} (typical μa when $V_{CB} = 5$)	1
V_{CB0} (minimum)	15
V_{EB0} (minimum)	2
h_{fe} (typical when $V_{CE} = -0.5$ $I_C = -10$ ma)	90

Microminiature transistors

Some tiny new p-n-p germanium alloy
 transistors are being made by Rauland,

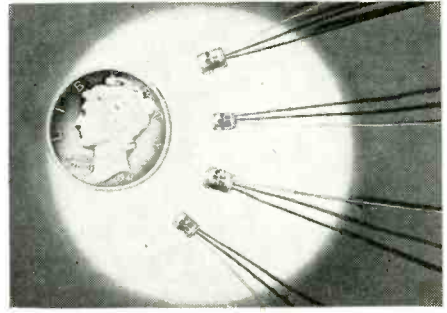

a subsidiary of Zenith. Their R-2 and
 R-3 units measure only 0.160 x 0.130
 and 0.130 x 0.100 inch, respectively.
 Designed for use as audio or if ampli-
 fiers, they have a noise factor of 5 db
 maximum and beta ranges exceeding
 300. Although the units are extremely
 small, they can dissipate up to 30 mw
 at 25°C.

6EW7

A 9-pin miniature tube containing
 two dissimilar triodes. One section is
 a medium-mu unit designed for use in
 vertical deflection oscillator circuits.
 The other triode section, a low-mu unit,

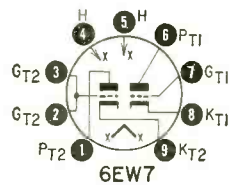

is intended for use as a vertical deflec-
 tion amplifier. When used in suitable
 circuits, it will fully deflect picture
 tubes having deflection angles up to
 110°.

Characteristics of the medium-mu
 section of the RCA 6EW7 in vertical
 deflection oscillator use are:

V_p	300
V_{G} (peak negative pulse)	400
I_k (peak ma)	77
(average ma)	22
P_p (watts)	1.5

Characteristics of the low-mu section
 in vertical deflection amplifier use are:

V_p (dc)	330
V_p (peak positive pulse)	1,500

V_G (peak negative pulse)	250
I_k (peak ma)	175
(average ma)	50
P_e (watts)	10

New from TI

Three new lines of germanium consumer type transistors have been announced by Texas Instruments. They include the GAM-1 (Germanium Alloy Mesa), claimed to have the industry's

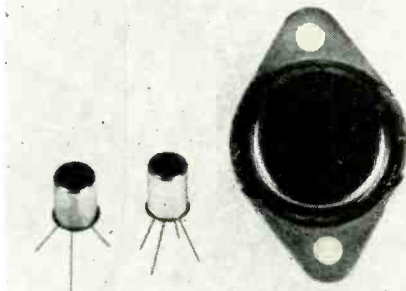

highest available gain in the broadcast band; the GAM-2, a high-frequency response series for FM use, and the Economy Power series for audio applications.

The GAM-1 units are particularly suited for AM-FM receivers, AM receivers and 27-mc CB transceivers. They supply 32-40 db of current gain at 455 kc.

The GAM-2 units for FM applications have high frequency response to 120 mc. Their noise figure at 100 mc is under 6 db.

The Economy Power transistors handle up to 25 watts and have breakdown voltages of 30, 45 or 60.

2N835

A high-speed n-p-n silicon epitaxial mesa switching transistor. With its typical storage time of 16 nanoseconds, the unit is one of the fastest silicon switching transistors available. It directly replaces the 2N706, -A, -B and -C silicon mesa transistors and provides

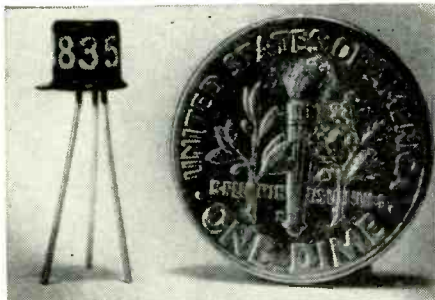
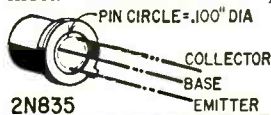

improved circuit performance. It is intended for use in ultra-high-speed logic circuits of data-processing equipment and computers.

Maximum ratings of the Motorola 2N835 are:

V_{CB}	25
V_{CE}	20
V_{EB}	3
I_c (ma)	200
P_{total} (watts at 25°C)	1
(watts at 100°C)	0.5

END

NEW

CARDIOID MICROPHONE

AMERICAN MICROPHONE'S NEW
MODEL D-55 CARDIOID MICROPHONE
**THE FINEST CARDIOID IN
THE P.A. FIELD**

"Made in America by Americans"

Frequency response is 70 to 15000 cps. Multiple impedance 50—150—Hi (40,000 ohms); output level is -54 db at Hi impedance (0 db = 1 volt/dyne CM²). Mylar diaphragm and rugged construction make the D-55 ideal for outdoor-indoor requirements. Front to back ratio is 15 to 20 db.

Available in matched pairs, phased, for stereo recording at no extra cost.

For true Hi Fidelity recording under varied acoustical conditions use the new American D-55 Cardioid.
List Price \$89.50

WRITE today for free American Microphone catalog.

West Plant: Los Angeles 18, Calif.
Main Plant: Rockford, Illinois, U.S.A.

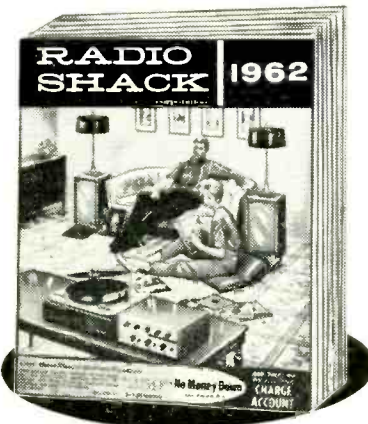

RADIO SHACK Corp.
Boston, Massachusetts

Send for your **FREE** personal copy of
RADIO SHACK'S 336-PAGE 1962 CATALOG
Nationwide standard of excellence in
Electronics, Music, Communications

Also receive all other issues for 1 year!
Our bigger, better catalogs offer the widest line of electronic parts and equipment in the world! Latest in Stereo, Hi-Fi, Ham Radio, Test Equipment, Pre-Recorded Tapes, Tape Recorders, Records, Component Parts—plus 30 pages of new fun-to-build kits. Every item is easy to own on new No Money Down Credit Terms. Every item is guaranteed to satisfy or your money back.

MAIL THIS COUPON TODAY

RADIO SHACK Corp. Dept. 61K10A
730 Commonwealth Ave., Boston 17, Massachusetts
Please send me Radio Shack's new 1962 Electronics Catalog and every new issue for the next 12 months—all FREE and POSTPAID.

Name _____
Address _____
City & Zone _____ State _____

Professional Technicians Use CASTLE'S Complete

TV TUNER OVERHAUL

ALL MAKES
ONE PRICE
\$9⁹⁵

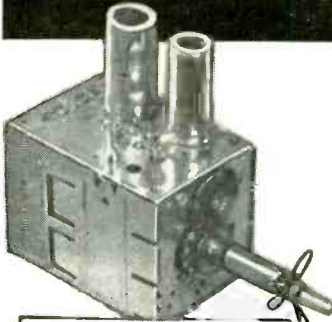

SAME DAY SERVICE!
on Popular Types
48 Hours most Others

VHF TUNERS • UHF TUNERS • UV Combinations*
Castle overhaul charge includes all labor and minor parts and written 90 day warranty. Tubes and major parts are extra at net prices. Tuner to be overhauled should be shipped complete; include tubes, shield cover and any damaged parts. Write down model number and state complaint. Pack well and insure.

NOW ALSO IN THE EAST

Castle pioneered TV Tuner Service almost a decade ago. Overhauling TV Tuners is our only business.

*One piece construction. Separate UHF and VHF tuners must be dismantled.



CASTLE TV TUNER SERVICE, INC.

NEW! 653 PALISADE AVE., CLIFFSIDE PARK, NEW JERSEY
• 5710 N. WESTERN AVE., CHICAGO 45, ILLINOIS
• IN CANADA: 136 MAIN ST., TORONTO 13, ONTARIO

WANT BACK ISSUES?

Back numbers of most issues of **RADIO-ELECTRONICS** are available upon request
This year's issues 50¢ — Last year's issues 55¢
Previous year 60¢, etc., up to a maximum of \$1 per copy.

RADIO-ELECTRONICS 154 West 14th St. New York 11, N. Y.

PROOF OF SUPERIORITY
NO OTHER MICROPHONE
CAN MATCH!

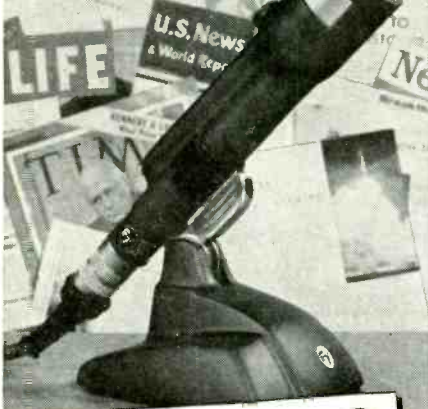

**LEADING NEWSWEEKLY
MAGAZINES PICTURE E-V
MORE OFTEN THAN THE NEXT
FOUR BRANDS COMBINED!**

Write now for catalog of
microphones preferred by top radio, TV,
newsreel and sound engineers!

Electro-Voice

ELECTRO-VOICE, INC.
Commercial Products
Div., Dept. 1011E
Buchanan, Michigan

A "brass-tacks" guide to TIME-SAVING TEST PROCEDURES!



BASIC ELECTRONIC TEST PROCEDURES is a big new 316-page manual with the kind of "brass tacks" training that helps you locate TV, AM and FM troubles in a jiffy. Teaches you exactly what instruments to use and exactly where and how to use each type. Tells how to substitute one instrument for another and how to develop time-saving, money-making test methods all along the line in all types of service jobs.

The manual that helps you CUT TEST TIME IN HALF!

Here are some of the subjects it covers: Current Checks; making measurements of Power, Capacitance, Inductance, Resistance, AF, RF, Phase, Distortion & Modulation; Checking Sensitivity, RF Gain, Fidelity, AVC Voltage, Operating Voltages, etc. Includes handy **VISUAL ALIGNMENT TECHNIQUES**. Even covers transmitter and industrial electronic test procedures. 190 how-to-do-it pictures and dozens of step-by-step troubleshooting procedure charts make things doubly easy. Price only \$8.00. Money-back guarantee.

PRACTICE 10 DAYS FREE

Dept. RE-101, Technical Division 623900
HOLT, RINEHART & WINSTON, INC.
383 Madison Ave., New York 17, N. Y.

Send **BASIC ELECTRONIC TEST PROCEDURES** Manual for 10-day free examination. If I like book, I will then send \$8.00 (plus postage) in full payment. Otherwise I will return manual and owe you nothing. (SAVE! Send \$8.00 with order and we pay postage. Same 10-day return privilege with money refunded promptly.) (#708933)

Name:

Address:

City, Zone, State:

OUTSIDE U.S.A.—\$5.00 cash—10-day money-back guarantee. (Above offer expires July 15, 1962)

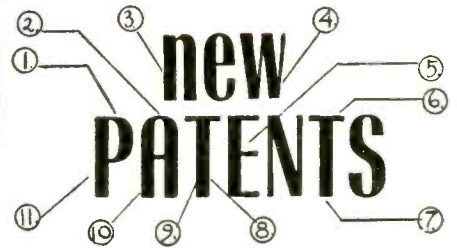

new PATENTS

QUALITY AUDIO OUTPUT

Patent No. 2,947,947

Sergio Bernstein-Bervery, Tarrytown, N. Y. (Assigned to General Precision, Inc.)

This audio output stage provides quality reproduction with an inexpensive output transformer. Its output impedance is low. It eliminates transients generated in conventional circuits when the load shifts from one half of the primary to the other half. In addition, effects of stray capacitance are minimized.

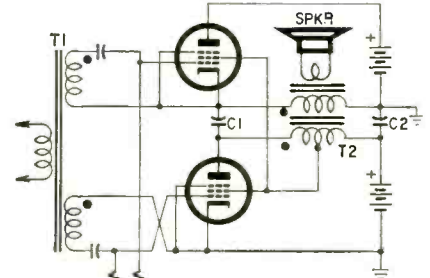

Fig. 1

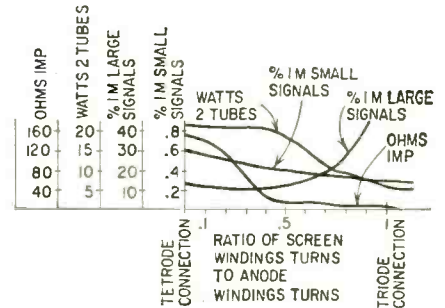

Fig. 2

T2 has two primaries which are coupled through C1 and C2 (Fig. 1). Thus they carry equal ac at all times and may be considered in parallel. The signal is identical in both windings, so no transients are generated. T2 need not be specially designed for low capacitance and leakage reactance and tight coupling.

Fig. 2 shows how output, distortion and impedance vary with screen-to-anode turns ratio. To take advantage of this, one primary of T2 is center-tapped for the screen.

VOLTAGE REGULATOR

Patent No. 2,956,172

Robt. A. Torkildsen, Milwaukee, Wis. (Assigned to General Electric Co.)

In this circuit (see diagram) the output voltage ratio E1:E2 tends to remain equal to R1:R2 in spite of variations in Z1 or Z2. For convenience we will assume a 1:1 ratio, or R1 = R2. R3 is relatively small. R4 balances the network to make E1 = E2 when Z1 = Z2.

At balance, both transistors conduct slightly and equally, since V1's base is more negative than the emitters while V2's base is more positive. R4 provides an approximate center tapping of the supply. Actually, it compensates for differences in transistor leakage currents.

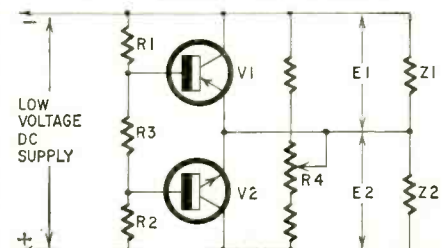

Suppose $Z1:Z2$ rises for any reason, then both emitters go more positive. Then $V1$'s resistance goes down, and $V2$'s resistance rises. Since $V1$ is across $Z1$, and $V2$ is across $Z2$, the change in $Z1:Z2$ is compensated by the opposite change in the resistance ratio $V1:V2$. Therefore the voltage ratio $E1:E2$ tends to remain constant.

TEMPERATURE-COMPENSATED AMPLIFIER

Patent No. 2,963,656

Samuel R. Parris, Ridley Park, Pa. (Assigned to Burroughs Corp., Detroit, Mich.)

In Fig. 1, $V1$ is a silicon n-p-n transistor with positive temperature drift of about $2.4 \text{ mv}/^\circ\text{C}$. $V2$, a germanium p-n-p transistor, drifts about $-1.8 \text{ mv}/^\circ\text{C}$. This circuit combines them to min-

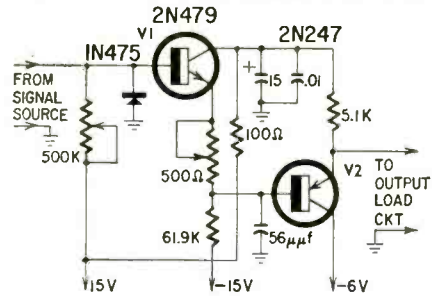

Fig. 1

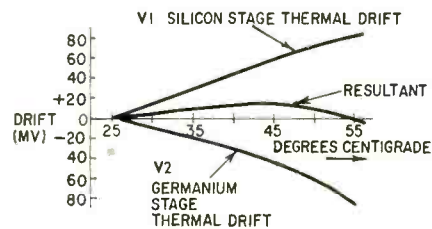

Fig. 2

imize drift over a wide range of temperatures (Fig. 2). This input diode prevents the input signal from going more than a few tenths of a volt negative.

The passband is from dc to 2 mc. Input impedance is 400,000 ohms, output is only 30 ohms. Source impedance Z should be about 20,000 ohms.

GAS-PRESSURE GAUGE

Patent No. 2,963,601

Lawrence J. Varnerin, Jr., Summit, N. J., and Geo. J. Schultz, Wilkins Township, Pa. (Assigned to Westinghouse Electric Corp.)

This gauge is especially suitable at pressures between .001 to 10 mm of mercury, a range above the reach of conventional gauges. It contains an outer cylinder, A1; a coiled filament, and an inner cylinder, A2. Diameters may be, respectively, $\frac{3}{4}$, $\frac{1}{2}$, $\frac{1}{8}$ in.

The tube is filled with the gas to be measured, as usual. Electrons emitted from the heated filament collide with gas molecules and break up the gas atoms into electrons and ions. The

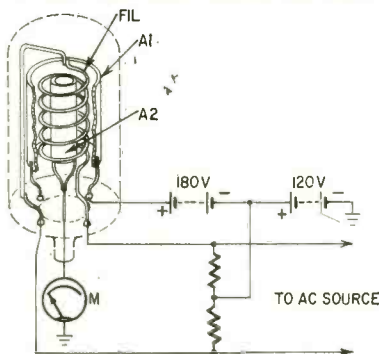

greater the gas pressure, the more collisions occur. The liberated ions are drawn toward the negative element A2 and are measured by M. Electrons are collected by the positive element A1.

Tube dimensions are such that linearity is maintained even at the high pressures mentioned above. The short electron path makes it unlikely that any electron will cause more than one collision before reaching A1. The short ion path prevents trapping on the tube structure. Also, A2 runs so hot (being close to the filament) that its atoms cannot trap ions. END



With Centralab Twist-Tab Radiohms

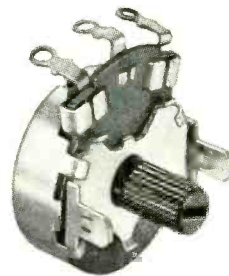

You'll get a big bang out of CENTRALAB tab-mounted Radiohm Controls—because they're easy to install and easy to adjust. These Twist-Tabs are tailored to the *minimum* shaft length needed for TV hidden controls. When a *longer* shaft is needed, it's simple to use the 2" polyethylene extension packed with each unit. Nothing to saw—a snip of the scissors gives the needed length, and the adjustment slot is still there, and still easy to get at.

CENTRALAB Twist-Tabs are available in 25 values from 200 ohms to 7.5 megohms... rated at $\frac{1}{2}$ watt, $\frac{15}{16}$ " diameter, $\frac{7}{16}$ " deep. Shoot over to your CENTRALAB distributor for full details.



THE ELECTRONICS DIVISION OF GLOBE-UNION INC.
902G EAST KEEFE AVENUE • MILWAUKEE 1, WISCONSIN
CENTRALAB CANADA LIMITED—AJAX, ONTARIO

B-6115 S

ELECTRONIC SWITCHES • VARIABLE RESISTORS • CERAMIC CAPACITORS
PACKAGED ELECTRONIC CIRCUITS • ENGINEERED CERAMICS

TEACH-R-MATIC®



ACTUAL DIA. 1 1/4"

NEW!

AUTOMATED TEACHING DEVICE

BE A RADIO-TV DIAGNOSTICIAN!

TEACH-R-MATIC self-teacher with Home Study Course TV-1 enables you to learn faster & easier. Makes home study more effective. Improves memory. Ideal for review. Provides practical home instruction in diagnosing TV and radio troubles.

ILLUSTRATES and gives symptoms of fifty oft-recurrent TV faults **PLUS** symptoms of fifty common radio faults. Provides **500 TESTS** on cards—**YOU SELECT ANSWERS**. **TEACH-R-MATIC** tells you automatically and immediately if selection is right or wrong. Also indicates by code where to look for defects causing troubles & how to remedy them. Score cards included to check proficiency and progress.

TEACH-R-MATIC can be used to study other subjects. New home study courses will soon be announced.

SPECIAL INTRODUCTORY OFFER!

Place order promptly and you will receive absolutely **FREE** Cisin's **RAPID TV TROUBLE SHOOTING METHOD** selling at \$1.00. This offer expires Oct. 31st, 1961

TEACH-R-MATIC is the invention of Harry G. Cisin, well-known educator, author and inventor. **FULLY GUARANTEED**. Money back in 5 days if not satisfied, if TV-1 is returned in original condition.

Special quantity discounts to correspondence schools, distributors and residence schools.

PRICE \$4.90

(postage 10¢)

Price includes **TEACH-R-MATIC** device and TV-1 Study Course

RUSH COUPON NOW!

H. G. Cisin, Consulting Engineer
Dept. RE-1, Amagansett, N.Y.

Enclosed find \$_____ Rush **TEACH-R-MATIC** device and **HOME STUDY COURSE TV-1**. Also include **FREE** copy of **RAPID TV TROUBLE SHOOTING METHOD** as per Special Offer.

Name _____

Address _____

City _____

Zone _____

State _____

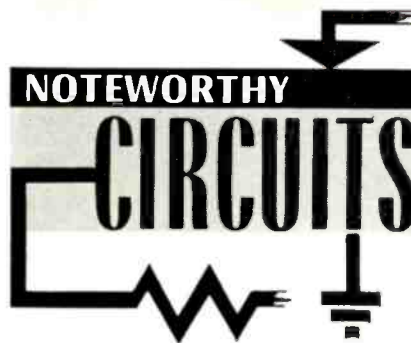

WAVEFORM GENERATOR

Pulse and sawtooth generators are widely used to develop sweep voltages and timing markers and for many other uses. The circuit shows a simple one-tube waveform generator that will find many applications on the service bench

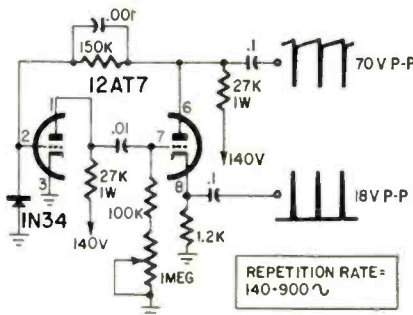

and in the home lab. Seventy-volt peak-to-peak sawtooth voltages with sharp spikes are available at the plate-circuit output and 15-volt positive pulses at the cathode. Repetition rate is variable from 140 to 900 cycles.—*Kenneth E. Walters*

IMPROVED IMPULSE RELAY

Impulse or ratchet relays are not readily available from many parts distributors, and they may not be made in the range of operating voltages you want to use. An item on page 142 of the November, 1957, issue of **RADIO-ELECTRONICS** shows how a spdt impulse relay can be improvised from three dpdt relays.

Here is an improved circuit that I've

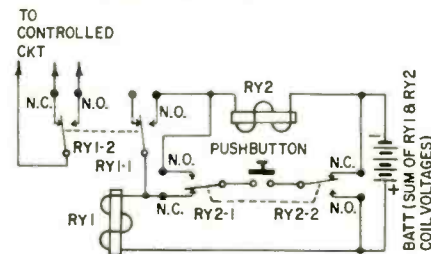

used for several years. It is simpler than the one described and uses only two dpdt relays. The circuit is shown with both relays de-energized. The relays have identical coils and each is rated at half the supply voltage.

When the button is pressed, RY1 is energized through contacts RY2-1 and RY2-2, and the circuit to the controlled device is made or broken through RY1-2. As soon as the button is released, RY2 energizes through RY1-1 and RY1's coil. RY1 remains energized

through contact RY1-1 and the coil of RY2.

When the button is pressed the second time, RY1 opens (it is shorted out by RY2-1, the pushbutton and RY2-2). Releasing the button opens RY2, leaving both relays de-energized and the controlled circuit ready for another cycle.—*Robert A. Belshe*

TRIGGERED SWEEP IMPROVEMENT

The triggered sweep in the Precise 300 and 308 oscilloscopes is a simplified circuit that does not give as clean operation as more expensive models. When using the triggered sweep, the length of the horizontal trace tends to vary with the time interval between the arrival of the signal being viewed and the signal following it. Thus, when viewing random pulses, the time base continually expands and contracts. When sweep amplitude is high, it overdrives the horizontal amplifier and develops a nonlinear trace. Here is a simple circuit modification you can add to your scope to improve its performance.

The original circuit, shown by solid lines, is a conventional cathode-coupled multivibrator. It is repetitive or free-running when the arm of the **TRIGGERED SWEEP** control is at the ground end. The sawtooth sweep voltage is developed as C1-b charges through P5-a and R28 while V5 is cut off. At the same time, C1-a is discharging through R29 and P5-b, making V5's grid more positive and gradually bringing it out of cutoff. When V5 conducts, it discharges C1-b and the cycle repeats. The time constants of the circuits involving C1-a and C1-b are adjusted so the charge on C1-b does not rise very much above 20 volts between sweeps.

For triggered operation, the arm of P6 is moved toward B-plus, placing a positive bias on the cathodes of V5 and V6. V5's grid returns to ground so it remains cut off and stops free-running operation. C1-b now charges until it reaches full B-plus voltage or until the next incoming signal drives V5 to conduction and stops the sweep. Thus, instead of discharging periodically when its voltage reaches 20, as in the free-running state, C1-b's charge may be close to B-plus before the next signal comes along to discharge it.

This trouble can be eliminated by adding the 6AL5 clamping diode as

shown in dashed lines. This circuit prevents C1-b's charge from approaching B-plus and holds it at a level slightly above the peak it would reach in repetitive operation. This level is set by the back bias applied to the

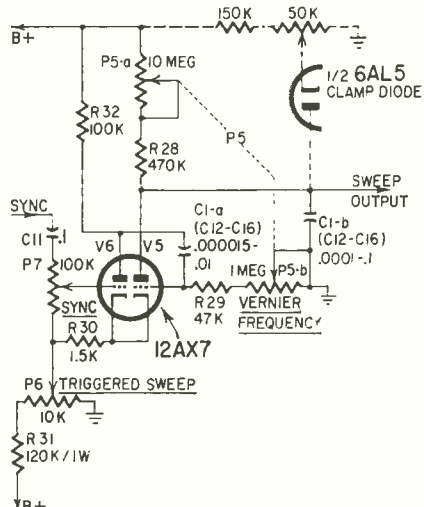

diode's cathode from the 50,000-ohm potentiometer. The charge on C1-b is clamped at the level set by the potentiometer. Thus each sweep is exactly the same length regardless of the rate of occurrence, and all sweeps are linear. To adjust the circuit, turn the 50,000-ohm pot to the B-plus end and then back down as far as possible without interfering with the normal repetitive sweep operation.

The 6AL5 and pot can be mounted in holes drilled in the long connecting chassis or on a small mounting plate fastened to the rear of the front sub-chassis by screws holding terminal strip H82A.

Many general-purpose scopes use cathode-coupled multivibrators in a conventional repetitive sweep circuit. You can adapt these for triggered sweep by installing the trigger control consisting of R31 and P6 and adding the 6AL5 diode clamp.—Charles Erwin Cohn

Q-MULTIPLIER AND BFO

The selectivity of a superhet if circuit can be increased by shunting the if signal path with a tuned circuit that includes a controlled amount of positive feedback to increase its Q. This arrangement is called a Q-multiplier and is gaining popularity in amateur and communications receivers. The diagram shows the combined Q-multiplier and bfo that are used in the new Lafayette Electronics HE-30 communications receiver.

The Q-multiplier and bfo is a Colpitts circuit using a 6AV6. With the SELECTIVITY control in the CW-SSB position, tube gain is high and the circuit oscillates and provides the beat signal needed for CW reception or SSB carrier reinsertion. C31 adjusts the frequency for the desired CW pitch or the clearest SSB signal. Stray coupling is used between the oscillator and the if

circuit. When the SELECTIVITY control is off the CW-SSB position, S4 closes and connects the tuned circuit to the mixer plate through C9. Positive feedback—though not sufficient to produce oscillation—increases the if selectivity. The amount of selectivity is controlled by R26 which varies the gain of the 6AV6. Response at the -6-db point can be varied from 2 kc (with the Q multiplier off) to 800 cycles. C31 tunes the Q-multiplier through the if pass band to reduce or eliminate interference from adjacent signals.

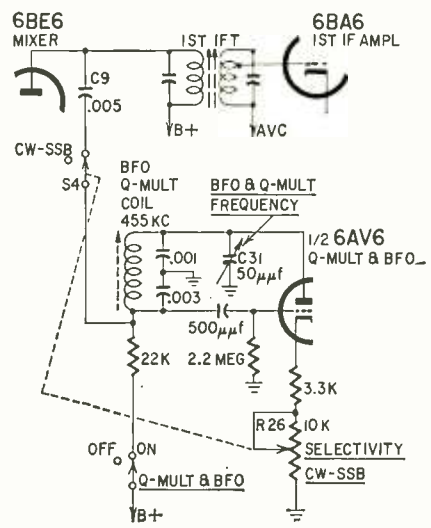

tion—increases the if selectivity. The amount of selectivity is controlled by R26 which varies the gain of the 6AV6. Response at the -6-db point can be varied from 2 kc (with the Q multiplier off) to 800 cycles. C31 tunes the Q-multiplier through the if pass band to reduce or eliminate interference from adjacent signals. END

smallest thest response

the all-new **SHURE** Sonodyne II

adjustable frequency response microphone

Life-like, natural reproduction achieved through a smooth response from 60 to 10,000 cps... without coloration. *Revolutionary Adjustable Frequency Response* feature permits you to roll off highs or lows, separately or together—provides additional flexibility in a variety of microphone applications. Omni-directional... high output dynamic element. Equipped with *reliable* on-off switch and "positive action" 150° swivel that permits you to "aim" the microphone at the source of sound. Model 540S priced at only \$29.97 audio net.



Write for literature:
Shure Brothers, Inc.
222 Hartrey Ave.
Evanston, Illinois
Dept. 12-J



By far the **BEST VALUE** obtainable in either wired or kit form... compare and you'll agree **"THE BEST BUY IS EMC."**

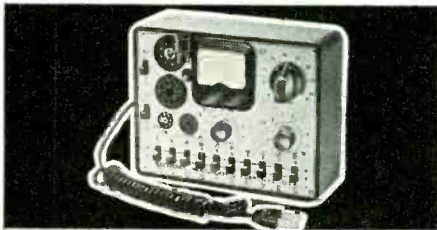

EMC Model - 211 Tube Tester - The smallest, lowest priced, domestic made tube tester on the market. It is completely flexible and obsolescent proof. It checks each section of multi-purpose tubes separately, checks all octal, loctal, 9 prong and miniature tubes for shorts, leakages, opens, intermittents as well as for quality. Quality is indicated directly on a two color meter dial using the standard emission test. Comes complete with instructions and tube charts in ring bound manual. Size 6 3/4" x 5 1/4" x 2 3/4" deep. Shipping weight: 3 lbs.
 Wired \$22.90 Kit \$14.90
CRT Picture Tube Adapter \$ 4.50

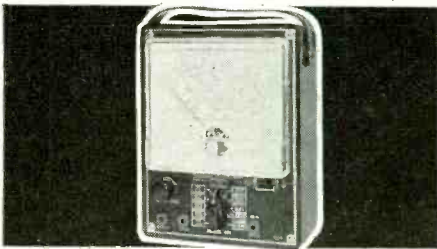

EMC Model 109 - Voltmeter - Features 20,000 OHMS volts DC sensitivity and 10,000 OHMS per volt AC sensitivity. Uses a 4 1/2, 40 microampere meter, with 3 AC current ranges, and 3 resistance ranges to 20 megohms, 5 DC and AC voltage ranges to 3000 volts and 3 DC current ranges; also 5 DB range.
Model 109 - With carrying strap, Weight 2 lbs. 5 ozs.; Size: 5 1/4" x 6 3/4" x 2 7/8" \$26.95
Model 109K - Kit Form 19.25
Model HVT - 30,000 Volt Probe for Model 109 7.95

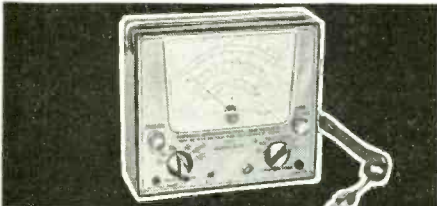

EMC Model 107A - Peak to Peak Vacuum Tube Volt-Ohm Capacity Meter - 6" meter cannot burn out - entirely electronic. Measures peak to peak AC voltages to 2800 volts in 6 ranges. Measures capacity in 6 ranges from 50 mmfd to 5000 mfd. Measures resistance in 6 ranges from .2 ohm to 1000 meg. Measures DC volts to 1000 volts in 6 ranges. Input resistance to 16.5 meg. Wired \$51.40 Kit \$36.50

Yes, tell me more, send me **FREE** a detailed catalog of the Complete EMC Line. Dept. RE-1061
 NAME
 STREET
 CITY STATE.....

EMC Electronic Measurements Corp.
 625 B'way, New York 12, N. Y.
 Ex. Dept., Pan-Mar Corp., 1270 B'way, New York 1, N. Y.



STOP GUN-TIP TARNISH

After prolonged use, the copper tip of a soldering gun becomes tarnished or corroded where the nuts or screws make

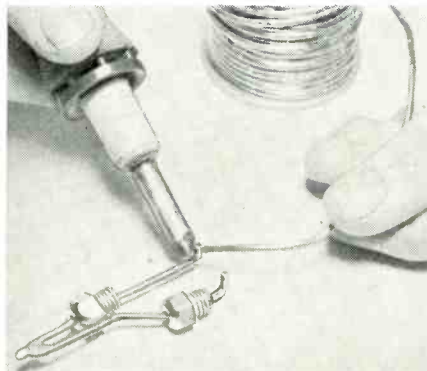

electrical contact with the tip. The corrosion causes a poor electrical contact, lowered tip temperature and slow heat-

Ask By Name For
GENUINE
"NO NOISE" your assurance
 of brand name
 quality

NO-NOISE PRODUCTS

Volume Control and CONTACT RESTORER
 • Cleans • Lubricates • Protects
 Not a Carbon Jet Solution
 2 oz. Bottle \$1.00
 6 oz. Spray Can \$2.25
 Net to Servicemen

NO-NOISE TUNER-TONIC with PERMA-FILM
 • Cleans, lubricates, restores all tuners, including wafer type.
 • Non-toxic, non-inflammatory.
 • For TV, radio and FM use.
 • Economical—a little does a lot.
 6 oz. Aerosol Can \$3.25
 Net to Servicemen

FREE with each can of **ELECTRONIC CHEMICAL products—5" PLASTIC EXTENDER**
 • Push Button Assembly
 • For Pin Point Applications
 • Does Not Cause Shorts
 Net To Servicemen

Electronic Chemical new formula EC-44
 Lubricates, conditions, cleans all electrical contacts. Economical... a little does a lot!
 6 oz. spray can \$3.50
 Net To Servicemen

ELECTRONIC CHEMICAL CORP.
 813 Communipaw Avenue Jersey City 4, N. J.

ing. Prevent this by removing the tip and tinning it with a soldering iron or gas flame.—Clyde A. Compton

HEATLESS TRANSISTOR CONNECTIONS

When connecting wires to lead type transistors, there's really no need to solder the connections for good electrical conductivity. Just daub on some printed-circuit silver or copper paint. To insure good mechanical strength, however, twist the wires tightly together before applying the paint.—Chester A. Clifford

LESS NOISE, MORE POISE

Nearly all record changers and turntables have a filter network that absorbs the click or jolt caused by turning them on or off. With high-amplification, however, this is not always fully effective, so some system that gives more complete muting is desirable.

When the added muting is controlled by a pushbutton, it is so useful that it soon becomes indispensable. It not only gives perfectly quiet stops and starts, but, even more important, it permits the operator to silence the pickup at any time. This aids the hand in setting down the stylus or lifting it up in normal playing but especially in the tricky operation of playing a selected part of a record.

Without muting, when the pickup is set down in the run-in groove, you often get a loud plop, either because of a rough spot or inexact placement. Reflexes make the hand jump, causing

ENGINEERING DEGREE IN SCIENCE MATH 27 or 36 MOS.

B.S. degree—36 mos. • B.E. degree—27 mos.

Accelerated year-round program prepares for early employment in fields of Science and Engineering. Regular 4-year program for B.S. Degree completed in 36 months. Special engineering degree program in 27. Classes start January, March, June, July, September. Quality education. Graduates employed from coast to coast. Government approved for veteran training. Students from 50 states, 40 countries, 20 buildings; dorms, gym. Campus. Save time and money. Earn board. Write for catalog, 1710 E. Washington Boulevard, Fort Wayne 2, Indiana.

INDIANA TECHNICAL COLLEGE

HOW TO PUBLISH YOUR BOOK

Join our successful authors in a complete and reliable publishing program: publicity, advertising, handsome books. Speedy, efficient service. Send for **FREE** manuscript report & copy of Publish Your Book.

CARLTON PRESS Dept. R6K
 84 Fifth Ave., New York 11, N. Y.

HI-FI RECORDING TAPE

Splice Free (except 2400')
 15 day money-back guarantee

1200' 7" Acetate	3-	12+	24+
1800' 7" acetate	1.79	1.59	1.45
1800' 7" mylar	2.09	1.99	1.85
2400' 7" mylar	2.69	2.59	2.49
2400' 7" tensitized mylar	2.99	2.95	2.90

Can Be Assorted. Add 15c Postage Per Reel.
 10c For 24+ Lot Orders.

HI-FI COMPONENTS TAPE RECORDERS available from wide variety of stock and shipped within 24 hours. Write for free wholesale catalogue. "WE WILL NOT BE UNDERSOLD." Write us and see why.

CARSTON 125-RD East 88 St. New York, 28, N. Y.

more noise and possibly damaging the grooves.

When there is separate muting, however, the operator presses a button with his left hand, sets the pickup down with his right and all is quiet even though the volume control is set at a normal listening level.

Similarly, lifting the pickup out of the groove is a maneuver that requires some care. All too often it makes a noise that shakes the hand that lifted the pickup that made the noise. This sequence can be avoided by placing one finger on one little button bearing down on one little switch.

The circuit is simple and can be added by anybody. You need two lengths of insulated wire and a snap-action momentary-contact switch.

Attach the two leads to the speaker terminals on the amplifier. Connect the switch across the other end of the new pair, mount it at the most convenient location and you'll wonder how you ever got along without it.

The degree of silence depends on size of the wire and length of the line. No. 18 is satisfactory for a run of 6 feet or more. A Microswitch is recommended for positive contact. The switch can be concealed under the turntable mounting base with only a small (home-made) plunger showing.—*Nicholas B. Cook*

PARTS RACK

A simple rack that makes for orderly arrangement and see-able inventory of various components is this parts rack which has shelves sloping downward

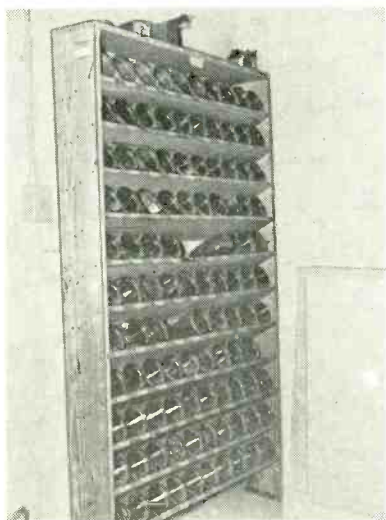

toward the rear. Containers are quart cans with their tops cut out and their edges smoothed. The unit provides 110 compartments in a minimum space.—*Harry S. Miller*

BATTERY-HOLDER REPAIR

Battery holders used in transistor construction projects have solder-lug terminals that are usually riveted to the battery connector. In practically all cases these riveted connections remain good mechanically, but they often develop a high resistance, causing a complete electrical failure. This can be cor-

direct road to earning a successful living in electronics — here it is!

RIDER'S BASIC RADIO

by M. Tepper



6-Volume 'pictured-text' course makes it easy for you to master radio communications

A BACKGROUND IN RADIO COMMUNICATIONS IS A SPRINGBOARD INTO MANY VITAL AREAS OF ELECTRONICS

Radio communications and the areas that comprise this subject—AC and DC electricity, vacuum tubes, receivers, transistors, and transmitters—is the foundation for many important branches of electronics—FM and AM radio, citizens band, amateur radio, mobile and marine communications, telemetry, radar, television, instrumentation, microwave, facsimile, ultrasonics, telephony, remote control, paging, etc. To know the fundamentals of radio communications is to be prepared for all of these important fields, and BASIC RADIO presents these fundamentals more clearly, more accurately than any text, or any group of texts ever published.

SPECIAL ILLUSTRATIONS MAKE SUBJECT EASILY UNDERSTANDABLE

Not only is the content of the course complete, but it is presented in such a manner that anyone regardless of previous education can grasp it quickly and know the subject thoroughly. The reason—carefully selected language, specially prepared illustrations—specially thought out presentation. These illustrations are not the typical ones found in most books on radio. They are specially conceived and selected for their ability to convey an idea, make complex thoughts simple to understand. You can't miss! There is at least one illustration to every page, one to support every idea—more than 650 illustrations in all in this six-volume course.

COVERS EVERYTHING YOU'LL NEED TO KNOW ABOUT RADIO COMMUNICATIONS TO GET AHEAD

This 6-volume pictured-text course covers the fundamentals and circuitry of radio communications. While it stresses fundamentals, it does not neglect the practical—it puts these fundamental principles to work. You will be able to read schematics—recognize circuits used in radio equipment. You will understand electricity and magnetism. Following the study of electricity, magnetism, circuit components, vacuum tubes, power supplies, oscillators and amplifiers—the various circuits are put to work in simple and elaborate radio receivers—AM and FM, auto and communications receivers including citizens band, mobile communication equipment, etc.

You are made thoroughly familiar with semi-conductors and transistors their applications; what they are—how they work and how they are used in radio. Transistor circuits and receivers with parts values are shown.

The last volume provides a thorough coverage of transmitters, antennas and transmission lines. You'll understand modulation and transmitter type oscillators, microphones, coupling methods and power supplies and transmitter schematics.

Volume I, DC electricity; Volume II, AC electricity; Volume III, vacuum tubes and vacuum tube circuitry; Volume IV, radio and communication receivers; Volume V, semiconductors, transistors and transistor receivers; Volume VI, transmitters, transmission lines and antennas.

A LOW COST ELECTRONIC EDUCATION 6-VOLUME COURSE ONLY \$13.85

This 6-volume course opens the wonderful world of electronics to you. The complete course costs only \$13.85 (soft covers). Or, you can select any volume covering the area of radio communications in which you wish to increase your knowledge. Buy this course today at parts distributors, bookstores or order direct using convenient coupon: FREE: Write for free brochure showing samples of pages demonstrating how special illustrations speed your learning.

-----10-DAY MONEY-BACK GUARANTEE-----
RE-10
JOHN F. RIDER, PUBLISHER INC.
116 W. 14th St., New York 11, New York

I want to save \$1.35 on cost of individual volumes.
Enclosed is \$..... Please send:
.....Set of.....Complete 6-vol. course in soft covers, \$13.85.
.....Set of.....Complete 6-vol. course in single cloth binding, \$14.85.
Send me individual volumes:
.....Vol. I, \$2.70....Vol. II, \$2.70....Vol. III, \$2.70....Vol. IV, \$2.50....Vol. V, \$1.90....Vol. VI, \$2.70.
.....FREE CATALOG.....FREE BROCHURE
We guarantee satisfaction or return to us within 10 days for full refund.

NAME.....
ADDRESS.....
CITY.....ZONE.....STATE.....

SUPER MAGNET SUPER SAVING!

Buy this Little Giant magnet, most powerful made, a sensational bargain! The low price of \$1.95 is less than 50% of what you'd pay for this magnet. Experimenters, hobbyists will find hundreds of uses for this powerful 4 oz. Alnico permanent magnet. LIFTS 5 lbs. EASILY. Limited quantity. Order several today. Measures 1 3/4 x 1 1/2". Item No. 86 \$1.50
Special Bargain (Shp. Chgs. 10c)



250 POWER TELESCOPE LENS KIT

Make your own high powered 6 ft. telescope! Kit contains 2" diam., 75" focal length, ground and polished objective lens and necessary eye pieces. Magnifies 50x to 250x. Full instructions.

ITEM NO. 123
\$2.95
(Shp. Chgs. 10c)



AMAZING BLACK LIGHT

250-watt ultra-violet light source. Makes fluorescent articles glow in the dark. Fits any lamp socket. For experimenting, entertaining, unusual lighting effects.



Ship. wt. 2 lbs.
ITEM NO. 87
\$3.45
(P. P. & Hdg. Chgs. 35c)

HUDSON SPECIALTIES CO., 160 W. 14th St. Dept. RE 1061, New York 7, N.Y.

I am enclosing full remittance for items circled below. (Be sure to include shipping charges.)

87 33 86 123

Name Please Print Clearly
Address
City Zone State



WATT-HOUR METER

Loading makes—reconditioned. Ideal for trailer parks. 100-110 volts, 60 cycles, 2-wire A.C. 5 amp. Heavy metal case 8 1/2" x 6 1/4" x 5". Easy to install. Ship. wt. 14 lbs.

ITEM NO. 33
NOW ONLY **\$4.50**
(P.P. & Hdg. Chgs. \$1.25)

PREPARE NOW FOR A
SECURE AND PROFITABLE CAREER
IN ONE OF THESE GROWING FIELDS
OF ELECTRONICS

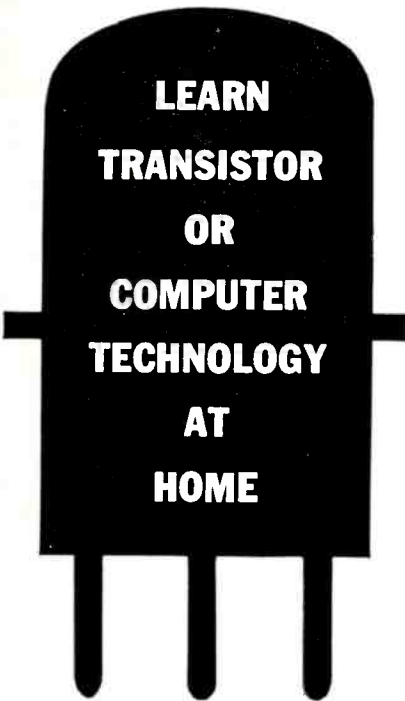

Learn with proven home study courses from the Philco Technological Center. Get practical knowledge with courses developed by specialists in electronics and training... men who know the kind of knowledge you need.

Choose from five courses:

1. Semiconductors—Transistor Principles and Practices. Learn theory, construction, applications of all types of transistors.
2. Introduction to Analog Computers—Covers theories and fundamentals of analog computers.
3. Analog Computer Systems (Advanced Level)—Covers the analog system concepts and methods.
4. Automatic Digital Computers—Digital computer theory, maintenance, installation, basic programming.
5. Programming for Digital Computers—Covers encoding, set-up and operation.

**MAIL COUPON TODAY
FOR FREE INFORMATION**

R-4

Philco TechRep Division
P.O. Box 4730
Philadelphia 34, Penna.

I'm interested in Semiconductors Analog computers Analog computer systems Digital computers Computer programming. Please send free information to:

Name _____
Address _____
City _____ Zone _____
State _____

PHILCO
TECHNOLOGICAL CENTER
P.O. Box 4730, Philadelphia 34, Pa.

rected by soldering the solder lug and rivet together. It is advisable to solder all such connections before assembling a new transistor project.—*J. E. Pugh, Jr.*

MULTIMETER SAFEGUARD

Many multimeters have selector switch positions which leave the internal batteries continually in circuit—for example, the low-ohms range of some meters. If the switch is left in that position when the meter is put aside, the batteries will go dead rapidly. To guard against this, wire a push-button in series with the appropriate terminal of the selector switch. Hold down the button to make a measurement. When you release it, the circuit opens.—*Charles Erwin Cohn*

DEPTH GAUGE STOPS DRILL

Try this any time it's necessary to limit the travel of a drill through a chassis or other objects or materials. Put the drill all the way in the chuck, then drill a hole lengthwise through a piece of dowel or soft pinewood stock.

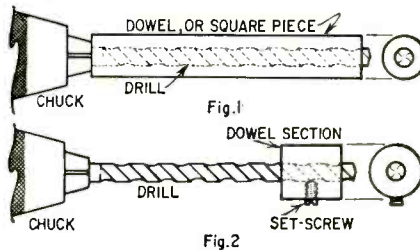

Cut the dowel so just enough drill end protrudes to drill through the chassis or material as in Fig. 1.

Another way of doing it is to cut a 3/4- or 1-inch length piece of dowel and cut a small setscrew hole in the side as in Fig. 2. Drill the setscrew hole small, so that the setscrew taps its own threads. If you have one of these depth gauges for each size of drill, you'll never punch a hole in a capacitor or in any other component.—*Frank W. Dresser* END

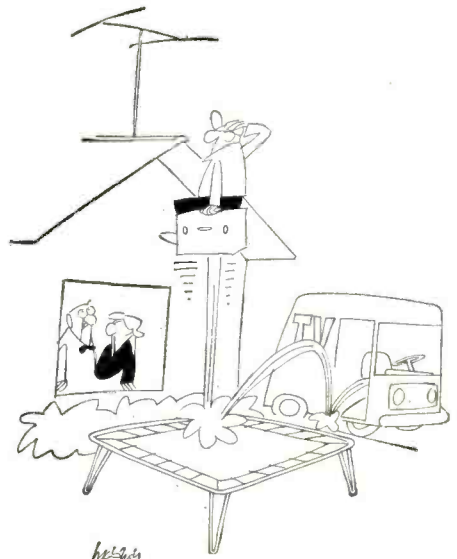

"Fastest antenna man in the West!"

**"TAB" FOR TRANSISTORS & DIODES!!!
FULL LENGTH LEADS**

Factory Tested & Guaranteed! U.S.A. Mfg. rd!

PNP HIPOWER 15 Amp Max 25°C
2N441, 2N277 \$1.80 @ 6/\$59, 25/\$35,
100/\$130, 2N442, 2N278, \$3.75 @
4/\$12, 25/\$64, 100/\$225, 3 Amp,
2N155, 2N156, 2N255, 2N256, 2N307,
2N554, TO3GP e80 @ .20/\$15, 100/\$65.

2N123 PNP e45 @ 12 for \$5, 100/\$37
2N292, 2N293 NPN e45 @ 12 for \$5, 100/\$37
2N223 PNP 30c @ 12 for \$5, 100 for \$65

GENERAL PURPOSE—PNP—COMPUTER GRADE!
Use as Amplifier—Oscillator—HIFI RF, IF
Logic—Servoamp—Power Supply
Pulse Amplifier or High Current Switch
Veb. Vee, Veb Approx 40V
GP 3C rated 300mw e65 @ .10 for \$5, 100/\$39
GP10C rated one watt 90c @ .06—\$5, 100—\$63

2N176/\$1.80, 2N270/95c, 2N670/\$1.60,
2N671/\$2 Kit PNP or NPN e39 @ .3 for \$1.
Round or Diamond Base Mica Mtg. Kit c30 @,
4/\$1, Power Heat Sink w/ Fins 80 Sq. @,
\$1.50, 4/\$5, Kit Glass Diodes Computer Grade
e20 @ .8 for \$1, 100 for \$7, 1000 for \$50.

"TAB", SILICON 750MA* DIODES Factory Tested Gtd.!

GENERAL PURPOSE SPECIAL 35c each 400 PIV at 300 MA 20 for \$6

rms/piv 17/25 10c	rms/piv 35/50 14c	rms/piv 70/100 24c	rms/piv 140/200 29c
rms/piv 210/300 39c	rms/piv 280/400 50c	rms/piv 350/500 64c	rms/piv 420/600 74c
rms/piv 490/700 87c	rms/piv 580/800 93c	rms/piv 630/900 \$1.10	rms/piv 700/1000 \$1.50

Low Priced * T200 SILICON DIODES
rated 380piv/266rms @ 200Ma @ 100°C
36¢ each; 10 for \$3.25; 100 for \$27; 1000 for \$230

Cap. or Batty. Derate 20%
POWER DIODES—STUDS 50PIV/35RMS
FACTORY TESTED—GTD!

1.5 Amp e30 @	100 for \$27, 1000 for \$225
3.0 Amp e50 @	100 for \$45, 1000 for \$390
6.0 Amp \$1.50 @	100 for \$100, 250 for \$200
12 Amp \$1.45 @	100 for \$125, 250 for \$225
25 Amp \$2.30 @	100 for \$200, 250 for \$400
70 Amp \$3.90 @	\$1.75, 100 for \$300
240 Amp \$4.50 @	.50 for \$220, 100 for \$4.00

*Derate 20% for Capacitive & Battery Load! Amp Ratings for Studs on Heat Sink!!!

SILICON—SU4G—SPECIAL!!!
OCTAL SILICON DIODE REPLACEMENT 1120Rms/
1600Piv \$6 @ .5 for \$25, 100 for \$475, 1000 !!

"TAB"
TERMS: Money Back Guarantee
Our 17th year. \$2 min. order
F.O.B. N.Y.C. Add shp charges
or for C.O.D. 25% Dep. Prices
shown subject to change.
111-GH LIBERTY ST., N.Y. 6, N.Y.
Send 25¢ for Catalog

**Purchasing
A HI-FI
SYSTEM?**

TIME PAYMENTS AVAILABLE
Up to 2 years to pay!

Send Us
Your
List Of
Components
For A
Package
Quotation

You Can Buy
With Confidence
AT AIREX

All merchandise is
brand new, fac-
tory fresh & guar-
anteed.
Free Hi-Fi Catalog

**AIREX
RADIO
CORPORATION**

- Jlm Lansing*
 - Altec Lansing*
 - Electrovoice
 - Hartley* • Viking
 - University* • Jensen
 - Acoustic Research
 - Janzen
 - Wharfedale
 - USL Citizen Band
 - Gonset
 - Hallicrafter
 - Texas Crystals
 - International
 - Crystals
 - Concertone
 - Bell • G.E.
 - Weathers
 - Harman-Kardon
 - Eico • Pilot
 - ESL • Frazier
 - Superscope
 - Dual Changer
 - Bogen • RCA
 - Dynakit • Fisher
 - H. H. Scott
 - Thorens* Sherwood*
 - TEC • Roberts
 - DeWald • National
 - Sony • Tandberg*
 - Challenger
 - Wallensak
 - Garrard
 - Miracord
 - Glaser-Steers
 - Rek-O-Kut
 - Polytronics
 - Norelco • Conrac
 - Fairchild
 - Pickering • Sonar
 - Audio Tape
 - Magnecord*
 - Rockford Cabinets
- *Fair Traded

85-RE Cortlandt St., N.Y. 7, WO 4-1820

BUSINESS and PEOPLE

James J. Nichols was appointed manager of the P. R. Mallory & Co. Distributor Div., Indianapolis, Ind. He had been general sales manager of the Mallory Metallurgical Co. He succeeds J. E. Templeton, who has been named director of Western operations. Harold C. Buell, vice president of Mallory, has been placed in charge of customer relations. William H. Starbuck was appointed director of markets. He comes from Stromberg-Carlson.



H. H. Scott, Inc., Maynard, Mass., has increased its manufacturing space by 50% through leasing a portion of Maynard Mills, less than a mile from its present facilities. The present plant will continue to manufacture wired components and will remain as the executive office.

C. E. (Pete) Seaman was appointed field marketing manager of Electro-Voice, Inc., Buchanan, Mich. He formerly headed needle and cartridge sales.



The Electronic Industry Show Corp., Chicago, announced that a recent study conducted by an independent consultant recommended the continuation of one 3-day electronic industry show each year in Chicago in May. It further recommended that the show be oriented toward distributors rather than their customers.

Joseph J. Kaleba joined Shure Brothers, Inc., Evanston, Ill., as manager of the product design and specifications section. He had been engineering supervisor at Controls Co. of America.

Jerry Borrevik joined the sales staff of Electro-Voice, Inc., Buchanan, Mich. He was an electrical engineering major at MIT.



Aerovox Corp., New Bedford, Mass. introduced a new slogan, Technical Leadership—Manufacturing Excellence, which will be used on all trade advertising and sales promotion material. A



modernized trademark was also introduced. Matthew Simon, sales manager, Distributor Div. (left) is shown discussing the trademark with Charles Golenpaul, vice president of the division. Aerovox also recently introduced a 2-year warranty on capacitors and resis-



Joseph S. Ramer (top left) joined Stancor Electronics, Inc., Chicago, as director of engineering. He comes to the company from Heath Co., where he was chief engineer. C. Edwin Williams (top right) joins Stancor as technical consultant at the Easton, Pa., plant. He had been with Measurements, Inc.



C. Kenneth Juno was appointed sales promotion manager of the Progress Webster Corp., Rochester, N.Y., a subsidiary of Progress Webster Electronics Corp. He comes to the company from General Dynamics/Electronics (Stromberg-Carlson Div.).



Milton S. Coleman was appointed national sales manager by Eric Electronics, Santa Monica, Calif., for its line of high-fidelity components and sound equipment. He was formerly with Philco Corp.



John de Leon (left) also joined the Easton plant as engineer. He had been with ITT Federal Laboratories.

FM MULTIPLEX STEREO BROADCAST MAKES HISTORY

CHICAGO, Ill.—Station WKFM made the world's first FM stereo multiplex broadcast simultaneous with their usual background music programming. Equipment used was designed, constructed, and installed by Sherwood Electronic Laboratories. Another World's "first" was achieved by Sherwood's sponsoring the FM Stereocast.



Edward S. Miller, Gen. Mgr. of Sherwood cues Frank Kovas, WKFM Pres., to start the pioneer stereocast.

PRESS PARTY

Gathered at the Gaslight Club in Chicago were members of the electronics industry and the press. The Stereo Multiplex broadcast was received via the new Sherwood S-8000 FM/MX Stereo Receiver—the first such unit on the market.



John Radtke, Sherwood's Chief Research Engineer, checks out WKFM's stereo multiplex transmitting equipment.



Sherwood's Bud Fields and Jerry Fields of Musicraft enjoy the first stereocast over Sherwood's new S-8000 64-watt Stereo FM Receiver.



Reporters from electronics publications enjoyed the change of pace at Chicago's Gaslight Club.

For details on the S-8000 or versatile Stereo MX adapters write Sherwood Electronic Laboratories, Inc., 4300 N. California Avenue, Chicago 18, Illinois. Dept. RE10

EVERYBODY PROFITS from the GERNSBACK FALL BOOK FESTIVAL

For the Service Technician—

Another big Book-Bonus Value. Save 50c on the paper-bound edition of the new 2-volume set.



NEW SHORTCUTS to TV SERVICING

By Leonard C. Lane

Gernsback Library Book No. 95, 2 volumes—160 pages each. Paper bound edition \$5.90. (\$3.20 each if bought separately.) Deluxe hard-cover edition \$9.90.

Originally prepared as a training course by one of America's leading electronic schools, it sold for many times this low price. Now for the first time in book form you can find all the hints, techniques, short cuts and inside tips you need to cope with today's complex servicing problems. Hundreds and hundreds of charts, diagrams, schematics and check lists make your path easier.

No math—no theory—only hardheaded facts on how to seek out and solve troubles in the front end, rf. if, agc, sync, picture tube, detector and other circuits. A handy workbench reference.

FOR HI-FI- FANS—

For the first time in the U. S. A.—this masterpiece.



A to Z in AUDIO—

By G. A. Briggs

No. 97—224 pages. Paper bound edition—\$3.20. Deluxe hard-cover edition—\$5. (For sale in U.S. and Canada only)

The renowned G. A. Briggs who twice filled New York's spacious Carnegie Hall with clamoring fans to enjoy his thrilling live vs recorded hi-fi demonstrations, commissioned us to publish this classic in the United States and Canada. It's much more than just an exhaustive glossary of places, people, terms and things in audio. (Some definitions run as long as four pages.) Briggs' knowledge of audio is matched by a delightful dry sense of humor. And there are hundreds of drawings, photos and cartoons. This one demands shelf space in the home of every audio man, technician, and component salesman.

NEW—EXCITING FOR INDUSTRIAL TECHNICIANS • SERVICE TECHNICIANS • STUDENTS • R/C FANS • EXPERIMENTERS... JUST OFF THE PRESS... TWO NEW G/L BOOKS READY FOR FALL SALE...

● INDUSTRIAL ELECTRONICS MADE EASY By Tom Jaski

(author of How to Get The Most Out of Your VOM)

Gernsback Library Book No. 99, 288 pages. Paper-bound edition \$3.95. Deluxe cloth-bound edition \$5.95.

In—or thinking about getting in—industrial electronics? This book is for you! From your point of view, the author tells you what and where industrial electronics is, how it compares with communications servicing. There's an analysis of induction, dielectric, microwave and supersonic generators—an explanation of techniques for transducers, control systems and servos—a description of counters, recorders and other readout and display devices used in industrial electronics. Finally there's a discussion of the techniques and instruments used in industrial servicing. When you finish this one you'll know which way industrial electronics is heading and how you can go along.

● RADIO-CONTROL HANDBOOK By Howard G. McEntee

Gernsback Library Book No. 93, 304 pages \$4.95 (revised edition).

The original sold over eight printings! Here it is completely updated with all the new developments in R/C included. A completely revised book—it assumes you know theory and concentrates on ideas, circuits, and construction. Offers complete data on receivers, transmitters, servos, pulsers and other components. (Prices slightly higher in Canada)

AT YOUR DISTRIBUTOR NOW—OR ORDER DIRECT

GERNSBACK LIBRARY, INC., 154 West 14th St. New York 11, N. Y.

Dept. 101

Please send me the books listed below, postpaid. My remittance of \$_____ is enclosed.

please list book numbers

paper-cover edition hardcover edition
please check one

NAME _____

STREET _____

CITY _____

please print

ZONE _____ STATE _____

GERNSBACK LIBRARY, INC.

154 West 14th Street, New York 11, N. Y.

In Canada: Len Finkler, 2 Tycos Dr., Toronto 19, Ont.

Export: Feffer & Simons, 31 Union Square, New York 3, N. Y.

tors in all markets. A 1-year warranty has been traditional in the industry.

Duane L. Billiet was named manager, marketing services, in an expansion of the Sales Dept. of the Delco Radio Div. of General Motors Corp., Kokomo, Ind. He recently completed a year's study on a Sloan Fellowship at Stanford University. Don C. Cripe, former sales analyst, was promoted to manager, sales operations analysis. He will be assisted by Clifford H. Baker, a new employee who will act as a marketing specialist. Richard L. Gerhart was named sales engineer for static machine controls. At the same time, Calvin E. Fields joined the semiconductor sales engineering staff.

United Catalog Publishers, Inc., Hempstead, N. Y., has established an in-plant typesetting shop to service its



various publications. Arthur L. Rabb (left), general manager of the company, is shown welcoming Robert Steinberg, manager of the new plant.

Lloyd F. Taylor was named vice president of Casco Products Corp., a subsidiary of Standard Kollsman Industries, Chicago. He will continue to serve as executive assistant to Leonard F. Cramer, president of Casco. Roland J. Fernekes, former assistant to the vice president, operations, was promoted to director of engineering.

Centralab, Electronics Div. of Globe-Union, Inc., Milwaukee, Wis., developed a new two-color envelope stuffer for distributor use for its L- and T-pad attenuators.

Sonotone Corp., Elmsford, N. Y., introduced a new three-color display for



its line of more than 200 electronic tube types.

B&K Manufacturing Co., Chicago, has established a twice-yearly picture-tube chart information service covering past and present B&K CRT models. For a small subscription fee, mailings will be made in May and November to all owners.

Shure Brothers, Inc., Evanston, Ill., is offering a prize of 20 cartridges to each of 17 distributors who have most successfully promoted its Limited Edition recording. **END**

new LITERATURE

Any or all of these catalogs, bulletins, or periodicals are available to you on request direct to the manufacturers, whose addresses are listed at the end of each item. Use your letterhead—do not use postcards. To facilitate identification, mention the issue and page of RADIO-ELECTRONICS on which the item appears. UNLESS OTHERWISE STATED, ALL ITEMS ARE GRATIS. ALL LITERATURE OFFERS ARE VOID AFTER SIX MONTHS.

NEW AND SURPLUS electronic equipment for aircraft, industrial, amateur, experimental and other electronic uses fill the 38 pages of *Catalog No. 105*. Antennas, radios, books, signal generators and other electronic gear are included.—Bill Slep Co., P.O. Box 178, Ellenton, Fla.

SILICON TRANSISTORS, *Designers Handbook*. A comparative study of the Raytheon 2N338 and similar high-frequency silicon transistors produced by four major manufacturers is presented in this 28-page illustrated booklet. Each manufacturer's transistor is analyzed as to electrical and mechanical characteristics, parameter distribution, design requirements, etc. Use your letterhead to request copy.—Raytheon Co., Warren Schoonmaker, Semiconductor Div., 150 California St., Newton, Mass.

SILICON RECTIFIER BULLETINS describe a series of miniature Trim-Line rectifiers. Data sheets give mechanical and electrical specifications.—Slater Electric Co., 241 Sunrise Highway, Rockville Centre, N. Y.

ELECTRONIC TEACHING AID for schools, experimenters, plants and laboratories are detailed in an 8-page brochure, *The DeVry Electronics Trainer System*.—Paromel Electronics Corp., 3956 Belmont Ave., Chicago 18, Ill.

SEMICONDUCTORS, *Short Form Catalog/Fall 1961*. Shows complete line of diodes and transistors. Includes silicon and germanium transistors and diodes, and silicon capacitors.—Hughes Aircraft Co., Semiconductor Div., Newport Beach, Calif.

INDUSTRIAL TUBES of all types are listed in *Electronic Tubes for Industry*. Transmitting, special-purpose, industrial receiving tubes and semiconductors are among the hundreds of items in the 14-page catalog.—United-National Labs Inc., 90 President St., Passaic, N. J.

ELECTRONIC DEVICES, 288 illustrated pages of them are in this 1961 *Indus-*

ELECTRONICS Engineering-Technicians

Bachelor of Science Degree, 30 Months

Save Two Years' Time

- Radio-Television Plus Color Technician (12 Months)
- Electronics Engineering Technology (15 Months)
- Electronics Engineering (B.S. Degree)
- Electrical Engineering (B.S. Degree)
- Mechanical Engineering (B.S. Degree)
- Civil Engineering (B.S. Degree)
- Architecture (B.S. Degree)

Approved for Veterans
DAY AND EVENING CLASSES

Write for Catalog and Registration Application.
New Term Starting Soon.

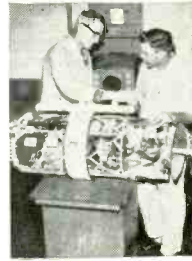

Heald's Microwave and Radar Laboratory Equipment.

HEALD'S ENGINEERING COLLEGE

Established 1863

Van Ness at Post, RE
San Francisco, Calif.

Your Name _____
Address _____
City _____
State _____



Save 30% on 4-track
Stereo Music on Tape!

Empty 3 in. plastic reels 7¢ ea.

BARGAIN PRICES!

SEND FOR OUR FREE

Tape Recorder/Blank/Pre-recorded Tape Catalog

SAXITONE TAPE SALES

(Div. of Commissioned Electronics Co., Inc.)
1776 Columbia Road Washington, D.C.

Components • Recorders • Tapes
SHIPPED PROMPTLY at WHOLESALE PRICES

FREE LIST

Packaged Hi-Fi
Low Quotes Air Mailed

AUDIO UNLIMITED 190-R Lexington Ave.
New York 16, N.Y.



NEW STEREO SONY STEREO TAPE DECK

Now, for less than the cost of a good record changer, you can add a versatile new dimension to your hi fi system.

■ The Sony 262-D tape deck has a 4 track stereo erase head and 4 track stereo record/playback head. Heads are wired to six output and input facilities for connection of external electronics to play and record four track stereo. This is the same quality mechanism used in the most expensive Sony Superscope tape recorders.

\$89⁵⁰

NOW AVAILABLE!

Complete your 262-D stereo system: the long-awaited Sony SRA-2 stereo recording amplifier provides instant connection to the Sony 262-D stereo tape deck for complete 4-track stereophonic and monophonic recording. Two V.U. meters, track selector switch, record safety interlock, microphone and radio inputs. No modifications necessary. \$89.50.

SUPERSCOPE INC.
Dept. T, Sun Valley, Calif.

SONY

SUPERSCOPE

The tapeway to Stereo

BECOME A RADIO TECHNICIAN FOR ONLY \$26.95

BUILD 20 RADIO CIRCUITS AT HOME

with the New **PROGRESSIVE RADIO "EDU-KIT"** only **\$26.95**

ALL Guaranteed to Work!

- A Complete Home Radio Course**
- 12 Receivers
 - 3 Transmitters
 - Signal Tracer
 - Signal Injector
 - Code Oscillator
 - Sq. Wave Generator
 - Amplifier

- No Knowledge of Radio Necessary
- No Additional Parts or Tools Needed
- Excellent Background for TV



FREE Set of Tools, Pliers-Cutters, Tester, Soldering Iron, Alignment Tool, Wrench Set.

WHAT THE "EDU-KIT" OFFERS YOU

The "Edu-Kit" offers you an outstanding PRACTICAL HOME RADIO COURSE at a rock-bottom price. You will learn radio theory, construction and servicing. You will learn how to build radios, using regular schematics; how to solder and wire in a professional manner; how to service and trouble-shoot radios. You will learn how to work with punched metal chassis as well as the new Printed Circuit chassis. You will learn the principles of RF and AF amplifiers and oscillators; detectors, rectifiers, test equipment. You will learn and practice code, using the Progressive Code Oscillator. You will build 20 Receiver, Transmitter, Code Oscillator, Signal Tracer, Square Wave Generator, Amplifier and Signal Injector circuits, and learn how to operate them. You will receive an excellent background for TV. In brief, you will receive a basic education in Electronics and Radio, worth many times the small price you pay, only \$26.95 complete.

PROGRESSIVE TEACHING METHOD

The Progressive Radio "Edu-Kit" is the foremost educational radio kit in the world, and is universally accepted as the standard in the field of electronics training. The "Edu-Kit" uses the modern educational principle of "Learn by Doing." You begin by building a simple radio. Gradually, in a progressive manner, and at your own rate, you construct more advanced multi-tube radio circuits, learn more advanced theory and techniques, and do work like a professional radio technician. These circuits operate on your regular AC or DC house current.

THE KIT FOR EVERYONE

You do not need the slightest background in radio or science. The "Edu-Kit" is used by young and old, schools and clubs, by Armed Forces Personnel and Veterans Administration, for training and rehabilitation.

One of the most important aspects of the "Edu-Kit" is the Consultation Service which we provide. We welcome students to send us their problems, whether related to any of the material covered in the "Edu-Kit" course, or encountered in other experiences in the field of electronics.

THE "EDU-KIT" IS COMPLETE

You will receive all parts and instructions necessary to build 20 different radio and electronic circuits, each guaranteed to operate. Our kits contain tubes, tube sockets, variable electrolytic, mica, ceramic and paper dielectric condensers, resistors, tie strins, coils, hardware, tubing, punched metal chassis, Instruction Manuals, hook-up wire, solder, selenium rectifiers, volume controls, switches, etc. In addition, you receive Printed Circuit materials, including Printed Circuit Chassis, special tube sockets, hardware and instructions. You also receive a useful set of tools, pliers, cutters, an alignment tool, professional electric soldering iron, Wrench set, and self-powered, dynamic Radio and Electronics Tester. The "Edu-Kit" also includes Code Instructions and the Progressive Code Oscillator. You will also receive lessons for servicing with the Progressive Signal Tracer and the Progressive Signal Injector, a High Fidelity Guide, FCC Amateur License Training Book, and a Quiz Book.

All parts, components, etc., of the "Edu-Kit" are 100% unconditionally guaranteed, brand new, carefully selected, tested and matched. Everything is yours to keep. The complete price of this practical home Radio and Electronics course is only \$26.95.

TROUBLE-SHOOTING LESSONS

You will learn to trouble-shoot and service radios, using the professional Signal Tracer, the unique Signal Injector and the dynamic Radio and Electronics Tester. Our Consultation Service will help you with any technical problems.

J. Stasattis, 25 Poplar St., Waterbury, Conn., writes: "I have repaired several sets for my friends, and made money. The 'Edu-Kit' paid for itself. I was ready to spend \$240 for a course, but I found your ad and sent for your kit."

FREE EXTRAS

- Set of Tools • Radio Book • Radio and Electronics Tester
- Electric Soldering Iron • Pliers-Cutters
- Alignment Tool • Tester Instruction Book • Hi-Fi Book • TV Book • Quiz Book • Membership in Radio-TV Club: Consultation Service • FCC Amateur License Training • Printed Circuitry • Certificate of Merit • Valuable Discount Card • Wrench Set

UNCONDITIONAL MONEY-BACK GUARANTEE

ORDER FROM AD—RECEIVE FREE BONUS RESISTOR AND CONDENSER KITS WORTH \$7.00

- "Edu-Kit" Postpaid. Enclosed full payment of \$26.95.
- "Edu-Kit" C.O.D. I will pay \$26.95 plus postage.
- Send me FREE additional information describing "Edu-Kit."

Name: _____
Address: _____

PROGRESSIVE "EDU-KITS" INC.
1186 Broadway, Dept. 181G, Hewlett, N. Y.

trial *Electronic Catalog 97*. More than 50,000 items are described, illustrated and indexed. For the engineer and industrial service technician.—Radio Shack, 730 Commonwealth Ave., Boston 17, Mass.

TAPE RECORDER purchasing and servicing are subjects of this 12-page illustrated booklet. It describes briefly the tape recorder mechanism and how it works, and clarifies the guarantees and service offered by the manufacturer. Prepared by the National Better Business Bureau in cooperation with the Magnetic Recording Industry Association. Available from your local Better Business Bureau or hi-fi dealer.

HI-FI COMPONENTS are described and illustrated in *Catalog AL 1302-1*. All components in this manufacturer's line are shown. This includes tuners, amplifiers, complete receivers, speakers, microphones and custom installations.—Altec Lansing Corp., Dept. LD, 1515 S. Manchester Ave., Anaheim, Calif.

ELECTRONIC KITS of all kinds are offered in this 1961 catalog. Printed in three colors, the 28-page brochure gives illustrated descriptions of stereo and mono hi-fi gear, test instruments, ham gear, CB and transistor radios. More than 80 items are covered.—EICO, Electronic Instrument Co., Inc., 33-00 Northern Blvd., Long Island City 1, N. Y.

TEST EQUIPMENT and accessories made by this manufacturer are described in detail in *Electronic Instruments*. The little pocket-sized booklet

includes meters, generators, scopes and tube testers. 16 pieces of equipment and 12 accessories in all.—RCA, Electron Tube Div., Harrison, N. J.

THE TAPE RECORDER in *Business and Industry* shows how tape recorders can be used in business. All phases are covered including management communications, personnel, sales, advertising, public relations.—Minnesota Mining & Manufacturing Co., 900 Bush Ave., St. Paul, Minn.

ELECTRONIC WIRE, CABLE AND TUBING, No. 62, completely indexed alphabetically, numerically and by Government and industrial specifications in new 52-page catalog. Eight new wire and tubing lines introduced in addition to already-existing 6,000 stock products. "E-Z" index chart for prompt location of any catalog item by number of conductors, wire size and whether it is shielded or not.—Alpha Wire Corp., 200 Varick St., New York 14, N. Y.

REPLACEMENT GUIDE to instrument rectifiers helps the technician keep his test equipment working. It tells which of this manufacturer's instrument rectifiers to use in a particular piece of test equipment. Listings are arranged alphabetically, by equipment makers' names.—Conant Laboratories, 6500 O St., Lincoln, Neb.

MULTI-STATION INTERCOM, Ektacom series G. 4-page folder hits important outstanding features of this new intercom. Last page catalogs the units available and the possible options.—Fisher

EICO new Transistor Stereo/Mono 4-track Tape Deck

Model RP 100W
Completely assembled, wired and tested with 3 heads, and stereo record and stereo playback preamplifiers.

Model RP 100K
Semi-Kit includes transport completely assembled and tested with 3 heads, and control electronics, stereo record, and stereo playback pre-amplifiers in easy-to-assemble kit form.

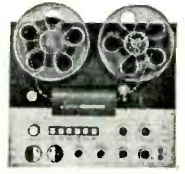

Write for full specifications

TAPE STORAGE OR CARRYING CASE
reg. 9.95, now 5.95
(Heavy wood construction, waterproof vinyl covering. Holds up to 24 tapes.)
reg. 2.45, now 1.49
(Pressed cardboard, holds 10 tapes or 60 45 rpm records.) Plus Postage



SAXITONE RECORDING TAPE

* Oxide guaranteed not to rub off or squeak—or money back. Compare ours with other "Bargain" tapes. You'll find it's more than just "price" when you deal with us. We are original pioneers in the tape recorder business and our reputation means everything to us.

600' acetate (plastic), 5"	.75
600' MYLAR 5" reel	.95
900' MYLAR (Polystyrene), 5"	.99
1200' MYLAR, 1/2 mil. 5" reel	1.18
1200' Acetate (plastic), 7"	1.19
1200' MYLAR, 1 1/2 mil. (Strong)	1.58
1800' acetate (plastic), 7"	1.79
1800' MYLAR 1 MIL thick, 7"	1.99
2300' MYLAR, untensitized, 7"	2.59
2400' MYLAR, tensitized, 7"	2.99

Studios, Large Users Even Lower. PLUS POSTAGE

Save 30% on 4-Track STEREO MUSIC ON TAPE!
Empty 3 in. Plastic Reels 7¢ ea.

BARGAIN PRICES! SEND FOR OUR FREE Tape Recorder/Blank/Pre-recorded Tape Catalog

NORELCO SPEAKER
Famous AD3800M, twin cone 8" (75-19,000 cycles) discontinued model, former list 16.00, usual net 9.90 going at 4.95 plus postage, (10 for 39.95). Other Norelco speaker sizes at bargain prices—SEND FOR SPEAKER SPECIFICATION SHEET.



SAXITONE TAPE SALES
(DIV. OF COMMISSIONED ELECTRONICS, INC.)
1776 Columbia Rd., NW, Washington, D.C.

TELL YOUR FRIENDS ABOUT RADIO-ELECTRONICS

CASH FOR YOU—REPAIR BUSTED

Electric APPLIANCES

Learn at Home • \$3 to \$5 an Hour

Spare Time, Full Time • Be Your Own Boss

FREE BOOK tells about profitable business you can run—right at home. Repair Electric Appliances, using simple tools. Pays \$3-\$5 an hour!

QUICK WAY TO GET STARTED
For less than 20¢ a day our easy, pictured instruction—backed by 45 years of success in home-training—prepares you for top earnings. Earl Reid of Thompson, Ohio, says: "Made \$510 in one month spare time." At no extra charge you get Appliance Tester, too. Finds trouble-spots, checks your work. Get your **FREE Book** and **FREE Sample Lesson!** Mail coupon below, letter or postcard, now.

CASH IN ON THIS BIG BOOM
400 MILLION Appliances are in American homes right now. People need them fixed. You make good money doing it. In your basement, garage, even your kitchen.

NATIONAL RADIO INSTITUTE, Appliance Div.
Dept. FK 1, Washington 16, D. C.
Send **Free Book, Free Appliance Repair Course Lesson.** Am interested in:
 Spare Time Earnings My Own Business Better Job

Name _____
Address _____
City _____ Zone _____ State _____
Accredited Member National Home Study Council

Berkley Corp., 1475 Powell St., Emeryville 8, Calif.

STOCK BUSINESS FORMS for Radio-Television-Service. This 32-page catalog offers every type of business form the technician may need. It includes items like salesbooks, file systems and job tickets. Each item is illustrated.—Oelrich Publications, 4308 Milwaukee Ave., Chicago 41, Ill.

SELENIUM PHOTOVOLTAIC CELLS discussed in *Bulletin No. 03-201-A*. Text, photographs and drawings demonstrate their features, selection and applications. 6 pages—Daystrom Inc., Weston Instruments Div., 614 Frelinghuysen Ave., Newark 12, N. J.

ELECTRONIC COMPONENTS line outlined in 60-page 1961 *Catalog No. 61*. Detailed schematic drawings and technical

data on all items. Partial listing of products' electrical ratings.—Herman H. Smith Inc., 2326 Nostrand Ave., Brooklyn 10, N.Y. **END**

50 Years Ago

In Gernsback Publications

HUGO GERNSBACK, Founder

Modern Electrics.....	1908
Wireless Association of America.....	1908
Electrical Experimenter.....	1913
Radio News.....	1919
Science & Invention.....	1920
Practical Electrics.....	1921
Television.....	1927
Radio-Craft.....	1929
Short-Wave Craft.....	1930
Television News.....	1931

Some larger libraries still have copies of Modern Electrics on file for interested readers.

- In October, 1911, *Modern Electrics*
- Hot-Wire Meter, by E. E. Ely.
- Silent Telephone Transmitter.
- Wireless Hints for the Amateur, by Edward Werner.
- A New Radio Hook-Up.
- Simple Contact Opener for Crystal Detectors, by P. Mertz.
- Sending Drawings by Wireless.
- New Compact Wireless Set, by Walter Neuman.
- A Miniature Tesla Coil, by Carl Dreher.
- Wireless Range Increaser, by Joseph E. Frisbee.

Now! DESIGN TRANSISTOR CIRCUITS FAST!

Here's the know-how you need to lick semiconductor circuit design problems!

Solve transistor problems fast, even if you've only worked with vacuum tubes before. **TRANSISTOR CIRCUIT ANALYSIS AND DESIGN** is the clear, concise, authoritative book by Franklin C. Fitchen, industrial consultant and originator of transistor techniques for General Electric, U.S. Army Ordnance Corps, and General Dynamics Corp.

This new book is complete with schematic diagrams and performance charts that combine the theory of transistor applications with the working knowledge to solve practical problems.

Technical Secrets Revealed

First this expert gives you a solid knowledge of bias current directions, characteristics curves, leakage currents, and amplification factors—plus a valuable briefing on Semiconductor Physics.

Then he gives you scores of practical analysis and design problems... helpfully discusses the "industrial approach" to electronics... and shows you how to design, quickly, new circuits and solve circuit problems from simple radios to complicated computers—with each step made clear through easy-to-understand charts and diagrams.

Try It FREE For 10 Days

Whether you're a repairman, technician, student, or practicing engineer, you'll find **TRANSISTOR CIRCUIT ANALYSIS AND DESIGN** invaluable. But don't take our word for it. Prove it to yourself by reading and using this book FREE for 10 days—without cost or obligation. Mail the coupon below, now, to:



D. Van Nostrand Company, Inc.
Dept. 1810A,
Princeton, New Jersey
Established 1848

D. VAN NOSTRAND COMPANY, INC., Dept. 1810A, Princeton, N. J.

Please rush me—for free examination—**TRANSISTOR CIRCUIT ANALYSIS AND DESIGN**. If now convinced it can help me design circuits and solve problems more quickly, I may return it within 10 days and owe nothing. Otherwise, I will send you \$3 plus small delivery cost, then \$3 a month for 2 months.

Name..... (Please Print)

Address..... Zone..... State.....

City.....

Check here and SAVE! Enclose \$9.00 and WE pay all shipping costs. Same ten-day money-back guarantee.

(In Canada: 25 Hollinger Rd., Toronto 16—price slightly higher.) Foreign and A.P.O. please send \$9.00 with order.



RADAR KING®

Detect police radar traps before they detect you

BUILD RADAR KING

Plans (deductible) \$1 Kits \$19.95

BUY RADAR KING—\$29.95

S and K band operation

Wardell Smith Electronic Designs
65 Glenwood Road Upper Montclair, N. J.
estb. 1924



OUT OF SPACE?

You bet we'd be... if we were to tell you all about AUDION's 'Out of this World Hi Fi Values'.



Write for free Catalog

audion
25-E Oxford Road
Massapequa, New York

CONVERT TO COLOR TV

COLORDAPTOR—A simple 10-tube circuit and rotating color wheel converts any size B & W TV to receive compatible color TV.
COLODAPTOR—Easily attached to any TV set, does not affect normal operation, often built from parts experimenters have on hand. **BRILLIANT COLOR!**

Complete booklet—gives theory of operation, all construction details, schematic, and sample color filters. **ONLY \$1.95**

Essential Parts Kit—All Special Parts—Coils, Delay Line, Crystal, Color Filters

Up to 16" Sets—**\$19.95** 17" and Larger **\$20.95**

Other Kits, Wired Chassis, Motors Available
COLORDAPTOR
1798 Santa Cruz, Menlo Park, Calif.

Buy STANDARD BRAND TUBES AT LOWEST PRICES

60% OFF LIST!

RCA • GE • SYLVANIA • WESTINGHOUSE

- ALL PREMIUM QUALITY TUBES. ALL BRAND NEW
- ALL TYPES IN STOCK. ALL FRESH STOCKS
- FULL ONE-YEAR GUARANTEE, excepting only burned out or broken tubes.

Type	Net ea.	Type	Net ea.	Type	Net ea.	Type	Net ea.
0Z4	.96	6AH4GT	1.32	6C4	.74	12AT7	1.22
1B3GT	1.16	6AH10	1.86	6CB6A	.90	12AU7A	.98
1R5	1.02	6AL5	.74	6CD6GA2.32	1.24	12AV6	.66
1U4	.94	6AN8A	1.30	6CG7	.98	12AX4GTB	
1U5	.82	6AN8A	1.40	6CG8A	1.26	12AX7	1.02
1X2A/B	1.22	6AQ5A	.86	6CL8	1.50	12B1A	1.08
2BN4	1.02	6AU4GT	1.34	6CQ8	1.32	12B6	.80
2CV5	1.12	6AU5GT	1.72	6CQ9	1.74	12BE6	.86
3AL5	.74	6AU6A	.84	6CY5	1.12	12BQ6GA	
3AU6	.86	6AV6	.66	6DE9	.98		1.78
3BC5	.94	6AV8A	1.42	6D6B	1.84	12BY7A1.22	
3BN6	1.20	6AX4GTA		6DT6	.86	12CU6	1.78
3BZ6	.90	6BA6	1.06	6E5	1.24	12DQ6B1.70	
3CH6	.90	6BE5	.80	6E8	1.12	12SA7	1.56
3DT6	.86	6BG6GA2.60		6K6GT	.94	12SR7	1.42
3V4	.94	6BG6GA2.60		6SA4	.82	12SN7GTA	
4RQ7A	1.60	6BH6	1.08	6SK7	1.42	12SQ7	1.32
5AQ5	.86	6BK7A/B	1.38	6SN7GTR	1.42	25BQ6GTB	
5DK7A	1.36			6TRA	1.34		1.84
5C6B	1.28	6BL7GTA		6UR4	1.32	25L6GT	.92
5CI8A	1.26			6V6GT	.86	35L6GT	.96
5U4GB	.84	6BN4	1.00	6V8GT	.96	35V4	.56
5X8	1.30	6BN6	1.20	6W6GT	1.12	35Z6GT	.74
5Y3GT	.70	6BQ6A1.74		6WG6GT	1.12		
6A1A	.68	6BQ7A	1.58	6X5GT	.82	50C5	.86
6AF4A	1.60	6BZ6	.90	6X8A	1.26	50L6GT	.96
6AG5	1.04	6BZ7	1.60	12AT6	.66	117Z3	1.10

MINIMUM ORDER \$10.00. Shipped PREPAID
No. C.O.D.s Please

This is but a PARTIAL listing of our more than 500 types in stock at all times. Order ANY type not listed above, take 60% off current list price, and we'll ship promptly, prepaid. Write for our grant current electronic catalog, featuring similar savings in equipment and components. Dept. 183.

ZALYTRON Tube Corporation
220 West 42nd St., New York 36, N.Y.

new BOOKS

BASIC TRANSISTORS, edited by A. Schure. John F. Rider Publisher Inc., 116 W. 14 St., New York 11, N. Y. 6 x 9 in. 146 pp. \$3.95.

This book tells what a transistor is and what it can do. It is a picture-text course. Each page is devoted to one basic idea, and includes large illustrations. A handy book for beginners and nontechnical readers.—IQ

ELECTRONIC FUNDAMENTALS AND APPLICATIONS (2nd Edition), by John D. Ryder. Prentice-Hall, Inc., Englewood Cliffs, N. J. 6 x 9 in. 721 pp. \$13.35.

This new edition emphasizes the growing importance of semiconductors in electronics. It begins with a discussion of particles and of circuit theory, leading to detailed studies of tubes and transistors. Engineering math, diagrams and tables help to analyze circuits and devices including amplifiers, oscillators, gas tubes, power rectifiers and photoelectric devices. The volume is comprehensive and detailed. It is excellent for reference or study.

TELEVISION TAPE RECORDING, by George B. Goodall. Robins Industries

Corp., Flushing 54, N. Y. 6 x 9 in. 47 pp. \$1.

TV tape recording is comparatively new, but it need not remain a mystery. The mechanism and characteristics of the Ampex Videotape machine are explained clearly and without math. Photos illustrate important parts of the machine. How to splice, edit and duplicate are also covered.

ELECTRICAL SAFETY, by H. W. Swann. Philosophical Library, 15 E. 40 St., New York 16, N. Y. 5 1/4 x 8 1/2 in. 292 pp. \$15.

This author calls on his wide experience as senior inspector to describe approved methods for avoiding hazards of shock, fire and explosion. He quotes from British electrical regulations and tells how to comply with them.

Among the topics are overload protection, grounding, inflammable surroundings, static charges, lightning. The book covers safety in the factory, hospital, power plant and the home.

101 KEY TROUBLESHOOTING WAVEFORMS FOR HORIZONTAL AFC-OSCILLATOR CIRCUITS, by Robert G. Middleton. Howard W. Sams & Co. Inc., 1720 E. 38 St., Indianapolis, Ind. 5 1/2 x 8 1/2 in. 128 pp. \$2.

In this critical circuit, defects often

School Directory

ENGINEERING COURSES



E.E.
Option Electronics or Power
Mechanical, Civil & Physics
Also in Liberal Arts
presented through

HOME STUDY

Resident Classes Also
Available if Desired
Specify course desired.
**PACIFIC INTERNATIONAL
COLLEGE OF ARTS
& SCIENCES**
Primarily a correspondence
school

5719-M Santa Monica Blvd. Hollywood 38, Calif.

GET INTO ELECTRONICS

V.T.I. training leads to success as technicians, field engineers, specialists in communications, guided missiles, computers, radar and automation. Basic and advanced courses in theory and laboratory. Assoc. degree in electronics in 28 mos. B.S. in electronic engineering obtainable. ECPD accredited, G.I. approved. Graduates in all branches of electronics with major companies. Start February, September, Dorms, campus. High School graduate or equivalent. Catalog.

VALPARAISO TECHNICAL INSTITUTE

Dept. C Valparaiso, Indiana



ENGINEERING EDUCATION for the Space Age

NORTHROP INSTITUTE of Technology is a privately endowed, nonprofit college of engineering offering a complete Bachelor of Science Degree Program and **TWO-YEAR** accredited technical institute curricula. Students from 50 states, many foreign countries. Outstandingly successful graduates employed in aeronautics, electronics, and space technology. Write today for catalog—no obligation.

NORTHROP INSTITUTE OF TECHNOLOGY
1181 West Arbor Vitae Street, Inglewood 1, California

Study in the "Valley of the Sun" ELECTRONIC ENGINEERING TECHNOLOGY

College-level resident schooling
Veteran-approved. Catalog on request
Middleton Institute of Electronics
2937 E. McDowell Rd.
PHOENIX ARIZONA

Get ahead in SERVICING

Write for details about the
**GERNSBACK LIBRARY
TECHNICIANS BOOK CLUB**

Gernsback Library, Inc.
154 West 14th St., N.Y. 11

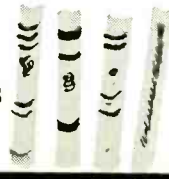

BUILD THE BEST HI-FI

save 1/2 with **EICO** KITS



ST40 AMPLIFIER 40 watt integrated stereo amplifier

Kit \$79.95 Wired \$129.95

ST96 TUNER FM/AM Stereo tuner ready for multiplex

Kit \$89.95 Wired \$129.95

NO technical experience is necessary. Each EICO kit comes complete with easy step-by-step instructions and picture diagrams — plus exclusive LIFETIME guarantee for service adjustment.

Come in for a no-obligation demonstration.

NOW AVAILABLE AT

Almo RADIO CO.

913 ARCH ST., PHILADELPHIA, PA.
201 CALHOUN ST., TRENTON, N. J.
219 LANDIS AVE., VINELAND, N. J.
1122 FRENCH ST., WILMINGTON, DEL.

550 MARKLEY ST., NORRISTOWN, PA.

Citizen's Band and Amateur Operators INCREASE THE RANGE of your transmitter

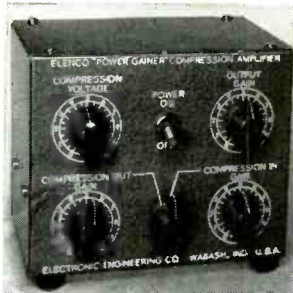

Only \$45.00

The New Improved Elenco

POWER GAINER

Audio Compression Amplifier
Now Available

- 4 TIMES power gain
- Simple connections to any CB or Amateur AM transmitter
- Can be used mobile or base
- Meets all F.C.C. requirements
- Many CB and Amateur operators report 50% to 100% increase in range.

Write for Details

"Elenco", sold by leading CB and Amateur equipment Dealers everywhere.

ELECTRONIC ENGINEERING CO.
Wabash, Indiana

SCHOOL DIRECTORY

B. S. DEGREE IN 36 MONTHS

INDUSTRY & GOVERNMENT NEED 50,000 NEW ENGINEERS A YEAR!
Accelerated year-round program puts you in the job-market a whole year earlier! Also B.E. degree in 27 mos. Aero., Chemical, Civil, Electrical, Mechanical, Electronics; Math, Chemistry, Physics. Quality instruction; widely recognized. Graduates employed from coast to coast. Self-help program. Modest rate. Start Jan., Mar., June, July, Sept. Catalog: 1510 E. Washington Blvd., Ft. Wayne 2, Ind.

INDIANA TECHNICAL COLLEGE

LEARN ELECTRONIC ORGAN SERVICING

This new, high paying profession can now be learned easily in your spare time.

- ★ Complete Training — All Makes and Models
- ★ Scientific Teaching Aids Make Learning Easy
- ★ No Prior Knowledge of Electronics Necessary

GET FULL DETAILS ON THIS AMAZING COURSE
WRITE FOR FREE BOOKLET

NILES BRYANT SCHOOL
Dept. L, 3731 Stockton Blvd.
Sacramento 20, California

LEARN

LEARN
RADAR MICROWAVES
COMPUTERS—TRANSMITTERS
CODE • TV • RADIO

Phlla. Wireless Technical Inst.
1533 Pine St., Philadelphia 2, Pa.
A Non-Profit Corp.
Founded in 1908
Write for Free Catalog to Dept. RE-10
Classes now forming

LEARN TRANSISTOR, COMPUTER OR RADAR ELECTRONICS AT HOME!

□ Prepare now for a profitable career in one of these growing fields. Learn theory and practical application of all makes and types with proven home study courses from the Philco Technological Center.

For FREE information write:

PHILCO
TECHNOLOGICAL CENTER
P. O. Box 4730, Dept. R-2, Philadelphia 34, Pa.

LEARN

TECHNICAL MANUAL WRITING AT HOME

Big demand, good pay, for trained writers. Home Study Course offered by A. C. W. Saunders, nationally known authority, instructs you in: **WRITING** and construction of commercial and military publications... **ILLUSTRATION** procedures... **LAYOUT** and printing. Write today for full particulars to:

ELECTRONIC TECHNICAL PUBL. CO.
P. O. BOX 306, ASTOR STA., BOSTON, MASS.

engineering degree in 27 months

You know the advantages college graduates have in industry — more income, rapid advancement. Important firms like Tri-State Graduates... regularly interview seniors on campus. Become an Electronics Engineer. Qualify faster here.

Bachelor of Science Degree in 27 Months

in Electrical (Electronics or Power major), Mechanical, Chemical, Aeronautical, Civil Engineering. IN 36 MONTHS B.S. in Business Administration (General Business, Accounting, Motor Transport Management majors). For earnest, capable, mature students. Small classes. More professional class hours. Beautiful campus. Well-equipped labs, modernized buildings, new dorms. Year-round operation. Enter Jan., Mar., June, Sept. Founded 1884. Write J. G. McCarthy, Director Admissions, for Catalog and "Your Career in Engineering and Commerce" Book.

TRI-STATE COLLEGE 24101 College Ave.
Angola, Indiana

FREE! ELECTRONICS CAREER KIT

If you're interested in breaking into a good-paying job in Radio-TV-Electronics, I.C.S. will send you absolutely free a famous Career Kit with 3 famous booklets that have helped thousands of others — just like yourself — on the road to real success. Includes:

- 1 "HOW TO SUCCEED" Career Guide — 36-page gold mine of career tips and information.
- 2 "JOB CATALOG" of opportunities in your field of interest.
- 3 "SAMPLE LESSON" (math) to demonstrate the famous I.C.S. method.

Send today for your free I. C. S. Career Kit with these 3 famous booklets. There's no obligation. This may be the big break you've been waiting for. Mark and mail the coupon today.

INTERNATIONAL CORRESPONDENCE SCHOOLS

Dept. 370871 Scranton 15, Penna.

Please send free Career Kit with 3 famous booklets

- General Electronics Radio-TV Serv'g Practical Electrician
 Industrial Electronics Sound Equipmt. Serv'g Profess'l Eng. (Elec.)
 Radio-TV Eng'r'g Electrical Eng'r'g Electrical Drafting
 Electronic Servicing Electrical Tech. Other _____

Name _____ Age _____
Address _____
City _____ State _____

FREE CAREER BOOKLET

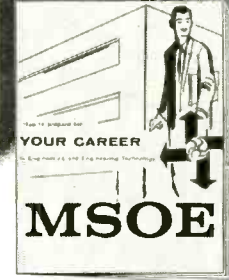

to guide you to a successful future in

ELECTRONICS RADIO-TV COMPUTERS ELECTRICAL ENGINEERING

This interesting pictorial booklet tells you how you can prepare for a dynamic career as an Electrical Engineer or Engineering Technician in many exciting, growing fields:

**MISSILES • RADAR • RESEARCH
ELECTRICAL POWER • ROCKETRY
AUTOMATION • AVIONICS
SALES • DEVELOPMENT**

Get all the facts about job opportunities, length of study, courses offered, degrees you can earn, scholarships, part-time work — as well as pictures of the Milwaukee School of Engineering's educational and recreational facilities. No obligation — it's yours free.

MILWAUKEE SCHOOL OF ENGINEERING

MAIL COUPON TODAY!

MILWAUKEE SCHOOL OF ENGINEERING
Dept. RE-1061, 1025 N. Milwaukee St.
Milwaukee, Wisconsin MS-113

Please send FREE "Your Career" booklet
I'm interested in Electronics Radio-TV
 Computers Electrical Engineering
 Mechanical Engineering
(PLEASE PRINT)

Name _____ Age _____
Address _____
City _____ Zone _____ State _____
 I'm eligible for veterans education benefits.
Discharge date _____

cause severe distortion or inability to hold the picture without affecting voltages at key points. That's where the scope comes in. The book illustrates 101 key waveforms that accompany defects. It tells the symptom, what tests should be made, and evaluates the effects of the trouble. The book is divided into three main sections, one for each of the basic horizontal circuits now in use. An extensive index is included.

OSCILLATOR CIRCUITS, by Thomas M. Adams. Howard W. Sams & Co. Inc., 1720 E. 38th St., Indianapolis, Ind. 5 1/2 x 8 1/2 in. 125 pp. \$2.95.

Many students feel the need for detailed and complete *physical* explanations of electronic phenomena. This book uses four colors to show current direction, feedback paths and phase relationships in circuits. It covers several types of oscillators, multivibrators and sawtooth generators. This approach is sure to clarify the inner workings of oscillators.—IQ

SEMICONDUCTOR DEVICES, by Rufus P. Turner. Holt, Rinehart & Winston Inc., 383 Madison Ave., New York 17, N. Y. 6 x 9 in. 278 pp. \$6.95.

This handbook is for the nonmathe-

matical technician and student. Experimenters will also find interesting circuits and useful data. In simple language the book describes such devices as rectifiers, transistors, Zener diodes, thermistors, photocells and parametric devices. Diagrams show typical applications, with the text giving component values and discussing circuit operation. A chapter on tests and measurements shows how to make setups to check the devices.

AN INTRODUCTION TO THE THEORY AND PRACTICE OF TRANSISTORS, by J. R. Tillman and F. F. Roberts. John Wiley & Sons Inc., 440 Park Ave. South, New York 16, N. Y. 5 1/2 x 8 1/2 in. 340 pp. \$8.

This book goes deep into mathematical analyses. It is written for engineers, physicists and specialists in semiconductors. Part 1 covers the properties of semiconductors and junctions. Part 2 discusses fabrication of semiconductors and their applications.—IQ

SEMICONDUCTORS AND TRANSISTORS, edited by Alexander Schure. John F. Rider Publisher Inc., 116 W. 14 St., New York 11, N. Y. 5 1/2 x 8 1/2 in. 138 pp. \$2.90.

This volume will provide a solid foundation for readers who understand

simpler types of mathematical equations. It begins with the study of atom structure and proceeds to the junction diode. Numerical examples show how to design circuits for optimum power, minimum distortion and proper impedance match.

This book can serve as an introduction for students who intend to proceed further in this field. END



"We give souvenir balloons to the kids."

R-E Classified ADS

RADIO & TV TUBES at Manufacturers' Prices! 100% Guaranteed! Brand-new! No rebrands or pulls! **UNITED RADIO**, Box 1000-R, Newark, N.J.

FREE confidential bargain sheets of electronic components—Lowest prices in the country! **KNAPP**, 3174 8th Ave. S.W., Largo, Fla.

ELECTRONIC RESEARCH SURPLUS, 2 1/2 lb—\$3. **PALAN ASSOCIATES**, 851 17 St. SW, Cedar Rapids, Iowa.

WANTED: BC-348's, laboratory equipment, manuals, klystrons. Cash, swap. **ENGINEERING ASSOCIATES**, 434 Patterson Rd., Dayton 19, Ohio.

TRANSISTORIZED products dealers catalog, \$1. **INTERMARKET**, CPO 1717, Tokyo, Japan.

WANTED—MISCELLANEOUS Quicksilver Platinum, Gold, Silver. Ores analyzed. **MERCURY TERMINAL**, Norwood, Mass.

COMPONENTS. Recorders, Tapes. **FREE** Wholesale Catalogue. **CARSTON**, 125-T East 88th St., New York 28, N.Y.

CASH PAID! Sell your surplus electronic tubes. Want unused, clean radio and TV receiving, transmitting, special purpose, Magnetrons, Klystrons, broadcast types, etc. Want military & commercial lab/test and communications equipment such as G.R., H.P., AN/UPM prefix. Also want commercial receivers and transmitters. For a fair deal write **BARRY**, 512 Broadway, New York 12, N. Y. Walker 5-7000.

DON'T BUY HI-FI COMPONENTS, Kits, Tape, Tape Recorders until you get our low, low return mail quotes. "We Guarantee Not To Be Undersold." Wholesale Catalog Free. Easy Time Payments Plan, 10% down—up to 24 months to pay. **HIFIDELITY CENTER**, 220 RC E 23 St., New York 10, N.Y.

ALL MAKES OF ELECTRICAL INSTRUMENTS AND TESTING equipment repaired. New and used instruments bought, sold, exchanged. **HAZELTON INSTRUMENT CO.**, 128 Liberty St., New York, N.Y.

BUY — SELL — TRADE cameras, lenses, telescopes, amateur radio equipment. **DENSON ELECTRONICS**, Box 85, Rockville, Conn.

GARAGE DOOR OPERATORS \$59.95. Rugged chain-drive automatic units. Highest quality. Free literature. **DEMSCO INC.**, Sebring 23, Ohio.

SPEAKER SALE. Component quotes. Tapes. **BAYLA CO.**, Box 131-RE, Wantagh, N.Y.

HIGHLY EFFECTIVE home-study review for FCC Commercial phone exams. Free literature. **WALLACE COOK**, Box 10634, Jackson 9, Miss.

LOANS by mail. \$100-\$600. Anywhere. Confidential. Write **UNION FINANCE**, Dept. RE, 323 East Camelback, Phoenix, Ariz.

THREE-LINE rubber stamp, \$1. **ELDRIDGE INDUSTRIES**, PO Box 2188, Trenton, N.J.

WE SELL only tubes and semiconductors. Authorized distributors for top-quality brands—G-E, Amperex, Eimac, Mullard, etc. Buy with confidence for less at **E T S**, 161 Washington St., New York 6, N.Y.

FRANCHISES MAKE PROFITS! Operate your own exclusive franchised business. Write today for free interesting details. **NATIONAL FRANCHISE REPORTS**, Dept. RE-528, 333 N. Michigan, Chicago 1.

DIAGRAMS FOR REPAIRING RADIOS, \$1; television \$2. Give make and model. **DIAGRAM SERVICE**, Box 672 RE, Hartford 1, Conn.

ENGRAVE dials, panels, nameplates with "Dupliscale" engraving machines. Details, sample engraving, 20¢. **DESCO DISTR'S**, 4329-CR Woodman, Van Nuys, Calif.

LEARN WHILE ASLEEP, Hypnotize with your recorder, phonograph or amazing new Electronic Educator endless tape recorder. Catalog, details free. **SLEEP-LEARNING ASSOCIATION**, Box 24-RD, Olympia, Wash.

PROMPT DELIVERY. We will not be undersold. Amplifiers, Tape Recorders, Tuners, etc. No catalogs. Air Mail Quotes. Compare. **L. M. BROWN SALES CORP.** Dept. R, 239 E. 24th St., New York 10, N. Y.

PROFESSIONAL ELECTRONIC PROJECTS—Organs, Timers, Computers, etc.—\$1 each. List free. **PARKS**, Box 1665, Lake City, Seattle 55, Wash.

NEW CONCEPT OF LEARNING SELF-HYPNOSIS! Now on tape or record! Free literature. **McKINLEY-SMITH CO.**, Dept. T5, Box 3038, San Bernardino, Calif.

500 PRINTED, GUMMED NAME AND ADDRESS LABELS, \$1.00. No C.O.D.'s. Print clearly. **RE-3, ADDISON MAIL ORDER**, 1840 Addison, Chicago 13, Ill.

BEFORE YOU BUY Receiving Tubes or Hi-Fi Components send now for your giant **FREE** Zalytron current catalog—featuring nationally known Zalytron First Quality TV-Radio Tubes, Hi-Fi Stereo Systems, Kits, Parts, etc. All priced to Save You Plenty—Why Pay More? **ZALYTRON TUBE CORP.**, 220 W. 42nd St., N.Y.C.

HIGHLY DIRECTIONAL MICROPHONE picks up a whisper a block away. Used by investigators, broadcasters. Build for about \$7.00 with simple materials. Plans, \$2.00. **DEE CO.**, Box 7263, Houston 8, Tex.

ADVERTISING INDEX

Radio-Electronics does not assume responsibility for any errors appearing in the index below.

Airex Radio Corp.	132	Halicrafters	112	Sherwood Electronics Labs. Inc.	133
Allied Radio	20-23	Harman-Kardon Inc.	3, 67	Shure Brothers Inc.	129
Almo Radio Co.	138	Heald's Engineering College	135	Smith (Wardell)	137
Atlas Sound Corp.	122	Heath Co.	64-65	Sonotone Corp.	10
Audio Unlimited Inc.	135	Holt, Rinehart & Winston Inc.	126	Sprague	30
Audion	137	Hudson Specialties Co.	131	Stancor Electronic Inc.	111
B & K Manufacturing Co.	27	Indiana Technical College	130	Standard Kollsman Industries Inc.	Inside Back Cover
Bell Telephone Labs	14	Jerrold Electronics Co.	8	Superscope Inc. (Sony)	135
Blonder-Tongue Labs	26	Key Electronics Co.	121	Sylvania Electric Products Inc.	97
Brooks Radio & TV Corp.	102	Lafayette Radio	80-83	TAB	132
Burstein-Applebee Co.	103	Lampkin Labs Inc.	111	Tarzian (Sarkes) Inc.	121
Capitol Radio Engineering Institute	106-109	Lektron	77	Transvision	124
Carlton Press	130	Mercury TV Tuner Repair	103	Triplett Electrical Instrument Co.	Inside Front Cover
Carston	130	Moss Electronic Inc.	116-119	Tung-Sol Electric Inc.	24
Castle TV Tuner Service	126	National Radio Institutes	11-12, 136	Turner Co.	123
Centralab Div. of Globe-Union	127	National Technical Schools	5	University Loudspeakers Inc.	99
Cisin (H. G.)	128	Olson Electronics	115	Vaco Products Co.	120
CLASSIFIED ADS	140-141	Paco Electronics Co. Inc.	87-90	Van Nostrand (D.) Co. Inc.	85, 137
Cleveland Institute of Electronics	9	Perma-Power Co.	76	Vidaire Electronics Manufacturing Corp.	111
Colordaptor	137	Phileo Corp.	132	Wen Products Co.	19
Commissioned Electronics	135, 136	Picture Tube Outlet	110	Winegard Co.	92-93
Coyne Electrical School	95	Progressive Edu-Kits Inc.	136	Zalytron Tube Corp.	137
DeVry Technical Institute	7	RCA Electron Tube Div.	Back Cover		
Dressner	110	RCA Institutes	71-72		
Dumont Emerson Corp., Granco Div.	69	RCA Test Equipment	16		
Dynaco Inc.	18	Rad-Tel Tube Co.	142		
Editors & Engineers	122	Radio Shack Corp.	29, 69, 76, 112, 125		
Electro-Voice Inc.	126	Radio-TV Training School	15		
Electronic Chemical Corp.	130	Rider (John F.) Publisher Inc.	131		
Electronic Engineering	138	Rohn Manufacturing Co.	77		
Electronic Instrument Co. (EICO)	31, 32	Sams (Howard W.) & Co. Inc.	25, 113		
Electronic Measurement Corp.	130	Saxitone Div. of Commissioned Electronics	135		
Electronic Publishing Co. Inc.	121	Schober Organ Co.	23		
Fisher Radio Corp.	110	Scott (H. H.) Inc.	13		
GC Electronics Co.	125	Sencore	101		
Gernsback Library Inc.	134				
Gold Products Co.	120				
Granco Div. Dumont Emerson Corp.	69				
Grantham School of Electronics	17				

SCHOOL DIRECTORY PAGE 138-139

Niles Bryant School
 Electronic Technical Publishing Co.
 Indiana Technical College
 International Correspondence School
 Middleton Institute of Electronics
 Milwaukee School of Engineering
 Northrop Institute of Technology
 Pacific International College of Arts & Sciences
 Phila. Wireless Technical Institute
 Philco Technological Center
 Tri-State College
 Valparaiso Technical Institute
 Printed in USA

Rates—50¢ per word (including name, address and initials. Minimum ad 10 words. Cash must accompany all ads except those placed by accredited agencies. Discount, 10% for 12 consecutive issues. Misleading or objectionable ads not accepted. Copy for December issue must reach us before Oct. 11, 1961.

RADIO-ELECTRONICS, 154 West 14 St., New York 11, N. Y.

RENT STEREO TAPES—over 2,000 different—all major labels—free catalog. **STEREO-PARTI**, 811-RE, Centinela Ave., Inglewood 3, Calif.

HELP WANTED. Experienced electronic technicians to service nuclear instruments. Part-time work within 100-mile radius of your home. Please supply resume. **RADIO-ELECTRONICS BOX 1000**, 154 W. 14 St., New York 11, N.Y.

INVENTIONS WANTED for immediate promotion! Patented, unpatented. Out-right cash; royalties; **CASCO**, Dept. 3, Mills Bldg., Washington 6, D.C.

CONVERT ANY TELEVISION to super-sensitive big-screen oscilloscope. Only minor changes necessary. Plans \$1.95. **RELCO**, Box 10563, Houston 8, Tex.

DIAGRAMS for TV, \$2.00; radio, \$1.00. State model and make of TV or radio. **HIETT DIAGRAMS**, P.O. Box 816, Laredo, Tex.

CIVIL SERVICE CAREER. Excellent benefits, security. Free list. **DONALD MARSH**, 8242 Au Sable Rd., St. Helen, Mich.

RADIO AND TV TUBES. Jobber-boxed. RCA, G-E, Sylvania, Westinghouse—65% off list price. Brand-new, no government surplus, no manufacturers' rejects. 25% deposit on all orders: balance COD. **FOB N.Y. SUTTON ELECTRONICS**, Box 503 Hicksville, N.Y.

STEREO Playback Tape Deck. Professional quality precision-made Telefunken heads. Dual speed. Special price \$59.95. Send for details. **UNIVERSAL DIST. CO.**, PO Box 204, Richmond Hill, N.Y.

PRESIDENTIAL PORTRAIT, J. F. K. 16x20 with handsomely engraved brass, nameplate. Sample and quantity prices, \$1.00. **PIERCE CO.**, Box 8871, Dallas, Tex.

6 TRANSISTOR RADIO, complete, guaranteed, \$13.50. **ZELECH**, 226 Shrewsbury, Redbank, N.J.

ROTARY SWITCHES. Average government cost \$33.00. Four types. Complete lot of 900 35¢ each, or \$2.00 each individually. **CONTRACTORS SURPLUS CO.**, Williamstown, Mass.

BUY/RENT COMEDY, PARTY RECORDS. Sampler and catalogs, \$1.00. **DRC**, 11024 Magnolia Blvd., No. Hollywood, Calif.

"NIPPO" CHECK PROTECTOR. \$9.95 complete! Satisfaction guaranteed! **ALBRIGHT**, Tipton, Ind.

EMERGENCY POWER. Convert auto type generator for 120-V 60-cy output to 750 W. Winding kit, instructions, less generator, \$7.95. **HOUCK**, Box 8331, Orlando, Fla.

3-TRANSISTOR, battery tape recorder, \$24.88. **RADEX**, 1161 W. Lincoln Blvd., Freeport, Ill.

100 DIFFERENT United States commemorative stamps. 1/2¢ to 10¢ face, used \$1.00; mint, \$4.95. **IRWIN**, Box 12D, Brooklyn 29, N.Y.

MONTHLY puzzle contests! Cash prizes! Details free! **SPENCE**, 11569 St. Petersburg, Fla.

BUY AT DISCOUNT! Save up to 47%. Name-brand merchandise. Free information. **VILLAGE DISCOUNT CO.**, Essexville, Mich.

RUBBER STAMPS. Three lines, \$1.00. Labels, cards, etc. Free catalog. **ALCO**, Box 244-R, Urbana, Ill.

MAKE ALL HAPPIER! Free Information. **ECONOMY**, Box 57036, Los Angeles 57, Calif.

COMMUNICATIONS TEST EQUIPMENT. Motorola frequency and deviation meter, \$375.00. Measurements model 80R generator, \$275.00. **DON CLARK COMMUNICATIONS**, 99 N.W. Main St., Blackfoot, Idaho.

BARBELLS, exercise equipment. Courses. Catalogue. 10¢. **GOOD BARBELL CO.**, Box 143, Siloam Springs, Ark.

"MEET — Attract — Win Beautiful Women!" Exciting free book offer! **GUIDE**, Box 363-RE, Mohegan Lake, N.Y.

PIANO technique simplified. \$1.25. **WALTER KAZAKS**, 234 E. 58 St., New York 22, N.Y.

PRINTING. Letterheads, envelopes, statements, billheads—the works. \$9.95 post-paid. (Samples). **OKAYPRINT**, Martins Ferry 7, Ohio.

PRECISION RESISTORS, carbon-deposit. Guaranteed 1% accuracy. Millions in stock. 1/2-watt. 8¢. 1-watt. 12¢. 2-watt. 15¢. Leading manufacturers. **ROCK DISTRIBUTING CO.**, 902 Corwin Rd., Rochester 10, N.Y.

SPEAK. SING with power. Self-training records. Thrilling! \$9.95. **CANFIELD 2018-K** Fifth Ave. So., Minneapolis 4, Minn.

WANT TO TRANSMIT FURTHER? Add No. 5686 final rf tube to get maximum efficiency 75%. Plus diagrams, information on many other ideas. \$1.00. **C. B. IMPROVEMENT CO.**, 70 Hill St., Bloomfield, N.J.

RADIOS, taperecorders, teleceivers, tele-amplifiers. Everything Japanese. **UNITA**, 545 Fifth Ave., New York 17, N.Y.

IMPORTED TRANSISTOR RADIOS, batteries. Lowest prices. List 10¢. **IMPORTS**, Dept. R-E, 828 Fullerton, Chicago 14, Ill.

ELECTRONIC SURPLUS CATALOG, 5,000 items. Send 10¢. **BILL SLEP CO.**, Drawer 178R, Ellenton, Fla.

FALL ROUNDUP of RAD-TEL Tube Values BUY 10 TUBES OF ANY ONE TYPE GET 1 FREE

You get 11 tubes (same type) . . . pay for only 10
Offer limited to the following types only:
1R5 - 1U5 - 3BC5 - 3BU8 - 5BK7 - 5U8 - 6AQ5 - 6BN6
6BU8 - 6CD6 - 6EA8 - 6U8 - 12CU6 - 12BH7 - 12W6

UP TO **75% OFF**
RAD-TEL'S FIRST QUALITY
BRAND NEW TUBES

500 MA SILICON RECTIFIER Epoxy construction, size of 1-watt resistor
Reverse at 450 Volts .3 ma

30¢ lots of 20 ea. | 35¢ lots of 10 ea. | 45¢ ea.

Each rectifier "Performance Tested" on an American TV Set

1 YR. GUARANTEE

ONE DAY SERVICE
SERVICEMEN:
Compare Rad-Tel's "Money-Saving" Fall Roundup of Tube Values. Buy 10 Tubes . . . get 1 Free Direct from Rad-Tel . . . FAST, DEPENDABLE SERVICE. Rad-Tel sells only Brand New Tubes.

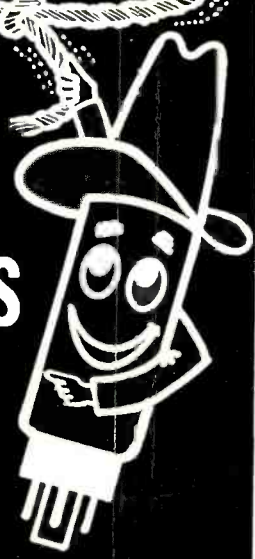

EACH TUBE INDIVIDUALLY & ATTRACTIVELY BOXED

Qty.	Type	Price	Qty.	Type	Price	Qty.	Type	Price
—	6AU7	.61	—	6J6	.67	—	12D4	.69
—	6AU8	.87	—	6J7	.62	—	12DB5	.69
—	6AV6	.41	—	6K6	.63	—	12DE8	.75
—	6AW8	.90	—	6L6	1.06	—	12DL8	.85
—	6AX4	.66	—	6N7	.98	—	12DM7	.67
—	6AX5	.74	—	6S4	.51	—	12DQ6	1.04
—	6AX7	.64	—	6S8	.76	—	12DS7	.79
—	6AX8	.92	—	6SA7GT	.76	—	12DT5	.76
—	6BA6	.50	—	6SG7GT	.41	—	12DT7	.79
—	6BA7	.84	—	6SH7GT	.49	—	12DT8	.79
—	6BA8	.88	—	6SJ7	.88	—	12DW8	.89
—	6BC5	.61	—	6SK7GT	.74	—	12DZ6	.56
—	6BC7	.94	—	6SL7GT	.80	—	12EG6	.54
—	6BC8	.97	—	6SN7GT	.65	—	12EK6	.56
—	6BD5	1.25	—	6SQ7	.73	—	12EL6	.50
—	6BD6	.57	—	6T4	.99	—	12EM6	.79
—	6BE6	.55	—	6T8	.85	—	12EN6	.78

—	6BF5	.90	—	6U8	.83	—	12EZ6	.53
—	6BF6	.44	—	6V6GT	.54	—	12F8	.66
—	6BG6	1.66	—	6V8	.86	—	12FA6	.79
—	6BH6	.65	—	6W4	.60	—	12FM6	.43
—	6BH8	.87	—	6W6	.71	—	12FR8	.91
—	6BJ6	.62	—	6X4	.39	—	12FX8	.85
—	6BJ7	.79	—	6X5GT	.53	—	12GC6	1.06
—	6BK7	.85	—	6X8	.80	—	12J8	.84
—	6BL7	1.00	—	6Y6G	.65	—	12K5	.65
—	6BN4	.57	—	7A8	.68	—	12L6	.58
—	6BN6	.74	—	7AU7	.61	—	12S8	.62
—	6BQ5	.65	—	7B6	.69	—	12SA7	.92
—	6BQ6	1.05	—	7EY6	.73	—	12SF5	.50
—	6BQ7	1.00	—	7F8	.90	—	12SF7	.69
—	6BR8	.78	—	7Y4	.69	—	12SH7	.49
—	6BS8	.90	—	8AU8	.83	—	12SJ7	.67
—	6BU8	.70	—	8AW8	.93	—	12SK7	.74

—	6BX7	1.02	—	8BH8	.90	—	12SL7	.80
—	6BY5	1.15	—	8BN8	.75	—	12SN7	.67
—	6BY6	.54	—	8BQ5	.60	—	12SQ7	.78
—	6BY8	.66	—	8C7G	.62	—	12U7	.62
—	6BZ6	.55	—	8CM7	.68	—	12V6	.53
—	6BZ7	1.01	—	8CN7	.97	—	12W6	.69
—	6BZ8	1.09	—	8CS7	.74	—	12X4	.38
—	6C4	.43	—	8CX8	.93	—	17AX4	.67
—	6C8	.90	—	8EB8	.94	—	17BQ6	1.09
—	6CB6	.55	—	8SN7	.66	—	17D4	.69
—	6CD6	1.42	—	9CL8	.79	—	17DQ6	1.06
—	6CE5	.57	—	11CY7	.75	—	17L6	.58
—	6CF6	.64	—	12A4	.60	—	17W6	.70
—	6CG7	.61	—	12AB5	.55	—	18FW6	.49
—	6CG8	.77	—	12AC6	.49	—	18FX6	.53
—	6CK4	.70	—	12AD6	.57	—	18FY6	.50
—	6CL8	.79	—	12AE6	.43	—	19AU4	.83

—	6CM6	.64	—	12AE7	.94	—	19BG6	1.39
—	6CM7	.66	—	12AF3	.73	—	19T8	.80
—	6CM8	.90	—	12AF6	.49	—	19V8	.79
—	6CN7	.65	—	12AJ6	.46	—	21EX6	1.49
—	6CQ8	.84	—	12AL5	.45	—	25AV5	.83
—	6CR6	.51	—	12AL8	.95	—	25AX4	.70
—	6CS6	.57	—	12AQ5	.60	—	25BK5	.91
—	6CS7	.69	—	12AT6	.43	—	25BQ6	1.11
—	6CU5	.58	—	12AT7	.76	—	25C5	.53
—	6CU6	1.08	—	12AU6	.51	—	25CA5	.59
—	6CY5	.70	—	12AU7	.60	—	25CD6	1.44
—	6CY7	.71	—	12AV6	.41	—	25CUE	1.11
—	6DA4	.68	—	12AV7	.75	—	25DN6	1.42
—	6DB5	.69	—	12AX4	.67	—	25EH5	.55
—	6DB6	.51	—	12AX7	.63	—	25L6	.57
—	6DE6	.58	—	12AY7	1.44	—	25W4	.68
—	6DG6	.59	—	12AZ7	.86	—	25Z6	.66
—	6DK6	.59	—	12B4	.63	—	32ET5	.55

—	6DN6	1.55	—	12BA6	.50	—	32L7	.90
—	6DQ6	1.10	—	12BA7	.84	—	35B5	.60
—	6DT6	.53	—	12BD6	.50	—	35C5	.51
—	6DT8	.79	—	12BE6	.53	—	35L6	.57
—	6EA8	.79	—	12BF6	.44	—	35W4	.42
—	6EB5	.72	—	12BH7	.77	—	35Z5	.60
—	6EB8	.94	—	12BK5	1.00	—	36AM3	.36
—	6EM5	.76	—	12BL6	.56	—	50B5	.60
—	6EM7	.82	—	12BQ6	1.06	—	50C5	.53
—	6EU8	.79	—	12BY7	.77	—	50EH5	.55
—	6EW6	.57	—	12BZ7	.75	—	50L6	.61
—	6EY6	.75	—	12C5	.56	—	57G3	1.00
—	6F5GT	.39	—	12CN5	.56	—	70L7	.97
—	6F6	.69	—	12CR6	.54	—	70Z5	.69
—	6GK6	.79	—	12CU5	.58	—	84, 6Z4	.46
—	6GN8	.94	—	12CU6	1.06	—	807	.70
—	6HG	.58	—	12CX6	.54	—	117Z3	.61
—	6J5GT	.51	—			—		

● NOT AFFILIATED WITH ANY OTHER MAIL ORDER TUBE COMPANY ●

SEND FOR FREE TROUBLE SHOOTER
GUIDE AND NEW TUBE & PARTS CATALOG

RAD-TEL TUBE CO.

DEPT. RE-106T 55 CHAMBERS STREET, NEWARK 5, N. J.

TERMS: 25% deposit must accompany all orders, balance COD. Orders under \$5: add \$1 handling charge plus postage. Orders over \$5: plus postage. Approx. 8 tubes per 1 lb. Subject to prior sale. Prices subject to change. No COD's outside continental USA.

Universal Replacement Parts Kit

MODEL 31T 3890

Popular Standard Coil field replacement parts used extensively by servicemen for STANDARD tuners manufactured from 1947-1956.

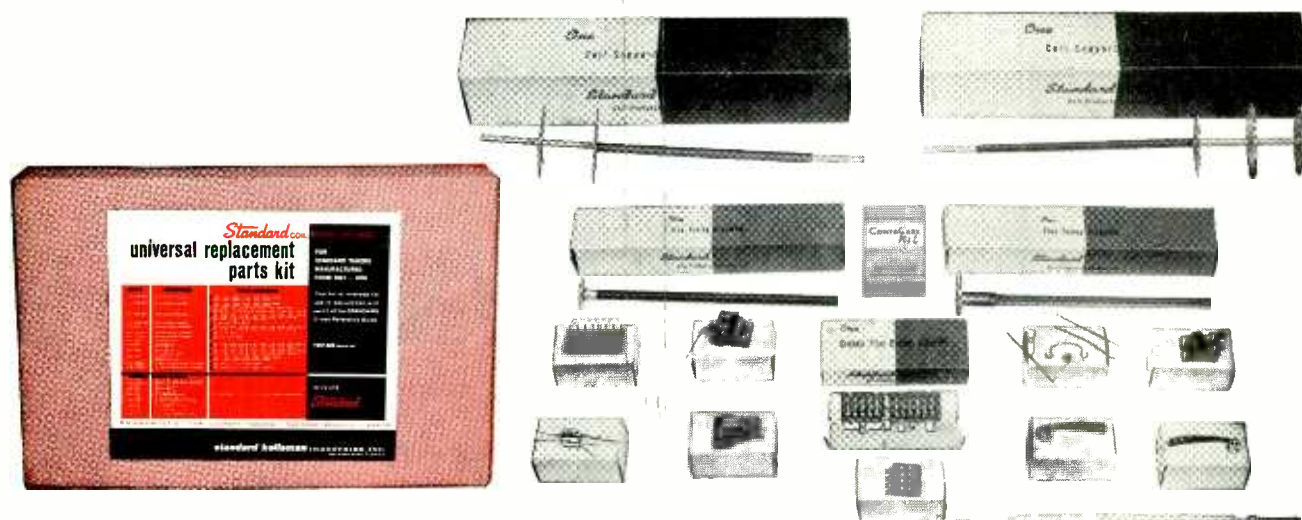

MODEL 31T 3890

A kit of mechanical and electrical parts for shop and field use to be used in conjunction with Section II of the STANDARD Cross Reference Guide. These parts make up 90% of the replacement parts most commonly used in field service.

INCLUDED

FREE

- Special IF alignment tool for late model STANDARD TV and FM tuners.
- Popular special springs, detent springs and roller assembly, detent ball assemblies, etc.

BE PREPARED... GET YOURS TODAY from any authorized

Standard **COIL** distributor

• **\$27.99 DEALER NET**

standard kollman INDUSTRIES INC.

FORMERLY STANDARD COIL PRODUCTS CO., INC., MELROSE PARK, ILLINOIS



“BUSINESS END” of a NOVAR tube

You're looking at the base of one of RCA's remarkable new novar tubes... the first in a new family of tubes that will mean better business for you through reduced call backs.

This new base—with 9 widely-spaced, heavy-gauge pins—characterizes novar, RCA's line of large all-glass integral base tubes designed to do the work of conventional tubes with molded bases. Because novars *outperform* these con-



ventional types, they are being selected for use in more and more radio and TV receivers as well as hi-fi equipment. From present indications, novar should become the standard of the industry.

Look for novar, RCA's latest contribution to electron tube design. Your Authorized RCA Electron Tube Distributor now has RCA-7868 novar and will soon have many other types to support your servicing business.

RCA ELECTRON TUBE DIVISION, HARRISON, N.J.



The Most Trusted Name in Electronics