

Radio-Electronics

FEB. 50c

TELEVISION • SERVICING • HIGH FIDELITY

A
GERNSBACK
PUBLICATION

**G-LINE FOR TV
REMOTE ANTENNAS**

**BUILD A DIRECT
FREQUENCY METER**

**PA AMPLIFIER
INCLUDES LECTERN**

HUGO GERNSBACK, Editor in Chief

**Biggest
Radio
Telescope
Scooped
Out Of
Earth See page 4**

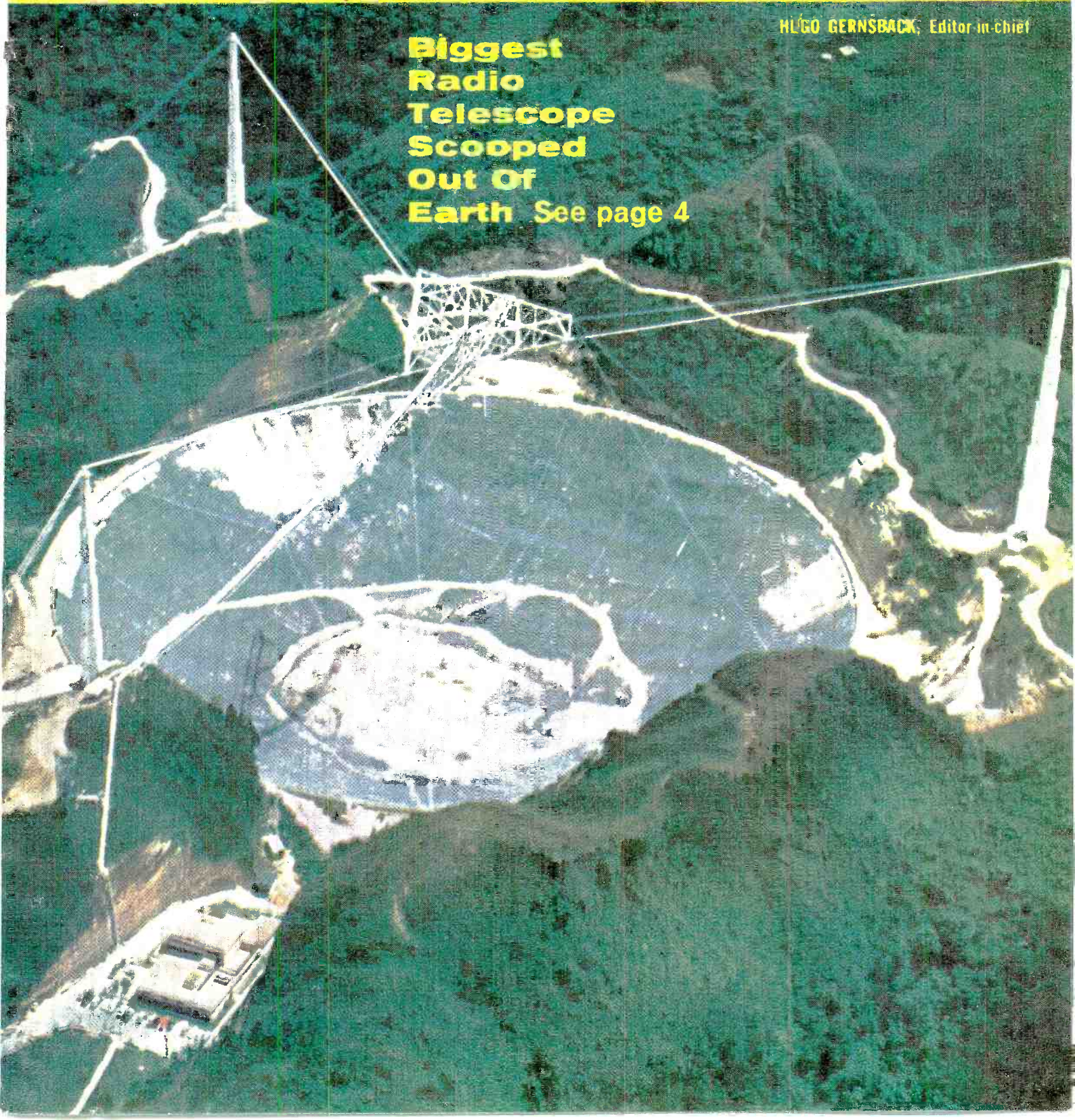

PROTECTS AGAINST • Bent Pointers • Burned-Out Resistors
 • Damaged Pivots • Overheated Springs • Burned-Out Meter
 • Changes in Accuracy Due to Overheating



Model 630-PLK

BURNOUT PROOF V-O-M

\$79.50
 Suggested U.S.A. User Net

USES UNLIMITED
 School Classrooms • Field Engineers • Application Engineers
 • Electrical, Radio, TV, and Appliance Servicemen • Electrical Contractors • Factory Maintenance Men • Industrial Electronic Maintenance Technicians • Home Owners, Hobbyists

FACTS MAKE FEATURES:

- 1** Comprehensive overload protection.
- 2** One selector switch minimizes chance of incorrect settings
- 3** Polarity reversing switch

Additional protection is provided by Model 630-PLK's new transistorized relay circuit. Transistorized overload sensing device does not load circuit under test, eliminating the possibility of damaging circuit components. A special meter shorting feature on "off" position offers high damping when moving tester. The exclusive patented Bar Ring Movement provides self-shielding and is not affected by stray magnetic fields. Wider spread scales, and unbreakable clear plastic window assure maximum readability. Diode network across meter protects against instantaneous transient voltage.

TRIPLETT ELECTRICAL INSTRUMENT COMPANY, BLUFFTON, OHIO

RANGES

DC Volts:	0-2.5-10-50-250-1,000-5,000 at 20,000 ohms/volt. 0-0.25 at 100 microamperes.
AC Volts:	0-3-10-50-250-1,000-5,000 at 5,000 ohms/volt.
Decibels:	-20 to +11, +21, +35, +49, +61, +75; "0" DB at 1 MW on 600 ohm line.
DC Microamperes:	0-100 at 250 Mv.
DC Milliampers:	0-10-100-1,000 at 250 Mv.
DC Amperes:	0-10 at 250 Mv.
Ohms:	0-1,000-10,000 (4.4-44 at center scale).
Megohms:	0-1-100 (4,400-440,000 at center scale).

Output Volts (AC): 0-3-10-50-250-1,000 at 5,000 ohms/volt; jack with condenser in series with AC ranges.

CARRYING CASE

Model 639-OS black leather carrying case, built-in stand, Flaps open to permit use of tester in the case. Suggested U.S.A. User Net.....\$12.10

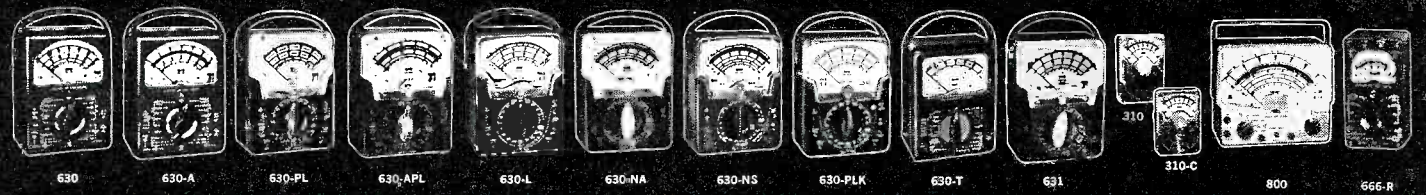

THE WORLD'S MOST COMPLETE LINE OF V-O-M'S. AVAILABLE FROM YOUR TRIPLETT DISTRIBUTOR'S STOCK

COLUMBIA STEREO TAPE CLUB NOW OFFERS YOU

ANY 4 STEREO TAPES

of these exciting pre-recorded 4-track

\$5.98
FOR ONLY
Value up to \$39.80 at regular Club prices

if you join the Club now and agree to purchase as few as 5 selections from the more than 150 to be offered in the coming 12 months

THE BARBRA STREISAND ALBUM
Happy Days Are Here Again
A Sleepin' Bee
Cry Me A River
8 MORE
COLUMBIA

9034. Also: A Taste of Honey, My Money's Loving Arms, etc.

WEST SIDE STORY
Original Soundtrack Recording
COLUMBIA

9004. "The most adventurous musical ever made."—Life

TCHAIKOVSKY: SWAN LAKE
Ballet Suite
ORMANDY
Philadelphia Orch.
Includes a Special Booklet and Rare Illustrations
COLUMBIA

9048. "A treat, a delight all over again."—N.Y. Journal-Amer.

ANDY WILLIAMS DAYS OF WINE AND ROSES
plus
• Can't Get Used to Losing You
• My Coloring Book
• 9 more
COLUMBIA

9033. Also: What Kind of Fool Am I?, May Each Day, etc.

Cherry Pink AND Apple Blossom White
COLUMBIA
Harry Murad's **HARMONICATS**

9060. Ramona, Ruby, Fascination, Mack The Knife, 12 in all

STRAVINSKY conducts The "FIREBIRD" COMPLETE BALLET
COLUMBIA

9047. "Brilliant performance... lush... rich."—Musical Amer.

JOHNNY'S NEWEST HITS
What Will Mary Say
That's The Way It Is • 10 MORE
JOHNNY MATHIS
COLUMBIA

9006. Also: Wasn't the Summer Short?, Marianna, etc.

The New ANDRE KOSTELANETZ
"Wonderland of Sound"
COLUMBIA

9015. Be My Love, Unchained Melody, Volare, 12 in all

ORFF: CARMINA BURANA
THE PHILADELPHIA ORCHESTRA
soloists and chorus
ORMANDY conducting
COLUMBIA

9038. "Superb... best of many performances."—Wash. Post

TIME OUT
THE DAVE BRUBECK QUARTET
COLUMBIA

9025. "It soars and swings... a breakthrough."—Playboy

LENER & LOEW Camelot
RICHARD BURTON
JULIE ANDREWS
ROBERT GOULET
and Original Broadway Cast
COLUMBIA

9003. "Most lavish, beautiful musical; a triumph!"—Kilgallen

Rhapsody in Blue
An American in Paris
Leonard Bernstein plays Gershwin
COLUMBIA

9035. "Fierce impact and momentum."—N.Y. World-Telegram

Themes for Young Lovers PERCY FAITH
I WILL FOLLOW YOU
MY COLORING BOOK
RHYTHM OF THE RAIN
9 more
COLUMBIA

9022. Also: Go Away Little Girl, Up on The Roof, etc.

THE GIANTS OF JAZZ
• BRUBECK
• ELLINGTON
• DAVIS-MONK
• CONDON
• 10 others
COLUMBIA

9031. A truly definitive cross-section of the great combos

BEETHOVEN "Emperor" Concerto
COLUMBIA
RUDOLF SERKIN
BERNSTEIN
N.Y. Philharmonic

9058. Most exciting and thrilling of all Beethoven concertos

TONY BENNETT
I Left My Heart in San Francisco
Tender Is the Night
Smile • 9 more
COLUMBIA

9028. Also: Love for Sale, Candy Kisses, Marry Young, etc.

GREAT MOTION PICTURE THEMES
EXODUS
NEVER ON SUNDAY
THE APARTMENT
plus 13 more
United Artists
COLUMBIA

9030. Also: Smile, Some Like it Hot, Magnificent 7, etc.

REX HARRISON JULIE ANDREWS MY FAIR LADY
ORIGINAL CAST RECORDING
COLUMBIA

9001. The best-selling Original Cast recording of all time

The Versatile HENRY MANCINI AND HIS ORCH.
LIBERTY

9009. Ebb Tide, The Breeze and I, Sleepy Lagoon, 12 in all

TCHAIKOVSKY Symphony No. 5
LEONARD BERNSTEIN
NEW YORK PHILHARMONIC
COLUMBIA

9057. "A wholly persuasive performance!"—N. Y. Times

MESSIAH
EUGENE ORMANDY
The Philadelphia Orchestra
THE MORMON TABERNACLE CHOIR
COLUMBIA

9044-9045. Two-Tape Set (Counts As Two Selections.) "Zestful... a powerful, vital statement!"—HiFi/Stereo Review

TWIN-PACK
Equivalent To Two Selections
COLUMBIA

Ray Conniff Singers
SO MUCH IN LOVE
COLUMBIA

9008. Chances Are, Just Walking in The Rain, 12 in all

THE BLUE DANUBE
A Johann Strauss Festival
COLUMBIA
PHILADELPHIA ORCH. - ORMANDY

9042. "Performances that really sparkle and glow."—High Fid.

A FESTIVAL OF MARCHES
March of the Tornadoes
American Salute
Stars and Stripes Forever
Meadowlands
COLUMBIA 9 more
PHILADELPHIA ORCH. ORMANDY

9059. "Abundance of pulsing rhythms."—St. Louis Globe Dem.

FIRST TIME! DUKE ELLINGTON MEETS COUNT BASIE
COLUMBIA

9024. "Walloping ensembles and stirring solos."—High Fid.

THE NEW CHRISTY MINSTRELS with RANDY SPARKS
This Land Is Your Land
Nine Hundred Miles
12 MORE
COLUMBIA

9007. Also: Railroad Bill, Cotton Pickers' Song, Whistle, etc.

MARY MARTIN in RODGERS & HAMMERSTEIN'S THE SOUND OF MUSIC
COLUMBIA
with Original Broadway Cast

9002. A show that's "perfectly wonderful!"—Ed Sullivan

FREE—if you join now
REVOLUTIONARY SELF-THREADING TAKE-UP REEL



Just drop the end of the tape over this reel, start your recorder, and watch it thread itself! Unique Scotch® process automatically threads up tape of any thickness, releases freely on rewind.

IF YOU ARE ONE OF THE FORTUNATE PEOPLE who own 4-track stereo tape playback equipment, you know the thrill of the near-perfect fidelity, the unsurpassed sound of tape. Now you have an exceptional opportunity to build an outstanding collection of superb stereo tapes at great savings through the most generous offer ever made by the Columbia Stereo Tape Club!

By joining now, you may have ANY FOUR of the magnificently recorded 4-track stereo tapes described here — sold regularly by the Club for up to \$39.80 — for only \$5.98!

TO RECEIVE YOUR 4 PRE-RECORDED STEREO TAPES FOR ONLY \$5.98 — simply fill in and mail the coupon today. Be sure to indicate which Club Division best suits your musical taste: Classical or Popular.

HOW THE CLUB OPERATES: Each month the Club's staff of music experts chooses outstanding selections for both Divisions. These selections are described in the Club Magazine, which you receive free each month.

You may accept the monthly selection for your Division . . . or take any of the wide variety of tapes offered in the Magazine to members of both Divisions . . . or take no tape in any particular month.

Your only membership obligation is to purchase 5 tapes from the more than 150 to be offered in the coming 12 months. Thereafter, you have no further obligation to buy any additional tapes . . . and you may discontinue your membership at any time.

FREE TAPES GIVEN REGULARLY. If you wish to continue as a member after purchasing five tapes, you will receive — FREE — a 4-track stereo tape of your choice for every two additional tapes you buy.

The tapes you want are mailed and billed to you at the regular Club price of \$7.95 (occasional Original Cast recordings somewhat higher), plus a small mailing and handling charge.

SEND NO MONEY — Just mail the coupon today to receive your four pre-recorded 4-track stereo tapes — ALL FOUR for only \$5.98!

IMPORTANT NOTE: All tapes offered by the Club must be played on 4-track stereo playback equipment. If your tape recorder does not play 4-track stereo tapes, you may be able to convert it simply and economically. See your local service dealer for complete details.

COLUMBIA STEREO TAPE CLUB Terre Haute, Ind.

SEND NO MONEY—mail coupon to receive 4 tapes for \$5.98

COLUMBIA STEREO TAPE CLUB, Dept. 424-1
Terre Haute, Indiana

I accept your special offer and have written in the boxes at the right the numbers of the 4 tapes I would like to receive for \$5.98, plus a small mailing and handling charge. I will also receive my self-threading reel — FREE! Enroll me in the following Division of the Club:

CLASSICAL POPULAR

I understand that I may select tapes from either Division. I agree to purchase five selections from the more than 150 to be offered in the coming 12 months, at the regular Club price plus a small mailing and handling charge. Thereafter, if I decide to continue my membership, I am to receive a 4-track, pre-recorded tape of my choice FREE for every two additional selections I accept.

Name..... (PLEASE PRINT)
Address.....
City..... Zone..... State.....

This offer is available only within the continental limits of the U.S.

48-IV

T3

EDITORIAL

- 25 Space Handicaps.....Hugo Gernsback

AUDIO-HIGH FIDELITY-STEREO

- 26 The MC's P.A.Leon A. Wortman
All-in-one amplifier, mike and speaker is reading desk, too
- 37 Line Voltage and Amplifier Distortion.....Harold Reed
- 44 Professional Stereo Line Amplifier.....Harold Reed
For studio or elaborate home systems
- 60 Audio Report: An FM Stereo Tuner and a Speaker System
Scott 310E and Electro-Voice EV Two

ELECTRONICS

- 28 The Bridged-T.....Jerry L. Ogdin
How to design and use a little-known notch circuit with many applications
- 33 Reactance Tables.....Ernest T. Thiersch
- 35 Trimming Resistors and Capacitors.....Martin H. Patrick
- 38 Auto-Photo Timer.....Joseph Giannelli
Correct enlarger exposures automatically
- 76 New Approach to Transistor Circuit Design.....Irving M. Gottlieb
After all, transistors can be voltage amplifiers

GENERAL

- 40 What's Your EQ?
- 50 Marvelous Electronic Diaper Change Indicator.....David W. Cramp
- 51 Automotive Alternators—How to Keep Them Working.....Charles J. Schauers
New field for electronic technicians

RADIO

- Cover Feature 36 Biggest Telescope on Earth Is IN The Earth.....Eric Leslie
Radar's scope may help protect us from future ICBM's
- 41 Improve FM Reception with a Wide-Band Detector.....Lloyd Vincent
Replace the detector transformer to reduce distortion

TELEVISION

- 31 TV Power Supply Troubles.....Jack Darr
Power supplies can cause some amazing symptoms
- 46 The G-Line.....Owen G. Patrick
How this ultra-low-loss line works and how to make it bring TV down a mountain
- 54 Service Clinic.....Jack Darr
How TV color circuits work
- 64 A Day at the Bench.....Warren Roy
Even if the roof doesn't leak, capacitors do

TEST INSTRUMENTS

- 34 Simplest Direct-Reading Frequency Meter.....I. Queen
One transistor, a meter and not much else
- 49 Simple Rf Wattmeter for CB.....Lyman E. Greenlee
Has other uses, too—such as low-power audio or ham measurements
- 68 Equipment Report: Sencore CR-125 and International Crystal C-12B
A flexible picture-tube tester and a CB frequency meter

THE DEPARTMENTS

- | | | | |
|------------------------|--------------------------------|------------------------|------------------|
| 23, 53, 88 Corrections | 92 New Patents | 6 News Briefs | 89 Technotes |
| 18 Correspondence | 95 New Products | 86 Noteworthy Circuits | 104 Try this One |
| 107 New Books | 101 New Semiconductors & Tubes | 99 Technicians' News | 103 50 years Ago |
| 106 New Literature | | | |



Member,
Institute of High Fidelity
Radio-Electronics
is indexed in
Applied Science
& Technology Index
(Formerly
Industrial Arts Index).

HUGO GERNSBACK, editor-in-chief and publisher. M. HARVEY GERNSBACK, editor. Fred Shunaman, managing editor. Robert F. Scott, W2PWG, technical editor. Peter E. Suthem, associate editor. Jack Darr, service editor. I. Queen, editorial associate. John J. Lamson, eastern sales manager. Wm. Lyon McLaughlin, technical illustration director.

A NEW WORLD OF OPPORTUNITY AWAITS YOU WITH N.T.S. ALL-PHASE HOME TRAINING IN ELECTRONICS



You can install and maintain electronic circuitry in missiles and rockets ... specialize in micro-waves, radar and sonar.

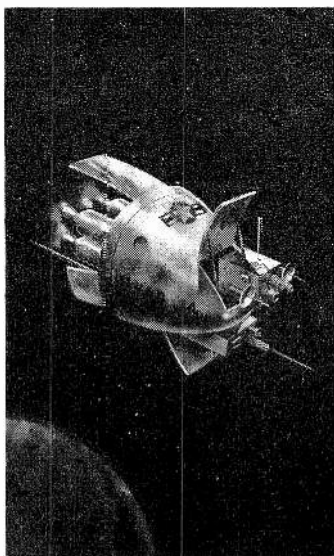

You can succeed in TV-Radio Communications ... prepare for F.C.C. License, service advanced satellites for industry and defense.

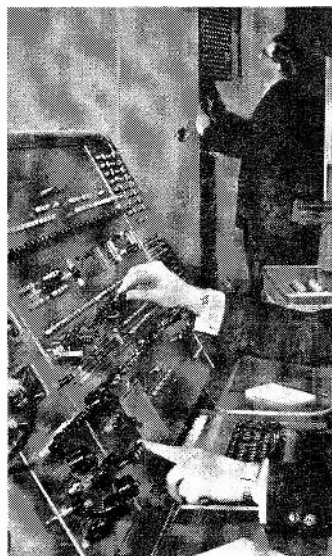

You can service and repair the electronic "brains" of industry — computers, data processing, and other automation equipment.



You can become a highly-paid TV-Radio Technician, an electronics field engineer, or succeed in your own sales & service business.

The N.T.S. Master Course enables you to do more, earn more in ELECTRONICS • TELEVISION • RADIO Yet N.T.S. Training costs no more than other courses far less complete

There's a good reason why N.T.S. Master-Training opens a wide new world of opportunity for you in Electronics, Television, Radio.

Everything you learn, from start to finish, can be applied directly to all phases of the Electronics Industry.

As a result, the N.T.S.-Trained Technician can move ahead faster, in any direction — from TV-Servicing to Radio Communications to Space-Missile Electronics and Automation for industry and defense. You can go wherever pay is highest and opportunity unlimited.

Electronic circuitry, for example, is one of science's miracles that is basic to the entire field of Electronics. It is used in satellites, computers and space capsules as well as in today's television sets and high fidelity equipment. N.T.S. shows you how to service and repair electronic circuitry for all electronic applications.

You work on many practical job projects. You build a short-wave, long-wave superhet receiver, plus a large-screen television set: from the ground up. N.T.S. training kits contain all the parts you need ... at no extra cost. (See box at right.) You also receive a professional Multitester to use during training and on the job.

ONE LOW TUITION. You need training related to all phases of Electronics. Industry demands it. Only N.T.S. provides it ... in ONE Master Course at ONE low tuition.

RESIDENT TRAINING AT LOS ANGELES

If you wish to take your Electronics-TV-Radio training in our famous Resident School in Los Angeles — the oldest and largest school of its kind in the world — write for special Resident School catalog and information, or check coupon.



NATIONAL TECHNICAL SCHOOLS

WORLD-WIDE TRAINING SINCE 1905
4000 So. Figueroa St., Los Angeles, Calif 90037

Accredited Member N.H.S.C.



YOU ENROLL BY MAIL AND SAVE MONEY. No salesmen means lower costs for us, lower tuition for you.

START NOW. A whole new world of opportunity awaits the man with Electronic Home-Training from National Technical Schools — a recognized leader in technical training for 58 years.



19 BIG KITS
YOURS TO KEEP



MAIL COUPON NOW FOR FREE BOOK AND ACTUAL LESSON!

NO OBLIGATION.
NO SALESMAN WILL CALL.

NATIONAL TECHNICAL SCHOOLS
WORLD-WIDE TRAINING SINCE 1905

National Technical Schools, Dept. RG-24
4000 South Figueroa Street, Los Angeles, California 90037

Please Rush FREE Electronics-TV-Radio "Opportunity" Book and Actual Lesson. No Salesman Will Call.

Name _____ Age _____

Address _____

City _____ Zone _____ State _____

Check if interested ONLY in Resident Training at L.A.
High school home study courses also offered. Check for free catalog.

RADIO NEWS BRIEFS

Sonar Doppler Navigates Surface Vessels

A Doppler navigator that automatically and continually plots a ship's position underway has been developed by Raytheon for the Navy. This works much like the Doppler radar now used to guide airplanes (RADIO-ELECTRONICS, August 1962, p. 42).

As the ship moves forward through the water, sound waves are beamed to the ocean's floor in four directions corresponding to the cardinal points of the compass. The returning echoes, changed slightly in pitch from the frequency of the original beam, are compared with the outgoing sound. The change is called the *Doppler effect* and is a direct measure of the motion of the vessel in the respective directions.

This change occurs only when the ship moves. The bottom echo from the sound signal beamed ahead of the vessel strikes the receiver sooner than it would if the ship were standing still. Therefore, the pitch is slightly higher. Echoes from the beams directed astern and to port and starboard of the ship likewise change in pitch in proportion to the motion of the vessel in these directions.

These differences in frequency are processed and compared electronically. The outputs are fed into step motors which drive the plotting pen over a standard US Coast and

Geodetic Survey or Navy Hydrographic Chart. The result is a precise tracing of ink across the face of the chart, the contact point of the pen being the actual position of the vessel with respect to the surface of the earth.

An earlier underwater Doppler radar was mentioned in RADIO-ELECTRONICS, February 1963, on page 16.

Child Bites Cheater Cord, Lives, But Loses Two Teeth

Joyce Ellen Cartwright, age 2, of Old Hickory, Tenn., pulled the cord out of the family TV set, put it in her mouth and bit it. Her mother reports that she saw her about 2 feet off the floor, coming down. "I thought she had climbed up on something and fallen off," Mrs. Cartwright said.

At the hospital, it was discovered that the child had third-degree burns at the corner of her mouth and partly down her throat. She had swallowed two of her teeth and a fragment of the TV cord.

Apparently the back of the set had been removed for some reason (possibly amateur troubleshooting) and the set was being operated with a simple cheater cord.

Precision Holes Bored With Laser Guidance

A system in which a beam of laser light acts as a "radar" to show the position of a boring-tool spindle

is described by Sperry Gyroscope Co. of Canada. The device would be used to bore holes as small as 1/20 inch—about the size of a pinhead—in tungsten and molybdenum steels. Tolerance would be 20 times finer than at present, about 5 millionths of an inch, or a quarter of the wavelength of red light.

To achieve these tolerances, a beam of laser light from the boring-tool spindle strikes the wall of the hole and is reflected to the spindle. Checking the elapsed time indicates the precise time the light has traveled, and thus can be used to show the radius of the hole. The radius indicated is compared with the desired radius and, if necessary, the spindle repositioned automatically to make the necessary corrections. The operation occurs on each revolution of the borer—to 6,000 times a minute.

Miniature Gas Laser Emits Visible Light

A helium-neon gas laser only 5 cm long and 1 mm in diameter has been developed by Eugene I. Gordon and Alan D. White of Bell Telephone Labs. Due to its shortness, the new laser oscillates at only one frequency. Larger gas lasers tend to operate at several frequencies simultaneously and are hard to stabilize against frequency fluctuation. The smaller lasers are much less susceptible to vibration and thus more stable.

The combination of stability and single-frequency oscillation makes it possible to use the laser as a very precise measuring instrument. If one of the end mirrors is connected to a positioning device, very slight changes in position will cause the laser to shift frequency. Displacements considerably less than one-millionth of an inch can be detected and, with an oscilloscope, readily measured.

Changing the spacing between the end mirrors varies the frequency

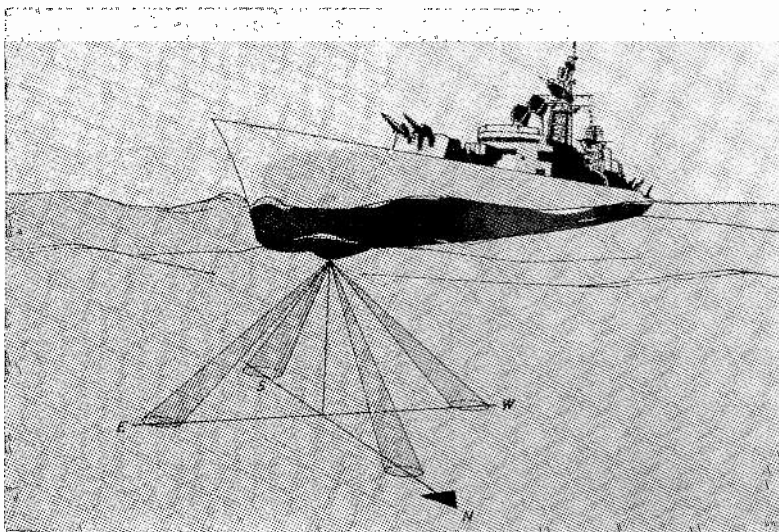

New nautical navigator's sonar devices continuously bounce four simultaneous signals off ocean floor. Returning echoes are compared with transmitted signal. Combined results make ink trace on ship's chart, showing ship's exact position.

Advertising Representatives: South — J. Sidney Crane & Associates, 22 8th St. N. E., Atlanta, Ga., Tel. TRinity 2-6720. Florida: Neff Associates, 15 Castle Harbor Isle, Fort Lauderdale, Fla., Tel. LOgan 6-5656. West—Husted-Coughlin, Inc., 1830 W. 8th St., Los Angeles, Calif., Tel. 389-3132. 444 Market St., San Francisco, Calif., Tel. GARfield 1-0151. **United Kingdom** — Publishing & Distributing Co., Ltd., Mitre House, 177 Regent St., London W.1, England.

Subscription Service: Address form 3579 and correspondence to Radio-Electronics, Subscriber Service, 154 West 14th St., New York, N. Y. 10011. When requesting a change of address please furnish an address label from a recent issue. Allow one month for change of address.



Men of most All Ages — from many walks of Life have profited by DeVry Electronics Training

Electronics training has given job opportunities to thousands of men of most ages. Many went on for years looking for the "big break," and never even thought they had a chance in electronics. Then, sooner or later, an item in the paper, a coupon in a magazine, a word of advice from a friend — led them to Electronics. It's an ideal field for the lad just graduated, the man just married, the man looking for a "second chance."

DeVRY TECH STANDS BACK OF EVERY DeVRY MAN — EVEN AFTER HIS TRAINING!

Thorough, practical training has made DeVry outstanding for 32 years. Equally important is DeVry Employment Service, which is always available to our trained men. In addition, DeVry Consultation Service helps our men with any technical problem they may face at any time.

Electronics training has done so much for so many men, and DeVry Tech offers practical programs to suit almost anyone 17-55. You can train in one of our modern laboratories, day or evening. Or, you can keep your present job and train at home — even earn while you learn! No previous technical experience is required to get started. Send for our free booklets today and find out how you, too, may prepare for a bright, more profitable tomorrow — in electronics.



DeVry Technical Institute

Chicago • Toronto

Accredited Member of National Home Study Council



SEND FOR FREE BOOKLETS

DeVRY TECHNICAL INSTITUTE

4141 Belmont Ave., Chicago 41, Ill., Dept. RE-2-U

Please give me your two free booklets, "Pocket Guide to Real Earnings" and "Electronics in Space Travel"; also include details on how to prepare for

a career in Electronics. I am interested in the following opportunity fields (check one or more):

- | | |
|------------------------------------------------------|-------------------------------------------------|
| <input type="checkbox"/> Space & Missile Electronics | <input type="checkbox"/> Communications |
| <input type="checkbox"/> Television and Radio | <input type="checkbox"/> Computers |
| <input type="checkbox"/> Microwaves | <input type="checkbox"/> Broadcasting |
| <input type="checkbox"/> Radar | <input type="checkbox"/> Industrial Electronics |
| <input type="checkbox"/> Automation Electronics | <input type="checkbox"/> Electronic Control |

Name _____ Age _____

Address _____ Apt. _____

City _____ Zone _____ State _____

Check here if you are under 16 years of age.

Canadian residents: Write DeVry Tech of Canada, Ltd.
970 Lawrence Avenue West, Toronto 19, Ontario

2086

NOW! CASTLE OFFERS YOU THE BIGGEST BARGAIN IN TV TUNER OVERHAULING!

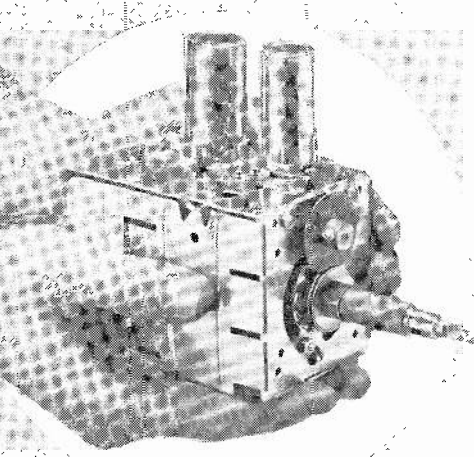

**ALL MAKES
ALL LABOR
AND PARTS
(EXCEPT TUBES)*
ONE PRICE**

9.95

ONE LOW PRICE INCLUDES ALL UHF,
VHF AND UV COMBINATION* TUNERS

In a decade of experience overhauling TV Tuners of ALL MAKES, Castle has developed new handling and overhauling techniques which give you . . .

Fast Service

A recent study at our Chicago Plant revealed that of all tuners accepted for overhauling, over 30% were completed and shipped within . . .
Seven Hours...all others within 24 Hours.

Simply send us your defective tuner complete; include tubes, shield cover and any damaged parts with model number and complaint. 90-Day Warranty.

Exact Replacements are available for tuners unfit for overhaul. As low as \$12.95 exchange. (Replacements are new or rebuilt.)

*UV combination tuner must be of one piece construction. Separate UHF and VHF tuners must be dismantled and the defective unit only sent in.

Pioneers in TV Tuner Overhauling

CASTLE

TV TUNER SERVICE, INC.

5715 N. Western Ave., Chicago 45, Illinois
653 Palisade Blvd., Cliffside Park, N. J.
Canada: 136 Main St., Toronto 13, Ontario

*Major Parts are additional in Canada

of laser oscillation within a 1,500 mc range centered at 473,000 gigacycles. To tune the laser over this frequency range, one of the end mirrors must move less than 12-millionths of an inch.

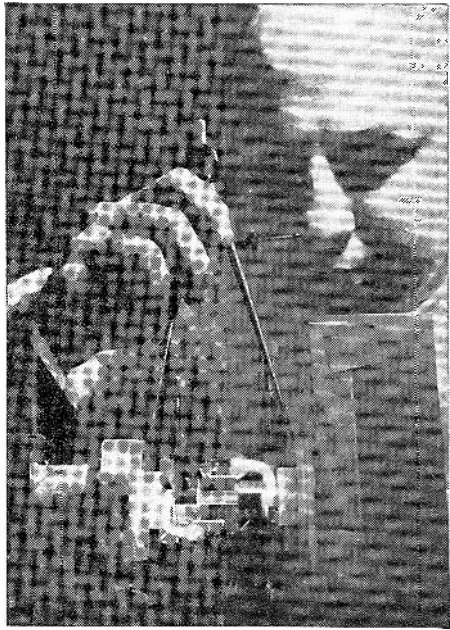

Dr. Eugene I. Gordon demonstrates the new laser. Spacing between end mirrors shown by dividers is 4 inches; length of active discharge tube is 2 inches. The mirror at Dr. Gordon's right is attached to a piezoelectric crystal. A voltage applied to the crystal changes its length, moves the mirror slightly, tuning the laser.

To increase laser gain so that the very short lasers could be made to oscillate, the helium 4 gas used in earlier lasers was replaced with the lighter helium 3 isotope, and the diameter of the laser discharge tube was reduced to 1 mm.

Mysterious Marine Sounds Traced Back to Whales

Ten years ago, Bell Laboratory oceanographers detected underwater sounds at 20 cycles or less, so strong as to rise 30 or 40 decibels above the level of background noise. These sub-sonic pulses, heard in pairs at the rate of about 3 a minute, moved about randomly at speeds varying between 2 and 8 knots.

Recent observations with hydrophones lead some scientists to believe that they may be the heartbeats of whales. According to Dr. Richard A. Walker of Bell Laboratories, the blue whale has a heart which weighs 1/2 ton, pumps 8 tons of blood and develops a useful output of about 10 horsepower. Such a heart could produce the powerful acoustical pulse that has puzzled the oceanographers.

Walker believes the sound may occur only when the whale's mouth is open to scoop up the tiny marine

animals on which it lives. When its mouth is closed, its tons of flesh muffle the heartbeat.

Trucking Company Saves With Mobile Radio

Savings of as much as 70% in driver-to-office communication expenses have been reported by trucking companies after installing two-way radios, according to Outercom Electronics Corp., manufacturers of mobile radio equipment.

According to one trucking company, a telephone call by a driver used to occupy an average of 12 minutes, much of which was spent parking the vehicle. Four drivers earning \$2.90 per hour and making only 3 calls per day each, would cost the company \$174 per month. To this must be added the actual cost of the calls and the extra mileage added driving to the nearest telephone. These expenses totaled \$312 monthly.

Installing mobile radios saved \$222 of that and added the extra profits from deliveries made in the time during which the trucks would otherwise be tied up making phone calls.

CALENDAR OF EVENTS

- Annual Computer Applications Symposium, Jan. 30-31; LaSalle Hotel, Chicago.
- International Exhibition of Electronic Components, Feb. 7-12; Porte de Versailles, Paris, France.
- International High Fidelity Show, Mar. 12-19; Paris, France.
- Los Angeles High Fidelity Music Show, Mar. 10-15; Ambassador Hotel, Los Angeles, Calif.
- IEEE International Convention, Mar. 23-26; Coliseum & N.Y. Hilton Hotel, New York, N.Y.

World's First Computer Becomes An Antique

UNIVAC I, Serial No. 1, which went into operation for the Bureau of the Census in March 1951, has been retired and presented to the Smithsonian Institution.

UNIVAC I was developed by J. Presper Eckert and Dr. J. W. Mauchly of the University of Pennsylvania, following work they had done with electronic devices to compute trajectories of artillery missiles during World War II. The Eckert-Mauchly Co. had affiliated with Remington Rand before UNIVAC was completed.

The computer was operated first in the Remington Rand plant in Philadelphia, processing data from the 1950 census. In 1952 it was transferred to the Census building at Suitland, Md., from which date it operated practically continuously 24 hours a day, 7 days a week until its final run.

Electronics Editor Dies; Worked on Radio News

G. C. Baxter Rowe, who was associated with Gernsback Publications

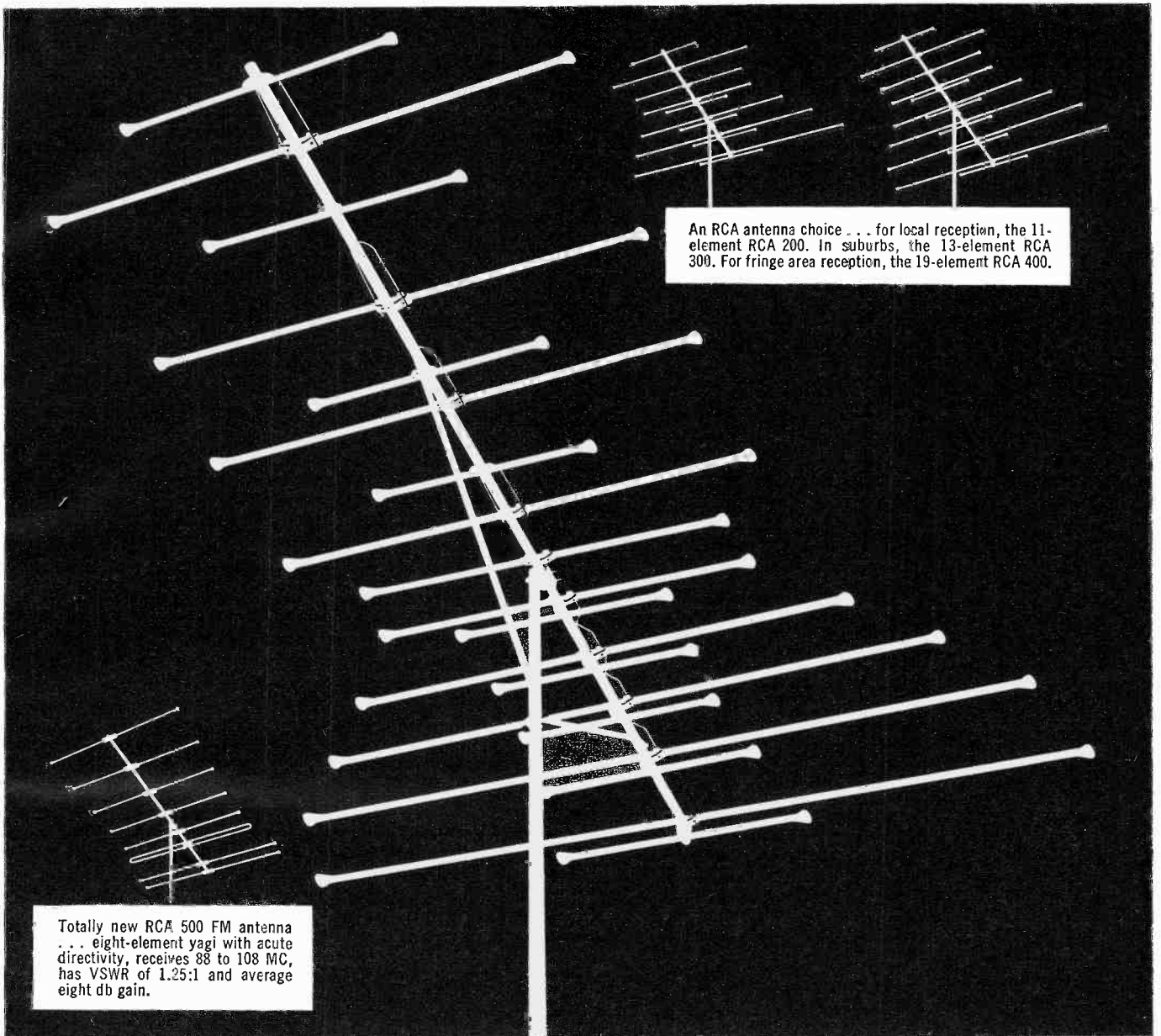

An RCA antenna choice . . . for local reception, the 11-element RCA 200. In suburbs, the 13-element RCA 300. For fringe area reception, the 19-element RCA 400.

Totally new RCA 500 FM antenna . . . eight-element yagi with acute directivity, receives 88 to 108 MC, has VSWR of 1.25:1 and average eight db gain.

RCA...Pioneer and developer of Color TV... Announces a new concept in outdoor antennas

Now the most trusted name in color TV brings you and your customers a whole new outdoor antenna line packed with top-value features. RCA puts together in a single line the best of all-channel yagi and multiple cross-driven element antenna types. You'll satisfy every customer's demand for sharpest color or black-and-white TV reception with this new RCA Series 200, 300 and 400 antennas.

RCA's electro-lens director system absorbs maximum incoming signal power, gives extremely high gain across

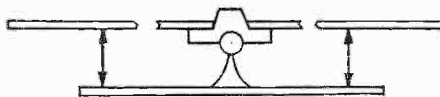

CAPACITIVELY COUPLED

the VHF band, offers excellent forward gain on the front end.

In addition to phasing low and high band directors for best high band performance, RCA and only RCA positions high band driven elements, *directly below* low band driven elements.

Through capacitance thus existing, RCA antennas feed energy *directly* into the transmission line from high band driven elements. An RCA exclusive!

A permanent gold *anodized* finish defends every RCA antenna's glossy finish from weather corrosion. Wrap-around mast clamp aligns antenna on mast, prevents boom crushing.

Just call your RCA Victor distributor. He'll tell you and show you all about new RCA 200, 300, 400 antennas—and that's *plenty!* Call now—sell soon!



THE MOST TRUSTED NAME IN ELECTRONICS

RCA PARTS AND ACCESSORIES, CAMDEN, N. J.



**First
to deliver
uniform,
peak
performance
on all UHF
channels**

BLONDER-TONGUE GOLDEN DART

- Unique use of Log Periodic principle.
- Polar pattern & 10 db gain uniform across entire UHF spectrum—for sharp, ghost-free pictures.
- Full bandwidth, flat response ($\pm 1/2$ db) on all channels—excellent for black & white and color TV.
- Completely pre-assembled—nothing to snap-out, no screws to tighten—mounts to mast in seconds.
- Smallest, most compact of all UHF antennas (17" long by 2 1/2" deep)—easy to piggyback with any VHF antenna.
- Rugged unitized welded construction—no movable joints.
- For deep fringe area reception, stack two Darts with sturdy, easy-to-use stacking bars.
- Supported by intensive advertising program.

Now you can offer a complete UHF installation—antenna, UHF converter or TV booster (if needed)—from the leader in UHF.

Get details on the exciting new Blonder-Tongue UHF Dart today.

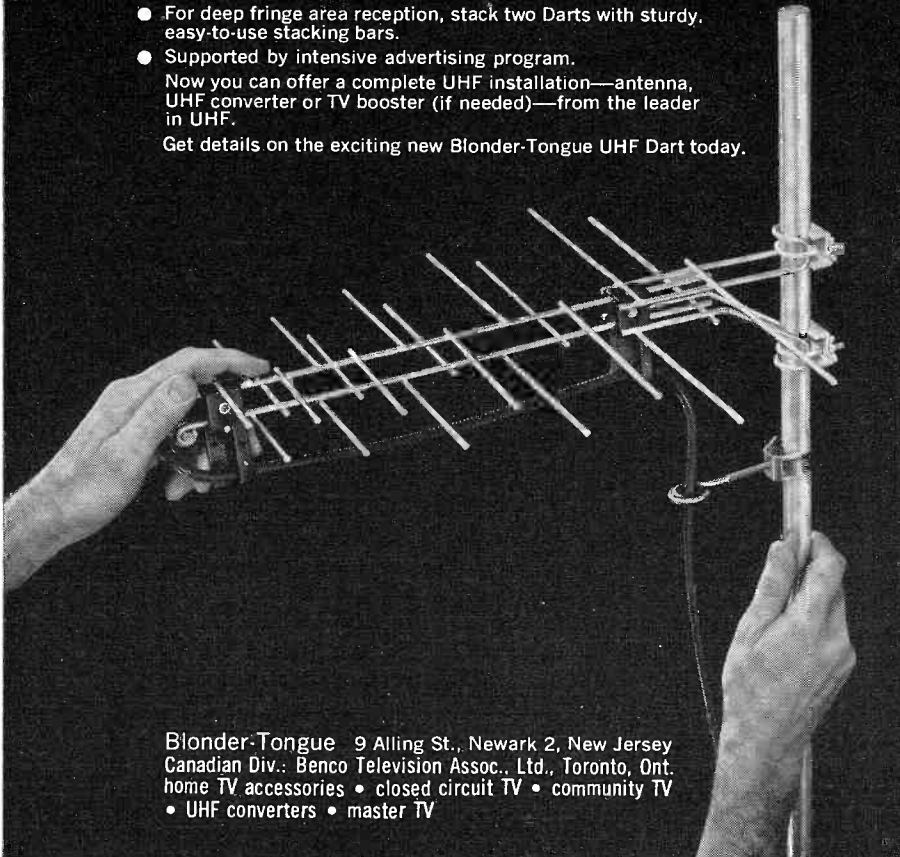

Blonder-Tongue 9 Alling St., Newark 2, New Jersey
Canadian Div.: Benco Television Assoc., Ltd., Toronto, Ont.
home TV accessories • closed circuit TV • community TV
• UHF converters • master TV

in the '20's, died in Port Chester, N.Y., at the age of 66. During the period with Gernsback, he was associate editor on *Radio News*. Later, he was an editor with the firm of John F. Rider, and from 1949 till his retirement in 1962, was associate editor of *Electrical Engineering*, the magazine of the American Institute of Electrical Engineers.

**Europe Heard
on Broadcast Band**

Low sunspot activity has made trans-Atlantic broadcast-band dx again possible this winter. Among European stations heard in the New York area in December were Monte Carlo on 1466 and Rome 1 on 845 kc. Best reception time was from 1 to 2 am EST, although reception was also possible sometimes around 5 pm. Most stations sign off at 6 or 7 pm but Rome and several others operate 24 hours a day.

European broadcasters in the 150–260-kc long-wave band have also been received. Best heard station is Paris on 164 kc, which operates on a 24-hour schedule.

Trans-Atlantic dx in these bands should be possible till late February and again next fall and winter. A very selective receiver is necessary.

The *World Radio Handbook* lists European broadcasters and their schedules.

**GI's Get Commands Via
New Lightweight Radio**

A new signal system devised by the Army Electronics Research & Development Laboratories in Fort Monmouth, N.J., will make it possible to



Sgt. First Class Taro R. Shimomura, of Honolulu, speaking into the 15-ounce transmitter, while wearing the army's new small receiver on his helmet.

supply receivers to every infantryman in certain combat groups. Transmitters would be supplied to the sergeants, who would thereby be able to keep in touch with their squads, even

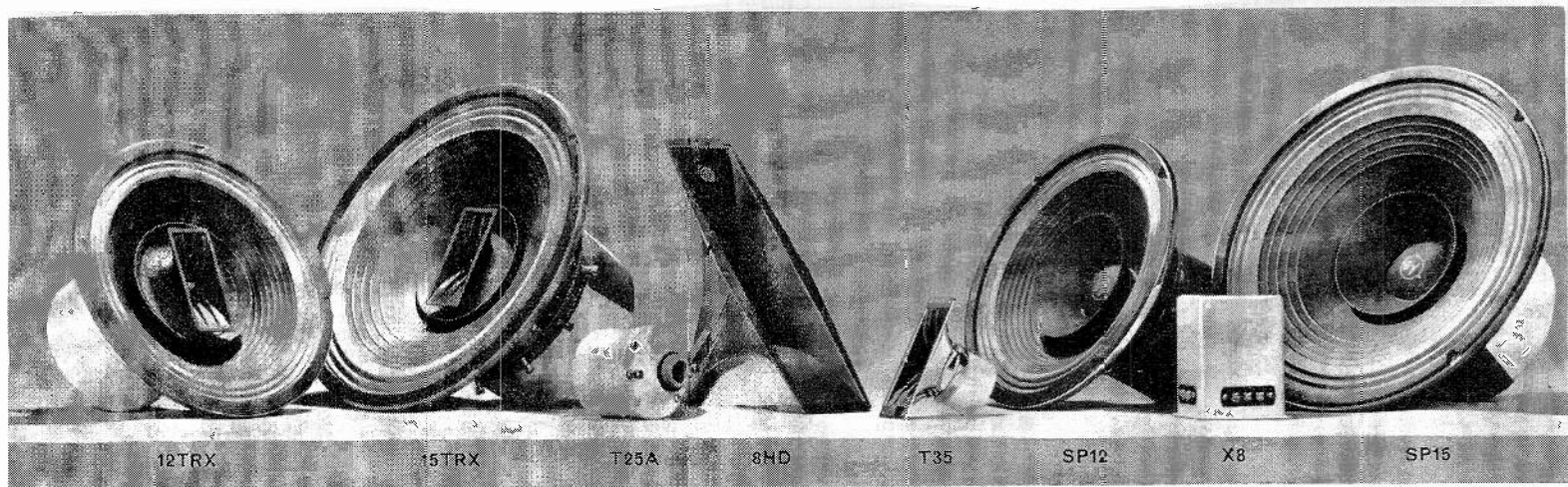

A Return to the Fundamental Concept of High Fidelity: SOUND OF UNCOMPROMISING QUALITY!

Before you make the final choice of speakers for your high fidelity system, take a moment to review your goals. What comes first—size, cost, or performance? If performance is of prime importance, then you owe it to yourself to look at—and listen to—Electro-Voice Deluxe component speakers. Granted, they are not the smallest or the least expensive speakers you can buy, but their design is predicated on the need for quality reproduction above all other considerations.

Your ear is the final arbiter of speaker system quality, but it may help you to know what's behind the unequalled popularity of E-V in the component speaker field. It begins with the finest engineering laboratory in the industry, finest not only in equipment, but also in the size of its staff and in its creative approach to electro-acoustics.

The basic design for E-V Deluxe components was laid down over a decade ago, and, despite numerous detail improvements, this approach is just as valid today. It begins on a firm foundation: the rigid die-cast frame that provides a stable basis on which this precision instrument can be assembled. It is this frame that assures that each E-V Deluxe speaker will forever maintain its high standard of performance by maintaining perfect alignment of all moving parts.

Added to this is a magnetic assembly of generous proportions that provides the "muscle" needed for effortless reproduction of every range at every sound level. In the case of the SP15, for example, four pounds, ten ounces of modern ceramic magnet (mounted in an efficient magnetic assembly weighing even more) provides the force needed for perfect damping of the 15-inch cone.

Within the gap of this magnetic system rides the unique E-V machine-wound

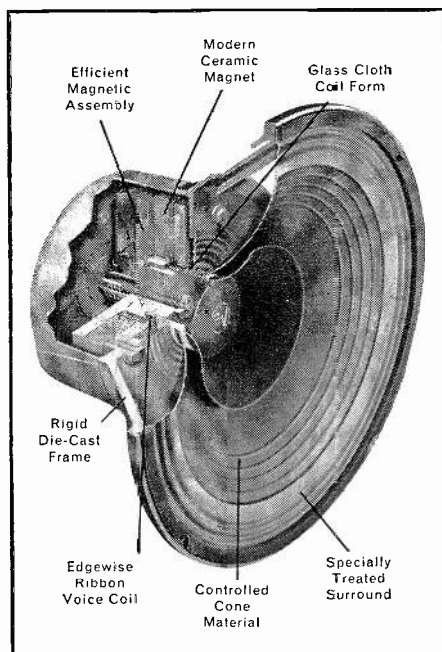

edgewise-ribbon voice coil. This unusual structure adds up to 18% more sensitivity than conventional designs. Production tolerances on this coil and gap are held to $\pm .001$ inch! The voice coil is wound on a form of polyester-impregnated glass cloth, chosen because it will not fatigue like aluminum and will not dry out (or pick up excess moisture) like paper. In addition, the entire voice coil assembly can be made unusually light and rigid for extended high frequency response.

In like manner, the cone material for E-V Deluxe components is chosen carefully, and every specification rigidly maintained with a battery of quality control tests from raw material to finished speaker. A specially-treated "surround" supports the moving system accurately for predictably low resonance, year after year, without danger of eventual fatigue. There's no breaking-in or breaking down!

Now listen—not to the speaker, but to the music—as you put an E-V Deluxe component speaker through its paces. Note that bass notes are neither mushy nor missing. They are heard full strength, yet in proper perspective, because of the optimum damping inherent in the E-V heavy-magnet design.

And whether listening to 12-inch or 15-inch, full-range or three-way models, you'll hear mid-range and high frequency response exactly matched to outstanding bass characteristics. In short, the sound of every E-V Deluxe component speaker is uniquely musical in character.

The full potential of E-V Deluxe component speakers can be realized within remarkably small enclosure dimensions due to their low-resonance design. With ingenuity almost any wall or closet can become a likely spot to mount an E-V Deluxe speaker. Unused space such as a stairwell can be converted to an ideal enclosure. Or you may create custom cabinetry that makes a unique contribution to your decor while housing these remarkable instruments. The point is, the choice is up to you.

With E-V Deluxe component speakers you can fit superlative sound to available space, while still observing reasonable budget limits. For example, a full-range speaker such as the 12-inch SP12 can be the initial investment in a system that eventually includes a T25A/8HD mid-range assembly, and a T35 very-high-frequency driver. Thus the cost can range from \$70.00 up to \$220.00, as you prefer—and every cent goes for pure performance!

Write today for your free Electro-Voice high fidelity catalog and list of the E-V audio specialists nearest you. They will be happy to show you how E-V Deluxe component speakers fulfill the fundamental concept of high fidelity with sound of uncompromising quality!

ELECTRO-VOICE, INC.

Dept. 244E, Buchanan, Michigan

Electro-Voice[®]
SETTING NEW STANDARDS IN SOUND

WHY bother with makeshift twist-prong capacitor replacements?

When you substitute capacitor sizes and ratings, you leave yourself wide open for criticism of your work . . . you risk your reputation . . . you stand to lose customers. It just doesn't pay to use makeshifts when it's so easy to get the exact replacement from your Sprague distributor!

Get the right SIZE,
right RATING every time
with improved

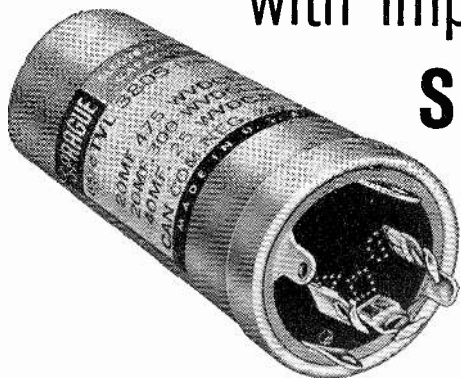

SPRAGUE TWIST-LOK® CAPACITORS!

Over 1,690 different capacitors to choose from!

The industry's most complete selection of twist-prong capacitors, bar none. Greater reliability, too. Exclusive Sprague cover design provides a leak-proof seal which permits capacitors to withstand higher ripple currents.

GET YOUR COPY of Sprague's comprehensive Electrolytic Capacitor Replacement Manual K-106 from your Sprague Distributor, or write Sprague Products Co., 81 Marshall Street, North Adams, Mass.



WORLD'S LARGEST MANUFACTURER OF CAPACITORS

66-126-63

though the men were widely scattered.

The receivers weigh 9 ounces, and the transmitter 15 ounces. The 9-ounce receiver has 13 transistors and 7 diodes together with batteries good for 24 hours.

With the receiver clipped on his helmet or in his pocket, each member of the squad, even though in a relatively remote location, can be as closely in touch with the leader as in the past, when it was often necessary to remain so close that a single enemy shell could wipe out an entire squad.

Rise In Engineering PhD's And MS's While BS's Decrease

The number of doctor's and master's degrees in engineering continues to increase, as it has been doing for the past 6 years, but the number of bachelor's degrees continues to decline.

A report released by the US Office of Education and announced jointly by the American Society for Engineering Education and the Engineering Manpower Commission of the Engineers Joint Council, stated that during the past 6 years engineering doctorates increased in number at least three times as fast as the total number of doctorates in all of the major academic fields.

Degrees have increased on the master's level also, at twice the rate of increase for the total number of master's degrees awarded in the US.

Bachelor's degrees, however, continue to decline in number, but preliminary figures indicate that the total engineering enrollment rose slightly this fall. Thus, a reversal of this trend is hoped for.

New Phone Cable Links Canada, South Pacific

A 9,400-mile, 72.8-million-dollar trans-Pacific telephone cable linking Canada with British dominions in the Pacific was opened early in December 1963.

The new route, the first telephone cable to be laid across the Pacific, includes more than 300 deep-sea repeaters, laid in depths up to 3 miles, to amplify the signal as it travels. Besides the telephone circuits, the new cable (known as COMPAC) includes facilities for telegraph, telex and phototelegraph services, as well as a music circuit capable of carrying broadcast programs.

It provides for 76 two-way speech channels (80 later), any one of which could be used for 22 teleprinter channels. The route of the line is from Vancouver to Keawaula,

YOUR FIRST CLASS COMMERCIAL F.C.C. LICENSE

Your Ticket To A Better Paying Job And Greater Job Security

We train you — prepare you to pass the FCC exam for your first class FCC license. The leading course of its kind, Grantham FCC License Preparation is available in resident classes in Los Angeles, Calif.; South Gate, Calif.; Seattle, Wash.; Kansas City, Mo.; and Washington, D.C. Or, if you prefer, our specialized training is available *in your own home* from our Home Study Department, Kansas City, Mo. Regardless of where or how you study with Grantham, you are taught *right* and prepared *quickly* for your first class FCC license.

Grantham Students Get Their Licenses

Following is a list of a few of the many students who have completed our FCC license preparation recently and obtained their *first class* FCC licenses:

Edwin Keister, 1201 Dennis Ave., Silver Spring, Md.
 Herbert Braswell, 416 E. Bellefonte Ave., Alexandria, Va.
 Floyd R. Henderson, 3219 Andrita St., Los Angeles, Calif.
 Gerald D. Herbert, Route 6, Bloomfield, Iowa
 William Seymour, 6924 - 32nd St., N.W. Washington, D.C.
 Nelson H. Crumling, 92 N. Second St., Mt. Wolf, Pa.
 Irvin Griffin, 2421 W. Lexington St., Baltimore, Md.
 Denis Christopherson, 4402 Waite Lane, Madison, Wis.
 David H. Klempel, Lambert, Montana
 Armand E. Pinard, P.O. Box 3193, Washington, D.C.
 Wayne A. Taylor, 4111 Nicholson St., Hyattsville, Md.
 William I. Brink, 12 Meade Ave., Babylon, L.I., N.Y.
 John Ponchock, Box 88, Coupon, Pa.
 John A. Cork, 3535 N. Utah, Arlington, Va.
 Charles Bartchy, 1222 S. Park Ave., Canton, Ohio
 Gene M. Walker, 1400 S. Wilcox Ave., Monterey Park, Calif.
 David Kaus, 5218 Canterbury Way S.E., Washington, D.C.
 Wm. S. Bullock, P.O. Box 1133, Atlantic City, N.J.
 James W. Logan, 464 DeLeon Dr., Miami Springs, Fla.
 Emory R. Valla, Box 616, Imperial, Pa.

Hall Blankenship, Route 2, Rockwood, Tenn.
 Charles D. Summers, 451 Hillcrest Dr., Statesville, N.C.
 William H. Ames, CMR 2, Box 2112, Travis AFB, Calif.
 Alexander Mikalaski, 4510 Rattenhouse St., Riverdale, Md.
 Wayne F. Murphy, 317 Jefferson St., Roanoke Rapids, N.C.
 Ralph Munday, 417 W. Pecan, Rogers, Ark.
 John L. Marlow, Box 384, Umatilla, Ore.
 Allen Lee Park, 3024 S. Buchanan St., Arlington, Va.
 Clarence E. Daly, 517 N. Allendale St., Baltimore, Md.
 John M. Quickel, Jr., 1418 Saratoga Ave., N.E., Washington, D.C.
 Garland Hadley, 205 E. Washington St., Shepherdstown, W. Va.
 George L. Heable, 214 N. Main St., Attica, Ohio
 Robert J. Maickel, 520 Market St., Havre De Grace, Md.
 Harold F. DeBruin, 1621 N. Morrison St., Appleton, Wisc.
 James Lee Winde, 805 Princeton Rd., Wilmington, Del.
 Thomas J. Bailey, 1005 Penn St., Hollidaysburg, Pa.
 Charles G. Suit, 8016 - 14th Ave., Hyattsville, Md.
 James R. Reese, Jr., Station WCFV, Clifton Forge, Va.
 Charles Deitzel, 342 Walnut St., Columbia, Pa.
 Norman Tilley, Jr., 8613 Piney Branch, Silver Spring, Md.
 Guy C. Dempsey, 1326 - 19th St., Washington, D.C.
 Earl J. Mahoney, Box 296, Newport, Vt.
 Joseph J. Hytovick, 260 Poplar St., Dickson City, Pa.
 Charles H. Hayden, 2607 Kirkwood Pl., Hyattsville, Md.
 James D. Neidermyer, R.D. 1, Leola, Pa.
 John D. Borin, 5356 Franklin Ave., Hollywood, Calif.
 Arthur C. McGuire, 1510 Mahiole Pl., Honolulu, Hawaii
 Roy Coleman, 769 Yale Ave., Baltimore, Md.
 Daniel F. Fountain, 710 Chrysler St., Kalamazoo, Mich.

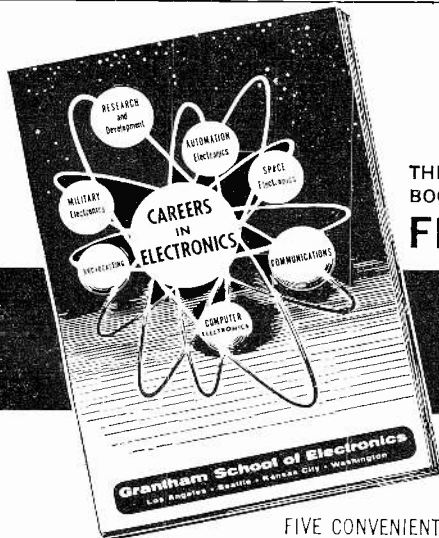

THIS 44 PAGE
 BOOKLET
FREE!

Our free, 44-page booklet, "Careers in Electronics," contains full details on how Grantham training can prepare you for your first class FCC license and for a successful electronics career. For your free copy, complete the coupon below and mail it to our National Headquarters Office (address in coupon), or write or telephone one of our teaching divisions which appear to the left. You'll be glad you did!



GRANTHAM
 SCHOOL OF ELECTRONICS



mail in envelope or paste on postal card

To: **GRANTHAM SCHOOL OF ELECTRONICS**

NATIONAL HEADQUARTERS OFFICE

1505 N. WESTERN AVE., LOS ANGELES, CALIF., 90027

Please send me your FREE 44 page booklet telling how I can get my commercial F.C.C. license quickly and can continue into advanced electronics if I wish. I understand there is no obligation and no salesman will call.

Name _____ Age _____
 (PLEASE PRINT)

Address _____

City _____

State _____

I AM INTERESTED IN: HOME STUDY RESIDENT CLASSES 44-B

FIVE CONVENIENT TRAINING DIVISIONS:

LOS ANGELES Division 1505 N. Western Ave., Los Angeles, Calif., 90027	HO 7-7727
SOUTH GATE Division 9320 Long Beach Blvd., South Gate, Calif., 90280	564-3421
SEATTLE Division 408 Marion Street, Seattle, Wash., 98104	MA 2-7227
KANSAS CITY Division 3123 Gilham Rd., Kansas City, Mo., 64109	JE 1-6320
WASHINGTON Division 821-19th Street, NW, Washington, D.C., 20006	ST 3-3614

New Sonotone Sono-Flex® Stylus

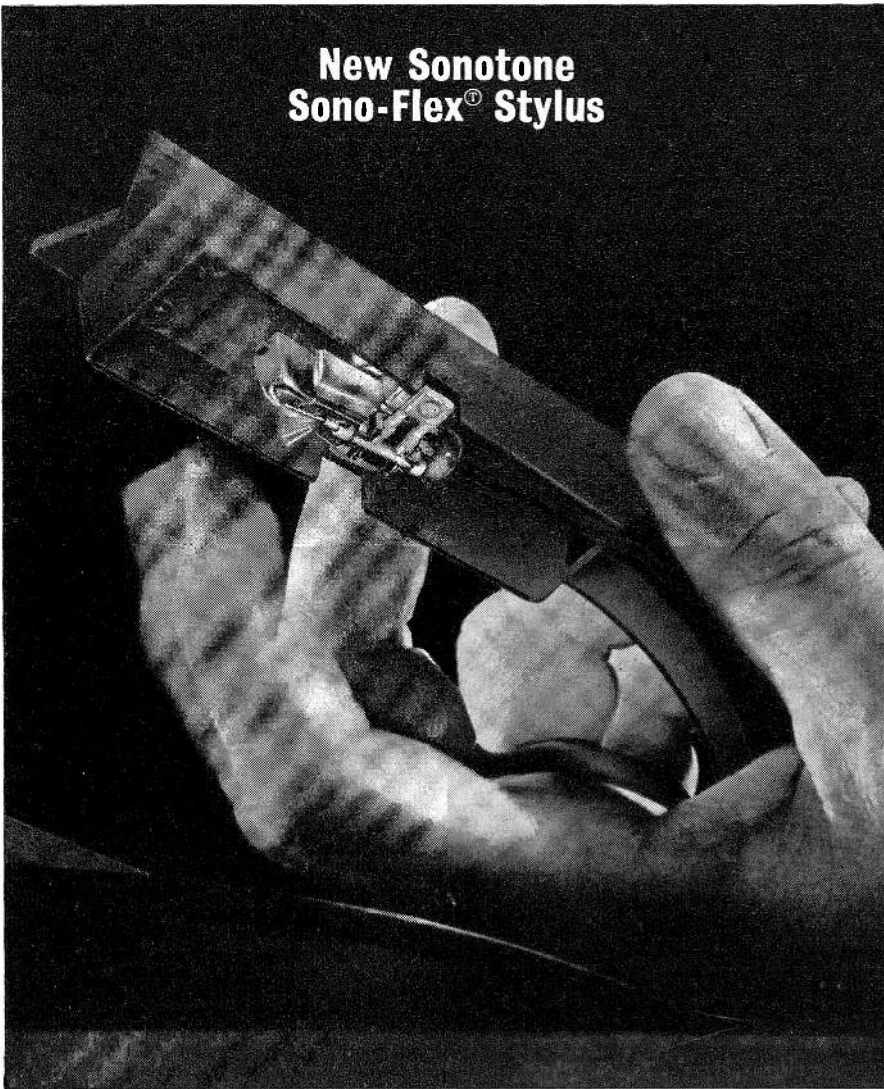

try this with any other cartridge
(at your own risk)

No way to treat a cartridge, for sure—That is, any cartridge except the Sonotone models featuring the new Sono-Flex® needle. No more bent or broken needle shanks caused by flicking off some lint, dropping the arm, or scraping it across the record.

The newly developed Sonotone Sono-Flex® needle to the rescue! Gripped in a resilient butyl rubber mount, you can flex this needle shank in a 360-degree orbit without breaking. Pluck it—flick it—bend it—bump it—it will continue to perform as good as new.

Moreover, the Sono-Flex brings advantages in performance never before offered by any replacement cartridge: Higher compliance, wider and flatter frequency response, lower IM distortion, and longer needle and record life.

Sonotone Sono-Flex® increases your profits two ways

□ Sonotone cartridges are better than ever, easier to sell, because they're better performers. Further, you eliminate callbacks because of broken needle shanks. Sono-Flex needles are standard right now in these Sonotone cartridges models: 9TAF, 16TAF, 916TAF and the Velocitone Mark IV.

□ Sono-Flex opens up lucrative needle replacement business for upgrading these Sonotone cartridges models: 9T, 9TA, 9TV, 9TAV, 16T, 16TA, 16TAF and 916TA, original equipment in over a million phonographs. Replacement is fast, simple—requires no tools—assembly snaps into position easily, and gives immediate proof of better performance plus abuse-proof, longer needle life.

See your distributor today and ask for Sonotone cartridges with the Sono-Flex® needle.

SONOTONE CORPORATION Electronic Applications Division Elmsford, New York
In Canada: **Atlas Radio Corp., Ltd., Toronto** • cartridges • speakers • batteries
• microphones • hearing aids • headphones

Hawaii (thus including the US), and then to Suva, Auckland and Sydney, Australia.

With the Atlantic link, laid in 1961, operators in London will be able to dial directly into the inland phone system of Australia, and eventually into Montreal, Vancouver and Auckland, as automatic exchanges are set up.

Acoustics of Large Halls Simulated by Ultrasonics

Program material recorded on tape and played back at 10 times its normal speed through ultrasonic equipment makes it possible to build models of concert halls one-tenth size and modify them for the best acoustics. The method was devised by Professor Spandock of Technological University in Munich, Germany.

A similar system, using water and ordinary soundwaves, has been used before, but since sound travels only five times as fast in water as in air, the models could not be scaled down as far as these new ones can.

Alaskan Court Stenos Are All-Electronic

Tape recorders are taking over from the ancient court stenographer in several Alaskan courts, reports Soundscribe Corp., manufacturer of special "tamper-proof" recording equipment.

The Alaskan system uses five microphones, one each for the judge, the clerk, the witness and each attorney. The mikes are monitored so that all are taped at the same level. A written record can be typed off by a typist. This eliminates the necessity for a highly skilled court reporter, and also eliminates the possibility of mistake or misinterpretation by the reporter. If there is any doubt about what was said, the original record can be played again.

Alaskan officials believe that the system saves nearly \$250,000 annually and cuts appeal time by 75%.

Brief Briefs

"Whistlers," those low-frequency noises produced by thunderstorms and traveling along the earth's magnetic lines of force, can produce variations in the strength of very low frequency (vlf) radio signals.

This discovery was made by Michael Trimpi of Stanford U. at a vlf Research Station in Antarctica.

Beginning April 19, 1964, the Restricted Radiotelephone Operator permit, now valid for limited operation of certain standard and FM broadcast stations, will no longer be valid. Limited operators will have to hold, as a minimum, a Third-Class Radiotelephone Operator permit, endorsed for broadcast operation. **END**

Tips for Technicians

Mallory Distributor Products Company
P.O. Box 1558, Indianapolis 6, Indiana
a division of P. R. Mallory & Co. Inc.

Choosing and using audio attenuators

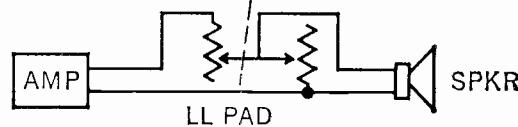
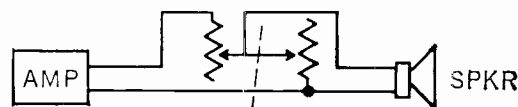
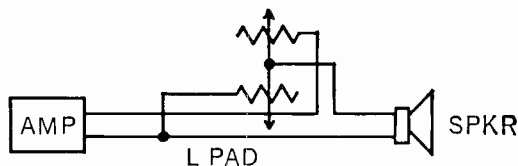
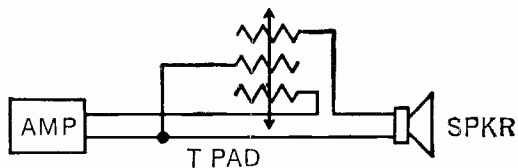
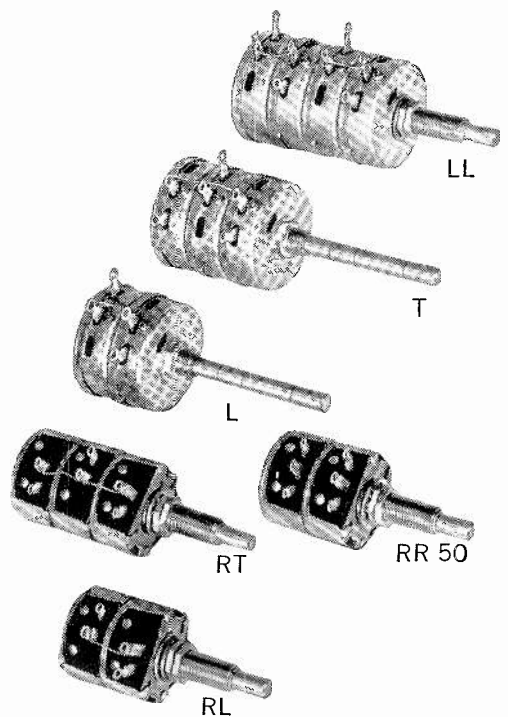

Ever notice that a hi-fi rig sounds *best* about mid-range on the level (volume) control? Man, those drums, fifes, bugles and train whistles sound GREAT! But, oh, those grouchy neighbors. Somehow they fail to appreciate three or four solid hours of this "pure" sound.

Fear not! There's a simple way to keep true hi-fi sound as well as your neighbors. All you need is an audio attenuator (a fancy name for audio control). There are two basic types of audio attenuators: T pads and L pads.

If yours is the *ultimate* in hi-fi rigs you need a T pad. It maintains a constant impedance between the amplifier and the speaker. You simply turn the amplifier up to optimum performance (somewhere around mid-range) (pretty doggone loud) and control *listening* level with the T pad. The "fi" is very "hi" but the level is reasonable and so are the neighbors.

Not all of us can afford the "ultimate". Budgets being what they are, we make a few compromises. Not that our hi-fi doesn't sound great—it does. It's just that it won't break the picture window. We may be able to get by with an L pad. This presents a constant impedance only to the amplifier. Strangely enough, an L pad often seems to *improve* the performance of an inexpensive speaker. Try it—you'll see!

If you have stereo, try an LL pad. That's a pair of L pads with a common shaft. You can balance your rig at the amplifiers and control level at the speakers with only one knob.

How about money? Mallory T, L, and LL pads will handle an "ear-busting" 15 watts of audio power! But if yours is the usual 10 watt system you'll need only an RT or RL pad... same extreme quality—only smaller and more economical.

Speaking of economy, try the new Mallory RR 50 Stereo Control. It does a terrific job on most popular stereo outfits. Just what you need for the recreation room or patio.

The whole point of this "tip" is to let you know that your Mallory Distributor has exactly the audio attenuator you need. All kinds of values and several price ranges. He's your "one stop" source for *all* of your electronic requirements. Stop in soon.

you get **PRODUCT PLUS** from your *Sylvania Distributor*



Was your name part of this hard-sell ad in



If you took advantage of the offer, February 8th TV Guide tells every reader in your neighborhood that you are the expert on whether they should repair or replace their TV set. And a helpful free booklet titled "Fix or Buy?" is in your hands for distribution free to your customers. ■ National advertising in TV Guide, the booklet, plus a banner advertising the booklet for your store—a triple-barreled way to hit your very best prospects. ■ Specials like this are available regularly through your participating Sylvania Distributor. They show that he is sincerely concerned with raising your profits and your prestige—and so is Sylvania. ■ You can expect more than the highest-quality tubes when you deal with your Product-Plus Sylvania Distributor.

SYLVANIA
 SUBSIDIARY OF
 GENERAL TELEPHONE & ELECTRONICS

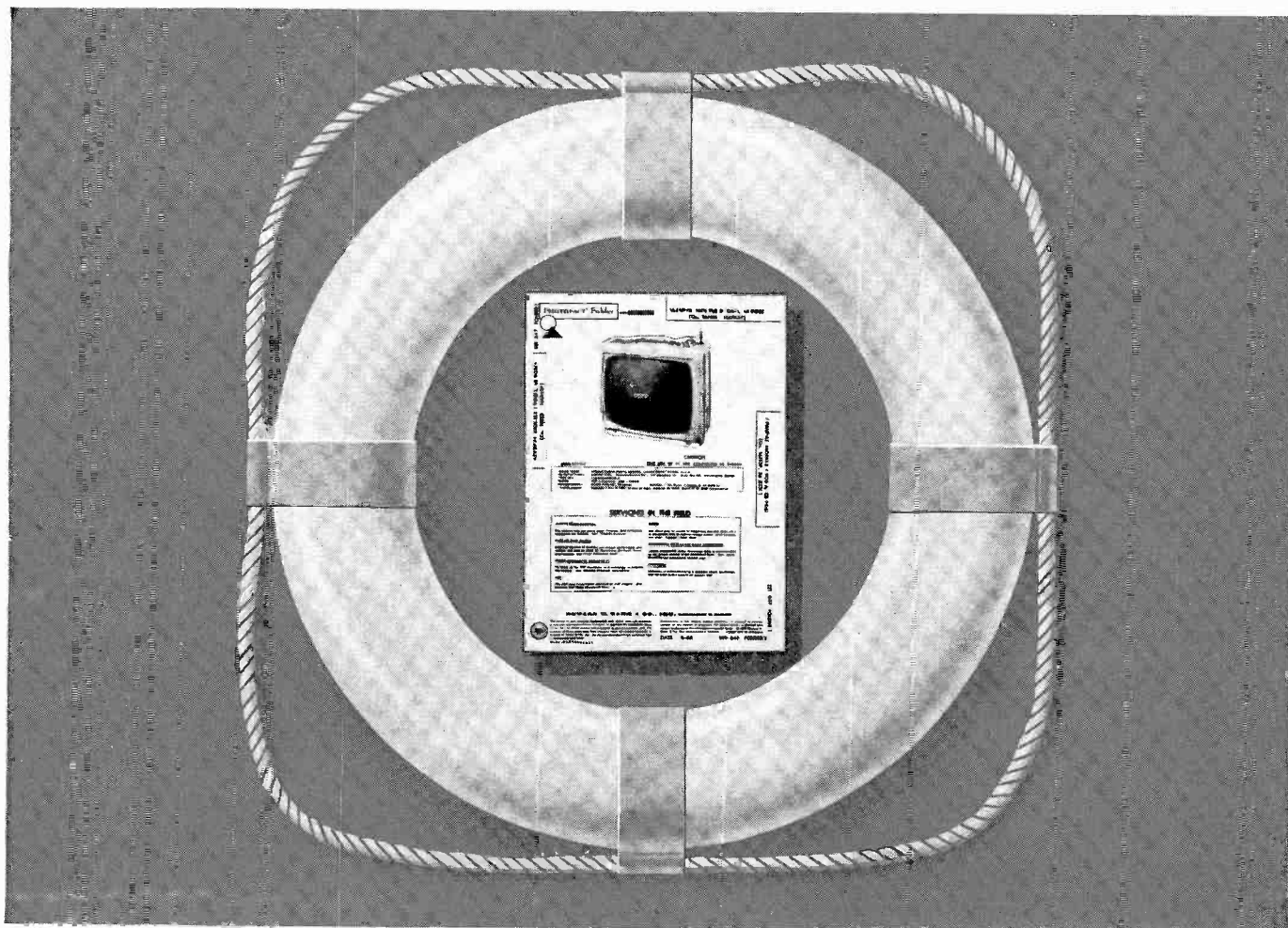

"It's a lifesaver."

We didn't say it. A lot of technicians have used these very words to describe PHOTOFACT. One particular letter (unsolicited) says it like this:

"I wouldn't think of being in business without PHOTOFACT. It's a lifesaver."

Others say they're sunk without PHOTOFACT. We don't really expect anyone to "drown" without it, but we do know it saves time and saves trouble and floundering around. We do

know it often means all the difference between making a profit and not.

There are over 40 "lifesaving" features in every PHOTOFACT Folder, time-saving features to show you the way to *fast* TV-radio troubleshooting. (Really keeps you on top of those tough-dog jobs.)

Users don't measure PHOTOFACT by its pennies-per-page cost. It's the time-saving, profit-making worth of

PHOTOFACT that counts.

Of course, you can get along without PHOTOFACT—a few do—and maybe they're making a living. But it's the hard way.

Doesn't it make good sense to see your Sams Distributor today for details on an Easy-Buy PHOTOFACT Library and Standing Order Subscription?

Or use the coupon below.

A PHOTOFACT LIBRARY PAYS ITS OWN WAY—

Now, more than ever, it pays to own PHOTOFACT—the world's finest TV-radio service data. Now, you can start or complete your PHOTOFACT Library this Easy-Buy Way:

- **FREE** with your order for 180 Sets—a deluxe 4-drawer file cabinet worth \$38.95 • **Only \$10 down** • 30 months to pay • **No interest or carrying charges** • **Prepaid transportation** • **Add-on privilege of a year's advance subscription to current PHOTOFACT on the same Easy-Buy contract** • **Save 30¢ per Set—special \$1.95 price applies on Easy-Buy (instead of the regular \$2.25 price).**

4 Ways to Select Your PHOTOFACT Library: 1. Complete your present PHOTOFACT Library. 2. Order a PHOTOFACT "Starter" Library—180 Sets (Sets 301 to 480—coverage from 1955 to 1960—only \$11.36 per month). 3. Order by brand name and year—see the handy selection chart at your Distributor. 4. Order a complete PHOTOFACT Library—get **FREE** file cabinets, *plus* a selection of invaluable books and Electronics Courses.

SEE YOUR SAM'S DISTRIBUTOR FOR FULL DETAILS, OR MAIL COUPON ▲

Howard W. Sams & Co., Inc., Dept. REF-2
4300 W. 62nd St., Indianapolis 6, Indiana

Send **FREE Photofact Cumulative Index**

Send full information on Easy-Buy Plan

Enter my Photofact Standing Order Subscription

My Distributor is _____

Shop Name _____

Attn. _____

Address _____

City _____ Zone _____ State _____

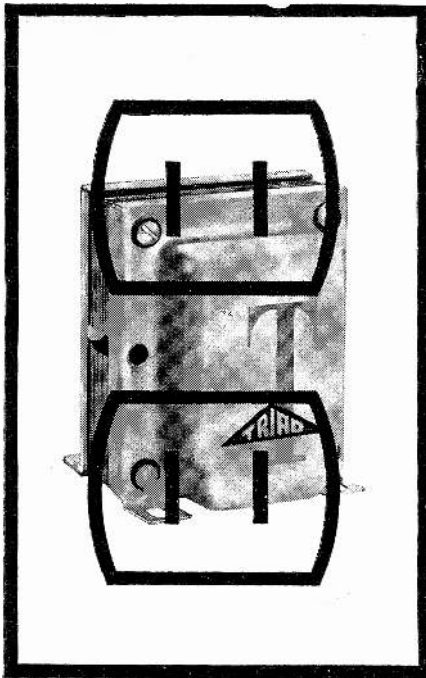

PLUG INTO HOUSE VOLTAGE ANYWHERE!

In auto, boat or plane, Triad's rugged DC-to-AC transistor power supply transformers make it possible for you to plug in a variety of handy household devices—television sets, radios, shavers, record players, dictating machines and heating pads. Two which operate with 12-volt inputs, for example, are the TY-75A which puts out 115 watts at 60 cps and the TY-76A which delivers 60 watts at 60 cps. With a little imagination and either of these units, you can quickly make mobile life far more pleasant and comfortable. Triad also makes a complete line of DC-to-DC transistor power transformers for use with 6, 12 and 28-volt battery-driven sources.

For Engineering Bulletin TY-63 and full details, including basic data, circuit diagrams, specifications and application notes, write to 305 North Briant Street, Huntington, Indiana.

T TRIAD DISTRIBUTOR DIVISION
A DIVISION OF LITTON INDUSTRIES

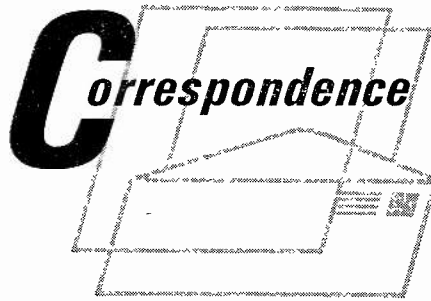

Darr's 3-Phase Problem

[We have received more than two dozen letters on the 3-phase power problem, published in the October issue. All of them feel that Darr was as buffaloes by the problem as the local "industrial technician." But only two have tried to guess what the difficulty was. The rest content themselves with pointing out that it is possible to get 230 or 115 volts single-phase, from a 3-phase line. Some of them simplify the matter by assuming a 4-wire line, or even a transformer with a secondary Y-connected.

Jack Darr is now "reconstructing the crime" with the help of the original photocell unit, and will (in an early issue, we hope) give a full report on the situation by a local electrical authority. Meanwhile, Mr. Austin's guess, below, appears to be the most reasonable solution we have received to date.—*Editor*]

Dear Editor:

Jack Darr's 3-phase problem ("What's your EQ?", October 1963) can be encountered in every detail in one—and only one—type of 3-phase distribution system. At one time, the grounded-delta circuit shown in the drawing was very common in small towns and out-

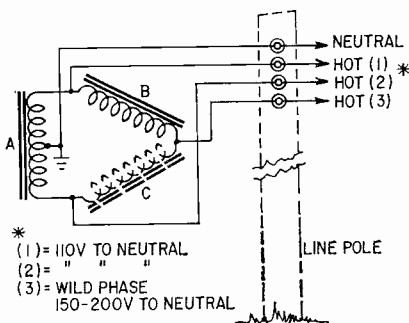

Transformer secondary connections for 220-volt, grounded-delta, "wild-phase" distribution system. Transformer A is usually much larger than B. Transformer C may or may not be present. If present, system is "closed delta"; if not, "open delta." (Primaries have been omitted for clarity.)

lying city areas where the 3-phase load was small compared to the lighting load.

It was used principally because 3-phase motors were commonly wound for 220 volts at that time, while lighting and appliances were strictly 110-volt. Because this is the only configuration that will give a 2-to-1 voltage ratio on a 3-

phase system, it was used in the interests of customer and power-company economy. It also came into play as a stopgap measure when a small customer demanded 3-phase service in an area with predominantly single-phase users.

This hookup can still be found, principally in farm towns where population and electrical load are declining, forcing power companies to make do with long-outmoded distribution systems.

Considering the speed with which Mr. Darr's "3-Phase Club" formed, perhaps it is only fair to say that his basic *problem* was technically accurate, and a situation that does occur when an inexperienced technician encounters this system. I have had to correct similar installations myself, including a few for the old hands!

Since the neutral is very rarely carried through to a 3-phase motor, the technician would probably have encountered a 3-wire line. If so, he made two basic mistakes. First, he should have tried a different phase. Second, it would be a violation of industry practice and electrical codes to pick up a current-carrying ground from the frame of the motor or a conduit. At best, it would be a noisy and erratic current path. At worst, the conduit may open up and put 110 volts on the whole frame of the motor, setting up a highly dangerous situation.

It would seem, then, that Mr. Darr's solution was the practical one, even though his explanation is technically inaccurate.

EUGENE AUSTIN

Lincoln, Neb.

A Man Who Got the Best

Dear Editor:

After reading Herman Burstein's "Get the Best from Those Ceramic Cartridges" (June, page 28), I tried his suggestions. I ran my cartridge as an "amplitude device" to the tuner input of my amplifier. I had been using it as a "velocity device" across a low-value resistor, feeding the magnetic input. It wasn't bad.

But loading the cartridge with 1,800 pf and using the tuner input gives me as good bass and better treble, with a couple of bonuses. The amplifier no longer "blocks up" on heavy signals, (Continued on page 23)

HAS THE SPACE AGE
OUTDATED
YOUR KNOWLEDGE OF
ELECTRONICS?

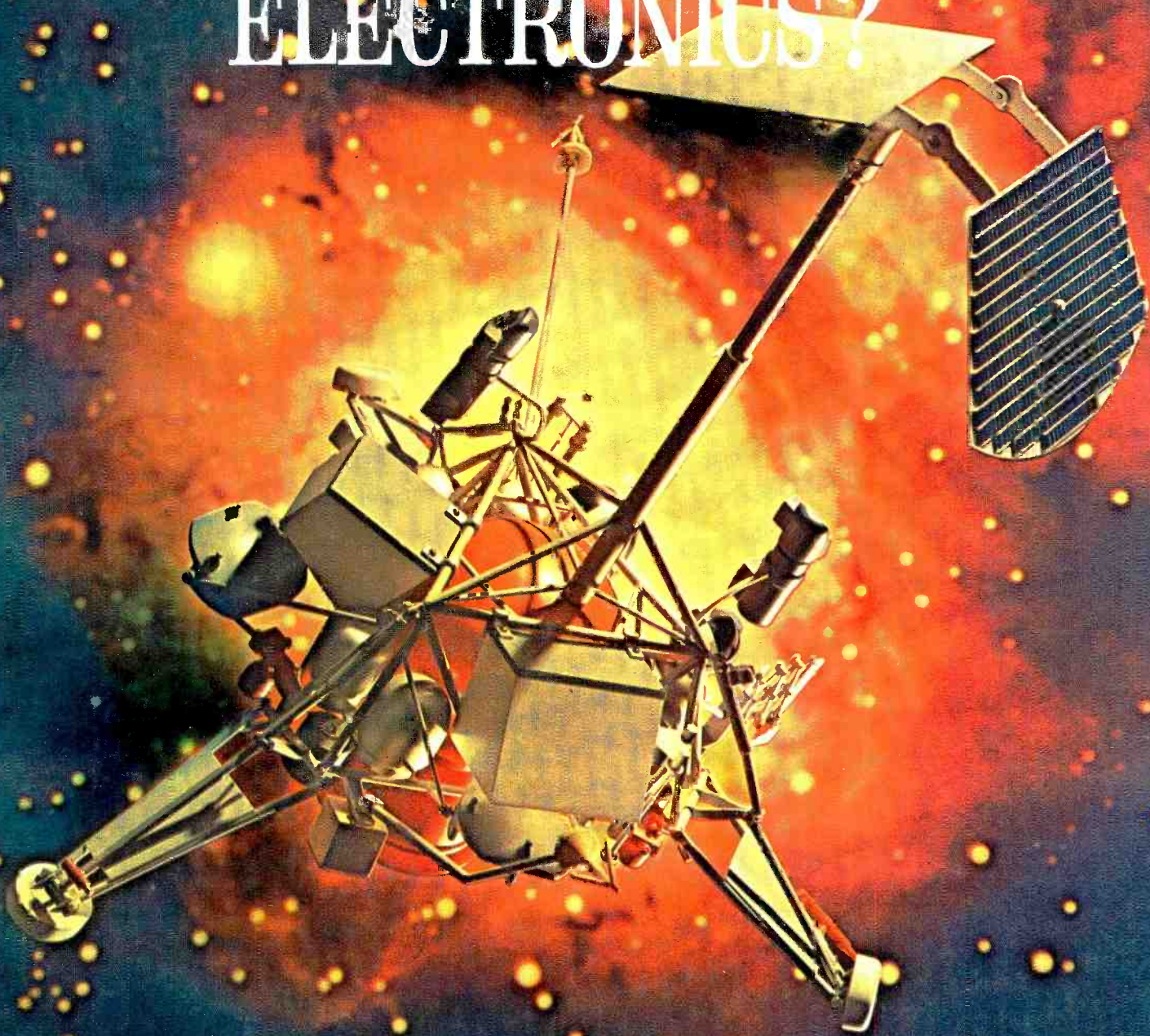

TURN PAGE FOR ANSWER **CREI** 

WHAT HAPPENS TO TRANSISTORS IN THE VAN ALLEN BELT? HOW ARE VACUUM TUBES USED IN SPACE? WHY CAN'T REGULAR LUBRICANTS BE USED ON MOVING PARTS IN A SPACECRAFT? TO WHAT EXTENT HAS THE SPACE EFFORT CHANGED RELIABILITY STANDARDS?

The answers to these questions reflect the changes taking place with space applications of electronics. For space electronics involves new and different uses of electronic principles. Conventional systems and components are frequently outdated. Technical breakthroughs come almost daily. Space electronics is as different from the electronics you know as the superheterodyne receiver is from the crystal set.

WHAT DOES THIS CHANGE MEAN TO YOU?

It means specialized knowledge of space electronics is essential for a career in this field. Nearly every major electronics organization and a good many of the smaller companies have become part of the space program. Guiding space vehicles, communicating with them through space and processing the vital information they gather demands knowledge that did not exist when you studied electronics. And this knowledge can't be acquired on the job, unless you are one of the few men privileged to work for a key space engineer or scientist.

Developments in space electronics are affecting almost every area of electronics. For instance, the same techniques used in the space program are used in electronic pack-

aging to reduce computers and television sets to a much smaller size. So knowledge of space electronics is an asset to a man in any field of electronics.

No question about it, for your career in electronics, you must supplement your present knowledge and experience with considerable new knowledge of space electronics.

CREI CAN HELP YOU PROTECT YOUR FUTURE

CREI now offers a new Home Study Program planned to help you protect your future in electronics by updating your education to space age requirements.

CREI's Program in Space Electronics enables you to study at home, on your own schedule through methods developed in CREI's 36 years of experience in technical education through home study.

Long and painstaking effort has been devoted to the preparation of this program. CREI faculty members have visited 14 government and private technical organizations in the space effort to determine exactly what knowledge of electronics they want in men they employ. Engineers and scientists from some of these organizations have been retained as consultants to supply the technical material that makes up the program.



**CREI
ANNOUNCES
A UNIQUE
HOME STUDY
PROGRAM IN
SPACE
ELECTRONIC
ENGINEERING
TECHNOLOGY**

with your choice of these specialties

SPACE DATA SYSTEMS Includes analog and digital computers, information theory, data acquisition and processing.

SPACE TRACKING SYSTEMS Includes microelectronics, space propagation, masers, lasers, infrared techniques.

SPACECRAFT GUIDANCE AND CONTROL Includes inertial navigation, space radar, star tracker systems, tracking networks.

- The first educational program developed specifically to help electronics men apply their experience to the space effort.
- Content of program developed to meet employment requirements as determined by consulting government and private organizations in the space field.
- Text material prepared with the help of engineers and scientists holding key positions in leading space-oriented organizations. (Names on request.) You study exactly the material technical organizations in the space effort want their employees to know.

**YOU ARE ELIGIBLE FOR THIS PROGRAM
IF YOU WORK IN ELECTRONICS AND HAVE A
HIGH SCHOOL EDUCATION.**

**FREE BOOK GIVES FULL INFORMATION. TEAR OUT
AND MAIL POSTPAID CARD or write CREI,
Department 1401-B, 3224 Sixteenth Street, N. W.,
Washington, D. C. 20010**



The Capitol Radio Engineering Institute
Founded 1927 Accredited Member of the National Home Study Council
Dept. 1401-B, 3224 Sixteenth St., N. W.
Washington, D. C. 20010



Please send me FREE book describing CREI Home Study Programs including new Program in Space Electronics. I am employed in electronics and have a high school education.

Name _____ Age _____

Address _____

City _____ Zone _____ State _____

Employed by _____

Type of present work _____

Check: Home Study Residence School G.I. Bill



NOW CREI OFFERS SPECIALIZED EDUCATION IN EVERY IMPORTANT AREA OF ELECTRONICS

SPACE DATA SYSTEMS (NEW)
SPACE TRACKING SYSTEMS (NEW)
**SPACECRAFT GUIDANCE
AND CONTROL (NEW)**
COMMUNICATIONS
**AERONAUTICAL AND
NAVIGATIONAL**
TELEVISION
AUTOMATION AND INDUSTRIAL
NUCLEAR
**SERVOMECHANISMS
AND COMPUTERS**

FIRST CLASS
Permit No. 288-R
Washington, D. C.

BUSINESS REPLY MAIL

NO POSTAGE STAMP NECESSARY IF MAILED IN THE UNITED STATES

Postage will be paid by



The Capitol Radio Engineering Institute

3224 Sixteenth Street, N. W.
Washington, D. C. 20010

VIA AIR MAIL

FREE BOOK GIVES COMPLETE INFORMATION
ON CREI HOME STUDY PROGRAMS
INCLUDING NEW PROGRAMS IN SPACE
ELECTRONICS. TEAR OUT AND MAIL
POSTPAID CARD FOR YOUR COPY TODAY.

(Continued from page 18)

and there's no more tendency to start rumbling on low bass. My thanks to Mr. Burstein and RADIO-ELECTRONICS.

J. E. CARTER

Jacksonville, Fla.

Safer Clock Relay

Dear Editor:

Reference article "Relay Prevents Clock Confusion" in "Try This One" (page 107, October 1963): Wouldn't a momentary contact spst switch connected from the armature to the top of

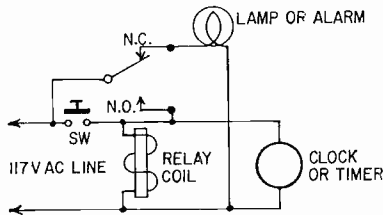

the relay coil in parallel with the N.O. contacts be a safer and more convenient way to energize the relay than "depressing the armature . . . manually"?

MSGT. CYRUS N. WELLS, JR.

Novato, Calif.

[Sure would. We thank you, Sgt. Wells, and Mr. Allen A. Gault of Baltimore who also came up with this solution.—Editor]

... But the Meaning Depends on the Viewer

Dear Editor:

"The Pattern Depends on the Probe" by Cunningham in the November issue was quite interesting. But it all depends on how a man gets used to his scope.

The smear shown in picture "a" is what I trace for—I use that direct probe. If I can pick up that smear at the tuner but lose it somewhere in the video circuit, there's the trouble.

How many TV service technicians who own a high-voltage probe really take the time to use it with their meters? The insulated screwdriver has taken over the job quite well.

PETER LEGON

Malden, Mass.

Long-Time Reader

Dear Editor:

My career in wireless began when I subscribed to *Modern Electrics* back in 1912 when I was 12. It was the inspiration which Mr. Hugo Gernsback's magazine afforded me which triggered my interest. I have been professionally in "wireless" since 1918. I wonder how many others were so affected by Mr. Gernsback's magazines and stories?

E. B. REDDINGTON

Staff Engineer

EIA

Washington, D.C.

END

Announcing the new line of world-famous Schober Organ Kits...

ASSEMBLE YOUR OWN ALL-TRANSISTOR SCHOBER ELECTRONIC ORGAN

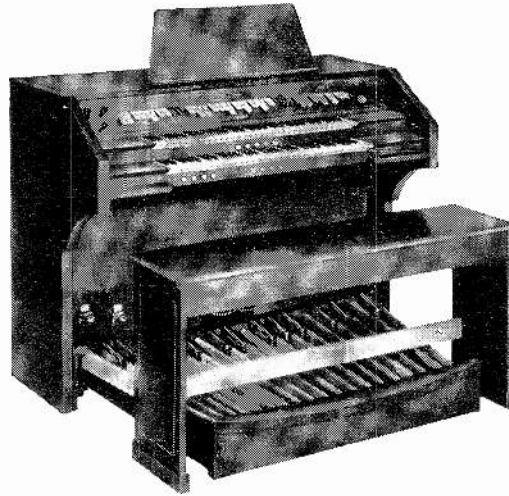

All-New, All-Transistor Schober Recital Organ

- 32 voices, 6 couplers delight professional musicians...make learning easy for beginners.
- Standard console, pedals, keyboard correspond exactly to pipe-organ specifications.
- Printed circuit construction and detailed, illustrated instructions make for easy assembly...no previous experience necessary.
- Highly accurate church and theatre pipe tone in 5 pitch registers make every kind of organ music sound "right".
- Optional: Combination Action, Schober Reverbatape Unit, Repetitive Theatre Percussions.
- All-transistor circuitry makes possible full 5-year guarantee.

Designed by organists for organists, the new Schober Recital Organ actually sounds like a fine pipe organ. The newly-invented Schober Library of Stops provides you with an infinite number of extra voices so that you can instantly plug in the exact voices you prefer for a particular kind of music. Thirteen-piston, instantly resettable Combination Action makes the

Recital Organ suitable for the most rigorous church and recital work. The Schober Reverbatape Unit gives you big-auditorium sound even in the smallest living room. An instrument of this caliber would cost you \$5000 to \$6000 in a store. Direct from Schober, in kit form (without optional percussions, pistons, Reverbatape Unit) costs you only \$1500.

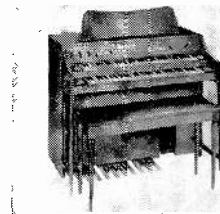

New, All-Transistor Schober Consolelette II

Here's the most luxurious "home-size" organ available today... with the same circuitry and musical design as the impressive Recital Organ. Full 61-note manuals, 17 pedals, 22 stops and coupler, 3 pitch registers, and authentic

theatre voicing leave little to be desired. Musically much larger than ready-made organs selling for \$1800 and more... the Consolelette II, in kit form, costs only \$850.

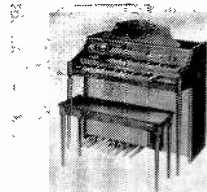

New Schober Spinet

The Schober Spinet is among the very smallest genuine electronic organs; only 39 1/4 inches wide, it will fit into the smallest living room or playroom—even in a mobile home. Yet it has the same big-organ tone and almost the

same variety of voices as the larger Consolelette II. The Schober Spinet far exceeds the musical specifications of ready-made organs selling for \$1100 and more. In easy-to-assemble kits... only \$550.

HERE'S WHY YOU SHOULD BUILD A SCHOBER ORGAN!

You cannot buy a finer musical instrument for over twice the price. You get the finest in musical and mechanical quality.

It's easy to assemble a Schober Organ. If you can read and use your hands, you can easily make your own superb organ. Everything you need is furnished... including the know-how; you supply only simple tools and time—no knowledge or experience is required.

You can buy the organ section by section... so you needn't spend the whole amount at once.

You can begin playing in an hour, even if you've never played before—with the ingenious Pointer System available from Schober.

Thousands of men and women—teenagers, too—have already assembled Schober Organs. We are proud to say that many who could afford to buy any organ have chosen Schober because they preferred it musically.

Schober Organ Kits are sold in the U.S. only by...

THE Schober Organ CORPORATION

43 West 61st Street, New York, N.Y., 10023

Dealers in Canada, Australia, Hong Kong, Mexico, Puerto Rico and the United Kingdom.

SEND FOR FREE SCHOBER BOOKLET

... Describes the exciting Schober Organ and optional accessories in detail; it includes a FREE 7-inch "sampler" record so you can hear before you buy.

Also available: 10-inch high-quality, long playing record... fully illustrates all three models with different kinds of music. Price is refunded with first kit purchase... \$2.00.



The Schober Organ Corp., Dept. RE-29
43 West 61st St., New York, N.Y., 10023

Please send me, without cost or obligation, the Schober Organ Booklet and free 7-inch "sampler" record.

Enclosed find \$2.00 for 10-inch quality, LP record of Schober Organ music. (\$2.00 refunded with purchase of first kit.)

Name _____
Address _____
City _____ State _____ Zip No. _____

Build your own top quality Eico Kits and save up to 50%

New Tape Deck

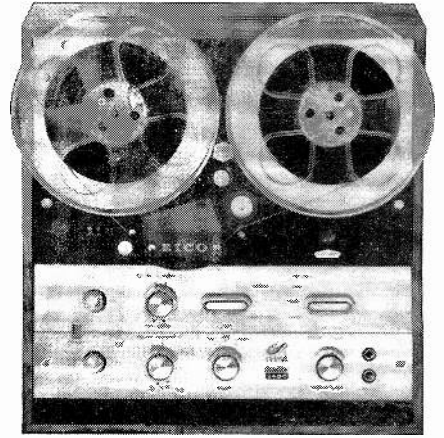

Eico Classic 2400 stereo/mono 4-track tape deck. Kit \$199.95; wired \$269.95 (Incl. oil finish walnut base)

New 3" Portable Scope

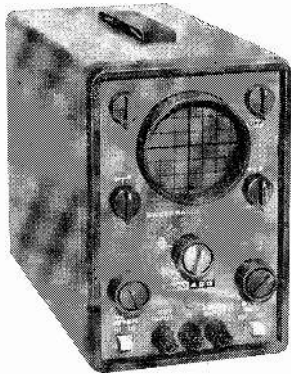

Eico 430 General Purpose 3" Scope. Kit \$65.95; wired \$99.95

TV/FM Sweep Generator

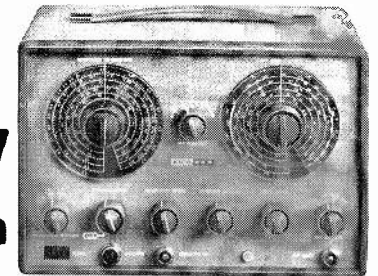

Eico 369 TV/FM Sweep generator, with built-in post injection marker adder. Kit \$89.95; wired \$139.95

New CB Transceiver



Eico 777 dual conversion 6 crystal-controlled channels, 5-watts. Kit \$119.95; wired \$189.95

New Stereo Rcvrs.

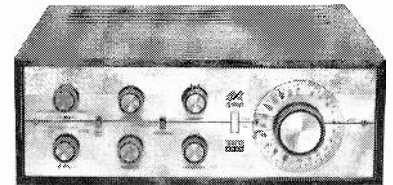

Eico Classic 2536 36-watt FM-MX Stereo Receiver. Kit \$154.95; wired \$209.95 (Incl. F.E.T.)
New Stereo Tuner Eico Classic 2200 FM-MX Stereo Tuner. Kit \$92.50; wired \$119.95 (Incl. F.E.T.)

New Stereo Amplifiers Eico Classic 2036 36-watt. Kit \$79.95; wired \$109.95. Eico Classic 2050—50-watt stereo. Kit \$92.50; wired \$129.95. Eico Classic 2080 80-watt stereo. Kit \$112.50; wired \$159.95.

New Tube Testers

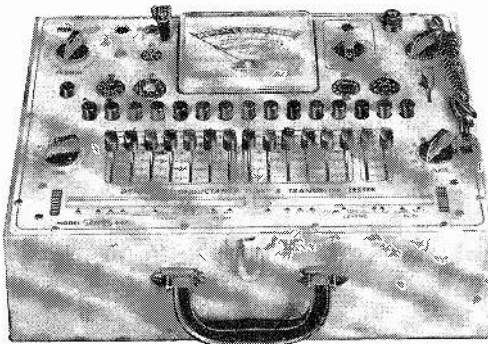

Eico 667 Dynamic Conductance Tube & Transistor Tester. Kit \$79.95; wired \$129.95.
Eico 628 Tube Tester. Kit \$44.95; wired \$59.95



Add 5% in West

EICO Electronic Instrument Co., Inc.
131-01 39th Avenue, Flushing, N.Y. 11352
Please send free New 1964 catalog C-2

Name of nearest Eico dealer

Name _____
Address _____
City _____
Zone _____ State _____



SPACE HANDICAPS

...To Remain Alive In Space Is Difficult...

Humans, who all their lives have lived in the protective blanket of the earth's atmosphere, find it difficult to dissociate themselves from it entirely; that is, to live in a perfect vacuum.

An entirely new environment, as well as new physical laws, which will always be full of surprises for man, exist in space or on the moon.

Once he leaves his comfortable, pressurized space cabin and ventures out into the harsh vacuum of space in his clumsy space suit, he must learn all over again how to live.

In this article we do not wish to go into too great detail about the weightlessness and dangerous, often deadly, radiation from the sun, such as ultraviolet, infrared, X-rays and others not too well understood as yet. (There are still other, nonsolar forms of radiation, such as cosmic rays and neutrons, all more or less deadly if humans are not insulated against them or are exposed to them too long.)

On the moon, the direct heat from the sun can reach a temperature higher than 200°F and a low during the lunar night of -250°F! On top of all this, a man in a space suit gives out as much heat as does a 150-watt lamp and it is continuous! This calls for portable air conditioning if one is to survive.

However, even if there is no air in space or on the moon, a man in a space suit need not necessarily broil or freeze to death. His white space suit will, first of all, reflect a large percent of the solar radiation. He can simply turn his back to the sun periodically. This then heats his freezing back and cools his front. Remember, too, that the inside of the space suit must contain a layer of pressurized air without which a human cannot live. Indeed, if an accidental puncture of the pressurized space suit occurs and if that puncture is not closed immediately, the man must perish within minutes in the lowered air pressure. He will literally blow up, because his body interior air puffs up his body like a balloon. A similar phenomenon occurs when we bring a deep-sea fish to the surface. Robbed of the tons of ocean pressure, the fish dies quickly from internal organ injuries.

We shall now speak of another hazard, too often forgotten: the *invisibility of man in space*. Space is practically dead black. The sun shines harshly in an inky-black sky. Starlight does not appreciably change that sky. Without air to diffuse the light rays, any object not directly in the sun becomes invisible.

Thus men walking in single file cannot see the men ahead. They would have to walk abreast. A man entering into the shadow of a large rock or cave becomes totally invisible from all sides—he just seems to disappear. The effect will be the same when spacemen must work outside a space ship to make repairs. If a man is in the shadow of the ship, as he often must be, his co-workers cannot see him. Two-way radios do not always help to find the missing man quickly, particularly if he has floated some distance and his companions are behind him. Remember, he is now invisible and today's two-way radios are not too directional.

This calls for (1) illuminated spacemen, and (2) highly directional two-way radios usually built into the space suit.

Both these points have been neglected so far. In the matter of illumination, a high-intensity pulsing light should be affixed to the top of the spaceman's helmet as well as to his back. It would be operated by a simple lightweight electronic pulser and a few batteries. To keep them recharged one could attach solar cells to the front and back of the spaceman. In the vacuum of space, solar cells receive more radiation; there may be an increase of up to 20% in output. These can then be used instead of batteries for constant electrical energy output. As one moves away from the sun in interplanetary space, the solar cells are no longer efficient. Thus, near the planet Neptune the output of a solar cell is less than one tenth of one percent of that on the earth.

The solar cells could furnish electricity directly as long as the spaceman is in the sun. But when he is in shadow, he will have to rely on the batteries for power.

As a safety standby in case of flasher failure, the spaceman should be provided front and back with high-efficiency luminous markers as well.

—H.G.

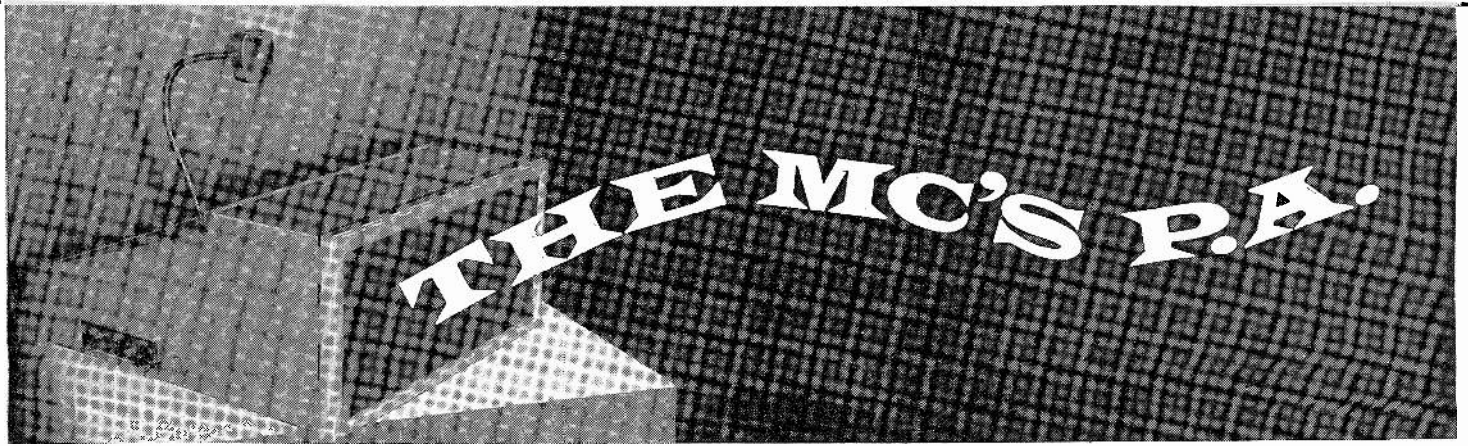

Meeting-hall voice booster is all-transistor

By LEON A. WORTMAN

A MASTER OF CEREMONIES USUALLY needs two things: a good story and a PA system. I don't have a good story at the moment but I do have a good PA system to offer. It's complete in one package, compact and economical. All-transistor, it includes preamplifier, power amplifier, loudspeaker, microphone, choice of ac power supply or long-life battery pack, and a lectern. Because of the exceptional portability, setup speed and built-in choices of power source, a

system like this appeals to those who feel the lack of manpower, electric power or money power.

The chassis measures 5 x 7 x 2 inches. It contains a three-stage preamplifier transformer-coupled to a push-pull 6-watt amplifier and a 117-volt ac power supply for operation from house current. One 12-volt "lantern" battery provides power when ac power lines are not accessible. For mobile work, a car battery can power the system. An accessory

cord with a plug for the cigarette lighter is a convenient way to obtain power.

The three-stage preamp can be built from scratch, or a ready-made unit purchased from a mail-order house. For those who prefer to "roll their own" all the way, a wiring diagram for an equivalent circuit is shown in Fig. 1. Fig. 2 shows the simple modifications made to the ready-made amplifier to adapt it for preamplifier use. The commercial "preamplifier" was made to be used as a small power amplifier. Therefore, it is equipped with an output transformer to match a speaker voice coil. However, in this application it must match the push-pull input of the large-signal power output stage. Either replace the transformer provided with the ready-made

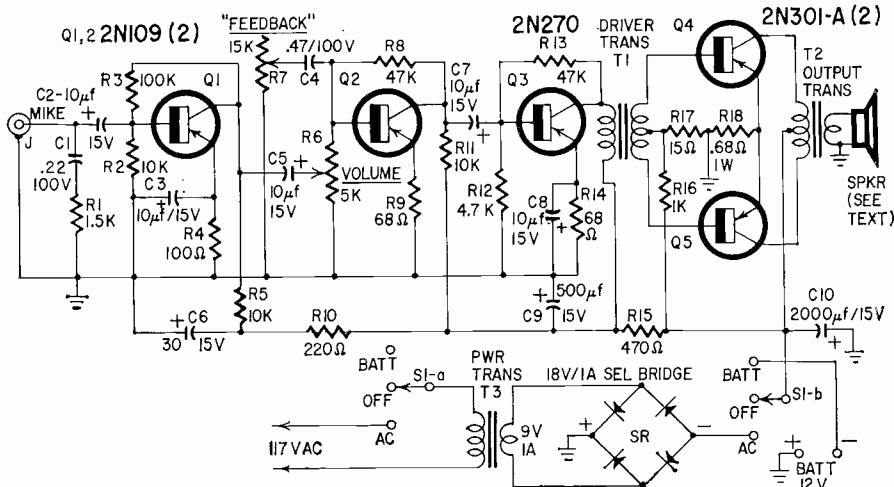

Fig. 1—Amplifier circuit works from 12-volt battery or ac line.

PARTS LIST, Fig. 1

- C1—.22 μ f, 100 v
- C2, C3, C5, C7, C8—10 μ f, 15 v, electrolytic
- C4—.47 μ f, 100 v
- C6—30 μ f, 15 v, electrolytic
- C9—500 μ f, 15 v, electrolytic
- C10—2,000 μ f, 15 v, electrolytic
- J—phono jack
- Q1, Q2—2N109
- Q3—2N270
- Q4, Q5—2N301-A
- R1—1,500 ohms
- R2, R5, R11—10,000 ohms
- R3—100,000 ohms
- R4—100 ohms
- R6—pot, 5,000 ohms, audio taper
- R7—pot, 15,000 ohms, audio taper
- R8, R13—47,000 ohms
- R9, R14—68 ohms
- R10—220 ohms
- R12—4,700 ohms
- R15—470 ohms
- R16—1,000 ohms
- R17—15 ohms
- R18—0.68 ohm, 1 watt

- All resistors $\frac{1}{2}$ watt, 10% except as noted
- S—2-pole 3-position rotary switch
- SR—rectifier, full-wave bridge, 18 v, 1 amp (International Rectifier Corp. M1B or equivalent)
- T1—interstage transformer: 500-ohm pri, 150-ohm ct sec (Stancor TA-38—use full primary)
- T2—output transformer: 48-ohm ct pri, voice-coil sec; 6 watts (Argonne AR-503)
- T3—selenium rectifier transformer (Stancor RT-201 or equivalent)
- Chassis—aluminum, 5 x 7 x 2 in.
- Case, speaker, microphone—see text
- Miscellaneous hardware

PARTS LIST, Fig. 2

- C1—.47 μ f, 100 v
- C2—500 μ f, 15 v, electrolytic
- C3—2,000 μ f, 15 v, electrolytic
- J—phono jack
- Q1, Q2—2N301-A
- R1—pot, 5,000 ohms, audio taper
- R2—pot, 15,000 ohms, audio taper
- R3—470 ohms
- R4—1,000 ohms
- R5—15 ohms
- R6—.68 ohm, 1 watt
- R7—82 ohms
- All resistors $\frac{1}{2}$ watt, 10% except as noted
- S—2-pole 3-position rotary switch
- SR—rectifier, full-wave bridge, 18 v, 1 amp
- T1—output transformer, used in reverse: 400-ohm ct pri to voice coil (Stancor TA-41)
- T2, T3—same as in Fig. 1
- Chassis, case, speaker, mike—same as in Fig. 1
- Miscellaneous hardware

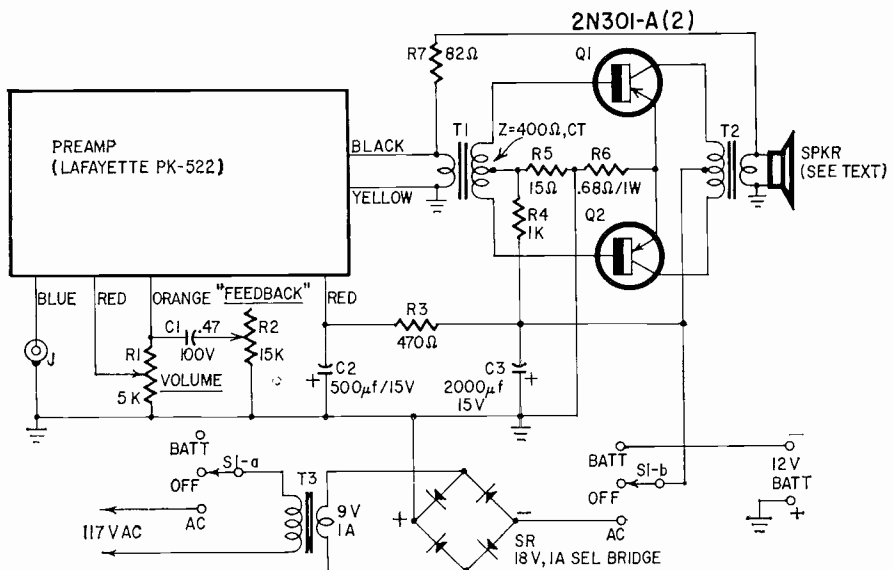
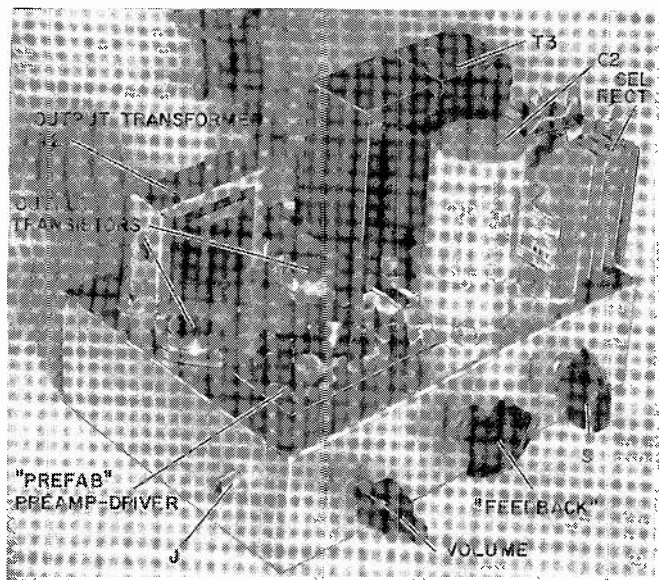

Fig. 2—Same output stage and power supply, but Q1, Q2, Q3 and associated components of Fig. 1 are replaced with prepackaged 3-stage amplifier.



Close up of amplifier-power supply chassis. This version uses prewired amplifier as preamp and driver.



Underneath the chassis. Prepackaged amplifier saves many parts and connections. Components shown are those of Fig. 2.

unit, or add another in cascade. I chose to *add* rather than *replace*. This simplified construction and provided a convenient way of introducing negative feedback. Either approach involves the same investment: one transformer.

Construction of the lectern or podium is, of course, up to you. My unit is shown simply as a guide. The speaker is an 8-inch unit rated at 10 watts. A mid-range speaker was selected for maximum efficiency at voice frequencies. A wide-range speaker with extended high-frequency response is not desirable because of its tendency to produce excessive "spill" or feedback.

Cut and assemble the compartment first. Use $\frac{3}{4}$ -inch plywood to keep cabinet vibration down. The outside dimensions of this section are 10x22x6 inches. Make the cutout for the speaker with a sabre or coping saw. Placement of the cutout is not critical. Acoustic isolation between the speaker and the microphone is essential for high audio output without feedback howl problems. Insulating materials (glass wool, rockwool, etc.) should be attached to the interior surfaces of the speaker compartment. The "feedback" control (basically a tone control designed to attenuate treble) is vital in eliminating "howl" at high volume settings.

After the speaker compartment is completed, add the side extensions. Cut two side pieces from $\frac{1}{4}$ -inch plywood. Glue and nail these to the sides of the speaker compartment. The back piece is $\frac{3}{4}$ -inch plywood, glued and nailed in position. Cut the bottom piece from $\frac{1}{4}$ -inch plywood or masonite. Strips of wood approximately $\frac{3}{4}$ x $\frac{3}{4}$ x 10 inches add bracing at the joints formed by the sides and the bottom. They are important.

The sloping board on which the

speaker rests his manuscript is made of $\frac{1}{4}$ -inch plywood. Braces of $\frac{3}{4}$ x $\frac{3}{4}$ stock are glued and nailed inside the lectern to support the sloping board. Install the braces so that the sloping board recesses $\frac{1}{4}$ -inch to provide a stop for the user's papers.

The amplifier chassis and the lantern battery are installed and secured inside the lectern, beneath the sloping board. A rectangular cutout in one side of the lectern provides easy access to the controls while the equipment is in use. Note that switch S1 has three positions. All power is off when the switch is at its center position. The clockwise position connects the amplifier to the ac power supply. The counter-clockwise position disconnects the power supply from the circuit and connects the amplifier to the batteries.

Filter capacitor C10 is in the circuit regardless of the power connection. It filters ripple when the amplifier is ac-operated and helps prevent the howl that can develop as the batteries age and their internal impedance rises.

The microphone must be a high-output type (crystal, ceramic or reluctance). A "boom" for the microphone is easily constructed from lighting fixture components. I used a gooseneck extension with male threading at both ends. A $\frac{3}{8}$ -inch hole was drilled in the center of a 2 x 2-inch piece of metal to accommodate one end of the threaded gooseneck. That assembly is then bolted to the sloping board. The microphone is attached to the free end of the gooseneck in any convenient way (depends on the case of the specific mike). The result is a very neat, professional-looking flexible boom.

Sanding, sealing and painting or staining give the final commercial touch. Screw-in 6-inch legs can be installed to raise the lectern to the proper height above the conventional dining table. They can be removed quickly without tools should the user find the added height incorrect. Portability can be improved with a hinged cover. My capabilities as a carpenter ran out at this point! END

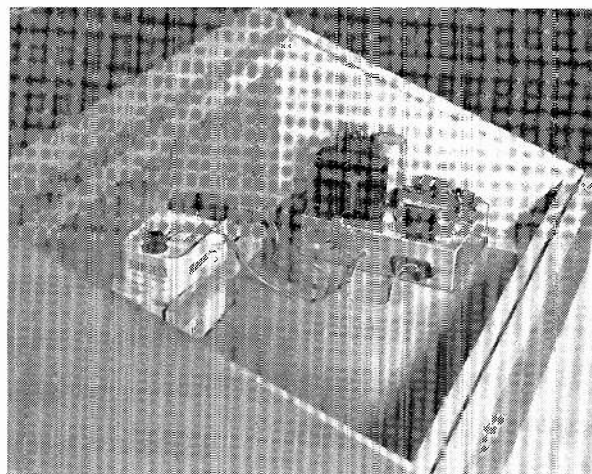

Inside the lectern. Amplifier and ac power supply are against far wall. Battery is secured on back wall of speaker compartment.

the bridged-T

Use it in communications receivers, hi-fi tuners and test equipment. **By JERRY L. OGDIN**

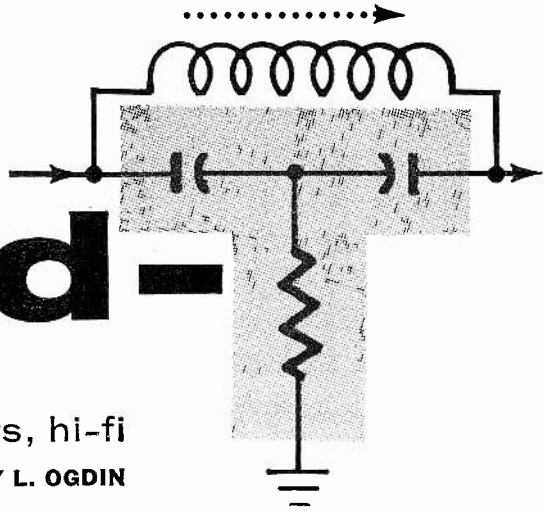

LITTLE HAS BEEN PUBLISHED ON BRIDGED-T (or T-notch) filters. This useful breed of circuit can attenuate or "notch out" an undesired frequency, as in harmonic-distortion analyzers and communications receivers. Used in a feedback amplifier, it can also select a "peak" or a desired frequency while rejecting all others.

A few years ago, the bridged-T filter gained new popularity in several amateur and communication receivers. There, the purpose was to attenuate an interfering carrier. (The bridged-T works from audio to higher radio frequencies.)

Fig. 1-a shows a typical bridged-T filter, designed for 455 kc. The inductor and capacitors resonate at the frequency to be notched out. Shunt resistor R has a unique function: it determines the amount of attenuation in the notch. Usually, with the optimum value of R, the notch depth is about 45 db. (That is,

the output at the notch frequency is about 45 db down from the input voltage.) R has an optimum value for maximum rejection, and any other value will give less notch depth and more bandwidth.

The bandwidth of the bridged-T filter depends also on the Q of the inductor. Fig. 1-b shows typical bandwidth curves for two inductors, one having a Q of 1, the other a Q of 100. The higher the Q, the narrower the bandwidth and the tighter the skirt selectivity.

Fig. 1-c is the same circuit as Fig. 1-a, drawn in equivalent-circuit form. Resistor R_s is *not* an actual resistor; it represents the ac resistance of the coil. Once this is known, the value of the shunt resistor of the network can be calculated.

The formula for resonance in this circuit is

$$f_o = \frac{1}{2\pi} \sqrt{\frac{2}{LC}}$$

and, for maximum null at the frequency of interest,

$$R = \frac{X_c^2}{R_s}$$

where $R_s = X_L/Q$.

The nomogram was developed to simplify the calculation of bridged-T filters. Easy to use, it makes the task of "turning the mathematical crank" to get an answer a lot simpler. First select a coil. Either calculate, measure, read out of a catalog or guess the inductance, and enter this information on the L scale. Next, set the frequency of operation on the f scale. Using a straightedge, connect the two points just marked, and read out the value of the capacitors required for resonance on the C scale.

If the Q of the coil is known, calculate the value of R_s according to the formula given above. Enter this on the R_s scale. Connect the point on the R_s scale and the point last crossed on the unmarked line between the L and R scales. After connecting these two points, read the R column to find the *approximate* value of the shunt resistor.

It's rare that the junkbox will yield a coil of known Q. In this case, construct the filter, insert a potentiometer, and "tune" for a null. It is good to do this even when the resistor value has been calculated, because according to Murphy's law, "if any error can possibly creep into any calculation, it will invariably do so."

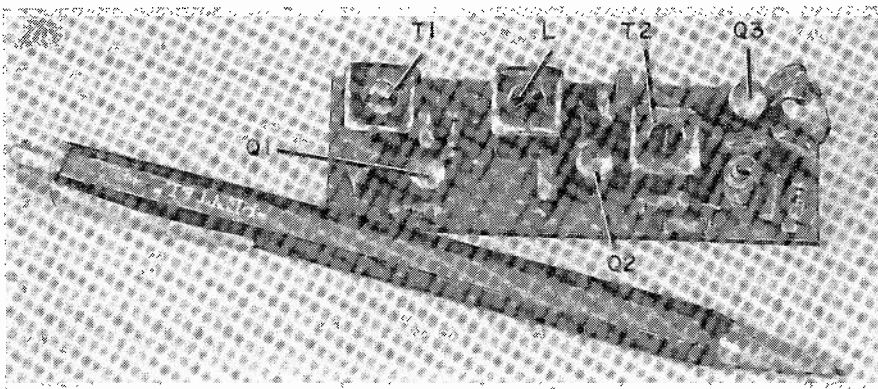

The i.f. amplifier of Fig. 7. It's 3/8 inches long by 7/8 inch wide.

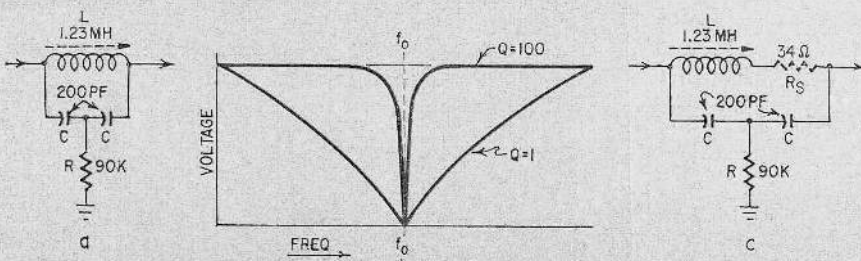

Fig. 1—Bridged-T for 455 kc. (b) Typical curve for high-Q and low-Q coils. (c) Equivalent circuit of (a) showing R_s , coil's resistive component.

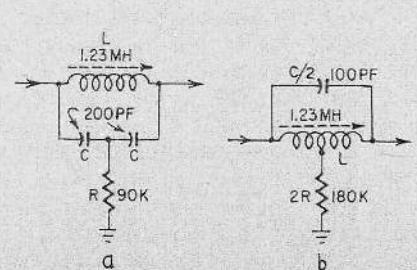
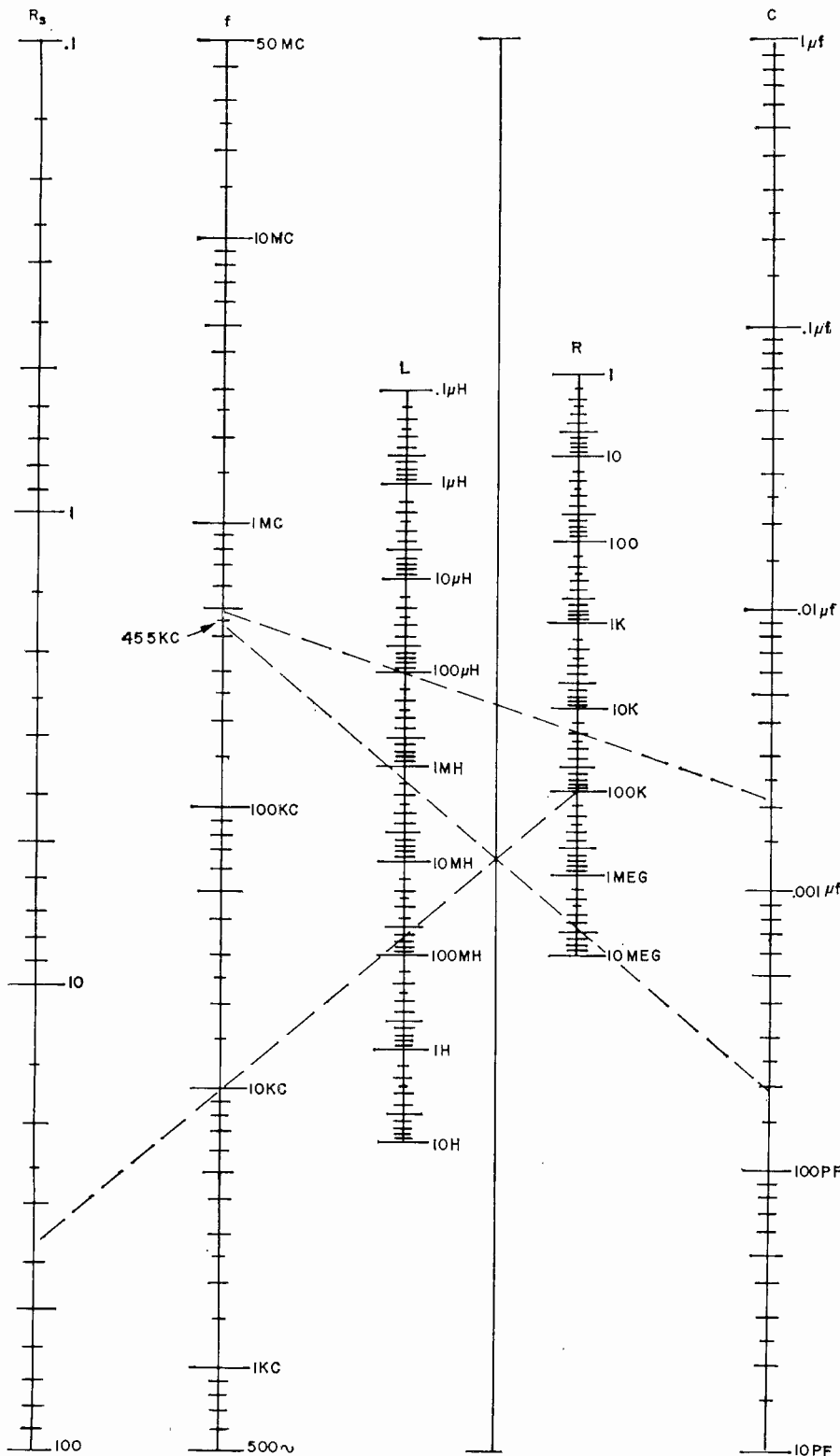

Fig. 2—Two different forms of the bridged-T filter.



To Use The Bridged-T Nomo

Mark off the inductance of the coil on the L scale, and set the intended frequency of operation on the f scale. With a straightedge, connect those two points. The line will intersect the C scale at the capacitance required to resonate with the inductor at f.

Knowing the frequency and selecting a suitable capacitance, you can find the proper inductance value in the same way.

If you know the Q of the coil, calculate R_s according to the formula $R_s = X_L/Q$. Mark this value on the R_s scale, and now draw a line from this point to the point where the line you drew to find L or C intersects the ungraduated line between the L and R scales. Extend the R_s line beyond that point and into the R scale. Read off the approximate value of shunt resistor R from the R scale.

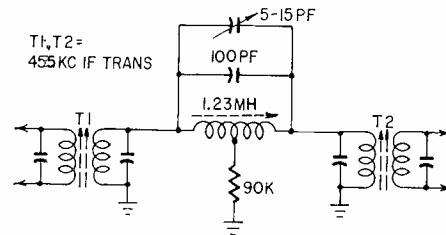

Fig. 3—A simple i.f. filter for notching out interference. The whole circuit should be substituted for one i.f. transformer. If only one side of each transformer in receiver is tuned, T1 and T2 should both have tuned side as primary.

The example shown on the nomogram is for the filter of Fig. 1-a.

The filters of Fig. 2-a and 2-b are electrically identical. If the inductor chosen has a center tap, use it. In that case, the single capacitor has one-half the value determined in the nomogram, and the value of the shunt resistor is doubled (assuming no change in the value of the inductor).

Using the filter

A bridged-T filter may be connected with either side as an input. The shunt resistor is connected to a point which is at ac ground. The impedance of the filter presented to an input source is approximately equal to the shunt resistor, and the source should have an impedance of less than that value. The output should be loaded lightly—that is, look into a high impedance.

A simple filter system that can be used with nearly any 455-kc i.f. amplifier is shown in Fig. 3. The variable capacitor is used to tune the notch over a small range to an interfering carrier. The 90,000-ohm resistor may be replaced with one of 22,000 ohms in series with a 75,000-ohm potentiometer. This provides variable notch depth and selectivity.

Another use for the T-notch is in high-fidelity AM tuners, where 10-kc heterodyne whistles are often disconcerting. The circuit of Fig. 4 can be used to attenuate 10 kc. Of course, the values shown on the schematic are only examples, and may be changed to suit the junkbox by using the nomogram.

Reversing the notch

Although the bridged-T is very good for rejection filtering, it cannot be

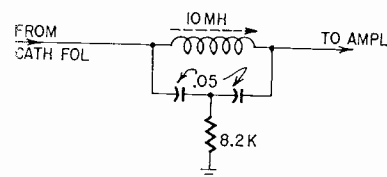

Fig. 4—A 10-kc "whistle filter" for hi-fi AM tuners. Use it from low impedance to high impedance.

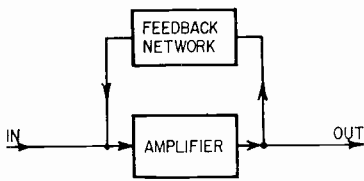

Fig. 5—"Classical" functional diagram of feedback amplifier. Here, amplifier has 180°-phase shift, feedback network 0°.

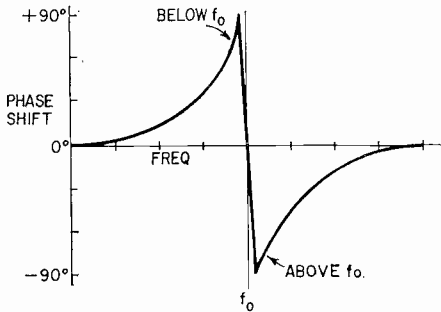

Fig. 6—Phase shift diagram for bridged-T. Note sudden, rapid change from +90° through 0° to -90°, which makes filter very selective.

directly wired for use in bandpass circuits. However, consider the basic voltage amplifier with negative feedback (Fig. 5). If, classical theory has it, we want to eliminate some frequency, we feed back that same frequency 180° out of phase with the input and the frequency cancels out. Conversely, if we want to amplify only one frequency, we feed back all *except* the desired frequency.

However, we must know the phase shift through the filter itself. Fig. 6 shows it at various frequencies. Near the center (resonant) frequency, the phase shifts rather violently from +90° to -90°, passing through the point of zero phase shift at the resonant frequency. Therefore, for a tuned bridged-T, the phase shift can be assumed to be zero.

Practical circuitry

The circuit of Fig. 7 is the result of research into an inexpensive selective i.f. amplifier. The bandwidth of the amplifier at various levels is shown in the table, but can be spread by reducing the value of filter resistor R1.

BANDWIDTH OF FIG. 7 AMPLIFIER

Level	Bandwidth
-6db	800 cycles
-20db	1.8 kc
-40db	9.5 kc

The amplifier is normally fed from a mixer circuit through the input transformer T1. (If you cannot get double-tuned transformers for transistors, use the scheme of Fig. 8.) The amplifier may also be fed from a converter or another i.f. amplifier. The first two transistors, Q1 and Q2, are connected in a form of the Darlington circuit (super-alpha pair). Usually, the Darlington circuit has both collectors tied together, but here it is more stable when the collector of the first transistor is decoupled for ac.

The secondary windings of the two i.f. transformers are returned to ground. If the bias were fed in series with the windings to the base of the transistors, the low dc resistance of the filter would change the operating points erratically. This is because, for dc, the bases of Q1 and Q3 would be connected together. The same components are used in either biasing scheme.

The phase difference between the two points to which the filter is connected must be 180°. The secondary of T1 is assumed to have zero phase shift. The coupling capacitor to the base of Q1, and transformer T2, each have equal and opposite phase shifts, which cancel out. The first transistor is an emitter follower (no phase shift) and the second transistor has a phase shift of 180°. Therefore, the total phase shift of the circuit with feedback is 180°, which is correct.

If, by accident, the secondary of T2 is reversed, the amplifier will oscillate.

The last transistor (Q3) is a class-B detector, and gives an additional 10 db gain. This transistor also functions as an agc amplifier, with the agc voltage taken from the collector. The 6,800-ohm resistor and the 3- μ f electrolytic decouple the agc and determine the time constant. The dc is then fed through the 47,000-ohm resistor to the base of Q1. If agc is not desired, these three components may be eliminated, and a 62,000-ohm resistor connected from the base of Q1 to the -9-volt line.

A 50- μ v input gives an audio output of 0.2 volt, peak to peak. Just at the point where the detector begins to saturate, the audio output reaches 1.5 volts peak to peak.

No attempt has been made to apply this circuit to vacuum tubes, but there is no reason it shouldn't work equally well. END

REFERENCES

1. Morkus and Zetuff, *Electronics for Communication Engineers*, McGraw-Hill.
2. *Selected Semiconductor Circuits*. NAVSHIPS 93484

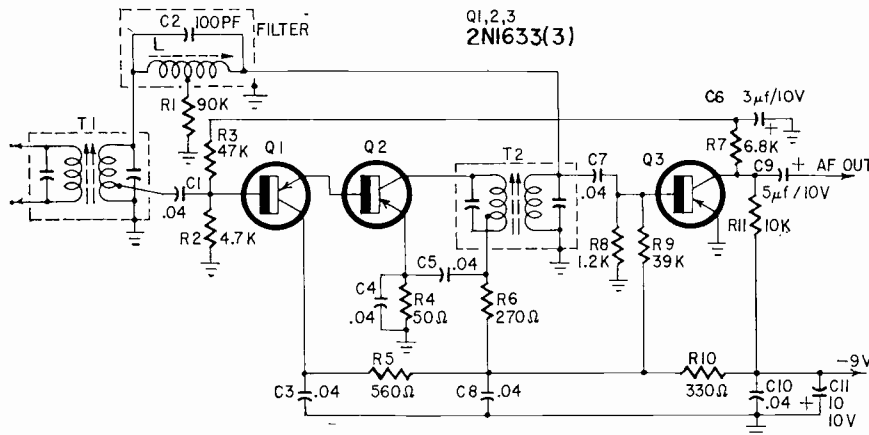

Fig. 7—Practical high-selectivity i.f. amplifier. Bridged-T network provides 100% negative feedback at all frequencies except 455 kc.

Parts List

- R1—90,000 ohms (see text)
- R2—4,700 ohms
- R3—47,000 ohms
- R4—50 ohms (use 47- or 51-ohm resistor)
- R5—560 ohms
- R6—270 ohms
- R7—6,800 ohms
- R8—1,200 ohms
- R9—39,000 ohms
- R10—330 ohms
- R11—10,000 ohms
- All resistors 1/2 watt, 10%
- C1, C3, C4, C5, C7, C8, C10—.04 μ f disc ceramic
- C2—100 pf ceramic or silver mica
- C6—3 μ f, 10-volt electrolytic
- C9—5 μ f, 10-volt electrolytic
- C11—10 μ f, 10-volt electrolytic
- L—1.23 mh slug-tuned coil, center-tapped. (If center-tapped coil not available, use two 200-pf capacitors instead of C4, as per Fig. 2-a.)
- Q1, Q2, Q3—2N1633 or similar
- T1—455-kc double-tuned i.f. transformer. Secondary tap 1,500 ohms
- T2—455-kc transistor i.f. transformer, 5,000-ohm secondary.

[The author states that these double-tuned i.f. transformers are not widely advertised or listed in catalogs but many distributors stock them as a kit of replacement transformers for Japanese radios. Check your dealer's counter display cards or bargain counter. If they are not available, use two Stancor RTC-8671 or J. W. Miller 9-C1 transformers connected back to back for T1 and T2. See text and Fig. 8.—Editor]

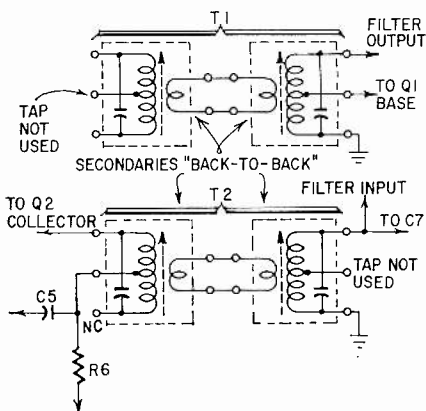
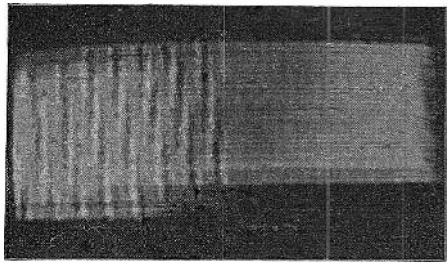
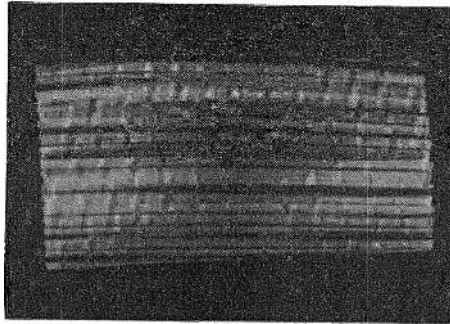

Fig. 8—How to wire four single-tuned i.f. transformers for use as T1 and T2. See parts list.



Horizontal oscillator way off?



Horizontal oscillator? Output?

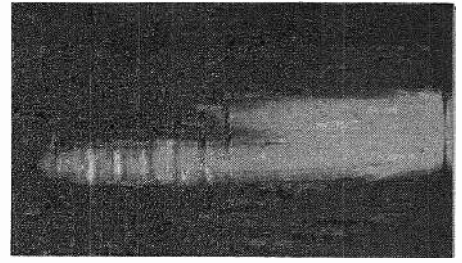

Shorted yoke? Arcing damper?

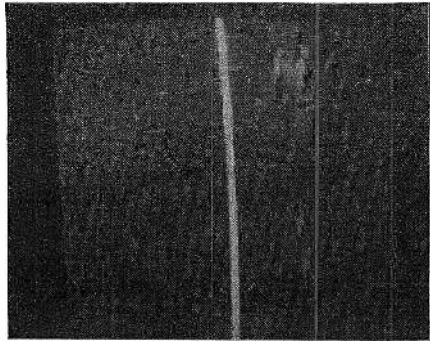

A drive line?

They're all caused by power supply troubles!



Bad vertical output stage?

TV

Power Supply TROUBLES

Simple? Not always! The photos here show some strange but perfectly possible symptoms

By JACK DARR
SERVICE EDITOR

LOW B-PLUS: EASY TO DISCOVER—A QUICK jab with a voltmeter. What causes it, though? The answer, as usual in TV service, is plural. Low B-plus voltage can be due to a weak rectifier, either tube or "dry". But it can also be due to an overload, heavy leakage or short somewhere in the distribution network. How can we find out which—quickly?

First, of course, replace the rectifier. Easy with a tube, not so easy with others, unless they're plug-ins. If the rectifiers aren't easy to get at, we can use other shortcut tests. Let's take the tube types first.

Replace the tube. If this doesn't cure the trouble, check the input filter capacitor. This acts as a reservoir for the charge fed into it by the rectifier. So, if we lose capacitance here (C1 in Fig. 1), down goes the output voltage. For a quick check, to save pulling a chassis, put a tube-base test adapter under the rectifier tube. Now we can read the voltage at the cathode (or filament, on 5U4's, etc.). Also, we can shunt a good capacitor across the input of the filter. If we leave the voltmeter hooked to the cathode while this is done, we can see the voltage jump back to normal if the old capacitor is open. Be sure to use test capacitors with at least a 450-volt rating! (About 40–60 μ f is the right size.)

If the input capacitor is OK, then our low B-plus must be due to an overload. Something is drawing too much current. What's causing this? One of three things: a shorted tube (not the rectifier—we've already changed that),

capacitor leakage, or—we'll get to the third in a minute. Let's try the more common troubles first.

A shorted tube should be caught in tube testing. We can break the B-plus circuit at the rectifier cathode and insert a 0–500 dc milliammeter, as in Fig. 2. Now we can pull tubes, one at a time, watching for the current to drop back to normal. We can also disconnect the various branches of the B-plus network, watching the drain on the meter. If the overload suddenly disappears, you've found the villain. You can also "ohmmeter" this trouble out, by checking resistance along that particular line.

Voltage readings will help pin down shorts and leakage. Look for overheated resistors—a sure clue!

Final word on this process: be *sure* to check *all* tubes before you start disconnecting wires! I remember one set that blew two big 5U4's very rapidly. Dead short in the B-plus. After hauling the thing 5 miles to town, I found the trouble: a dead-short 6BQ7 in the tuner! This makes one feel very intelligent! So now I check *all* tubes before I make any diagnoses of "shorted filter capacitors"! Quick check: connect an ohmmeter across B-plus to show the short, then lift tubes from the sockets, one at a time.

Now for the third cause: incorrect grid bias on one of the high-current tubes—the horizontal output, vertical output and audio output tubes. The rest will not draw enough current, unless they are shorted, to drop voltage much.

However, the 6BQ6 draws 100 ma; the 6CM7, 70 ma, and the 6AQ5 (audio or vertical), 100 ma. If these tubes lose drive or bias, they can pull enough cur-

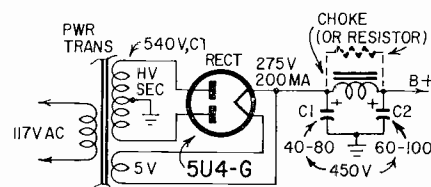

Fig. 1—Basic circuit of typical transformer type power supply.

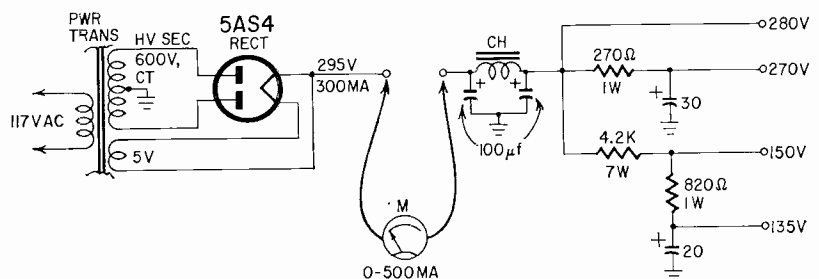

Fig. 2—Where to hook a milliammeter to read total B-plus drain.

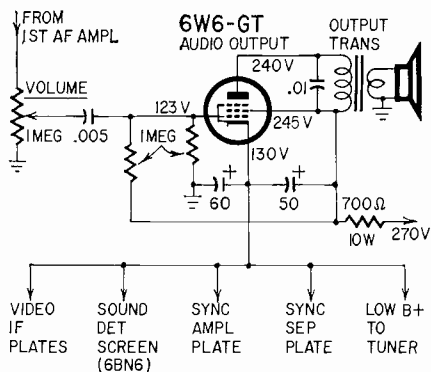

Fig. 3—Stacked B-plus circuits have troubles all their own. Audio output tube here is part of voltage divider, drops about half of 270 volt B-plus. Tube bias affects plate voltage in most other sections of set.

rent to cause trouble. In the mysterious cases where everything's all right but nothing works, try checking the bias on all of these tubes. A drop of 5 volts grid bias can cause a 100-ma change in plate current on some types.

Stacked-B circuits can cause some obscure troubles, too. Look at Fig. 3. Here, the audio output tube cathode is the source of the 130-volt line. Note how many other stages are fed from this. A defect in the audio stage can show up as sync trouble, sound trouble, video i.f. overload, looking exactly like age trouble, and even cause the CRT to black out if that 130 volts happens to be used for its bias!

Watch out for grid voltages on the audio tube. Notice the two 1-megohm resistors in the 6W6 grid? These form a voltage divider across the 270-volt line. The voltage at the junction is the grid bias of the audio output tube. If one of these drifts in value, away goes the grid bias, and off goes the 130-volt line! Leakage in the coupling capacitor can be responsible for this, too. You'll get the "volume control affects the picture" symptom: the leakage will put the 1-megohm control into the audio grid dc circuit, and its setting will change the bias, thus changing the 130-volt line again!

Transformerless circuits

Voltage-doubler circuits are used in "transformerless" TV sets. They give higher dc voltages without a power transformer. The full-wave circuit of Fig. 4 is not found too often any more. The ac line must "float," and the circuit requires extra parts.

Low output voltage can be due to weak rectifiers or partly open (weak) capacitors. To check, measure the dc voltage across each rectifier, also across the doubler capacitors C1 and C2 in Fig. 4. You should get about 135 volts across each. Less than 100 volts each means trouble. You can shunt capacitors across suspected units, or even shunt rectifiers

across suspected weak ones, watching the polarity, of course. If this brings the voltage up, the original is below standard. Replace it.

In this circuit, an open filter capacitor, C3, will not cause much voltage drop. All it will do is increase the ripple. Partly open capacitors in the doublers drop the B-plus; "weak" rectifiers are usually seleniums. Silicon types tend to short out abruptly and completely, instead of losing voltage output.

The half-wave doubler circuit of Fig. 5 is one that puzzles novices (and a few old heads, too). When they see the electrolytic capacitor connected "direct to the ac line," they wonder if their instructors knew what they were talking about! However, the "shunt rectifier" on the other side takes care of that. There

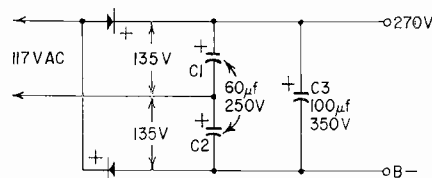

Fig. 4—Typical full-wave voltage doubler. Not too often used any more without transformer.

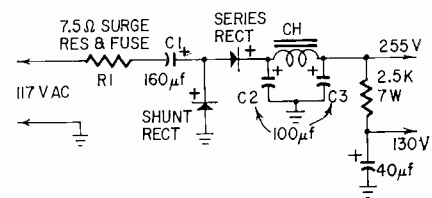

Fig. 5—Common half-wave doubler. C1 charges on positive half-cycle of ac line voltage, then discharges through series rectifier on negative half-cycle, adding its charge to the voltage rectified in normal half-wave fashion.

is never any actual ac across this capacitor (unless, of course, the shunt rectifier is shorted). Then, rectifier and capacitor must be replaced. (Along with the fuse!)

Low voltage in this circuit is most often due to loss of capacitance in C1, the doubler capacitor. C2 and C3 will not affect the dc output. If they weaken or open, they increase the ripple.

Overloads react differently on both doubler circuits. If heavy, they should burn out the fuse. Many circuits combine fusing with the surge resistor in the "fusible-resistor" types (R1 in Fig. 5). Because of the "direct-to-line" connection, the current-carrying ability of this circuit is limited only by the size of the rectifiers and capacitors used. In making replacements, if the original rectifier seems a bit close, that is, a 300-ma rectifier in a circuit drawing 260 ma, use the next larger size—say, a 500-ma. This will increase the service life considerably. If

silicon rectifiers replace seleniums, the B-plus voltage will be higher, because of the lower rectifier drop. Be careful. Don't wind up with too much voltage on your filter capacitors!

Check the surge voltage, the peak dc voltage when the set is turned on, cold. If this exceeds the working voltage rating of the capacitors, increase the value of the surge resistor. If capacitors are replaced in such circuits, always use new ones with higher voltage ratings.

Obscure troubles

Now let's look at some more obscure troubles. The real cause for these is usually too much impedance in the power supply. The ideal supply would have zero impedance between B-plus and ground. There could then be no coupling of circuits in the supply, and no feedback. Practical circuits can have impedances as low as 1 ohm or even less. Main cause of too much impedance is loss of capacitance in filter capacitors, or a high power factor, which reduces the filtering efficiency.

The scope is the best way to check for this. If the power supply has a low impedance, it won't develop much "signal" across it. Checking at the rectifier cathode in a good B-plus supply, we see, as in Fig. 6, a ripple of about 20 volts peak to peak. At the output, after filtering, the ripple is down to less than 2 volts p-p (Fig. 7). This is a transformer supply with full-wave rectifier; ripple frequency, 120 cycles. Notice that every

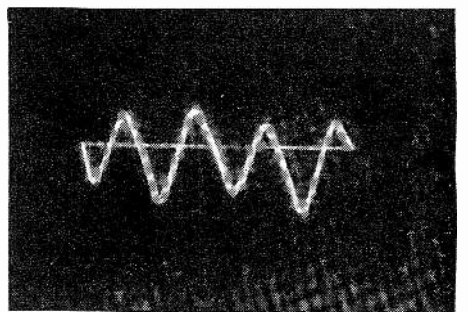

Fig. 6—Normal 120-cycle ripple pattern at cathode of full-wave rectifier. About 20 volts peak to peak.

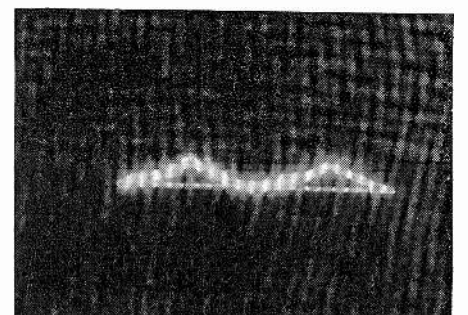

Fig. 7—Normal ripple at output of same power supply. Peak-to-peak voltage is down to about 1.9.

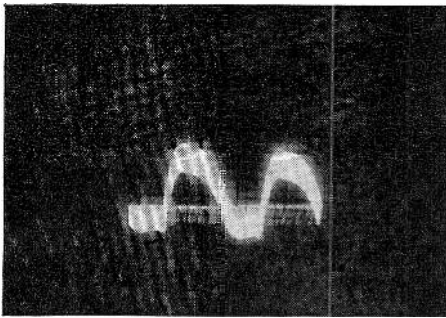

Fig. 8—Ripple at output with weak output filter capacitor (capacitance below normal). Peak-to-peak voltage up to about 24. Thickening of trace due to horizontal-frequency "hash" developed across impedance of weak output filter.

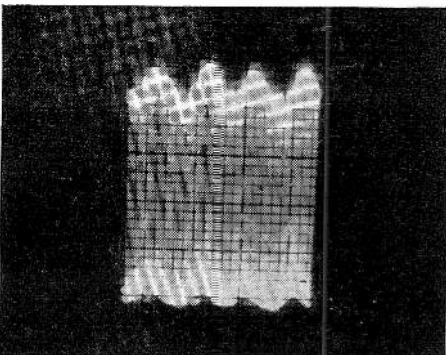

Fig. 9—Same power supply, output filter completely removed (or open). Scope sweep set at 30 cycles. Blurring caused by continual motion of scope trace. Peak-to-peak voltage now about 120.

other cycle is low? This is due to heavy loading on the B-plus by the vertical output stage. Since this is 120-cycle ripple, and the loading is 60-cycle, we see a drop in every other cycle. This, if severe, could mean poor B-plus regulation.

If the output filter capacitor has lost capacitance, the impedance of the power supply rises. Look at Fig. 8, which shows the ripple at the filter output, as in Fig. 7, but with a too-small electrolytic capacitor. This waveform is 24 volts p-p. Note the "thickening" of some parts;

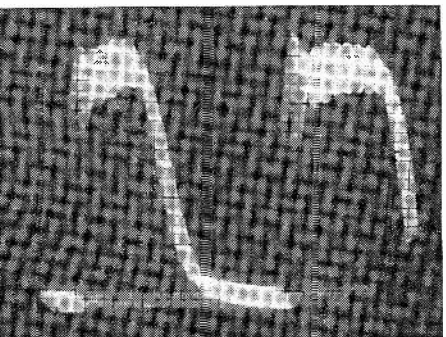

Fig. 10—Same conditions as Fig. 9, with scope sweep at half horizontal scanning frequency (7,875 cycles). This is a horizontal-frequency component of ripple. Feedback through power supply impedance threw horizontal oscillator off completely, and raster disappeared!

this is due to horizontal sweep frequencies developing across the increased impedance. This much ripple can cause instability, hum and other troubles.

If the output filter capacitor opens completely, we can see some real troubles! Fig. 9 shows this waveform, at the same point. "Ripple" is now a whopping 120 volts p-p, and the waveform itself is so jittery that it was hard to photograph. This was taken at 30-cycle sweep.

The same waveform, at 7,875-cycle sweep, shows the reason for the failure of the set's horizontal circuits, which went into violent "squegging" as soon as this capacitor failed. Feedback, through

the increased impedance of the power supply, was so high that the whole sweep circuit was disrupted. This is the horizontal-frequency component in the waveform of Fig. 9. Fig. 10 expands the sweep so that the horizontal pulses can be seen.

The moral is simple. The B-plus circuit is a basic part of the set, as basic as the 117-volt ac line! Unless it's in good shape, nothing is going to work right! Take the very small amount of time necessary to be sure that it's in good shape. One jab with a voltmeter and another with a scope and you've got it made! END

reactance tables

By ERNEST T. THIERSCH

I USE INDUCTIVE AND CAPACITIVE REACTANCES quite often and have gotten tired of calculating out a particular value each time I need it. This goes for using nomographs or slide rules too. To avoid this I drew up the two charts shown

here. I use them so often that I thought others would find them useful too.

My original calculations were carried to many more digits, but three are accurate enough for my needs and better than much of my test equipment.

INDUCTIVE REACTANCE

$$X_L = 2\pi fL = 6.28fL$$

When X_L is in | ohms | megohms
L is in | henries | microhenries

f is always cycles per second

L (henries)	1.00	2.00	3.00	4.00	5.00	6.00	7.00	8.00	9.00
10	62.8 kΩ	126 kΩ	188 kΩ	251 kΩ	314 kΩ	377 kΩ	440 kΩ	503 kΩ	565 kΩ
11	69.1	138	207	267	346	414	484	553	622
12	75.4	151	226	302	378	452	528	603	679
13	81.7	163	245	327	408	490	572	653	735
14	88.0	176	264	352	440	528	616	704	792
15	94.2	188	283	377	471	565	660	754	848
16	101	201	302	402	503	603	704	804	905
17	107	214	320	427	534	641	748	855	961
18	113	226	339	452	565	679	792	905	1.02 meg
19	119	239	358	476	597	716	836	955	1.07
20	126	251	377	503	628	754	880	1.01 meg	1.13
30	188	377	565	754	942	1.13 meg	1.32 meg	1.51	1.70
40	251	503	754	1.01 meg	1.26 meg	1.51	1.76	2.01	2.26
50	314	628	942	1.26	1.57	1.88	2.20	2.51	2.83
60	377	754	1.13 meg	1.51	1.88	2.26	2.64	3.02	3.39
70	440	880	1.32	1.76	2.20	2.64	3.08	3.52	3.96
80	503	1.01 meg	1.51	2.01	2.51	3.02	3.52	4.02	4.52
90	565	1.13	1.70	2.26	2.83	3.39	3.96	4.52	5.09

When multiplying f or L by 10, multiply X_L by 10.

CAPACITIVE REACTANCE

$$X_C = \frac{1}{2\pi fC} = \frac{.159}{fC}$$

When X_C is in | ohms | megohms
C is in | farads | microfarads

f is always cycles per second

f Kc	C = 100 pf	200 pf	300 pf	400 pf	500 pf	600 pf	700 pf	800 pf	900 pf
10	159 kΩ	79.5 kΩ	53.1 kΩ	39.8 kΩ	31.8 kΩ	26.5 kΩ	22.7 kΩ	19.9 kΩ	17.7 kΩ
11	144	69.1	48.2	36.2	28.9	24.1	20.7	18.1	16.1
12	133	63.3	44.2	31.6	26.5	22.1	18.9	16.6	14.7
13	122	58.4	40.8	30.6	24.5	20.4	17.5	15.3	13.6
14	114	56.8	37.9	28.4	22.7	18.9	16.2	14.2	12.6
15	106	53.1	35.4	26.5	21.2	17.7	15.2	13.3	11.8
16	99.5	49.7	33.2	24.9	19.9	16.6	14.2	12.4	11.1
17	93.6	46.8	31.2	23.4	18.7	15.6	13.4	11.7	10.4
18	88.4	44.2	29.5	22.1	17.7	14.7	12.6	11.1	9.83
19	83.8	41.9	27.9	20.9	16.8	14.0	12.0	10.5	9.31
20	79.5	39.8	26.5	19.9	15.9	13.3	11.4	9.95	8.84
30	53.1	26.5	17.7	13.3	10.6	8.84	7.58	6.63	5.89
40	39.8	19.9	12.1	9.95	7.96	6.63	5.68	4.97	4.42
50	31.8	15.9	10.6	7.96	6.37	5.31	4.55	3.98	3.54
60	26.5	13.3	8.84	6.63	5.31	4.42	3.79	3.32	2.95
70	22.7	11.4	7.58	5.69	4.55	3.79	3.23	2.84	2.53
80	19.9	9.95	6.63	4.97	3.98	3.32	2.84	2.49	2.21
90	17.7	8.84	5.89	4.42	3.54	2.95	2.53	2.21	1.96

When multiplying f or C by 10, divide X_C by 10.

Simplest

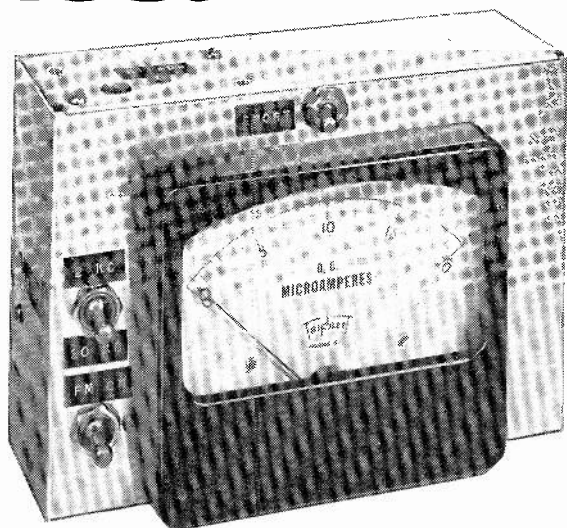

direct-reading frequency meter

Read audio frequencies from 200 to 20,000 cycles right off the meter

By I. QUEEN EDITORIAL ASSOCIATE

HAVE YOU EVER OWNED A DIRECT-READING frequency meter? Very handy thing. This instrument can be read to about 1% or better, except near zero. It uses a single transistor powered by a small mercury or dry cell. A 4½-inch meter indicates frequency to three decimals.

Many technicians rely on their scope to compare the ac line (or other standard) with the unknown frequency. This method is precise on certain related frequencies. For example, you can easily recognize a frequency of exactly 300 cycles, but how about 320 or 340? (If the unknown is not stable, you may even have difficulty measuring 300 cycles.) With a direct-reading frequency meter, you have only to read the result from a meter scale.

Transistor Q flattens the peaks of the incoming signal to produce a square wave. This is differentiated by C1-C4 and the low shunt resistance of the meter (an R-C network), and the resulting pulses are rectified. The charge on C5 (and hence the voltage across it) is proportional to the pulse rate, which is the same as the input frequency. Meter M, connected across C5, reads the voltage there. Thus M's reading is directly proportional to frequency over a wide range.

The input signal amplitude must be sufficiently high. The instrument saturates at about 5 volts input. Before you make a measurement, be sure you are applying about 5 volts. The input im-

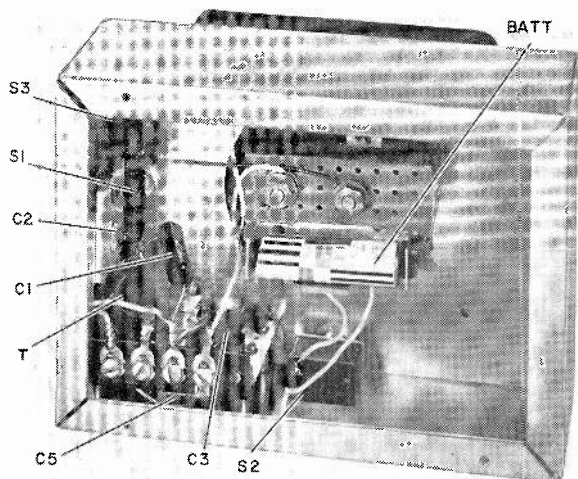

Rear view (upside down, to show the subchassis). Plenty of room—big meter fixes size of case.

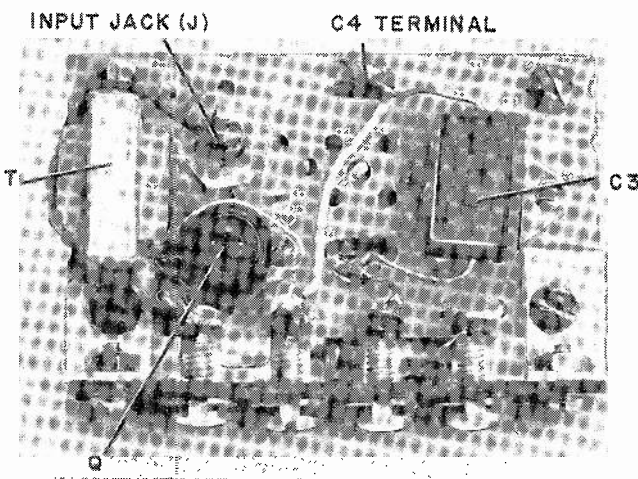

Tiny subchassis is a 1½ x 3-inch piece of perforated phenolic board.

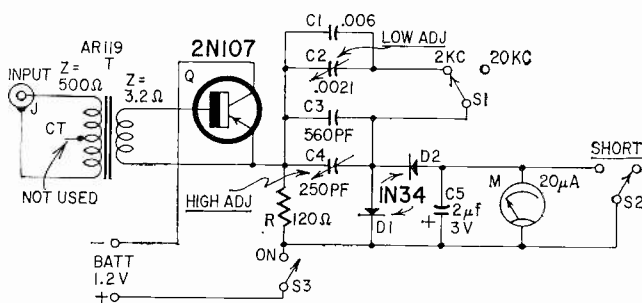

Circuit of the frequency meter.

- R—120 ohms
- C1—.006-μf paper
- C2—.0021-μf mica trimmer
- C3—560-pf mica
- C4—250-pf mica trimmer
- C5—2 μf at 3 volts, electrolytic
- Q—2N107
- T—miniature output transformer: 500-ohm primary, 3.2-ohm secondary (Argonne AR-119 or equivalent)
- M—20-μa dc meter
- D1, D2—1N34
- J—phono jack
- S1, S2—spdt toggle switch
- S3—spst toggle switch
- BATT—1.2- or 1.5-volt mercury or dry cell
- Transistor socket
- Aluminum chassis, 2 x 5 x 7 in.
- Miscellaneous hardware

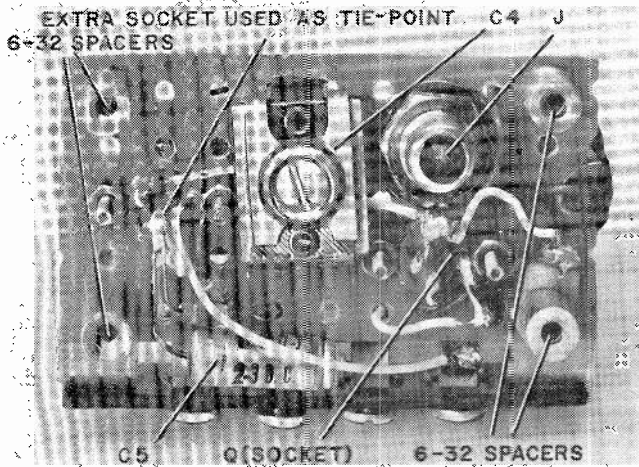

Other side of sub-chassis shows most of the remaining parts.

BENCH



TESTED

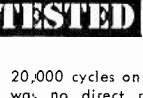

This device was given to a member of the editorial staff for testing. This is what he reported:
 "Unit is accurate and easy to read from 200 to 2,000 cycles on its lower range, and from 1,500 to 20,000 cycles on the higher. Below 200 cycles there was no direct relationship to frequency... meter needs about 4.5 volts rms to read accurately... at 4 volts rms the reading is still usable.
 "This device can take over where 60-cycle Lissajous patterns get too hard to read."

pedance of the frequency meter is approximately 3,000 ohms.

Use known signal frequencies to calibrate the frequency meter. Switch to the 20-kc range first and apply a frequency under 20 kc. Adjust C4 to make the meter reading correspond to the frequency (i.e. 18 μ a for 18 kc). Now check other settings in this range. You will probably find, as I did, that small readings are somewhat lower than they should be. I solved the problem by changing the meter's mechanical zero setting to about $\frac{1}{4}$ μ a. With a little juggling between the meter zero and the signal calibration, you will find you can

obtain very high accuracy except close to zero.

Now switch to the 2-kc range and again apply known frequencies. Adjust C2 as required, but don't change the zero setting of the meter again.

After careful calibration and zero setting, I obtained exact readings at 16.5, 8.25 and 4.1 kc on the 20-kc range, and 1.65 kc, 960 cycles and 120 cycles on the low range. By "exact," I mean better than 1%.

The 20- μ a meter is a very sensitive and delicate instrument and should receive special care. For this reason it is equipped with a "short" switch. When

the meter is not in use, keep it shorted. Avoid applying frequencies higher than 20 kc (or 2 kc when you are switched to the low range). When I band-switch some audio oscillators, the needle of the frequency meter tends to swing violently upscale. To be safe, keep the meter shorted while switching bands. Though I did not think of it at the time, it would probably be better to use a momentary-contact, normally closed toggle or push-button switch, and simply "push to read."

The capacitors C1-C4 shown determine the calibration of this instrument. A higher capacitance increases the meter reading. The values shown were suitable for my instrument, but slightly different values may be needed for others. END

Trimming Resistors and Capacitors

By MARTIN H. PATRICK

WE OFTEN need to trim off a resistor by using another in parallel with it. Then the trial-and-error method starts. A handy time-saving setup to have about the bench is shown in Fig. 1. Used in conjunction with an ohmmeter, you simply adjust the potentiometers until you arrive at the required resistance reading, flick a switch and read the correct parallel value on the same scale.

Another handy device used for the same purpose is the resistor-capacitor chart shown in Fig. 2. To find the correct resistance value of resistors in parallel, place a straightedge on the chart so that one value is covered on the vertical column, R, and the other value on the horizontal column, R. The combined value will be the point where the line crosses the diagonal, R_T-C_T .

Example: what value resistor would I use in parallel with 4 ohms to reduce it to 3 ohms? Placing the straightedge on 4 of the vertical column and on 3 of the diagonal R_T line, we find that the line crosses 12 on the horizontal line, the value to be added. In this case it is 12 ohms.

Other values can be interpolated: 4 ohms can be read 40 ohms and 12 ohms can be read 120 ohms, resulting in an answer of 30 ohms. To prevent error, always bear in mind that the answer will be a number less than the smallest resistance found in the parallel circuit.

When computing more than two re-

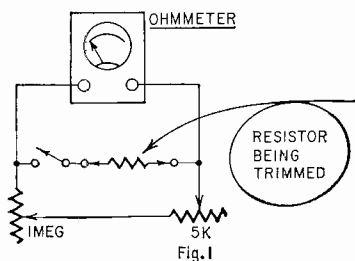

sistors in parallel, first find the combined resistance of any two and add this value of the next resistor, and so on. Thus: What is the total resistance of 3, 4 and 12 ohms connected in parallel?

First find the combined resistance of 4 and 12 ohms, which is 3. Now add the remaining resistance, 3 ohms, proceed-

ing as before, to the 3 ohms (combined resistance of 4 and 12 ohms), arriving at an answer of 1.5 ohms.

Any combination of resistances within reason can be used with this chart. For example, 6 becomes 60,000 and 12 becomes 120,000 ohms. Placing the straightedge across 6 and 12, we find the answer 4 which becomes 40,000 ohms. Thus the combined resistance of a 60,000-ohm resistor in parallel with a 120,000-ohm resistor is 40,000 ohms.

The same holds true for capacitors in series. What is the value of capacitance when a 0.3 μ f is connected in series with a 0.6 μ f? Placing the straightedge across values 3 and 6, we find the line crossing C_T at 2. Thus the answer 0.2 μ f. END

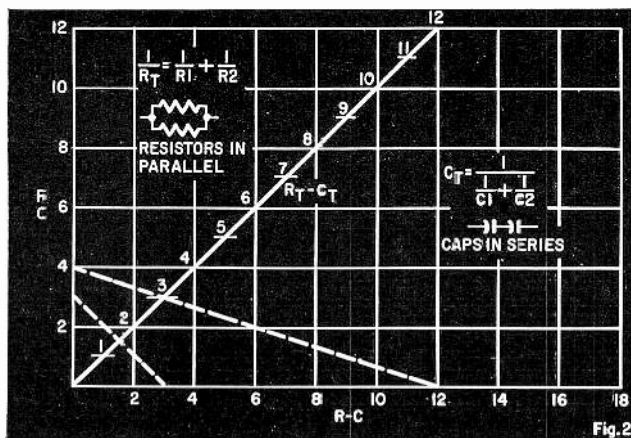
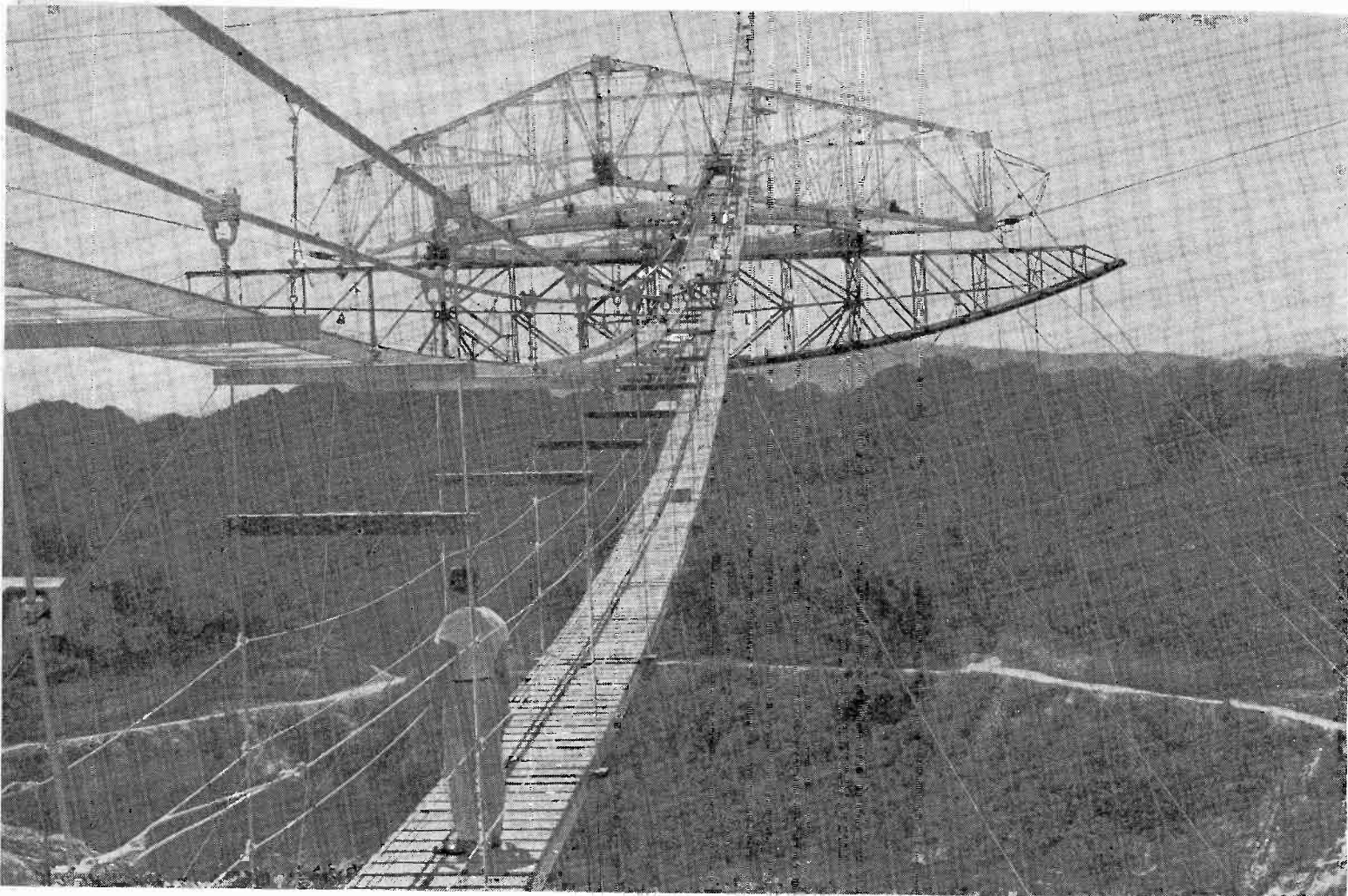

Fig. 2—Simple graph for working with series resistors and parallel capacitors. You can find the resultant of two knowns or the value of an unknown needed to provide a required value of resistance or capacitance. The text describes its use.



Transmission lines and electrical cabling are carried on this 700-foot catwalk (photographed during construction), which also provides access for personnel. The waveguide and electrical wiring had not been installed when this photograph was taken.

Cover
Story

BIGGEST telescope on earth is IN the earth

By ERIC LESLIE

THE WORLD'S BIGGEST RADAR-RADIO telescope, illustrated on our cover, is a partly natural, partly artificial spherical hollow in the hills 12 miles south of Arecibo, Puerto Rico.

Why such a telescope? And why at Arecibo? What is the new instrument expected to accomplish?

Its chief purpose is to study the ionosphere. Satellites and rocket probes as well as radar soundings have given us many new facts about this region whose several layers surround the earth at distances ranging from less than 50 to more than 250 miles. The study has been limited by the small amount of information that could be obtained from existing instruments.

Prof. William Gordon of Cornell University envisioned a system using an extremely powerful transmitter and an antenna of much higher gain than any in existence. He believed that it would be possible to study the changes in the ionosphere by the back-scattering of free

electrons from the various layers at uhf. This would make it possible to measure electron density and temperature, determine auroral ionization and detect transient currents in the ionosphere. Prof. Gordon suggested that the antenna would probably have to be a stationary dish in a natural bowl in the earth. It should be near the equator, he said, so that the solar system would be included in the scanning angle.

The Armed Forces are very much interested in all information obtainable about the ionosphere, as an aid in ICBM detection and decoy discrimination. Therefore, funds were supplied by the Advanced Research Projects Agency as part of the Project Defender Program for exploring ICBM defense techniques. The Air Force Cambridge Research Laboratories was assigned to provide technical management. The laboratories immediately suggested that instead of the usual parabolic reflector a spherical one be used, with a phased-line feed.

This would make it possible to direct the beam over an angle of 20° from the zenith, a much wider angle than would be possible with a parabolic antenna.

The Arecibo site was selected for several reasons. It is within 18° of the Equator and thus in a favorable position to scan the ecliptic, in which the sun and the planets move. There was a natural bowl of very nearly the correct size and shape.

The temperature varies very little, so structural materials would not be greatly affected by climatic changes. The sheltered area among higher hills is protected from heavy winds, and the location is relatively remote from sources of man-made interference.

Even though the bowl was nearly perfect, 300,000 cubic yards of material had to be blasted from some spots, while 200,000 cubic yards were added in others. The big reflector was then constructed of sheets of ½-inch galvanized steel mesh, placed on a cable grid that

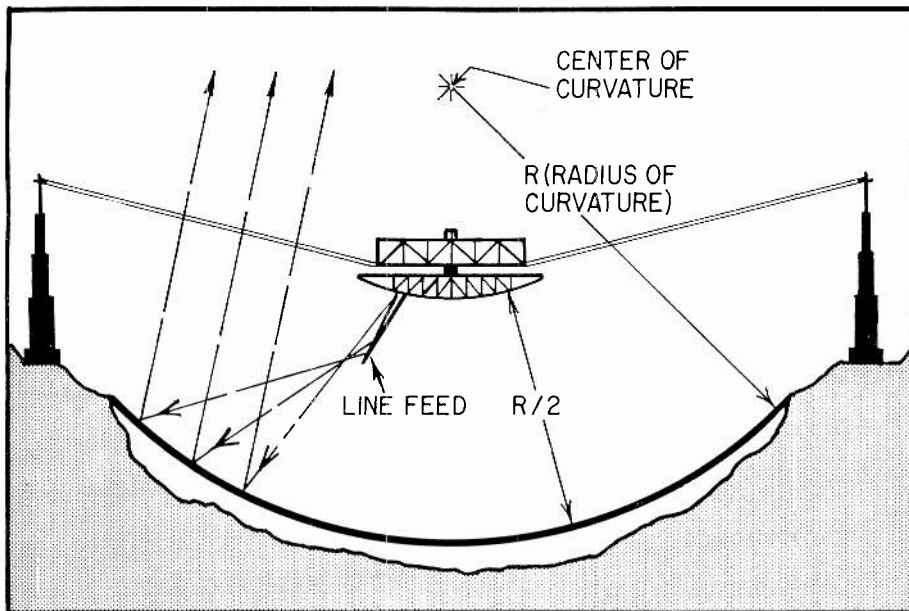

How signals are beamed into the vertical bowl to produce a parallel beam. The shape and slotting of the line feed control the amplitude and the phase of the energy radiated at each point along its length. The vertical angle of the beam can be varied by moving the line feed along the feed arm.

criss-crosses the bowl north-south and east-west. To maintain its shape, the reflector is contoured with vertical tie-down cables every 6 feet, and loaded when necessary with steel ballast rods. The surface forms part of a perfect sphere, with a tolerance of only ± 1 inch.

Since the radar beam can be steered only 20° from the zenith, a complete hemisphere is not necessary. The radius of curvature is 870 feet, while the dish is 1,000 feet across (a total of 18.5 acres).

Signals are beamed at this reflector in a special way: from a 96-foot line feed made of aluminum and mounted 435 feet (half the radius) above the reflector. The reflector being spherical rather than parabolic, the signal can be steered 20° in any direction from the zenith. The line feed is so shaped that signals from different parts of it reach the reflector bowl with different intensities. The lengths of its radiating slots are calculated to vary the phase of these signals so that a beam of parallel rays will be reflected from the bowl. The line feed is suspended from a crescent-shaped track called the feed arm, so the vertical angle can be varied. The feed arm in turn is suspended from a circular azimuth track girder, approximately 129 feet in diameter. Thus, the line feed can be positioned in azimuth within 1 minute of arc, and in elevation to within 0.8 minute of arc.

The structure which holds this transmitting and positioning equipment is a triangular platform, 216 feet on a side, suspended from three concrete towers. Each of these is 700 feet from the center of the reflector, and rises 468 feet above its upper edge. The trans-

mission line, 1,300 feet of waveguide, carries power from the transmitter building just outside the bowl to the line feed.

Two ingenious waveguide joints were necessary to get power to the line feed: a rotary joint to take care of antenna rotation, and a crescent-shaped one for the linear joint. This is a piece of waveguide 160 feet long inside the larger curved waveguide on the lower surface of the feed arm.

The transmitter can be operated as a continuous-wave radar at 150 kw or as a pulsed radar with a peak power of 2.5 megawatts. The transmitter is now operating at 430 mc, although it is expected to operate later at 40 mc, and probably also at a frequency of 900 mc or higher.

Though most of its time will be spent studying the ionosphere, the new telescope will have other uses. With 40,000 times the power of the Millstone Hill radar in Massachusetts, which first detected reflected signals from the planet Venus, it should be able to contact Venus, Mars or Mercury whenever any one of them is in the field of view. Millstone Hill had to wait till Venus was near its closest approach to the earth. Moreover, the new telescope will be able to produce directly observable signals, instead of having to sort them out of background noise with the help of a computer. It will probably also be able to make contact with Jupiter and Saturn when they are in favorable positions. It may also improve the accuracy with which we can determine the astronomical unit of distance, and we may even be able to observe the atmosphere of the sun with radar.

END

Line Voltage & Amplifier Distortion

EVER HAD DIFFICULTY IN TRACKING down the cause of high distortion in an audio system? This story is based on actual experience.

In an installation that included a pair of 20-watt power amplifiers using 5881 tubes, I found the distortion at the 20-watt level to be 3.6% at 1,000 cycles. The amplifiers had a rated 20-watt distortion figure of 0.5% or less. This was a justifiable complaint.

Operating the system at full 20-watt output, I made a stage-by-stage check with an oscilloscope. The waveform was good up to the input of the voltage amplifier before the phase-inverter-driver for the output tubes. At the output of this stage, waveform distortion was noticeable. Here, it seemed, was the point to troubleshoot the circuit!

But that assumption was misleading. The distortion from this stage on was not due to a circuit defect, but was caused by overdriving the stage to obtain full output from the power tubes. But why was this overdriving necessary?

I took dc voltage readings in the various stages. Deviations from normal seemed reasonable until I got to the 5881 output tubes. There, the plate and screen voltages were almost 50 volts below that required for 20-watt output. The power supply rectifier circuit tested OK.

Then I checked the 117-volt power line. It measured 95 volts! The reason? It was heavily loaded with electrical and electronic gear and ran a good distance back to the main power distribution box.

I was able to boost the supply to the audio system to a scant 112 volts with a Variac. The distortion in the 20-watters dropped to 0.55% at full output.

In this case it is obvious that at least another 115-volt circuit was needed to handle some of the load. But in some parts of the country where the supply-line voltage is normally low, a variable transformer to boost the supply voltage may be used to advantage if the low supply is causing audio amplifier distortion.

Incidentally, there was another undesirable condition attributable to this low voltage. The tape recorder used with the equipment was very slow in starting and in reaching normal speed, sometimes requiring a little manual assistance. This also was remedied by the 17-volt boost provided by the power control.

—Harold Reed

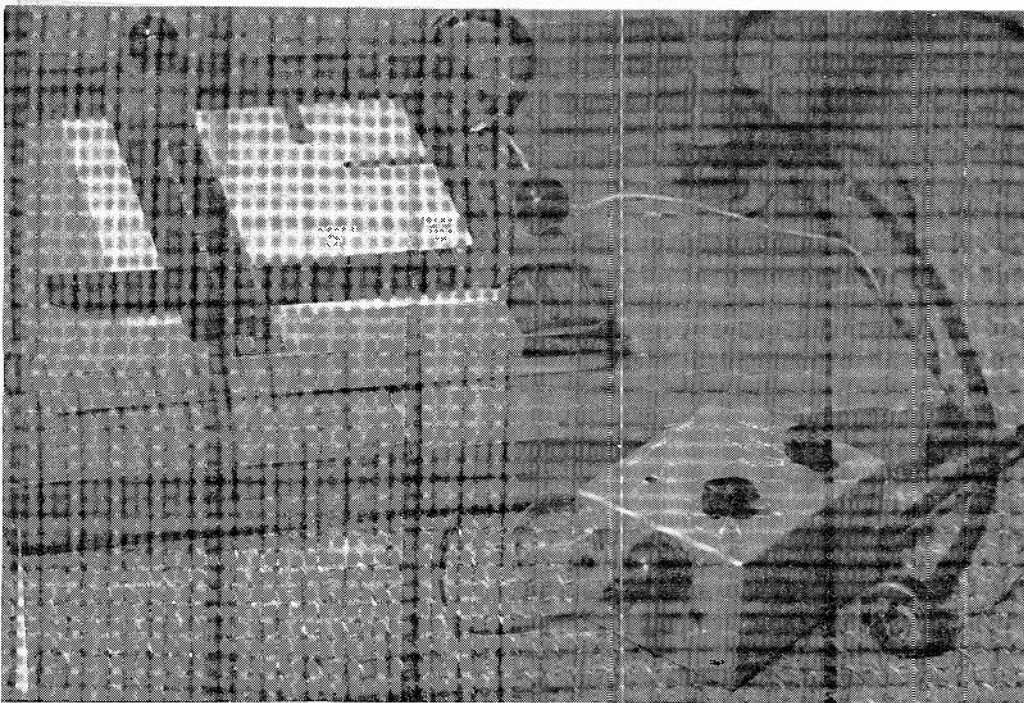

This picture (unretouched) was made by exposing the same paper six times, through a movable mask, from the same negative. The left-most strip was made with the enlarger diaphragm wide open; exposure turned out to be about 1/2 second. Each successive strip to the right was made with smaller and smaller aperture and correspondingly longer exposure. The rightmost one took 45 seconds. But the exposure time was "figured" automatically by the Auto-Photo Timer: notice the uniformity of contrast and tone.

AUTO-PHOTO TIMER

Perfectly exposed enlargements every time—even with changes in paper, diaphragm setting and negative densities **By JOSEPH GIANNELLI**

THOSE OF YOU WHO MIX PHOTOGRAPHY and electronics have very likely run into one of the biggest headaches in making good enlargements: correct exposure. This timer will expose your paper correctly even with changes in diaphragm setting. And it compensates for different papers and negative densities.

The Auto-photo uses a kind of photoelectric feedback, utilizing the light reflected from the paper on the enlarger easel to control the length of the exposure. Fig. 1 is the circuit diagram.

PC is a photoresistive element so placed that it "sees" the photographic paper. Its resistance varies from a few thousand ohms in bright light to a few megohms in darkness. PC and R17 act as a voltage divider to vary the voltage on the grid of V1-a. V1 is arranged as two cathode followers with a diode and a relay coil between them. When S1 is set to EXPOSE, the enlarger lamp is on. The photocell picks up the light and establishes a dc voltage on V1-a's grid. Because of the shape of the photocell and

the way it's mounted, it integrates the light over the paper surface quite well.

As long as V1-a's cathode is more positive than V1-b's, D1 cannot conduct and RY1 remains unenergized (lamp on). C2 is now charging to the voltage set by R7 through R9-R10. This rising voltage is compared with that at the cathode of V1-a, and when the cathode of V1-b becomes 5 volts more positive than V1-a's cathode, D1 conducts. RY1 is energized and the enlarger lamp extinguished. RY2 then shorts out the cell

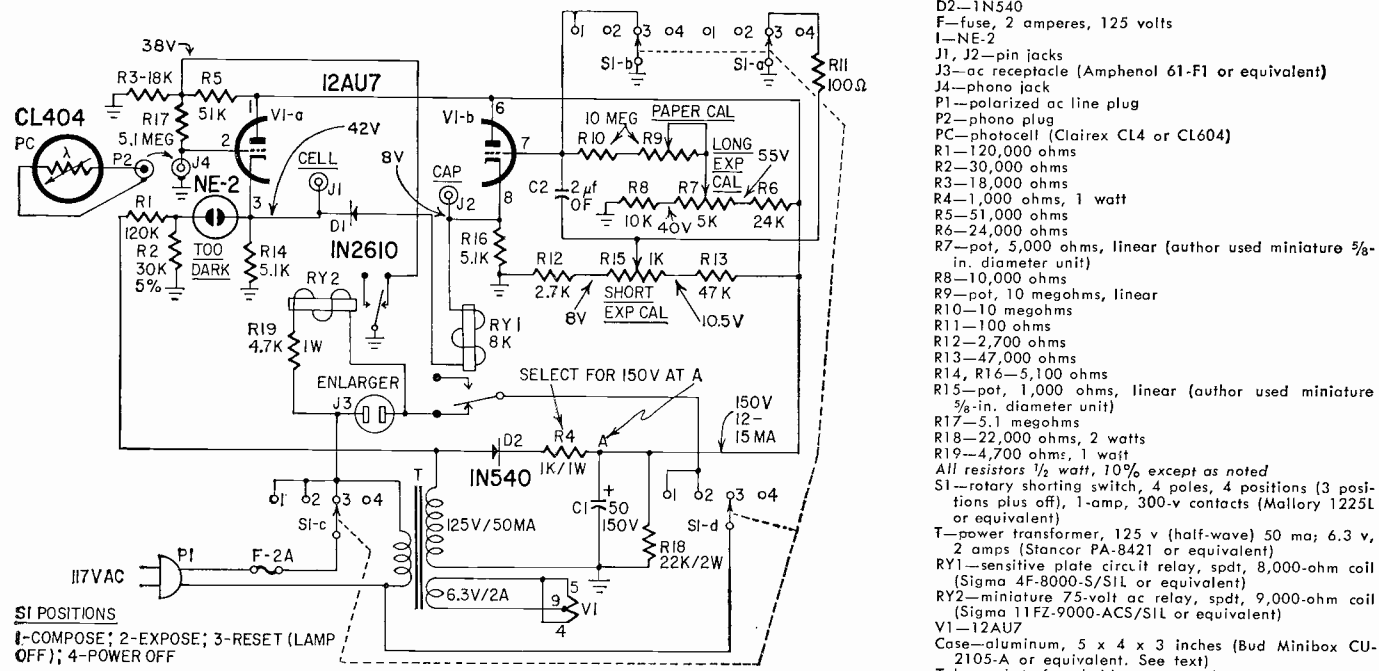

Fig. 1—The Auto-Photo Timer's circuit.

- C1—electrolytic, 50 μ f, 150 volts
- C2—oil-filled, 2 μ f, 200 volts
- D1—1N2610
- D2—1N540
- F—fuse, 2 amperes, 125 volts
- I—NE-2
- J1, J2—pin jacks
- J3—ac receptacle (Amphenol 61-F1 or equivalent)
- J4—phono jack
- P1—polarized ac line plug
- P2—phono plug
- PC—photocell (Clairex CL4 or CL604)
- R1—120,000 ohms
- R2—30,000 ohms
- R3—18,000 ohms
- R4—1,000 ohms, 1 watt
- R5—51,000 ohms
- R6—24,000 ohms
- R7—pot, 5,000 ohms, linear (author used miniature 5/8-in. diameter unit)
- R8—10,000 ohms
- R9—pot, 10 megohms, linear
- R10—10 megohms
- R11—100 ohms
- R12—2,700 ohms
- R13—47,000 ohms
- R14, R16—5,100 ohms
- R15—pot, 1,000 ohms, linear (author used miniature 5/8-in. diameter unit)
- R17—5.1 megohms
- R18—22,000 ohms, 2 watts
- R19—4,700 ohms, 1 watt
- All resistors 1/2 watt, 10% except as noted
- S1—rotary shorting switch, 3 poles, 4 positions (3 positions plus off), 1-amp, 300-v contacts (Mallory 1225L or equivalent)
- T—power transformer, 125 v (half-wave) 50 ma; 6.3 v, 2 amps (Stancor PA-8421 or equivalent)
- RY1—sensitive plate circuit relay, spdt, 8,000-ohm coil (Sigma 4F-8000-S/SIL or equivalent)
- RY2—miniature 75-volt ac relay, spdt, 9,000-ohm coil (Sigma 11FZ-9000-ACS/SIL or equivalent)
- V1—12AU7
- Case—aluminum, 5 x 4 x 3 inches (Bud Minibox CU-2105-A or equivalent. See text)
- Tube socket, fuse holder, metal tubing and miscellaneous hardware

voltage, to prevent V1-a's cathode from going to its high dark voltage and de-energizing RY1 and causing it to oscillate. Since the cathode of V1-b has to be 5 volts above the cathode of V1-a to energize RY1, zero time must be considered from this 5-volt level, and not from zero volts. R15 sets up the proper level for this purpose — important at low cell voltages (high light levels and short exposures).

The voltage drop across the cell is not linear with varying light values. This is partly due to the cell itself and the value of R17. To make sure that the charge voltage across C2 tracks perfectly with the cell voltage at various light values, a plot of cell voltage vs incident light was made. This plot shows correct exposure for each increment of light, and was made from many trial exposures at various light levels.

R17 was chosen empirically, until it gave a curve that could easily be duplicated ("tracked") with a capacitor's charge curve (see Fig. 2). The charge voltage on C2 was then made to agree with the plot of Fig. 2. The voltage across R7 is used to calibrate the top end of the charge curve near 95% of the applied voltage. This is the region where the longer exposures are made. Remember that decreasing light causes an increase in cell voltage.

When the enlarger lamp is automatically extinguished, put S1 in the RESET position, which shunts 100 ohms across C2, discharges it, opens the lamp circuit and de-energizes RY1. You are now ready for your next exposure.

A COMPOSE position is provided on S1 to turn on the enlarger lamp for setting up, focusing and diaphragm adjustments. Returning S1 to RESET will extinguish the lamp so that you can put photographic paper in the easel. Switch to EXPOSE, and you will have another correct exposure.

The neon bulb connected to the

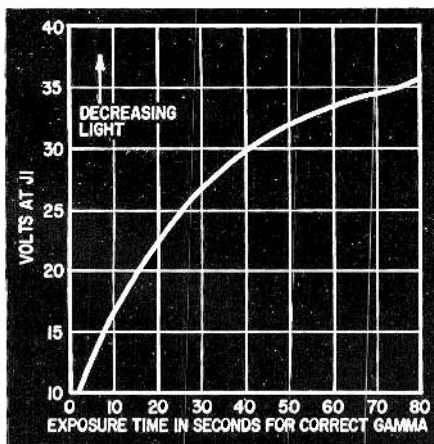
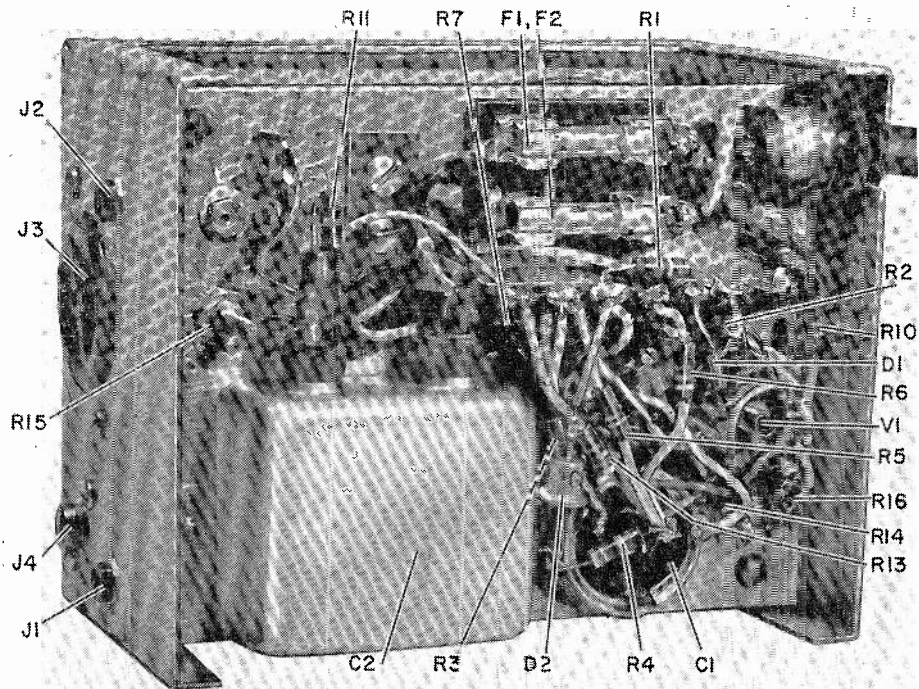

Fig. 2—Plot of cell voltage (measured at J1) vs exposure time, using a 150-watt enlarger lamp and Kodak G2 paper. The charge rate of C2 is adjusted to match this curve as closely as possible.



The open back of the Timer. Layout is not critical.

cathode of V1-a and the junction of R1 and R2 serves as an indicator which ignites when light value falls beyond the reliable range of the unit. A 1-minute exposure requires a surprisingly small amount of light (much less than .01 foot-candle), and this seems more than adequate for even the most severe enlarging conditions.

Construction

The whole unit is housed in a Bud 5 x 4 x 3-inch Minibox, labeled with decals. [This box is very compact and you'll have to be careful with your layout to fit all parts into it. We suggest using a 6 x 5 x 4-inch such as the Bud CU-2107-A or equivalent to simplify parts placement. The two relays, power

transformer, 12AU7 are above the sub-chassis. S1 and R9 are on the front panel. —Editor] The photocell is external and plugs into the side of the unit. A 1/16-inch thick, 3 3/4 x 4 7/8-inch plate, mounted on two posts, is used as a subchassis. The jacks and receptacle can be laid out on the side of the box once the other components are mounted. The neon indicator is mounted with cement (Miracle Adhesive) on top of T, directly under the opening at the top of the box. C2 is mounted beneath T.

The Sigma 4F and 11FZ relays must be insulated from the chassis plate. A piece of thin fiber on both sides will do the trick, with the mounting holes drilled oversized. Two pieces of 3/8 x 1 1/16-inch curtain rod are drilled and

The Auto-Photo Timer in its case. Just in front is the tube and bracket that holds the photocell to the enlarger stand. You can see the cell at the opening of the tube.

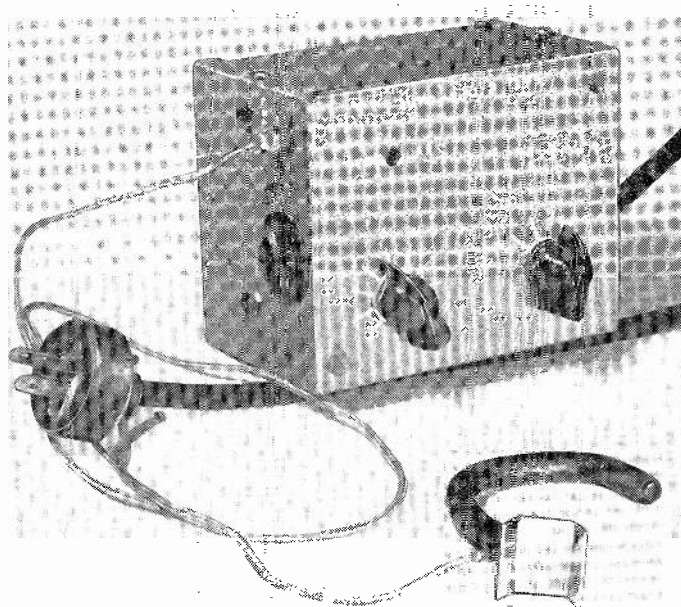

tapped for 6-20 screws. Mount the ends to the inside of the box with flat-head screws. The other ends support the chassis plate.

The photocell is mounted inside a 3/8-inch copper tube bent into a half-round so that the seeing end is 3 inches off the photographic paper, and mounted on the easel to look into the center of a 5 x 7 image. The seeing end must be outside the projected image so that it doesn't cast a shadow on the photographic paper. Once this is done, mount the tubing permanently to the easel, solder the cell to 3 feet of shielded phono cable and pull the cable through a hole in the bottom of the tube. Secure the cell in the seeing end with a small wooden wedge and install a 13A Cinch phono plug on the other end of the phono cable. Paint the tube a flat black.

Mount filter capacitor C1 from the bottom of the chassis plate—it would stand too high if mounted on top. Fasten with a makeshift strap soldered to the case of T.

Calibration and test

Before applying power, recheck wiring and diode polarities. Set S1 to RESET and check for the voltages indicated on the schematic. Read the voltages with a vtvm, J4 open-circuited.

To set up Sigma 4F relay Y1 for proper operation, place a .010-inch shim between armature and pole and adjust the normally open contacts so that this circuit is closed when the armature is

pressed lightly. Adjust spring tension so that the relay energizes with about 5 volts across the coil (measured with a vtvm). Do this by plugging the photocell into J4, shading the cell so that about 15 volts appears at J1 and switching S1 from RESET to EXPOSE. With the voltmeter across the coil, the relay should click in at 5 volts.

Now you can make adjustments to set the charge curve of C2 so it will track with the plot of Fig. 2.

Attach the photocell to your easel and set R9 to center position. Be sure that your enlarger lamp is 150 watts, and that your safelight illumination does not fall on the easel. All other lights are out. Set S1 to COMPOSE and adjust the enlarger for a 5 x 7 image, with no negative in place. Adjust the enlarger diaphragm until 10 volts appears at J1. Set S1 to RESET, then to EXPOSE. The enlarger lamp should go out in 2 seconds. If you do not have a stopwatch, find a windup clock with a loud tick. Listen to the "tick-tock" and you will find that every "tock" is a 1/2-second interval—four "tocks" for every 2 seconds. Repeat the RESET and EXPOSE switching, adjusting R15 until the lamp goes out in 2 seconds.

To calibrate the high end, adjust the enlarger diaphragm until 33 volts appears at J1 with S1 in the COMPOSE position. Return S1 to RESET, then to EXPOSE. The lamp should now extinguish in 60 seconds. If not, adjust R7, repeating the test until it does. If you

have trouble getting 33 volts at J1 even with the enlarger diaphragm fully closed, put a negative in your enlarger to cut out more light.

To calibrate the mid-range, set S1 to COMPOSE and adjust the enlarger diaphragm for 25 volts at J1. Set S1 to RESET, then to EXPOSE. The lamp should extinguish in 25 seconds—if not, adjust R9.

Since the adjustments of R7, R9 and R15 are interdependent during calibration, repeat the adjustments until they agree within 15% to 20% of the plot in Fig. 2.

The NE-2 should fire when approximately 36 volts appears at J1. Select a different value of R2 if necessary.

Operation

R9, mounted on the front of the box, has its rotation marked off in 10 numbered positions. This serves as a calibration control for various paper types. R9 works independently of R7 and R15 once the unit is calibrated. Just select a position on R9 that gives the correct exposure for a particular paper, and make a note of it. If you change paper grade or manufacturer, place R9 in the correct new position and leave it there.

A 150-watt enlarger lamp has a Kelvin rating of about 2,800. A higher-wattage bulb has a higher Kelvin rating, decreasing the sensitivity of the photocell. You may have to trim resistances R6-R10 if you use another lamp. END

WHAT'S YOUR

EQ?

Three puzzlers for the student, theoretician and practical man. Simple? Double-check your answers before you say you've solved them. If you have an interesting or unusual puzzle (with an answer) send it to us. We will pay \$10 for each one accepted. We're especially interested in service stinkers or engineering stumbers on actual electronic equipment. We get so many letters we can't answer individual ones, but we'll print the more interesting solutions—ones the original authors never thought of.

Write EQ Editor, Radio-Electronics, 154 West 14th Street, New York, N. Y.—10011.

Answers to this month's puzzles are on page 62.

Neon-Bulb Circuit

In the circuit shown, one neon lamp requires a minimum of 74 volts for ioni-

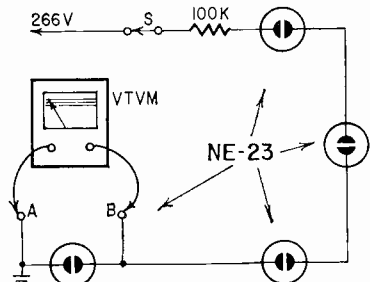

zation and four in series require a minimum of 296. After ionization, the drop across each lamp is 59 volts and the total current 0.3 ma.

Assuming that the lamps are non-conducting when switch S is closed (because 266 volts is not enough to start conduction), what change will occur when a vtvm with an input resistance of 10 megohms is connected across terminals A and B? Also, what reading will the voltmeter have and what will happen when the voltmeter is disconnected from the circuit?—Kendall Collins

The Innocent Black Box

A black box has only two terminals. When I use an ohmmeter to check the resistance in the R x 1 range, the meter reads 25 ohms. When I change

the range to R x 10, the meter reads only 10 ohms. The meter has been recently checked for calibration and is good. The black box does not contain any voltage source. What does it contain?—H. D. Varadarajan

A No-Signal Stinker

In this old Stromberg-Carlson radio (1210), there is no signal through the 6SC7 stage. The tube is new and good. B-plus voltages are OK, all resis-

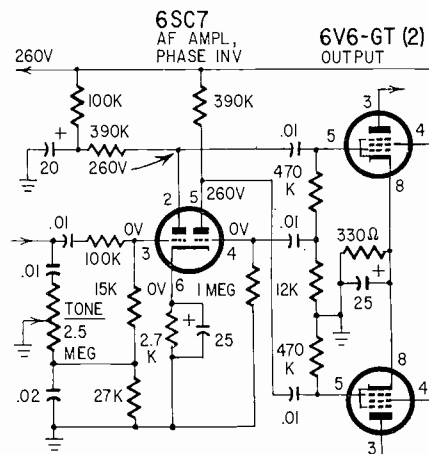

tors and capacitors are good, and measure close to rated values. What's wrong?—Jack Darr

By LLOYD VINCENT

FM reception today offers the near-ultimate in high-fidelity listening. In many hi-fi tuners, FM as well as AM, the detector is the chief source of distortion. There was a time when this distortion was of little concern but, with today's audio amplifiers virtually distortionless, detector distortion has taken on new importance. Anything that can improve the detector stage is well worth the effort. But what can be done to improve the FM detector?

Basically, the trouble stems from a discriminator or ratio-detector transformer that does not have enough bandwidth to handle the i.f. signal. Fig. 1 shows the response characteristic of a typical discriminator or ratio detector, commonly called the S-curve. Note that the curve is linear up to a certain point (A) on either side of the center frequency, f_c . Beyond this point, the curve is no longer linear and the detector output is not proportional to the frequency deviation. When the i.f. signal swings into this non-linear area, distortion appears in the output.

There are two reasons why the i.f. signal might swing too wide for the existing detector transformer: If the FM station overmodulates on peaks, the signal will exceed the linear portion of the average transformer (Fig. 2-a). Unfortunately, there are FM stations that do overmodulate—some inadvertently, a few deliberately. The second and more frequent cause of excessive signal swing is a detector transformer with a linear portion not wide enough to accept a heavily modulated, but not overmodulated, signal. The effect is essentially the same as that of the overmodulated signal. There, the signal was too wide for a standard transformer. Here, the transformer is not wide enough for a standard signal. There is a fine difference between the two, but the effect is the same. When the signal swings beyond the linear portion, the output is distorted (Fig. 2-a).

Surprisingly enough, the standard FM signal can be wider than it is usually considered to be. An FM signal which is being modulated 100% by a 15-kc tone has significant sidebands as far as 120 kc away from the center frequency. Thus, to hold distortion to a minimum, a transformer with a linear portion at least 240 kc wide is required. Stereo multiplexing places even more stringent demands upon the high-frequency response of both the transmitter and receiver.

Another type of distortion closely related to these two occurs when a signal that could fall entirely within the linear portion of the curve is forced to swing into one of the nonlinear areas by the receiver being mistuned, because of human error or oscillator drift. This is shown in Fig. 2-b. Also, music is not a single note but a combination of many. The high-frequency components can "ride" on the stronger low fre-

improve FM reception with a wide-band detector

Add one to any FM tuner or radio—you'll
be amazed at the difference

quencies and combine to overmodulate the transmitter (Fig. 3).

Increasing bandwidth

If we can make the linear portion of the detector curve wide enough, we can eliminate distortion caused by these three conditions. Little can be done to the detector circuit to increase its bandwidth, so the obvious solution is to replace the existing detector transformer with one that has a wider linear portion and greater peak-to-peak separation.

But just how wide should the ideal transformer be? A bandwidth of 240 kc is required for low-distortion detection of a 15-kc note at full deviation.

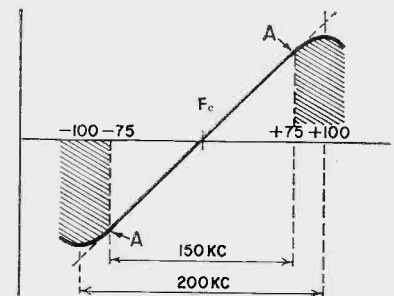

Fig. 1—S-curve of a typical FM detector. Distortion occurs if the FM signal swings past the linear portion into the shaded areas.

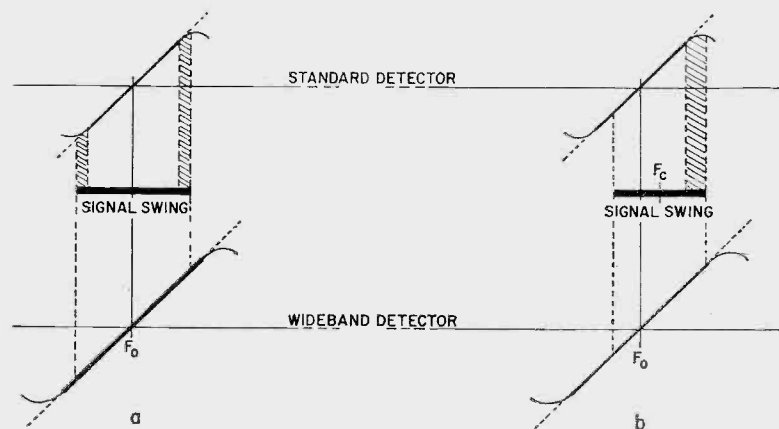

Fig. 2—S-curve of a wide-band transformer compared with a standard one. The heavy part of each curve represents its linear portion. In (a), the swing, represented by the horizontal bar, is too great for the standard transformer and distortion occurs on both positive and negative peaks. In (b), the signal is tuned off center and distortion occurs on one peak. In both cases, the output of the wideband transformer is not distorted.

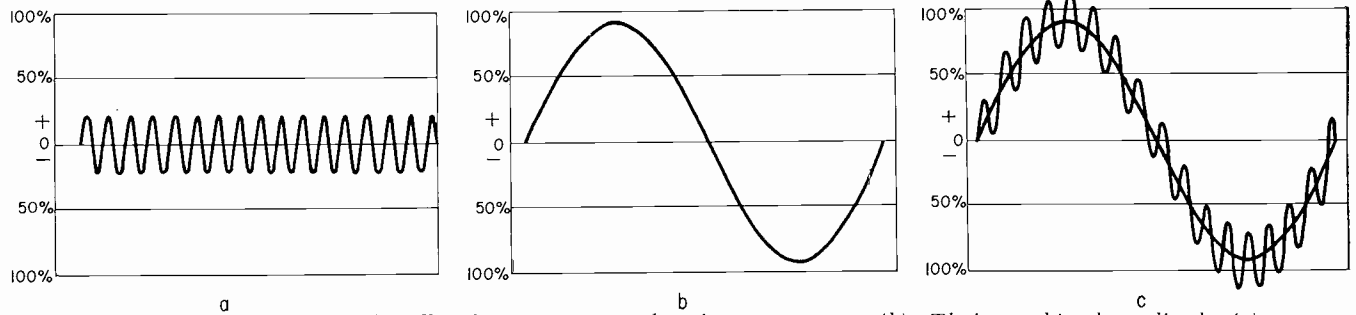

Fig. 3—A high frequency tone (a) will ride on a strong low-frequency tone (b). Their combined amplitudes (c) can cause the FM transmitter to be overmodulated.

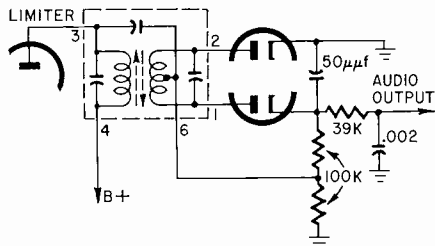

Fig. 4—Typical discriminator type of FM detector.

To this, add 20 kc to allow for oscillator drift, overmodulation, etc. This means we should have a transformer with a linear portion at least 260 kc wide.

Discriminator and ratio-detector transformers are usually described in terms of peak-to-peak separation, if any mention of bandwidth is made. The linear portion of a transformer's curve is generally equivalent to 70% to 75% of the peak-to-peak separation. Thus, the greater the peak-to-peak separation, the better the overall performance of the receiver. Not only will the distortion be lower, but the effects of oscillator drift will be lessened. Tuning will be easier and less critical, and the capture ratio of the tuner will be improved. Consequently, there will also be better separation of adjacent signals.

Improved transformers available

In the past the service technician or audiophile has been able to do very little about the bandwidth of his discriminator or ratio-detector transformer. But recently transformers with greater bandwidths have been developed. The Stanwyck Winding Co. has marketed a transformer (S-626) which has a peak-to-peak separation of 325 kc and a linear portion 250 kc wide. Thordarson-Meissner makes a transformer (17-3487) with 400-kc peak-to-peak separation. Eico, in its FM tuner kits, uses a ratio-detector transformer with a 600-kc peak-to-peak spread and a 400-kc linear portion. The Scott FM tuners use a discriminator with a 2-mc bandwidth.

The J. W. Miller Co. is now marketing a wide-band ratio-detector transformer (1465-WB) with 800-kc peak-to-peak separation, and a wide-band discriminator transformer (1464-WB) with 900-kc separation. These two units are readily available and can be used to improve the performance of many FM tuners and radios in use today.

Using the Miller 1465-WB for ratio-detector circuits and the 1464-WB

for discriminator circuits (because they offer the greatest bandwidth of any of the replacement transformers presently available), I have replaced many older transformers. The results have proved to be well worth the effort.

Improvement noted

Three hi-fi FM tuners and five FM radios have been improved this way. Two of the radios and one of the tuners were AM-FM combinations. AM circuitry in an FM receiver has no effect upon the FM detector stage, even though some sets use *if* stages common to both signals.

The degree of improvement depends largely on the bandwidth of the old transformer. In the Eico HF-90 FM tuner, which already had a transformer with 600-kc peak-to-peak separation, the improvement was rather subtle. It was noticeable only on very loud passages and also on one of the local stations that frequently overmodulates. The improvement in the AM-FM radios was immediately obvious. Even the other two FM tuners showed a marked freedom from high-frequency breakup on the louder passages.

None of the receivers was realigned—at least not immediately after

can be replaced with a wide-band transformer by any qualified service technician. The charge should be modest. If the receiver is several years old, check the overall receiver alignment while it is on the bench. With a little care and caution, the replacement can be made by anyone who can read schematics and has had at least a little experience with a soldering iron, such as building a kit.

A word or two of warning: Do not disturb the lead dress of any wires in the set except those going to the detector transformer! Even these should not be moved any more than necessary. Also, while the physical arrangement of the terminals on the bottom of the old and new transformers may appear identical, the internal connections to these terminals can be and often are different. Therefore, the new transformer should be wired according to the schematic and not according to the previous physical connections.

Three basic FM detector circuits are used in hi-fi equipment today. These are the discriminator (Fig. 4), and the balanced and unbalanced ratio detector (Fig. 5). The terminal numbers shown are those of the wide-band transformers. Fig. 6 shows the terminal arrangement on the bottom of the transformer.

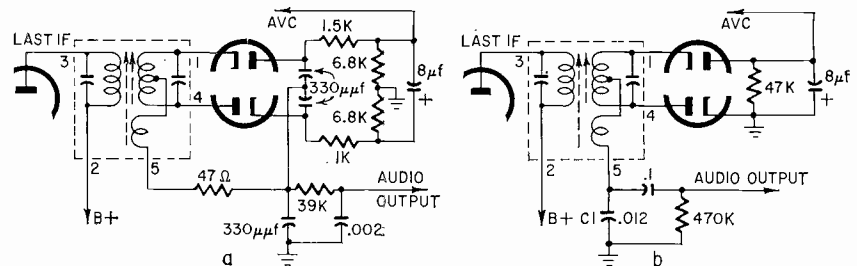

Fig. 5—Two types of ratio detectors: a—balanced, b—unbalanced.

the new transformer was installed. Instead, the new wide-band transformer was aligned with the frequency to which the *if* section of each particular receiver was peaked. This was done so that any improvement resulting from realignment would not be credited to the new transformer. (Eventually several of the receivers were completely realigned for optimum performance. But the improvements mentioned were noted before that.)

Installing a new transformer

The existing detector transformer

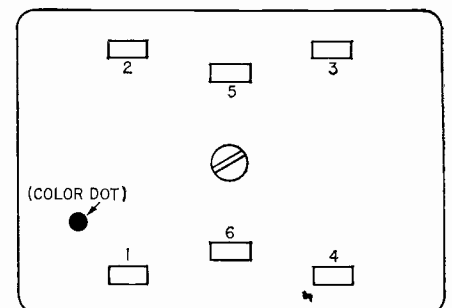

Fig. 6—Base-terminal arrangement of Miller 1464-WB and 1465-WB transformer.

A ratio-detector transformer should of course, be replaced with a ratio-detector transformer, and a discriminator with a discriminator type. (The one exception might be the discriminator that is preceded by only one limiter stage. The use of a ratio detector, with the required circuit changes, would be an improvement over the original design.) If there is any doubt about which type of detector a set uses, check the connection of the diodes to the existing transformer. If the plates of both diodes are connected to the transformer secondary, it is a discriminator. If the plate of one diode and the cathode of the other diode are connected to opposite ends of the transformer secondary, it is a ratio detector.

Alignment

Once the new transformer has been installed, all that is left to do is to touch up the alignment of either the new transformer only or the entire receiver. Just which should be done depends on the test equipment available, the experience and ability of the individual and the age and condition of the receiver.

The audiophile whose experience has been limited to kit building probably does not have the equipment or the knowledge to make a complete i.f. alignment. If it is warranted either by the age or condition of the set, or the demand for absolute optimum performance, it can be done by a qualified service technician. On the other hand, if the set is in good condition, a slight touchup of the adjustments of the new transformer can be made fairly easily by the average audiophile, without using test equipment, if the procedure given here is followed carefully.

First, allow the receiver to warm up for 20 or 30 minutes. Then tune in a very weak signal. If there is no weak signal in your area, the same effect can be obtained with a strong signal by substituting a short piece of wire for the antenna or by loosely coupling the antenna lead-in to the receiver. A pad (Fig. 7) could be constructed to attenuate the incoming signal. The signal should be reduced to the point where both noise and the detected audio can be heard, with the audio somewhat the louder of the two.

Disable the afc. Next, rock the receiver tuning control back and forth, stopping at the point where the audio is the loudest. Many receivers have a meter, an "eye" or some other similar tuning indicator. It can be used in the normal way to determine when the receiver is precisely tuned to the incoming signal. For even greater accuracy, hook a vtvm to the limiter grid. You'll find it much easier to spot the peak. To avoid mistuning, it is wise to recheck the setting of the tuning control one or two times during alignment. It will prevent mistuning caused by tuner drift—you'll be sure you're accurately tuned to the station while aligning.

Now adjust the bottom slug (the primary) of the new detector trans-

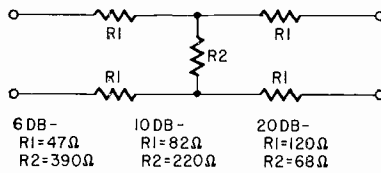

Fig. 7—H-pad for signal attenuation. Values are given for three degrees of attenuation. Two or more pads can be cascaded if necessary.

former for the loudest audio. Probably no more than one turn in either direction will be required. It is wise to note how far and in which direction the slug has been turned, so that it can be returned to its original setting if necessary. Do not rely on the tuning indicator at this point. Instead, adjust for maximum audio.

Next, adjust the top slug for minimum noise and maximum audio. Particular attention should be given to the "hissing" sound referred to as noise. As the top slug is tuned through the proper point, this noise will drop off sharply and will then begin to increase again after the proper point has been passed. The change in audio amplitude around this point is not nearly so pronounced as the change in noise level. This sharp null in the noise represents the point at which the transformer secondary is properly tuned. Chances are good that the top slug will not have to be turned more than a quarter turn in either direction.

There is usually some interaction between the two adjustments. It is possible that the slugs will have to be adjusted alternately several times. The final adjustment should be made to the top slug. If the receiver does not null and peak as just described, the entire i.f. section probably needs realignment.

Bandwidth of i.f. stages

With the new wideband ratio-detector or discriminator transformer installed and aligned, the question of whether to increase the bandwidth of the i.f. transformers might arise. While there are ways to do this, it is doubtful that it is necessary or even advisable.

H. H. Scott while using an extremely wide, 2-mc detector circuit in its FM tuners, still uses the standard 150-kc i.f. bandwidth. This is a good compromise between low distortion and good selectivity. Certainly a 150-kc i.f. bandwidth does not nullify the benefits of a wideband detector or discriminator.

Nothing can be obtained for nothing, of course, and there is one penalty for installing the wideband circuit. Audio output drops appreciably. This is not an important factor in my case, but might be important to listeners in fringe areas.

Installing a wideband ratio detector or discriminator is easy and simple. The improvement in receiver performance, especially in reduced distortion, is more than worth the time and effort for those who desire the best in high-fidelity FM reception. END

Educational Television May Nudge Out Textbooks?

Educational TV may be as commonplace as textbooks by 1970, believes Stanley Lapin of Adler Electronics. Speaking to the Third Annual Educational Television Conference, Mr. Lapin stated that the FCC ruling opening 30 channels in the 2,500-mc band for ETV eliminates two major barriers—high costs and insufficient channels. He told the conference that a two-channel ETV system in the 2,500-mc range can be installed in a large city for as little as \$2.25 per student. Student costs would probably run higher in smaller population units, though equipment for 2,500 mc would be substantially cheaper than previously available ETV systems.

Meanwhile, Robert E. Lee, FCC Commissioner, told the same conference that educators are not using the television available to them—neither closed circuit TV nor the present channels now allotted to ETV. "The FCC," he said, "has set aside valuable frequencies and pleaded with educators that they be used."

R-E Abbreviations

RADIO-ELECTRONICS is adopting the modern abbreviation "pf" for " $\mu\mu\text{f}$ ". (The "p" in this case is short for pico, meaning "very small." Both the "p" and the " $\mu\mu$ " represent 10^{-12} .) This abbreviation has been coming into more and more common use in the past year or two, and is especially handy for people who do not have the character " μ " on their typewriter keyboards.

We are also using "Q" instead of "V" to designate transistors. While usage has been split on this, "Q" is now used by the majority of American publications.

Music to Type By

Young stenos who have grown up listening to music while doing their homework can transcribe recorded dictation the same way—if they happen to work for Equitable Life Assurance Society. Built by McGraw-Edison's Voice-writer Division, the firm's system puts a music background on an office network of 43 transcribing machines, so the boss's voice has a canned-music accompaniment.

PROFESSIONAL

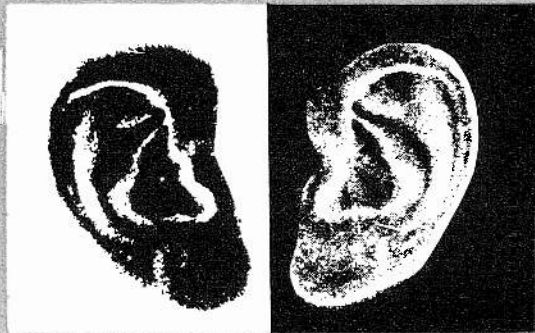

STEREO

LINE AMPLIFIER

High-quality unit has continuous bass and treble compensation

By HAROLD REED

MOST PROFESSIONAL AUDIO INSTALLATIONS (and some home systems) use line (intermediate) amplifiers to make up for losses between preamps and power amplifiers, and to insure plenty of drive voltage for the power amplifiers. In broadcast studios these are often called program amplifiers.

When stereo came in, many outfits simply doubled everything, although this wasted space, power and money. Moreover, the gain of the channels was often unequal and had to be compensated somehow.

The design shows a four-tube pro-

fessional stereo line amplifier with separate bass and treble tone controls in each channel.

The two channels are identical, part for part, so only one need be described. The input signal enters through T1, a wide-range input transformer that steps up the 500/600-ohm line impedance to about 50,000 ohms. It passes on to V1-a through the Baxandall type tone control network (which can be bought complete and prewired as Centralab C3-300). Part of V1-a's output is fed back to the input of the network, since the Baxandall circuit is a feedback sys-

tem. V1-b is a straight "gain" stage, and V2-a drives the output line (again 500/600 ohms) through T2, a stepdown transformer. R10 provides a feedback loop around V1-b and V2-a. R23 serves as an output level control, and also terminates the output properly.

Construction details

The original amplifier, built for the Navy, was on a 2 x 13 x 7-inch aluminum chassis fastened to a 10½ x 19-inch rack-mount panel. This allowed room for the VU meter and switch, which appear in the photos but are not part of

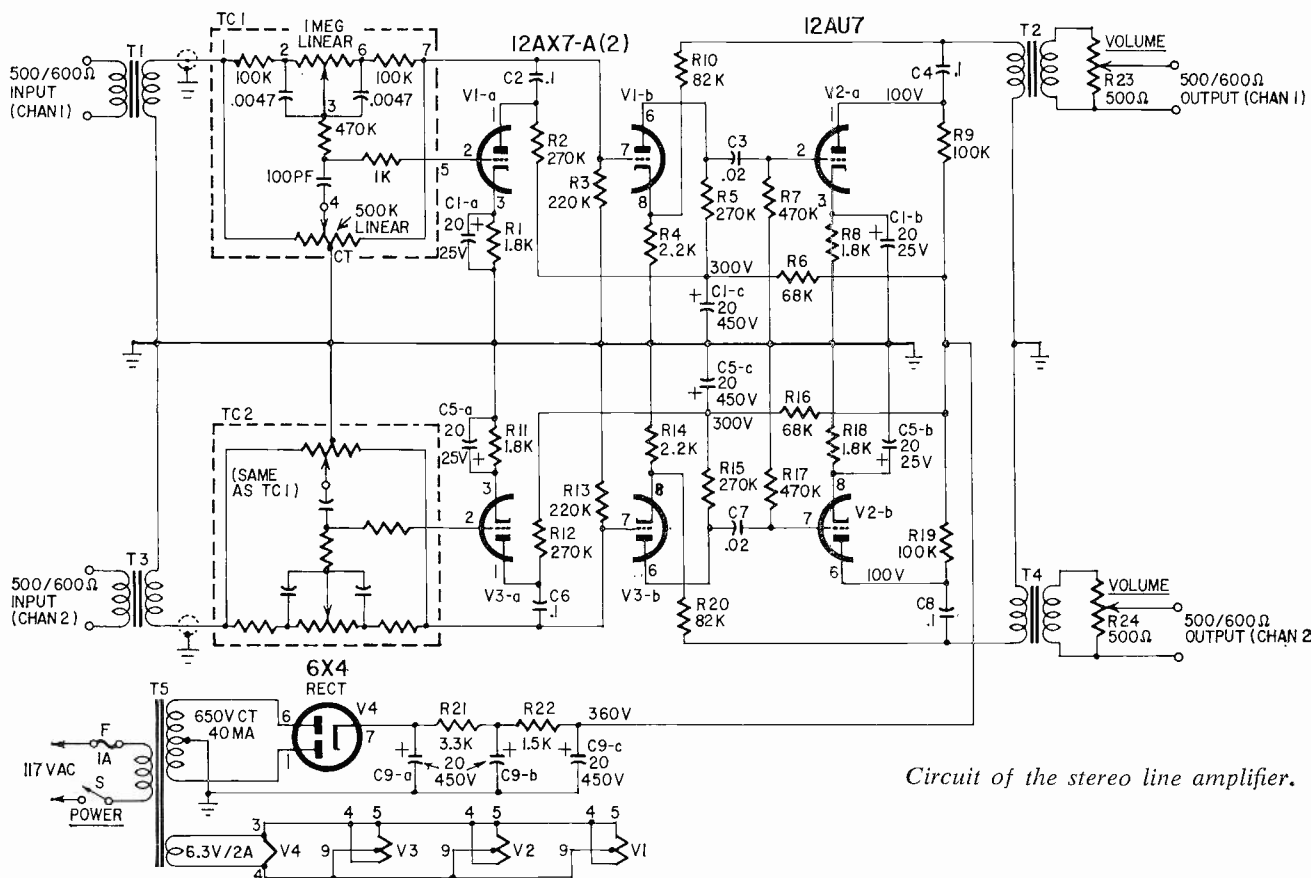

Circuit of the stereo line amplifier.

the amplifier and are not in the schematic. If you build the amplifier, you can use a much smaller chassis. While layout is not especially critical, you are dealing with relatively low-level audio, and since this is a stereo amplifier, there may be crosstalk problems if you take gross liberties in layout and wiring. Use the usual precautions in building the amplifier. Particularly, keep the signal transformers well away from the power transformer. In the original, shielded leads were used between input transformer secondaries and tone controls.

All external connections except ac power are made to the barrier terminal strip on the back of the chassis.

Performance

Each channel has a voltage gain of 42, or 32.5 db. Used with a G-E VR-22 stereo cartridge and a G-E stereo preamp with 32 db gain, the line amplifier delivers about 2 volts output across 500 ohms. A 50,000-ohm to line transformer was used at each preamp output, giving a voltage stepdown of 20 db.

Hum and noise are 75 db below 2 volts out. Distortion was 0.5% at 50 and 1,000 cycles, and 0.8% at 15,000 cycles. Frequency response is down 1.3 db at 50 cycles, 0.5 db at 15,000 cycles, taking 1,000 cycles as 0-db reference. The tone controls give bass boost and cut of 11 db at 100 cycles. Treble boost and cut are 10 db and 12 db, respectively, at 10,000 cycles. Negative feedback in each channel is 13 db.

The amplifier also works well with Fisher PR-6 preamplifiers, which give a gain of 40 db in this service. Using the PR-6's, the line amplifier will drive low-sensitivity amplifiers—ones that require 1.5 volt or more input—to full output with R23 and R24 turned only about a third of the way up.

The stereo line amplifier, though useful almost anywhere, is especially suited for stereo PA systems. END

- R1, R8, R11, R18—1,800 ohms
- R2, R5, R12, R15—270,000 ohms
- R3, R13—220,000 ohms
- R4, R14—2,200 ohms
- R6, R16—68,000 ohms
- R7, R17—470,000 ohms
- R9, R19—100,000 ohms
- R10, R20—82,000 ohms
- R21—3,300 ohms
- R22—1,500 ohms
- R23, R24—potentiometer, 500 ohms

(Ohmite AB type CU5011 or equivalent)

All fixed resistors 1/2 watt, 10%

C1, C5—electrolytic, 20–20 μ f, 25 v, 20 μ f, 450 v (author used 20–20/450, 20/25)

C2, C4, C6, C8—0.1 μ f, 400 v, paper

C3, C7—0.02 μ f, 400 v, paper

C9—electrolytic, 20–20 μ f, 450 v

T1, T3—input transformer, 500-ohm pri to 50,000-ohm sec (UTC A-11)

T2, T4—plate-to-line transformer, 15,000-ohm pri to 500-ohm sec (UTC A-24)

T5—power transformer, 650 vct, 40 ma or higher; 6.3 v, 2 a or higher

TC1, TC2—Centralab C3-300 tone control (includes R-C network and pots). Available from many parts stores and mail-order houses even though not in all catalogs. Network alone, less pots, is PC-190.

V1, V3—12AX7-A

V2—12AU7

V4—6X4

F—fuse, 125 v, 1 a

S—spst toggle switch

Chassis—2 x 13 x 7 inch aluminum

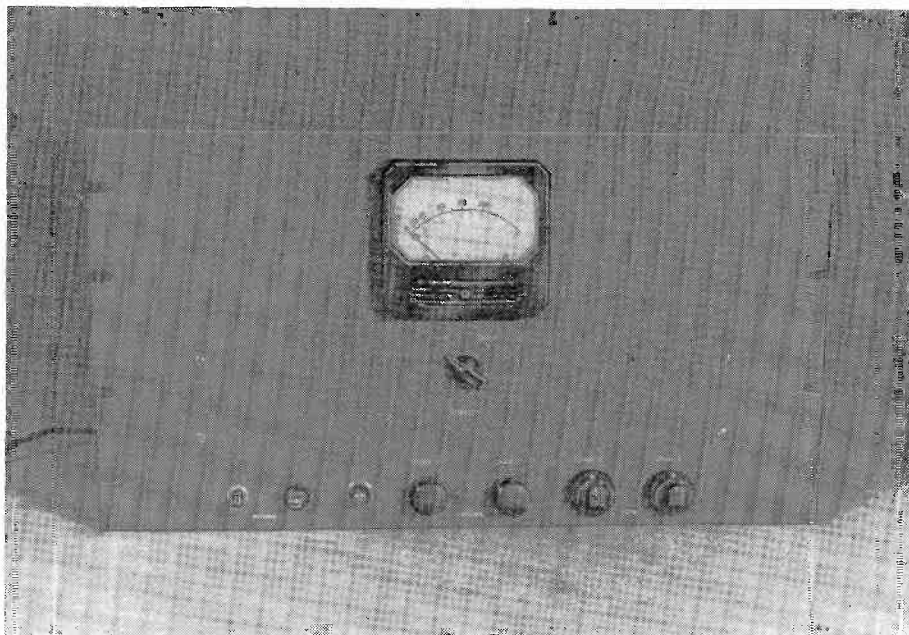

Finished product. Though shown here with oversize rack-mount panel, amplifier could be built into other equipment or housed in cabinet. VU meter and selector are not essential part of circuit.

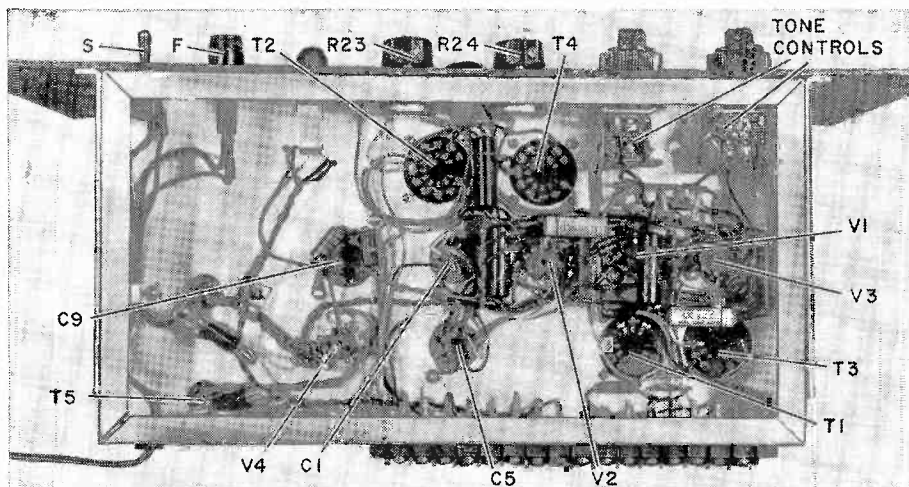

Under the chassis. Large chassis makes wiring easy.

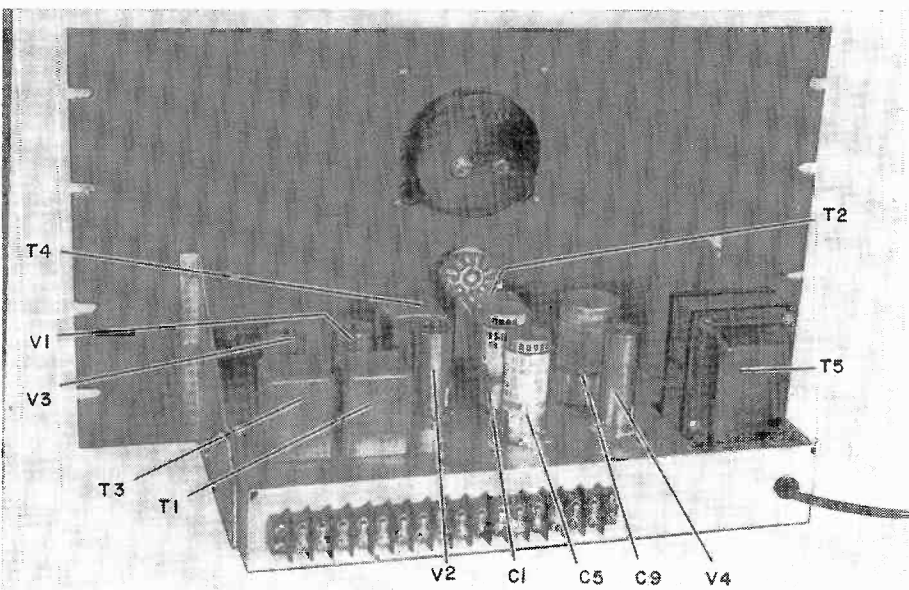

Rear view shows distinctly professional appearance. All connections except ac power are made to terminal strip.

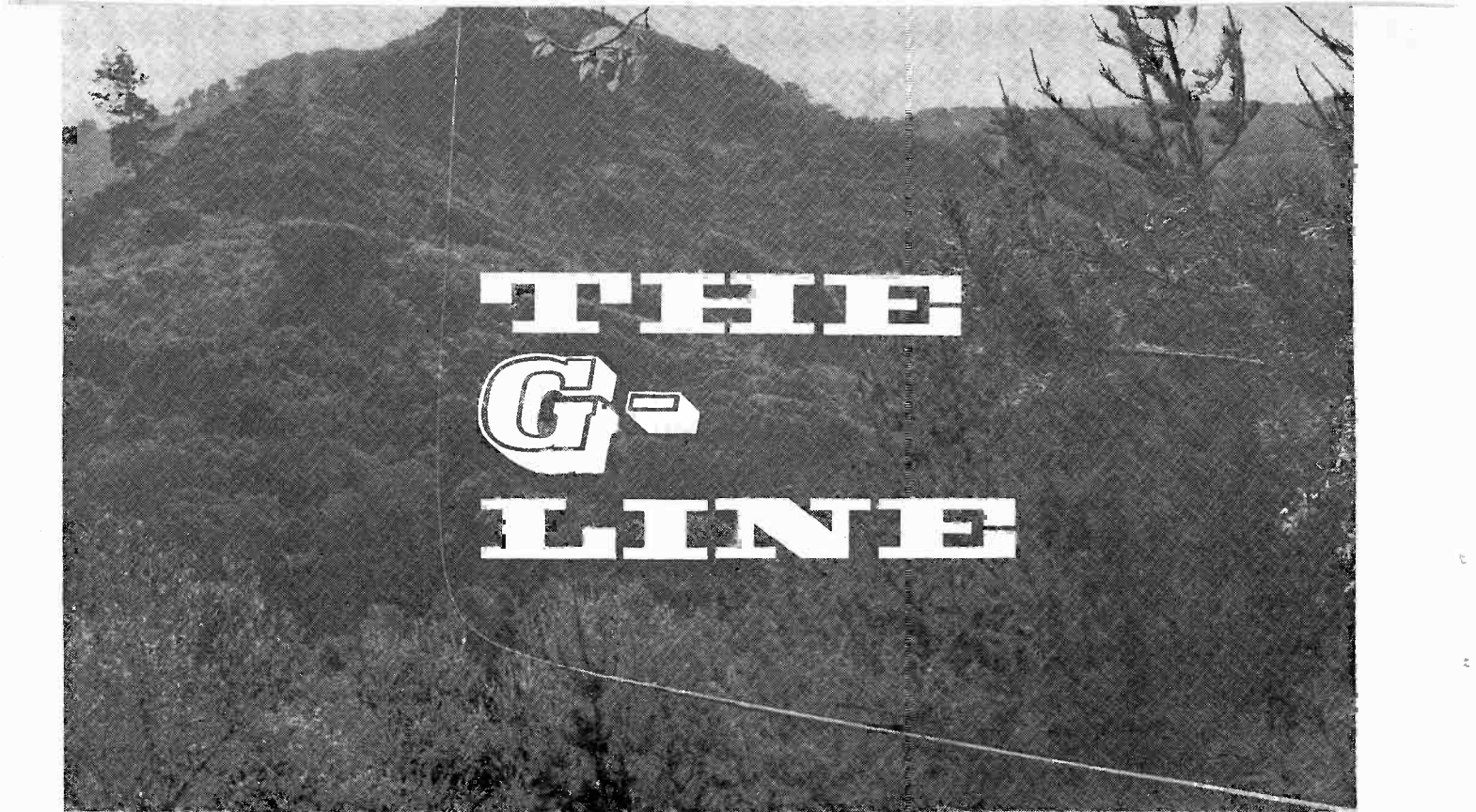

THE G- LINE

... Like a glass of water without the glass. This single, unshielded transmission line is nonradiating, and has extremely low loss

By OWEN G. PATRICK

MY WIFE (BLESS HER UN-ELECTRONICS-oriented little heart) had been chipping away for quite some time with "Why can't we have all those good TV channels the Cinch Joneses get?"

My explanation that we live in a valley, walled in by mountains, while the Joneses, though a mere 5 miles away, are in the open; that the "good channels" are 100 airline miles from the both of us, but *they* could receive them and *we* could not, cut little or no ice at all.

"Well, you're in electronics, so do something about it" was her understanding reply.

When neighbor Bill added his "Say, why don't you—" to hers, the ground was freshly plowed and ready to seed. Perhaps I could make like a modern-day Merlin and conjure up those "good channels," thus making Number One happy. I must admit that, in addition to the stimulus of the challenge, I too liked Perry Mason.

There were acceptable signals from San Francisco, San Jose, Sacramento and Oakland atop a 600-foot hill known locally as Saddle Mountain. The big problem was how to transport all that flickering drama over some 3,400 feet of rough terrain to our house on the floor of Carmel Valley.

Since the name G-Line is a trade mark used by Surface Conduction, Inc. for their products which are also protected by patents, we have asked for and received permission to publish this article under this name. The permission was given in view of the fact that it represented a private study proving both the ingenuity of the author and the reality of the G-Line.

I began to consider common forms of transmission lines, and found that none were right for us. Coaxial lines, even the more recent types developed for community antenna distribution systems have fairly high losses in the upper vhf. These lines are also expensive and require messenger support, which means frequent poles and special equipment.

The relatively high loss of 3,400 feet of this line would also require an antenna-site amplifier, which means duplexing power and rf on the transmission lines. Open wires are not as lossy as coaxial lines, but they too present problems, not the least of which is radiation.

If lines with spacers are used, there will be losses in the dust and moisture bridges formed at each spacer. Open-wire lines (without spacers) were considered—two wires under tension, separated only at the supporting poles—but this type of line will modulate the signal, causing video flutter somewhat like sound bars. This is due to a rapid impedance variation when the lines "sing" in gentle winds. Also, this type of line is subject to bird-perching, which usually results in the conductors being shorted together.

I finally decided to abandon the usual lines and techniques and to investigate waveguides. Not the rectangular or round "plumbing" usually associated with the term, but the external waveguide, a "surface waveguide," as it was termed by George Goubau, who developed it at Fort Monmouth in 1953.

The *G-line*, as it came to be called, is just a single insulated wire. When rf power is properly given to and taken away from this single conductor, it responds with some amazing results. Its loss is very low, approximately 6 db/mile over the vhf TV band. This means the output voltage from a 1-mile line is half that of the input. Unlike coax or open-wire line, its loss does not increase with frequency. It does not radiate. Its impedance is approximately 300 ohms, and it is inexpensive.

G-line is not a panacea for *all* situations. For those of you who live in an area given to long periods of snowfall, read no further, for this and heavy ice loading on the line will increase attenuation severely. Rainfall and fog, however, affect the line very little.

If a situation requires abrupt sharp turns, the line can make it, but the rf cannot, and will spit right off the turns. This doesn't mean you can't make turns with the G-line. It just means that you have to make the turns gently, with a large radius.

The G-line's last shortcoming is that it must be held clear of all objects for a radius of a half wavelength at its lowest operating frequency. This includes buildings, poles, the ground, metals and foliage.

Why — and how — it works

Sommerfeld, in 1899, suggested the possibility of an external waveguide, but attempts to transmit rf energy in this way failed. Then George Goubau, a German-born physicist, discovered that

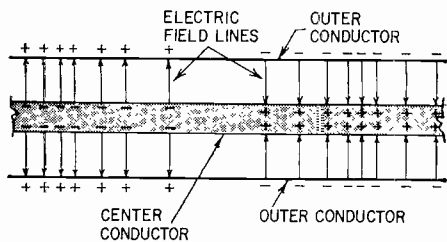

Fig. 1—Pattern of charges and imaginary, symbolic electric field lines describe electrical configuration on ordinary coax cable.

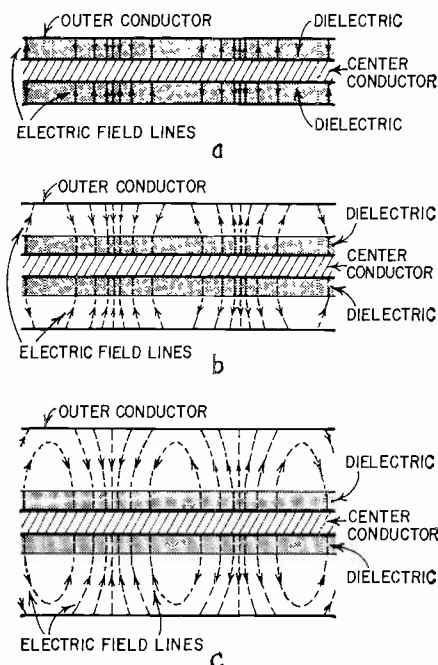

Fig. 2—This is how G-line develops logically from coax. In (a), dielectric is continuous from inner to outer conductor; field lines are straight. In (b), discontinuity appears in dielectric at boundary between plastic and air (their dielectric constants are different) and lines curve. Drawing (c) shows how field lines begin to curve back onto center conductor as outer conductor is moved farther away.

all the line needed to make it propagate was insulation.

Examining the electric field within a longitudinal section of solid-dielectric coax line, you can better understand the role of the insulation Goubau found so necessary. The electric field lines vary in direction and magnitude with the distance along the line. The entire pattern, maintaining relationships shown in Fig. 1, moves away from the source at nearly the speed of light. Notice particularly that the electric lines are shown beginning on charges on the surface of a conductor and extending to charges on the opposite conductor.

All of this is just another way of saying that there is a difference in potential and that electric lines of force are depicted as beginning and terminating on charged bodies. That is, they begin and terminate on charged bodies if

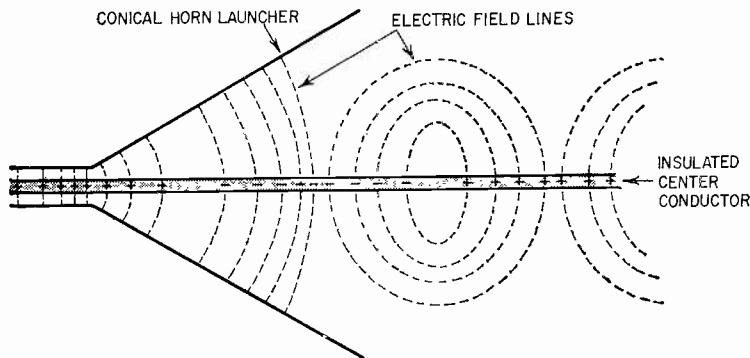

Fig. 3—Gradually expanding outer conductor is means of transforming coax into G-line. One such "launcher" must be at each junction between G-line and coax.

the transmission line is not to radiate. Herein lies the problem, for what we plan to do is to expand the outer conductor gradually, until it becomes so large that, in effect, it doesn't exist electrically.

Normally this would mean that the electric lines of force beyond this point would have only one body on which to begin or end, and hence could detach themselves from the conductor and join heads to tails, forming closed loops that move away from the wire, taking all the energy with them. That is, if the outer conductor is removed, we expect the inner conductor to become an antenna. This is true if the dielectric before and after expanding the outer conductor is the same (air, as an example). However, our example is a solid-dielectric line, and the secret to the operation of the surface waveguide lies in continuing this solid dielectric after the outer conductor is removed.

Where the outer conductor has an increased diameter, the dielectric is no longer all solid; it is part air and part solid. The speed with which the charges move on the surface of conductors depends, among other things, on the surrounding dielectric. The charges, to which the electric lines are attached, tend to move with a greater velocity on the surface of the outer conductor than on the inner conductor, thus forcing the electric lines to curve (Fig. 2).

If we continue this process, gradually making the outer conductor larger and larger, the electric lines will bend in an arc so that they begin at a charge of one polarity on the inner conductor and end with an opposite charge on the same inner conductor (Fig. 3). Thus the electric field becomes imprisoned by one conductor and cannot detach itself, whereupon the expanded outer conductor is unnecessary and can be omitted.

In practice, the enlarged portion of the outer conductor is called a *launcher*. A complete transmission system requires one at each end of the line. The one at the receiving end has been called a *catcher*.

All this seems to suggest that these launchers should be exponentially shaped. Experiments show that this

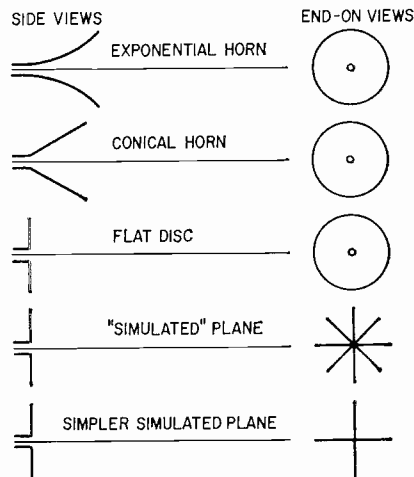
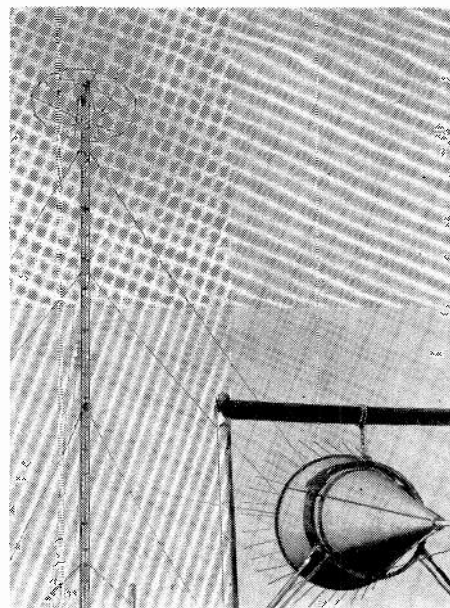

Fig. 4—Exponential or conical horns are near-ideal transformers; actual or simulated disc termination is simpler to make and nearly as effective.

form is not necessarily best, and in any case, not many of us have the wherewithal to construct such a gadget. I decided to corrupt the optimum in favor of a design that was easy to make and



The launcher in the foreground feeds 1,250 watts of vhf power via G-line to a small directional array halfway up the medium-wave tower in the background. This installation is in Munich, Germany.

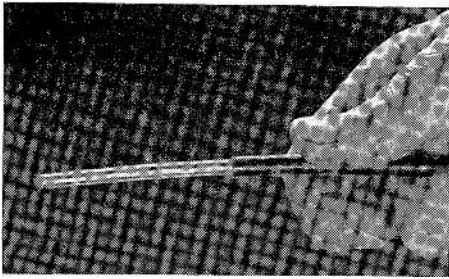

Fig. 5—Author used No. 6 aluminum wire with plastic insulation for G-line.

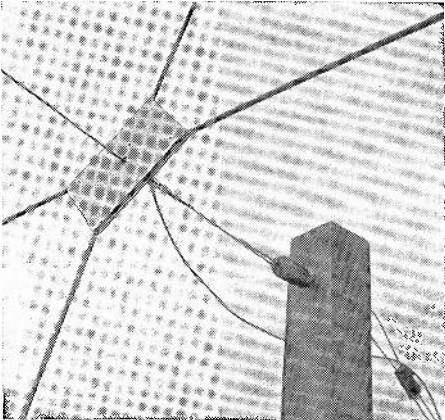

Fig. 6—Front of launcher, looking from G-line side, showing support pole and guying arrangement.

much less expensive. Fig. 4 shows the natural transition from the ideal to the simplified practical. This simplification only adds about 1 db loss overall.

Put one up

The wire I used in our system is No. 6 aluminum with a black commercial-grade polyethylene jacket (Fig. 5). Aluminum was selected because this system consisted of two 1,700-foot spans and here the weight is important. Any plastic-insulated wire will do, such as common No. 14 or No. 12 solid-copper house wire. Rubber-insulated and so-called "weatherproof" wire should not be used; those dielectrics are lossy and absorb power.

Ideally, the line should be constructed from wire with an overall diameter twice that of the conductor itself. However, variation from this formula does not change the performance greatly.

Our launchers were made with four 1/2-inch x 6-foot aluminum tubes located between and along the diagonals of two 12-inch x .060 inch aluminum squares (Figs. 6, 7). Two small squares of 1/4-inch Plexiglass or Lucite with holes in their centers to admit the bared end of the wire form the insulator block. A knockout punch cut relief holes in the centers of the two aluminum plates. The entire sandwich was secured by 1-inch 6-32 machine screws.

The size, height, weight and whether or not "deadmen" will be used at the terminals of the G-line will depend on the particular circumstances. Saddle Mountain's two 1,700-foot catenaries were suspended between 6 x 6-inch x 10-foot posts set in the ground 3 feet and tied back to expandable anchors. These supports were later found to be far more rugged than necessary since this line required only a 200-lb stress.

Be careful not to exceed the maximum load rating of the wire under the strongest winds expected in your area.

The tie between the supports and the line is 1/4-inch nylon rope. Since nylon is very slippery and doesn't knot well, it was bound with copper wire. Nylon rope can be kept from unraveling by fusing the ends with a match or cigarette lighter flame.

The bared end of the G-line is passed through the hole in the launcher insulator (Fig. 8). A slotted bolt connector is slipped over the wire at the rear of the launcher and the wire is then formed around a small cable "thimble" and once again passed through the wire connector.

Once the connector is in place, the nylon tether is secured to the thimble and the G-line is ready to raise.

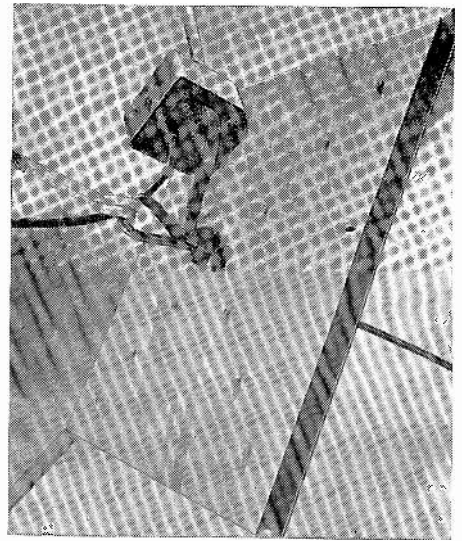

Fig. 8—Rear of launcher shows "eye" bent into aluminum wire, and nylon support rope. Box on back of launcher "sandwich" is transformer to match G-line to 72-ohm coax. Short piece of ribbon lead-in goes from 300-ohm side of transformer to end of G-line.

In our system, 72-ohm coaxial feed lines are used to and from the launchers. Weather-tight transformers such as Jerold's model TO-374 or Taco's Magi-Mix No. 1597 match the G-line's 300-ohm impedance to that of the coaxial line.

Even though transformation to an intermediate impedance of 72 ohms between the G-line and the TV set required a transformer at both ends, it was well worth the small additional cost to be able to run the interconnecting line next to water pipes, on the ground and through walls with complete freedom. With 300-ohm line, a transformer should still be used, even though the impedance of the G-line matches that of the ribbon. A 300-ohm line is balanced, and the G-line is inherently unbalanced.

Our system has been in operation more than 6 years. It has survived winds over 80 mph and has withstood the tests of time and weather with complete success. Its entire cost was less than that of the set we couldn't use without it and everybody's happy. Now don't let a little thing like a mountain range stand between you and Perry Mason! **END**

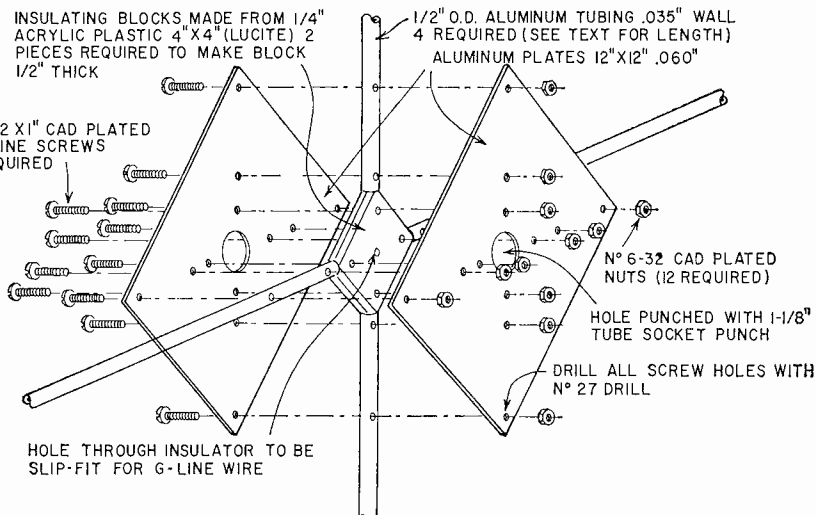

Fig. 7—Exploded view of launcher assembly.



"Get a load of what I found in your set, Mrs. Broadway—dead about 3 years, I'd say!"

SIMPLE RF WATTMETER for CB

A load as well as a meter, device reads rms power from dc to about 50 mc

By LYMAN E. GREENLEE

THE SIMPLEST COMBINED DUMMY-LOAD-and-"wattmeter" is still a light bulb. But, by itself, a bulb is not an accurate meter. The best you can do is guess at the transmitter power.

This little instrument combines a small pilot lamp with a pair of solar cells and a microammeter. Fig. 1 shows the schematic. The meter reading depends on only the light output of the bulb, which in turn depends on only the power the bulb gets from the transmitter.

Two selenium self-generating solar cells are connected in parallel and mounted close to the pilot lamp. The rf current lights the bulb, and the dc output from the solar cells goes to microammeter M through the rf choke, bypassed by C to remove any stray rf from the microammeter. Observe polarity when you wire the solar cells.

Mount the assembly in a light-tight case. R is a 1,000-ohm calibrating pot shunting the meter (M), and is adjusted *only* when calibrating the instrument to set the 0-500 microammeter to full scale. After calibration, it may be locked or sealed in position permanently, and will not be disturbed unless recalibration is necessary. A burned-out pilot bulb may be replaced without recalibrating the instrument, if it is of the same make and type as the original.

The pilot light is mounted in a socket which is a push fit inside a rubber grommet. To change bulbs, pull out the socket. A clip holds the coax line and socket in place on the front panel. Wrap bulb and socket with a small piece of plastic tape to make sure the bulb will

not work loose. I bent a U-shaped piece of tin-can metal and soldered it to the back of R to act as a reflector and to confine the light from the bulb to the solar cells. The only purpose of the reflector is to increase the reading of the microammeter. If the meter can be made to read full scale without it, leave it off. Mount the solar cells close to the bulb, as shown in the photo.

There is some variation in solar cells. Before using them, check each one by connecting it directly to the microammeter. A good cell should give a full-scale reading when held close to a 60-watt light bulb. If it doesn't, the cell is weak and will not work in the wattmeter.

Wiring is simple and not critical, since the leads carry direct current. Mount C and RFC exactly as shown in the photo, with C across the meter.

Calibration

Fig. 2 shows the calibrating circuit. Calibrate the instrument by adjusting the rheostat, taking readings of the ac voltmeter and milliammeter and comparing with the corresponding readings of the microammeter. First, set the rheostat to apply full rated voltage to the bulb. Adjust R so that the microammeter reads full scale. Calculate wattage by multiplying voltage and current. *Example:* If the ac meters read 6 volts and 120 ma, the power is 0.72 watt ($6 \times 0.12 = 0.72$). With a No. 40 bulb, set the microammeter to full scale with 1 or 1.2 watts maximum input to the pilot lamp. With a 46 bulb, the maximum level should not exceed 2 watts. These wattage levels *can* be exceeded by 25% or



The wattmeter. Scale should be calibrated in watts. At top, cable ends in phono plug; adapter, top left, fits screw type coax connector. Other end of coax is soldered directly to lamp socket terminals, visible above clamp at bottom of case.

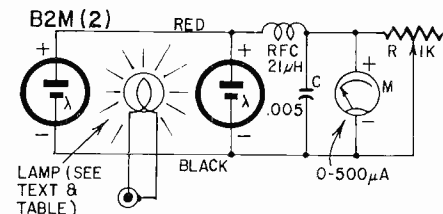

C—.005 µf ceramic
M—meter, 0-500 µa, full scale
R—pot, 1,000 ohms, wirewound
RFC—21-µh rf choke (Ohmite Z-28 or equivalent)
Selenium cells (2)—International Rectifier Corp. type B2M

Lamp—see text and table
Phono plug
Coax cable (RG-58A/U)

Case—Bakelite, with panel, 6 x 3 x 2 inches. (A metal case such as the Bud CU-2105-A Minibox, 5 x 4 x 3 in., is preferable. It reduces radiated interference when checking transmitter. Connect coax shield to case at lamp socket.)

Fig. 1—Circuit of wattmeter. Meter reading depends on light output of bulb.

SUITABLE PILOT BULBS			
Type	Voltage	Current (amps)	Max. Watts at design voltage
40 or 47	6-8	0.15	1.2
46	6-8	0.25	2.0
1447	18	0.15	2.7
1449	14	0.20	2.8
1487	12-16	0.20	3.2
432 or 433	18	0.25	4.5
1458	20	0.25	5.0

These levels can be exceeded by 25% without danger of burnout. Choose a bulb your transmitter will light to average brilliance.

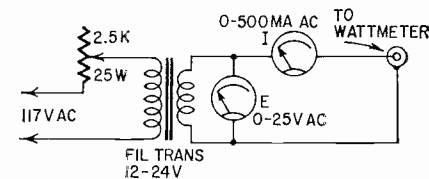
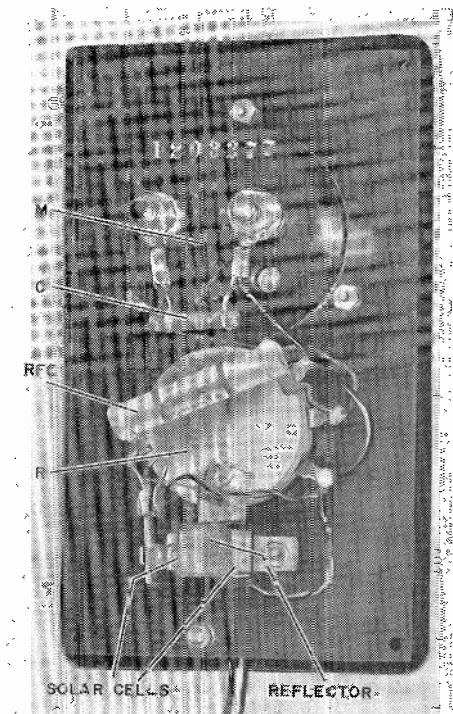

Fig. 2—The calibrating circuit.



Wiring is very simple, and not critical.

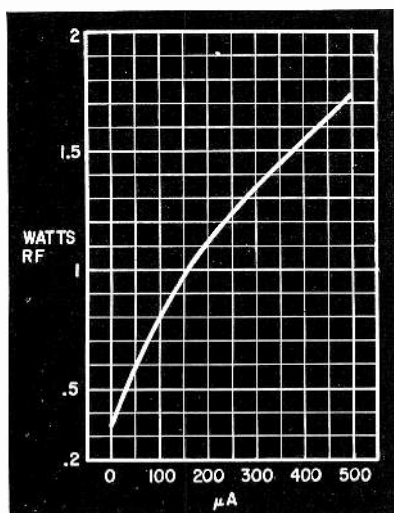

Fig. 3—Calibration curve for No. 46 pilot lamp from 0.5 to 1.75 watts. Your curve will depend on lamp type you use, but should hold for all lamps of same type.

more. But for maximum bulb life, calibrate within manufacturer's rated limits. After determining the full-scale maximum position and adjusting R, continue calibrating by varying the rheostat to reduce the current to the bulb. Plot points on a graph like Fig. 3 for the various microammeter readings. Vary the rheostat to reduce the reading of the microammeter to even values such as 450, 400, 350 μ a, etc. For each of these checkpoints, read voltage and current, multiply to get wattage, and transfer this wattage value to the graph. Do not reset R.

The instrument can be used for checking power output or alignment, either with or without modulation. Plug the meter into the antenna jack, turn on the transmitter and take a reading. Don't leave the meter connected to the transmitter for a long time because heat from the lamp may affect the sensitivity of the solar cells. Ventilation inside the closed meter box is not good, so take a reading and disconnect the meter.

By installing a phono plug on the end of the coax line and making up an adapter to an Amphenol connector, the wattmeter will fit virtually all CB transceivers. This adapter can be made up by soldering a Switchcraft 3501-FP phono jack to an Amphenol UG-203/U plug. The end of the Amphenol sleeve must be reamed out until the Switchcraft jack is a press fit into the sleeve. Use a short length of bare wire to connect the center prong of the Amphenol plug.

A transmitter with a maximum output of less than $\frac{1}{2}$ watt will not give a satisfactory reading with a 5-watt pilot bulb such as the type 1458. If it is hard to get a reading, make sure the bulb is not burned out and that the transmitter will actually light a bulb similar to the one in the wattmeter. END

marvelous electronic diaper change indicator

By DAVID W. CRAMP

A REAL HAGGARD-LOOKING GUY WAS waiting for me when I opened the shop one Saturday morning.

"Boy, am I glad to see you," he said. "You're the only TV guy who can help me."

"Well, I'll try," I told him. "What seems to be the difficulty?"

"I hate to change diapers," he said.

"Diapers?" I asked. "You sure you got the right place?"

"Yeah, I got the right place. I heard of you. It's like this. All day long my wife watches the soap operas on TV. She don't move from the set and she has it turned up as loud as it'll go. Even the commercials. Now our new baby is very little and isn't housebroken yet. Every night when I get home my wife is glued to the set and the baby is crying away only you can't hear him on account of the loud TV. I go in to say hello to the baby and find him wet and crying. I feel sorry for him and change his diaper which hasn't been changed since I left for work.

"I tell my wife she should change the baby's diapers when he cries and she says she does every time she hears him cry but she can't hear him on account of the loud TV."

"Why don't you get her to turn the set down?" I asked.

"I suggested that, but we live in a duplex with cardboard walls and she says she has to keep our set turned up or she hears the set next door and that lady is stupid and has lousy programs on all day and my wife can't concentrate on her own programs with all that noise from the next apartment."

"Would your wife change the baby's diapers if she was able to tell when he was wet?" I asked.

"Oh, yes! Deep down she really loves the little fellow and she could duck out and change him during some of the less interesting commercials."

"Well, then," I reassured him, "you can relax. Your troubles are over. I'll be over Monday night and fix you up."

"Oh, thank you, sir!" He practically gurgled as I backed up to keep him from licking my hand in gratitude.

Monday night I went over to his house with a little black box, a dozen new diapers with a two-pronged connector sewed in one corner of each one, and a crystal microphone. We put one of the new diapers on the baby and I hooked up the other stuff and we turned on the TV set and waited. Nothing happened so after we waited 15 minutes I had the guy feed the baby a bottle of warm water. Ten minutes later the set

started to howl.

"What's that?" the man asked.

"That tells you that your baby needs changing," I told him."

We checked and sure enough, the diaper was wet.

"Now," I said, "you tell your wife every time the set howls she is to go to the baby's room, unplug his diaper from this wire leading from this little black box and that'll stop the howling. Then get her to put one of these diapers on the baby and plug it into the little black box."

"Will it work every time?" he asked.

"Every time," I assured him. "As long as your wife uses these diapers I brought and they're dry when she puts them on the baby."

Well, he begged me to tell him how the indicator worked but I refused, because I wanted to keep it a secret until I could apply for a patent. Now that everything is set I can reveal the secret.

First, I bought a dozen diapers. Then I took some fine wire from the secondary of an old transformer and

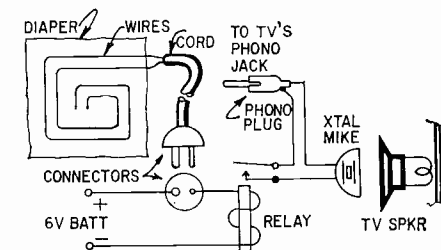

soaked off the insulation with acetone. I cut 24 three-foot lengths of this wire and soldered one end of each wire to a separate prong on the male ends of 12 two-pronged connectors. My wife wove the two wires from each connector through a different diaper and sewed the connector to a corner of the diaper. She was very careful not to allow the wires to come closer than $\frac{1}{2}$ inch to each other. I then made up the circuit shown below.

The relay stayed open so long as the diaper remained dry. As soon as the diaper was wet by the baby, the salt in the urine formed an electrolyte, completing the circuit between the wires woven into the diaper. This closed the relay and fed the mike input into the TV set through the phono jack. Since I had taped the mike to the speaker grill, a terrific feedback howl started and kept going until the diaper was unplugged. A new dry diaper kept the circuit open until the next wetting.

Where do you write to find out about getting the Nobel Prize? END

AUTOMOTIVE ALTERNATORS

HOW TO KEEP THEM WORKING

If you own a car or work on mobile radio gear this article is must reading

By **CHARLES J. SCHAUERS**

ANYONE WHO HAS ENOUGH ELECTRICAL gear in his car to draw a lot of current from his auto battery will find an alternator valuable. Even with the engine idling, the alternator provides several times the current delivered by the ordinary dc generator. This has made it popular with radio amateurs, CB radio operators, police departments, the military and anyone else whose car is packed with current-gobbling air conditioners, spotlights, radios, etc. In many

late-model cars, alternators are standard equipment.

An alternator is not complicated. It is easier to work with than an ordinary generator—think of it as a sort of “inside-out” generator. That is, the armature is stationary and the field revolves within it. Its output is three-phase ac which is instantly converted to dc by built-in silicon diode rectifiers.

Instead of a commutator, the alternator uses slip rings. These, their brushes and the bearings are the only

An earlier article by Mr. Schauers, “Installing an Alternator,” appeared in the November 1962, issue on page 34.

parts that wear. Fewer moving parts mean fewer troubles. The small slip-ring brushes used carry only an excitation voltage and last much longer than the load-carrying brushes on generators. The design of the alternator permits current to be taken directly from the stationary armature and insures long operating life for the unit—as much as 3 to 10 times the normal life of a dc generator.

The new Leece-Neville alternator (now in stock at distributors in every principal city) is the 6000 series rated at 40 amperes. Designed specifically for passenger cars, it replaces the old dc generator.

As simple as any electromechanical device can be, the 6000 is a medium-duty unit that delivers 5 to 10 amperes at curb idle (500 rpm). It consists of a pair of end housings, a ceramic brush holder, a stator, rotor, six tiny rectifiers

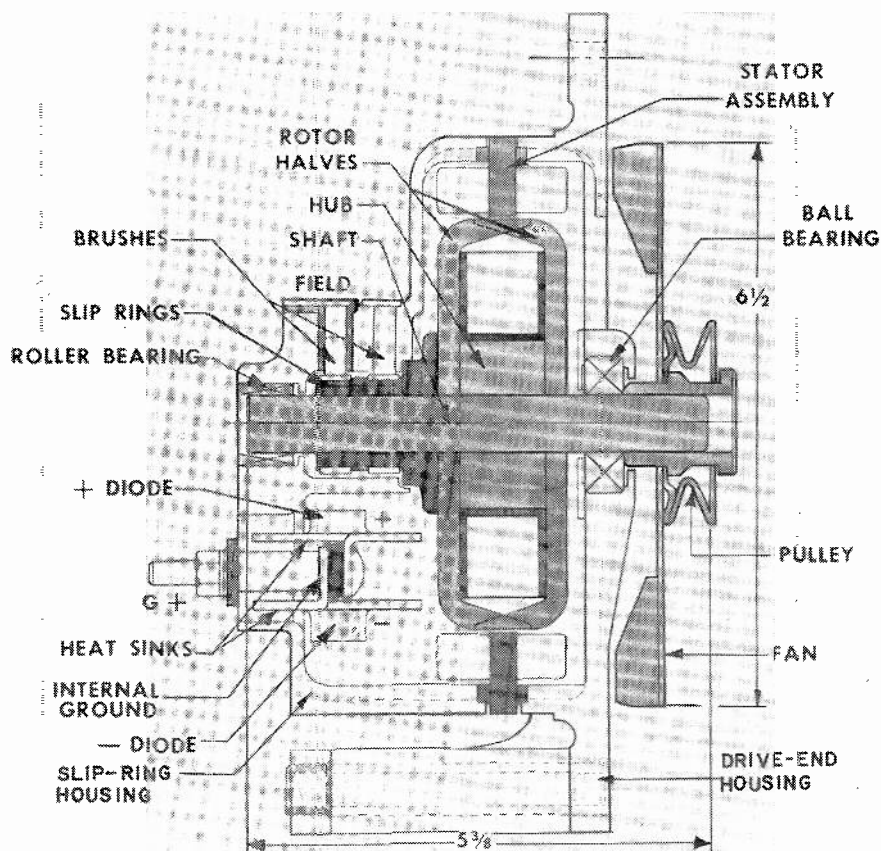

Fig. 1—Cutaway view of alternator with working parts identified.

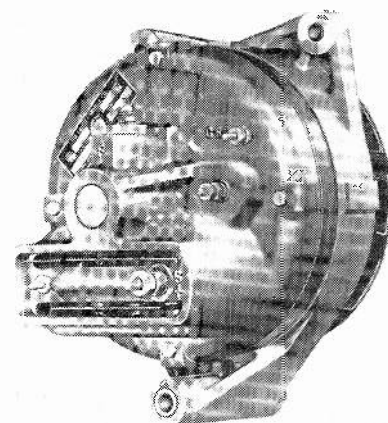

Fig. 2—Rear view of a fully assembled alternator.

held between a pair of heat sinks, a cooling fan and a drive pulley. Four through-bolts, equally spaced around the periphery of the unit, hold the assembly together. Fig. 1 is a cutaway view of the alternator and Fig. 2 shows now it looks from the rear assembled. Fig. 3 shows it mounted in a car.

Construction

The drive-end and slip-ring housings are rugged, lightweight die-cast aluminum. The drive-end housing supports the stator and rotor at one end, and will hold the alternator when mounted on the engine. If desired, the slip-ring end housing, stator and rectifiers may be easily removed for testing. The drive-end housing is mounted on the engine and holds the rotor in position. This speeds service, since the entire alternator assembly does not have to be taken out and replaced.

The slip-ring housing supports the opposite end of the main components, and also contains the ceramic brush holder and silicon rectifiers, which are held in an extended air scoop to enhance cooling. Since the scoop may interfere with installation, the through-bolts can be loosened and the entire slip-ring housing rotated to a different quadrant to eliminate mounting problems.

Two brushes—one insulated and one grounded—provide the electrical connection between the slip rings and the field terminal and ground. The brushes are in a molded ceramic holder that inserts in the slip-ring housing only one way, holding the brushes perpendicularly in line with the rotor shaft to avoid improper installation and possible regulator damage.

The insulated brush contacts the field terminal through the brush spring. The ground brush contacts a ground strap attached to the brush holder. One of the two brush-holder retaining screws goes through the strap and holder into the brush end housing, making a ground connection to the housing.

The powdered bronze-graphite brushes are interchangeable to reduce inventory problems. If field current exceeds 5 amperes, the compression coil type brush springs collapse as a further safety measure.

Voltage output is developed in the stator, which consists of a laminated steel frame and three windings. The enameled copper-wire windings are wound into slots machined in the inner diameter of the frame. The design of the windings makes the stator self-current-regulating so a separate current regulator is not needed.

A lead is connected between the junction of the three stator windings and a terminal on the brush end housing. This neutral terminal provides a con-

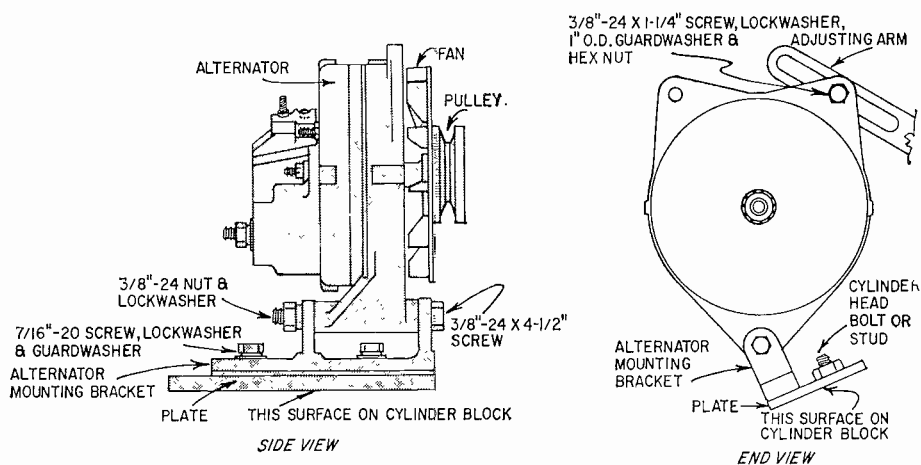

Fig. 3—Two sketches showing how an alternator is mounted in a car.

venient method for reaching the connected ends of the windings for testing stator continuity and ground. It also energizes the load relay on 12-volt regulator systems using a charge indicator light.

The rotor is a solid steel shaft with two 6-fingered pole pieces, a field coil and a slip-ring assembly mounted on it. The two pole pieces overlap to encase the field coil, making it in effect, a 12-pole rotor. The current flowing through the field coil provides the stator with the magnetic field needed to produce the required voltage and current.

The slip rings consist of a pair of $\frac{7}{16}$ -inch-wide brass sleeves supported by a bakelite insulator that separates them from the rotor shaft and each other. The two ends of the rotating field coil are attached to them, so they serve as a connection between the coil and the brushes.

If the field coil, pole pieces or shaft needs replacement, a complete rotor assembly must be installed. The slip-ring assembly can be replaced but the rotor components cannot.

Six silicon diodes are mounted on two metal heat sinks. These diodes convert the ac output of the alternator to usable dc. Three positive diodes on one heat sink connect directly to the alternator output terminal and are insulated from the other housing. The other heat sink, with three negative diodes, connects directly to the alternator housing and ground side of the system. One positive and one negative diode are connected to each of the three stator windings (Fig. 4). A ceramic capacitor is connected between the insulated heat sink and ground, to reduce voltage surges and protect the diodes from damage while the alternator is operating.

In typical negative-ground systems, output from each stator winding leaves the alternator by way of the positive diodes and the output terminal and returns through the negative diodes. In a positive-ground system, the flow is the opposite. The rectifiers permit flow in

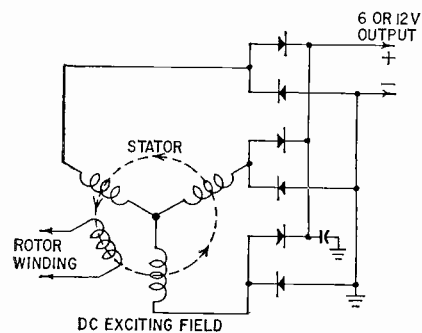

Fig. 4—Electronic circuit of alternator for negative-ground systems.

only one direction, eliminating the need for a circuit breaker or cutout relay.

A cooling fan is mounted on the drive end of the rotor shaft. It draws cooling air over the rectifiers. The rotor shaft is supported on the drive end by a ball bearing, and on the slip-ring end by a roller bearing. Both are prelubricated, and require no regular service.

The regulator

A load relay and a double-contact voltage regulator make up the two parts of the regulator, which is installed in the same location as the original regulator on the car. A series of openings in the regulator's base make the installation easy.

The load relay opens and closes the main charging circuit between the alternator and battery, and also energizes the alternator field coil by connecting the field circuit to the battery. The relay consists of a magnetic switch that is operated by voltage obtained either from the alternator neutral terminal or from the battery. If used on a system with a dash ammeter, the relay is energized when the ignition switch is closed. If used on a system with a charge indicator light, it is energized when the alternator starts to charge. Besides its other functions, the load relay is also a safety device that disconnects the battery from

the alternator when the system is not operating.

The voltage regulator controls the alternator output by governing the flow of field current, thereby limiting the charging voltage to prevent overcharging the battery and subsequent damage to lights and accessories. The double-contact regulator does this two ways. If current flow is high or alternator speed is relatively low, it operates on its upper contacts to insert resistance into the field circuit and reduce the current flow. If current flow is low or alternator speed is relatively high, it operates on its lower contacts to ground the insulated end of the field and interrupt the current flow.

Maintenance

The maintenance required by the 6000 series alternator is much, much less than for an automotive dc generator. However, any electromechanical device requires maintenance periodically. If maintenance instructions are followed implicitly, an alternator will give excellent service.

If you run into trouble in the charging system, remove the F-lead from the alternator and attach a jumper from terminal F to terminal B. This takes the regulator out of the circuit and allows full-field operation. With the engine idling, the alternator should show a high rate of charge in the full-field condition. If it does not, the battery, system wiring or the regulator should be suspect.

If the alternator does not show a high rate of charge when running full-field, it should be removed from the vehicle immediately.

Disassemble the alternator according to the instructions furnished by the manufacturer. Then check the rotor to see whether it is open or shorted. Do this by measuring the resistance of the coil with an ohmmeter on the slip rings. Resistance should be between 3.8 and 4.2 ohms for the 12-volt and 1.9 to 2.1 ohms for the 6-volt alternator.

If you find the brush springs are collapsed when you remove the brushes, the rotor probably has a shorted coil and the entire rotor should be replaced.

Never measure the rotor coil resistance at the field terminals; it will not be a true reading. This is due to the variability of the slip-ring and brush contact resistance when the alternator is not operating.

Clean the rotor if it checks out OK. Brush it with a good cleaning solvent. Remove the solvent by brushing with kerosene and wiping the rotor dry. Never dip the entire rotor into a cleaning bath.

Inspect the slip-ring assembly. If it is defective, replace it. Do not try to repair it. Next, inspect the slip-ring brushes. If they are burned, broken or

cracked, replace them. Replace brushes that are $\frac{3}{16}$ inch long or shorter (due to wear).

Disconnect the silicon rectifier section from the stator by unsoldering each diode. The test recommended by Leece-Neville is to hook up a 24-volt battery in series with a 24-volt test lamp. If the test bulb lights when applied to the individual rectifier in one direction (forward), and does not light in the other direction (reverse), the rectifier is OK. If the lamp lights in both directions, the rectifier is shorted. If the lamp does not light in either direction, the rectifier is open. The procedure recommended by the manufacturer for replacing the rectifiers should be followed to a "T."

Before resoldering the rectifiers to the stator, check the stator for grounds. You do this the same way you would check an armature in the old dc generator. A lamp in series with 117 volts and a pair of test leads are used for the check. Touch the test prods to each stator lead and the stator core. If the lamp does not light, everything is OK—there are no grounds.

The same test lamp can be used to check stator winding continuity. Each of the three stator phases is checked separately and should show a closed circuit.

After a complete electrical check and visual examination, clean the stator in the same manner as the rotor.

If the alternator has undergone a complete overhaul, replacing the bearings is a must.

The alternator is reassembled by starting at the end of the disassembly instructions and working back. Then install the alternator in the car and check charging under full-field condition. Recheck the voltages, readjust the fan belt, and when you're sure everything is right, give the customer a wide smile.

Radio noise

A properly operating alternator creates little or no radio interference. Sometimes, however, the regulator may act up and create an annoying clicking noise. This can be eliminated by replacing the regulator or cleaning and readjusting the old one according to service instructions furnished with the unit.

If a new regulator does not make for quiet operation, connect a 10-ohm resistor *in series* with a 0.1- μ f capacitor across the regulator voltage terminals. *Never* try a capacitor across *any* regulator terminals without a resistor in series or burned points will result.

Coaxial type capacitors in the regulator supply leads will help reduce conducted noise.

The author acknowledges with much gratitude the assistance and material provided by Leece-Neville Co. and Mr. James E. Stratton to make this article possible.

END

Correction

Mr. Geisler noticed that he had supplied the wrong diagrams for Figs. 9 and 10 of the "Transistor Power Amplifier Directory" (October 1963, page 34) at about the same time that errors in these circuits were reported by Capt. W. B. Bernard of Longboat Key, Fla., and Richard J. Wolski of Bytom, Poland. The correct diagrams for Figs. 9 and 10 are shown.

Note that 1.5-volt batteries have been added to both circuits. They must be disconnected when the amplifiers are not being used.

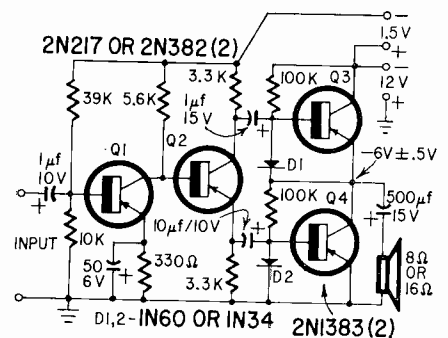

Fig. 9

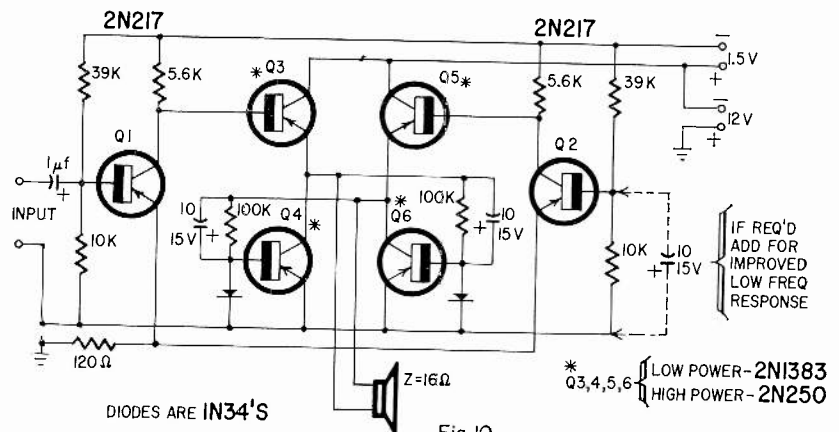

Fig. 10

by Jack Darr
Service Editor



This column is for your service problems—TV, radio, audio or general and industrial electronics. We answer all questions individually by mail, free of charge, and the more interesting ones will be printed here.

If you're really stuck, write us. We'll do our best to help you. Don't forget to enclose a stamped, self-addressed envelope. Write: Service Editor, Radio-Electronics, 154 West 14th Street, New York 10011.

SUBJECT THIS MONTH IS OFF-COLOR troubles. No, we're not going to tell dirty jokes! We're talking about off-color response from the color circuits. Since we have two signal paths for the video information, one for the brightness and the other for the color, we can have all kinds of troubles!

Look for what *is* there, and for what *isn't*. In some of the older circuits, the color amplifiers were hooked up so that you lost the color amplified by that particular tube. For example, if the red amplifier went out, no reds. The picture went blue-green. Most later models, because of the dc coupling used in color video circuitry, seem to *increase* the color. If the red amplifier goes out, the red gets brighter. Here's a "frinstance". We pulled tubes from an RCA CTC9 chassis to see what would happen, and this is what we found. (See Fig. 1.)

6CG7, green amplifier: picture turned bright green and lost focus.

6CG7, red, blue amplifiers: picture turned bright purple, lost focus.

12AZ7, X and Z demodulators: no effect at all on black and white picture, total loss of color signal on color.

You might repeat this test on the next color set you service; the results will tell you about what's going to happen if a given tube goes out. Of course, these are all twin triodes: if only one half goes out, as is common in some of these tubes, you'll lose only the color associated with the one tube. Most likely, instead of losing the color, you'll lose *control* over it. The screen will show *more* of that color.

If the dead tube has been getting weaker for quite a while, the color-temperature controls may have been adjusted to make up for that. So, when the new tube is installed, you'll have to check the color temperature, at least, and probably readjust it. Always keep

the "Kine Gain" (RCA's name) as low as possible, for maximum life on the Big Bottle. Happy hue-hunting!

Hourglasses and onions

This Philco makes an hourglass-shaped pattern on the screen. If I reverse the line plug, the thing changes to an onion shape. When the line plug is pulled out, the raster flashes back to normal for a split second before it goes out. Everybody I ask says they never saw such a thing, but I've got it, and I get slightly violent thinking of it! I need help!—M. S., Wooster, Ohio

Hang on, help's on the way! This pattern (Fig. 2) is obviously due to some kind of a 60-cycle influence. The basic cause is the horizontal oscillator going into and out of oscillation at a 60-cycle rate. Somewhere, a 60-cycle sine wave is getting into your horizontal oscillator. From the amplitude characteristics, I'd say that it looked as if the *plate supply* was raw ac!

So, up scope and after 'em! Trace the B-plus supply lines to your horizontal oscillator to see where this is getting in. Since this seems to be a 60-cycle pattern, and your power supply is a voltage doubler (which would show a 120-

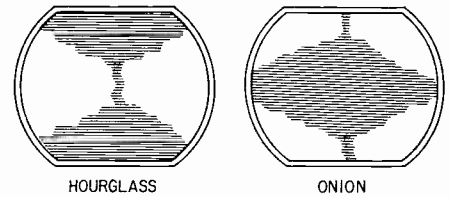

Fig. 2—Hourglass or onion shape. Depends on which way line plug is inserted.

cycle pattern), I'd say there was some heater-cathode leakage somewhere.

This could be in the oscillator tube, the afc tube or even in the horizontal output tube. I'd substitute every tube that is in any way associated with the horizontal circuits, and even in the sync circuits. Also, I'd bridge filters. If this didn't help, and some of the filters were multiple units, I'd disconnect some and try shunting with individual units. Of course, this needs to be done only if the scope shows the 60-cycle waveform on the B-plus supply lines. After you find the 60-cycle waves, leave the scope hooked at that point, and start shunting capacitors, etc., until you find something that will take them out.

Be sure to replace the 10DE7 vertical output tube and the damper; heater-cathode leakage in either could cause this trouble. Also, stray leakage to chassis from the horizontal oscillator grid circuit could be the villain.

Toy-train transformer

I have a toy-train transformer with a dc circuit for powering special gadgets. The train runs OK, but I don't get any dc: none of the gadgets works—no whistle, etc. I've taken the transformer apart, but I can't find the rectifier! Could (Continued on page 57)

Fig. 1—Color demodulators and amplifiers. If the demodulator tube goes out, all color disappears. Black-and-white not affected. If color amplifier is pulled, corresponding color dominates picture, which also goes out of focus. Handy to keep in mind for diagnosis.

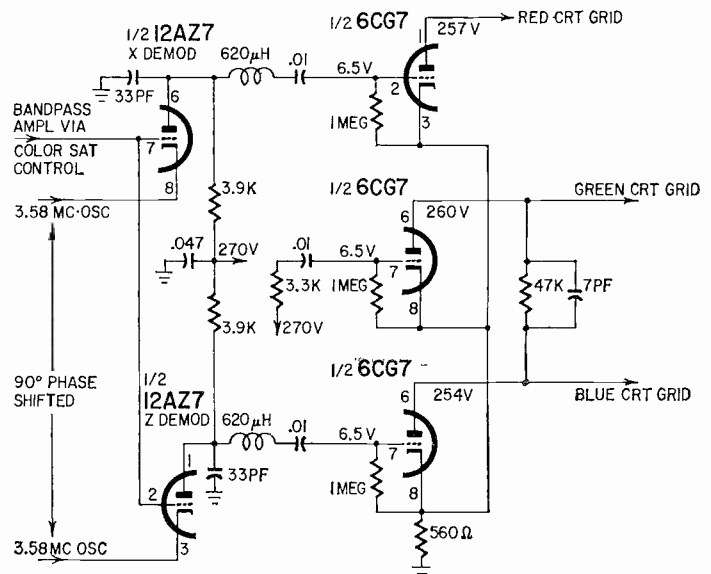



Now NRI offers you
 9 ways to prepare
 for advancement or
 turn your hobby into
 a new career in
**TELEVISION-RADIO
 ELECTRONICS-
 AUTOMATION**

**TRAIN WITH
 THE LEADER**



No matter how much or how little education you have, one of NRI's nine career-training courses can help you toward more interesting work, a more profitable future. For nearly half a century, NRI has maintained the confidence and respect of students, graduates and the Electronics Industry by constantly providing the best possible home-study training at a cost most anyone can afford.

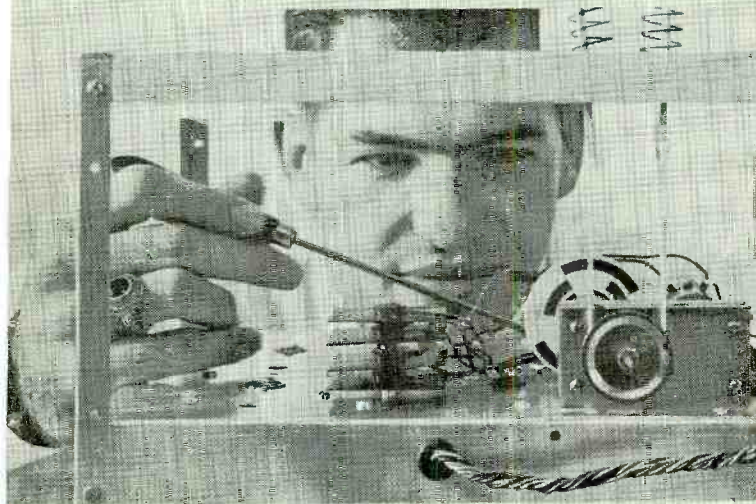

*You train at home in
 your spare time with the
 oldest and largest home
 study school of its kind*

SEE OTHER SIDE ➤

SPECIAL EQUIPMENT INCLUDED

Specializing makes it possible for NRI to provide a variety of courses to fit the needs of any ambitious man interested in TV-Radio, Electronics-Automation. Courses built around NRI's time-proved "Learn-by-practice" method make learning easier, faster, more interesting. Most NRI courses include—at no extra cost—special training equipment to give shop and laboratory experience in your own home. All equipment is yours to keep. As the oldest and largest school of its kind, NRI has nearly 50 years of experience training tens of thousands of men of all ages and varying educations. Read on the other side of this page what NRI offers, then check the course of most interest to you and mail the postage-free form today. Find out about Electronics opportunities, NRI training, NRI trial plan, convenient terms.

CUT OUT AND MAIL ➤

FIRST CLASS
 PERMIT
 NO. 20-R
 (Sec. 34.9, P.L. & R.)
 Washington, D. C.

BUSINESS REPLY MAIL
 No Postage Stamp Necessary If Mailed In The United States

POSTAGE WILL BE PAID BY



National Radio Institute
3939 Wisconsin Avenue
Washington 16, D. C.

Join the Thousands Who Trained for Success with NRI

CHOOSE YOUR CAREER



Thousands of NRI graduates throughout the U. S. and Canada are proof that it's practical to train at home. NRI graduates are in every kind of Electronics work. Here are five typical success stories. Catalog tells more about what NRI graduates do and earn. Mail the postage-free form.



"I HAD A PROMOTION BEFORE I FINISHED the Communications Course," reports Ronald L. Ritter, 113 Helms Dr., Eatontown, N. J., "as well as the satisfaction I could handle a job of responsibility." He works for the U. S. Army Electronic Laboratories, Ft. Monmouth. He received one of the highest grades in Army proficiency tests.



SPARE TIME EARNINGS OF \$3,800 in one year reported by Emerson A. Breda, 1620 Larkin Ave., San Jose 29, California. He has a Radio-TV Servicing shop as completely equipped as you would want for a full-time business. Says Mr. Breda, "The training I received from NRI is the backbone of my progress."



"THE FINEST JOB I EVER HAD" is what Thomas Bilak, Jr., RFD 2, Cayuga, N. Y., says of his position with the G. E. Advanced Electronics Center at Cornell University. He writes, "Thanks to NRI, I have a job which I enjoy and which also pays well."



HAS SERVICE BUSINESS OF HIS OWN. Don House, 3012 2nd Place, Lubbock, Texas, went into his own full-time business six months after finishing the NRI Radio-TV Servicing course. "It makes my family of six a good living," he states. "We repair any TV or Radio. I would not take anything for my training with NRI. I think it is the finest."



MARINE RADIO OPERATOR is the job of E. P. Searcy, Jr., 1916 Fern St., New Orleans, La. He works for Alcoa Steamship Company, has also worked as a TV transmitter engineer and holds FCC Radio-Telephone License. He says, "I can recommend NRI very highly."

SEE OTHER SIDE



Cut Out and Mail—No Stamp Needed



NATIONAL RADIO INSTITUTE
3939 Wisconsin Avenue
Washington 16, D.C. 3F

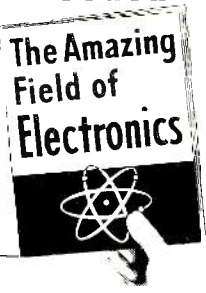

Please send me your Electronics, Radio-TV catalog with complete information on 9 ways to train at home. (No cost or obligation. No salesman will call)

Name _____ Age _____
(Please Print)

Address _____

City _____ Zone _____ State _____

ACCREDITED MEMBER NATIONAL HOME STUDY COUNCIL

1 TELEVISION-RADIO SERVICING
Learn to service black-and-white and color TV sets, AM-FM radios, stereo hi-fi, PA systems, etc. A profitable, interesting field for part-time or full-time business of your own.

2 INDUSTRIAL-MILITARY ELECTRONICS
Learn Principles, Practices, Maintenance of Electronic equipment used today in business, industry, defense. Covers Electronic controls and measurement, computers, servos, telemetry, multiplexing, many other subjects.

3 COMPLETE COMMUNICATIONS
A comprehensive training program for men seeking careers operating and maintaining transmitting equipment in Radio-TV Broadcasting or mobile, marine, aviation communications. Prepares you for FCC License.

4 FCC LICENSE
Prepares you quickly for First Class License exams. Every communications station must have one or more FCC-licensed operators. Also valuable for Service Technicians. You train at home.

5 BASIC ELECTRONICS
An abbreviated, 26-lesson course covering Automation-Electronics, Radio-Television language, components and principles. Ideal for salesmen, hobbyists and others who find it valuable to be familiar with the fundamentals of this fast-growing industry.

6 MATH FOR ELECTRONICS
A short course package of carefully prepared texts that take you from basic arithmetic review through graphs and electronic formulas. Quick, complete and low in cost.

7 AVIATION COMMUNICATIONS
For men who want careers working with and around planes. Covers direction finders, ranges, markers, loran, shoran, radar, landing systems, transmitters. Prepares you for FCC License exams.

8 MARINE COMMUNICATIONS
Shipboard transmitting equipment, direction finders, depth indicators, radar are all covered in this course. You prepare for your First Class Radiotelephone License with Radar Endorsement.

9 MOBILE COMMUNICATIONS
Training in installation and maintenance of mobile equipment and associated base stations like those used by fire and police departments, taxi companies, etc. Prepares you for your First Class FCC License exams.

CUT OUT AND MAIL FOR FREE CATALOG

(Continued from page 54)

I get a surplus transformer and make a new one?—A. F., New York, N. Y.

The first one of these I saw almost drove me nuts! Only two wires went to the track, yet we could blow whistles, throw switches, etc., by pushing buttons on the transformer! After quite a while, another man and I finally took the transformer apart, and found out how it works (Fig. 3)! The dc is "superimposed" on the low-voltage ac which runs

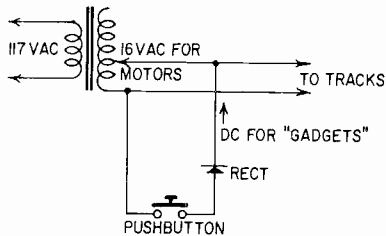

Fig. 3—One method used to actuate accessories in a toy train layout. Rectifier produces mixed dc-and-clipped-ac output when switched in. When rectifier is out of circuit, power is pure ac.

the train motors. We couldn't find a rectifier, either. It is evidently potted inside the transformer somewhere.

Your transformer ought to work as is, if you just add another rectifier to replace the one which is evidently either open or shorted.

Just connect a surplus dry rectifier to the 16-volt ac output of the transformer and wire it through the control pushbutton on top, and it ought to work as well as ever. You can even use small silicon TV replacement rectifiers, since the current drain is pretty small.

Glass replacement for 21MP4

What tube would you recommend to replace the 21MP4 metal kine? I'd like to use an all-glass tube.—A. J. K., Milwaukee, Wis.

The 21YP4 or 21YP4A will replace the 21MP4 metal tube. This is a very common conversion. Most technicians are glad to get a chance to eliminate any metal-cone tube, because of the shock hazard. Be sure to ground the external coating on the new tube.

Horizontal off-frequency

I had quite a few troubles in an old RCA KCS-40. Now I've got them down to one: the horizontal oscillator's off frequency. I've got four pictures on the screen, sidewise. The oscillator is running on the fourth harmonic. I can adjust coils and things and get it down to about two pictures, but no further. Any suggestions?—R. H. N., Great Lakes, Ill.

Let's get one thing straight before we start. Four complete pictures on the screen would *not* indicate that the oscillator was running on its fourth harmonic, but on the "1/4th" harmonic: 3937.5 cycles! The fourth harmonic

would be 4 times 15,750 cycles, 63,000 cycles! This might sound academic, but it is important. Why? Because the frequency of operation indicates the nature of the defect in such cases.

If the frequency is far *below* normal, too *slow*, it means that one of the frequency-determining parts in the circuit is far too *big*! The coil (for example) is set for far too much inductance, or a too-big capacitor has been installed. Symptom on the screen: four pictures, *not* overlapping but complete.

If the oscillator frequency is too high, one of the parts is *smaller* than it should be. This is a more probable situation. A capacitor has opened up, some turns in a coil are shorted, etc. Symptom: multiple *overlapping* images. You can plainly see that parts of each picture are actually overlaid on the rest.

Funny snow

I've got a funny one on an Emerson 1120D TV; it's got a built-in antenna on the back cover. I replaced a tube in it and it worked. Channels 11 and 13 come in fine, but channel 2 has white flecks all over the screen! When I took the back off to see what was the matter, they disappeared; put the back on again, and there they are. Finally, I disconnected one side of the antenna, and everything works fine! Now, give me an explanation for this, so I'll know what's going on the next time!—R. L. B., Baltimore, Md.

This is "spike" radiation from the horizontal sweep, getting into the built-in antenna, which is very close to the horizontal sweep cage, yoke, etc., on one side of the set. I'd say that you probably disconnected the half of the antenna closest to the sweep.

You got the snow on the low channel, but not on the two high ones. This is natural, as the low channels are much more susceptible to pulse interference than the high ones. You can verify this by checking the difference in auto ignition-noise pickup between low and high channels, on any kind of antenna.

There are several cures for this condition. The most obvious is a bit of shielding on the horizontal sweep system. Try wrapping the yoke leads in metal foil, grounding this with a wrapping of bare wire at each end. Rabbit-ears on top of the cabinet, or one of those "under-the-rug" antennas would also cure the trouble, in this one set, which seems to be a mild case.

In severe cases of this trouble, clean up all the flyback shielding. Once in a while you'll find a set where some genius has left the flyback shield off entirely! Make a new one out of copper screen or any suitable metallic material, and wrap the yoke leads. In a few cases, a severe corona discharge from the bell of the picture tube, the high-voltage rectifier socket, and so on, causes trouble.

IT PAYS TO USE AEROVOX!

Profit from Experience

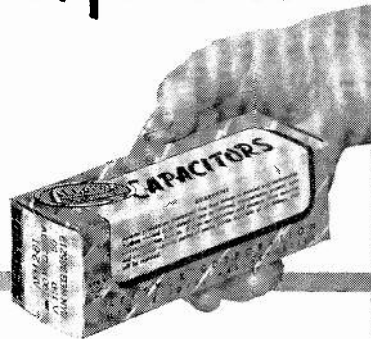

...use a single Aerovox exact replacement electrolytic capacitor every time!

Your customers don't have to look into the back of their sets to know they can rely on your skills and integrity for dependable service—they know from experience. They may never know what brand of capacitors you use, for example. But you know from your own experience that you simply can't afford costly callbacks or dissatisfied customers by using makeshifts or inferior replacements. That's why it pays to use a single Aerovox exact replacement capacitor every time.

There's just no substitute for the quality produced through years of continuous research and development by experienced Aerovox engineers, and our advanced manufacturing and quality control techniques. What's more, you have the most trusted and complete line of 'lytics to choose from to fill all of your service needs. Take the AFH, PR and PRS capacitors, to mention just a few of the most widely used types.

Yes, you protect your reputation and your profits by specifying "Aerovox only" when you order from your regular Aerovox distributor salesman or counterman.

AFH twist-prong 'lytics feature 85°C operation, improved sealing, high-purity aluminum foil construction throughout, ruggedized prongs and mounting terminals. Tops for filter audio bypass in TV-radio and amplifiers.

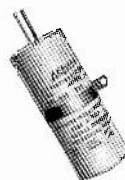

PR wax-filled tubulars manufactured to same high standards as more expensive metal-cased units. Made for exact replacements in TV receivers and antenna rotating devices. Available in singles, duals, triples, quads, and quints for 0-65°C operation.

AEROVOX
CORPORATION
DISTRIBUTOR DIVISION, NEW BEDFORD, MASS.
Technical Leadership—Manufacturing Excellence

All
new
from
Sony

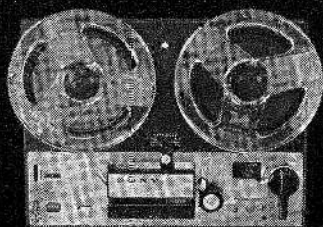

a stereo
deck
with
3 heads!

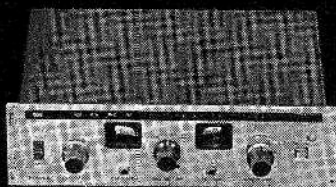

and
stereo
recording
amplifier

Now you can add famous Sony 4 track stereo tape playback to your present hi fi system. Handsomely styled in gold and grey, with 3 heads, 2 speeds, vertical or horizontal mounting, automatic shut-off, tape counter and pause control, the new Sony 263-D is a remarkable value.

Less than \$119.50

For stereo recording, add the new Sony SRA-2L recording amplifier that instantly connects to the 263-D. Its matching gold and grey decor makes a handsome companion for your 263-D. All new from Sony!

Less than \$99.50

■ All Sony Stereorecorders are Multiplex Ready! ■ In New York visit the Sony Salon, 585 Fifth Avenue ■ For literature or name of nearest dealer write Superscope, Inc., Dept T Sun Valley, California.

SONY SUPERSCOPE

The Tapeway to Stereo

Clean all the parts well. Check all solder joints first, to be sure they're well rounded off and not loose. Then spray with corona dope. *Corona dope is not a substitute for sloppy workmanship!*

CRT diagnosis

Can you tell whether a CRT is bad by observing the video information at its input? This assumes that sweep and high-voltage circuits are working properly.
—J. V. C., Houston, Tex.

Yes and no! If your scope showed a signal of about 50 volts p-p at the input of the CRT (Fig. 4) and, at the same time, you had other symptoms — dim

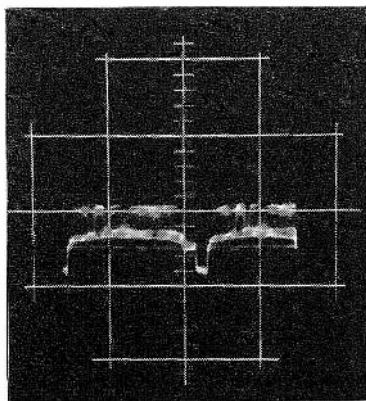

Fig. 4—The amplitude of this signal is about 50 volts peak to peak.

raster, loss of focus, smearing and haziness and very low contrast—I would say this would help. However, in a matter involving CRT replacement, with the attendant expense, be sure to use *all* the clues available before you make up your mind.

Capehart CX-33 conversion

I have a Capehart CX-33, which uses a 170-AR picture tube; this tube is shorted. Can I replace this tube with a 21ZP4B? I'm going to mount it on the wall. Will the present horizontal output transformer work with the new tube, and what additional drive and high voltage will I need to scan the new tube?
—F. K., Newark, N. J.

This should be a practical conversion. Your original 170-AR picture tube has a deflection angle of 70°, and so does the 21ZP4B. The rated high voltage for this chassis is 11 kv, which should be sufficient to operate the larger tube. You might get slightly better results with the type 21EP4, which also has a 70° deflection angle.

Your major problem will probably be width. This should be fairly easy however, if you overhaul the horizontal output stage carefully, and put it into first-class condition. If it is insufficient, try adding a small capacitor across the damper tube, about a 200 pf, with a voltage rating of at least 5 kv, and adjusting width and horizontal linearity coils. Check the plate current of the 6BG6 out-

put tube after all adjustments have been completed. It should not be over 100 ma. Check the screen resistor, and adjust the screen voltage to not over 350. (You might get a little more width, if the screen voltage is less than 350 at present, by raising it to that figure. Not over it, though!)

Sheraton flyback replacement

I can't find any information on a Model T-5410 Sheraton TV. Needs a new flyback. Can you tell me who made this set, and where I can get the flyback?
—W. L. W., Jackson, Tenn.

This set, I'm fairly sure, was originally made by Video Products Corp., and you'll find the service data for it in Sams Photofacts 218, Folder 10, under Chassis 250XL.

The flyback can be replaced by a Triad D-43 or Merit HVO-25, if the original part number was ET-119.

Stewart-Warner: bigger CRT

Can I convert a Stewart-Warner 9104A TV set from a 12LP4 to a 16LP4, or to a 17ATP4? Would I have to use a new flyback and vertical output transformer?
—J. W., Columbus, Ohio.

If you use the 16LP4 on the Stewart-Warner you won't have to make very many changes in the chassis. Stewart-Warner, along about that period, was noted for conservative design. In other words, you ought to have plenty of reserve to drive the larger tube with the original parts, assuming they are all in good shape.

The 12LP4 and the 16LP4 both have the same basing and deflection angle; the only difference lies in the amount of ulior voltage required: 12LP4 specifies 11,000, and the 16LP4, 12,000. However, I have seldom found too much difference in brightness with the high voltage off only 1,000 volts. Besides, I think you can push the old Stewart-Warner up to 12 kv without too much trouble, by increasing the drive, etc. You could even raise the output by such measures as cutting the 6BG6 screen resistor down a little to raise the screen voltage. Watch your cathode current, though; don't let it get above 105 ma, or you'll shorten the tube life.

Conversion to the 17ATP4 would be quite a lot more difficult, and I would not recommend it for the added 3/4 inch or so of screen width. This is a 90° tube and you definitely would have to change the yoke, flyback and vertical output transformer, and probably the horizontal and vertical output tubes, too. In addition, the horizontal drive would have to be increased by something like 40%, and you might find yourself rebuilding the horizontal oscillator stage, too! Therefore, the 16LP4 would be a much more practical conversion. END

Here's your only "middleman"...

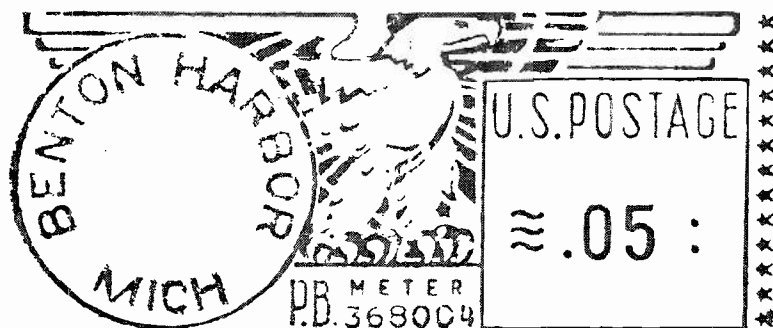

when you buy a Heathkit!

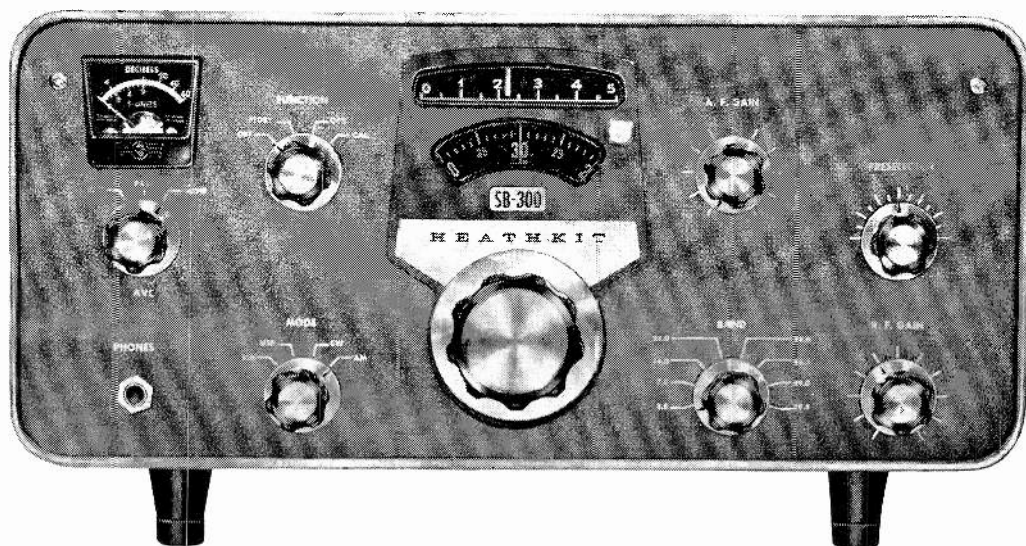

Just a few postage stamps from Uncle Sam is all it takes to move your Heathkit from factory to you. There's no one in between . . . no distributors . . . no dealers . . . no one to add expensive, unnecessary cost. What does this mean to you? It means you have eliminated middleman profits . . . received more for your money! It means that you have put your money in the product, not its distribution. It means you get better quality and better performance at lower cost . . . the traditional Heathkit benefits.

And there are other advantages to dealing directly with the factory. You enjoy close, personal contact with the people who designed and built your kit . . . people who are interested in its performance as a finished product. Free consultation services and personal assistance are available to answer any questions you may have about the selection, construction, and use of any Heathkit. Original replacement parts and factory repair are at your service should you ever need it. Fast, to-your-door delivery is another convenience.

Add to these the significant savings of do-it-yourself assembly and you'll see why Heathkit equipment is world-famous for quality and value . . . your best buy in electronic kits!

A Superb Example of Heathkit Quality . . . The New SB-300 SSB Amateur Receiver . . . Only \$265.00!

Check these Features!

- Professional styling & features at 60% savings!
- Complete coverage of 80 through 10 meter amateur bands with all crystals furnished, plus provision for VHF converters
- Prebuilt, calibrated linear master oscillator (LMO)
- 25 KC per tuning knob revolution offers bandspread equal to 10 feet per megacycle
- Built-in crystal calibrator
- 2.1 KC crystal bandpass filter
- Stability of 100 CPS after initial warm-up
- Wiring harness & two heavy-duty circuit boards for easy assembly.

Check these Specifications!

Frequency range (megacycles): 3.5 to 4.0, 7.0 to 7.5, 14.0 to 14.5, 21.0 to 21.5, 28.0 to 28.5, 28.5 to 29.0, 29.0 to 29.5, 29.5 to 30. **Intermediate frequency:** 3.395 megacycles. **Frequency stability:** 100 cps after warmup. **Visual dial accuracy:** Within 200 cps on all bands. **Electrical dial accuracy:** Within 400 cps on all bands. **Backlash:** No more than 50 cps. **Sensitivity:** Less than 1 microvolt for 15 db signal plus noise-to-noise ratio for SSB operation. **Modes of operation:** Switch selected: LSB, USB, CW, AM. **Selectivity: SSB:** 2.1 kc at 6 db down, 5.0 kc at 60 db down (crystal filter supplied). **AM:** 3.75 kc at 6 db down, 10 kc at 60 db down (crystal filter available as accessory). **CW:** 400 cps at 6 db down, 2.5 kc at 60 db down (crystal filter available as accessory). **Spurious response:** Image and IF rejection better than 50 db. Internal spurious signals below equivalent antenna input of 1 microvolt. **Audio response: SSB:** 350 to 2450 cps nominal at 6 db. **AM:** 200 to 3500 cps nominal at 6 db. **CW:** 800 to 1200 cps nominal at 6 db. **Antenna input impedance:** 50 ohms nominal. **Muting:** Open external ground at Mute socket. **Crystal calibrator:** 100 kc

crystal, ±.005%. **Front panel controls:** Main tuning dial; function switch; mode switch; AGC switch; band switch; AF gain control; RF gain control; pre-selector; phone jack. **Rear apron connections:** Accessory power plug; HF antenna; VHF #1 antenna; VHF #2 antenna; mute; spare; anti-trip; 500 ohm; 8 ohm speaker; line cord socket; heterodyne oscillator output; LMO output; BFO output; VHF converter switch. **Tube complement:** (1) 6BZ6 RF amplifier; (1) 6AU6 Heterodyne mixer; (1) 6AB4 Heterodyne oscillator; (1) 6AU6 LM osc.; (1) 6AU6 LMO mixer; (2) 6BA6 IF amplifier; (1) 6AU6 Crystal calibrator; (1) 6HF8 1st audio, audio output; (1) 6AS11 Product detector, BFO BFO amplifier. **Power supply:** Transformer operated with silicon diode rectifiers. **Power requirements:** 120 volts AC, 50/60 cps, 50 watts. **Dimensions:** 14 1/2" W x 6 3/8" H x 13 3/8" D.



FREE CATALOG

Send for your Free copy today! Fully describes over 250 exciting Heathkits at savings of 50% or more! Choose from the world's largest selection of quality instruments in easy-to-assemble kit form!



HEATH COMPANY

20-2-2

Benton Harbor, Mich. 49023

Please send free 1964 Heathkit Catalog.

Name _____

Address _____

City _____ State _____ Zip _____

AM-135

Buy Now—See Order Blank Page

audio equipment report

FM STEREO TUNER

and

A SPEAKER SYSTEM

Scott 310E and Electro-Voice EV Two

THE SCOTT 310E IS THE MOST SENSITIVE, versatile, complex and high-priced tuner in the renowned Scott line with the single exception of the 4310 Broadcast Monitor, virtually the same except for VU meters and some facilities useful chiefly in broadcast service. It is quite possibly the most elaborate and flexible tuner on the market for handling stereo multiplex reception and its aberrations.

The 310 contains the same rf and i.f. section as several other tuners in the line. An extremely well designed cascode rf stage and mixer, three wide-band i.f. amplifiers, two limiters and a wide-band ratio detector yield an IHF sensitivity in the region of $2 \mu\text{V}$ and a practical high-fidelity sensitivity at least as good as that of any other tuner on the market. To minimize cross-modulation and overload distortion, agc is applied to the rf and one i.f. stage. Where maximum sensitivity is needed, a switch reduces the agc to a minimum.

The capture ratio is among the best and the selectivity good enough to make adjacent-channel reception possible. This portion of the tuner has had several years of use in previous Scott tuners and has earned them a reputation among the top two or three on the market.

No matter how sensitive the tuner, multiplex stereo reception presents problems. The 310E is notable for the quite elaborate measures it takes to deal with them. The multiplex is a rather complex version of the switching type circuit, employing a 6U8, two 12AU7s and eight diodes, and delivers as good stereo as I have heard.

Three additional double triodes and five diodes, plus two relays, are used in an automatic switching and muting system. There are switched high-frequency rolloff filters for both the main and sub-channel. This system provides automatic

interchannel noise suppression and automatic switching of mode of operation, plus adjustments to make marginal signals tolerable, offering a so-far unprecedented flexibility and convenience of operation.

To begin with, there is an interchannel muting or "squelch" circuit with a threshold control on the panel. This can be adjusted to receive the weakest signal capable of giving any semblance of high-fidelity, or to work on extremely strong stations only. In any event, it will provide interstation noise muting in fringe as well as primary areas. It can also be adjusted to mute the receiver if a signal fades below any chosen threshold level. Normally it would be adjusted to mute the receiver when any signal falls below a level that yields high-fidelity quality. A relay does the actual switching, without any objectionable transients. A small pilot light indicates when the squelch is operating.

A switch provides a choice of three modes of operation. In the first position, the 310E is strictly a monophonic receiver. All programs, mono or stereo, are played back monophonically. In the second position the tuner switches automatically for mono or stereo programs. If a station changes from mono to stereo, or vice versa, the tuner automatically accommodates itself to the changes. In the third position it becomes a stereo-only receiver, responding only to stations broadcasting stereo and passing over any monophonic programs.

One big problem with stereo reception, especially in the fringe areas, is that signal levels are often too low for good stereo reception, or may fade below the good-signal threshold from time to time. It is often possible to receive the same program satisfactorily in the mono mode. Hence most tuners provide a

switch so the tuner can be switched to mono under such circumstances.

The 310E has a uniquely satisfactory answer to this problem. There is a Stereo Threshold circuit with a control on the front panel. This can be adjusted so that when a stereo signal falls below any desired level, the tuner automatically switches to mono. If the signal again rises to a satisfactory level, the tuner switches back to stereo automatically. Thus the program is heard with the least amount of noise and without interruption. The shift from stereo to mono is far less noticeable than a sharp increase in noise and distortion would be. This control circuit also works through a relay which is free of transients. (There is occasionally an increase in distortion for a short time just before the control trips.)

The 310E provides means for dealing with marginal stereo reception if you insist on listening to it. Sensitivity can be increased by throwing the agc switch to the PARTIAL position. The subchannel is the most likely to be marred by noise; to offer relief from this the function switch has a position that switches a high-frequency rolloff filter into the sub-channel audio. There is a sacrifice in stereo separation. For even noisier situations, you can switch a filter into the main channel to attenuate the high-frequency noise, multiple-path distortion, etc., without affecting channel separation.

It takes some time to learn how to operate all this wealth of control circuitry to best advantage. Once it is mastered, it certainly does offer just about every imaginable way of dealing with either stereo or mono reception problems, and makes reception just about as noise-free as possible. These advantages are accompanied by a surprising lack of "bad features." I found it possible to set the two relays chattering by some combination settings of both the SQUELCH and STEREO THRESHOLD, but apparently this is not likely to happen in actual use. The relays make an audible click as they go in and out but it would not normally be heard over program material.

As in all Scott tuners, the tuning is very smooth and—with the tuning meter

SPECIFICATIONS

(All specifications are the manufacturer's)

- Usable sensitivity (IHF): $1.9 \mu\text{V}$
- Cross-modulation rejection: 85 db
- Signal-to-noise ratio: 65 db
- Harmonic distortion: 0.5%
- Drift: .02%
- Frequency response: 30 to 15,000 cycles, ± 1 db (IHF measurements made only from 30 to 15,000 cycles. Tuners actually have wider frequency range.)
- Capture ratio: 2.2 db
- Selectivity: 50 db
- Stereo separation: 35 db or higher [Mfr does not give frequency—Editor]
- Audio hum: 66 db below 1 volt audio output
- AM suppression: 60 db
- Detector bandwidth: 2 mc
- Dimensions (with optional cabinet): $15\frac{1}{2} \times 5\frac{1}{4} \times 13\frac{1}{4}$ inches

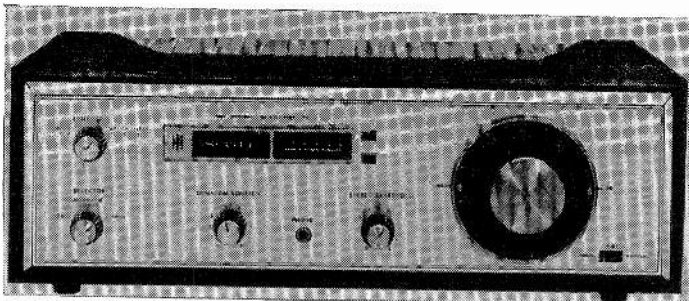

H. H. Scott's 310E FM stereo tuner.

Most people build a HEATHKIT® but

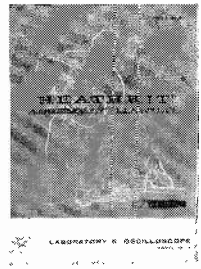
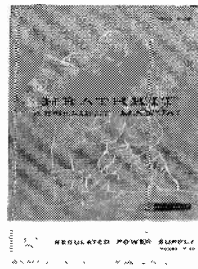
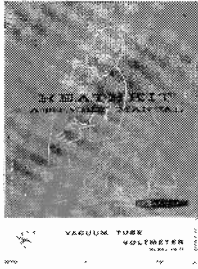

Many people buy them factory assembled!

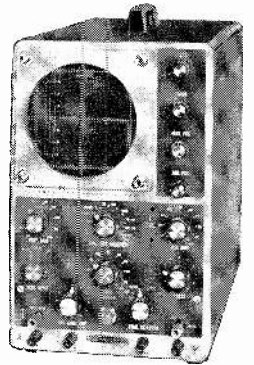
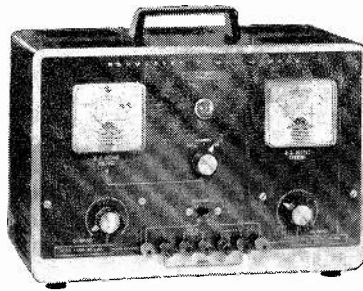
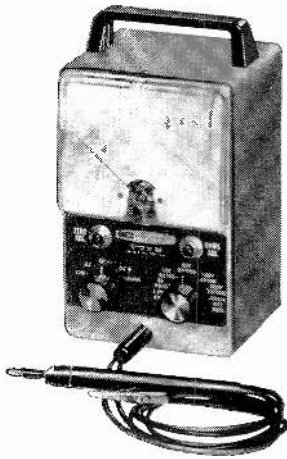

Most people prefer to build Heathkits because of the extra savings and knowledge realized through do-it-yourself assembly! Heathkit construction manuals are world-famous for their clarity and attention to detail with simple step-by-step instructions, large pictorial diagrams for easy assembly, plus complete information on the use and maintenance of your instrument for effective and dependable results in every application.

But, many people prefer to buy Heathkit units factory assembled because they recognize the high quality and performance they provide at low cost! You even save over other comparable factory built units because you buy direct from the manufacturer, eliminating middleman profits and expensive distribution costs!

Whichever way you prefer to buy Heathkits, you'll find their dependable time-proven circuitry, top-grade components and latest design features the perfect answer to your test equipment needs! Compare these Heathkit favorites with any other and you'll see why Heathkit is your best buy!

Heathkit IM-11 VTVM... World's Largest Selling VTVM! • Finest quality components throughout for long life and dependable performance • Single test probe convenience • 7 AC, 7 DC and 7 Ohms ranges • Large, easy-to-read 4½" 200 UA meter • 1% Precision resistors for high accuracy. *Kit IM-11... 5 lbs. \$24.95*
Assembled IMW-11... 5 lbs. \$39.95

SPECIFICATIONS—Meter scales: DC & AC (RMS): 0-1.5, 5, 15, 50, 150, 1500 volts full scale. AC peak-to-peak: 0.4, 14, 40, 140, 400, 1400, 4000. Resistance: 10 ohm center scale x1, x10, x100, x1000, x10K, x100K, x1 meg. Measures .1 ohm to 1000 megohms with internal battery. Meter: 4½" 200 ua movement. Multipliers: 1% precision type. Input resistance DC: 11 megohms (1 megohm in probe) on all ranges. Circuit: Balanced bridge (push-pull) using twin triode. Accuracy: DC ± 3%, AC ± 5% of full scale. Frequency response: ± 1 db, 25 cps to 1 mc (600 ohm source). Tubes: 12AU7, 6AL5. Battery requirement:

1.5 volt, size "C" flashlight cell. Power requirements: 105-125 volt 50/60 cycle AC 10 watts. Dimensions: 7¾"H x 4-11/16"W x 4¾"D.

Heathkit Laboratory AC VTVM ... for Precision AC Work! • 10 Voltage ranges—0.01 to 300 volts RMS full scale • ± 1 DB, 10 CPS to 500 KC frequency response • 10 Megohm input impedance for high accuracy • Calibrated DB scale for audio measurements • VU type ballistic damping of meter movement • *Kit IM-21... 5 lbs. \$33.95*
Assembled IMW-21... 5 lbs. \$52.95

SPECIFICATIONS—Frequency response: ± 1 db 10 cps to 500 kc, ± 2 db 10 cps to 1 mc, all ranges. Ranges: VOLTS—Ten ranges from 0.01 to 300 volts RMS full scale. Decibels: Total range —52 to +52 db, meter scale —12 to +2 db (0 db = 1 mw in 600 ohms), ten switch selected ranges from —40 db to +50 db in 10 db steps. Input impedance: 10 megohms shunted by 12 uuf on ranges 10 to 300 volts, 10 megohms shunted by 22 uuf on ranges .01 to 3 volts. Tube complement: (1) 6AW8, (1) 6EJ7/EF-184. Accuracy: Within 5% of full scale. Power requirements: 105-125 volts AC, 50-60 cycles, 10 watts. Dimensions: 7¾"H x 4-11/16"W x 4¾"D.

Heathkit Variable-Voltage Regulated Laboratory Power Supply • Ideal for all types of circuit design & development work • Furnishes B+, bias and filament voltages • DC output variable from 0 to 400 volts • Panel meters monitor output voltage and current • Rugged, well-rated components throughout for dependability and long life • *Kit IP-32... 16 lbs. \$56.95*
Assembled IPW-32... 16 lbs. \$84.95

SPECIFICATIONS—Output: 0-400 volts regulated DC at 0-100 ma cont., 125 ma intermittent, 0 to —100 volts DC at 1 ma variable bias voltage, 6.3 volts AC at 4 amps, filament voltage. Regulation: Output variation less than 1% from no load to full load; Output variation less than ± 0.5 volt for a ± 10 v. change at 117 v. AC input. Ripple: less than 10 millivolts RMS, ripple, jitter and noise. Output impedance: less than 10 ohms, DC to 1 mc. Meters: Voltmeter 0-400 V or 0-150 V.; Milliammeter 0-150 ma. Dimensions: 13"W x 8½"H x 7"D.

Heathkit "Extra-Duty" Lab 5" Oscilloscope • Professional styling & features at low cost • Full 5 MC bandwidth—ideal for Color TV servicing • Heath patented

sweep circuit—10 CPS to 500 KC • Push-pull vertical & horizontal output amplifiers • Finest oscilloscope value in the industry! *Kit IO-12... 24 lbs. \$76.95*
Assembled IOW-12... 24 lbs. \$126.95

SPECIFICATIONS—(Vertical) Sensitivity: 0.025 volts RMS per inch at 1 kc. Frequency response (referred to 1 kc level): ± 1 db 8 cps to 2.5 mc; +1.5 to —5 db, 3 cps to 5 mc; response at 3.58 mc, —2.2 db. Rise time: 0.08 microseconds or less. Input impedance: (at 1 KC) 2.7 megohms at X1; 3.3 megohms at X10 and X100. (Horizontal Channel) Sensitivity: 0.3 volts RMS per inch at 1 kc. Frequency response: ± 1 db 1 cps to 200 kc; ± 3 db 1 cps to 400 kc. Input impedance: 4.9 megohms at 1 kc. Sweep generator: Range—10 cps to 500 kc in five steps, variable, plus any 2 switch-selected preset sweep frequencies in this range. Synchronizing: automatic lock-in circuit using self-limiting synchronizing cathode follower. Power requirements: 105-125 volts 50/60 cycles AC at 80 watts; fused. Dimensions: 14¾"H x 8¾"W x 16"D.



FREE 1964 CATALOG

See these and over 250 other exciting Heathkits available in easy-to-build kit form. Save 50% or more by doing the easy assembly yourself! Send for your free catalog today!



HEATH COMPANY
Benton Harbor, Mich. 49023

20-2-1

Please send my free Heathkit Catalog.
 Enclosed is \$ _____, plus postage.

Send model _____.

Name _____

Address _____

City _____

State _____ Zip No. _____

TE-122

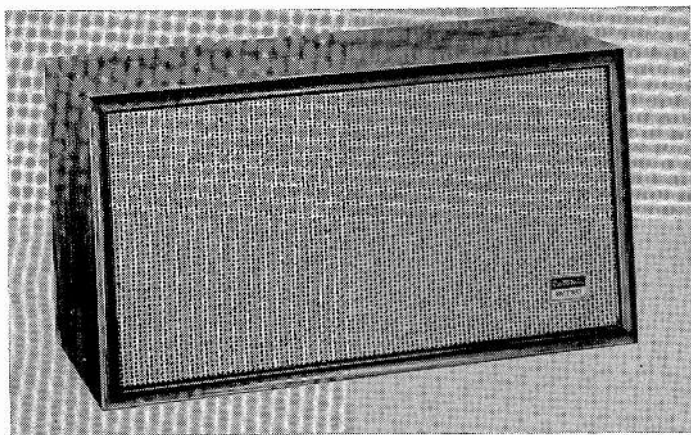

The Electro-Voice EV Two speaker system.

—easy to resonate for minimum distortion. There is no afc, but the tuner is inherently stable and wide enough in bandwidth to stay on tune for days at a time. Individual level controls for each channel permit loudness of radio reception to be adjusted to equal that of other program sources. There are two sets of output jacks, one for preamp and another for tape recorder, line or what-not. Furthermore, the tape recorder can be plugged into a jack on the panel.

In short, the 310E is sensitive enough to provide stereo reception anywhere it is possible at all, and with its automatic circuitry makes it possible to hear the program without interruptions or noise and with a minimum of attention by the user. Those to whom the price of \$280 is not a deterrent will find it a highly satisfactory and satisfying piece of equipment.

The E-V Two

THE ELECTRO-VOICE TV TWO'S ARE NOT small as bookshelf speakers come today, and not light. But they supply precisely what is missing in a few of the smaller speakers—the awesomeness and presence which a good fundamental, low-distortion bottom-end response yields.

The EV Two is the middle-priced member of a new line of three acoustic-suspension systems. The EV One is a thin-line system with a 10-inch woofer. The EV Two and Four share the same 12-inch woofer and the same cabinet. The Four has a mid-range speaker as well as a compression horn-loaded tweeter; the Two has the woofer and tweeter only. The Four is priced at \$134, the Two at \$106; and both are available in kit form for \$94 and \$80, respectively. The low- and high-end response are virtually identical; the difference is largely in the mid-range.

The response of the Two's we tested is smooth and virtually free of distortion at moderate levels down to about 40 cycles. They go considerably lower, though doubling distortion is noticeable below 40 cycles (on sine waves but not on music). The middle and high end seem more assertive than in the AR's

SPECIFICATIONS	
<small>(All specifications are the manufacturer's)</small>	
Type of system:	2-way, shelf-size, acoustic suspension
Speakers:	12-inch cone woofer; ring-diaphragm compression-loaded horn tweeter
Frequency response:	30 to 15,000 cycles
Crossover:	800 cycles
Rated impedance:	8 ohms
Power capacity:	30 watts
Size:	14 x 25 x 13½ inches
Finish:	Choice of wood veneers, finished 4 sides
Available in kit form, prefinished 4 sides.	

and KLH's. This, and a more alive, less tautly damped bottom, are the features which most immediately distinguish this new line from the older acoustic suspension systems. The transient response is good though the sound is not as "dry" as in the AR's. This I suppose is in keeping with what is almost a traditional Electro-Voice emphasis on vibrancy and liveness of tone, and offers an overall sound quality intermediate between that of the older acoustic-suspension systems and that of typical bass-reflex or ducted-port types. It should appeal to many.

Instead of a continuously variable pad for controlling the balance between woofer and tweeter, these speakers have a slide switch that provides three high-end curves. Middle position is flat, and the other two offer a boost or drop from 2,000 to 5 db at 20,000 cycles. This seems to me a sensible simplification. Actually this is about as close as most people ever come to balance and assures a more uniform response from the pair than usually achieved with continuous controls. It offers much less opportunity for misadjustment.

The Two's are not small. They are slightly larger than AR-3's—14 x 25 x 13½ inches. They weigh about 40 pounds apiece. Their design is simple and tasteful, and they can be used either vertically or horizontally. The name plate can be rotated accordingly.

In brief, the EV Two's produce a quite spectacular sound, with a big low-down bass, sharp and rather assertive high end and an overall tone quality that is the best, to my ears, that Electro-Voice has yet produced.—Joseph Marshall

The answers to

WHAT'S YOUR



Neon-bulb circuit

The purpose of the voltmeter is to start the four neon lamps on a voltage lower than the combined firing voltage of four lamps. For several microseconds after the vtvm is connected across terminals A and B, the IR drop across both the ballast resistor and the voltmeter is low, and as a result, most of the supply voltage is applied to three lamps. This voltage level is above the combined firing voltage of three lamps and the lamps fire.

When the three unbridged lamps are lit, the rise in current produces an IR drop that exceeds 74 volts across the 10-megohm voltmeter resistance. This causes the bridged lamp to fire. After four lamps have fired, the maintaining voltage across each lamp is 59, and the IR drop across the ballast resistor is 30 volts. For practical purposes, the voltmeter reading is 59 volts. When the voltmeter is disconnected, the lamps will continue to glow and the total current will decrease by approximately 6 microamperes.

The Innocent Black Box

The black box contains a flashlight bulb. An ohmmeter allows a high circuit current of 50 to 80 ma (normally) for reading low ohms in the R × 1 range. This heats the lamp filament and the meter reads hot resistance. But in the R × 10 range, current is very low and meter reads almost cold resistance.

No-signal stinker

Only one possibility here. (Note that there is *no voltage drop* across those big plate resistors!) Grid voltage is zero, cathode voltage zero, so the tube isn't blocked. *The tube heater is not burning!* Since the tube is good, this is probably a socket trouble. This is a metal tube, so you wouldn't see it at first; you'd have to wait for it to get warm. Check: measure heater voltage on the ends of the base pins, not on the socket terminals.

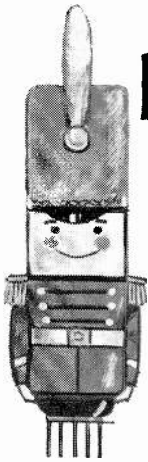

Ready for final inspection-

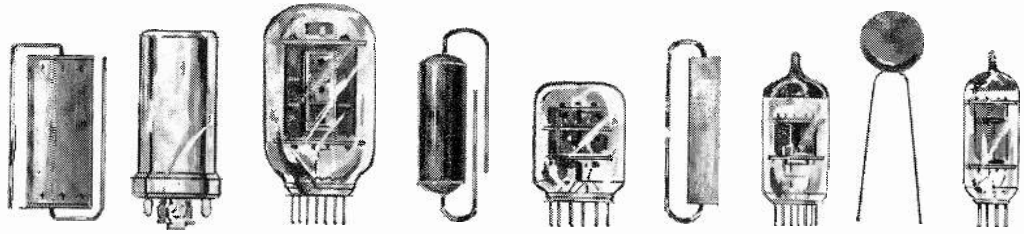

with Heathkit® quality test apparatus!

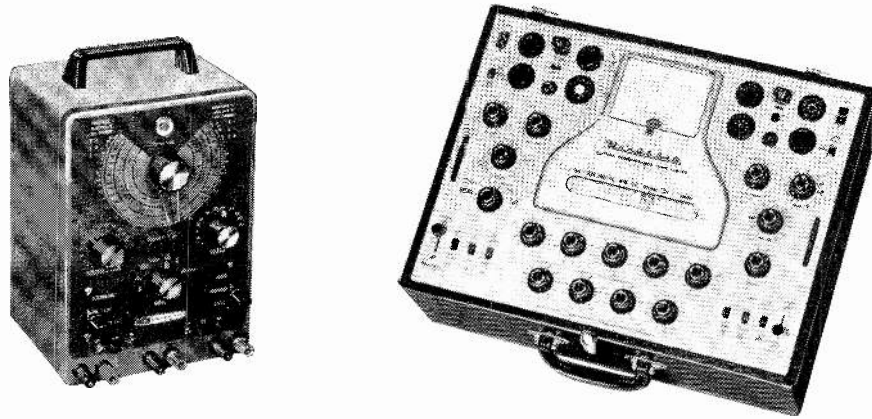

Line up those faulty, suspected or questionable electronic components encountered in daily service work and give them a complete and thorough test with accurate, dependable Heathkit test instruments! Heathkit test equipment is recognized nation-wide for its value and performance at low cost. Latest design features and quality components team-up to bring you complete up-to-date test facilities that are unsurpassed in their field. As the world's largest kit manufacturer Heath brings you extra savings through volume purchasing power in addition to savings realized by buying direct! Equip your lab or service shop with Heathkit *now* and enjoy the finest at the lowest cost!

Heathkit Deluxe Capacitor Checker

- Safely tests all capacitor types—including miniature electrolytics
- Low bridge voltage
- Direct reading scale—no involved calculations
- Measures capacity or resistance directly with internal standards
- 16 switch-selected leakage testing voltages
- Calibrated power factor control
- "Eye" tube indicator
- Measures "L", "C", or "R" with external standard
- Easy to build and operate with complete instructions furnished
- An instrument no test bench should be without!

SPECIFICATIONS—Test circuit: AC bridge, powered through special bridge transformer by an internal 60 cycle supply or by an external audio generator with 10 volts output. Upper frequency limit: 10 kc. **Capacitance, 4 ranges:** 10 uuf

to .005 ufd; .001 ufd to .5 ufd, .1 ufd to 50 ufd, 20 ufd to 1000 ufd. **Capacitor leakage:** DC test voltages from 3 to 600 volts in 16 steps. **Resistance, 3 ranges:** 5 ohms to 5000 ohms; 500 ohms to 500 K ohms; 50 K ohms to 50 megohms. **Comparator circuit:** External standard R, L or C; Max. Ratio 25-1. **Power supply:** Transformer-operated, half-wave rectifier. **Power requirements:** 105-125 volts AC, 50/60 cycles, 30 watts. **Dimensions:** 9 1/4" high x 6 1/2" wide x 5" deep.

Kit IT-11 . . . 7 lbs. \$29.95

Heathkit Mutual Conductance Tube Tester

- Finest tube tester value in the industry!
- Provides complete and thorough tests of all tube types
- Indicates Gm to 24,000 micromhos
- Ultra-sensitive grid current test
- Direct reading ohmmeter leakage test
- Built-in switch-operated calibration circuit
- Constant current heater supplies
- Life test
- Built-in adapter for compactron, nuvistor, novar & 10-pin miniature tube types
- Tube data subscription service available.

SPECIFICATIONS—Power requirements—Voltage: 105-125, 60 cycle AC. **Watts:** 10-60 (dependent upon tube under test). **Plate supply:** (SILICON RECTIFIERS). **DC volts:** 26, 90, 135, 225 ±, variable 80 to 200 (Separate DC supply for space charge grids). **AC volts:** 20, 45, 177. **Bias supply:** (SILICON RECTIFIER). **Low range:** 0 to negative 5 volts DC. **High range:** 0 to negative 20 volts DC. **Signal voltages:** 2, 1, .5, .25 volts AC 5000 cycles. **Filament supply voltage:** .65, 1.1, 1.5, 2, 2.5, 3.3, 5, 6.3, 7.5, 10, 13, 20, 27.7, 35, 47, 70 and 115. **Currents:** 300, 450, 600 ma. (Note: Filament voltage is reduced 10% during life test). **Testing circuits Gm:** (Mutual conductance-amplifiers) 0-24,000 micromhos. **Emission:** Rectifiers and diodes. **Leakage:** Direct reading ohmmeter. **Grid current:** 1/2 microampere sensitivity. **Voltage regulators:** Firing voltage and regulation tolerance. **Low power thyatrons:** Grid characteristics, conduction capabilities. **Eye tubes:** Cont. of grid characteristics. **Meter AC:** 1000 ohms/volt (1 volt full scale). **DC:** 89 ma full scale. **Scales:** Gm: 0-3000 micromhos, VR test volts: 0-200 volts. **Leakage:** 6-10 megohms. **Diodes O.K., Rectifiers O.K., Line check arrow** at midscale. **Tube complement:** (1) 3A4 oscillator, (1) 12AV6 meter con-

trol. **Calibration circuit:** Built-in switch operated. **Socket accommodations:** 4-pin, 5-pin, 6-pin, 7-pin combination and pilot light, 5 & 7-pin nuvistor, 7 pin miniature, 7-pin sub-miniature, 8-pin sub-miniature, octal, loctal, 9-pin miniature, 9-pin, Novar, ten-pin miniature, 12-pin Compactron. **Line voltage adjustment:** Continuously variable. **Roll chart mechanism:** Constant tension, free rolling, thumbwheel operated, illuminated. **Dimensions:** Cabinet (outside): 17 1/2" W x 13 1/2" H x 8 1/2" D. **Panel and chassis:** 17" W x 12 1/2" H x 5 1/2" D.

Kit TT-1A . . . 34 lbs. \$149.95

FREE CATALOG
Send for your Free copy today! Fully describes over 250 exciting Heathkits at savings of 50% or more! Choose from the world's largest selection of quality instruments in easy-to-assemble kit form!

HEATHKIT®
by Daystrom
HEATH COMPANY 20-2-3
Benton Harbor, Mich. 49023

Please send free 1964 Heathkit Catalog.
 Enclosed is \$ _____, plus postage.

Send model(s) _____

Name _____

Address _____

City _____ State _____ Zip _____

TE-124

Buy Now! See Order Blank Page!

A DAY AT THE BENCH

Meanwhile, back at the shop...the rainy-day blues

By WARREN ROY

IT WAS A GOOD DAY FOR ANTENNA WORK—raining cats and dogs. But, fortunately, not a single antenna call was on the books. My partner Luke was making house calls—his week for them—and I was at the bench trying to put a dent in the conglomeration sitting there. My only real problem was to decide which set to hit first—the G-E whose vertical hold had drifted away, the RCA with horizontal pulling, the Crosley with a partially negative picture or the tape recorder with a frying noise.

Eny, meeny, miney, mo, it was the Crosley, a model J-21TKMF. The job ticket showed that I had made the house call. Trouble was, all strong local stations produced a picture that was slightly or partially negative. Substituting tubes did no good, so the set was brought to the shop.

Plugged in, turned on and antenna hooked up, it showed the same symptoms as during the house call. Contrast and fine tuning had no effect on the negative. Yet, if I turned the agc control from side to side, I could eliminate the trouble on the affected channels, but then there would be no picture at all on the weaker stations. Obviously, the trouble was somewhere in the agc system.

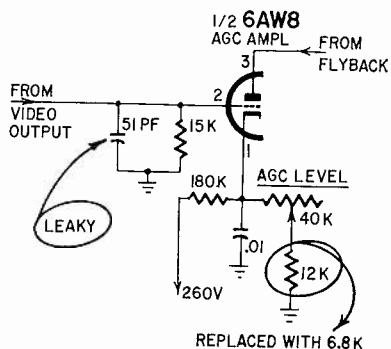

Fig. 1—"The fault had to be somewhere between the video amplifier plate and the agc amplifier grid."

A check with the scope at the agc amplifier grid showed that not enough video was getting through, yet the video amplifier was delivering. The fault had to be somewhere between the video amplifier plate and the agc amplifier grid. It was, after a half hour of lifting capacitors, a leaky 51-pf ceramic (Fig. 1). I replaced it and discovered a new problem. I couldn't get anything but snowy pictures on all channels. No matter how the AGC LEVEL control was adjusted, still snow.

A careful check showed no other fault in the circuit but, if a bias box was connected to the agc line, a normal picture would appear. At this point, I got the notion that perhaps the AGC LEVEL control wasn't giving me enough range. To check this, I temporarily jumped the 12,000-ohm resistor in series with the control. Now I could set the control for a good picture on all channels. For safety's sake, I replaced the 12,000-ohm unit with a 6,800-ohm resistor. Now a normal picture could be tuned in on any channel.

Well, now that this one was out of the way it was time to check the horizontal pulling in the RCA. In the meantime, I left the Crosley running, just to make sure nothing else went wrong. Then just before shutting down a bit later, I'd touch up the linearity and height, check the focus and wipe off the kine faceplate.

RCA 700 series color set

So it's down the bench to the next one... This too looked like agc trouble: horizontal pulling here and there, noticeable enough to disturb any normal viewer. The bias box came out again for a quick check. Disable the agc, hook in the box. No change. So it really is horizontal pulling, after all.

Over came the scope. And there was the clue: hash at the horizontal oscillator grid. Tracing back down the line, it was coming through from the sync output, but how? The only thing along

the line is an 82-pf ceramic, C611 (Fig. 2). It being on a printed-circuit board, it was easier to lift out the whole capacitor than just one end. The capacitor tester said the C611 was good, but since I already had it out, I replaced it with a new one anyway. Good thing I did, too. Once the new cap was in place, the horizontal pulling was gone. It took a bit of careful checking to find out why—slight leakage in the old capacitor that the checker didn't reveal—but at least I knew that, when that set went back, it wouldn't give the same trouble again.

Lunch time. But before I broke, I went back to the Crosley, noted it was still going strong, tuned it up, turned it off and moved it over to the outgoing shelf. Luke would return it tomorrow.

Tape recorder fun

After lunch it looked like a chance for a little entertainment. I'd get to listen to a jazz tape or two while testing that RCA 7-TRC tape recorder. Customer brought this one. It's supposed to be portable, but weighs about 60 pounds (tons?). The trouble was a kind of frying noise when playing prerecorded tapes. After playing one of Duke Ellington's latest, I was sure it was in the machine and not on the tape. Off for the scope again, in what turned out to be a vain attempt to track down the hash.

It was everywhere in the playback circuit and nothing would reveal the source. Finally, I hooked up a little audio amplifier we keep around the shop and connected a length of shielded cable, with a loop of hookup wire at one end, to the amplifier. Moving the loop around near the recorder revealed the same hash coming through my amplifier. A little searching around showed the noise was loudest when the pickup coil was close to the NORMAL level indicator lamp in the recorder. A new lamp stopped the frying. What the old lamp was doing to cause this noise I'll never know, but it was doing a real good job. I played the other side of Duke Ellington and decided it sounded much better without the frying. Called the recorder

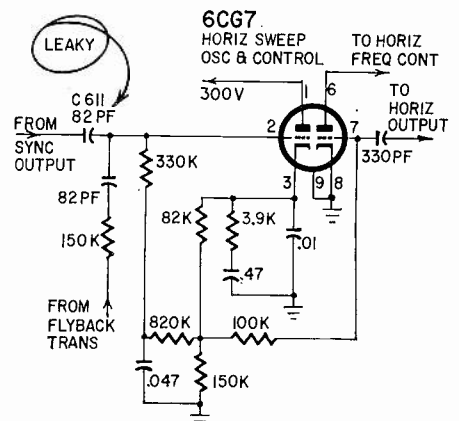
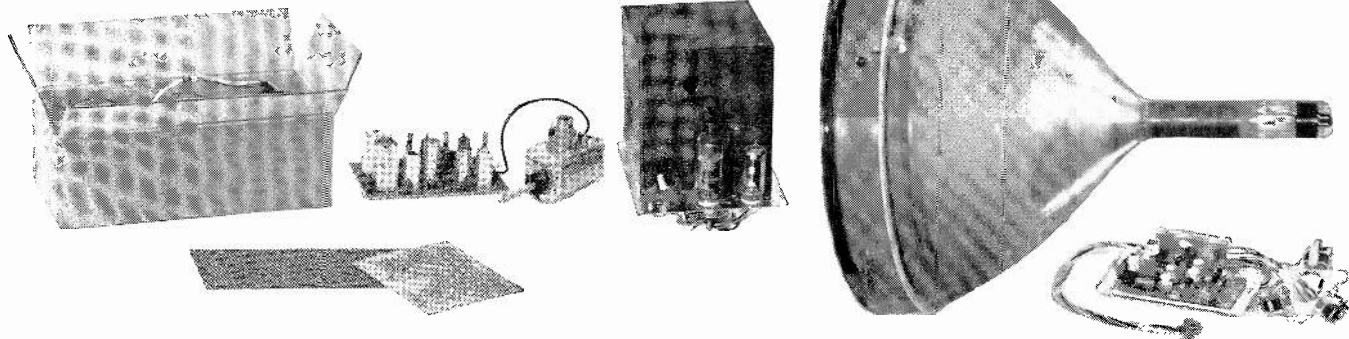
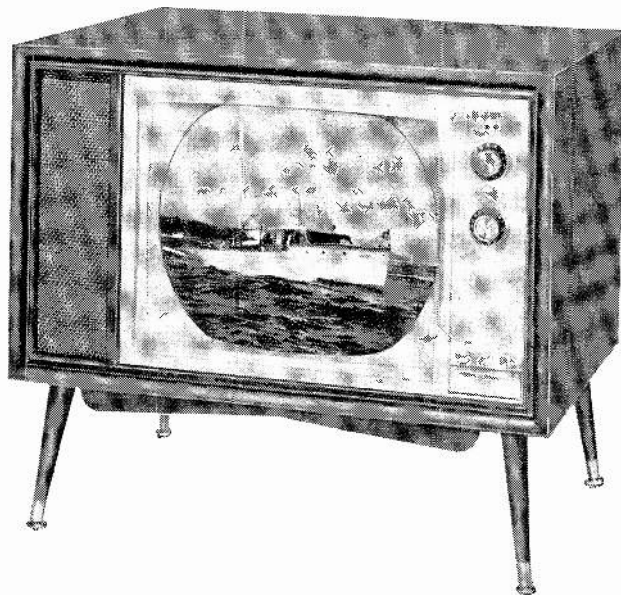

Fig. 2—"The only thing along the line is an 82-pf ceramic..."

From Parts...



To Picture In Just 25 Hours



Heathkit High Fidelity Color TV For As Low As \$349

25 hours of relaxing, rewarding fun! That's all! And you've built the *new* Heathkit High Fidelity 21" Color TV with the finest color circuitry, components, and performance possible today. Goes together quickly, easily. *No* special skills or knowledge required! So simple anyone can build it! You'll enjoy 21 inches of beautiful, high fidelity picture that reproduces every color naturally, realistically, faithfully... you'll enjoy high fidelity sound that's sharp, crisp, clean...and you'll enjoy features and performance comparable only to units costing 50% more!

Compare these Heathkit features with others: • 27 tube, 8 diode circuit with optional UHF • High definition RCA 70° 21" color tube with anti-glare, bonded-face safety glass Automatic Color Control • Gated Automatic Gain Control for peak performance • 24,000 volt regulated picture power • Hi-Fi sound with outputs for speaker and hi-fi amplifier • Deluxe Nuvistor tuner with "push-to-tune" fine tuning for individual channels • 3-stage high gain video I.F. • Line thermistor for longer tube life and thermal circuit breaker for component protection • Degaussing coil and built-in dot

generator for perfect picture adjustments • All critical circuits factory-built and tested • Can be custom mounted or installed in handsome walnut cabinet • One year warranty on picture tube, 90 days on parts.

Save On Maintenance Costs! In addition to the initial savings you realize by building this set yourself, you'll save on expensive repair bills too. The simple-to-follow Heathkit instruction manual contains circuit diagrams and a "Servicing Hints" section so you can easily make adjustments and replacements should it ever become necessary.

Versatile Installation! The chassis, tubes, and front panel of the Heathkit Color TV can be mounted in the handsome GRA-53-1 walnut-finished hardboard cabinet. Or if you prefer, it can be mounted in a wall or custom cabinet, and the sound signals fed to an external amplifier unit. Required custom mounting space dimensions: 24-3/4"D x 22-1/4"H x 28"W. In this case the GRA-53-3 Custom Mounting Kit should be ordered to provide physical support between the chassis and front panel.

Optional UHF! An optional UHF tuner is available for coverage of channels 14 to 82.

Kit GR-53, chassis and tubes, 118 lbs. \$349.00
 GRA-53-1, walnut cabinet, 70 lbs. . . \$49.00
 GRA-53-2, opt. UHF tuner, 3 lbs. . . \$20.00
 GRA-53-3, custom mounting kit, 10 lbs. \$4.00

FREE 1964 CATALOG
 See these and over 250 other exciting Heathkits available in easy-to-build kit form. Save 50% or more by doing the easy assembly yourself! Send for your free catalog today!

HEATHKIT
by Daystrom

20-2-5

HEATH COMPANY
 Benton Harbor, Mich. 49023

Enclosed is \$ _____, plus shipping. Please send model (s) _____

Please send my Free 1964 Heathkit Catalog.

Name _____

Address _____

City _____ State _____ Zip _____

CL-166

Buy Now! See Order Blank Page

all signal no noise

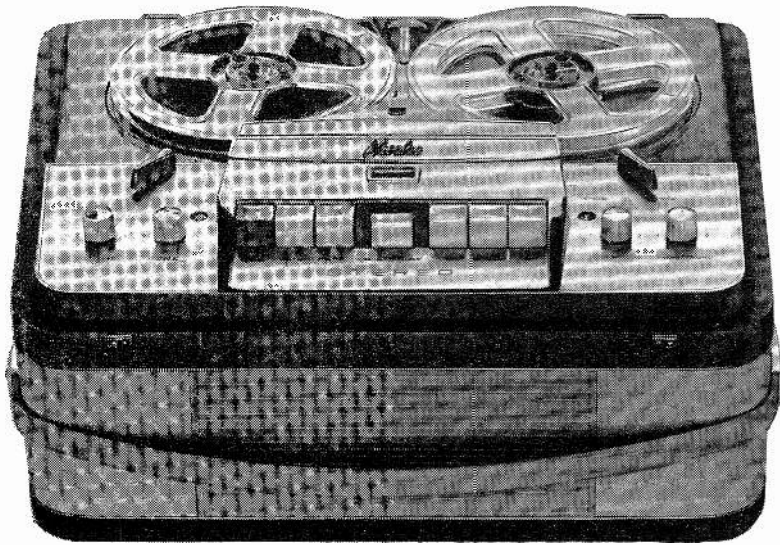

The most noise-free recordings you have ever heard are to be made on the new all-transistorized Norelco Continental '401' Stereo Tape Recorder, the only recorder using the newly developed AC 107 transistors in its two preamplifiers. The only transistor specifically designed for magnetic tape head preamplifiers, the AC 107 utilizes specially purified germanium to achieve the extraordinary low noise figure of 3 db, measured over the entire audio band (rather than the usual single frequency). This noise figure remains stable over large collector-emitter voltage swings and despite large variations in source resistance.

Hear the new transistorized Norelco Continental '401' • 4-track stereo/mono record and playback • 4 speeds: 7½, 3¾, 1⅞ and the new 4th speed of 15/16 ips which provides 32 hours of recording on a single 7" reel • fully self-contained with dynamic stereo microphone, two speakers (one in the removable cover for stereo separation), dual preamps and dual recording and playback amplifiers • self-contained PA

Norelco

system • mixing facilities • can also play through external hi-fi system • multiplay facilities.

SPECIFICATIONS: Frequency response: 60-16,000 cps at 7½ ips. Head gap: 0.00012". Signal-to-noise ratio: better than -48 db. Wow and flutter: less than 0.14% at 7½ ips. Recording level indicator: one-meter type. Program indicator: built-in, 4-digit adjustable. Inputs: for stereo microphone (1 two-channel); for phono, radio or tuner (2). Foot pedal facilities (1). Outputs: for external speakers (2), for external amplifiers (1 two-channel); headphone (1). Recording standby. Transistor complement: AC 107 (4), OC 75 (6), OC 74 (2), OC 44 (2), 2N1314 (2), OC 79 (1). Line voltage: 117 volts AC at 60 cycles. Power consumption: 65 watts. Dimensions: 18½" x 15" x 10". Weight: 38 lbs. Accessories: Monitoring headset and dual microphone adapter.

For a demonstration, visit your favorite hi-fi or camera dealer. Write for Brochure S-2. North American Philips Co., Inc., High Fidelity Products Division, 100 East 42nd St., New York, N. Y. 10017.

MAKE MORE MONEY

Join the Technician's Book Club. Read helpful electronics books by leading authors — at tremendous savings. Books sent on approval. Write for free bulletin.

GERNSBACK LIBRARY, Inc.

Dept. 123C, 154 West 14th Street, New York, New York 10011

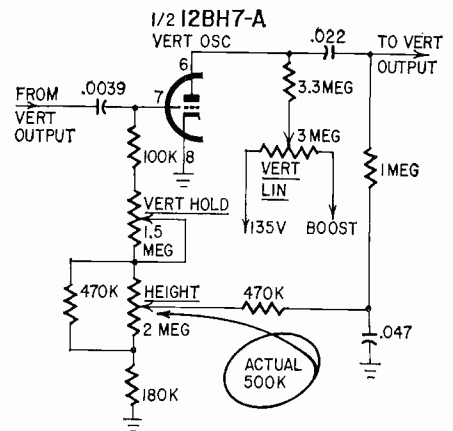

Fig. 3—"Sure enough, it was no longer 2 megohms like it was supposed to be..."

owner, telling him he could come and pick up the machine any convenient time.

Vertical hold next

With pleasure out of the way (for today, anyway) it was time to get to the G-E 14T007 portable with the bad vertical hold. The customer's report showed that it started to go bad some two months back, but he could correct it with the vertical hold control. But now, nothing would help. Adjusting vertical hold would slow down the rolling but wouldn't stop it.

With the set running, the roll was obvious, but I noted as each picture went by it seemed a bit stretched toward the top. As I adjusted the height control, the rolling stopped, but the picture was badly distorted.

The drifting-off report from the customer convinced me that something in the vertical circuit had changed in value so instead of reaching for the scope I went to the ohmmeter. Fifteen minutes of resistance checks didn't turn up a thing, until I remembered that height control. Sure enough, when the variable resistor was removed (Fig. 3), it was not the 2 megohms it was supposed to be, but about 500,000 ohms. In series with the vertical hold control, it altered the vertical frequency enough to throw vertical sync so far off that the hold control couldn't keep the picture still.

A new control from the parts shelf, and the set was working like a dream.

Now I had everything back under control, so I thought I'd sit back a while and wait for Luke to return with the day's new batch of shop work. So I sat back and tuned in a soap opera. Right then the picture disappeared behind a curtain of snow. Checked the antenna and tuner, nothing wrong. Glanced over at another set on the bench and discovered it too showed a snow storm.

"I guess you just can't escape it," I muttered to myself. "It's a day for antenna work after all—on my own!" END

TAKE Heathkit's Deluxe Transistor Stereo Amplifier

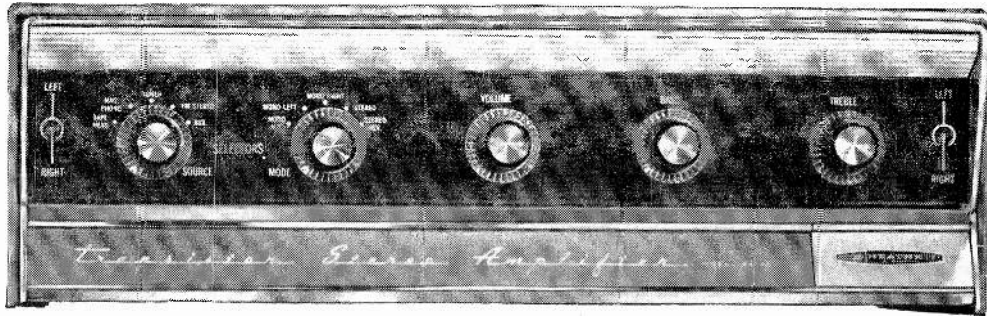

ADD the Deluxe Transistor AM-FM Stereo Tuner

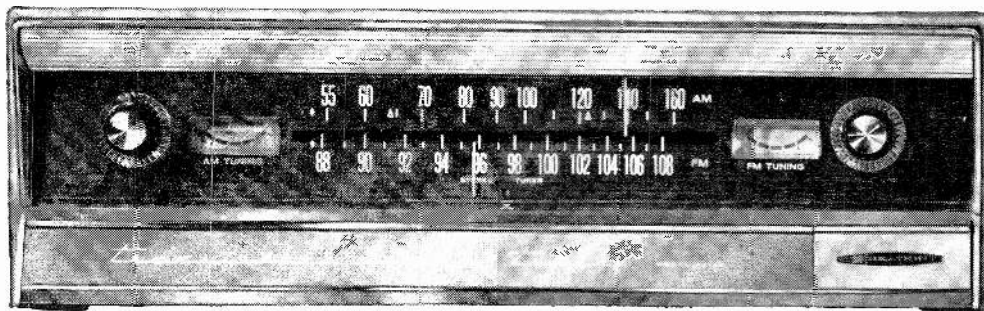

ENJOY Total "Transistor Sound" Performance

Each instrument with its characteristic sound reproduced realistically, faithfully, naturally. This is "transistor sound." No faltering, no fading, no compromising... just the quick, clean sound that only transistors can reproduce. You enjoy this totally different dimension in stereo listening with the *total* transistor performance of the Heathkit *deluxe* 70-watt Stereo Amplifier *and* matching AM, FM, FM Stereo Tuner.

Added performance features and luxurious decorator styling. You enjoy "extras" like the unique "push-push" off/on switch, concealed secondary controls to prevent accidental system changes, automatic switch-to-stereo feature of the tuner, and pre-built, prewired encapsulated component modules in the amplifier for quick, easy assembly. You enjoy handsome matched tan vinyl-clad steel cabinet styling with polished aluminum trim and soft refracted lighting... complements any decor! Both units are easy to build... easy to own! Just a few of the reasons why you should move up to this all-transistor duo. Consider the AA-21 Amplifier...

Full 70 watts of continuous power, 100 watts music power at ± 1 db from 13 to 25,000 cps. Additional features include 26-transistor,

10-diode circuitry for cool, "hum-free" operation, smooth power delivery, and fast effortless "transient response"; complete freedom from microphonics; front-panel mounted controls with 5-position dual concentric source switch, 5-position mode switch, and dual concentric volume, bass and treble controls; circuit breaker protection of output transistors and AC power; and encapsulated preamplifier circuits in 6 epoxy-covered modules, all factory wired and sealed, ready for easy installation. Check the AJ-43 Tuner...

Enjoy extra convenience. Automatic switching to stereo; automatic stereo indicator light; filtered stereo tape recorder outputs for direct "beat-free" recording; Stereo Phase Control for maximum separation and minimum distortion; Automatic Gain Control for constant volume; 25-transistor, 9-diode circuitry for lower power consumption and cool operation; individual AM & FM tuning meters for pin-point tuning; effortless fly-wheel tuning; transformer operated power supply; and preassembled FM tuning unit and 4-stage FM I.F. circuit board for fast assembly.

Experience the "transistor sound" of tomorrow, with the total transistor performance

of Heathkit's Deluxe Transistor Twosome today! You'll be delighted with the advanced features, advanced styling, advanced sound... all at a typical Heathkit value price. Order both units now!

Kit AA-21, amplifier, 29 lbs. \$139.95

Kit AJ-43, tuner, 18 lbs. \$119.95

FREE 1964 HEATHKIT CATALOG

See Heathkit's complete line of advanced stereo/hi-fi equipment as well as color TV, electronic organ, radios, amateur radio, test & lab, marine, and educational equipment. Over 250 in all... the world's largest selection! Send for yours now!



HEATH COMPANY 20-2-6
Benton Harbor, Mich. 49023

Enclosed is \$ _____, plus postage. Please send model (s) _____

Please send my Free 1964 Heathkit Catalog.

Name _____

Address _____

City _____ State _____ Zip _____

HF-159

Buy Now! See Order Blank Page!

equipment reports

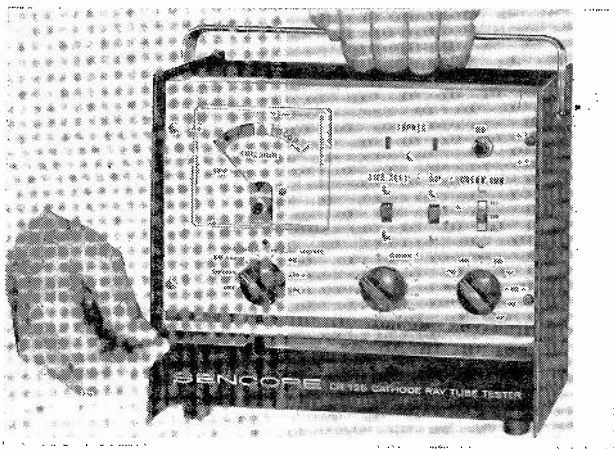

◀ Sencore
CR-125

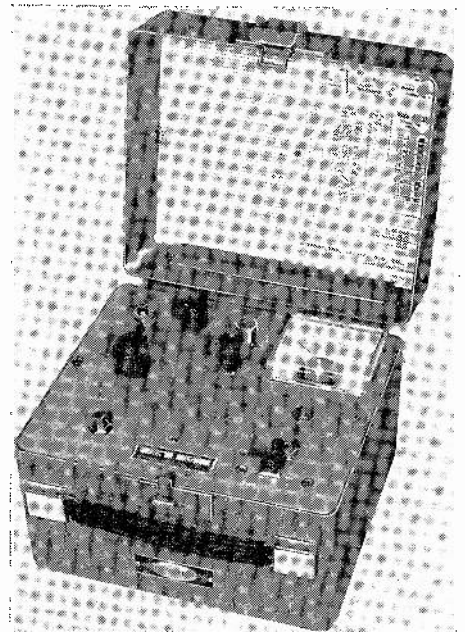

▶ International
Crystal
C-12B

Flexible Pix-Tube Tester and CB Frequency Meter

THE "POPULATION EXPLOSION" IN picture-tube types has demanded greater flexibility in picture-tube testers. Instead of the fixed voltages of the first CRT testers, the modern instrument must have as many variables as a standard tube tester. The Sencore CR-125 is a good example.

Heater voltages are variable from 1 to 12 in 1-volt steps, with a COLOR setting at 6.3 volts. G2 voltage can be set at 50 volts for the "low-G2" tubes, or 350 for the others. This is a necessity, since too much voltage on this element can damage a good tube! Variable grid bias checks the cutoff point on a tube and also checks open control grids. Shorts tests are made with the usual neon lamps. The three guns of a color tube may be tested separately.

The "rejuvenation" circuit, the technician's best friend in public relations,

has some novel features. A three-step switch selects either normal, slightly higher or still higher heater voltage: for instance, 6.3, 7.5 and 9.0. The "rejuvenation" voltage is applied by the discharge of a large capacitor; pushing the REJ button discharges this capacitor through the tube elements in the usual way. However, the button must be released to recharge the capacitor. This eliminates one possibility of "overrejuvenation" or blowing out previously welded elements.

The voltage applied is regulated by the condition of the tube (its current drain, etc.).

Six CRT sockets are provided, on a three-foot cable: one for all standard CRT bases, plus one for each "special" base connection. The large base for color tubes is there, and a socket for the proposed new color tube, a smaller one. The

special bases are labeled and are a different color.

A setup chart gives all data on heater voltage, bias and G2 setting, plus the need for the special sockets. As new tubes are issued, new setup charts will be sent to all registered owners of the CR-125.

The socket cables and line cord stow handily in a snap-lid compartment in the case. A well written instruction book gives a lot of information, plus a parts list and schematic. Much information we like to know is included: the meter, for instance, is scaled in the usual "BAD-?-GOOD," but the book gives the actual beam current corresponding to each sector: 0-200 μ a, BAD; 200-300 μ a, ?; and above 300 μ a, GOOD. The high end of the meter scale is deliberately suppressed to take care of the occasional tube that will read high. A 0-500- μ a meter movement is used.

I tried this instrument on several tubes, including an ancient 21AXP22 color tube, and got very good results. Properly used, the CR-125 can be a valuable addition to your instrumentation, make a lot of friends and save a lot of time.

—Jack Darr

International Crystal C-12B

IF YOU HAVE A FIRST- OR SECOND-CLASS Radiotelephone license and want to go into CB servicing as a specialty, you can now do it on the proverbial shoestring. All you need to start is one of the new low-cost frequency meters or standards such as the International Crystal C-12B and your basic radio test instruments.

The C-12B is a portable frequency standard for servicing transmitters, trans-

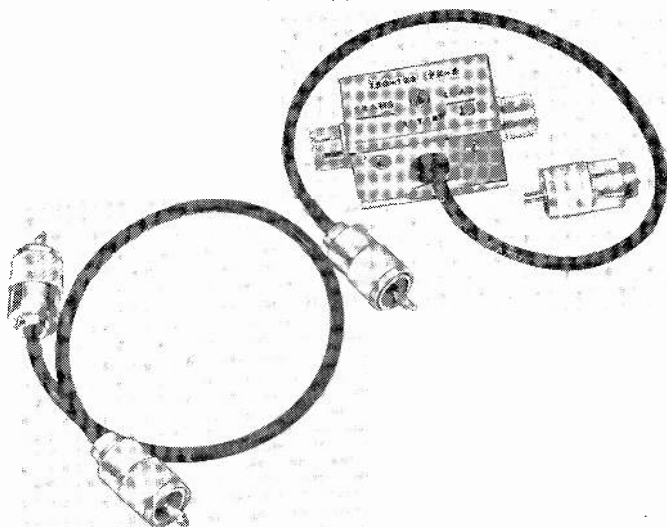

This pickoff box used on the C-12B is a vital component. Cable at left joins box to CB transmitter, connector at right contains dummy load. Cable fixed to box goes to C-12B.

What makes Heathkit your best bet for kit value?

Advanced Engineering Design and Features

Heathkit products incorporate the latest in design features for outstanding performance and operating convenience. Each new kit design is put through several stages of rigid, precision-demanding tests that assure you of finest quality for extra years of reliable service.

Each Heath product group has its own staff of engineers and technicians who are specialists in electronic kit design. This is your assurance that your Heathkit will assemble in the easiest possible manner and meet or exceed its published specifications.

Complete, Easy-to-Follow Assembly Manuals

Heathkit construction manuals are world-famous for their clarity and attention to detail. Each step of assembly is so carefully detailed that it's almost impossible to make a mistake. Large pictorial diagrams guide you every step of the way . . . show where each part is connected. Heathkit manuals are complete! . . . separate sections include tips on the operation, use, maintenance and service of your kit to assure extra years of trouble-free service.

Extra Service for You

Free factory consultation service. An expert staff of technician-correspondents is ready to assist you in the selection, use and operation of your Heathkit. Should you

experience any difficulty with your kit or its construction, just drop them a line and they will be happy to assist you in every way.

Factory service facilities. Factory-trained technicians in our modern, non-profit service department will thoroughly test and repair any Heathkit for a low minimum service fee as outlined in the kit manual.

Factory authorized service centers. An exclusive chain of Heathkit authorized service centers has been organized to provide fast, convenient, local service and parts replacement.

You Enjoy Biggest Savings

You buy direct. Dealing direct with the manufacturer eliminates extra "middle-man" profit margins and high distribution costs. This makes it possible to bring you more real quality at minimum cost.

You cash in on quantity buying. The Heath Company is the world's largest manufacturer of electronic equipment in kit form. This dominant position in the field with its tremendous purchasing power results in extra savings through volume buying that are passed on to you in the form of lower priced kits.

You save high labor costs. You do the easy assembly yourself following simple directions . . . it's like paying yourself several dollars an hour! It's actually fun to build

your own equipment and you'll learn more about it as the assembly progresses.

World's Biggest Kit Selection

Over 250 kits to choose from! Whatever your interest, whatever your need, Heathkit has a kit for you. Select from a complete line of Stereo Hi-Fi music components and systems, Test and Laboratory instruments, Amateur Radio equipment and accessories, Marine electronics gear, Citizen's Band Radio, Educational kits, Automotive, and General Hobby items, including an Electronic Organ, Color TV, Garage Door Opener and many more! . . . all at savings of up to 50%!

Liberal Credit Plan

Heath's easy time-pay plan lets you order and build the kits you need now while you pay for them in easy, convenient monthly installments. You pay no money down on orders of \$25 to \$600 . . . take as long as 18 months to pay. Liberal credit terms are also available on orders over \$600. Simply drop us a line for details. As an extra feature you can "add-on" purchases of \$25 or more after three payments on the original order.

Export Models Available

Export models are available on certain popular Heathkit items for 115/230 volt 50-60 cycle AC operation. Write for full details on the particular products in which you are interested.



HEATH COMPANY
Benton Harbor, Michigan 49023

Buy Now—Use this Order Blank

20-2-4

Note: All prices and specifications subject to change without notice.

Enclosed find check
 money order.

Please ship C.O.D.

On Express orders do not include transportation charges—they will be collected by the express agency at time of delivery.

On Parcel Post orders include postage for weight shown.

All prices are net F.O.B. Benton Harbor, Michigan and apply to Continental U. S. and Possessions only. 20% deposit is required on all C.O.D. orders.

Quantity	Model	Description	Wt.	Price Ea.	Total

SHIP VIA: Parcel Post Express Freight Best Way

Postage

Total

NAME _____ (Please Print)

ADDRESS _____

CITY _____ STATE _____ ZIP NO. _____

Please send free Heathkit Catalog.

CL-167

ceivers and receivers in the 27-mc Citizens band. It uses 23 crystals—one for each CB channel—as frequency standards with a frequency stability of .0025% from 32° to 125° F and .0015% from 50° to 100° F.

Transmitter frequencies are measured by beating them against the standard crystal for the channel being checked. A direct-reading counter (audio-frequency meter) shows the frequency difference in cycles and whether the transmitter's frequency is within tolerance.

Transmitter power output up to 5 watts can be measured with ±0.25-watt accuracy. An auxiliary circuit measures

modulation percentage. A dummy load, an inductive type power takeoff attenuator box and connecting cables are supplied.

Operation

The C-12B is a relatively simple instrument and is easy to use. Here, a small amount of the transmitter's output signal is tapped off the PK (pickoff) box and fed into the frequency meter. In setting up, the first step is to test the self-contained batteries with the built-in voltmeter. The next step is to measure the transmitter's power output. (At least 1 watt output is needed for accurate modulation - percentage measurements

and at least ½ watt is needed for accurate frequency measurements.) The C-12B becomes an rf voltmeter that measures the voltage across the dummy load when the RF LEVEL control is fully clockwise and the selector switch is at RF. Readings of 20, 40, 60 and 80 indicate power outputs of approximately 1, 2, 3 and 4 watts, respectively.

The signals from the transmitter and the 1L4 crystal oscillator are heterodyned in a crystal mixer. A low-pass filter removes the input and sum frequencies. The difference frequency is amplified and converted to a square-wave voltage that is rectified to produce a meter reading directly proportional to frequency. A reading of 1,300 cycles or less (the green area of the meter scale) indicates that the transmitter is within the required .005% tolerance.

A higher reading shows that the transmitter's crystal is beyond tolerance or that the oscillator must be retuned. To see if the transmitter's frequency is high or low, just press the HI-LOW switch. This shunts a capacitor across the standard crystal to shift its frequency a few hundred cycles. If the meter reading—and the beat note heard in the phones—rises, the transmitter frequency is high. The note and meter reading fall if it is low.

Checking modulation

Before checking modulation percentage, establish a carrier reference by adjusting the RF LEVEL control so the meter reads 20. Then, with the FUNCTION selector set at MOD, speak into the mike and read modulation percentage directly from the meter. The modulation meter circuit is the conventional AM type that compares the peaks of the detected audio envelope with the preset carrier level.

Aligning receivers

When aligning the receiver's rf circuits, just advance the RF LEVEL control, turn on the C-12B and adjust the receiver's tuned circuits for maximum avc voltage.

The C-12B can be used to calibrate the shop's signal generator so it can be used as a source of modulated precision signals on the CB channels. Simply disconnect the dummy load and connect the generator's output terminals to the LOAD end of the PK box. (This connects the generator directly to the receiver's antenna terminals.)

After setting the C-12B and transmitter to the same channel, we depress the tester's power switch and tune the signal generator for zero beat in the set's speaker. The signal generator is now precisely tuned to the desired channel. We now release the tester's power switch and proceed to use the signal generator for receiver alignment.—Robert F. Scott

More useful than ever!

ALL
New!
COMPLETELY
INTEGRATED



CRT 445

Checks and Corrects
B & W and COLOR
Picture Tube Troubles

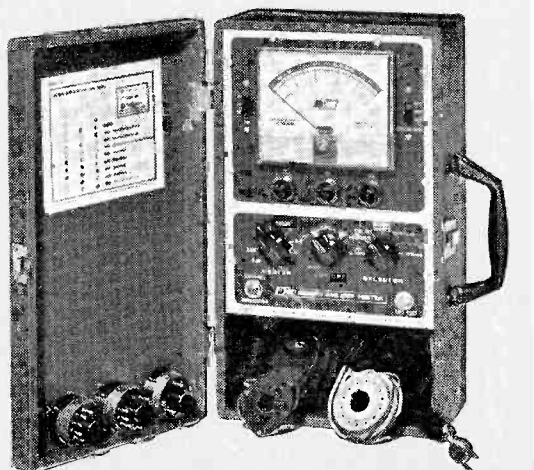

THE INDUSTRY'S STANDARD

*Most Widely Used Today
by Professional Servicemen*

Includes all desired features. Does the job in a few minutes right in the home without removing tube from TV set.

**SAVES CUSTOMERS—ADDS SERVICE INCOME
MAKES NEW TUBE SALES EASIER**

Gives new life to weak or inoperative tubes. Checks for leakage, shorts, open circuits and emission. Removes inter-element shorts and leakage. Repairs open circuits and low emission. Restores emission and brightness. Life Test checks gas content and predicts remaining useful life of picture tube. Quickly pays for itself. Net, \$74.95

TESTS AND REJUVENATES

all picture tubes at correct filament voltage from 1 to 12 volts.

TESTS AND REJUVENATES

all Hi G-2 and Lo G-2 picture tubes, including tubes that require as low a G-2 voltage as 30 volts. Supplies all three necessary voltages: Hi G-2, Low-1 G-2, and Lo-2 G-2.

TESTS AND REJUVENATES

110° tubes and the new 19° and 23° tubes.

TESTS AND REJUVENATES

color picture tubes, including the new 90° 23° 23BG22. Checks and corrects each gun of color tube separately.

Subscribe to
New
Picture Tube
Information
Service

UP-DATE YOUR B&K CRT WITH THESE ACCESSORIES

Model C40 Adapter. For use with previous Models 400 and 350 CRT's—to test and rejuvenate TV color picture tubes and 6.3 volt 110° picture tubes. Net, \$9.95

Model CR48 Adapter. For use with previous Models 400 and 350 CRT's—to test and rejuvenate 110° picture tubes with 2.34, 2.68, and 8.4 volt filaments. Net, \$4.95

See Your B&K
Distributor,
or Write for
Catalog
AP21-E

B&K MANUFACTURING CO.

DIVISION OF DYNASCAN CORPORATION

1801 W. BELLE PLAINE AVE. • CHICAGO 13, ILL.
Canada: Atlas Radio Corp., 50 Wingold, Toronto 19, Ont.
Export: Empire Exporters, 253 Broadway, New York 7, U.S.A.



top performance with low voltage in FM-AM PORTABLE RADIOS

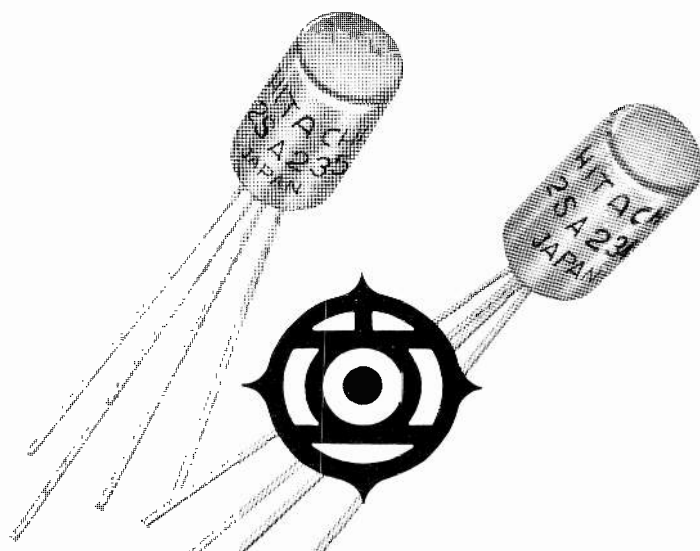

UNIFORMITY

LOW COST

CUT-OFF FREQ. 135 MC.

LOW OUTPUT CAPACITANCE

the **HITACHI 2SA234, 2SA235** dot-mesa transistor

The HITACHI 2SA234 — 2SA235 are your best choice for use in many types of radios from 6 transistor pocket-portables to AM-FM stereo sets. They are germanium p-n-p dot mesa transistors with a cut-off frequency of 135 mc. Gain and S/N performance do not deteriorate at as low as 3 volts. This allows designs using as few as two standard flashlight cells, and longer effective battery life, a definite advantage over many more expensive transistor types. The very low common base output capacitance and HITACHI's careful attention to uniformity of manufacture, offer you stable, trouble free production runs of transistor radios. The performance/price ratio cannot be beat. Write us for production quantity quotations.

HITACHI	2SA234	2SA235
COLLECTOR-BASE VOLTAGE	20 V	20 V
COLLECTOR CURRENT	10 MA	10 MA
COLLECTOR DISSIPATION	80 MW	80 MW
COMMON BASE OUTPUT CAP.	2.1 pf	2.1 pf
BASE SPREADING RESISTANCE	55 Ω	50 Ω
CUT-OFF FREQUENCY	120 MC	135 MC
POWER GAIN	26 dB 10.7 MC	13 dB 100 MC



TOKYO, JAPAN

CABLE ADDRESS: "HITACHY" TOKYO

666, 5th Ave., New York 19, N.Y., U.S.A. Tel: JUDSON 6-4757
100 California St., San Francisco, Calif., U.S.A. Tel: YUKON 1-7871

333, N. Michigan Avenue, Chicago 1, Ill., U.S.A. Tel: 726-4572/4
Graf Adolf Strasse 37, Duesseldorf, West Germany Tel: 10846

FEBRUARY, 1964



Why Fred got a better job . . .

I laughed when Fred Williams, my old high school buddy and fellow worker, told me he was taking a Cleveland Institute Home Study course in electronics. But when our boss made him Senior Electronic Technician, it made me stop and think. Sure I'm glad Fred got the break . . . but why him . . . and not me? What's he got that I don't. There was only one answer . . . his Cleveland Institute Diploma and his First Class FCC License!

After congratulating Fred on his promotion, I asked him what gives. "I'm going to turn \$15 into \$15,000," he said. "My tuition at Cleveland Institute was only \$15 a month. But, my new job pays me \$15 a week more . . . that's \$780 more a year! In

twenty years . . . even if I don't get another penny increase . . . I will have earned \$15,600 more! It's that simple. I have a plan . . . and it works!"

What a return on his investment! Fred should have been elected most likely to succeed . . . he's on the right track. So am I *now*. I sent for my three *free* books a couple of months ago, and I'm well on my way to Fred's level. How about you? Will you be ready like Fred was when opportunity knocks? Take my advice and carefully read the important information on the opposite page. Then check your area of most interest on the postage-free reply card and drop it in the mail *today*. Find out how you can move up in electronics too.

How You Can Succeed In Electronics

. . . Select Your Future From Five Career Programs

The "right" course for your career

Cleveland Institute offers not one, but five different and up-to-date Electronics Home Study Programs. Look them over. Pick the one that is "right" for you. Then mark your selection on the reply card and send it to us. In a few days you will have complete details . . . without obligation.

1. Electronics Technology

A comprehensive program covering Automation, Communications, Computers, Industrial Controls, Television, Transistors, and preparation for a 1st Class FCC License.



2. First Class FCC License

If you want a 1st Class FCC ticket *quickly*, this streamlined program will do the trick and enable you to maintain and service all types of transmitting equipment.

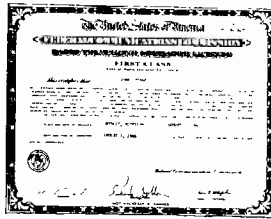

3. Broadcast Engineering

Here's an excellent studio engineering program which will get you a 1st Class FCC License and teach you all about Program Transmission and Broadcast Transmitters.



4. Electronic Communications

Mobile Radio, Microwave, and 2nd Class FCC preparation are just a few of the topics covered in this "compact" program . . . Carrier Telephony too, if you so desire.

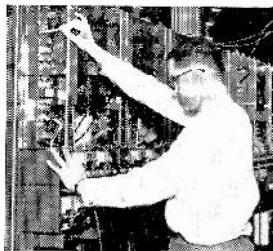

5. Industrial Electronics & Automation

This exciting program includes many important subjects such as Computers, Electronic Heating and Welding, Industrial Controls, Servomechanisms, and Solid State Devices.



An FCC License . . . or your money back!

In addition to providing you with comprehensive training in the area indicated, programs 1, 2, 3, and 4 will prepare you for a Commercial FCC License. In fact, we're so certain of their effectiveness, we make this *exclusive* offer:

The training programs described will prepare you for the FCC License specified. Should you fail to pass the FCC examination after completing the course, we will refund *all* tuition payments. You get an FCC License . . . or your money back!

Cleveland Institute's new "Check-Point Plan" helps you learn faster and better

Cleveland Institute uses the new programmed learning approach. This "Check-Point Plan" presents facts and concepts in small, easy-to-understand bits . . . reinforces them with clear explanations and examples. Students learn more thoroughly and faster through this modern, simplified method. You too will absorb . . . retain . . . advance *at your own pace*.

Job placement service . . . another CIE extra to help you get ahead in electronics

Once enrolled with CIE, you will get a bi-monthly listing of the many high-paying interesting jobs available with top companies throughout the country. Many Cleveland Institute students and graduates hold such jobs with leading companies like these: American Airlines, American Telephone and Telegraph, General Electric, General Telephone and Electronics, IBM, Motorola, North American Aviation, New York Central Railroad, Raytheon, RCA and Westinghouse.

Electronics is a fast moving, dynamic industry . . . Cleveland Institute keeps you current

The Electron Bulletin is CIE's bi-monthly digest of new developments in the world's fastest growing industry. As a CIE student, you will get a free copy throughout your training to keep you up-to-date on Masers, Lasers, Solid State Devices, and other new inventions.



Full accreditation . . . your assurance of competence and integrity

Cleveland Institute of Electronics is accredited by the Accrediting Commission of the National Home Study Council. You can be assured of competent electronics training by a staff of skilled electronics instructors.

**Your Future In Electronics Is
Up To You. Make It A Brighter One.
Mail Reply Card Today.**

Cleveland Institute of Electronics

Dept. RE-88 1776 E. 17th St., Cleveland 14, Ohio

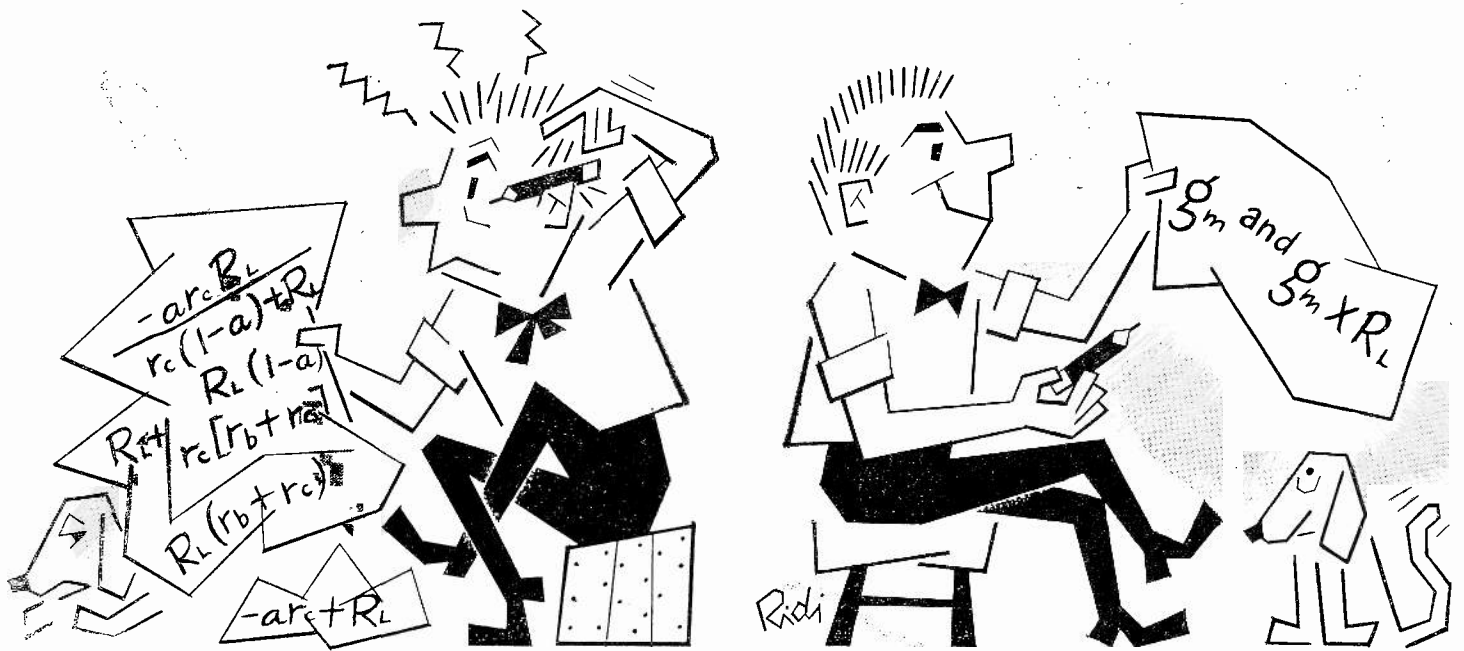

By IRVING M. GOTTLIEB

A new and refreshing insight into transistor operation that simplifies circuit design and may well revolutionize transistor data charts

AFTER WE HAVE MORE OR LESS SUCCESSFULLY bridged the gap between basic tube and transistor operational theory from a practical point of view, we find that most technical literature, instead of being helpful, unnecessarily widens this gap. We are often reminded of the similarities between tubes and transistors as amplifying devices. Yet the literature formulates the relationships between transistor parameters with respect to the grounded-base (also called "common-base") circuit. This configuration is equivalent to a grounded-grid tube, though the most common transistor circuit—the grounded emitter—is the equivalent of the ordinary grounded-cathode tube amplifier. In both tube and transistor amplifiers, we are vitally interested in the voltage gain, yet we are told to deal with the transistor as a current amplifier. If we are still not convinced, we collide head-on with a monstrosity such as:

$$\text{Voltage gain} = \frac{-a r_c R_L}{r_c [r_b + r_e(1 - \alpha)] + R_L(r_b + r_e)}$$

where

- a = short-circuit current multiplication factor for common-base circuit
- r_b = base resistance
- r_c = collector resistance
- r_e = emitter resistance
- R_L = load resistance.

(The minus sign indicates polarity reversal.)

Sadly enough, this is still an approximation, even if we could lay hold of the various elusive quantities contained in the equation. The temptation is overwhelming to ask, "Is this necessary?" Why not use g_m and $g_m \times R_L$ instead, as with vacuum tubes? Indeed, why not?

First, let us try to find out how we got into the present state of affairs. The first transistors were point-contact devices, and functioned most stably and predictably in the grounded-base circuit. Thus the grounded- (common-) base configuration was considered the "natural" one. The input diode, unlike a tube in class-A operation, consumed current. Accordingly, the transistor was thought of as "current-actuated." This notion was reinforced by the fact that the injected charge carriers constitute current flow.

Then, when the junction transistor made the common-emitter circuit popular, the current-transference property was retained as the figure of merit of transistor action. An effort was made to reconcile tube and transistor design with the "duality" theory. In this concept, which depends on currents in transistors being equated to voltages across tubes, a parallel network for tubes, for example, would be dealt with in terms of an equivalent series circuit

for transistors. Inductors for the one would become capacitors for the other, and so on. This approach does have mathematical validity. For most practical transistor applications, it becomes a complex patchwork, which attempts unsuccessfully to smooth the effects of a wrong turn made in the past.

A new trend of thought

We'll take a short pause while you object to our endeavor to treat the transistor like a tube. An oft-heard axiom is that in the transistor, the input current wave, rather than the input voltage wave, must represent the signal information. That is, to obtain an amplified voltage sine wave across the output load resistance, we must apply a current sine wave to the input circuit.

Let us imagine the transistor is new to us, and that we follow our intuition and think in terms of voltage gain. First, the circuit designer must part company with the physicist, in connection with the "current" approach. Rather than think of injecting a current into the base-emitter diode, let us consider that we impress a voltage across the base-emitter diode.

This is sound reasoning, for the transit of the charge carriers (current flow) in a forward-biased p-n diode is caused by an electric field. The current flowing through the base-emitter diode is due to, and governed by, the voltage

STEREO

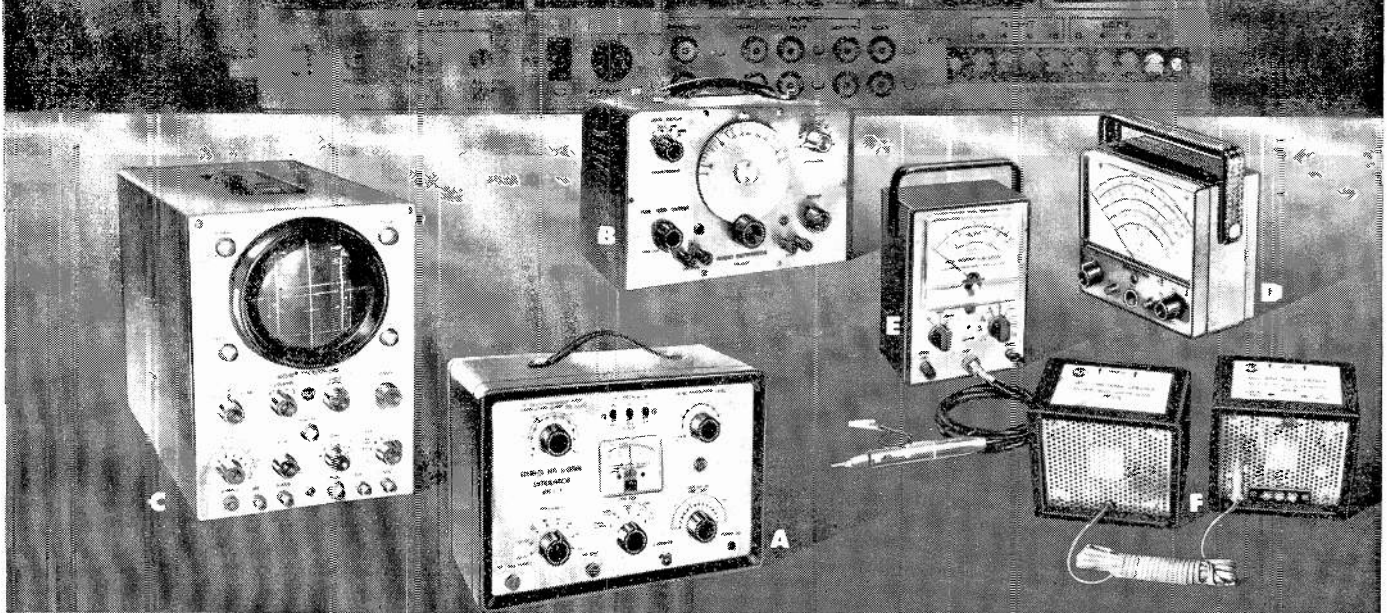

Let **RCA** equip you with **EVERYTHING YOU NEED FOR STEREO SERVICING**

RCA—entertainment leader of the world—now offers you a complete set of test instruments to put you in the stereo servicing business. And now's the time to get in because it's growing bigger and more profitable by the day.

A. NEW! RCA WR-51A FM STEREO SIGNAL SIMULATOR

Generates signals necessary to service and maintain stereo multiplex FM receivers and adaptors. Generates... Choice of 4 FM signals—Left Stereo, Right Stereo, Special Phase Test, Monaural FM • Choice of 8 sine-wave frequencies (400 cps, 1Kc, 5Kc, 19Kc, 28Kc, 38Kc, 48Kc, 67Kc) available separately or for modulating FM signals • 100 Mc carrier tuneable ± 0.8 Mc to permit selection of a quiet point in the FM band • 19 Kc subcarrier, crystal-controlled within ± 2 cps • 100 Mc sweep signal adjustable from 0-750 Kc at 60 cps rate • Choice of 3 composite stereo output signals—Left Stereo, Right Stereo, Special Phase Test • Choice of 3 sine-wave frequencies for composite stereo

signals • Crystal controlled markers for receiver if and rf alignment • Zero-center meter for checking the balance of stereo amplifier output. **\$249.50***

B. RCA WA-44C AUDIO GENERATOR

Generates sine-wave and square-wave signals over range of 20 to 200,000 cps to test audio systems. Can be used to measure intermodulation distortion, frequency response, input and output impedance, speaker resonance, transient response and phase shifts. Less than 0.25% total harmonic distortion over range of 30 to 15,000 cps. **\$98.50***

C. RCA WO-91A 5" OSCILLOSCOPE

A high-performance, wide-band 'scope—serves as a visual VTVM. Choice of wide band (4.5 Mc—0.053-volt rms/inch sensitivity)

or narrow, high-sensitivity band (1.5 Mc—0.018-volt rms/inch sensitivity). New 2-stage sync separator provides solid lock-in on composite TV signals. **\$249.50***

D. RCA WV-98C SENIOR VOLTOHMYST®

For direct reading of peak-to-peak voltages of complex waveforms, rms values of sine-waves, DC voltages, and resistance. Accuracy: 3% full-scale on both AC and DC, with less than 1% tracking error. Color-coded scales differentiate peak-to-peak from rms readings. New 0.5 volt full scale DC range for use with low-voltage transistor circuits. $6\frac{1}{2}$ " meter. **\$79.50***

E. RCA WV-76A AC VTVM

Measures voltages down to 0.001 volt. Decibel scale for measure-

ments from -40 to +40 db. Built-in amplifier which may be used separately as a preamplifier. Typical applications include: frequency response tests of preamplifiers, power amplifiers and tone control circuits, signal tracing; measurements of audio level, power level and gain; amplifier balancing applications and general audio voltage measurements. **\$79.95***

F. RCA WG-360A STEREO PHASE CHECKER

A quick, simple, positive way to check phase alignment of low and mid-range speakers in stereo systems. Completely "sound-powered". Snag-proof recessed grille design. For use with a VOM, VTVM, or oscilloscope. **\$14.95***

See Them all at your Authorized RCA Electronic Instrument Distributor

RCA Electronic Components and Devices, Harrison, N.J.

*User price (optional)



The Most Trusted Name in Electronics

impressed across the terminals of this diode.

In *practical* junction transistors connected in the grounded- (common-) emitter circuit, there is considerable departure from the assumed linear-output (or load-voltage) vs input-current curve. Even if this ideal relationship were exhibited by practical transistors, it would still be a permissible approximation to deal with input voltage. This is because the input-current vs input-voltage curve is *substantially straight* for values above the onset of conduction (Fig. 1).

The transistor is reminiscent of a tube operating in the positive control-grid region. Let's retain the same approach we would use with such a tube: *A signal voltage is impressed at the input. What is the value of the amplified signal voltage developed across the load resistance?*

Generally, the approach advocated in this article yields very satisfactory

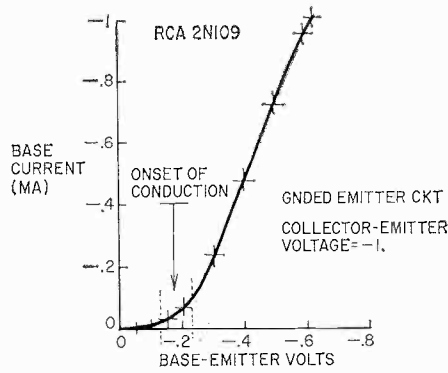

Fig. 1—Base current versus base-emitter voltage for a 2N109. Note near linearity of curve above onset of conduction.

results. The more rigorous design approach (current input) is often frustrated by complex variables difficult to cope with, or nonprecise data. For example, such transistor parameters as

r_o , r_b , alpha (and therefore beta) vary with operating point and temperature. Manufacturer's tolerances are generally quite sloppy, as compared with tube specifications, so circuit design by the classical formulas frequently requires a pretty healthy admixture of cut-and-try. I find that the transconductance method is most often quicker and better.

Why not use g_m ?

The concept of transconductance is as applicable to the transistor as to the tube. Transconductance is a transfer function which defines the ratio of a change in output current to a small change in input voltage, while the voltage on the output electrode is maintained constant during the measurement. Thus we see that the higher the transconductance of an amplifying device, the greater the control of output

styled to blend with any tv set

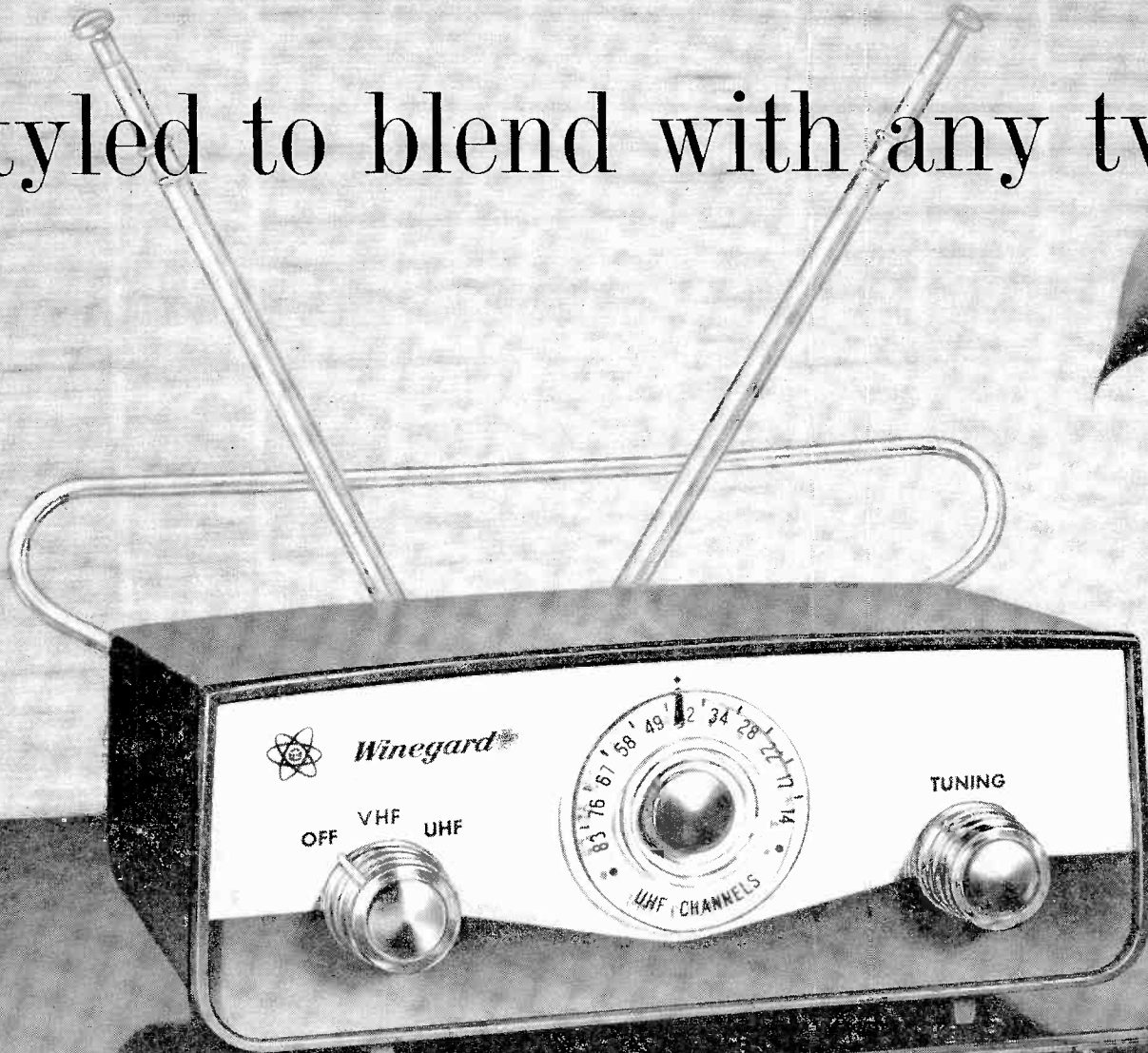

current exerted by the grid, base or other control element.

It is a simple matter to insert a load resistance in the output circuit of an amplifier so that the current variations appear as voltage variations of greater amplitude than those applied to the input circuit. All this, of course, is "old hat," but it is important to recognize the universality of the transconductance parameter. Transconductance is readily derived from a simple procedure.

Let us connect a transistor as in Fig. 2. Although a p-n-p type is shown, the basic ideas apply to n-p-n transistors when you reverse the polarity of the bias supplies. The objective is to obtain data relating output current, I_c , to input voltage, E_{be} (or V_{in}). We then plot a curve as in Fig. 3. This is analogous to a curve relating plate current to grid voltage in a tube. As with a tube, the slope of this output vs input voltage

curve indicates the value of transconductance (figure of merit). Generally, such curves are not absolutely straight, so the measurement of slope requires judgment, and must inevitably be an average or approximate value.

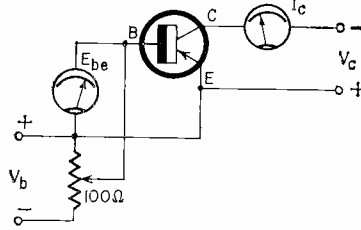

Fig. 2—Simple circuit for obtaining data for transconductance graph. For small transistors, V_b and V_c may be 1.5 and 4.5 volts, respectively.

We know that for reasonably distortionless class-A operation, the choice of operating point, output load resistance and maximum input-signal amplitude must be such that only the fairly linear portion of the transconductance curve is involved. This presents no great problem. For most germanium transistors, these curves rapidly approach a straight line once the base-emitter diode is biased in excess of one-tenth to several tenths of a volt. (In silicon transistors, the onset of conduction occurs at a slightly higher value.)

As with tubes, transconductance is now derived from the ratio of a change in output current to the small change in input voltage responsible for it. If these quantities are graphically scaled off in amps and volts, the ratio is dimensionally in *mhos*. If one or the other quantity is plotted in terms of *milli* or *micro* units, we must affix the appropriate multiplying factor before our transcon-

Winegard uhf converters

6 HIGH PERFORMANCE UHF CONVERTERS REGULAR AND AMPLIFIED WITH BUILT-IN UHF AND VHF ANTENNAS

Now Winegard engineering, styling and merchandising have combined to bring you the finest UHF converters on the market. Models UC-100A (one tube) and UC-200A (two tube) have built-in UHF and VHF antennas to receive all channels 2-83. Models UC-310 and UC-410 have a transistorized pre-amplifier that improves signal-to-noise ratio up to 12 DB. All models are furniture styled in handsome polystyrene cases in rich autumn brown trimmed with brushed gold. *Look at these features:*

- 3 gang capacitive tuning element eliminates sliding contacts in main circuit.
- Oscillator has new 6DZ4 tube... no drift, no microphonics... has better performance and longer life.

- Safe, cool chassis—isolated power supply with silicon rectifier.
- Only cabinet that is *completely* enclosed.
- Lowest noise 1N82A mixer diode • Exceed FCC radiation requirements • Exact 300 ohm impedance match
- Work perfectly with color or black and white

Models UC-200, UC-200A, UC-310 and UC-410 UHF converters have AC receptacle for TV set with "on-off" control that turns on TV set and also switches to UHF or VHF. All models have a built-in dial light.

Ask your distributor or write today for specification sheets on Winegard UHF converters.

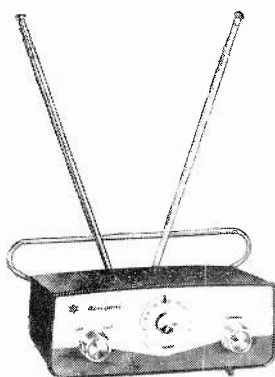

Model UC-100 UHF converter (one tube) \$29.95

Model UC-100A UHF converter (one tube) with built-in UHF and VHF antennas \$34.95

Model UC-200 UHF converter (two tube) with nuvistor IF amplifier stage \$42.50

Model UC-200A UHF converter (two tube) with nuvistor IF amplifier stage and built-in UHF and VHF—antennas \$47.50



Model UC-310 high gain converter with built-in transistor RF amplifier and nuvistor IF amplifier—improves signal-to-noise ratio up to 12 DB \$64.95

Model UC-410 high gain converter with built-in power supply, nuvistor IF amplifier and remote transistor RF pre-amp for mounting on antenna or anywhere along transmission line. For very weak signal areas, this is the most sensitive UHF converter made. \$69.95.

World's most complete line of TV-FM reception equipment



Winegard Co.

3013 B KIRKWOOD BOULEVARD, BURLINGTON, IOWA



FREE SCOTT CUSTOM STEREO GUIDE

New 24-page 1964 Custom Stereo Guide packed with photos, descriptions, and specifications of all Scott tuners, amplifiers, tuner/amplifiers, speakers, and kits. Also... articles and pictures on decorating your home with stereo, selecting a tuner and amplifier, and how FM multiplex stereo works. Send for your Scott Custom Stereo Guide today.

Rush me the new 1964 Scott Guide to Custom Stereo.

Name.....

Address.....

City..... Zone..... State.....

H.H. Scott, Inc. 57002

111 Powdermill Road, Maynard, Massachusetts

EXPORT: Morhan Exporting Corp., 458 Broadway, N.Y.C. CANADA: Atlas Radio Corp., 50 Wingold Ave., Toronto



Television RADIO-ELECTRONICS Electricity ELECTRONICS COYNE

TRAIN QUICKLY! OLDEST, BEST EQUIPPED SCHOOL of ITS KIND in U.S.

Get practical training in New Shop-Labs of Coyne. Prepare for a better job and a successful future in a top opportunity field. Advanced education or previous experience not needed. Employment service to graduates.

Enroll NOW—Pay Later

Finance Plan and Easy Payment Plan. Also Part Time Employment help for students.

FREE BOOK Clip coupon or write for Free Illustrated Book, "Your Opportunities in Electronics"—Describes all training offered. No obligation and No Salesman Will Call. Act NOW

B. W. Cooke, President

CHARTERED
NOT FOR PROFIT
Established 1899

COYNE ELECTRICAL SCHOOL
1501 W. Congress Pkwy.,
Chicago, Dept. 24-N

COYNE Electrical School
1501 W. Congress Pkwy., Chicago 7, Ill.
Dept. 24-N

Send FREE book "Your Opportunities in Electronics" and details of all training you offer

NAME..... AGE.....

ADDRESS..... PHONE.....

CITY..... STATE.....

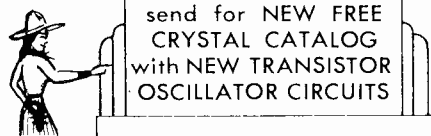

3 PLANTS TO SERVE YOU BETTER HERMETICALLY SEALED PRECISION GROUND CUSTOM-MADE NON-OVEN CRYSTALS



Gold or silver plated, spring mounted, vacuum sealed or inert gas, high freq. stability, 10 milliwatt max. current cap. Meet mil. specs.

1000KC to 1600KC (Fund. Freq.)	Prices on Request
1601KC to 2000KC (Fund. Freq.)	\$5.00 ea.
2001KC to 2500KC (Fund. Freq.)	4.00 ea.
2501KC to 5000KC (Fund. Freq.)	3.50 ea.
5001KC to 7000KC (Fund. Freq.)	3.90 ea.
7001KC to 10,000KC (Fund. Freq.)	3.25 ea.
10,001KC to 15,000KC (Fund. Freq.)	3.75 ea.
15MC to 20MC (Fund. Freq.)	5.00 ea.

OVERTONE CRYSTALS

15MC to 30MC Third Overtone	\$3.85 ea.
30MC to 40MC Third Overtone	4.10 ea.
40MC to 65MC Third or Fifth Overtone	4.50 ea.
65MC to 100MC Fifth Overtone	6.00 ea.

DRAKE 2-B Receiver Crystals \$4.00
(All Channels—Order by Freq.)

OVEN-TYPE CRYSTALS

For Motorola, GE, Gonset, Bendix, etc.

Add \$2.00 per crystal to above prices

SUB-MINIATURE PRICES slightly higher

ORDER FROM CLOSER PLANT TEXAS CRYSTALS

DEPT. RE
1000 Crystal Drive
FORT MYERS, FLORIDA
Phone 813 WE 6-2109
TWX 813-334-2830
AND
4117 W. Jefferson Blvd.
LOS ANGELES, CALIF.
Phone 213-731-2258
TWX 213-737-1315

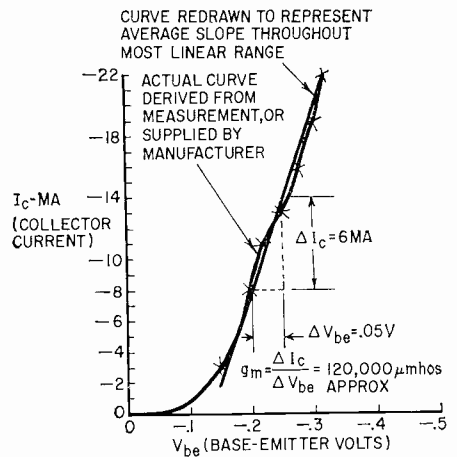

Fig. 3—Transconductance curve for a 2N109.

ductance value.

For example, if we find we are dividing a change of 10 ma by a change of $\frac{1}{10}$ volt, our ratio is 100 millimhos, or $\frac{1}{10}$ mho. As it is our prime objective to emulate tube-design techniques, we note that this ratio is also equivalent to 100,000 micromhos. (Incidentally, this is representative of typical cheap transistors, not "hot" units. High-power transistors have transconductance values on the order of several million micromhos.)

It is natural to wonder whether any correlation or mathematical relationship exists between the grounded-emitter current gain factor, beta, and transconductance. The answer is no; beta in itself does not inform us whether the transconductance is high or low. However, the quantity beta/input resistance is dimensionally a conductance, and correlates fairly well with transconductance derived from the graphical procedure previously outlined.

The input resistance here is the average over the excursion of the input-signal voltage wave. This relationship does not lend itself quite as well to practical designs, but does provide additional insight into the nature of transistor amplification. For example, knowing that this ratio correlates closely to the actual transconductance would lead us to postulate that power transistors (those with collector currents in the range of a number of amperes) could have higher values of transconductance than small-signal types. This, indeed, tends to be the case.

From theory to practice

From a practical standpoint, the use of transconductance in general, and the relationship voltage gain = $g_m \times R_L$ in particular, greatly facilitates comparison of predicted with actual performance. This is because instruments in common use for measuring signal levels indicate voltage, not current. Thus, the operation of an experimental or bread-

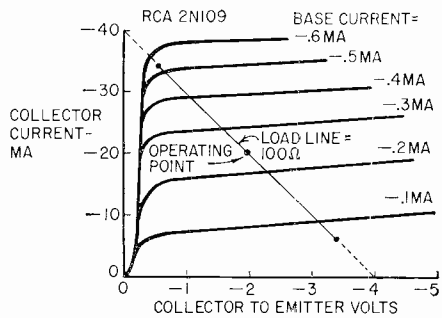

Fig. 4—Conventional method of showing transistor characteristics in common-emitter circuit. Unlike vacuum-tube practice, the family of “anode” (collector) curves is plotted against different input (base) currents.

board amplifier is quickly evaluated by connecting oscilloscopes or vtm's to the input and output circuits. The accuracy of this method improves as load resistance R_L is made smaller. For a majority of small-signal applications R_L values up to several thousand ohms permit good results to be obtained.

To extend this approach further, we would like to see transistor manufacturers supply collector family curves with respect to input voltage rather than with respect to input current as is prevailing practice. In Figs. 4 and 5, we see the collector characteristics of an RCA 2N109 transistor dis-

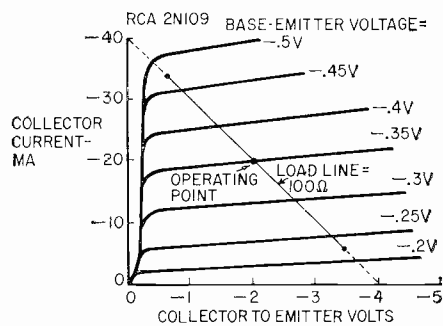

Fig. 5—Suggested method of showing transistor characteristics in common-emitter circuit. The collector curves are plotted against base-emitter voltages instead of currents as in Fig. 4.

played with input current and with input voltage as a variable parameter. Surprisingly, the load line in the latter instance traverses incremental collector curves which are quite evenly spaced. This indicates low distortion in class-A operation, provided we do not drive the transistor too close to zero collector current.

The author would be very grateful for comments and criticism pertaining to this admittedly “off-beat” analysis of transistor operation. In the meantime, give it a try and see if you don't agree that it deprives the transistor of a good deal of elusiveness!

**Save your
Meter Movement
Make it
Burnout Proof!**



Metergard MODERNIZES YOUR OLD METER!

Installed in minutes . . . on most any meter . . . such as the Simpson 260 or Triplett 630, etc. Positively prevents meter movement burnout or damage . . . even if subjected to as much as 100 times overload. Accuracy not affected by more than 1/4 of 1%. Not a fuse. No moving parts . . . nothing to wear out. End the time loss, expense and aggravation of meter movement repair due to burnout.

SATISFACTION GUARANTEED OR YOUR MONEY BACK. ONLY \$2.95

See your distributor today; if he does not stock Metergard, send check or M.O. to Dept. RE-1.



LECTROTECH INC.
P. O. Box 531, Skokie, Illinois

ALL NEW SENCORE component substitutor

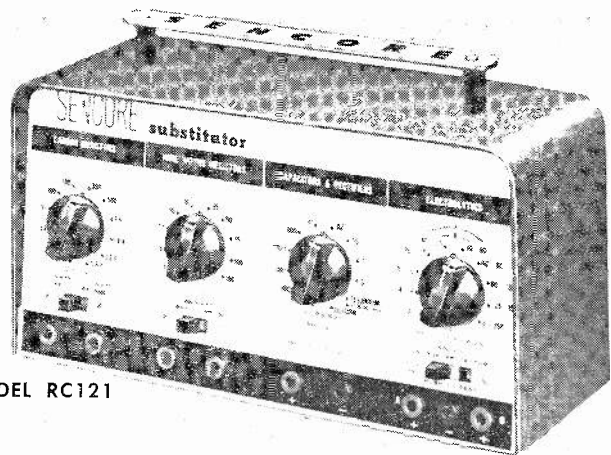

MODEL RC121

All your favorite Sencore Substitution Time-Savers in One Compact Unit

A complete range of carbon resistors, wire wound power resistors, capacitors, electrolytics, and universal selenium and silicon rectifiers.

Imagine, all of these hard to locate parts at your finger tips for on the spot substitution. Say goodbye to messy, crumpled parts, unnecessary unsoldering and soldering of components for testing purposes only. Save valuable servicing time and be sure, by substituting.

NEW . . . each section operates independently with a value close enough for every substitution need. Components in each section are isolated from chassis and from the other sections. For example, a complete power supply can be constructed using the RC121 Components only.

NEW . . . dual electrolytics provided. A new circuit enables you to substitute up to 25 single electrolytic values or 9 duals. Exclusive surge protector provides protection on both singles and duals for both you and the circuit.

You save space and money. Equivalent Sencore substitution-pieces purchased individually (H36, PR111, RS106, ES102) cost you \$54.00

RC121 (all hand wired, all American made) only **3995**

RC121K (Kit) 27.95

Now in stock at your Sencore Distributor. See him today!

SENCORE
ADDISON 2, ILLINOIS

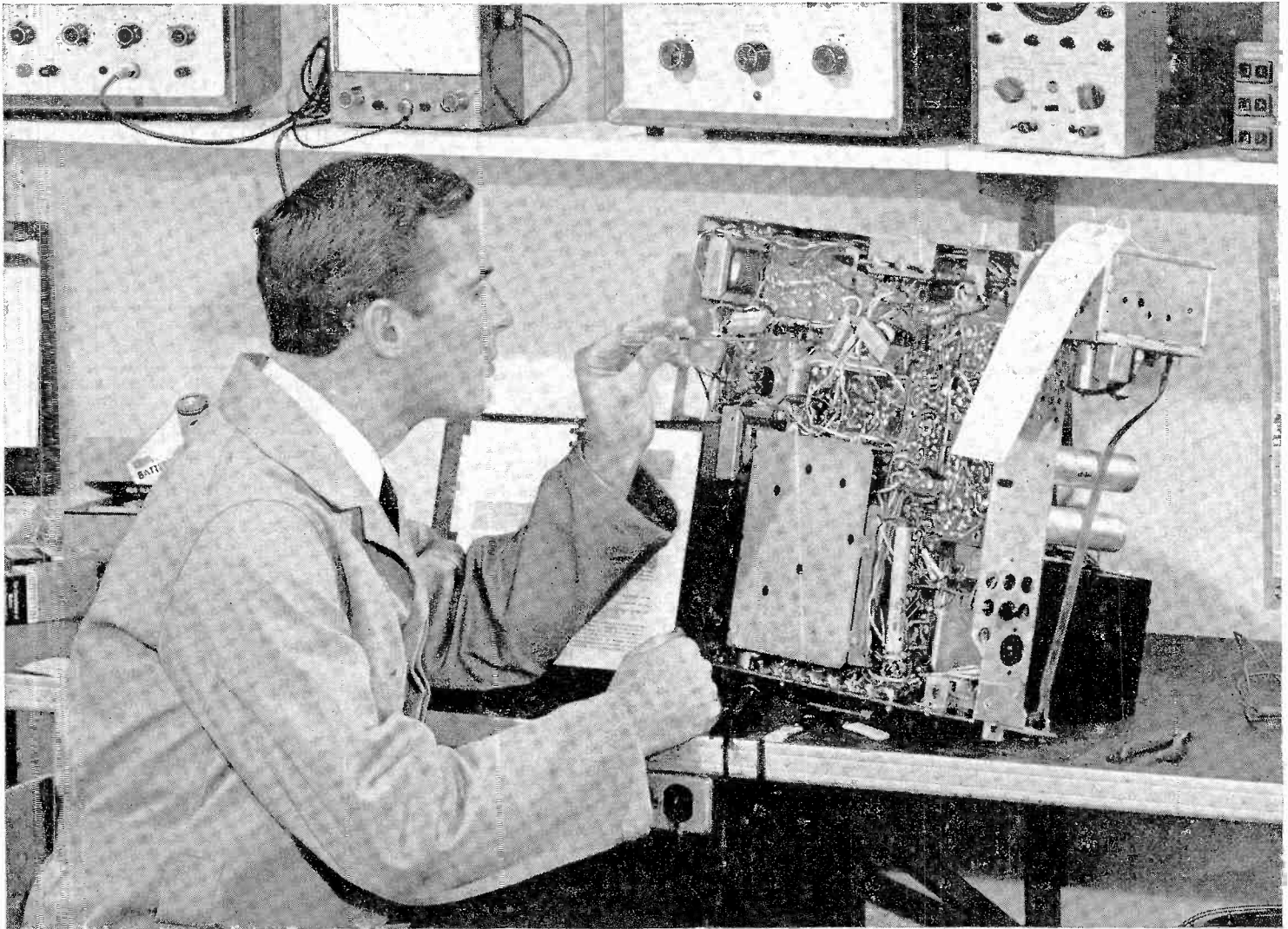

RCA TRAINING **can be the smartest investment you ever made!**

Start building a profitable career in electronics now!
NEW RCA "AUTOTEXT" will help you learn faster and easier!

If you're considering a future in electronics, now is the time to start! A great new teaching aid—"AUTOTEXT" developed by RCA, and introduced by RCA Institutes, Inc., will help you master the fundamentals of electronics almost automatically! "AUTOTEXT" is a system of programmed instruction, proved with thousands of students. Even people who have had trouble with conventional home training

methods in the past are finding it easier and more fun to learn this new way. All you need is an interest or inclination in electronics, RCA "AUTOTEXT" will help you do the rest! And the future is unlimited; the jobs are available! The important thing is to get started now!

Founded in 1909, RCA Institutes is one of the largest technical schools in the United States devoted exclusively to electronics. The very name

"RCA" means dependability, integrity, and scientific advance. RCA Institutes offers the finest facilities of home training. A Service of the Radio Corporation of America, RCA Institutes, Inc. gives you the technical instruction you need to plan, build, and realize the career you want in today's fastest growing field.

Investigate your future now at RCA Institutes. It can be the smartest investment you ever made.

HOME TRAINING COURSES

In addition to the new "Introduction to Electronics" RCA Institutes offers this complete selection of Home Training Courses:

- Electronic Fundamentals
- Electronic Fundamentals (in Spanish)
- TV Servicing
- Color TV Servicing
- Transistors
- Communications Electronics
- FCC License Preparation
- Mobile Communications
- Automation Electronics
- Automatic Controls
- Industrial Applications
- Nuclear Instrumentation
- Digital Techniques
- Computer Programming
- Drafting

Liberal Tuition Plan. All RCA Institutes Home Study courses are available under a Liberal Tuition Plan. This plan affords you the most economical possible method of home study training. You pay for lessons only as you order them. If, for any reason, you should wish to interrupt your training, you can do so and you will not owe a cent until you resume the course. No other obligations! No installment payments required.

RCA Personal Instruction. With RCA Home Study training you set your own pace in keeping with your own ability, finances and time. RCA Institutes allows you ample time to complete the course. Your lesson assignments are individually graded by technically trained personnel, and helpful comments are added where required. You get theory, experiment, and service practice beginning with the very first lesson. All lessons are profusely illustrated. You get a complete training package throughout the entire course.

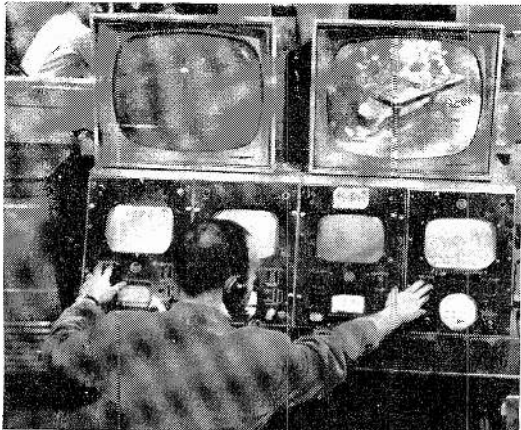

You Get Prime Quality Equipment. All kits furnished with the course are complete in every respect, and the equipment is top grade. You keep all the equipment furnished to you for actual use on the job... and you never have to take apart one piece to build another.

CLASSROOM TRAINING

in New York City and Cherry Hill, N. J. (near Camden)—You can study electronics in the city of your choice.

No previous technical training required for admission. You are eligible even if you haven't completed high school. RCA Institutes Resident Schools in New York City and RCA Technical Institute in Cherry Hill, N. J. offer training that will prepare you to work in rewarding positions on research and production projects in fields such as automation, transistors, communications, technical writing, television, computers, and other industrial and advanced electronics applications. If you did not complete high school, RCA will prepare you for such training with courses specially designed to provide the basic math and physics required for a career in electronics.

Free Placement Service. RCA Institutes graduates are now employed in important jobs at military installations with important companies such as IBM, Bell Telephone Labs, General Electric, RCA, and in radio and TV stations all over the country. Many other graduates have opened their own businesses. A recent New York Resident School class had 93% of the graduates who used the FREE Placement Service accepted by important electronics companies... and had their jobs waiting for them on the day they graduated!

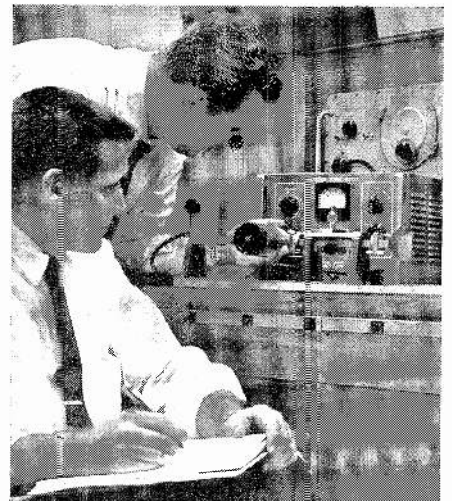

Coeducational Day and Evening Courses. Day and Evening Courses are available at Resident Schools in New York City and Cherry Hill, N. J. You can prepare for a career in electronics while continuing your normal full-time or part-time employment. Regular classes start four times each year.

**SEND POSTCARD FOR FREE ILLUSTRATED BOOK TODAY!
SPECIFY HOME STUDY OR NEW YORK OR CHERRY HILL, N. J. RESIDENT SCHOOL.**

RCA INSTITUTES, INC. Dept. RE-24 A SERVICE OF RADIO CORPORATION OF AMERICA, 350 WEST 4TH ST., NEW YORK, N. Y. 10014



The Most Trusted Name in Electronics

EASY, ECONOMICAL, SURE way to LEARN ELECTRONICS

Gernsback's Basic Series Books

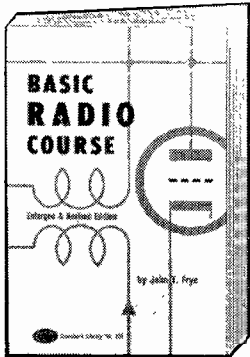

BASIC RADIO COURSE

Learn radio in this easy-to-understand, easy-to-read book. A perfect way to start your electronics career. #104—\$4.10

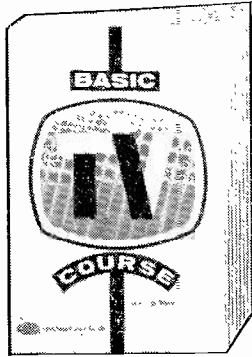

BASIC TV COURSE

Television as it is today. An excellent first reader in television electronics science. #105—\$4.10

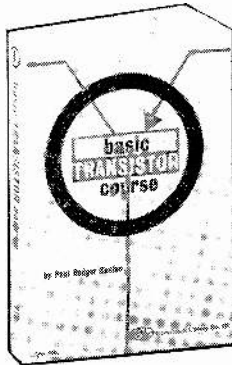

BASIC TRANSISTOR COURSE

THE book on transistor fundamentals. Must reading for electronics-minded men. #111—\$4.10

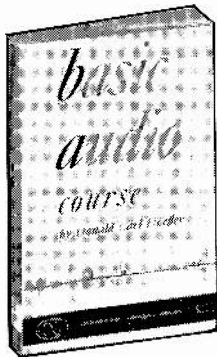

BASIC AUDIO COURSE

Audio high-fidelity systems from pre-amp to speaker. How and why audio systems work. #66—\$2.75

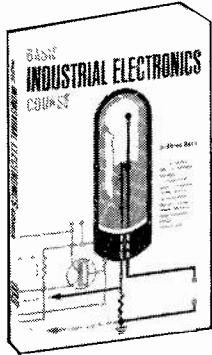

BASIC INDUSTRIAL ELECTRONICS COURSE

Just out! Breaks down complex industrial equipment into familiar devices. #109—\$4.10

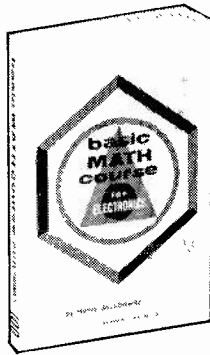

BASIC MATH COURSE FOR ELECTRONICS

Takes math out of the dreary textbook world and into the exciting Electronics Age. #100—\$4.50

Buy Now From Your Electronic Parts Distributor or Fill Out Coupon:

----- 10-DAY EXAMINATION -----

- 104 66
 105 109
 111 100

Remittance Must Accompany Order

Gernsback Library, Inc.
 154 W. 14th St., New York, N. Y. 10011

Name:

Address:

City:State:

Enclosed is \$.....

RE2A

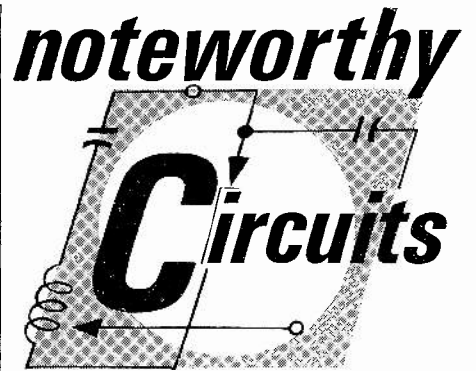

Volume Limiter for Your TV

Do the kids drive you mad by turning up the TV volume till the house shakes? Here's a little circuit that will put a stop to that problem. All you do is add a screwdriver-adjust potentiometer ahead of the volume control as in the diagram. You use this control as the vol-

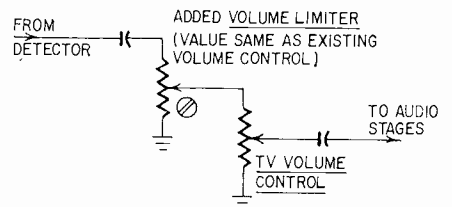

ume limiter. Once installed, turn set volume all the way up and adjust the volume limiter control, located where the kids can't get at it, to set the volume to the maximum level that will not disturb you. Now the volume cannot be turned up too far. For the volume limiter, use a pot with the same value as the existing volume control. Circuits of this type are commonly used in hotel and motel versions of standard TV.—Warren Roy

Re: Quick-Start Circuit

I enjoyed reading "Start Your Car Fast" (December 1962) and the related correspondence and ideas discussed in the February, April and August 1963

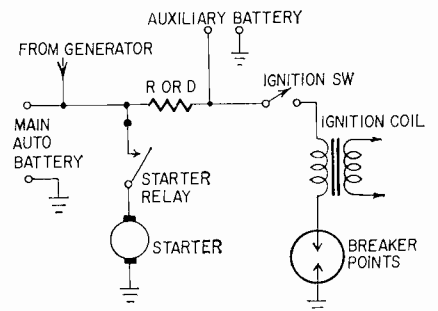

issues. However, the complicated circuits, switches and relays that have been recommended are not really necessary. Here is a simple circuit that my brother developed in 1935 for a 1933 Chevrolet.

R is a 10-ohm 10-watt resistor between the two batteries. (A 12-volt system requires a 20-ohm 10-watt resistor.) When starting, current drawn from the auxiliary battery is negligible,

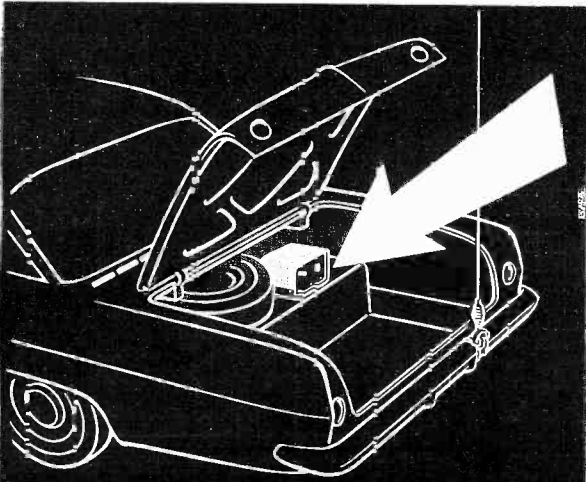

For . . .

REMOTE CONTROL OPERATION

LIMITED SPACE INSTALLATION

you need the **NEW MODEL 1000**
EXECUTIVE TRANSCEIVER

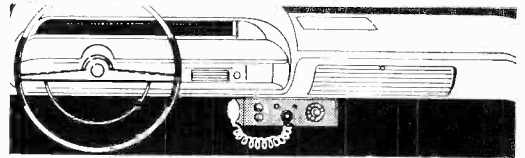
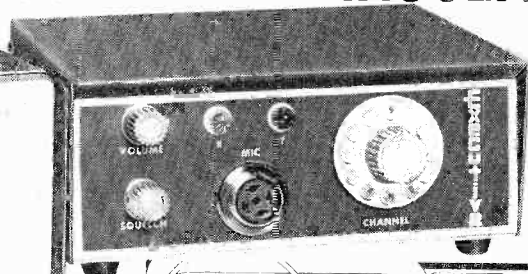
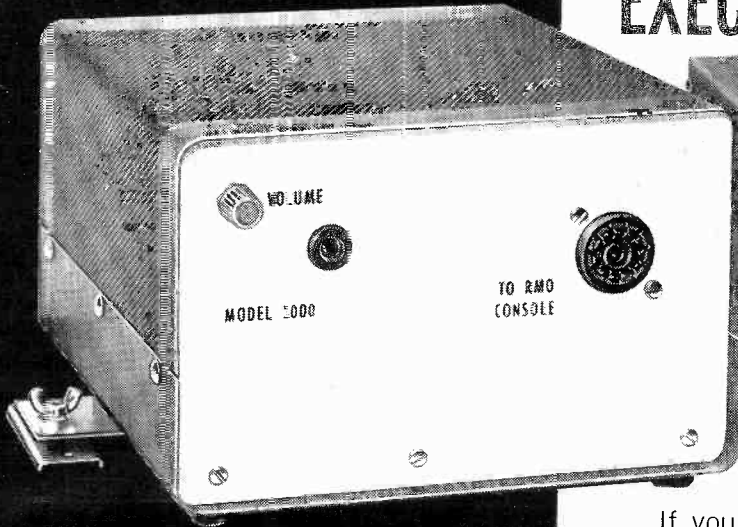

If you are looking for a citizens band transceiver designed for limited space or remote operation, then you need International's Model 1000* transceiver . . . the very latest in the Executive series of fine two-way radios.

Engineered for flexible installation, the Model 1000* may be used in a car, boat or plane. Operates on 6 or 12 vdc and 115 vac. Features include: series gate noise limiter, high frequency crystal filter for reducing adjacent channel interference, delayed avc system, speech clipper amplifier and crystal filter. All frequency control circuits are housed in International's new (RMO) remote console.

The console, 2½" H x 7" W x 5" D, mounts under the dash. Nine receive and nine transmit crystal sockets are provided for the selection of any desired channel. The illuminated Channel Selector (an International exclusive) makes channel selection easy. Console panel provides: on-off switch, volume and squelch controls, channel selector, microphone receptacle, transmit and receive indicator lights.

Model 1000, complete with remote console, mobile mounting brackets for transceiver and console, cables, 1 set of channel 9 crystals, microphone, speaker. Cat. No. 600-115 . . . \$259.50

*Model 500, similar features but does not contain delayed avc, speech clipper amplifier and crystal filter. Cat. No. 600-114 . . . \$179.50

WRITE TODAY
FOR INTERNATIONAL'S 1964 CATALOG.

INTERNATIONAL
CRYSTAL MFG. CO., INC.

18 NORTH LEE • OKLAHOMA CITY, OKLA.

UNIVERSAL

From Factory to You
at Lowest
Prices

10% OFF—on orders of 10 or over



PM SPEAKERS

Money Back Guarantee
if not the Best
at any Price

Top Quality with Alnico #5 Magnets

2" — .45oz ... \$.59	4"x6" — 1oz ... \$1.39	8" — 1oz (a bargain at double our price) ... \$1.39
3" — .45oz62	4"x6" — 1.47oz ... 1.56	8" — 1.47oz best seller in 8" Speakers ... 1.79
3 1/2" — .68oz(*) ... 1.00	5"x7" — 1.47oz ... 1.82	8" — 3.16oz for HI-FI, Stereo, TV, Etc ... 2.48
3 1/2" — 1.47oz(*) ... 1.22	5"x7" — 2.15oz ... 1.98	8" — 6.8oz with Whizzer, concert tone ... 3.79
4" — .68oz ... 1.00	6" — 1oz ... 1.37	10" — 4.64oz (2 new "TFNS" added to our ... 3.84
4" — 1oz ... 1.12	6" — 1.47oz ... 1.59	10" — 6.8oz line—by popular demand) ... 4.48
4" — 1.47oz ... 1.24	6" — 2.15oz ... 1.86	12" — 2.15oz biggest value ever offered ... 2.99
5" — 1oz ... 1.14	6" — 3.16oz ... 2.39	12" — 3.16oz takes volume with clarity ... 3.82
5" — 1.47oz ... 1.36	6"x9" — 1.47oz ... 1.97	12" — 6.8oz with Whizzer, over 10 watts ... 4.96
5" — 2.15oz ... 1.58	6"x9" — 3.16oz ... 2.39	12" — CO-AX 6.8oz 15 watts, 50-15000cps ... 7.99
5" — 3.16oz ... 1.73	6"x9" — 6.8 oz ... 3.98	15" — FULL RANGE 6.8oz concert tone ... 7.84

(*) TWEETER SPEAKER

AUDIO OUTPUT TRANSFORMERS

50L6 ... 39¢	50L6 push pull ... 69¢
6K6, 6V6 ... 43¢	6K6 push pull ... 78¢
3V4, 3Q4 ... 49¢	6L6 push pull ... 98¢
6L6 ... 89¢	UNIVERSAL ... 98¢

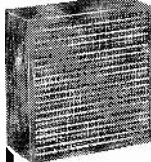

SPEAKER Baffle Cabinets

New Streamlined Style...designed and constructed for resonant tone. In Walnut, blonde or unfinished

4" ... \$1.67	5"x7" ... \$2.98
5" ... 1.94	6"x9" ... 3.42
6" ... 2.28	10" ... 3.57
8" ... 2.84	12" ... 4.39

Supplied as shown or with sloping front for wall mount

1—SQ. YARD GRILLE CLOTH \$1
most popular brown & gold design

UNIVERSAL RECORDING TAPE

3" MYLAR 300' ... \$.49	3" ACETATE 150' ... 34¢
3 1/4" MYLAR 600'88	3" ACETATE 225' ... 39¢
5" MYLAR 600' ... 1.00	5" ACETATE 600' ... 79¢
5" MYLAR 900' ... 1.29	7" ACETATE 1200' 98¢
7" MYLAR 1200' ... 1.47	
7" MYLAR 1200' ... 1.94	TAPE REELS
7" MYLAR 2400' ... 2.69	3" ... 18¢
	5" ... 27¢

\$200 HEARING AID For \$2

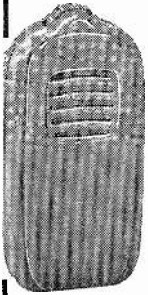

Each HEARING AID is a Complete AUDIO AMPLIFIER and includes

CRYSTAL MICROPHONE
3 SUBMINIATURE TUBES
Superb Beige CABINET

TOP ITEM for Experimenters can be modified and converted to: RADIOS — INTERCOMS — TRANSMITTERS — SECRET LISTENING DEVICES — MICROPHONE — Etc.

5" x 2 1/2" x 1" — Shpg. Wt. 1 lb.
Complete as illustrated incl. SCHEMATIC DIAGRAM (less Earphone & Battery) ... \$2

BROOKS RADIO & TV CORP., 84 Vesey St., New York 7, N.Y.

EIGHT INSTRUMENTS IN ONE

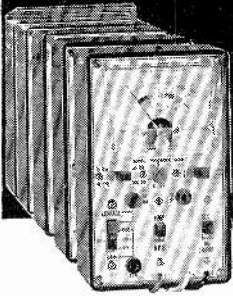

- Out-of-Circuit Transistor Analyzer
- Dynamic In-Circuit Transistor & Radio Tester
- Signal Generator
- Signal Tracer • Voltmeter
- Milliammeter
- Battery Tester
- Diode Checker

Transistor Analyzer Model 212

Factory Wired & Tested — \$18.50
Easy-to-Assemble Kit — \$13.50

YOU DON'T NEED A BENCH FULL OF EQUIPMENT TO TEST TRANSISTOR RADIOS! All the facilities you need to check the transistors themselves — and the radios or other circuits in which they are used — have been ingeniously engineered into the compact, 6-inch high case of the Model 212. It's the transistor radio troubleshooter with all the features found only in more expensive units. Find defective transistors and circuit troubles speedily with a single, streamlined instrument instead of an elaborate hook-up.

Features:

Checks all transistor types — high or low power. Checks DC current gain (beta) to 200 in 3 ranges. Checks leakage. Universal test socket accepts different base configurations. Identifies unknown transistors as NPN or PNP.

Dynamic test for all transistors as signal amplifiers (oscillator check), in or out of circuit. Develops test signal for AF, IF, or RF circuits. Signal traces all circuits. Checks condition of diodes. Measures battery or other transistor-circuit power-supply voltages on 12-volt scale. No external power source needed. Measures circuit drain or other DC currents to 80 milliamperes. Supplied with three external leads for in-circuit testing and a pair of test leads for measuring voltage and current. Comes complete with instruction manual and transistor listing.

EMC, 625 Broadway, New York 12, N.Y.

Send me FREE catalog of the complete value-packed EMC line, and name of local distributor.

NAME _____ RE-82

ADDRESS _____

CITY _____ ZONE _____ STATE _____

EMC

ELECTRONIC MEASUREMENTS CORP.
625 Broadway, New York 12, New York
Export: Pan-Mar Corp., 1270 B'way, N.Y. 1

Buy

from Radio-Electronics Classified ads

Sell

through Radio-Electronics Classified ads

so its terminal voltage is virtually unaffected. The auxiliary battery charges through the resistor.

R can be replaced by a rectifier polarized so the auxiliary battery is kept charged and cannot discharge into the starter or the main battery.—Robert C. Lovick

Freeloading Transistor Power

Using something that would otherwise be wasted is the same as getting something for nothing. The diagram shows how the Spectran model 100 Spectrum Analyzer uses power ordinarily dissipated in the cathode resistor of the output amplifier to supply the transistorized portions of the analyzer.

The cathode resistor of a power amplifier is usually returned to ground. Here the return is made through a Zener diode. The diode voltage is less than the bias. The operating point of the output stage is maintained by using smaller cathode resistors.

Incorporate this idea in an audio

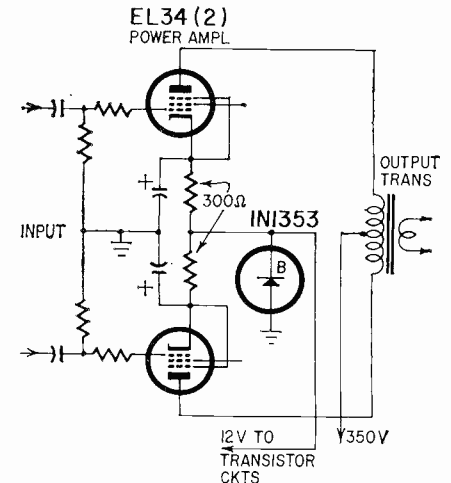

amplifier and you'll have a convenient source of operating voltage for a transistorized preamplifier. Use decoupling to prevent feedback.—Karl E. Springer

Correction

The photo of the tower-mounted TV antenna at the top of page 44 of the December issue was incorrectly credited to Winegard.

Here is a photo of the Winegard

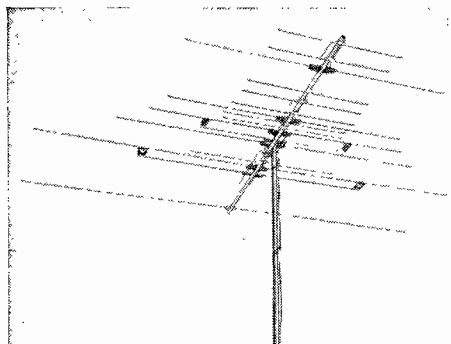

model C-42 Colortron antenna which should have run in that position.

TECHNOTES

Improving Noisy CCTV Amplifiers

After several years of continuous service, even the best closed-circuit TV amplifier systems deteriorate. That's the time to see if you can improve on the original performance, not just restore it.

In many of the systems I've run across, I replaced a 6CB6 with an E180F (Mullard or equivalent). This special-purpose tube has a gold-plated grid and base pins, and a

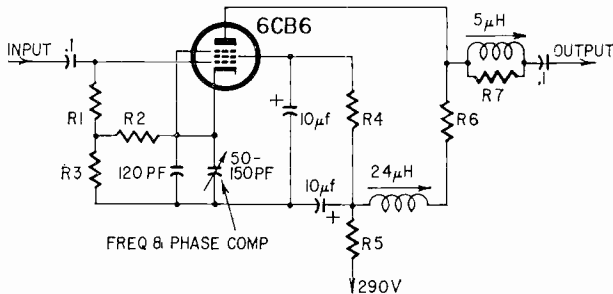

transconductance of 16,000 μmhos with very low noise. The diagram shows a typical circuit.

To get best results, change several resistor values as shown in the table below. Even if the original tube isn't a 6CB6, or if the values in your circuits are different, the chart will be a guide.

	6CB6	E180F
R1	510,000 ohms	220,000 ohms
R2	150 ohms	150 ohms
R3	7,500 ohms	3,300 ohms
R4	3,000 ohms	2,200 ohms
R5	3,000 ohms	1,800 ohms
R6	1,500 ohms	750 ohms
R7	6,800 ohms	4,700 ohms

The same change makes a noticeable improvement in ordinary TV sets.—*B. C. Terrell*

[The E180F is available from Allied and other electronics supply houses.—*Editor*]

Zenith 19R20, etc.: Cogwheel

A severe cogwheel effect in the picture on one of these chassis at high or normal brightness, that disappears at low brightness settings, is caused by core saturation in the horizontal output transformer.

Replace the transformer to cure this.—*Jim Wilhelm*

RCA KCS45-49 Hint

Replacing the 2- μf agc filter capacitor (C124) has corrected many tricky and borderline conditions in these chassis.

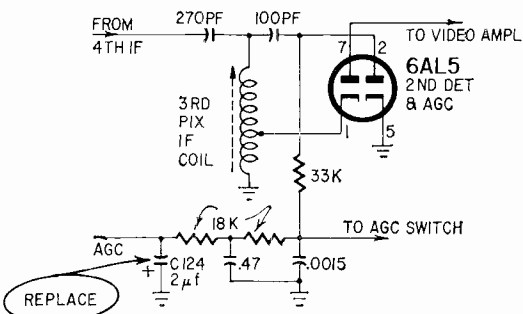

BECOME A RADIO TECHNICIAN
for only \$26.95

BUILD 20 RADIO

CIRCUITS AT HOME

with the New Progressive
RADIO "EDU-KIT"®

Reg. U.S.
Pat. Off.

All Guaranteed to Work!

PRACTICAL only
HOME
RADIO
COURSE \$26.95

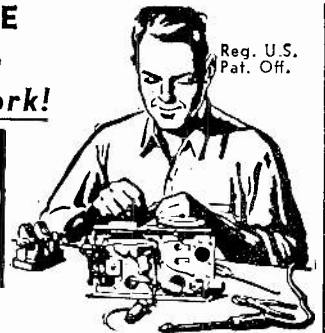

NOW INCLUDES

- ★ 12 RECEIVERS
- ★ 3 TRANSMITTERS
- ★ SQ. WAVE GENERATOR
- ★ AMPLIFIER
- ★ SIGNAL TRACER
- ★ SIGNAL INJECTOR
- ★ CODE OSCILLATOR

TRAINING ELECTRONICS
TECHNICIANS SINCE 1946

- ★ No Knowledge of Radio Necessary
- ★ No Additional Parts or Tools needed
- ★ Excellent Background for TV
- ★ School Inquiries Invited
- ★ Attractively Gift Packed

FREE EXTRAS

- SET OF TOOLS • RADIO & ELECTRONICS TESTER • ELECTRIC SOLDERING IRON • TESTER INSTRUCTION MANUAL • MEMBER-SHIP IN RADIO-TV CLUB • CONSULTATION SERVICE • HI-FI GUIDE
- QUIZZES • TV BOOK • FCC AMATEUR LICENSE TRAINING
- RADIO BOOK • PRINTED CIRCUITRY • PLIERS-CUTTERS
- ALIGNMENT TOOL • WRENCH SET • CERTIFICATE OF MERIT
- VALUABLE DISCOUNT CARD

WHAT THE "EDU-KIT" OFFERS YOU

The "Edu-Kit" offers you an outstanding PRACTICAL HOME RADIO COURSE at a rock bottom price designed to train Radio & Electronics Technicians, making use of the most modern methods of home training. You learn radio theory, construction, servicing, basic Hi-Fi and TV repairs, code, FCC amateur license requirements.

You will learn how to identify radio symbols, how to read and interpret schematics, how to mount and lay out radio parts, how to wire and solder, how to operate electronic equipment, how to build radios. Today it is no longer necessary to spend hundreds of dollars for a radio course. You will receive a basic education in radio, worth many times the small price you pay, only \$26.95 complete.

THE KIT FOR EVERYONE

The Progressive Radio "Edu-Kit" was specifically prepared for any person who has a desire to learn. Radio "Edu-Kit" has been used successfully by young and old in all parts of the world, by many Radio Schools and Clubs in this country and abroad. It is used for training and rehabilitation of Armed Forces Personnel and Veterans throughout the world you learn.

The Progressive Radio "Edu-Kit" requires no instructor. All instructions are included. Every step is carefully explained. You cannot make a mistake.

PROGRESSIVE TEACHING METHOD

The Progressive Radio "Edu-Kit" is the foremost educational radio kit in the world, and is universally accepted as the standard in the field of electronics training. The "Edu-Kit" uses the modern educational principle of "Learn by Doing." Therefore, you construct radio circuits, perform jobs and conduct experiments to illustrate the principles which you learn.

You begin by examining the various radio parts included in the "Edu-Kit." You then learn the function, theory and wiring of these parts. Then you build a simple radio. With this first set, you will enjoy listening to regular broadcast stations, learn theory, practice testing and troubleshooting. Then you build a more advanced radio, learn more advanced theory and techniques. Gradually, in a progressive manner, and at your own rate, you will find yourself constructing more advanced multi-tube radio circuits, and doing work like a professional Radio Technician.

Included in the "Edu-Kit" course are 20 Receiver, Transmitter, Code Oscillator, Signal Tracer, Square Wave Generator and Amplifier circuits. These are not unprofessional "bread board" experiments, but genuine radio circuits, constructed by means of professional wiring and soldering on metal chassis, plus the new method of radio construction known as "Printed Circuitry." These circuits operate on your regular AC or DC house current.

In order to provide a thorough, well-integrated and easily-learned radio course, the "Edu-Kit" includes practical work as well as theory; troubleshooting in addition to construction; training for all, whether your purpose in learning radio be for hobby, business or job advancement. The "Edu-Kit" includes material, ranging from simple circuits to well-advanced topics in Hi-Fi and TV. Your studies will be further aided by Quiz materials and our well-known FREE Consultation Service.

THE "EDU-KIT" IS COMPLETE

You will receive all parts and instructions necessary to build 20 different radio and electronics circuits, each guaranteed to operate. Our Kits contain tubes, tube sockets, variable, electrolytic, mica, ceramic and paper dielectric condensers, resistors, tie strips, coils, hardware tubing, punched metal chassis, Instruction Manuals, hookup wire, solder, selenium rectifiers, volume control switches, knobs, etc.

In addition, you receive Printed Circuit materials, including Printed Circuit chassis, special tube sockets, hardware and instructions. You also receive a useful set of tools, a professional electric soldering iron, and a self-powered Dynamic Radio & Electronics Tester. The "Edu-Kit" also includes Code Instructions and the Progressive Code Oscillator, in addition to the F.C.C.-type Questions and Answers for the Radio Amateur License training. You will also receive lessons for servicing with the Progressive Signal Tracer and the Progressive Signal Injector, and a High Fidelity Guide and Quiz Book. Everything is yours to keep.

J. Statistis, of 25 Poplar Pl., Waterbury, Conn., writes: "I have repaired several sets for my friends, and made money. The "Edu-Kit" paid for itself. I was ready to spend \$240 for a course, but I found your ad and sent for your Kit."

UNCONDITIONAL MONEY-BACK GUARANTEE

The Progressive Radio "Edu-Kit" has been sold to many thousands of individuals, schools and organizations, public and private, throughout the world. It is recognized internationally as the ideal radio course.

By popular demand the Progressive Radio "Edu-Kit" is now available in Spanish and English.

It is understood and agreed that should the Progressive Radio "Edu-Kit" be returned to Progressive "Edu-Kits" Inc., for any reason whatever, the purchase price will be refunded in full, without quibble or question, and without delay.

The high recognition which Progressive "Edu-Kits" Inc. has earned through its many years of service to the public is due to its unconditional insistence upon the maintenance of perfect engineering, the highest instructional standards, and 100% adherence to its Unconditional Money-Back Guarantee. As a result, we do not have a single dissatisfied customer throughout the entire world.

ORDER FROM AD—RECEIVE FREE BONUS RESISTOR AND CONDENSER KITS WORTH \$7.00

- Send "Edu-Kit" Postpaid. I enclose full payment of \$26.95.
- Send "Edu-Kit" C.O.D. I will pay \$26.95 plus postage.
- Send me FREE additional information describing "Edu-Kit."

Name
Address

Progressive "EDU-KITS" Inc.

1186 Broadway, Dept. 217G
Hewlett, N. Y.

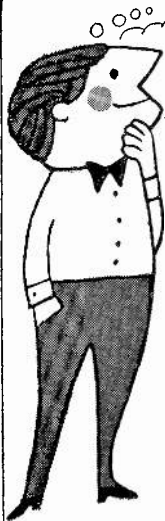

WHAT CAN YOU DO WITH PHOTOCONDUCTORS?

Use headlights to open the garage door...build a model railroad crossing guard...make a light meter...or invent your own project, using the new Sylvania photoconductor kit. 52-page booklet, included, gives instructions and circuits for 20 fascinating do-it-yourself projects.

Ask for Photoconductor Kit PCK-10 at Sylvania Electronic Distributors, or send \$9.95 (plus 50¢ handling charge) to Dept. PCK-10, Sylvania Electric Products Inc., 1025 Westminster Drive, Williamsport, Pa., and we'll send one postpaid.

Mention this magazine.

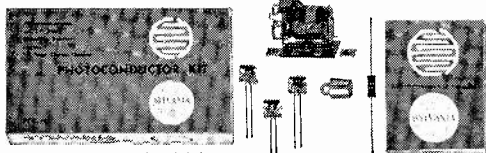

NEW SYLVANIA KIT

contains 3 photoconductors, AC/DC relay, resistor, mounting bracket, how-to-build-it booklet.

ELECTRONIC TECHNICIANS

IMMEDIATE OPENINGS

■ RADAR FIELD ENGINEERS

1. Excellent Stateside locations for men who qualify as Radar Field Engineers. Must have 3 years' experience in ground or shipboard systems and 2 years' technical education.

2. Alaskan openings also available for men who have 3 years' experience on heavy ground radar, one year of which must have been on an AC and W site.

■ TEST EQUIPMENT TECHS

Stateside and Overseas openings for men who have 3 years' electronic experience, 2 years of which must be in the repair and calibration of test equipment.

Interested Candidates, Please Write or Send Resume To Department 804.

PHILCO TECHREP DIV.

A Subsidiary of Ford Motor Company

P. O. BOX 4730 PHILADELPHIA, PA., 19134

An Equal Opportunity Employer

In most sets, an S-shape weave in the picture has been corrected by changing that capacitor. So too has soft, unstable vertical hold. A dark, overloaded picture can be caused by a shorted C124. When open, it can be responsible for certain kinds of horizontal tearing.

I have recently made it standard operating practice to replace this capacitor in any set that still has the original.—*Charles B. Randall*

Wilcox-Gay Recordio R-804

Owners of this recorder may find a sudden loss of audio, heralded by smoke and the smell of a burning transformer. The fault is in the tiny F-4 silicon rectifier, which shorts out as a result of power-line surges. The little rectifier was probably used to save space, but isn't suitable for this job—the voltage is too high.

The remedy is to put a fuse in the ac line and replace the F-4 with a miniature 75-ma selenium rectifier. Because of space limitations, you will have to mount the new rectifier directly on the five-lug terminal strip.—*Robert E. Forschner*

Longer Battery Life for EICO 555/565 Vom's

If you use the resistance ranges on these meters frequently, the four penlight cells (size AA) will wear out in about a month. I replaced mine with a Mallory TR-146 mercury battery in series with a 100,000-ohm pot. The mercury battery has a much longer life than the zinc-carbon cells,



Fig. 1

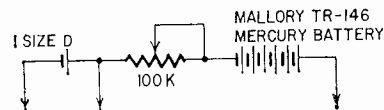

Fig. 2

and once its voltage does start to drop, the pot's resistance can be reduced to compensate.

You can find space inside the case for the battery and the pot. Fig. 1 shows the original circuit, and Fig. 2 the modification.—*Allan Glaser*

Philco Chassis TV-440

Complaint: Horizontal weave.

Solution: Pins 3, 6 and 7 of the afc tube (a 6AL5) are tied together on the printed-circuit board, and the foil conductor is grounded to the chassis through a metal screw. This screw tends to loosen slightly, giving a ground path of greater than zero ohms resistance. The 6AL5 heater supply then gets into the horizontal circuit.

Tighten the screw to prevent recurrence, or, better yet, solder a jumper to the chassis.—*Charles Andrews*

Hotpoint 14S202

Complaint: Plays a few minutes, then the raster leaves abruptly. Stability also affected by fine-tuning.

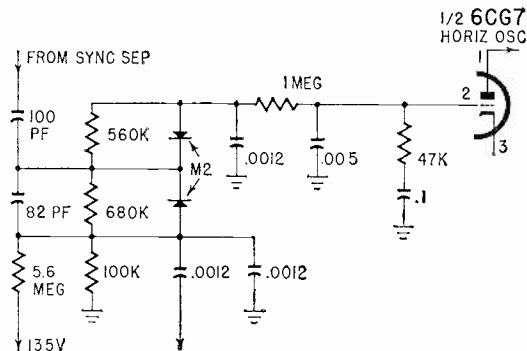

Cause: Dual selenium diode M2 (see diagram) becomes unbalanced. Change it, and be sure to use heat sink when soldering.—*William Porter*

END

NEW SAMS BOOKS

Practical Transistor Theory

by E. Patrick Weisner. Up-to-date coverage of transistor devices, how they're used, and how they work. Written on a practical level for easy understanding by electronics technicians and students who have no need for high-level design theory. Explains basic principles of transistor operation; describes typical circuits and how they work; concentrates on explaining operation of modern semiconductor devices, and their application. 160 pages; 5½ x 8½". Order PTW-1, only \$2.95

ABC's of Television

by Len Buchwalter. Whether you are technically trained or not, this book will prove an invaluable reference on television. Using simplified block diagrams and down-to-earth text, it takes you through the whole process of television operations, from the studio cameras to the picture tube in the home receiver. Gives you a clear understanding of basic principles involved in TV transmission and reception (both black-and-white and color), with emphasis on how TV sets work. Chapters: Basic Principles; Creating the TV Signal; TV Antennas; What the Receiver Does; The Tuner; The IF Amplifier; Detection & Amplification; Synchronizing the Picture; The Picture Tube; How to View a Test Pattern; How Color TV Works; and other TV Systems. \$1.95 128 pages; 5½ x 8½". Order ATV-1, only...

Science Projects in Electricity/Electronics

by Edward M. Noll. This third volume in the popular Science Projects Series demonstrates basic principles of electricity and electronics through the construction of fascinating projects which are not only instructive but also useful. Clear text and illustrations explain modern electronics systems. Projects include transistor power amplifiers; radio-frequency amplifier; detectors and converters; wide-range oscillator; AM-FM modulators; radio remote control; light relay and industrial circuits. Ideal for self-instruction or as a science class project guide. 144 pages; \$2.95 5½ x 8½". Order SPN-1, only...

Calculus for the Electronics Technician

by Allan Lytel. Provides electronics technicians with a sound foundation in calculus, one of the basics required for a better understanding of electronics design. Includes a thorough explanation of basic differential and integral calculus, starting with the fundamental concepts of functions and variables. Examples are kept as geometrical as possible, and abstract concepts are avoided. Uses the limit process and its relation to the rate of change of a function to develop the concept of the derivative and differentiation. Clearly explains Riemann integration and discusses infinite series. Includes helpful problem sets and appendices. Anyone with a knowledge of high-school algebra can profit from this book. \$4.95 224 pages; 5½ x 8½". Order CAL-1, only...

Passive Audio Network Design

by Howard M. Tremaine. A practical ready-reference handbook for audio technicians and engineers, on the design, construction, operation and testing of passive networks. Includes sections on: Attenuator Circuits, including many basic designs and various balanced and unbalanced configurations; Equalizer Circuits, including variables, resonant circuits, recording and reproducing networks, etc.; Filter Circuit designs; Test and Measurement Techniques for checking networks. Requires only an average mathematical background for full understanding. \$4.95 288 pages; 5½ x 8½". Order AHT-1, only...

Closed Circuit TV Handbook

by Leon A. Wortman. The first comprehensive guide to closed circuit TV systems and applications. Provides complete details for the interested nontechnical reader, as well as for technical personnel who require a guide for planning, installing, operating, and maintaining CCTV systems. Describes various types of equipment available and their applications. Discusses systems for educational, commercial, and industrial uses; shows how CCTV is used in research, health and medicine, military, public utilities and services, etc. Includes chapters on installation considerations, operation and service. 320 pages; \$7.95 5½ x 8½", hardbound. Order CLC-1, only...

HOWARD W. SAMS & CO., INC.

Order from your Sams Distributor today, or mail to Howard W. Sams & Co., Inc., Dept. RE-2, 4300 W. 62nd Street, Indianapolis 6, Ind.

Send me the following books:

- PTW-1 SPN-1 AHT-1
 ATV-1 CAL-1 CLC-1

\$_____ enclosed. Send FREE Booklist

Name _____

Address _____

City _____ Zone _____ State _____

My Distributor is _____

IN CANADA: A. C. Simmonds & Sons, Ltd., Toronto 7

new Patents

Radiolocation by Satellite

PATENT No. 3,063,048

Frank W. Lehan, Glendale, and Glenn L. Brown, Los Angeles, Calif. (Assigned to Space-General Corp., Glendale, Calif.)

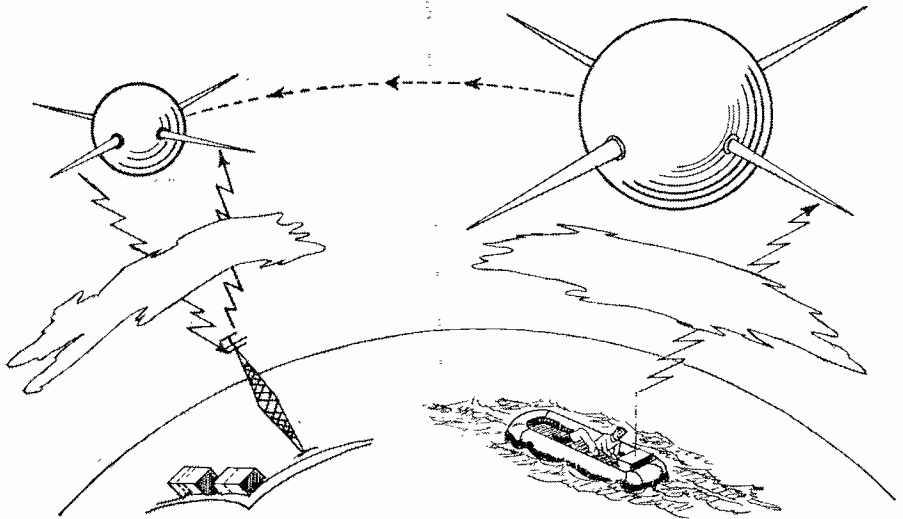

Shipwrecked survivors or lost nose cones can be quickly located with the aid of orbiting satellites. A constant-frequency signal, transmitted from a drifting lifeboat or other source, is recorded together with time markers generated in the satellite. Due to Doppler effect, the frequency undergoes maximum rate of change at the instant the satellite

and the source are closest.

Later, the satellite passes over a receiving station and the signal is played back. The time markers show the exact instant when the frequency underwent its maximum rate of change. Calculation will disclose where the satellite was at that instant. This idea is in many ways simpler than earlier ones.

Improved Regulator

PATENT No. 3,099,790

Thomas G. Marshall, Jr., Franklin Park, N. J. (Assigned to RCA)

One common type of regulator uses a Zener diode in series with the base of a transistor (see diagram). Since the load voltage remains nearly equal to the diode voltage, the output is held constant. The transistor permits a larger current to be controlled than the Zener itself can handle.

Zener voltage, however, changes somewhat with diode current. This affects regulation. This invention utilizes a pilot lamp to maintain a steady current through the diode. Since the filament resistance rises with its temperature, the current tends to remain constant even when the input is varied over a small range.

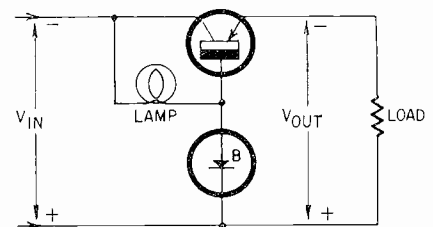

The combination of lamp and diode improves the regulation.

Self-Orienting Sun Battery

PATENT No. 2,993,125

Charles W. Geer and William W. Jacquish, Los Angeles, Calif. (Assigned to Hoffman Electronics Corp.)

The output of a solar cell is maximum when it faces the sun directly. This panel of cells is arranged to track the sun automatically. It is mounted on a joint which permits tilting in any direction. Weights can be raised or lowered to adjust the center of gravity of the device.

A transparent tube with an absorbent layer is filled with ether. A reflecting shield is placed above the tube. If the sun's rays arrive obliquely, only the far end of the tube is heated. The ether vaporizes, then condenses on the cooler side. This weights the panel to tilt toward the sun. The absorbent prevents the liquid from running to the low side.

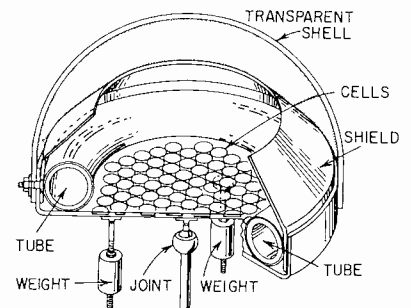

FREE!

MAIL
THIS
CARD
TODAY

LAFAYETTE RADIO ELECTRONICS

1964
CATALOG
NO. 640

LAFAYETTE RADIO ELECTRONICS

OUR 43rd YEAR
1964
CATALOG NO. 640
INDEX PAGE 415

422
GIANT-
SIZE
PAGES

FREE—LAFAYETTE'S 422 PAGE 1964—CATALOG—640

Friend's Name

Address

City Zone

State

DEPT. JB-4



Mail Order and
Island Sales Center
SYOSSET, L.I., N.Y.

- | | | | | |
|--------------------------------------------------------------------------------------------------|-------------------------------------------------------------------------------------------------------------------------------------------|-----------------------------------------------------------------------------------------|-------------------------------------------------------------------------------------------------------------------------------|----------------------------------------------------------------------------------------------------------------------|
| JAMAICA, N.Y.
165-08 Liberty Ave.
Apt. 1-7500
Open MON. & FRI.
Til 8:45 P.M. | NEW YORK, N.Y.
100 - 6th Avenue
1st Floor
Worchester 5300
Open THUR. Til 8:45 P.M. | BRONX, N.Y.
542 E. Fordham Road
Fordham 7-8812
Open THUR. Til 8:45 P.M. | SCARSDALE, N.Y.
691 Central Park Avenue
1st Floor
Glenwood 2-2700
Open MON. THURS. - FRI.
Til 9:30 P.M. | 111 Jericho Turnpike
Sung By Plaza Dept.
Sung 1-14
Open MON. - FRI.
Apt. 1000 713 1000 - 1 7100 |
| BOSTON, MASS.
110 Federal Street
Riverside 2-7830
Open MON. & WED. Til 8:45 P.M. | NATICK, MASS.
1400 Worcester Street
Rt. 9 Opp. Shopper's World
Phone: 812-8144
Open WED. - THURS. - FRI. Til 9:30 P.M. | NEWARK, N.J.
24 Central Avenue
Newark 2-1961
Open WED. Til 8:45 P.M. | PLAINFIELD, N.J.
139W. 2nd Street
Plainfield 6-4710
Open THUR. Til 8:45 P.M. | PARAMUS, N.J.
182 Route 17
1st Fl. North of Garden State Plaza
Open MON. - WED. - FRI. Til 8:45 P.M. |

LAFAYETTE
GIVES YOU MORE IN '64

- **MORE CATALOG-** the biggest in our 43-year history; 422 giant-size illustrated pages.
- **MORE SELECTION-** if it's in hi-fi or electronics, it's at Lafayette.
- **MORE SERVICE-** more and more orders fully processed in 24 hours.
- **MORE BUYING POWER-** choose from Lafayette's three Easy-Pay credit plans.

43 YEARS OF DEPENDABLE SERVICE AT
LAFAYETTE'S TRADITIONALLY LOW PRICES

10 CONVENIENT LOCATIONS

- | | |
|----------------------------------------------------------------------------------------------------------------------------------|------------------------------------------------------------------------------|
| SYOSSET, N. Y. 111 Jericho Turnpike.
(2 Blocks West of So. Oyster Bay Rd.)
Mail Order and Long Island Sales Center. | BRONX 58, N. Y. 542 E. Fordham Road |
| JAMAICA 33, N. Y. 165-08 Liberty Avenue
(Off Merrick Rd.) | NEWARK 2, N. J. 24 Central Avenue |
| NEW YORK 13, N. Y. 100 6th Avenue
(Just North of Canal St.) | PLAINFIELD, N. J. 139 W. 2nd Street |
| SCARSDALE, N. Y. 691 Central (Park) Avenue
(1/2 Mile North of Ardsley Rd.) | PARAMUS, N. J. 182 Route 17
(1 Mile North of Garden State Plaza) |
| | BOSTON 10, MASS. 110 Federal Street |
| | NATICK, MASS. 1400 Worcester Street
Rt. 9 Opposite Shopper's World |

Name

Address

City Zone

State

DEPT. JB-4

FREE—LAFAYETTE'S 422 PAGE 1964—CATALOG—640



FREE
To A Friend
1964 Lafayette Catalog

Mail this card
for your FREE
1964 Lafayette Catalog



LAFAYETTE RADIO ELECTRONICS

P.O. BOX 10

SYOSSET, L.I., N.Y.

Place Stamp Here

LAFAYETTE RADIO ELECTRONICS

P.O. BOX 10

SYOSSET, L.I., N.Y.

Place Stamp Here

FREE!

LAFAYETTE 422-Pg. 1964 CATALOG!



"World's Hi-Fi & Electronics Shopping Center"

LAFAYETTE GIVES YOU MORE IN '64

MORE TAPE RECORDERS...

From miniature portable recorders to complete tape decks... for fun at home to professional use, you'll find just the recorder you need at a popular Lafayette price.

LAFAYETTE PROFESSIONAL-TYPE 4-TRACK STEREO RECORDER

A complete recording studio in one case! Record 4-track stereo and monaural, plays 4 and 2-track stereo and 4-track monaural. Two matched stereo speakers. With 2 mikes, output cables, 7" take-up reel, 1200 ft. reel of tape.



169⁹⁵

RK-155WX

MORE CITIZENS BAND...



HE-100L

Lafayette offers more transceivers, more Walkie-Talkies and more accessories than ever before.

39⁹⁵

2-for-78.88

LAFAYETTE 12-TRANSISTOR C.B. WALKIE-TALKIE

The walkie-talkie with more new features—variable noise squelch, separate microphone and speaker, push-pull audio output. 12-transistors, diode, thermistor. Available with optional plug-in 117V power pack. With carrying case, batteries, earphone, crystals.

MORE STEREO HI-FI...



You'll find a complete selection of stereo hi-fi equipment at Lafayette. All famous brands plus Lafayette's own top-rated components.

LAFAYETTE 24-WATT STEREO HI-FI PHONO SYSTEM

Outstanding Performance At A Budget Price

LAFAYETTE SYSTEM PRICE

129⁵⁰

with FREE Accessories LS-225WXM



MATCHED COMPONENTS
Garrard Autoslim 4-Speed Automatic Changer
Lafayette LA-224 24-Watt Stereo Amplifier
Wood Base for Changer.
Empire 880 Diamond Needle Stereo Cartridge
2 Lafayette SK-124 2-Way Speaker Systems.

FREE with purchase of this system—record cleaning kit, stylus pressure gauge, all necessary hook-up wire and cable.

MORE HAM GEAR...



wired HE-30WX 79⁹⁵

semi-kit KT-320 64⁹⁵

Amateurs everywhere make Lafayette their headquarters for all their gear... from receivers and transmitters to the smallest accessory.

LAFAYETTE PROFESSIONAL-QUALITY 8-TUBE AMATEUR COMMUNICATIONS RECEIVER

4-band coverage—designed for today's crowded amateur bands. Outstanding bandwidth, selectivity and sensitivity with built-in Q-multiplier and edgewise S-meter.

MORE THAN EVER BEFORE...

- More Radios • More Test Equipment • More Tools
- More TV and Radio Tubes, Parts, Accessories
- More Cameras • More Optics
- More P.A. Equipment • More Books

NO MONEY DOWN... UP TO 24 MONTHS TO PAY

new Products

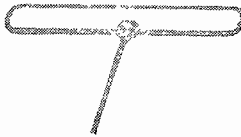

DEPTH SOUNDER. Recorder and indicator in single cabinet. Recorder scaled to 240 feet; flashing light indicator has normal scale of 120 feet but calibrated to 360 feet. Dual unit designed to

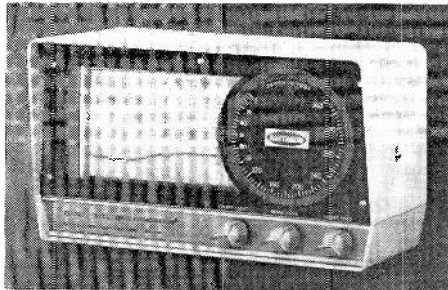

use same transducer used in *DE-122*, *DE-705A*, *DE-716* and *DE-718A*.—**Raytheon Co.**, Lexington 73, Mass.

BURGLAR ALARM FOR APARTMENT DWELLERS installs on inside of apartment door. No external wiring, no drilling through door, no exterior lock or key. 2 separate time-delay components permit occupants to leave or re-enter

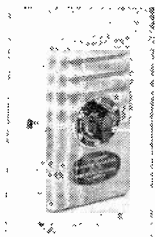

without sounding alarm. Time delay of 12–15 seconds after door opens cancelled by inserting proper key and turning to off. Alarm may then be reset to "Alert."—**Dadco**, PO Box 112, Hillside Manor Br., New Hyde Park, N. Y.

HEAVY-DUTY BUMPER MOUNT accepts all standard butt antennas with $\frac{3}{8}$ -24 threads. Bronze die-cast base with heavy chrome plating.

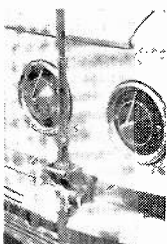

Stainless steel bracket adjusts to vertical position regardless of placement on bumper.—**Webster Mfg.**, 317 Roebling Road, S. San Francisco, Calif.

LOG PERIODIC UNIDIRECTIONAL ARRAYS. Trapezoidal, nonplanar feeds used with

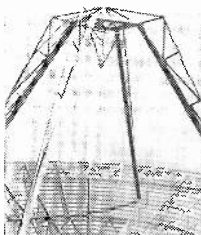

antenna or by themselves. Beamwidths changeable. *Model ALP-100*: frequency range 100 mc to 2,000 mc; gain 6 db; vswr less than 3:1. 3-db and 10-db beamwidths 70° and 125° respectively. Average

power 100 watts. *Model BLP-100*: same as *ALP-100*, but covers frequency range from 1–7 kmc.—**Antenna Systems Inc.**, Grenier Field, Manchester, N. H.

INDOOR TV ANTENNA for color and black-and-white TV. Vhf, uhf and FM. Two separate antennas; electrically lengthened or short-

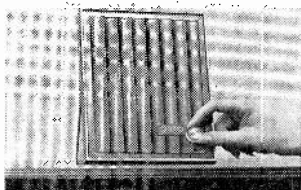

ened to match station's frequency.—**Gallo Electronics Corp.**, 12 Potter Ave., New Rochelle, N. Y.

ALL-CHANNEL YAGI TV ANTENNAS, models *DG600*, *DG620*, *DG700*. Separate Yagi sections for low and high vhf bands, *DG620* peaked

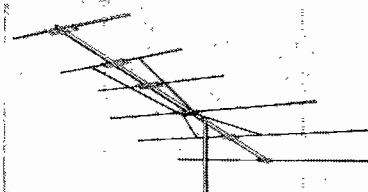

for extra gain on low band. *DG700* additional director.—**Clear Beam Antenna Corp.**, PO Box 471, Canoga Park, Calif.

UNITARY HI-FI SPEAKERS, *Sigma* series. 7 new 8- and 12-inch models: *SG-80*, dual 8-in. cone; *SG-84*, 2-way 8-in. coaxial; *SG-210*, 3-element

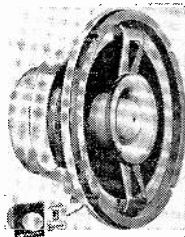

12-in. coaxial; *SG-88*, 8-in. coaxial with through-bore, horn-loaded compression tweeter; *SG-20*, 3-element 12-in. coaxial; *SG-222*, multi-cell 12-in. horn coaxial; *SG-223* (illus.), reflex horn coaxial.—**Jensen Mfg. Co.**, 6601 S. Laramie, Chicago.

MULTIPLE SPEAKER SYSTEM. 18-inch woofer with bass response to 16 cycles. Hartley 200MS, 10-inch unit, handles middle and high fre-

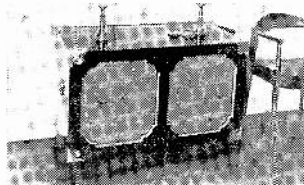

quencies. Crossover 400 cycles.—**Hartley Products Co.**, 519 E. 162 St., Bronx, N. Y.

CONSOLE SPEAKER SYSTEM uses pair of electrostatic radiators for treble; heavyweight

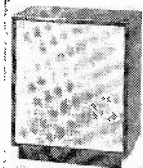

woofer with high-compliance cone. Response 30 to beyond 30,000 cycles per second.—**Neshaminy Electronic Corp.**, Furlong, Pa.

HI-FI CARTRIDGE, *model M44*. No-scratch, retractile stylus tracks at 15° vertical angle, proposed as RIAA standard and used by major record companies to cut records. Reduces IM and harmonic distortion 75 to 90% compared to earlier versions. Frequency response flat 20–20,000 cycles;

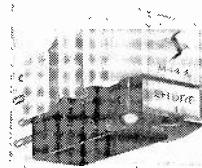

channel separation more than 25 db at 1,000 cycles.—**Shure Brothers Inc.**, 222 Hartrey Ave., Evanston, Ill.

ALL-TRANSISTOR, ALL-MODE STEREO RECEIVER, *model AR-13*. Solid-state circuitry, two 20-watt power amplifiers, 2 separate preamplifiers, wide-band AM, FM and FM stereo tuner. Automatic switching to stereo plus stereo indicator light; 2 filtered tape recorder outputs, high-gain rf stage and high-Q rod antenna. Amplifier specs: power output per channel: 20 watts/8-ohm load, 13.5 watts/16-ohm load, 9 watts/4-ohm load. IHF

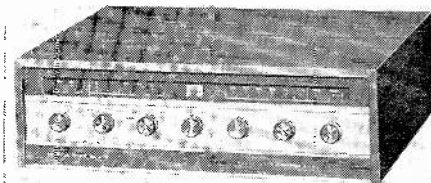

music power output: 33 watts/8-ohm load. Power response: ± 1 db from 15 cycles to 30 kc rated output; ± 3 db from 10 cycles to 60 kc rated output. Harmonic distortion below 1%. Channel separation: 40 db at 20 kc, 60 db at 1 kc.—**Heath Co.**, Benton Harbor, Mich.

STERECORDER, *Sony model 600*, 4-track stereo and mono recorder. Vertical or horizontal operation, mike and line mixing, source and tape monitoring. 2 VU meters, sound-with-sound, sound-

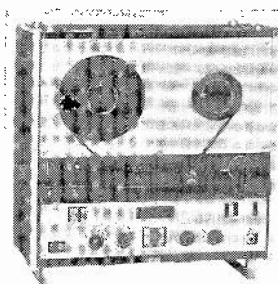

on-sound, separate monitor level controls, hysteresis-synchronous drive motor. $7\frac{1}{2}$ and $3\frac{3}{4}$ ips. Frequency response 30–18,000 at $7\frac{1}{2}$ ips; signal-to-noise 50 db; flutter and wow 0.17% or better at $7\frac{1}{2}$ ips; bias frequency 100 kc; inputs: 2 high-level line, 2 mike or magnetic phono. Outputs: 2 600-ohm 8-db lines. 600-ohm binaural earphone monitor.—**Superscope Inc.**, Audio Electronics Div., 8150 Vineland Ave., Sun Valley, Calif.

TAPE RECORDER, *Retro-matic 220*, 2-speed quarter-track stereo recorder with 2-directional playback. Capstan between 2 playback heads so tape pulled over head in forward or reverse playback. Automatic reverse playback controlled by timed silence-sensing device to detect end of program. Amplifier 6 watts per channel, 20–25,000

CHOSEN BY Popular Science
AS THE BEST THAT
MONEY CAN BUY
(WITHOUT FRILLS)

This photo and caption (the price is an approximation) appeared in the September 1963 POPULAR SCIENCE as part of an article entitled "The Low-Down on Hi-Fi Stereo." It is a picture



of those high fidelity components which, according to a panel of experts, provide the best sound possible today.

The panel carefully considered return-for-the-money, but "where there was a more expensive component that produced a detectable improvement in sound, it was chosen."

These components are recognizable to hi-fi enthusiasts as the AR two-speed turntable, the Dynakit PAS-2 preamplifier, the Dynakit Stereo 70 dual power amplifier, and the AR-3 loudspeakers.*

*They have been on demonstration as a system for several years at the AR Music Rooms, on the west balcony of Grand Central Terminal in New York City, and at 52 Brattle St., Cambridge, Mass. No sales are made there; you may ask questions if you like, but most people just come and listen.

ACOUSTIC RESEARCH, INC.
24 Thorndike St., Cambridge, Mass. 02141

Please send me literature on Dynakit and AR high fidelity components. RE

NAME _____
 ADDRESS _____

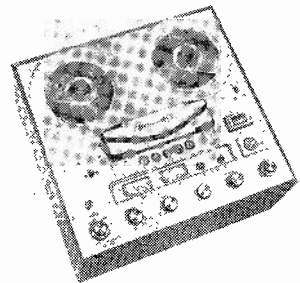

cycles response for record/playback at 7½ ips.—**Viking of Minneapolis, Inc.**, 9600 Aldrich Ave. So., Minneapolis, Minn. 55420.

4-TRACK STERECORDER, model 200. 2 mounted speakers in lid of carrying case for speaker separation up to 15 feet. 2 VU meters, separate record buttons, 4-track mono or sound-

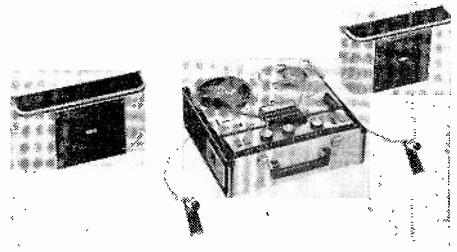

on-sound recordings, 2 speeds, digital tape counter. Power requirements: 70 watts, 110-117 volts ac, 60 cycles. Frequency response: 50-14,000 cycles at 7½ ips. Signal-to-noise ratio: 45 db. Inputs: 2 mike and 2 high level. 29 lb.—**Superscope Inc.**, 8150 Vineland Ave., Sun Valley, Calif.

ALL-BAND NUVISTOR PREAMP, 6 through 160 meters. Noise figures 1.5 to 3.4 db depending upon band. Gain exceeds 20 db. Panel contains

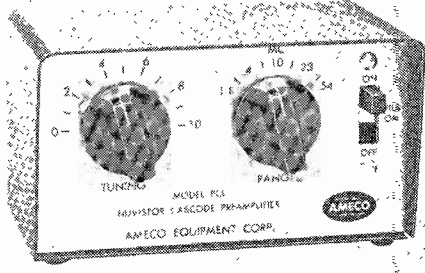

bandswitch, tuning capacitor and 3-position switch. Power requirements: 120 volts at 7 ma and 6.3 volts at 0.27 amp.—**Ameco Equipment Corp.**, 178 Herricks Rd., Mineola, N. Y.

FM TUNER-AMPLIFIER, model 3102 for professional offices, markets, schools, office buildings and other places for background music from FM programs or phonograph records. Use any number of paging microphones. Remote switching

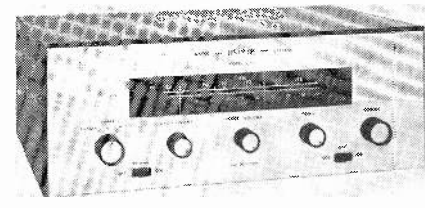

mutes music when mikes used. Amplifier output 15 watts at less than 2% distortion. Response flat 50-20,000 cycles. Output 4, 8, 16 ohms; 25- and 70-volt lines. Separate tuner, mike volume controls.—**Truetone Electronics Inc.**, 14660 Raymer St., Van Nuys, Calif.

TRANSISTOR AUTOMATIC FM MULTIPLEX TUNER, model 4312. Silver-plated, nuvistorized front end. Wide-band i.f. and detector stages. Usable sensitivity 1.9 µv (IHF); signal-to-noise ratio 65 db; harmonic distortion 0.5%, drift .02%; frequency response 20-20,000 cycles ±1 db. Capture ratio 2.0, selectivity over 35 db, spurious response rejection 85 db, audio hum (db below 1 volt) 66; AM suppression 60 db; separa-

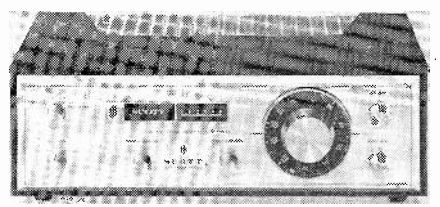

tion over 30 db.—**H. H. Scott Inc.**, Dept. P, 111 Powdermill Rd., Maynard, Mass.

PANEL METERS, No. 740 (round) and **793M** (square). Anti-static-treated distortion-free

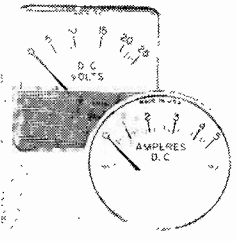

fronts. Milliammeter, ammeter or voltmeter ranges.—**Hoyt Electrical Instrument Works Inc.**, 42 Carleton St., Cambridge 42, Mass.

30,000-OHMS-PER-VOLT MULTITESTER, model TE-60. 33-µa 4-in. meter with 2-color calibrations. Sensitivity 30,000 ohms per volts dc and 15,000 ohms per volt ac. 1% precision resistors

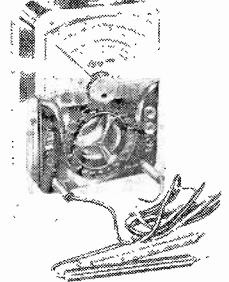

used for all multipliers. Full-scale ranges: dc volts: 0-0.25, 1, 2.5, 10, 25, 100, 250, 500, 1,000; ac volts: 0-2.5, 10, 25, 100, 250, 500, 1,000; direct current: 0-.05, 5, 50, 500 ma, 0-12 amps; resistance: 60,000 ohms; 6 and 60 megohms; decibels: -20 to +56. 2 lbs.—**Lafayette Radio Electronics Corp.**, 111 Jericho Turnpike, Syosset, N. Y.

FLASHLIGHT WITH CONTINUITY TESTER, No. 308CT. Plug, clips and insulated leads for checking wiring, circuits, fuses, grounds, shorts,

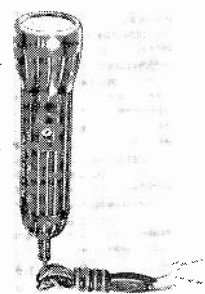

opens, controls, switches and relays for appliances, radio, TV, tubes, lamps and bulbs.—**Union Carbide Corp.**, 270 Park Ave., New York, N. Y.

CATHODE REJUVENATION TESTER, model 445. Tests and rejuvenates all picture tubes

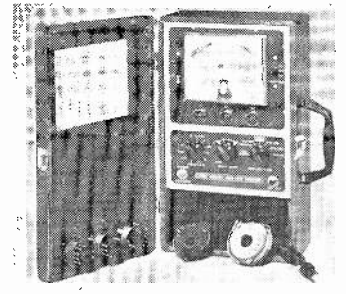

at correct filament voltage from 1 to 12, all Hi G-2 and Lo G-2 picture tubes, including tubes that require 30 volts, 110° tubes and 19- and 23-in. tubes, also color.—**B&K Manufacturing Co.**, 1801 W. Belle Plaine Ave., Chicago, Ill.

TEST OSCILLATORS. Metered outputs calibrated in either volts or dbm. *Model 208A:* monitor meter and output attenuator; 5- μ v to 2.5-volt signals into 600 ohms. *Model 208A-DB:* meter and

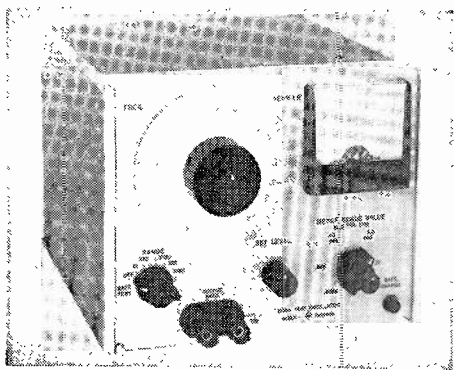

attenuator calibrated in dbm, attenuator variable from 0 to 10 db in 1-db steps. Both oscillators' frequency range 5 cycles to 560 kc; frequency stability usually better than 5 parts in 10⁶; hum and noise less than .05% at maximum output; distortion less than 1%.—**Hewlett-Packard Co.**, 1501 Page Mill Rd., Palo Alto, Calif.

DIPPED TUBULAR CAPACITORS, type DPMH. Exceeds environmental requirements of MIL-C-14157. Operating temperature range 55 to 125°C, with no derating. Aluminum electrodes



separated by Kraft-polyester-film dual dielectric. Sizes from 0.340 x 0.690 to 0.900 x 1.56 in. Capacitance range .001 to 0.47 μ f at 200 to 600 vdc. Radial leads for printed boards and point-to-point wiring.—**Cornell-Dubilier Electronics Div.**, 50 Paris St., Newark 1, N. J.

ULTRAMINIATURE CAPACITORS. Sample kit *USK-63:* four UY02's, two UY03's and two UY05's, with capacitance ranges between

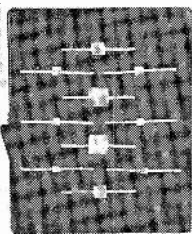

5 and 2,000 pf. Glass encapsulated, ceramic-fixed.—**JFD Electronics Corp.**, 15 Ave. at 62 St., Brooklyn 19, N. Y.

FLYBACKS. Exact replacements for recent Westinghouse TV's. *Part No. HO-368,* exact replacement for 21 chassis and 90 models; *Part No.*

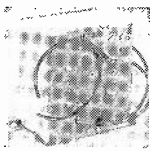

HO-369. 14 chassis and 73 models; *Part No. HO-370,* for 4 chassis and 28 models.—**Stancor Electronics Inc.**, 3501 Addison St., Chicago, Ill.

UNIVERSAL 2-WATT WIREWOUND CONTROL. *Model U39* shaftless potentiometer with contact arm grounded to housing. Fiber adapter plate furnished with each control. Resistance values from 5 to 5,000 ohms. Use as potentiometer or

DOUBLE BONUS SALE

FREE \$25.00 BONUS #1 WORTH OF
FREE \$1.00 BONUS #2 PLUS
CHOOSE ANY \$1.00 ITEM LISTED BELOW FREE
 Add 25¢ for handling

BOTH BONUS #1 AND #2 FREE WITH ANY \$10.00 ORDER

- FACTORY TESTED SEMI-KON-DUCTORS**
- 3 ONE WATT ZENERS, 6v. gold, axial leads ...\$1
 - 'TEXAS' 20W, TO5 CASE TRANSOR, 2N1039 \$1
 - 20 TOP HAT RECTIFIERS, 750 mil, untested ...\$1
 - 10-WATT ZENER REGULATOR, silicon, stud ...\$1
 - 2-2-amp SCR SILICON CONTR. RECT., untested \$1
 - 4 2N219 TRANSISTORS, mixer-convt. TO22 ...\$1
 - 5 2N155 TYPE POWER TRANSISTORS, TO3 case \$1
 - 10 PHILCO 30-MC TRANSISTORS, TO1, npn ...\$1
 - 4 TEXAS INSTR. SILICON TRANSISTORS, npn, TO22 \$1
 - 4 CK721 TRANSISTORS in new aluminum case, npn ...\$1
 - 3 SILICON NPN 2N333, TO5 TRANSISTORS ...\$1
 - 4 SUBMINIATURE 2N131 TRANSISTORS, rf-if, npn \$1
 - 25 "EPOXY" SILICON DIODES, untested ...\$1
 - 10 SWITCHING TRANSISTORS, npn, 2N440 equals ...\$1
 - 2 CBS 35W PWR TRANSISTORS, 2N1434, npn, stud \$1
 - 10 FAMOUS CK722 TRANSISTORS, npn ...\$1
 - 15 PNP TRANSISTORS, asst. types and cases ...\$1
 - 15 PNP TRANSISTORS, asst. types and cases ...\$1
 - 5 100-mc 5B-100 TYPE TRANSISTORS, TO1 case \$1
 - 15 CBS GERMANIUM DIODES, IN34 equals ...\$1
 - 2-2N341 NPN SILICON TRANSISTORS, 1 watt ...\$1
 - 3 CBS 20-WATT TRANSISTORS, npn, stud. 2N1320 \$1
 - 3 CBS 20-WATT TRANSISTORS, npn, stud. 2N1321 \$1

— KIT OF THE MONTH — 25 FOR
25 Transistors \$1
 INCLUDES PNP-NPN TO5 CASE—NEVER BEFORE

— BACK BY POPULAR DEMAND —
3-TRANSISTOR AUDIO AMPLIFIER, Subminiature 1.98
 • PRINTED CIRCUIT • WIRED
 • Incl. Transistors • For P.A. etc.

- WORLD'S MOST POPULAR \$1 PARTS PAKS**
- 10 "MICRO" SNAP SWITCHES, 115 vac, 15 amp ...\$1
 - 4 TIME DELAYS, 1.2 microsecond, encapsulated ...\$1
 - 6 MAGNET CORE TRANSISTOR "LOGIC" transistors \$1
 - RADIATION DETECTOR TUBE #5980, geiger c'ntr \$1
 - 30 PRECISION RESISTORS, 1/2, 1, 2W, 1% ...\$1
 - 5 TANTALUM ELECTROLYTICS, only 1/4x1/4" sizes \$1
 - 25 "CORNING" LOW NOISE RESIST'S, 1/2, 1, 2W \$1
 - 300-FT. HOOKUP WIRE, asst. colors, sizes ...\$1
 - 50 ALLEN BRADLEY 1-WATT's, resistors, 5% too \$1
 - 60 TUBULAR CONDENSERS, to .5mf to 1KV ...\$1
 - 40 DISC CONDENSERS, 27mf to .05mf to 1KV \$1
 - 60 TUBE SOCKETS, receptacles, audio, etc. ...\$1
 - 10 PANEL SWITCHES, rotary-micro-slide-power \$1
 - 10 TRANSISTOR SOCKETS, for npn-npn transistors \$1
 - 30 POWER RESISTORS, to 50W, to 24 Kohms \$1
 - 50 MICA CAPACITORS to .01mf, silvers too ...\$1
 - 10 VOLUME CONTROLS, to 1 meg, switch too ...\$1
 - 50 RADIO & TV KNOBS, asst. colors, styles ...\$1
 - 10 TRANSISTOR ELECTROLYTICS, 10 to 100 mf \$1
 - \$25 RADIO-TV SURPRISE, wide variety ...\$1
 - 50 COILS & CHOKES, rf-if, osc-peaking-etc. ...\$1
 - 35 ALLEN BRADLEY TWO WATTERS, 5% too ...\$1
 - 100 ASST. HALF WATT RESISTORS, 5% too ...\$1
 - 60 HI-Q RESISTORS, 1/2, 1, 2W to 1 meg, 5% too \$1
 - 10 PHONO PLUG-IN JACK SETS, tuners-amps ...\$1
 - 50 TERMINAL STRIPS, asst. 1-to-10 lug types ...\$1
 - 60 CERAMIC CONDENSERS, discs, npo's to .05mf \$1
 - 4 TRANSISTOR TRANSFORMERS, worth \$25 ...\$1
 - 40 WORLD'S SMALLEST RESIST., 5% too, 1/10W \$1
 - 40 SUBMINIATURE COND., to .05mf, ceram too \$1
 - 100 PARTS SURPRISE, worth \$25, p. ckt too ...\$1
 - INFRA-RED PHOTO DETECTOR TRANSDUCER ...\$1
 - INFRA-RED PARABOLIC REFLECTOR & FILTER \$1
 - 3 "TINY" V. CONTROLS, w/switch, 2K, to 1 meg \$1

TRANSITRON SCR'S

SILICON CONTROLLED BRAND NEW RECTIFIERS

PRV	5 Amp	10 Amp	25 Amp
50	1.00	1.50	2.50
100	1.50	1.95	2.95
150	1.79	2.25	3.45
200	1.95	2.75	3.75
250	2.25	2.95	3.75
300	2.69	3.19	3.75
350	2.95	3.50	—
400	—	3.95	4.25

- 5 SUN BATTERIES TO 1 1/2" sizes, lite sensitive \$1
- 25 AMP SWITCHING TRANSISTOR, TO3 case ...\$1
- 30 "KLIP IN" DIODES, like IN82 of CBS ...\$1
- 25 SEMI-KON-DUCTORS: transistors, diodes, rect. ...\$1
- 40-WATT TRANSISTORS, 2N174 type, TO36 ...\$1
- 2-15 AMP 100PIV AXIAL LEAD RECTIFIERS ...\$1
- 5 GENERAL ELECTRIC 2N107 PNP TRANSISTORS \$1
- 4 GENERAL ELECTRIC 2N170 RF NPN TRANSISTORS \$1
- 15 UPRIGHT SILICON SUN CELL 3/8x1 1/2 \$1
- HOFFMAN SATELLITE SILICON SUN CELL \$40 ...\$1
- 2 "MESA" 4-WATT TRANSISTORS, npn, silicon, TO5 \$1
- 4 2N35 NPN TRANSISTORS, TO22 ...\$1
- 6 TRANSISTOR RADIO SET, osc-if's-driver-p.p. ...\$1
- 2-25-AMP SILICON STUD RECTIFIERS ...\$1
- 40-WATT POWER TRANSISTORS, threaded case \$1
- 2 500MC 'MESA' TRANSISTORS, npn, TO18 case \$1
- 1 20-AMP SILICON CONTROLLED RECTIFIER ...\$1
- 1 85 WATT SILICON PWR TRANSR, npn, 2N1212 \$1
- 10 2-AMP SILICON POWER RECTIFIERS, stud ...\$1
- 2 TRANSITRON 1N429 ZENER REFERENCE ...\$1
- 1-150 WATT TRANSR 2N1046, npn, TO3 case \$1
- 1 3-AMP 1500PIV SILICON STUD RECTIFIER ...\$1
- 3 2N255 POWER TRANSISTOR EQUALS, TO3 case \$1
- 4 2N43 OUTPUT TRANSISTOR EQUALS, TO5 case \$1
- 2 150-MC. MESA TRANSISTORS, 2N703, npn ...\$1

TRANSISTORIZED PHOTO CELL RELAY

• 2 TRANSISTORS • WIRED • PRINTED CIRCUIT • ALARMS, ETC. **1.98**

10¢ FOR OUR "SPRING" BARGAIN CATALOG ON:
 Semiconductors Poly Paks Parts

POLY PAKS

TERMS: send check, money order, include postage, wt. per pak 1 lb. Rated, net 30 days. CODs 25%

P.O. BOX 942R
 SO. LYNNFIELD, MASS.
 "PAK-KING" OF THE WORLD

WANT BACK ISSUES?

Back numbers of most issues of RADIO-ELECTRONICS are available upon request:
 This year's issues 50¢
 Last year's issues 55¢
 Previous year 60¢, etc.
 Maximum\$1.00

RADIO-ELECTRONICS
 154 WEST 14TH STREET, NEW YORK, N.Y. 10011

FREE Catalog
 OF THE WORLD'S FINEST ELECTRONIC GOV'T SURPLUS BARGAINS

HUNDREDS OF TOP QUALITY ITEMS — Receivers, Transmitters, Microphones, Inverters, Power Supplies, Meters, Phones, Antennas, Indicators, Filters, Transformers, Amplifiers, Headsets, Converters, Control Boxes, Dynamometers, Test Equipment, Motors, Blowers, Cable, Keys, Chokes, Handsets, Switches, etc., etc. Send for Free Catalog—Dept. RE.

FAIR RADIO SALES
 2133 ELIDA RD. • Box 1105 • LIMA, OHIO



Olson

FREE

Fill in coupon for a FREE One Year Subscription to OLSON ELECTRONICS Fantastic Bargain Packed Catalog—Unheard of LOW, LOW, DISCOUNT PRICES on Brand Name Speakers, Changers, Tubes, Tools, Stereo Amps, Tuners, CB, Hi-Fi's, and thousands of other Electronic Bargains. Credit plan available.

NAME _____
 ADDRESS _____
 CITY _____ ZONE _____ STATE _____

If you have a friend interested in electronics send his name and address for a FREE subscription also.

OLSON ELECTRONICS, INC.
 744 Forge Street, Akron, Ohio 44308

Beware
 OF
CHEAP
IMITATIONS

INSIST ON
"NO NOISE"

- **VOLUME CONTROL** and Contact Restorer
- **TUNER-TONIC** for ALL tuners including wafer type
- **FORMULA EC-44** for ALL electrical contacts

FREE with ALL No-Noise Products
 5" Plastic Extender Push-button Assembly for pin-point applications. Does not cause shorts!

14 Years of Recognized Leadership

ELECTRONIC CHEMICAL CORP.
 813 Communipaw Ave., Jersey City 4, N. J.

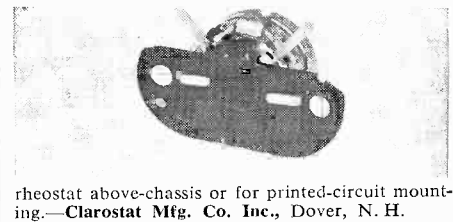

rheostat above-chassis or for printed-circuit mounting.—**Clarostat Mfg. Co. Inc.**, Dover, N. H.

OPEN RELAY FOR MECHANICAL ACTUATION of control circuits in electromechanical devices. Nylon lifter; longer actuation arm can be supplied. 6 to 220 vac; 6 to 119 vdc. Coils operate

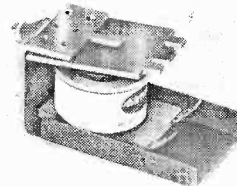

continuously at 10% above or 15% below rated voltage. Standard units for 10 and 15 amp.—**Artisan Electronics Corp.**, 171 Ridgedale Ave., Morristown, N. J.

CHARGE-RETAINING BATTERIES. Low standing loss. Linear, relatively flat voltage on discharge. Voltage practically linear between 2.12



and 1.95. Retains electrical characteristics during repetitive cycles.—**Electric Storage Battery Co.**, Wisco Div., 1222 18 St., Racine, Wis.

HAND CRIMP TOOL, model 816 for interchangeable crimping heads for solderless commercial terminals and connectors or MS-3190 type

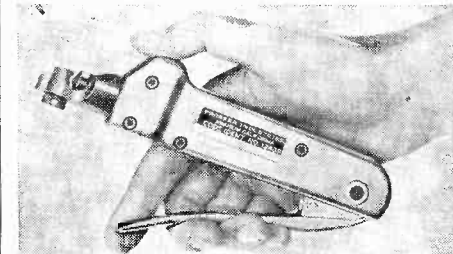

contacts. 2 heads for wire sizes 16 through 26. Ratchet mechanism will not release connector until crimp cycle complete.—**Prosser Industries Inc.**, 900 E. Ball Rd., Anaheim, Calif.

All specifications from manufacturers data.

Silicon Rectifier Standards

Late in 1963, the National Electrical Manufacturers Association (NEMA) published the first comprehensive standards for silicon rectifier diodes and stacks.

The standards are intended to clear up confusion in manufacturing and specifying diodes because of wide variations in testing and rating methods. The 65-page standards book (known officially as *NEMA-EIA Standards for Silicon Rectifier Diodes and Stacks*) sells for \$5 a copy from NEMA, 155 E. 44 St., New York 10017.

The book contains standardized definitions, terminology, symbology, rating methods, physical configurations, as well as extensive supplementary material on military specifications.

ZIP stands for the Post Office Department's new Zoning Improvement Plan. When renewing your **RADIO-ELECTRONICS** subscription, or sending us a change of address, please let us know what your ZIP Code is. We'll add it to your address mailing plate... and you'll get speedier delivery service from the Post Office. By the way, when writing to us, address: **RADIO-ELECTRONICS**, 154 West 14th St., New York, N. Y. 10011.

ELECTRONICS

Engineering-Technicians

Bachelor of Science Degree, 30 Months
 Save Two Years' Time

Radio-Television Plus Color Technician (12 Months)
 Electronics Engineering Technology (15 Months)
 Electronics Engineering (B.S. Degree)

Electrical Engineering (B.S. Degree)
 Mechanical Engineering (B.S. Degree)
 Civil Engineering (B.S. Degree)
 Architecture (B.S. Degree) (36 Months)

Approved for Veterans
DAY AND EVENING CLASSES

Write for Catalog and Registration Application. New Term Starting Soon.

Your Name

Address

City

State

HEALD'S
ENGINEERING COLLEGE
 Est. 1863—100 Years
 Van Ness at Post, RE
 San Francisco, Calif.

technicians' News

Five Named to Calif. Radio-TV Repair Agency

Sacramento, Calif.—California Gov. Edmund Brown has named five members to serve 4-year terms on a new board aimed at curbing abuses in TV and radio repair.

The men are Keith V. Anderson, president of Handy Andy TV & Appliances; Earl C. Loughboro, Ventura; Mrs. Ruben E. Jimenez, Manhattan Beach; Miles J. Rubin, Los Angeles, and Thomas Schneider, Berkeley.

The new bureau was created in connection with the state licensing law, which requires registration of all persons engaged in electronic repair, and prohibits fraudulent repair and advertising practices.

Small-Business Subcommittee Hears TV Technicians' Story

Service technicians, reported Frank Moch, executive director of the National Alliance of Television & Electronic Service Associations (NATESA), follow a traditional formula in charging for services rendered. Approximately 60% of the total bill for a house call is for labor, 40% for service. Speaking before the distribution subcommittee of the House Select Committee on Small Business (Rep. James Roosevelt, chairman), Moch declared that there is a "gross fallacy" in this formula, and pointed out that legitimate markups on parts used, as is normal practice in other service trades, are "absolutely essential to survival of the servicer."

Moch quoted the Government's own statistic that TV-radio service people average less than \$90 for a week that often runs as much as 86 hours.

The cause of this "continuing strangling of the very essential radio-TV service industry," Moch said, is rooted in the practice of certain wholesalers of selling at wholesale prices to the general public, thus putting themselves in competition with retail dealers and servicers. He quoted from two letters he received from the Federal Trade Commission and the Justice Department in answer to queries made "so we might know where we stand." The FTC cited two cases in

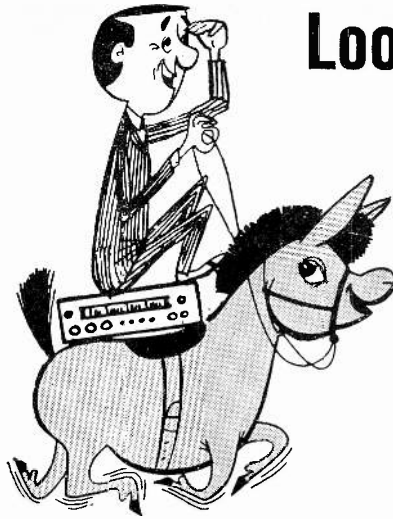

Looking for new ways to ride your electronic hobby horse?

Get these great electronic "fun books" from Gernsback Library. They'll show you new construction methods and techniques, give you latest circuit facts and boost your hobby enjoyment.



Fun with Radio-Controlled Models, by Edward L. Safford, Jr. Simple projects for the beginner. Covers steering, motor and engine control, relays, escape-ments, installation. No. 106 \$3.20



Fun with Electricity, by Thomas Kennedy, Jr. From a spool-and-magnet motor to more complex voltmeters. Great way to start a youngster—or beginner of any age! No. 83 \$2.65

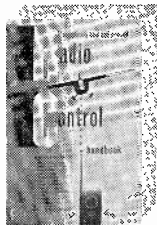

Radio-Control Handbook (revised edition), by H. G. McEntee. The standard handbook in this field—now with new info on servos, actuators, receivers, transmitters for remote control. No. 93 \$4.95



Model Radio-Control, by E. L. Safford, Jr. Completely new and enlarged book explains theory and gives construction details for plane, auto, boat, remote controls. No. 74 \$2.65



Radio-Control Manual, by E. L. Safford, Jr. Step-by-step guide to the ultimate in R/C systems. How to start with basic system, advance to multi-channel system by adding components. No. 91 \$3.20



Electronic Puzzles and Games, by Mathew Mandl. Build fascinating electronic games with the simplest tools. Easy-to-follow step-by-step instructions with photos and diagrams. No. 70 \$1.95

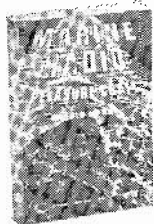

Marine Radio for Pleasure Craft, by Harold McKay. Covers theory, operation, maintenance of marine radio—plus info on radar, depth, direction finders. Station list; FCC regulations. No. 84 \$2.95



Electronic Hobbyists' Handbook, by Rufus P. Turner. Scores of tested, debugged circuits for garage-door openers, amplifiers, oscillators, power supplies, controls, etc. No. 69 \$2.50

Order from your electronic parts store—or clip handy coupon below and mail to us with your remittance.

GERNSBACK LIBRARY, INC.

154 West 14th Street, New York, N.Y. 10011

Gentlemen:

I enclose \$..... Please send me the books checked. I understand I may return them within 10 days if not fully satisfied.

Name.....

Address.....

City.....Zone.....State.....

RE2
 106 83
 93 74
 91 70
 84 69

REMITTANCE MUST ACCOMPANY ORDER



FREE

send today
for your

1964 **ALLIED** CATALOG

save most on:

- Stereo Hi-Fi
- Famous Knight-Kits®
- Tape Recording
- Phonographs
- CB Radio
- Amateur Gear
- P.A. Systems
- Test Instruments
- Electronic Parts, Tubes, Transistors, Tools, Books

444 Value-Packed Pages. World's largest selection of top money-saving buys, including exclusive products available only from ALLIED. Get fastest service, easy-pay terms, satisfaction guaranteed or your money back. Send coupon today for FREE 1964 Catalog.

Use the Allied Credit Fund Plan

ALLIED RADIO



ALLIED RADIO, Dept. 2-B
100 N. Western Ave., Chicago 80, Ill.

Send FREE 1964 ALLIED Catalog

Name _____
PLEASE PRINT

Address _____

City _____ Zone _____ State _____

which a wholesaler was defined as "one who sells to the trade for resale." Yet in a later communication, Moch pointed out, the FTC claimed that a wholesaler, selling direct to consumers at prices that his dealers cannot meet, "is simply making use of his lawful competitive advantage."

The result of such deals, Moch declared, is to make the servicer look like "a real crook when he asks for suggested list prices."

In closing, Moch said, "the proven successful system of specialization which made of this nation a merchandising marvel, cannot be sold down the river to the advantage of a few people with the buying power of many small businessmen."

Manufacturers Move To Curb CATV

The *Hoosier Test Probe*, organ of the Indiana Electronic Service Association, reports a vigorous "common effort against the uncontrolled growth of community antenna systems throughout the country" being made by 12 leading antenna and accessories manufacturers. The organization formed for the purpose is called TAME: Television Accessory Manufacturers Institute. (The *E* is there apparently just to make a word out of the abbreviation.)

TAME is alarmed by the "great

number [of cable TV systems] which are emerging in areas where good TV reception has been attainable for years with a properly designed TV antenna installation."

Conceived by Morton Leslie of JFD, George Gemberling of Alliance, Sam Schlüssel of Channel Master, L. H. Finneburgh of the Finney Co. and Robert Fleming of Winegard, TAME will be a permanent organization with representation in Washington.

The group will try to air its side of the argument over cable systems versus private antennas. It intends to conduct public relations and educational campaigns "in all areas where cable systems are proposed and in operation." END

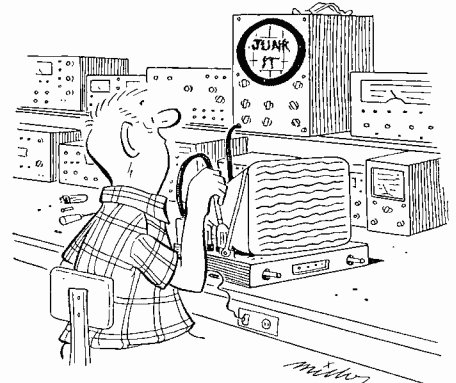

MARSHAL SALE

or even a Sheriff Sale can't beat or equal our prices---HOW DO WE DO IT? Our TREMENDOUS BUYING POWER & PURCHASING EXPERIENCE make it possible. We invest Thousands of Dollars (in just a single item) to create a GOOD DOLLAR BUY . . . resulting in the AMAZING and EXCITING OFFERS that follow:

10% OFF & FREE GIFTS ON ORDERS OF \$10 OR OVER (ON DOLLAR BUYS)

- \$15.00 RADIO PARTS "JACKPOT" handy assortment \$1
- 3-ASST. SIZES RADIO CHASSIS PANS drilled & plated \$1
- 3-VARIABLE CONDENSERS asst. popular super-het types \$1
- 50-RADIO & TV SOCKETS all type 7 pin, 8 pin, 9 pin \$1
- 50-ASST. RADIO KNOBS all selected popular types \$1
- 3-1/2 MEG VOLUME CONTROLS with switch, 3" shaft \$1
- UNIVERSAL 4" PM SPEAKER Alnico 5 magnet, quality tone \$1
- UNIVERSAL 5" PM SPEAKER Alnico 5 magnet, quality tone \$1
- 3 - SPEAKER CABINETS for 2 1/2" to 3" speaker, all purpose \$1
- UNIVERSAL 3" PM SPEAKER for Cabinet above (or others) \$1
- 2-UNIVERSAL 2" PM SPEAKERS for Trans Radios, Intercom \$1
- 10-SPEAKER PLUG SETS deluxe type, 2 conductor, wired \$1
- 3 - AUDIO OUTPUT TRANSFORMERS 50G1 type \$1
- 3 - AUDIO OUTPUT TRANSFORMERS 6R6, 6V6 \$1
- 3-AUDIO OUTPUT TRANSFORMERS 3V4, 3Q4, 384 \$1
- 4 - I.F. COIL TRANSFORMERS 456kc, most popular type \$1
- 3 - I.F. COIL TRANSFORMERS 262kc, for Auto Radios \$1
- 3 - I.F. COIL TRANSFORMERS 10.7mc for FM \$1
- 15 - RADIO OSCILLATOR COILS standard 456kc \$1

- 100 - ASSORTED 1/2 WATT RESISTORS some in 5% \$1
- 70 - ASSORTED 1 WATT RESISTORS some in 5% \$1
- 35 - ASSORTED 2 WATT RESISTORS some in 5% \$1
- 50-PRECISION RESISTORS asst. list price \$50 less 98% \$1
- 20 - ASS'TED WIREWOUND RESISTORS, 5, 10, 20 watt \$1
- 50 - ASST. DISC. CERAMIC CONDENSERS popular numbers \$1
- 50 - ASST. CERAMIC CONDENSERS some in 5% \$1
- 50-ASST. MICA CONDENSERS some in 5% \$1
- 50 - ASST. TUBULAR CONDENSERS. 001 to .47 to 600v \$1
- 20 - STANDARD CONDENSERS .047-600v 85° top quality \$1
- 10 - ASST. RADIO ELECTROLYTIC CONDENSERS \$1
- 5 - ASST. TV ELECTROLYTIC CONDENSERS \$1
- 3 - ELECTROLYTIC CONDENSERS 50/30-150v \$1
- 2 - ELECTROLYTIC CONDENSERS 40/40mf-400 volts \$1
- 10 - ASSORTED VOLUME CONTROLS less switch \$1
- 5-ASSORTED VOLUME CONTROLS with switch \$1
- 5 - 50K VOLUME CONTROLS less switch \$1
- 5 - 1/2 MEG VOLUME CONTROLS less switch \$1
- 5-ASST. 4 WATT WIREWOUND CONTROLS \$1

- \$15.00 TELEVISION PARTS "JACKPOT" best buy ever \$1
- 6-TV ALIGNMENT TOOLS most useful assortment \$1
- 70° FLYBACK TRANSFORMER universal incl schematic diagram \$1
- 70° TV DEFLECTION YOKE wired network, incl schematic \$1
- 90° FLYBACK TRANSFORMER universal incl schematic diagram \$1
- 90° TV DEFLECTION YOKE wired network, incl schematic \$1
- TV VERTICAL OUTPUT TRANSFORMER popular 10 to 1 type \$1
- TV VERTICAL BLCKG. TRANSFORMER for 630TV & others \$1
- 20 - ASSORTED TV KNOBS ESCUTCHEONS etc. \$20 value \$1
- 20-ASSORTED TV COILS I.F. video, sound, ratio, etc. \$1
- 20 - ASSORTED GRID CAPS for 1B3, 1X2, 6BG6, 6BQ6, etc. \$1
- 4-ASST. TV ION TRAPS for all type TV Receivers \$1
- 4-TV CENTERING RINGS \$1
- 2 - RATIO DETECTOR COILS 10.7mc \$1
- 2 - SOUND DISCRIM. COILS 10.7mc \$1
- 3 - TV CARTWHEEL CONDENSERS 20kv-500 nmf \$1
- 2 - TV CARTWHEEL CONDENSERS 30 kv-500 nmf \$1
- 3 - HV RECTIFIER SOCKETS for 1B3, mounted \$1
- 3 - HV RECTIFIER SOCKETS for 1X2, mounted \$1

MARKET SCOOP COLUMN

- TRANSISTOR RADIO KIT set of parts (less transistors) \$1
- \$17.50 WEBSTER DIAMOND CARTRIDGE =SC2-D Stereo \$1
- 4-IBM COMPUTER SECTIONS loaded with valuable parts \$1
- WESTERN ELECTRIC Piece of Equipment with valuable parts \$1
- 2-PRINTED CIRCUIT BOARDS Parts over 100-count guaranteed \$1
- HEARING AID AMPLIFIER incl. 3 Tubes, Mike, etc. (as is) \$1
- 50-G.E. FLASHLIGHT BULBS ±PR-9, 2.7 volts \$1
- 50-RCA PHONO PLUGS Standard for phonos, male \$1
- 10-SYLVANIA 1U4 TUBES brand new Jan. individual cartons also serves as 1U4 \$1
- 2-TUNGSOIL 5U4 TUBES \$1
- 10-ASSORTED TUBES Radio, Television and Industrial \$1
- 3-TOP BRAND 35W4 TUBES \$1
- 5-SYLVANIA 6AK4 TUBES \$1
- 10-SYLVANIA 2C4 TUBES \$1
- 10-TOGGLE SWITCHES SPST deluxe U.L. approved, 101 uses \$1
- G. E. EQUIPMENT SECTION with sockets, condensers, etc. \$1
- CHAPT ZU DI MITZIA "JACKPOT" double your money back if not completely satisfied \$1

BROOKS RADIO & TV CORP., 84 Vesey St., Dept. A, New York 7, N. Y. TELEPHONE ORlandt 7-2359

New Semiconductors and Tubes

New hi-frequency power transistor

A new "overlay" transistor for uhf space communications is producing as much as 5 watts of rf at 500 mc, according to RCA, maker of the new device.

The heart of this transistor is a tiny checkerboard structure, far smaller than the head of a pin. It consists of a mosaic made up of 156 individual high-frequency transistors, microscopic in size. These units are integrated by a new overlay structure and applied on a sili-

con wafer by a photo-etch process.

The device, branded TA-2307, is

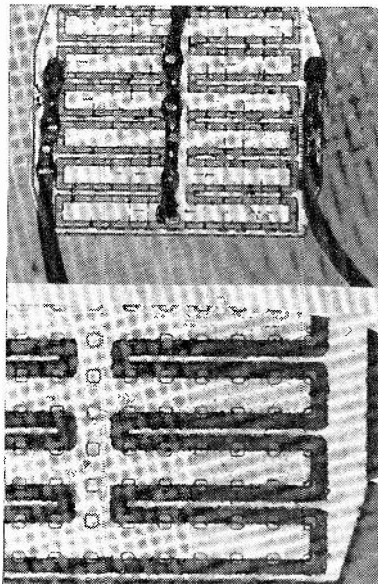
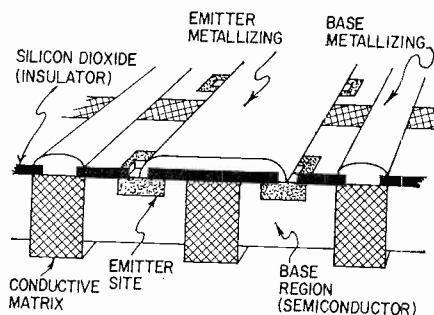

FIX ELECTRIC APPLIANCES

PAYS \$3 TO \$5 AN HOUR
Spare Time, Full Time • Learn at Home

FREE BOOK offered below shows how YOU can now have a good-paying business of your own, right in your home. No experience needed, just simple tools. Learn to repair Electric Appliances. Pays \$3-\$5 an hour!

400 MILLION Appliances are in American homes right now. 76 Million MORE bought each year. People need them fixed, good times or bad. YOU make good money doing it. In your basement, garage, even on your kitchen table.

Quick Way To Get Started For less than 20¢ a day our easy, pictured instruction—backed by 45 years of success in home training—prepares you for top earnings in this booming field. Earl Reid of Thompson, Ohio says: "Made \$510 in one month spare time. NRI course is priceless." At no extra charge you even get all parts for your own Appliance Tester, too. Finds trouble-spots, speeds and checks your work.

Get your **FREE Book** and **FREE Sample Lesson!** Mail coupon below, letter or postcard, now.

FREE BOOK • FREE LESSON

NATIONAL RADIO INSTITUTE, Appliance Division
Dept. FB4, Washington 16, D. C.

Send **Free Book, Free Appliance Repair Course Lesson.** Am interested in:

Spare Time Earnings My Own Business
 Better Job

Name
Address
City Zone State

Accredited Member—National Home Study Council

SHOP FOR THE
NEWEST AND THE LATEST
IN ELECTRONICS IN RADIO-ELECTRONICS
MARKET CENTER
ON PAGE 101

IMMEDIATE DELIVERY . . . SCIENTIFIC LIGHT PACKING for safe delivery at minimum cost. **HANDY WAY TO ORDER** — Pencil mark items & enclose with check or money order, add extra for shipping, excess refunded with advantage to customer. Tearsheet will be returned with order, as your packing slip.

- | | | | |
|-------------------------------------------------------------------------------------------------------------------------------------------------------------------------------------------------------------------------------------------------------------------------------------------------------------------------------------------------------------------------------------------------------------------------------------------------------------------------------------------------------------------------------------------------------------------------------------------------------------------------------------------------------------------------------------------------------------------------------------------------------------------------------------------------------------------------------------------------------------------------------------------------------------------------------------------------------------------------------------------------------------------------------------------------------------------------------------------------------------------------------------------------------------------------------------------------------------------------------------------------------------------------------------------------------------------------------------------------------------------------------------------------------------------------------------------------------------------------------------------------------------------------------------------------------------------------------------------------------------------------------------------------------------------------------------------------------------------------------------------------------------------------------------------------------------------------------------------------------------------------------------------------|----------------------------------------------------------------------------------------------------------------------------------------------------------------------------------------------------------------------------------------------------------------------------------------------------------------------------------------------------------------------------------------------------------------------------------------------------------------------------------------------------------------------------------------------------------------------------------------------------------------------------------------------------------------------------------------------------------------------------------------------------------------------------------------------------------------------------------------------------------------------------------------------------------------------------------------------------------------------------------------------------------------------------------------------------------------------------------------------------------------------------------------------------------------------------------------------------------------------------------------------------------------------------------------------------------------------------------------------------------------------------------------------------------------------------------------------------------------------------------------------------------------------------------------------------------------------------------------------------------------------------------------------------------------------------------------------------------------------------------------------------------------------------------------------------------|----------------------------------------------------------------------------------------------------------------------------------------------------------------------------------------------------------------------------------------------------------------------------------------------------------------------------------------------------------------------------------------------------------------------------------------------------------------------------------------------------------------------------------------------------------------------------------------------------------------------------------------------------------------------------------------------------------------------------------------------------------------------------------------------------------------------------------------------------------------------------------------------------------------------------------------------------------------------------------------------------------------------------------------------------------------------------------------------------------------------------------------------------------------------------------------------------------------------------------------------------------------------------------------------------------------------------------------------------------------------------------------------------------------------------------------------------------------------------------------------------------------------------------------------------------------------------------------------------------------------------------------------------------------------------------------------------------------------------------------------------------------------------------------------------------|--------------------------------------------------------------------------------------------------------------------------------------------------------------------------------------------------------------------------------------------------------------------------------------------------------------------------------------------------------------------------------------------------------------------------------------------------------------------------------------------------------------------------------------------------------------------------------------------------------------------------------------------------------------------------------------------------------------------------------------------------------------------------------------------------------------------------------------------------------------------------------------------------------------------------------------------------------------------------------------------------------------------------------------------------------------------------------------------------------------------------------------------------------------------------------------------------------------------------------------------------------------------------------------------------------------------------------------------------------------------------------------------------------------------------------------------------------------------------------------------------------------------------------------------------------------------------------------------------------------------------------------------------------------------------------------------------------------------------------------------------------------------------------------------------------------------------------------------------------------------------------------------------------------------------------------------------------|
| <ul style="list-style-type: none"> <input type="checkbox"/> 1—LB SPOOL ROSIN-CORE SOLDER 40/60 \$1 <input type="checkbox"/> 50—ASSORTED PRINTED CIRCUIT SOCKETS best types ... \$1 <input type="checkbox"/> 20 — INSTRUMENT POINTER KNOBS selected popular types ... \$1 <input type="checkbox"/> 25 — ASST. CLOCK RADIO KNOBS in colors \$1 <input type="checkbox"/> 50 — ASSORTED TERMINAL STRIPS 1, 2, 3, 4 lugs \$1 <input type="checkbox"/> 100' — FINEST NYLON DIAL CORD best size, .028 gauge .. \$1 <input type="checkbox"/> 20—ASST. PILOT LIGHTS #44, 46, 47, 51, etc. \$1 <input type="checkbox"/> 20 — PILOT LIGHT SOCKETS bayonet type, wired \$1 <input type="checkbox"/> 10 — SURE-GRIP ALLIGATOR CLIPS 2" plated \$1 <input type="checkbox"/> 10 — SETS PHONO PLUGS & PIN JACKS RCA type \$1 <input type="checkbox"/> 100 — ASST RUBBER & FELT FEET FOR CABINETS best sizes \$1 <input type="checkbox"/> 50—ASSORTED #3AG FUSES Popular assorted ampere ratings \$1 <input type="checkbox"/> 1000—ASST. HARDWARE KIT screws, nuts, wash'rs, rivets, etc. \$1 <input type="checkbox"/> 250—ASST. WOOD SCREWS finest popular selection \$1 <input type="checkbox"/> 250—ASST. SELF TAPPING SCREWS #6, #8, etc. \$1 <input type="checkbox"/> 150—ASST. 6/32 SCREWS and 150 6/32 HEX NUTS \$1 <input type="checkbox"/> 150—ASST. 8/32 SCREWS and 150—8/32 HEX NUTS .. \$1 <input type="checkbox"/> 150—6/32 HEX NUTS and 150—8/32 HEX NUTS .. \$1 <input type="checkbox"/> 500 — ASSORTED WASHERS most useful selected sizes \$1 <input type="checkbox"/> 500 — ASSORTED RIVETS most useful selected sizes \$1 | <ul style="list-style-type: none"> <input type="checkbox"/> 100—MIXED DEAL "JACKPOT" Condensers, Resistors, Surprises \$1 <input type="checkbox"/> 15—ASST. ROTARY SWITCHES all popular types \$20 value ... \$1 <input type="checkbox"/> 4—TOGGLE SWITCHES SPST, SPDT, DPST, DPDT ... \$1 <input type="checkbox"/> 10 — ASSORTED SLIDE SWITCHES SPST, DPDT, etc. ... \$1 <input type="checkbox"/> 100'—MINIATURE ZIP CORD 2 conductor, serves 101 uses .. \$1 <input type="checkbox"/> 10—6' ELECTRIC LINE CORDS with plug \$1 <input type="checkbox"/> 4 — 50' SPOOLS HOOK-UP WIRE 4 different colors \$1 <input type="checkbox"/> 50 — STRIPS ASSORTED SPAGHETTI handy sizes \$1 <input type="checkbox"/> 100 — ASSORTED RUBBER GROMMETS best sizes \$1 <input type="checkbox"/> 50' — INSULATED SHIELDED WIRE #20 braided metal jacket \$1 <input type="checkbox"/> 32'—TEST PROD WIRE deluxe quality, red or black .. \$1 <input type="checkbox"/> 200'—BUSS WIRE #20 tinned for hookups, special circuits, etc. \$1 <input type="checkbox"/> 250—ASST. SOLDERING LUGS best types and sizes \$1 <input type="checkbox"/> 50—FUSES #3AG, 1 AMP. \$1 <input type="checkbox"/> 50—FUSES #3AG, 5 AMP. \$1 <input type="checkbox"/> 4 — ITT TRANSISTOR 9-VOLT BATTERIES (as Eveready #216) \$1 <input type="checkbox"/> 30—BALL POINT PENS retractable, assorted colors ... \$1 <input type="checkbox"/> 8—ASST. LUCITE CASES hinged cover, handy for parts \$1 <input type="checkbox"/> EMERGENCY AUTO LAMP Red dome blinker, incl Battery saves lives on highway stops .. \$1 | <ul style="list-style-type: none"> <input type="checkbox"/> STANDARD TUNER UHF STRIPS \$1 26K, 34K, 43K, 46K, 48K, 51K, 54Q, 56F, K or Q, 58K each .. <input type="checkbox"/> 50—ASSORTED TV PEAKING COILS all popular types \$1 <input type="checkbox"/> 1—TV FOCALIZER adjustable for any ohmage \$1 <input type="checkbox"/> 1—INDOOR TV ANTENNA hi-gain, 3 section, tiltproof ... \$1 <input type="checkbox"/> 50'—HI-VOLTAGE WIRE for TV, special circuits, etc. .. \$1 <input type="checkbox"/> 100' — TWIN TV LEAD-IN WIRE 300 ohm, heavy duty .. \$1 <input type="checkbox"/> 50' — FLAT 4-CONDUCTOR WIRE many purposes \$1 <input type="checkbox"/> 5 — TV HI-VOLT ANODE LEADS 20" length \$1 <input type="checkbox"/> 10—TV PICTURE TUBE SOCKETS wired with 20" leads \$1 <input type="checkbox"/> 5—TV CHEATER CORDS with both plugs \$1 <input type="checkbox"/> 3—CONNECTORS #50-239 \$1 <input type="checkbox"/> 3—CONNECTORS #PL-259 \$1 <input type="checkbox"/> 100'—RG/59U CO-AX Standard 72 ohm type \$4 <input type="checkbox"/> 10—DIODE CRYSTALS 1N34 \$1 <input type="checkbox"/> 10—ASST. DIODE CRYSTALS 5-1N69 and 5-1N64 \$1 <input type="checkbox"/> 2—SILICON RECTIFIERS 750ma, 400 PIV \$1 <input type="checkbox"/> 3—SILICON RECTIFIERS Top Hat 500ma-400 PIV \$1 <input type="checkbox"/> 3—SELENIUM RECTIFIERS 2-65ma and 1-75ma \$1 <input type="checkbox"/> 2—SELENIUM RECTIFIERS 1-100 ma and 1-250 ma .. \$1 <input type="checkbox"/> 2—SELENIUM RECTIFIERS 1-65ma and 1-450ma \$1 | <ul style="list-style-type: none"> <input type="checkbox"/> 1—SQ. YARD GRILLE CLOTH \$1 most popular brown & gold design <input type="checkbox"/> 10—DUAL CONTROLS \$1 350-1 meg, long shaft, 101 uses <input type="checkbox"/> 30—GOOD-ALL CONDENSERS \$1 .19-600v (tests .25-1000v) ... <input type="checkbox"/> 8 — ASTRON ELECTROLYTIC CONDENSERS 8mfd-450v \$1 <input type="checkbox"/> 5—C D ELECTROLYTIC CONDENSERS 30/20-350v, 10-250v \$1 <input type="checkbox"/> 15—STANDARD ELECTROLYTIC CONDENSERS 2mfd - 450v .. \$1 <input type="checkbox"/> 200 — TUBULAR CONDENSERS 100-.002 and 100-.004 \$1 <input type="checkbox"/> 20 — ASST. DIODE CRYSTALS fine assortment. Latest types .. \$1 <input type="checkbox"/> \$20—SHURE M-7D DIAMOND NEEDLE exact replacement ... \$3 <input type="checkbox"/> 3 — \$2.50 SAPPHIRE NEEDLES guaranteed 5000 playings ... \$1 <input type="checkbox"/> 2—SAPPHIRE STYLUS NEEDLES for all type pickups \$1 <input type="checkbox"/> 5 — ASST. SELENIUM RECTIFIERS 65ma, 100ma, 300ma, etc. \$1 <input type="checkbox"/> 3—3" RECORDER TAPES Quality acetate, 150 feet \$1 <input type="checkbox"/> 12—3" RECORDER TAPE REELS \$1 <input type="checkbox"/> STANDARD CASCADE TUNER \$9 21mc, 3 3/4" shaft, complete with Tubes and schematic diagram .. <input type="checkbox"/> 5" MYLAR RECORDER TAPE \$1 600' <input type="checkbox"/> 6—5" RECORDER TAPE REELS \$1 <input type="checkbox"/> TELEPHONE JACK, PLUG & \$3 50" extension wire & instruct. <input type="checkbox"/> TOP BRAND 15" PM SPEAKER \$7 full range, 10 oz. ceramic <input type="checkbox"/> STANDARD 41mc TV TUNER \$9 Complete with Tubes, schematic for installation, long shaft |
|-------------------------------------------------------------------------------------------------------------------------------------------------------------------------------------------------------------------------------------------------------------------------------------------------------------------------------------------------------------------------------------------------------------------------------------------------------------------------------------------------------------------------------------------------------------------------------------------------------------------------------------------------------------------------------------------------------------------------------------------------------------------------------------------------------------------------------------------------------------------------------------------------------------------------------------------------------------------------------------------------------------------------------------------------------------------------------------------------------------------------------------------------------------------------------------------------------------------------------------------------------------------------------------------------------------------------------------------------------------------------------------------------------------------------------------------------------------------------------------------------------------------------------------------------------------------------------------------------------------------------------------------------------------------------------------------------------------------------------------------------------------------------------------------------------------------------------------------------------------------------------------------------|----------------------------------------------------------------------------------------------------------------------------------------------------------------------------------------------------------------------------------------------------------------------------------------------------------------------------------------------------------------------------------------------------------------------------------------------------------------------------------------------------------------------------------------------------------------------------------------------------------------------------------------------------------------------------------------------------------------------------------------------------------------------------------------------------------------------------------------------------------------------------------------------------------------------------------------------------------------------------------------------------------------------------------------------------------------------------------------------------------------------------------------------------------------------------------------------------------------------------------------------------------------------------------------------------------------------------------------------------------------------------------------------------------------------------------------------------------------------------------------------------------------------------------------------------------------------------------------------------------------------------------------------------------------------------------------------------------------------------------------------------------------------------------------------------------|----------------------------------------------------------------------------------------------------------------------------------------------------------------------------------------------------------------------------------------------------------------------------------------------------------------------------------------------------------------------------------------------------------------------------------------------------------------------------------------------------------------------------------------------------------------------------------------------------------------------------------------------------------------------------------------------------------------------------------------------------------------------------------------------------------------------------------------------------------------------------------------------------------------------------------------------------------------------------------------------------------------------------------------------------------------------------------------------------------------------------------------------------------------------------------------------------------------------------------------------------------------------------------------------------------------------------------------------------------------------------------------------------------------------------------------------------------------------------------------------------------------------------------------------------------------------------------------------------------------------------------------------------------------------------------------------------------------------------------------------------------------------------------------------------------|--------------------------------------------------------------------------------------------------------------------------------------------------------------------------------------------------------------------------------------------------------------------------------------------------------------------------------------------------------------------------------------------------------------------------------------------------------------------------------------------------------------------------------------------------------------------------------------------------------------------------------------------------------------------------------------------------------------------------------------------------------------------------------------------------------------------------------------------------------------------------------------------------------------------------------------------------------------------------------------------------------------------------------------------------------------------------------------------------------------------------------------------------------------------------------------------------------------------------------------------------------------------------------------------------------------------------------------------------------------------------------------------------------------------------------------------------------------------------------------------------------------------------------------------------------------------------------------------------------------------------------------------------------------------------------------------------------------------------------------------------------------------------------------------------------------------------------------------------------------------------------------------------------------------------------------------------------|

BROOKS RADIO & TV CORP., 84 Vesey St., Dept. A, New York 7, N. Y. TELEPHONE: Cortlandt 7-2359

TUBES

Tubes are new, seconds or used and so marked.
ONE YEAR GUARANTEED

OZ4	6BA6	6K7	12AT7
1B3	6BC5	6Q7	12AU7
1J3K3	6BD6	6S4	12AX7
1H5	6BG6	6SA7	12BA6
1L4	6BH6	6SC7	12BD6
1U4	6B7	6SH7	12BE6
1X2	6BL7	6SL7	12BF7
3CB6	6BN6	6SLZ	12BL6
5U4	6BQ6	6SN7	12BY7
5V4	6BZ6	6SQ7	12C5
5Y3	6C4	6SR7	12CA5
6A6	6C6	6U7	12SN7
6AB	6CB6	6UB	12SQ7
6AB4	6CD6	6V6	25L6
6AC7	6CF6	6W4	25Z6
6AG5	6CG7	6W6	35W4
6AK5	6CG8	6X4	35Z3
6AL5	6CW7	6Y5	35Z4
6AN8	6CZ5	7A7	35Z5
6AQ5	6D6	7AB	50L6
6AS5	6DA4	7B6	24
6AT6	6DE6	7B7	27
6AT8	6DO6	7B8	41
6AU4	6EM5	7C5	45
6AUS	6F6	7N7	47
6AU6	6H6	7Y4	75
6AV6	6J5	12AD6	77
6AW6	6J6	12AE6	78
6AX4	6K6	12AF6	84/624

33¢
PER TUBE
**100 TUBES OR MORE:
30¢ PER TUBE**

If not shipped in 24 hrs
**YOUR ORDER
FREE!**

★ ★ ★
SEND FOR FREE LIST OTHER TUBES, CRT'S, SELF SERVICE TESTERS, RADIO AND TV COURSES ALL AT LOW PRICES.
★ ★ ★

Special!
With every \$10 Order
25¢ per tube
(No Limit) from this list.

6AG5 6SN7
6AUG 6J6 6V6
6AQ5 6K6 6W4

TERMS: FREE POSTAGE ON PREPAID USA ORDERS. Under \$5.00 add 50¢ for handling. Send 25% deposit on C.O.D. orders. No Canadian or foreign C.O.D.'s — include postage. No 24 Hr. Free Offer on personal check orders. 5-DAY MONEY BACK OFFER!

CORNELL ELECTRONICS CO.
Dept. RE7 4217 University Ave.,
San Diego, Calif. 92105 • Phone: AT 1-9792

COYNE PIONEERS NEW WAY TO LEARN TELEVISION

Men who want to open their own Radio-TV Service Businesses, or get a big pay job in Electronics can now, for the first time, take their basic training at home in spare hours — then finish with TWO WEEKS of personal training on actual projects in the great shop-Labs of Coyne in Chicago.

NO EXTRA COST FOR TUITION
Yes, Coyne again leads the way. For men who can't spend six months or longer in our resident school, we now give you all your basic training with 2150 photos and diagrams in spare hours at home. Then, let you finish with practical, personal training in our Chicago Shops. And, we have not added one cent to the low, low cost of our home training course. Your post-graduate work in Chicago is free of all tuition charges. The basic home training you receive is not an old radio course up-dated. It is up-to-the-minute in Radio, TV, Color TV, UHF, and Transistor service. The 2150 photos and diagrams with their simple explanations make it easy to learn — and quick — in spare hours.

NO "KITS" TO PAY FOR—LOW COST—SMALL PAYMENTS
Save the cost of "put together" kits. Get your practical work in Chicago under guidance of same instructor who teaches our resident students and on same equipment. Pay less — and pay in small monthly checks. Upon graduation, you get Free Certificate entitling you to two weeks in Chicago without extra cost.

FREE!
Sending for this book has been the first step to success in businesses of their own for many men who owe their prosperity to Coyne training. Send your name, today.

COYNE ELECTRICAL SCHOOL
Chartered as an Educational Institution Not for Profit
1501 WEST CONGRESS PARKWAY
DEPT. 24-H5 • CHICAGO 7, ILLINOIS

B.W. Cooke, Pres. Home Training Division, Dept. 24-H5
1501 W. Congress Parkway, Chicago 7, Ill.
Please mail free book and offer of two weeks personal training in Chicago without extra tuition for home study graduates. Explain low monthly payments.

NAME _____
ADDRESS _____
CITY & STATE _____

hermetically sealed in a ceramic-metal case. All leads are isolated from the package.

The upper photo shows the complete structure with leads bonded on. The lower closeup shows clearly the individual emitter elements, each 0.5 mil square.

Miniature rectifier assemblies

This series of encapsulated power rectifiers includes full-wave bridge, voltage-doubler and full-wave center-tap configurations. The size of the tiny plastic-case units is indicated in the photo.

These point up what seems to be a trend in "B-plus" rectification for electronic equipment, from tubes to seleniums to individual silicones to "prepack-

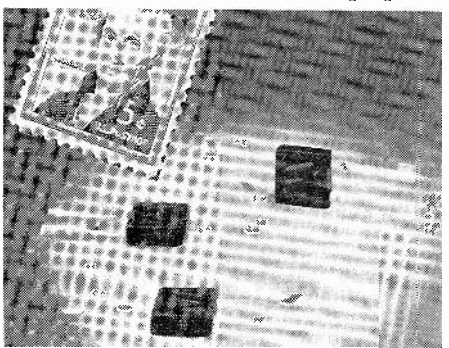

aged" rectifier circuits such as these (See "Silicon bridge rectifiers," "New Semiconductors and Tubes," November 1963, page 98).

The full-wave bridge and full-wave center-tap units are available with piv's of 25 to 1,000 volts and 1-amp output current rating. The doublers have the same voltage ratings with a maximum current of 0.5 amp.

Selenium logic diodes

But... selenium is not yet dead. General Electric has just announced two

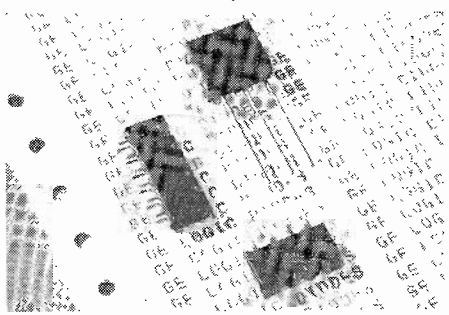

low-cost selenium logic diode types for computer applications. They are to be priced as low as 5 cents apiece in quantity orders.

The diodes are produced in two-, four- and six-cell packages, designed flexibly so that the units can be used common-cathode, common-anode or individually.

Where's the rub? Simply that these diodes are not nearly as fast as the more elegant and expensive germanium or silicon types. Reverse recovery time is 1.75 μsec; forward turn-on time, 1.5

5 CORES

WETS FASTER **MELTS FASTER**

Solders **Better**

ERSIN
Multicore
5-CORE SOLDER
WORLD'S FINEST

11C INDICATED QUANTITY

Multicore Sales Corp. Port Washington, NY

NEW PRICES from

QUIETROLE

the oldest, most widely proved and sold radio and TV lubricant

2 oz. bottle	LIST
with dropper	\$1.49
4 oz. bottle	LIST
	2.54
4 oz. bottle (brush-n-cap)	LIST
	2.64
8 oz. bottle	LIST
	5.07
6 oz. spray can —	LIST
— with extender	2.79
3 oz. spray can —	LIST
— with extender	1.79

Quietrole is your guarantee of the most effective, quick silencer of noisy radio and TV controls — the quality product that is a top value. Get Quietrole at quality jobbers.

Some territories still available for experienced representation.

manufactured by
QUIETROLE Company
Spartanburg, South Carolina

μsec. Their capacitance is high and their working temperature range limited — from 30 to 85°C.

The two types are similar except that one will carry up to 20 ma maximum and has a capacitance of 100 to 225 pf, while the other can carry only 10 ma maximum but has 15 to 40 pf capacitance.

Applications include digital circuitry at 50 kc or less, voltage stabilizing circuits, diode capacitor memory for low-word-capacity register type storage, and solid-state relays.

Dual transistors

Just as dual (and eventually triple) tubes made the scene in the early 1930's, so now dual transistors are becoming more familiar.

Hughes Semiconductors has announced two dual p-n-p silicon alloy transistors, the 2N2871 and the 2N2872. They have two completely independent devices in one TO-5 package with six leads.

The transistors are designed for chopper service, dc-to-ac conversion, or

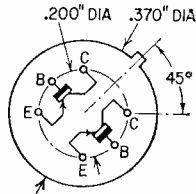

INTERNAL CONNECTIONS
(BOTTOM VIEW)
2N2871, 2N2872

any other low-level saturation switching. Nothing appears to have been sacrificed by bringing two units into one case. Maximum collector current per unit at 25°C ambient is 100 ma, and total power dissipation is 400 mw. The collector junction temperature can rise as high as 165°C.

Breakdown voltages between all three elements of each unit are 60 for the 2N2871 and 110 for the 2N2872. Typical switching speed is 1 mc. END

50 Years Ago

In Gernsback Publications

HUGO GERNSBACK, Founder

Modern Electrics	1908
Wireless Association of America	1908
Electrical Experimenter	1913
Radio News	1919
Science & Invention	1920
Practical Electrics	1921
Television	1927
Radio-Draft	1929
Short-Wave Craft	1930
Television News	1931

Some larger libraries still have copies of Modern Electrics and the Electrical Experimenter on file for interested readers.

In February, 1914, Electrical Experimenter

The Radiosound Detector, by H. Gernsback.
Currents of Ultra-High Frequency, by H. W. Secor.
An Efficient Transmitting Loose Coupler.
An Extra Large Amateur Aerial.
The Goldschmidt Radio Tower at Tuckerton.
A Novel Oscillation Transformer, by Alvin Spicer.
An Efficient Loose Coupler, by Eugene Dynner.

FEBRUARY, 1964



Your 1964 copy is waiting

FREE! For fun and pride in assembly, for long years of pleasure and performance, for new adventures in creative electronics mail the coupon below and get Conar's new 1964 catalog of quality do-it-yourself and assembled kits and equipment. Read about items from TV set kits to transistor radios . . . from VTVM's to scopes . . . from tube testers to tools. And every item in the Conar catalog is backed by a no-nonsense, no-loopholes money back guarantee! See for yourself why Conar, a division of National Radio Institute, is just about the fastest growing entry in the quality kit and equipment business.

CONAR

MAIL THIS COUPON NOW

BC4C

CONAR 3939 Wisconsin Ave., Washington 16, D.C.

Please send me your 1964 catalog.

Name _____

Address _____

City _____

Zone _____

State _____

CONVERT SURPLUS RADIO GEAR INTO AMATEUR AND C.B. EQUIPMENT



SURPLUS RADIO CONVERSION MANUALS — 3 Volumes —
\$3.00 ea. (foreign, \$3.50)

VOLUME I — BC-221 Freq. Meter; BC-342 Rcvr.; BC-312 Rcvr.; BC-348 Rcvr.; BC-412 Radar Oscilloscope; BC-645 Xmtr./Rcvr.; BC-946 Rcvr.; SCR-274 (BC-453A Series) Rcvr.; SCR-274 (BC-457A Series) Xmtrs.; SCR-522 (BC-625, 624) Xmtr./Rcvr.; TBY Xcvr.; PE-103A Dynamotor; BC-1068A/1161A Rcvr.; Electronics Surplus Index; Cross Index of A/N Vac. Tubes; Amateur Freq. Allocations; Television and FM Channels. Book #311

VOLUME II — BC-454 or ARC-5 Rcvrs.; AN/APS-13 Xmtr./Rcvr.; BC-457 or ARC-5 Xmtrs.; ARC-5 V.H.F. Xmtr./Rcvr.; GO-9/TBW Xmtrs.; BC-357 Marker Rcvr.; BC-946B Rcvr. as Tuner; BC-375 Xmtr.; Model LM Freq. Meter; TA-12B Bendix Xmtr.; AN/ART-13 (Collins) Xmtr.; Simplified Coil-Winding Charts; Selenium-Rectifier Power Units; AVT-112A Light Aircraft Xmtr.; AM-26/AIC to a Hi-Fi Ampl.; Surplus Beam Rotating Mechs.; ARB Rcvr. Diagram Only. Book #322

VOLUME III — APN-1; APN-4; ARC-4; ARC-5; ART-13; BC-191, 312, 342, 348, 375, 442, 453, 455, 456-459, 603, 624, 696, 1066, 1253; CBY-5200 series; COL-43065; CRC-7; DM-34; DY-2; DY-8; FT-241A; LM Power Supply; MBF; MD-7/ARC-5; R-9/APN-4; R-28/ARC-5; RM-52-53; RT-19/ARC-4; RT-159; SCR-274N, 508, 522, 528, 538; T-15 to T-23/ARC-5; URC-4; WE-701-A. Schematics only: APA-10; APT-2; APT-5; ARR-2; ASB-5; BC-659; BC-1335A; CPR-46ACJ. Book #333

THE SURPLUS HANDBOOK (Receivers and Transceivers) —
\$3.00 ea. (foreign \$3.50)

VOLUME I — Schematic Diagrams and large photographs only — APN-1; APS-13; ARB; ARC-4; ARC-5 (L.F.); ARC-5 (V.H.F.); ARN-5; ARR-2; ASB-7; BC-222, 312, 314, 342, 344, 348, 603, 611, 624, 652, 654, 659, 669, 683, 728, 745, 764, 779, 794, 923, 1000, 1004, 1066, 1206, 1306, 1335; BC-AR-231; CRC-7; DAK-3; GF-11; Mark II; MN-26; RAK-5; RAL-5; RAX-1; SCR-522 Super Pro; TBY; TCS; Resistor and Capacitor Color Codes; Cross Index of A/N V.T. and Commercial Tubes. Book #510

EDITORS and ENGINEERS, Ltd.

Summerland 5, California 93067



Dealers Electronic distributors, order from us. Bookstores, libraries, newsdealers order from Baker & Taylor, Hillside, N. J. Export (exc. Canada), order from H. J. Snyder Co., 440 Park Ave. So., N. Y. 16.

SEE YOUR COSTS SHRINK WITH KEY DISCOUNTS

Prove it for yourself! Rush us your list of stereo hi-fi components for an immediate price-busting quotation.

Enjoy these advantages:

- LOWEST PRICES
- SPEEDY DELIVERY
- FACTORY WARRANTY
- EASY PAYMENT PLAN

For a real eye-opener, send for our valuable money-saving audio discount catalog A-17, featuring the latest in stereo equipment.



KEY ELECTRONICS CO.
518 East 95th St., Bklyn. 12, N.Y.

coming next month

Electronics

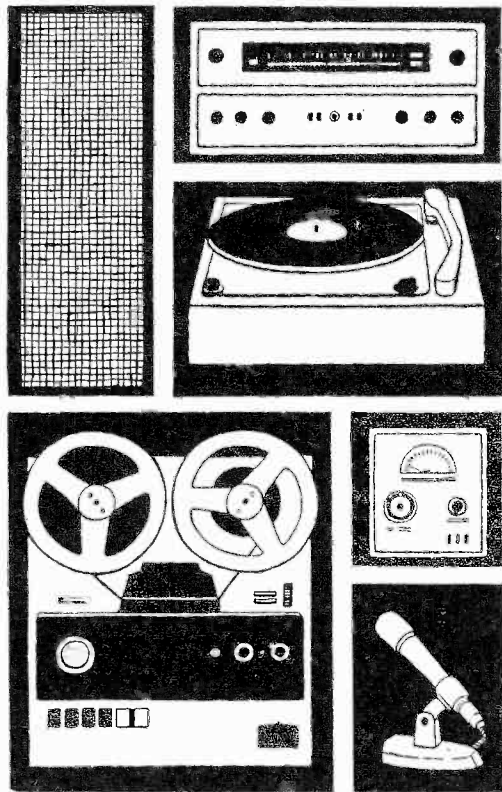

Radio-Electronics HIGH FIDELITY— TAPE RECORDER ISSUE

The March issue of Radio-Electronics will feature TAPE RECORDERS and HIGH FIDELITY. This exciting issue will contain a complete editorial section on tape recorders and high fidelity units and components, including a directory of accessories for the audiophile.

Here are just some of the features which will be in the issue:

Humless preamp you can build Four transistors solve the problem of preamplification and treble and bass compensation without introducing any signal from the supply lines.

Choosing the right tape What are the differences between tapes? Do particular machines do better with one type than with another that has equally good specs? What about "white box" tapes?

Test Records and Tapes There are a number of these on the market at the moment. How do they differ? What special features are offered? Which tape or record for you?

Vertical Tracking Angle Distortion Is it important in stereo recording? Will the new 15° stylus angle reduce or eliminate it?

Accessories for the Audiophile A wide range of items, from head demagnetizers to stylus gages, are available to make life easy for the audio enthusiast. Who makes them? Where can they be obtained? And are there any new widgets the audiophile has not heard of yet?

MARCH ISSUE (on sale February 18)

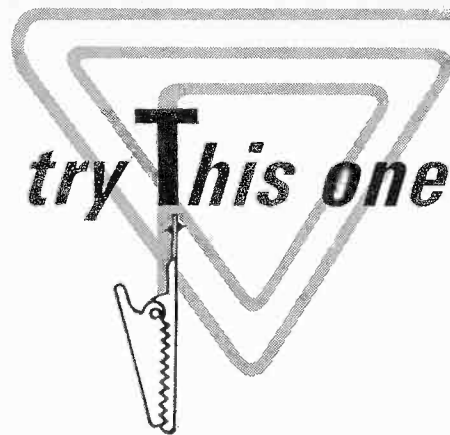

Cheater Idea

It's not hard to forget a cheater cord in a set. You put the back on, check the set and walk off, leaving the

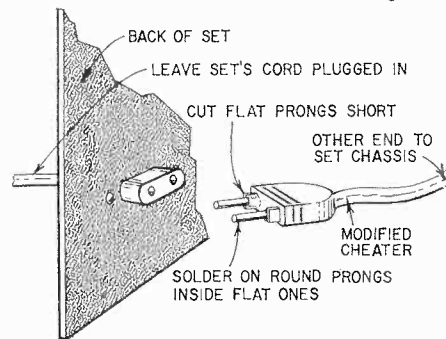

cheater plugged in. Another frequent misfortune is finding the only available wall outlet behind a chair or a piano. Well, don't move the furniture.

Fix up a cheater cord as shown in the drawing. Partly cut off the flat prongs of the plug, and solder round cheater type prongs on the *inner* sides of the original flat ones. Now, instead of fumbling for a wall outlet, plug the modified cheater plug into the female interlock connector on the set's removable back. The female end of the cord goes to the male chassis connector as usual. In effect, you use the back of the set as a temporary extension cord.

And you very likely won't forget to take your modified cheater cord with you when you leave.—Edmund Daly

Adapter Measures VR-Tube Current

Because a VR tube is glowing, it does not mean the correct current is flowing in it. A test adapter socket right on top of the chassis makes it possible to check the current.

Use adapter sockets that can be

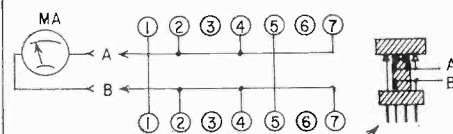

7-PIN MINIATURE ADAPTER FOR OA2, OB2, OC2, 5651, ETC.

cross-connected in any desired way. Connect as in the diagrams. The cath-

RADIO-ELECTRONICS

ode lead is broken and a vom, set to read current, is connected from A to B in the schematic. All other connections are straight through from male to female of the adapter. I used a piece of red spaghetti on A to show polarity.

To investigate a VR tube, turn the set off, pull the regulator tube, and put in the proper test adapter with tube on

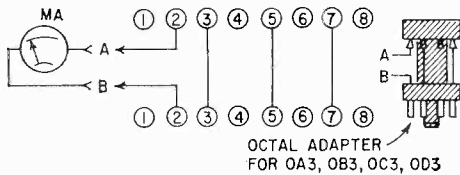

top, connect current meter, turn set on and read milliamperes. A tube manual will give you the maximum and minimum currents.

A word of caution! Don't turn the set on with just the adapter but no gas tube. Some of the components might be damaged by excessive voltage.—Fred H. Horan

Feet for Home-made Gear

The little plastic caps you push down on to spray stuff out of aerosol cans make excellent "mar-less" feet for home-built equipment. The holes in them, though they don't go all the way through, are just about right for 4-40 or 4-36 screws, but should be reamed out far enough and deep enough to countersink

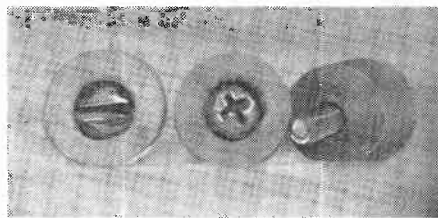

the screw head.

Wood screws can be used, of course, if you want to attach the feet to a wood cabinet.—James Wallace

Flatiron Is Short Tester

When you service a TV set that blows the customer's fuses, plug it into

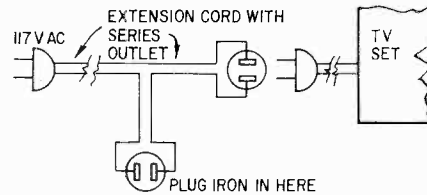

his ac line through an extension cord with a series-wired outlet, and plug his electric iron into that outlet. If there is a short, the iron will heat up to full temperature just as it would if plugged directly into a wall outlet.

If the TV set is OK, the iron will get only barely warm.

This idea may save you a fuse-replacing trip to the basement.—Charles Andrews END

"New 1964 Catalog" #12

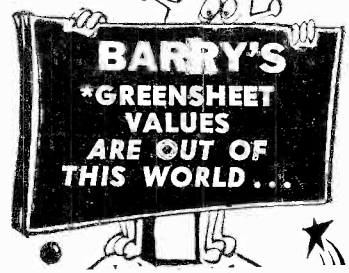

A complete catalog of specialized industrial Electronic TUBES and COMPONENTS... featuring Barry Electronics savings to industry. Servicemen, Experimenters, and purchasing agents.

RCA 21" COLOR CATHODE RAY PICTURE TUBE =21AXP22A UNUSED ORIGINAL CARTON SPECIAL \$90.

We'll also purchase your equipment and unused tubes. Send details:

BARRY ELECTRONICS

512 BROADWAY, New York, N.Y. 10012

14 YEARS OF BUYERS' CONFIDENCE

CORPORATION

Walker 5-7000 AREA CODE 212 TWX: 571-0484

Please send me a copy of the new 1964 "Greensheet" and add my name to your mailing list. (RE-2)

Name Title
Company
Address
City State

Jobs look for YOU in ELECTRONICS

Learn FAST—Earn FAST

MTI'S Unique, Exclusive SELECT-A-SKILL Training Helps You PICK YOUR JOB. STARTS YOU EARNING RIGHT OFF.

Want to take advantage of Today's Biggest Opportunities? Ready to step into a well-paid job that can mean from 25% to 60% MORE PAY? Interested in being YOUR OWN BOSS—in a profitable sparetime or fulltime business? All this is WAITING FOR YOU in ELECTRONICS—the world's most exciting and fastest moving industry.

Why You Can GET READY SO MUCH FASTER with MTI Training

With MTI's unique Exclusive SELECT-A-SKILL methods you waste no time on training you may never need. You choose the field you want—INDUSTRIAL ELECTRONICS, COMMUNICATIONS ELECTRONICS or RADIO and TV SERVICING! MTI gives you the specific training in that special field right at home or through resident classes in Jacksonville, under the personal supervision of top-ranking experts. Best of all, you LEARN BY DOING—by actually working out experiments and building electronic equipment with MTI's SEVEN BIG OUTFITS and KITS that DON'T COST YOU ONE SINGLE CENT EXTRA!

An Accredited Member of the NHSC

MTI has already proved the outstanding value of its SELECT-A-SKILL home study training through the success of thousands of men of all ages. Most of them had no previous experience. Few had more than a high school education—many hadn't gone that far.

MAIL COUPON TODAY for FREE BOOK and SELECT-A-SKILL OPPORTUNITY FINDER

The coupon brings you MTI's big, fascinating book, "Pick Your New World of Opportunity in Electronics," plus the unique Select-a-Skill Opportunity Finder that takes the guess work out of your future—gives all the facts about the kind of jobs open, salaries and what you need to step into YOUR BIG OPPORTUNITY in double-quick time. Mail coupon NOW!

MASSEY TECHNICAL INSTITUTE

(An Accredited Member, National Home Study Council)

Dept. 14-BB-02, Jacksonville 6, Fla.

Right Where Everything That's New in Electronics is Happening

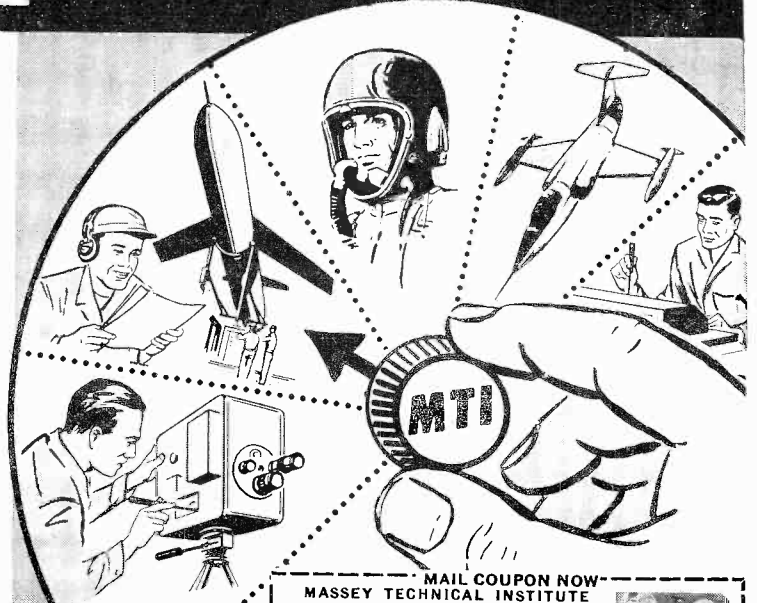

SKILLS PAY BILLS

Take no chances! With millions unemployed there's NO PLACE for men who lack the special skills so vital today! Let MTI give you the training you NEED to insure your future!

MAIL COUPON NOW

MASSEY TECHNICAL INSTITUTE
Dept. 14-BB-02, Jacksonville 6, Fla.
Please rush to me, without obligation your FREE BOOK "Pick Your New World of Opportunity in Electronics" PLUS your SELECT-A-SKILL Opportunity Finder.

I am interested in:

Home Training Classroom Training

Name.....

Address.....

City..... Zone.... State.....

(PLEASE PRINT)

powerful and portable

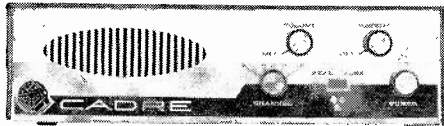

POWERFUL — 5-watts, 5-channel crystal-controlled channels, 100% all-transistor, the Cadre series of transceivers can be used in any vehicle, boat or office. They deliver sharp, clear reception over the greatest transmission range possible in the 27 mc citizens band. Five fixed crystal-controlled channels spell accurate, fast communication contact. Sensitive dual superheterodyne circuit responds to weakest signals. Tuned ceramic filters increase selectivity. Reception is clear, free of noise—automatic noise limiter defeats ignition noise; adjustable squelch eliminates annoying background signals. Extended range AGC provides uniform audio output. Solid state circuitry throughout means no heat problems, no tubes to burn out, ability to withstand vibration and shock, negligible current drain, compact size.

Four Cadre 5 watt, 5-channel models.

CADRE 515—AC/DC unit for use anywhere. \$199.95

CADRE 510-A—AC/DC unit. 23 ch. manual tuning. \$219.95

NEW! CADRE 520—DC only with DC power cord and mounting kit—ideal for mobile and portable use—operates from 12 volt auto battery or special battery pack. \$187.50

NEW! CADRE 525—for complete field portability. Standard AC cord permits recharging of two built-in nickel-cadmium batteries, telescoping antenna, carrying handle. \$269.95

PORTABLE — Power is only a part of the story with Cadre transceivers. These units go anywhere—operate anywhere. An optional accessory, (Cadre 500-1 Portable Pack) adapts Cadre 510, 515 and 520 for field use. The Portable Pack is a lightweight case which contains rechargeable battery supply (two 500-2 nickel-cadmium 6-volt batteries). These units can be used for base or mobile application as well as in the field. Cadre 5-watt models in the Portable Pack weigh less than 9 lbs. Cadre 500-1, \$29.95, Cadre 500-2, \$10.95.

For the finest CB transmission anywhere, rely on Cadre. For literature write:

CADRE 5-WATT ALL TRANSISTOR CB RADIOS



CADRE INDUSTRIES CORP. □ COMMERCIAL PRODUCTS DIVISION ENDICOTT, NEW YORK Canada: Tri-Tel Assoc., 81 Sheppard Ave. W., Willowdale, Ont. Export: Morhan Export, B'way, N. Y. 13.

booklets New Literature charts catalogs

1964 RADIO ELECTRONIC MASTER catalog now available at electronic parts distributors. Lists more than 175,000 components and accessories on 1,607 pages. Detailed index pinpoints the thousands of items displayed. List of distributors offering the catalog is available from the publisher.—**United Catalog Publishers Inc.**, 645 Stewart Ave., Garden City, N. Y. 11533.

AVAILABLE ORGAN LITERATURE listed in 16-page booklet. Includes pamphlets, books, magazines and recordings on organs, organists, organ music, history and building.—**Organ Literature Foundation**, Nashua, N. H. 03060.

SUBMINIATURE SQUARE TRIMMING POTENTIOMETERS described in 2-page catalog sheet. Specs for precision and military applications; physical drawings and tolerances; charts for standard resistances, resolution and power ratings.—**Techno-Components Corp.**, 18232 Parthenia St., Northridge, Calif.

POWER AND HAND CRIMPING TOOLS literature gives specs and descriptive photos. Also describes interchangeable heads used on each model.—**Prosser Industries, Inc.**, 900 East Ball Rd., Anaheim, Calif.

TRIMMER AND PRECISION POTENTIOMETERS described in 40-page catalog. Includes quick reference index, illustrations, features, electrical mechanical and environmental specs.—**Date Electronics, Inc.**, Columbus, Neb.

EMITTER BYPASS (Transfilter) described in *Bulletin 94-20*, 2 pages. Ceramic Transfilter shown in ordinary radio circuit. Circuit diagrams. Set of curves compares selectivity of i.f. stage employing device as emitter bypass vs conventional capacitor bypass.—**Clevite Corp.**, Piezoelectric Div., 232 Forbes Road, Bedford, Ohio.

HIGH-SPEED SWITCHING RELAYS (Micro-Scan), typical circuit applications and specs described in 8-page *Relay Catalog F-5174*. Includes relay definitions, circuit diagrams.—**James Electronics, Inc.**, 4050 N. Rockwell St., Chicago, Ill.

ZENER-DIODE DATA REFERENCE CHART B-108 lists about 500 types with dissipation ratings from 500 mw to 50 watts and Zener voltages from 6.8 to 200. 8 case styles illustrated. Outline drawings, specs.—**National Transistor**, 500 Broadway, Lawrence, Mass.

LOW-FREQUENCY CRYSTALS described in 6-page brochure. Specs and characteristics. Curves and data on series resistance, frequency vs temperature, average equivalent constants, Q values and holder dimensions vs frequency for JT, XY, NT, HT, 5°X, DT, DD and CT crystal cuts.—**Monitor Products Co., Inc.**, 815 Fremont Ave., So. Pasadena, Calif.

DC TO 30-MC SCOPE described in illustrated brochure, *RD1805A*. For use with plug-in preamplifiers. Technical specs, block diagram.—**Hickok Electrical Co.**, RD Instruments Div., 10514 Dupont Ave., Cleveland 8, Ohio.

MOTOR GENERATOR SETS described in 4 brochures. General line and specialized sets. Discusses models and sizes available, construction features, latest specs.—**Kato Engineering Co.**, 1415 First Ave., Mankato, Minn.

TRANSFORMER CATALOG describes standard, MIL-spec and custom transformers. Complete listings of manufacturer's line of 60- and 400-cycle units. Engineering data on filament, filament/plate and plate transformers, power supply filter reactors, military-standard audio and pulse/toroidal transformers and reactors.—**Ferranti Electric Inc.**, Light Equipment Div., Industrial Park No. 1, Plainview, N. Y.

INDIUM ANTIMONIDE INFRARED DETECTORS. 16-page brochure for users of single-crystal photovoltaic detectors. Explains optimum methods for measuring parameters considered most important when specifying InSb infrared detector characteristics. Also discusses fabrication of de-

tectors.—**Philco Corp.**, Special Products Operations, Lansdale Div., Lansdale, Pa.

INTEGRATED CIRCUIT SCHEMATICS featured in 6-page catalog. Includes flip-flop, half-adder, bias driver, single and dual nand/nor gates, i.f. and video amplifiers, etc. More than 500 all together, including molecular circuits manufactured by Fairchild Semiconductor Corp., Westinghouse Molecular Div., Siliconix, Motorola.—**Semiconductor Specialists Inc.**, Attn. Hal Choisser, 5700 W. North Ave., Chicago 39, Ill.

ANTENNAS AND ACCESSORIES presented in 16-page illustrated catalog. Vhf, uhf, FM, master antenna systems. Specs.—**Jerrold Electronics Corp.**, Distributor Sales Div., 15th & Lehigh Ave., Philadelphia 32, Pa.

STEREO RADIO-PHONO CONSOLES described in illustrated catalog. Specs, photos, line drawings and explanations of interior features.—**H. H. Scott, Inc.**, Dept. P., 111 Powdermill Rd., Maynard, Mass.

HI-FI SPEAKERS AND KITS covered in 24-page catalog *No. 165-J*. Headphones, private stereo listening, speaker components and system kits. Illustrations, specs.—**Jensen Manufacturing Co.**, 6601 So. Laramie Ave., Chicago, Ill. 60638.

AIRCRAFT BATTERIES described in 4-page brochure. Lists specs, special data about nickel-cadmium batteries, and military and FAA-approved batteries.—**Sonotone Corp.**, Battery Div., Elmsford, N. Y.

POWER TUBES. 36-page booklet *PG-101F* covers vacuum power tubes, vacuum gages, ignitrons, rectifier tubes, thyratrons now available from manufacturer. Full specs, illustrations, graphs.—**RCA Electronic Components & Devices**, Harrison, N. J. 60¢.

1964 ELECTRONICS CATALOG includes industrial electronics, professional and consumer audio, amateur radio, component parts from 187 manufacturers. 400 pp., full specs, illustrations.—**Harvey Radio Co., Inc.**, 104 W. 43 St., New York, N. Y. 10036.

HIGH-FREQUENCY VARIABLE TRANSFORMERS described in 28-page bulletin *P463H*. Ratings and complete technical data for variable transformers which deliver continuously adjustable voltage from 400-, 800- and 1,600 cycle ac power lines.—**Superior Electric Co.**, Dept. P463H, Bristol, Conn.

MIKE, SPEAKER, ACCESSORIES CATALOG. 8 pages, specs, photos. Covers special speakers, drivers, radial projectors, sound columns, paging speakers, mike adapters and fittings, etc.—**Atlas Sound**, 1419-51 39th St., Brooklyn 18, N. Y.

INCANDESCENT PILOT LAMPS described in spec sheet. Also data about manufacturer's line of extended-service pilot lights. Explains reliability, endurance, contains charts showing effect of voltage variation on lamp life, light output and lamp current; results of vibration tests.—**Sylvania Electric Products Inc.**, 60 Boston St., Salem, Mass.

STANDARDS AND COMPONENTS, 8-page bulletin, describes manufacturer's line of standard resistors, inductors and capacitors. Covers fixed-value components, decade boxes, attenuators, voltage dividers and variable inductors. More than 150 standards.—**General Radio Co.**, West Concord, Mass.

TRANSISTORIZED POWER CONVERTER described in spec sheet. Converts engine current of boat to house current. Illustrations.—**Stanley S. Wyman**, Route 2, Box 156, Zephyrhills, Fla.

GUIDE TO STEREO HIGH FIDELITY. 1964 164-page catalog of hi-fi components and accessories, including PA, amateur radio and CB products. Indexed by product and manufacturer. Photos, specs.—**Airex Radio Corp.**, 85 Cortlandt St., New York, N. Y. 10007.

Any or all of these catalogs, bulletins, or periodicals are available to you on request direct to the manufacturers, whose addresses are listed at the end of each item. Use your letterhead—do not use postcards. To facilitate identification, mention the issue and page of RADIO-ELECTRONICS on which the item appears.

UNLESS OTHERWISE STATED, ALL ITEMS ARE GRATIS. ALL LITERATURE OFFERS ARE VOID AFTER SIX MONTHS.

new Books

SILICON CONTROLLED RECTIFIER HOBBY MANUAL, edited by T. O. Reich. *General Electric, Rectifier Components Dept., W. Genesee St., Auburn, N. Y. 5 1/2 x 8 1/2 in., 70 pp. Paper, \$1.00.*

Contains some 15 short articles describing construction of devices using a silicon controlled rectifier as well as introductory material on the device and some information on replacing rectifier tubes with (ordinary) silicon rectifiers. **END**

MARINE ELECTRONICS HANDBOOK (2nd Edition), by Leo G. Sands. *Howard W. Sams & Co., Inc., 4300 W. 62 St., Indianapolis 6, Ind. 5 1/2 x*

8 1/2 in., 288 pp. Paper, \$4.95.

Technical information, Government regulations and marine station listings. Tells how to select radio and safety equipment; covers installation, operation and maintenance.

BASIC ELECTRICITY, prepared by Bureau of Naval Personnel. *Dover Publications, Inc., 180 Varick St., New York 14, N.Y. 6 1/4 x 9 1/4 in., 447 pp. Paper, \$2.65.*

Covers the subject thoroughly in conventional manner from electrical concepts to alternating current instruments, magnetic amplifiers, and servomechanisms.

AUTO RADIO SERVICING MADE EASY, by Wayne Lemons. *Howard W. Sams & Co., Inc., 4300 W. 62 St., Indianapolis 6, Ind. 5 1/2 x 8 1/2 in., 128 pp. Paper, \$2.95.*

Practical information on repair, adjustment and installation with emphasis on

transistor circuits. Includes signal-seeking tuners.

PULSE FUNDAMENTALS, by John M. Doyle. *Prentice-Hall, Inc., Englewood Cliffs, N.J. 6 x 9 in., 499 pp. Cloth, \$16.00.*

Multivibrators, wave shaping and switching are among the topics covered in this comprehensive text for technicians and students. It includes many practical examples of circuit design.

INTERMODULATION AND HARMONIC DISTORTION, by Howard M. Tremaine. *Howard W. Sams & Co., Inc., 4300 W. 62 St., Indianapolis 6, Ind. 5 1/2 x 8 1/2 in., 176 pp. Paper, \$3.95.*

An authoritative handbook on audio distortion and its measurement. Describes several commercial instruments; details construction of a lab-type IM analyzer.

INTRODUCTION TO ELECTROMAGNETIC FIELDS AND WAVES, by Charles A. Holt. *John Wiley &*

Radio-Electronics Market center

SILICON TOP HATS OR DIODES 750 MA **LOWEST PRICES GUARANTEED**

LOW LEAKAGE NEWEST TYPE

PIV/RMS 50/35 .05 ea.	PIV/RMS 100/70 .09 ea.	PIV/RMS 200/140 .12 ea.	PIV/RMS 300/210 .18 ea.
PIV/RMS 400/280 .23 ea.	PIV/RMS 500/350 .28 ea.	PIV/RMS 600/420 .38 ea.	PIV/RMS 700/490 .50 ea.
PIV/RMS 800/560 .58 ea.	PIV/RMS 900/630 .68 ea.	PIV/RMS 1000/700 .78 ea.	PIV/RMS 1100/770 .98 ea.

ALL TESTS! AC & DC & FWD & LOAD
100 Dif. Pre. Res. 1/2, 1, 2 WATT-1% Tol. \$1.25
G.E. IN91 Diode-10 for \$1.00, 100 for \$8.00
Special 1000 PIV-750 MA. 10 for \$7.50

SILICON POWER DIODE STUDS

Amps	PIV	Sale	Amps	PIV	Sale
3	50	\$0.15	30	50	\$.95
3	100	.30	35	100	1.20
3	200	.45	35	200	1.50
3	300	.60	40	300	2.00
3	600	.60	50	50	2.25
12	50	.60	50	100	3.25
12	100	.80	50	200	4.00
12	200	1.00	100	50	2.75
12	400	1.50	100	100	3.50
12	600	2.00	100	300	4.00

Money Back guarantee. \$2.00 min. order. Orders F.O.B. NYC. Include check or money order. Shpg. charges plus. C.O.D. orders 25% down.
WARREN ELECTRONIC COMPONENTS
NYC 7, NY 87 Chambers St. Wo 2-5727

METER and EQUIPMENT REPAIR and CALIBRATION

Free estimates and mailing pack.
Free catalog on manufacturer's and military surplus parts and equipment.
Special of the Month:
Filter choke 7 HY at 150 MA \$99 F.O.B.

BIGFLOW ELECTRONICS
P.O. BOX 71, DEPT. E1 BLUFFTON, OHIO

Convert any television to sensitive
BIG-SCREEN OSCILLOSCOPE
with minor, inexpensive changes. Ingenious circuit. No electronic experience needed to follow our clearly illustrated plans. **TECHNICIANS, HAM'S, EXPERIMENTERS, RADIO CASTERS.** Use in shop, school, lab. Any set—any size screen.
FULL PLANS \$2
RELCO, Dept. RE-2, Box 10563, Houston 18, Tex.

TIME & PLACE

The time to sell is when you have a customer. And the place to sell is where you have some 157,000 customers—Radio-Electronics Market Center.

TRANSISTORS*NEW**

I.F., converter, switch, audio, also high frequency: PNP and NPN
Power transistors—20 to 70 watts3/\$1.00
Brand New—original package; full leads: Guaranteed— RCA, CBS, Raytheon, Texas Instru., U.S. Transistor, General Transistor, Philco.
Telex Stereo Earphones (III-PI)pr. \$12.50
PM Speaker—1 3/4" diam. X 1" deepca. \$1.50
1N37—1N535 Tophat; Raytheon, Motorola, General Electric; Rectifier, Siliconca. .40
1N60—Micro-miniature diodes8/\$1.00
Stud type Rectifier—400 PIV—750 MA.50
Zener Diodes—12 volt; 1 amp.\$1.00
Transistor sockets—3 lead—(Cinch Co.)10/\$1.00
Driver Transformer—sub-miniature—1/2-1/2-1/2 for transistor P.C. center-tapped2/\$1.00
Audio Output Transformer—sub-miniature—1/2-1/2-1/2 for Transistor P.C. center-tapped2/\$1.00
2K and 10K ohm volume control with switch—P.C. (CTS) miniature3/\$1.00
500 K ohm volume control with switch (Cutler-Hammer)4/\$1.00
455 KC. I.F. sub-miniature transformer2/\$1.00
455 KC. Dual I.F. sub-miniature transformerea. .60
Parts for 2 Watt Audio Power amplifier Consisting of 3 transistors, including 1 power transistor, resistors, electrolytic capacitors, together with schematic. Can be built in a 2" X 2" box\$3.00
Preampl. to Match Aboveea. \$1.50
Parts for 12 volt, 1 amp. REGULATED power supply with schematic and instructions\$8.95
Code Oscillator module; completely assembled Matchbook size with schematic, etc.\$1.00
P.A. Amplifier Module; completely assembled with schematic—3 lead and instructions with switch—P.C. (CTS) Dual Flasher Module, transistorized flipflop\$2.00

WRITE FOR FREE ADDITIONAL CATALOG.
Minimum order \$3.00
Prepaid Postage Free in U.S.

TRANSISTORS UNLIMITED COMPANY
Post Office Box #442, Great Neck, L. I., New York

CONVERT TO COLOR TV

COLORDAPTOR—A simple 10-tube circuit and rotating color wheel converts any size B & W TV to receive compatible color.

COLORDAPTOR — Easily attached to any TV set, does not affect normal operation, often built from parts experimenters have on hand, **BRILLIANT COLOR!**

Complete booklet—gives theory of operation, all construction details, schematic, and sample color filters.\$195

Essential Parts Kit—Includes all special parts—coils, delay line, crystal, color filters. Add \$100 for sets over 18".\$19.95

COLORDAPTOR 1798 Santa Cruz, Menlo Park, Calif.

RENT STEREO TAPES

FREE BROCHURE | Postpaid 2 to 5 day delivery (48 States)

stereo-parti
1616-D TERRACE WAY, SANTA ROSA, CALIF.

TELEVISION CAMERA KIT \$120.00

Kit comes to you with all major parts pre-assembled on chassis. Easy to follow step-by-step instructions. Less Lens & Vidicon tube which are available as accessory items.

SPERA ELECTRONICS 37-10 33 St., L. I. City 1, N.Y.

LOW-COST BUSINESS AIDS FOR RADIO-TV SERVICE

Order books, invoice forms, job ticket books, service call books, cash books and statement books for use with your rubber stamp. Customer file systems, book-keeping systems, many others. Write for **FREE 32 PAGE CATALOG** now.

OEIRICH PUBLICATIONS
6556 Higgins Rd., Chicago, Ill. 60656

TREASURE FINDERS

Supersensitive new transistor models detect buried gold, silver, coins, firearms. Locate Indian burial grounds, explore beaches, shacks, ghost towns. \$19.95 up. **FREE CATALOG.**

RELCO Dept. RE-2, Box 10563, Houston, Texas 77018

FREE CATALOG!

148 PAGES • NEARLY 4,000 BARGAINS
OPTICS • SCIENCE • MATH

Completely new, enlarged edition. New items, categories, illustrations. 148 new, easy-to-read pages packed with nearly 4000 items. Dozens of electrical and electromagnetic parts, accessories. Enormous selection of Astronomical Telescopes, Microscopes, Binoculars, Magnifiers, Magnets, Lenses, Prisms. Many war surplus items: for hobbyists, experimenters, workshop, factory. Write for catalog "EH".

CLIP AND MAIL COUPON TODAY

EDMUND SCIENTIFIC CO., Barrington, N. J.
PLEASE SEND ME FREE CATALOG "EH"
Name
Address
City State



Classified Ads

Rates—55¢ per word... minimum 10 words. Payment must accompany all ads except those placed by accredited advertising agencies. Misleading or objectionable ads not accepted. Copy for April issue must reach us before February 14th. Figure one word: name of city (New York), name of state (New Jersey). Sets of characters as in key (741-RE), also abbreviations as 8x10 mm, A.C., D.C., C.O.D. Hyphenated words not normally considered such count as two words (Hi-Fi). ZONE NUMBER FREE. RADIO-ELECTRONICS, 154 West 14 St., New York, N. Y. 10011.

WANTED

QUICK CASH... for Electronic EQUIPMENT, COMPONENTS, unused TUBES. Send list now! **BARRY**, 512 Broadway, New York, N. Y. 10012, 212 WALKER 5-7000.

G.R. H.P. L&N, etc., Tubes, manuals, military electronics. **ENGINEERING ASSOCIATES**, 434 Patterson Road, Dayton 19, Ohio.

PROFITABLE OCCUPATIONS — INVESTIGATE ACCIDENTS. Earn to \$1,700 monthly. Men urgently needed. Car Furnished. Expenses paid. No selling. No college education necessary. Pick own job location. Investigate full time, or earn \$6.44 hour spare time. Free Information. No obligation. Write **UNIVERSAL**, CER-2, 6801 Hillcrest, Dallas 5, Texas.

MANUFACTURE Cleaners — Polishes — Anything. Formula catalog, 10¢. **KEMERON**, Park Ridge, Ill.

Audio—Hi-fi

HI-FI COMPONENTS. Tape Recorders at guaranteed "We Will Not Be Undersold" prices. All Brands in stock. 15 day money back guarantee. 2 year warranty. Write for quotation, your requirements. No Catalog. **HI-FIDELITY CENTER**—1797 1st Ave., N. Y., N. Y. 10028.

WRITE for highest discounts on components, recorders, tapes, from franchised distributors. Send for FREE monthly specials. **CARSTON**, 125-R East 88, N.Y.C. 10028.

LPS LIKE NEW Top Labels \$1.00 for lists. Refunded first order. **RECORDS** Hillburn P. O. Hillburn, N. Y. 10931.

4/TR STEREO TAPES—bought, sold, rented, traded! Bargain closeouts! Catalog/**COLUMBIA**, 9651 Foxbury, Rivera, Calif.

SALE ITEMS — tapes — recorders — component quotes. **BAYLA**, Box 131-RE, Wantagh, N. Y.

WRITE FOR LOWEST QUOTATIONS. Components, Recorders, No Catalogs. **HI-FIDELITY SUPPLY**, 2817-SC Third, New York 55, N.Y.

RENT STEREO TAPES—over 2,500 different—all major labels — free brochure. **STEREO-PARTI**, 811-RE, Centralia Ave., Inglewood 3, Calif.

TAPE recorders, Hi-Fi components, Sleep-learning equipment, Tapes, Unusual values. Free catalog. **DRESSNER**, 1523 Jericho Turnpike, New Hyde Park 5, N.Y.

RECORDS! Discounts on all LP's. Free details. **CITADEL RECORD CLUB**, 545 5th Ave. Dept. 4, New York 17, N. Y.

CUSTOM HI-FI SLIMLINE SPEAKERS Floor models from \$32.95 (prepaid) **RIDEOUT ELECTRIC CO.**, Fontana, Calif.

ATTACH ADAPTOR to conventional Stereo Amplifier. Add two speaker cabinets. Witness natural sound reproduced with full incremental locations. Unit encapsulated. Guaranteed. \$39.95 Prepaid USA. **STEREOSPHERE** Dept. R, P.O. Box 3009, Huntsville, Alabama 35811.

BUSINESS AIDS

MAKE \$25-\$50 WEEKLY clipping newspaper items for publishers. Some clippings worth \$5.00 each. Particulars free. **NATIONAL**, Box 718, Long Beach, New York.

1,000 Business Cards. "Raised Letters" \$3.75 postpaid. Samples. **ROUTH**, RE2, 2633 Randleman, Greensboro, N.C. 27406.

MORE TV SERVICE COMPANIES ARE GETTING more calls and making more money with our circulars. Information free. **JASON**, 2336 Orthodox, Philadelphia, Pa. 19137.

\$100 WEEKLY POSSIBLE. Address-mail letters featuring real merchandise. Get \$10 orders in every mail-keep \$8 profit. Everything furnished. Details free. **NATIONAL PLANS**, Box 718, Long Beach, New York.

MISCELLANEOUS

PRINTING PRESSES, Type, Supplies. Lists 5¢. **TURNBAUGH SERVICE**, Mechanicsburg, Pa.

EARN MONEY; RECORD WEDDINGS, CHOIRS. Sell records made from your tapes. Send \$1.00 for detailed instructions regarding format, tape tips, prices. **BARRIE LABS**, Box 206, North Wales, Pa.

ELECTRONICS BOOKS, used, bought, sold. **WILKINS**, 1487 Villaret, San Antonio, Texas, 78224.

ANTIQUA EDISON CYLINDER PHONOGRAPHS released from 50 years storage. All work. Complete, Concert Horn, Cylinders. Each—\$70. **WHITLOCK'S STORAGE**, 114 State, Brewer, Me.

AMAZING ELECTRET PLASTIC has 5000 Volt permanent static charge. Send \$1.00 for sample. **GOOD SALES CO.**, P.O. Box 468, Flemington, N. J.

EDUCATION/INSTRUCTION

FCC LICENSE in 6 weeks. First Class Radio Telephone. Results Guaranteed. **ELKINS RADIO SCHOOL**, 2603E Inwood, Dallas, Tex.

LEARN ELECTRONIC ORGAN SERVICING. New Home Study courses covering all makes electronic organ including transistors. Experimental kits — schematics — troubleshooting. Accredited NHSC-GI Approved. Write for free booklet. **NILES BRYANT SCHOOL**, 3631 Stockton Blvd., Dept. F. Sacramento 20, Calif.

SLEEP LEARNING. Hypnotism! Tapes, records, books, equipment. Details, strange catalog FREE. **RESEARCH ASSOCIATION**, Box 24-RD, Olympia, Wash.

MATHEMATICS. ELECTRONICS. Pay as you learn. Free brochure. **INDIANA HOME STUDY INSTITUTE**, P.O. Box 282, Saxonville, Mass.

CANADIAN INSTITUTE OF SCIENCE & TECHNOLOGY LTD. The world wide institute of home study—now offers a complete course in basic electronics, incorporating only the elementary principles of mathematics, for as little as \$40.00—send for details and your free sample lesson now. 498 Garden Bldg., 263 Adelaide St., West, Toronto.

Electronics

TV CAMERA components at lowest prices. Send 10¢ for money-saving list. **VANGUARD**, 190-48-99th Ave., Hollis, N. Y. 11423.

10 RADIO, TELEVISION DIAGRAMS. Our choice. \$1.00 Plus 20¢ stamps. **DIAGRAMS**, Box 1151 RE, Manchester, Conn. 06042.

ELECTRONIC MANUFACTURER, Tax Exempt, offers engineering and/or production at 60%. **MILLES ENGINEERING**, Las Marias, Puerto Rico.

GOVERNMENT SURPLUS. Voltmeters — \$1.05, Freqmeters—\$4.37, Transmitters—\$6.18, Oscilloscopes, Multimeters, Speakers, Parts. Typical Surplus Prices. Exciting Details FREE. Write: **ENTERPRISES**, Box 402-F17, Jamaica 30, New York.

BRAND NEW TUBES. World's lowest prices on Radio, TV - industrial - special purpose tubes. Write for free parts catalog. **UNITED RADIO CO.**, Newark, N. J.

CONVERT any television to sensitive, big-screen oscilloscope. Only minor changes required. No electronic experience necessary. Illustrated plans \$2. **RELCO**, Box 10563, Houston 18, Tex.

DIAGRAMS FOR REPAIRING RADIOS \$1.00. Television \$2.50. Give make, model. **DIAGRAM SERVICE**, Box 1151 RE, Manchester, Conn.

PROFESSIONAL ELECTRONICS PROJECTS — Organs, Timers, Computers, etc.—\$1 up. Catalog free. **PARKS**, Box 1665, Seattle, Wash. 98125.

CB TRANSMITTERS \$6.00. Other bargains, send 10¢ for list. **VANGUARD**, 190-48 99th Ave., Hollis 23, N.Y.

DIAGRAMS; RADIO, \$1.00 T.V. \$2.25. **SCHEMATICS**, 618 4th St., Newark, N.J. 07107.

"COIL WINDING METHODS" Handbook—50¢. Experimenters' catalog 250 exclusive items—25¢, refundable. **LABORATORIES**, 1131-B Valota, Redwood City, Calif.

General

Canadians

GIANT SURPLUS BARGAIN PACKED CATALOGS. Electronics, Hi-Fi, Shortwave, Amateur, Citizens Radio, Rush \$1.00 (Refunded), **ETCO**, Box 741, Dept. R. Montreal 1, Can.

BEFORE You Buy Receiving Tubes, Test Equipment, Hi-Fi Components, Kits, Parts, etc... send for your Giant Free Zalytron Current Catalog, featuring all STANDARD BRAND TUBES all Brand New Premium Individually Boxed. One Year Guarantee—all at BIGGEST DISCOUNTS in America! We serve professional servicemen, hobbyists, experimenters, engineers, technicians. WHY PAY MORE? **ZALYTRON TUBE CORP.**, 461 Jericho Turnpike, Mineola, N. Y.

SERVICES

SPEAKER RECONING. Satisfaction Guaranteed. **C & M RECONO CO.**, 18 E. Trenton Ave., Morrisville, Pa.

METERS—MULTIMETERS REPAIRED and calibrated. **BIGELOW ELECTRONICS**, Box 71-B, Bluffton, Ohio.

TRANSISTORIZED products dealers catalog, \$1. **INTERMARKET**, CPO 1717, Tokyo, Japan.

ALL MAKES OF ELECTRICAL INSTRUMENTS AND TESTING equipment repaired. **HAZELTON INSTRUMENT CO.**, 128 Liberty St., New York, N.Y.

Sons, Inc., 605 Third Ave., New York 16, N. Y.
5 3/4 x 9 in., 583 pp. Cloth, \$12.50.

Vectors and basic field equations, for engineering students. Mathematical analysis of transmission lines, waveguides, antennas.

ELECTRONIC TESTS AND MEASUREMENTS, by Robert G. Middleton. Howard W. Sams Co., Inc., 4300 West 62 St., Indianapolis 6, Ind. 5 1/2 x 8 1/2 in., 288 pp. Cloth, \$6.95.

Practical information on setting up and using test equipment. Covers a wide range of measurements including amplifiers, transistor characteristics, bridges, etc.

UNDERSTANDING TRANSISTORS AND HOW TO USE THEM. Allied Radio Corp., Chicago 80, Ill. 5 1/2 x 8 1/2 in., 96 pp. Paper, \$5.00.

A practical book for beginners. How to build your own radio, wireless broadcaster, capacity relay, many other devices.

END



"Let's see... I need one 5U4-G."

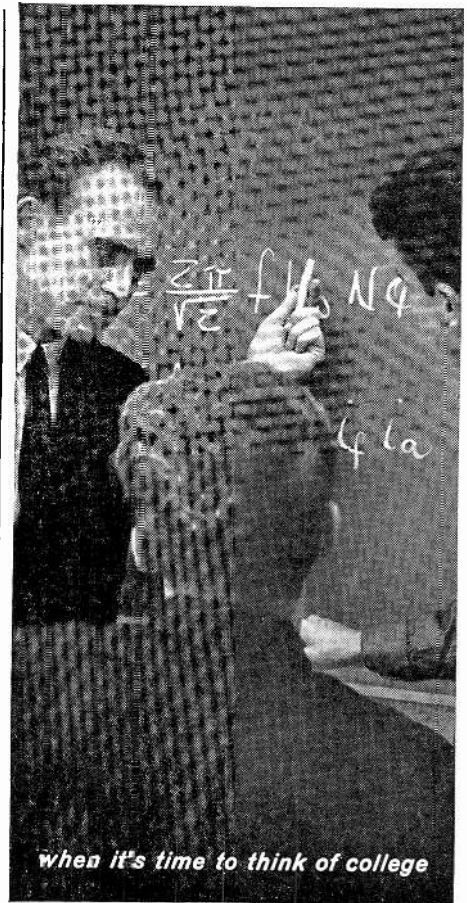

when it's time to think of college

SCHOOL DIRECTORY

FOR AN ELECTRONICS CAREER
Write For Free Catalog RE
WEEKLY TUITION

MICROWAVE TECHNIQUES—TV
INDUSTRIAL ELECTRONICS
COMPUTERS—RADIO
TRANSMITTERS—RADAR

PHILADELPHIA WIRELESS
TECHNICAL INSTITUTE
1533 Pine Street Philadelphia 2, Pa.
Founded in 1904 • A Non-Profit Corp.

Engineering Technician
A.S. Degree—2 Years
Electronics Engineer
B.S. Degree
Evening Courses Available

ELECTRONIC TECHNICAL INSTITUTE
970 W. Manchester Ave., Inglewood, Calif.
4863 El Cajon Blvd., San Diego, Calif.

ENGINEERING EDUCATION
for the Space Age

NORTHRUP INSTITUTE of Technology
is a privately endowed, nonprofit college of engineering offering a complete Bachelor of Science Degree Program and TWO-YEAR accredited technical institute curricula. Students from 50 states, many foreign countries. Outstandingly successful graduates employed in aeronautics, electronics, and space technology. Write today for catalog—no obligation.

NORTHRUP INSTITUTE OF TECHNOLOGY
1181 West Arbor Vitae Street, Inglewood 1, California

EARN Electronics DEGREE
Engineering

You can earn an A.S.E.E. degree at home. College level HOME STUDY courses taught so you can understand them. Continue your education, earn more in the highly paid electronics industry. Missiles, computers, transistors, automation, complete electronics. Over 27,000 graduates now employed. Resident school available at our Chicago campus—Founded 1934. Send for free catalog.

American Institute of Engineering & Technology
1139 West Fullerton Parkway, Chicago 14, Ill.

B. S. Degree in 36 months

Small professionally-oriented college. Four-quarter year permits completion of B.S. Degree in three years. Summer attendance optional. *Engineering*: Electrical (electronics or power option), Mechanical, Civil, Chemical, Aeronautical. *Business Administration*: General Business, Accounting, Motor Transportation Administration. One-year Drafting-Design Certificate program. Outstanding placement of graduates. Founded 1884. Rich heritage. Excellent faculty. Small classes. 200-acre campus. Well equipped labs. New library. Residence halls. *Modest costs*. Enter March, June, Sept., Jan. *For Catalog and View Book*, write J. G. McCarthy, Director of Admissions.

TRI-STATE COLLEGE
2424 College Avenue • Angola, Indiana

GET INTO
ELECTRONICS

V.T.I. training leads to success as technicians, field engineers, specialists in communications, guided missiles, computers, radar and automation. Basic & advanced courses in theory & laboratory. Electronic Engineering Technology, an ECPD accredited Technical Institute curriculum, Assoc. degree in 29 mos. B.S. also obtainable. G.I. approved. Graduates in all branches of electronics with major companies. Start Feb., Sept. Dorms, campus. High school graduate or equivalent. Catalog.

VALPARAISO TECHNICAL INSTITUTE
Department C, Valparaiso, Indiana

C. L. Foster, President, Central Technical Institute, says:



"Why be satisfied with home study electronics training that goes only half way?"

Get facts about new, modern training in
PRACTICAL ELECTRONICS
plus... bonus training in
APPLIANCE and ELECTRICAL REPAIR and WIRING

Trained Men Needed NOW
FOR...
• Color TV Servicing
• Broadcasting
• Industrial Electronics
• Manufacturing
• Guided Missile Systems
• Hi-Fi and Sound Installation

One of America's Leading Electronics Schools Now Offers Important "Plus Training"

Rush coupon to find out how much more Central Technical Institute offers! Our new course in **Practical Electronics Technology** prepares you for a good paying career in this booming industry. Qualify for opportunities open to trained men in Radio-TV Servicing, Color Television, Manufacturing, etc. Get **bonus** training **without added cost** in profitable Appliance Servicing and Electrical Wiring. Earn extra money in spare hours while training! New easy-to-understand "plain language" lessons! You "learn-by-doing" with training kits we supply. Graduate resident training available, with full credit for home study. **Practical Electronics Technology** also gives you essential background for optional advanced training in Broadcasting, Communications, Nuclear Power or Aero Space Industry to help you specialize. Rush coupon for new FREE BOOK. Est. 1931... Accredited by National Home Study Council.



FREE BOOK - MAIL COUPON

Central Technical Institute, Dept. 03024
1644 Wyandotte St., Kansas City 8, Mo.

Rush latest edition "Practical Electronics" telling about careers in Electronics for trained men—FREE!

Name.....
Address.....
City.....Zone.....State.....

find out about engineering at MSOE

Planning your education correctly now will enhance your career later! That's why you should obtain all the facts about MSOE programs in Electrical and Mechanical Engineering and Technology.

Learn about courses leading to 4-year Bachelor of Science and 2-year Associate in Applied Science degrees. Find out about MSOE scholarships, financial aids, job placement opportunities, and other services.

Assure yourself of a bright future in the exciting field of space age engineering and technology. Write for your free "Career" booklet which will tell you about educational advantages at MSOE.



MSOE

MILWAUKEE SCHOOL OF ENGINEERING
Dept. RE 264
1025 N. Milwaukee St.
Milwaukee, Wisconsin 53201

Tell me about an engineering career through residence study in:

Electrical fields Mechanical fields

Name..... Age...

Address.....

City, State.....

FREE

NEW 1964 GIANT CATALOG

100'S OF BARGAINS NOT IN ANY OTHER CATALOG

100's of new items listed for first time

EVERYTHING IN HI-FI AND STEREO

Satisfaction GUARANTEED or your money back!

TOP VALUES IN POWER & HAND TOOLS

TUBE PARTS ETC. AT LOWEST PRICES

100's of pages packed with savings

SAVE UP TO 50% ON CHOICE KITS

NO MONEY DOWN PLUS NEW REVOLVING CHARGE ACCOUNT

FOR 37 YEARS THE OUTSTANDING MONEY SAVING BUYING GUIDE FOR:

- Stereo & Hi-Fi Systems and Components
- Tape Recorders
- Electronic Parts, Tubes, Books
- Phonos & Records
- Ham Gear
- Test Instruments and Kits
- Cameras and Film
- Public Address
- Citizens Band
- Transistor & FM-AM Radios.

BURSTEIN-APPLEBEE CO. Dept. RE,
1012-14 McGee St., Kansas City 6, Mo.

Rush me the FREE 1964 B-A Catalog.

NAME _____

ADDRESS _____

CITY _____ STATE _____

RUSH COUPON TODAY

COMING NEXT MONTH:

Radio-Electronics HIGH FIDELITY-TAPE RECORDER ISSUE

MARCH ISSUE (SEE PAGE 104)

ADVERTISING INDEX

Radio-Electronics does not assume responsibility for any errors appearing in the index below

Acoustic Research Inc.	96
Aerovox Corp.	57
Allied Radio Corp.	100
Arco Electronics, Inc. (Arcolytic Div.) Cover 3	
B & K Manufacturing Co.	70
Barry Electronics Corp.	105
Blonder-Tongue Labs.	10
Brooks Radio & TV Corp.	88, 100-101
Burstein-Applebee Co.	110
Cadre Industries Corp.	106
Capitol Radio Engineering Institute	19-22
Castle TV Tuner Service	8
CLASSIFIED ADS	108
Cleveland Institute of Electronics	72-75
Columbia Stereo Tape Club	3
Conar Instruments (Div. of National Radio Institute)	103
Cornell Electronics	102
Coyne Electrical School	80, 102
DeVry Technical Institute	7
Editors & Engineers	103
EICO Electronic Instrument Co.	24
Electro-Voice Inc.	11
Electronic Chemical Corp.	98
Electronic Measurement Corp. (EMC)	88
Fair Radio Sales	97
Gernsback Library	86, 99
Grantham School of Electronics	13
Heald's Engineering College	98
Heath Co.	59, 61, 63, 65, 67, 69
Hitachi Ltd.	71
International Crystal Mfg. Co., Inc.	87
Key Electronics Co.	103
Lafayette Radio	93-94
Lectrotech Inc.	81
(P. R.) Mallory Co., Inc.	15
Massey Technical Institute	105
Multicore Sales Corp.	102
National Radio Institute	55-56, 101
National Technical Schools	5
North American Phillips Co., Inc. (NORELCO)	66
Olson Electronics Inc.	98
Philco (Techrep Div.)	90
Polypaks	97
Progressive "Edu-Kits" Inc.	89
Quietrol Co.	102
Rad-Tel Tube Co.	91
RCA Institutes	82-85
RCA (Parts and Accessories)	9
RCA (Test Equipment)	77
RCA (Tube Division)	Cover 4
(Howard W.) Sams & Co.	17, 92
Schober Organ Corp.	23
(H. H.) Scott, Inc.	80
Sencore	81
Sonotone Corp.	14
Sprague	12
Sony Corp. of America	58
Sylvania Electronic Instrument Co.	16, 90
Texas Crystals (Div. of Whitehall Electronics)	80
Triad Distributor Div.	18
Triplett Electronic Instrument Co.	Cover 2
Winegard Co.	78-79
MARKET CENTER	107
Bigelow Electronics	
Coloraptor	
Edmund Scientific Co.	
Oelrich Publications	
Relco	
Spera Electronics	
Stereo-Parti	
Transistors Unlimited	
Warren Electronic Components	
SCHOOL DIRECTORY	109
American Institute of Engineering & Technology	
Central Technical Institute	
Electronic Technical Institute	
Milwaukee School of Engineering	
Northrop Institute of Technology	
Philadelphia Wireless Technical Institute	
Tri-State College	
Valparaiso Technical Institute	

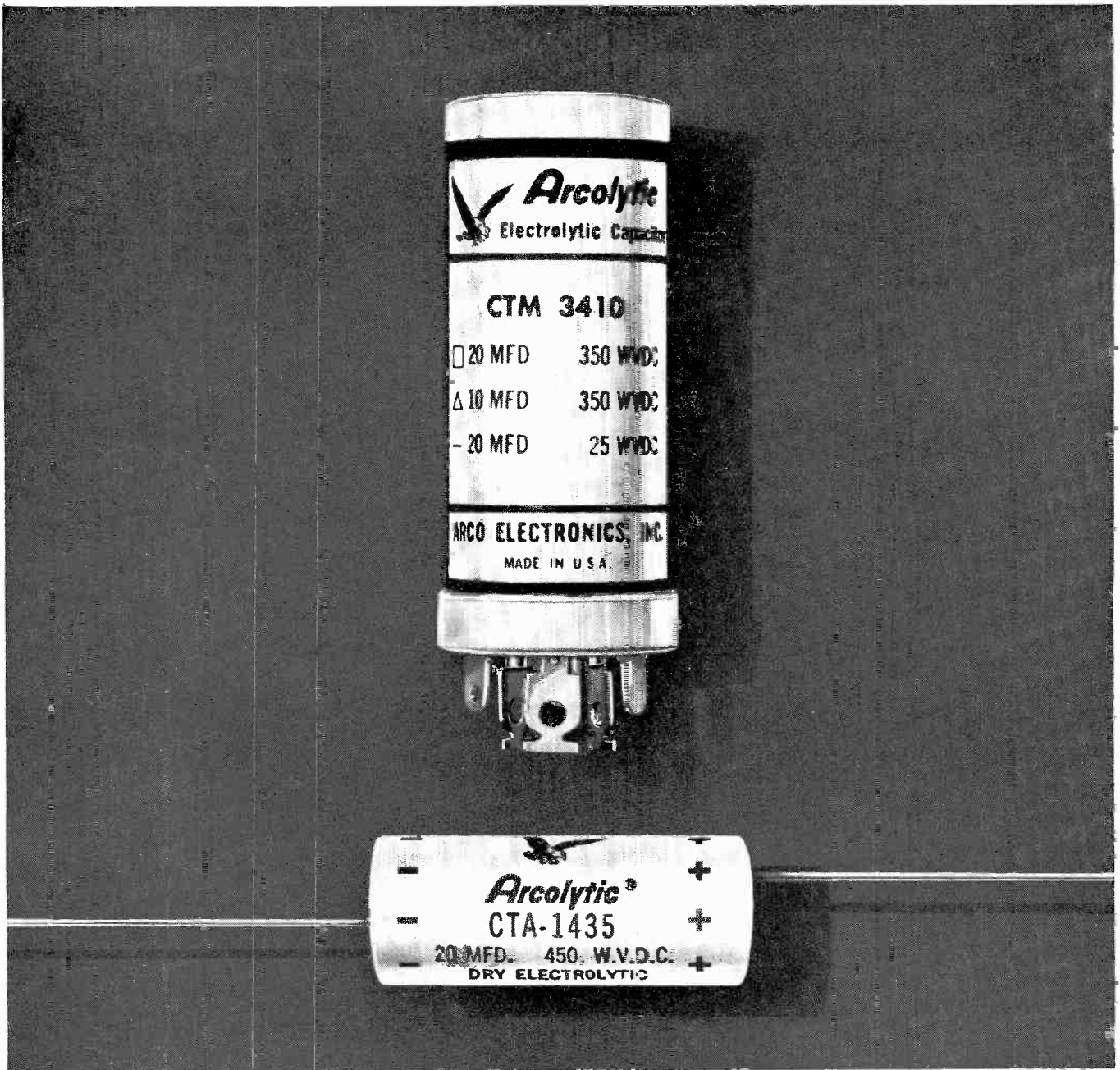

For quality and service...**ARCOLYTIC!**

These superior quality electrolytic capacitors are made of 99.99% pure aluminum foil . . . designed to operate at 85°C, and withstand high ripple and surge voltages. All are made and tested to EIA RS-154. Premium grade materials and construction make Arcolytics last longer—on the shelf . . . and in the set! Over 1400 values to meet all requirements for tubular and twist-mount electrolytics—single, dual, triple or quad-



riples capacitance in voltage combinations for radio, tv and industrial electronics. All unconditionally guaranteed! No extra charge for this high quality. You can get your Arcolytics in any quantity within 24 hours from coast to coast. They're stocked in depth at Arco's reserve warehouses serving authorized

Arco distributors throughout the nation. Call your Arco distributor today!

ARCO

electronics inc.

Community Drive, Great Neck, New York

Branches: Dallas 7 □ Los Angeles 35

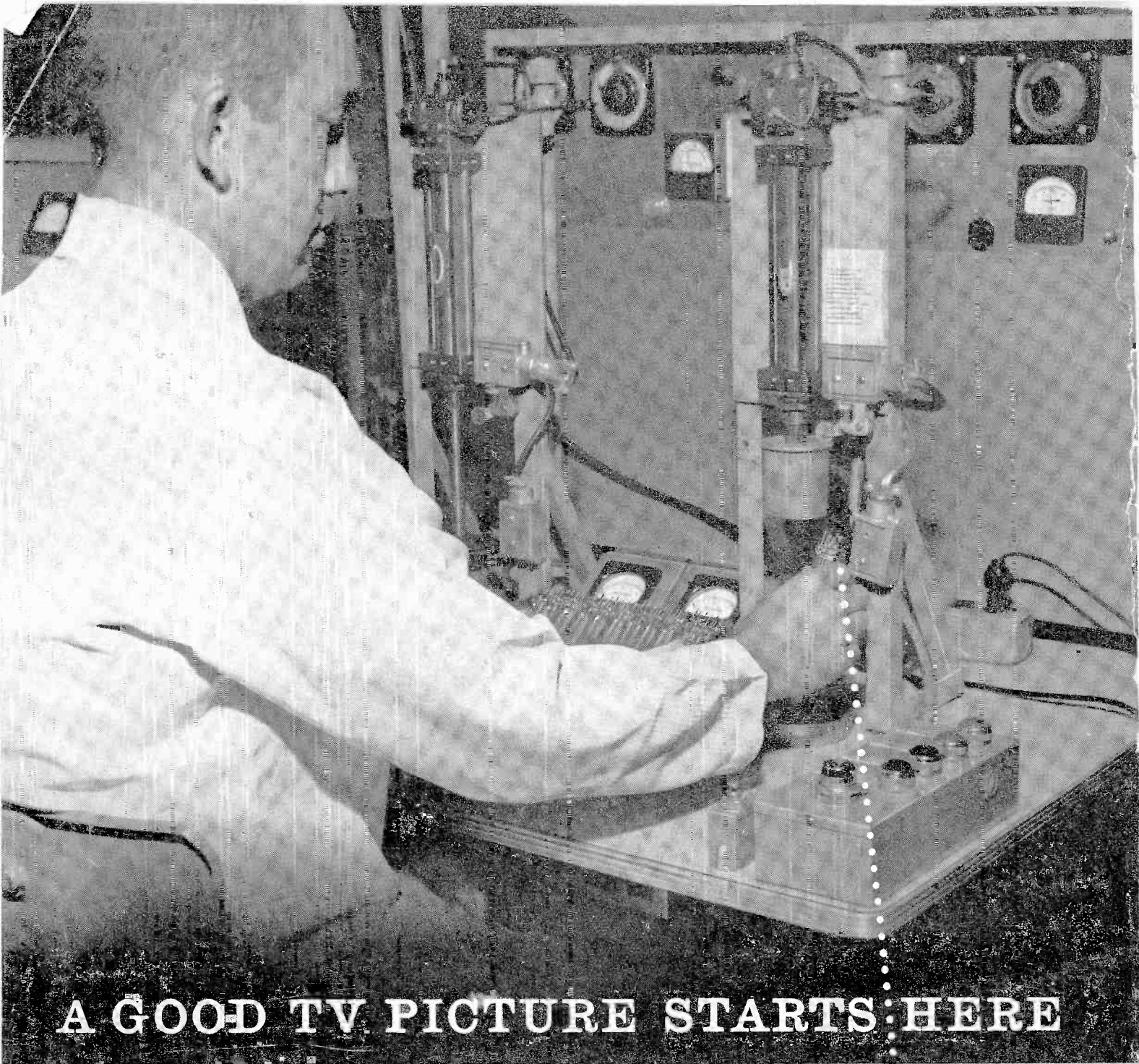

A GOOD TV PICTURE STARTS HERE

It Depends on a Leakproof Stem Seal

The slightest leakage of air weakens the high vacuum of a TV picture tube...resulting in a costly callback and a dissatisfied customer for you. This is why RCA takes extra precautions to maintain the vacuum in Silverama picture tubes.

Potential trouble spots are the glass-to-metal lead-wire seals in the electron-gun stem assembly (below). At RCA, stem assemblies are batch tested for leakage in a supersensitive leak detector *before* they go into electron guns.

So sensitive is this detector that it can pinpoint a leak that would not affect tube performance for years...a leak so tiny that no other inspection method could hope to find it.

Yet the slightest sign of a leak is cause for rejection of a stem. This extra precaution is one more example of the care that goes into every phase of Silverama manufacture...and one more reason why RCA Silverama should be your first choice in replacement picture tubes.

Silverama is made with an all-new electron gun, finest parts and materials, and a glass envelope that has been thoroughly cleaned and inspected prior to re-use.

RCA ELECTRONIC COMPONENTS AND DEVICES, HARRISON, N. J.



The Most Trusted Name in Electronics

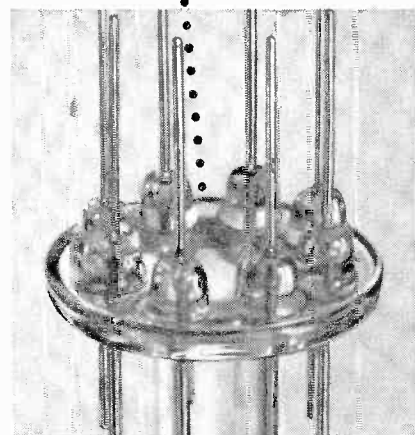

Stem assemblies are tested on a special high-vacuum leak detector. Detector is a helium mass-spectrometer, detecting passage of helium "tracer" gas through any of the glass-to-metal seals. A stem assembly passing this rigorous test is ready to become a vital part of an RCA Silverama® Picture Tube.