

RADIO & Television RETAILING

Including
**ELECTRICAL
APPLIANCES**
Section

See pp. 57-86

CALDWELL-CLEMENTS, INC. ★ NOVEMBER 1945



**USE
EVERY
SALES AID
NOW, TO
BUILD BIG
CHRISTMAS
ORDERS!**

**Profit Pointers in AM, FM,
Sets, Service and Records**

Selective Distribution



What's That?

Plenty! It means that Mallory is not content merely to manufacture the finest replacement parts made. It wants you to have them *where* and *when* you need them—with assistance *when you need it* on the *best way* to use them. That's why it has selected for your area the most outstanding distributor it could find: one

completely familiar with the electronics field, alert and intelligent, willing and able to give you *any* help you need—from problems of procurement to problems of merchandising. Selective Distribution means a Mallory wholesaler fitted by experience to save you time and worry. Get to know him better!

Here's What Your MALLORY Distributor Will Do For You:

1

Offer you a complete line of Mallory replacement parts... many of them first developed by Mallory research... ALL of them guaranteed against premature failure by years of service in the field.

2

Meet the maximum number of your application needs with the minimum number of parts. His program of Mallory Standardization will reduce your investment, simplify replacement, speed up delivery.

3

Give you detailed information on prices, parts, catalog numbers... work his head off to get you the items you need when you need them... give you prompt, efficient service *always*.

4

Provide you with bulletins, booklets, catalogs, letters, giving complete data on what to use and where to use it... offer you special publications and new developments and technical service fundamentals.

5

Offer his own personal experience in helping you solve unusual or difficult problems... help you train sales and service personnel... give you the extra help you need to meet emergencies.

6

Provide you, if asked, with sound methods of keeping your business on the beam... give you special promotion materials to help you sell your story to the public.

The Part Your Mallory Distributor Plays Is Important TODAY—to YOU!

P. R. MALLORY & CO., Inc., INDIANAPOLIS 6, INDIANA



*More than ever—
ALWAYS
INSIST ON*

P. R. MALLORY & CO. Inc.
MALLORY
APPROVED
PRECISION PRODUCTS

**VIBRATORS • VIBRAPACKS* • CONDENSERS
VOLUME CONTROLS • SWITCHES • RESISTORS
FILTERS • RECTIFIERS • POWER SUPPLIES**

ALSO MALLORY "TROPICAL"™ DRY BATTERIES, ORIGINALLY DEVELOPED BY MALLORY FOR THE U. S. ARMY SIGNAL CORPS, NOT PRESENTLY AVAILABLE FOR CIVILIAN USE.

*Reg. U. S. Pat. Off.

RADIO & Television RETAILING*

Including Radio and Television Today

Including
**ELECTRICAL
APPLIANCES**
Section

IN THIS ISSUE

NOVEMBER, 1945

ORESTES H. CALDWELL
Editor

M. CLEMENTS
Publisher

JOHN L. STOUTENBURGH
Managing Editor

HELEN THURMAN
Associate Editor

WILLIAM E. MOULIC
Technical Editor

CHARLES F. DREYER
Art Director

Assistant Editors

NATHANIEL J. KERN

SOLOMON HELLER

E. T. BENNETT

RUTH MORRIS

STEPHEN I. HALL
Merchandising Editor

BUSINESS DEPARTMENT

LEE ROBINSON
Sales Manager

M. H. NEWTON
Business Manager

J. A. SAMBORN

R. P. FOX

G. B. ANDREWS

B. V. SPINETTA
Circulation Manager

BEN MORRIS
Promotion Manager

J. COSIN
Research

B. HALL
Production

Branch Offices

CHICAGO

R. Y. FITZPATRICK
201 N. Wells St.
RAN 9225

CLEVELAND

DUDLEY B. TROTT
Citizens Bldg., 350 Euclid Ave.
MAin 8270

LOS ANGELES

ROBERT W. WALKER
Walker & Minton
403 W. 3rd St.
VAndike 9348

SAN FRANCISCO

ELI C. MINTON
Walker & Minton
62 Post St.
SUitor 5568

★ Radio, Television and Records

COVER: Put Selling Aids to Work!

EDITORIAL—Use What You Have to Get the Sale	29
RADIO, TELEVISION, RECORDS, APPLIANCES TODAY	30
HOW TO SELL CUSTOMERS "UP"	32
FORMULA FOR SALES INCREASE	34
TODAY'S DEALER AND AUTO RADIO	36
THE 1946 TELEVISION PICTURE	38
RADIO SHOWCASE—Presenting the New Sets	40
NETWORK SHOWS HELP THE DEALER SELL	46
MORE DOLLARS IN DISCS	48
PROFITABLE RECORD SELLING	50
TEEN-AGE RECORD MARKET	52
SERVICE IS A SALES FUNCTION	55
RADIO DIRECTORY	56

★ Electrical Appliances

COVER: Remind Customer to Call You

WHO SELLS THE APPLIANCES?	59
NEW APPLIANCE MERCHANDISING METHODS	60
APPLIANCE OPERATING COSTS	62
STORE "FACE-LIFTING" UPS SALES	64
NEW APPLIANCE SHOWCASE	68
REFRIGERATOR SERVICE TIPS	84
APPLIANCE DIRECTORY	85
LATEST PROMOTION MATERIAL	86

★ Service and Sound

NEW PRODUCTS OFFERED	88
WHO'LL SERVICE FM AND TELEVISION	93
SERVICING FILTER CAPACITORS	96
AUTO VIBRATOR STANDARDIZATION	102
GARAGE DOOR ACTUATOR	107
GET READY FOR TELEVISION	114
SERVICE DRAWS SALES	116
SETS SCENE FOR SALES	126
DISTRIBUTOR NEWS	132
MANUFACTURER CHANGES	145
NEWS OF THE INDUSTRY	135 to 178



CALDWELL-CLEMENTS, INC.—TEL.: PLAZA 3-1340—480 LEXINGTON AVE., NEW YORK

How ECA Radio Builds BRAND LOYALTY



ECA Radios and Radio-Phonographs will be available in a complete line—a model for every purpose. Each set carries the ECA Radio WARRANTY TAG of Accurate Performance Rating.

...to help your store

Surveys covering ALL leading makes of radios—show that an alarming number of consumers *never buy the same brand of radio twice*. And—when consumers change brands—they usually change stores. Here is how ECA Radio is building *brand loyalty*—to keep your customers . . . and their friends . . . LOYAL TO YOUR STORE.

● ECA RADIO MAKES FINER SETS

Built into these amazing post-war ECA Radios are the experience gained during our 21-year background in radio and our wartime experience in making vital radar test equipment. Each part we

use costs more—so every ECA Radio will give the consumer much more—in tone, in performance, in value.

● ECA RADIO WARRANTS THE PERFORMANCE

A Warranty Tag attached to every ECA Radio rates the set as to sensitivity, speaker size, frequency range and other important points. It also warrants that the set will perform in accordance with the ratings given. The ECA Radio Warranty Tag is an "informative label" that gives the consumer the facts, and solidifies his confidence in *your store*.

FEATURES OF ECA RADIO DEALER FRANCHISE

Greater brand loyalty is only one of MANY advantages you get with the ECA Radio Dealer Franchise . . . others are:

- Complete line—sold direct
- Heavier deliveries, because only limited number of dealers will be selected
- Freight paid to your city
- Protected dealer profits
- "Pre-sold" consumers
- Extensive advertising

A FEW FRANCHISES STILL OPEN
—WRITE FOR DETAILS TODAY

DYNAMIC NATIONAL ADVERTISING . . .

Full page advertisements reaching millions of readers are appearing in leading national magazines—Collier's . . . American Home . . . and others. Every ad emphasizes the finer quality of ECA Radios . . . dramatizes the ECA Radio Warranty Tag . . . the exclusive DI-FUSA-TONE® feature and other acoustic and electronic innovations of ECA Radios—and directs people to ECA Radio Franchised Dealers.

*Reg. U. S. Pat. Off.



ELECTRONIC CORP. OF AMERICA

45 WEST 18TH STREET, NEW YORK 11, N. Y.



Sensational,
New

MUSICAL INSTRUMENT

Fascinating

EDUCATIONAL TOY

**TRAFFIC
BUILDER!**

**CROWD
CATCHER!**

**PROFIT
BOOSTER!**

**EVERYONE CAN PLAY IT!
EVERYONE WILL LOVE IT!**

typatune*

RETAILS (complete with MUSIC BOOK) at \$14.95

TYPATUNE is quality-made—needs no tuning, no servicing. Has 32 musical notes—2½ chromatic octaves—indicated by letters of alphabet arranged exactly like standard typewriter keyboard. TYPATUNE Music Book with each instrument enables anyone to play TYPATUNE and learn touch-typing automatically. Smart wood case—attractively finished in red and green. Size 11½" x 10" x 3¾" . . . weighs about 5 lbs.

Red-hot for promotion at any time in Toy, Music, Gift, Stationery Departments. Order now—for your Christmas push!

typatune* inc. 45 West 18th Street
New York 11, N. Y.

*REG. U. S. PAT. OFF.

It's the talk of the toy trade! From all over the country orders are pouring in. Big stores, small stores, chain organizations—they're planning Typatune promotions—preparing to cash in on this terrific toy item. No wonder! TYPATUNE fascinates men, women, and children. Looks like a stream-lined portable typewriter—but it's actually an amazing musical instrument . . . at a popular-gift price. Anyone can play TYPATUNE . . . and everyone *wants* to!

PROMOTIONAL HELPS—National advertising and publicity . . . counter and window displays . . . envelope stuffers . . . newspaper mats . . . demonstration instructions . . . all to help bring you *more traffic, more sales, more profits!*

USE THIS ORDER COUPON NOW!

TYPATUNE, Inc.
45 West 18th Street
New York 11, New York

Gentlemen:

Enter our order for _____ dozen TYPATUNES (assorted colors). Price is \$14.95 per TYPATUNE, less 40%—Terms: 2%, 10 days, Net 30 . . . F.O.B., N. Y. C.

Manufactured by Electronic Corp. of America

STORE NAME

BUYER

ADDRESS

CITY STATE

(Attach to your order blank)

RR-11

MERIT
CVC
Since 1924
FINE
RADIO
PARTS

A PRODUCT OF
Merit
TRANSFORMERS
POWER
AUDIO
CHOKES

MERIT COIL & TRANSFORMER CORP.
4427 NORTH CLARK STREET CHICAGO 40, ILL.

MERIT COIL & TRANSFORMER CORP.
TELEPHONE
4427 North Clark St. Long Beach 6311 CHICAGO 40, ILL.

27,000 Copies!

A Statement from the Publisher on Progress in Circulation

In the past six months the circulation of RADIO & Television RETAILING has increased almost fifty per cent. In June our net paid ABC was 19,942. By December, guaranteed distribution will be over 27,000. You may be interested in knowing some of the factors which caused this increase.

We are facing now the reverse of what happened from 1940 through 1944. At every opportunity we eliminated or dropped subscriptions from men who left the radio business to enter military service or work in war plants. This caused our paid circulation to contract—down to 17,000. Today, seemingly from every field, new capital and new retailers are setting up shop to produce—and to sell—more radios and electrical appliances than ever before. Veteran dealers and returning servicemen gaze with equal fascination on our field.

From 17,000 and then 19,000, we have gone now to 27,000. It appears that one of the first things new retailers and manufacturers are doing is to subscribe to our magazine—voluntarily. No ceiling is being set for RADIO & Television RETAILING—we are allowing it to seek its own level. With no arbitrary circulation goal to meet, no special circulation-getting methods are needed.

The current vast activity engulfing the entire trade is a manifestation of what is happening in the national economy. Our duty here is to look out for the retailers in our field by publishing the kind of magazine which is the most helpful to them. In doing so, we automatically deliver to manufacturers the buying outlets of the nation. We have been doing that for twenty years. We hope to continue doing so.

M. Clements



**20,000
VOLTS
IN A
2³/₈" BULB!**

ANOTHER "FIRST" BY NATIONAL UNION RESEARCH LABORATORIES

An example of how war-time research by National Union engineers is helping to lay the foundation for vastly improved post-war Television, FM and radio reception, is this new half wave high vacuum rectifier—the NU 1Z2.

Here is a miniature with the voltage-handling capabilities heretofore possible only in full size tubes. For a high voltage rectified supply in the operation of radar and television equipment, the NU 1Z2 saves space—operates with increased efficiency—is exceptionally rugged. Its low filament power consumption suggests many new fields in circuit design and application, especially to the "ham" and experimenter.

For the distributor and service dealer, such original N. U. electron tube developments are creating new opportunities for profitable N. U. Tube replacement sales—today and in the future.

*National Union 1Z2
High Voltage Rectifier*

Inverse peak anode voltage- max.....	20,000 volts
Peak anode Current.....	10 ma.
DC Output Current.....	2 ma.
Filament Voltage.....	1.5 volts
Filament Current.....	300 ma.

The NU 1Z2 is designed to withstand shocks in excess of 500 G's.

Maximum overall length.....	2.70"
Maximum seated height.....	2.37"
Maximum diameter.....	.75"
Bulb.....	T5½
Base Miniature Button.....	7 pin
Mounting position.....	Any

**NATIONAL UNION
RADIO AND ELECTRON TUBES**

NATIONAL UNION RADIO CORPORATION • NEWARK 2, N. J.



The new Magnavox Belvedere, authentic Chippendale at its conservative best.

The Magnavox Line Offers a Lasting Investment in Gracious Living for Customers of Fine Stores

WHEN CUSTOMERS HEAR the new Magnavox their acclaim will be universal. For to hear Magnavox is a thrilling demonstration of *all* the wonders of radio science. After comparing the tone of Magnavox with all other radio-phonographs, they will agree that in Magnavox all the music is so faithfully reproduced that listening becomes a new and wonderful experience.

Not only a superb musical instrument, each of the new Magnavox models is truly fine furniture. Customers may choose from a variety of models, from authentic traditional to the most refined contemporary styling. Each is a masterpiece of furniture craftsmanship that offers as well, the utmost in functional convenience and acoustical efficiency.

The Magnavox dealer enjoys the added prestige and customer satisfaction that accompany the sale of a quality instrument. There is further, the non-competitive, profit-protecting Magnavox franchise that assures ample markets and good profits.

In looking to the future, and continuing customer satisfaction and good will, look to Magnavox for leadership. The Magnavox Company, Fort Wayne 4, Indiana.



KEN-RAD

Little Giant MINIATURE TUBES



Better than ever

● Power-packed Ken-Rad Miniature Tubes have helped to popularize the friendly companionship of portable radios . . . Now still finer tube performance is assured by Ken-Rad's association with new, large research and engineering facilities . . . The ever-growing consumer demand for Ken-Rad *quality* means increased *profits* for Ken-Rad Tube Dealers!

Write for your copy of
"Essential Characteristics"
the most complete digest of
tube information available.

178-D13-8850

KEN-RAD

DIVISION OF GENERAL ELECTRIC COMPANY

OWENSBORO, KENTUCKY

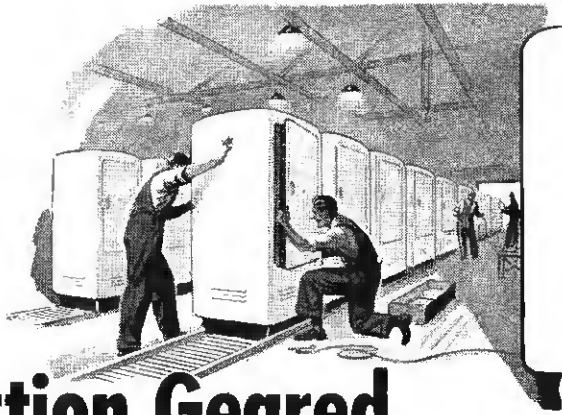

Production Geared

Would you like to get double duty out of your first year's factory production? Do you want the quick distribution you will need during reconversion? Then consider the \$4,496,734,000 Chicago market—a rich, compact area located at the heart of America, easily accessible to factory shipments and salesmen alike. Here is a market with a huge pent-up demand for radios, washing machines, refrigerators, "big unit" products generally. Moreover, it is fortified by diversified income and billions in savings.



to Faster Sales

No matter whether your production is large or small, the Chicago market will reward your attention as the place to get the consumer buying you want. This strategic area offers quick sales and solid dealer and consumer preference when the first easy selling conditions pass and the competition gets tough. Long famous for its big volume purchases, the Chicago market has repeatedly broken factory and branch sales records.



Available for your study and use is a specific Tribune sales program based on the findings of an auto and household appliance investigation among consumers and dealers. To get these pertinent facts, address: C. S. Benham, Manager, National Advertising, Chicago Tribune, Tribune Tower, Chicago 11, Illinois.

Get started quickly in this great market at one low cost and through a single advertising medium—the Chicago Tribune. One out of every three families in 756 cities and towns of 1000 or more population in this area reads the Tribune on weekdays. On Sundays, it is practically every other family. Only the Tribune offers you a choice of monoroto, coloroto, comicolor, newsprint color and black-and-white printing—whichever you prefer—at one of the lowest milline rates in the country. For marketing facts and merchandising ideas, call a Tribune representative.

in the great Chicago Market!

CHICAGO TRIBUNE
THE WORLD'S GREATEST NEWSPAPER

September average net paid total circulation:
Daily, over 1,025,000; Sunday, over 1,300,000

Many headlines like this
have raised the question

**RADIO RACKETEERS
ASSAILED BY COURT**

Declaring that radio repairmen were fleecing customers by charging all the traffic.

Should Radio Service Dealers be *Licensed?*

RAYTHEON

HAS THE ANSWER!

and will announce it shortly . . .

Screaming headlines in the New York Times, the World Telegram, the Herald-Tribune, articles in *The Reader's Digest*—you know the unfavorable talk they have helped spread, the hardship they have worked on every *honest* radio service dealer.

DEALER LICENSES DISCUSSED

You are well aware that federal regulation, *dealer-licensing* and even finger printing, are being suggested and discussed by a lot of influential people.

What's the answer? *Raytheon will announce it shortly* for Raytheon has been working for years on a new, foolproof way to protect the public—and to help the *ethical radio service man*. A revolutionary new merchandising plan that will raise the public's opinion of the radio servicing profession and protect the reliable service dealer from outside interests.

GREAT COMPETITIVE ADVANTAGE

You can see the tremendous competitive advantage this Raytheon plan will give every dealer who can qualify! Watch for all the facts on the Raytheon program to protect the public — and help the honest service-dealer!

Raytheon Manufacturing Company

RADIO RECEIVING TUBE DIVISION

NEWTON MASSACHUSETTS • LOS ANGELES • NEW YORK
CHICAGO • ATLANTA

COPYRIGHT 1945 RAYTHEON MANUFACTURING COMPANY



DEVOTED TO RESEARCH AND THE MANUFACTURE OF TUBES FOR THE NEW ERA OF ELECTRONICS

YES, THE "HAMS" ARE COMING BACK IN DROVES!



With the re-opening of the 2½ meter band, you have probably felt already the initial impact of a tremendous "ham" buying surge. This demand will mount rapidly during the coming months. Before the war there were 60,000 licensed radio amateurs in the United States. QST estimates a growth to 250,000 within five years. The ham market can mean real profits for you.

Hytron is paving the way for you. A brand new Hytron transmitting and special purpose tube catalogue has just been published. It is written for the ham in ham language. A two-page spread is scheduled for the 1946 ARRL handbook. September and October issues of QST carry full-page advertisements featuring the new Hytron OA2, OB2, and 2E25.

The Hytron transmitting and special purpose tube line is complete. Particularly stressed are the low and medium power tubes the average amateur wants to buy. Hytron has an established and enviable reputation for very-high-frequency tubes like the HY75, HY114B, and HY615. WERS amateur operators used these tubes almost exclusively during the war. The tubes are not obsoleted by the new amateur band changes to 144-148 mc. and 220-225 mc.

Wartime experience is helping Hytron engineers to maintain their lead on the higher frequencies. New Hytron v-h-f and u-h-f tubes are now in the works. Prepare to meet the snowballing amateur demand for Hytron tubes. Round out your stock today. Plan to add the new types as they are announced.



OLDEST MANUFACTURER SPECIALIZING IN RADIO RECEIVING TUBES

HYTRON

RADIO AND ELECTRONICS CORP.

MAIN OFFICE: SALEM, MASSACHUSETTS



Wherever the

GAROD LINE

is shown...

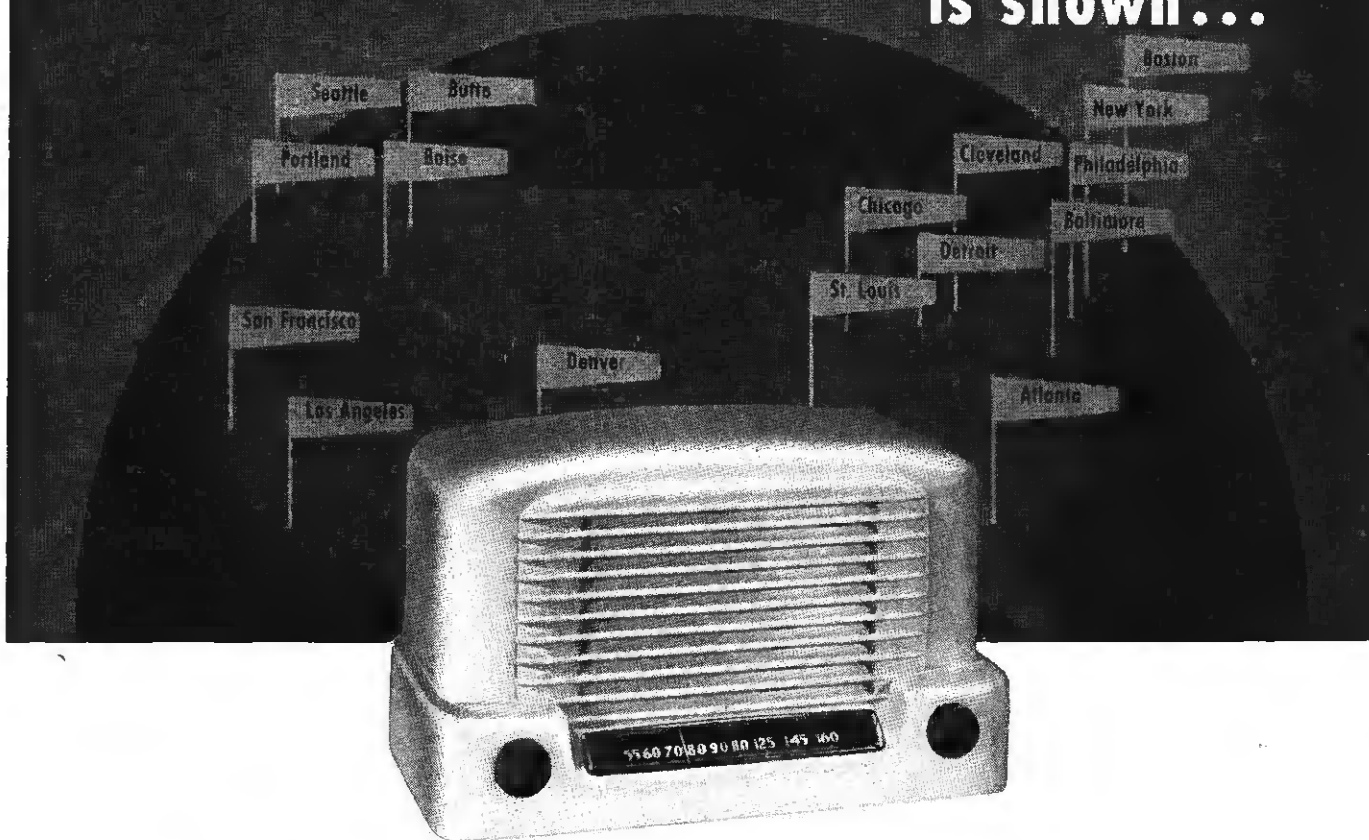

dealers say, *“this is it, boys!”*

Not until you've seen what dealers in these cities have seen will you appreciate the magnetism of the Garod Line. And this isn't something the advertising man dreamed up. He's been at all the "Shows", talked to the dealers, heard them talk among themselves, and seen names being signed to franchise agreements. The Garod Line will be shown in your territory soon... contact your local Garod distributor now.

GAROD  **RADIO**

GAROD RADIO CORPORATION • 70 WASHINGTON STREET • BROOKLYN 1, N. Y.

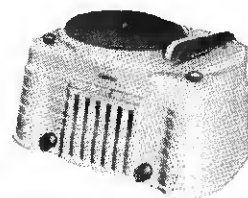
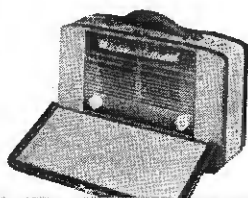
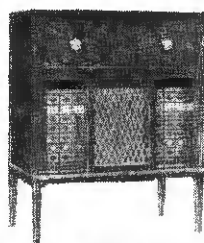

ARVIN

Top Flight

RADIOS

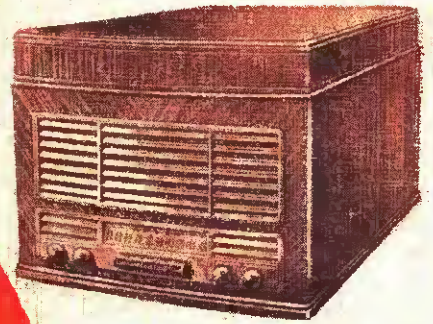

6-TUBE Model 669
with Automatic Changer
Walnut Wood Veneer Cabinet

Here's The

7 TABLE RADIOS

● In every group, the Arvin line gives you a broad spread of customer buying interest—with exceptional sales appeal in the features and price of each model.

Seven table radios from 4 to 6 tubes, including two battery sets, in beautiful, practical cabinets. And top flight small set performance will win you sales for the larger Arvins. Here is a wide range of selling opportunities in table radios—at list prices from \$12.00 to \$30.00 approximately.

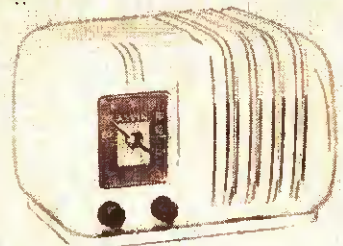

5-TUBE AC-DC Model 544
Ivory or Walnut Plastic Cabinet



4-TUBE AC-DC Model 444
Ivory or Walnut Finish
Non-breakable Cabinet

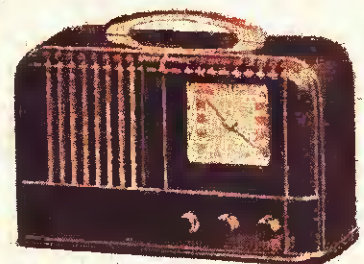

6-TUBE AC-DC Model 664
Walnut or Ivory Plastic Cabinet

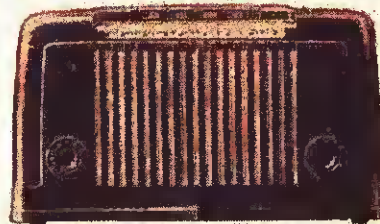

5-TUBE AC-DC Model 555
Walnut or Ivory Plastic Cabinet



6-TUBE AC-DC Model 666
Walnut Wood Finish Cabinet



4-TUBE BATTERY Model 541B
Walnut Wood Finish Cabinet

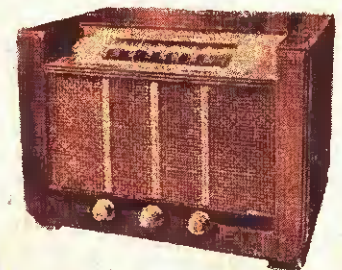

5-TUBE BATTERY Model 641B
Walnut Wood Finish Cabinet

You'll Profit
with **ARVIN**

ARVIN is the name on products of experience coming from



5-TUBE Model 559
with Automatic Changer
Walnut Wood Finish Cabinet

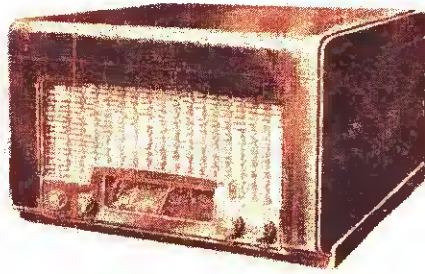

5-TUBE Model 558
with Record Player
Walnut Wood Finish Cabinet

4 PORTABLES

● Model 524 shown below is a 5-tube battery-electric 3-way portable in attractive, durable plastic case. Three other models in plastic and aluminum cases—including a pocket portable—complete this fast-moving, popularly-priced group. List prices from \$25.00 to \$45.00 approximately.



4 TABLE COMBINATIONS

● Fine phonograph mechanisms with 5 and 6 tube radios, in cabinets to satisfy any preference. Two models with record players and two with automatic changers. This group will be in strong demand. At list prices from \$25.00 to \$70.00 approximately.

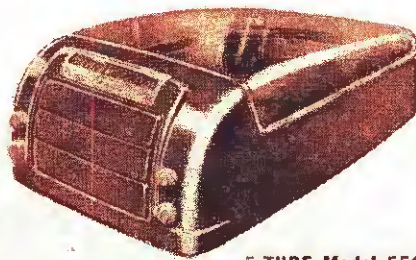

5-TUBE Model 556
with Record Player
Ivory Finish Non-breakable Cabinet

LINE!



10-TUBE Model 888
with Automatic Changer and FM
Walnut Wood Veneer Cabinet

5 FLOOR MODELS

● Featuring this group is Model 1088 . . . exquisite in styling . . . incomparable in performance. Twelve tubes; automatic record changer; extremely selective, sensitive, hi-fidelity circuit; multi-band, including FM. Model 888 also has multi-band coverage and FM in a 10-tube hi-fidelity circuit. Other models give you a wide range of cabinet variety and performance features at list prices from \$65.00 to \$200.00 approximately. Top Flight sales opportunities, now and for the future, are yours with ARVIN.



12-TUBE Model 1088
with Automatic Changer and FM
Walnut Wood Veneer Cabinet



6-TUBE Model 670
with Automatic Changer
Walnut Wood Finish Cabinet

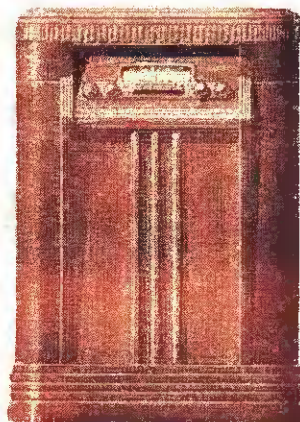

6-TUBE Model 668
Radio Console
Walnut Wood Finish Cabinet



6-TUBE MODEL 669X
with Automatic Changer
Walnut Wood Veneer Cabinet

**LOUD
SPEAKERS**

**BY
Jensen**

**WHERE
QUALITY
IS ESSENTIAL**

*Designers and
Manufacturers of
Fine
Acoustic Equipment*

**COMING
ATTRACTIONS**



Jensen
SPEAKERS WITH

ALNICO 5

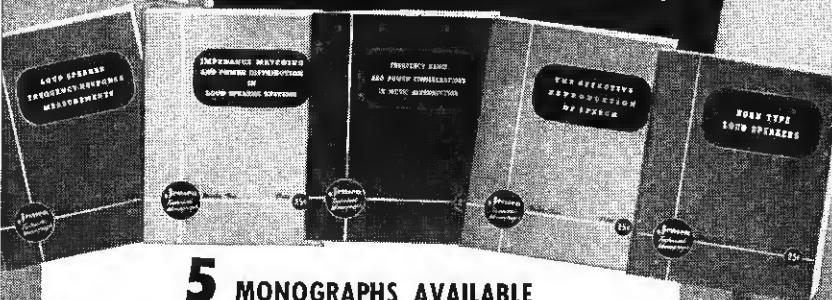

5 MONOGRAPHS AVAILABLE

1. Loud Speaker Frequency-Response Measurements
2. Impedance Matching and Power Distribution.
3. Frequency Range in Music Reproduction.
4. The Effective Reproduction of Speech.
5. Horn Type Loud Speakers.

25c
Each

FREE to the Armed Forces, Colleges, Technical Schools, Libraries.

JENSEN RADIO MANUFACTURING COMPANY • 6625 SOUTH LARAMIE AVENUE, CHICAGO 38, ILLINOIS
IN CANADA—COPPER WIRE PRODUCTS, LTD., 137 RONCESVALLES AVENUE, TORONTO

WE'RE ALWAYS IN THERE...

Punching!



Mention the name FADA to any man or woman and the response is immediate . . . FADA means fine radio receivers to Americans everywhere. There's a reason for this widespread acceptance. We're Always In There Punching With Our Advertising and Sales Promotion! Even during the war years, when our entire production went to supply military needs, the name FADA has been constantly brought to the attention of millions of potential radio consumers through Billboards, Newspapers, Radio, and Magazines.

That's why the FADA franchise means so much more. That's why we suggest that you get detailed information from your distributor about the profit-building FADA franchise, or write to us direct!

Watch! Next Month's Issue for Photographs and Descriptions of FADA'S Point-of-Sale Dealer Helps.

PLACE YOUR FAITH IN THE

FADA
Radio

OF THE FUTURE

Famous Since Broadcasting Began!



FADA RADIO AND ELECTRIC COMPANY, INC., LONG ISLAND CITY, N. Y.

NEW!

...the MOST COMPLETE REPLACEMENT VIBRATOR GUIDE ever published



Ready for you NOW...

Long hailed as one of the most helpful publications in the radio service field, the Mallory Replacement Vibrator Guide has run through 17 editions since 1934. Now comes the largest, most comprehensive edition of all — easier to read, easier to use, more valuable than ever before!

If you're an old timer in radio service, you'll recognize that a great deal of new material has been added. There's a whole new section on buffer capacitor circuits. Another section shows you how to service old radio sets that need obsolete or discontinued types of vibrators. Still another contains a complete cross-index of all vibrators.

Mallory is the first manufacturer in this post-war period to offer this up-to-date Guide. It's yours, as usual, without cost. Get a free copy of the Mallory Replacement Vibrator Guide at your nearest Mallory distributor.

P. R. MALLORY & CO., Inc., INDIANAPOLIS 6, INDIANA

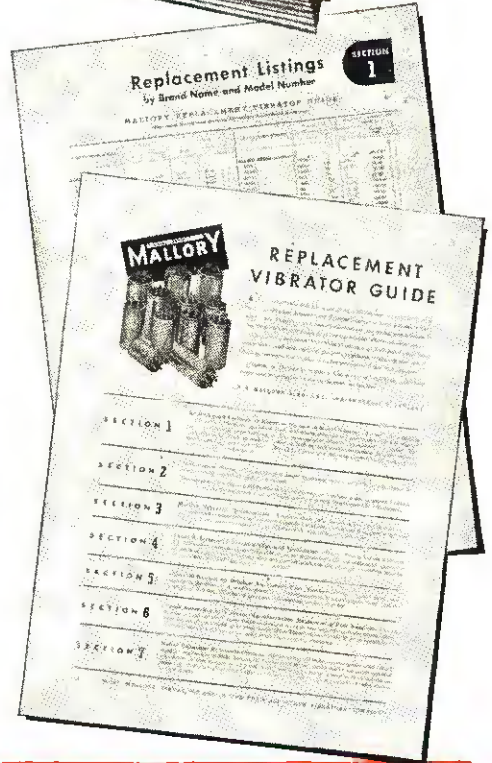

More than ever—
ALWAYS
INSIST ON

P. R. MALLORY & CO. Inc.
MALLORY
APPROVED
PRECISION PRODUCTS

VIBRATORS • VIBRAPACKS* • CONDENSERS
VOLUME CONTROLS • SWITCHES • RESISTORS
FILTERS • RECTIFIERS • POWER SUPPLIES

ALSO MALLORY "TROPICAL" DRY BATTERIES, ORIGINALLY DEVELOPED BY MALLORY FOR THE U. S. ARMY SIGNAL CORPS, NOT PRESENTLY AVAILABLE FOR CIVILIAN USE.

*Reg. U. S. Pat. Off.



Save that Song
ON "The Wire
that Remembers"

IT'S a precious strain—all her own. And priceless to those who love her. Will it be left only to fragile human memory? Will it fade forever?

No. Today it can be captured, cherished and repeated over and over. It can be heard again years from now.

How? On the Lear wire that remembers — a simple way of making lasting recordings. It's a way that puts hours of song, voices or radio broadcasts on a spool of hair-like wire. Anything you don't want to keep is erased simply by recording something else over it.

Wire Recording is but one of the fine things you'll find in Lear Radios. There are advanced FM, television, far-reaching short wave and record-changing phonograph radio combinator's with a new conception of rich-toned fidelity.

Such radios as these have never been available before. For Lear's fifteen years of radio design and manufacture have been devoted to the exacting needs of aircraft radio. So expect to be thoroughly pleased when you hear a Lear Home Radio. You'll know quickly that there is extra worth for every dollar you pay. See for yourself—visit your Lear dealer at your first opportunity.



LEAR
RADIO

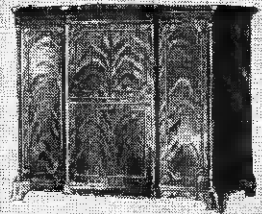

Designed
and Made in Grand Rapids

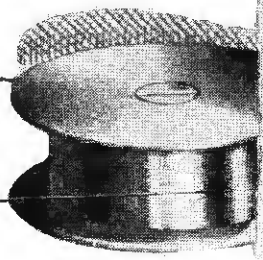
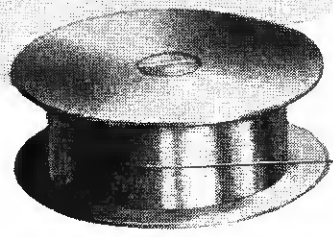

This is the Lear advertisement running in color in the current national magazines. It is another in the big advertising campaign that keeps interest mounting in Lear Radios.

And this is only part of the support Lear dealers are receiving. Every Sunday over the American Broadcasting Company network from 1:15 PM to 1:30 PM, E.S.T., Lear presents the ORSON WELLES ALMANAC, featuring this noted actor, writer and narrator.

At the same time there are aggressive merchandising and promotion plans which add still further to the growing acceptance for Lear Radios.

If you are interested in being able to offer your customers these unusual radios, write for full information about the Lear Franchise.

Lear, Incorporated, Home Radio Sales: 230 E. Ohio St., Chicago 11, Illinois—Radio Division: Grand Rapids 2, Michigan.

We said it in 1935
We repeat it in 1945

Centralab RADIOHMS for all Replacements

There is no compromise with QUALITY . . . and Old Man Centralab has kept the faith through all the trying years. That is why the returning Radio Servicemen who "remember" as well as those who have newly entered the fold ask for and use CENTRALAB RADIOHMS on all Replacement jobs. Always specify CENTRALAB Radiohms.



**CALLING all
Servicemen!**



Producers of:

- Variable Resistors
- Selector Switches
- Ceramic Capacitors,
- Fixed and Variable
- Steatite Insulators
- and Silver Mica Button-type Capacitors.

Centralab

Division of GLOBE-UNION INC., Milwaukee

R-DAY IS YOUR DAY!

WILCOX-GAY CORPORATION
 CHARLOTTE, MICHIGAN

Announces

R-DAY
is coming!

R-DAY
is on its way!

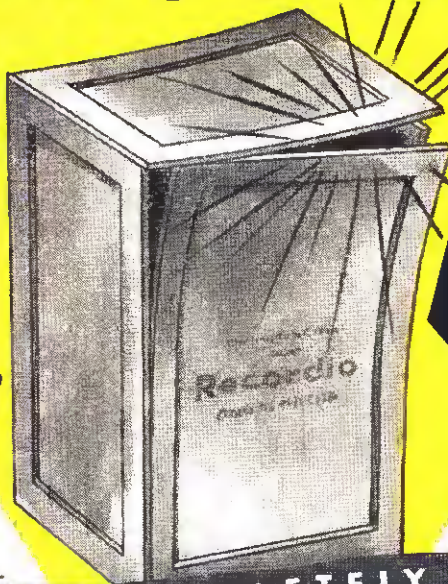

R-DAY...
that glorious, gainful
day when you start
selling the complete-
ly new RECORDIO.
greatest of them all.

THE COMPLETELY NEW

Recordio

WORLD'S NEWEST, FINEST HOME RECORDING INSTRUMENT

WHEN YOU SEE the new RECORDIO you'll know that master craftsmen painstakingly fashioned the cabinet of finest wood.

WHEN YOU HEAR the full brilliant range of glorious tones and overtones of the radio receiver you'll know it a superb instrument engineered by highly skilled technicians. But...

WHEN YOU RECORD on the RECORDIO, then play back the RECORDIO DISC and hear the depth and purity of note, the true fidelity of tone, the delicate shadings of sound, THEN YOU'LL BE CERTAIN that RECORDIO is America's finest instrument, that it leads the way to a vast, barely tapped potential of pleasant entertainment. Then you'll know this completely new RECORDIO leads its field, that by no means is it an interim model, that it is the instrument you want to sell.

Since developing the first successful home recorder, Wilcox-Gay has maintained leadership in manufacturing fine recording instruments for home, commercial, and professional use. The Corporation's research, development, production and wide application of RECORDIO during war years advance the new RECORDIO decades beyond its normal progress.

R-Day is on the way! Write Wilcox-Gay for franchise information.

WILCOX-GAY CORPORATION
 CHARLOTTE, MICHIGAN

Manufacturers of

Recordio Discs

and

Recordioint

CUTTING AND PLAYBACK NEEDLES



DEALERS: Mail This Today!

Wilcox-Gay Corporation
 Charlotte, Michigan

Gentlemen: Tell me more about the coming RECORDIO opportunity that is still open in my territory.

Store Name.....

Address.....

City..... Zone..... State.....



With this instrument a new era in tube testing begins

... Remember ...

As you read below the many other features of this pioneering instrument, remember this: It is a Simpson instrument, with all that implies in creative engineering research, in controlled testing and manufacture. Simpson products are not "assembled", they are engineered and built in the Simpson plant. Practically every component part, from the dial and movement to the beautifully designed panels and the bakelite cases and panels, is made by Simpson. It is this that makes Simpson's the "instruments that stay accurate" with ideas that stay ahead.

SIMPSON MODEL 330 MUTUAL CONDUCTANCE TUBE TESTER

1. Size—15½" x 9½" x 6½".
2. Case—Sturdy plywood construction with heavy fabricoid covering, corners trimmed in leather, rustproof hardware—removable cover with slip type hinges.
3. Panel—Heavy molded bakelite, beautiful satin grained finish. All characters, numerals, and dial divisions are engraved and filled in white, insuring long wearing qualities.
4. Meter—4½" rectangular of modern design with artistic four-colored dial indicating good, fair, doubtful, and bad—also "Percentage of Mutual Conductance" scale.
5. Sockets provided for all types of tubes with two spare socket positions.
6. Neon glow tube incorporated to indicate shorted tubes.
7. New simplified revolutionary switching arrangement (see description above).
8. The tube chart provided is arranged for quickly identifying the tube and setting the controls.
9. Tests tubes with voltage applied automatically over the entire operating range and under conditions approximating actual operation in a radio set.

Ask Your Jobber

The New Simpson Mutual Conductance Tube Tester Brings To Radio Servicemen and Dealers An Entirely New Method of Testing Tubes And A Revolutionary New Switching Arrangement!

Tube manufacturers consider that a radio tube has reached the end of its usable life when it falls to 70% of its rated value. Until now there has never been an instrument to test tubes in percentage terms.

But now here is such an instrument. The new Simpson Model 330 tests tubes in terms of percentage of rated dynamic mutual conductance—a comparison of the tube under test against the standard rated micromho value of that tube. The colored zones on the dial coincide with the micromho rating or the percent of mutual conductance, indicating that the tube is good, fair, doubtful or definitely bad. Thus, at a glance, you can check the tube against manufacturers' ratings. If, for any reason, it becomes desirable to know the actual value in micromhos, the percentage reading may be easily converted.

This is the way tubes should be tested—the way testers always should have worked—but Simpson is first again in bringing this needed development. It tests tubes with voltage applied automatically over the entire operating range, reproducing more completely than ever before the actual conditions under which a tube functions in a radio set. No instrument, not even delicately adjusted laboratory devices, can do this 100%. But this new Simpson Mutual Conductance Tester approaches perfection as never before.

Besides this revolutionary new method, Simpson offers you an equally revolutionary switching arrangement. The circuit is so arranged that, even though there are numerous combinations possible, very few switches require moving to test any one tube. Many of the popular tubes are tested in the "normal" position without moving any of the nine tube circuit switches.

Ten push button switches and nine rotating switches of six positions each provide infinite combinations in tube element and circuit selection. Only a few settings are necessary for the most complicated tube. The tube chart provided is arranged for quickly identifying the tube and setting the controls.

When you have finished a tube test, the Automatic Reset takes over to speed and simplify the next test. Just press the reset button and instantly all switches, both push button and rotary, return to normal automatically!

Here is the test instrument you have had a right to expect from Simpson. With greater flexibility in its circuit and switching arrangement than any other tester can provide, it gives maximum provision against obsolescence. It's the tester of a new era.

SIMPSON ELECTRIC COMPANY
5216 W. KINZIE ST., CHICAGO 44, ILLINOIS

Simpson

INSTRUMENTS THAT STAY ACCURATE

WATCH FOR OTHER SIMPSON DEVELOPMENTS . . . THEY ARE EQUALLY WORTH WAITING FOR

SYLVANIA NEWS

RADIO RETAILER EDITION

NOV. Published by SYLVANIA ELECTRIC PRODUCTS INC., Emporium, Pa. 1945

SYLVANIA "LOCK-IN" ADVERTISEMENTS SELL THIS SUPERIOR TUBE TO NATION'S MILLIONS

Appearing in eight national magazines, with an audience of over 10,000,000

YOUR NEXT RADIO NEEDS "LOCK-IN!"

PROVED IN RADAR! BEST FOR YOUR SET!

LOOK FOR LOCK-IN TUBES BEFORE YOU BUY A RADIO!
Why? Because more than any other tubes, Lock-In are in step with the trend in modern radio—a trend toward higher and higher frequencies.
Proved in Radar and secret radio equipment—Lock-In are perfect for FM and Television. Be sure your next radio is fully up-to-date! Look for Lock-In!

PERFECT FOR EVERY TYPE OF RADIO!

TOPS FOR FM AND TELEVISION!

DEFIES JARRING - STATIC PUTS!

SYLVANIA ELECTRIC

Brooklyn Office, 500 Fifth Ave., New York 10, N.Y.

Makers of Radio Tubes; Fluorescent Lamps; Fixtures; Wiring Devices; Electric Light Bulbs; Electronic Devices

This full page "Lock-In" ad appears in eight national magazines—including The Saturday Evening Post, Time, Fortune and Newsweek—telling over ten million people why Lock-In Tubes are the best tubes for their radios.

Many Set Makers to Include Them in Next Models

There are two important reasons why radio retailers will find the Sylvania Lock-In radio tube one of their best-sellers and biggest profit-makers. First, the Lock-In has advantages possessed by no other radio tube made. Second, the story of this remarkable tube is being directed to millions through Sylvania national advertisements.

These ads will boost your profits by further popularizing a tube already famous for the vital part it played in communications during the war. Today, set manufacturers are looking to the Sylvania Lock-In Tube as the perfect electronic unit for every type of set—including FM and Television.

WHY THEY ALL WANT LOCK-IN RADIO TUBES

- 1. ELECTRICALLY,** Lock-In Tubes are more efficient. Element leads are brought directly through a low-loss glass header to become sturdy socket pins—effecting a much desired reduction in lead inductance and inter-element capacity.
- 2. MECHANICALLY,** Lock-In Tubes are more rugged. Support rods are stronger and thicker. There are fewer welded joints and no soldered joints. The elements can't warp or weave and the "Lock-In" lug is made of metal—not plastic.

SYLVANIA ELECTRIC

Emporium, Pa.

MAKERS OF RADIO TUBES; CATHODE RAY TUBES; ELECTRONIC DEVICES; FLUORESCENT LAMPS, FIXTURES, WIRING DEVICES; ELECTRIC LIGHT BULBS



just released!
**50 pages of parts
and
their technical data**

Standard items are "keyed" with jobber part numbers, making it simple and convenient to order from your local distributor.

Included are:

- **POTENTIOMETERS AND RHEOSTATS** in 5 different sizes ranging from 3 to 15 watts. Simple in design, rugged, and dependable.
- **"T" & "L" PAD ATTENUATORS** in 5 different designs for controlling volume in circuits of microphones, loud speakers, phonograph pick-ups, mixers, audio and public address amplifiers.
- **SWITCHES** that are compact in size, simple in design, and of highest quality material are your assurance of dependable service with economical cost. Standard types and circuits.
- **LEAF SPRING STACK ASSEMBLY SWITCHES**—Low-cost, practical, dependable Contact Switch Assemblies for use in coin machines, record changers, electrical medical instruments or wherever simple leaf switches are required—available to meet innumerable different specifications and arrangements.
- **PHONE PLUGS AND JACKS** are available in various styles. Jacks include the famous "Imp" Type, and the Short and Long Frame Types. Phone Plugs supplied in two- and three-conductor types . . . for practically every type of application.

This Utah Catalog, No. U.C.-44, is 50 pages loose-leaf bound, and provides the engineer with complete technical data and blueprint details. Copies available without obligation upon written request on your business letterhead and mention of your position. Write today for your copy!



UTAH RADIO PRODUCTS COMPANY

820 NORTH ORLEANS STREET • CHICAGO 10, ILLINOIS

Utah Electronics (Canada) Ltd., 300 Chambly Road, Longueville, Montreal (23) P. Q. • Ucoa Radio, S. A. Misiones 48, Buenos Aires

Here's **WHY** they're raving

FARNSWORTH'S FAMOUS

OUTSTANDING PHONOGRAPH RADIOS!

Wherever shown, these new Farnsworth Quality combinations have won enthusiastic acclaim by dealers. They represent the certainty of continuous prestige and profit for the holder of the Farnsworth Selected Dealer Franchise!

EK-262—"The Comrade"—Superbly designed with matching record compartment base providing almost convenience and storage capacity—a stand out automatic phonograph-radio.

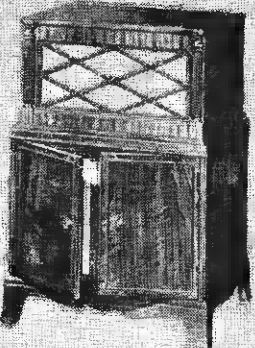

EK-264—"The Companion"—Chairside combination with built-in record storage space. Walnut or Golden Harvest.

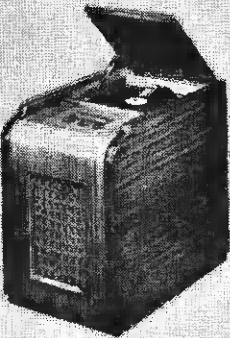

EK-263—"The Vogue"—Simple, graceful, modern lines mark this cabinet, in selected walnut and maple or Golden Harvest Blonde. A "natural" for that great new market.

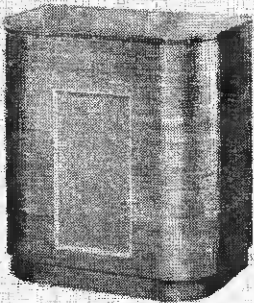
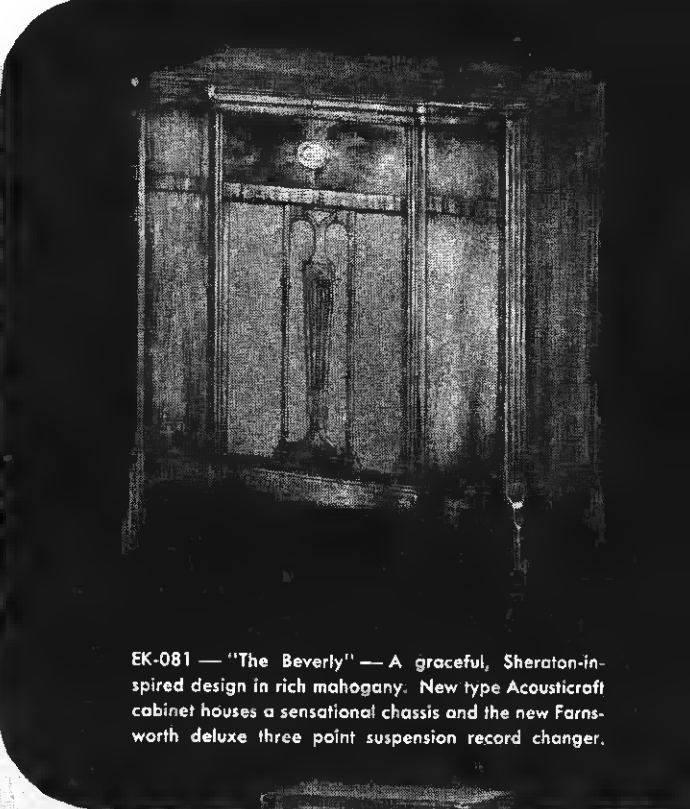
EK-081—"The Beverly"—A graceful, Sheraton-inspired design in rich mahogany. New type Acousticraft cabinet houses a sensational chassis and the new Farnsworth deluxe three point suspension record changer.



EK-082—"The Regent"—Massive design for wide market appeal, characterizes the traditional styling of this new model.

★ On these two pages are just a few examples of the top value in the industry's most expertly balanced line

FARNSWORTH

Farnsworth Television & Radio Corporation, Fort Wayne 1, Indiana • Farnsworth Radio and Television Receivers and Transmitters • Aircraft Radio Equipment • Farnsworth Television

About the New Farnsworth Line!

QUALITY LIVES AGAIN!

OUTSTANDING TABLE MODEL RADIOS!

Farnsworth—famous for top Quality in consoles and combinations—is now outstanding with new table model and "outdoor" lines. These brilliant-engineered, superbly styled models are going to keep Farnsworth Retail Dealers ahead of the field.

PHONOGRAPH
RADIOS

TABLE MODELS

PHONOGRAPHS

PORTABLES



ET-061—Breathtaking design. Plastic and wood effect with interchangeable "waffle grill" and knobs in blue, red or green.

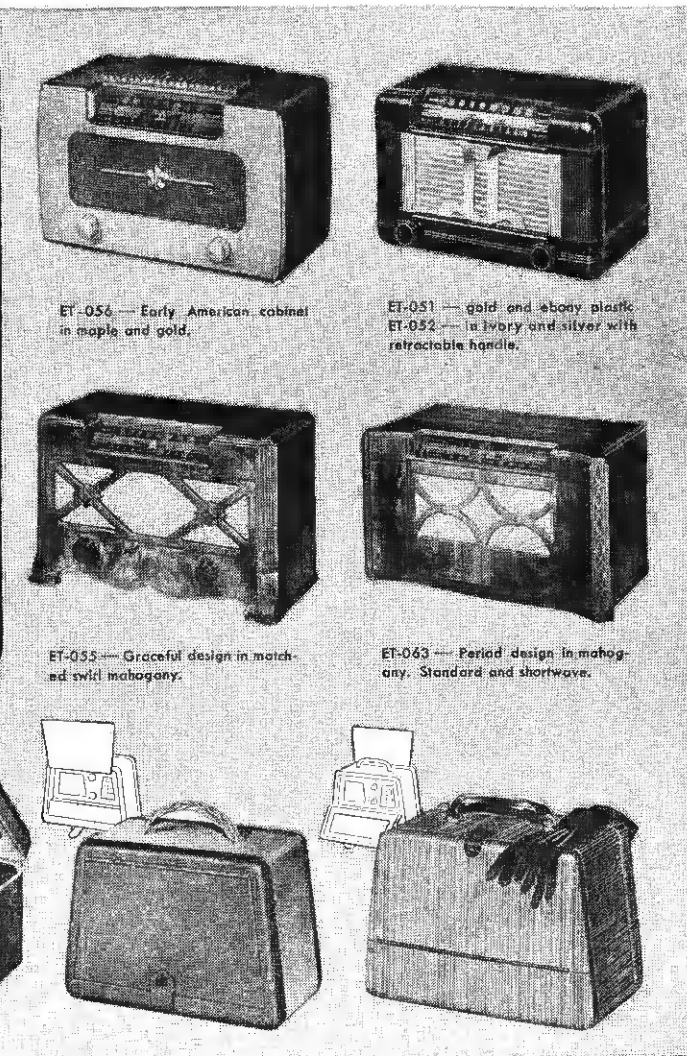

ET-056—Early American cabinet in maple and gold.

ET-051—gold and ebony plastic
ET-052—ivory and silver with retractable handle.

ET-055—Graceful design in matched swirl mahogany.

ET-063—Period design in mahogany. Standard and shortwave.



EP-020—"The Traveler"—electric phonograph in smart contrasting simulated leather.



EP-030—Deluxe portable automatic phonograph in simulated leather carrying case.



EP-350ST—"The Triple-Play"—compact portable in smart luggage leather.

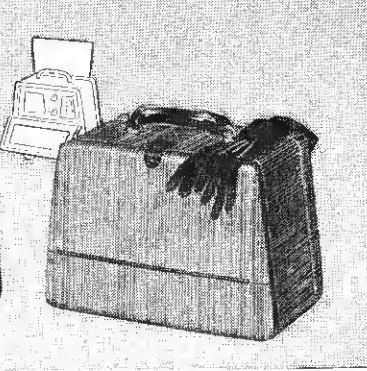

EP-350DL—"The Sophisticate"—ultra-smart pin-striped plasticised fabric cover.

Television • Radio • Phonograph-Radio

Tubes • Halstead Mobile Communications and Traffic Control Systems for Rail and
way • the Farnsworth Phonograph-Radio • the Capehart • the Capehart-Panamuse.

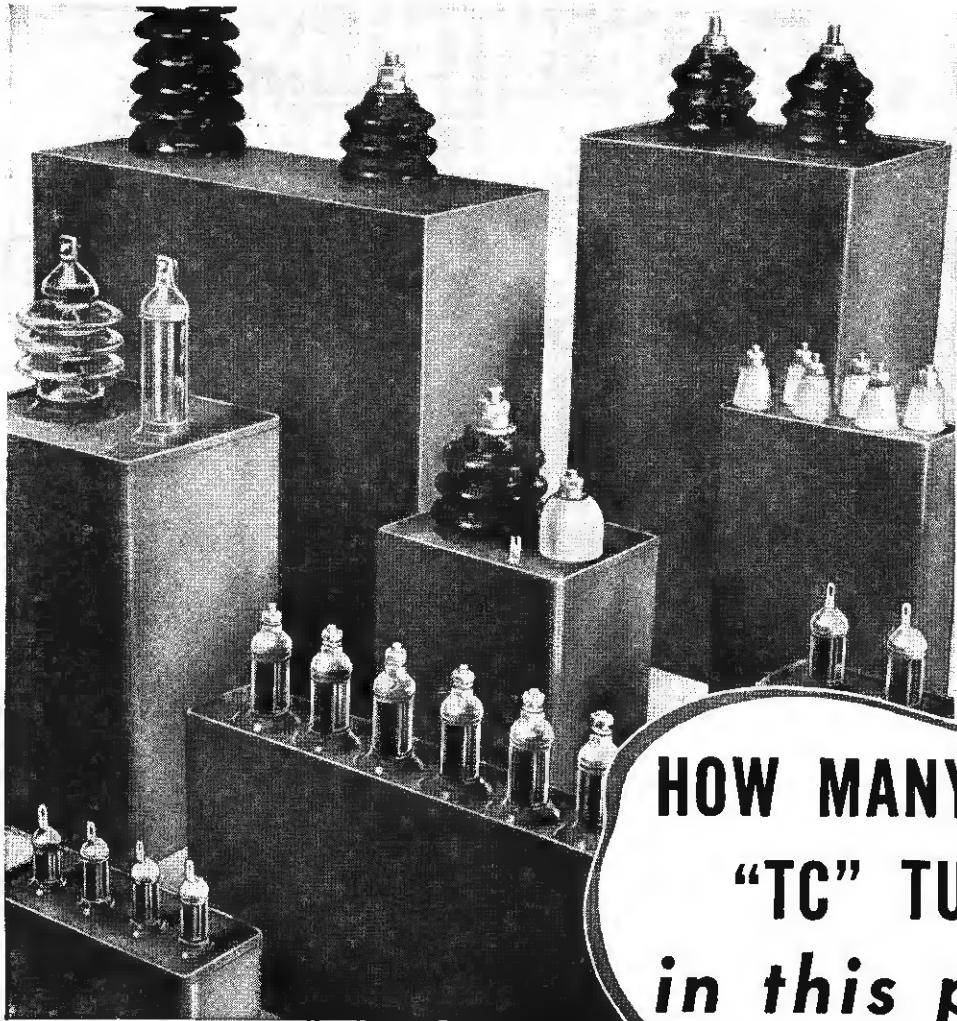

**HOW MANY SPRAGUE
"TC" TUBULARS
in this picture?**

THESE big energy storage capacitors are recent Sprague Electric Co. types developed for flash-photography, high-voltage networks, welding and other exacting wartime uses.

Consider thousands upon thousands of these giants in terms of the vast quantities of "TC" Tubular Capacitors and other service types that could have been made with the same investment of time and materials, and the Sprague wartime record looms even more impressive.

Every replacement type that has occasionally been missing from jobbers' stocks has been

more than accounted for by the FIVE separate Army-Navy "E" citations that Sprague has achieved. Moreover, a constant and steadily increasing supply of Sprague Atoms and "TC" Tubulars still makes it possible to match 9 out of 10 replacement requirements "on the nose!"

As always — as long as the need exists — see Sprague TRADING POST on Page 130.

**Sprague Products Company
North Adams, Mass.**

(Jobbing Sales Organization for Products of the Sprague Electric Co.)

SPRAGUE



MARK WARNOW

parades a new hit for Sonora!



DICK TODD

sings a new hit for Sonora!



NEW YULETIDE HIT!

"All Around The Christmas Tree"

RECORDED EXCLUSIVELY BY SONORA

A couple of GI's got together to write the first peacetime Christmas hit. The result was "All Around The Christmas Tree." Mark Warnow's Hit Parade Orchestra plays it. Dick Todd sings it, with the Hit Parade Chorus. And only SONORA has recorded it . . . with that faithful, brilliant, lifelike tone that's "Clear as a Bell."

It's a sure-fire hit . . . and it will be pushed by plenty of holiday plugging on Warnow-Todd broadcasts, plus plenty of promotion by SONORA in the nation's leading magazines.

Backed up by a gay Warnow medley of all-time favorites—"Happy Little Songs"—this SONORA Christmas exclusive is the gift record. You sell it enclosed in a bright and beautiful Christmas envelope. List, 63¢, including envelope and excise tax. Stock up on this profit-maker—SONORA record No. 3000—order from your SONORA record distributor today!

Sonora Records
Clear as a Bell

HOME ENTERTAINMENT AT ITS BEST

RECORD DEALERS:

Write for name and address of your nearest SONORA record distributor.
SONORA PRODUCTS, INC., 2023 West Carroll, Chicago 12, Illinois.



All Around

the Christmas

Tree

THE NEW

Stromberg-Carlsons

START ROLLING SOON!

A WHOLE new line of Stromberg-Carlsons—and just wait till you see and hear them! *New* in their engineering. *New* in their cabinet designs. *New* in their price range. *New* in their broader scope of models. They'll give new meaning to the old saying, "There is nothing finer than a Stromberg-Carlson!"

All new Stromberg-Carlsons take advantage of every latest engineering advance in the science of electronics. FM sets have both present and newly approved tuning ranges for clear and satisfactory reception of international short wave, precision tuning is made easy with spread-band dials. Floor models employ speaker systems with either full-floating suspension or Carpinchoe speaker and the famous acoustical labyrinth. Phonograph models use newly designed record-changers that perform to entirely new standards of speed

and simplicity of operation. All new Stromberg-Carlsons have built-in antenna systems for all tuning ranges on their dials. Special plug-in provision is made in many models for the incorporation of Stromberg-Carlson wire-recording and reproduction.

Almost everyone has wanted—even if he couldn't afford—Stromberg-Carlson quality, Stromberg-Carlson perfection of reproduction. The new line lets authorized dealers meet practically any customer's demand with a model expressly suited to his own individual taste and needs. Yes, today, Stromberg-Carlson is the ideal radio for the *main* radio in any home!

Make Stromberg-Carlson the *main* radio in your showroom; cash in on the heavily advertised Stromberg-Carlson *main* radio theme. You'll find it the radio of real profit-opportunity.

STROMBERG-CARLSON

ROCHESTER 3, NEW YORK

RADIOS, RADIO PHONOGRAPHS, TELEVISION, SOUND EQUIPMENT AND INDUSTRIAL SYSTEMS
TELEPHONES, SWITCH BOARDS AND INTERCOMMUNICATION SYSTEMS

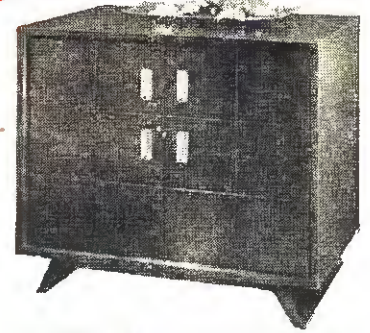

THE NEW WORLD — 1121-M2 . . . New Automatic Radio Phonograph designed for tomorrow's living.



THE AUTOGRAPH — 1135 PL . . . The perfect Automatic Radio Phonograph in a cabinet of classic 18th Century design.

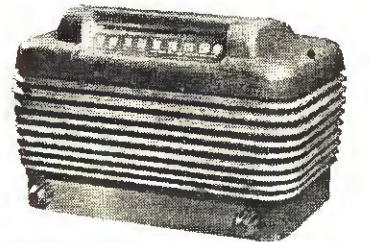

THE DYNATOMIC — 1101HB . . . New sleek table radio with unique portability feature.

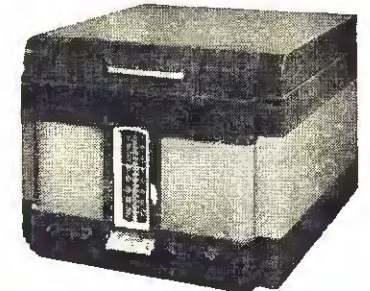

THE BEAUX ARTS — 1110 PTW . . . New, amazingly compact, automatic table radio-phonograph in smart modern design.



THE HEPPLEWHITE — 1121 PG . . . New, automatic radio-phonograph in a beautifully finished cabinet of Hepplewhite inspiration.

RADIO & Television RETAILING

Including Radio and Television Today

O. H. CALDWELL, Editor * M. CLEMENTS, Publisher * 480 LEXINGTON AVENUE, NEW YORK 17, N. Y.

Use What You **HAVE**— to Make the Sale

By the time this issue reaches the dealer, Christmas shopping will have begun. It will gather impetus and increase in volume right up until the night of December 24th.

The retailer in this field is faced with a perplexing and uncertain situation with respect to supplies of merchandise.

He is having a difficult time trying to get a line on how much of this-and-that he'll have to sell.

All he can safely bank on right now is the knowledge that he will have an adequate supply of some things—a short supply of others. He is unable, though, at this stage of the game to classify the coming supply accurately.

Need for "Sewing Up" Orders

In view of the present production, pricing and distribution "crazy quilt" pattern, the wise dealer is preparing to *use what he has* to make the sale. He will sell and deliver that merchandise which he has in quantity, but he will have to *take orders* for future delivery of scarce merchandise and *sell* the customer in order to hold the business.

Warned not to dispose of present demonstrator models, the merchant will make every effort to get the customer to sign on the dotted line for delivery *very soon*.

Use Circulars, Ads, Blow-Ups

Where he has no exhibit models of a wanted radio or appliance, he can use manufacturers' circulars. He can sell from cut-outs, mock-ups, ads. Many radio and appliance makers have already supplied dealers with valuable printed selling helps. Others have advised that dealer aid material is on the way—for delivery before Christmas.

This Christmas will be an unusual one. The dealer will have to use what he has to make the sale. In lieu of certain merchandise, he'll have to get signed sales

contracts, issue gift certificates and perform other unfamiliar tasks in order to get the sale.

The past war-time Christmases have been celebrated half-heartedly, but now that World War II is over, and families are being reunited, this holiday season will be enjoyed to its fullest extent.

Store Appearance Important

In addition to making out the best he can with what he will have to sell, the dealer should decorate his store interior and show windows so that they will present a festive appearance. Such decorations serve two purposes: Promote good-will and keep shoppers in a holiday mood. (For suggestions on decorating, see page 39, October issue).

With the present puzzling merchandise picture staring him in the face—with strikes and delays in pricing arrangements making it impossible for him to get accurate information, the dealer still must attempt to make his store appear to be headquarters for Christmas shopping.

"Headquarters"—the Theme

Suitable decorations and attractively displayed merchandise *on hand* will serve to suggest to the customer substitutes for certain gifts in mind which will not be available.

So this Christmas season the merchant will have to use what he has to hold the sale and sell what he has on hand.

Before long, though, merchandise will be rolling in and dealers' sales efforts then will no longer be hampered by shortages, governed by expediency.

There's another reason why dealers should make efforts to "hold" all customers by using all available sales tools now. They will need to increase sales volume to make up for lower discounts—certainly "in the works". This is the time to pave the way for future selling.



RADIO, Electrical Appliances,

DEALER MARGINS, 34% AND 38% ON RADIO—OPA's new pricing order fixes approximate discounts. Lower figure is for receivers bought through jobbers; higher percentage is on sets bought by dealer from manufacturer. Pointing out that retailers will not have to make profit-cutting cash discounts and trade-ins, OPA says dealers should net more profit on new margins than in 1941 at approximately 40%—says realized margin in '41 was 30.9%. The new order provides that no dealer may demand a trade-in as a condition to selling a radio to a consumer. No change made in price increase schedule for manufacturers, set in a previous regulation.

FIRST DOWN, THEN UP—Present postwar slow-downs and industrial troubles were not unexpected. Now economic authorities are pretty united in predicting continued lows in general employment and production into the first part of 1946. By middle of the coming year, up-turn into general record prosperity will take place. See a \$155,000,000 year for 1946.

REFRIGERATOR MARGINS CUT—Distributors—margins reduced slightly over one percentage point as compared with "initial margins" (those included in the original asking price) on record in March 1942, but should yield returns at least as high as those realized in 1941, says OPA.

Retailers—dollar-and-cent prices listed in the regulation or to be added later. These allow a margin in each case less than recorded in 1941 initial margins by slightly over one percentage point. Here, also, says OPA, there will be no actual reduction, dollar-wise or percentage-wise, in 1941 realized margins, since dealers will not find it necessary to accept trade-ins at above their resale value, or hold special sales in order to stimulate consumer buying.

ARMY STORE EQUIPMENT—Dealers who are looking for store fittings may be able to pick up slightly-used store equipment from some of the Army post exchanges now shutting down. This furniture and apparatus belongs to individual post personnel; is not Army surplus.

LATEST ON TUBE SITUATION—250,000 each of the critically needed tube types would fill national dealer backlog demands at this time. Retailers now have larger stocks of tubes on hand than ever before—most of them "dogs" they've gotten in "assortments." Prediction on production—Replacement supply may continue to be inadequate for another month, but during first quarter of 1946 there should be enough for all needs—replacement and new sets.

FM's \$1,750,000,000—Chairman Porter, FCC, predicts nearly 3,000 FM stations in the next few years, costing a quarter-billion dollars. And if half of existing broadcast receivers are replaced with AM-FM sets, the consumers will invest a billion and a half more. Within five years he expects television sales to be running a billion dollars per year.

NO DARK HORSES—With a number of new brands of receivers now coming onto the market, the industry has been fearful of an onslaught of "dark horses" in the postwar distribution picture. But a brand-preference survey made in September among 5,000 dealers shows among the first fifteen most-popular names only one company which was not in the business pre-war!

"BED-SIDE" TELESET ON WAY?—A large electronic firm having interests here and abroad, is said to be readying a tiny video receiver employing a 1½ by 2 in. viewing tube.

TELECHRON IN RADIO BUSINESS?—Warren Telechron announces that its "Musalarm," described as a "combination clock and clear-toned handsome little radio," will be on the market around the first of the year. The station is selected the night before and next morning music coaxes one from the arms of Morpheus. Will retail for about \$19.95.



MALE AND FEMALE GIFT BUYERS differ in their shopping habits experienced retailers know. Women, by and large, do their Xmas shopping earlier and with more deliberation than do the men. Stores in this field sell to a vast army of wild-eyed males who rush in to buy table appliances—and even expensive radios and major appliances as gifts for the home—at the last minute. The Saturday and Monday preceding this Xmas will again see many husbands, fathers, brothers dashing into stores "hell-bent" to buy gifts—with very little time left in which to beat the gong.

CHICAGOANS ARE FLOCKING to the postwar electric appliance and radio show now being held in the entire first-floor showrooms of Commonwealth Edison. Sponsored by the Electric Assn., booths may only be leased by manufacturers, but may be manned by distributors, and dealers may bring customers in and take orders themselves.

TWENTY-FIVE YEARS OLD is broadcasting this month, as NAB and RMA celebrate the quarter-century anniversary of the art. RMA has planned to distribute commemorative window displays and booklets to 25,000 radio retailers this month, as well as to present statuettes to all U. S. broadcasting stations, with appropriate local ceremonies participated in by local dealers and distributors. Celebration is based on the fact that a Detroit station went on the air in August, 1920, and that the November election results of that year were broadcast by Westinghouse which also built and sold the first home receivers for the occasion, 25 years ago this month.

Records, and Television, TODAY

HALF NEW CARS NEED RADIOS—*Before the war, 35 to 40 per cent of the new cars coming from Detroit were equipped with radios before sale. Post-war ratio is expected to go slightly higher, but not above 50 per cent. This still leaves a tremendous field for radio sales by the independent auto-radio dealer, for the motor-car people are thinking and planning for six million new cars yearly—far above anything heretofore in automobile history! (See also pages 36 and 37).*

SOME ONE-PRODUCT MANUFACTURERS thinking favorably of going into diversified production these days. There's been plenty of nail-biting, griping and aspirin-swallowing by makers who've seen their one-line plants stand still while controlling agencies hemmed, hawed and harumphed over prices, etc.

GET READY TO "SELL" NOT "TAKE" orders! *Stating that "purchasing power when an individual has a job and purchasing power, even though savings are unchanged, after the individual has been laid off are two entirely different things," G. E. Whitwell, vice-president in charge sales for the Philadelphia Electric Co., goes on to tell of the case of a dealer who recently was able to obtain four electric water heaters. "He has a list of what he calls 'super prospects'; each one had been demanding a water heater prior to the end of the war. This dealer had to contact twelve of these 'super prospects' before he sold the four heaters. I think we need more and better selling right now rather than less."*

REMOTE-CONTROL TELE ANTENNA—Dealers attending Distributor D. W. May's meeting in New York report being shown a television dipole having remote-control pushbuttons at set which enabled (1) dipole to be rotated and (2) rod-lengths to be "tromboned" for tuning to particular station.



WILD SCRAMBLE TO GET AHEAD of the other fellow in placing first radio and appliance models on dealers' floors. Makers and jobbers jittery over floods of pressure letters from retailers who urge speed—fear the competitor will get the jump on them. A quieting note is sounded by Maytag General Salesmanager Verne R. Martin, who says, "Fortunately lasting success is not dependent upon some quirk of fate like being in the field a week ahead of another with floor models."

RETAIL COMPETITION IN MIDDLE WEST increasing. One town of 5,000 which had 7 electrical appliance retailers before the war, now has 22, including new "chain" branch stores.

TELEVISION INSTITUTE for West Chester, Pa., dealers proposes central display room for demonstrating television sets, training school for dealers and their salesmen, and a centralized television service department to install and keep initial customers' sets at top efficiency. Competing manufacturers would cooperate with local leaders in setting up this pioneer plan.

AN AUTOMATIC FOR EASY WASHER is in the works, but officials will not go into detail as to *what* and *when*. The firm has just brought out a portable spin-dry washer which it expects to deliver to dealers around the end of this month.

CREDIT RATES TO DEALERS SLASHED!—H. T. McCann, vice-president, Commercial Credit Corp., reveals that his firm will finance retailers' floor planning, inventories, etc., at rates 50 percent below pre-war levels. The organization is increasing substantially the number of its offices. A new departure from previous policies is the opening of many new branches in small towns throughout the country.

SOMETHING NEW IN RADIO SETS—An ac-dc table model "combination" which permits the radio to be detached and used as a portable, announced by Westinghouse along with 9 other models now in production.

OPA HAS OFFICIALLY ANNOUNCED that 80 per cent of the 7.7 per cent price increase granted to manufacturers of washers and ironers will be absorbed by retailers. The balance of the increase will be taken up by distributors. Consumers will pay pre-war prices for these appliances. Tom Joyce, general manager of Raymond Rosen & Co., Philadelphia distributors, states that "it looks very much as though the dealer's margin on washing machines will be cut 13 per cent over what prevailed before the war."

INTER-DEPENDENCE—Recently a group of prominent Americans attracted wide attention by drafting a set of principles for promoting human harmony and international peace. They emphasized faithful performance of individual responsibilities and exercise of sympathetic tolerance and understanding. And they called it their Declaration of Inter-Dependence. Your editors believe it is time a similar Declaration of Inter-Dependence be drawn up for the radio-electrical-appliance industries. And so we present the four panels found in this position on the following pages, for your comment and criticism.

In This Issue — THREE MAGAZINES IN ONE — RADIO; ELECTRICAL APPLIANCES; SERVICE
Latest Radio Merchandise, pages 40 to 45 Newest Electrical Appliances, page 68, 69, 73, 74, 77, 78, 80, 83
New Things for Service and Sound, page 88
Listing of Radio Manufacturers, page 56 Listing of Electrical Appliance Makers, page 85

"Sell" Yourself the

Higher Priced Radios, Appliances Increase Profit Rate, Volume—Cater to Buyer - Desire to Own the Best



NEW Salesmanager Says:



Higher-priced radios are made of better parts, have better tone, better appearance and greater range.

More expensive refrigerators provide more space; have more refinements than cheaper "stripped" models. Larger size models permit owner to buy and store more foods.

Larger-capacity washers save time. Each higher-priced model offers increased advantages.



Two-slice automatic toasters prevent burned toast; don't require attention; speed up toast making; are cheaper to operate than lower-wattage non-automatics.



Better vacuum cleaners use higher powered motors; do a more efficient cleaning job and have more improvements.



First-line table appliances have better finishes, often higher wattages. Stay bright and new, easy to clean.



Adequate-sized ranges, sold with "extras," clocks, controls, etc., keep customers "sold" on your firm long after additional cost has been forgotten.



Large-enough room coolers and electric fans eliminate customer complaints—keep users on your prospect list.

Powerful, well-made mixing machines make happy customers. Cheaper machines, not capable of doing a good job, make customers regret you "saved" them money.

• Let's sit in on a "sales meeting" being held in the store of Independent Retailer Smith, Anytown, U.S.A. Smith's is not a very small store, nor is it a very large one. The

proprietor has been established many years, and now, in order to seek his share of the business in the offing, and realizing that competition will soon be stiffer than ever before, Dealer Smith has hired a salesmanager with new ideas, two salesmen and a "combination" saleswoman and bookkeeper.

CAST OF CHARACTERS

Salesmanager Salesmen A and B
Dealer Smith Saleswoman C

Salesmanager: "In previous meetings we have explained the features of the radios and appliances we sell. We have gone into techniques of meeting customers, arranging time payments and so forth, and today we are going to lay plans for making more money. More money for the firm and more money for the sales-force."

Dealer Smith: "Sounds interesting. That's what we're all in business for—to make money."

Salesmanager: "Right. Now, we've dealt previously with problems associated with closing sales and the necessity for increasing the number of sales. Today, we'll discuss the importance of increasing the size of each sale."

New Ideas Needed

Salesman A: "You mean selling 'up'?"

Salesman B: "That's old stuff, selling 'em 'up'. Hope you have some new approaches to the subject, Mr. Salesmanager."

Salesmanager: "I feel certain I have. For example, 'selling up' used to consist, for the most part, of forcing the customer to pay more regardless of circumstances."

"Now, we're going to work differently. We're going to put ourselves in the customer's place. We're going

to sell ourselves the idea that all human beings naturally desire to own the best. We're going to ask ourselves whether we'd rather have a two-hundred - and - fifty - dollar radio-phonograph or a fifteen-dollar table model. Let's sell ourselves that the customer is smart in buying a better radio or appliance.

Sales Sincerity

"Let's get the tongue out of our cheek in selling 'up'. Try to sell the customer something we'd like to buy ourselves, and the battle's half won."

Dealer Smith: "In other words, you mean, don't look at the buyer who can be sold 'up' in the light of being a 'sucker'?"

Salesmanager: "Exactly. Consider that you're doing the customer a favor in selling a larger or better unit."

Saleswoman: "I can see the reasoning back of that. A few years ago we bought a five-foot refrigerator because it was cheaper—a little less than the six foot. In no time at all we regretted that we hadn't bought the larger size. My mother even felt slightly resentful toward the dealer for not trying harder to influence us in getting the bigger one."

Price Soon Forgotten

Salesmanager: "A good example of 'under-selling'! We must realize that the buyer is more price-conscious at the time of the sale than afterward. More often than not, after purchase, the customer wishes he'd bought a higher-priced radio or appliance. Seldom does the purchaser wish after the sale that a cheaper item had been selected."

Salesman B: "All this discussion does put 'selling up' in a new light. I was taught in the old school, where we just high-pressured a customer into spending more. Used a lot of old-time arguments, too, such as 'pride of ownership' and the 'neighbor bought one' angle. We didn't believe that the customer was wise in spending more."

to "Sell" Customer UP!

Dealer Smith: "Well, we want to believe in the value of the upped-sale ourselves. If you don't believe the customer should spend more, don't urge it."

Salesman A: "That's fair enough. It's a real incentive toward honest selling."

Salesmanager: "Yes, indeed it is. Sincerity is contagious. You can do a better job selling a better model if you believe in it yourself. In employing sincerity you become a salesman, not an actor."

"Let's cite a few examples. A woman comes in in answer to an advertisement offering a special in a non-automatic hand-iron at \$2.95. If you convince her that a \$12 iron is a better buy, and she purchases, you've killed two birds with one stone. You've made four times as much commission and you'll make a friend of the customer. She'll thank you for selling her a lighter iron—an iron that heats up quicker, costs less to operate because of its thermostat and is more convenient because of its heat selection feature—is safer because it can't overheat."

"Every time a customer of yours sits down to listen to the high-priced radio you sold him 'up' to, he'll be grateful to you for recommending such a good quality set—and he'll have forgotten all about the fact that he spent much more than he intended to."

Saleswoman: "But how about ad-

vertising a very low-priced unit—what we call a . . ."

Dealer Smith: "You mean something like a 'loss-leader'?"

Saleswoman: "That's it! Well, women are usually skeptical about such ads, and when they call at a store to see the product advertised, and the salesman tries to show them everything else but it, they don't like it at all. How about this question, Mr. Salesmanager?"

Salesmanager: "The answer to it is simple. Whenever we advertise a special and a customer asks for it, show it at once, and never 'beat it down' in the customer's mind. Explain the features and offer to show higher-priced models, but if the customer is insistent in purchasing the special, sell it cheerfully and readily."

Buyers Get More for More

Salesman B: "Aren't all customers suspicious the moment you try to show them something selling for more than they ask to pay?"

Salesmanager: "As a rule, yes. That's a common human trait. You must try to overcome this feeling on the part of the customer."

Dealer Smith: "How, for example?"

Salesmanager: "Well, at the risk of being trite, let's conduct a simulated meeting between a customer and a Smith salesman. We're not going to do this often, and we don't

want to embarrass any of our staff. We know that a salesman often shows up in a poor light in simulated sales affairs and does a swell job when he actually confronts the buyer. This time, I'll be the Smith salesman and the Saleswoman will act as a customer."

Salesman B: "Look out for him, Miss Saleswoman, he used to sell food freezers in the Aleutians."

Saleswoman: "I'll take a chance. Now I'm here to look at that 6-foot special refrigerator you advertise for \$169."

Salesmanager: "Certainly, Mrs.?"

Saleswoman: "Mrs. Jones. I live on Adams Street."

Salesmanager: "I'll write the name and address in my notebook. Now, here is the refrigerator we advertised."

Saleswoman: "What's the matter with it?"

Salesmanager: "'Matter with it'—just what do you mean, Mrs. Jones?"

Saleswoman: "Well, my husband said there must be some 'catch' to a refrigerator at so low a price."

Salesmanager: "I assure you there's no catch, Mrs. Jones. It's made exactly the same as the higher-priced models by the same manufacturer. The construction of the cabinet mechanism is identical with the de luxe models."

Saleswoman: "Then why is it cheaper?"

Salesmanager: "I'll show you, Mrs. Jones. Over here we have the de luxe model. Notice the difference in the interior. Sliding shelves, enclosed evaporator and a special compartment for meat-keeping."

Saleswoman: "How much is this model?"

(Continued on page 120)

★ Declaration of Inter-Dependence—1 ★

For the Whole Radio-Electrical-Appliance Industry

1. Dealers, distributors, manufacturers and servicers can enjoy healthy prosperity and growth only as all groups prosper and grow.
2. The aim of all industry groups must be: To bring to every American home and every individual the fullest use and enjoyment of radio and electrical appliances.
3. Every transaction and sale must earn a profit.
4. Instead of fighting over existing business, the radio-electrical-appliance trade should develop new sales demand through cooperative "creative selling."
5. Trade abuses, price cutting, wholesale-at-retail policies and "industrial discounts" must be abolished.
6. Servicing is a function of merchandising. And the operation of a service department is a responsibility that must accompany sales.
7. In the long-run the interests of dealer, distributor, and manufacturer are identical.
8. The present "seller's market" is merely temporary; long-time profits and stability rest upon creative and aggressive selling.

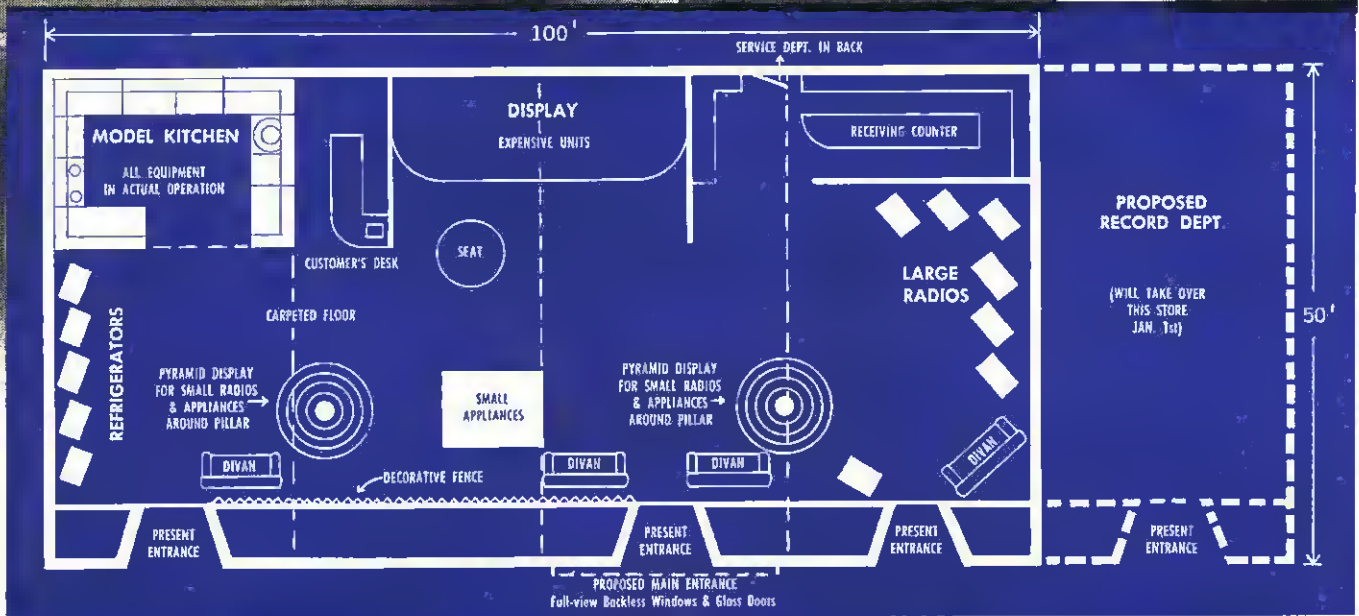

Diagram for more dollars! Radio City Sales Co., stressing wide selection, attractive display and efficient demonstrating facilities, has laid out this store with idea of offering customer everything but an excuse to "shop around" elsewhere.

Made-to-Order Selling

Detroit Dealer Designs Plan to Make Buying Easy for Customers—Sales "Closing" Easy for Salesmen

● Radio City Sales Co., 3712 Woodward Ave., Detroit, is following a plan designed to attract customers to its store and to sell them once they enter.

In order to attract customers, the firm uses large space in newspapers and makes the most of its 100-foot storefront which is exposed to an estimated 180,000 passers-by per day.

Expands, Modernizes

Three years ago, Radio City Sales Co. started in business with one store. (See storefront illustration.) In a short time, three adjoining stores in the building were taken over, and the first of the year, the company will take lease on the remaining one, thus giving them the entire building. The section to be taken over in January will be devoted to the sale of records.

Advertising, store modernization, a large line of leading makes, im-

proved sales techniques, in-store demonstrations and a wide range of prices to suit all income-bracket consumers, are implements the company will use to increase sales and profits.

The company will glamourize all its merchandise. Special efforts will be made to sell de luxe models in music and appliance merchandise. Right now the firm is making an extensive selling campaign on Ansley Dynatone electronic pianos. These sell for \$895 each. Radio City Sales Co., via extensive publicity it has been able to secure in Detroit newspapers, direct mail and outstanding in-store display and demonstration, has booked 150 orders for these instruments. Some of the orders are paid in full, and most were accompanied by payments.

Through aggressive solicitation, the firm has booked an order for 131 panel radios to be installed in a Detroit hotel.

Between eight and ten thousand dollars has been spent thus far in store improvement. The drawing accompanying this article shows the unique floor arrangement. Small radios and appliances will be displayed on pyramids built around pillars. Refrigerators will be displayed against one wall of the store, which is 50 feet deep. Near the refrigerators will be a modern kitchen, now being constructed. Along the opposite wall, de luxe radios will be displayed. Large pieces, such as de luxe Ansleys and other makes, will be featured in unique displays, set apart from other merchandise.

Franchise-Obtainers

The lighting fixtures will be replaced by crystal chandelier drops. There are divans and comfortable chairs set about for the convenience of customers, and there are modern desks where purchase contracts may be filled out.

One main entrance, consisting of glass doors, flush with the show windows, will be installed, and the other present entrances will be closed, and will become part of the show windows.

Because of its aggressive merchandising tactics, the size and appearance of its store and the fact that local banks are willing to extend substantial credit, Radio City Sales Co. has been able to secure a large number of valuable franchises from manufacturers and jobbers.

Sales-Getting Methods

One of the methods the company uses in order to build up a large prospect list is that of inviting each customer to enter his name in the firm's "guest album," along with any comments the visitor may care to make about any of the new merchandise shown him by the salesperson.

Since Radio City Sales Co. always makes it a point to invite visiting notables or artists playing in any of the local theatres to make a call at the store, the customer is duly impressed with the array of well-known names in the album, and is usually glad to make some comment, in addition to leaving his name and address.

The company is now in the process of selecting and training salesmen. Both selection and training techniques have been carefully worked out and will be strictly enforced. Radio City Sales Co. will hire only men who have not previously sold radios or appliances.

This is done because the management does not want to engage men who may have preconceived ideas of selling in this field, or who may want to stick along with out-moded methods, or at best, methods which



Pillar bases are utilized to form attractive display pyramids, shown above. Heavily carpeted floor, divans and chairs make customers comfortable—create a "buying mood."

are not in line with the thinking going on at this store.

Salesmen selected will be thoroughly trained in presenting Radio City Sales Co.'s lines of sets and appliances. The formula will be "get the order without forcing it."

No "Eager Beaver" Tactics

The lines will be known, and there will be such a variety of models and prices that the management feels that its floor salesmen should be able to make customers feel at home—make them buy without using "eager beaver" methods, and remove from the customers' minds the desire to "shop around" elsewhere.

Because a first-class store, with

attractive, comfortable surroundings is desired above all things, the firm will not display any used merchandise on its showroom floor. Naturally, the company expects it will have to take a certain number of trade-ins, but the items will be transferred to another store to be operated by the firm itself, where used merchandise will be sold.

The profitably-operated service department, consisting at present of three men, will be enlarged later.

The person who, in less than four years, built a hole-in-the-wall shop into one of the most attractive and prosperous shops in the country, is a woman—the present owner-presi-

(Continued on page 122)

★ Declaration of Inter-Dependence—2 ★

For the Radio-Electrical-Appliance Retailer —

1. All industry groups must cooperate from the point of view of what is best for the public and profitable for the dealer.
2. Business belongs to the man who goes after it fairly.
3. Operating costs must be studied and made known, so that goods and services will be sold only at a profit.
4. Radio-electrical-appliance selling deserves modern stores, modern methods, and an invariable policy of friendly courtesy.
5. The dealer should take an active part in his community's cultural, business and civic affairs.
6. Predatory price cutting and misleading advertising have no place in radio-electrical-appliance selling.
7. The local dealer is, for his customers and his community, the accredited representative of the whole radio-electrical-appliance industry.

The Dealer's Place in the

Leading Makers Outline Plans—New Improvements Seen in Car Receivers



More new cars—old cars—on the road! More profits in sales and service!

• Active sales participation in the auto radio field lies ahead in the immediate future for the independent dealer and maintenance man. While it is true that considerable numbers of new cars will be sold equipped with sets, many autos will go into the hands of buyers without them, and such buyers will, for the most part, go to the independent to purchase their car radios.

Automobile manufacturers are planning to produce six million cars a year, and the independent retailer is certain to get a big share of this business as he did in the past.

In addition to the new car business, the dealer can also look forward to selling a lot of sets to the owners of about sixteen million non-radio equipped cars now in use.

It is quite safe to assume that owners of these "old cars," having been unable to buy car sets for a few years, will demand them as

soon as auto radio receivers begin to appear on the market. The number of sales in this "old car" field will not be affected if, as expected, many of the used cars are turned in for new ones. In such cases, cars will be resold and new owners will be equally anxious to buy the sets.

There are also plenty of used cars not in operation, as well. These, for the most part are stock in dealers' hands and "stored" vehicles.

Competitive Factor Low

Now that the gas shortage is over, auto dealers all over the country are once again rolling used cars out for display—and many a price has been slashed. With restrictions lifted, the used car market will boom in sales volume—and car set sales will boom with it.

To make up in a large measure for the amount of car set business he is unable to obtain, the independent auto radio dealer and maintenance man does not have as many competitors as the home set dealer, since this phase of the radio business is highly specialized and many a retailer and servicer stays out of it entirely.

What lies ahead in the way of new things in sets and accessories for the auto radio dealer and his customers in 1946?

What's New in Auto Radio

Technically, a number of improvements are on the way. Motorola's new auto radios will stress more vibrant tone, and unusual power output in all models. Sets will be smaller, and microphonics will be eliminated. Motorola is also designing push-buttons that will need no tools to adjust. Push-button alignment will thus be greatly simplified.

A greatly improved signal-to-noise ratio will also be present in these new Motorola sets, which will reduce background noise considerably. Service operations will be

facilitated by making parts in all models completely interchangeable.

Following his declaration that "the outlook for auto radio business for the independent radio dealer was never better than it is today," James M. Skinner, Jr., general manager, Philco accessory division, promises that his company "will soon announce the greatest auto radio line in Philco history, one with many new features that will have great popular appeal and outstanding values, and hence is sure to become an important source of profit for Philco auto radio dealers.

"Philco, which developed the first practical automobile radio set in 1931 and ever since has been the world's largest automobile radio manufacturer, is laying plans to capture an even greater share of this huge auto radio market," says Mr. Skinner.

Foot Control Explained

Zenith is putting out a foot control to be used with its auto radios. This is a safety device that permits the driver to keep his hands on the wheel, and his eyes on the road, while tuning in different stations and adjusting the volume of his set.

Another foot control device that Zenith is preparing is a silencing button that will blot out radio reception for a period of one minute when it is stepped on by the driver. This button is intended for use in emergencies, or—the manufacturer says—when undesired sections of the program occur. Power to silence offensive "commercials" may soon be in use by car radio owners—a development that will undoubtedly make sponsors strive to improve their commercials.

Comments of some of the radio manufacturers regarding their auto radio plans are given below.

F. D. Masters, manager of Stewart-Warner's radio division, says: "We do not plan to manufacture an auto radio of any kind."

New Auto Radio Picture

E. C. Bonia, sales manager of Sparks-Withington: "The only auto radio that we plan to build is for the Ford Motor Car Co. We will not build any for distribution through our own outlets."

Burl Buckner, sales manager, Arvin radio division, Noblitt-Sparks Industries, Inc.: "We are leaving the manufacture of automobile radio sets out of our program and are devoting all of our space and manpower to the production of home sets."

Same Sales Set-Up

K. T. Milne, sales manager, Delco radio division, General Motors Corp.: "As you probably know, Delco radio division has, in the past, manufactured automobile radios only for the various automobile divisions of General Motors Corp. and for United Motors Service. These divisions have handled their own distribution to dealers either as original factory installed equipment or as an accessory item. Consequently, most of the details of design, pricing and distribution are determined by the policies of these divisions rather than by Delco Radio. As well as can be determined, this method of operation will be continued in the postwar period."

H. A. Johanson, vice-president, sales division, Wells-Gardner & Co.: "The two automobile radio receivers which we will include in

our initial production are entirely pre-war in type. We do not anticipate completing our development work on new models until mid-1946.

"Our merchandise is, practically speaking, sold through chain store and mail order sources of distribution, with a sprinkling of department store accounts. We do not have a jobber-dealer plan of sale, and the independent radio dealer is usually not in a position to order sufficient merchandise to treat with us.

"We do not anticipate any particular change in the merchandising possibilities of car radios during 1946, as compared to pre-war, and while we can see the desirability of offering an FM car radio, we believe some little time will be necessary to overcome the engineering obstacles to that type of installation."

Antenna Sales Outlook

Manufacturers of radio antennas have some interesting comments.

R. B. Stuart, sales manager, Radel Manufacturing Co., says: "We feel confident that the independent radio dealer will find a ready sale in considerable volume for car antennas. The potential sales of new cars certainly justify this prediction. In addition to installations on new sets, there will also be replacement sales, which will be required because many of the aeri-

als in use are worn and damaged.

"A number of improvements have been made in our antennas. Our shortest aerial—a three section model, has an extended length of 70 inches. This is substantially longer than comparable pre-war models, and will give the motorist a correspondingly better signal-to-noise ratio.

"The lead cable has a special aircraft type connector where it joins the aerial. This not only gives a noise and rattle-proof connection, but simplifies connection during installation.

"Our new radar-type lead cable with its 'Q' of over 500 multiplies signal pick-up efficiency of the antenna several times."

Seek Exclusive Features

H. R. Wiesenberger, vice-president, Ward Products Corp., says: "We manufacturers are having difficulty in procuring materials with which to resume the manufacture of auto radio antennas where we left off in 1942.

"There will not be anything revolutionary in the way of improvements at first; however, developments will follow rapidly. This does not mean that any antennas purchased now will be obsolete; as in many other fields, however, every manufacturer will strive for exclusive features."

★ Declaration of Inter-Dependence—3 ★

The Distributor Will—

1. Recognize the great responsibility of the jobber's middle position in (a) providing wholesale outlets for economical manufacturing, while (b) supplying dealers with needed merchandise promptly and efficiently.
2. Sell at "wholesale only" and to established radio-electrical-appliance dealers.
3. Maintain a one-price house, extending the same rate of discount to every dealer.
4. Give no "courtesy discounts" to laymen—they are my customer's customers!
5. Help my dealers by furnishing them prompt and efficient service.
6. Place my commitments so the manufacturer may best plan his production.
7. Look upon my dealers as branches of my own business, and safeguard their interests as I would my own.

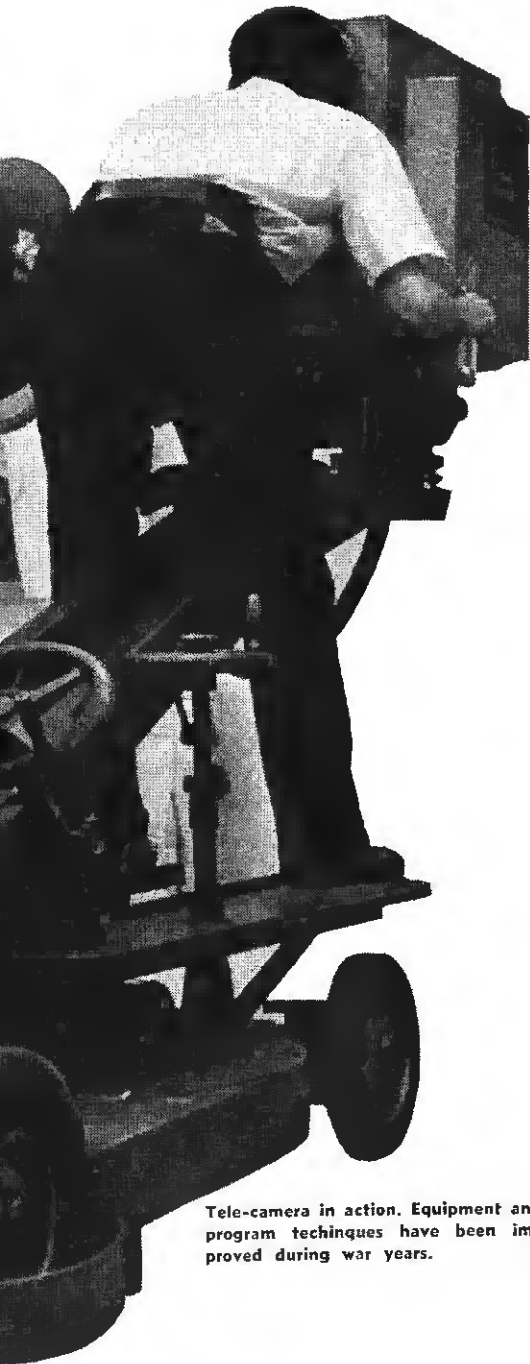

Tele-camera in action. Equipment and program techniques have been improved during war years.

What Dealers May TELEVISION

Here Is the Outlook as Seen by Industry Leaders. Prospects Bright for Video-Set Sellers

DR. ALLEN B. DuMONT
DuMont Laboratories, Inc.
Passaic, N. J.

There should be several thousand television receivers installed and operating in various metropolitan areas by the end of 1946. Perhaps even more, in justifying the efforts of many telecasters who are rapidly coming on the air.

The majority of those television receivers will be in the \$200 to \$600 price range. A rugged set of adequate screen size cannot be sold for less, and the average household cannot afford more. Direct-viewing tube sets will be favored especially in the popular 8 x 10 inch and 13½ x 18 inch screen sizes. Flat-faced tubes will provide undistorted images of high brilliance, good contrast and excellent resolution, comparing favorably with theatre movies. The former drawback of excessive cabinet depth resulting from the direct-viewing tube has been overcome by a cradle mounting whereby the tube is normally vertical when not in use yet swings to the horizontal position and projects beyond the cabinet only during actual use. In the more costly sets, projection-on-screen reception will be available, but relatively few households can afford such luxury.

FRANK M. FOLSOM
Executive Vice-Pres.
RCA Victor Div.
Radio Corp. of America
Camden, N. J.

Some 7,000,000 families in metropolitan New York, Philadelphia, Albany-Schenectady, Cincinnati, Chicago and Los Angeles will be within the range of nine active television transmitters in 1946. To approximately 400,000 initial purchasers among these prime prospects, the industry should market at retail prices approximately \$80,000,000 worth of television receivers in 1946, assuming that all factors are favor-

able for an intensive merchandising program.

RCA Victor will supply (1) low priced models for creating the largest possible audience, and (2) deluxe equipment providing large screen television plus radio of exceptional quality. We hope to market television sight and sound low cost receivers during the second quarter of 1946.

RCA Victor television distribution will be limited to those dealers ready, willing and able to properly install and service television receivers and to back up our new advertising and promotion with the most intensive retail and direct selling effort ever accorded any merchandise. Our merchandising program will be based on the determination to see that purchasers of RCA Victor television instruments receive the most outstanding television performance in the industry.

PALMER M. CRAIG
Chief Engineer
Phileo, Inc.
Philadelphia, Pa.

War-time research will contribute to better, finer receivers, both for AM and FM, and television sets in many ways. New skills have been cultivated and nurtured in all branches of the industry. Circuits and techniques developed to meet special war needs as well as new tubes and components, will allow us to accomplish hitherto impossible results.

In connection with the design and production of radar equipment for the Army and Navy, perhaps the greatest progress of all has been made in developing the technique for measuring infinitesimal qualities far more exactly. All these advances will bear fruit in the post-war period. Dealers and the public are sure to find more brilliant and life-like tone, better selectivity and greater sensitivity in post-war radio receivers and more life-like reproduction in the new television sets.

• With billions of war dollars recently invested in radar research and development which will apply specifically to new television techniques, the new television arts are now set to plunge rapidly ahead as manufacturers' reconversion is completed.

First, of course, the set makers have had to give attention to immediate demands for radio receivers, but early in 1946 the first of the new television sets will be coming off the production lines.

To give our dealer-readers a first-hand view of the commercial prospects ahead for television in 1946, we have asked leading figures in the television field to comment on the picture as they see it:

Expect of in 1946

E. A. NICHOLAS
President

Farnsworth Television & Radio
Fort Wayne, Ind.

All the factors of design and price are not yet definitely determined, and changes may well come in the near future. However, the fundamentals of television transmission and reception appear to be pretty well worked out for the present.

At the beginning, I believe the industry will offer two general receiver designs—one a table and the other a console type. The table model will be designed for direct viewing utilizing 7" and 10" tubes. The second type will be a more elaborate console with projection by the reflection method

(Continued on page 54)

DR. RAY H. MANSON
President

Stromberg-Carlson Co.
Rochester, N. Y.

From the standpoint of actual mass production of receivers, there is the matter of picture tubes. It is my understanding that 7" and 10" direct-viewing tubes have been standardized, with a view of getting machine production of the glass blanks or envelopes. Until this is done, no large production at reasonable cost can be expected for the picture

(Continued on page 54)



Scene in studio of General Electric's Schenectady station WRGB which for network telecasts also links up with NBC's Empire State transmitter WNBT.

J. R. POPPELE
President

Television Broadcasters Assn.
Inc., WOR, New York

Types of receivers and prices will vary from the low bracket to the "expensive class." While few of the manufacturers have as yet announced their complete line of video receivers, it appears quite likely that lower priced sets (\$100 to \$250) will be either direct viewing table or floor models, while the \$300 and higher sets will include larger direct viewing screens and projection-type images, with picture sizes ranging from 18 by 13 inches to 18 by 24 inches and perhaps larger.

Estimates on how many television sets will be manufactured and sold in 1946 are difficult to make. Surely, a great demand for new receivers exists in areas like New York, Schenectady, Philadelphia, Chicago and Los Angeles, where stations are now operating, and there is every reason to believe that many thousands of receivers will be sold in these cities

as soon as they reach retailers. However, several additional video stations are likely to go on the air before the end of 1946, and each new station in a presently unserved area will open new markets for video sets.

PAUL W. KESTEN
Executive Vice-President
CBS, New York

Television as an advertising medium will flower into full color in 1946. This should multiply its appeal as a commercial medium by at least 100%. Together with color, which CBS plans to demonstrate privately before January 1st and publicly early in the year, the new pictures will provide vastly greater definition and detail. 1000-line black and white pictures will supersede the present 525-line pictures. This combination of superior black and white and superior color will parallel the growing emphasis on American product design—in which eye-appeal has be-

(Continued on page 54)

★ Declaration of Inter-Dependence — 4 ★

As a Manufacturer, I Will—

1. Recognize that my distributors and dealers must be selected with utmost care, giving preference to those with reliability, integrity, and ability to render service.
2. Adopt a definite dealer policy—favoring the independent dealer whose primary business is the sale of radios and electrical appliances.
3. Keep my products out of the hands of those who have not the best interests of the radio-electrical-appliance industry at heart.
4. Gauge production to prevent liquidation and price cutting—protect dealers and jobbers on discontinued models or those on which price is to be lowered.
5. Protect my jobbers' territories by not setting up over-competition.
6. Keep my product prominently before the public, and help dealers with their local newspaper advertising.
7. Cooperate actively and effectively with my distributors and dealers, to the ends of more profits for us all and better service to the public.

RADIO SHOWCASE

Admiral RADIO PHONOGRAPH

"Slide-a-Way" automatic record changer is incorporated in this model. Admiral Corp., Chicago 47, Ill.—RADIO & Television RETAILING

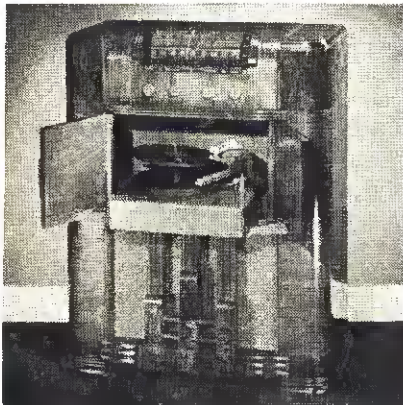

Admiral RADIO

Two band radio in streamlined ivory or walnut plastic cabinet. Admiral

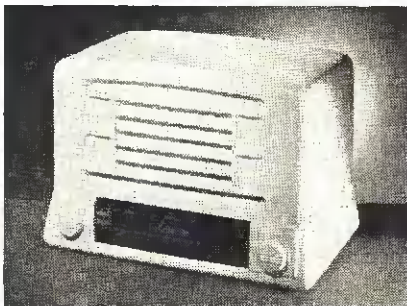

Corp., Chicago 47, Ill.—RADIO & Television RETAILING

Ansley RADIO PHONOGRAPH

The Century is available with or without matching cabinets. These cab-

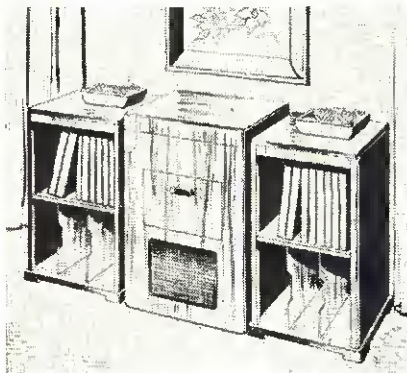

inets provide storage for about 500 records. Models 53, 54 and 63 chassis have automatic record changing Dynaphone unit. Ansley Radio Corp., 21-10 49th Ave., Long Island City 1, N. Y.—RADIO & Television RETAILING

Ansley CONSOLE

The Skyline incorporates the DYNAPHONE. Ample record space provided. In oak or birch, with choice of several finishes. The fabric panel will be offered in a choice of several colors and

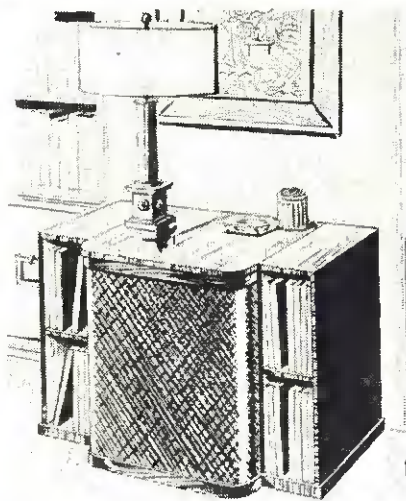

is easily removable. It can be changed when the color scheme of the room is changed. Models 53, 54, and 63 chassis have record changing Dynaphone. Ansley Radio Corp., 21-10 49th Ave., Long Island City 1, N. Y.—RADIO & Television RETAILING

Arvin RADIO PHONOGRAPH

Model 556 is a table combination in an ivory finish cabinet. Radio is 5-tube, ac-dc; phonograph is ac, and plays 10-

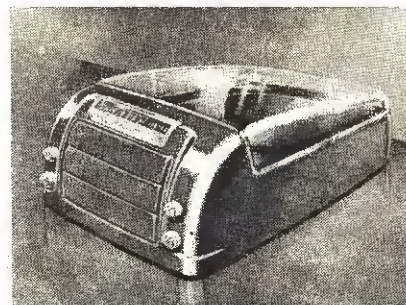

in. records manually. Two of the five tubes are dual-purpose types. Speaker

is 5-in. electrodynamic. Concealed, built-in loop antenna is present. Reception is on American band, 540-1600 kc. Noblitt-Sparks Industries, Inc., Columbus, Ind.—RADIO & Television RETAILING

Arvin PORTABLE RADIO

Model 642 is a 6-tube battery-electric portable that operates on enclosed batteries outdoors, or 110 v ac or dc indoors. Reception is on American band, 540-1600 kc. Batteries are in 200-hour single pack 9-volt "A" and 90 v "B." Speaker is 6-in. pm type. Case is made

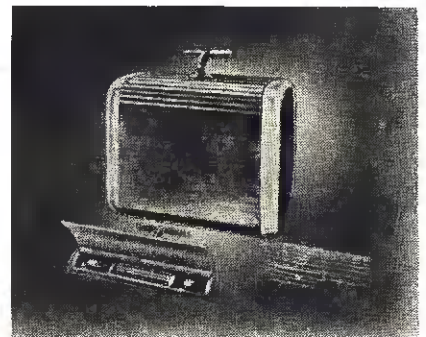

of non-breakable aluminum, with door that encloses tuning controls. Carrying handle folds flat against case when desired. Noblitt-Sparks Industries, Inc., Columbus, Ind.—RADIO & Television RETAILING

Crosley RADIO

66TW is a table model receiver, with 6 tubes, 2 bands for broadcast and overseas reception, and large size dial. Speaker is electrodynamic. Other features include automatic sensitivity control, signal web antenna, and continuous tone control. 4 watts undistorted output. White bakelite cabinet is 9-9/16 in. high, 14-9/16 in. wide, and 7-9/16 in. deep. Crosley Corp., Cincinnati 25, Ohio—RADIO & Television RETAILING

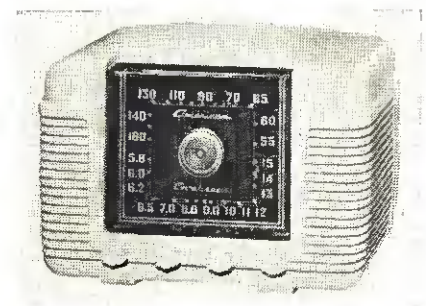

Latest Radio Merchandise from Humming Production Lines. Manufacturers Shifting Into High Gear to Satisfy Heavy Pent-Up Consumer Demand

Crosley RADIO PHONOGRAPH

66CP is a 6-tube console model with an automatic record changer, 2-band reception: broadcast and overseas. Undistorted output is 4 watts; maximum power output is 6 watts. Speaker is 10-in. electrodynamic type. Signal web antenna, floating jewel tone system, and automatic sensitivity control are among the other features. Full lift-top lid has new type of hinge for closing. Crosley Corp., Cincinnati 25, Ohio—RADIO & Television RETAILING

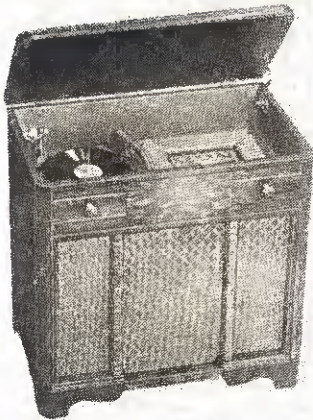

Following is a larger unit of the ECA line.

7-tube chairside combination with gentle action record changer. Phonograph slides to either right or left, so that model can be positioned at either side of chair with no necessity to lift top. Undistorted power output of radio

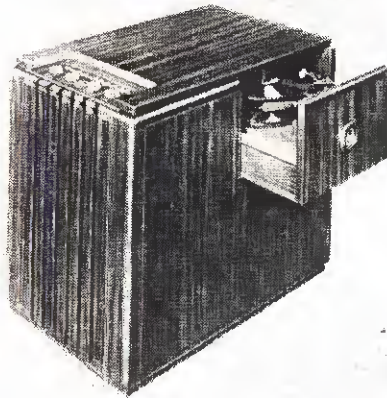

is 2½ watts. Speaker is 8-in. size. Provision for convenient servicing through top of set, where entire chassis may be exposed, is present. Electronic Corp. of America, 45 W. 18th St., New York 11, N. Y.—RADIO & Television RETAILING

Utah WIRE RECORDER

The Magicwire is a portable reproducing device capable of making recordings on a moving steel wire and reproducing them immediately. Re-

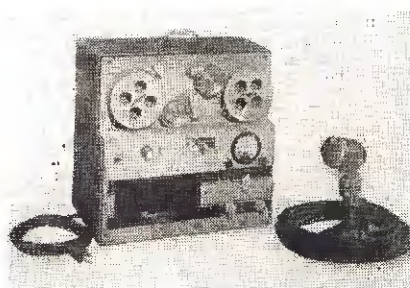

cordings may be temporary or permanent, as desired. Permanent wire recordings may be played back thousands of times without sign of change from original quality. Unit will record in any position. At any time when the recording wire has served its purpose, it may be cleared of its record and the same wire used for another recording. The recorder and reproducer includes a full-wave rectifier tube, 3-stage audio amplifier, 30 kc oscillator tube, record-listening unit, and drive motor

and associated mechanism. Utah Radio Products Co., Chicago 10, Ill.—RADIO & Television RETAILING

Meck RADIOS

Trailblazers are 5-tube superhets. Small white model is in the hands of

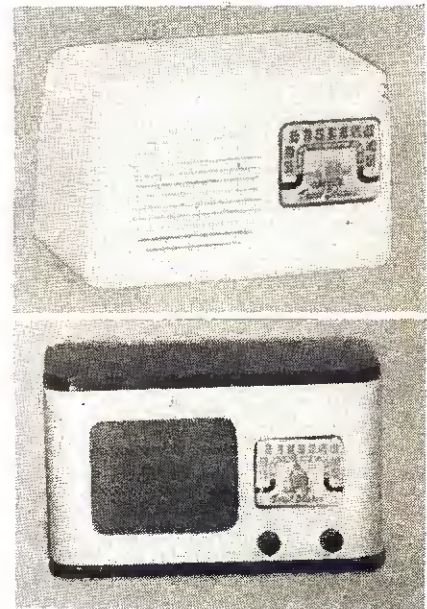

dealers, retails for approximately \$16. Larger model shown is on its way. John Meck Industries, Inc., Plymouth, Ind.—RADIO & Television RETAILING

Belmont POCKET RADIO

Pocket radio receiver, 3 in. wide, ¾ in. thick, 6¼ in. high. Weight 10 oz., including batteries. Retail prices start



at approximately \$30. Raytheon Mfg. Co., Inc., 60 E. 42nd St., New York 17, N. Y.—RADIO & Television RETAILING

(Continued on page 42)

ECA RADIO PHONOGRAPHS

Model 106 is a 5-tube table model combination with gentle action automatic record changer. Light weight crystal pickup is used. Undistorted power output is one watt. Sensitivity is uniform over entire tuning band.



Slide rule illuminated dial has "bomb-sight" indicator and convex dial shield. Electronic Corp. of America, 45 W. 18th St., New York 11, N. Y.—RADIO & Television RETAILING

New Radio Merchandise

Sentinel RADIO

Model 294-W is a 6-tube ac-dc superhet with two bands—short-wave and broadcast. An rf stage has been added to increase sensitivity. Built-in loop



aerial, full range tone control, and illuminated slide rule dial are provided. Output is beam power type. 6-in. pm speaker is used. Cabinet is of walnut bakelite. Sentinel Radio, 2020 Ridge Ave., Evanston, Ill.—RADIO & Television RETAILING

Sentinel PORTABLE

Model 285-P is a 6-tube ac-dc or battery superhet, with self-contained 300-hour batteries. An rf stage is provided for increased sensitivity. Clear vision

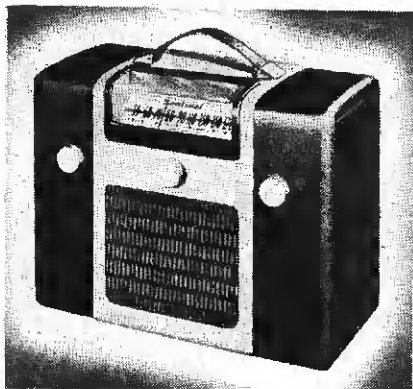

slide rule dial has protecting plastic crystal. Aerial is built-in loop type. Automatic volume control present. Speaker is 5-in. pm model. IF transformers have iron cores. Sentinel Radio, 2020 Ridge Ave., Evanston, Ill.—RADIO & Television RETAILING

Fairchild SPOTTER RECORD-PLAYER

The Language Master is basically a record player with a device that permits the accurate spotting and repeating of any desired passages on a record. For classroom, library, or private study use. Fairchild Camera & Instrument Corp., 88-06 Van Wyck Blvd., Jamaica 1, N. Y.—RADIO & Television RETAILING

U. S. Television RADIO

Clearsonic R2003 is an ac-dc superhet with 7-tube performance. Five inch speaker, walnut or mahogany cabinet. U. S. Television Mfg. Corp., 106 Seventh Ave., New York 11, N. Y.—RADIO & Television RETAILING

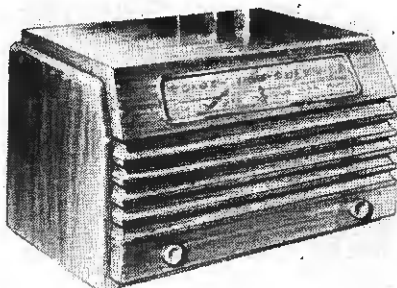

U. S. Television RADIO PHONOGRAPH

Clearsonic R2004 is an ac-dc table combination with a constant speed

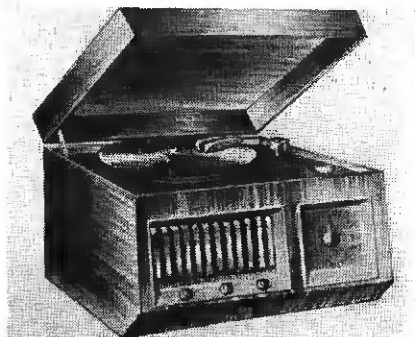

turntable and feather-light playing arm. 7-tube performance. U. S. Television Mfg. Corp., 106 Seventh Ave., New York 11, N. Y.—RADIO & Television RETAILING

Temple RADIOS

Table model E-622. Two band radio. 535 to 1700 kc and 6 to 17 mc. 1.5 watt output, permanent magnet speaker, ac-dc operation. Long slide rule dial; self-contained loop. Lists at approximately \$40. Templetone Radio Mfg. Corp., New London, Conn.—RADIO & Television RETAILING

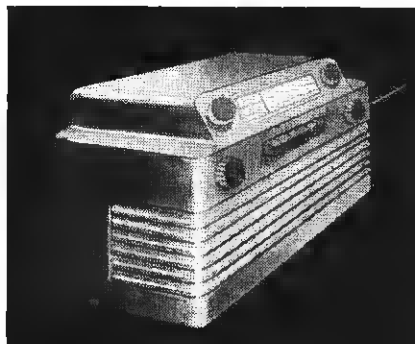
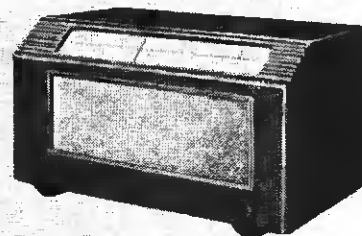

Table model E-514. One band, 535 to 17 kc. Two watts output, permanent magnet speaker, 105-125 volt, ac-dc operation. Slide rule dial; self-contained



loop. Retails for approximately \$30. Templetone Radio Mfg. Corp., New London, Conn.—RADIO & Television RETAILING

Stewart-Warner RADIO

6-tube, 2-band, ac-dc set, in walnut cabinet with chrome grille. Stewart-Warner Corp., Chicago 14, Ill.—RADIO & Television RETAILING

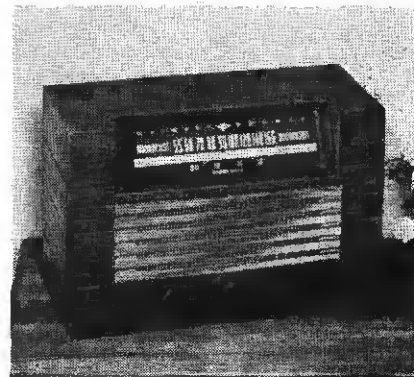

Stewart-Warner RADIO-PHONOGRAPH

Table type, model 9009-B, 6-tube ac set. Single band, including police calls.



Phono section has record changer. Stewart-Warner, Chicago 14, Ill.—RADIO & Television RETAILING

From Busy Factories

RCA Victor RADIO

Model 56X uses 6 tubes, including dual purpose type. Extra-large "Magic Loop" is present. Speaker is 5-in. dynamic type. Angle-vision dial is recessed, and has new "bull's-eye" pointer. Cabinet is made of walnut

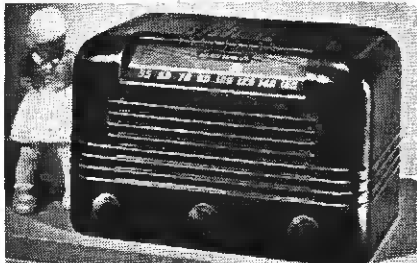

plastic. List price approx. \$24.95. RCA Victor, Radio Corp. of America, Camden, N. J.—RADIO & Television RETAILING

RCA Victor PORTABLE

Model 54B is a "personal" that can be carried in a topcoat pocket. Cubic content is 1/3 less than in the RCA Victor prewar "personal." Room-sized volume may be obtained. 4 miniature

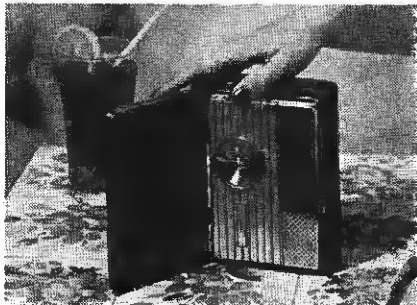

tubes include dual purpose types, giving 6-tube performance. Dimensions are 3 1/4 x 4 1/4 x 6 1/4 in. Weight is 3 1/2 lbs. List price approximately \$25. RCA Victor, Radio Corp. of America, Camden, N. J.—RADIO & Television RETAILING

Garod RADIO

Model 5A2 is a 5-tube ac-dc superhet in a two-color plastic cabinet. Lucite

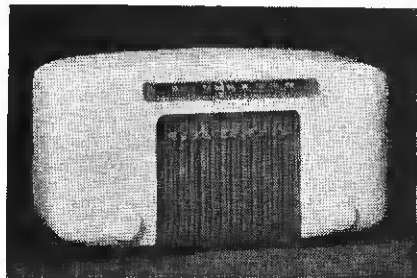

dial scale is present. New "Grand" tone circuit is incorporated. Antenna is concealed loop type. Garod Elec-

tronics Corp., 70 Washington St., Brooklyn 1, N. Y.—RADIO & Television RETAILING

Garod RADIO PHONOGRAPH

Model 8BPY6 is a console combination housed in a breakfront cabinet. Walnut and mahogany finishes. Radio is 8-tube ac-dc superhet, with 3-gang capacitor. Push-pull audio output is used.

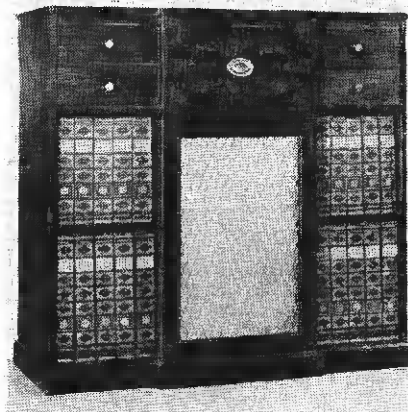

Large auditorium speaker is present. Phonograph is in hide-a-way drawer in center of cabinet. Two post record changer loads 12 10-in. or 10 12-in. records. Garod Electronics Corp., 70 Washington St., Brooklyn 1, N. Y.—RADIO & Television RETAILING

Stromberg-Carlson RADIO PHONOGRAPH

Futura is a console type combination. Radio is a superhet with standard broadcast and short-wave bands, and both present and new FM bands. Push-button and manual tuning are incorporated. Audio output is ten watts. 12-in. electrodynamic speaker in float-

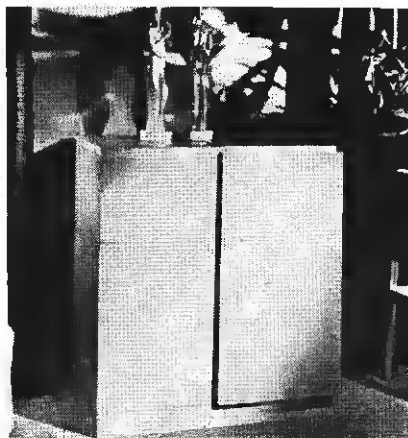

ing suspension is used. Shift in production plans will delay manufacture of this model. Will probably appear late in January, 1946. Stromberg-Carlson Co., Rochester 3, N. Y.—RADIO & Television RETAILING

Stromberg-Carlson TABLE SET

The Impresario. 6-tube, superhet, radio-phonograph table model. AM and

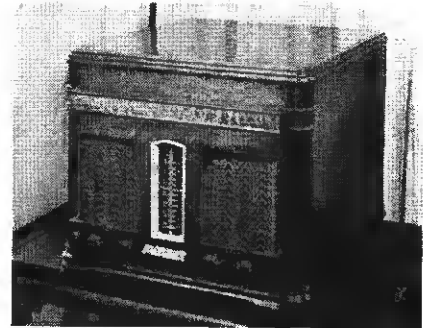

spread-band short wave band. Record changer is automatic. 6 push-buttons. Dial is vertical slide-rule type. Stromberg-Carlson Co., Rochester 3, N. Y.—RADIO & Television RETAILING

GTR RADIOS

General Cadet model 5-A5 is housed in a plastic case that is available in ivory, black, burgundy, green and mahogany. General verwood model 2-A5 comes in a Prima Vera blonde wood

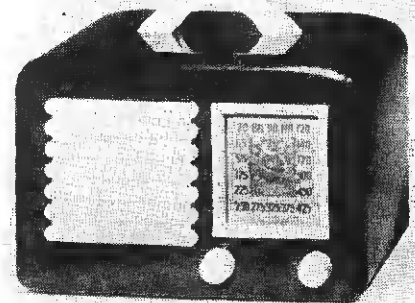

Model 5-A5

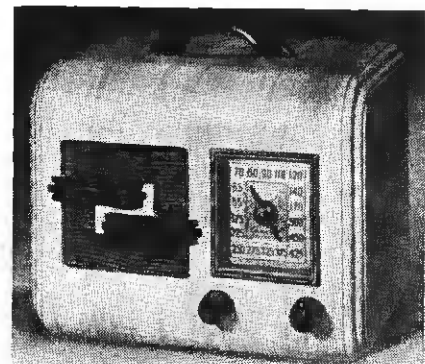

Model 2-A5

cabinet. Both models are 5-tube superhets, with built-in antenna and five-inch pm speaker. General Television & Radio Corp., 2701-17 Lehmann Ct., Chicago 14, Ill.—RADIO & Television RETAILING

Reconversion Steps Up New

GE RADIO

Table model, 9 other table models, a portable, and a console radio-phonograph will be in dealers' stores some

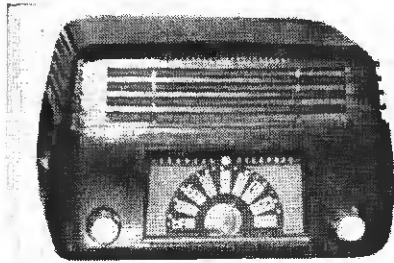

time in November. General Electric Co., Schenectady, N. Y.—RADIO & Television RETAILING.

DeWald RADIO PHONOGRAPH

Model A-603 is a table combination with an automatic record changer. Radio is a 6-tube superhet. Speaker is large, electrodynamic type. Phono mo-

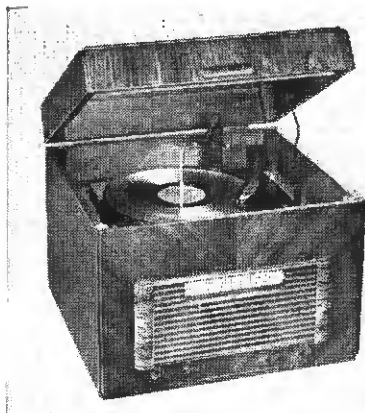

tor is self-starting. Lightweight pick-up has permanent point needle that minimizes needle-scratch. Changer plays 12 ten-inch, or 10 twelve-inch records with the lid closed. DeWald Radio Mfg. Corp., New York 3, N. Y.—RADIO & Television RETAILING

DeWald RADIO

The A-501 "Lyre" is a five tube superhet featuring ac-dc operation; standard

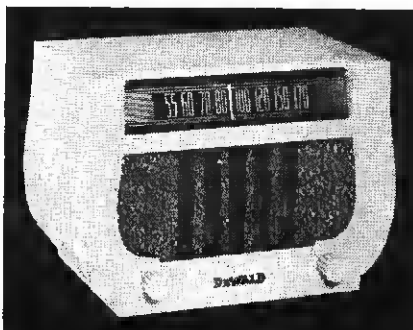

American broadcast and police reception; and easy-vision, slide rule dial. Built-in "Looptenna" is used. Speaker is large, dynamic. Automatic volume control is incorporated. Output is beam power type. DeWald Radio Mfg. Corp., 436-440 Lafayette St., New York 3, N. Y.—RADIO & Television RETAILING

Radiotechnic Lab WIRE RECORDER

Model 55 Magnetic Wire Recorder is capable of making instantaneous recordings on wire with either a dynamic or crystal type of microphone in the input circuit. Continuous recording time is 66 minutes. Automatic timing device capable of turning the ma-

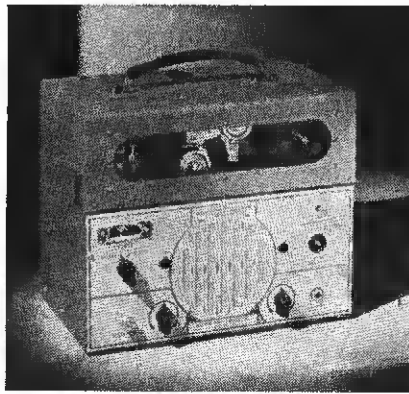

chine off after the proper time has elapsed for recording may be timed to the listener's discretion. Radiotechnic Laboratory, 1328 Sherman Ave., Evanston, Ill.—RADIO & Television RETAILING

Ultratone PHONOGRAPH

Model CM-6 is a closed top single record player. Size is 14 in. wide, 12 in. deep, and 8½ in. high. Plays ten or twelve in. records with lid closed. Features include heavy duty pm



speaker, tone control, separate on-off switch for motor and amplifier, and feather weight crystal pick-up. Constant speed, self-starting phono-motor is used. Audio Industries, Michigan City, Ind.—RADIO & Television RETAILING

Ultratone PORTABLE RECORD PLAYER

Model PM-6 is electrically amplified, single record type. Size is 14 in. wide, 15 in. deep, and 7 in. high. Heavy duty pm speaker, tone control, and separate on-off switch for motor and amplifier

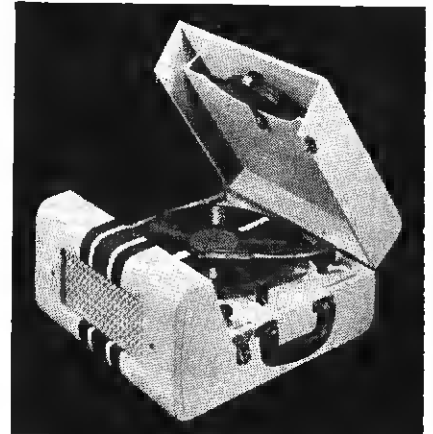

are featured. Cabinet is made of 3 ply veneer covered with durable leatherette. Record storage compartment provided in cover. Audio Industries, Michigan City, Ind.—RADIO & Television RETAILING

Harris ELECTROTONE RECORDER

Model 100 records up to 13-in. acetate or pressings. Power output is 6 watts. Pickup uses astatic true tangent crystal. Governor-controlled, 78 rpm, 50-60 cycle motor is present. Speaker is 8-in. electrodynamic type. Weight 35 lbs.,

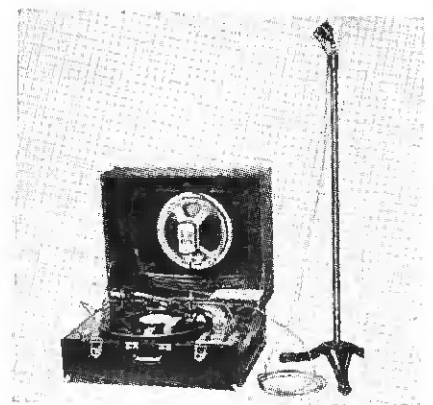

price \$69.50. Harris Mfg. Co., 2422 W. 7th St., Los Angeles 5, Cal.—RADIO & Television RETAILING

Harris ELECTROTONE RADIO PHONOGRAPH

Model 4000 is a portable type. Plays 10-in. or 12-in. records automatically. Custom-built radio receives on standard

Radio Merchandise Flow

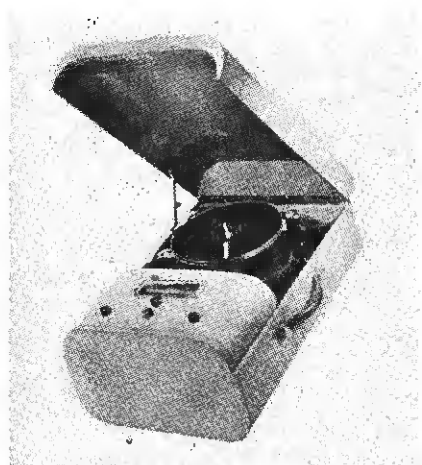

plastic sets, in walnut and ivory finishes. Easy view dial, pm speaker, and built-in "Automatiscop Loop" are included among features. Automatic Ra-

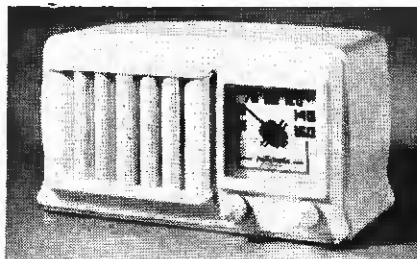

dio Mfg. Co., 122 Brookline Ave., Boston 15, Mass.—RADIO & Television RETAILING

Radio Craftsmen RADIO

Designed for kitchen use. 5-tube ac-dc wall model with polished glass shelves

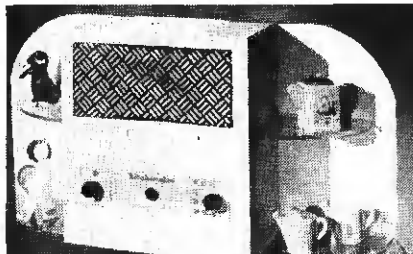

attached. Cabinet is of baked enamel with grill and trims in red, black or blue. Receiver is mounted on wall by means of special mounting brackets, and contains a built-in aerial. Dimensions are 22 x 11 x 6 in. Glass escutcheon diffuses light across the panel. Radio Craftsmen, Inc., 1341 S. Michigan Ave., Chicago 5, Ill.—RADIO & Television RETAILING

Wilcox-Gay RECORDER

Model 6A10 is a portable type dual speed recorder. Will be ready for de-



livery about the first of December. Wilcox-Gay Corp., Charlotte, Mich.—RADIO & Television RETAILING

broadcast and short-wave. Performs on 110-220-250 v ac or dc, on land, sea, aboard ship, or in any foreign country. Priced at \$200. Harris Mfg. Co., 2422 W. 7th St., Los Angeles 5, Cal.—RADIO & Television RETAILING

Automatic RADIOS

5-tube ac-dc portable set, model C60. Standard batteries with rejuvenation feature. Dial is full vision. Self-contained aerial and pm speaker are present.

Models 601 and 602 are 5-tube ac-dc

FOR LATEST ELECTRICAL APPLIANCES SEE PP. 68, 69, 73, 74, 77, 78, 80, 83

New Book for Dealers on Merchandising Methods

To improve the relations between dealers and their customers amid the confusion of regulations, laws, directives, etc., the National Assn. of Better Business Bureaus, Inc., has issued a book entitled "Guide for Retail Advertising and Selling."

The book is designed to curb any unfair merchandising practices and to straighten out any misunderstandings between business and its customers. The contents of this publication strike at the heart of a problem in which all merchants are interested—that of maintaining public confidence in business.

The Guide may be obtained for \$1 from any local Better Business Bureau, or direct from the association at 308 Frederick Bldg., Cleveland 15, Ohio.

Emerson Sales Manager

Phil Glad, manager of field inspection at Emerson Radio and Phonograph Corp. for the past two years, has been appointed southern sales manager for the firm, Ben Abrams, president, announces. Glad will have headquarters in Atlanta.

Meck Receiver Gets OPA Price Approval

OPA price approval of a radio set for civilian use has been granted to the John Meck Industries, Plymouth, Ind.

The approval has been placed on a miniature five-tube superheterodyne table model. The retail price established was \$15.95, an approximation of 1942 prices, according to OPA authorities.

The set has been in production for several weeks, and will be distributed in volume to dealers throughout the country immediately.

ECA Exhibits 6 New Sets; Radios Have "Rating Tag"

Electronic Corp. of America held the first showing of its new line of ECA radios recently. Samuel J. Novick, president, and Jack Geartner, sales manager, addressed the meeting.

Six sets, all ready for production in 1945, were shown, including five and seven tube table models and four radio-phonograph combinations. Two of the combinations are table models; one is a luggage type with handle for easy portability, and the fourth is a chairside

model with phonograph compartment sliding out to left or right.

Every ECA receiver will carry an informative labelling tag which contains performance data about the set. On the same tag as the performance rating data is the manufacturer's guarantee that the particular set will perform in accordance with the accurate performance rating established for it.

More Sparton Shipments

Ed Bonia, general sales manager of the radio and appliance division of the Sparks-Withington Co., announces that the factory expects to be making shipments to dealers this month. A greatly increased advertising program for the last four months of 1945 has been launched.

Hallicrafters FM Adapter

The Hallicrafters Co. held special demonstrations of its FM converters in Chicago for radio engineers and executives of leading radio manufacturing companies.

The converters enable pre-war FM receivers to receive on the new 88 to 108 megacycle band established by the FCC.

Again We Say —

HURRY

Studio Eyefuls from
Sponsored by Radio

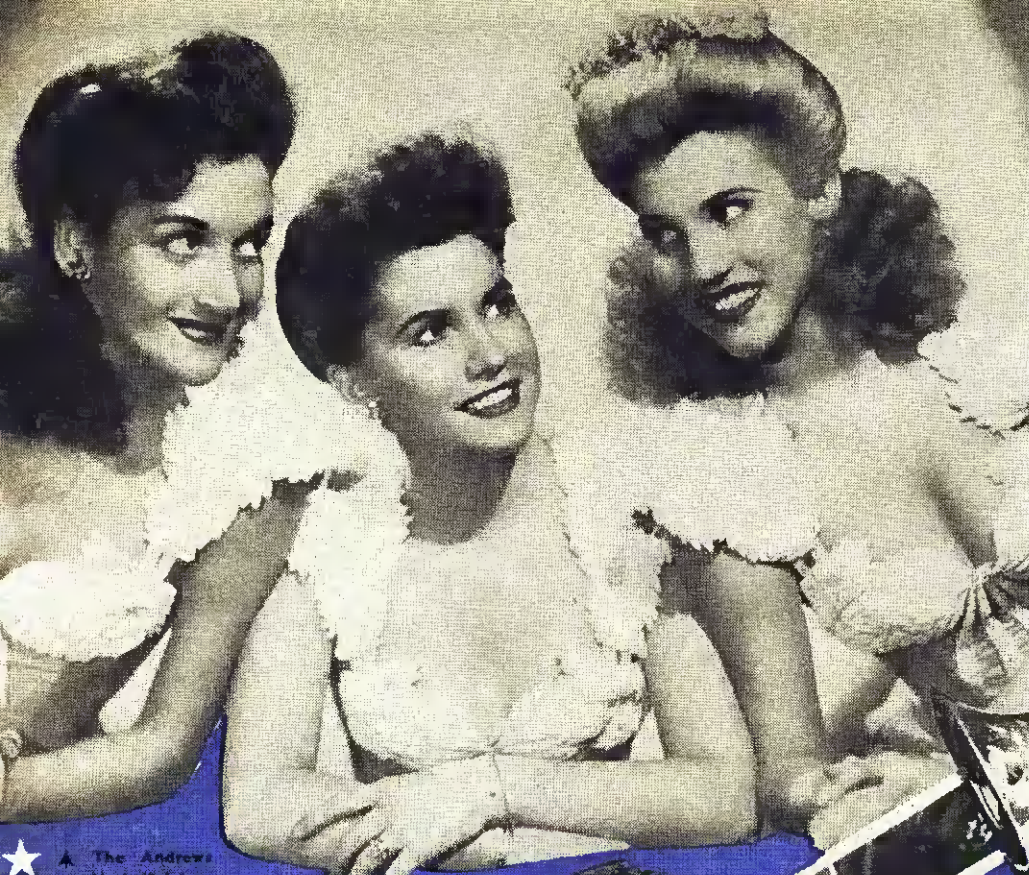

★ ▲ The Andrews Sisters on Nash-Kelvinator's show over CBS Wednesdays, 10:30 to 11:00 PM.

Tommy ★
Dorsey on the
RCA Show,
Sunday after-
noons at 4:30
over NBC.



★ ▲ Joan Brooks, Mon-
days through Fridays,
11:15 to 11:30 PM,
for CBS.



★ ▲ Orson Welles, commentator for
Lear, Inc. on its show over ABC,
Sundays, 1:15 to 1:30 PM.



★ ▲ Starring for Philco Corp.
on its Sunday evening show, Martha
Tilton, Radio Hall of Fame, at 8:00
ABC.



★ ▲ "Breakfast with Dorothy and Dick" on WOR, Mondays through Fri-
days, at 8:15 AM. Westinghouse Lamp Division is one of their sponsors.

TELEVISION!

Recent Broadcast Programs

Electrical Appliance Manufacturers

▶ Two of General Mills' soap opera stars: Sarajane Wells in "Woman in White"; and Patricia Dunlap, in the fetching hat, is cast in "Today's Children", both over NBC.



★ John Charles Thomas, for Westinghouse on its Sunday afternoon program over NBC at 2:30.

★ Ted Malone interviews a charming guest for Westinghouse over ABC.

★ Y at the party, featuring... and the famous... register, Linkle... over CBS, Monday through Fridays, 8 PM.

★ Jeannie, soprano in Phil Spitalny's "Hour of Charm" for General Electric, Sundays at 10:00 P.M. on NBC.

★ A Four Chicks and Chuck, Cosmo Record artists, on the record company's own program, "Cosmo Tune-Time", over the Mutual Network, Saturdays 8:30 to 9:00 P.M.

Brown MUSIC CO.



"DOUGH" in DO-Re-Me

Kansas Firm Draws "Record" Crowds—Builds Set and Appliance Sales

• The background of the sales staff of an attractive new radio-appliance-record store in Kansas City, Kans., a busy community and a thriving industrial and business center, is drawn from many types of retail stores.

At the Brown Music Co., as modern as tomorrow, there is a record saleswoman who has been employed with the record section of a large drug "chain," and another record saleswoman with department store experience. Mrs. Mildred Wade, the store's competent manager, chalked up six years as director of a mail order house record department. And to top it off, the owner, Harry J. Brown, is a former juke box distributor.

A blend of all this sales talent,

"tailored to order," has given the store a sales send-off that should pay off in handsome profits. This Kansas city was "ripe" for a store that dealt, in large volume, with records, and Dealer Brown and his aggressive sales manager, Mrs. Wade, were quick to seize the opportunity.

"Mixed" Clientele Buys

The eye-appealing pink-stuccoed building, with interior in blond wood and pink walls, is a radio-record store proprietor's dream. Surplus space in the rear of the establishment is undergoing conversion into a trim repair shop. Upstairs, there are handsomely-designed display quarters for ex-

hibiting "at their best" record players, radio-phonograph combinations, refrigerators, and other appliances.

No store, asserts Mrs. Wade, has a more mixed clientele. Cowboy records are going "great guns" because of the large farming population. Foreign language records get a fine play from those residents interested in discs of this type.

So brisk has been the children's record business, including those of pre-school age, and the five to ten year olds, that it was found necessary to devote a display section exclusively to these youthful devotees. Attractive murals with an appeal to the youthful record fans are overhead. Movie-conscious teen-agers call for recordings which

were heard in the local cinemas.

The classics are not neglected. Customer interest in classical recordings has been surprisingly sharp.

Opened this past summer, the store's advertising and sales promotion program isn't completely under way, but it is evident that Mrs. Wade avoids the hit-and-miss variety of sales-building methods. Spot announcements on radio station KCKN, ads in "The Kansan", and Missouri newspapers, spotlight new record releases.

Currently, Mrs. Wade is bidding for a well-placed broadcast spot which precedes a record show that is among the most popular broad-

casts. Brown's will also sponsor a new record show over the air as soon as Mildred Wade uncovers a suitable spot. She is particular that this "location" on the air is right for record buyers. Night shows have her vote in preference to day-time shows, because she insists record buyers are a night-time radio audience.

Large Juke Box Trade

It certainly has done this establishment no harm that the owner has a background in juke box distribution as many of his former associates in this field are among the store's clients.

Obtaining the confidence and the

good-will of the juke box operators has proved to be an excellent policy. Sales to the nickelodeon trade have boosted the firm's volume. Frequently, a juke box owner buys as many as 50 records each time he visits this store. This retailer's past experience in the distribution of music machines has proved to be a valuable asset.

Sales aptitude of the establishment's experienced staff is shown by the high "sales batting average" on accessory merchandise. Six out of ten persons who enter the store have been sold either needles or some other accessory by the simple expedient of suggestive selling. The

(Continued on page 176)

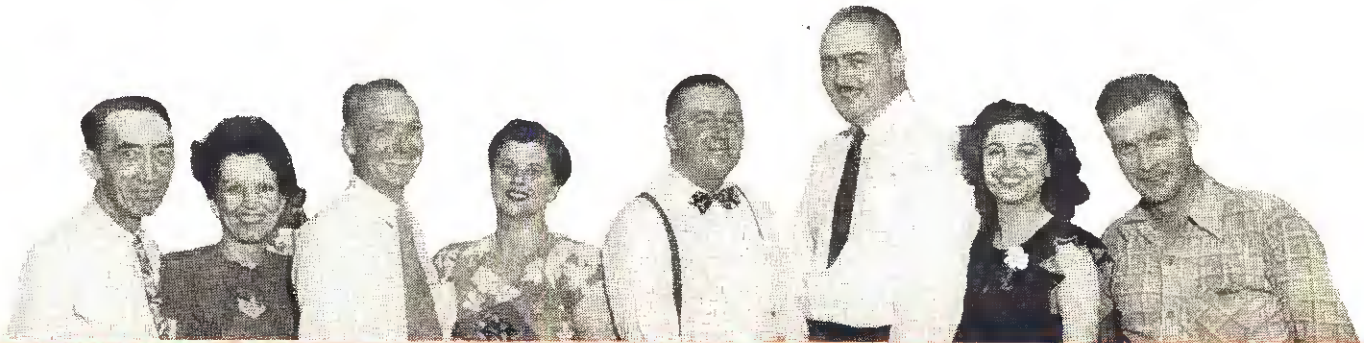

On opening day, staff of Brown Music Co. and two distributing firm representatives pose for the photographer. Left to right: Glenn Raudebush, bookkeeper; Margaret Whipple, record sales; George Shearer, representative, Federal Distributing Co.; Mildred Wade, manager; Harry J. Brown, owner; Jeff Wilson, representative, Columbia Record Co.; Jana Nowak, record sales, and John Nelson of the service department. Below, a whole floor is devoted to the sale of records. Upsairs there are modernly designed display rooms for radios and electrical appliances.





"live" talent on two Springfield radio stations does much to foster sales of hill-billy records.

It is to discs of classical music, however, that Paul Hoover has slanted his sales efforts. A specially-designed listening booth for devotees of the Old Masters exclusively is used to boost sales of the classics. Classical patrons enjoy the privilege of taking home classical albums on trial, and the fact that eight out of ten retain the albums testifies to the workability of this procedure.

Sells the Musicians

Dealer Hoover sponsors a thirty-minute program of classical music on a local radio station. The second floor of the Hoover building has facilities for a recital hall where local talent may show off their musical ability before the home folk. The local musicians union also makes use of the hall for meetings. Most of the members own record players, and appreciate the free use of the hall sufficiently to buy most of their records from Hoover.

customers enjoy recording their own talents, and they also purchase recordings of their hill-billy singing idols.

Layout for More Sales

The store arrangement includes a spacious record department, with two 10-foot counters, several self-service sheet music racks, and a recently remodeled radio section. Ninety per cent of the radio stock will be in combination sets because of the terrific sales demand the dealer foresees for these sets. "The Middle West," says Hoover, "is taking to recorded music, and now the people are record enthusiasts."

Radios and electrical appliances will be displayed in a section separated from the rest of the store as Hoover likes the idea of escorting combination prospects into a room designed exclusively for showing this merchandise. The radio and appliance department will have a sales force working on the outside as well as on the floor. A maintenance department is also planned.

Up Go Record Profits!

Dealer Capitalizes on Keen Interest in Discs; Store Is "Record Headquarters" for "Fans"; Pushes Sale of Classical Platters

• The residents of southern Missouri are tremendously record-conscious. One indication of this disc-interest is reflected in the soaring record stocks of radio-record store proprietors. One example is the Hoover Music Co., of Springfield, a southwestern Missouri city boasting two colleges, O'Reilly General Hospital for the Army, 65,000 inhabitants, and some of the best fishing resorts.

Paul Hoover, the establishment's owner, confesses that his pre-war stock wouldn't have amounted to over \$500; but he values his present record department at \$6,000.

A fondness for all sorts of recorded music has developed among residents of the Ozark country, running the gamut of hill-billy to classical, with the former especially relished by the residents of outlying Ozark hill country. The

local interest in records has been given added impetus during the war by the fact that thousands of World War II veterans are patients in O'Reilly General Hospital. The recreational division of the hospital purchases classical recordings as a morale-builder for the patients. Hundreds of wives, mothers, sweethearts of the hospital patients reside for months in the city to be close to the disabled veterans. The tastes of these visitors run more to the classical albums, according to Paul Hoover. Sales to these purchasers average \$5 and \$6.

However, Paul Hoover, does not slight the popular and hill-billy trade. His store is headquarters for the younger set, and the boogie-woogie fans. Cowboy vocalists and instrumentalists from the stations make use, at low cost, of this dealer's recording equipment. These

Upper left, Dealer Hoover waits on a record customer. He finds selling classical albums "on trial" profitable. Sales of hill-billy discs are tied in with local radio broadcasts. Below, record enthusiasts browse through albums. This establishment is very popular with the younger set who prefer to buy discs here.



WE'RE TELLING

30,000,000 PEOPLE!

BE READY WHEN THEY ASK YOU

ADD THESE MEMORABLE ALBUMS TO YOUR LIBRARY

THE WINDMILL AND HIS GLEE CLUB
 Sacred songs rendered in the
 full chorus & solo by and
 12 vocalists. 10 songs. 10
 inch. No. DA-155 \$3.00



OLYMPIA (Original Broadway
 Musical) Members of
 the original cast. 10 songs. 10
 inch. No. DA-153 \$3.00



THE CRUCIBLE — **CRAMMY WAY**
 Selections from the Academy
 Award picture. 10 songs. 10
 inch. No. DA-157 \$3.00



CAROUSEL Everything you
 liked about "Oklahoma!"
 Members of original New
 York cast. 10 songs. 10 inch.
 No. DA-156 \$3.00



JACQUA KIFFE Favorite solo
 songs by the world's greatest
 media sensation. 8 songs. 10
 inch. No. A-153 \$3.00





CARMEN JONES Opera with an
 American action. Members of
 original Broadway cast. 12
 songs. 10 inch. No. DA-156
 \$3.00



SONG OF MONKEY Members of
 original New York cast. 10
 songs. 10 inch. No. DA-154
 \$3.00



REVERENDS' CONVENT ALBUM
 Virtuoso vocal solo, hilarious
 favorite songs. 9 songs. 10
 inch. No. A-152 \$2.75



THE HEAVY HUNTER Gay oper-
 etta with famous Viennese
 melodies. 12 songs. 10 inch.
 No. DA-154 \$3.00



RUSSIAN CHARADES Buff back
 the first time. Cast with
 dancing to three. Cast
 includes 8 songs. 10 inch. No.
 A-138 \$2.50



HERE are just a few of the good things wait-
 ing for you in hundreds of Decca albums.
 Brilliant shows of Broadway and Hollywood
 (usually with the original casts). Great works of
 literature, history, poetry, drama... brought to life
 by actors and actresses you know and love. Lan-
 guage courses that entertain you while you learn.
 Run through the Decca catalog at your dealer's.
 Hear the selections you want. Add them to your
 exciting living library of Decca albums.
(Prices do not include Federal, state or local taxes)

DECCA RECORDS

ASK FOR THEM... AT YOUR DECCA DEALER

© Decca, Reg. U.S. Pat. Off.

IT'S here...merchandising on the grand scale! Decca's eye-catching, hard-selling ads are going into 30 million homes via highly-read Sunday supplements and top-flight national magazines... selling popular Decca albums to every member of the family. Be ready when they ask you for these and other fast-selling Decca hits. Place your orders now!

DECCA DISTRIBUTING CORPORATION



Executive Offices: 50 West 57th Street, New York 19, N. Y.

In Canada—The Compo Company, Ltd., 131-41 18th Avenue, Lachine, Montreal

"TEEN-AGER" MARKET



Victor's Vaughn Monroe shared guest honors recently with two "typical teen-agers", selected from New Haven, Conn., teen groups, on the Saturday Senior Swing program. This show airs over American's national hookup on Saturdays, 1:00 to 1:30 pm. Monroe's Victor album, "On the Moonbeam", is a favorite.

America's Youth Is Music-Minded. It's YOUR Market to Develop NOW.

• Teen-Agers can be "sold"! The enterprising retailer never lived who turned down a profitable market just because it was "hard to handle". And while some dealers may cry "Breakage"!—many merchandisers have found selling to the teeners means more profit for them in discs.

Youth's enthusiasm is hard to beat—anywhere in the land! And who-

Snapped at Haynes-Griffin, New York. Young music lovers go for the "long-hair" jazz classics, too. Asch's John Kirby album is one they buy.



◀ Harry Sultan, New York dealer, whose business, in one year after war's start, changed from 80% classical to 90% popular, has made a study of merchandising to the teen-agers, as he sells to them every day. Affectionately referred to by his myriad of young customers as the "Sultan of Swing", Harry stocks plenty of variety for them to pick from. Operating under a no-charge-for-breakage rule, Harry Sultan has continued to show a handsome profit in discs sold to the teeners. Decca's line sells well to this group, he finds. ▶ Further evidence that teen-agers are in the national spotlight is this scene from "There Ought to Be a Law", educational television program over WCBW (CBS, New York). Music is among topics for discussion by all students.



or DISCS

ever saw a teen-ager alone?—They travel in DROVES! Clubs and canteens are their favorite fun. One retailer told us of the many clubs teeners form around their chosen performers. One "Wilbur Evans Club" requires 5-time attendance to the artist's current show for membership, and each member of the club is pledged to buy every record the singer waxes!

In the few minutes it took to snap the picture of Harry Sultan's store which you see on these pages, Sultan's record manager, Henry Brum, sold several sets of Bing Crosby's album "Going My Way" (Decca).

Other alert merchandisers of discs tell us they value the tremendous word-of-mouth advertising and resultant sales they enjoy through teen-agers' enthusiastic mention of their stores, and the fact that they buy their records there as well as listen to the latest on platters.

National network shows for the young people feature music of today's popular artists, all of whom record. ABC's Senior Swing program even features a "record reporter", who tells the fans about the latest on discs, weekly.

▼ Stores are taking the initiative with the teeners in forming clubs for them. Hearn's Miss Palmer plays some favorite platters for the members of its Hi-Club. Capitol's Stan Kenton and Victor's Perry Como are among the pin-ups. Records are a part of a teen-ager's routine!

► Jerry Wayne, popular recording star for Cosmo Records, was a guest on NBC's Teen-Timers show (Saturdays, 10:00 to 10:30 am). Lower right, Eileen Barton, featured vocalist on the program, is shown with a teener. Eileen recently signed with Cosmo Records as one of their singing stars. She knows what teeners want.

▲ Columbia's Benny Goodman, among the tops in Teen-Age record ratings. Here he is at an autograph-session in the Varla Record Shop, Louisville, Ky. Teeners flock to buy his discs.



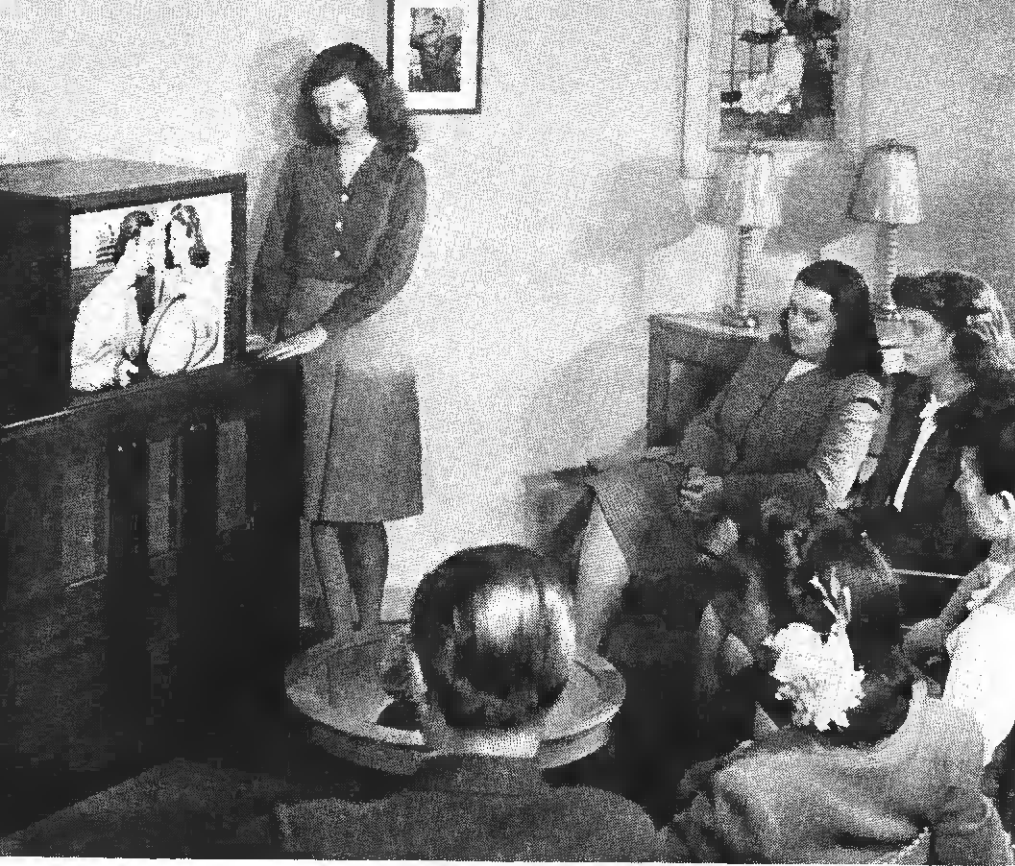

"Projection" sets, with large screen like this, will sell for \$400 to \$1,000.

TELEVISION 1946

(Continued from page 39)

come enormously important for everything from breakfast foods to vacuum cleaners. In a word, 1946 should see television break out of its drab pre-war cocoon and fly through the air with the greatest of ease — on the higher frequencies, of course.

EDGAR KOBAK
President

Mutual Broadcasting System
New York, N. Y.

I am thinking for '46 in terms of 300,000 to 500,000 sets. These should fall, generally, in two categories: the small or table model direct-viewing set, with an 8 x 10 inch screen size, in the \$200 bracket; and a large console projection type set with an 18 x 24 inch screen, costing around \$400.

What Shakespeare said — "The show's the thing wherein I'll catch the conscience of the king," — applies now to our television public and is the essence of television's growth. We are accustomed to excellent stage and movie productions; we will be satisfied with nothing less on our television screens. This means tremendous expenditure in programming which can only be absorbed and justified by wide distribution. In the television frequency

bands, such distribution will require national networks because of the inherent limitations of range of the individual stations.

By the end of the coming year, the common carriers tell us, we can expect television networks at the most from Boston to New York to Philadelphia, to Washington. From then on the prospects look brighter, but until we can have national distribution comparable with oral broadcasting and the motion pictures, television cannot grow to its fullest stature.

Farnsworth

(Continued from page 39)

on a screen size of about 16" by 22". Based on present cost trends, retail prices probably will range from approximately \$150 upward, depending on type of picture tube and method of projection. Later on, the de luxe trade will demand larger, more expensive console units that will furnish not only television but also complete AM-FM reception as well as automatic record changing phonograph entertainment.

With regard to an estimate on the number of sets the industry expects to sell in 1946, this is again problematical but based on the five major centers of population now having at least one or more television broadcasting stations, I offer the conser-

vative estimate of 100,000 sets of all types that can be absorbed in these markets during the year 1946. On the other hand, during the first full year of operation, and depending on the speed with which commercial interests take up television broadcasting and the resultant number of transmitters that will be erected throughout the country, it is easy to forecast a sale during that first full year of a minimum of 250,000 television units.

Stromberg-Carlson

(Continued from page 39)

tubes. Also I understand that a 5" projection-type tube in two designs of envelopes is to be provided—one with a curved screen for the so-called Schmidt system and a flat screen for straight optical projection. I have no way of determining how many picture tubes of all sizes can be produced, but this factor alone will limit the number of television receivers which can be produced in any one year. It is one thing to obtain orders from dealers for large quantities of television receivers and still another to manufacture these receivers, including the tubes. My guess is that the total television receivers which can be made in 1946 will not reach 1,000,000 and may be nearer 500,000.

Tube Standardization

As to size of image, in the direct-viewing designs of receivers, the majority will probably be built up around the 7" and 10" tubes. No doubt, a few handmade tubes of small or larger size may be provided by some television manufacturers, but mass production will center around the tubes which are standardized and which can be made by mass production methods. The projection type of set is more difficult to produce. It requires very careful workmanship in adjustment but the large-size picture certainly will have an appeal which cannot be overlooked.

As to prices, it is too early to say just what costs on components will be but, on the basis of prewar prices, it would appear that a good reliable television receiver, handled through standard distribution channels and with 7" or 10" tubes, but without radio or phonograph provisions, would have to sell for \$175 and up and that the projection type set with AM-FM receiver and some other special equipment, such as phonograph, would run up well above \$500.

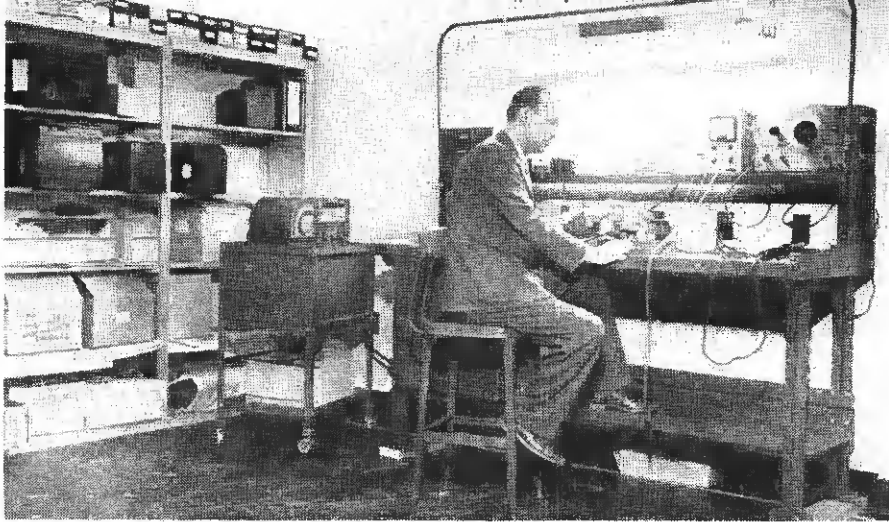

Wilson at his test bench. He is allowing "plenty of room" for increased sales volume.

Maintenance Builds Prospect File. 4-Point Plan Used to Stimulate Profits

Service "Insures" Sales

• John J. Wilson, proprietor of the Shirlington Radio Shop, 2782 S. Randolph St., Arlington, Va., is all set to get the most profits out of radios and appliances he is currently receiving.

Not only is this retailer building sales and good-will at present, but he is also preparing the groundwork for future selling. Four "approaches" are being used by the store to insure profitable operation.

1. An attractive store with the accent put on eye-appealing design and customer convenience.
2. Friendly, personal customer dealings.
3. Selling well-known brands of merchandise at reasonable prices.
4. Offering prompt and efficient service work.

Store Front Pulls 'Em In

Wilson first goes after business from the "outside." This means an eye-arresting store front which has genuine "pulling power." The store front, while not elaborate, is neat and in good taste.

When the prospective purchaser first enters the establishment, he is already partially sold by the warm and attractive surroundings. "You have to put 'em at ease before you can sell 'em!" says Wilson.

To improve the "selling atmosphere," the store's owner arranges the limited quantity of radios and appliances he receives in the attractive displays on the floor as well as on the shelves and showcases.

Ample floor space is provided to exhibit the new merchandise in the most effective manner. "We do not plan to crowd our goods or our customers," Wilson asserted. "We have allotted sufficient room for our

salespeople in which to move around and show the best features of the new postwar receivers."

The dimensions of the store are 16 by 40 feet. While the store is of modest size, the proprietor is out to do a "whale of a job in it."

Dealer Wilson is primarily a merchandiser but he is not underestimating the importance of the service department. To accommodate the large amount of repair work, which this dealer foresees for the future, he is allowing enough room to permit rapid and skilled work.

"Double-Duty" Repairs

The service department of this store will be operated not only for the profit this work may bring but also to supply a live mailing list. The names brought in from servicing will be used as hot prospects for the sale of goods.

The office and repair sections are divided by movable partitions. Here, as well as on the sales floor, good taste is applied in building a warm atmosphere. Attractive fluorescent lighting and walls painted a pleasing blue are featured in the establishment's interior.

Wilson is especially proud of the store's lighting. "The lighting fixtures we use," he declared, "help to make the store a pleasant place in which to work. Correct lighting is important and can help to build more sales. Efficient lighting also helps to make the store more handsome."

The service department is noteworthy because of its neatness and proper layout. The floor and shelves are not cluttered, and there is an absence of confusion which some service stores displayed before and

during the recent war period.

The service bench will accommodate six technicians. Storage bins for parts are easily accessible and surround the walls.

Shipping and receiving is handled through a door at the rear of the store. The floor layout has been planned to promote maximum efficiency.

When the store opened for business on August 25 of this year, Wilson got off to a flying start by using common sense mixed with showmanship. First, the dealer issued blotters to the public on which he stressed the complete and dependable radio service he was prepared to offer.

Source for Mailing List

Customers arriving at the store on the opening day received a card on which they wrote their names and addresses. From this source, the dealer obtained an up-to-date mailing list which is being used to sell radios and appliances. One of the store's first customers received an electric portable phonograph free of charge. In this manner, Wilson introduced himself to his community.

"I'm going to handle complete lines of well-known brands," this dealer stated. "Among these will be Westinghouse, GE, RCA, etc.

"I intend to make this store attractive and popular headquarters for radios and appliances, as well as for television. The backbone of this business is the giving of dependable sales and service at reasonable prices. By rendering a good service to the community, I hope to maintain a consistent and high volume of profitable business."

WHERE TO BUY RADIO & TELEVISION RECEIVERS

Listing the manufacturers whose products cover one or more of the six groups of greatest importance to retailers and distributors.

The following manufacturers of radio receivers have returned our editorial questionnaire giving the information needed for these listings:

	Home AM-FM	Combinations	Television	Auto Radio	Amateur	Commercial*
Admiral Corp., 3800 W. Cortland St., Chicago, Ill.	•	•	•	•	•	•
Air Communications Co., 2233 Grand Ave., Kansas City, Mo.	•	•	•	•	•	•
Aircor Corp., Fairfax & Fuston Rds., Kansas City, Kans.	•	•	•	•	•	•
Air King Prod. Co., Inc., 1523 63rd St., Brooklyn, N. Y.	•	•	•	•	•	•
American Communications Co., 306 Broadway, New York, N. Y.	•	•	•	•	•	•
Andrea Radio Corp., 43-20 34th St., Long Island City, N. Y.	•	•	•	•	•	•
Anslay Radio Corp., 21-10 49th Ave., Long Island City, N. Y.	•	•	•	•	•	•
ARF Products, 7713 Lake St., River Forest, Ill.	•	•	•	•	•	•
Autocrat Radio Co., 3855 N. Hamilton Ave., Chicago	•	•	•	•	•	•
Automatic Radio Mfg. Co., Inc., 122 Brookline Ave., Boston	•	•	•	•	•	•
Aviola Radio Corp., 703 Ivy St., Glendale, Calif.	•	•	•	•	•	•
Bell Radio Co., 125 E. 46th St., New York, N. Y.	•	•	•	•	•	•
Belmont Radio Corp., 5921 W. Dickens Ave., Chicago, Ill.	•	•	•	•	•	•
Bendix Radio, Div. of Bendix Aviation Corp., Baltimore, Md.	•	•	•	•	•	•
Browning Laboratories, Inc., 750 Main St., Winchester, Mass.	•	•	•	•	•	•
Collins Radio Co., 2920 First Ave., Cedar Rapids, Iowa	•	•	•	•	•	•
Colonial Radio Corp., 254 Hano St., Buffalo, N. Y.	•	•	•	•	•	•
Columbia Electronic, Inc., 105 E. 122nd St., New York, N. Y.	•	•	•	•	•	•
Communications Co., Inc., 300 Green Ave., Coral Gables, Fla.	•	•	•	•	•	•
Communications Equip. Co., 523 W. 6th St., Los Angeles	•	•	•	•	•	•
Concert Master Rad. & Tel. Co., 1400 Winona Ave., Chicago	•	•	•	•	•	•
Concord Radio Corp., 901 W. Jackson Blvd., Chicago	•	•	•	•	•	•
Coronet Radio & Television Corp., Front St., Hempstead, L. I.	•	•	•	•	•	•
Crosley Corp., 1329 Arlington St., Cincinnati, Ohio	•	•	•	•	•	•
Crystal Products Co., 1519 McGeo Trafficway, Kansas City, Mo.	•	•	•	•	•	•
Decca Radio, Div. of General Motors Corp., Kokomo, Ind.	•	•	•	•	•	•
DeWald Radio Mfg. Corp., 440 Lafayette St., New York, N. Y.	•	•	•	•	•	•
Allen B. DuMont Laboratories, 515 Madison Ave., New York	•	•	•	•	•	•
Dynavox Corp., 40-35 21st St., Long Island City, N. Y.	•	•	•	•	•	•
Eckstein Radio & Television Co., 1400 Harmon Pl., Minneapolis	•	•	•	•	•	•
Echophone Radio Co., 2611 So. Indiana Ave., Chicago, Ill.	•	•	•	•	•	•
Electrical Research & Mfg. Co., 3001 E. Pico Blvd., Los Angeles	•	•	•	•	•	•
Electromatic Mfg. Co., 88 University Pl., New York, N. Y.	•	•	•	•	•	•
Electronic Corp. of America, 45 W. 18th St., New York, N. Y.	•	•	•	•	•	•
Electronic Devices Co., 601 W. 26th St., New York, N. Y.	•	•	•	•	•	•
Emerson Radio & Phono. Corp., 111 8th Ave., New York, N. Y.	•	•	•	•	•	•
Espey Mfg. Co., Inc., 33 W. 46th St., New York, N. Y.	•	•	•	•	•	•
Fada Radio & Electric Co., Inc., Long Island City, N. Y.	•	•	•	•	•	•
Farnsworth Television & Radio Corp., Ft. Wayne, Ind.	•	•	•	•	•	•
Federal Telephone & Radio Corp., 591 Broad St., Newark, N. J.	•	•	•	•	•	•
Flush Wall Radio Co., 15 Washington St., Newark, N. J.	•	•	•	•	•	•
Franklin Photographic Industries, 223 W. Erie St., Chicago	•	•	•	•	•	•
Freed Radio Corp., 200 Hudson St., New York, N. Y.	•	•	•	•	•	•
Galvin Mfg. Corp., 4545 Augusta Blvd., Chicago, Ill.	•	•	•	•	•	•
Garod Radio Corp., 70 Washington St., Brooklyn, N. Y.	•	•	•	•	•	•
General Electric Co., Bridgeport, Conn.	•	•	•	•	•	•
General Television & Radio Corp., 2701 Lehmann Ct., Chicago	•	•	•	•	•	•
Gibllan Bros., 1815 Venice Blvd., Los Angeles, Calif.	•	•	•	•	•	•
Globe Electronics, Inc., 225 W. 17th St., New York, N. Y.	•	•	•	•	•	•
Gray Radio Co., W. Palm Beach, Fla.	•	•	•	•	•	•
Hallcrafters Co., 2611 S. Indiana Ave., Chicago, Ill.	•	•	•	•	•	•
Hamilton Radio Corp., 510 6th Ave., New York, N. Y.	•	•	•	•	•	•
Hammarlund Mfg. Co., 460 W. 34th St., New York, N. Y.	•	•	•	•	•	•
Harris Mfg. Co., 2422 W. 7th St., Los Angeles	•	•	•	•	•	•
Harvey Machine Co., Inc., 6200 Avalon Blvd., Los Angeles	•	•	•	•	•	•
Harvey-Wells Electronics, Inc., Southbridge, Mass.	•	•	•	•	•	•
Herbach & Rademann Co., 522 Market St., Philadelphia, Pa.	•	•	•	•	•	•
Hoffman Radio Corp., 3430 So. Hill St., Los Angeles, Calif.	•	•	•	•	•	•
Howard Radio Co., 1735 Belmont Ave., Chicago, Ill.	•	•	•	•	•	•
Hudson American Corp., 25 W. 43rd St., New York, N. Y.	•	•	•	•	•	•
Industrial Tool & Dye Works, Inc., Minneapolis, Minn.	•	•	•	•	•	•
International Detroit Corp., Beard Ave., Detroit, Mich.	•	•	•	•	•	•
Jefferson-Fravis Radio Mfg. Corp., 245 E. 23rd St., New York	•	•	•	•	•	•
Ray Jefferson, Inc., 40 E. Merrick Rd., Freeport, L. I., N. Y.	•	•	•	•	•	•
Kaar Engineering Co., 619 Emerson St., Palo Alto, Calif.	•	•	•	•	•	•
Keith Radio Products, Bedford, Ind.	•	•	•	•	•	•
Kingston Radio Co., Inc., Kokomo, Ind.	•	•	•	•	•	•
Laurehk Radio Mfg. Co., 3931 Monroe Ave., Wayne, Mich.	•	•	•	•	•	•
Lear, Inc., 230 E. Ohio St., Chicago, Ill.	•	•	•	•	•	•
Lincoln Electronics Corp., 653 11th Ave., New York, N. Y.	•	•	•	•	•	•

Manufacturers not listed may furnish data for the next issue. No advertising obligation. Additions or revisions will be made monthly.

	Home AM-FM	Combinations	Television	Auto Radio	Amateur	Commercial*
Fred M. Link, 125 W. 17th St., New York, N. Y.	•	•	•	•	•	•
Magnavox Co., 2131 Bueter Rd., Ft. Wayne 4, Ind.	•	•	•	•	•	•
Maguire Industries, Inc., W. Putnam Ave., Greenwich, Conn.	•	•	•	•	•	•
Majestic Radio & Television Corp., St. Charles, Ill.	•	•	•	•	•	•
Marco Industries, 245-A So. Beverly Dr., Beverly Hills, Calif.	•	•	•	•	•	•
Mason Radio Products Co., Kingston, N. Y.	•	•	•	•	•	•
E. W. McGrade Mfg. Co., 406 W. 34th St., Kansas City, Mo.	•	•	•	•	•	•
John Meek Industries, Plymouth, Ind.	•	•	•	•	•	•
Medco Mfg. Co., 5 W. 45th St., New York, N. Y.	•	•	•	•	•	•
Megard Corp., 1601 S. Burlington Ave., Los Angeles, Calif.	•	•	•	•	•	•
Meissner Mfg. Co., 936 N. Michigan Ave., Chicago, Ill.	•	•	•	•	•	•
Midland Mfg. Co., Decorah, Iowa	•	•	•	•	•	•
Midwest Radio Corp., 909 Broadway, Cincinnati, Ohio	•	•	•	•	•	•
James Millen Mfg. Co., 150 Exchange St., Malden, Mass.	•	•	•	•	•	•
Minerva Corp. of America, 238 William St., New York, N. Y.	•	•	•	•	•	•
Music Master Radio Corp., 750 Main St., Hartford, Conn.	•	•	•	•	•	•
National Co., Inc., 61 Sherman St., Malden, Mass.	•	•	•	•	•	•
Noblitt-Sparks Industries, Inc., Columbus, Ind.	•	•	•	•	•	•
Northern Radio Co., 2208 4th Ave., Seattle, Wash.	•	•	•	•	•	•
Packard-Bell Co., 3443 Wilshire Blvd., Los Angeles, Calif.	•	•	•	•	•	•
Packard Mfg. Corp., 2900 Columbia Ave., Indianapolis, Ind.	•	•	•	•	•	•
Pan American Electric Co., Inc., 132 Front St., New York, N. Y.	•	•	•	•	•	•
Phileo Corp., Tioga & C Sts., Philadelphia, Pa.	•	•	•	•	•	•
Philharmonic Radio Corp., 528 E. 72nd St., New York, N. Y.	•	•	•	•	•	•
Pilot Radio Corp., 37-06 36th St., Long Island City, N. Y.	•	•	•	•	•	•
Precision Specialties, 210 N. Western Ave., Los Angeles, Calif.	•	•	•	•	•	•
Radio Craftsmen, Inc., 1341 S. Michigan Ave., Chicago	•	•	•	•	•	•
Radio Engineering Laboratories, Inc., 36th St., L. I. City, N. Y.	•	•	•	•	•	•
Radio Process Co., 7618 Melrose Ave., Los Angeles, Calif.	•	•	•	•	•	•
Radio & Television, Inc., 244 Madison Ave., New York, N. Y.	•	•	•	•	•	•
RayEnergy Radio & Television Corp., 32 W. 22nd St., New York	•	•	•	•	•	•
RCA Victor Div., Radio Corp. of America, Camden, N. J.	•	•	•	•	•	•
Regal Electronics Corp., 20 W. 20th St., New York, N. Y.	•	•	•	•	•	•
Remler Co., Ltd., 2101 Bryant St., San Francisco, Calif.	•	•	•	•	•	•
Rex Products Co., 1313 W. Randolph St., Chicago, Ill.	•	•	•	•	•	•
E. M. Sargent Co., 219 9th St., Oakland, Cal.	•	•	•	•	•	•
Schuttig & Co., 9th & Kearny St., N.E., Washington, D. C.	•	•	•	•	•	•
Scophony Corp. of America, 527 5th Ave., New York, N. Y.	•	•	•	•	•	•
Scott Radio Labs, Inc., 4450 Ravenswood Ave., Chicago, Ill.	•	•	•	•	•	•
Sentinel Radio Corp., 2020 Ridge Ave., Evanston, Ill.	•	•	•	•	•	•
Satchell-Carlson, Inc., 2233 University Ave., St. Paul, Minn.	•	•	•	•	•	•
Sheridan Electronics Corp., 2850 S. Michigan Ave., Chicago	•	•	•	•	•	•
Signal Electronics, Inc., 114 E. 16th St., New York, N. Y.	•	•	•	•	•	•
Sonora Radio & Television Corp., 325 N. Hoyne Ave., Chicago	•	•	•	•	•	•
Sonotone Corp., 570 5th Ave., New York	•	•	•	•	•	•
Sparks-Withington Co., Jackson, Mich.	•	•	•	•	•	•
Stewart-Warner Corp., 1826 Diversey Pkwy., Chicago, Ill.	•	•	•	•	•	•
Stromberg-Carlson Co., 100 Carlson Rd., Rochester, N. Y.	•	•	•	•	•	•
Symphonic Radio & Electronic Corp., Main St., Cambridge, Mass.	•	•	•	•	•	•
Taybarn Equipment Co., 120 Greenwich St., New York, N. Y.	•	•	•	•	•	•
Tech-Master Products Co., 123 Prince St., New York, N. Y.	•	•	•	•	•	•
Teletone Radio Co., 609 W. 51st St., New York, N. Y.	•	•	•	•	•	•
Telicon Corp., 851 Madison Ave., New York, N. Y.	•	•	•	•	•	•
Templestone Radio Mfg. Corp., New London, Conn.	•	•	•	•	•	•
Trav-Ler Karenola Radio & Tel. Corp., 571 W. Jackson, Chicago	•	•	•	•	•	•
Trebzor Radio Co., Box 497, Pasadena, Calif.	•	•	•	•	•	•
United Cinephone Co., Torrington, Conn.	•	•	•	•	•	•
United States Television Mfg. Co., 106 7th Ave., New York, N. Y.	•	•	•	•	•	•
Viewtone Co., 203 E. 18th St., New York, N. Y.	•	•	•	•	•	•
V-electrical Engineering Co., 828 N. Highland Ave., Los Angeles	•	•	•	•	•	•
Walker, Inc., 403 W. 8th St., Los Angeles, Calif.	•	•	•	•	•	•
Watson Mfg. Corp., 4640 W. Harrison St., Chicago, Ill.	•	•	•	•	•	•
Watterson Radio Mfg. Co., 2700 Swiss Ave., Dallas, Texas	•	•	•	•	•	•
Wells-Gardner & Co., 2701 N. Kildare Ave., Chicago, Ill.	•	•	•	•	•	•
Western Electric Co., 120 Broadway, New York, N. Y.	•	•	•	•	•	•
Westinghouse Electric Corp., Receiver Div., Sunbury, Pa.	•	•	•	•	•	•
Whiting & Davis, Inc., 23 W. Bacon St., Plainville, Mass.	•	•	•	•	•	•
Wilcox Electric Co., Inc., 1400 Chestnut St., Kansas City, Mo.	•	•	•	•	•	•
Zenith Radio Corp., 6001 Dickens Ave., Chicago, Ill.	•	•	•	•	•	•

*Commercial or Special.

Republication prohibited. See copyright notice, page one.

New Dealer Group Meets

Members of the newly-formed Radio & Electronic Dealers & Servicemen Assn., Inc., Brooklyn, N. Y., learned how to employ disabled war veterans in their stores at a recent general membership meeting. Guest speaker was John H. Singleton of the New York regional office of the Veterans Administration.

The association is interested in acquiring new members. Inquiries are invited. Dealers and servicemen should write to the president of

the organization, Irving P. Horowitz, Sutter Radio Service, 1044 Rutland Rd., Brooklyn, N. Y., for data on the group's activities

Pfaltz Joins NEWA

Albert Pfaltz has joined the staff of the National Electrical Wholesalers Assn., to engage in public relations and promotional activities for that organization, according to an announcement by Charles G. Pyle, managing director.

Plans Stores in Mexico

Robert L. Shannon, Houston, Tex., will establish numerous radio and electrical appliance stores throughout the Republic of Mexico with headquarters at Mexico City. About \$60,000 will be invested in this business which will merchandise and service radios, television receivers, refrigerators, etc., in many Mexican towns. Operations will get under way about the first of the coming year. Mr. Shannon is located at 2501 Galveston Rd., Houston.

Section of **RADIO *Television* RETAILING**

ELECTRICAL APPLIANCES



**Remind Her to
GIVE YOU A CALL
for Refrigerators, Washers,
Ranges, Small Appliances.**

DUAL-TEMP...

TRADE MARK REGISTERED

BY...

Admiral



Here's what the home-maker wants in her new **ELECTRIC REFRIGERATOR** according to a recent survey made by the editors of a leading women's magazine!

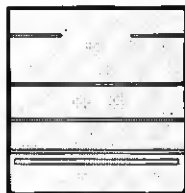
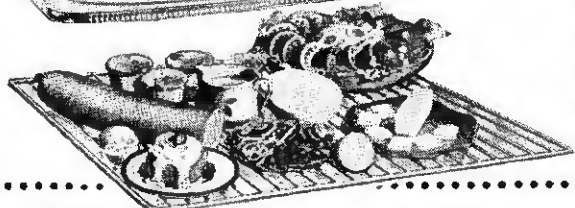
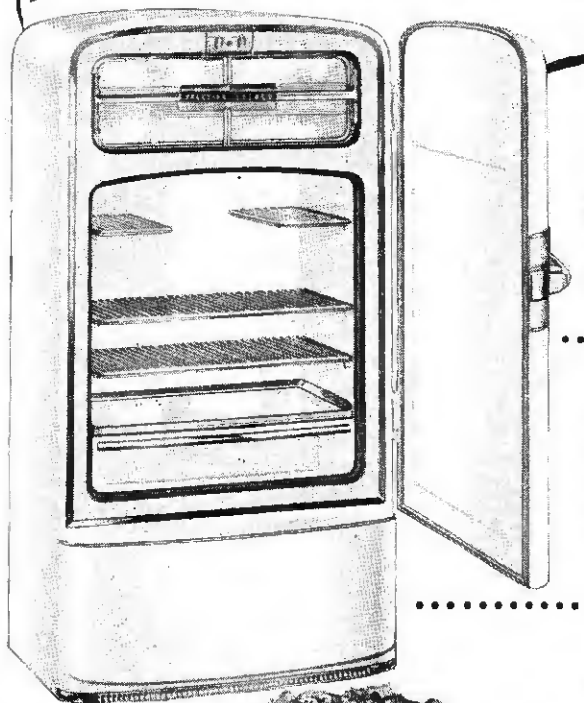

WOMEN WANT . . .

More storage space for frozen foods *plus* a quick-freeze compartment.

WOMEN WANT . . .

More space for food . . . greater ease and convenience in handling food.

WOMEN WANT . . .

Less "waste" of food due to food drying out or spoiling while stored away.

WOMEN WANT . . .

Better methods of defrosting . . . less fuss and bother with water-filled trays.

Gives them what they want!

DUAL-TEMP'S GOT IT! . . .

A built-in Freezing Locker that stores 80 lbs. . . nearly 2 bushels . . . of frozen food. *Really* quick freezes meats, fruits, vegetables at 5° below zero. Makes hundreds of ice cubes.

DUAL-TEMP'S GOT IT! . . .

A spacious food compartment with *extra* room for large size objects. More shelf area for easier food handling . . . and all because the usual space-stealing coils are gone!

DUAL-TEMP'S GOT IT! . . .

Foods stay moist and fresh in *uncovered* dishes! No moisture-stealing coils! 85% humidity maintained throughout food storage compartment. Sterilamp protection, too!

DUAL-TEMP'S GOT IT! . . .

No more defrosting! Dual-Temp *has* no coils to defrost . . . no evaporator tray filled to overflowing! Ends the nuisance of spilled water . . . in the refrigerator or on the floor!

Admiral Corporation

Chicago 47, Illinois

RADIOS . . . DUAL-TEMP REFRIGERATORS . . . HOME FREEZERS . . . ELECTRIC RANGES

ONLY ADMIRAL CAN BUILD A DUAL-TEMP!

"Independent" Tops Field

He Builds Up Trade Names, Holds Prices, Maintains Service. Benefits Manufacturer, Jobber, Consumer

• The independent radio-electrical appliance dealer, whose stores are familiar landmarks in towns and cities throughout the country, will, in the coming market, account for the most radio-electrical home appliance sales, even as he has done in the past.

In addition to leading in number of sales, the independent retailer will continue to render valuable services to the manufacturer, the jobber and the consumer, as follows:

1. **The independent merchant** will obtain a **higher average price** for the manufacturers' products. He will not deliberately cut price in "unloading" drives. He will uphold the prestige of the manufacturer in rendering top-notch technical service for the consumer. He will build up consumer good-will for the product because he knows **more about** the equipment. He helps keep manufacturer prices up because he is the first outlet geared to drop immediately any make going all-out for sales through discount houses and other questionable sources.

2. **The independent merchant** will provide steady, all-year-round business for the distributor. Unlike many of his larger competitors, the independent does not drop in now and then on the jobber with large "flash" orders accompanied by efforts to secure large discounts. The independents' orders come in with the regularity of clock-work, and are profitable to the wholesaler. Being equipped and willing to render a lot of free service under guarantee periods, the independent's business, from the service angle, costs the wholesaler less to handle.

3. **The independent merchant** gives the consumer the benefit of his experience and judgment in selecting makes. He is always on hand to meet the customer personally—face to face when problems arise. Consumers trust the independent, because they know that he could not have survived except through honest methods. They know that he depends upon repeat business. The consumer expects and

believes that the appliances he buys from the independent will be honestly and skillfully maintained because the independent has built up this reputation for himself—and this reputation is well known all over the nation.

In the minds of the buying public, the independent radio-appliance retailer is, fortunately, a "marked man." His establishment presents no identification problems to the

such maintenance services as plumbing, heating, electrical contracting, etc. Geographical location has a great deal to do with the stocking of unrelated lines by the dealer.

For the most part, though, in the new order of things, the bulk of the business in electrical appliances for the home will be sold by the independent **specializing** in radio and electrical appliances, who may or

Retail Outlet Rating Chart

Compilation of a confidential survey by RADIO & Television RETAILING shows how various retail establishments selling radios and appliances compare with each other in salient selling and operating features. 10 is the highest rating in each category.

	Primary Interest in Product	Interest in Nationally Advertised Brands	Price Maintenance	Servicing Facilities	Owner-Customer Contacts	Standing in Community	Knowledge of Products	%
Independent Radio, Record or Appliance Dealer	10	10	10	10	10	9	10	99
Furniture Dealer	6	9	9	4	9	9	6	74
Department Store (Non-chain or syndicate)	4	8	6	5	4	9	8	63
Hardware Store	2	9	10	2	8	9	2	60
Automotive Outlet (Non-chain)	2	7	6	3	7	8	3	51
Chains and Syndicates	1	3	4	2	0	5	2	24
Mail Order Houses	1	0	10	2	0	7	2	31

shopper—even the shopper in a strange community.

While it is true that "independent" stores selling radios and electrical appliances vary in pattern, they are quite readily identified by the consumer.

Often, because of location or other factors, the independent retailer combines one or more unrelated lines with his radio and electrical appliance products.

There are numbers of independent radio-electrical appliance retailers who sell pianos and other musical instruments, furniture, hardware, farm equipment, automotive supplies. Many also offer

may not be carrying other lines as well.

Nearly every consumer in the United States knows that he can expect better brands and better service from the independent—and, for the most part consumers only buy from chains, mail-order houses, etc., because of cut prices or ridiculously "easy" credit terms.

With a generally prevalent and growing skepticism on the part of the public toward high-pressure selling outlets, and with an evident trend on the part of the utilities to bow out of the retail sales picture, the independent retailer in this field has a brilliant future.

"Live" In-Store

Modern Facilities Plus Know-How Up Show-Room Sales—Cost Less Than Sales in the Home

• There is a lively interest in "live" in-store demonstration techniques.

While retail merchandising authorities agree that door-to-door and other outside selling activities will always be important factors in increasing sales volume, they nevertheless see in-store demonstrations becoming more and more effective in closing sales.

Smart retailers also see the possibilities of increased profits through in-store sales. They know it costs less to close a sale in the store than it does in the home.

Refrigerators

Food preservation at low cost—convenience of interior arrangement—appearance—quiet operation. Show only most attractive and **COLORFUL** foods in store demonstrator—offer a prospective customer a glass of some cold beverage—stress long life of equipment and all features advertised by manufacturer. Point out low price when total cost is spread over number of years it will last.

They know that the efficient store demonstration can be performed in a more convincing manner and under more ideal conditions than it can be done in the customer's house. Every experienced salesman knows about the frequently encountered problems associated with home demonstrations. The groping about under furniture to find an outlet and a suitable antenna for the radio—the worry about whether or not the kitchen receptacle is fused heavily enough to operate the washer—the rug the lady wants one to "vacuum" when the outlet is too far away.

In addition to offering opportunity to make more efficient and tell-

ing sales presentations, in-store demonstrations save the dealer money because they will serve to cut down the number of after-sale calls. If the customer is taught how to operate the appliance thoroughly, "show-me-how-to-run-it" visits will be reduced in number.

Display-in-Action

To be effective, in-store live demonstration facilities must be skillfully and conveniently arranged. All operating facilities should be in "apple-pie" order, and displays kept clean and polished.

Nothing will "kill" a sale quicker than a faulty demonstration in the store or in the home, so following are some suggestions:

1. Make sure that there's an un-failing supply of hot and cold water for the automatic washers. Make certain that drains are clean.

2. Be sure that there will be no current failure. Employ adequate wiring and the right size fuses.

3. Be sure sales staff is thoroughly familiar with all appliance operating controls so that there will be no embarrassing fumbling about for levers, switches, etc.

A real in-store radio and appliance demonstration set-up costs money to install and operate, but many merchants think the investment will prove well worth while in present-day selling. Merchandise used for demonstration purposes will eventually become "used" equipment, and when later models need to be installed, the demonstrators will have to be sold, for the most part, at reduced prices.

Sales Punch

The merchant who installs live demonstrations will not get very far unless he "goes all out" for this method. A sketchy, poorly arranged set-up will result in nothing better than spotty and inconsistent sales, past experience shows.

In addition to the costs of electric current and the expense of replacing equipment when newer models come out, the merchant going on an all-out basis for in-store demonstration must also realize

Washers

Use brightly colored clothes to enhance demonstration—stress gentle washing action, sanitary reasons for washing in home. With automatics, let sales talk go along with the various sequences of washing, rinsing, drying. Point out that all is done without attention on part of housewife. With non-automatic spinners and wringers, point out advantages such as fluffiness of clothes when removed from spin-basket, and speed with which wringer types may be operated. Invite customer to bring in own garments to be washed. Stress economy of washing when compared with commercial laundries. Point out rugged construction, long life of equipment.

Electric Ranges

No scrubbing of bottom of cooking utensils, no smoke, no soot, no danger. Demonstrate oven insulation by placing ice cubes on top of oven while it's in operation. Describe automatic control features. Show how slow, controlled heat can make cheap meat cuts tender, inviting. Have accurate figures on low costs of operating in your vicinity.

Demonstration Techniques

that it's going to cost him money to keep the exhibits clean, and to handle and change clothes to be washed, food in refrigerators, etc.

Vacuum Cleaners

Employ dramatic demonstration methods. Use attractive rug or carpet. Demonstrate power by "lifting" rug—cleansing ability by pulling bicarbonate of soda or other white powder through rug. Show how it picks up lint, etc. Be sure to stress any and all features described by manufacturer.

On the profit side of the in-store demonstration, however, advocates of this plan see sales consummated faster than by any other method, exceptionally valuable advertising features, and possibilities for increased sales per customer due to exposure to so many different appliances in actual operation.

Use Dealer Helps

In-store demonstration lends itself well in encouraging greater use of manufacturers' sales promotion material.

For example, the flip-over book, mounted on an easel, becomes a much more potent sales weapon when it is used to accompany an actual "live" demonstration. The salesman, demonstrating, for instance a sequence washer, uses the flip-over book to simplify in the customer's mind the various operation phases going on in the machine. From a sales point of view, the timing is perfect, the book taking the customer on a step by step "tour"; glamorizing the product, stressing its labor-saving features, etc.

Sales chart—demonstration tie-

ins also serve to educate the salesman, making him more familiar with the product, and aiding him in memorizing the most telling sales points.

Some salesmen object to reading sales charts and similar material to customers on the grounds that they are "canned" presentations, but none will object to using them in connection with an actual demonstration. Their use in this fashion does not make the customer conscious of the fact that the sales-

Complete Electric Kitchens

Sell appearance, convenience, cleaning ease, modernity. Show by actual demonstration how many steps are saved in preparing food—stress length of time the woman of the home spends in the kitchen—how the family's health is dependent to a great degree upon its daily meals. Point out that while investment is quite large, life of the equipment is long. Groundwork only can be laid in selling complete kitchens for existing homes, so offer to visit the customer for the purpose of making a sketch of the layout to be followed by a set of proposals. In-store demonstration of complete kitchens, where attempt is made to sell as a "package," will call for outside work also. Efforts devoted toward selling "complete" kitchens will not be lost because, if the dealer fails to sell the "whole works," he can usually sell single pieces of equipment.

Small Appliances

Make toast in the automatic. Let customer operate it. Make coffee in the coffee-maker, and "subject" customer to aroma and taste of the beverage. Dramatize the electric hand iron. Let customer use several to make choice. Use a colored light in the circuit to show customer how often the automatic iron is "off" while it's in use. Steam velvets, etc., with the steam iron. Stress light weight and efficient design. Show customer clock display of models, all in operation, and suggest types for various rooms in the home.

man is actually reading from the pages.

Actual demonstration of equipment must be orderly, must be planned and "canned" to the extent that what the salesman says will accompany what the article being demonstrated is actually doing. The clever demonstrator does not forget some important step which will force him to go back to a certain phase of the demonstration—he keeps going ahead.

Get a Crowd

In order to avoid unnecessary expense, dealers are urged to try to make demonstrations in front of as many persons as is possible at one time, but there should be enough salespeople to take care of all the customers, so that the salesman who happens to be conducting the demonstration will not be interrupted in his efforts to sell his own "prospect."

A noted merchandising authority claims that 40 per cent of all retail in-store sales are "emotional" sales. If this is so, in-store live demonstration facilities should bring increased profits to the dealer who is willing to go in for them on the proper scale.

"How Much Does It COST to OPERATE?"

Overcome "Expense" Objection to Buying Additional Appliances—Ready Answers Help Increase Sales Volume

• When your customer wants to know the approximate cost of operating a radio or appliance, be certain that you have an answer ready—an answer the customer may readily understand.

A great many home-owners hesitate buying additional appliances because they fear such devices will increase their electricity bills.

Most of the buyers have exaggerated ideas about costs of operating radios and appliances, and dealers know customers who hesitate buying an electric clock because "it runs all the time, and costs a lot to operate." While such "notions" may seem ridiculous to the retailer, it is a fact that they exist in the minds of many, and it is up to the dealer to set the buyer right in these matters.

Effective Technique

By comparing radios and appliances with electric light bulbs in operating costs, and giving the customer a rough idea of how much per hour they cost to run, the dealer will be able to break down much of the resistance to sales which is based on such operating costs.

In most communities the utility offers "sliding" rate scales, and where this practice prevails, the dealer should point out to the customer that the more current he uses, the lower the rate.

The salesman who has appliance operating costs on the tip of his tongue helps break down still another sales barrier, and, importantly enough, also becomes an "expert" in the eyes of the customer.

The simple features about a product which may be "elementary" to the salesman are likely to be glossed over in any sales presentation—and they might be most important and enlightening to the customer if they were explained.

More and more there is less and less sales resistance to new electrical "servants" for the home,

but the purchase of additional equipment by some people is still held in abeyance because of preconceived ideas that electric consumption bills will increase materially as a result.

The accompanying table has

been prepared by the editors for the convenience of dealers. Items marked * cost even less than the figure shown because they are intermittent in operation, cutting in and out or automatically dropping to lower wattages:

USE THESE FIGURES IN SELLING

Appliance	Average wattage	Cost per hr at 4c kw-hr rate
Blanket, electric	215*	1/2 of 1¢
Broiler	1000	4¢
Clocks, electric	2	8/1000 of 1¢
Coffee maker, glass	450	2¢
Cooker (egg)	600	2¢
Corn popper	550	2¢
Curling iron	20	8/100 of 1¢
Dishwasher	350	1¢
Food freezers, domestic	200	8/10 of 1¢
Fan, 8", desk	25	1/10 of 1¢
Fan, 10", desk	45	2/10 of 1¢
Fan, 12", desk	50	2/10 of 1¢
Fan, attic ventilator, 24"	200	8/10 of 1¢
Fan, attic ventilator, 48"	320	1¢
Grill, sandwich	800	3¢
Hair dryer	100*	4/10 of 1¢
Heaters, space	660-1250	3 to 5¢
Irons, hand, automatic	800-1000*	3 to 4¢
Ironers	1400*	6¢
Juice extractor	50	2/10 of 1¢
Mixers, food	75	3/10 of 1¢
Oil burner	250	1¢
Pads, heating	75*	3/10 of 1¢
Percolator	450	2¢
Range, cooking	7500	special rate
Radio, small	30	1/10 of 1¢
Radio, large	100	4/10 of 1¢
Television set	300	1¢
Razor, electric	10	4/100 of 1¢
Refrigerator	200	8/10 of 1¢
Room coolers	600	2¢
Roaster	1320*	5¢
Sewing machine	80	3/10 of 1¢
Stove, table, 3-heat	350-550-1000	1-2-4¢
Sun lamp (SI bulb)	400	2¢
Toaster, automatic	800*	3¢
Vacuum cleaner	250	1¢
Waffle iron, automatic	800*	3¢
Washing machine	200	8/10 of 1¢
Waxer, floor	200	8/10 of 1¢

In 9 out of 10 American homes



Betty Crocker

WOMEN KNOW BETTY CROCKER... SHE CAN MAKE SALES FOR YOU

9 out of 10 American housewives use one or more General Mills products . . . buy them regularly. Betty Crocker and her Home Service Staff do a large part of this selling . . . by offering friendly practical help to homemakers. The million letters they write to her every year reveal the faith women have in her and in the products she recommends.

The millions who listen regularly to Betty Crocker's broadcasts prove the continuing loyalty of her following. This loyalty and confidence pay off in sales . . . 400,000,000 packages of General Mills products last year!

Betty Crocker's active sponsorship of General Mills Home Appliances will put the full force of her influence directly into your business . . . will uncover new, growing markets . . . create ever-richer profit potentials for you.

COUNT ON GREAT THINGS FROM GENERAL MILLS

Count on distinguished appliances . . . new in design . . . different in basic operating principles . . . with practical features that mean greater usability and value for homemakers. Count on vigorous support for dealers . . . through aggressive advertising and alert merchandising and selling action. Count on profits.



General Mills
makes news

BETTY CROCKER IS A REGISTERED TRADE MARK OF GENERAL MILLS, INC.

GENERAL MILLS, INC., HOME APPLIANCE DEPARTMENT • MINNEAPOLIS 13, MINNESOTA

Electrical Appliance Store Organization

Boston Dealer Attributes 400% Sales Climb to Modern Store, Modern Methods, Excellent Location

• The new, modern radios and electrical appliances arriving at dealers' stores must be displayed and sold in modern settings, believes M. S. Gronich, proprietor of the ABC Electric Co., operating the ABC Home Appliance Co., at 1116 Boylston St., Boston, Mass.

"Merchandise may be scarce now, and customers may be clamoring for goods, but this only a temporary situation," Gronich declares. "I want to sell my patrons the idea that this store is the place to buy electrical goods now and in the future."

This dealer has taken out an "insurance policy" on current and future business by completely remodeling his store. "Give customers a

pleasant place in which to buy receivers, refrigerators, washers, etc., and they will keep coming back—and bring their friends with them, too!" this appliance retailer states.

The smart and attractive appearance, interior and exterior, of this establishment has already made a "hit" with purchasers in this area. Customers enjoy buying here.

When the revamped store opened for business, the sales volume leaped ahead. Gronich reports that business increased 400 per cent since the establishment was modernized. And with a limited supply of merchandise, too!

While the boost in volume may be

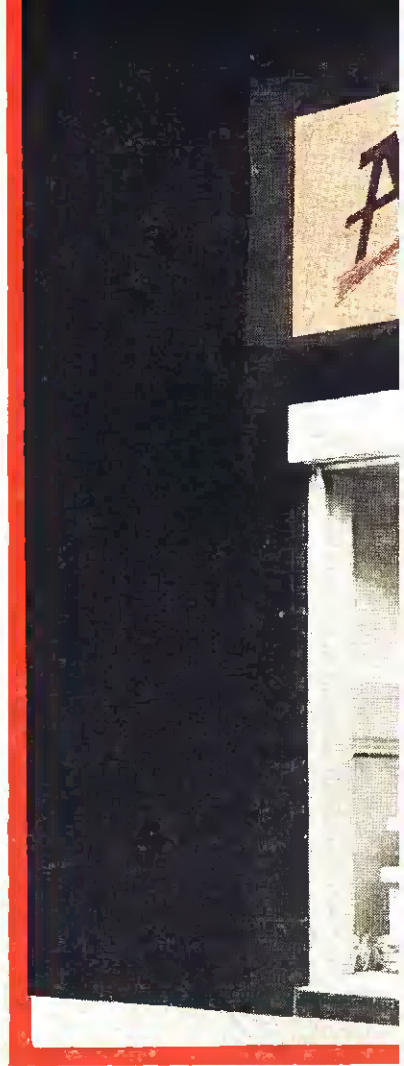

A store with plenty of customer-appeal helps increase sales. View of ABC's inviting interior as seen from the balcony





and appliances arrive in quantity. Now we are prepared to cope with volume merchandise," Gronich said.

The best and most modern materials were used in revamping this establishment. The dealer's plan before construction was started was to remodel the store in a manner which would make the most favorable impression on prospective purchasers.

Fresh Start

"Many radio-appliance retailers are starting from 'scratch,'" Gronich said. "What I mean is that many customers were dissatisfied with the service they received from some stores during the war period. These purchasers are searching for those stores which they like, and to which they want to 'attach' themselves.

"In that sense, we are all starting out fresh. This is the time to hold on to old customers and win the confidence of many new ones. I feel that I can accomplish this, first of all, by giving the public an efficient, attractive place.

"Those purchasers who are floaters, or who are simply shopping around, are quite likely to be partially or wholly convinced that this

(Continued on page 122)

The Proprietor's ABC's of Profitable Selling:

A-tractive store.

B-est known brands in wide variety.

C-ourteous salesmanship and service.

"Give customers a pleasant place in which to buy and they will keep coming back—and bring their friends with them." says Gronich.

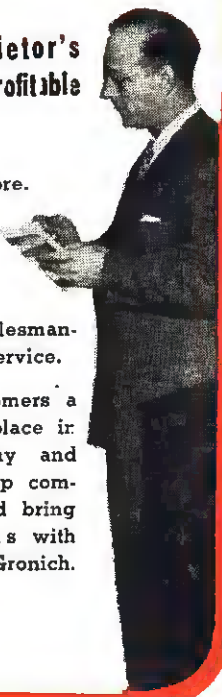

due in part to the store's excellent location, this merchant feels that the establishment's modern appearance should get most of the credit.

The volume of service work, in addition to sales of available radios and appliances, has also forged ahead since modernization.

On the Right Track

Remodeling the store cost the owner \$5,000. "I feel that the money I spent on renovating was a smart investment," Gronich asserted. "The way business is going at present is an indication that I was on the right track when a thorough remodeling job was decided upon."

The main floor of the store measures 30 feet wide and 125 feet deep. A balcony at the rear of the establishment is 30 by 35 feet. A service department located in the basement occupies a space 30 by 75 feet.

"I'm glad that we have completely rebuilt our store before radios

Owner M. S. Gronich, left. At right, the service section is all "dressed up"



"LARGEST VOLUME..."

A Boston distributor praises
our collection service and
credit policies.

Your service at all points has been excellent but the feature which stands out in my mind is the manner in which you handle collections and the timing of your credit policies.

"In my experience I have observed that there are some people in most any finance organization who know the answers, but in your local offices knowledge of your plans and policies seems to be general among all employees.

"Your offices always seem to know when to tighten up and when to loosen up a little so as to get the **LARGEST VOLUME** of business with the least chance for loss on the collections."



L. J. McALLISTER CO.
BOSTON, MASS.

NORGE DISTRIBUTORS

COMMERCIAL CREDIT COMPANY

BALTIMORE 2, MARYLAND

Capital and Surplus more than \$80,000,000

LOOK, WHAT'S HAPPENED TO WESTINGHOUSE TRAFFIC APPLIANCES!

New Styling.. New Items.. New merchandising aggressiveness!



Lurelle Guild

Lurelle Guild has restyled Westinghouse Traffic Appliances. He is recognized as an outstanding designer. His styling of Chase giftware, International Silver, Mohawk rugs, Wear-Ever utensils—and many others—distinguishes him as the foremost of designers for retail trade. *Styled by Guild* will mean the most beautiful appliances in America . . . *Built by Westinghouse* guarantees top performance.



After

Added to the Westinghouse engineering pre-eminence, there is now an utterly new concept in designing; the last word in eye-appeal. The new Guild-styled Percolator (above) comes out of the kitchen to sparkle in the living room . . . a coffee maker designed with all the elegance and graciousness of silverware.

Before

You'll be amazed at the *completeness* and the *smartness* of the Westinghouse Traffic Appliance Line that is headed your way. We are set up to give these popular items (plus many new and exciting ones to come) a new meaning in the bright new merchandising era. Westinghouse will give this line . . . collectively and individually . . . greater emphasis than ever before. Why? Because the *right* line, priced right, aggressively merchandised and widely advertised, will increase your profits—not only in the traffic appliances themselves, but also in the whole line-up of electrical merchandise.

As an example of Westinghouse aggressiveness, the entire line has been restyled by Guild. You know that styling sells appliances. Westinghouse proved this when we introduced the first Streamline Iron. We proved it again with our high-style line of Fans . . . and our immensely popular Roaster-Oven. You've seen these appliances and you've been reading a lot about style trends—but you haven't seen anything until you see what Lurelle Guild (rhymes with styled) has done with the Westinghouse Line of Traffic Appliances. Obviously, to put

products on your shelves quickly, the first Westinghouse Traffic Appliances will not incorporate this new style concept . . . but *soon*, the Guild-styled items will be coming along. Note the Percolator on the left. In the coming months you will see equal styling and improvements covering the complete line, the *hottest* sales-making Traffic Appliances on the market.

Your Westinghouse Distributor has a Retailer Agreement on Traffic Appliances. See him today for more profits tomorrow.

WESTINGHOUSE ELECTRIC CORPORATION, MANSFIELD, OHIO
ELECTRIC APPLIANCE DIVISION
Plants in 25 Cities . . . Offices Everywhere

*Tune in: John Charles Thomas, Sunday, 2:30 p.m., EST., NBC.
Listen to Ted Malone, Monday through Friday, 11:45 a.m., EST., ABC Network.*

Every house needs
Westinghouse
MAKER OF 30 MILLION ELECTRIC HOME APPLIANCES

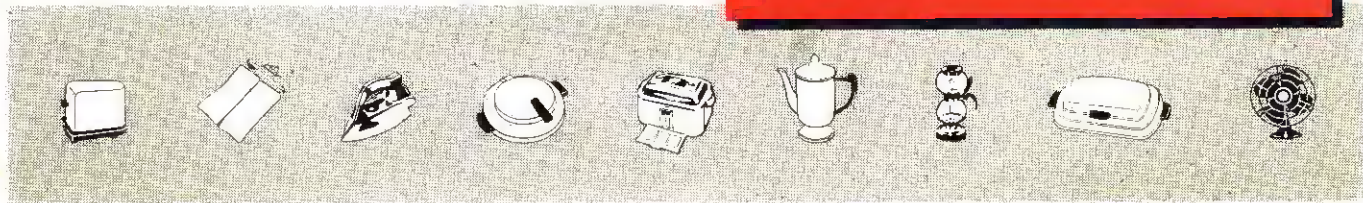

Refrigerators
Washers
Ironers
Ranges
Vacuum Cleaners
Food Freezers

Electrical APPLI

Admiral RANGE

New Admiral range which will be available by approximately the first of



next year. Admiral Corp., Chicago, Ill.—RADIO & Television RETAILING

Edin THERA-RAY

Dual purpose sun and heat lamp with built-in timer, easily interchangeable ultraviolet and infra-red bulbs. Brings "summer sun" into the home, and pro-

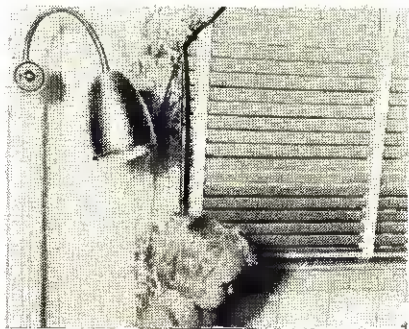

vides relief from minor muscular aches. Two tone tan, green, and black with chrome. Edin Electronics Co., Worcester, Mass.—RADIO & Television RETAILING

Empire IRONER

Portable ironer, weighs 23 lbs. Few parts; roll is 21" long. Starts and stops by touch of elbow on lever. Both hands are free to guide clothes. Motor and

gears inside the roll. Empire Ironer, Inc., 817 Main St., Cincinnati 2, Ohio—RADIO & Television RETAILING

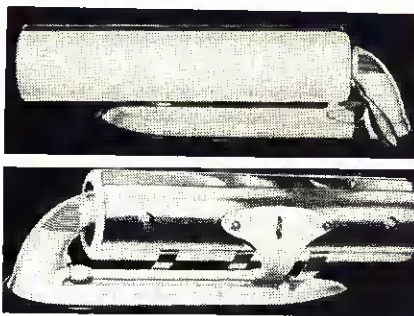

F. L. Jacobs HOME LAUNDRY

The completely automatic Laundrall features the Top-Fil-Dor which allows upright posture when putting in or removing clothes and prevents water from

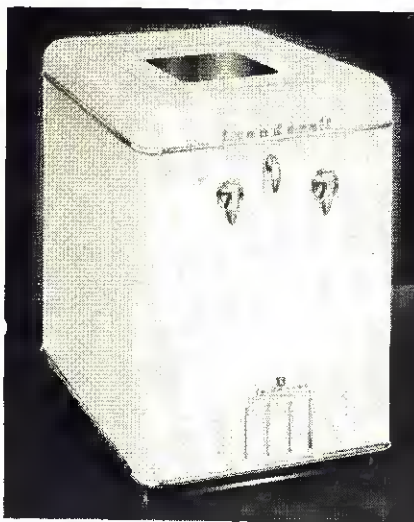

spilling when it is opened; reverse-rotation cylinder washing action; the Roto-Drier cycle for damp-drying; Hydro-Pel transmission. Table-top height. White with chrome trimming. F. L. Jacobs Co., Home Appliance Div., Detroit 1, Mich.—RADIO & Television RETAILING

Crosley REFRIGERATORS

The Crosley Shelvador refrigerator, 1945 model, SE-746, shown, has net food storage capacity of 7.3 cu. ft., is

60½" high, 30¾" wide and 20½" deep. Other features: total shelf area 13.81 sq. ft.; 5 aluminum shelves in door; can make 112 cubes or 12 lbs. of ice at one freezing; has one shucker-type, one pop-out, and three regular trays; new, improved hermetically-sealed Electrosaver unit with 10-point temper-

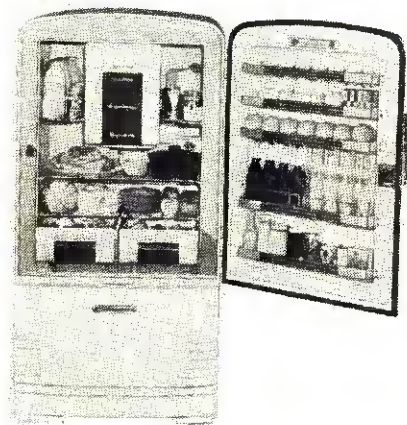

ature control; hermetically-sealed steel cabinet with air-tight door seal; bonderized and finished in Dulux; oversized freezer with frozen food storage space and removable shelf; porcelain meat chest holding 10 to 14 lbs has sliding glass cover; two sliding vegetable crispers; removable glass shelves also serve as covers for the crispers; tilt-forward storebin for foods not requiring refrigeration; one-piece molded door trim; new automatic pull-tight positive-seal door latch with plastic and chrome handle. Production is also under way on the SS-746 Crosley refrigerator, which has the same net food storage capacity, shelf area, and overall dimensions as the SE-746. It makes 77 cubes, or 8 lbs. of ice at one freezing. The Crosley Corp., Manufacturing Div., Cincinnati 25, Ohio.—RADIO & Television RETAILING

GE WASHER

Model AW-322. Wringer-type washer with a capacity of 8 lbs. of dry clothes. Aluminum alloy activator gives triple washing action—soaking, flexing and rubbing. Spring-mounted pump empties the tub in approximately two minutes. Activator control lever located at hand-height, shifts horizontally for easy oper-

ANCE Showcase

★ Toasters
★ Reosters
★ Hand Irons
★ Mixers
★ Clocks
★ Coffee Makers

ation. Powered by a 1/4 horsepower GE motor. Tub finished in gleaming white

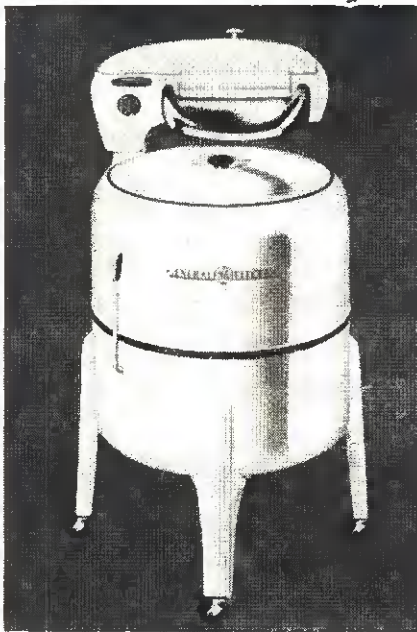

porcelain enamel. General Electric Co., 1285 Boston Ave., Bridgeport 2, Conn.—RADIO & Television RETAILING

GE ROTARY IRONERS

Model AR-18 (top). Portable ironer 28" long, 13" high, 10" deep; weight

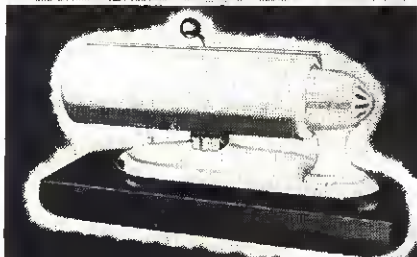
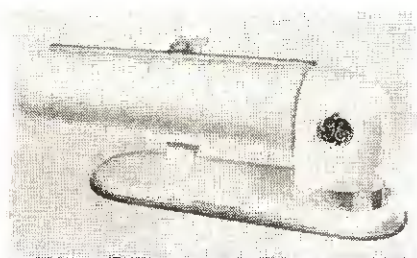

33 lbs. Ironer shoe is chrome plated, provides 110 square inches of ironing surface. 6" diameter roll is open at end for convenient operation. Automatic control handle fits in operating head and permits starting and stopping roll and applying pressure.

Model AR-17 (bottom). Same as the AR-18 except that it is manually controlled. Fingertip lever starts and stops roll and serves as pressing control. Automatic latch holds control in pressing position. Operating lever located for operation with either hand. General Electric Co., 1285 Boston Ave., Bridgeport 2, Conn.—RADIO & Television RETAILING

Norge REFRIGERATOR

Net content 7.08 cu. ft. Shelf space is 13 sq. ft. Safety-sealed fast freezer. Enamel freezer door. Four ice-cube trays. Two half-shelves; three full-width

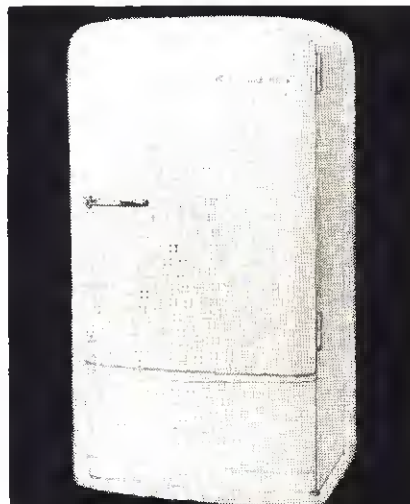

shelves. Additional features include a "Handfroster," a "Coldpack for meat storage," and a double-width "Hydrovoir." Unit powered by "Rollator" hermetically sealed compressor unit. Norge Division, Borg-Warner Corp., Detroit, Mich.—RADIO & Television RETAILING

Norge ELECTRIC RANGE

Features three fast-heating cooking units and utility cooker; six-heat slow make and break switches; two oven heating elements; oven heat control with pre-heat, back and broil switch and signal light; one-piece, acid-resisting

porcelain enameled cooking top and back guard; three utensil drawers;



counterbalanced oven door; heavily insulated. Norge Division, Borg-Warner Corp., Detroit, Mich.—RADIO & Television RETAILING

Easy WASHER

Portable Whirldry washer washes, rinses and spins clothes damp-dry in one white porcelain enamel tub. 18" high, 16" wide. Weighs 33 lbs. For fre-



quent small washes. Easy Washing Machine Co., Solar and Spencer Sts., Syracuse, N. Y.—RADIO & Television RETAILING

(Continued on page 73)



New **NORGE**
★ **GAS RANGE**



A Borg-Warner Industry

NORGE

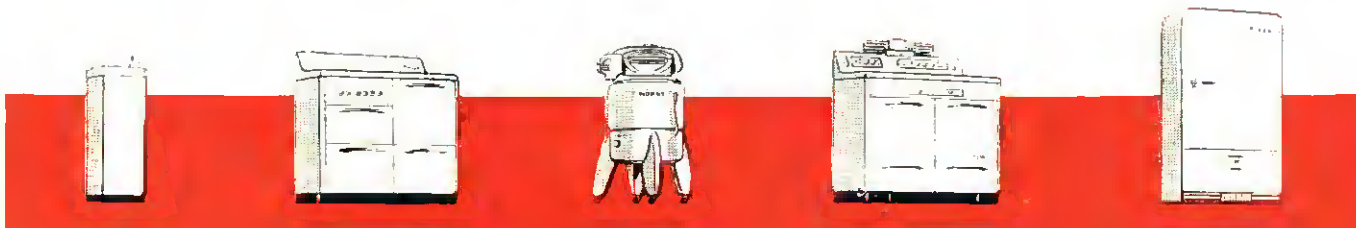

Built to be the Greatest Value in its field!

NOW SELLING!

A gigantic Norge factory at Effingham, Illinois, devoted to the production of ranges exclusively, is turning out the new 1946 Norge gas ranges in ever-increasing quantities . . . they are whisked away to Norge distributors and dealers, and from there they are eagerly welcomed into homes all over America.

The new Norge Model N-401 gas range (illustrated) is 38" wide, 26 $\frac{3}{4}$ " deep, 42" in over-all height and 36" high at cooking top; oven size, 16" x 14 $\frac{1}{2}$ " x 20". It has one giant and three standard Spiro-Speed burners; four Hi-Lo click simmer valves; automatic top burner lighter; one-piece, porcelain-enameled cooking top and back guard; tank-type oven and broiler lining; low-heat, Modi-Fire oven burner; oven temperature control; safety oven lighter; Fiberglas insulation; two utensil drawers; pull-out, drop-front broiler with smokeless grill; flush-to-wall design; front toe-recess. For natural, artificial or bottled gas.

Gas range sales will come easy to the Norge dealer. . . Model N-401 is the first of several, each designed to be the greatest value in its price field!

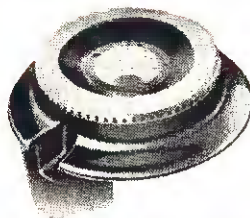

SPIRO-SPEED BURNERS. one of them giant size, deliver clean, spiral-patterned flames which are accurately controlled to provide even heat distribution and maximum economy.

COOKING TOP AND BACK GUARD

is one-piece, acid-resisting, porcelain-enameled steel. Rounded corners and angles accentuate beauty, facilitate cleaning.

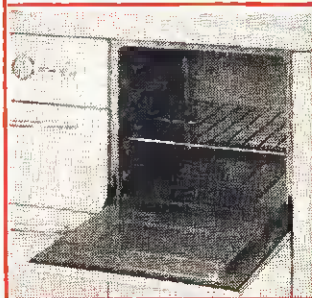
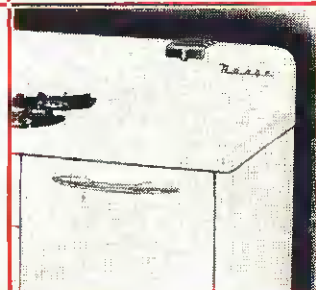

LARGE, TANK-TYPE

OVEN. 16 x 14 $\frac{1}{2}$ x 20 inches, is porcelain-enameled, with pressed-in rack guides and stops; has Fiberglas insulation and is vented through back guard.



HOUSEHOLD APPLIANCES

"See NORGE before you buy"



NORGE DIVISION, BORG-WARNER CORPORATION • DETROIT 26, MICHIGAN
IN CANADA: ADDISON INDUSTRIES, LTD., TORONTO, ONTARIO

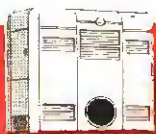



Women Say...

"I WOULDN'T BE WITHOUT MY TRILMONT HEATER"

AND here's why: the Trilmont electric heater works on an entirely new principle by producing "black heat" from non-radiant coils.

Unlike most electric heaters, it heats the entire room—not just a spot. And its oversize, non-glowing coils will last indefinitely—no servicing required. It needs no fan, no moving parts to circulate a full volume of healthful warmth wherever auxiliary heat is wanted.

Right now is the time to stock, display and *sell* the Trilmont. Write or wire for complete data and name of nearest distributor.

Specifications: Width 19½", Height 18¼", Depth 9¼", 120 Volts, 1200 Watts. AC or DC current. Weight 19 lbs. Carries Underwriters' approval.

O.P.A. LIST PRICE IS **\$33.00** including cord set.

95c EXTRA AT AND WEST OF THE MISSISSIPPI

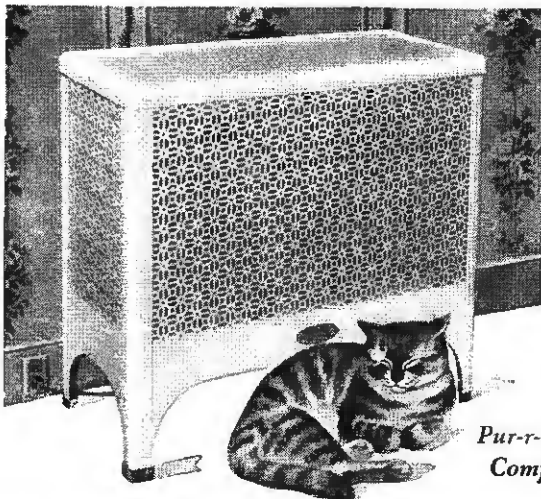

Pur-r-fect Comfort

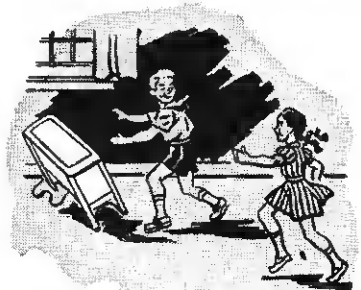

Safe

No need to tell the children "not to touch." All four sides are always cool... no danger to your youngsters or to pets.



Efficient

Radiates a gentle penetrating heat that warms but does not burn. No fans or noisy moving parts! Use it in any room!

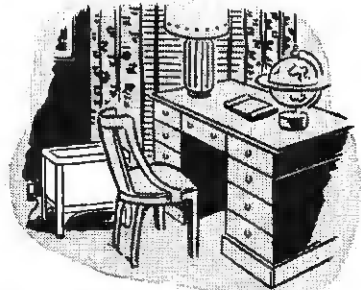

Handsome

A life-time investment in appearance and comfort. Ivory-enameled to blend with walls and woodwork.

TRILMONT PRODUCTS COMPANY

PHILADELPHIA 3, PENNA.

Continuing Latest Electrical Appliances

Bendix WASHER

"Standard" model of Bendix automatic home laundry. New postwar model with 14 new improvements.

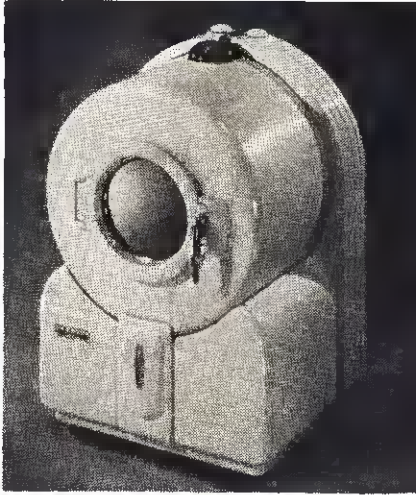

Samples have been delivered to all Bendix appliance retailers throughout the country.

Bendix Home Appliances, Inc., South Bend, Ind.—RADIO & Television RETAILING

Bendix HOME IRONER

This automatic home ironer which will incorporate features of the rotary and flat-plate types, has an adjustment for leg clearance from 22½" to 23½"; adjustable lapboard; three open, usable ends—two on the shoe and one on the roll; and a utility shelf on each side of machine. The shoe can be released a total of 4" from roll. There is adjustable shoe pressure; two roll speeds and two

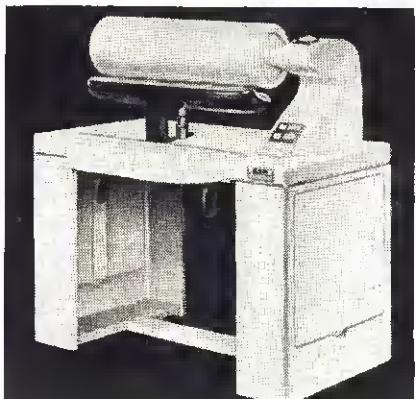

thermostats for independent temperature control for both ends of shoe; fingertip and adjustable knee controls; fully automatic safety release; and both motor and temperature indicators illuminated on the control panel. Under-the-roll operation gives complete visibility of

work. Production will be begun next spring by Bendix Home Appliances, Inc., South Bend, Ind.—RADIO & Television RETAILING

Frigidaire REFRIGERATOR

Cold-Wall model CPD 9-42. Operates on Cold-Wall principle. Finish, porcelain inside and out, including interior door panels. Shelf area, 17.8 sq. ft.; food storage, 8.5 cu. ft.; frozen storage, 1.685 cu. in. plus 4 lbs. of ice, 1.863 cu. in. total; ice making, 12 lbs. of ice at one freezing; meat-tender, 346 cu. in. capacity. Cold-Wall Moist Storage, 7.2

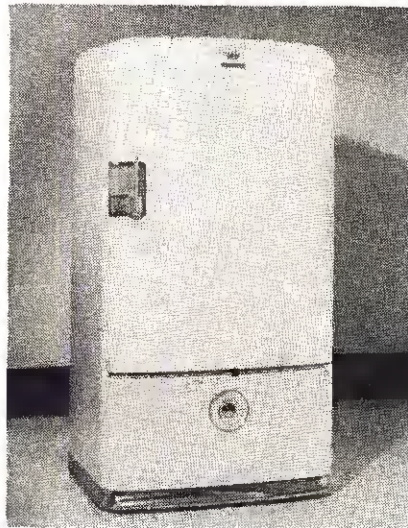

cu. ft.; 2 sliding glass-topped hydrators with total 1.410 cu. in. capacity; dimensions, 64¾" high, 33½" wide at base, 28 7/16" deep, including cabinet appointments and space at rear for ventilation. Glass storage tray, with crystal dish and basket set. Refrigerant, F-114; 1/9 hp. motor—5 year protection on entire sealed mechanism. Frigidaire Division, General Motors Corp., Dayton 1, Ohio—RADIO & Television RETAILING

Warren Telechron CLOCKS

Three Telechron clocks to be on the market about first of year are the "Switch-Alarm," shown, "Musalarm" and "Lite-Call" models. The "Musalarm" is a combination clock and radio. By setting alarm and selecting station the night before, sleeper is awakened by music. Auxiliary buzzer goes off 10 min. later and rings until shut off. Streamlined, maroon-colored plastic case. \$19.95 retail. "Switch-Alarm" is similar in use to "Musalarm" but not built into a radio. By plugging radio into clock, radio can be turned on at pre-determined time. Is also a standard type of alarm clock. Can be used to turn on an electric light at given time. \$5.95 retail. "Lite-Call" is standard type alarm clock with audible

signal. Will make a light flash intermittently when plugged into clock. Desirable for the hard-of-hearing; will not awaken entire household. \$6.95 retail. The "Telealarm Jr.," announced previously by the manufacturers, has a new alarm device which controls the volume of the signal by use of con-



trol lever. \$3.95 retail. Warren Telechron Co., Ashland, Mass.—RADIO & Television RETAILING

Westinghouse VACUUM CLEANER

Two new features have been added to Westinghouse's pre-war floor cleaner: "stepped wheels," which automatically adjust the distance from rug nap to cleaner nozzle, and the "penetrator" brush which digs into rug nap and relays embedded dirt to nozzle. The models incorporate a "bifurcated" handle—

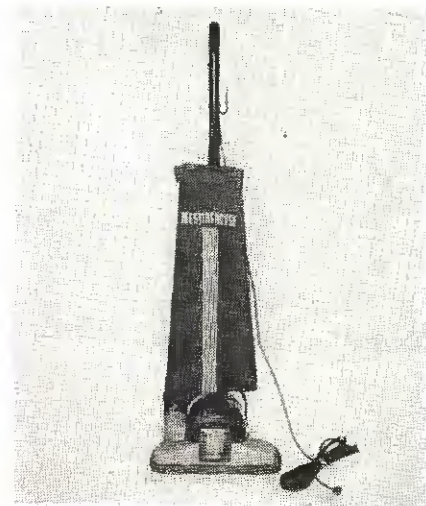

two metal tubes attached to the cleaner's sides and joined near the top to form the grip—and plastic motor housing for lighter weight. Westinghouse Electric Corp., 246 E. Fourth St., Mansfield, Ohio.—RADIO & Television RETAILING

(Continued on page 74)

Continuing Latest Electrical Appliances

Hotpoint FLAT IRONER

New type flat plate ironer particularly adaptable for towels, linens and other



flat work. Edison General Electric Appliance Co., Inc., 5600 West Taylor St., Chicago 44, Ill.—RADIO & Television RETAILING

Hotpoint REFRIGERATOR

Deluxe refrigerator with 7 cu. ft. storage capacity with shelf area of 13.4 sq. ft. Has Thriftmaster vacuum sealed unit which has been refined to permit greater compactness than previous models. Refrigerator is finished in two coats of baked-on white Calgloss enamel with chrome plated brass hinges and door

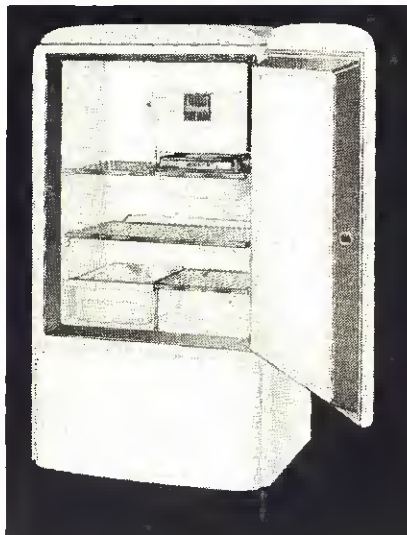

hand.e. Interior finished in a one piece porcelain construction. Equipment includes four popice cube trays, a high humidity vegetable compartment drawer with heavy glass top, one sliding shelf

of heavy rust-resistant wire and a six-way cold storage compartment. Box is 59" high, 31" wide and has an exterior depth including ventilation space and door handle of 28½". Carries five-year protection plan with one year warranty on complete refrigerator. Edison General Electric Appliance Co., Inc., Chicago, Ill.—RADIO & Television RETAILING

Universal ELECTRIC RANGE

Speedking, deluxe model #1652, features Multi-Heat Control with individual signal lights for each surface unit. Built in the back splash of this model is a combination electric clock timer and minute minder. Timer is connected so that it may be used not only to time-control the oven, but also the built-in economy cooker or appliance outlet located on back splash.

The range is equipped with a two unit speed 16 x 16 x 19 inch seamless porcelain enamel oven. Oven is controlled by a combination oven switch and automatic pre-heat cut-off thermostat which automatically cuts off top unit in oven being used, when the oven



Model 1652

has been set for pre-heat cooking. Automatic oven light; warming unit; utility drawers. The range has a porcelain enamel finish and is 40" wide, 26" deep with a cooking platform 36" from the floor.

Super Clipper, medium priced model #1651, is similar to the Speedking, except that it does not include the built-in control and timer, nor the switching mechanism which makes it possible to throw this timer in circuit with the built-in cooker or appliance outlet. Combination clock and timer may be installed to provide time control.

Super Planet, low priced model #1051, is identical with the Super Clipper except that the surface unit is controlled through the medium of single five heat switches and open control is through the medium of an oven selector switch and thermostat. Does not include auxil-

ary oven light or warmer drawer unit. Landers, Frary & Clark, New Britain, Conn.—RADIO & Television RETAILING

Whirlpool WASHER

The new 1900 Whirlpool "baby" portable washer recently exhibited at the Commonwealth Edison showroom in



Chicago holds 2 lbs. of clothes, has 2½-gal. water capacity. Diameter 13"; height, 20" without wringer. Centrifugal water pump speeds emptying of tub for rinsing. Expected to retail at about \$34.80. Nineteen Hundred Corporation, St. Joseph, Mich.—RADIO & Television RETAILING

Lovell CLOTHES DRYER

Cabinet 36" high, 25" deep, 30" wide. Will be produced in both electric and gas models. Capacity 10 lbs. of dry clothes. Fully automatic. When dial is set properly, the dryer stops automat-



ically when the clothes are dry or have reached the degree of damp-dryness desired. Thermostatic control keeps clothes temperature well within a safe range while being dried. Has lint collector and control. Lovell Mfg. Co., Erie, Pa.—RADIO & Television RETAILING

(Continued on page 77)

Another Famous First!

SYSTEMEERING

FOR
GREATER PROFITS

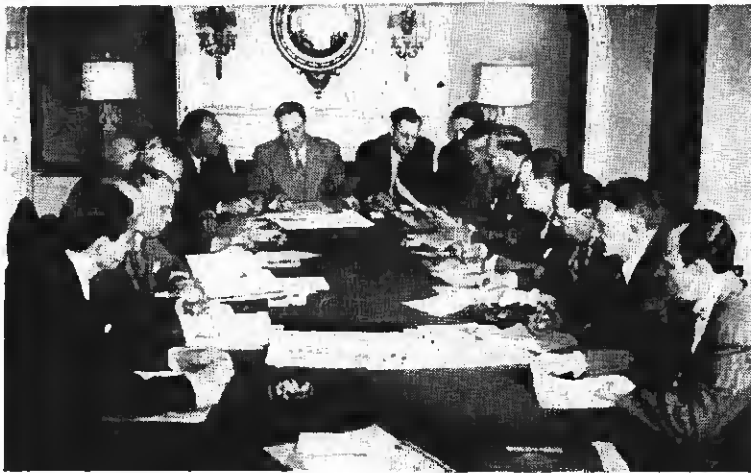

Business experts from the Burroughs Adding Machine Co., Moore Business Forms, Inc. and the Shaw-Walker Co. join with Universal under the direction of Dr. O. P. Robinson, Professor of Retailing, New York University, to bring the latest retailing techniques to dealers through Universal's new Systemeering Guide.

FOR PROFIT-WISE DEALERS • A Complete Guide to the Scientific Control of Retailing

Following the sensational success of Moderneering—The Store Planning Guide, Universal now offers Systemeering—The Guide to Profitable Retailing which points the way to creating and conserving a surplus by means of planned and coordinated management.

Systemeering is another big step in Universal's "Help the Dealer" program which started with the "U" Plan for "V" Day and will continue in high gear as the new Universal appliances and housewares become available.

**REQUEST
YOUR COPY
TODAY!**

*Copyright 1945, Landers, Frary & Clark



UNIVERSAL

LANDERS, FRARY AND CLARK • NEW BRITAIN, CONN.

Universal Electrical Appliances Distributed in Canada Exclusively by Northern Electric Company, Ltd.

Systemeering Division RT
Landers, Frary & Clark, New Britain, Conn.

Gentlemen:

I plan to "moderneer" the business operations of my store—please send me complete Systemeering Guide.

Name: _____

Address: _____

City: _____

*There's a Great Day
Coming for
Philco Dealers*

Great things are coming
your way soon from
Philco, the Leader...

Be ready!

Continuing Latest Electrical Appliances

Electromaster RANGES

Model T41-1 differs from Model 15-1S (see below) in that it is 21" wide in comparison to 39½". It has spun glass oven insulation; service-free stationary upper

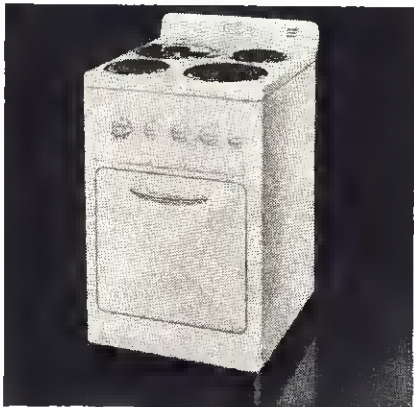

oven unit; full cooking capacity in space-saver design, 21" wide; stainless porcelain enamel cooking table; removable crumb tray. Electromaster, Inc., Detroit, Mich.—RADIO & Television RETAILING

Electromaster RANGES

Model 15-1S occupies floor space 39½" wide, 24" deep; table height, 36"; overall height, 48" with lamp; oven size 16½" wide, 15¼" high, 19¼" deep (with door closed). Finished in all white porcelain enamel with white Plaskon and chromium trim. Acid-resistant top. Two storage drawers, ball-bearing rollers. Warming drawer with ball-bearing rollers and indicator light. Convenience



outlet. 6-qt. Vita-Miser Cooker with 4-position adjustable trivet. Master indicator light for surface units. New-type removable chromium grill for oven vent. Soft-glow table lamp included as standard equipment. 5-heat control on cooker—1200 watts on "High", 600 on "Medium", 300 on "Low", 150 on "Very Low", and 75 on "Simmering". Oven equipped with Electromaster Twin-Units having total wattage of 4500. 2500 w. upper unit for broiling. Oven includes 2 baking racks with lock stop; porcelain enameled broiler pan with smokeless

broiler rack; automatic illumination; automatic, hydraulic positive-action thermostat with indicator light (automatic preheating). Seth Thomas oven control clock available at extra cost. TK enclosed surface units controlled by 5-heat switches. Rated wattage 11,200. Approximate shipping weight 280 lbs. All ranges furnished for 115/230 v., 3-wire service unless otherwise specified.—Electromaster, Inc., Detroit, Mich.—RADIO & Television RETAILING

Electro-Mite WASHER

Small electric, agitator-equipped washer with detachable tub, which can be moved from stove to washer



base after water has been heated. Menasco Mfg. Co., 850 S. San Fernando Blvd., Burbank, Calif.—RADIO & Television RETAILING

Horton IRONER

Horton Diamond Jubilee Table Model Ironer is completely automatic. The single control lever controls pressing, ironing and releasing of the shoe. 1500-watt

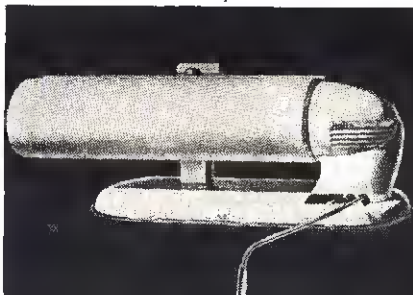

element. Open at both ends for ironing sheets, shirts, ruffles. Light weight for easy placement in any room. Production to begin in a few months. Horton Mfg. Co., 731 Osage St., Fort Wayne, Ind.—RADIO & Television RETAILING

Speed Queen IRONER

Ultra deluxe cabinet model. 26" roll. 2-speed shoe with insulated lip. Ruff er plates. Improved shoe bracket for uniform and maximum pressure. Acid-resisting porcelain table top. Dual ther-



mostat controls. Added features include: two end tables, lap board; pilot light, 18" table top; automatic knee control; knee "press" control; locking devices on 2 casters. Finished in white with red trim. Barlow & Seelig Mfg. Co., Ripon, Wis.—RADIO & Television RETAILING

Speed Queen WASHER

Electric model in medium price range. Bowl-shaped tub, double wall construction arc-cuate drive transmission, aluminum agitator, and all-aluminum safety-roll wringer. Free shift, automotive type clutch. All steel chasses. Sunlight oversized ¼ h.p. motor, built to

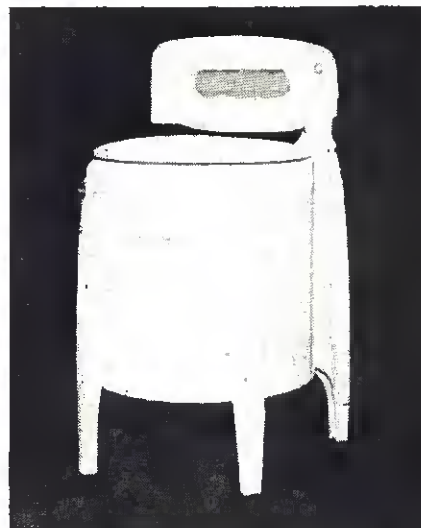

own specifications. White baked enamel finish trimmed in red. Gasoline motor powered washers should be available by first of the year. Barlow & Seelig Mfg. Co., Ripon, Wis.—RADIO & Television RETAILING

(Continued on page 78)

Continuing Latest Electrical Appliances

Gibson HOME FREEZER

6 cu. ft. capacity, vertical type freezer. Four freezer shelves provide extra direct contact surfaces which facilitate faster freezing. Vertical design, manu-

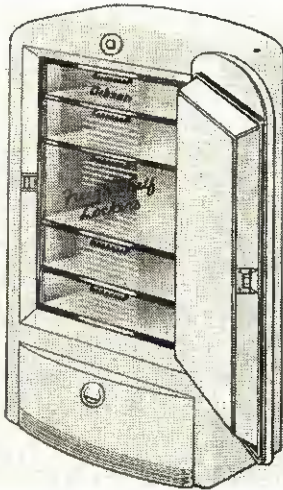

facturer says, makes selection of packages easier, and saves space. Cabinet similar to that of a deluxe refrigerator. Gibson Electric Refrigerator Corp., Greenville, Mich.—RADIO & Television RETAILING

Thor AUTOMAGIC SINK

This new dishwasher, clotheswasher and sink combination unit is made of white-enameled steel with black linoleum top, stainless steel trim, stands

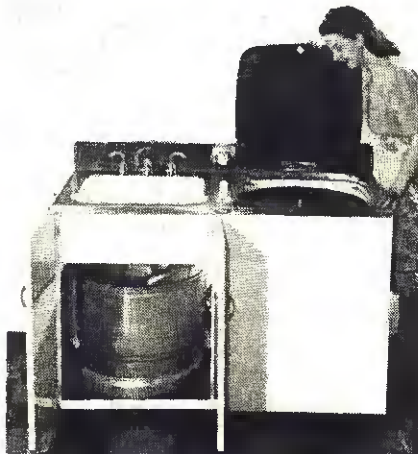

36" high, 54" long, 25" deep, and contains a bowl of white porcelain enamel. Beneath the sink bowl is storage space for either clothes or dishwasher tubs. Under hinged drain board of sink unit is the clothes-dishwasher combination, which, by switching tubs, will wash either dishes or laundry. Separate, readily interchangeable sets of tubs and accessories for dishes and clothes. Water quantity and temperature for washer reg-

ulated in sink faucets and by means of button control is switched to washer tub. The dial control for the washer which automatically controls washing, rinsing, and drying, is located on back splash panel of sink. Cabinet is complete, requires only plumbing and electrical connections, and may be purchased for either right or left hand installation. Available early in 1946. Hurley Machine Div., Electric Household Utilities Corp., Chicago, Ill.—RADIO & Television RETAILING

Thor GLADIRON

Single knee lever leaves both hands free to guide the work on the Thor Automagic Gladiron. Slight pressure on lever starts, stops and controls speed of



the sleeve-size roll. Roll and roll-supporting housing of such small size as to permit both the roll and the housing to fit inside of sleeves or trouser legs.

Allows such pieces to be ironed single thickness without creases. Shoe, located at back of the ironing roll, contains heating element and is lifted and lowered into all ironing positions by same knee lever as controls the starting, stopping and speed. Shoe can be tilted face up and locked into trough position to hold wet towel for steaming ties or piled fabrics. Entire machine folds up to occupy 1 $\frac{3}{4}$ sq. ft. of floor space. Hurley Machine Division, Electric Utilities Corp., Chicago, Ill.—RADIO & Television RETAILING

Coolerator REFRIGERATOR

R75 mechanical refrigerator 31 $\frac{1}{2}$ " wide, 25 $\frac{1}{4}$ " deep, 60 $\frac{3}{4}$ " high. Gross cu. ft. volume 9.50; total storage volume 7.83; frozen storage volume 1.61 cu. ft.; frozen food compartment temperature 8° F. Coolerator Co., Duluth, Minn.—RADIO & Television RETAILING

(Continued on page 80)

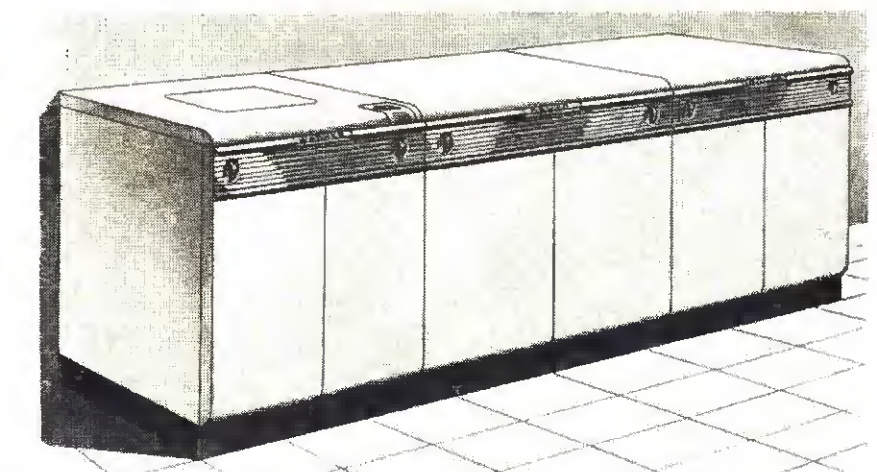
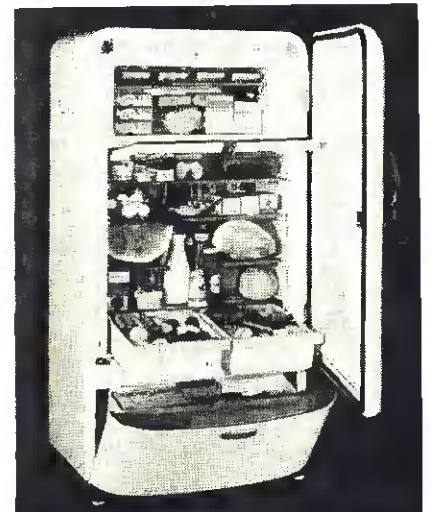

Blackstone COMBINATION LAUNDRY

Provides automatic washing, rinsing, drying and ironing in a unit of standard counter height and depth, and 80" in length. Blackstone Corp., Jamestown, N. Y.—RADIO & Television RETAILING



"WRONG, Mr. Frippe!"

The Crosley Kitchen Salesman is NOT a hatchet man!

"You FURNISH a kitchen, the Crosley way. No tearing out or rebuilding. Listen—here's a prospect!"



1 PROSPECT: What a beautiful sink!
SALESMAN: Lots of clear work surface—cabinet storage space—recessed knee-hole for working while seated.



2 SALESMAN: Here's how we furnish the range and cooking center. The wall cabinet hangs on that hanger strip just like a picture—no fuss or bother.
PROSPECT: How perfectly simple—and how convenient!



3 SALESMAN: Crosley Shelvador and food preparation center—goes together the same way.
PROSPECT: So sensible—so beautiful—so practical!
SALESMAN: Yes—and so economical!

Crosley—NEW Way to Modern Kitchens!

Women sell themselves when they see how easily any kitchen can be modernized the Crosley way—simply by *furnishing*, instead of the usual building job.

And it can be done one step at a time or all at once—from a single cabinet or a complete work center to the entire kitchen.

Only a dozen items are stocked by dealers to furnish practically any kitchen with modern beauty in convenient, time-saving arrangement. Crosley dealers are ready to promote this completely new and practical method of furnishing better kitchens—for old houses as well as new ones, for modest homes as well as mansions.

CROSLEY

THE CROSLEY CORPORATION, CINCINNATI, OHIO

Radio • Radio-Phonographs • FM • Television • Short Wave
Electronics • Radar • Refrigerators • Home Freezers
Kitchen Sinks and Cabinets • Laundry Equipment • Ranges

Home of WLW, "The Nation's Station"



4 You just can't keep a woman from showing off her new Crosley furnished kitchen! She becomes your best saleswoman—sending a steady stream of good prospects to you.

Continuing Latest Electrical Appliances

Dexter SINGLE TUB

Equipped with stream-lined aluminum wringer. Washer has improved "sealdheet" all around tub which helps keep water hot all through the washing;

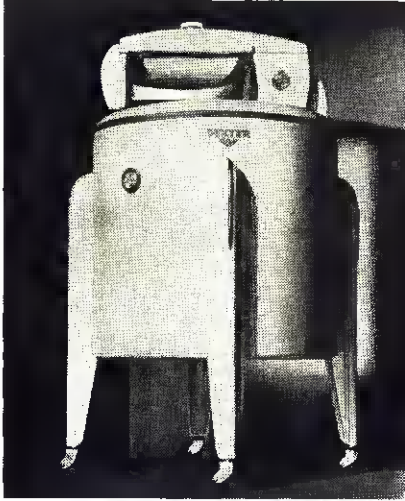

Automatic "temptgauge" with dial on cabinet shows water temperature. The Dexter Co., Fairfield, Iowa.—RADIO & Television RETAILING

Rittenhouse DOOR CHIMES

Brookdale Model No. 250, designed expressly for kitchens and breakfast nooks. Sounds 2 notes for front door and 1 note for rear door. Operates on standard 10 volt doorbell transformer. Finished in white and chrome or ivory

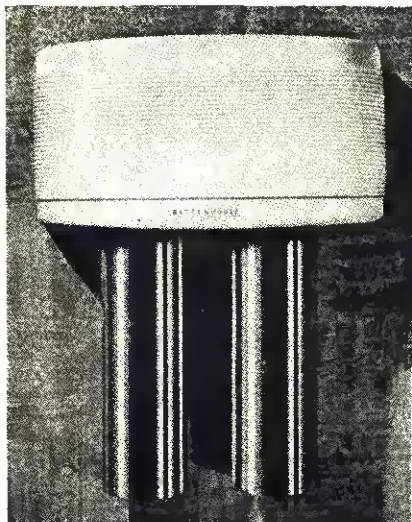

and brushed brass. Size 7" wide x 9 3/4" high. \$4.95 list price.

Utility model, No. 220. Compact chime for general signalling service. Low volume signalling. Provides both 2-note and 1-note signals. Operates on standard 10 volt doorbell transformer. Fin-

ished in white or ivory enamel. Size 7" wide x 4" high. \$2.95 list price. A. E. Rittenhouse Co., Inc., Honeyoye Falls, N. Y.—RADIO & Television RETAILING

Conlon WASHER and IRONER

Details and specifications will appear in a future issue. Conlon Corp., 1824 S. 52nd St., Chicago, Ill.—RADIO & Television RETAILING

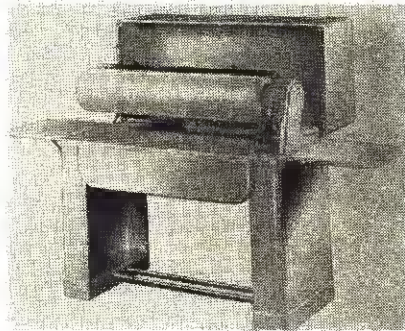
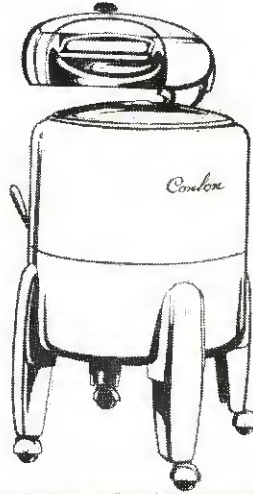

Servel AIR CONDITIONER

The Servel All-Year Gas Air Conditioner is compactly built in one unit, with fingertip control. Designed for residential and small commercial use, it heats and humidifies in cold weather, cools and dehumidifies in hot weather, and circulates and filters air at all times.

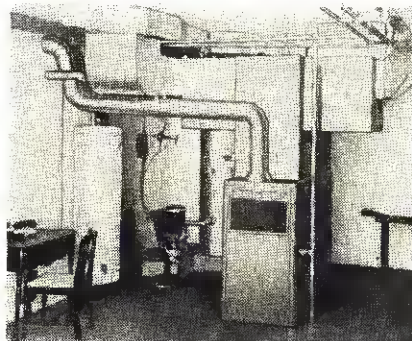

With this system, which will go into production as soon as conditions permit, it is possible to have heating and cooling the same day, by flipping a switch located in any one room. Servel, Inc., Evansville, Ind.—RADIO & Television RETAILING

Servel WATER HEATER

New automatic storage type gas water heaters with 100 per cent safety controls on main burner and pilot, will be offered in 30-gal. (as illustrated), 20-gal. and 45-gal. models. Spherical tank in 20-gal. model, elongated spheres in others. Overall dimensions of 30-gal. model are: 24" wide; 44 3/8" high; 26 3/4"

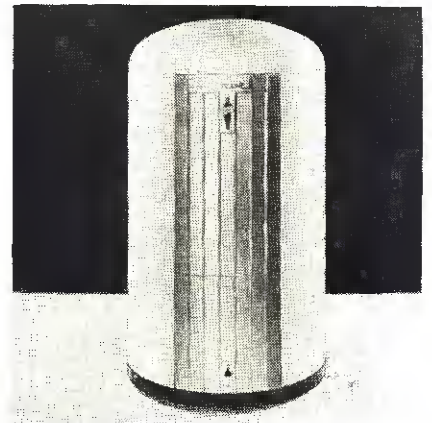

deep, including draft diverter. Shorter and greater in diameter than conventional 30-gal. automatic gas water heaters. Insulation to average more than 50 per cent thicker than in conventional type. May be used with liquefied petroleum gas. Servel, Inc., Evansville, Ind.—RADIO & Television RETAILING

Redi-Electric HEATER

Steel body 22" long, 18" high, 6 1/4" deep. Two switches, high and low heat, 1320 and 660 watts. Finished in baked

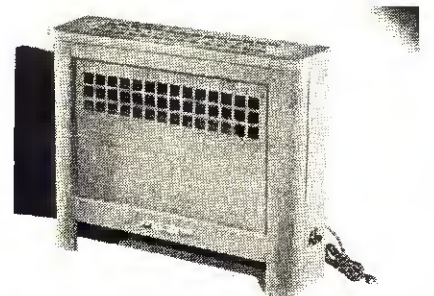

enamel in brown or ivory. Standard model is priced at \$14.95; the deluxe model, with humidifier, is priced at \$17.95. Redi-Electric Co., 141 W. 24th St., New York, N. Y.—RADIO & Television RETAILING

(Continued on page 83)

IN PRODUCTION



**the safer
no-burn heater
most people
prefer**



NATIONALLY ADVERTISED IN



WITTIE
PORTABLE
ELECTRIC *Steam* HEATER

YOU'VE never seen a heater like this! Wittie Portable Electric Heater provides *real STEAM* heat . . . quickly and economically. Not just "fire-place" heat . . . but uniform warmth that's air-circulated to every corner of the room. Wittie is safer and cleaner, because it has no exposed glowing coils to cause fire or burn. In light-weight luggage design—handsome as a piece of furniture.

SPECIFICATIONS: 21½ x 17 x 7¼ inches; automatic safety shut-off; 2-stage heat regulator; operates on AC current; three attractive colors; in "Fan-Blow" or Convection models to suit individual needs.

Established 1932. Wittie's War Role—designing, engineering, and building ventilating equipment used in tanks, planes, and ambulances.

WITTIE MFG. & SALES CO.

General Offices and Plant: 1414 S. Wabash Ave., Chicago 5, Ill.

Branch Offices and Representatives in New York, Kansas City, Los Angeles, and Detroit.

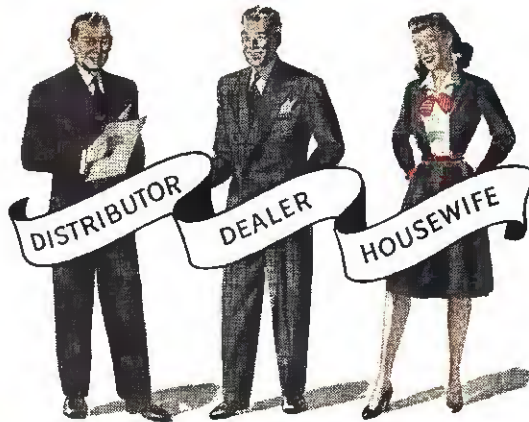

Gibson

**GIVES THEM THE FEATURES
THEY WANT!**

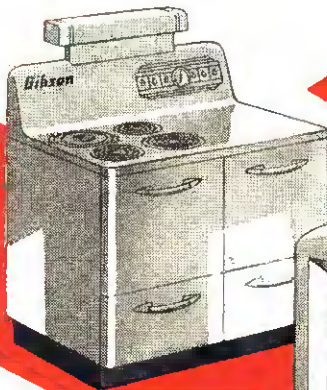

GIBSON KOOKALL ELECTRIC RANGE

Automatic control—set it—forget it . . . turns itself on and off; Two oven heating elements; waist high broiler; only range with exclusive Ups-A-Daisy, the innovation homemakers demanded.

GIBSON FREEZ'R SHELF REFRIGERATOR

Has exclusive "firsts": Freez'r Locker . . . Moist Chiller . . . Built-in Strata-Zones; different temperatures, different humidities; full-width, unobstructed shelves.

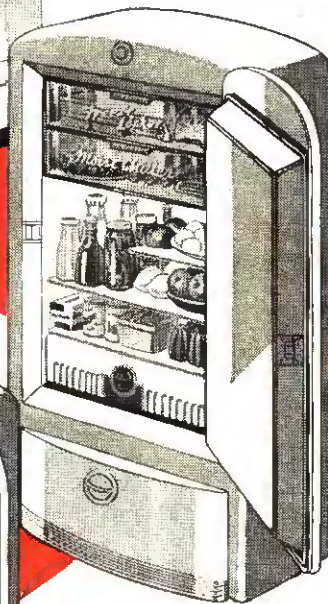
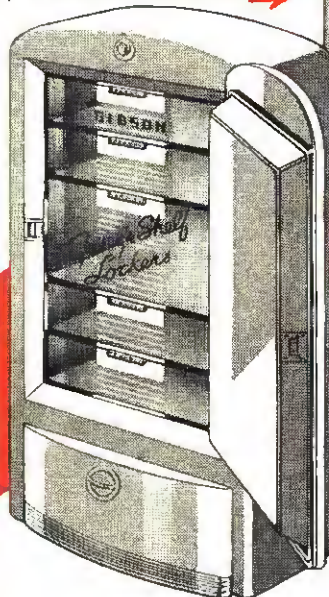

GIBSON HOME FREEZER

New type—VERTICAL design . . . Compartments are handy, glass doors, shelves—no "diving" for frozen food packages. Takes only about half the floor and wall space of old model "deep" boxes! Direct contact freezes faster.

Gibson has 68 years of manufacturing experience. Today Gibson is the fastest growing refrigerator manufacturer. Each item in the Gibson short, fast-selling line is provided with outstanding features that both distributor and dealer know the customer wants.

Sold through independent distributors and dealers.

GIBSON REFRIGERATOR COMPANY
GREENVILLE, MICHIGAN



the new Juice King

FINEST HOME JUICER

**Cuts Squeezing Time in Half
with the Single Stroke Handle**

JUICE KING sets the pace in home juicer design and efficiency with the Single Stroke Handle and these five other important features:

1. Juice-All Strainer . . . gets the juice
2. Interlocking cup, strainer, and base
3. Deep-Well Cup
4. Steel Handle
5. Open Design

For the utmost in beauty and fine workmanship, see the new JUICE KING.

Dotted line shows how one turn of the Single Stroke Handle squeezes the juice from a half orange. It's easy . . . and fast!



NATIONAL
ADVERTISING

on the new JUICE KING is appearing in Good Housekeeping . . . Ladies Home Journal . . . Better Homes & Gardens.

NATIONAL DIE CASTING CO.

Touhy Ave. at Lawndale
Chicago 45, Ill.

Continuing Latest Electrical Appliances

Ironrite IRONER

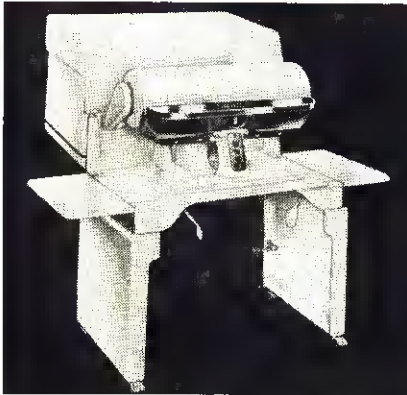

Two knee controls, one for starting and stopping, the other for pressing. Additional features include: pointed ends to facilitate ironing ruffles; both ends open and usable; clothes go under, not over, the roll. Ironrite Ironer Co., Detroit, Mich.—RADIO & Television RETAILING

Sperti SUNLAMPS

The Aristocrat, model P-100, fits into any traveling or over-night bag, operates on ac or dc current, 102-125 v. Projects full ray of ultraviolet and infra-red ray lights producing skin tan.



Model S-200

Chrome trim with black crackle finish case. Integral adjusting supporting bracket for hanging the lamp or standing it on desk or dresser.

Another new lamp, the Selector, model S-200, is selective in projection of either ultraviolet or infra-red rays, or combination of both. Triple reflector type, containing two infra-red burners on either side of ultraviolet generator. Deluxe; streamlined appearance; operates on ac or dc; contains mercury generator from which ultraviolet rays produce a quick tan; can extend to height of 80½" from stationary stand. Universal adjustment

permits reflectors to radiate light in almost any direction and at any angle. Appliance Div., Sperti, Inc., Cincinnati, Ohio.—RADIO & Television RETAILING

Steam-o-Matic IRON

Automatic steam iron; further developments to be made when full-scale production gets under way. \$14.25 OPA

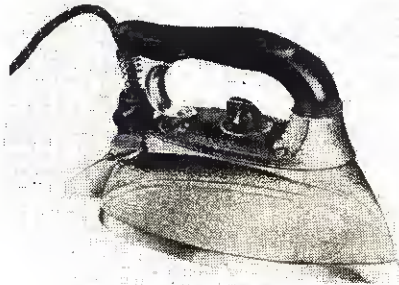

approved list price. Waverly Tool Co., Irvington, N. J.—RADIO & Television RETAILING

Petipoint IRON

Electric iron with air-cooled handle; dual soleplate for regular or "close"

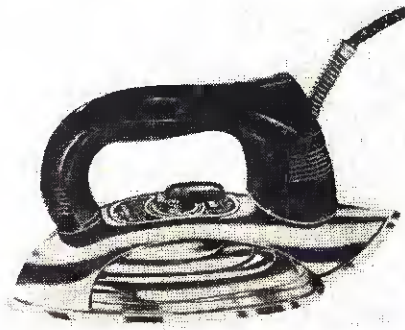

ironing; side-rest to prevent toppling; automatic heat control. \$14.25 OPA approved list price. Waverly Tool Co., Irvington, N. J.—RADIO & Television RETAILING

Edin AIR-RAY

Germicidal lamp to effectively help guard children against air-borne bac-



teria. Ultra-violet rays destroy germs. Edin Electronics Co., 207 Main St., Worcester, Mass.—RADIO & Television RETAILING

Westinghouse DISHWASHER and WASTE DISPOSER

The dishwasher and the waste-away can be installed separately or together. New dishwasher has three rinse cycles, one pre-wash and two following the five-minute wash period. Machine automatically cleans and drains itself, then shuts off. Dishes dry when top is opened and machine shuts off.

The waste-away garbage disposer is the companion appliance to the dishwasher. Westinghouse Electric Corp., Mansfield, O.—RADIO & Television RETAILING

Smithway STOKER

Manufacturer claims 24 exclusive features. These include turret-top of hopper deep drawn from a single piece of sheet steel; lower easy-to-fill hopper; monotwin assembly of feed tube and air duct allowing greater freedom for angle installations in cramped quarters; special plug-in motor connection; special SMITHway motor—completely enclosed, capacitor type, heavy duty design starts

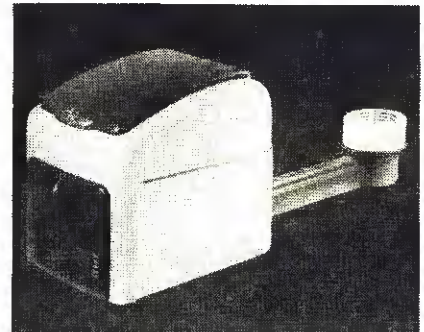

easily under full load. A. O. Smith Corp., 3533 N. 27th St., Milwaukee, Wis.—RADIO & Television RETAILING

Toastmaster TOASTER

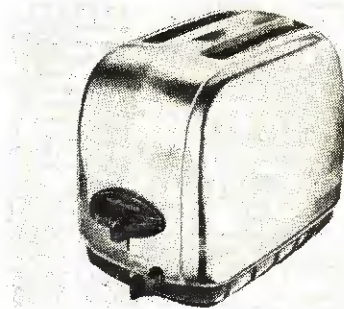

Postwar model Toastmaster. Samples have already been received by distributors. McGraw Electric Co., Toastmaster Products Div., Elgin, Ill.—RADIO & Television RETAILING

FOR LATEST RADIO MERCHANDISE SEE PP. 40 TO 45.

Norge Service Methods

Replacing Open Rollator Shaft Seal Assembly

The shaft of Norge Open Rollator extends from within to outside Rollator housing. Since Rollator housing is filled with high-pressure gas, some means had to be devised to prevent gas from seeping out through the shaft opening. This was accomplished by employing a shaft seal assembly.

The shaft seal assembly consists of two separate parts: (1) the seal ring, which is sealed tightly on the shaft and rotates with it; and (2) the seal bellows assembly, which is stationarily bolted and sealed to the

Rollator housing around shaft. The perfectly smooth, mirror-polished "nose" of the stationary seal bellows assembly fits tightly, by spring action, against the equally smooth top surface of rotating seal ring, to provide a gas-tight seal between the two parts.

If a seal leak should develop, permitting the refrigerant and oil to escape, the shaft seal assembly must be changed. To change the shaft seal, first remove the Rollator, then proceed with the following steps:

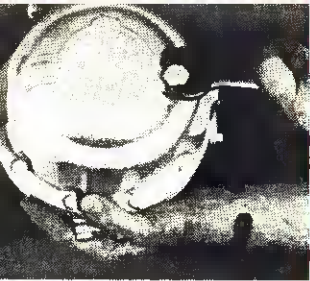

Remove oil filter plug.



Pour oil from Rollator into waste container.



Remove six cap screws holding bellows assembly in place.

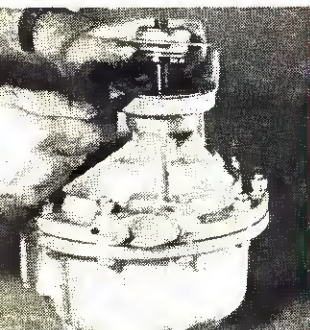

With knife blade, break seal bellows assembly loose; lift it off, then scrape off old gasket.

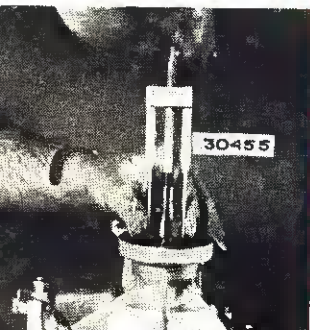

Hook flanged legs of Norge seal ring puller (part No. 30455) under seal ring. Start turning the handle. Ring will come out.

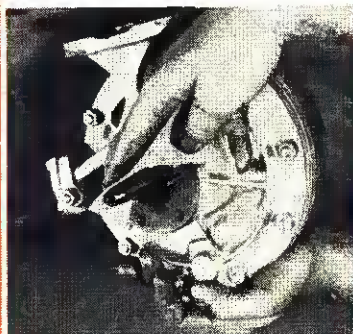

6 If there is any rust on shaft, remove it with fine sandpaper.

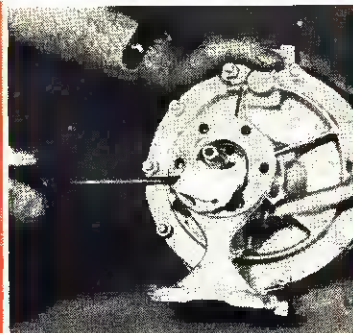

7 Wrap a cloth around screwdriver and, with it, wipe out the shaft counterbore thoroughly until clean.

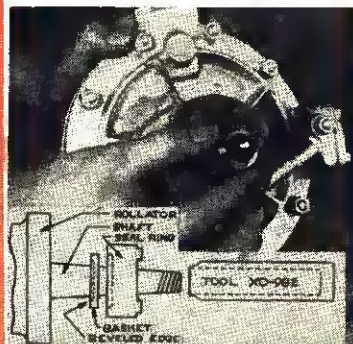

8 Inspect new seal ring. Be sure beveled edge of ring gasket faces outward. Place ring on the shaft so that ring key is in shaft key slot. Press ring down firmly using Norge tool (part No. XC-982). Do not hammer ring in place.

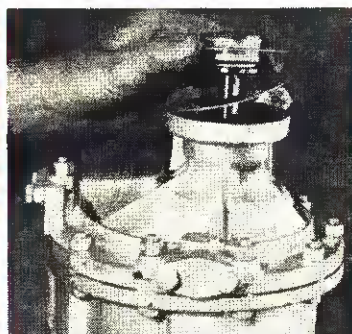

9 Place a drop of clean refrigerant oil on the face of the ring. Put on a new gasket. Place new seal bellows assembly in position with two metal rings on top of bellows assembly.

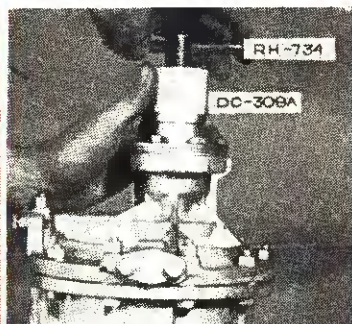

10 Place Norge seal aligning tool (part No. DC-308A) on seal, as shown. Insert Norge seal wrench (part No. RH-734), start turning handle. Seal bellows assembly will draw down evenly and snug against housing. Then install two top and two bottom screws and remove tools.



11 Place oil-throw ring on shaft with the projection in the key slot of shaft. Place washer on top of oil-throw ring.



12 Place oil-throw ring retainer over shaft.



13 Install the last two cap screws which hold the oil-throw ring retainer in place.

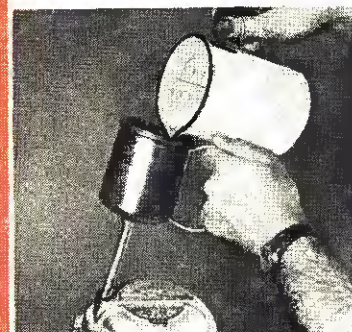

14 Now add correct charge of new Norge oil. Add 24 oz. if the Rollator is used on a low side float system; 17 oz. if used on a high side float system. Reinstall oil plug. Rollator is again ready for use.

WHERE TO BUY ELECTRICAL APPLIANCES

Listing the manufacturers whose products cover one or more of the seven groups of greatest importance to retailers and distributors.

The following manufacturers of electrical appliances have returned our editorial questionnaire giving the information needed for these listings.

	Refrigerators	Laundry Equip.	Vac. Cleaners	Elec. Ranges	Gas Ranges	Freezers	Traffic Appl.
del Precision Products Co., No. Hollywood, Calif.							
Admiral Corp., 3800 W. Cortland St., Chicago							
Airmaster Corp., 4317 Ravenswood Ave., Chicago, Ill.							
Air Way Electric Appliance Corp., Toledo, Ohio							
Astor Bros. Co. (ABC), East Peoria, Ill.							
Amana Society, Refrigeration Division, Amana, Iowa							
American Electrical Heater Co., Detroit, Mich.							
American Ironing Machine Co., Altoona, Ill.							
American Refrigerator & Machine Co., No. Minneapolis							
American Stove Co., 4301 Perkins Ave., Cleveland							
Apex Electric Mfg. Co., Cleveland, Ohio							
Appliance Industries of America, Chicago							
Appliance Mfg. Co. (Duchess), Alliance, Ohio							
Aristocrat Clock Co., 245 5th Ave., New York, N. Y.							
Armstrong Products Co., Huntington, W. Va.							
Automatic Washer Co., Newton, Iowa							
Barlow & Seelig Mfg. Co. (Speed Queen), Ripon, Wis.							
Barr Mfg. Co., Weedsport, New York							
Barton Corp., West Bend, Wis.							
Beam Mfg. Co., Webster City, Iowa							
Bell Appliance & Radio, 125 E. 46th St., New York, N. Y.							
Bellix Home Appliances, Inc., South Bend, Ind.							
Ben-Hur Mfg. Co., 634 E. Keefe Ave., Milwaukee, Wis.							
Berger Electric Co., 109-07 72nd, Forest Hills, N. Y.							
Bersted Mfg. Co., Fostoria, Ohio							
Berman Electric Co., 4140 Fullerton Ave., Chicago, Ill.							
Berkstone Corp., Jamestown, New York							
Buffalo Forge Co., 205 Mortimer St., Buffalo, N. Y.							
Bulkins Appliance Corp., South Bend, Ind.							
Bumco Products, Inc., 57 William St., New York, N. Y.							
Bumfield Mfg. Co., Grand Haven, Mich.							
Busco Products Co., 512 Hancock Ave., Bridgeport, Conn.							
Central Rubber & Steel Corp., Findlay, Ohio							
Chicago Dryer Co., 2210 No. Pulaski Road, Chicago, Ill.							
Chicago Electric Mfg. Co., 6333 W. 65th St., Chicago, Ill.							
Chicago Flexible Shaft Co. (Sunbeam), Chicago, Ill.							
Regulators & Devices Mfg. Corp., 100 Prince St., New York, N. Y.							
Clayton & Lambert Mfg. Co., 1427 Tireman, Dearborn, Mich.							
Clement Mfg. Co. (Cadillac), Chicago, Ill.							
Clock Products Co., 55 E. Washington St., Chicago, Ill.							
Clonon Corporation, 1824 So. 52nd Ave., Chicago, Ill.							
Colerator Co., Duluth, Mich.							
Compland Refrigeration Corp., Sidney, Ohio							
Conroy Glass Coffee Brewer Co., 221 N. LaSalle St., Chicago							
Cribben & Sexton Co., 700 No. Sacramento Blvd., Chicago							
Crosley Corporation, Cincinnati, Ohio							
Cryofreeze Division, Motor Products Corp., No. Chicago, Ill.							
Cycle Appliance Division, General Motors, Rochester, N. Y.							
Cyjur Electric Works, 124 Blecker St., New York, N. Y.							
Detroit Michigan Stove Co., 6900 E. Jefferson, Detroit							
Dexter Company, Fairfield, Iowa							
Dominion Electric Mfg. Co., Mansfield, Ohio							
D. Dormeyer Mfg. Co., 4316 N. Kilpatrick Ave., Chicago							
Duric Duitz & Co., 5220 16th Ave., Brooklyn, N. Y.							
Dual-Air Fan Co., St. Elgin, Ill.							
Dusy Washing Machine Co., Syracuse, N. Y.							
Dynamaster Products Co., 9th Ave., Nashville, Tenn.							
Edison G. E. Appliance Co. (Hotpoint), Chicago, Ill.							
Edwards Company, Norwalk, Conn.							
Electric Steam Prods. Corp., Detroit, Mich.							
Electro-King Mfg. Co., 503 N. LaSalle St., Chicago, Ill.							
Electromaster, Inc., 1803 E. Atwater St., Detroit, Mich.							
Electromode Corp., Div. Am. Foundry Eq. Co., Mishawaka, Ind.							
Emerson Electric Mfg. Co., 1824 Washington Ave., St. Louis, Mo.							
Empire Appliance Co., 480 Lexington Ave., New York							
Empire Ironer, Inc., 817 Main, Cincinnati Ohio							
Esco Cabinet Co., Esco Bldg., W. Chester, Pa.							
Esco Stove Co., Hamilton, Ohio							
Essex Vacuum Cleaner Co., 6066 Hamilton Ave., Detroit							
Expert Die & Stamping Co., Grand Rapids, Mich.							
Grady Electric Co., 11 S. LaSalle St., Chicago, Ill.							
G. W. Farber, Inc., 141 S. 5th St., Brooklyn, N. Y.							
Gardner Mfg. Co., 8669 S. Michigan Ave., Chicago							
Genesee Stove Co., Gardner, Mass.							
Genel Refrigerator Co., Eadon & Kennedy Sts., Philadelphia, Pa.							
Genlin-McAllister Corp., 135 S. LaSalle St., Chicago, Ill.							
Geneshand Aire Co., 210 N. Clinton St., Chicago, Ill.							
Genl. Friedrich, Inc., San Antonio, Texas							
Genl. Laire Div., General Motors Corp., Dayton, Ohio							
G. Geier Co. (Royal), 540 E. 105th St., Cleveland, Ohio							
General Aircraft Equipment, Inc., So. Norwalk, Conn.							
General Die & Stamping Co., 262 Mott St., New York, N. Y.							
General Electric Co., Appl. & Merch. Dept., Bridgeport, Conn.							
General Mills, Inc., Chamber of Com. Bldg., Minneapolis, Minn.							
Genl. Power Washer Co., 1025 Walnut St., Morton, Ill.							
Genl. Tractor Mfg. Co., 403 Communipaw Ave., Jersey City, N. J.							
Genl. Refrigerator Co., Greenville, Mich.							
G. Gilbert Co., 319 Peck St., New Haven, Conn.							
Gillian L. Gilbert Clock Co., Winsted, Conn.							
Gillian Bros., Inc., 1815 Venice Blvd., Los Angeles							
Gilson Electric Mfg. Co., 216 No. Clinton St., Chicago, Ill.							
Glenwood Range Co., Taunton, Mass.							
Globe-American Corp., 101 E. Broadway, Kokomo, Ind.							
Globe Electric Corp., 200 William St., New York, N. Y.							
Globe and Home Appliance Co., 2323 E. 67th St., Cleveland, Ohio							
Globe & Dudley Co., 222 3rd Ave., Nashville, Tenn.							
Globe Beach Co., Div. of Scovill Mfg. Co., Racine, Wis.							
Globe Mfg. Co., Two Rivers, Wis.							
Globe Instrument Co., 2915 N. Western Ave., Chicago, Ill.							
Globe Stove Co., Cleveland, Tenn.							
Globe-Mor, Inc., 203 N. Wabash Ave., Chicago							
Globe & Munchausen, 20 Superior St., Buffalo, N. Y.							
Globe-Shaw Co. (Vaculator), 311 No. Desplaines St., Chicago							
Globe Mfg. Co. (Kitchen Aid), Troy, Ohio							
Globe Co., 8 So. Michigan Ave., Chicago, Ill.							
Globe Mfg. Co., 131 Osage St., Ft. Wayne, Ind.							
Globe Fan & Ventilating Co., 92 Warren St., New York							
Globe Mach. Div. (Thor), Elec. Household Util. Corp., Chicago							
Globe-Aire Co., 626 N. Robertson Blvd., Los Angeles, Calif.							
Globe Electric Ventilating Co., 2874 N. Crawford Ave., Chicago							
Globe Inghram Co., Bristol, Conn.							
Globe International Appl. Corp., 1027 Metropolitan Ave., Brooklyn							
Globe International Detroit Corp., 1501 Beard St., Detroit, Mich.							
Globe International Harvester Co., 180 N. Michigan Ave., Chicago							
Globe Ironer Co., 38 Piquette St., Detroit, Mich.							

Manufacturers not listed may furnish data for the next issue. No advertising obligation. Additions or revisions will be made monthly.

	Refrigerators	Laundry Equip.	Vac. Cleaners	Elec. Ranges	Gas Ranges	Freezers	Traffic Appl.
F. L. Jacobs Co. (Laundrell), 1043 Spruce St., Detroit							
Jawett Refrigerator Co., 10 Letchworth St., Buffalo, N. Y.							
Jordan Refrigerator Co., 235 N. Broad St., Philadelphia, Pa.							
Kalamazoo Stove & Furnace Co., Kalamazoo, Mich.							
Kelvinator Leonard Div., Nash Kelvinator Corp., Detroit, Mich.							
Knapp Monarch Co., 3501 Bent Ave., St. Louis, Mo.							
Koral Elec. Mfg. Co., 43-22 Van Dam St., L. I. City, N. Y.							
Landers, Fray & Clark, 47 Center St., New Britain, Conn.							
Larson Mfg. Co., 9819 Rearmain St., Oakland, Cal.							
Leach Relay Co., 5915 Avalon Blvd., Los Angeles, Calif.							
A. G. Lindemann & Hoverson Co., Milwaukee, Wis.							
Lowell Mfg. Co., 539 E. Illinois Ave., Chicago, Ill.							
Lydon-Briher Mfg. Co., St. Paul, Minn.							
Magic-Aire, Inc., 1730 Ivanhoe Rd., Cleveland, Ohio							
Majestic Electric Appliance Co., Inc., Canton, Ohio							
Malleable Iron Range Co. (Monarch), Beaver Dam, Wis.							
Manning Bowman & Co., Meriden, Conn.							
Marlin Mfg. Co., 37 E. 21st St., New York, N. Y.							
Martin-Parry Corp., York, Pa.							
Maytag Co., Newton, Iowa							
Menasco Mfg. Co., Burbank, Calif.							
Merit-Made, Inc., 94 Elm St., Buffalo, N. Y.							
Herman Miller Clock Co., Zeeland, Mich.							
Miracle Electric Co., 36 So. State St., Chicago, Ill.							
Moe-Bridges Corp., 1415 Illinois Ave., Sheboygan, Wis.							
Montag Stove Works, 2011 N. Columbus Blvd., Portland, Ore.							
Morrow Co., 400 W. Madison St., Chicago, Ill.							
National Die Casting Co., Touhy & Lawndale Ave., Chicago, Ill.							
National Motor Co., 3500 Cene St., Detroit, Mich.							
National Stamping & Elec. Wks. (White Cross), W. Lake, Chicago							
Naxon Util. Corp., 2101 W. Walnut St., Chicago, Ill.							
Newark Stove Co., Newark, Ohio							
New Haven Clock Co., 133 Hamilton St., New Haven, Conn.							
Nineteen Hundred Corp., St. Joseph, Mich.							
Noblitt Sparks Industries (Arvin), Columbus, Ind.							
Norge Div., Borg-Warner Corp., E. Woodbridge, Detroit, Mich.							
Nu-Tone Co., 821 E. 3rd St., Cincinnati, Ohio							
Ohio Electric Co., 629 9th Ave., New York, N. Y.							
One Minute Washer Co., Kellogg, Iowa							
Panelectric Products Div., Gen. Aire. Eq., South Norwalk, Conn.							
Philo Corp., Tioga & C Sts., Philadelphia, Pa.							
Portable Elevator Mfg. Co., Refrig. Div., Bloomington, Ill.							
Portable Products Corp., 420 Blvd. Allies, Pittsburgh, Pa.							
Prentiss Div., Electric Vacuum Cleaner Co., Inc., Cleveland, Ohio							
Pressed Steel Car Co., 122 S. Michigan Ave., Chicago, Ill.							
Prevors Elec. Mfg. Co., 122 18th St., Brooklyn, N. Y.							
Proctor Elec. Co., Div. Proctor & Schwartz, Inc., Philadelphia							
Quillen Bros. Refrig. Co., 1639 Lafayette Rd., Indianapolis, Ind.							
Redi-Electric Co., 141 W. 24th St., New York, N. Y.							
Refrigeration Corp. of America, 225 W. 57th St., New York, N.Y.							
Regina Corp., Rahway, N. J.							
Revere Clock Co., McMillan at Dover, Cincinnati, Ohio							
Reynolds Elec. Co., 2650 W. Congress St., Chicago, Ill.							
A. E. Rittenhaus Co., Inc., Honeoye Falls, N. Y.							
Rival Mfg. Co., 2415 E. 15th St., Kansas City, Mo.							
Robbins & Burke, Inc., 29 Lansdowne St., Cambridge, Mass.							
Robbins & Myers, Inc., Springfield, Ohio							
Roberts & Mander Stove Co., Hatboro, Pa.							
Co. B. Roper Corp., Blackhawk Div., Rockford, Ill.							
Rotor-Beam Corp. of America, Inc., 1008 Dakin St., Chicago, Ill.							
Round Oak Co., Downing, Mich.							
Rutenber Electric Co., Marion, Ind.							
Samsun United Corp., 1700 University Ave., Rochester, N. Y.							
Sanitary Refrigerator Co., Fond du Lac, Wis.							
Savage Arms Co., Turner St., Utica, N. Y.							
Schaefer, Inc., 801 Washington Ave., Minneapolis, Minn.							
Schelm Bros., East Peoria, Ill.							
Scott & Fetzer, 11401 Locust Ave., Cleveland, Ohio							
Seeger Refrigerator Co., Arcade & Wells Sts., St. Paul, Minn.							
Seeger Sunbeam Elec. Mfg. Co. (Goldspot), Evansville, Ind.							
Servel, Inc., Evansville, Ind.							
Sessions Clock Co., Forestville, Conn.							
Seth Thomas Clock Co., Div. Gen. Time Inst. Corp., Thomaston, Ct.							
Sheridan Electronics Corp., 2850 S. Michigan Ave., Chicago, Ill.							
Signal Electric Mfg. Co., Menominee, Mich.							
Siles Co., 80 Pliny St., Hartford, Conn.							
F. A. Smith Mfg. Co., 801 Davis St., Rochester, N. Y.							
Sparks-Withington Co., Jackson, Mich.							
Sperti, Inc., Beech & Kenilworth Sts., Cincinnati, Ohio							
Standard Gas Equip. Corp., Bayard & Hamburg, Baltimore, Md.							
Stern Brown, Inc., Long Island City, N. Y.							
Stiglitz Furnace & Foundry Co., Portland Ave., Louisville, Ky.							
B. F. Sturtevant Co., Hyde Park, Boston, Mass.							
Sun Chief Electric Co., Winsted, Conn.							
Sun Kraft, Inc., 213 W. Superior, Chicago, Ill.							
Superior Electric Prod. Corp., Cape Girardeau, Mo.							
Swartzbaugh Mfg. Co. (Everhot), 1336 W. Bancroft St., Toledo							
Tappen Stove Co., Inc., Mansfield, Ohio							
Thermador Electric Mfg. Co., S. Riverside Dr., Los Angeles, Calif.							
Timb Aircraft Corp., Van Nuys, Calif.							
Toastmaster Prods. Div., McGraw-Electric Co., Elgin, Ill.							
Toastwell Co., 620 Tower Grove Ave., St. Louis, Mo.							
Trilmont Prod. Co., 24th at Walnut, Philadelphia, Pa.							
Tyler Fixture Co., Niles, Mich.							
United States Time Corp., 630 5th Ave., New York, N. Y.							
Victor Electric Prod., Inc., 2950 Robertson Ave., Cincinnati							
Victor Products Corp., Hagerstown, Md.							
Vidrio Prod. Corp., 134 W. 54th St., Chicago, Ill.							
Voss Bros. Mfg. Co., Davenport, Iowa							
Waage Mfg. Co., 632 N. Albany Ave., Chicago, Ill.							
Ward Refrigerator & Mfg. Co., 6601 So. Alameda, Los Angeles							
Waring Products Corp., 331 Madison Ave., New York, N. Y.							
Warren Telephon Co., Ashland, Mass.							
Waverly Tool Co. (Steam-O-Matic), Grove St., Irvington, N. J.							
Weber Showens & Fixture Co., Avalon Blvd., Los Angeles, Calif.							
Welbilt Stove Co., Manassas, Va., N. Y.							
Westlox Div., General Time Instrument Co., LaSalle, Ill.							



Point-of-Sale Aids

Circulars, Booklets, Signs and Other Selling Helps Ready for Appliance Retailer

● Manufacturers of electrical appliances are speeding merchandise to dealers' stores as fast as conditions will permit.

In addition to advertising their products nationally, producers are promoting various sales helps to pave the dealers' way to greater profits.

Admiral has made available signs to help the dealer arrest traffic and draw trade into his store. These attractive "eye catchers" are being offered to merchants on a cost-sharing basis.

Admiral's signs provide space for the dealer's name. Colors, lettering, and lighting have been designed to provide maximum brilliance and attention-getting value. Illuminated electric clocks with the firm's name are also available.

The company has completed the first set of actual size Flex-O-Plan displays. These sales aids, made in accordance with the suggestions outlined in the firm's Flex-O-Plan booklet, are on exhibit at the Graybar Electric Co., Admiral distributors in the St. Louis area.

Arvin is readying promotional material to back up the sale of its products. These helps will be placed at the disposal of retailers in the near future.

GE has prepared, among other things, material to help the merchandising of food freezers. The company sees a vast market for home and farm freezers, and is providing information on how the merchant can get his share in this tremendous market. Tips are given on selling methods, etc.

Hotpoint is offering a new booklet entitled "Recipes for Hot Water"

which glamorizes the hot water heater. Written in a light, humorous manner, the booklet is designed to help the dealer sell more of this appliance. The brochure is illustrated with cartoons, and provides a new and interesting slant on the hot water heater.

Kelvinator is continuing to give aid to retailers who have just received its brochure entitled "Displaying Appliances of Tomorrow" designed to help in setting up an appliance department. The company is assisting merchants in establishing profit-pulling stores.

Landers, Frary & Clark's guide to store operation "Systemeering" which is at the disposal of retailers is providing means for efficient store management. The company is cooperating with dealers to help them run stores at a greater profit.

Additional sales helps available from the firm are its Universal signs. Two types are available, 721-D carries the dealer's name illuminated along with the Universal name; 721-C is a skeleton neon sign. These aids are designed to attract street traffic, in-store traffic, and window shoppers.

Norge has placed at the appliance dealer's disposal handsome electric signs and in-store appliance displays to help steer more profits in his direction. Norge signs on the storefront, in the windows, or in the appliance department, will help to establish the retailer's store as the Norge appliance headquarters for the community.

Attractive Norge displays for refrigerators, washing machines, and ranges are obtainable to attract appliance buyers. Clocks are included to help the dealer attract more attention—and more profits.





FOR SETS THAT SELL "ON SIGHT" select the via-Graybar lines

**RADIO, RADIO-PHONO,
AND TELEVISION SETS**

MAJOR APPLIANCES

SMALL APPLIANCES

The radios and combination sets that Graybar distributes will go a long way toward *selling themselves* in your store. In appearance and in performance, they're designed for universal buy-appeal. They're products of responsible manufacturers. They're backed by effective consumer advertising. Appliances, too, must meet the same requirements to qualify for distribution via Graybar.

That's why you'll be wise to feature the "via-Graybar" lines in your store. Besides, Graybar gives you expert merchandising help — and our local warehouses simplify stocking and delivery. Call or write us, and we'll come right over with the whole inspiring story. *Graybar Electric Company . . . in over 80 principal cities. Executive Offices:*

Graybar Building, New York 17, N. Y. 4596

DISTRIBUTION IS MERCHANDISE *and Men*



Meet V. K. Stalford, our District Merchandising Manager at Detroit — one of the Graybar specialists throughout the nation who are helping dealers with personnel training, display, and promotion of appliances and radios.

Stalford joined Graybar as a salesman, after nineteen years of selling and merchandising experience with prominent electrical manufacturing, supply-distributing, and appliance-distributing companies.

He's a member of the Electrical Association of Detroit and a Past Master of his Masonic Lodge.

via
Graybar

Merchandising Department

New Products Offered

Weston VOLT-OHM-MILLIAMMETER

Model 655 provides 33 ac and dc voltage, direct current, and resistance ranges, with simplified switching ar-

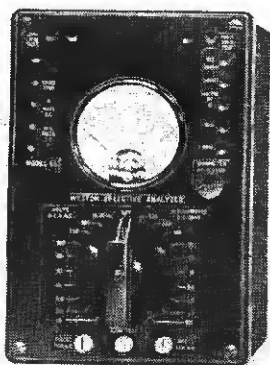

angement for rapid operation. Weston Electrical Instrument Corp., 605 Frelinghuysen Ave., Newark 5, N. J.—RADIO & Television RETAILING

Simpson VOLT-OHM-MILLIAMMETER

Model 260 provides resistance of 20,000 ohms per volt on dc, 1,000 ohms per volt on ac. Current readings from 1 microampere to 500 ma. Resistance



range is from 1/2 ohm. to 10 megohms. Price, complete with test leads, \$33.25. Carrying case is \$4.25. Simpson Electric Co., 5200-5218 W. Kinzie St., Chicago 44, Ill.—RADIO & Television RETAILING

Electro BATTERY ELIMINATORS

New models P and Q. Cost runs to a few cents per hundred hours of operation. No liquids or moving parts. Units operate in any position. Completely

filtered, hum-free, and silent in operation. Model P is for use where ac is available. Operates any 1.4 v—4, 5 or 6 tube battery radio from 115 v 60 cycle source. Model Q is used in places

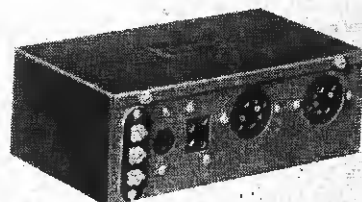

ages, cars, motorboats, etc. Operates any 1.4 v—4, 5 or 6 tube radio from 6 v dc source. Electro Products Laboratories, 549 W. Randolph St., Chicago 6, Ill.—RADIO & Television RETAILING

GE FLUORESCENT LAMP STARTER

New "Watch Dog" starter for 15 and 20 watt fluorescent lamps. Average rated life is three years. Unit timed to light the lamp at the right instant. This not only conserves emissive material essential to long lamp life, but also pro-

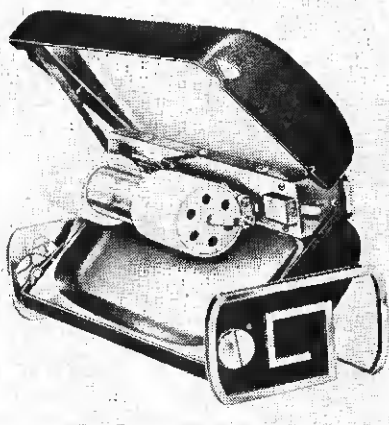

longs the life of the starter. Quick, certain lockout of dead lamps is made possible by close tolerances in the starter's mechanism, which also eliminates blinking and flickering. When a dead lamp is removed, the starter is reset simply by pressing a button at its top. The new lamp is then inserted, and the starter brings it into the circuit immediately. General Electric Co., 1285 Boston Avenue, Bridgeport 2, Conn.—RADIO & Television RETAILING

Supreme SET TESTER

Model 504-A tests tubes, current, voltage, resistance, batteries, and capaci-

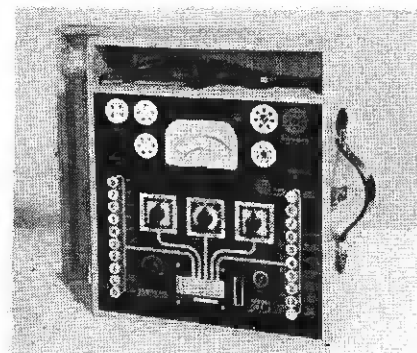

tors. Multi-section push-button switches simplify operation. 4 1/2 in. meter has sensitivity of 500 microamps. Supreme Instruments Corp., Greenwood, Miss.—RADIO & Television RETAILING

Kellems TUBE PULLER

For straight-sided tubes. Especially suited for loctals. Pulling up on the device contracts its sides, and thus increases friction on the tube envelope. Perfectly straight pull—no side pull with



danger of bending prongs in the tube. Size shown is for the regular 1 1/8 in. straight-sided radio tube. Wires of the puller are made of stainless steel. Kellems Co., Saugatuck, Conn.—RADIO & Television RETAILING

Speco PULPIT MICROPHONE STAND

Portable, adjustable stand. Contains universal joint that is controlled by a single thumb screw. Microphone can be extended full length in one operation, revolved 360 degrees, and tilted to any desired angle. Felt facing and ball and socket clamp-on make this stand suitable for speakers' rostrums, church pulpits, banquets, and any other occasions where mobility and lightness of weight are necessary. Special Products Co., Silver Spring, Md.—RADIO & Television RETAILING

SEE PP. 68 TO 83 FOR NEW ELECTRICAL APPLIANCES; AND PAGES 40 TO 45 FOR NEW RADIOS

Want a share of Leadership?

Carry RCA
Preferred Type Tubes
The Tubes with the
Best Known Name



Now RCA Offers
a Complete Line
of Dry Batteries, Too

In Metal, Miniature, or Glass—
THE FOUNTAINHEAD OF MODERN
TUBE DEVELOPMENT IS RCA

Listen to
"The RCA Victor Show,"
Sundays, 4:30 P. M.,
EST, NBC Network



62-6686-98



RADIO CORPORATION OF AMERICA

TUBE DIVISION • HARRISON, N. J.

LEADS THE WAY . . In Radio . . Television . . Tubes . .
Phonographs . . Records . . Electronics

NEW RCA VICTOR

"Kick Off" models win acclaim



THE "PERSONAL"—RADIO OF A HUNDRED USES—and a hundred reasons why your customers want it. RCA Victor 548 has one-third less cubic content than the famous and fast-selling RCA Victor pre-war "Personal." Camera-type construction. Fits easily in a topcoat pocket. 4 RCA Victor miniature-type tubes. Tunes 540-1600 kc. Approximate list price: \$25.00.



SMALL IN SIZE—LONG IN ITS REACH—RCA Victor 56X5 is a real distance getter that we call the "12,000 miler." 6 RCA Victor Preferred-Type tubes including one rectifier tube. Tele-tube RF amplification. Foreign band coverage from 8900 to 12,000 kc, including "spread" features on the 31- and 25-meter bands. Modern cabinet of rich walnut finish. 8½" high; 14¾" wide; 7⅞" deep. Approximate list price: \$34.95.

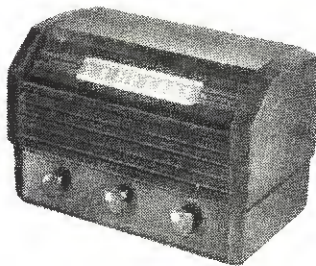

ITS BEAUTY ALONE WILL SELL IT! RCA Victor 56X3 follows the new functional design—attracting all eyes with its simplicity and beauty. Recessed-angle, Spread-Vision Dial extends across entire front. Large, easy-to-see cream numerals against maroon background. Has 6 RCA Victor Preferred-Type tubes including one rectifier tube. Tuning range: 540-1620 kc. 8¼" high; 14¼" wide; 7¼" deep. Antenna connection for weak signal areas—no ground needed. Another great value typical of RCA Victor. Approximate list price: \$29.95.

A FARM BATTERY SET CONVERTIBLE TO LINE POWER—RCA Victor 55F can be readily converted to 105-125 volt AC operation by the RCA Victor "Electrifier." Features 5 RCA Victor Preferred-Type low-drain tubes and On-and-Off "Battery Saver" indicator. Tunes 540-1720 kc. Uses single AB pack, 1.5 volts "A" and 90 volts "B." Cabinet 9¼" high; 18" wide; 10½" deep. Approximate list price: \$32.50.

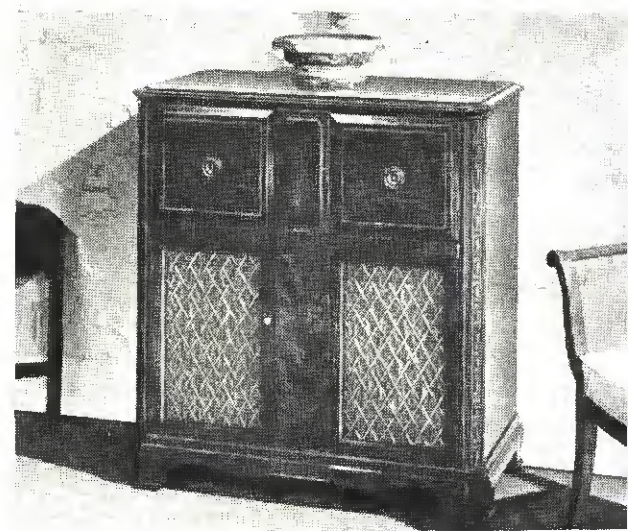
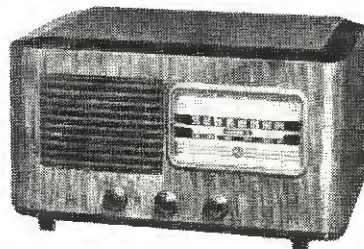

DELUXE RADIO-PHONOGRAPH COMBINATION—Here's a superb creation—Victrola® 59VI. Roll-out record changer accommodates twelve 10" or ten 12" records. Permanent-point pick-up. 9 RCA Victor Preferred-Type tubes including one rectifier tube. 3 bands. American and foreign reception. Automatic tuning. Continuous bass and treble tone control. No lids to lift. Height, 36⅞"; width, 35⅝"; depth, 17⅞". Approximate list price: \$200.00.

LINE A SMASH HIT!

distributor showings throughout the nation!

NEVER before has RCA Victor introduced a line of merchandise amid such enthusiastic acclaim from distributors and dealers. Striking new notes in beauty, low performance highs, and new peaks in value. "Kick Off" models are destined to write a new chapter in profit history.

Deliveries will be made at the earliest possible moment consistent with the availability of materials. We are making an all-out effort to help suppliers with their conversion problems so that we can answer the question all-important to you: "When will we have merchandise?" Keep in touch with your distributor.

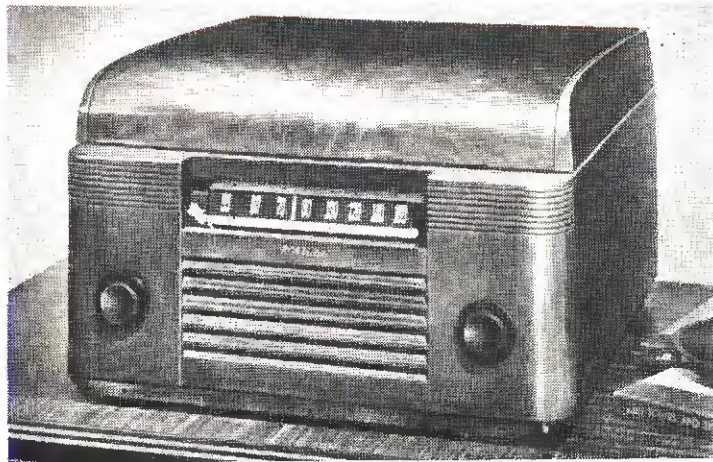

A COMPLETE ENTERTAINMENT UNIT—The double pleasure of radio and records magnificently brought together—and at low cost. *Victrola*® 55U is almost 1/3 smaller than RCA Victor pre-war radio-phonographs. Cabinets of walnut finish in classical modern design. 5 RCA Victor Preferred-Type tubes including one rectifier tube. Magic Loop. Automatic Record Changer plays up to 12 records. Multi-play needle supplied as standard equipment. Approximate list price: \$79.95.



LEADER OF THE LOW-PRICED FIELD! RCA Victor 56X uses 6 RCA Victor Preferred-Type tubes including one rectifier tube. Has extra-large Magic loop antenna and superheterodyne circuit for strong reception. Husky 5-inch dynamic speaker. Cabinet molded of attractive, rich-looking walnut plastic. Angle-vision dial and "bull's-eye" pointer. Tunes 540-1620 kc. 7 3/4" high; 12" wide; 6 3/4" deep. Approximate list price: \$24.95.

GREAT PERFORMER AT SURPRISINGLY LOW COST! *Victrola*® is housed in a cabinet of fine walnut or mahogany veneers. Features automatic record changer and radio raise independently. Excellent domestic and foreign reception. Push-button tuning. 3-point tone control. 5 watts output! Approximate list price: \$179.95.



MAKE MULTIPLE SALES WITH THIS ONE—for kitchen, bedroom, den! RCA Victor 56X2 is modern in both its looks and performance. Cabinet of molded plastic with antique ivory enamel baked at high temperature. Has easy-grip plastic knobs and a composition back cover to match cabinet. 6 RCA Victor Preferred-Type tubes including one rectifier tube. Selective superheterodyne circuit. New "bull's-eye" pointer. Extra-large Magic Loop antenna and super-sensitive dynamic speaker. 7 3/4" high; 12" wide; 6 3/4" deep. 540-1620 kc. Approximate list price: \$26.95.



RCA VICTOR

RADIO CORPORATION OF AMERICA • RCA VICTOR DIVISION • CAMDEN, N. J.
In Canada: RCA VICTOR COMPANY LIMITED, Montreal

Reg. U. S. Pat. Off.

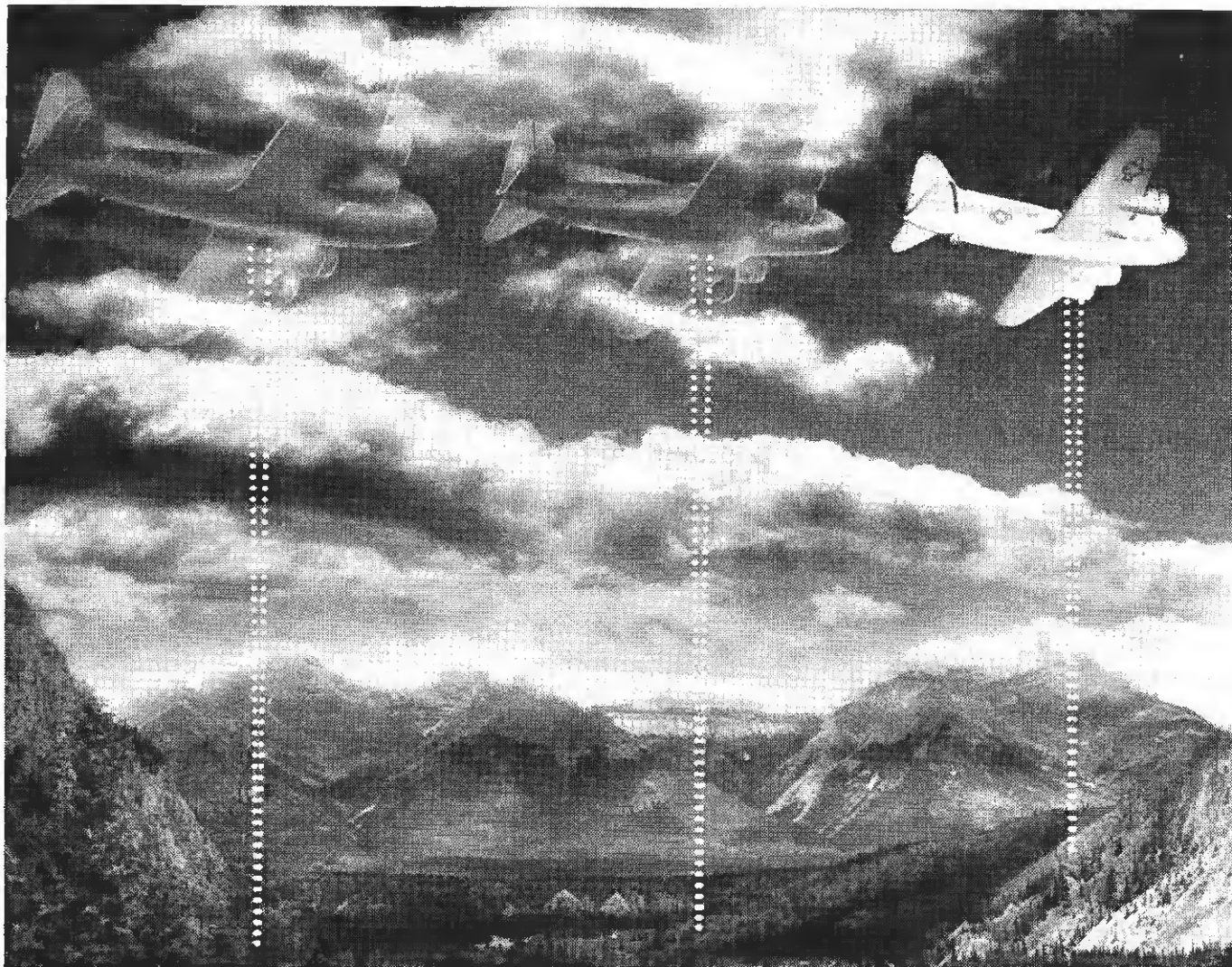

The RCA Radio Altimeter assures that the last mountains have been passed before letting down to the airport in the valley below.

Measuring "every bump on the landscape" —at 20,000 Feet!

A radio altimeter—that indicates the exact height above land or sea—is another RCA contribution to aviation.

Old-style altimeters gave only the approximate height above sea level—did not warn of unexpected "off-course" mountains.

To perfect a better altimeter was one of science's most baffling problems. So RCA developed an instrument so accurate it "measures every bump on the landscape" from the highest possible altitudes... so sensitive it can measure the height of a house at 500 feet!

This altimeter—actually a form of radar—directs radio waves from the airplane to earth and back again... tells the pilot ex-

actly how far he is from the ground...warns of dangerously close clearance... "sees" through heaviest fog or snow.

All the radio altimeters used in Army, Navy and British aircraft were designed and first produced by RCA. This same pioneering research goes into every RCA product. So when you buy an RCA Victor radio, Victrola, television receiver, even a radio tube replacement, you enjoy a unique pride of ownership. For you know it is one of the finest instruments of its kind that science has yet achieved.

Radio Corporation of America, Radio City, New York 20. Listen to *The RCA Show*, Sunday, 4:30 P. M., E. T., over NBC.



The RCA radio altimeter will be a major contribution to the safety of post-war commercial flying. The section at the left sends the radio waves to earth and back again while the "box" at the right—timing these waves to the millionth of a second—tells the navigator the plane's exact height in feet.



RADIO CORPORATION of AMERICA

Servicing FM and Tele

Proper Maintenance a "Must," Say Industry Leaders

● FM sets, soon to be in the hands of consumers, to be followed shortly thereafter by television receivers, will require specialized service and installation by the dealer in order that users be satisfied, be kept sold and become boosters.

Opinions of experts, including manufacturers and broadcasters, indicate that they believe the average well-equipped radio dealer, who possesses sufficient technical knowledge will be able to handle all maintenance and installation problems of FM and television.

The following comments are from some of the leaders in the industry:

Stromberg-Carlson Co.:

"I can see no difficulty in the handling of the FM sets as there are no greatly different elements in the circuit design which would require special training, as is required in television which involves quite a number of specialized circuits which are quite similar to those used in radar and Army and Navy equipment.

Past Experience Helpful

"Returned service men who have had experience with radar and similar equipment should have ample fundamental training to handle the installation and servicing of television receivers and they certainly would have no difficulty in handling frequency modulation receivers. As for the small dealer who cannot afford this type of service man, he will probably have to go to some independent servicing organization for help in taking care of installations and special locations where signals are weak and for periodic servicing of the instruments.

"In view of the above, I believe it is wise for your magazine to advocate both methods of providing service. The large dealer, naturally being equipped with a well trained service organization, should be able to take care of practically all servicing of FM and television receivers, whereas the small dealer would call on the independent service organization for some difficult installations and for all servicing outside of that of replacing worn out tubes.

"Another point which might be stressed is that of setting up a

schedule of periodic servicing, the same as some automobile agencies advocate and provide. Some dealers have already employed this type of servicing and have found that it provides greater satisfaction on the part of the owner of the receiver and that the cost of providing such service is well within reason."

Ray H. Manson, President

DuMont Labs:

"Of course servicing will be the vital factor in the growing acceptance and continuing popularity of television. I believe the well-equipped and well-manned radio shop can handle such servicing, but it will require considerable special equipment along with special training preferably at the factory or under the manufacturer's guidance. I am hoping that radio shops will assume this responsibility for other-

and television come into general use.

"The local dealer handling known brands of merchandise and backing his sales up with high-quality service is in the strongest possible position to compete with the new outlets handling various types of electrical appliances."

Courtney Pitt, Asst. to President

Farnsworth:

"The success and acceptance of television by the American public will depend entirely on the character of service which the instrument will render in the home. Therefore, proper installation of the receiver is of first and vital importance. Regardless of the quality of a receiver, it cannot provide its maximum service unless its initial installation adequately meets the needs of the particular location.

"It is my opinion that at least dur-

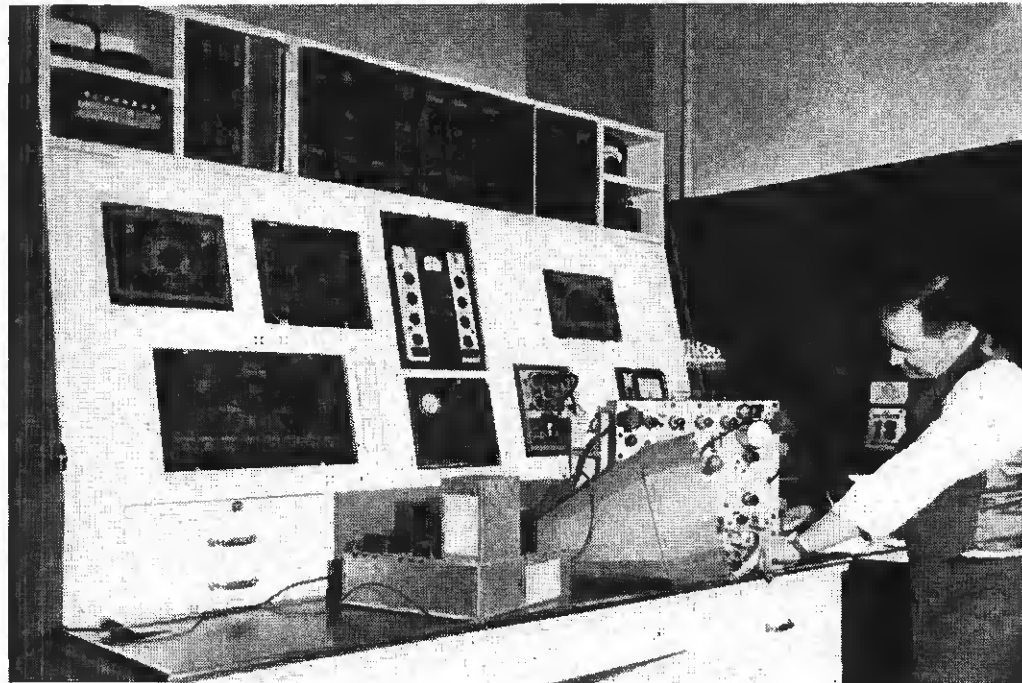

Dealers can handle own FM and television service if they have the facilities. One retailer set for this work is V. M. Wintermute, Plainfield, N. J. (see page 26, Jan., 1945 issue.)

wise it must remain a factory service." Allen H. DuMont, President

Philco:

"We at Philco believe that it is essential that every good dealer have his own service department. This was true before the war, and it will become even more important as FM

ing the initial stages of television merchandising, only the highest type of radio shops will be equipped to render the proper and adequate kind of installation and service. It may be that these few large dealers, doing a considerable volume of business, may be justified in setting

(Continued on page 120)



Back the Victory Loan with your advertising!

Here's what you can do to help put over the Victory Loan—our last “all out” effort! To help bring our battle-weary men home and give the finest medical care to our wounded heroes! To show every one in your community that *your store is backing up the Victory Loan!*

A Your community measures your support of the Victory Loan by your Bond advertisements! In all your advertising, include the Victory Loan “drop-ins” supplied by your newspapers. Use the Victory Loan Insignia and your own Trade Group Emblem *in every advertisement!*

B For top Victory Bond sales on Armistice Day, the Thanksgiving season, and Pearl Harbor Day, use mats of special Bond advertisements, which you can get from your newspapers!

C Advertise, display, and put your best selling effort behind the new Franklin Delano Roosevelt Memorial \$200 Bond!

Make every working day a Victory Bond Day! And be sure employees buy their quota, too, through the Payroll Savings Plan! If you do not have the Campaign Book, get in touch with your local Retail War Finance Chairman or the head of your own Trade Group. The Victory Loan is our final big drive—make it **YOUR BEST!**



The Treasury Department acknowledges with appreciation the publication of this message by

RADIO & TELEVISION RETAILING

This is an official U. S. Treasury advertisement prepared under auspices of Treasury Department and War Advertising Council

EYE APPEAL SELLS RADIOS!

one of the superior appearance features of new G-E radios—

G-E MULTI-WEAVE METAL GRILLES!

*Appearance
appeal*

ANOTHER OF THE 8 BIG
REASONS* WHY AMERICA
WILL BUY THE NEW

 *Electronic*
RADIO LINE

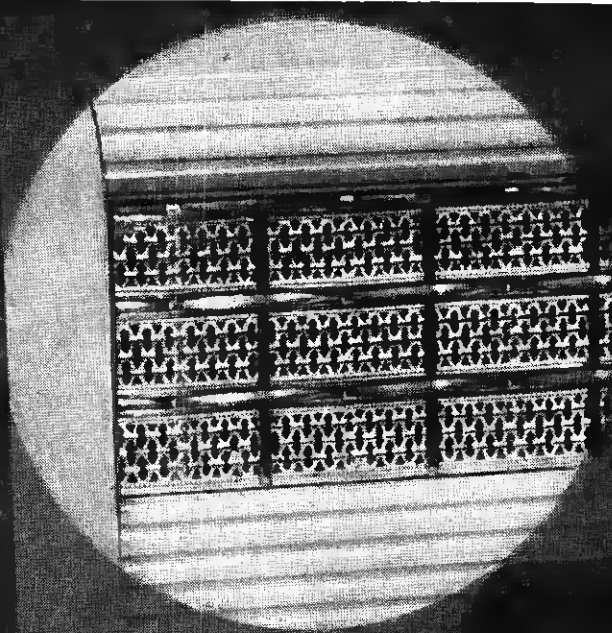

*G.E.
first again!*

NEW G-E MULTI-WEAVE
METAL GRILLES REFLECT
MODERN DESIGN INFLUENCE
... ATTRACTIVE, VERSATILE,
RUGGED, NON-RATTLING,
EXTREMELY PRACTICAL
AND PERMANENT.

*G.E. is first in
Radio and
Television
FIRSTS!*

APPEARANCE is one of the two principal factors required to sell radios—successfully. In addition to outstanding cabinet designs and materials, General Electric—as a plus feature—is making extensive use of the new G-E Multi-weave metal grilles.

The clean-cut beauty and attractive designs of these grilles demand attention from your customers. G-E Multi-weave metal grilles don't deteriorate; they're not damaged easily—fingers won't poke through them; they're never

ragged and unsightly . . . they're designed to retain their original luster and attractiveness for the life of the radio.

The new G-E Radio line has everything that adds up to quick and profitable sales. It's backed by the greatest consumer advertising campaigns of any home radio manufacturer. For complete information, consult your nearest G-E Radio Distributor or write Electronics Department, General Electric Company, Bridgeport, Conn.

- | | | |
|----------------------------|------------------------------|--------------------------|
| * 1. G-E Alnico 5 Speakers | 3. G-E Superior Quality | 5. G-E Appearance Appeal |
| 2. G-E Radio-Phonographs | 4. G-E Electronic Reproducer | 6. (See next Ad) |
| | 7. (See coming Ad) | 8. (See coming Ad) |

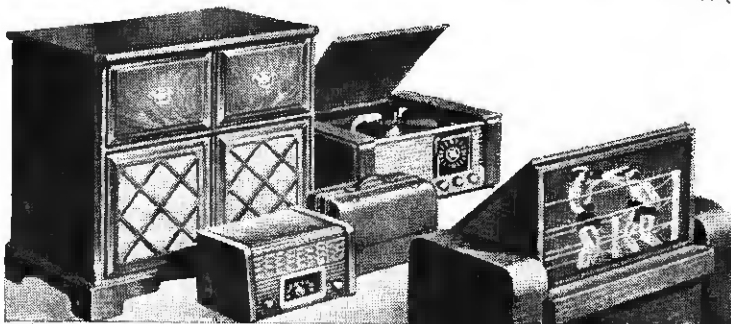

GENERAL  ELECTRIC

PORTABLES • TABLE MODELS • CONSOLES • FARM SETS
AUTOMATIC PHONOGRAPH COMBINATIONS • TELEVISION

Electrolytic Capacitors

Wet and Dry Types. Common Filter Capacitor Defects. First of Two Parts.

• Filter capacitor failures are among the commonest of set troubles. Troubleshooting and replacement of faulty units are generally simple operations. In a number of cases, however, more than elementary knowledge is called for.

These capacitors may be divided into two main types: the wet and the dry electrolytic. Symbols for these are shown in Figure 1. Radio servicemen usually use dry electrolytics for replacements, be-

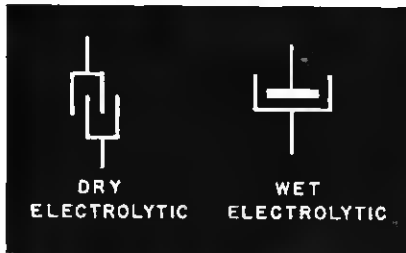

Fig. 1.—Electrolytic capacitor symbols.

cause of the difficulties often encountered in mounting wet types. It may be useful, however, to compare the two, to see whether such a preference is always justified.

Leakage current in the wet capacitor is higher than that in the dry type, especially after periods of idleness. From one point of view

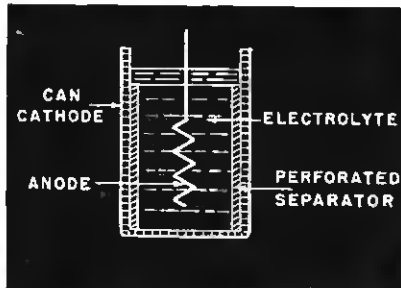

Fig. 2.—Electrode separation in wet electrolytic is great enough to make shorts unlikely.

this is a defect, because increased electrical losses result, and an extra load is placed on the source of current supply.

From another point of view, however, this excessive leakage current has a beneficial effect, in that it produces a decrease in the voltages on the tubes and other set components, during the first minute of operation after the set has been turned on. Damage to these com-

ponents, that might otherwise result from excessive voltages in the warming-up period, is thus avoided.

Another point of superiority of the wet electrolytic is its near immunity to permanent short-circuits. The electrodes are separated by a much greater distance in the wet than in the dry type (see Fig. 2). Besides being rigid and self-supporting, the electrodes in the wet electrolytic often have a thin, perforated sheet of celluloid or hard rubber positioned between them. Thus, even in case of their accidental displacement, the possibility of a short-circuit between them is remote. Similarly, occasional sparks at the electrodes are not likely to damage the capacitor.

Arcing Effect

In the dry electrolytic, a sudden overvoltage may cause an arcing over between the foils, puncturing the paper spacer. This short-circuit often heals itself; many times, however, it is permanent, and the capacitor has to be replaced.

On the debit side of the wet electrolytic's characteristics are, its larger size, compared to the dry type, and the fact that it must be mounted so that the active surface of the anode is completely covered with the electrolyte. The installation must also allow the vent to function freely.

Filter capacitor troubles may be grouped as follows: open-circuit and intermittent open circuit; loss of capacity; short-circuit and intermittent short-circuit; and internal high resistance.

An open-circuited filter capacitor, or capacitor section, is generally easy to detect. A hum that cannot be eliminated by turning down the volume control, distortion, and decreased signal, are the usual symptoms. Sometimes a motorboating sound, or squeals, with no reception, may be heard.

In some instances, however, detecting an open electrolytic is not quite simple. Take the case of a battery portable, with an open filter

(Continued on page 98)

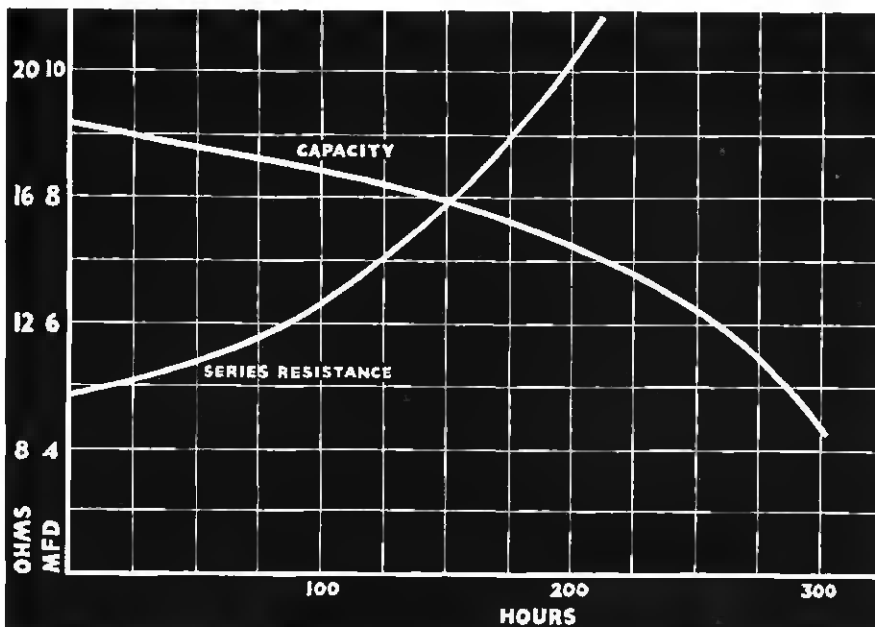
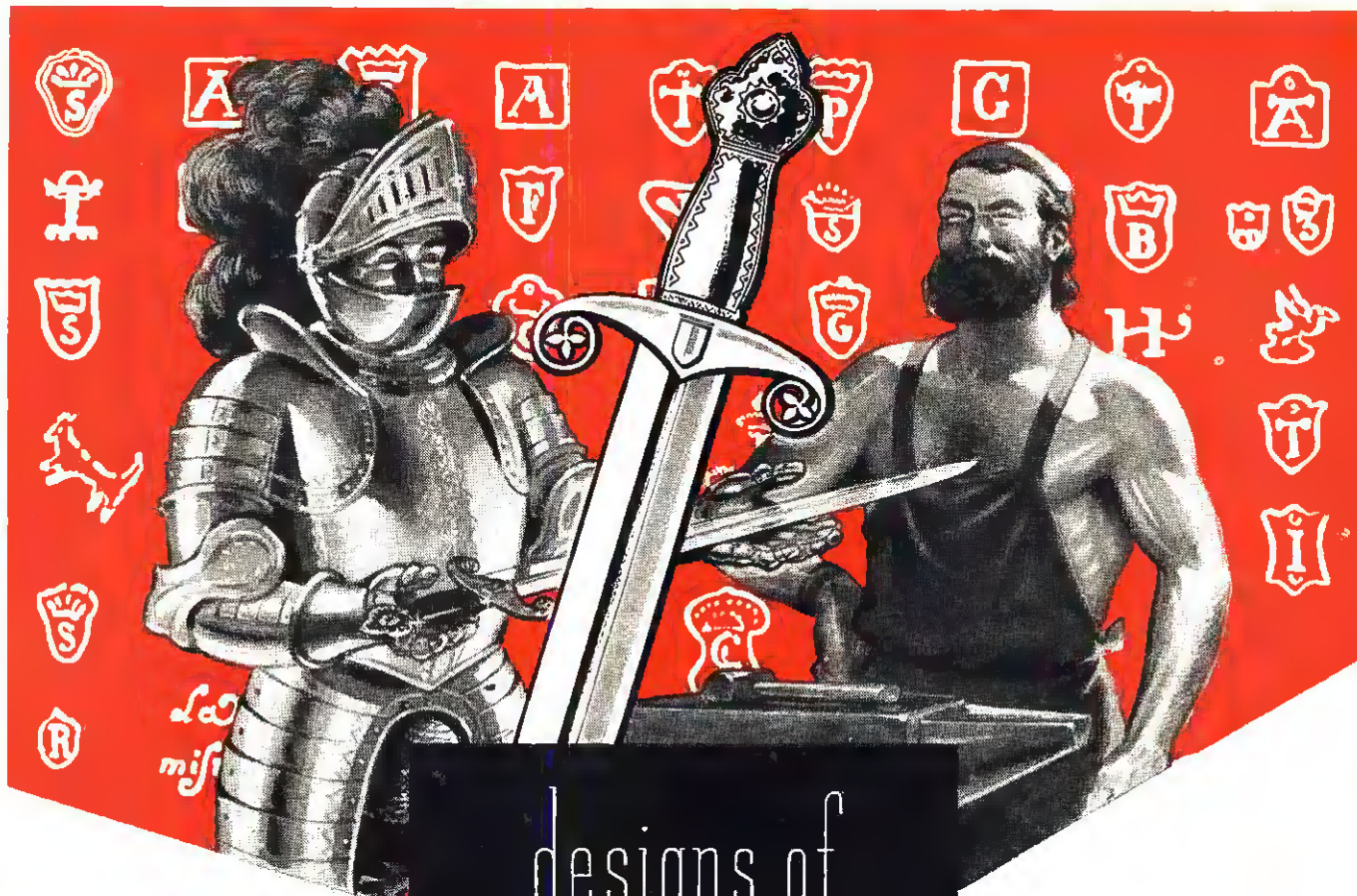

Fig. 3.—Graph shows the effects of abnormally high operating temperatures on the series resistance and capacitance of electrolytic capacitors. These excessive temperatures are particularly apt to occur in midget sets, where ventilation is poor. Filtering effectiveness is reduced both by the increase in series resistance and the decrease in capacitance.



designs of
DISTINCTION

In medieval times discriminating knights journeyed to Toledo, Spain, to obtain hand-wrought blades of steel. Only the famed guildsmen of Toledo could produce the flawless metal from which they fashioned graceful foils and swords of sleek beauty.

For hundreds of years these proud guildsmen stamped their guild marks or signatures on their creations.

A few firms today still preserve that spirit of craftsmanship. You find it in the plants of Detrola Radio. That is why the "guild mark" of Detrola Radio on a radio receiver, record changer or other electronic instrument is a guarantee of production quality. The world's finest merchants, and their customers recognize the value of this mark.

DIVISION OF INTERNATIONAL DETROLA CORPORATION  DETROIT 9, MICHIGAN

Detrola Radio

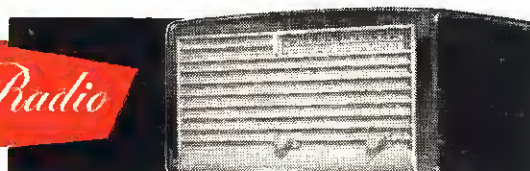

Electrolytic Capacitors

(Continued from page 96)

capacitor which caused no hum or distortion, only decreased volume. Tuning up the i-f trimmers increased the volume, but caused the set to break out into oscillations. Trouble in the i-f section was naturally suspected, and the real fault was only found after a good deal of testing. An oscilloscope would have been very useful in this case, since the wave image on the screen would have quickly shown that the B supply was not properly filtered.

Decreased Capacity

Losses in filter capacity produce symptoms that are similar to open-circuit conditions, but are less intense. Hum, distortion, and low volume may be present individually, or together. Sometimes a lowered capacity filter on the output side of the choke may cause squeals on high volume only, and imitate the symptoms of a partially open volume control in a duo-diode-triode circuit; or it may produce a b-r-r-r sound that generally accompanies missing shield can conditions. Quick recognition of the varied symptoms means time saved in testing.

Open or partially open filter ca-

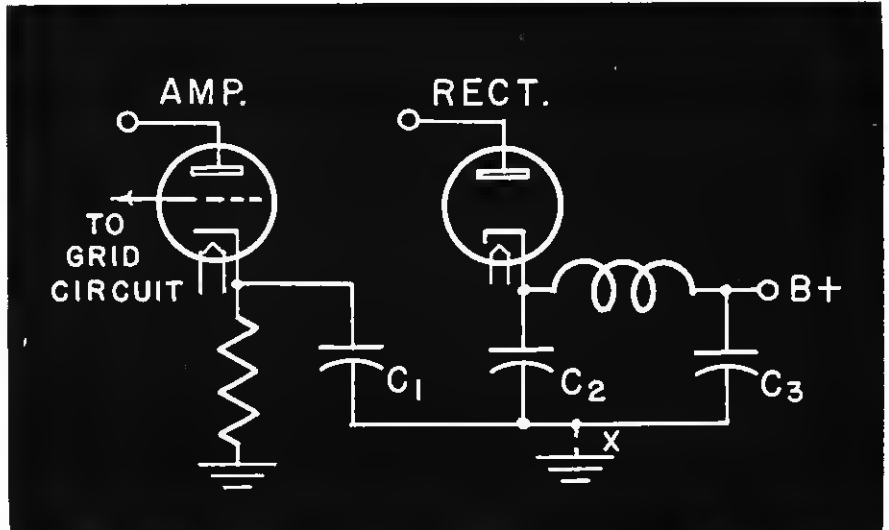

Fig. 4.—An open in the common negative of a filter pack will cause feedback effect. Unbypassed ac will oscillate between rectifier and amplifier cathodes.

pacitors sometimes have peculiar symptoms associated with them that may lead the inexperienced radioman astray. In one repair job, moving the set's aerial lead about intensified a low hum, and produced squeals. This led the radioman to look for undesired inductive effects. Actually, the trouble lay with a partially open filter capacitor on the output side of the choke.

Intermittent openings in filter capacitors sometimes cause testing delays. Squeezing and tapping the

suspected unit may help to bring on the opening. Heating the capacitor, or turning the set off and on, may also bring on the intermittent. Once an electrolytic definitely sounds open, however, it is probably wiser to replace it at once, than to wait for it to repeat.

Opens in the common negative

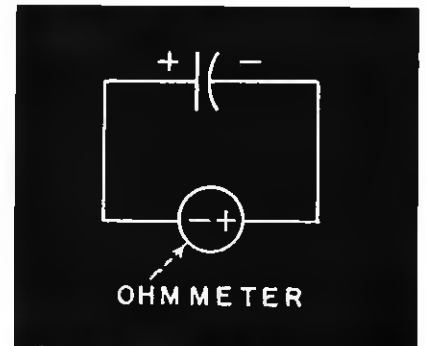

Fig. 5.—Checking electrolytic with ohmmeter.

COMMON TROUBLES IN ELECTROLYTIC FILTER CAPACITORS

Trouble	Symptoms
Open choke input filter capacitor	Subnormal voltage from cathode of rectifier to B—(when choke is in B circuit); non-tunable hum, distortion, reduced volume.
Open choke output filter capacitor	Decreased volume, hum, distortion, appearing individually or together.
Shorted filter capacitor (in B circuit)	Low B voltage, no reception; choke or speaker field will overheat if short is in capacitor on output side of these units.
High resistance in filter capacitor	Motor-like, intermittent noise; especially apt to occur when set is first turned on.
Open in common negative of filter pack	Loud hum, distortion, that do not disappear when filter capacitors are bridged.

lead of multiple electrolytics are not uncommon. Bridging tests will not help in these cases, unless all the positive terminals of the electrolytic are first disconnected. A quick check for an opening of this sort is to unsolder the common negative lead of the suspected unit and see if the symptoms become worse. If they do not, the common negative is most likely open.

When the common negative of a multiple capacitor pack (see Fig. 4) in which an r-f cathode by-pass and filter electrolytic exist side by side, opens, the feed-back produced will often result in a motorboating sound. When a power tube cathode by-pass and filter electrolytic have a common negative, an open in this

(Continued on page 102)

"The ONE INDISPENSABLE LINE" in Radio Merchandising!

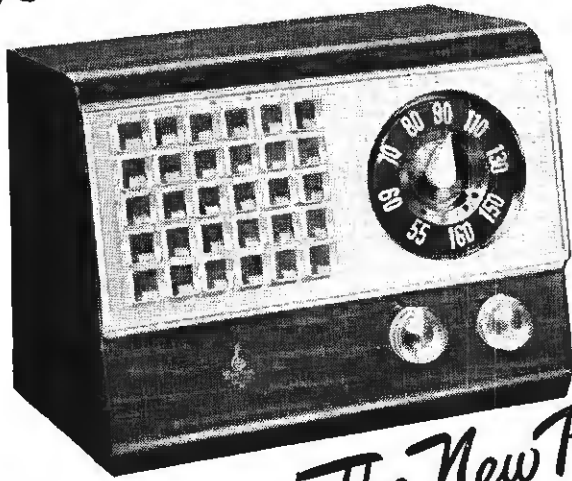

Because—more so than any other factory-distributor-dealer set-up—it meets EVERY product-promotion-policy need—because there is a forthcoming Emerson Radio or Phonoradio for every purpose and every purse of EVERY family in America—Emerson Radio has become the one "INDISPENSABLE LINE" in any progressive retail operation. Regardless of whatever other makes are carried, Emerson Radio is the "STAPLE" without which no retail business is complete.

The New Post-War Emerson Radio and Television

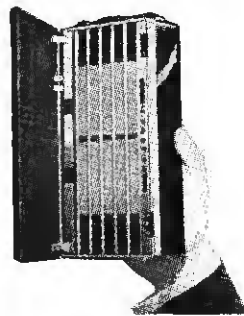
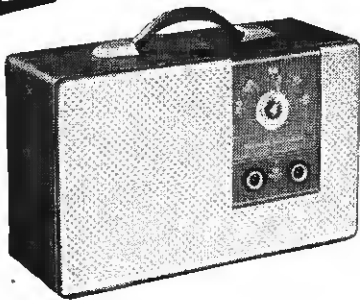

"Head Start" Campaign with sensational, constructive promotion—with tremendous advertising coverage coast to coast—months ahead of the radio industry with specific products and prices—Emerson is establishing solid post-war business-building foundations for its Franchised Dealers.

YOUR featuring of the "INDISPENSABLE LINE" will reap the rewards of product-promotion-policy LEADERSHIP.

EMERSON RADIO AND PHONOGRAPH CORPORATION, NEW YORK 11, N. Y.

WORLD'S LARGEST MAKER OF SMALL RADIO

WHY **TELETONE** IS NOW BECOMING
AMERICA'S *Buy*-WORD
AND *Style*-WORD
IN SMALL RADIOS



CREATED by men who for many years have distinguished themselves in the small radio field — and produced by an organization devoted exclusively to the manufacture of small radios — TELETONE radios *have to be good* to get where they're going. And once you see them you will quickly appreciate all the advantages of TELETONE'S specialized skills and modern techniques, learned and proved in wartime experience. Cleverly engineered, painstakingly built, smartly styled and designed to suit American tastes, TELETONE is now becoming America's *buy*-word in small radios!

A limited number of dealer territories now available to Department and Radio Specialty stores. Write for particulars.

TELETONE RADIO • TELEVISION • FM



TELETONE RADIO COMPANY, 609 W. 51st St., New York 19, N. Y.
Producers of Small Radios and Small Radio-Phonographs Exclusively

**ONLY
PERFORMANCE
PAYS OFF!**



It's no photo finish with the new HQ-129-X. This new professional-type receiver is way out in front when it comes to performance. Every feature of the HQ-129-X is the outgrowth of years of building commercial receivers.

Write for descriptive booklet — place your order with your dealer today to insure early delivery.

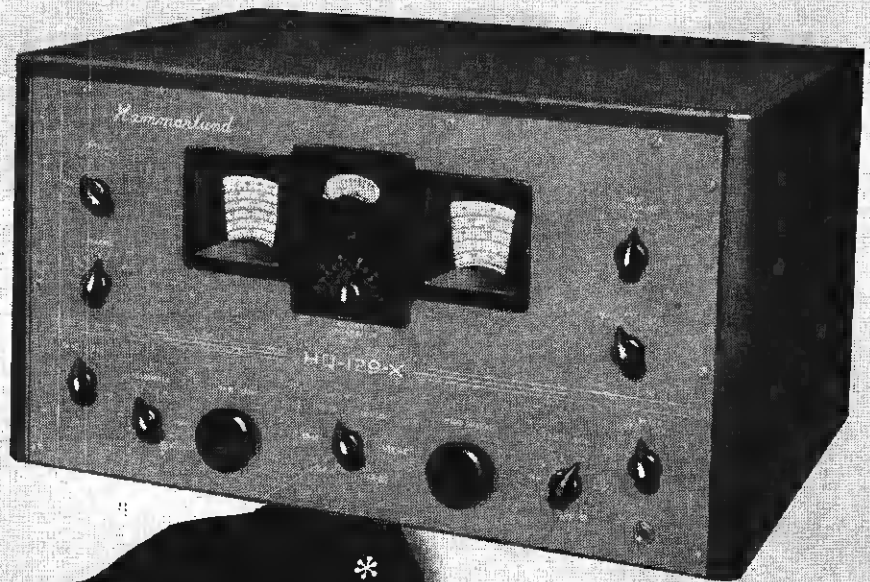

HQ-129-X \$129*
 AMATEUR NET
 LESS SPEAKER

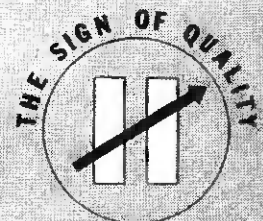

WRITE TODAY FOR BOOKLET!

ESTABLISHED 1910

HAMMARLUND

THE HAMMARLUND MFG. CO., INC., 460 W. 34TH ST., NEW YORK 1, N. Y.
 MANUFACTURERS OF PRECISION COMMUNICATIONS EQUIPMENT

PRICES SUBJECT TO CHANGE WITHOUT NOTICE

Capacitors

(Continued from page 98)

common will generally produce an auto-horn type of noise.

Sometimes a loss of capacity in a filter electrolytic is so slight, that it is difficult to detect improvement with the unaided ear, when the unit is bridged with a new one. A voltage test from rectifier cathode to B—will often be useful in these cases, especially when the decrease in capacity is present in the input filter capacitor.

An easily read increase of several volts may result when the new unit is crossed over the old one, showing definitely that the original unit was defective, whereas the distortion caused by this unit may have been barely noticeable to the ear.

Shorted Electrolytics

Short-circuited electrolytics are generally quite simple to detect. Visible symptoms are often present in such cases. When the plate of an ac rectifier tube overheats, a shorted electrolytic is indicated. A burnt-out rectifier cathode is usually the sign of a shorted filter capacitor. When replacing any blown-cathode rectifiers that are still scarce, it is a wise policy to change the electrolytics even when the original ones check perfect, since a subsequent short-circuit may blow the tube.

Presence of a blue glow in an 80 type vacuum rectifier while it is being tested is sufficient reason for its being discarded, as it will probably short during operation. The glow is due to gas being released during overload. Presence of blue glow on the glass walls of other type tubes, however, may be an entirely normal fluorescent condition, resulting from electron bombardment of the glass.

Ohmmeter Test

Fig. 5 shows a rough ohmmeter test that may be applied to electrolytic capacitors, to check their leakage. Electrolytics used as filters in power supplies should register a resistance of at least 400,000 ohms. A less dogmatic and possibly more useful test is to check the capacitor with the polarity as shown in Fig. 5, then reverse the polarity. One reading should be ten times as great as the other, if the capacitor is good.

Next month we will complete our survey of electrolytic defects by considering high resistances in filter capacitors. Repairs and replacements of electrolytic filter capacitors will also be discussed.

Service Notes

Auto Vibrator Standardization

A standardization plan that may have a wide-spread influence on the auto radio vibrator replacement business has been prepared by Electronic Laboratories, Indianapolis, Ind. The new E-L plan offers four vibrators to serve 1,122 auto-radio models, comprising 95% of the replacement demand. Greatly reduced inventory and faster turnover will thus be made possible.

Plug-In Filter Capacitors

Editors, RADIO & Television RETAILING:

In the past ten years, I have serviced enough sets to conclude that a great percentage of set troubles are due to filter capacitor failures. In view of the wide knowledge of this fact, it seems to me that some manufacturer should have thought of using plug-in filter units a long time ago. These units could be placed beside the tubes, and withdrawn for checking or replacement in a fraction of the time it takes to unsolder, check and replace the capacitors at present.

It may be that capacitor design requirements have prevented such a development. I would much rather believe that, than to suggest that it was not done because it would eliminate fifty per cent of the radio serviceman's profit in labor charges.

Bear in mind that I am not averse to earning an honest dollar, but it does seem that with circuits becoming increasingly complicated, unnecessary service work could be eliminated.

I believe that plug-in filter capacitors would be quite a selling feature. Anyone who has ever paid half of the original cost of a set to "check tubes and replace filter" would be delighted with this feature, I am sure, and radiomen would be equally well pleased.

Alameda, Calif. ROBERT TENNANT
438 Cottage Street

Plug-in filter capacitors are used in aircraft and military equipment. They are not being used in commercial receivers because the cost of the sets would be unnecessarily increased.

Plug-in filter capacitors, like a great many other design changes, would undoubtedly facilitate radio service. These features are not incorporated, however, because the business of manufacturing radios is a highly competitive one, and manufacturers feel that any extra costs must justify themselves, must help sell more radios, before they are added to the price of a set.

Improvements of the sort described would not, manufacturers feel, help sell more radios for this reason: Sets will need service whether repairs are made simpler or not, and the public will not appreciate such essentially slight improvements to the extent of paying more for radios in which they are present.—Editors.

Correction— Rider, Volume 14

In the October issue of RADIO & Television RETAILING, the price of Rider's Perpetual Trouble Shooter's Manual, v. 14, was incorrectly quoted as \$11.00. The correct price is \$12.50.

Forcing Intermittents to Recur

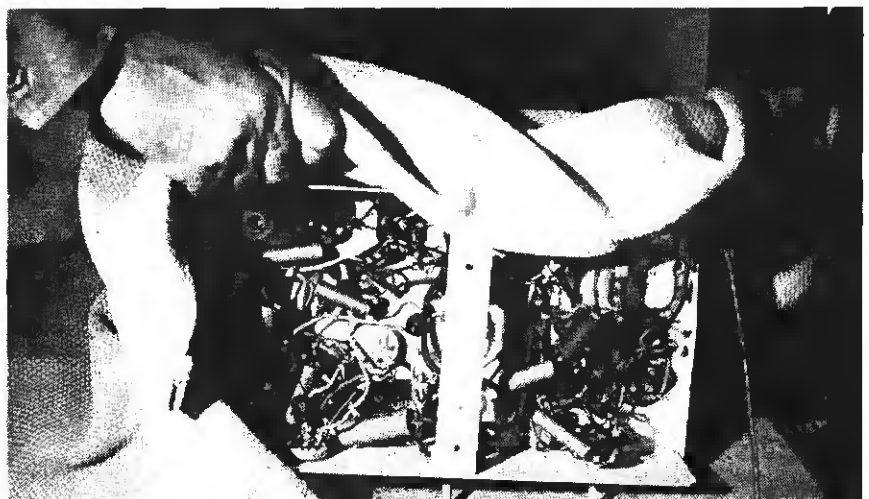

Intermittent radio components may often be forced into the open by covering chassis interior with a cloth, and overheating the various parts for short periods of time.



This is no Puppet Show

Here's a man you know—too well. The Japanese
China-doll by his side is his wife.

This is not the opening scene in a puppet show.
You will notice there are no strings attached to
either of them, especially to the little man with
the glasses. He does not operate by pulled strings.
Instead, he pulls the strings. Those strings
are not visible either.

When we say Hirohito pulls the strings there's no
tongue in our cheek. We're banking on the words
of a man who knows—a man who was there.

His name is John Williams, a man who kept
watch on the Japanese menace during years
of newspaper work throughout the Pacific area.

He was one of the men who helped organize
a counter-Jap network in the Pacific.

"The American people are being fooled about
the real war role of Hirohito, 'God'-emperor of
Japan"—and Williams doesn't mince any words
in telling why we're being fooled in his article.

"Hirohito...Booby Trap For Americans," appearing
in the October issue of TRUE.

Sound, timely articles like this one are a big
reason why men read TRUE, The Man's

Magazine. It's exciting, adventurous—so TRUE-ly
adventurous that 750,000 fellows step up to their
newsstands each month and plank down their
25¢ a copy. They like it because it's real—
real TRUE from front to back.

750,000 fellows will buy the October issue of TRUE. (A million in December)

The December TRUE will carry more than 70 pages—30,000 lines of advertising.

40 men's wear advertisers—25 liquor advertisers—more than 130 different advertisers spending
nearly \$300,000 are using TRUE this year.

There's nothing like TRUE—for you.

A true AD-VENTURE



Charley Jacobs, Advertising Manager
of Klein's Sporting Goods, Chicago, writes:

"You might be interested
in knowing the results of our first advertising
venture in TRUE. We ran a 92-line ad on
Jungle Boots at \$4.95 in your May issue; up to
July 23, we have sold 220 pairs."

(Ed. addition: Klein's 21-line ad in July had pulled
337 requests for their 25-cent catalog by July 27!)



The Man's Magazine true

FAWCETT PUBLICATIONS, INC.

295 Madison Avenue, New York 17, N. Y.

WORLD'S LARGEST PUBLISHERS OF MONTHLY MAGAZINES

sells men

EVERY WESTINGHOUSE RADIO

IS

Completely new!

NOT A SINGLE "WARMED OVER" PRE-WAR MODEL. EVERY SET IS PACKED WITH REAL SALES ADVANTAGES

These pace setting Westinghouse radios are examples of the resourceful engineering and the originality that characterizes the entire Westinghouse line. Every set is packed with new sales features that you can demonstrate and sell.

Get in touch with your Westinghouse radio distributor today and make a date to see and hear these fine instruments. Home Radio Division, Westinghouse Electric Corporation, Sunbury, Pa.



THE DUO

A revolutionary new radio-phonograph with an automatic record changer and a slide out carryabout radio that can be used anywhere in the house! The low slung, compact, air-stream cabinet is in beautifully marked mahogany veneer . . . the automatic changer is operated with a single button—it is simple and will stay in adjustment . . . built-in loop antenna . . . continuously variable tone control . . . 6 tubes, including rectifier . . . Standard Band.

Lift out the radio . . .

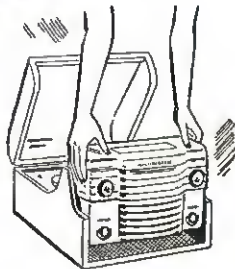

. . . and play it anywhere.

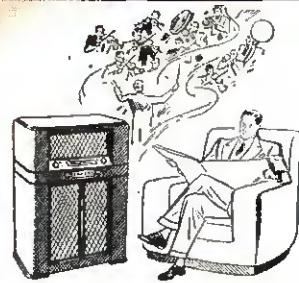

THE
AMAZING
NEW
PLENTI-POWER
CIRCUIT

THE CONCERT GRAND

An automatic radio-phonograph in an exquisite bow cabinet. The exclusive PLENTI-POWER CIRCUIT gives this moderately priced, 7-tube instrument 10 watts of undistorted output—more than most 12-tube sets had prewar. Extra large record storage space. Six electric push buttons. Single button control automatic record changer. Continuously variable tone control . . . 7 tubes including rectifier. Standard and Shortwave Bands.



RADIO'S FIRST NAME

THE LITTLE JEWEL

only 9 $\frac{1}{4}$ " x 6" x 6". Never before has such performance been packed into a set of this size. It's a console radio in capsule form—with power output you'll have to hear to believe... air-stream cabinet in ivory or pastel green plastic and gold satin finish metal... completely enclosed and styled on all sides... retractable, disappearing handle... built-in loop antenna... 6 tubes including rectifier. Standard Band.

Never before has such performance been packed into a set of this size.

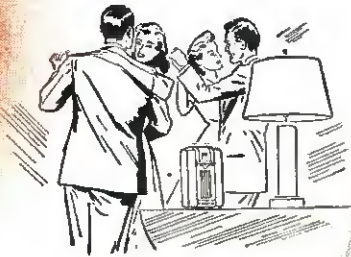

The exclusive Westinghouse PLENTI-POWER CIRCUIT provides the extra reserve of power you need for true-to-life performance. For example, it gives the popularly priced 7-tube Westinghouse sets more undistorted output than most 12-tube sets had prewar. And the Westinghouse 4-tube instruments have nearly twice as much undistorted power as comparable prewar sets... 17 watts of flawless output that reproduces the program with the full brilliance of completely natural tone.

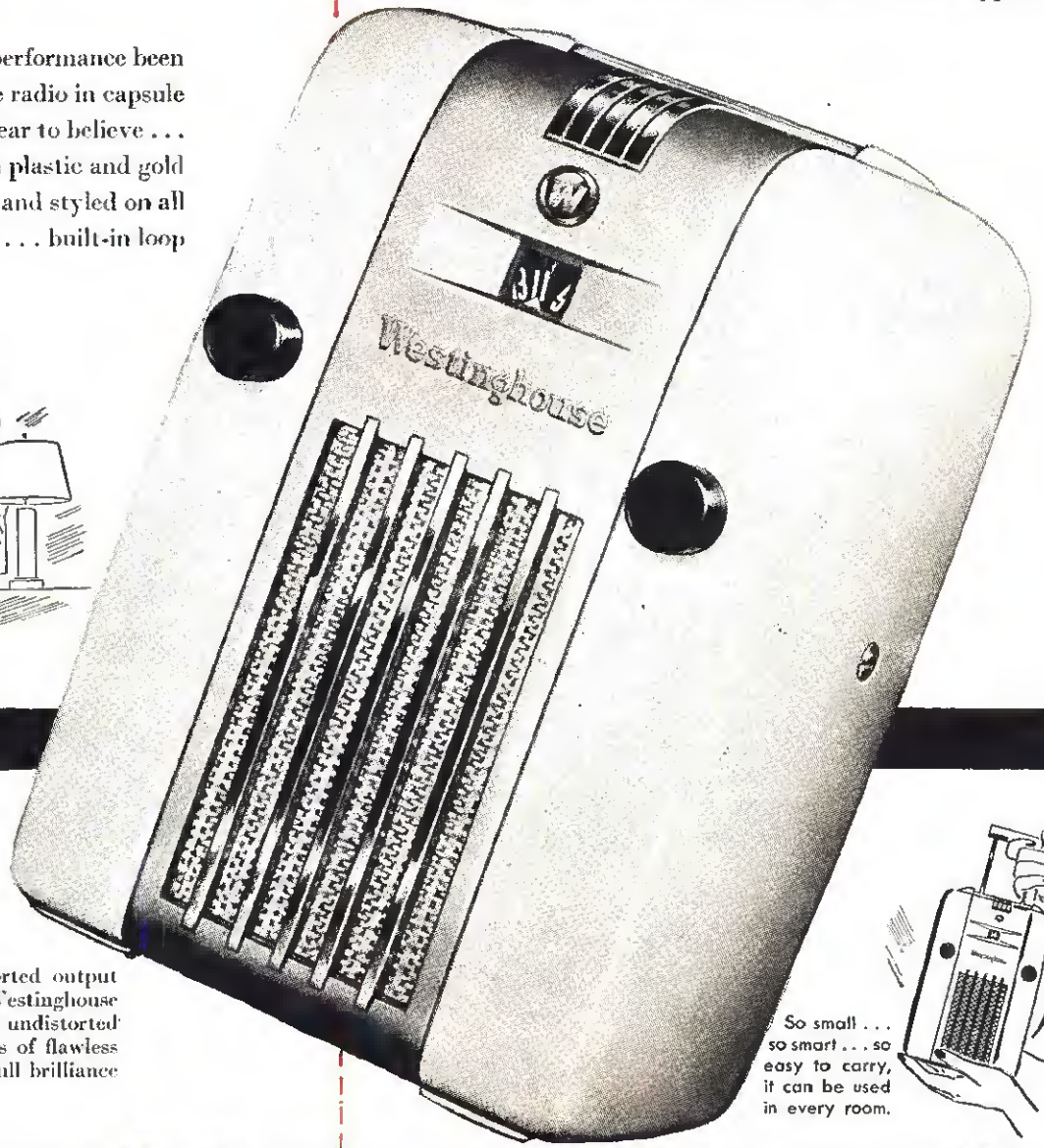

So small... so smart... so easy to carry, it can be used in every room.



THE FM CENTURY

The finest reception of FM, AM, and Shortwave—at the lowest possible cost! You can't buy finer radio engineering at any price. The exclusive Westinghouse PLENTI-POWER CIRCUIT provides 17 watts of undistorted output... nearly twice as much undistorted output as prewar sets with a comparable number of tubes. It provides the full power you need for full-color reception. Rich mahogany veneer cabinet... striking eye... six electric push buttons... 14 tubes, including rectifier. FM, Standard, Shortwave and facsimile bands.



THE SYMPHONIC 14

A magnificent musical instrument... a masterpiece of cabinet craftsmanship! The exclusive PLENTI-POWER CIRCUIT gives this instrument 17 watts of undistorted power... true-to-life FM that only the finest engineering can provide... the most dependable automatic record changer ever built... entire width of cabinet is available for record storage space... hand-rubbed crotch mahogany veneer cabinet. 14 tubes including rectifier. FM, Standard and Shortwave Bands.



6 to 10 times the record storage space as in the same size prewar cabinet.

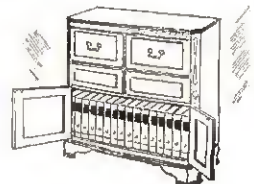

IS **Westinghouse**
RADIO TELEVISION

60% Better

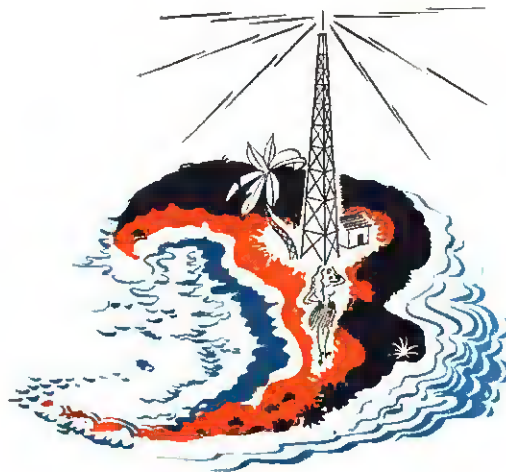

All of the advanced knowledge gained during the war will be incorporated in Stewart-Warner radio receivers at the start of civilian production. The result will be top

performance estimated at 60% better than in prewar sets

A vertical rectangular graphic with an orange-to-yellow gradient background. At the top, the words "STEWART-WARNER" are written in a bold, black, sans-serif font. Below this, the word "Radios" is written in a large, elegant, black cursive script. Underneath "Radios", the text "CHICAGO 14, ILLINOIS" is printed in a smaller, black, sans-serif font. At the bottom of the graphic is a logo consisting of a shield with the letters "SW" inside, flanked by the words "STEWART" and "WARNER" on either side, all within a decorative border.



Garage Door Actuator

Simple Modification of Auto Radio Permits Remote Control

• Experimentation on the remote operation of garage doors from a switch or pushbutton on the automobile dashboard has been going on for a number of years. R. G. Rowe, of Niagara Falls, N. Y., has suggested a cheap, simple, rugged and reliable method of achieving this desired remote control. This method (for which a patent has been applied) involves the modification of a standard automobile receiver.

An induction receiver-relay unit is also needed for setting up inside the garage (see Fig. 1). The schematic for this induction relay circuit is shown in Fig. 2A. A 1C21 or an 0A4G cold cathode tube is used. The low impedance receiving loop, which represents a preferred form of antenna system, is buried in the approach driveway. It is coupled through a four-to-eight-ohm line and a conventional line-to-grid transformer to the starter anode of the cold cathode tube.

Resonating Circuit

The circuit may be resonated as shown by a variable capacitor shunting the transformer secondary. Another satisfactory tuning arrangement uses a line-to-grid transformer provided with a 500-ohm primary winding tapped at 4 to 8 ohms. As indicated in Fig. 2A, the total primary is shunted by the tuning capacitor, and the low impedance loop connected to the low impedance terminals.

In the typical operation of a relay

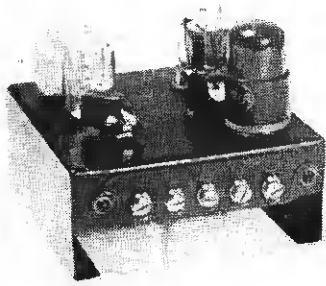

Fig. 1.—Induction receiver-relay unit with sensitivity control is set up inside garage.

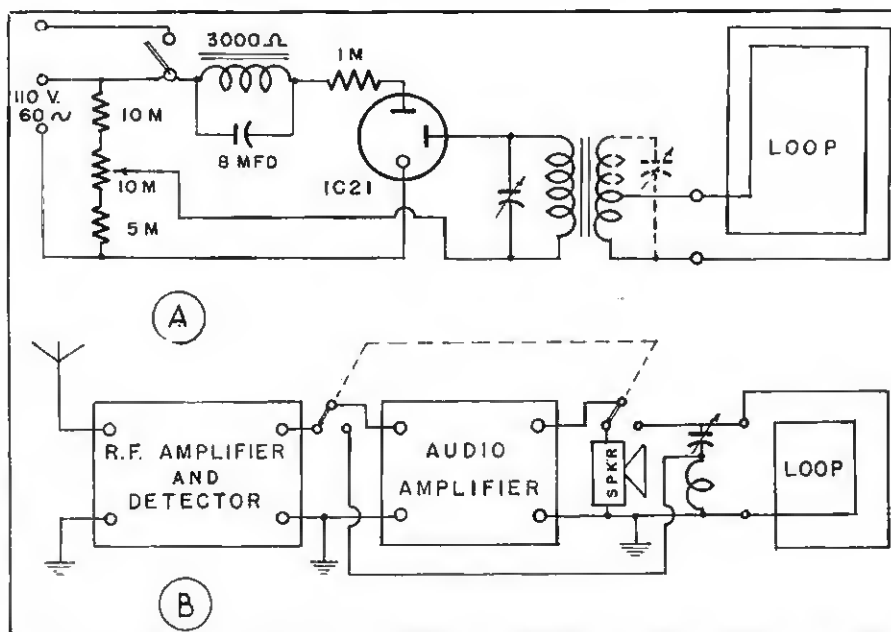

Fig. 2.—A shows a type of induction receiver circuit suitable for use in the system described. B is a schematic showing a conventional radio receiver adapted to operate as control transmitter if switch is in right-hand position. Audio section is provided with feedback connection to generate signal applied to loop antenna at the right.

tube, the starter anode is maintained at a potential just below the breakdown voltage by means of the bleeder resistance hook-up. The extra voltage is supplied by the tuned circuit r-f voltage input. When signal of the correct frequency is received, the starter anode triggers the gas triode tube, and the resultant current actuates the relay that operates the garage door. The tube ceases to pass current when the carrier voltage is removed.

Operating Cost Reduction

With the receiver interconnected with the electrical circuit of a garage door operator, it will have extremely long standby periods and short operating periods. It follows that, during standby periods, the receiving apparatus must consume little or no power line energy to reduce operating costs, yet must be instantaneously responsive to the receipt of the actuating signal. The cold cathode tube used in the circuit requires zero standby power.

The necessary modification of an automobile receiver to serve as a transmitter is shown in Fig. 2B. The audio section is used to generate the

desired power at frequencies of from 10 to 20 kc. The diagram shows the ganged selector in the "receive" position, enabling the normal aural reception of broadcast signals. In the "transmit" position, a low impedance loop antenna shunted by a

(Continued on page 111)

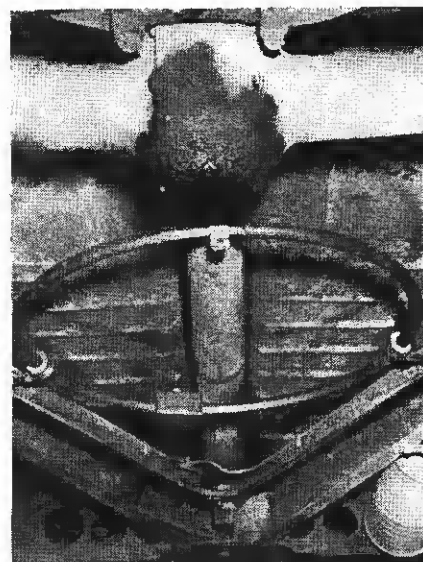
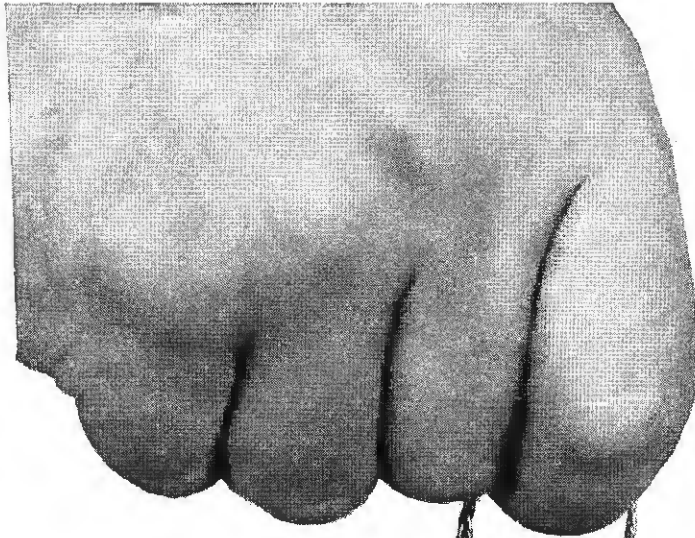

Fig. 3—Type of loop used is shown, as well as the method of mounting under the car.



HOT TUBES

— **Get a Kellems Tube Puller**

— TUBES, VIBRATORS —

— anything with "OUCH" temperature
or "pinch" clearance

KELLEMS COMPANY

Saugatuck, Conn.

FOR BIGGER RADIO

AND RADIO PHONOGRAPH

PROFITS

GET ON THE BEAM WITH

Bendix



PRODUCT

ADVERTISING

MERCHANDISING

SALES PROMOTION



NOW you can get the "***INSIDE STORY***"

Right now Bendix is ready to put you on the profit beam with a *great* product . . . with *great* advertising . . . with *great* merchandising . . . with *great* sales promotion plus a *great* sales training program. Bendix Radio distributors everywhere have the complete story on greater profit plans that will make the Bendix dealer the leading radio merchant wherever he is located.

Today Bendix makes good on its promises! Bendix is ready. The public is ready, and you, too, can get ready by contacting your Bendix Radio distributor or by writing direct to Bendix Radio Division, Baltimore 4, Maryland, for his name and address. He is ready now to give you the "Inside Story on the Franchise with a Future." Wire, phone or write today!

BUILD BEST WITH BENDIX . . . FOR PRESTIGE . . . PROFITS . . . PERMANENCE!





Switches

Shown above are a few of the many types of micro-switches, toggle switches, knife switches, rotary switches, band switches, etc., now available through the Hallicrafters Co., Chicago, agent for the Reconstruction Finance Corporation under contract SIA-3-24.

Other radio and electronic components such as resistors and condensers are also available in large quantities. Send the coupon for further details.

hallicrafters RADIO

THE HALLICRAFTERS CO., AGENT FOR RFC UNDER CONTRACT SIA-3-24
MANUFACTURERS OF RADIO AND ELECTRONIC EQUIPMENT

THESE VALUABLE ITEMS *Available Now*
or very soon. Write, wire or phone for further information.

• head phones • test equipment • component parts •
marine transmitters and receivers • code practice equip-
ment • sound detecting equipment • vehicular operation
police and command sets • radio beacons and airborne
landing equipment.

CLIP THIS COUPON NOW

RFC DEPARTMENT 303, HALLICRAFTERS
5025 West 65th Street • Chicago 38, Illinois

Send further details and price on Switches and component parts

Send listings of other available items

Especially interested in.....

NAME.....

ADDRESS.....

CITY..... ZONE.....

STATE.....

Garage Door Actuator

(Continued from page 107)

series resonant LC circuit, is substituted for the audio reproducer, and the normal amplifier input voltage is replaced by a regenerative feedback voltage from the resonant circuit.

Oscillation Frequency

The audio amplifier oscillates at a frequency determined roughly by the constants of the LC circuit, and may be tuned over reasonably wide limits by variable capacitor C. It may be desirable to employ a resistance-capacity combination in place of the LC circuit to introduce waveform distortion in the loop current. Certain non-sinusoidal waveforms effectively increase the control radius of the transmitter, while retaining the same average power input to the amplifier. Fig. 3 shows one type of loop antenna supported from the frame of a 1940 Ford V-8 automobile, and also illustrates the fact that the plane of the loop is sufficiently high to be well protected.

A Philco Model No. 1740 Ford au-

tomobile receiver has been altered, according to the outlined plan, as illustrated in Fig. 4. It was found necessary to provide another section on the ganged selector switch



Fig. 5.—In modified automobile receiver, escutcheon "Door" button might be one of the "push-buttons."

to eliminate the shunting effects of the high frequency by-pass capacitors when transmitting. Further, it was found desirable to remove the r-f filter condenser from the 7B6

plate circuit and relocate it in the grid circuit ahead of the selector switch. The receiver escutcheon is illustrated in Fig. 5, showing the location of the "Garage Door" push-button.

With a one-foot radius receiving loop buried in the center of the approach driveway, the present system permits control of the doors and garage lights for a distance of some seven or eight feet, which is more than adequate for the intended purpose.

The requirement that the automobile receiver be in operation at the instant remote control is desired, is met by the use of instant heating tubes, and instant heating or cold cathode rectifier.

The receiver manufacturer will be able to supply the modified receiver, complete with adequately labeled selector switch and output terminals for induction remote control, at an attractive market price. In fact, with an appropriate sales campaign, the receiver so equipped will have a definite sales advantage over standard receivers. The induction loop antenna and attendant remotely controlled apparatus may be added at the discretion of the ultimate consumer.

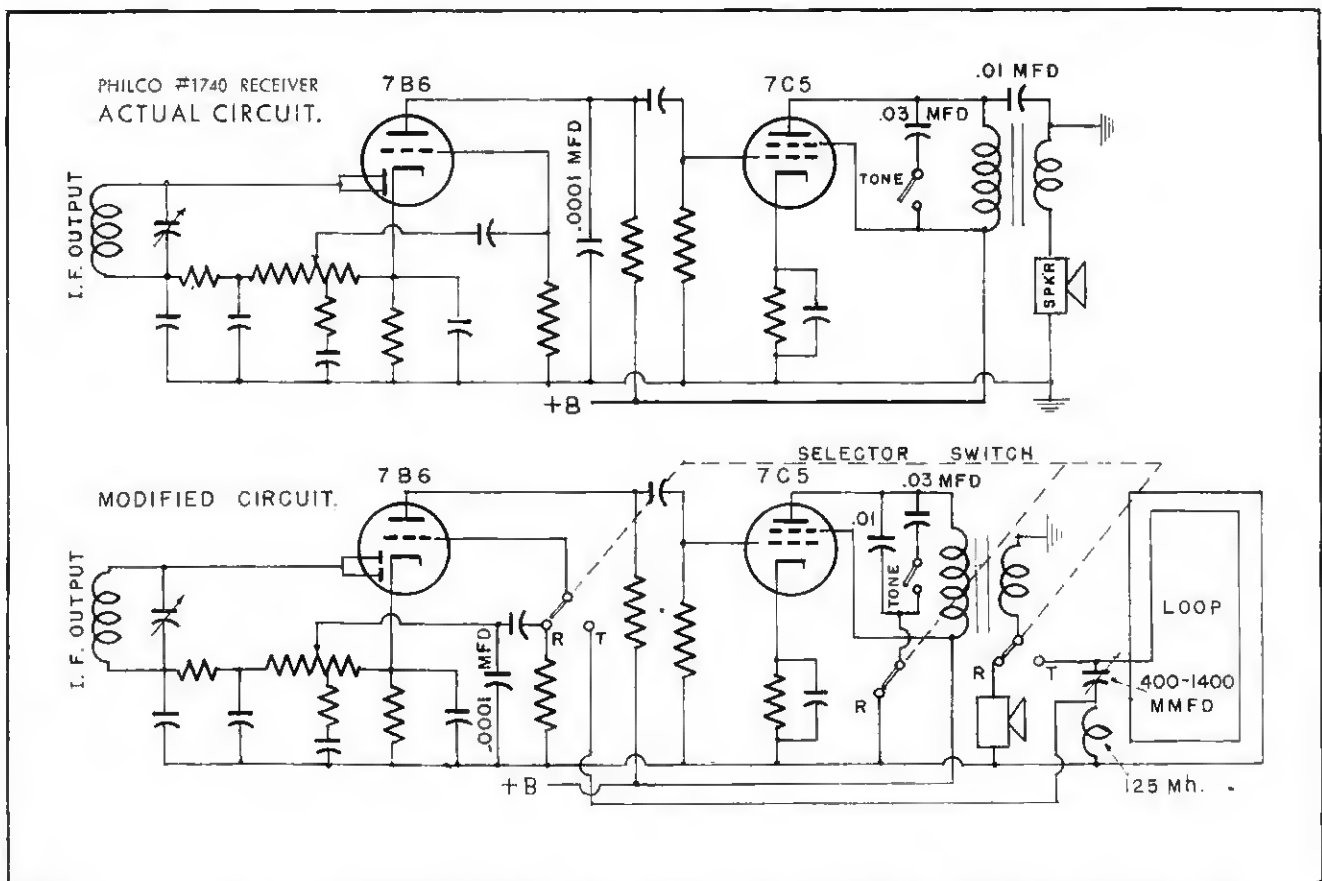

Fig. 4—At top is the wiring diagram of the actual circuit used in a standard Philco automobile radio set for broadcast reception. Below shows the modification required to adapt equipment as a control transmitter. Added parts are switch, variable capacitor, choke and loop.



more efficient
...in miniature

The old quill was picturesque but it lacked the compactness, convenience and dependability of our modern fountain pen. Its development was the usual evolution. Changes and reduction in size made for greater efficiency. The same took place in the development of the modern miniature electronic tube.

While the reduced size of TUNG-SOL Miniatures alone warrants a preference for them, their greater efficiency has resulted in their general adoption, especially for high frequency circuits. Smaller elements make them more rigid. Shorter leads result in lower lead inductance. TUNG-SOL Miniatures have low ca-

capacity and high mutual conductance.

The many advantages of TUNG-SOL Miniatures will cause them to be used in much of the new equipment. It is important that TUNG-SOL Jobbers and Dealers are in position to supply miniatures as well as G-C's-metal and large glass tubes.

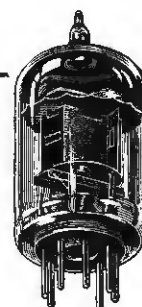

ACTUAL SIZE

TUNG-SOL

vibration-tested

ELECTRONIC TUBES

TUNG-SOL LAMP WORKS INC., NEWARK 4, NEW JERSEY
Also Manufacturers of Miniature Incandescent Lamps, All-Glass Sealed Beam Headlight Lamps and Current Intermittors



**Automatic
Radio**

**DESIGNED
TO MEET
THE DEMAND...**

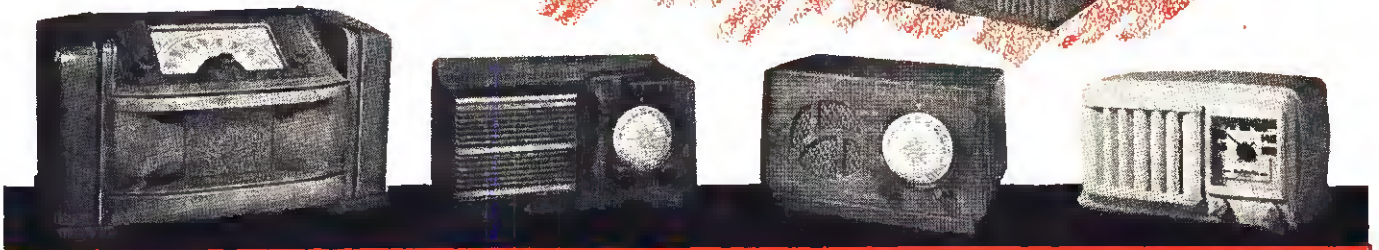
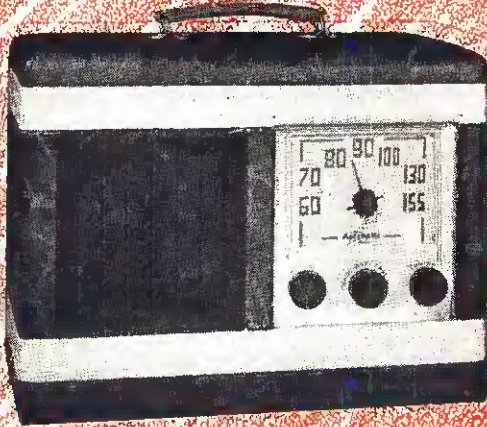

REJUVENATION

Pat. No. 2222196

RENEWS LIFE! The new Portable **AUTOMATIC** Radios actually **RECHARGE THEIR OWN BATTERIES** for up to 2 to 3 times normal life! Only with **AUTOMATIC RADIO** can you get this great feature!

Yes, these new Automatic Radios — Portables — Table models — Phono-Radio combinations, with or without automatic record changers — are designed to meet the demand.

Twenty-five years' experience in the art of making fine radios — plus new skills and materials developed and perfected in war production — are packed into these sales-making postwar **AUTOMATIC** Radios. The rich-

looking cabinet designs and new performance features leave nothing to be desired.

A word to the wise — dealers, if you want your share of the radio business in your community, get in touch with us right away. We will put you in touch with the jobber in that territory. Don't wait — get set to sell a line that will give you continuous public demand — Automatic Radio.



Automatic

RADIO MANUFACTURING CO., Inc.
122 Brookline Avenue, Boston, Mass.



What to Do About it **NOW**

**Get Set to "Cash In" on Tele Receiver Sales;
Here Are Some Practical Tips on How to Do It**

• A comparatively short time ago Television was the engineer's hobby and rich man's toy.

Now, as 1946 nears, Television promises to be the manufacturer's bonanza, the dealer's best-seller and the consumer's must-buy electronic appliance!

Today—right now—is the time for the enterprising dealer to reserve a seat on the Television bandwagon.

And the first step he should take in setting himself up as the Television merchant and expert of his community is to publicize himself as such—now.

There are many methods the retailer can employ to identify himself with the Television picture. He can use his show windows to carry Television messages, and to stress the fact that his store will be headquarters for the coming electronic marvel. He can and should supply a few interviews or articles on Television for his local newspapers. Even without yet having

Television service or a television receiver, he can install a demonstration booth—an attractively outfitted room, where reproductions of Television advertisements and let-

tered signs can help "sell" tomorrow's customers.

The foresighted dealer can study Television—plan the selling techniques, which will involve pleasing

not only the ear, but also the far more critical eye. He can scan his radio "prospect" list, and remind his customers that early 1946 Television production is likely to be very limited, and that delivery of sets will be on a first-come first-served basis, thus giving him an excuse for lining up business in advance, and saving himself a lot of frantic running about when the new sets are here.

Never mind worrying about the obstacles confronting Television now. They will be solved!

Consider the demand! It's here, and is very real, and very large.

So, the dealer should tell his customers that Television is coming, and that he is going to be equipped to sell and service it.

To put yourself in a strong position to sell Television tomorrow you must talk about it today.

Why Television Sales Will Soar

1. A new and increasing demand on the part of the **LAYMAN** (the prospective purchaser). The great amount of publicity in newspapers, nationally circulated magazines and manufacturer advertising is whetting the public appetite to such an extent that the demand **WILL HAVE** to be satisfied.
2. Improved electronic warplant techniques have brought the cathode-ray tube into **COMMON** and **THOROUGHLY UNDERSTOOD** use.
3. Trained factory personnel is now available in **SUFFICIENT** number to **IMMEDIATELY** proceed to manufacture Television sets. The **EXPERIMENTAL** phase has already been passed.
4. Electronic warplants have learned a new concept of the meaning of **MASS PRODUCTION**. They have learned how to convert and revamp plants with amazing rapidity.
5. America's foremost radio engineers are **NOW** working on the broadcast problems confronting Television, and all express the opinion that these will be readily solved.
6. The problems of financing Television broadcasting are being easily met. Already, advertising agencies and prospective sponsors are evincing more interest now in Television than in any other medium.

HILDEGARDE SAYS:

"Darling, quel amour... ce magnifique DuMont Teleset!"



Star of NBC's Raleigh Room, Tuesdays at 10:30 P. M.

Discerning dealers everywhere will echo Hildegard's enraptured superlatives when they see and hear the incomparable performance of the DuMont Teleset†. For DuMont reception quality is more than mere chance. DuMont's 14-year pioneering leadership in radio-electronics eloquently bespeaks ability to achieve the DuMont goal — to build the finest Television-FM sets!

DuMont national advertising is steadily cultivating your postwar customers . . . sowing the expectation of exceptionally bright clear pictures, exquisite FM tone, inspired cabinet artistry, technical dependability! These are *tested* attributes of DuMont-engineered Television-FM receivers. That is why there will be pleasure, prestige and profits for you in displaying and selling DuMont Telesets!

†Trade-Mark Reg.

Copyright 1945, Allen B. DuMont Laboratories, Inc.



ALLEN B. DUMONT LABORATORIES, INC., GENERAL OFFICES AND PLANT, 2 MAIN AVENUE, PASSAIC, N. J.
TELEVISION STUDIOS AND STATION WABD, 515 MADISON AVENUE, NEW YORK 22, NEW YORK

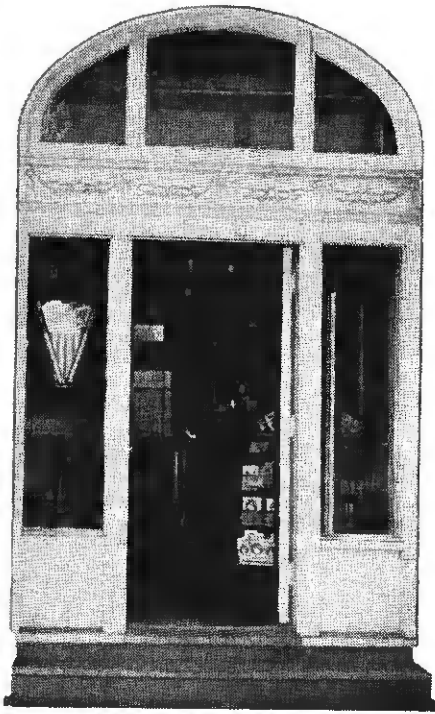

devoted to the display of these goods.

During the past year, the store has taken many orders for new merchandise, and has already placed its own orders with suppliers. "Once goods begin to arrive in greater quantities, our profitable operation is assured," the owner declared. "Initially, we will sell as fast as merchandise is obtained."

Although parts of the establishment have already been modernized, Christopher has further store-improvement plans.

As soon as possible, the storefront will be revamped. Glass will be used extensively in remodeling the exterior to permit passers-by an unobstructed view of the interior.

At present, a large stone pillar at

the front of the establishment blocks a view of the sales floor from pedestrian traffic. This obstruction will be removed. Interior displays will then be built so that the entire floor will be a show window.

"We know that it's impossible to do a good sales job if new merchandise is displayed in unattractive surroundings," Christopher asserted. "We're taking every precaution to insure a high sales volume. To start, we have arranged the store to act as an appealing 'backdrop' for the new sets and appliances."

Displays Sell Goods

To sell more of the electrical fixtures which the firm handles, these items have been attractively displayed on one side of the store.

One wall has two deep recesses papered in deep rose against which various types of electrical lighting fixtures are shown. Shelving running horizontally against the wall displays a neat arrangement of other merchandise.

The ceiling has been rewired to show an effective display of different kinds of electrical lighting equipment. The store has found that more goods are sold when displays are neat and appealing."

Christopher is convinced that

(Continued on page 174)

Service Draws Sales

Dealer's "Trump Cards" Are Good-Will, "Live" Mailing List, Service; Goal Is Large Profits

• I. Christopher, proprietor of the Belknap Electric Co., 1513 Belknap, Superior, Wis., is all set to do a large volume business in radios and electrical appliances.

First, the store has as one of its assets the good-will of its customers; secondly, a good mailing list has been built up during the war years from appliance servicing; thirdly, the firm is offering expert maintenance work on receivers and appliances sold by the store.

Aims at Volume Sales

"I can't see how we can miss our mark—merchandising at high profits—when we are prepared to give our customers quality merchandise, pleasant surroundings in which to buy, and the services of skilled technicians," Christopher stated.

The firm will place most of its efforts on the sale and repair of large appliances. Radios and refrigerators will be stocked much more heavily than other appliances, and most of the floor space will be

Above, customers entering here find pleasant and attractive surroundings in which to buy. Below, good-looking displays boost volume.



*Something new in
women's magazines
appeared October 17*

TODAY'S WOMAN is tailored to fit today's young woman.

Her world and her outlook have widened and changed during these last, fast-moving years. She's amazingly well-informed. She has a deep, personal interest now in things that once never mattered to her. She has new ambitions, different wants. She's living in a new era.

So she gets this *new* magazine.

Today's Woman is the service magazine for the young wife, mother, homemaker in her middle twenties. She's the blueprint behind the book.

Everything in Today's Woman will help and serve this young woman.

There'll be lots of good fiction "bull's-eyed" at her... her kind of stories by writers like Thyra Samter Winslow, Margaret Culkin Banning, Adela Rogers St. John, and Phyllis Duganne . . . illustrated by Mario Cooper, Leslie Saalberg, Walter Biggs, Bill Brown and other top-notchers.

There'll be an unusually large and smartly arranged "service department" crammed with stimulating, practical advice on Fashion, Beauty, Food, Home Decoration—suggestions *young* women can use.

Today's Woman used to be called Life Story. It starts its exciting new existence with the 600,000 new stand sales (at 25¢ a copy) that Life Story piled up every month.

The market that buys 89% of all merchandise is the "young, middle-income housewife group" that Today's Woman specifically reaches. Your advertising will influence them economically there . . . in Today's Woman.

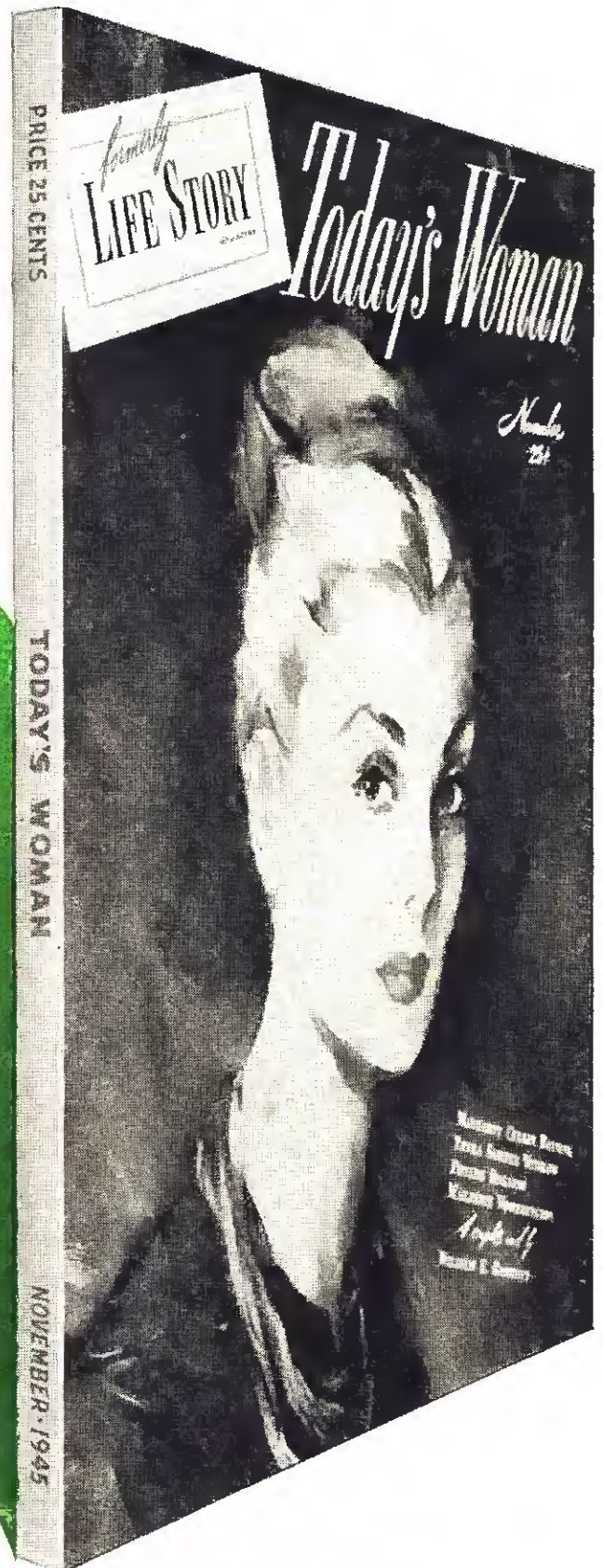

Today's Woman

THE NEW MAGAZINE

FAWCETT PUBLICATIONS, INC. 295 Madison Avenue, New York 17, N.Y. World's Largest Publishers of Monthly Magazines

They'll Have Everything...



The best of all that's new in radio

Delco home radios will be in production soon . . . table models, consoles and portables . . . in FM and AM combinations and with standard broadcast bands. They'll provide the best of all that's new in radio . . . sets that set the pace in styling and performance . . . a line that covers the entire range of customer demand. For *engineering vision* and *manufacturing precision* . . . backed by long experience in producing Delco auto radios and Delco home radios . . . intensified by wartime accomplishments in building military radios and electronic equipment . . . *look to Delco Radio!*

ENGINEERING VISION—

MANUFACTURING PRECISION

They Finished Their Job—Let's Finish Ours
BUY VICTORY BONDS

DELCO RADIO  A UNITED MOTORS LINE

Delco Radio
DIVISION OF
GENERAL MOTORS



A background of *Performance*—over 50 years—is the *inside story* of the popularity that has brought leadership to *Thordarson* transformers. *Performance* over the years, after all, is the only true test of product quality.

Consumer acceptance will continue because *Thordarson* research and design engineers are never satisfied just keeping abreast of the times. These men are continually developing many transformer components which are instrumental in the production of new and better performing devices and equipment for the electronics industry.

This same pioneering spirit has been responsible for many new *Thordarson* transformer applications and developments during the war . . . all of which will be available shortly for civilian requirements.

Thordarson's well-tested methods of sales promotion and distribution will continue their joint task of making *Thordarson Transformers*, together with complete information on their applications and use, available to everyone in the field.

Always think of Thordarson for top-notch transformers!

500 WEST HURON ST., CHICAGO, ILL.

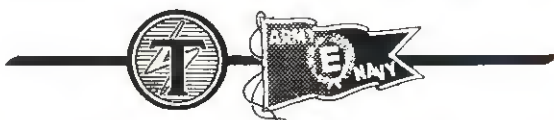

ORIGINATORS OF TRU-FIDELITY AMPLIFIERS

THORDARSON

ELECTRIC MANUFACTURING DIVISION

MAGUIRE INDUSTRIES, INCORPORATED

Sell the Customer Up

(Continued from page 33)

Salesmanager: "\$270, Mrs. Jones."

Saleswoman: "That's a lot more to pay for sliding shelves and a meat-keeper."

Salesmanager: "But that isn't all you get. There are several other features which I will describe to you shortly. But there's still a very good reason why this refrigerator is worth much more than the model you first looked at."

Saleswoman: "What is this feature?"

Salesmanager: "A very important one, I can assure you, Mrs. Jones. Will you tell me how many there are in your family?"

Saleswoman: "Six."

Salesmanager: "Six persons. Well, the feature is that the storage capacity of the de luxe model is larger. Seven cubic feet instead of six. This feature alone will save you money. You will be enabled to buy and store more foods at times you are offered good buys. Then, too, the interior won't be crowded when company comes; you can make many more ice-cubes. Other features include a special new finish on the shelves; a thermometer, and a special bin for storing vegetables."

Stress Extra Features

Saleswoman: "Well, extra size is a feature, but doesn't it cost more to run the larger size?"

Salesmanager: "The additional cost is so slight, it isn't even worth considering. Both use the same size motor—one-sixth of a horsepower."

Saleswoman: "We find the refrigerator we now have is a trifle too small."

Salesmanager: "In that case, the larger would be a much better buy. After all, a refrigerator lasts a long time and you want to be sure to make a wise decision. I'll be glad to send this one to you. You know the maker's reputation and you know that Dealer Smith has been in business here for a long time and will make sure that it is properly installed and serviced."

Saleswoman: "Well, there's one other problem. What about my old refrigerator? Will you make me an allowance for it?"

Salesmanager: "Well, we could make some sort of allowance, but I have a better suggestion."

Saleswoman: "Such as?"

Salesmanager: "Sell it privately.

Right now, as you know, refrigerators are scarce, and you could get a fair price for it by placing an advertisement in the local newspaper."

Saleswoman: "More than you'd allow?"

Salesmanager: "I'm sure you could. Now, since you're certain that this is a leading make and that our firm is reputable, and that the de luxe is the right size, why not order it now?"

Saleswoman: "Well, I'm still a little uncertain about spending the extra money."

Salesmanager: "If I were in your place, I'd certainly buy this one. If your present one is too small, it certainly seems that you should have a larger one, and enjoy the extra features as well."

Reliability Important Factor

Saleswoman: "Perhaps I should look at some other makes. Another dealer might give me an attractive allowance."

Salesmanager: "Mrs. Jones, it is true that another dealer may offer you a seemingly high trade-in for the old refrigerator, but you may depend upon it that it will not be a famous make like ours; it may have no established list price, and you cannot be certain that it will perform well, or be satisfactorily serviced if it fails to run properly."

Saleswoman: "I'm convinced. I will give you an order."

Salesmanager: "Thank you, Mrs. Jones. I'm certain that you will be entirely pleased. I had hoped that you would buy the de luxe model because it is much better suited to your needs."

Tele and FM Installation

(Continued from page 93)

up the required facilities and render a satisfactory service.

"Television generally will be sold through wholesale distributors. We consider it the function of the wholesale distributor either to arrange a complete installation and service facilities as part of his business activity, or make arrangements with some properly qualified outside servicing organization to install and service the receivers sold by that distributor's dealers. In either case proper charges should be made to the dealer and consumer for these services.

"The manufacturer of the equipment also has a definite responsibility

in working with the distributor in arranging for the proper service setup. Especially trained and equipped service specialists from the factory should be available to the distributor to supply him with any required technical information and to help train the distributor's service organization in the operation of the specific product of that manufacturer.

Good-Will for Television

"Looking ahead into the immediate postwar television market, there is no one element more important than proper installation and service. If the initial sets sold to the American public perform satisfactorily they will create enthusiasm and additional sales."

Ernest H. Vogel, Vice-President

Westinghouse:

"In our opinion a modern and progressive service department properly handled is essential to successful radio merchandising.

"We have learned during the last few years that there is not a more important factor in successful selling of goods than service."

F. M. Sloane, Manager Service Dept.

Television Broadcasters Assn.:

"A great need at present is for more trained servicemen to handle installations and servicing of television sets. Veterans of the war, trained in electronics, might prove the best to handle these tasks and their entry into television servicing should be encouraged."

J. R. Poppele, President

RCA Victor:

Adequate service of the better type cannot be separated from sales. It is an integral part of any successful enduring radio sales program. Whether or not a successful radio retailer operates his own service department or contracts for service seems academic to the writer, provided this function is controlled by those responsible for sales.

Service a "Must"

"To sum up, I consider it a 'must' for every retailer to make available to the consumer, service commensurate with the product he sells and the reputation of his firm. The means of attaining this seem secondary, if properly controlled."

H. G. Baker,
General Sales Manager,
Home Instrument Division

Big News

... We are making PHONOLAS again!

● Here they come ... those new postwar Phonolas! Better now than ever ... the brilliant outcome of our 26 years as America's foremost manufacturer of fine portable phonographs *plus* 3 years' experience building sound equipment for the armed forces. New tonal perfection, new functional beauty of design, new operational improvements have resulted.

● Quantities available are limited, but as material deliveries improve, our production will increase to meet the goals we have set for ourselves. Acoustic models now—amplified models *very* soon ... both produced to high standards of quality, beauty and performance ... at competitive prices!

Memo to Canadian dealers ... In Canada watch for MELODIER Models ... the same product under a trade name adopted especially for Canada.

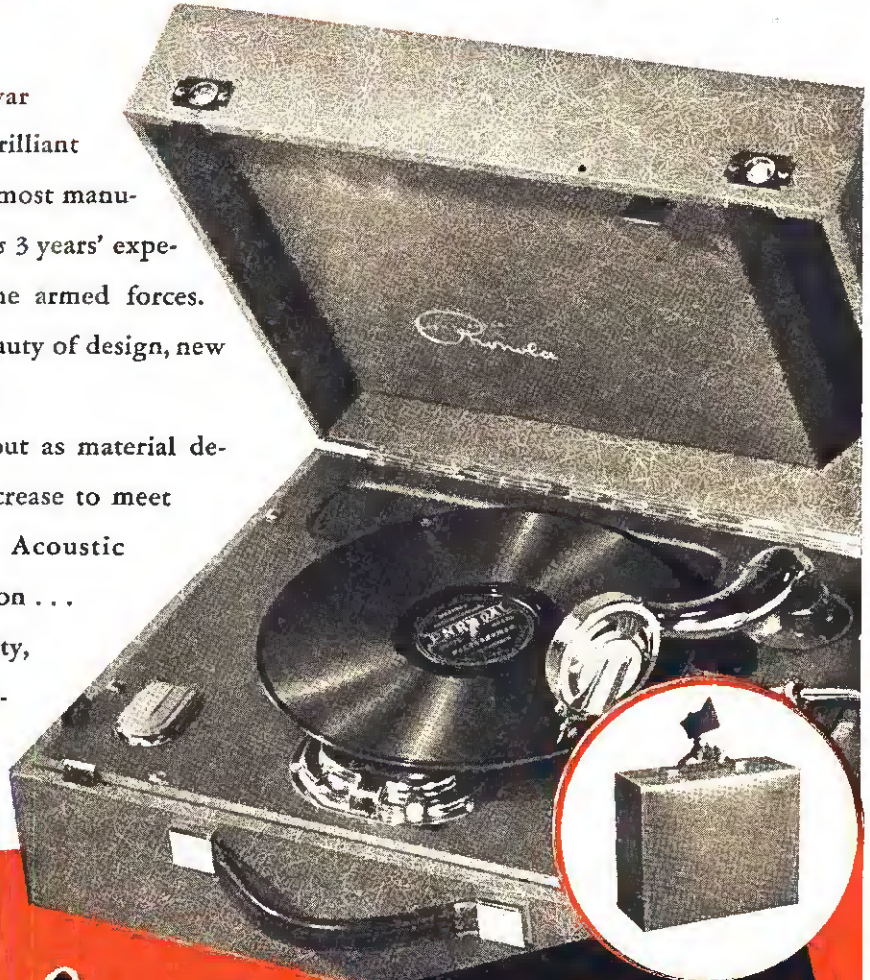

Phonola

ACOUSTIC AND ELECTRONIC PHONOGRAPHS

WATERS CONLEY COMPANY
ROCHESTER, MINNESOTA

HERE ARE THE PHONOLA DISTRIBUTORS:

Alabama	Watts-Newsome Company	Birmingham	Missouri	Artophone Corporation	Saint Louis		
Arizona	Albert Mathias Company	Phoenix	Nebraska	Omaha Appliance Company	Omaha		
California	H. R. Basford Company	San Francisco	New Jersey	E. B. Latham & Company	Newark		
	Ray Thomas Company	Los Angeles	New York	Roskin Bros., Inc.	Albany		
	B. K. Sweeney Electrical Company	Denver		Western Merchandise Distributors, Inc.	Buffalo		
Connecticut	Roskin Distributors, Inc.	Hartford		Roskin Bros., Inc.	Middletown		
Florida	Cain & Bultman, Inc.	Jacksonville		Times Appliance Co., Inc.	New York City		
Georgia	The Yancey Company, Inc.	Atlanta		Chapin-Owen Co., Inc.	Rochester		
Illinois	The Sampson Company	Chicago		Onondaga Supply Company	Sycamore		
Indiana	Rodefelt Company	Indianapolis	North Carolina	Southern Bearings & Parts Co., Inc.	Charlotte		
Iowa	The Roycraft-Iowa Company	Des Moines		Bennett Radio Co., Inc.	Columbus		
Kentucky	Electric Appliance Distributors of Kentucky	Louisville	Ohio	Modern Distributing Company	Cincinnati		
	Walther Brothers	New Orleans		Philco Distributors, Inc.	Toledo		
Louisiana	Farrar-Brown Company	Portland		Strong, Carlisle & Hammond Co.	Cleveland		
Maine	Jos. M. Zamoiski Company	Baltimore	Oklahoma	Miller Jackson Company	Oklahoma City		
Maryland	Columbia Wholesalers, Inc.	Boston	Oregon	Sunset Electric Co.	Portland		
Massachusetts	Philco Distributors, Inc. (Detroit Division)	Detroit	Pennsylvania	Motor Parts Co.	Philadelphia		
Michigan	The Roycraft Company	Minneapolis		Ludwig Hommel & Co.	Pittsburgh		
Minnesota	Federal Distributing Co.	Kansas City	Rhode Island	Simons Distributing Co.	Providence		
Missouri							

Eastern and Export Sales Office
17 E. 42nd Street, New York City, VA. 6-2079

Midwestern and Western Sales Office
224 S. Michigan Ave., Chicago, HAR. 1880

Tennessee

Woodson and Bozeman, Inc.	Memphis
Albert Mathias and Company	El Paso
The Southwestern Company, Inc.	Dallas
Crumpacker-Covington Co.	Houston
Southern Equipment Co.	San Antonio
Flint Distributing Co.	Salt Lake City
Benj. T. Crump & Co.	Richmond
Sunset Electric Co.	Seattle
Columbia Wholesalers, Inc. of Washington	

Utah

Virginia

Washington

Washington, D.C.

West Virginia

Wisconsin

Charleston Electrical Supply Co. Charleston

Radio Specialty Co. Milwaukee

Export Agents: American Steel Co., New York City

Appliance Sales Set-Up

(Continued from page 61)

is their store the moment they cross the threshold. Modernizing the store gave us a chance to start out on the right foot in this post-war period."

To present a modern, streamlined appearance, the latest in building materials was used. These included the substitution of plaster for metal walls, and the use of asphalt floor covering.

The store's offices have been soundproofed. "The office staff will be very busy as soon as we start quantity selling. Soundproofing will give the office employes the chance to work more efficiently, undistracted by store noises," Dealer Gronich maintained.

Soundproofing has also been applied to the record listening booths. The firm has its eyes on large record and radio-phonograph combination sales. The company hopes to sell more discs and sets in rooms which bar outside noises.

Emphasizing the importance which this retailer attaches to records and radio combinations, the space formerly occupied by the offices has been used for four soundproofed booths. The business offices have been moved to the third floor of the building.

The \$5,000 spent on modernizing the store did not include the outlay for fixtures. An expenditure of \$850 was made for the purchase of eight new fixtures with which to display new radios and appliances "at their best."

Effective Windows for Display

To simplify window dressing, the area behind the front windows is on the same level with the store floor. This will expedite the exhibiting of heavy electrical appliances at the front of the establishment.

The windows themselves are large. The glass reaches down almost to the sidewalk. The advantage of this, Gronich explained, is that the whole store is put on display.

The store front, made almost entirely of glass, is eye-catching, smart and modern, in keeping with the interior of the establishment. The color scheme of the exterior is black, yellow, and dull chrome.

As merchandise arrives at the store, this dealer places the new goods in strategic positions. Radios are placed at the right of the store, and electrical appliances on the left. To give shoppers an oppor-

tunity to see all the merchandise on display, advertised articles are placed on the rear balcony. This means that customers must pass through radio-appliance displays on the main floor in order to get at the advertised merchandise.

On reaching the balcony, purchasers have an excellent view of the entire store. Thus, they are able to see all the goods on display.

Advertising Important

Advertising plays a prominent part in the store's operation. Gronich spends approximately \$400 a month advertising in Boston daily papers.

A unique idea in the maintenance end is the establishment's "service bar." Located on the street floor, under the balcony, this section "feeds" work to the service department in the basement.

The firm's repair section is very active and it is helping to keep the sales volume in larger figures. Three technicians are employed in this work. Two trucks are used to call for and deliver radio or appliance service jobs.

Among the leading brands handled by the company are Admiral, GE, Bendix appliances, and Zenith.

Radio City

(Continued from page 31)

dent, Pearl Williams—who has spent approximately a third of her thirty years selling things. "And I sold plenty," she declares. "I'm a born seller."

Miss Williams employed salesmanship in 1941 when she persuaded a bank to lend her \$5,000—the same bank, incidentally, which guaran-



Manager Lieb shows owner, Miss Williams, first postwar set received in store.

teed her credit up to \$500,000 January of this year.

Her first year she put the business on a paying basis by a coup in buying at cost and selling at profit \$55,000 worth of washing machines and other appliances from areas all over the country. The merchandise she bought was later sold at retail from the store and to large department stores.

Under the guidance of Miss Williams, and the general manager, M. D. Lieb, Radio City Sales Co. seems destined to go places in retail selling, and the owner-president is optimistic that the firm will do a large and profitable business. Asked how she managed to build up the present enterprising business, she said, "I did this by selling sizzle as well as steak. Before I'm through I'll make myself a millionaire."

Dealer Aids

Bendix radio has a sales builder which is aimed primarily at the younger set. The company is supplying its outlets with attractive paper cut-outs of men in military uniform. Children go for these colorful novelties, and their parents are also favorably impressed.

John Meck Industries is offering dealers a great variety of helps. These include advertising slugs for telephone directories, prepared news releases, folders, catalogues, movie stills, adv. mats, price tags, business cards, window display material, decals, direct-mail pieces, banners, 3-dimensional display pieces, streamers, etc., and has in the works some attractive outdoor signs.

Permo, manufacturers of Fidelity needles, is presently engaged in a Christmas sales promotion program for its products. The firm is offering holly boxes, leaflets, and Christmas tree easel stands for the holiday trade.

RCA Victor has made available new sales promotion aids especially prepared to aid dealer in this great new market, and dealers are urged to write in for them now.

Sonora has new material on the presses which will give retailers further information on better merchandising techniques. These sales helps, in addition to others which are currently obtainable, are planned to build more store traffic and extra sales volume.

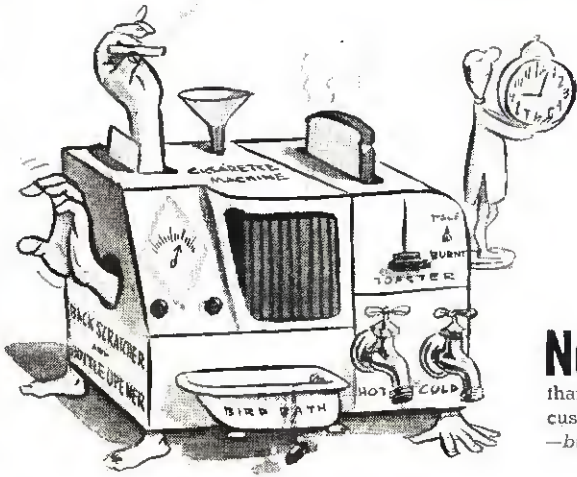

What and What not to look for in the Olympic Radio Line

No! Not one gadget, gimmick or dornick that's of interest to only a few (if any!) of your customers. Olympic offers a full line of features —but only those you *KNOW* will sell.

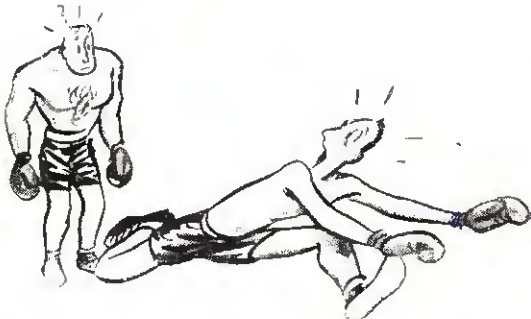

No! Nary a "Palooka" in the whole Olympic line. On every count—bar none—Olympic will be ruggedly competitive. Styled by world-famous designers, Olympic has the kind of eye appeal that makes for prized possession. It has the matchless ear appeal of 'tru-base,' AND the pocketbook appeal to clinch the deal—Olympics are priced *right*. So hold onto your hat—especially when Olympic's striking big advertising program gets under way.

No! "Brainstorm" styling is out... Olympic offers a compact, merchandisable line of table radio-phonograph combinations, table sets, consoles and portables... 24 in all... every one styled by time-proved home appliance designers. Never a laggard to tie up your inventory or subtract from your profits!

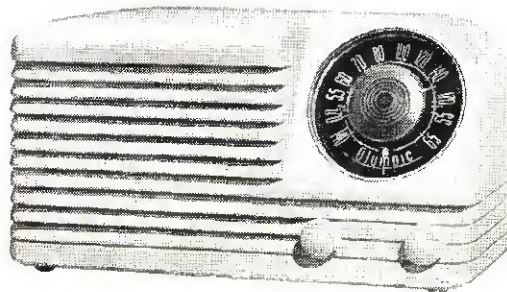

Yes!... 'TRU-BASE'... And only Olympic offers amazing 'tru-base'—revolutionary wartime invention which gives even to modestly-priced table sets the magnificently lifelike tone hitherto found only in large, costly consoles.

An actual electronic invention on the radio circuit, 'tru-base' (patent applied for) recovers the all-important bass tones until now lost by all

but the most expensive radio receivers.

But get the whole, eye-widening Olympic story, fully told in the Olympic Radio brochure, "A Man Has To Think Twice." Just send coupon below. Today. See for yourself why some of America's most hard-boiled radio retailers call Olympic one of the hottest propositions of the Post-War Era.

Olympic
The only Radio with Tru-Base

MAIL THIS COUPON TODAY!

Olympic Radio & Television Division
Hamilton Radio Corp., Dept. R-115
510 Sixth Avenue
New York 11, N. Y.

Please send full details on Olympic Radio and the brochure, "A Man Has To Think Twice."

Name _____ Title _____

Store Name _____

Street Address _____

City _____ State _____

"TYPICAL" TRANSFORMERS

...*The Best!*

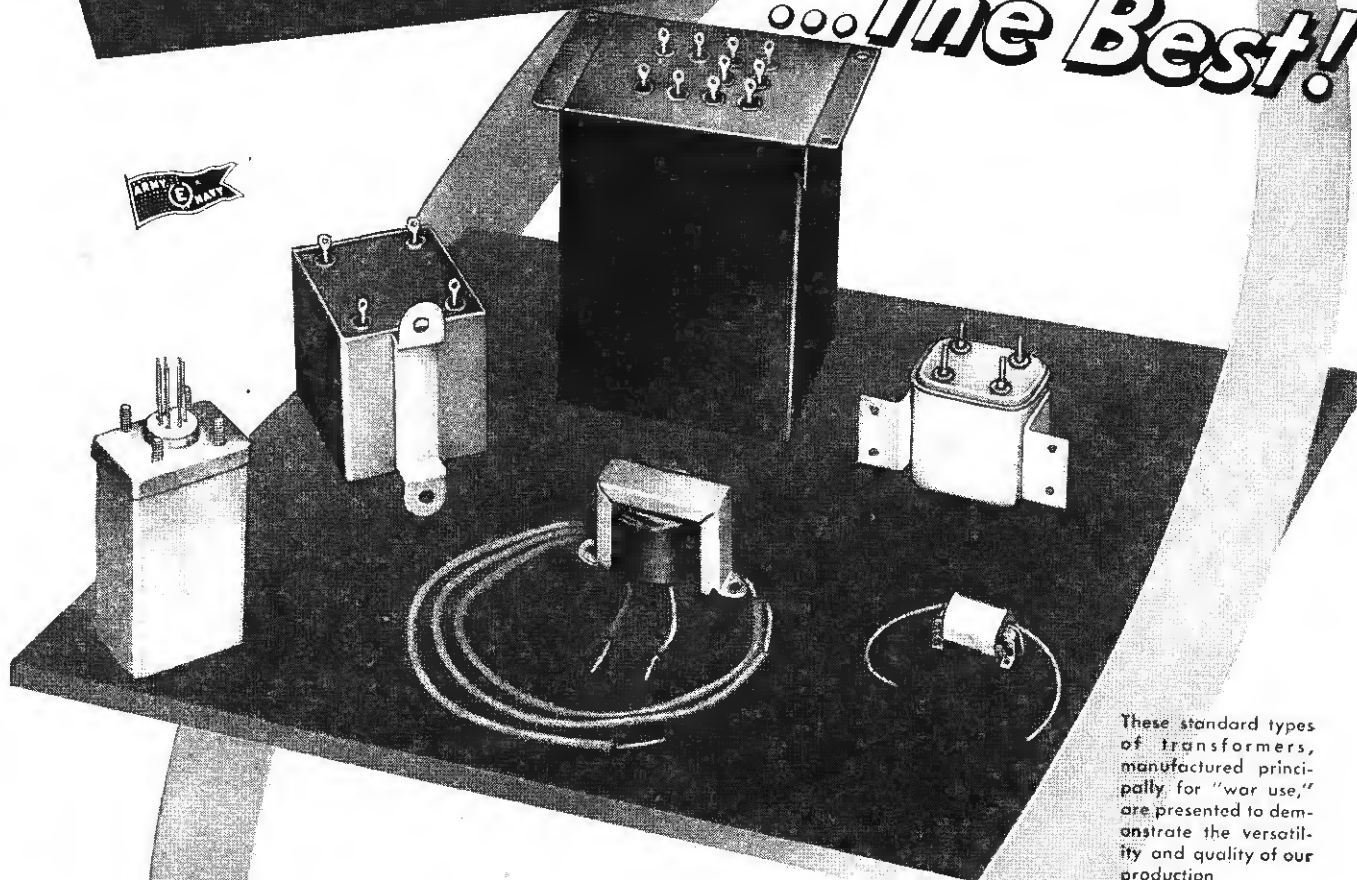

These standard types of transformers, manufactured principally for "war use," are presented to demonstrate the versatility and quality of our production.

and now, a look at the future



Our engineering and production departments will shortly announce a number of startling advancements, in the way of new constructions and new models. Our production facilities will be adequate to take care of most any unusual demand and will cover a wide range of applications. If you are in the market for any type of transformer, we urge you to contact us for suggestions.

Write for catalog.

SWAIN NELSON COMPANY

GLENVIEW, ILLINOIS



BE READY WITH SENTINEL WHEN THAT LID IS LIFTED!

Be ready to cash in by offering a Sentinel radio for every room in the home; Radio-Phonographs, Consoles, Table Models, Portables, AM and FM, AC-DC and battery operated. Also, specially designed radios for the farm.

Sentinel's new colors, new materials and new styles have been approved by noted interior decorators and famous home furnishings authorities.

Sentinel's unmatched Studio Tone, finer performance and long-life, trouble-free operation are built-in

qualities that keep your customers sold, your profits from leaking away.

Sentinel's powerful national advertising and new, modern merchandising methods assure a steady demand, increasing sales.

When that lid is lifted, you can count on being ready—with Sentinel—for those quick radio profits!

*for Studio tone
in Your Home*



Sentinel *Radio*

2020 RIDGE AVENUE, EVANSTON, ILLINOIS

Sets Scene for Sales

Dealer Plans Separate Store for "Live" Display of New Goods

• "Sure the public is already 'sold' on new radios and electrical appliances," declares Herman L. Rubin, owner of Rubin's Radio, 33rd and York St., Philadelphia, Pa., "but 'live' demonstrations will still be important."

To get set for doing a "bang-up" job in receivers and appliances, this dealer will display his merchandise in actual operation, and in a home-like atmosphere. However, this dealer plans to use a separate store for this purpose.

Across the street from Rubin's store, a complete appliance center will be set up. Convincing demonstrations will be used for all major electrical goods to boost sales. At this "branch" store, merchandise will be put on display only; no goods will be sold here.

After seeing appliances "in action," customers will be directed across the street to the main store where sales will be closed.

Until merchandise begins to arrive in greater quantity, however, Rubin will use his present establishment for display and sales.

Insures Future Sales

To increase the sales volume at present, and to insure future sales, the store will show its merchandise in the most attractive manner. For example, the firm plans to have a revolving pyramid display of table appliances in the center of the

store. Rubin feels that a display of this type should have a healthy effect on the sales volume of these items.

Small electrical appliances have sold very well at this establishment. Electric clocks, particularly, are in demand here, and the owner believes that there is a large and profitable market for this merchandise. Electric door chimes are also much sought after in this area.

New Sources of Profit

Before the war, Rubin had successful selling experience with a small, electrically operated apartment-size washing machine. This dealer is looking forward to carrying this item again as soon as it becomes available.

Occasionally, radio-appliance retailers find some items for which there is a great demand in their communities. Frequently, these goods are "stumbled upon by accident," and the dealer knows that he has something really profitable when the merchandise goes over with a "bang."

Rubin's "discovery" was the electric sewing machine. Reluctantly this merchant took on a line of this item to test out its salability. After a brief trial, the store's owner was amazed to see the sales volume on sewing machines climb steadily.

This dealer's success with sewing appliances has convinced him of the

profitable nature of these goods. Sewing machines have already become part of the store's permanent lines.

The proprietor of this establishment is completely "sold" on the value of advertising and publicity. "A man may build a better mousetrap, but he will never sell one unless he tells people about it," he stated. "Radios, refrigerators, etc., are no exceptions."

Ads are inserted daily in the city's newspapers—morning as well as afternoon editions—and also on Sundays. "Advertising brings 'em in," Rubin declared.

Before the war, the store sponsored 15-minute programs over the air, but when merchandise shortages set in, this form of promotion was discontinued. With radios and appliances returning, however, the firm plans to resume broadcasting.

Traffic Builds Volume

The store's corner location—with windows facing two streets—gives Rubin a merchandising advantage. This is especially true during the summer months. At that time of the year, the city's annual music festival is held in a park near the establishment. This affair attracts music lovers to the vicinity of the store, creating much street traffic.

A large record department is maintained at the store, and all types of discs are for sale. While classics and popular platters have contributed to the volume, recordings for children have done exceptionally well.

Rubin has his eyes on large volume sales of auto radios. Prior to the war, the store sold many of these sets. The firm's technicians did their own installations. The firm expects to stress this part of its business in the future.

When questioned as to whether "chains" and other operators of this type were threats to his business in the future, Rubin replied: "I should say not! I, as well as other dealers, was able to merchandise profitably before and during the war despite large buying syndicates. I see no reason why we shouldn't continue to do so in the future."

Here Rubin demonstrates a set to a customer. He sells his patrons so that they stay "sold."



Majestic Radios Soon Available!

According to present production schedules—based on current supplies of parts and materials—all Majestic dealers soon will have their initial stocks of Majestic radios.

It's a line of radios that have been designed, styled, and priced to sell easily . . . to sell at a profit to the dealer . . . to make satisfied customers.

Naturally, every dealer cannot immediately receive all the Majestic radios he can sell. For several months, demand will continue far ahead of the entire industry's ability to produce. But we say this to our dealers:

Majestic's total production will be divided among Majestic dealers on the fairest possible basis.

Furthermore, as a Majestic dealer you will not only receive

a *fair* share of Majestic's production—you will also receive a *substantial* share of it. Majestic's Controlled Distribution Plan limits the number of Majestic dealers in any area, so that *more* of Majestic's total production can be assigned to each dealer who does hold the Majestic franchise.

These are only the first of the benefits Majestic dealers will enjoy as a result of Majestic's plan of operation. You are going to see many more in the months ahead.

October 15, 1945



E. A. Tracey, President

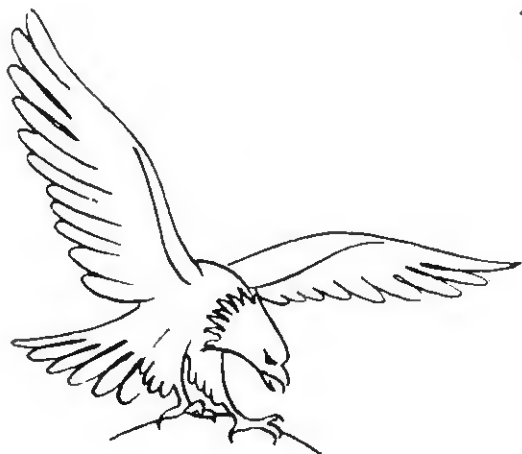

Majestic

Majestic Radio & Television Corporation
St. Charles, Illinois

Greater Values . . . Greater Profits with **HOWARD** *Radios*



New popular Howard table radio. Skillfully engineered in one and two band models. Attractive ivory or walnut plastic or wood cabinets.

TO AMERICA'S PROGRESSIVE RADIO DEALERS AND DISTRIBUTORS:

We here at Howard, with a successful background of over twenty-five years in radio, have demonstrated our ability to produce radios and radio-phonograph combinations that lead in any competitive situation.

One of the reasons why we can continue this leadership stems from the fact that many of the basic components comprising Howard Radios are designed, engineered and produced right in our own plant -- some of them under valuable patents registered in our name.

This policy of Howard engineering and production personnel working together under one roof with the most modern equipment, makes it possible to maintain the most efficient manufacturing schedules and highest degree of quality control -- factors that add up to greater value for the consumer and more profitable business for you.

HOWARD RADIO COMPANY
CHICAGO 13, ILLINOIS

America's Oldest Radio Manufacturer

**Advertised Nationally to
Millions Every Month--**

American Home, Liberty, House
Beautiful, House & Garden, Redbook,
Cosmopolitan.

21 STAR ★ FEATURES



Ready Now . . . the New 1946 EASTERN AMPLIFIERS

QUANTITY performance is the keynote of the new 1946 21-Star-Feature series of Eastern Amplifiers. Each model contains the many built-in features exclusively listed as Eastern developments and innovations.

The 21 Star Features include the new Eastern's *AMPLITUDE, a unique circuit component, insuring constant operation under all conditions—Eastern's *UNICABLE construction, eliminating the troubles associated with old-fashioned "floating" com-

ponents—Eastern's *ROTO-VUE scale dials—Eastern's "Coded Cable Wiring Harness"—and many other Eastern contributions to "Soundest Sound" values. And back of this 1946 picture stands Eastern's well-known policy of "Ethical Engineering."

For complete information and price list—for the first edition of our 1946 Catalog—write today! Eastern Amplifier Corporation, 794 E. 140th St., New York 54, N. Y.—Dept. 11A.



*U.S. Reg'n Applied For

EASTERN AMPLIFIERS

SPRAGUE TRADING POST

A FREE Buy-Exchange-Sell Service for Radio Men



THE IDEAL REPLACEMENTS FOR ALL DRY ELECTROLYTIC CAPACITOR TYPES

HELP WANTED—Radio repair man, good location and plenty of work. Culbertson Radio Shop, c/o J. E. Hoffman, Culbertson, Mont.

WANTED—Old or new electric or battery sets, good or bad, playing or dead; also new or used Aerovox model 95 L-C checker. Will sell new tubes, 6F5, 6X5GT, 35Z5GT/G, 01A, 46, 55, 2B7 or trade for 12v., 25v., 35v. and 50v. tubes of equal value. Edward Howell, Rt. 2, Dillon, S. C.

FOR SALE—Recorder with microphone, never used, \$10. Raymond Nuss, RD #1, Box 51, Doylestown, Ohio.

WANTED—50L6, 35L6, 1A7, 12SA7 tubes. Roy Goodwin, Benn Hill, Ga.

WILL TRADE—Jewell #560 signal generator, battery operated. Want late model used tube tester or typewriter. J. C. Jones, 10-C-1 Uphur Drive, Wilmington, N. C.

FOR SALE—Browning FM tuner, BL3000A with power supply, 40-54 mc. and some 2A7 tubes. Herb. Grosser, 24 Birch ave., Methuen, Mass.

WANTED—Good signal generator, recorder and recording equipment. Stanley Markowski, 420 Varick st., Utica 4, N. Y.

WANTED—Test equipment such as volt-ohmmeter, multimeter, set and tube tester. Will trade 8mm. motion picture outfit with projector, camera, films, screen, reels, etc. Also have new 50L6, 35Z5, 6A7, 35L6, etc., new radio tubes for sale. Raforad C. Styles, Brentford, S. Dak.

FOR SALE—Stancor 10P transmitter, phone and CW. Excellent condition, \$25. L. C. Chapman, Rt. 1, Columbus, Miss.

WANTED—Rider's #7 to 13, any condition. Also signal generator, tubes or other radio parts. Thomas E. Vilt, Garfield Hts. Radio & Electric, 4471 E. 131st st., Garfield Heights 5, Ohio.

FOR SALE—Radio tubes at O.P.A. ceiling, new. Send for list. Also have many condensers, resistors, PM speakers, coils, books, etc. What have you and what do you want? Andrea Radio, 107 Franklin ave., Rochelle Park, N. J.

WILL TRADE—Thirty coils, six variable condensers, audio transformers, gang switches, tubes 10, 24A, 27, 30, 32, 35, 41, 43, 47, 75, 77, 78, 84; power transformer and ear speaker. All used. Want tube tester. Truman Zook, R.R. 4, Delphi, Ind.

FOR SALE—Uickok #49 tube tester for

almost all tubes, \$25; Sterling ac-de tube and set analyzer, "as is," \$7.50; 35mm. Devry silent mp projector, \$40, or will trade for 8mm. home projector. Breakhill's Radio Shop, Republic, Mo.

WANTED—Scope transformer Inca Q-90 or equivalent. 1200v @ 10 ma., 6.3v @ 0.6 amp, 2.5v @ 1.75 amp, 6.3v winding insulated for 1500v. Bob Hamilton, 4615 W. Walker, Seattle 6, Wash.

FOR SALE—RCA and Crosley tubes U-2224 and many others. Write for list. Paul McCain, 516 Park ave., Garland, Texas.

FOR SALE—Hallcrafters 8-39 communications receiver, portable, works on battery and ac-de. New. D. Jarden, 7149 Ardleigh st., Philadelphia 19, Pa.

URGENTLY NEEDED—Tube tester, signal generator, multimeter, late models and good equipment only. Also Rider's manuals. What have you? Harold R. Ramsay, 3012 S. Hilldale, Los Angeles 7, Calif.

FOR SALE—Johnson 200DD35, split stat- or transmitting card, 202 mmf. each section, spacing .080 inches rated at 3750 volts breakdown. Also Johnson 200FD20 split stator grid condenser for use with above, 207 mmf. each section, .045 spacing rated at 2000 volts breakdown. Amateur net price was \$14. Will sell for \$10. Frank Craven, 2216 S. 7th st., Philadelphia, Pa.

FOR SALE—Two vacuum tube voltmeters; 2 Leeds-Northrup variable inductance standards; 1 Leeds-Northrup high-resistance insulation test set. Henry Wagner, 4411 Indianapolis Blvd., East Chicago, Ind.

WANTED—Test equipment and Rider's volumes 6 to 13. Write full details. G. Brokaw, Rt. 4, Box 544, Stockton, Calif.

FOR SALE—N.R.I. radio training course, \$12. Henry Bouw, DeFaction, N. Y.

WANTED—Following tubes: 9001, 9002, 815, 956, 958, 955. Pvt. William Beswick, 35978142, Co. A, 204th Bn., 63rd Regt., Camp Blanding, Fla.

FOR SALE—Complete tools and parts for radio shop including tube tester. Edwin P. Healy, 118 Leafwood road, Middlesboro, Ky.

SELL OR TRADE—Hammarlund Pro; National FB-7; public address outfit with two speakers, mike, cables and cases complete; Motorola car set; Eastman folding 3-a camera; electric hair clippers and Stanley combination plane. Glenn Watt, Chanute, Kans.

FOR SALE—Crosley Flyer, 5-tube a-c Super, table model, two bands. A-1 condition, \$35; also Majestic personal portable, with cartoned batteries, perfect, \$10. G. Samkofsky, 527 Bedford ave., Brooklyn, N. Y.

WANTED—Test equipment such as all-wave signal generator, all-purpose tube tester and/or complete radio shop. O. K. Lowther, Winokur, Ga.

FOR SALE—Used Green Flyer phono motor with turntable—110v, 60 cycle, \$6.50; pair Raytheon RK-18 transmitting tubes, \$5 ea; G-E 2 1/2" type DW52, Thermo couple type 0 to 3, R.F. ammeter, \$5.60, new. Want Rider manuals 12, 13 and 14. Jefferson Radio Service, 4105 Eddy st., Chicago 41, Ill.

WANTED—Old ham apparatus and magazines dating back to spark transmitter days. Otto Hinkelmann, 148-10 61st road, Flushing, N. Y.

FOR SALE—I.R.E. Proceedings complete, well kept, Vol. 13, 1925 to Vol. 32, 1941, with index. F.O.B. Harry A. Bremer, 43 Washington ave., Lake Hiawatha, N. J.

SELL OR TRADE—N.R.I. vacuum tube voltmeter #44GP with test leads. James W. Hoskins, 212 Middlefield road, Palo Alto, Calif.

FOR SALE—Complete set 4V-AW coil set covering from 13 to 270 meters, and 12-BS-GT tube. \$5 for both. David Strickland, 1125 N Baylen st., Pensacola, Fla.

WANTED—Oscillograph, complete, in operating condition, 3" or 5", with tubes, etc.; also good television, ham receiver, 17-tubes or equivalent. Give full information. PFC. Jos. Zukauskas, Battery C, 390 F.A.B.N., APO 94, c/o Postmaster, New York City.

FOR SALE—Genemotor, 6v input, 300v d-c output; Hollywood sound motion picture projectionist course, 20 lessons. Lem Cross, 1002 Tourmaline, San Diego 9, Calif.

WILL TRADE—2v tubes; 3, 30—5, 32—1, 33—1, 34—3, 1D5—3, 1H4—2, 1J6—1F7. All in working order. Want 4 or 6" Standard 0-1 mil. meter. A. Roberson, Box 236, Alex, Okla.

WANTED—Complete set Rider's Manuals. Thomas Fenimore, 201 York st., Burlington, N. J.

FOR SALE—10 lbs. used radio parts, coils, knobs, var. condenser, fixed condensers, tube sockets, etc., \$3. Jimmy Mowry, R.R. 22, Princeton, Ind.

WANTED—Good used radio dictionary. Milton Zipper, 364 East 94th st., Brooklyn 12, N. Y.

FOR SALE—Underwood #5 typewriter, \$50. Will trade critical tubes at list on deal. Goodwin Radio Shop, Rankin, Ill.

WANTED—Cornell Dubilier BF-50; Aerovox LC; Supreme 599; RCP 309; BCP 703; Readrite 432A. Also other test equipment, shop equipment, tubes, parts, etc. Will sell or trade new tubes in cartons. Edward Howell, Rt. 2, Dillon, S. Carolina.

5 TIMES HONORED by distinguished service citations.



YOUR OWN AD RUN FREE!

For three wartime years, the Sprague Trading Post helped radio men sell, trade or buy needed materials. Now, with the advent of Peace, this free advertising service will continue as long as the need exists.

We'll gladly run your ad free in the first available issue of one of the 5 magazines in which the Trading Post appears. All we ask is that it be written clearly and concisely, that it be confined to radio materials, and that it fit in with the spirit of this service.

As always we know we can count on you to use Sprague Condensers and Koolohm Resistors—and to ask for them by name!

HARRY KALKER, Sales Manager

Dept. RRT-115, SPRAGUE PRODUCTS CO., North Adams, Mass.

Jobbing distributing organization for products of the Sprague Electric Co.



SPRAGUE CONDENSERS

KOOLOHM RESISTORS

T.M. REGISTERED U. S. PATENT OFFICE

Obviously, Sprague cannot assume any responsibility, or guarantee goods, services, etc., which might be exchanged through the above advertisements

Here's your big, profitable tube market!

—the millions of radio owners who

HEAR

G-E programs on the air



READ

G-E magazine advertising



USE

G-E lamps and appliances



● These people all are G.E. conscious. In 7,000,000 homes they listen to programs featuring General Electric tubes and radio sets. National magazines with a total circulation of 30,000,000 give them a similar message. And everywhere they see the famous G-E monogram on lamps, refrigerators, ranges, electric irons, and other home appliances.

● YOU can profit from this big, hungry market by selling G-E radio tubes. Arrange now for a sharp increase in your tube business in the months ahead. Write for information about G-E tube selling rights to Electronics Department, General Electric Company, Schenectady 5, N. Y.



Hear the G-E radio programs: "The World Today" news, Monday through Friday, CBS. "The G-E All-Girl Orchestra," Sunday, NBC. "The G-E House Party," Monday through Friday, CBS.

GENERAL ELECTRIC

176-05-8650

With the Wholesalers

New Minneapolis Jobber Plans More Franchises

The Northwest Distributing Co. of Minneapolis has begun operation at 1012-14-16 LaSalle Ave. as a distributor of electrical appliances in Minnesota, western Wisconsin and parts of the Dakotas. It has purchased and remodeled the one-story building, with frontage of 60 feet on LaSalle and depth of 138 feet.

President and general manager of the new company is H. B. Fisher; W. R. Stephens is chairman of the board; Floyd A. Whitaker, vice-president; W. L. Grover, secretary-treasurer, and L. G. Miner, sales manager.

Northwest Distributing Co. has 168 dealers already under contract throughout the northwest and plans to increase the number to 250 or more. It wholesales nationally known and advertised lines of radios, refrigerators, ranges, and washers.

Gets Roycraft Co. Post

Announcement is made of the appointment of Joe Neuman as manager of the Columbia record division of The Roycraft Co., Minneapolis. Mr. Neuman was formerly connected with Lyon and Healy, Chicago.

Joins Lindsay & Morgan



H. R. Kreutter will handle appliance service for Savannah, Ga., distributor firm.

Named by Philco Jobber; Branch Office Moves

The W. Bergman Co., Inc., Buffalo, N. Y., distributors for Philco products, announce the appointment of Richard Levy as parts division manager. Levy returns to the firm after a leave of absence, during which he served with the Signal Corps and the Army Air Forces.

The firm's division, the Bergman Norge Co., has made public the acquisition of a new building at 94-96 Elm St., at Eagle, in Buffalo, which it is currently occupying. This branch distributes Norge appliances, Domestic sewing machines, and Simplex ironers in the western New York and northern Pennsylvania area.

Arizona Wholesaler Plans New Lines; Moves Offices

R. M. Lance, general manager of General Refrigerator Distributors, 509 W. Adams St., Phoenix, Ariz., reports that the company contemplates early addition of a line of radios, and a full line of appliances, both major and minor types. The company has moved into larger quarters, where it occupies 7,500 sq. ft. of floor space, with front display and office floor 50x65 ft.

Lines handled at present are exclusively refrigeration, namely products of Sherer-Gillett Co., Marshall, Mich.; Seeger, of St. Paul, Minn.; United Refrigerator Mfg. Co., St. Paul, and Milk Producers' Equipment Co., St. Louis, Mo. Of these, all products are for commercial refrigeration, except the Seeger line, which includes both household and commercial types.

Territory covered is the entire states of Arizona and New Mexico.

Irving Duke is president and Hal Symonds secretary-treasurer of this company. R. M. Lance, general manager, is building a sales organization and arranging for supplementary lines to distribute in Arizona and New Mexico.

Northwest Distributor Elects Vice-President

Frank C. Porter has been elected to the office of vice-president of the F. B. Connelly Co., it is announced.

The Connelly firm is northwest distributor of home appliances, houseware and hardware items serving the states of Washington, Oregon and the territory of Alaska. Included in its products are Norge refrigerators, frozen food cabinets, ranges, washers and heaters, Ironrite ironers, Majestic radios, phonographs and records.

Rejoins F. B. Connelly Co.



Lieut. (GI) F. Fanning is greeting dealers in Seattle jobber's office after 34 months in service.

Joins New York Jobber

William H. Power, Jr., formerly with the Stromberg-Carlson Co., has joined the sales staff of the Fitzsimmons Co., 123 North Water St., Rochester, N. Y.

The company is distributor in western New York for Admiral radios, refrigerators, electric ranges, home freezers, Filter-Queen cleaners, Kitchen-Maid cabinets, Automatic washers, Lonergan space heaters and a complete line of electrical traffic appliances.

His Firm Expands



Samuel Poncher, president, Newark Electric Co., New York and Chicago, announces Chicago quarters has added 7,000 square feet of floor space.

Emerson Jobber for Conn.; Franchising Plans Set

Emerson Radio of Connecticut, located in the Capitol National Bank Bldg., Hartford, Conn., has been appointed exclusive distributor of Emerson radio for this state, it is announced by Emerson Radio and Phonograph Corp. executives, J. William Jennings and Morton Cherof will be in charge of operations.

The new management states that fair and constructive policies have been completed for the equitable sharing of merchandise by Connecticut dealers as rapidly as it becomes available. Plans are completed for the granting of dealer franchises to qualified outlets and for the provision of all essential materials, and instructions for local capitalization on Emerson's national and local advertising campaigns.

With Southern Wholesaler

L. W. McWhinney has joined McDonald Bros., Memphis, Tenn., distributors for Philco. He will be in charge of radio parts and service for the firm. Prior to this appointment, Mr. McWhinney was with the Philco Corp. in Philadelphia, where he trained technicians from various armed forces groups.

(More jobber news on pages following)

Clarion

Masterpiece AM-FM Grand

**For the Best in
Home Entertainment**

Yes, your customers will thrill with delight when they have an opportunity to see and hear the new CLARION Radio. Whether their preference is for an impressive FM radio-phonograph combination with automatic record changer... a table model... or a sleek feather-weight portable, they will find far-reaching advances in faithful reception and full colorful tone. You can place full confidence in the name CLARION RADIO. It is a product of long experience, brought to new perfection through advanced wartime techniques.

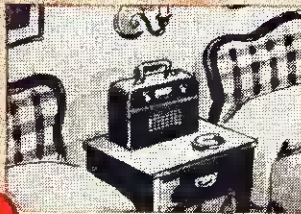
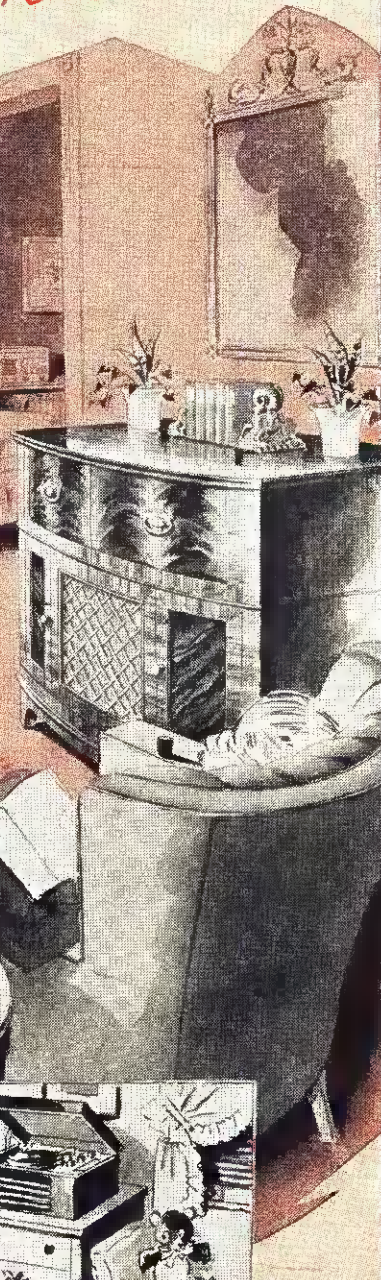

For the
Bedroom
or Den



For the New Kitchen

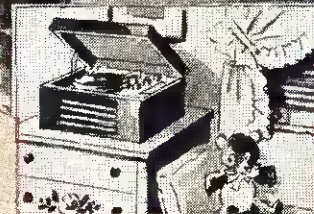

For the Living Room



AM-FM RADIOS - PHONOGRAPH
COMBINATIONS - TABLE MODELS
- PORTABLES - FARM SETS

WARWICK MANUFACTURING CORP.

4640-50 West Harrison St.

Chicago 44, Illinois

YEARS OF PROVED PERFORMANCE



Creation in Sound

Igor Stravinsky Hears New Tonal Magic in Recordings of His Own Compositions

This is creation . . .

This is the light of a thousand suns . . . the descending rumble of color as it runs the gamut of the spectrum . . . the crashing of a thousand shapes in juxtaposition.

This is the music of Stravinsky . . .

See the first light of day in the tocsin voice of the bassoon . . . the fall of night in a cataclysm of sound . . . the first moments of life itself in the passionate, rhythmic throbbing of the bass . . .

☆ ☆ ☆

Igor Stravinsky himself sits before the Meissner listening intently . . . amazed to find such tonal richness in music that is recorded . . .

Soon, in the "Rites of Spring" and other great music reproduced by your own Meissner, you like Stravinsky, will hear a quality of tone so vibrant . . . so alive . . . it will be difficult to realize that the artists themselves are not before you.

☆ ☆ ☆

Very soon, too, in addition to fidelity and clarity of tone that has been praised by Stravinsky and many other of the world's great artists, composers and conductors, you will be able to bring to your own home the complete new world of sound that is the Meissner . . . enjoy finer reception of standard broadcasts . . . thrill to the crystal clear tones of FM . . . and hear entertainment and news from the world's far places with Meissner Super-Short-

wave . . . all housed in luxurious authentic period and modern cabinets created by the nation's most skilled craftsmen.

Write the Meissner Manufacturing Company's sales offices today — 936 North Michigan Avenue, Dept. B, Chicago, Ill., for the name of your nearest Meissner dealer.

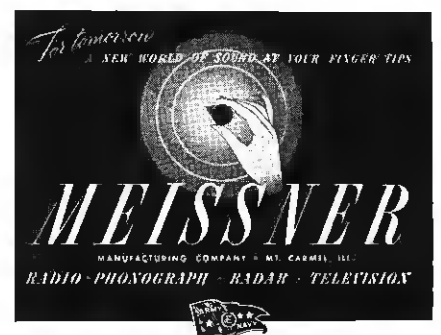

Reprint of advertisement in The Atlantic, Fortune, Harper's Magazine, House Beautiful, House & Garden, National Geographic, Town & Country



Your Community will point with pride to its Meissner Dealer

Why? Because the man who will be the Meissner dealer in your community has already established a reputation for quality and service with a clientele that appreciates the finest in any product. He has the facilities, the ability and the financial strength required to add an instrument such as the Meissner electronic radio-phonograph to his present line. He knows that the many people in his community who have responded to advertising like that shown here will naturally look to him for their postwar Meissner.

☆ ☆ ☆

You may be the Meissner dealer in your community. In many areas, Meissner exclusive dealer franchises are still available. The men who obtain these franchises will find new profits and prestige beginning now, for there is an immediate group of prospects who have been attracted to the Meissner by an extensive national advertising campaign.

If you meet the requirements outlined above, write to our Chicago office—936-B North Michigan Avenue, Chicago, Ill. today. An executive of our company will contact you at the earliest possible opportunity.

MEISSNER
MANUFACTURING COMPANY • MT. CARMEL, ILL.

Please address your inquiries
to Chicago Office:

936-B NORTH MICHIGAN AVENUE
CHICAGO, ILLINOIS

Jobber Appointments

GAROD RADIO CORP., Brooklyn, N. Y., Louis Silver, sales manager, announces the following distributor appointments: • George W. Bauer & Son, Utica, N. Y. • Electric Products Corp., Nashville, Tenn. • Chapman Drug Co., Knoxville, Tenn. • Clemons Bros. Co., Chattanooga, Tenn. • Mill Distributors Inc., Charlotte, N. C. • Monarch Sales Co., Birmingham, Ala. • Wilson Distributing Co., Columbia, S. C.

F. L. JACOBS CO., Detroit, Mich., has named the Sterling Supply Co., St. Louis, Mo., as Laundrall distributor for that area.

LEAR, INC., Home Radio Division, Chicago, Ill., Nate Hast, merchandise manager has announced the following distributors: • Brown & Halfpenny, Dallas, Tex. • Hunt-Marquardt, Inc., Boston, Mass. • Parker-Montana Co., Billings, Mont.

FRANKLIN-McALLISTER CORP., Chicago 3, Ill., has appointed the Bimel Distributing Co., distributor in the Cincinnati, O., territory for the McAllister Bagless Vacuum Cleaner.

STEWART-WARNER CORP., Chicago, Ill., announces the following as distributors of Stewart-Warner home radios: • The Treasure State Gas and Electric Co., Butte, Mont. • Arizona Mercantile Co., Phoenix, Ariz. • Central Rubber and Supply Co., Indianapolis, Ind. • Tracy & Co., Inc., Providence, R. I.

NINETEEN HUNDRED CORP., St. Joseph, Mich., has named the following distributors to handle 1900 Whirlpool home laundry equipment: • H. R. Bas-

ford Company, San Francisco, Cal. • Graybar Electric Co., Inc., Los Angeles, Cal. • Brown-Camp Hardware Co., Des Moines, Ia. • Graybar Electric Co., Milwaukee, Wis. • Edgar A. Brown, Inc., Cleveland, Ohio • Hollander & Co., Inc., St. Louis, Mo. • Porter Burgess Co., Dallas, Tex. • Home Appliance Dist. Co., Denver, Colo. • Columbia Electric & Mfg. Co., Spokane, Wash. • Edward Joy Co., Syracuse, N. Y. • Cumberland Sales, Nashville, Tenn. • Memphis Rubber & Supply Co., Memphis, Tenn. • Dale Distributing Co., New York, N. Y. • Miami Valley Distributing Co., Dayton, Ohio • Dixico, Inc., Birmingham, Ala. • Modern Distributing Co., Cincinnati, Ohio • Electric Supply Co., Tampa, Fla. • Modern Distributors, Inc., Huntington, W. Va. • M. L. Foster Co., Oklahoma City, Okla. • Modern Radio Supply, San Antonio, Texas • Good Housekeeping Shop, Columbus, Ohio • Monarch Sales Co., Indianapolis, Ind. • Graybar Electric Co., Inc., Atlanta Ga. • Palmetto Electric Supply Co., Columbia, S. C. • Pierce-Phelps, Inc., Philadelphia, Pa. • United Appliance Co., Fort Worth, Tex. • Pettit Distributing Co., Fort Wayne, Ind. • Wehle Electric Co., Buffalo, N. Y. • RCA Victor Distributing Corp., Chicago, Ill. • John J. Weis Sales Co., Inc., Scranton, Pa. • RCA Victor Distributing Corp., Kansas City, Mo. • Republic Supply Corp., Detroit, Mich. • Rhode Island Distributing Co., Pawtucket, R. I. • Robinson Distributing Corp., Seattle, Wash. • Victor Shaw Co., Charlotte, N. C. • Southwest Furniture, Ltd., Houston, Tex. • The Toledo Merchandise Co., Toledo, Ohio • H. M. Tower Corp., New Haven, Conn. • Tri-State Distributors, Albany, N. Y.

Gross Places Large Order With Stromberg

An order for a 1946 quota of home radio receivers has been placed with the Stromberg-Carlson Co., of Rochester, N. Y., by Benjamin Gross, president of Gross Distributors, Inc., New York. The order is said by the firm to be the largest yet signed in this area by any radio manufacturer. Charles M. Sherwood, eastern district merchandiser for the Stromberg-Carlson Co., represented the firm in this transaction.

"Back Door" Selling Is Bad Business, Says Shobe

Describing it as "essential to the continuance of pleasant, profitable, and proper business relations between dealers and their distributors," Cy Shobe of Shobe Inc., Memphis, Tenn., has put into effect a statement of business ethics.

"Dealers cannot retain confidence long in a distributor who cuts their throats, and throat-cutting is the polite way to describe distributors who sell at whole-

sale within a franchised dealer's trading area the product that dealers are buying through them, and stocking and displaying in accordance with the terms of his franchise," Mr. Shobe declared.

"Shobe Inc. never has sold merchandise other than to a properly franchised dealer who is in business, stocking and demonstrating the product and paying his retailer's license. However, I believe it is essential to the continuance of pleasant, profitable and proper business relations between dealers and their distributors that the dealer be assured good, honest, dependable distributor service which will protect him from even trivial instances of this unfair 'back door selling'."

New Eastern Wholesaler

A new radio and electrical appliance distributing organization has been formed in Newark, N. J., known as Electronic Distributor, Inc., 1146 Raymond Commerce Bldg., Walter Ferry, director of sales for the newly-formed firm, states that he is interested in receiving inquiries from manufacturers looking for jobbers.

RADIART VIBRATOR GUIDE (Most Complete Published)

*Makes
Vibrator Servicing
Easy!*

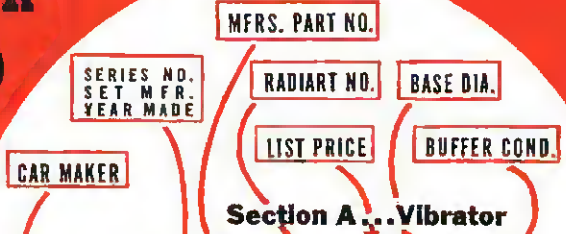
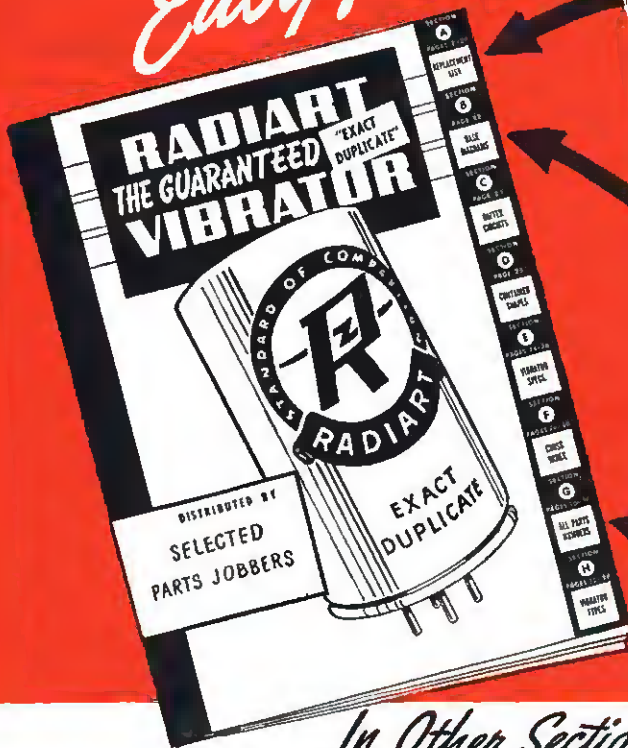

Section A...Vibrator

Name, Model No.	Mfrs. Part Number	Radiart Number	List Price	Base Dia.	Surfer Condenser
CHRYSLER					
C1808 (Elec. P. B.) (Philco—1941),...	83-0027	5326P	3.00	A	.005
25C6 (Wells-Gardner—1938),...	19A32	5437	5.95	AB	.018
600 (Mech. P.B.) (Colonial—1941),...	43697	5301	3.55	A	.004
601 (Colonial—1942),...	911545	5301	3.55	A	.004
800 (Philco—1941),...	83-0027	5326P	3.00	A	.005

Every model listed includes all available data. The correct Radiart Replacement number and other essential information is determined instantly.

SECTION "B"—Cross

Diagram Number	Shape	Voltage	Diam.	Ht.	Freq.	Identifying Characteristics	Max. Load Amps
B 3417	2	6	1 1/4	4 1/2	105	6
3815	9	6	1 1/4	4 1/2	105 Spec. Cup	6
C 5309	1	6	1 1/2	2 3/8	105	6
5331	1	6	1 1/2	3 3/8	105	6
D 4256	1	6	1 1/2	3 1/4	105	10
4256-12	1	12	1 1/2	3 1/4	105	6

In addition to conventional base diagram drawings this section is unique in that it groups all similar base types together indicating readily the differences between vibrators with the same base wiring. All characteristics are shown, including frequency and maximum load limit of each type.

In Other Sections..

Section "C"—Buffer Condenser Values and Circuits.

Section "D"—Container Shapes permitting an easy method of "visual" identification.

Section "E"—Complete Vibrator Specifications arranged numerically by number. Contains necessary data not published in any other replacement guide.

Section "F"—Long a favorite with users of this guide. The only cross-index of all other manufacturers or merchandisers of vibrators, converting their type numbers to the Correct Radiart Replacement.

Section "H"—Numerical Listing of Radiart Vibrators. Furnishes complete information as to all models serviced by each unit. Also advises year each type was originated.

SECTION "G"—Original Radiart and Original Equ.

Original Equipment Part No.	Radiart No.	Original Equipment Part No.	Radiart No.	Original Equipment Part No.	Radiart No.
75	3283	1974	5301	8539	
80-161	6421	2080	3417	8540	
82B	6341M	2110	3417	8541	
83-0017	5326P	2269	5413	8542	
83-0025	5326P	2404	5340M	8601	
83-0026	5326P	2501	5411	8602	

Another Radiart Vibrator Guide EXCLUSIVE feature. When called upon to duplicate a vibrator and no information is available except the number on the old one, use this cross-index which shows the original manufacturer's number (as stamped on vibrator) and the CORRECT Radiart Replacement.

Manufactured by the makers of RADIART Rust Proof Aerials.



Radiart Corporation

3571 W. 62nd STREET

CLEVELAND 2, OHIO

Export Division
25 Warren St., New York 7, N.Y.

Canadian Office
455 Craig St., W., Montreal, Canada

NOW AVAILABLE

FOR ALL CIVILIAN USE...



..... AT NO MORE COST THAN
STANDARD UNSEALED INSTRUMENTS

*Marion Glass-to-Metal Truly Hermetically Sealed
2 1/2" and 3 1/2" Electrical Indicating Instruments*

IMPROVED PRODUCT • APPEARANCE • PERFORMANCE • RELIABILITY
Write for details of a Marion Franchise to our
Jobber Sales Division



MARION ELECTRICAL INSTRUMENT CO.

MANCHESTER, NEW HAMPSHIRE

Jobber Sales Division: Electrical Instrument Distributing Co.
453 BROADWAY NEW YORK, N. Y.

EXPORT DIVISION • 458 BROADWAY • NEW YORK 13, N. Y., U. S. A. • CABLES: MORHANEX

Post Advertising



HAVE SPOKEN

FOR MORE YEARS,

AS new models appear, millions turn first to the advertising pages of the Post for a preview of the new radio, phonograph and television sets. Leading radio dealers know that these Post readers form the nucleus of those who are the first to buy the new and better models.

Post readers are alert to all that is new and progressive. Their living standards and incomes are high above the average. They have the money to buy the things they want.

Year after year, in every community, in every neighborhood, in every income group—Post readers are the first to buy the new and better things. They set the pace, creating and influencing the demand that establishes brand preference.

That is why leading radio dealers from coast to coast find it pays to feature brands that are featured in the Post.

THE SATURDAY EVENING
POST

*Survey after survey proves that people pay more attention to advertising in
The Saturday Evening Post than in any other magazine.*

Pages



**WITH MORE
AUTHORITY,**

**TO MORE
PEOPLE**

**WITH MORE
INFLUENCE,**

than those of Any
Other Magazine

**WAR
IS HELL**

on Batteries too!



but again

RAY-O-VAC RADIO BATTERIES
prove their dependability!

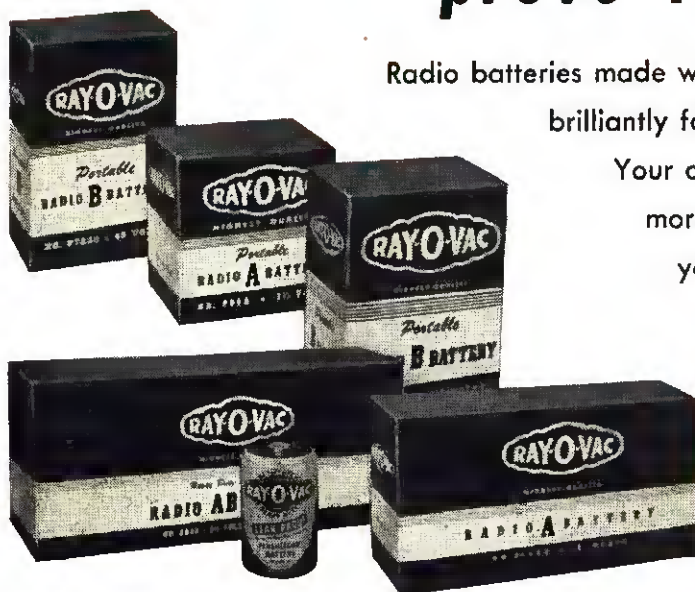

Radio batteries made with the very same cells that are performing so brilliantly for our fighting men NOW ARE AVAILABLE.

Your customers want the radio batteries that deliver more hours of dependable service — that's why you should feature war-proved RAY-O-VACS!

**RAY-O-VAC
BATTERIES**

RAY-O-VAC COMPANY, MADISON 4, WISCONSIN

OTHER FACTORIES AT CLINTON, MASS. • LANCASTER, OHIO • SIOUX CITY, IOWA • FOND DU LAC, WIS. • MILWAUKEE, WIS. • KANSAS CITY, MO.

Minimum

SERVICE CALLS



*Sales that
stay put*

MODEL 56 WEBSTER RECORD CHANGER

... as new as the Post-War Era

As you know—the amount of profit to be made largely depends on the service expense required. That's why Webster Record Changer, Model No. 56, can be depended upon for increased earnings. Also—it's easier to sell. Webster's famous name—plus new brilliance of performance and new mechanical perfection mean quick and lasting customer acceptance. The facts below tell the story.

- ✓ Perfectly crafted — highly styled — beautiful lines.
- ✓ Changes all standard records. Plays ten 12" or twelve 10" records in one loading.
- ✓ Fast change cycle—approximately 4 seconds.
- ✓ Simple, fool-proof operation. Can not be "jammed."
- ✓ Automatic shut-off after last record has played.
- ✓ Feather light needle pressure.
- ✓ Longer life for records—no cracks—no chipped edges.
- ✓ Dependable heavy-duty Webster 4 Pole motor—cushion mounted for silent operation. No audible rumble or "wow."
- ✓ Records drop quietly—velvet soft heavy-pile turntable covering.
- ✓ Installation done from top—quick, easy mounting.
- ✓ 14-inch square mounting base. Over-all depth—above and below mounting board—9 inches.
- ✓ Built for lasting performance. Practically no service calls are required.



**ASK YOUR
DISTRIBUTOR
ABOUT IT!**

KEEP UP A GOOD HABIT—BUY VICTORY BONDS

WEBSTER  **CHICAGO**

5610 BLOOMINGDALE AVENUE
CHICAGO 39, ILLINOIS

31 YEARS OF CONTINUOUS SUCCESSFUL MANUFACTURE

AMERICA'S FOREMOST RETAILING

for



FITTING A MAGAZINE TO THE RETAILER'S NEEDS

What goes on in a typical dealer's store is a valuable cue for the activities of other retailers and it is almost a directive for the publisher. He sees where and how he can give the greatest help to the retailer and deliver the greatest buying power to the advertiser.

Many radio-appliance retailers, finding it difficult to cope with a great variety of trade publications, each covering only a single phase of the industry, have expressed their preference for an overall editorial service in a single complete magazine.

As evidence of this, look at the paid subscriptions to RADIO RETAILING—more than all other radio trade papers combined, and more from independent retailers than any other trade publication in the entire radio-electrical field.

The dominant position of RADIO RETAILING is again shown in surveys made by manufacturers for their own guidance. While the manufacturers do not publicize the results, they are usually willing to interchange such information. So if you ask your friend, you will find that RADIO RETAILING is always FIRST in a survey of radio dealers and always first or second when the query goes to radio and electrical appliance dealers.

With 24,000 dealers buying RADIO RETAILING (out of 27,000 distribution), it is obvious that this magazine has something which advertisers also will buy. And they are doing so. They are keeping RADIO RETAILING at its unprecedented wartime average of more than 100 pages of advertising per issue.

A DOUBLE PREFERENCE— BY READERS AND ADVERTISERS

The dominant position of RADIO RETAILING is partly due to the fact that this magazine best meets the needs of the enterprising retailer in his MUST reading. It helps him keep his fingers on the pulse of the consumer market, keeps him alert to opportunities for the sale of additional products, enables him to sense the needs of his community or trading area, focuses his attention on the two inseparables—merchandising and servicing—and gives him a feeling of assurance that he will not miss seeing the important announcements of manufacturers. RADIO RETAILING is KEYED, precisely and authoritatively, to all of these subjects and many others.

NOW — 3 MAGAZINES IN 1

With the appearance of ELECTRICAL APPLIANCES, a special section devoted exclusively to appliances, and further development of the SERVICING section, the readers of RADIO RETAILING now have the advantage of a publishing service which, in terms of convenience and helpfulness, gives them the equivalent of three magazines in one.

SURVEY PROVES THAT RETAILERS FAVOR—

- an overall retailing magazine rather than partial publishing service.
- increasing editorial emphasis on electrical appliances.
- instructive articles for the 9 out of 10 who do their own servicing.

The following results were shown in a survey of 10,000 paid subscribers to RADIO RETAILING, representing almost half of the total subscriptions from retailers:

- Q. Do you want RADIO RETAILING to give you merchandising and servicing material —one, or the other, or both?
86% said they wanted BOTH.
- Q. Do you intend to sell electrical appliances?
93% answered "Yes."
- Q. Will you do your own servicing or have it done outside?
89% said they DO THEIR OWN.

WATCH "Radio Retailing" IN 1946 — BIG THINGS ARE COMING!

The re-styled RADIO RETAILING, with its large size, fine coated paper and new format, its new ELECTRICAL APPLIANCES Section, a magazine-within-a-magazine, and the expanded SERVICING department, are merely the first steps in a program of not-

able services to come in 1946. They will include features of vital importance to retailers in their resumption of merchandising and a comprehensive service to manufacturers in their distribution and trade promotion. To borrow from the vernacular "Ya ain't seen nuthin' yet".

PUBLICATION

RADIO *and* ELECTRICAL APPLIANCES

Keyed to all activities in the dealer's store, "Radio Retailing" is an **INDUSTRY MAGAZINE** helping the retailer in all departments
27,000 copies a month

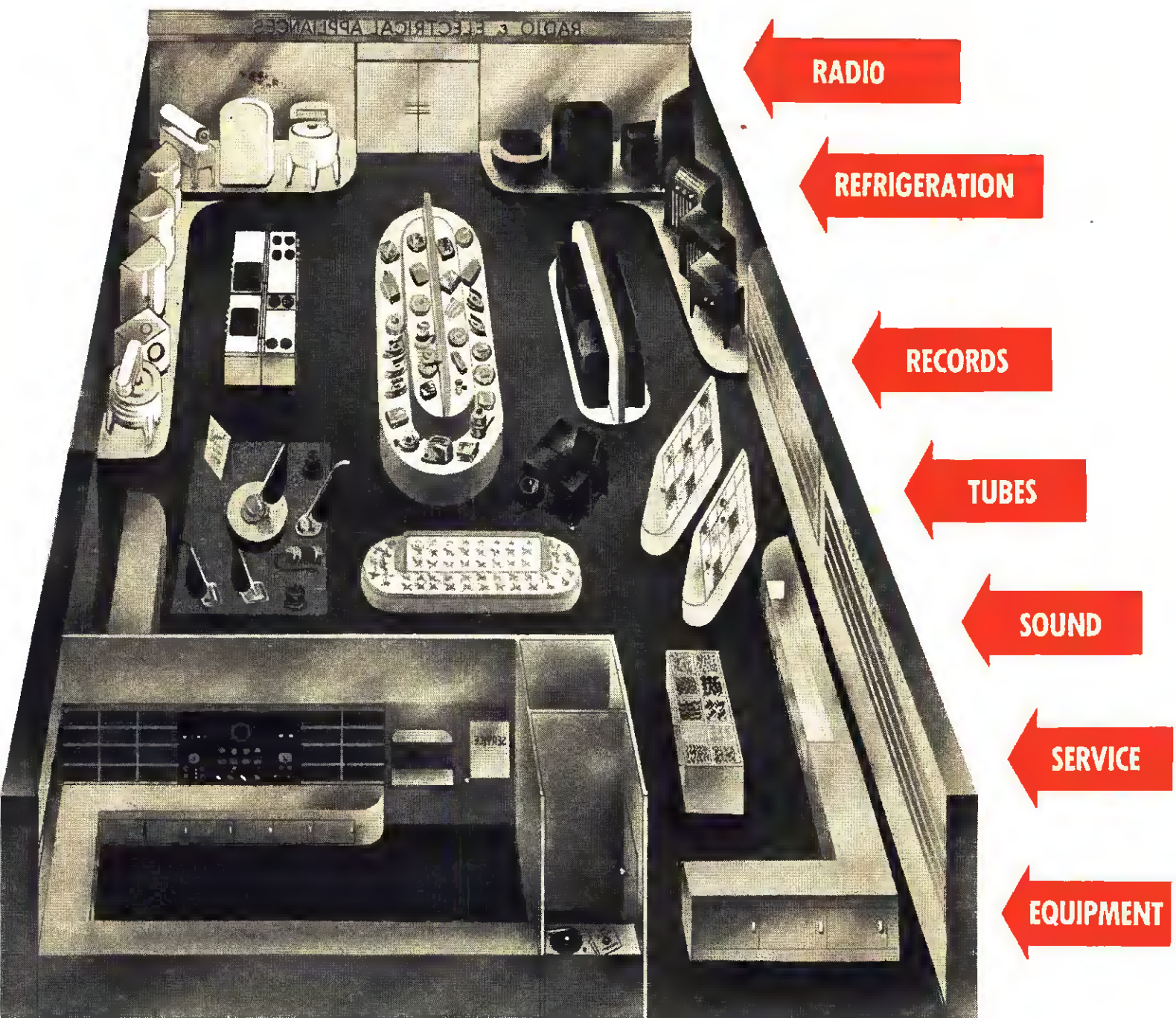

CALDWELL - CLEMENTS, INC.

480 Lexington Avenue, New York 17, N. Y., Plaza 3-1340

RADIO
Television
RETAILING

ELECTRICAL
APPLIANCES

SERVICE
& SOUND

3 magazines in one

*You've Made Money on Radio Sets,
Parts, Service, RCA Tubes—*

**NOW YOU HAVE A NEW OPPORTUNITY
WITH RCA RADIO BATTERIES—**

**The Batteries That Are Radio-
Engineered For Extra Listening Hours!**



RCA Radio-Engineered Batteries for All Types of Sets...and a Complete Line of RCA Dry Batteries.

"RCA All The Way" means even more today—for the new RCA battery line is a volume builder that can't be beat! The battery line ties in perfectly with other RCA products you sell...whether it be tubes, parts, radio sets, or your own service.

Small Inventory—In RCA radio batteries you get a high-volume line of merchandise that can be handled on a small inventory. The RCA battery line has been streamlined—only 35 types enable you to replace batteries in 99% of all battery-operated sets, both portable and farm types.

Customer Acceptance—Radio-set owners respect the name RCA. They know it represents a quarter of a century of radio experience

National Advertising Keeps RCA Products Moving—Your RCA products—including batteries—benefit from all of RCA's continuing national advertising. Top-flight sales-promotion ideas are developed to keep your RCA products moving in a steady stream from factory to your customers. Counter displays, booklets, catalogs, and many other items, will be made available to you to help sell RCA batteries.

Get in touch with your RCA tube distributor *today*. Let him help you get on the RCA battery bandwagon of profit.

MAIL THIS COUPON TODAY! 

Listen to
"THE RCA SHOW,"
Sunday, 4:30 P. M.,
EST, NBC Network



Dear Mr. RCA Tube Distributor:

I'm interested in increasing my battery profits by handling the new line of RCA Radio-Engineered batteries. Please mail me all details of the RCA battery plan as soon as possible.

Name.....

Company.....

Address.....

City.....State.....

62-6734-107

RADIO CORPORATION OF AMERICA

TUBE DIVISION • HARRISON, N. J.

LEADS THE WAY... In Radio... Television... Tubes...
Phonographs... Records... Electronics

Names in the News

DuMont Appoints Marx to Head New Division

Dr. Allen B. DuMont, president of Allen B. DuMont Laboratories, Inc., has announced the appointment of Ernest A. Marx as general manager of a new division of the organization, known as the television division. The new division will be responsible for the manufacture and sales of all television receiving and transmitting equipment, as distinct from the line of cathode-ray tubes and electronic instruments which are also manufactured.

On Bendix Ad Staff

Kenneth Davis, Robert Lowery and Gene Hill have been added to the advertising staff of Bendix Home Appliances, Inc., South Bend, Ind. The three appointees assumed their new duties under the direction of Walter J. Daily, advertising director.

Named Arvin Ad Manager

Glenn W. (Tommy) Thompson, vice-president in charge of sales for Arvin products, recently announced the appointment of Guy C. Cyr as advertising manager of Noblitt-Sparks Industries, Inc.

Proctor Personnel Change

Proctor Electric Co., Philadelphia, has named Walter Kelly district manager of the Philadelphia territory, transferring him from a similar post at Baltimore. Mr. Kelly replaces T. J. Kenna, recently transferred to the Chicago office.

Fada District Manager

Fada Radio & Electric Co., Inc., Long Island City, New York, announces the appointment of LeRoy H. Knibb as mid-western district manager with headquarters at the Drake Hotel in Chicago.

Takes Blackstone Post



J. M. Wicht named vice-president, manager, Blackstone Corp., Jamestown, N. Y.

Stromberg Promotes Frye

James A. Frye, Detroit district representative of the Stromberg-Carlson Co., has been promoted to the post of manager of radio and appliance sales in the company's Chicago branch office.

The firm's Chicago branch office distributes, in addition to its own product, Estate stoves, Blackstone washing machines, Procter appliances and the Schaefer "Pak-A-Way" home and farm freezers.

Norge Appointments

Three appointments to the company's headquarters sales staff are announced by M. G. O'Harra, vice-president and general sales manager of the Norge division of Borg-Warner Corp.

They involve three men who have been identified with the distribution of household appliances. They are: Howard L. Clary, named sales promotion manager; Harry J. Holbrook, manager of electric range sales, and John P. Morgan, southwest central regional sales manager.

Promoted by Bell Systems

Harry E. Harris, previously sales engineer, has been appointed general sales manager of the manufacturers and jobbers sales division of the Bell Sound Systems, Inc.

Rejoins Farnsworth



Capt. Pierre H. Boucheron has been appointed director of public relations for Farnsworth Television & Radio Corp.

Toastmaster Sales Heads

W. E. O'Brien, general sales manager, Toastmaster Products division, McGraw Electric Co., has announced the appointments of Harold E. Adams and Arthur S. Miller, Jr., as eastern and western sales managers, respectively, of the domestic appliance department. Both men will be located in Elgin, Ill.

Gibson Names Aarvig

Appointment of Floyd H. Aarvig as divisional sales manager for western Wisconsin, Minnesota, North and South Dakota, Nebraska, Colorado and eastern Wyoming is announced by F. E. Basler, vice-president in charge of sales, Gibson Refrigerator Co.

Emerson Sales Manager

Edgar G. Herrmann has been named sales manager of the Emerson Radio & Phonograph Corp., it was announced. Mr. Herrmann's appointment will enable Mor-



Edgar G. Herrmann

ris Rosenfeld, who has been acting sales manager, to continue as eastern regional sales manager for the firm.

Prior to this appointment, Mr. Herrmann was associated in various executive capacities with the Zenith Radio Corp.

Westinghouse Appointee

Appointment of W. S. Lefebvre, former western sales manager of the Philco Corp., as assistant sales manager of the Westinghouse home radio division, Sunbury, Pa., is announced by Harold B. Donley, manager of the division. Lefebvre will maintain offices at Sunbury.

Returns to Premier

Premier division, Electric Vacuum Cleaner Co., Inc., Cleveland, Ohio, has announced the return to the organization of V. J. Rader. Mr. Rader takes up his former post as manager of the Philadelphia division with headquarters in that city.

Heads New Aireon Office

Jack Kaufman has been named a vice-president of the Aireon Mfg. Corp., according to announcement by Randolph C. Walker, president.

Kaufman recently joined the organization to head the new San Francisco office, which has been opened on the Coast.

THEY'RE HERE!

THE FINEST

MODEL E-512
Table Model AC-DC

RADIOS EVER



MODEL E-514
Table Model AC-DC

TO BEAR THE

TEMPLE NAME

MODEL E-511
Table Model — Radio-Phonograph

Yes, Temple is on the job — the job of making the finest radios ever to carry this famous name. Soon the *complete* Temple line — from handsome table models to magnificent radio-phonograph combinations will come forth to set new

standards of performance and eye appeal.

It pays to team up with Temple!



TEMPLE TONE RADIO MFG. CORP., New London, Conn.

EXECUTIVE OFFICES: 220 East 42nd Street, New York, N. Y.

FM... TELEVISION... RADIO-PHONO' COMBINATIONS

"FM that also means Finest Made"



Your IRC Distributor is now prepared to furnish you with all of the many types of resistance devices you most frequently need in your electronic servicing and installation work.

Months ago IRC made plans and preparations to provide you with ample quantities of quality controls and resistors immediately civilian restrictions were eased or abolished. Today, the results of those plans can pay off in added profits for you.

Every Cataloged Item in Stock

Every item shown and described in IRC's new Service Catalog No. 50 is now either on your Distributors' shelves or can be obtained for you practically over-night. This is possible because of newly created Servicemen's Stock Room recently set up at the IRC plant. That this stock will be kept well supplied is assured by IRC's tremendous production capacities which were stepped up to an all-time high to meet heavy war quotas.

If you do not have your copy of the new IRC Service Catalog No. 50 get one from your Distributor today or write direct to Dept. 21-K.



INTERNATIONAL RESISTANCE CO.

401 NO. BROAD STREET • PHILADELPHIA 8, PA.

IRC makes more types of resistance units, in more shapes, for more applications than any other manufacturer in the world.



THIS NEW MIGHTY MIDGET



No. 412

has changed the lives of this whole family of "MINI-MAX" BATTERIES



No. 482



No. 467



No. 420

The four batteries shown above are approximately $\frac{2}{3}$ of actual size

EVEN BEFORE PEARL HARBOR, battery construction principles developed by National Carbon Company were making possible new strides in portable radio and electronic equipment. Then came the war. The company was called upon to develop even more radical improvements in battery construction to meet the needs of light and extremely portable military communications of all types, and so the tiny 22½ volt "Eveready" "Mini-Max" "B" battery was born—a battery well under half the size of anything of comparable voltage—easy to carry as a match box!

This is what this new, improved battery construction means. It means a brand new line of portable radio equipment—equipment that will give the idea of the "personal radio" an entirely new meaning. It makes possible radio sets for individual use—sets so small that they can be slipped into the pocket of a vest, or carried in a woman's handbag. Portable radio business will not merely pick up where it left off December 7, 1941. It will be years ahead of itself.

Engineers and designers are already aware of the possi-

bilities of this new battery. They are already at work on new radio and electronic devices which exploit its portability. And at this time may we invite all these creative men to avail themselves of our experience, our laboratories and to consult with our engineers. National Carbon Company, Inc. extends to you complete cooperation.

The words "Eveready" and "Mini-Max" are registered trade-marks of National Carbon Company, Inc.

Now that radio batteries are back again, National Carbon Company is offering an extremely useful new Portable Radio Battery Replacement Guide. Write for your copy today to our nearest Division Office listed below.

NATIONAL CARBON COMPANY, INC.

Unit of Union Carbide and Carbon Corporation

General Offices: NEW YORK, N. Y.

Division Sales Offices: Atlanta, Chicago, Dallas, Kansas City, New York, Pittsburgh, San Francisco.

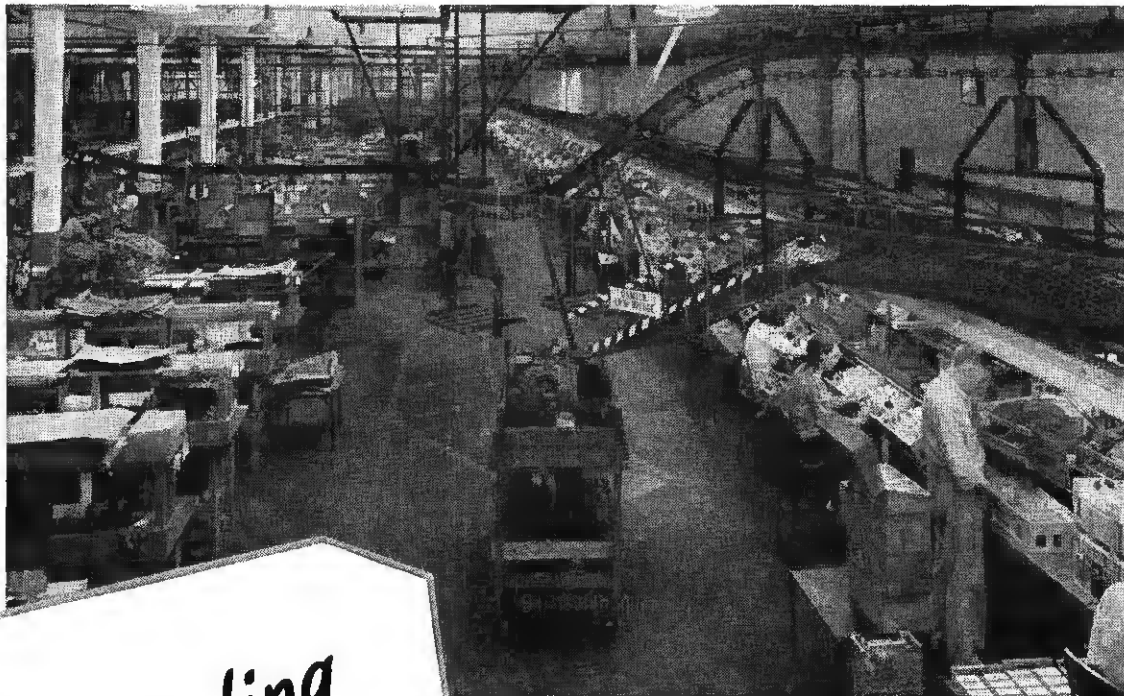

Heading
your way
SOON

SPARTON IS READY!

HERE'S NEWS! News of first importance to every one who owns, or expects to own an *exclusive* Sparton Radio franchise!

Sparton will be shipping radios—soon. *A lot of them!*

Superb Consoles, Table Models and Radio-Phonograph Combinations—all with new and exciting features! Many equipped for FM.

A steady flow of production is assured with five completely modern plants plus the addition of a high-quality cabinet factory.

Sparton is ready! But—*remember*—all Sparton Radios are sold under the SCMP (Sparton Cooperative Merchandising Plan) to *one* dealer in each community.

If you are interested in being the *exclusive* Sparton dealer in your community, write Ed Bonia, Sales Manager, The Sparks-Withington Company, Jackson, Michigan.

THE SPARKS-WITHINGTON CO., JACKSON, MICH.

SPARTON

RADIO'S RICHEST VOICE SINCE 1926

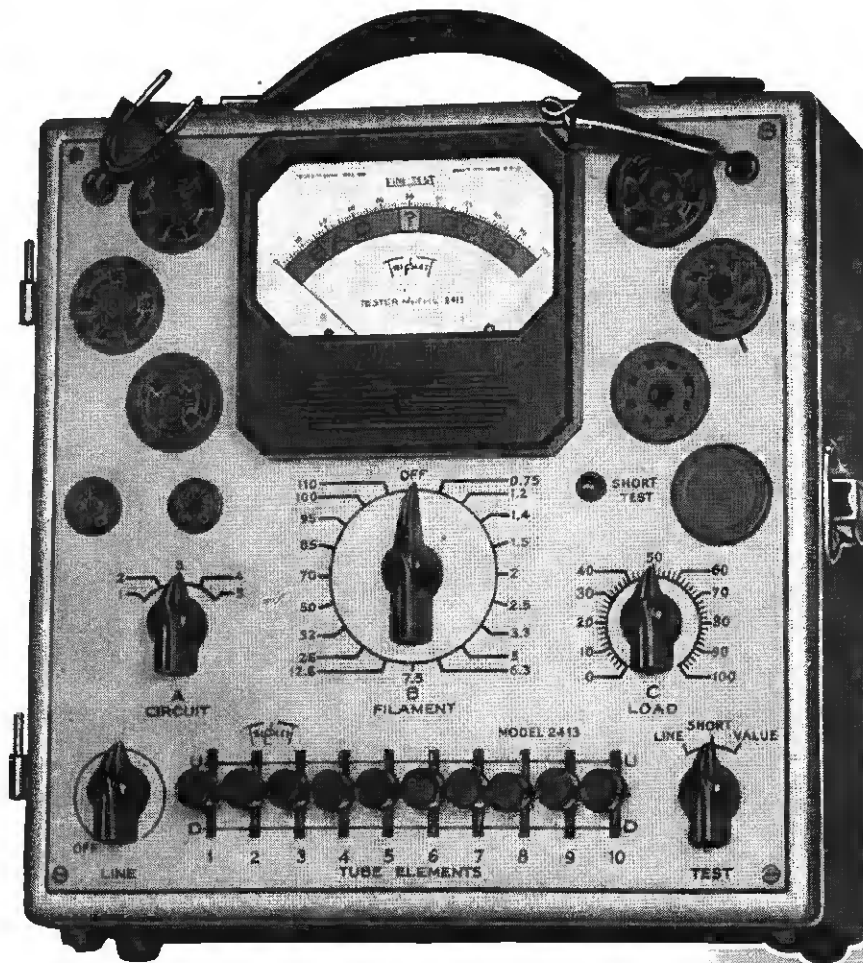

**MODEL
2413**

T
is another
member of the
NEW TRIPLETT
Square Line

The New Speed-Chek Tube Tester

MORE FLEXIBLE • FAR FASTER • MORE ACCURATE

Three-position lever switching makes this sensational new model one of the most flexible and speediest of all tube testers. Its multi-purpose test circuit provides for standardized VALUE test; SHORT AND OPEN element test and TRANSCONDUCTANCE comparison test. Large 4" square RED • DOT life-time guaranteed meter.

Simplicity of operation provides for the fastest settings ever developed for practical tube testing. Gives individual control of each tube element.

New SQUARE LINE series metal case 10" x 10" x 5½", striking two-tone hammered baked-on enamel finish. Detachable cover. Tube chart 8" x 9" with the simple settings marked in large easy to read type. Attractively priced. Write for details.

Additional Features

- Authoritative tests for tube value; shorts, open elements, and transconductance (mutual conductance) comparison for matching tubes.
- Flexible lever-switching gives individual control for each tube element; provides for roaming elements, dual cathode structures, multi-purpose tubes, etc.
- Line voltage adjustment control.
- Filament Voltages, 0.75 to 110 volts, through 19 steps.
- Sockets: One only each kind required socket plus one spare.
- Distinctive appearance with 4" meter makes impressive counter tester—also suitable for portable use.



Triplet

ELECTRICAL INSTRUMENT CO. BLUFFTON, OHIO

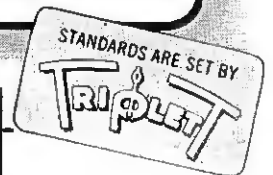

**Watch Sonora
Go Places!**

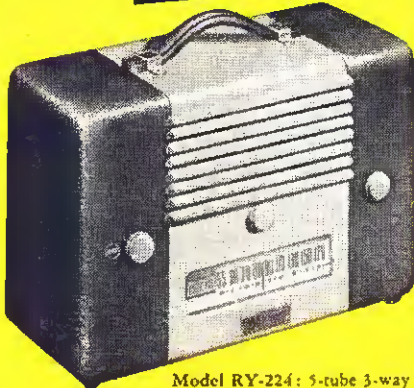

Model RY-224: 5-tube 3-way superhet red and tan luggage type portable. Works from self-contained batteries, or 110 volt AC or DC circuit. Big dynamic speaker gives "Clear as a Bell" tone of a fine home radio, anywhere, any time.



Model RJR-214: 5-tube AC Table Model Phono-Radio with automatic record changer that's swift, sure, silent. Plays ten 12" or twelve 10" records for 35 minutes of thrilling listening. Featherweight crystal pickup. Permanent needle. Dynamic speaker. Automatic volume control. Distinguished styling.

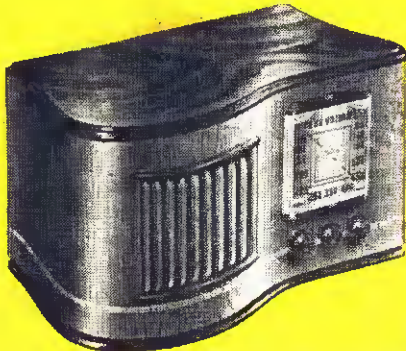

Model RCU-208: 6-tube AC-DC superhet table model, in distinctively styled walnut cabinet. Newly perfected patented chassis circuit gives astounding big set reception that sounds like a console!

SONORA MEANS SATISFIED CUSTOMERS

No matter where today's radio customers live, they're from Missouri when it comes to buying new radios. They say "Show me." They demand proof of performance, proof of tone quality.

Sonora delivers that proof, with a complete line of outstanding new radios like the three shown here, radios that actually demonstrate tone superiority. That's important, because it's *tone* that makes the sale!

Powerful Sonora advertising is telling the world about Sonora's "Clear as a Bell" tone, boldly inviting your customers to compare any Sonora for tone with any other radio in its price class. It's a challenge, and Sonora radios back up that challenge with proof . . . with the famous Sonora tone that's "Clear as a Bell." That's why Sonora means business—good business—for you! SONORA RADIO & TELEVISION CORP., 325 North Hoyne, Chicago 12, Illinois.

THE RADIO QUESTION OF THE MONTH

Asked by Sonora Dealer Richard Hirsch, Hudson-Ross, Inc., Chicago.

Answered by Mr. Joe Gerl, president of Sonora.

Q.: In the new market, what will be the proportion of sales between straight radios and combinations?

A.: Before the war sales of combinations were about ten per cent of the total. I estimate that future phono-radio sales will amount to 70% of the total, while the balance will be portables, small models as extra sets, and various novelty units.

Joe Gerl

Sonora 
Clear as a Bell

HOME ENTERTAINMENT AT ITS BEST

RADIOS . . . FM COMBINATIONS . . . TELEVISION SETS . . . RECORDS . . . PHONOGRAPHS . . . RECORDERS

RADIO *& Television* RETAILING's* Annual RADIO TRADE DIRECTORY

Now in Process

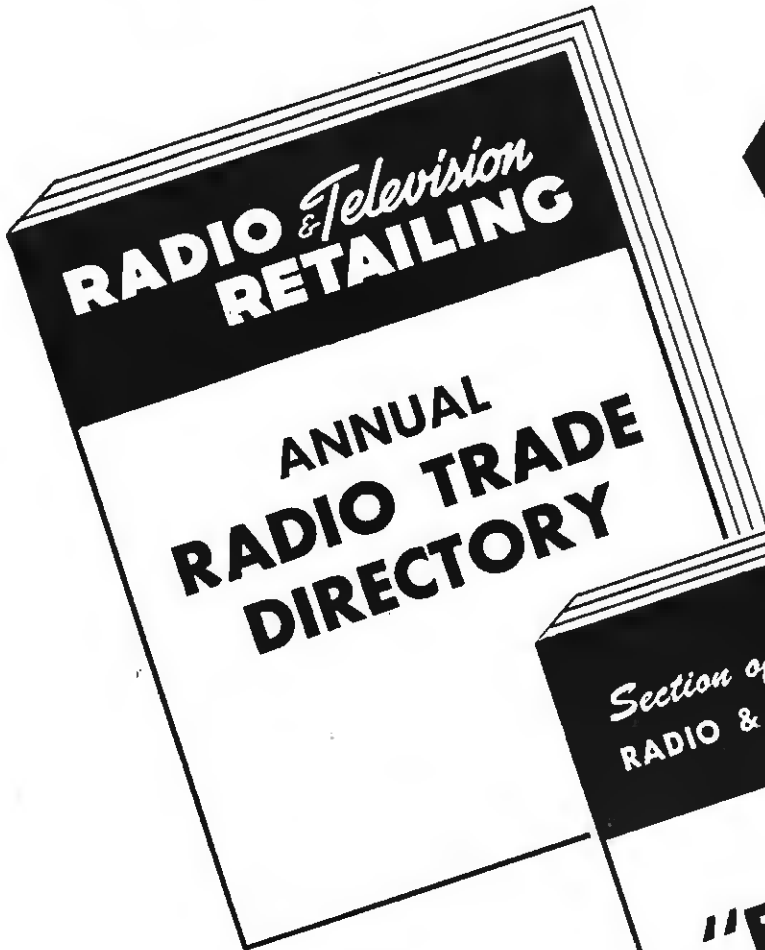

← The first — and original — RADIO TRADE DIRECTORY, published by RADIO RETAILING for twenty years will make its re-appearance early in 1946. With a guaranteed circulation of 27,000, it will have the largest distribution of any radio directory serving the industry.



→ Now, the original RADIO TRADE DIRECTORY will be joined by its twin section "ELECTRICAL APPLIANCES" DIRECTORY, which will also be published in the same issue. Two big directories by the trade's leading publishers for 20 years.

*"Retailing" used in connection with "Radio" is registered in the U. S. Patent Office, and is the exclusive property of Caldwell-Clements, Inc., publishers of RADIO & Television RETAILING and its magazine-within-a-magazine ELECTRICAL APPLIANCES. Do not confuse this with any other retailing directory.

Caldwell-Clements, Inc. 480 Lexington Avenue, New York 17—Plaza 3-1340

Cleveland 14

Chicago 6

Los Angeles 14

San Francisco 4

Edgar Riedel Resigns from Raytheon

Edgar S. Riedel, for 13 years general sales manager of the receiving tube division of Raytheon Mfg. Co., Newton, Mass., has announced his resignation from the firm.

Mr. Riedel is nationally known in the field of radio distribution, advertising and sales. He was one of the nine original organizers of the Radio Manufacturer's Assn. at Chicago in 1923.

"Eddie" Riedel has been engaged in radio merchandising since the first day of



Edgar S. Riedel

broadcasting, when he manufactured Thorola sets, parts and speakers. During the first four years of broadcasting, he manufactured and marketed over two million Thorola and Thorophone horn type loud speakers.

During the "B" eliminator days for Raytheon, as general sales manager, he was active in licensing the 45 manufacturers who built their "B" eliminators around the firm's BH gaseous rectifier, which at that time was the company's only product. This was the first step toward AC radio sets. After, Mr. Riedel aided in establishing Raytheon's first replacement sales policy through jobbers whose outgrowth composes the firm's present replacement tube distributors.

During the period that National Carbon had an option to buy Raytheon, and handled its tube sales, marketing 4 pillar radio tubes under Eveready-Raytheon's name, Mr. Riedel resigned and accepted the position as vice-president and general sales manager of Utah Radio Products Co., Chicago.

In 1933, when National Carbon Co. canceled its contract with Raytheon, giving up its option and receiving tube sales were turned back to Raytheon, Eddie Riedel rejoined Raytheon as its general sales manager, which position he has held until his present resignation.

GE Sales Manager

Ralph J. Mowry has been named sales manager of General Electric's Newark, N. J., appliance distributing branch.

DELICIOUS & Refreshing
Chiclets

AERVOX
HI-FARAD
DRY
CONDENSERS
TYPE
PBS
12
989
450

A 450-volt 12 mfd. Aerovox Type PBS cardboard-case electrolytic. Note size comparison.

A 450-volt 8 mfd. Dandee or midget metal-can electrolytic, compared with a book of matches.

Space and Money SAVERS

● They're available again, those extra-compact low-priced Aerovox electrolytics, for radios that must last a while longer. Type PBS cardboard-case electrolytics pack a lot of capacitance into small bulk, while the Adjustmount feature permits handy mounting or stacking. And where a metal-can job is preferred, there are Dandee midget electrolytics. Either type can squeeze that extra measure of capacitance and working voltage into the tightest chassis for top-flight performance. ● Order an assortment from your Aerovox jobber. Ask for latest catalog. Or write us direct.

AERVOX



Capacitors

INDIVIDUALLY TESTED

AERVOX CORPORATION, NEW BEDFORD, MASS., U. S. A. • SALES OFFICES IN ALL PRINCIPAL CITIES
Export: 13 E. 40 ST. NEW YORK 16, N. Y. • Cable: 'ARLAB' • In Canada: AERVOX CANADA LTD., HAMILTON, ONT.

OHMITE RESISTORS

+
Your Guide to
**DEPENDABLE
RESISTANCE
CONTROL**

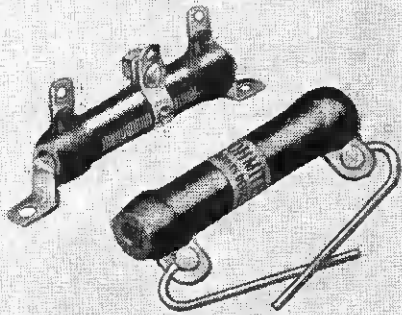

The service-record of Ohmite Brown Devil and Dividohm Resistors before and during the war . . . is your best guide to resistance-control now. Ohmite construction insures long, trouble-free performance . . . makes these units favorites for the best in resistor replacement.

Write for Stock Unit
Catalog No. 18

Authorized Distributors Everywhere



OHM'S LAW CALCULATOR

Figures ohms, watts, volts, amperes...easily. Solves any Ohm's Law problem with one setting of the slide. Send only 10c in coin.

OHMITE MANUFACTURING CO.
4873 FLOURNOY ST. • CHICAGO 44, U. S. A.

Be Right with **OHMITE**
RHEOSTATS • RESISTORS • TAP SWITCHES

Distribution Plans Told at Electromaster Meeting

Details of the new distribution and sales program for Electromaster electric ranges and water heaters were announced by Gerald Hulett, vice-president of the company, at a meeting of district managers.

The meeting, opened by Electromaster President R. B. Marshall, was attended by the following:

Leonard Leavis, whose territory covers most of New England; H. K. Dewees, representative for the majority of southern cities between Atlanta and Miami; Earl Sigler, the Texas-Louisiana sales district; P. L. Miles, who handles the middlewest area; F. E. Drouillard, representing Detroit and Michigan; Albert M. Solen, of the Denver-to-Phoenix territory; Thomas Fielder, whose district includes south Texas and part of Oklahoma; Alex Kuehlthau, representing the northwest; Ben Sanderson, whose territory embraces the state of California; Edward Kramer, of the Iowa-Nebraska territory, and David Kirk, whose district covers Missouri.

H&S Distributing Co. Names Sales Manager

Arthur A. Gerbig has been appointed sales manager of the H&S Distributing Co., of Philadelphia, according to an announcement by Alex Haberman, president. Gerbig's efforts will be directed toward the sale of the Lear home radio and Learecorder line, which is being handled exclusively by H&S in the Philadelphia territory.

Eureka Appoints Noble

Frank Noble has been appointed sales promotion manager of the Eureka division of Eureka Vacuum Cleaner Co., it is announced by George T. Stevens, vice-president and manager of the division.

Noble will be in charge of all sales promotion activities and display materials for the Eureka division.

Sponsoring Radio Shows

Nash-Kelvinator Corp. is presenting a new radio show Wednesday evenings featuring the Andrews Sisters and heard over the Columbia Broadcasting System. Electric Auto-Lite Co., makers of batteries and other electrical goods, is sponsoring "The Dick Haymes Show" Saturday nights, also over CBS.

Kelly Rejoins Roycraft

When Col. J. E. Kelly got back to his pre-war job as district sales supervisor for The Roycraft Co., after many months overseas, his first call brought him face to face with Ted Nelson, whom he had not seen since the African invasion. Nelson is now working in the radio service department at Johnston Bros., Philco dealers at Lake and Nicollet, Minneapolis.

Col. Kelly is at present visiting Philco dealers throughout the state of Minnesota.

Employees Share Bonds



W. J. Halligan, left, Hallicrafter Co. president, presents \$1,300 in war bonds to returning veteran as his share of company's purchase for its employees in service.

Proctor Appointments

J. C. Ivy has been appointed Denver district manager, by Robert M. Oliver, vice-president of the Proctor Electric Co.

Mr. Ivy's territory will be under the jurisdiction of Lt. Col. Charles P. Culbert, western regional sales manager.

Pressed Steel Car Co. to Make Appliances

Pressed Steel Car Co., Inc., intends to manufacture a full line of major appliances. The electric range will be produced first, to be followed by the other appliances as their facilities are made available. All products will be sold through distributors.

Farnsworth Appoints

The Farnsworth Television & Radio Corp., Fort Wayne, announces the following recent appointments as one of the steps in its postwar program:

E. S. Needler has been named manager of the special products sales division with headquarters in the company's general offices at Fort Wayne.

R. L. Colfax has been promoted to the position of general purchasing agent.

A. E. Sibley becomes divisional manager for Capehart's east central territory where he will supervise sales and distribution in a region embracing sections of Ohio, Pennsylvania, New York and West Virginia.

Wilfred H. Bryant has been appointed credit manager, replacing Mr. Sibley.

Frank Harris has been appointed export manager for the company.

Admiral Telecasts

Admiral Corp. has returned to the television air waves and is again presenting its video series "Young Chicago" over station WBKB. The performers on this program have been taken from Chicago public schools with the intent to develop these youths into future television stars. The telecast is seen Thursdays at 8 p.m.

"Miracle" in Production; New Products Planned

J. Meyer Friedman, president, Miracle Electric Co., announces that the Miracle table appliances and vacuum cleaners are in production and that complete production will follow as quickly as materials are available.

New products the firm plans include all-metal automatic coffee makers of vacuum and drip type, a food mixer with built in power unit and governor controlled 12-speed motor, a portable food mixer, two automatic electric irons, a steam iron that can be used wet or dry, both an electric and a non-electric vacuum cleaner. A waffle iron, toaster, automatic hot plate, two burner plate, and three different type massagers complete the line.

Universal Factory Rep

V. Hutto has been appointed Georgia factory representative for the Universal Microphone Co., Inglewood, Calif. He will work out of the Atlanta, Ga., office of Stan Wallace, factory rep of Lutz, Fla.

Free Burgess Catalogs

A new, more complete guide for the replacement of all radio batteries has been issued by Burgess Battery Co., Freeport, Ill. It is available free by writing to the factory, department RG.

The guide combines a listing of the correct replacement batteries for portable and farm radios. It also includes a listing of the private brand portables. Many new manufacturers are listed, and the number of sets covered exceeds 1,000. Also available is a numerical and alphabetical listing of all Burgess Battery products, which enables a quick identification of any stock number.

Takes Emerson Post



Commander Herbert C. Outerman, on terminal leave from the Navy, has been appointed executive assistant to the president of Emerson Radio and Phonograph Corp.

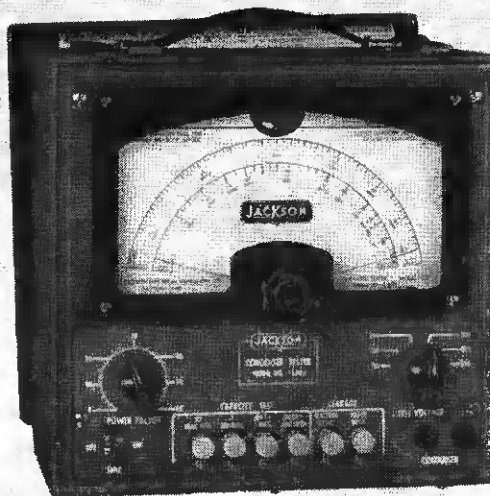

CONDENSER TESTER

Model 650-A

RANGE—.00001 to 1,000 mfd.

Automatic Push Button Controlled—Amazing in speed and simplicity of use. Capacity readings almost instantaneous! Leakage test by just pressing a button.

The Model 650 is a modern, accurate and complete instrument for detecting faulty condensers—ELECTROLYTIC, PAPER or MICA.

Scale is glass enclosed and is equipped with SCALE EXPANDER indicating pointer—doubles effective scale length.

Measures all values direct reading in Microfarads.

Ranges

.1	to 100 mfd.	.001 to .1	mfd.
.00001	to .001 mfd.	50	to 1000 mfd.

Measures power factor on direct reading dial. Power Factor range calibrated from 0 to 60%.

Complete selection of test voltage. 20 volts to 500 volts.

Electron ray tube indicates exact balance or shows if leakage is present.

Instantaneous leakage indication—No guess-work with this modern tester. Has

built-in amplifier stage which responds to slightest leakage, if present.

Dimensions—8½" x 8½" x 6"—Unit welded steel, finished in grey morocco. Equipped with removable hinged metal lid and completely equipped with tubes, test leads and ready to operate.



The Jackson "Service Lab"

When steel again becomes plentiful, standard size Jackson instruments will be available conveniently assembled in a complete testing unit.

BUY WAR BONDS



AND STAMPS TODAY

JACKSON

Fine Electrical Testing Instruments

JACKSON ELECTRICAL INSTRUMENT COMPANY, DAYTON, OHIO

**MAKE
IT
MOVE**



**with
ALLIANCE**

Thousands of Alliance "Even-Speed" phonomotors are now leaving the high speed production lines of Alliance every day. We've done our best, during the war years, to keep all of our customers supplied despite the limited quantities military production permitted us to make. But now we're reconverting, stepping up production and quality beyond any previous peak . . . to give you the best, most dependable motor we've ever made! So plan now to drive your turntables, recorders and combination record changers with Alliance Phonomotors!

WHEN YOU DESIGN — KEEP
alliance
IN MIND

ALLIANCE MANUFACTURING CO.
ALLIANCE, OHIO

Universal Cooler, Utah Merge Into Detrola

The merger of Universal Cooler Corp., Marion, Ohio, and Utah Radio Products Co., Chicago, into International Detrola Corp. has been approved at meetings conducted by all three companies.

The merger unites companies with a total of 9 manufacturing plants in this country and in Canada. The products of these plants include home and automobile radio receivers, loud speakers and other radio component parts, commercial refrigerating units, domestic refrigerators and furniture cabinets.

Reelected by Farnsworth

At the annual meeting of the Farnsworth Television & Radio Corp. the following officers were reelected for the coming year: E. A. Nicholas, president; Ernest H. Vogel, vice-president in charge of sales; Edwin M. Martin, vice-president and secretary; B. Ray Cummings, vice-president in charge of engineering; J. P. Rogers, vice-president and treasurer; Paul H. Hartmann, assistant treasurer, and Fred A. Barr, assistant secretary.

The resignation of Philo T. Farnsworth as a vice-president of the company was accepted. It is announced that he will continue as a director.

Join E-L Sales Staff

John W. Cyler and F. Theodore Hegeman are new additions to the sales department of Electronic Laboratories. Cyler has been in charge of the order department. Hegeman will represent the firm in each of its sales fields, according to Walter E. Peck, vice-president and sales manager.

Get First Belmont Sets

The first radios manufactured by the Belmont Radio Corp., Chicago, to be delivered to the Minneapolis, Minn., area, arrived by airplane. Charles M. Hofman, Belmont executive, delivered this plane load of 5-tube Coronado sets to retail stores in the Twin-Cities district.

Jobbers Visit Stromberg

Among the radio distributors of the Stromberg-Carlson Co. who recently visited the firm's plant at Rochester, N. Y., were: Henry O. Berman, president of the firm bearing his name, Baltimore, Md.; Edward Huletz, president of Huletz Electrical Co., Seattle, Wash.; and K. J. O'Brien of the Island Supply Co., Grand Island, Neb. The distributors were shown advance 1946 models of the company line by Clifford J. Hunt, manager of radio sales.

Named Garod Ad Manager

Joseph G. DeVico has been appointed advertising manager of the Garod Electronics Corp., Brooklyn, N. Y., according to an announcement by Louis Silver, sales manager.

Receiver Sales Head



John S. Mills, general sales manager of New York's Teletone Radio Co. S. W. Gross is president. The firm is making small sets and combinations.

Treasury Dep't Sponsors Video Shows in Chicago

A series of specially prepared Treasury-sponsored television victory bond half-hour programs is being beamed direct to the students in Chicago's public schools each Wednesday afternoon.

Using the facilities of the B & K Television system, the Victory bond programs will be broadcast over WBKB, and will, in addition to the Chicago public school receivers, be seen by a bond-buying audience at the television screens, Treasury Center, Commonwealth Edison Bldg.

Olympic Dealer Meetings

A series of nation-wide dealer meetings scheduled by the Hamilton Radio Corp., maker of Olympic radios, are being held at Hartford, Conn., to be followed by sessions in 23 other distributor cities, including New York. A second series of meetings will be held early in 1946 to cover the remaining 48 distributing centers.

The meetings, being conducted in conjunction with the 72 Olympic distributors throughout the country, are under the direction of John F. Crossin, director of sales, who is being assisted by Charles E. Staudinger, executive vice-president of Sherman K. Ellis & Co., Inc., Hamilton's advertising agency.

Joins American Central

The appointment of W. Graham Riley as district manager in Chicago, for American Central Mfg. Corp., is announced by C. Fred Hastings, general sales manager of the Connersville, Ind., firm.

Chicago Sales Rep

Arthur A. Foosner has been appointed sales representative for the Chicago area by Quam-Nichols Co., 33rd Pl. and Cottage Grove Ave., Chicago, Ill., manufacturers of radio speakers and equipment.

Atomic Radio Retailer!

When news of the atomic bomb broke to the public, George Laszlo, president of the radio and electrical appliance store at 2 E. 33 St., New York, changed his establishment's name to Atomic Radio & Television Co., Inc.

"I feel that the word 'atomic' in our name has good advertising value," Mr. Laszlo said. "Already, the store's title has created considerable interest."

The firm has signed several franchises for many well-known brands and will carry full lines of radios, electrical appliance and records.

WABD Halts Telecasts; Shifting to New Channel

DuMont television station WABD has discontinued broadcasts until December 15 while the station shifts from its former channel 4 (78 to 84 megacycles) to the new channel No. 5 (76 to 82 megacycles), Leonard F. Cramer, executive vice-president of Allen B. DuMont Laboratories, Inc., announces. Permission for the move has been granted by the FCC.

"The promptness of the FCC's action will permit television receiver production to go ahead more quickly and will obviate the necessity of modifying the tele-sets first produced in the reconversion period," Cramer said.

News from "Rep" Chapters

Three chapters of the Representatives of Radio Parts Manufacturers, Inc., have recently added new members to their rosters, as follows: Los Angeles chapter: John B. Turbegen, 1406 S. Grand Ave., Los Angeles 15. The California chapter has accepted the membership application of T. M. Graner who is associated with the W. I. Otis & Co., the head and founder of which recently passed away. O. N. Jones of 1085 The Arcade, Cleveland 14, O., has joined the Buckeye chapter. Jerry W. Miller of 5917 S. Main St., Los Angeles 3, Calif., has become an associate member of the Los Angeles chapter.

At a recent meeting of the Wolverine chapter, the following new officers were elected for the ensuing year: president, H. E. Walton; vice-president, J. P. Davenport, and secretary-treasurer, Robert Misk. The Hoosier chapter made the following choices: president, Leslie M. DeVoe; vice-president, Chuck Southern; treasurer, Bruce McPherson, and secretary, Bud Fisch.

Martin Friedman, a member of the Mid-Lantic chapter, has moved his office to Room 1504 Real Estate Trust Bldg., Philadelphia 2, Pa.

Mueller Company Expands

Mueller Electric Co., Cleveland, Ohio, manufacturers of battery and test clips, is planning an expansion program which will add about one-third to its present manufacturing space. As a step in this direction, the construction of a new plating and finishing plant has begun.

WOLVERINE

Manufacturers of
RADIO, ELECTRICAL AND
ELECTRONIC COMPONENTS

ELECTRONIC PRODUCTS MFG. CORP.
DEXTER, MICHIGAN

NEW SOLDERING GUN

THE SPEED IRON*



Patent Applied For
100 Watts 115 Volts 60 Cycles

Soldering Heat in 5 Seconds

Wherever you have a soldered joint in radio, electrical or electronic repair and service work, the Speed Iron will do the job faster and better.

The transformer principle gives high heat—in 5 seconds—after you press the trigger switch. Convenient to hold with a pistol grip handle, the compact dimensions of this new soldering tool permit you to get close to the joint. The copper loop soldering tip permits working in tight spots. The heat is produced by the high current flowing through the soldering tip—permitting direct and fast transfer to the soldered connection.

If you want to save time on soldering jobs with a tool that is ready to use in 5 seconds, get a Speed Iron today. See your radio parts distributor or write direct.

*T.M. Reg. U. S. Pat. Off.

WELLER MFG. CO.

DEPT. RR-1 • EASTON, PA.

A Better Selection of

RADIO CABINETS & PARTS

from LAKE!

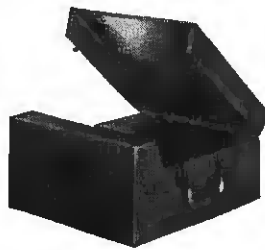

Portable Phonograph case in brown leatherette covering. Inside dimensions 17 1/2" long, 13" wide, 7 1/2" high. Has blank motor board and opening for speaker. As illustrated at left, specially priced at...

\$7.95

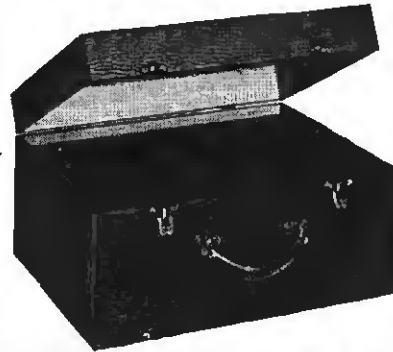

Portable Phonograph case, of sturdy durable plywood, in handsome brown leatherette finish. Inside dimensions 16 1/2" long, 14" wide, 9 1/2" high. Has blank motor board. As illustrated above, specially priced at..... **\$6.95**

Also blank table cabinets of walnut veneer in the following sizes, with speaker opening on left front side: (*Note: *7 has center speaker grill.)

#1	8 1/2"	L x 5 1/2"	H x 4"	D \$1.95
#2	10 1/2"	L x 6 3/4"	H x 5"	D \$2.75
#3	13 1/2"	L x 7 3/4"	H x 6 1/2"	D \$3.25
#7	10 1/2"	L x 7"	H x 5 1/2"	D \$2.50
#8	17"	L x 9"	H x 9 1/2"	D \$4.50
#9	21"	L x 9 1/4"	H x 10 1/2"	D \$5.50

*Speaker Opening in center of front side. Cabinets available in Ivory color and Swedish Modern. Write for prices.

POWER TRANSFORMERS

- 4, 5, or 6 Tube—6.3V at 2 amp. 50 Mill Power Transformer.... **\$2.45**
- 7, 8, or 9 Tube—6.3V at 3 amp. 70 Mill Power Transformer.... **\$2.65**

All types of radio cabinets and parts are available at Lake's Lower prices. A large stock is listed in our catalog.



SERVICEMEN—RETAILERS
Join our customer list today.

Write for our NEW 12 page, illustrated, elaborate catalog!

Dept. B

Lake Radio Sales Co.
615 W. Randolph Street
Chicago 6, Ill.

CBS Experimenting with Color Tele

Full-color, high frequency television "is no longer a theory, but a fact," according to testimony submitted to the FCC by Paul W. Kesten, executive vice-president of the Columbia Broadcasting System. Kesten stated:

"Full-color television pictures have actually been broadcast by CBS on the new ultra high frequencies. They have not only been successfully demonstrated in the laboratory, but have been transmitted through the air across New York from one building to another many blocks away, where they were received with clarity."

Dr. Peter C. Goldmark, television engineer for CBS, also revealed before the FCC that the "manufacture of receiving and transmission equipment for color tele is already in progress."

Dr. Goldmark stated that the General Electric Co. will produce receivers for color reception under a cooperative agreement with CBS. The first GE sets are expected to be available before February, 1946.

Join Bendix Appliances

Bendix Home Appliances, Inc., South Bend, Ind., has appointed three division managers, according to a recent announcement. They are Charles G. Mason, who will represent the sales department in Michigan, Indiana, Illinois, and Ohio; Harold P. Bull, of Manchester, N. H.; and Neal E. Schuman, who will make his headquarters in Seattle, Wash.

RecordDisc Lowers Prices

Sidney S. Gould, president of Record-Disc Corp., 395 Broadway, New York City, announces lower prices on Record-Disc home recording blanks. These prices are:

	6 1/2"	8"	10"
Bond Base	10c	20c	30c
Steel Base	20c	30c	40c
Aluminum Base	25c	35c	45c

Dealers to Get GE Sets in Time for Xmas Selling

General Electric radios will be back on the market this fall in time for Christmas buying, Paul L. Chamberlain, manager of sales of the receiver division, has announced.

Sets will begin appearing in dealers' stores this month. By Christmas it is expected a total of twelve models will be available, including an ac-dc battery portable, a radio phonograph console incorporating the new GE electronic reproducing system, and ten table models in cabinets of wood and plastic.

"By the time the Christmas rush is at its height," Chamberlain said, "we will have been in production almost three months, and should be in a position to supply our dealers with enough merchandise to meet the most urgent of the anticipated radio demands."

"All of these plans are, of course, contingent upon the availability of materials and components," he explained.

"GE will begin production of its full radio line early next year," Chamberlain said.

The firm will devote much of its immediate manufacturing resources to low-priced sets, all of new design and containing some features which were unknown or limited only to the higher priced sets before the war.

"We plan to start with the more standardized and lower-priced merchandise so as to make available to the public the greatest number of radios as soon as possible," he added.

Electrical Dealers Meet

The Philadelphia Electrical Assn. held a large dinner party for members of the organization. One of the topics discussed at this affair was the function of the organization's recently-created retail appliance dealers division. This branch of the association is pledged to build goodwill and better the status of the appliance retailer.

President of the organization is Howard L. Miller; managing director is John A. Morrison.

"BLESSED EVENTS"



E. F. Moran, Sperti V. P.

Edwin Farley Moran, manager of the electronic division of Sperti, Inc., Cincinnati, Ohio, has been appointed vice-president. Activities of this division are concerned principally with air sterilization by ultra violet, vacuum tubes, switches, and hermetic sealing. The company has plans for considerable expansion in this field.

Mr. Moran is well known to the electrical and houseware trade throughout the country, and for a number of years headed his own sales organization representing many prominent manufacturers.

Sylvania War Record

A recent announcement by the Navy Bureau of Ordnance revealed that eight plants of Sylvania Electric Products Inc. received a total of 22 special awards granted to contractors who worked on the Navy's secret VT proximity fuze program, also known as "Project A".

Be Go-Getters, Hoffman Head Advises Retailers

H. Leslie Hoffman, president of the Hoffman Radio Corp., Los Angeles, speaking at a meeting of the Radio and Electronics Servicemen's Assn. in this city, said, in part, that radio technicians have been fortunate in being able to maintain customer contacts through the war period. He declared they should be in the best of positions to capitalize on prospect lists because they know who needs a new radio set.

They should become better business men, he said, and make up their minds to go to the customer instead of having the customer come to them. By way of suggestions, Hoffman stated that technicians should brighten their stores; work out attractive window displays; identify their places of business; select a good line; sell on quality and performance, and start selling right now.

Speed Queen Appointment

Appointment of Major Reg. P. James, as division manager for the east-central division comprising the states of Ohio, Indiana and Michigan, has been announced by P. J. Daniels, director of sales for Barlow & Seelig Mfg. Co., Ripon, Wisc.

Released from active duty with the Army, Major James has assumed his new duties as Speed Queen sales representative, with headquarters at the Lorraine Hotel, Toledo, Ohio.

Tells of Display Methods

The fundamentals of store layout and store and window display were discussed by R. O. Johnson, director of display for the Commonwealth Edison Co., Chicago, at a meeting of the Radio and Electrical Appliance Dealer Group of the Electric Assn. in Chicago. Johnson's talk also dealt with the problem of making the most profitable use of store space.

Today's New Trend is toward Webster Electric Pickups



Webster Electric Pickups have won their present position of pronounced preference among those who make, sell and own radio-phonograph combinations because of their superb performance.

These fine quality pickups are precision-built to meet the highest standards of tonal beauty in record reproduction. Sensitive, delicate, responsive . . . they cover the entire range of vocal and orchestral tone with unsurpassed clarity and fidelity. Despite a constantly increasing demand for Webster Electric Pickups and Cartridges, each one must meet the most rigorous inspection tests before it leaves the factory.

Now is the time to take full advantage of the lively pickup replacement market in your territory. Standardize on Webster Electric Pickups; you will build lasting good will among your customers, and will add substantially to your own profits. We make models to fit most makes of radio-phonograph combinations. Write us for full details today.

KEEP ON
BUYING BONDS



(Licensed under patents of the Brush
Development Company)

WEBSTER ELECTRIC

Racine, Wisconsin, U.S.A. • Established 1909 • Export Dept.: 13 E. 40th Street, New York (16), N.Y. Cable Address "ARLAB" New York City

"Where Quality is a Responsibility and Fair Dealing an Obligation"

Check These Exclusive

KWIKHEAT

SOLDERING

IRON

Advantages!

KWIKHEAT'S Built-in

Thermostat is Thrifty

- ★ SAVES TIPS
- ★ SAVES TIME
- ★ SAVES EFFORT
- ★ SAVES WEIGHT
- ★ SAVES CURRENT
- ★ SAVES THE IRON

**HOT IN 90 SECONDS
READY FOR USE...!**

Its many exclusive features put the Kwikheat Soldering Iron in a class by itself. That's why it wins enthusiastic praise from those who use it—why Kwikheat is fast becoming America's most talked-about iron—why you certainly want to stock it... lists at \$11. Write today for complete information.

6 TIP STYLES
Interchangeable

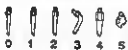

YANATTA
Kwikheat
THERMOSTATIC SOLDERING IRON
A Division of
Sound Equipment Corp. of California,
3903 San Fernando Rd., Glendale 4, Calif.

... WRITE FOR DETAILS

Protect Tele Set Buyer, DuMont Tells FCC

A proposal that the FCC assure the public and industry that its plans for allocation of television channels "is permanent to the extent that the public purchasing receivers should expect at least 10 years' use therefrom" was presented by Dr. Allen B. DuMont, president of Allen B. DuMont Laboratories, Inc., at FCC hearings.

Dr. DuMont questioned the Commission's statement indicating that the present 13 television channels available below 300 megacycles "are insufficient to make possible a truly nationwide and competitive television system. Hence, the Commission has made available the space between 480 and 920 mc. for experimental television where more space exists and where color pictures and superior monochrome pictures can be developed through the use of wider channels."

Rejoins Times Appliance

Lieut. Henry Stephens has returned from the Army Air Forces to rejoin the Times Appliance Co., New York, as manager of its radio and television department. Lieut. Stephens has been with the firm for 18 years and is well known to distributors and dealers in this area.

NAMM Appoints Members to 5 Committees

The following committees have been appointed by President E. R. McDuff, of the National Assn. of Music Merchants:

Music in Industry Committee: Melville Clark, Clark Music Co., Syracuse, chairman; Kenneth W. Marks, M. Doyle Marks & Son, Elmira; J. Middaugh, Mid-Bell Music Co., Fort Dodge; L. L. Smith, L. L. Smith Piano Co., Albia; J. J. Gourlay, Gourlay Bros, Lincoln.

Community Music Committee: Charles M. McCarthy, Associated Stores, Miami, Florida, chairman; W. H. Richardson, Birkel-Richardson Co., Los Angeles, Calif.; C. D. Bond, Weaver Piano Co., Inc., York, Pa.; H. V. Russell, The Music Shop, Springfield, Ill.; Alonzo Leach, Des Moines, Iowa; Rudolph Siegling, Siegling Music House, Inc., Charleston, S. Car.; H. D. Conrad, Conrad & Son Piano Co., Corydon, Ind.; Bernard Kram, Kram-Sebree Music Co., Frankfort, Ind.; Frank O. Wilking, Wilking Music Co., Indianapolis, Ind.; E. C. Sonders, Sonders Music Shop, Muncie, Ind.; Albert H. Harwick, Harwick Music Shop, Columbus, Ohio; Ernest W. Cooper, Music & Art Center, Riverside, Calif.

Music in the Church Committee: H. C. Wildermuth, Blaine, Wildermuth, Toledo, Ohio, chairman; Eugene Smart, Smart's Music Store, Mansfield, Ohio; J. J. Ruhs, Audubon Music Co., Audubon, Iowa; Edmund Gram, Edmund Gram, Inc., Milwaukee, Wisc.; Eugene R. Jaeger, Southern California Music Co., San Diego, Calif.; Leslie L. Steward, Heaton's Music Store, Columbus, Ohio.

Store Affiliation Committee: H. Q. Purucker, Purucker Dean Smith, Med-

ford, Ore.; David Dean Smith, David Dean Smith, Inc., New Haven, Conn.; L. R. Spencer, Spencer's Harmony Hall, Iowa City, Iowa; S. Poppler, Poppler's, Grand Forks, N. Dak.; Austin Lee, Columbia Music Co., Milwaukee, Wisc.; W. Curtis Busher, Emerson Piano House, Decatur, Ill.; Stanley J. Schlosser, Edmund Gram, Inc., Milwaukee, Wisc.; Paul Rinne, Indiana Music Co., Indianapolis, Ind.; C. B. Goodenough, Goodenough Music Service, Beloit, Wisc.

Merchandising Help Committee: Walter J. Massey, Massey Piano Co., Des Moines, Iowa, chairman; A. Davidson, Boutell's, Minneapolis, Minn.; W. W. Benedict, Benedict Piano Co., Ottumwa, Iowa; Jean M. M. Kuyper, Kuyper's Music House, Pella, Iowa; Les Reed, Les Reed Music Co., Mason City, Iowa; Neil M. Lauman, Lauman's Music Supply Shop, Michigan City, Ind.; B. E. Neal, Neal-Clark-Neal, Buffalo, N. Y.; J. Van de Walle, Van's Music Store, Seymour, Ind.; Elmer L. Bristow, R. C. Bristow & Son, Petersburg, Va.; Walter J. Korzinek, Korzinek Music Shop, Manitowoc, Wisc.; J. D. Hobbie, Jr., Hobbie Bros., Roanoke, Va.; James A. Brown, Brown Music Co., Jackson, Miss.; Helen Gunnis, Helen Gunnis Music Shop, Milwaukee, Wisc.; Lyle E. Markham, Markham Music Co., Erie, Pa.; A. W. Anderson, Jones Piano House, Fort Dodge, Iowa; Stuart D. Julius, Julius Music House, York, Pa.; E. A. Grunden, Northwest Piano Co., Minot, N. Dak.; G. L. Bunt, Davidson Co., Des Moines, Iowa; Ira D. Langlois, Langlois Piano House, Madison, Wisc.; Justus H. Larson, The Larson Co., Thief River Falls, Minn.; Oliver D. Rone, Rone Music Co., Bloomington, Ind.; E. H. Hancock, Seymour, Ind.; Beatrice E. Mihaly, Genesiee Music & Instrument Co., Rochester, N. Y.; Roy Hafsoos, Flenner, Hafsoos Music House, Milwaukee, Wisc.

Simpson Wins "E"

The Simpson Electric Co., Chicago, has been awarded the coveted Army-Navy "E" for excellence in the production of war materials.

Ex-Appliance Salesman



Eric A. Johnston, new movie industry "czar," began his career as vacuum cleaner salesman.

In Selling, Never Take ANYTHING for Granted

Don't try to judge the customer's buying ability by his appearance.

Never let yourself believe that your customer cannot afford to pay more — no matter what he says.

When the customer says, "I'll think it over", don't take it for granted that he will. He may "think it over" in your competitor's store. Try to close the sale.

You should not believe that the objections the prospective customer offers to your product are serious. Most of such objections are made for two reasons: 1. The customer wants information. 2. The customer wants to assure himself that he's not making a mistake in buying.

When the customer says he can buy the same radio or electrical appliance cheaper elsewhere, don't believe it — "check" it at the competitor's. Buyers making such claims are more often than not sincerely misinformed. Usually the "cheaper" radio or appliance is of another make — another model.

Try not to permit the shopper to say "no", but if he does, don't take it for granted. Mind-changing is a common trait with most of us.

Don't take it for granted that you've the sale "in the bag" until you have the signed order.

Never take it for granted that the customer is a "dumb-bell" so far as your equipment goes. Electronic engineers buy radios, electrical engineers buy motor-driven and "heating" appliances, musicians buy record-players and dietitians buy ranges. Answer questions intelligently — honestly.

New Maytag Products; Buys Interest in Firm

Addition of an automatic type washer, and automatic clothes drier, both gas and electric, a gas range and an electric frozen food locker to the Maytag line of household appliances is revealed by President Fred Maytag II.

The announcement followed a series of conferences of Maytag branch managers and distributors held at the home office in Newton, Iowa, at which the new products were previewed. They will be added to the line of conventional type washers and ironers produced by the company.

The firm recently purchased a minority interest in the Globe-American Corp., Kokomo, Ind., which will produce Dutch Oven gas ranges exclusively for Maytag. Fred Maytag II, and vice-presidents George Umbreit and Roy A. Bradt have been elected to the Globe-American board of directors.

No date has been announced as to when the new products will be made available to the public, although president Maytag expressed an opinion that the gas range and the frozen food locker, would be on the market about the first of the year. No date has been revealed when the automatic washers and driers will be ready for distribution.

Wait for these new

HICKOK

Radio Service Instruments

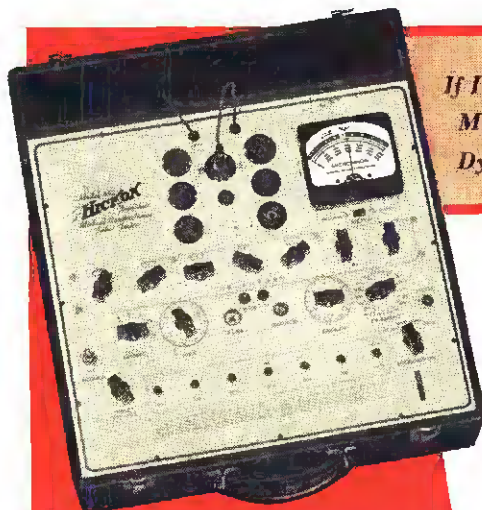

Model 532
Tube Tester

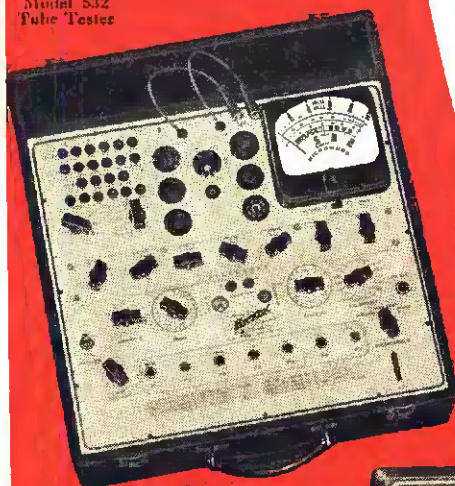

Model 534
All Purpose Tube and Set Tester

**THE HICKOK
ELECTRICAL
INSTRUMENT CO.**

10523 Dupont Avenue
Cleveland 8, Ohio

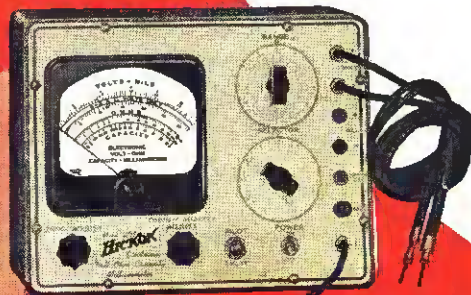

Model 203
Electronic Volt-Ohm Capacity Millimeter

If It Isn't A Hickok Indicating
Micromhos It's Not
Dynamic Mutual Conductance

Your patience in waiting for these new 1946 HICKOK models will be richly rewarded for these new HICKOK tube and set testers make still closer tests, with finer accuracy, rejecting tubes that might get by with an ordinary tester.

Now you have 7 selector switches instead of 2. That aims to prevent obsolescence. Isn't that worth waiting for?

What's more, Dynamic Mutual Conductance, indicated in Micromhos, is a duplicate of the manufacturer's method of checking when he makes the tubes. Remember, if it isn't a HICKOK Indicating Micromhos, it isn't Dynamic Mutual Conductance.

The new Electronic Volt-Ohm-Capacity Milliammeter Model 203 reads as low as 1.0 mmf and up. It will measure at frequencies to over 10 mc with no frequency error and the ohm meter will measure up to 10,000 megohms.

Keep patiently in touch with your jobber and you will soon get the instruments that are held in highest esteem.

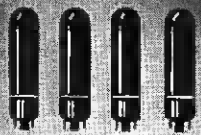

4 STANDARD TYPES
 of Amperite Regulators replace over 400 types of AC-DC Ballast Tubes now in use.
 Amperites are real REGULATORS... have patented Automatic Starting Resistor which prevents initial surge and saves pilot light.
 Ask Your Jobber.

AMPERITE

THE *Simplest* WAY TO REPLACE **BALLASTS**

WRITE FOR REPLACEMENT CHART
AMPERITE Co. 341 BROADWAY, NEW YORK, N. Y.

Signal Corps TELEGRAPH KEY



Genuine U. S. Signal Corps key with switch to close contacts, polished durable enameled metal base mounted on a bakelite base, key lever is nickel-plated brass-silver contacts; packed in new, original boxes. Shipping weight, 1 lb. 10 for \$11.00 **\$1.29** ea.

Army-Navy Type HEADPHONES

Type HS-33



Moisture-proof, sensitive and durable. Extra heavy-duty bakelite cap. Soft rubber cushions included, bi-polar magnet 300 ohms. Furnished with cord and plug leather headband. Shipping weight, 2 lbs. **\$3.95** ea.

Order from your jobber.
 Write for our illustrated literature featuring all types of radio parts.
 Dept. B.
ARROW RADIO CO.
 2205 W. Division St., Chicago 22, Ill.

Conlon Plans Automatic and Small-Size Washers

Reconversion to peace-time manufacturing by the Conlon Corp., Chicago, Bernard J. Hark, president and chairman of the board, includes plans to produce both automatic and apartment-size household washers, according to an announcement by the company.

"These appliances are being engineered now, and are scheduled to go into production after we are running full-blast on standard washers and ironers, as before the war," said the company's vice-president and general manager, I. N. Merritt.

New Sylvania Booklet

Sylvania Electric Products, Inc., has issued a booklet entitled "20 Years of Achievement in Radio" which reviews the company's developments during the past two decades. The booklet deals with the growth of the firm, the various aspects of the production, and its employee-employer relationship.

Scott Marine Radios

Scott Radio Laboratories Inc., of Chicago, announces that it is in production for civilian use of its non-radiating 12-tube marine receiver.

According to Frank Beiser, executive vice-president of Scott, orders are being received through regular dealer channels for home radio use, or for use aboard ship.

Manages Ken-Rad Division

J. M. Lang has been appointed manager of the Ken-Rad division of the General Electric Co.'s electronics department, with headquarters at Owensboro, Ky. This announcement is made by George W. Nevin, manager of the tube division. Lang succeeds C. J. Hollatz.

New Parts Distributor

Irving Phillips Wolfe announces the formation of a radio parts distributing firm in Poughkeepsie, N. Y., under the name of Chief Electronics.

Located at 224 Main St., this new organization will serve the Mid-Hudson, Catskill Mountain, eastern New York, and northwestern Connecticut territories. Featured at the firm is a special amateur radio parts department.

Xmas Note for Record Dealers

New Sonora record releases for your Xmas trade: "All Around the Christmas Tree", single disc in showpiece envelope, featuring Dick Todd and Mark Warnow's orchestra; a new Uncle Don album, "Land O' Song"; and a new album of old tunes, "Old Timers" starring the Ben Yost Singers.

New Recoton Needle Lines

The Recoton Corp. is offering its new lines of sapphire phonograph needles at-

tractively packaged and in ready-to-display units. The firm's Supra needle retails for \$4 and is available in a plastic container. The company's Primus needle retails for \$2 and is packaged 12 needles to a card for display by the dealer.

Eastern Amplifier "E"



Participating at the Eastern Amplifier Corp., New York, "E" award were, l. to r., Lt. Commander William Warburton, Harry Friedlander, treasurer, Leonard A. Meyerson, president.

Don't Mislead Consumers, Advises Nate Hast

There has been a bit too much enthusiasm on the part of the radio trade in its presentations to the public, according to Nate Hast, merchandise manager of the home radio division of Lear, Inc., and the reaction from the customers is far from being perfect. There have been too many promises, too many inducements, without sufficient material to back them up, Mr. Hast believes.

"The worst thing in the world any manufacturer can do is to build up a reputation for his product, and then fail to deliver," said Mr. Hast.

GE New York Manager

C. P. Dunning has been appointed local manager in New York for the General Electric Co.'s appliance and merchandise department, it has been announced by C. R. Pritchard, general sales manager for the department.

Hotpoint Chicago Manager

H. W. Nagel has been appointed manager of the Chicago sales district of Edison General Electric (Hotpoint) Appliance Co., W. H. BonDurant, central regional manager, announced. Mr. Nagel succeeds L. E. Buxton.

Gets ECA Franchise

J. M. Winer, president of Dynamic Electronics-New York Inc., has announced the signing of a contract with Electronic Corp. of America to serve as franchised ECA radio dealer in this city.

This Issue's Front Cover

The attractive front cover of this issue was photographed by RADIO & Television RETAILING in the headquarters of the Electrical & Gas Assn. of New York, 480 Lexington Ave., through the courtesy of Ralph Neumuller, executive vice-president, and William Oglesby, technical manager.

FM Frequency Allocations

Federal Communications Commission on Sept. 12 issued its list of frequencies which have been assigned to FM stations for operation in the new high frequency band. Following is the complete list:

METROPOLITAN STATIONS			
City and Call Letters	Radiated Power kw	Antenna Height	Frequency
Baton Rouge, La. WBRL	20	500	96.1
Binghampton WNBZ-FM	10.5	657	96.7
Boston WBZ-FM	20	455	95.7
Chicago WBBM-FM	10*	668	99.3
Chicago WDLM	20*	479	99.7
Chicago WEHS	12*	616	100.1
Chicago WGNB	20*	472	98.9
Chicago WWZR	12*	611	98.5
Columbus WELD	20	341	94.5
Detroit WENA	10.5	663	96.9
Detroit WLOU	20	362	96.5
Evansville WMLL	20	281	94.7
Fort Wayne WOWO-FM	20	300	95.9
Hartford WDRG-FM	7.0	758	94.3
Hartford WTIC-FM	9.5	673	93.5
Indianapolis WABW	20	290	94.9
Kansas City KOZY	20	500	99.9
Kansas City KMBC-FM	20	500	97.9
Milwaukee WMFM	20*	310	92.3
Nashville WSM-FM	8.5*	720	100.1
Philadelphia KYW-FM	20	382	93.1
Philadelphia WCAU-FM	20	366	95.5
Philadelphia WFIL-FM	20	464	94.3
Philadelphia WIP-FM	18	520	93.9
Philadelphia WIBG-FM	20	358	95.1
Philadelphia WPEN-FM	20	455	95.9
Pittsburgh KDKA-FM	6.5	783	94.1
Pittsburgh WTNT	20	500	94.5
Rochester WHEF	20	387	98.5
Rochester WHFM	20	261	98.9
Salt Lake City KSL-FM	8.5	720	100.1
Schenectady WGFM	6	805	95.3
Schenectady WBCA	6	805	95.7
South Bend WSBF	20	312	101.3
Springfield, Mass. WBZA-FM	20	500	99.1
Superior, Wisc. WDUL	20	500	92.3
Worcester, Mass. WTAG-FM	20	477	102.1
Worcester, Mass. WGTR	9.5	680	101.7
Alpine, N. J. WFMN	6.0	795	100.9
New York WQXQ	11.5	632	100.5
New York WABF	15	567	98.5
New York WGYN	4.0	905	100.1
New York WFGG	7.2	747	99.7
New York WHNF	20	455	99.3
New York WNYC-FM	15	560	98.1
New York WBAM	15	559	96.9
New York WABC-FM	5	850	97.3
New York WAAF-FM	1.6	1258	97.7
Jersey City WAAW	13.5	590	96.1

RURAL STATIONS

Mt. Washington, N. H. WMTW	10	97.9
Winston-Salem, N. C. WMIT	200	97.3

The following metropolitan stations may operate from their present sites with the power indicated below until such time as the Commission considers all of the applications in the Los Angeles area.

Los Angeles KHJ-FM	4.8	870	99.7
Los Angeles KTLO	4.8	870	100.1

*This antenna height is based upon previously authorized antenna construction, and a minimum antenna height of 500 feet above average elevation will be required in the future unless a showing is made to the contrary that such an antenna height is not feasible.

A Perfect Recording Disc!

TRU-KUT

(FAITHFUL REPRODUCTION OF VERSE OR MUSIC)



ANNOUNCING

NEW

low

PRICES!

DISCS IN:

PAPER

GLASS

ALUMINUM

BASE

Instantaneous Recording Blanks . . . Perfect cutting and longer life

For Immediate Delivery!!

	Base	Size	List Price
NO WARPAGE	#1367 (Paper)	6 1/2"10 ea.
		8"20 ea.
		10"30 ea.
ABSOLUTE FLATNESS	# 891 (Aluminum)	6 1/2"25 ea.
	# 892 (Aluminum)	8"35 ea.
NO PEELING OF COATING	# 893 (Aluminum)	10"45 ea.
	#1393 (Glass)	8"60 ea.
		10"80 ea.
		12"	1.00 ea.
SUFFICIENT WEIGHT TO PREVENT SLIPPAGE	#1571 (Steel)	6"15 ea.

Outstanding Characteristics: HIGH QUALITY HEAVY COATING ASSURED UNIFORM CUT EASY CUTTING EXCELLENT HIGHS LOW NEEDLE WEAR NO CUTTING THRU COATING and a high degree of permanence.

These blanks are nitrate coated to insure high fidelity and long wearing qualities.

NECESSARY Accessories FOR RECORDING BLANKS

Record Sweeper No. 1139

LIST PRICE: \$1.00

Walso Record-Ease

No. 1174

JUST PLACE SWEEPER BESIDE THE RECORDING TURNTABLE, START YOUR RECORDER AND LET THE SWEEPER WORRY ABOUT THE THREADS

LIST PRICE per 2 oz. bottle, ea. 60c MAKES RECORDING EASIER, ELIMINATES SHAVING TROUBLE AND PROLONGS LIFE OF THE CUTTING NEEDLE BY REDUCING FRICTION. APPLY TO RECORDING BLANK BEFORE CUTTING

NOTE: For the best cutting results . . . we recommend the **RECOTON** cutting needles. Lists: 25c, \$1.50 and \$5.00. For longer life and better tone value use **RECOTON** playback needles. Lists: 10c and 50c per package.

USUAL DISCOUNTS JOBBERS INVITED

TRU-KUT discs are FULLY GUARANTEED to give the best results on home or professional recording

105 EAST 12th STREET THE FAVORITE MFG. CO. NEW YORK 3, N. Y.

IMMEDIATE DELIVERY FROM STOCK

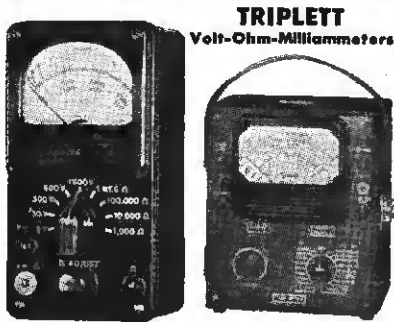

TRIPLETT Volt-Ohm-Milliammeters
 TRIPLETT 600 15.25
 TRIPLETT 600-H 16.00
 TRIPLETT 1200-S 34.67
 Servicemen's Priority

MASCO AMPLIFIERS

Complete with tubes.

17 Watt	30.30
25 Watt	42.60
35 Watt	54.60
50 Watt	70.50
17 Watt with Phono-top	42.30
25 Watt with Phono-top	52.20
35 Watt with Record-changer	89.10

TURNER MICROPHONES

Model	Type	Cord	Level	Each
BX	Crystal	7'	-55	\$3.85
22X	Crystal	7'	-52	10.88
23X	Crystal	20'	-52	13.23
BD	Dynamic	7'	-52	8.53
38D	Dynamic	20'	-54	14.70

SPEAKER BUYS!

4" PM square	51.35
4" 450 ohm, square	7.40
5" PM 2 watt	1.25
5" 450 ohm	1.50
10" PM 11 watt	7.20
12" PM 16 watt	10.14
12" PM 17 watt	14.25

SPRAGUE - CORNELL DUBILIER AEROVOX CONDENSERS

8 mfd 450v Upright can	76¢
16 mfd 450v Upright can	1.12
20 mfd 450v Upright can	1.23
8 mfd 450v Tubular	44¢
16 mfd 450v Tubular	65¢
20 mfd 450v Tubular	44¢
20-20 mfd 150v Tubular	76¢
40-20 mfd 150v Tubular	82¢
30-30 mfd 150v Tubular	79¢
30-30 mfd 150v Tubular	94¢

RADIART VIBRATORS

Type	Equal	Each
S-1	4-4	\$1.35
5300	294	2.09
5326P	509P	1.76
5334	868	2.09
5341M	901M	1.76
5400	248	3.50
5426	716	3.50

ORDER OTHERS BY MAKE AND SET MODEL
 CRYSTALS M22 2.94 L40 2.35 LP8 4.70
 PICKUPS 2.97, 3.30, 3.90
 MOTORS 3.17, 3.33

PHILCO BEAM OF LIGHT
 Selenium Cell only, no holder 1.80

20% deposit required on all C.O.D. orders. 2% transportation allowance on orders of \$25.00 or more accompanied by payment in full.

RADIO SUPPLY & ENGINEERING CO., Inc.
 128 SELDEN AVE. DETROIT 1, MICH.

Iceberg Locker Systems Appoints Sam Mitchell

Ross R. Smith, president of Iceberg Refrigerated Locker Systems, Inc., announces the appointment of Sam C. Mitchell as general sales manager with headquarters in the Empire State Building, New York.

Mr. Mitchell was sales and promotion manager of the Hamilton Radio Corp., and previously director of sales promotion and advertising of the Kelvinator Corp. and western sales manager of the Crosley Corp.

Joins Emerson in South

Lt. Col. A. Earle Fisher, recently placed on inactive status with the Army Air Corps, has joined Emerson Radio and Phonograph Corp. as southern field representative, Ben Abrams, president, announces.

Sonora Samples in N. Y.

Barth-Feinberg, distributors in Greater New York of Sonora radios and records, expects to release sample sets of Sonora radios to dealers in that area the first week of this month, according to an announcement by Henry Feinberg.

AVCO Appoints Cosgrove

Irving B. Babcock, president of the Aviation Corp., announces that R. C. Cosgrove has been appointed vice-president in charge of sales for AVCO. Mr. Cosgrove will continue as vice-president of the Crosley Corp., which was recently acquired by AVCO. The new appointee is also president of the RMA.

Meck Delivering Sets

John Meck Industries has been making a "whirlwind delivery" to dealers throughout the country of samples of its OPA \$15.95 price approved set. According to the firm, this radio is the first receiver to get an OPA price approval.

Joins Bendix Appliances

M. R. Rodger has been appointed utility sales manager of Bendix Home Appliances, Inc., South Bend, Ind., according to W. F. Linville, sales manager.

TELEVISION!

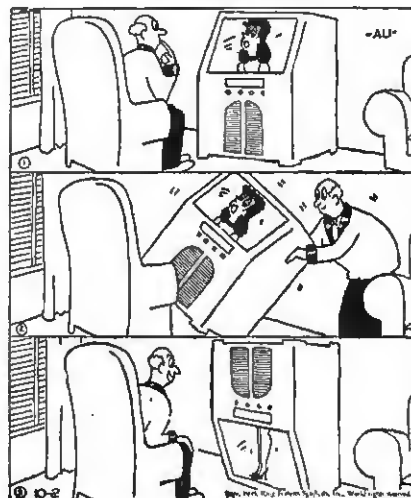

Hotpoint Pricing Policy

Edison General Electric (Hotpoint) Appliance Co., announces a nation-wide pricing policy by which all of its appliances would be delivered to consumers at a uniform price, instead of the formerly practiced f.o.b. factory policy.

Veteran Available

Recently discharged from Army, veteran wants contact with eastern radio manufacturer to serve as field service engineer or consultant in Southern California area. Classified radio engineer by Army, member of IRE, holds first class radio-telephone license, 25 years' experience including several years as design engineer. Married, sober, dependable. Box A, Care of Editors, RADIO & Television RETAILING, 480 Lexington Ave., New York 17, N. Y.

STATEMENT OF THE OWNERSHIP, MANAGEMENT, CIRCULATION, ETC., REQUIRED BY THE ACTS OF CONGRESS OF AUGUST 24, 1912, AND MARCH 3, 1933

Of RADIO & TELEVISION RETAILING, published monthly at New York 17, N. Y., for Oct. 1, 1945, State of New York, N. Y., County of New York, N. Y.

Before me, a Notary Public in and for the State and county aforesaid, personally appeared Orestes H. Caldwell, who, having been duly sworn according to law, deposes and says that he is the Editor of RADIO & TELEVISION RETAILING and that the following is, to the best of his knowledge and belief, a true statement of the ownership, management (and if a daily paper, the circulation), etc., of the aforesaid publication for the date shown in the above caption, required by the Act of August 24, 1912, as amended by the Act of March 3, 1933, embodied in section 537, Postal Laws and Regulations, printed on the reverse of this form, to wit:

1. That the names and addresses of the publisher, editor, managing editor, and business managers are: Publisher, M. Clements, Rumson, N. J. Editor, Orestes H. Caldwell, Catroek Road and Bible St., Cos Cob, Conn. Managing Editor, John L. Stoutenburgh, 584 Riverside Dr., New York, N. Y. Business Manager, M. H. Newton, 583 W. 215th St., New York, N. Y.

2. That the owner is (if owned by a corporation, its name and address must be stated and also immediately thereunder the names and addresses of stockholders owning or holding one per cent or more of total amount of stock. If not owned by a corporation, the names and addresses of the individual owners must be given. If owned by a firm, company, or other unincorporated concern, its name and address, as well as those of each individual member, must be given.) Caldwell-Clements, Inc., 480 Lexington Avenue, New York 17, N. Y. M. Clements, O. H. Caldwell, Charles Schatret, Trustees, 480 Lexington Ave., N. Y. C. M. Clements, Trustee, Rumson, N. J. O. H. Caldwell, Trustee, Catroek Rd. and Bible St., Cos Cob, Conn. Charles Schatret, Trustee, Darien, Conn. Peter Kes, 111 Hamilton Rd., Ridgewood, N. J. McGraw-Hill Pub. Co., * 350 W. 42nd St., New York, N. Y.

3. That the known bondholders, mortgagees, and other security holders owning or holding 1 per cent or more of total amount of bonds, mortgages, or other securities are: (If there are none, so state.) None.

4. That the two paragraphs next above, giving the names of the owners, stockholders and security holders, if any, contain not only the list of stockholders and security holders as they appear upon the books of the company but also, in cases where the stockholder or security holder appears upon the books of the company as trustee or in any other fiduciary relation, the name of the person or corporation for whom such trustee is acting, is given; also that the said two paragraphs contain statements embracing affiant's full knowledge and belief as to the circumstances and conditions under which stockholders and security holders who do not appear upon the books of the company as trustees, hold stock and securities in a capacity other than that of a bona fide owner; and this affiant has no reason to believe that any other person, association, or corporation has any interest direct or indirect in the said stock, bonds, or other securities than as so stated by him.

(Signed) Orestes H. Caldwell

Sworn to and subscribed before me this 21st day of September, 1945.
 W. Kenneth Reynolds,
 Notary Public New York County.
 Notary Public N. Y. County Clerk's No. 95.
 Notary Public N. Y. County Register's No. 538-R-7.
 (My commission expires March 30, 1947.)

*Represents minority stock interest which was purchase price for Radio & Television Retailing. Majority stock and control continue in hands of O. H. Caldwell and M. Clements.

Porter Sees Vast Demand for Television Sets

Paul Porter, chairman of the FCC, predicted a demand for one-billion dollars worth of television receivers after five years. Mr. Porter, speaking at a dinner party in honor of Justin Miller, newly-appointed president of the National Assn. of Broadcasters, also saw video stations operating in 187 cities throughout the country in the period of time specified.

Rejoins Premier

Edwin A. Hamala returns to the position of advertising manager of the Electric (Premier) Vacuum Cleaner Co., Inc., Cleveland, Ohio, the post he held prior to military service with the Army.

Manages GE Sales Branch

Robert A. Graves has been appointed manager of dealer sales for the New York appliance distributing branch of the General Electric Co., it is announced by Earle Poorman, manager of the branch.

RCA Announces New Lines

The RCA Victor division has announced to its distributors its first post-war line of RCA Victor radios and radio-phonograph combinations.

Preceded by a national pre-selling advertising campaign, the company's line has been revealed by Joseph B. Elliott, general manager of the firm's home instrument division, as including nine models.

Radio Ready for Future Wars, Says RMA Head

The radio industry again will be "ready for any future war-time emergency, just as it was ready for World War II," R. C. Cosgrove, president of the Radio Manufacturers Assn., has declared.

Mr. Cosgrove said that the radio industry is by no means slowing its research into "new things" which will be of great value in the event of future wars "we fervently hope will never take place."

Camburn Expands Lines

The Camburn Products Co., 490 Broome St., New York 13, N. Y., for many years producers of auto radio antennas, announces that it is currently producing lines of antennas for auto radio, television and FM sets, and other goods, as part of its expansion program.

According to M. B. Bernstein, president, the firm will sell through sales representatives and radio distributors. Mr. Bernstein also revealed that the company will erect new modern plants in Long Island, N. Y.

Scott Wire Recorder Due

Executives for the Scott Radio Laboratories Inc., of Chicago, franchise holders for the Armour magnetic wire sound producer and recorder, state that improved models of the wire recorder will be ready shortly for home recording. These models will be available to dealers who handle Scott radios.

Motorola Reconverted

William H. Kelley, Motorola sales manager, announced recently that the firm is now fully reconverted on production and distribution. He asserted that the coast-to-coast Motorola distributing or-

ganization is completely set up and ready to go.

Mr. Kelley said that the Motorola distributor list comprised ninety separate sales and service organizations located throughout the nation.

New RCA Television "Eye"

A new television camera tube of new design and sensitivity emerged for exhibition by the Radio Corp. of America in a series of studio and remote pickups in which it not only transmitted scenes illuminated by candle and match light but performed the feat of picking up scenes with infra-red rays in a blacked-out room.

A Truly Inspiring* motion picture gives fresh impetus to home disc recording . . .

ERNIE PYLE'S
"STORY
OF
G. I.
JOE"



*The New York Times

One of this picture's great moments is when Sergeant Warnicki, portrayed by Freddie Steele, plays a home recording made of his child's voice. All over America, people are seeing and re-seeing the "Story of G.I. Joe". All over America, the real meaning of home recordings is given substance through the medium of this heroic picture. Here is a splendid opportunity to promote your RecordDisc Home Recording Department. See the picture . . . tie-up with it . . . now!

\$100.00 FOR BEST WINDOW DISPLAY

Contact your RecordDisc representative or write for tie-up plan and details of \$100.00 Window Display Contest.

RECORDISC

HOME RECORDING BLANKS

Bond base, steel base, aluminum base of improved quality and at new low prices. Prompt deliveries.



Lester Cowan presents Ernie Pyle's "Story of G.I. Joe", starring Burgess Meredith as Ernie Pyle. Released thru United Artists.

THE RECORDISC CORP.

395 BROADWAY, NEW YORK 13, N. Y. • CABLE ADDRESS RECORDISC, NEW YORK, N. Y.
EXPORT DEPT.: ROYAL NATIONAL COMPANY, INC. 89 BROAD STREET, NEW YORK

Everything FOR THE SERVICE DEALER

We have, ready for immediate delivery, a complete stock of tools, replacement parts, inter-communication systems, public address systems, test equipment . . . everything in radio equipment for the progressive service dealer. For big profit items . . . for quick delivery . . . place your order now with Leo.

6 TUBE AC-DC KIT

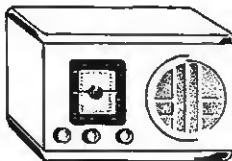

Complete,
ready for
assembly.

\$23.75

Cat. No. 7-691

A two-band, superheterodyne kit with all tubes, speaker, chassis, and all parts for easy assembly. Broadcast band from 540 to 1620 KC. Short wave from 5.7 to 18.3 MC. Cabinet, \$5.25.

WRL MULTITESTER

All purpose tester.
Money back
guarantee.

\$18.75

less leads

Cat. No. 16-439

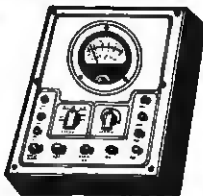

Handles AC DC Voltmeter, DC Milliammeter, high and low range Ohmmeter. 3" meter with sturdy D'Aronsva movement. Size 5 1/2 x 8 x 3 1/4.

Exclusive at WRL!

Our latest flyer . . .
12 page V-J edition
of merchandise and
radio values. FREE.

Handy Tube-Base
Calculator 25c

Giant Radio Reference
Map, 3 1/2 x 4 1/2 ft. . . 15c

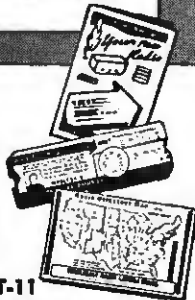

MAIL TODAY RT-11

Wholesale Radio Laboratory
744 West Broadway Council Bluffs, Iowa

- Rush _____ WRL Multitesters. Cost, \$ _____
- Send _____ 6-tube AC DC Kits and cabinets. Cost, \$ _____
- I want a tube-calculator. 25c enclosed.
- Ship me your radio map. 15c enclosed.
- Send me your new V-J Flyer free.

Enclosed is \$ _____; Balance C.O.D.

Name _____

Address _____

Town _____

State _____

I am an amateur; experimenter;
 service man.

We invite industrial inquiries
for electronic equipment and
devices of all kinds.

QUICK SERVICE FROM LEO
"same day" delivery service
from the heart of the nation
. . . on anything in radio.
Order today.



**Wholesale
RADIO LABORATORIES**

Farnsworth Expansion

E. A. Nicholas, president of Farnsworth Television & Radio Corp., has announced plans for supplementing the company's facilities in order to manufacture more of the component parts which go into its completed products. The company has purchased the Lucretia St. plant of the Hosdreg Co., Inc., at Huntington, Ind.

Mr. Nicholas also announced a new building project at Fort Wayne, Ind., stating that an east wing would be added to the company's administration and engineering building.

Protect Buyer, Gerl Urges

Urging that the radio industry adopt an "informative labeling policy to protect the consumer against inferior merchandise," Joseph Gerl, president of Sonora Radio & Television Corp., hit at "radio manufacturers whose production and merchandising policies leave much to be desired." Gerl spoke to radio dealers in Pittsburgh.

GE Shows New Radios

In its first postwar radio conference at Bridgeport, Conn., and Schenectady, N. Y., the electronics department of the General Electric Co. unveiled its complete line of radios, to be marketed within the next twelve months, before a group of radio distributors from principal cities throughout the country.

Plan In-Store RCA Tele

Arthur C. Kaufmann, executive head of Gimbels-Philadelphia, announces that arrangements have been completed with the RCA Victor division of Radio Corp. of America for an extensive demonstration of in-store television specifically designed to show the power of video as a department store selling medium.

Returns to Sales Post



1st Lieut. John G. Zitlis, three and a half years in Army Air Forces, resumes sales manager position with Haynes-Griffin, well-known New York City retail firm.

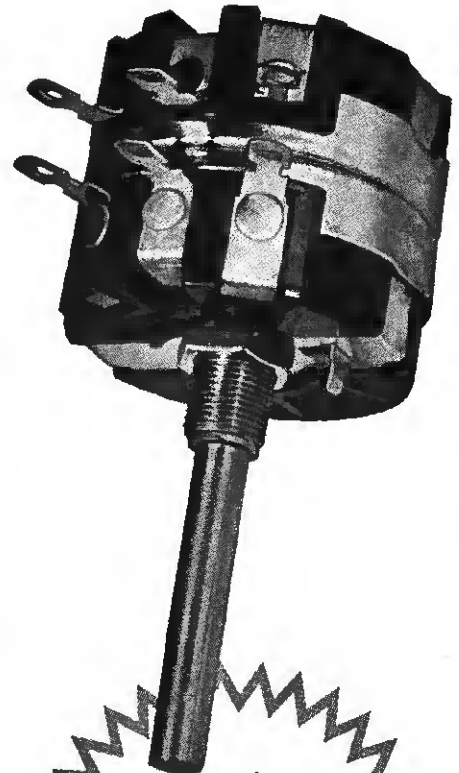

★ The improved, tougher Type 58 Clarostat wire-wound control provides, among other notable advantages, a neat, more rugged, still more effective tandem dual assembly as here shown. Also with or without power switch.

The metal locating pin on front unit will not break or tear off. The bushing, keyed into the bakelite case, cannot slip or turn when locking nut is tightly drawn up. 1500 v. breakdown insulation between windings and shaft. Each center rail is in one piece with its terminal. Direct connection between winding and "L" and "R" terminals.

Ask Our Jobber . . .

Ask about Clarostat wire-wound controls now becoming generally available again. Ask for latest catalog. Or write us direct.



CLAROSTAT MFG. CO., Inc. - 285-7 N. 6th St., Brooklyn, N. Y.

Distributors Review 16 New Bendix Models

To a preview-audience of some 200 Bendix radio distributors and their representatives from eastern states, Bendix radio division of the Bendix Aviation Corp. held the first showing of their home radios and radio-phonographs in New York.

Presenting 7 chassis housed in 16 cabinets and departures in cabinet styling, the new line embraces plastic table models which will retail from approximately \$19.95 with a new concealed grip and enclosed back; wood table sets embodying new style features; table combinations with single control record changers; con-

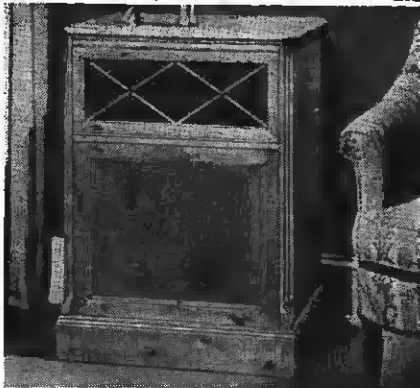
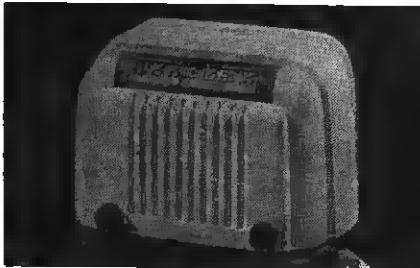

Above, 526-B, plastic set; built-in handle; standard and police bands; ac-dc. Has 5 tubes, including 2 double purpose types. Below, 676-C; combination with automatic changer. Standard and police bands; 8 tube performance through 6 tube circuit using 2 double purpose tubes. Choice of walnut or knotty pine cabinet.

soles with new "furniture" style treatments for buyers who still want "a radio that looks like a radio"; radio-phonograph combinations of period design in which the new "Swingadoor" record changer is featured and special attention focused on large record-storage space and ease of operation.

Production of the plastic table set is already under way and shipping quantities are being built up with deliveries planned for this month.

Bendix plans to ship the 6-tube wood table model in November, and the company feels it will be able to begin delivery on the first floor model combination in December. There is, it was stated, a definite possibility that Bendix will be delivering table combinations in time for late Christmas shoppers.

Plans New Tele Station

Application has been filed with the FCC for permission to build and maintain a commercial video station on Channel No. 2 by the Lancaster Television Corp., Lancaster, Pa.



Those Who Don't Own Them WANT THEM!

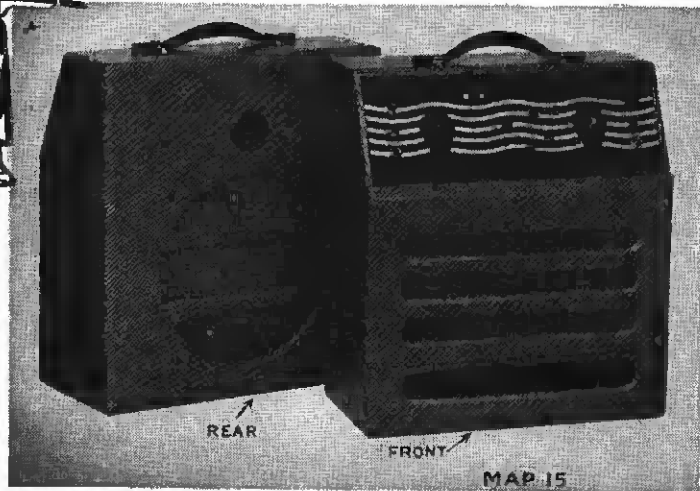

MASCO Musical Instrument Amplifying System MAP-15... Unsurpassed for True Tonal Reproduction of Reed, String and Percussion Instruments

SPECIFICATIONS:

Power Output: 15 Watts.
Controls — Two: Master Volume, Tone.
Switches: On-Off A.C.
Tubes: 2-7F7, 2-6L6GA, 1-5Y3G.
Inputs — Three: One Microphone,
Two Instruments.
Power Consumption: 95 Watts.
Frequency Response: 30 to 12,000 cycles.
Speaker — 12" electro dynamic
Safety Fuse, Pilot Light Indicator.

Three inputs allow for three instruments together or 1 microphone and 2 instruments. Attractive Case. Superb MASCO internal construction.

List price including tubes \$71.25

WRITE FOR CATALOG 45-D

Ask your jobber for full details of this and other Masco Sound Equipment

MARK SIMPSON MANUFACTURING CO.

MANUFACTURERS OF



Masco Sound Systems and Accessories

186-194 WEST FOURTH STREET :: NEW YORK 14, N. Y.

Telephone CHelsea 2-71123-4

SERVICE TO SERVICEMEN... THAT'S STANCOR'S RECORD

Standardize
ON

STANCOR

Call your nearest Stancor Jobber...
or write us for his address

Transformers

STANDARD TRANSFORMER
1500 N. HALSTED STREET • CHICAGO



CORPORATION

BOOKS THAT TELL YOU HOW

3 new books that give you the basic knowledge for successful work in post-war radio.

1. PRINCIPLES OF RADIO FOR OPERATORS



By Atherton. Clear instruction on the operating principles of all parts of radio, including antennas, with full details about equipment and procedures for construction and operation. Many visual aids to help the beginner. \$3.75.

2.



INTRODUCTION TO ELECTRONICS

By Hudson. A simply written but scientifically reliable explanation of the theory, construction, and uses of the various electron tubes and other electronic devices, showing their enormous potentialities for future developments. \$3.

3.



INTRODUCTION TO PRACTICAL RADIO

By Tucker. An outstandingly clear, thorough training in the basic principles of radio circuits and their components, with full explanations of the necessary mathematics at the points where it is used. \$3.

FREE EXAMINATION

By using the coupon below you can procure copies of these books to look over for 7 days without cost or obligation on your part. Send for your copies today.

Special note to Dealers

YOU CAN MAKE A DOUBLE PROFIT THROUGH HANDLING BOOKS

1. Books bring you better buyers. They stimulate the interest and knowledge that makes steady customers. The more your customers learn about radio the more they will buy from you.

2. Books are a profitable stock item. Our trade discounts allow you a good profit on each sale. Our wide promotion insures their sale without effort on your part.

Let these books be salesmen for you. Let them make you an easy profit. By returning the coupon below you can get copies for your book counter at the full dealer's discount. Cuts and copy for your catalog listings are also available. Write to our Technical Book Dept. for information.

The Macmillan Co., 60 5th Ave., New York 11

Please fill my order for the books checked by number below, with the understanding that if I return them within 7 days my bill will be cancelled.

Please fill my order, at dealer's discount, for _____ copies of the books checked.

SIGNED _____

ADDRESS _____

1. 2. 3.

Emerson Names Pacent

Dorman D. Israel, vice-president in charge of engineering and production at Emerson Radio and Phonograph Corp., has announced the appointment of Louis G. Pacent, Jr., as manager of the production services department. For the past year Pacent has served Emerson as chief industrial engineer.

Muter Acquires Rola Co.

The Muter Co., Chicago, manufacturers of radio parts, has acquired The Rola Co., Inc., Cleveland, and its subsidiary, the Rola Co., manufacturers of dynamic and permanent magnet speakers for radios, according to an announcement by Leslie F. Muter, president of the former firm. Larry King is now Rola president.

Aireon Vice-President

R. R. "Rudy" Greenbaum has been elected a vice-president of Aireon Mfg. Corp. The announcement is made by R. C. Walker, president.

M. Greenbaum's experience in the automatic music field is being utilized by Aireon in its new automatic phonograph division which he is setting up.

Krich-Radisco Appointee

Announcement is made of the appointment of Frank M. Schmitt to the newly created post of advertising and sales promotion manager for Krich-Radisco, Inc., New Jersey radio and electric appliance distributor.

Prior to his association with the Krich organization, Schmitt was advertising manager of Freed Radio Corp., New York.

West Coast Rep Active

Norman B. Neely has resumed active management of his firm, Norman B. Neely Enterprises, Hollywood, Calif. Mr. Neely is West Coast manufacturers' representative for several leading electronic companies.

Dealers Get RayEnergy Sets; Plan New Models

RayEnergy Radio and Television Corp. of America, 32 West 22nd St., New York City, is making nationwide deliveries to retail outlets of its new RayEnergy "Maestro" table model radio at \$14.75 and its "Champion" semi-portable radio at \$25.75; both OPA retail ceiling prices (plus tax).

A. A. Harman, president of the company, announces that the firm is now readying for early delivery, radios in the popular 6 tube AC-DC and battery models, as well as a "personalized coat pocket" model, and radio-phonograph-combinations.

Newcomb to Offer Catalog

Newcomb Audio Products Co., Los Angeles, has in preparation a new 24-page catalog which is promised for release this month. The company offers for sale eight audio amplifiers, claimed to be superior to past products.

Proctor Appoints Snyder

E. I. "Al" Snyder has been appointed the Seattle district manager by Robert M. Oliver, vice-president of the Proctor Electric Co., Philadelphia, makers of the "Never-Lift" iron and other appliances.

CASH OR TERMS

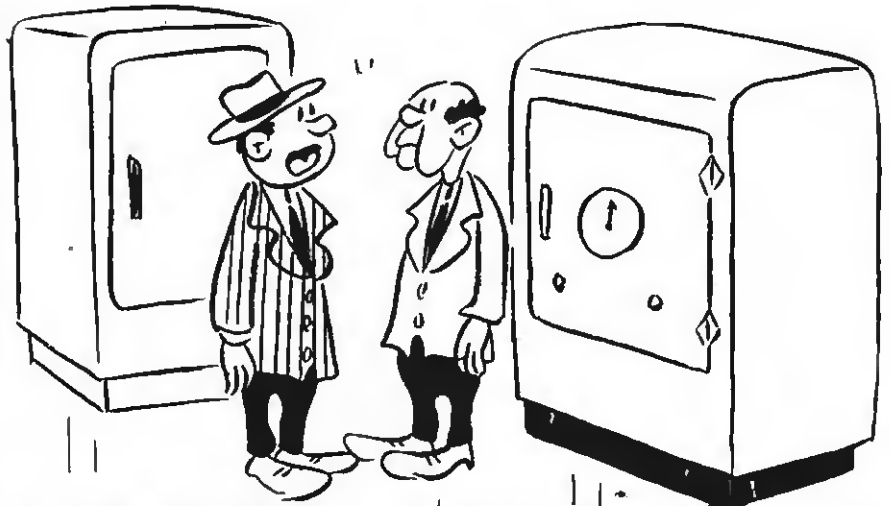

"But I don't want one with a radio built in. Some of the programs my wife listens to would turn the food sour!"

Baltimore Jobber Moves

Henry Wilson, general manager of Arvin-Salmanson Co., Inc., announces that new headquarters of this company have been established on a permanent basis at 2126-30 Edmonson Ave., Baltimore 23, Md.

The firm was organized over a year ago to act as exclusive wholesale distributor for Arvin radios and for electrical appliances, manufactured by Noblitt-Sparks Industries, Inc.

Distributor for Lear

Lear home radios in the Cincinnati territory will be distributed by Chambers Radio Supply Co., 1104 Broadway, Cincinnati, it is announced by Nate Hast, merchandise manager in charge of the home radio division of Lear, Inc.

Associated with Chambers are Carl Trimble, his store manager, Roy Meyers, Arthur Weitzel, and John Hill.

Garod a "Hot Line!"

Jobbers and retailers have been told by company officials that the new line of Garod sets is "hot", and those jobbers who attended a showing of the receivers in Chicago's Hotel Knickerbocker, October 12, are more sold than ever on the truth of the statement. As the curtains spread apart at the show to reveal the new models, a fire broke out. The curtains burst into flame, and Leonard Ashback, Chicago jobber was burned. The fire was speedily brought under control.

Zenith Official's Advice

Management of American industry must become sales minded and create a sustained demand for consumer goods, this year, next year, and in years to come, if it is to maintain a high level of employment and preserve our competitive system of free enterprise, according to J. J. Nance, vice-president of Zenith Radio Corp.

Minn. Dealer Buys Store; Servicing to Build Sales

The Greg Radio Laboratory owned and managed by G. M. Gregerson, has purchased the former Alpine Radio Shop, University near Snelling, St. Paul, Minn.

Location is midway between St. Paul and Minneapolis, where trade can be drawn from both cities. To promote the new store, Gregerson is carrying on an extensive advertising campaign using trade union papers, a veteran publication and daily newspapers often, and radio advertising three days a week.

Gregerson plans to play up strongly the advantage of purchasing radios or appliances at a store which is prepared to render all future service necessary. Such knowledge establishes confidence. Service also keeps purchasers in touch with the store and creates regular customers. "Good service builds strong business," is Gregerson's creed.

BELL

Nation-wide Acceptance RUNS INTERFERENCE FOR YOU!

Proved in war and peace, BELL Sound Systems offer you advantages that give you a head start in meeting the sound needs of every prospective sound user. You'll throw competition for a loss when you let BELL nation-wide acceptance run interference for you. BELL matched units combine readily to fill the requirements of every application — and they are priced right.

BELL Equipment includes BELfone Intercom Systems . . . Industrial Voice-Paging and Broadcasting Equipment . . . Permanent and Portable Amplifying Systems . . . Recording and Disc Playing Units . . . Electronic Sound Devices . . . Many Others. Contact one of the BELL Representatives listed here for complete information.



— a new and better approach to long-profit, high-volume Sound Equipment Sales!

BELL
SOUND SYSTEMS, INC.
1186 Essex Ave. Cols. 3, Ohio
Export Office—4900 Euclid Ave.
Cleveland 3, Ohio



BELL REPRESENTATIVES

ATLANTA, GA., Henry W. & Abby N. Burwell
105 Forrest Ave., N.E.
BOSTON 9, MASS., H. A. Chamberlin
31 Milk St.
CHICAGO, ILL., Paul H. Miles
333 N. Michigan Ave.
CLEVELAND, OHIO, John O. Olsen
1456 Waterbury Pl., Lakewood
DETROIT 26, MICH., J. P. Davenport
604 Kerr Bldg.
FORT WAYNE 3, IND., B. L. MacPherson
1724 Alabama Ave.
GREELEY, COLO., Gordon G. Moss
Post Office Box 428
HOUSTON, TEXAS, G. G. Willison
Tex-O-La Sales Co., West Bldg.
KANSAS CITY 6, MO., Maury E. Bettis & Co.
Rm. 400, B. M. A. Bldg.
LOS ANGELES, CALIF., Harry A. Lasure
2216 W. 11th St.
MEMPHIS, TENN., J. M. Cartwright
1276 Peabody Ave.
MINNEAPOLIS, MINN., M. E. Foster
Andrews Hotel
NEW YORK, N. Y., Wesley Scharp
67 W. 44th St.
PHILADELPHIA, PA., J. E. McKinley
628 Terminal Bldg., 401 N. Broad St.
PORTLAND 1, OREGON, Dale G. Weber
7026 S. W. Capital Highway
SAN FRANCISCO 3, CAL., Hodges and Glomb
1264 Folsom St.
TORONTO ONT., CANADA, Howard N. Reid
L. D. Cahoon and Co. Ltd.
2271 Danforth Ave.



Your Vacuum Cleaner Belt Problem Solved

NO MORE WORRYING ABOUT—the Makes and Models they fit because: Every bag is marked with Make and Model Numbers and the transparent bags keep the belts fresh and clean. The Price Problem because: The price is prominently printed on each bag

ORDER NOW! 8 assorted belt cards consisting of 96 belts will fit 130 makes and models. Your Cost\$10.08 net—Plus Postage

Retails for \$24.00

Free with above: Our New Catalog Listing 4531 items and 2911 illustrations giving list prices and your cost in code.

THE JESSE COMPANY

2438 W. North Ave.

Chicago 47, Ill.

WHILE THEY LAST!

SPECIALS

**"IN HARD TO GET"
RADIO ITEMS**

SPEAKERS...

3 1/2"-4"-5" P. M.each \$1.29
7 inch-6 V. Motorola, Auto Speaker, each 1.95
5 inch-450 Ohms.....each 1.59

SUPER VALUES

Spark Plug Suppressors, Cont. Carbon, 10 for \$1.39
GC Ne-O-Lite Testors, Display card of 20 5.59
JFD Adaptors, Boxed, Choice in lots of 10 29¢
JFD Line Cords, Boxed, Choice of 5 Resistances 1.97

Mazda Pilot Lights, 10 to box, each 42 1/2¢
Volume Controls with Switches, Boxed, Any Ohms.....each 59¢
Volume Controls, for Battery Sets, 2 Meg with DPDT switches, Boxedeach 69¢

JFD Ballast Tubes, Choice 5 Numbers, Boxed\$1.97
Resistor Kits, 20 Values 98¢
8 Prong Wafer Sockets, per 100..... 3.00
Test Leads, \$1.25 Value, net.....each 65¢
20 Amp. Auto Fuses, Pre-War Metal Boxes, Killark, per 100..... 1.95
GC Chemical Laboratory, Special..... 4.59

ANTENNA LOOPS

Sets of 3 assorted\$1.47
Trf Coils, per pair 89¢

CONDENSERS

20 x 20 at 150 V.-Atlas Condensers, Lots of 10each 21¢
10 Tubeltr at 50 V.-Atlas, Lots of 10each 1.89
.015-400 V. By Pass Condensers, Per 100 3.00
.02-600 V. By Pass Condensers, Per 100 4.39
.0003 Micamolds, 15' for..... 47¢

MISCELLANEOUS

SOLDER ON SPOOLS—ROSIN CORE
Divisolb 35¢
Standardlb 45¢
Philco Vibrators, 2 1/4" x 4 5/8"..... 1.69

Radio BELMONT Supply
Well. 5157
1921 W. Belmont Ave.,
Chicago 13, Ill.

Joins Wholesale Firm



H. D. Scibird is new merchandising manager of sewing machine and vacuum cleaner division, J. N. Ceazan Co., Los Angeles.

Manages Admiral Division

L. H. D. Baker, vice-president, appliances division, Admiral Corp., Chicago, announces the appointment of Harold D. Conklin as manager of the appliances division.

Returns to May Corp.

Byron R. Forster has been named by the D. W. May Corp., distributors for the New York and New Jersey area, to handle the firm's special accounts. Forster's assignment with the company marks the renewal of a former 15-year association with this distributing organization.

Wilcox-Gay New Line

Climaxing a series of national distributor meetings, officials of the Wilcox-Gay Corp. addressed a group of eastern jobbers in New York at which new models of Recordio home recorders and Recordiopoint needles were introduced.

The firm's "Lucky 13 Sales Plan" was featured at this function. Speakers included W. L. Hasemeier, vice-president in charge of sales; D. E. McGraw, assistant sales manager; G. E. Murphy, sales promotion manager; Robert F. Timm, of the Cramer-Krasselt Advertising Agency.

To Tung-Sol Position



John Van der Veer has become western manager for equipment sales of tubes for the Tung-Sol Lamp Works, Inc., Newark, N. J.

Better
ATLAS SOUND
Equipment
Ready for YOU



DOUBLE REENTRANT PROJECTOR
Many sizes. From 15 in. air column to 6 foot air column.



360 RADIAL, CHANDELIER PROJECTORS
Double Reentrant. For driver units. 3 and 4 foot air column lengths.



DRIVER UNITS
Various Power Handling Capacities. Newest types of indestructible Phenolic Diaphragms.



MINIATURE TYPE REENTRANT PROJECTORS—BOOSTER SPEAKERS

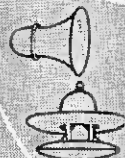

CONE TYPE PARABOLICS and CHANDELIER BAFFLES
for all size cone speakers.



MICROPHONE SUPPORT STANDS
20 types and sizes. All Fittings, Adaptors and Accessories. Floor Stands, Desk Stands, Banquet Stands, Boom Stands.

Wooden and Metal Cone Speaker Enclosures, Baffles, Carrying Cases, Loud Speaker Support Stands and Brackets.

ATLAS SOUND CORPORATION

1451 39th St., Brooklyn 18, N. Y.

20 Years Ago

From the November, 1925, Issue
of Radio Retailing

GETTING LEADS IS A SCIENCE—Illinois dealer gets and sells his prospects by using signs on roads, county newspaper advertising, direct-mail campaigns, equipping his delivery car with a receiver and making demonstrations with it, and by employing a threshing machine foreman, a bank teller, a grocery clerk and a mailman as part-time salesmen.

"CHRISTMAS IS COMING—PREPARE NOW FOR THE HOLIDAY CROWDS"—headline

PERSONAL CONTACTS—One of the main points in this dealer's merchandising philosophy for maintaining his success in retailing radios.

"Know Your Selling Costs"—Every merchant's first commandment.

TOMORROW'S RADIO DEALER—The trend is to the salon type of store . . . away from the "warehouse" atmosphere . . . and directed toward the class of showroom which reflects the atmosphere of the rooms in which the family gathers nightly at home.

A PLEA—"Let's Soft Pedal the Adjectives in Radio Copy."

"FIVE HOMES OUT OF SIX STILL HAVE NO RADIOS"—Editorial

WHAT'S NEW IN RADIO—Automatic battery charging regulator which keeps storage battery charged; a photo-electric cell which may be used for pictures by radio and telegraph, television, etc.; a radio frequency transformer; and a lightning arrester.

Named by Zenith Jobber

In preparation for an expansion of business now that manufacturing is so well under way, J. J. Nance, vice-president of Zenith Radio Corp., has announced the following appointments to Zenith Radio Distributing Corp., wholly-owned subsidiary, which is exclusive wholesale distributor of the firm's radios and hearing aids in the Chicago area and throughout the northern half of Illinois: general manager, James H. Hickey; sales manager, Charles F. Parsons, Jr.; division manager, Thomas B. Stone.

VITROHM RESISTORS AND RHEOSTATS

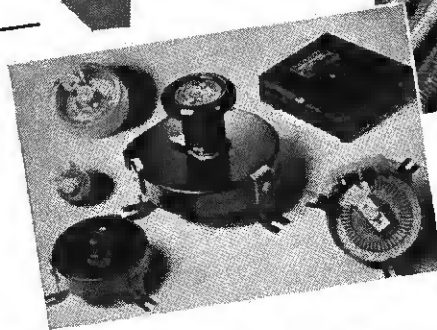

RESISTORS that withstand heat, moisture, vibration and other adverse conditions. Wide range of types, ratings, terminals and enclosures.

RHEOSTATS that include the widest range of sizes, types and current ratings from the tiny ring types for radio to huge power assemblies.

Ward Leonard Vitreous Enamelled Wire-Wound Resistors and Rheostats are now available at radio parts distributors.

Better than ever before, because they incorporate refinements and developments brought about through the war period.

Write for your copy of the Radio and Electronic Resistor Catalog.

WARD LEONARD ELECTRIC CO.

Radio and Electronic Distributor Division
53 WEST JACKSON BLVD., CHICAGO, ILL.



WARD LEONARD
ACCEPTED MEASURE OF QUALITY

RESISTORS
RHEOSTATS
RELAYS

AMCON

AN AMERICAN SOLUTION TO
YOUR CAPACITOR PROBLEMS

ALL TYPES - BY-PASS
AND ELECTROLYTIC

DATA SHEETS
ON REQUEST

AMERICAN CONDENSER CO.
4410 No. Ravenswood Ave. • Chicago 40, Ill.

RADIO

PRODUCTION
and REPRODUCTION

will be better because of

MONARCH

MEASURING • TESTING • CALIBRATING
EQUIPMENT



Joins Cosmo Records

Mortimer S. Palitz has returned from the armed forces to become vice-president in charge of recording, artists and reper-



Mortimer S. Palitz

toire of Cosmo Records, Inc., New York.

While in the Army, Palitz was recording director of Army V-Discs. Prior to the war, he was chief of recording for the Columbia Recording Corp.

With American Central

The appointment of Clyde T. Graham as district manager in Dayton, Ohio, for the American Central Mfg. Corp., is announced by C. Fred Hastings, general sales manager of the Connersville, Ind., firm.

To Emerson Jobber's Post

Ben Neutra has been appointed sales manager of Emerson Radio of Pennsylvania, A. Irving Wirtz, president, announces. Mr. Neutra is well known to the Pennsylvania radio trade, having covered Philadelphia dealers and distributors for the past twenty years.

Espey Export Agent

M. Zigman, president of the Morhan Exporting Co., New York, announces that his company has been appointed export representatives for Espey Mfg. Co., Inc., New York, manufacturers of radio receiver sets.

Get Toastmaster Samples

Every Toastmaster distributor in the country has already received his first sample of the firm's postwar model automatic toaster, it has been announced by William E. O'Brien, general sales manager, Toastmaster products division, McGraw Electric Co.

The company's distributors have been requested to provide a sample toaster for each retailer from their initial allotment to be retained by the retailer for display and to permit taking customer orders.

It's Here!
**ALL-STEEL
CABINET**

*Quick
Delivery!*

*for Parts
Storage*

ORDER NOW
FROM



RADIO
WAREHOUSE

Write for our
FREE
Bargain Bulletin!

Heavy gauge Steel Cabinet with three drawers, each divided into nine adjustable compartments. Ideal storage for your resistors, condensers, nuts, bolts, etc. 11 3/4" wide, 11 3/4" deep, 7 3/4" high; drawers 2 1/2" deep. Weight, 18 lbs. A swell buy!

CLIP AND MAIL
COUPON TODAY!
(This offer good
only in U.S.A.)

\$6.50

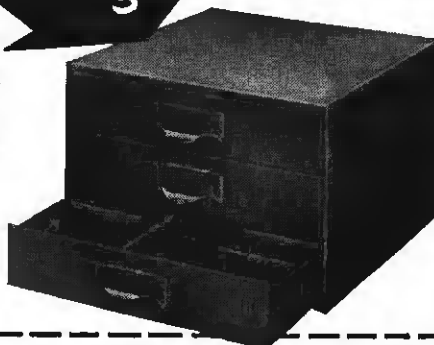

Olson Radio Warehouse 73 E. Mill St., Dept. 2, Akron, O.

Please ship me one All-Steel Parts Cabinet by express. I enclose \$6.50
 check money order. I will pay express charge upon arrival.

NAME.....

ADDRESS.....

Just the thing!

IT'S A "NATURAL" FOR CHRISTMAS

The **FM HOLLY GIFT BOX**
An outstanding Christmas Promotion

A glittering Fidelitone Master needle dressed in a brilliant open-faced red-and-green holly gift box displayed on a beautiful, full-color, 14 inch Christmas tree easel stand.

It is smart... It's attractive... It will give months of pleasure.

Truly a "natural" for Christmas sales.

Gift boxes and Christmas tree displays are available through your Fidelitone distributor.

PERMO, INCORPORATED
8415 RAVENSWOOD AVE. CHICAGO 26

AUTO ANTENNAS

Designed for
LEADERSHIP

Leaders in the auto antenna field for over a decade, JFD offers for prompt shipment auto antennas with these advantages:

1. Seamless Admiralty Brass Tubing
2. High-Polished Chromium Plating
3. Stainless Steel "Snap Back" Top Rod
4. Heavily Insulated Shielded Loom Lead
5. 100% Low Loss Construction

Eight Fast Selling Sizes and Types

Write for FREE literature #344

JFD
J. F. D. Manufacturing Co.
4111 Ft. Hamilton Parkway,
Brooklyn 19, N. Y.

WHERE TO BUY

RADIO AND TELEVISION RECEIVERS	Home AM-FM Combinations Television Auto Radio Amateur Commercial	See page 56 for Radio Retailing's up-to-date listing
ELECTRICAL APPLIANCES	Refrigerators Laundry Equip. Vac. Cleaners Elec. Ranges Gas Ranges Freezers Traffic Appl.	See page 85 for Radio Retailing's up-to-date listing

Another service to the reader.
Revisions to be made monthly.
Copyrighted—Republication forbidden.

SET BUILDERS SPECIALS

Radio and New Items
Phono Kits _____ for the Ham

Send for our NEW
FALL CATALOG

Complete line of ALL TYPES of Radio Parts. Write today

McGee Radio & Electric Co.
R-1145, 1225 McGee Street, Kansas City, Missouri

RADIO Wholesale REPAIR

RETAILERS and SERVICEMEN

This is the Answer to Your Radio Repair Troubles!

Just SEND us the SET via Railway Express. We REPAIR and RETURN. You ADD MARK-UP AND DELIVER. That's all there is to it.

- Complete Stocks—We can fix 'em all.
- 90 day guarantee
- Prompt service
- OUR LOW PRICES mean more Markup for you.

Send that set to

SHEFFIELD RADIO CO. 915 BELMONT AVE. CHICAGO 14, ILL.

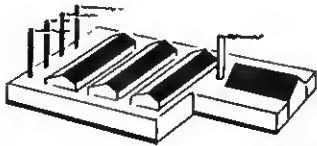

AMPLICALL Electronic Tool of Business

Rauland AMPLICALL Paging and Two-Way Communications Systems are helping business swing back to peacetime production with an efficiency never before thought possible. AMPLICALL'S ability to communicate instantly, locate in a hurry, save steps and time, actually multiplies manpower—gets much more productive work done daily! All of these factors plus quality of product, are enabling Rauland's progressive distributors to do an outstanding sales job now while building for a secure future.

1. AMPLICALL Weatherproof Speaker
2. AMPLICALL Paging Control Unit
3. W200 Series AMPLICALL Intercommunication unit with facilities for up to 24 master stations and up to 12 possible conversations simultaneously.

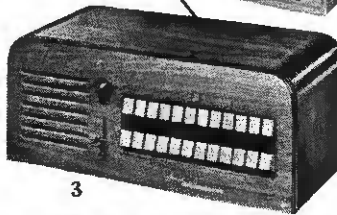
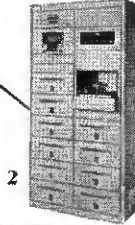

Electroneering is our business

RADIO - RADAR
SOUND

COMMUNICATIONS
TELEVISION

THE RAULAND CORPORATION • CHICAGO 41, ILLINOIS

Now an entirely new line!

*Quality
sound equipment
by
Newcomb*

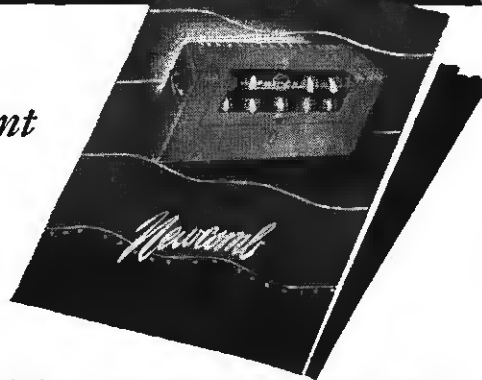

PRESENTING our newest line of amplifiers... they offer you greater excellence in sound reproduction than has ever before been available to the public address field. Designed and produced by an organization devoted exclusively, for more than seven years, to the perfection of fine sound equipment, they embody all the practical benefits of today's

most advanced electronic achievements.

Send for the catalog... compare Newcomb with others... you'll find no other amplifier has so many advantages.

T H E S O U N D O F Q U A L I T Y

Newcomb

AUDIO PRODUCTS CO.

MANUFACTURERS

DEPT. A 2815 S. HILL STREET, LOS ANGELES 7, CALIFORNIA

Service Sells

(Continued from page 116)

customer comfort will play an important part in radio and electrical appliance merchandising. "This may be especially true in 'selling up' or when selling higher priced items. Purchasers can appreciate the tone values of FM reception when they are at ease. Television receivers and expensive appliances can be sold easier when customers are relaxed," this dealer emphasized.

In view of the foregoing, the owner has taken "pains" to see that prospective customers are made comfortable.

In-Store Hospitality

A space has been set aside for attractively-upholstered easy chairs and settees where purchasers may sit in comfort. Floor lamps placed in this area round out the "homelike atmosphere".

Traffic appliances—all nationally advertised lines—will be effectively grouped in one section of the establishment. The store feels that small appliances can be good profit builders and hopes to cash in on these.

Retailer Christopher sees his store, as one of the most efficient radio and electrical appliance establishments in his trading area. He hopes to guarantee satisfaction to the customer by offering quality servicing.

Appliances sold will be serviced—if necessary—by the store. A well-equipped workshop is maintained with technicians who are thoroughly trained in their lines of work. The firm is a staunch believer in keeping customers happy.

"We built up a great deal of prestige and good-will during the war period and we intend to remain in our customers' good graces in this postwar period. Servicing will be one of the ways we'll accomplish this," Christopher maintained.

Electrical wiring and the sale of electrical lighting fixtures comprise a substantial part of the store's business. The firm will continue with these phases of its operation along with the merchandising of radios and electrical appliances.

New Sentinel Plant

Ground has been broken for the erection of a new modern plant, according to E. Alschuler, president of Sentinel Radio Corp., Evanston, Ill.

It is estimated that production of 3,000 radio sets per day on a single shift schedule can be maintained in the new plant.

Electro
ELECTRICAL AND RADIO EQUIPMENT

BATTERY ELIMINATORS



Announcing! Our New Models P and Q. They include every achievement of wartime ingenuity, and lift battery radio reception to new heights of satisfaction. Cost but a few cents per hundred hours of operation. Sturdily constructed—no liquids or moving parts—operate in any position. Completely filtered, hum free, and silent in operation. Universal plugs and sockets to fit any radio.

MODEL P—For use in any place where normal AC is available. Operates any 1.4 volt—4, 5 or 6 tube battery radio from 115 v. 60 cy. source.

MODEL Q—For use wherever AC lines are not available—Farms, cottages, camps, or in car, motorboat, etc. Operates any 1.4 volt—4, 5 or 6 tube radio from 6 volt DC source.

NOTE: Due to critical material shortages at this time, our production is necessarily limited and deliveries can be made only through our present established jobbers. Canadian representative, Atlas Radio Corp., Toronto, Canada.

ELECTRO PRODUCTS LABORATORIES

Pioneer Manufacturers of Battery Eliminators
549 WEST RANDOLPH STREET CHICAGO 6, ILL.



FIRST CHOICE... OF AMERICA'S RADIO DEALERS

Radio dealers, too, recognize the factors that long ago made Ward Antennas most popular with auto manufacturers and dealers. They see the top quality, precision workmanship, and now the new war-created designs that make Ward better than ever! The world's finest antennas for car and home were made, are made, and will continue to be made by Ward. Place your order for Ward Antennas now!



BUY VICTORY BONDS

THE WARD PRODUCTS CORPORATION
1523 EAST 45th STREET - CLEVELAND 3, OHIO

UNUSUAL...?

Yes, there are many Vaco shafts and bits which do appear unusual because they were created to perform some unusual service... better, faster and easier! There are 173 types of

VACO AMBERYL

plastic handle drivers. You will undoubtedly find just the drivers you want in our regular line, or we can create something special for you. Write for catalog.

VACO PATENTS MAKE JOBS
PRODUCTS CO.

309 E. ONTARIO ST. • CHICAGO II, ILL.
Canadian Warehouse: 560 KING STREET, WEST • TORONTO 2, ONTARIO

A REAL SALES OPPORTUNITY IN ELECTRONICS

If you have a technical background, here is an opportunity to make real money selling high quality electronic parts and equipment to radio parts jobbers in this area. A manufacturer whose products are already well accepted by the trade needs a representative at once. Outline education, qualifications and prior business experience. Please enclose recent photograph. Box 109, Radio & Television Retailing, 480 Lexington Ave., New York 17, N. Y.



FREE TO YOU COLOR CODE AND OHMS LAW CALCULATOR

A great convenience. Easy to work. Solves many problems. Attach coupon to your letterhead Free to radio men, engineers, etc.

BA
BURSTEIN-APPLEBEE
COMPANY
1012 McGee St.
Kansas City 6, Mo.

Mail Coupon Now

BURSTEIN-APPLEBEE COMPANY
1012 McGee, Kansas City 6, Mo.

Send me FREE Color Code and Ohms Law Calculator along with latest catalog

I am _____
STATE CONNECTION IN INDUSTRY
NAME _____
ADDRESS _____
TOWN _____ STATE _____

IT'S NEW! IT'S POST-WAR
SUPREME Model 565
VACUUM TUBE VOLTMETER

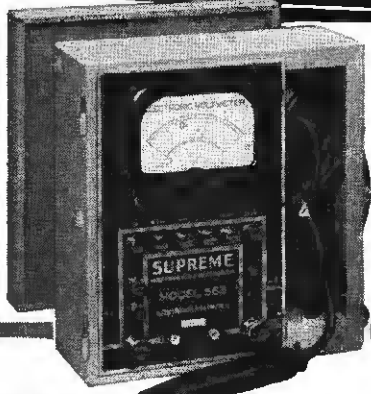

NEW PROBE Stream-lined
 Hand Fitting Incorporating
 new High Frequency Diode

RANGES:
 DC 0-1, 2.5, 10, 50, 250, 500
 AC 0-1, 2.5, 10, 50, 250
 EXTENDED TO 5000 VOLTS BY EXTERNAL MULTIPLIERS

FREQUENCY RANGE:
 Negligible frequency error from
 50 cycles to 100 megacycles.

INPUT RESISTANCE:
 DC—80 megohms on 1 volt range; 40 megohms on 500 volt range
 AC—40 megohms on 1 volt range; 20 megohms on 250 volt range

INPUT CAPACITY OF PROBE: 5 micro-micro farads

SUPREME INSTRUMENTS CORPORATION GREENWOOD MISSISSIPPI

ALWAYS GETS A HAND!

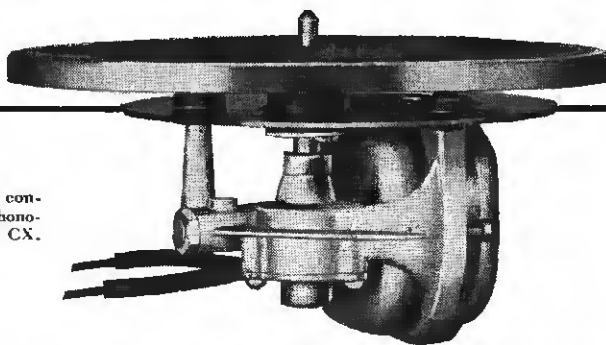

General Industries constant-speed electric phonograph motor—Model CX.

Users and the trade have always given hearty applause to General Industries phonograph mechanisms. Owners like the fine fidelity of every note or syllable—and sales and service departments are strong for their reliability and freedom from maintenance troubles.

You get this same old-time satisfaction from our *Smooth Power* turntable motors, recording assemblies and record-changer recorder com-

binations as we return to civilian production. As always, General Industries equipment will earn your approval.



THE GENERAL INDUSTRIES COMPANY
DEPT. M ELYRIA, O.

Do-Re-Me

(Continued from page 49)

dividends received from accessory sales reflect an unusually heavy trend toward the purchase of needles and other important items. With radio-phonograph combinations returning to dealers' stores, sales of records and related goods should spell more profits.

"Nothing magical about the way our record department is paying off," declares Mildred Wade. "It is all tied in with realizing that every record customer is an accessory prospect, and acting accordingly. Timid, inexperienced, or careless sales assistants overlook the opportunity to sell accessories, but the ability of our sales staff eliminates the loss of accessory sales." Mrs. Wade considers the margin of profit on accessories, needles, cabinets, etc., as being very good. This explains why so much sales effort is placed behind these products.

Special Orders

The "may I order it for you?" inquiry to a patron requesting an out-of-stock item is no idle question at the Brown Music Co. If the customer answers in the affirmative, a special order for the item is dispatched immediately. On arrival of the record, the patron is notified as soon as possible by telephone or mail. This may seem routine to many aggressive radio-record dealers, but strict adherence to the plan of treating each one of these orders with special attention has amassed quite a "stock" of good-will for the store. Customers like Brown's, and prove it by coming back.

Response to frequent advertisements, suggesting that readers register at the store for early delivery of radios and appliances, points to abundant sales as soon as electrical merchandise arrives at the store in large quantities. The registration also provides a handy mailing list for all relations between the establishment and prospective customers.

It isn't too early to predict a glowing future for this new and growing midwest radio-appliance-record store. An alert sales staff, a sound sales promotion schedule, astute supervision, and an atmosphere that should suit the most discriminating buyers is a set-up that should enable the company to by-pass whatever merchandising pitfalls may lie ahead.

AUTOMOBILES ↗
HOMES ↗
BOATS ↗
HANDY TALKIES ↗

ANTENNAS



SNYDER
 MANUFACTURING CO.
 PHILADELPHIA 40, U.S.A.

MANUFACTURERS—START TO FINISH

"Columbia" is a reliable source

**IMMEDIATE DELIVERY
 from STOCK!**



2 CONDUCTOR MICROPHONE CABLE

The best mike cable available fully shielded—live, flexible buna rubber outer jacket.

Random lengths from 25 ft. to 250 ft., while quantity lasts. Per 1000 ft.\$37.50

PLASTIC PARALLEL RIP CORD

2 CONDUCTOR—No. 18 Ga. Stranded

Easy to strip—easy to separate. The finest obtainable for radios, lamps, appliances, etc. Approximately 3000 ft. on reel.

Per 1000 ft.\$14.95

OR

250 ft. Metal Spools. Per 100 ft.\$1.65

INSULATED ELECTRICAL WIRE

Gauges #22 to #4

Available for immediate delivery from stock in single and multi-conductors.

18 CONDUCTOR CABLE

Plastic paired conductors. One conductor of each color is ribbed for easy identification, and can be used either paired or coded. Shielded with Synthetic Rubber outer jacket.

Approximately 1500 ft. on large wood reel.

Per 1000 ft.\$100.00

Per 100 Ft.\$12.50

Write for Complete Circular No. 6
 ORDER FROM YOUR JOBBER or write direct

COLUMBIA WIRE & SUPPLY CO.

4104 N. PULASKI RD., CHICAGO 41, ILLINOIS

Electricity

Models range from 250 to 25,000 watts. A. C. types from 115 to 660 volts; 30, 45, 180 cycles, single or three-phase and 105, 200 and 300 cycles, single phase. D. C. types from 5 to 4000 volts. Also available in dual voltage and special frequency types.

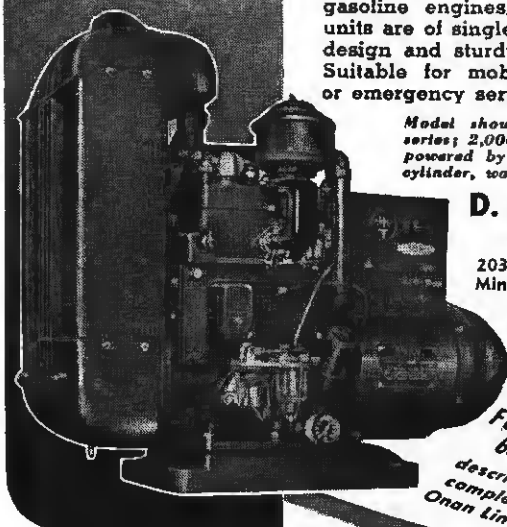

FOR RADIO AND ELECTRONIC APPLICATIONS

• **ONAN ELECTRIC GENERATING PLANTS** supply reliable, economical electrical service for electronics and television applications as well as for scores of general uses.

Driven by Onan-built, 4-cycle gasoline engines, these power units are of single-unit, compact design and sturdy construction. Suitable for mobile, stationary or emergency service.

Model shown is from W2C series; 2,000 to 3,500 watts; powered by Onan-built, two-cylinder, water-cooled engine.

D. W. ONAN & SONS

2037 Royalston Ave.
 Minneapolis 5, Minn.

Write For Folder 690-A describing complete Onan Line

New!



Porta-Power MODEL "H"

featuring . . .

HUM - FREE OPERATION



Size 2 1/8" x 4 1/2" x 6 3/4"
Shipping weight 5 pounds.

Two section filter, composed of three very high capacity condensers, and two oversized iron core chokes in the "A" supply:— and two high capacity condensers and an oversized choke in the "B" supply positively block out hum.

Universal sockets for battery plugs.

Fits in 99% of all portables.

Circuit designed for optimum voltage regulation and changes in line voltages.

Weighs 4 1/2 Pounds — and every ounce essential to topnotch performance.

O. P. A. APPROVED

PRICE MODEL "H" \$15.00

PROVIDES

"A"

1.5v at 200 m.a.
1.35v at 250 m.a.
1.55v at 300 m.a.
1.35v at 350 m.a.

"B"

90v at 13 m.a.
101v at 8.5 m.a.

of 4, 5, or 6 tube, 1 1/2 volt battery Farm or portable radios from 105-125 volt, 50-60 cycle lines.

Jobbers — write for details . . . Dealers — See your jobbers

GENERAL TRANSFORMER CORP. . .

1250 W. Van Buren St., Chicago 7, Ill.

INDEX To Advertisers

NOVEMBER, 1945

	Page		Page
Admiral Corp.	58	Merit Coil & Transformer Corp.	4
Aerovox Corp.	153	Meissner Mfg. Co.	134, 135
Alliance Mfg. Co.	156	Monarch Mfg. Co.	172
American Condenser Co.	171	National Carbon Co., Inc.	148
Amperite Co.	162	National Die Casting Co.	82
Arrow Radio Co.	162	National Union Radio Corp.	5
Atlas Sound Corp.	170	Newcomb Audio Products Co.	174
Automatic Radio Mfg. Co.	113	Noblitt-Sparks Industries, Inc.	12, 13
Bell Sound Systems, Inc.	169	Norge Div., Borg-Warner Corp.	70, 71
Belmont Radio Supply	170	Ohmite Mfg. Co.	154
Bendix Radio Div. of Bendix Aviation Corp.	109	Olson Radio Warehouse	172
Burstein-Applebee Co.	175	Onan & Sons, D. W.	177
Caldwell-Clements, Inc.	142, 143, 152	Permo, Inc.	173
Centralab	18	Philco Corp.	76
Chicago Tribune	8	Quam-Nichols Co.	179
Clarostat Mfg. Co., Inc.	166	Radiart Corp.	136
Columbia Wire & Supply Co.	177	Radio Corp. of America	92
Commercial Credit Co.	66	RCA Victor Division	90, 91
Crosley Corp.	79	RCA Tube Division	89, 144
Decca Distributing Corp.	51	Radio Supply & Engineering Co., Inc.	164
Delco Radio Div. of General Motors	118	Rauland Corp.	174
Detrola Radio Div. of International Detrola Corp.	97	Ray-O-Vac Co.	140
DuMont Laboratories, Inc., Allen B.	115	Raytheon Mfg. Co.	9
Eastern Amplifier Corp.	129	Recordisc Corp.	165
Electro Products Laboratories	175	Saturday Evening Post	138, 139
Electronic Products Mfg. Corp.	157	Seeburg Corp., J. P.	Cover 3
Electronic Corp. of America	2, 3	Sentinel Radio Corp.	125
Emerson Radio & Phonograph Corp.	99	Sheffield Radio Co.	173
Fada Radio & Electric Co., Inc.	15	Simpson Electric Co.	20, 21
Farnsworth Television & Radio Corp.	24, 25	Simpson Mfg. Co., Mark	167
Favorite Mfg. Co.	163	Snyder Mfg. Co.	177
Galvin Mfg. Corp.	Cover 4	Solar Capacitor Sales Corp.	180
Garod Radio Corp.	11	Sonora Radio & Television Corp.	27, 151
General Electric Co.	95, 131	Sound Equipment Corp.	160
General Mills, Inc.	63	Sparks-Withington Co.	149
General Industries Co.	176	Sprague Products Co.	26, 130
General Transformer Corp.	178	Standard Transformer Corp.	167
Gibson Refrigerator Co.	82	Stewart-Warner Corp.	106
Graybar Electric Co.	87	Stromberg-Carlson Co.	28
Hallicrafters Co.	110	Supreme Instruments Corp.	176
Hamilton Radio Corp.	123	Swain Nelson Co.	124
Hammarlund Mfg. Co., Inc.	101	Sylvania Electric Products, Inc.	22
Hickok Electrical Instrument Co.	161	Telephone Radio Co.	100
Howard Radio Co.	128	Templetone Radio Mfg. Corp.	146
Hytron Radio & Electronics Corp.	10	Today's Woman	117
International Resistance Co.	147	Trilmont Products Co.	72
Jackson Electrical Instrument Co.	155	Triplett Electrical Instrument Co.	150
Jensen Radio Mfg. Co.	14	True	103
Jesse Co.	169	Tung-Sol Lamp Works, Inc.	112
J. F. D. Mfg. Co.	173	U. S. Treasury	94
Kellems Co.	108	Utah Radio Products Co.	23
Ken-Rad, Div. of General Electric Co.	7	Vaco Products Co.	175
Lake Radio Sales Co.	158	Ward Leonard Electric Co.	171
Landers, Frary & Clark	75	Ward Products Co.	175
Lear, Inc.	17	Warwick Mfg. Corp.	133
McGee Radio & Electric Co.	173	Waters Conley Co.	121
Macmillan Co.	168	Webster Chicago Corp.	141
Magnavox Co.	6	Webster Electric Co.	159
Maguire Industries, Inc., Thordarson Div.	119	Weller Mfg. Co.	157
Majestic Radio & Television Corp.	127	Westinghouse Electric Corp.	104, 105
Mallory & Co., P. R.	Cover 2, 16	Electric Appliance Div.	67
Marion Electrical Instrument Co.	137	Wholesale Radio Laboratories	166
		Wileox-Gay Corp.	19
		Wittie Mfg. & Sales Co.	81

While every precaution is taken to insure accuracy, we cannot guarantee against the possibility of an occasional change or omission in the preparation of this Index.

WATCH FOR THE

QUAM
Advertisers Come

QUAM-NICHOLS CO., 33rd Place and Cottage Grove, Chicago 16, Illinois

A Revolutionary New Speaker for the
Post-War Market, to be available soon

THE EYES
HAVE IT

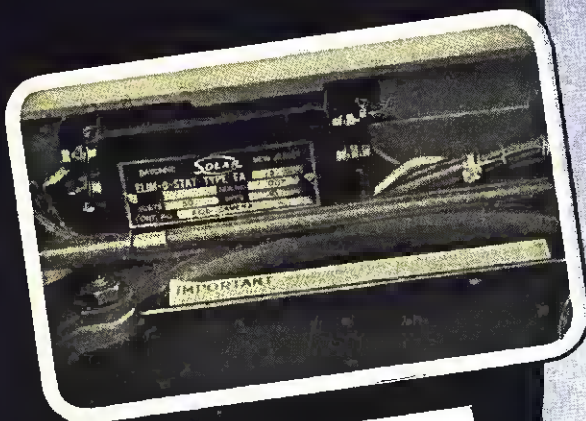

BACK AGAIN!
Solar Elim-O-Stats for noise suppression
in all Household Electrical Appliances.
Order NOW from your Solar Distributor.



Quick as a wink the Fairchild Night Owl Camera records enemy movements intended to be hidden by darkness. Quick as a flash the radio of the photo-reconnaissance plane keeps touch with its base — and clearly — for Solar Elim-O-Stats are part of the electronic equipment of these highly perfected cameras. This is but one of many instances where Solar Elim-O-Stats are being used to absorb local interference and keep speech channels free. Let Solar advise you on radio-noise suppression.



SOLAR WEST N. Y. BAYONNE PLANT PLANT
ARMY-NAVY EXCELLENCE AWARDS
A TOTAL OF TEN

SOLAR MANUFACTURING CORP.
285 Madison Avenue • New York 17, N. Y.

**SIMPLE?
DEPENDABLE?
TROUBLE-FREE?**

Yes!

• These three basic factors . . . the very foundation of good record changer operation . . . are built into the new superior line of SEEBURG RECORD CHANGERS. From the drafting board to the finished product . . . the dependability of SEEBURG RECORD CHANGERS have been achieved by the fewer moving parts of the simple, sturdy mechanism.

SEEBURG RECORD CHANGERS Dependable

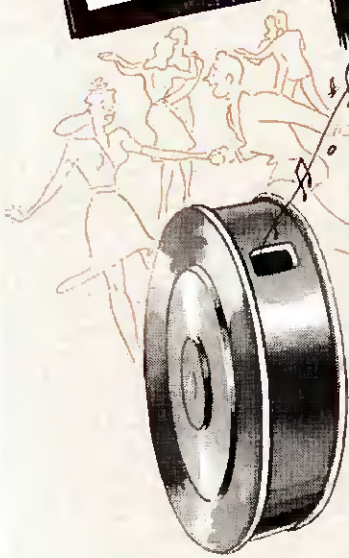

SEEBURG WIRE RECORDERS

• The SEEBURG WIRE RECORDER taxes the imagination . . . yet, it is an accomplished electronic achievement. One simple control knob operates the SEEBURG WIRE RECORDER to reproduce or record speeches, plays, meetings, music, radio programs, etc. There are no needles or discs used.

IT WILL BE NECESSARY . . .

for radio manufacturers to make provision in their circuits to accommodate the SEEBURG WIRE RECORDER and we therefore invite prompt inquiries from interested radio manufacturers.

Seeburg

J. P. SEEBURG CORPORATION • CHICAGO

**WE'RE SINGING THE PRAISES OF MOTOROLA
TO 38,000,000 OF YOUR PROSPECTS!
IN 32 NATIONAL MAGAZINES!**



YOU bet we look pleased as we appear in the new Motorola ad! And that broad smile of satisfaction is just the kind of reaction you'll get from your customers the very first time you flick the switch of the Motorola and let it sing and play its way into their hearts. It's easy as can be to sell the new Motorola Radio, because just to hear it is to know that this is the finest radio that money can buy!"

"We're telling the story of Motorola's brilliant

tone, accurate record reproduction and outstanding quality to 38,000,000 families through the pages of The American Weekly, Life, Newsweek, Esquire, Fortune, Popular Publications (18 magazines), Saturday Evening Post, Collier's, American Magazine, Cosmopolitan, Liberty, This Week Magazine, National Geographic and the rotogravure sections of 21 large metropolitan newspapers. That's the kind of support that creates sales for you!"

Motorola **A-M**
F-M **Radio**

F-M & A-M HOME RADIO • AUTO RADIO • AUTOMATIC PHONOGRAPHS • TELEVISION • AIRCRAFT RADIO • POLICE RADIO • RADAR