

Vol. 3  
RCA to Zenith

# Radio Manufacturers of the 1920's

By Alan Douglas



# **RADIO MANUFACTURERS OF THE 1920's**

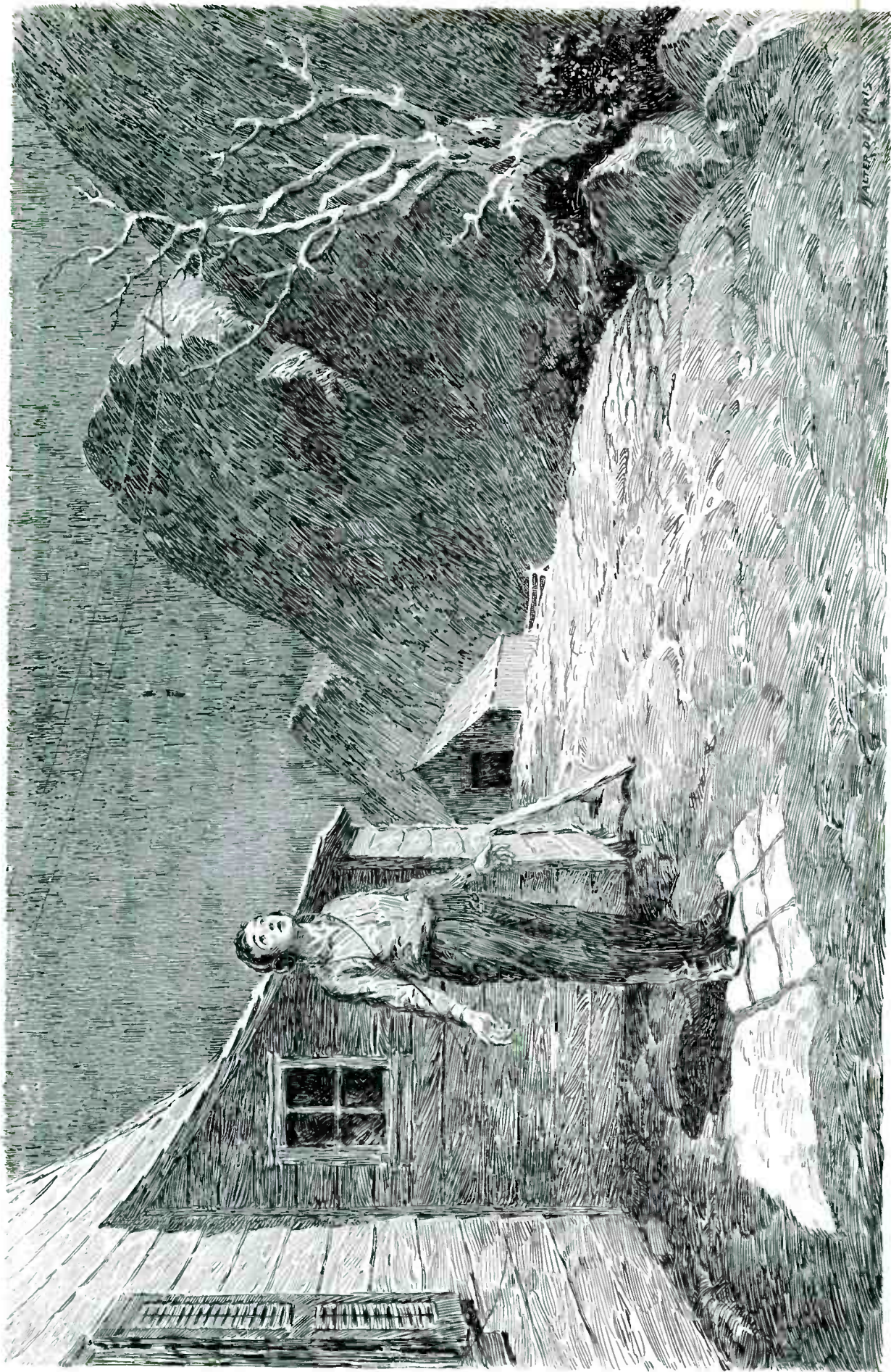

IN TUNE WITH THE INFINITE

Judge, April 22, 1922, pp 16-17.

# RADIO MANUFACTURERS OF THE 1920's

**BY ALAN DOUGLAS**

Vol. 3 — RCA to Zenith

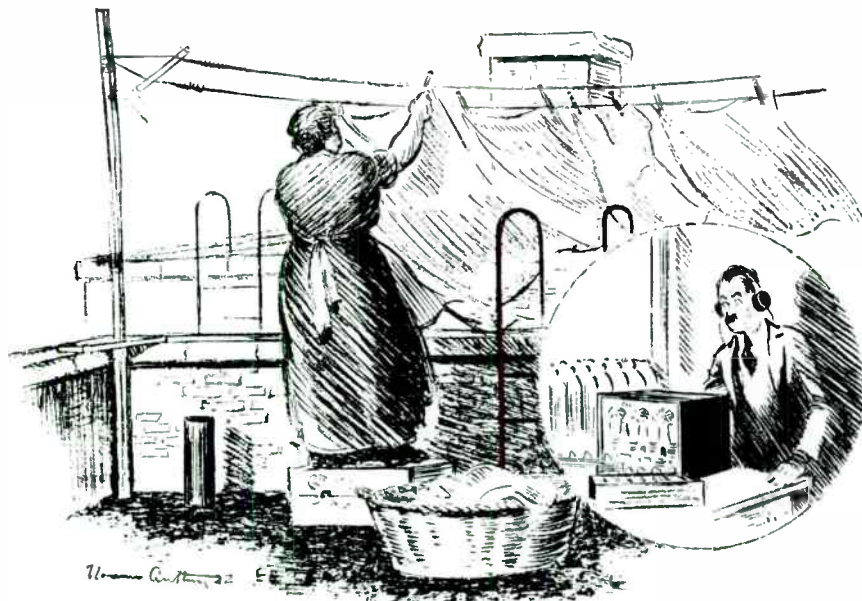

A Busy Wire.

*Judge, April 22, 1922, p. 31.*

The Vestal Press, Ltd.  
Vestal, New York 13851

**A note about the cover:**

The MAJESTIC (actually a 1930 model) is from the collection of James Spalik of Kirkwood, New York  
The RCA is owned by Harvey N. Roehl of Vestal, New York, and it came from the Murray Clark collection  
The ATWATER KENT was loaned by Joyce Demchak of Johnson City, New York

**Library of Congress Cataloging-in-Publication Data  
(Revised for Vol. 1)**

Douglas, Alan, 1943-  
Radio manufacturers of the 1920's.

Includes indexes.

Contents: v. 1. A-C Dayton to J.B. Ferguson, Inc. —  
v.2. Freed-Eisemann to Priess.— v. 3. RCA to Zenith.

1. Radio supplies industry — United States — History.

I. Title.

HD9696.R363U6345 1991 338.7'62138418'0973 87-31088

ISBN 0-911572-67-8 (v. 1)

ISBN 0-911572-68-6 (pbk. : v. 1)

ISBN 0-911572-93-7 (v. 3 : cloth)

ISBN 0-911572-94-5 (v. 3 : paper)

©1991 by Alan Douglas

For additional copies of this book  
or for our complete catalog, write to:

The Vestal Press Ltd.  
PO Box 97  
Vestal, NY 13851-0097

All Rights Reserved  
Printed in the United States

First printing 1991

# Contents

RCA	1
Scott	69
Silver-Marshall	81
Slagle	93
Sleeper	99
Sonora	107
Sparton	115
Splitdorf	125
Steinite	135
Stewart-Warner	143
Stromberg-Carlson	153
Thermiodyne	167
R. E. Thompson	175
Thorola	183
Tri-City	187
C. D. Tuska	210
Ware	219
Western Coil	215
Western Electric	225
Workrite	239
Zenith	247
Index	279

# Acknowledgments

In addition to those published in volumes 1 and 2, my special thanks go to: John Anderson (RCA), Jim Clark (Scott), George Harris (Scott), Will Jensby (Radio Shop), Rupert Loftus Brigham (Western Electric), Stewart Oliver (Radio Shop), Bob Paquette (RCA), Thomas S. Pletcher (Zenith), J.W.F. Puett (Scott), Eric Sanders (Western Coil), and Ed Taylor (RCA).

Alan Douglas  
June 1991

# RCA

## Radio Corporation of America

**W**e know it now as RCA, but in the twenties, it was simply the “Radio Corporation.” Born with a silver spoon in its mouth to be the chosen instrument of American radio communications, it should have also been predominant in radio receivers. After all, it was the exclusive radio sales agent for the four largest electrical manufacturing companies: General Electric Company, American Telephone & Telegraph Co., Wireless Specialty Apparatus Co., and (after 1921) Westinghouse Electric & Manufacturing Co. Among them, these firms controlled nearly every worthwhile patent in radio, made most of the commercial equipment, made every (legal) vacuum tube, and had strong ties with their overseas counterparts to obtain the best foreign technology. All they did not control was the amateur market — mere crumbs.

The Radio Corporation was only a sales agent and actually made nothing. But the activities of these four manufacturing companies are so closely intertwined that it is convenient to treat the Radiolas as Radio Corporation models, bringing the manufacturing companies into the account as necessary.

### RADIO CORPORATION OF AMERICA IS FORMED

New Company to Take Over Radio Rights of General Electric Company and Properties of the American Marconi Company

A new company, the Radio Corporation of America, has been formed to take over the radio rights of the General Electric Company. It has also proposed to the Marconi Wireless Telegraph Company of America to take over its patents and stations and some of its assets. Directors of the American Marconi Company have approved the arrangement and called a meeting of shareholders for Nov. 20 to pass upon it finally.

Edward J. Nally, vice-president and general manager of the American Marconi Company, said in a statement:

The American Marconi Company has the disadvantage of having a substantial percentage of its stock held abroad, and because of patent agreements with the British Marconi Company, of having its operations limited in the United States.

The research laboratories and engineering force of the General Electric Company have been working for a number of years on radio matters, and radio apparatus of great value has been developed, which was used by the government during the war for important communications.

*Electrical World (Nov. 8, 1919)*



David Sarnoff

The Radio Corporation was born without much fanfare in October 1919; a year passed before it advertised any products.



## Westinghouse

The story begins with Westinghouse, even though it did not join the "radio group" until June, 1921. Whether by foresight or by luck, Westinghouse saw the potential of radio broadcasting long before General Electric. Frank Conrad, General Engineer of the company, had been experimenting in radio in East Pittsburgh since 1912; by 1915, this activity warranted forming the Radio Engineering Section under Louis W. Chubb. Licensed as 8XK on August 1, 1916, Conrad built a 20-watt Transmitter and installed it in his home for tests with the factory five miles away. The following year, Westinghouse was awarded a Signal Corps contract for 75 SCR69 transmitters and 150 SCR70 receivers, designed by Conrad, who kept his ham station on the air during the war as 2WM for testing them. With this Army contract came Donald G. Little, who later, on completion of his Signal Corps service in 1919, became Conrad's assistant. Other military contracts were for the SE1012A in 1918 and the SE1414, both built to Navy designs ("SE" from Bureau of Steam Engineering, which had charge of radio work).

With the war's end went the profitable military contracts, but Westinghouse executives expected a compensating increase in commercial and amateur radio. So Conrad and Little began design work in the fall of 1919 on the new RA and RB receivers. At the same time, Westinghouse attempted to purchase the Fessenden heterodyne patents from the International Radio Telegraph Co., successor to Fessenden's old National Electric Signalling Co., coincidentally located in Pittsburgh. Unsuccessful in cherry picking International's main assets, Westinghouse agreed in



MR. FRANK CONRAD, 8XK  
—An Example for the Amateur—

QST (Feb. 1921)

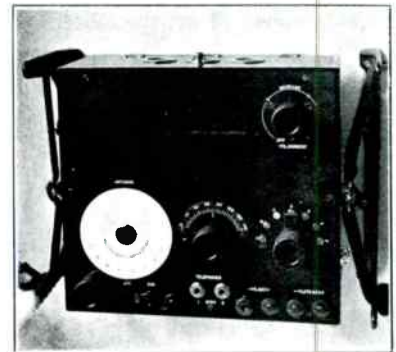

Proc. I.R.E. (April 1920)

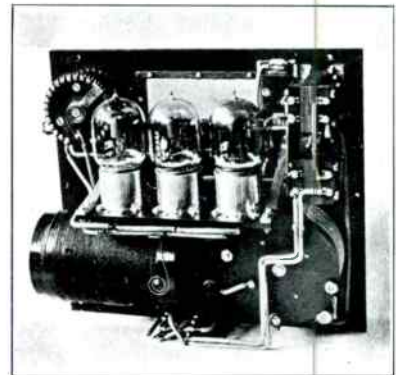

The SE1414 aircraft receiver was designed in the Radio Test Shop, Washington Navy Yard, and built at the Westinghouse Newark Works.

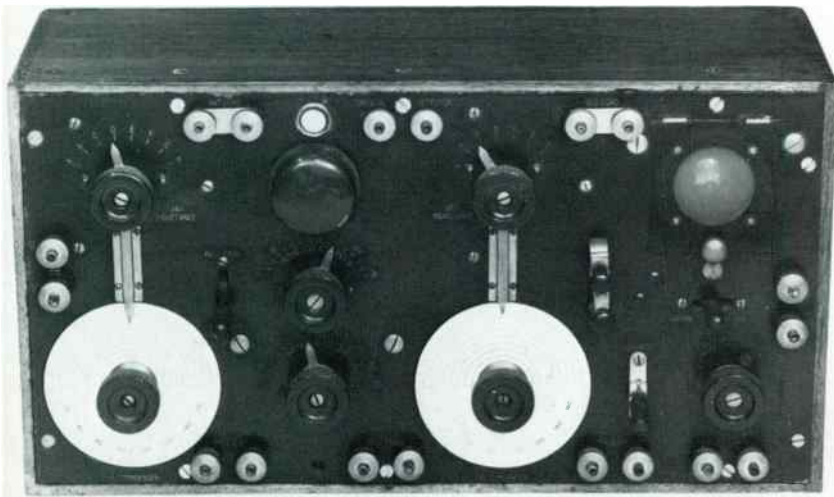

New England Wireless & Steam Museum.  
SE1012 radio compass receiver.

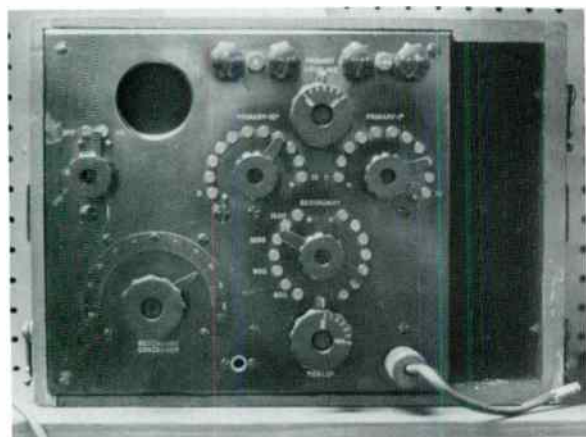

Don Patterson photo

SCR 70 Signal Corps Museum, Ft Gordon, GA

**RADIO TELEGRAPH TRANSMITTING SET  
TYPE SCR-69**

The radio telegraph transmitting set, type SCR-69, is an undamped wave set which is intended primarily for use as an instruction unit. It is designed to serve somewhat the same purpose as the French E-3 or E-10 sets and is issued only to organizations in training. Light weight, high efficiency and sharp tuning are its special characteristics. Three kinds of undamped wave sending may be used with the one set, making it possible to communicate with a receiving station whether the latter is equipped with a heterodyne or an ordinary rectifying detector set. This feature makes it more or less universal in character and particularly suited to use under training conditions where several types of receiving sets may be employed. In case the batteries of a heterodyne or autodyne receiving unit working with this transmitting set should fail, it would still be possible to use this same set by sending buzzer-modulated waves and receiving by ordinary crystal detection.

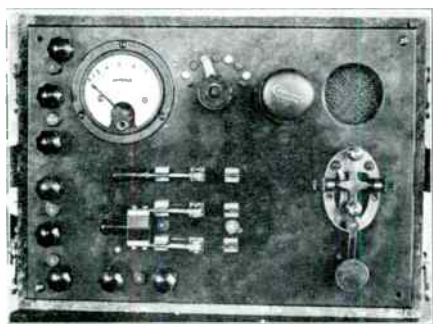

Operating Panel of Type SCR-69 Transmitting Set

As the operating characteristics of this set have not been satisfactory, only a comparatively small number of sets will be manufactured, and it is anticipated that these will be displaced in the near future by the type SCR-79 set.

3

About December 1920, the RB was built at the Newark Works. More than 300 were leased to the United States Shipping Board Emergency Fleet Corporation, and a few were later used at the Westinghouse broadcast station for monitoring and inter-plant communication.

May, 1920, to purchase the company itself for \$2.5 million. A patent exchange was worked out with the Navy to allow use of the Federal arc transmitter patents, giving Westinghouse the elements of a complete system. S. M. Kintner, President of International, left for Europe to negotiate traffic agreements.

But Kintner returned empty-handed. The Radio Corporation had already signed exclusive agreements with every country worth mentioning, freezing out any latecomers. That left the ship-to-shore business, and there, by virtue of having taken over the old American Marconi Co., the Radio Corporation had a commanding lead in shore stations and ship installations. Westinghouse proposed a broadcast news service to ships at sea, but the shipowners were not interested.

What to do? Cancel the agreement with International (only \$300,000 of the \$2.5 million had been paid) and forget the whole thing? On September 2, 1920, vice president Owen D. Young of General Electric phoned his old friend Guy Tripp at Westinghouse, offering to take International off his hands.

President Tripp not only refused the offer, but moved in the opposite direction. On October 5, he acquired an option to buy Armstrong's regeneration patent and superhet application for \$335,000 (plus another \$200,000 if a patent-office interference with de Forest should be decided favorably). This option was exercised on November 4.

Meanwhile, vice president H. P. Davis noted that Frank Conrad's test transmissions from 8XK were being received by a growing circle of fans; and on September 29, a Pittsburgh department store even advertised complete receivers for this purpose. Davis persuaded Conrad to build a larger station at the East Pittsburgh plant, obtained a license from the Commerce Dept., and put KDKA on the air on November 2, 1920. Several weeks afterward (once Westinghouse owned the Armstrong patent), nameplates were attached to the first production run of about 1,500 RA's and DA's already on hand, and they were offered for public sale.



Ralph Muchow

# WESTINGHOUSE Radio Receiving Equipment

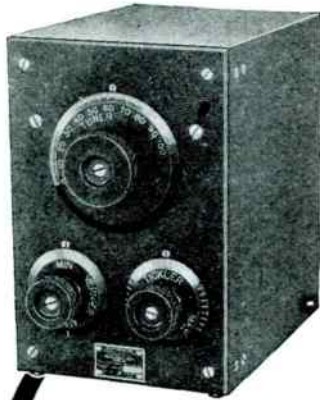

Type RA Short-Wave Tuner  
Style 307189—180-700 Meters



Type DA Detector Amplifier  
Style 307190—2-stage, 3 tubes  
Audio Frequency



**T**HIS high-grade Westinghouse regenerative Tuner, and tube detector amplifier embody the latest ideas of two noted radio engineers, Edwin H. Armstrong and Frank Conrad.

This apparatus provides a most efficient set for telegraph and telephone reception over the amateur and normal ship wave length ranges.

**Simple in Design—Easy to Operate—Single-tuning Circuit  
Highly Efficient**

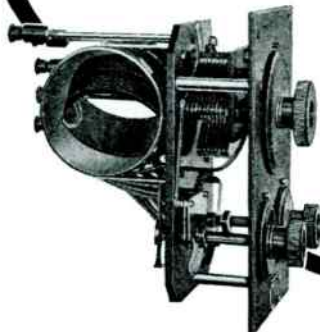

Interior View of Type RA Short-Wave Tuner

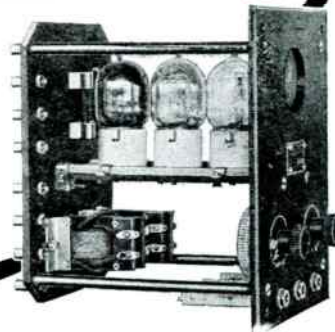

Interior View of DA Detector Amplifier

Our Radio Folder No. 4446 will interest you.—Ask your dealer for a copy  
**WESTINGHOUSE ELECTRIC & MANUFACTURING COMPANY**  
EAST PITTSBURGH, PA.

# Westinghouse

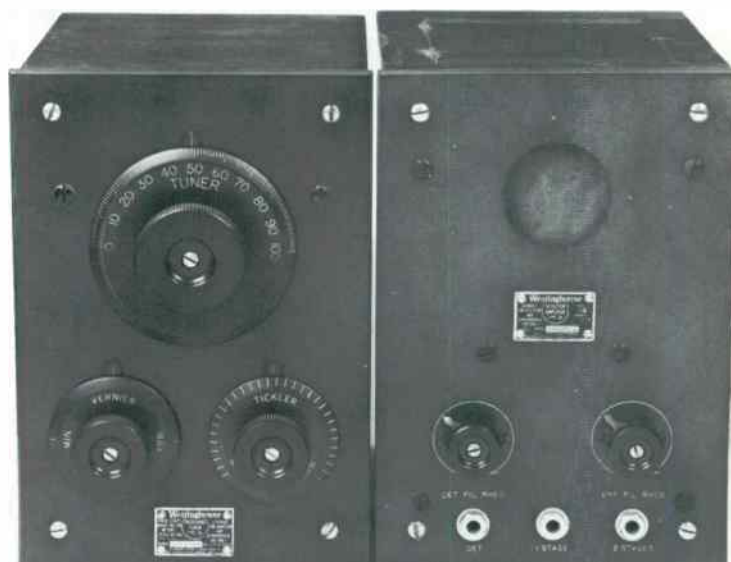
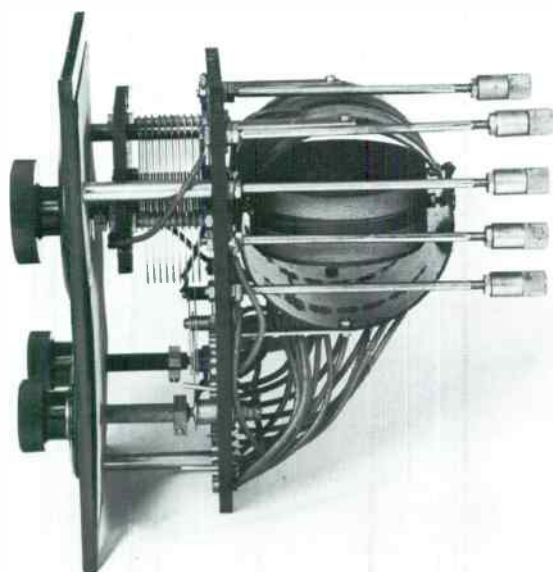

RA, DA April 1921 \$65, \$65

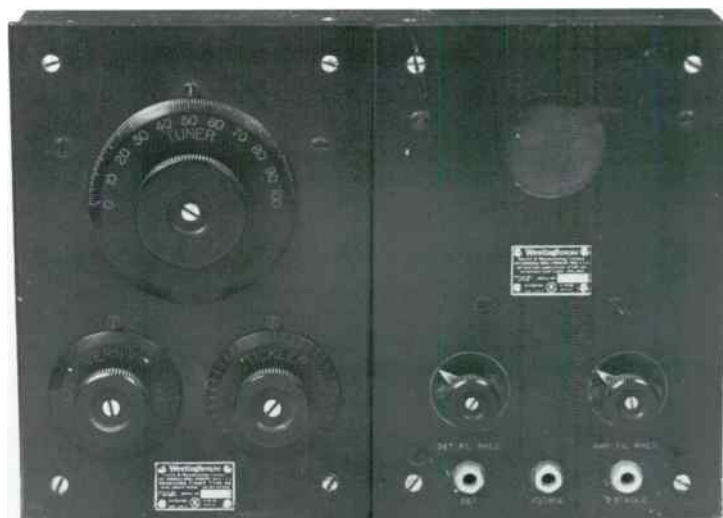
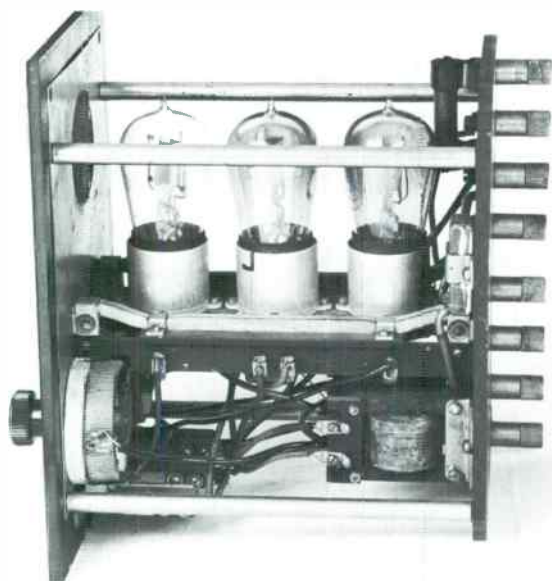

RC June 1921 \$125

In 1920, Frank Conrad revised the design of an amateur tuner he and Donald Little had built the year before and had samples made in the model shop. In April and May, 1920, he used the early production sets in tests on tugboats in New York harbor. Conrad applied for patents on the RA tuning circuit (#1,515,186 and #1,502,848 on coupled variable L and C) in June and July, 1920. The first production run of about 1400 RA's and 1600 DA's was made in 1920 at the Shadyside Works in Pittsburgh, a plant that made automotive equipment (nameplates dated 11/30/20).

In January 1921, production was transferred to the Electric Home Appliance Division at East Springfield, Massachusetts, where roughly 20,000 units were made up to November 1921 (RA plate dated 9/28/21, DA dated 5/19/21; later both combined in single cabinets as model RCs). The last run (plates dated 5/29/22) was of RC's only, the RA panel bearing no serial number. In all, between 80,000 and 85,000 RCs were made.

Other patents: #1,667,863 to Little on the RA's mechanical design; #1,572,877 to Max Batsel on the DA's. Conrad described the electrical circuitry in *Proc. I.R.E.* vol.10 no.6, Dec. 1922, pp.426-439.



Larry Leonard

Aeriola Jr. (RE) July 1921 \$25

During June 1921, a contest was held among Westinghouse employees to name the RE. From the 1402 names submitted, the newly formed Radio Sales Dept. chose "Aeriola Junior." RCA sold 24,249.



Aeriola Sr. (RF) Dec. 1921 \$65 with tube

Circuit designed by Max Batsel, radio engineer at E. Pittsburgh (after 1929, with RCA as chief engineer for several divisions, finally Defense Electronic Products). Patent 1,499,331 filed Dec. 11, 1922. 55,102 sold through RCA.

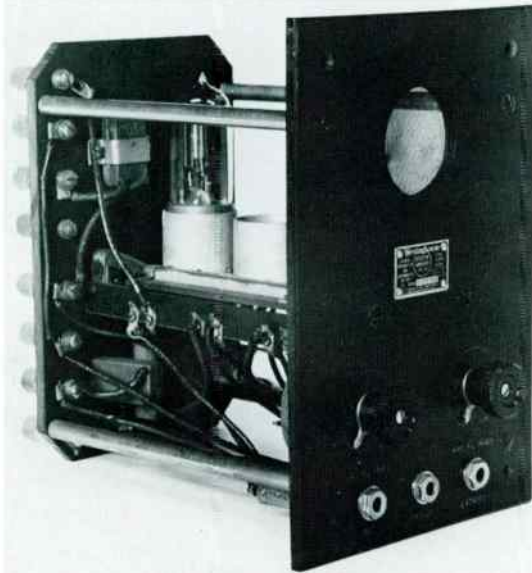

The DR, a resistance-coupled version of the DA, dates from about December 1921, but was not advertised. It used the WR21 tube (high- $\mu$ , European base) as did the Aeriola Grand. Most examples have serial numbers just above 10,000. The DR shown here has standard UV sockets and takes WR21s in UV bases.

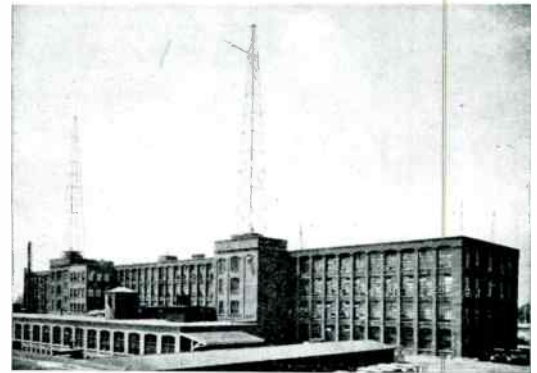

The Springfield radio station, which supplies the power for station WBZ, the Boston Herald-Traveler radio station.

The Westinghouse plant and WBZ towers at East Springfield, Massachusetts. Though no longer owned by Westinghouse, the building and towers are still there, off I-291.

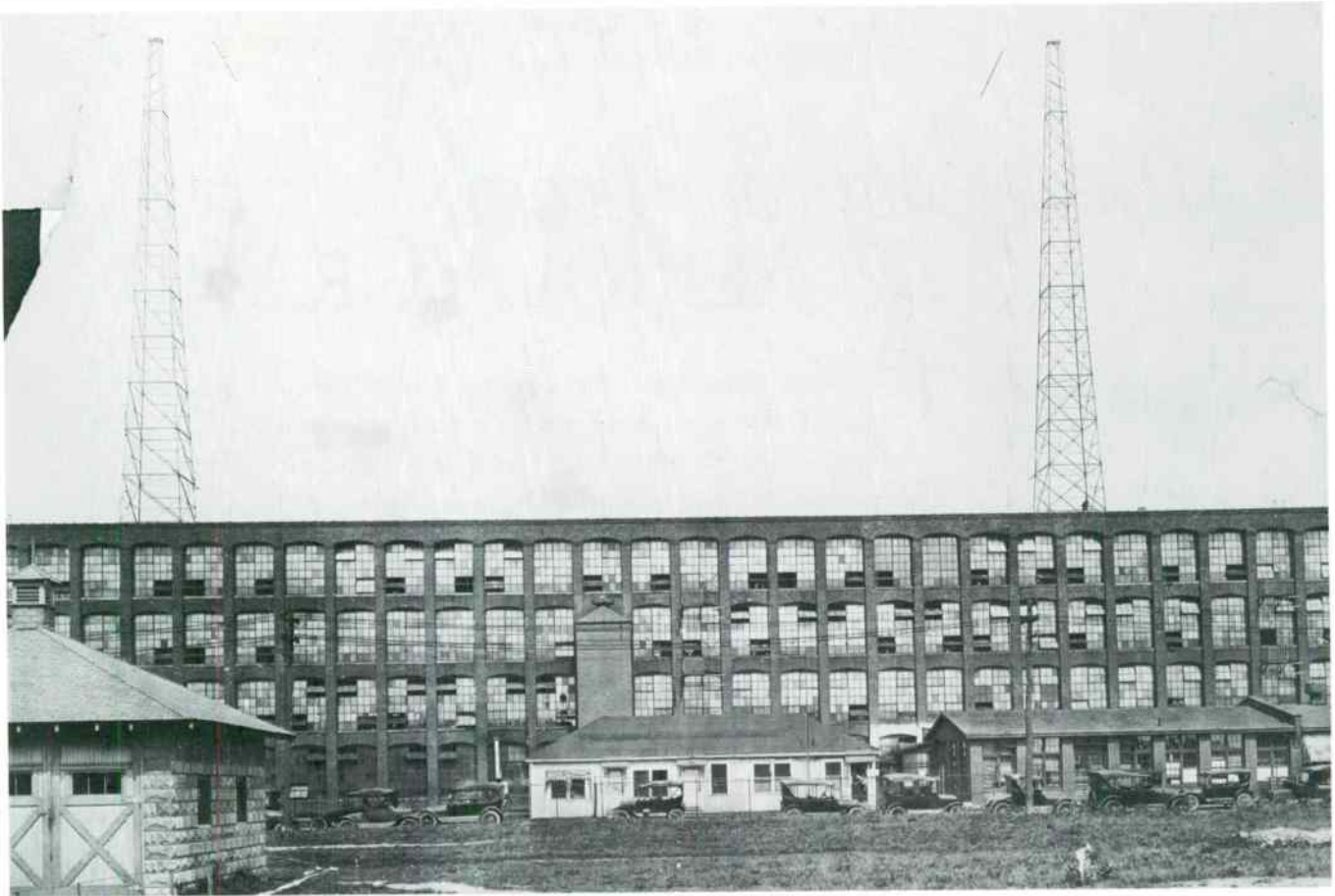

When the Radio Corporation realized that it could not operate without the Fessenden and Armstrong patents, Westinghouse was brought into the "radio group" fold in June, 1921. It contracted to produce 40% of the radio apparatus sold by the Radio Corporation while General Electric would make 60 percent. If orders for one period didn't work out to this ratio, orders in subsequent periods would be adjusted to compensate. Further, if either company couldn't meet its quota, it could ask Wireless Specialty to manufacture for it with WSA's share included in the 40% or 60%, or not included, by mutual consent.

Even after joining the radio group, however, Westinghouse continued to advertise its own receivers and act as its own sales agent until February 1, 1922. Clearly, the Radio Corporation was not prepared for, nor interested in, the broadcast-receiver market before that date. In fact, the boom in late 1921 and early 1922 caught these companies by surprise in another respect: it threatened to make their carefully negotiated contracts worthless. Westinghouse sold tens of thousands of RC models during the boom, to

say nothing of Aeriola Juniors and Seniors, while General Electric had nothing to offer but components and tubes. Obviously, something had to be done to balance the accounts; the Radio Corporation would have to sell mainly GE products the following year while Westinghouse marked time.



Completing Sets at the Westinghouse Electric and Manufacturing Company's Radio Works, Springfield, Massachusetts

*Radio Enters the Home*

## THE WIRELESS AGE

# When Marconi heard the AERIOLA GRAND



© UNDERWOOD &amp; UNDERWOOD

"IT comes closest to the dream I had when I first caught the vision of radio's vast possibilities. It brings the world of music, news and education into the home, fresh from the human voice. It solves the problem of loneliness and isolation.

"The Aeriola Grand is at present the supreme achievement in designing and constructing receiving sets for the home—a product of the research systematically conducted by scientists in the laboratories that constitute part of the R C A organization."

*G. Marconi*



Look for this  
trade mark at  
your dealer

## The importance of the Symbol R C A

CRUDE radio apparatus of a kind can be made even by embryonic organizations. But the vitally important inventions that have made radio the possession of every man, woman and child are those protected by patents owned by the Radio Corporation of America and developed as the result of costly research conducted in the engineering laboratories of the Radio Corporation of America.

The name-plate of a Radio Set is all-important in the purchase of radio apparatus. If it bears the letters "R C A" the public and the dealer are assured that at the time of its introduction it is the highest expression of the advancing art of radio.

Any R C A dealer will be pleased to show you the Aeriola Grand and to let you judge its wonderful quality for yourself.

There is an R C A set for every purse—Prices range from \$18 to \$350.

In tone quality, in simplicity of manipulation the Aeriola Grand is unrivalled. A child can snap the switch and move the single lever that tunes the Aeriola Grand and floods a room with song and speech from the broadcasting station.

Aeriola Grand  
with stand  
\$350

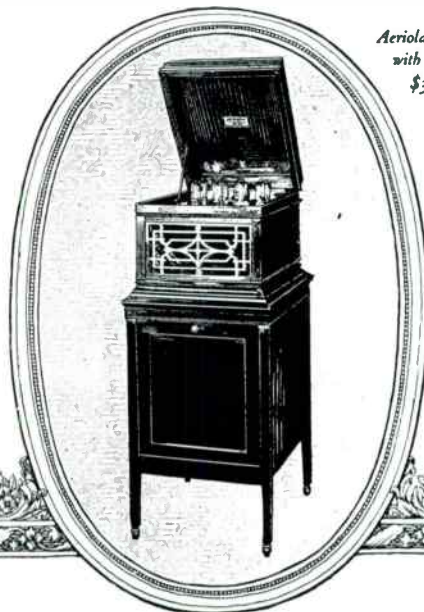

# Radio Corporation of America

Sales Dept. Suite 2064  
233 Broadway  
New York City

District Office  
10 South La Salle St.  
Chicago, Ill.

When writing to advertisers please mention THE WIRELESS AGE



Rich Elskamp

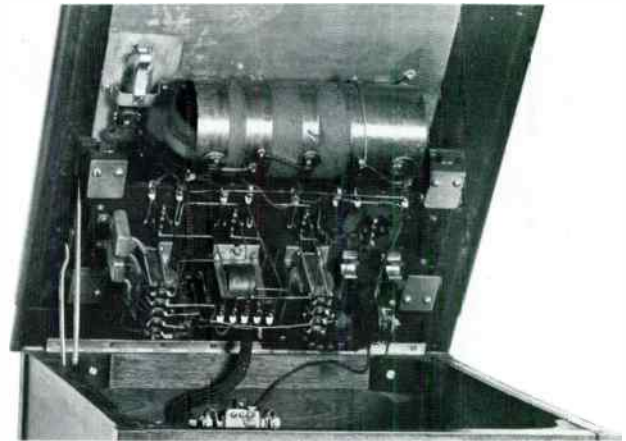

New England Wireless & Steam Museum

Radiola Grand Jan. 1923 \$350

The Radiola Grand design must have been nearly completed by August 1922, as it is mentioned in an IRE paper by tube engineer F. S. McCullough. Its nameplate is dated October 4 or 16.



Aeriola Grand (RG) March 1922 \$325 with tubes

According to its nameplate date, the Grand was designed by October 1921. It used a regenerative detector followed by three resistance-coupled audio stages using WR21 tubes. Four WB800 ballast tubes in series with the WR21 filaments eliminated the need for rheostats, making the Grand very simple to use. Arthur Van Dyck of GE saw a Grand at Sarnoff's home on February 19, 1922. He sketched the circuit and recorded his reactions in his notebook: "Tunes very critically. Sometimes tubes howl & only way to stop is to hit audio tube a blow. CW stations interfere badly."

The only complete Aeriola Grand known to exist is in the Ford Museum; it probably came directly from RCA in the 1930s. RCA dealers were authorized to replace all Aeriola Grands already sold with Radiola Grands, at no cost.



# Radiola Combination For Super Selectivity

## Incorporating Units RT, RA, AR, DA

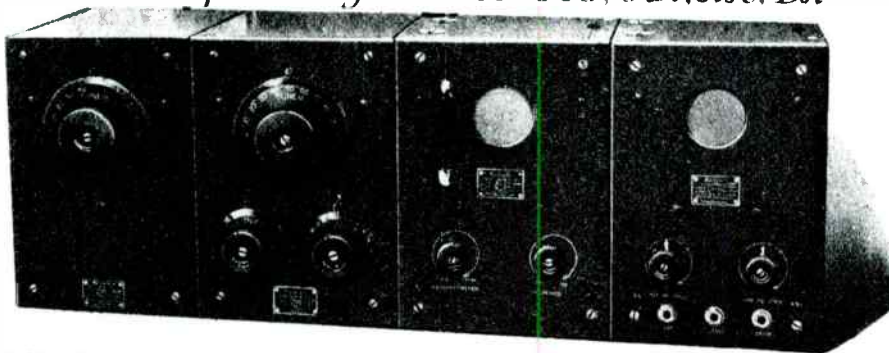

**R**ADIOLA Super Selective Combination consists of Models RT primary coupler; RA secondary coupler; AR 3 stage radio frequency unit, and DA detector, 2 stage audio amplifier illustrated, in the order given, at the head of these pages. It is designed for use with an outdoor antenna for broadcast reception over long distances, and under conditions where extreme selectivity is desired.

Model RT is an antenna coupling device providing a continuously variable inductance and capacity on the one shaft, controlled by the single dial on the panel. The unit is virtually a very loosely coupled and therefore highly selective primary circuit with variable series capacity and readily controlled for the minute variations in tuning.

Model RA embodies the secondary circuits. The largest dial at the top of the panel is for rough secondary adjustment, while the smaller adjustment in the lower right hand section is for very close or vernier tuning. The dial opposite this, controls regeneration (when used as a regenerative set).

*"There's a Radiola for every Purse"*  
 {10}

Model AR is a three stage, radio frequency amplifier of extraordinary sensitivity. Provision is made for variation of negative potential on the grid in the potentiometer control located in the lower left hand section. A single rheostat on the opposite side controls the filament brilliancy of all three tubes.

Model DA provides for the detector and two stages of audio frequency amplification. One rheostat controls the detector filament and another regulates the amplifier tubes. Three jacks make possible the selection of various degrees of signal intensity and, as with Model AR, the brilliancy of the tubes may be observed through the screened opening.

Altogether, these four models constitute a modern, sensitive receiver with a high degree of selectivity. What is equally important, the controls are very simple to manipulate. Full instructions for connections and operation accompany the units in the package.

Radiola Combination RT, RA, AR, DA.

Price .....\$263.00

*"There's a Radiola for every Purse"*  
 {11}

1,655,985. WIRELESS RECEIVING CABINET. FRANK CONRAD, Pittsburgh, Pa., assignor to Westinghouse Electric & Manufacturing Company, a Corporation of Pennsylvania. Filed Apr. 18, 1922. Serial No. 555,215. 6 Claims. (Cl. 250-14.)

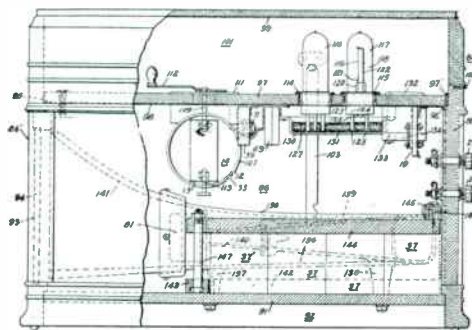

1. As an article of manufacture, a cabinet comprising a chamber, a movable lid for said cabinet, a movable cover for said lid enclosing a space therebetween, means for maintaining said cover in an elevated position, said lid being provided with a perforation, a tuning device carried on the under side of said lid and having a controlling member accessible from the top of the lid, an electron tube, means for so supporting said tube that the same may extend up through said perforation, and a switching device disposed on said lid and controlling said electron tube.

The RT antenna tuner and AR three-stage untuned RF amplifier were available about August 1922 for \$45 and \$80. Either or both could be used with the RA, DA or RC.



(left) DB August 1921 \$5  
 Made by Westinghouse.

(right) UD1432 May 1923 \$2.30  
 Made by Wireless Specialty.  
 A model UD1430 sold for \$1.60.

U.S. Patent Office, Jan. 10, 1928

Rich Elskamp

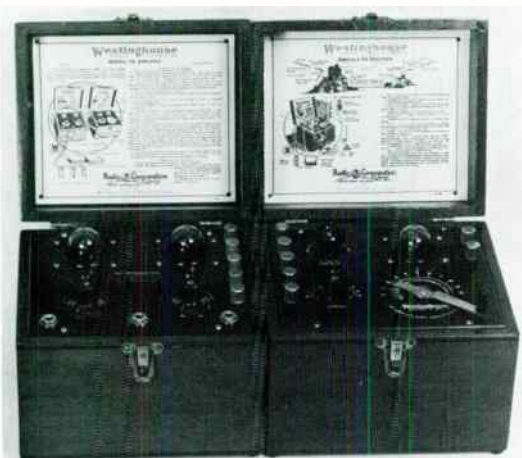
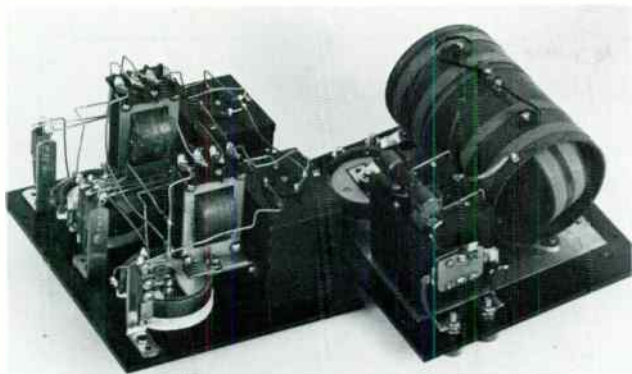

RS May 1923 \$85

Essentially an Aeriola Sr. and one-stage amplifier squeezed into a single cabinet, forerunner of the Radiola III. 4613 were made.

The model AC two-stage amplifier first appeared in a Westinghouse radio catalog of about March 1922, for \$68. It was specified as having a molded panel and mahogany cabinet. Some time after December 1922, the Aeriola Sr. was also given a molded panel (it had been painted wood) and its poplar cabinet was changed to mahogany. Still later, nameplates were added to both sets and they became the "Radiola Senior" and "Radiola AC" (shown below).

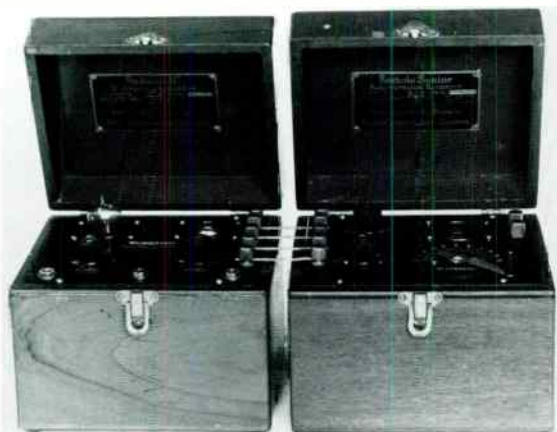

New England Wireless & Steam Museum

## A Two Tube Radiola

[Radiola RS]

**B**UILT like Radiola Senior—but with two tubes instead of one. For greater distance—and a chance to use a loud speaker on the nearby stations. The same compactness and portability. The same sensitivity and exactness of construction. If the Senior performed wonders for a one-tube set—count on new wonders for the new RS.

Light enough to carry with you. Powerful enough, with its Radiotrons WJZ-44—detector and one-step amplifier—to listen in from farthest mountain top camp to the big cities. Neat—and finely finished, as every Radiola is. What a summer of fun it means!

Are you interested in to  
**BROADCAST CENTRAL**  
The Radio Corporation's  
great Duplex Station  
WJZ-WJY  
Amulius Hall, New York City

The world of radio is  
united by  

*"There's a Radiola for every purse"*  
at the nearest Radio or Electrical Store  
Radio Corporation of America  
Incorporated in New York  
410 Broadway, New York  
Patent Office: 410 Broadway, New York  
411 a building 9, San Francisco, Cal.

**Radiola**

RADIO CORPORATION OF AMERICA  
Price \$85.00 (includes carrying case)  
Please send me more Radio Product literature  
reference R-12 or R-13.

Name \_\_\_\_\_  
Address \_\_\_\_\_  
City \_\_\_\_\_ State \_\_\_\_\_  
Zip \_\_\_\_\_

Radio News (Aug. 1923)

**SCHENECTADY WORKS OF GENERAL ELECTRIC COMPANY**

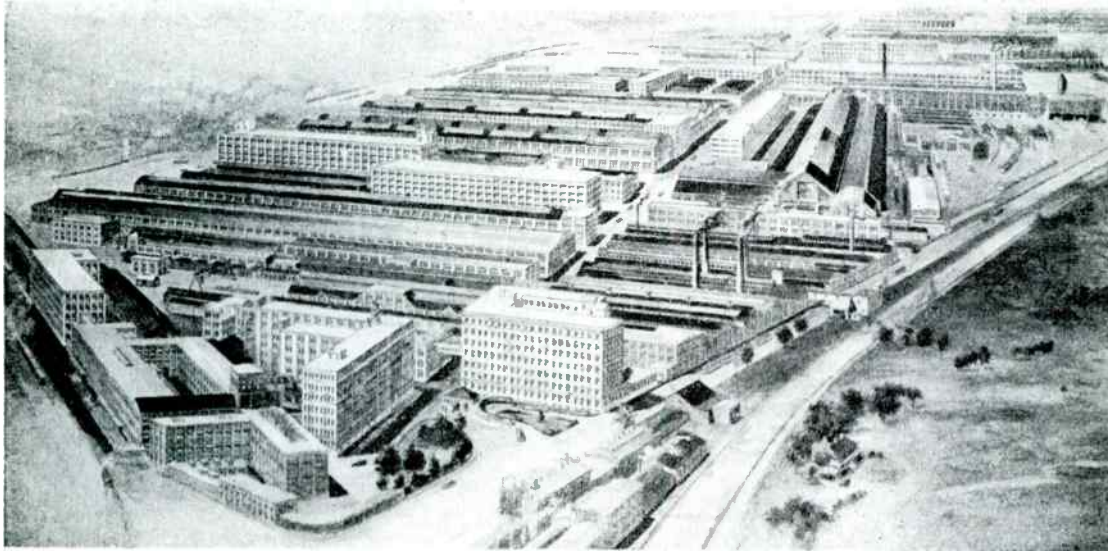

Ground area, 523 acres

21,000 Employees

Floor space, 5,968,000 sq. ft.

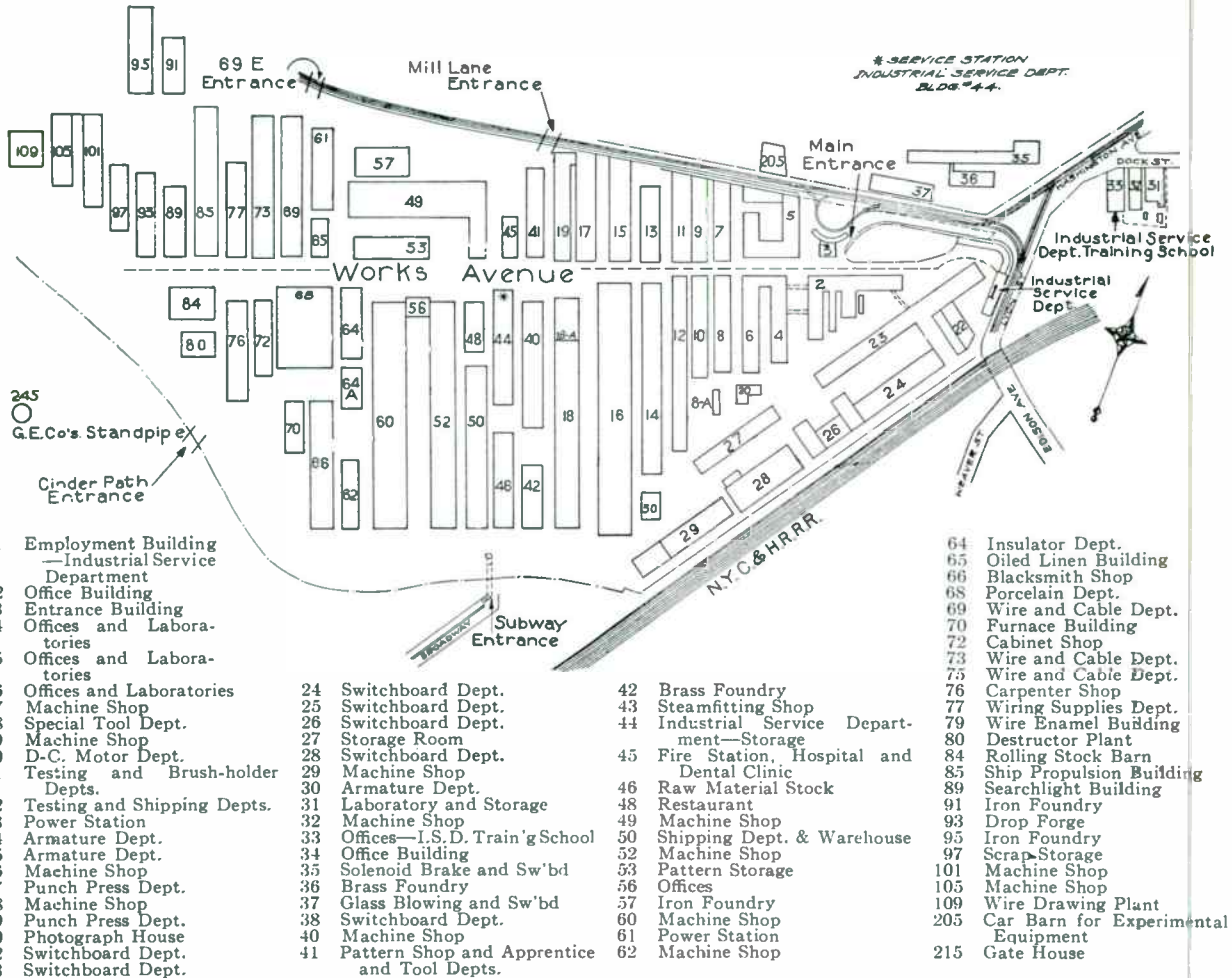

## General Electric

The General Electric Company had been making radio receivers since the war, as had Westinghouse, and vacuum tubes and alternators long before that. When the Radio Corporation was created, GE took over American Marconi's factory at Aldene, New Jersey (and, therefore, most of Marconi's production personnel), so was much more heavily involved with radio than was Westinghouse. But it was commercial radio, not broadcast: ship installations and point-to-point communications. GE even built a prototype broadcast receiver in 1920 at the Radio Corporation's request, but it made no impression. As late as February 1922, GE's executive in charge of radio, E. P. Edwards, told the Broadcast Conference in Washington:

*This wave of enthusiasm for general broadcasting, I believe, if it is not curbed legally, will die a somewhat natural death. Perhaps not on the part of the small boy, but on the part of some of those aspirants who want to broadcast everything there is, because I think very few of them realize what it is. My company is beginning to study this situation, and we are not anxious to go into it on a wholesale scale.*

Edwards went on to discuss the economics of broadcasting. It might be noted that GE had already decided to build a broadcasting station at Schenectady; towers were going up on Building 40 by October, 1921.

In receiver production, the first hint of GE's awakening is an entry on December 2, 1921, in the engineering notebook of Arthur F. Van Dyck, in charge of receiver design. Among the sketches and tests for commercial gear, and some notes on an amateur loop-antenna set to use the developmental Y-1641 (later UV199) tube, appears a design for a simple \$10 crystal set that became the ER753.

About the same time, the AR1300 and AA1400

This is presumably the experimental receiver model made by the Lighting Dept. of GE headed by E.P. Edwards, under a \$2000 appropriation from the Radio Corporation (see Archer, *Big Business and Radio*, pp. 14-16). Now in the museum of the Antique Wireless Association in Holcomb, NY.

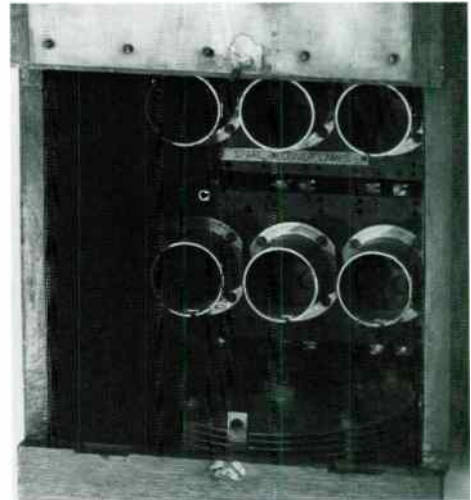

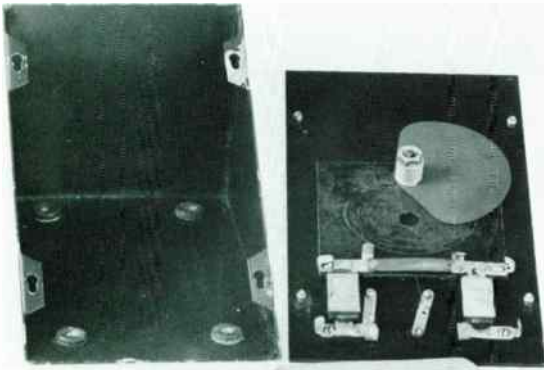

ER753 April 1922 \$18

Design was begun on Dec. 2, 1921, and completed by Feb. 2, 1922. For tuning, a rotating copper vane varied the pancake coil's inductance.

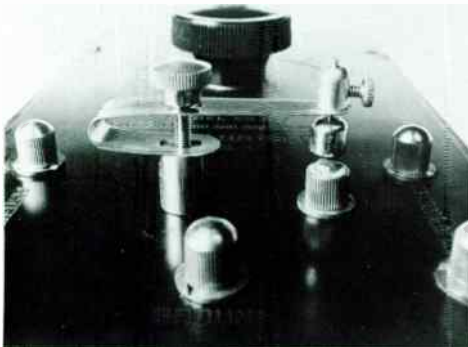

All Radio Corporation crystal sets (Aeriola Jr., ER753, Radiola I, Radiola V) used "Perikon" detectors: zincite in the movable cup, bornite or chalcopyrite in the fixed one.

About the same time, the AR1300 and AA1400 began to take shape as Van Dyck worked out the circuit and mechanical design. He borrowed some features from already-existing commercial sets and continually compared his results to a sample of the Westinghouse RC in the GE lab (work on the AA1400 as a component of commercial systems had been authorized as far back as July 30, 1921). In early March, he took the first production samples to New York City to demonstrate to Radio Corporation officials, particularly Elmer E. Bucher, manager of the Sales Department. Bucher has been characterized by Carl Dreher in *Sarnoff: An American Success* as a "brash, verbally brilliant former editor of *Wireless Age* and sales manager of RCA with a record of antagonizing almost every interest he dealt with, whether outside the company or within." Van Dyck recorded the March 6 test in his notebook:

*My general impressions are that EEB's attitude is prejudiced against GE. Anything from WSA or WEMCo is good and anything from GE is bad. All their good points he dwelt on gleefully and did not mention any of ours. Bucher said he thought tuner was not as good as WEMCo—the tickler not as efficient. I told him there was no such thing as tickler efficiency. Asked him if he meant we shouldn't manufacture them & he said oh no go ahead but improve it soon as possible. We thought perhaps (Langley and I) that he was stirring us up to greater efforts.*



Ralph &amp; Elinor Williams

Radiola I Aug. 1922 \$25

RCA records show that either 7826 or 8064 was made.



Arthur F. Van Dyck



Mr. E. E. Bucher

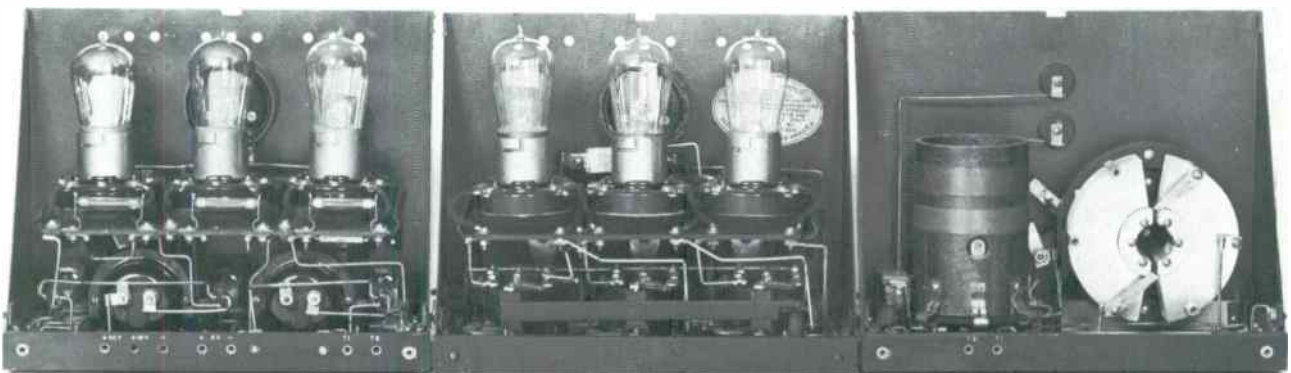
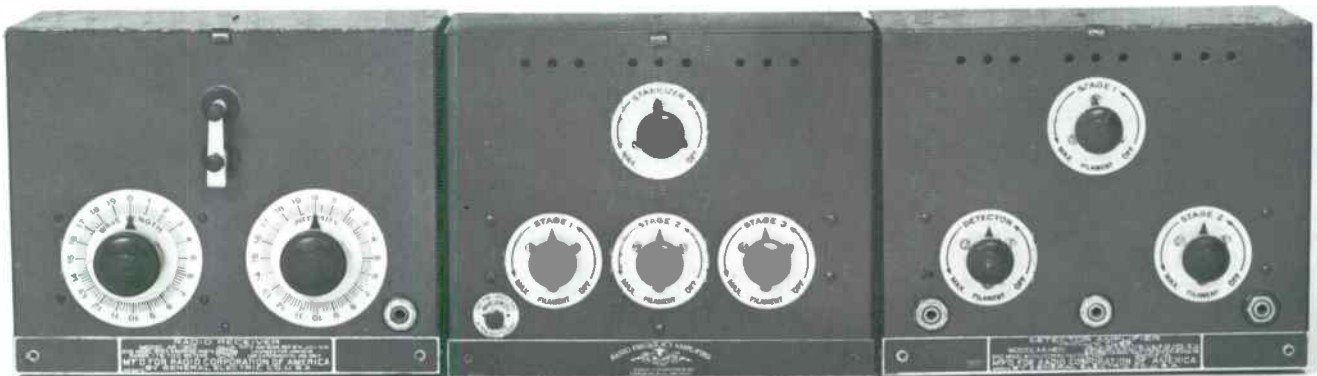

Left to right: AR1300 (June 1922, \$50), AA1520 (Aug. 1922, \$80), AA1400 (June 1922, \$75). The AR1300 could be used by itself as a crystal set, or with a detector-amplifier as a regenerative tuner. The AA1520 three-stage untuned RF amplifier allowed use of a loop antenna. The original AA1400 had one untuned RF stage, detector, and one audio stage, but the production version used a detector and two audio stages. All these sets, like the shipboard equipment on which they were patterned, were in brass or zinc cases, painted green, with silver-plated dials.



Building 77, May 1922

Hall of History Foundation, Schenectady

# AR 1300+AA 1400= Most Versatile of Receivers

*Crystal or Vacuum Tube Detection with the Same Set*



RADIO RECEIVER MODEL AR-1300 is a new single-circuit tuner, incorporating unusual features of design, which makes it ideal for the broadcast enthusiast.

The unit can be used for crystal detector reception, and when so used it is a complete receiver. Simply plug in at the telephone jack, adjust the detector crystals, tune in, and the instrument is ready. Only two tuning operations are required.

AR-1300 can also be used in connection with the vacuum tube amplifier set Model AA-1400 (see opposite page). When so used the crystal detector is switched off and the signal amplification controlled by regeneration.

Signals are received over the wave length band of 180-700 meters. This meets the requirements of present-day broadcasting.

Price of Radio Receiver Model AR-1300 . . . \$50.00

THE set meets the demand of the novice who wishes to start with a simple crystal detector and later to pass on to vacuum tube detection and amplification.



Here we see Radio Receiver AR-1300 and detector amplifier AA-1400 combined in an ideal set for the home. Both sets are enclosed in metal EZKASE so that they are effectively shielded from the undesirable capacity effects of

the operator's body. These two radio units are General Electric products. The price of the units as here combined is \$125.00 (antenna, tubes and batteries not included). See them at your nearest radio dealer.



DETECTOR AMPLIFIER MODEL AA-1400 is a compact, easily operated amplifier unit. It consists of a vacuum tube detector and two stages of audio-frequency amplification. To increase the strength of broadcasted concerts, beyond the possibilities of simple crystal detection, use it with radio receiver Model AR-1300.

The three vacuum tubes employed in Model AA-1400 (a detector and two stages of amplification) are furnished with separate rheostats. Thus the operator is enabled to control very closely, the strength of incoming entertainment.

The left-hand telephone jack plugs in only on the detector tube. The central jack furnishes detection and one stage of audio-frequency amplification. The right-hand jack gives maximum amplification, i.e. detection with two stages of amplification.

A special arrangement incorporated in this amplifier practically eliminates distortion of music when Model AA-1400 is used.

Price, Detector Amplifier, Model AA-1400 (without tubes) . . . \$75.00

**Radio Corporation of America**  
 Sales Department, Suite 1801  
 233 Broadway, New York City

**Radio Corporation of America**  
 Sales Department, Suite 1801  
 233 Broadway, New York City

Wireless Age (June 1922)

Right: Dr. Alfred N. Goldsmith in his office at City College of New York, where the RCA Research Department was first located.

Below: This "Radiola" (a name coined by Goldsmith) was built by the Research Dept. in 1921. Goldsmith, around 1928, gave it to Arthur Van Dyck, who built a glass case for it and displayed it in his office. When Van Dyck retired from RCA in the early 1950s he returned it to Goldsmith. It is now in the Smithsonian. Note the three Western Electric "peanut" tubes. This photo was taken in 1929.

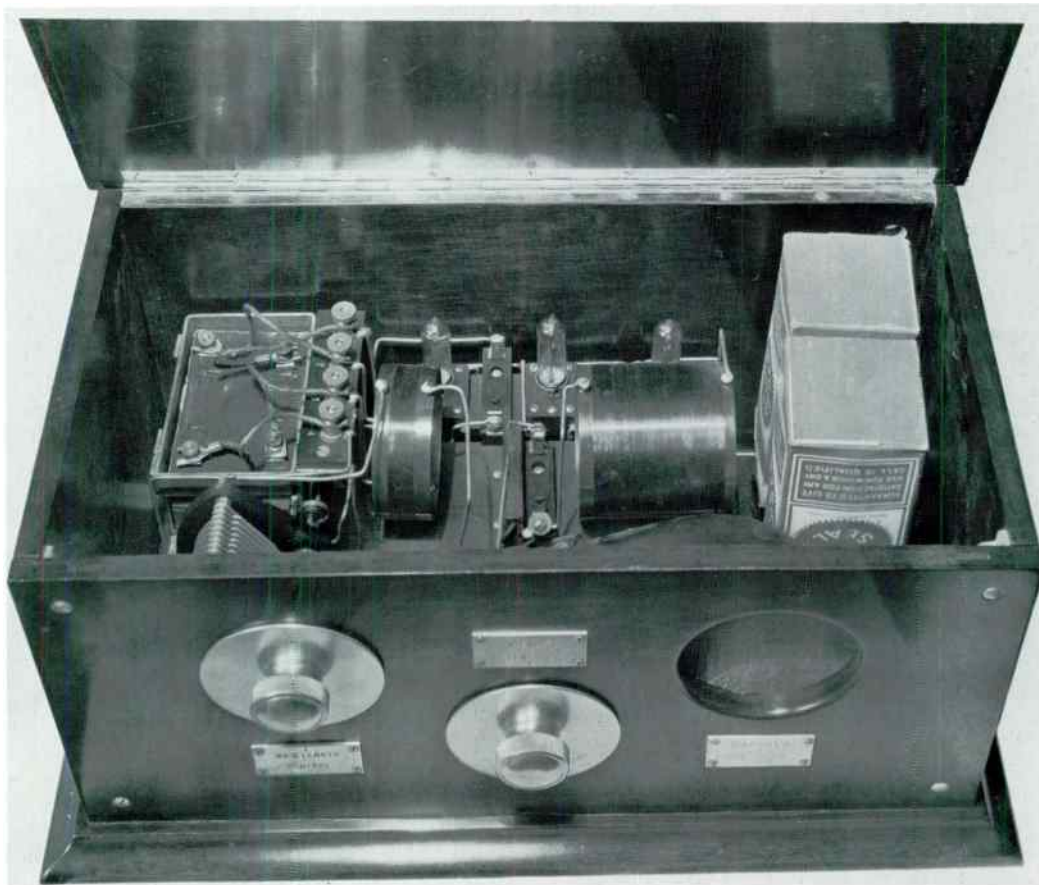





Radiola II May 1923 \$97.50 9594 made.

In May 1923 RCA was offering three competing portable models: Wireless Specialty's Radiola Special, Westinghouse's RS, and GE's Radiola II. But GE was still running way behind in sales (it was supposed to make 60% of RCA's merchandise), so to insure that customers bought the "right" one, only the II was widely advertised.

Nevertheless, the Radio Corporation did accept the GE sets (it had no choice as GE called the shots at the executive level) and began promoting them, though the boom had collapsed back in May and sales for the next several months were nil.

1922 -1923

Meanwhile, plans were being made for the 1922-1923 season. First of all, the Radio Corporation had to obtain a larger proportion of its sets from GE to fulfill the 40% - 60% agreement. Therefore, the foundation of the 1922-1923 line was to be a series of four "Radiolas," all made by GE. "Radiola" was an adaptation of the Aeolian Company's "Pianola" trademark, which had become almost a generic term for player piano, besides having spawned the names Victrola, Amberola, and others.

The Radiola I was a simple modification of the ER753 with the pancake coil replaced by a variometer like the Aeriola Junior's and in a wooden case rather than green metal. It was ready for production by June 20, 1922. The remaining three Radiolas would use the recently perfected UV199 tube, a great advance from the homeowner's point of view over the old storage-battery type UV201 and whose production was exclusively controlled by GE. The Radiola II was a two-tube set; the III, a three-tube portable with batteries and horn built in; and the IV, a three-tube home model with batteries and horn. These were all specified on July 25, 1922.

As it turned out, the final Radiola 1922-1923 line was somewhat different: the II became a self-contained portable (sans horn) and the III was dropped. Also, probably as a result of production delays and problems with making the UV199 in quantity, the old green boxes were dressed up and offered as the Radiolas V and VI. These used the UV201A tube (after March, the WD12). Radiolas II and IV were not available until after the Christmas selling season while UV199's were scarce for another several months. Meanwhile, Westinghouse was producing perhaps 50,000 RC's in mid-1922 as well as Aeriola Seniors, and had the Radiola Grand ready to go in October (it was held back until the IV's introduction). GE found it difficult to catch up. But what was worse, while the Radio Corporation was fiddling, its competitors were running away with the market.

The Literary Digest for October 6, 1923 55



## Third Down — Two Yards to Gain!

### Get the Returns with a Radiola

Wild shouts from the crowd—"Hold that line! Hold that line!" Every play—every cheer from the rooting section. Clear and loud and real. With a Radiola.

It must be a Radiola. Look for the mark. When the "bunch" comes round to get the scores—you know your set will work. When the club holds open meeting, and the club room's filled—you can count upon it—always. When the big news is coming over—or an opera—a Broadway play—important stock reports—the set with the Radiola name and the RCA mark is always at the peak of performance.

Whether it's a one-tube Radiola, or the stately four-tube Radiola Grand, the name with the backing of the greatest research laboratories in the world stands for quality in every point of make, finish and performance.

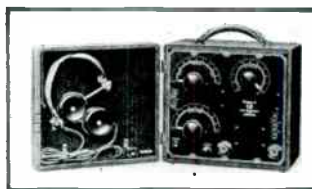

Radiola II.

One of the most popular of Radiolas, because it's portable. At home, its fine walnut finish makes it mighty attractive. With all its batteries inside, its handle, and its convenient size, it can be carried everywhere, on trips and visits. With even an improvised antenna, it will pick up good big distances—clearly. And over short distances, it will operate a loudspeaker.

Complete \$97.50

### Radio Corporation of America

Sales Department 233 Broadway, New York      District Sales Offices 10 So. La Salle St., Chicago, Ill.      433 California St., San Francisco, Cal.

# Radiola

Send for the free booklet that describes every Radiola

RADIO CORPORATION OF AMERICA  
Dept. 2091. (Address office nearest you)  
Please send me your free Radio Booklet.

Name \_\_\_\_\_  
Street Address \_\_\_\_\_  
City \_\_\_\_\_ R. F. D. \_\_\_\_\_  
State \_\_\_\_\_



This symbol of quality is your protection



Radio Corporation display at the American Radio Exposition, Grand Central Palace, New York, December 21-30, 1922. Models introduced: Radiolas IV, V, VI, Grand. Also shown: "Radiola" Senior with wooden panel, AC amplifier, RC. AR1375, AG1380 loop antenna.



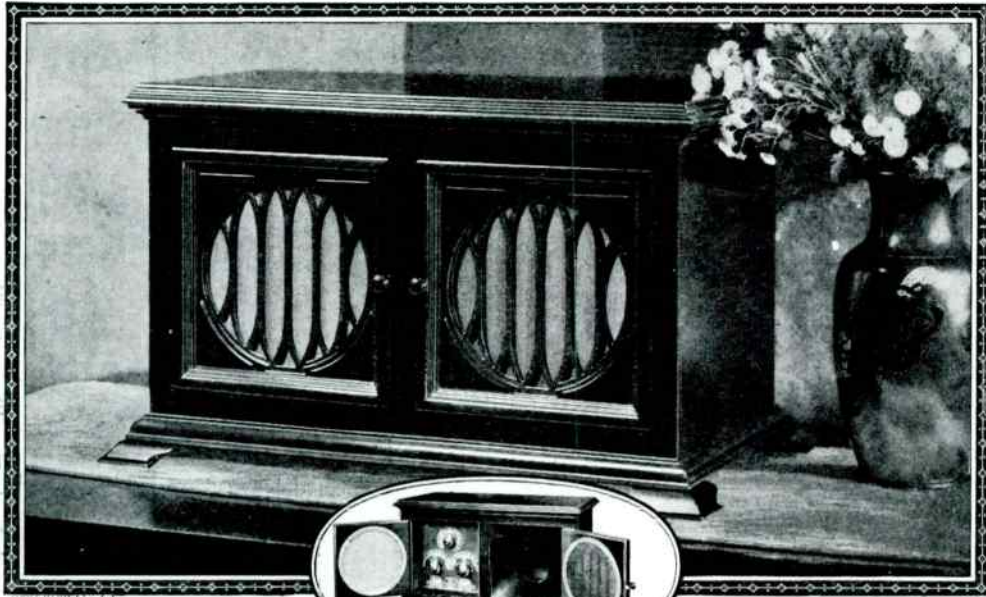

*Radiola IV.* A long distance receiver made with the perfection for which RCA is famous. Mahogany finished cabinet; with four tubes (one spare); head phones and plug; silk covered wires. \$275

*Opera from the Stage—Football from the field*  
*with a*  
**Radiola IV**

Tune in—then shut the doors. Sit back and listen to the music that's being sung a hundred miles away. Dance to fine orchestras playing in the big cities. Call in the crowd when the big game is on. It's real!

Enclosed in its fine cabinet—with all its workings hidden—with its batteries inside—and its loudspeaker built-in—Radiola IV is a great achievement. Simple, powerful, dependable. Not only by virtue of its radio construction, but by the perfection of its workmanship and finish. It gets distance—gets it simply and clearly, at the turn of a knob. And fits with dignity into the finest living room.

Tune in—the air is crowded! Fun—music—education—big, exciting events. Listen in on them all with a Radiola IV.



This Symbol of quality is your protection



This Symbol of quality is your protection

Send for the free booklet that describes every Radiola

Ask for RADIOLAS at the nearest radio or electrical dealer

Radio Corporation of America

Sales Offices:

233 Broadway, New York

10 So. LaSalle Street, Chicago, Ill.

431 California Street, San Francisco, Cal.

# Radiola

REG. U. S. PAT. OFF.

## RADIOTRONS

Look for the name RADIOTRON and the RCA mark on every vacuum tube you buy.

Radiotron WD-11 Radiotron UV-199

Radiotron WD-12 Radiotron UV-200

Radiotron UV-201A

Radio Corporation of America  
 Dept. 2086. (Address office nearest you.) Please send me your free Radio Booklet.

Name \_\_\_\_\_

Street Address \_\_\_\_\_

City \_\_\_\_\_ R.F.D. \_\_\_\_\_

State \_\_\_\_\_

Radiola IV Feb. 1923 \$275

First model completed by April 29, 1922. Additional cabinet samples obtained from outside suppliers by June 26, 1922. Design approved by RCA July 25, 1922. Displayed at American Radio Exposition, Dec. 21-30, 1922.



Ron Boucher

Wireless Specialty AA1381 1-tube receiver, AG1380 loop, and Western Electric 10A outfit displayed by the Atlantic Radio Co. of Boston at a radio show about 1922.

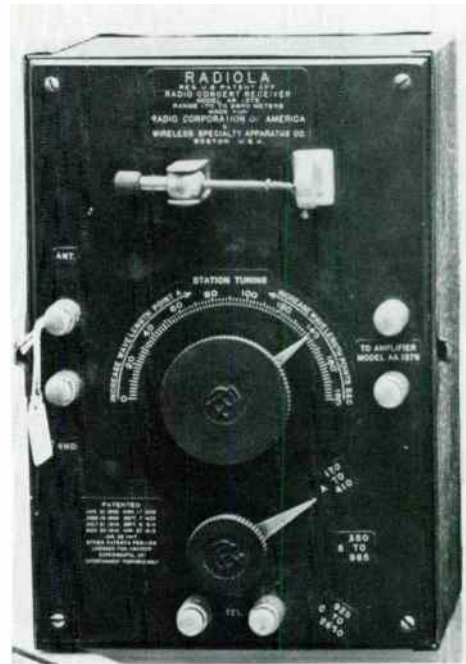

Antique Wireless Assoc.  
Museum Gift of Fred Penard

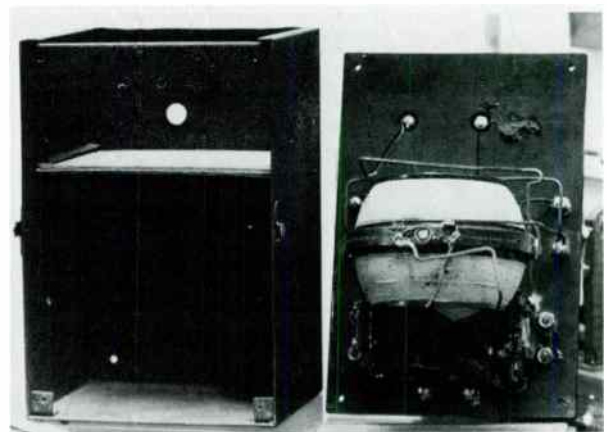

The AR1375 (June 1922, \$40) made by Wireless Specialty Apparatus Co., appeared in the Radio Corporation's catalog *Radio Enters the Home* where it competed with the \$18 ER753 and the \$25 Aeriola Jr. Whether because of price, or availability, very few were sold; most were later converted to Radiola Specials. RCA records show that 635 were made.

The Literary Digest for March 24, 1923 85



# IMPROVED ~ at Lowered Cost!

A NEW vacuum tube has made it possible. Radiola V and Radiola RC have been topping them all in popularity for dependability and long range—receiving over thrilling distances—up to 1,500 miles and more. Now both are converted to dry battery operation. This means greatly lowered cost—gives the far-away farmer the same good service it gives the city man. Complete now at a combination price remarkably low.

**Radiola V or Radiola RC Complete \$142.50**  
*The New Way:* Complete for dry battery operation, including three new type WD-12 Radiotron vacuum tubes; pair of head telephones; "A" battery consisting of three dry cells; "B" battery consisting of three 22½ volt units. \$142.50.

*The Old Way:* The price of Radiola V or Radiola RC, when equipped for storage battery operation, formerly came to \$207.50.



This symbol of quality is your protection

**RADIOLA V**  
as illustrated

A long distance receiver built for a life time—ruggedly—solidly. A sensitive detector, with two stages of amplification. Meticulously finished—attractive—and simple to operate.

Radiola RC included in the new adjustment—similar in quality and performance.

# Radiola

REG. U.S. PAT. OFF.  
Radio Corporation of America

Sales Department 233 Broadway New York  
 District Sales Offices  
 10 So. LaSalle Street Chicago, Illinois  
 433 California Street San Francisco, California

"There's a Radiola for every purse"



**Radiola V Jan. 1923 \$132.50**  
**Radiola VA March 1923 \$142.50 complete**  
 (uses AA1400A with dry-cell tubes)

The Radiola V was an AR1300 and AA1400 with a wood-grain paint job, brown dials, wooden base and lid, and an added vernier tuning condenser. 21,138 of them were made.

**Radiola VI Jan. 1923 \$162.50**

The Radiola VI, a dressed-up AA1520 and AA1400, required the Wireless Specialty AG1380 tuned loop to make a complete receiver. Sales figures: 17 in 1922, 670 in 1923, 2087 in 1924.



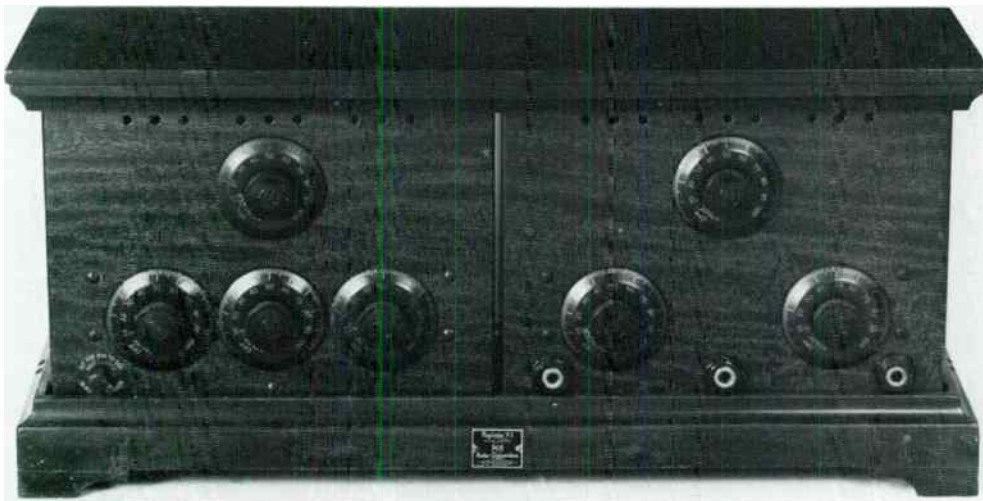

36

JANUARY, 1923

RADIO MERCHANDISING

37

# New Quick Sellers of the Radiola Line



**Radiola No. V. Price \$132.50**



**Radiola No. VI. Price \$162.50**

Here they are—the two latest developments of the RCA laboratories, Radiola V and Radiola VI.

These two new complete Radiolas open up new opportunities for Radio profits. They can be sold with perfect assurance that they will stay sold.

**Radiola V, Price \$132.50**

Radiola V is a practical receiver for use with an outside antenna. It is a sturdy and efficient unit embodying all the essentials of tuning, detecting and amplifying, and special provision is made for "vernier" or fine tuning adjustment. Loud speaking results of unusual tone quality are possible in local broadcast reception, and the use of head telephones will permit reception from the more distant broadcasting stations.

Everything considered, Radiola V constitutes one of the finest broadcast receivers available today. It will be a good seller.

**Radiola VI, Price \$162.50**  
*(Without Accessories)*

Radiola VI brings the realization of indoor loop reception at last. It has a big sales field for apartments and other places where outside antenna cannot readily be erected. Radiola VI is the new, three-stage radio-frequency amplifier designed particularly for use with a loop antenna. It is rugged of construction and extremely sensitive in operation.

Radiola VI will give excellent results with a loud speaker for local broadcast reception and of course the substitution of head telephones for the loud speaker would increase the range considerably.



*This symbol of quality is your protection.*

**DEALERS!**—Radiolas V and VI represent two new and profitable items to any radio stock. Order them now from your jobber.

**Order This Window Display**  
—It Will Boost Radio Sales

Here is a real snappy window display that will make radio sales jump. Get it today.

Get it from your RCA jobber or send \$2.00 direct to the Radio Corporation of America. You will get prompt service.



## Radio Corporation of America

WORLD WIDE WIRELESS

Sales Division, Suite 2003  
233 Broadway  
New York City

District Sales Offices,  
10 So. La Salle St.,  
Chicago, Ill.

433 California St.,  
San Francisco, Cal.

Say you saw it in RADIO MERCHANDISING.

Say you saw it in RADIO MERCHANDISING.



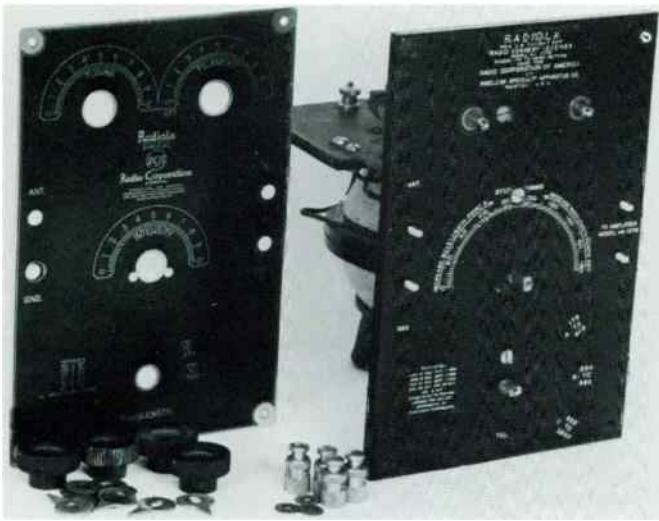

Removing the panel of a Radiola Special reveals its true ancestry.

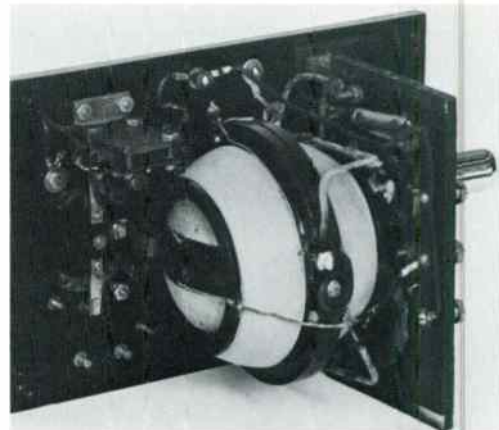

Special May 1923 \$62.50 complete.

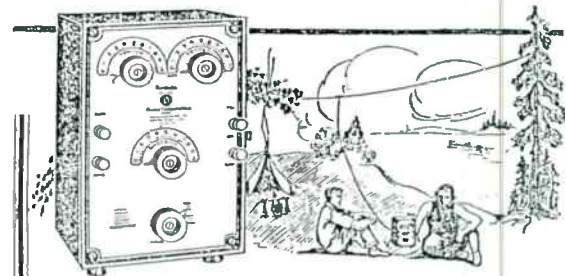

## RADIOLA SPECIAL

### The Ideal Set For Summer

*Radiola Special* is just the set for camping and hiking trips. Sturdy enough, with its metal case, to withstand the rough usage it is bound to get. Attractive enough to take its place in the most finely appointed home. And yet compact and efficient enough to please the most critical radio connoisseur.

*Radiola Special* is the universal set, the outfit that will meet your every demand for radio entertainment. Whether it be your large antenna at home or just a wire thrown over a tree at camp, *Radiola Special* will bring in the concerts loudly and clearly. The well-known regenerative feature assures that.

The ingeniously constructed metal case and cover, finished in "crystal-line green," makes *Radiola Special* weatherproof. The minimum of controls and the original design make *Radiola Special* ever so simple to operate. And the special price makes *Radiola Special* very easy to acquire.



**\$62.50**



COMPLETE WITH UV199 VACUUM TUBE AND BRANDES SUPERIOR HEADSET

*You will want to inspect Radiola Special; to listen in on it yourself. The following dealers have Radiola Special on display for your convenience:*

- |  |   |   |
|--|---|---|
| H. P. BARAN<br>2325 Broadway                           | DIXIE RADIO CO.<br>133 Seventh Ave., Cor. 18th St.  | MODEL'S<br>191 Fulton Street                                |
| BLACKMAN<br>ELECTRIC CO.<br>667 West 181st St.         | DUNLAP SPORTING<br>GOODS CO.<br>Far Rockaway, L. I. | NOTTONSON<br>RUBBER CO.<br>69 West Broadway                 |
| BROOKLYN<br>RADIO SERVICE<br>513 Myrtle Ave., Brooklyn | DUCKMAN'S<br>5027 Third Ave., Brooklyn              | OREMONT RADIO CO.<br>97 Chambers St.                        |
| CITY RADIO CO.<br>71 Cortlandt St.                     | FRIEDLANDER<br>RADIO SERVICE<br>192 Chambers St.    | S. S. S. RADIO CO.<br>119 West 22nd St.                     |
| COLUMBUS SHOP<br>874 Columbus Ave.                     | HILZ & GOETZ<br>2334 Myrtle Av. n., Brooklyn        | P. SIMPSON<br>136 West 116th St.                            |
| CRESCENT RADIO CO.<br>95 Chambers St.                  | LIBERTY RADIO CO.<br>106 Liberty St.                | SPECIALTY<br>SERVICE CO.<br>4th Ave & Pacific St., Brooklyn |

NY Globe (June 2, 1923)

Radiola VII Sept. 1923 \$290

Introduced at the RadioWorld's Fair in late September, but the *NY Evening World* for November 10, 1923 said "on the market for three weeks." 1692 were made.



Floyd Bennett

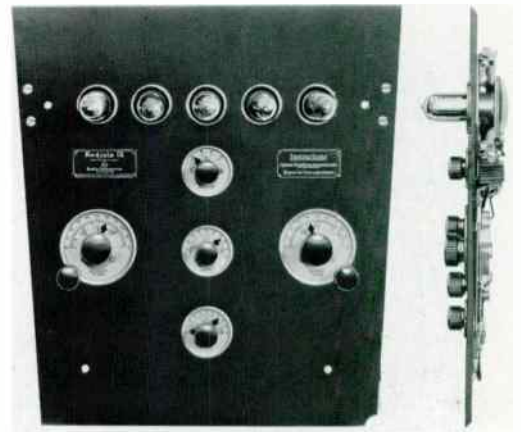

Radiola IX Nov. 1923 \$215 with tubes

Its panel was cut to fit several makes of phonographs. A metal box held the batteries.

Radiola VIIIA ca Sept. 1923

Appears in a distributor's catalog, but without price, and probably was never sold.



Pettingell - Andrews catalog, courtesy of Merrill Bancroft



Radiola VIIIB March 1924 \$275 with tubes

In this RCA publicity photo, the nameplate reads "Radiola IX." 2569 of these were made. The VIIIB was being discounted by mid-April 1924, evidently having been dumped by RCA then.

1923 -1924

The 1923-1924 season started early for RCA: ten months early, in February 1923. It had to in order to give the manufacturing companies time to design and tool up for the new models for production in the second half of the year. And so David Sarnoff (appointed vice president and general manager in September 1922, and finally able to wield a little power) ordered five million dollars' worth of receivers in February from GE and Westinghouse, regenerative models with tube-capacity neutralization. Just two days after he had done so, E. H. Armstrong demonstrated a prototype superheterodyne with two outstanding features: by combining tube functions, he had reduced the tube count from eight to five; and by using dry-cell WD11s, he had made his model portable. Sarnoff saw a chance: if the manufacturing companies could produce it in time, he could beat the pants off the competition. For once, RCA could lead the pack rather than be two years behind. Furthermore, Western Electric had just delivered a sample of its new 4A superhet to RCA for evaluation and was rumored to be placing one in the White House. Sarnoff knew that if RCA didn't offer one soon, Western Electric would.

Convincing his fellow executives — and, almost certainly, Owen Young of GE — that it was worth the gamble, Sarnoff cancelled the previously placed orders, and asked GE and Westinghouse to develop the superhet instead. After conferences in March, Westinghouse elected not to undertake the job, preferring to stick with its already designed regenerative models, the Radiolas III and X, while GE began work on what would become the Radiola Superheterodynes. GE's proposed models in the original 1923-1924 line included the VII, VIII, and IX. The number VIII was



Rich Elskamp



Super-VIII Feb. 1924 \$425 with tubes

Cabinet design patent 70.662, filed July 19, 1924, by Robert C. Edwards.



AR812 Feb. 1924 \$220



422608 TESTING BENCH FOR CATACOMBS OF RADIOLA SUPER HETERODYNE AND RADIOLA SUPER VIII. INDEX 654 7 1 24

re-assigned to the superhet while the VII and IX designs were turned over to Wireless Specialty for limited production, very likely as insurance in case the superhet did not work.

And it almost didn't. There was a great deal of development to be done before the production engineers could take over and create a manufacturable product. At one impasse, Armstrong had to be called in to help; there was a two-month delay while he and the GE engineers investigated a previously unnoticed thermal-hiss problem. It proved insoluble (until the model 28 of 1925-1926 with separate oscillator and mixer tubes); but finally, the RCA technical staff okayed the design anyway.

In fact, RCA did miss the 1923-1924 Christmas selling season, holding up its entire line and making do with a few Wireless Specialty Radiola VII's and the hopelessly outdated 1922-1923 Radiolas. Not for two more months was the superheterodyne ready. But Sarnoff had won his gamble, for it made more money for RCA than anything until the AC models 17 and 18 in 1927-1928. Between February 29, 1924, when the first one left GE, and May 30, 1925, a whopping 148,300 of them were produced.



431610 CATACOMBS. READY FOR TEST. INDEX 6-280 8 7 23

Hall of History Foundation, Schenectady



The UZ1320 (facing page), made by GE, was first advertised in August 1923, for \$36.50. By August 1923 it was superseded by the UZ1325 (left) at \$25. The Westinghouse FH (right) was offered for \$36.50 in Dec. 1923, reduced to \$25 in August 1924.



Hall of History Foundation, Schenectady



424753 VIEW ON SECOND FLOOR, BLDG. 77, SCHENECTADY WORKS, OCT. 1924.  
INDEX E-320 10 11 24



Radiola X Feb. 1924 \$245 with tubes

This was probably one of the original 1923-1924 line that was pushed aside by the super-het. 14,000 were produced. The X horn was especially well engineered. Cabinet design patent 68,850 by Robert C. Edwards.



Hall of History Foundation, Schenectady

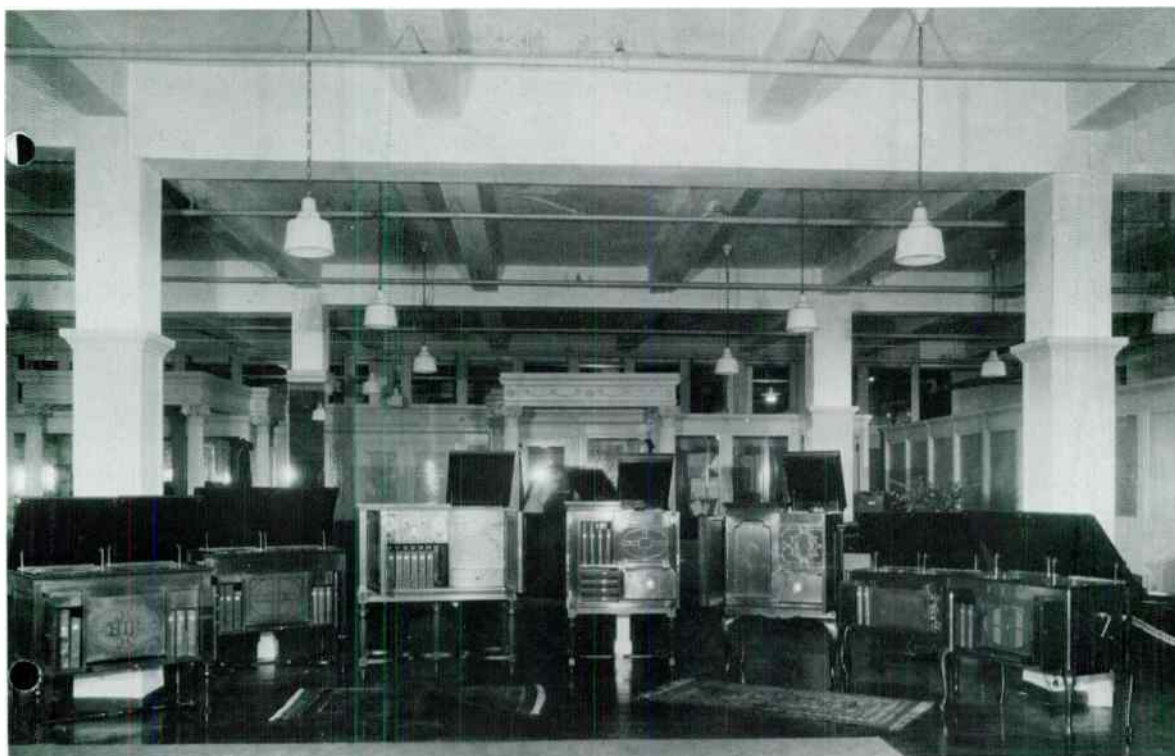

Display of Brunswick Radiolas at the Eastern Phonograph Division showrooms, 799 Seventh Ave., New York City. From left to right:

100	Raleigh	Regenoflex	\$475
160	Tudor	Superheterodyne	\$550
--	Beaux Art	Superheterodyne	--
260	Hudson	Superheterodyne	\$600
360	Empire	Superheterodyne	\$650
30	Royal	III & Balanced Amp	\$190 & \$35
35	Westminster	III A	\$285



Model 5KR



Model 5NO

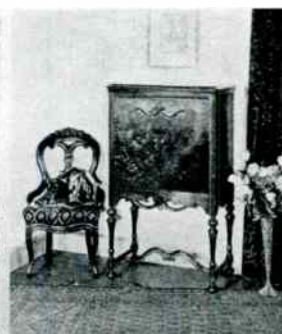

Model 3KRO



Model 5NC8

Talking Machine Journal (Oct. 1928)

Both Brunswick and Victor teamed with RCA to make radio-phonograph combinations. Brunswick Radiolas were first advertised in October 1924, Victor Radiolas in October 1925.

# Christmas is Christmas



RADIO CORPORATION OF AMERICA

Dept. .712 (Address office nearest you)

Please send a Christmas booklet on Radiolas to

Name \_\_\_\_\_

Street \_\_\_\_\_

City \_\_\_\_\_ R. F. D. \_\_\_\_\_

State \_\_\_\_\_

*Want a Radiola this Christmas?*

A gentle hint does wonders. Send us the name of the relative who doesn't know what to get you and we'll mail to him—or her—a book about all the Radiolas from \$35 to \$425. It may help. Or send for the booklet yourself for Christmas ideas.

**Radio Corporation of America**

Sales Offices: 233 Broadway New York 10 So. La Salle Street Chicago 28 Geary Street San Francisco, Cal.

Radiolas manufactured and distributed in Canada by the Canadian General Electric Company, Toronto, and the Westinghouse Company, Limited, Hamilton, Ontario.

# —with a Radiola

A Radiola stretches away through the narrow walls of the city apartment. It makes a new world of the old farm kitchen. It reaches out and out, and brings home the fun!

There'll be Christmas carols on Christmas morning. There'll be music and laughter and lectures and sports—day after day—week after week. The new generation will grow up with a bigger world to live in. The older generation will get new joy out of life. *Everybody wants a Radiola!*

*"There's a Radiola for every purse"*



**Radiola Regnoflex**  
(Shown in illustration.) Remarkable for its *tone quality!* Selective and non-radiating. With compartments to hold all the batteries. With four Radiotrons WD-11, and Radiola Loudspeaker. . . . . \$191

**Radiola Super-VIII**  
The Super-Heterodyne in a stately mahogany cabinet with loudspeaker built in. Entirely complete except batteries. . . . . \$425



**Radiola Super-Heterodyne**  
With no antenna, no connections, it gets distance—gets it clearly—gets it easily—without interference. With six Radiotrons UV-199, and Radiola Loudspeaker. Entirely complete except batteries. . \$269



**Radiola X**  
The Regenflex circuit in a rich mahogany cabinet that encloses its own loudspeaker. Entirely complete except batteries and antenna. . . . . \$245



**Radiola III-A**  
Gets big distance on the loudspeaker! With four Radiotrons WD-11, with Brandes Headset, and Radiola Loudspeaker. Clear-toned—compact—simple. . . . . \$90.



Every Radiola is simple to operate. Uses only dry batteries. Needs no technical knowledge. Needs no fussing and no fixing. Is a beautiful piece of mechanism, and a fine piece of furniture.

A variation of the X, in a cheaper cabinet. Like the X, it went through three circuit changes in its lifetime, and in spite of its name, the reflex idea was dropped after the first change.

(facing page) Regnoflex Feb. 1924 \$150





Radiola IIIA Feb. 1924 \$65 with tubes  
RCA figures state that either 164,624 or "nearly 500,000" Radiola IIIAs were produced.

Radiola III Feb. 1924 \$35 with tubes  
Balanced Amplifier \$30  
103,701 Radiola IIIs were made.

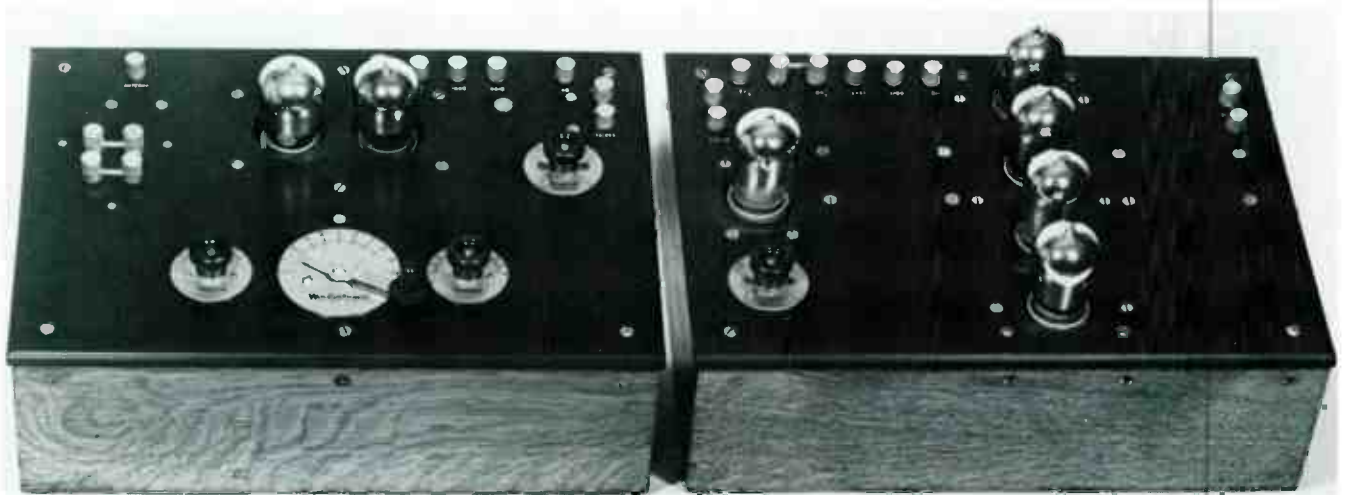

This receiver and amplifier were made by Westinghouse for a Founders Day banquet at H. J. Heinz Co. of Pittsburgh, on October 11, 1924. The proceedings at the main banquet in Pittsburgh, where 3000 diners gathered in a converted factory building, were broadcast by short wave over KDKA to 7000 more people, in 62 cities in the U.S., Canada, and Great Britain. These receivers, one in each banquet hall, picked up the program at about 3000 kHz and fed it to the local PA system. Identical equipment was then in use by Westinghouse network stations, for rebroadcasting KDKA's programming. Supposedly, AT&T at one time refused to rent suitable phone lines to its competitor Westinghouse. 20 receivers and 28 amplifiers were stored for years in a Heinz official's attic, until they were discovered by a furniture dealer about 1976.

Radiola III and IIIA were also made in Canada, those made by Canadian Westinghouse using WD11s, and those by Canadian General Electric using UV-199s. A three-tube model 53 resembling the III was produced too.

# Radiola

Models III-III A Made by C.G.E. now equipped with UV-199 Radiotrons

## ALL THAT IS BEST IN RADIO IN ONE STORE

OF course you are making this a Radio Christmas! Here, at Overland, you can do all your Christmas radio shopping. You can see and hear all that is best in the field of radio—the finest products of the country's leading manufacturers.

In our convenient demonstration room, assisted by trained radio salesmen, you can select the set best suited to your needs and desires.

And quite important is the fact that at Overland interest in the sale does not cease when payment is made. Every Overland installation is guaranteed to be satisfactory. Service is yours to demand at any time.

### Radiola III-a

A four tube Radiola—new—splendidly built—to bring in distance. Extraordinary value—with four tubes, and head-phones.

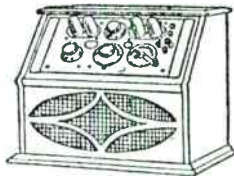

Here is an exceedingly handsome gift. The highly efficient Radiola III-A in a beautiful mahogany finished cabinet with the popular slant front—with built-in loud-speaker and space for all batteries. Cannot be equalled for beauty and efficiency at anywhere near the price—Complete, ready to operate.

**\$65.00**

Price with Speaker, \$90

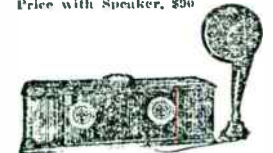

**\$99.00**

### Radiola

#### SUPER-HETERODYNE

SET ONLY ..... **\$220.00**  
Complete with 6 tubes and loud speaker..... **\$269.00**

The aristocrat of all radio sets. No antenna, ground wires or loop; all built into the cabinet—the last word in radio receiver construction.

A new shipment just received permits us to give immediate delivery or set one aside for you to be installed any time before Christmas. Also on exhibition and demonstration the pick of all the best makes and types of receiving sets, in a complete price range, to suit every purse and every radio desire including—

**ATWATER-KENT      GAROD      WARE**  
**STROMBERG-CARLSEN**

and other equally well known and popular makes.

The Overland stock of the newest and best in high grade accessories offers to Christmas radio shoppers an opportunity to select a radio gift, sure to be highly appreciated by any owner of a receiving set. Our salesmen will be glad to show them and make helpful suggestions. Convenient terms of payment may be arranged on Receiving Sets

# OVERLAND

RADIO EQUIPMENT CORPORATION  
108 WEST 40TH ST.  
BET. 67WAY & 6TH AVE., NEW YORK CITY.

By the fall of 1925, the III and IIIA were a year and a half old (two years, counting the six-month delay in their introduction) which made them practically stone-age relics. And the least-expensive new models in the RCA line (the Radiola 20) sold for \$102.50, no match for competitive sets like the \$80 Atwater Kent 20 compact. So, taking its cue from aftermarket cabinets already being sold by others, RCA offered the IIIa DeLux, for \$57.50, shown here in the dealers' house organ for October 15, 1925.

Few, if any, inexpensive radio receivers have earned such enviable reputations as Radiolas III and IIIA. Coupled with their already well established and exclusive features, these instruments, built by the Canadian General Electric Company, are now equipped with the celebrated UV-199 Radiotrons. This departure in construction places Radiolas III and IIIA in a class by themselves.

#### The Advantages of the UV-199

The UV-199 uses from 30 to 35% less battery power than other dry cell tubes. The filament current consumption per tube amounts to only .06 amperes.

The UV-199 is not only an exceptional audio-frequency amplifier, but has proved to be an excellent radio-frequency amplifier.

The filament of the UV-199 is the result of eight years' work in the Company's research laboratories.



#### RADIOLA IIIA

For those who prefer to make their initial radio installation as inexpensive as possible, Radiola IIIA was designed, and realizing that most users would shortly desire to add to the installation, Radiola Balanced Amplifier was designed to go with it. However, for those who wish a complete receiver at minimum cost, Radiola III and the Balanced Amplifier were placed in one cabinet and on a single Panel—Radiola IIIA. This set was designed for ordinary domestic use, where distance reception may be had at minimum expense.



Sole Distributors to the Music Trades

BRUNSWICK-BALKE COLLENDER COMPANY of Canada, Limited  
Toronto - Montreal - Winnipeg - Vancouver

A Canadian General Electric Product

#### THE TOWN CRIER

Page Three

#### Radiola III A D Lux

New Cabinet And Power Amplifier Radiotrons

You've Got To See the beautiful new cabinet which has been designed for Radiola IIIA—the III and Balanced Amplifier to fully appreciate it. It is genuine mahogany, 17 1/2" deep and 14 1/2" high. The cabinet is made of a three ply cabinet material with an aluminum tone arm. Carefully designed and carefully finished so that the output of the loud speaker unit will be amplified with full volume. There is plenty of space inside the cabinet for all batteries including six "A" cells.



Radiola III A D Lux Complete With Radiotrons and 30

Never before has the public had the opportunity to buy a cabinet type Radiola with self-contained loud-speaker and batteries at such a phenomenally low price. Thousands of prospective buyers who can afford to spend \$200.00 to \$250.00 for a radio set, will jump at the chance to own this beautiful Radiola IIIA De Luxe. They have wanted cabinet type Radiolas but they could not afford the higher priced instruments and would not be satisfied with lower priced competitive sets.

You've Got To Hear Radiola IIIA equipped with the new dry battery power amplifier Radiotrons UV-120, to understand how much these tubes have increased the volume and quality of reproduction. The clear, smooth operation of Radiolas III and IIIA has been praised by thousands. Now, by using the UV-120 Radiotron, there has been added volume equal to that obtained from many five tube storage battery sets. And, with this increase in volume, comes a very marked improvement in the quality of reproduction. We can safely say you will be astonished the first time you hear a Radiola IIIA or Radiola III with a Balanced Amplifier, using the UV-120 Radiotrons.

If the UV-199 Radiotrons are to be used in Radiola IIIA or Radiola III with the Balanced Amplifier, it is only necessary to obtain some standard adapters like No. 4215N at 1.95 per item in the WD-11 sockets. These adapters will take the small UX bases.

In the case of Radiola IIIA use one UX-199 Radiotron in the detector socket (the one marked with the number 1 in Fig. 10243) and three UX-120 Amplifiers in the remaining three sockets. The 4 1/2 volt "A" potential may be had obtained from six dry cells connected in series multiple; the plus "B 20" should be increased to 45 volts, plus "B 90" to 145 volts and the "C" voltage should be supplied by a separate 22 volt battery. (A resistance of approximately three ohms should be placed in series with the plus "A" lead to supplement the resistance of the rheostat in the set.) The Radiola III and Balanced Amplifier combination uses two UX-199 Radiotrons in the III and two UX-120 Radiotrons in the Balanced Amplifier. Six dry cells connected in series multiple, will be necessary to give 4 1/2 volts "A" potential. For the Radiola III use 90 volts "B" and a 4 1/2 volt "C" battery. For the Balanced Amplifier use 135 volts "B" and a 2 1/2 volt "C" battery.

Order some of these IIIA De Luxe Radiolas from your distributor today so you will be ready for the Christmas rush. A beautiful cabinet worthy of any living room, great loud speaker volume, and so easy to control that any child can operate it, Radiola IIIA De Luxe offers the greatest value on the market today.

The Christmas gift of thousands! How many will you sell?

New York Herald-Tribune (Dec. 21, 1924).

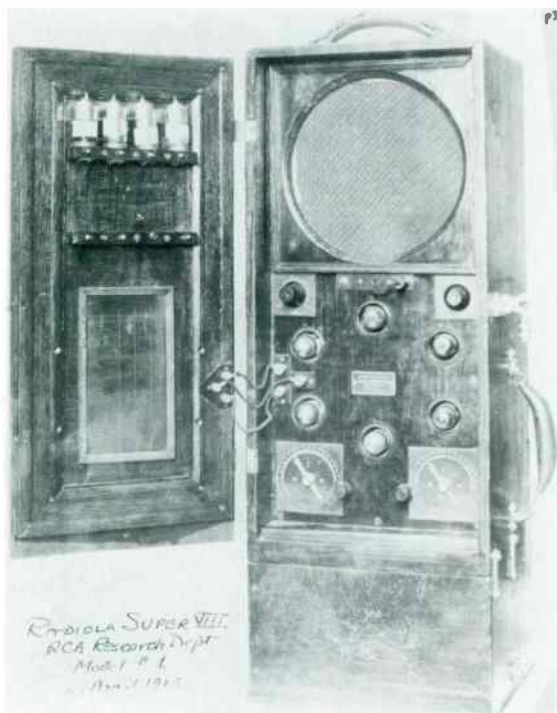

Model no. 2 is now in the Ford Museum

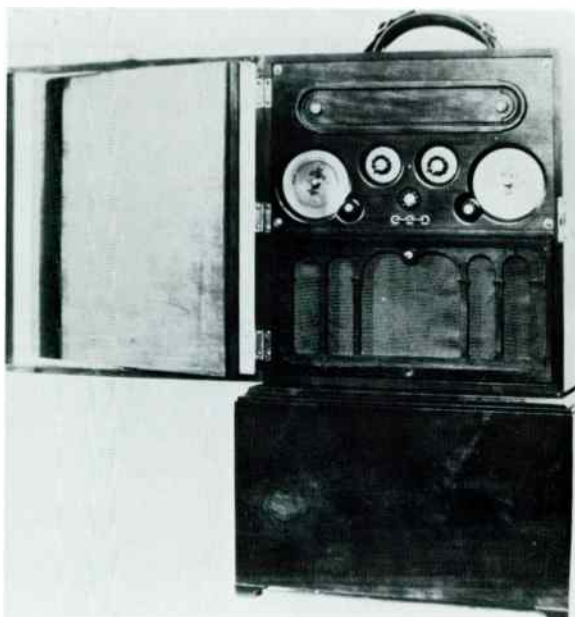

Rich Elskamp

Radiola 26 May 1925 \$225 with tubes 19,507 made.

The 26 was the product of RCA's Technical and Test Dept., particularly the creation of Arthur F. Van Dyck (later the dept. head, when it became the License Laboratory). Portable models had been built in April and June 1923, until work on the production models took precedence for the next few months. In early 1924 Van Dyck returned to his portable, designing a much smaller model around GE's catacomb by May 1, and another by June 4. This last model, with only cosmetic changes, became the 26. Van Dyck received three patents on its features: 1,763,382; 1,808,941; 1,824,517.

According to a 1962 account by James D. Booth, with Westinghouse at East Springfield from 1920, the Radiola 26 was repackaged from the AR812 ("porterable") superhet and made by Westinghouse.

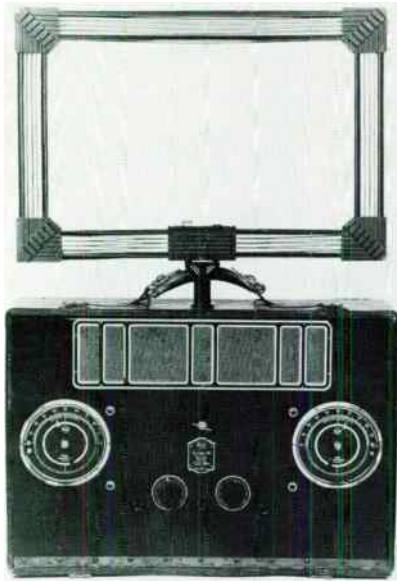

Ralph &amp; Elinor Williams

Radiola 24 May 1925 \$195 with tubes

While the 24 was cheaper than the 26, and offered the same performance, it was discontinued by Christmas 1925. Either Westinghouse had to get a contract to balance the 40%-60% agreement, or perhaps Sarnoff preferred a model designed by his own organization to one created by GE (for a parallel action by Sarnoff, see Dreher, *Sarnoff, An American Success*, pp. 63-67). 7079 were made between April 30 and July 31.

## The Radiola Portable Super-Heterodynes

**I**N selecting a Portable Radiola Super-Heterodyne, you have in mind a certain mission for the set. Either you want a receiver that is exclusively portable and that can be laid aside for one in a more luxurious cabinet when you are home, or else you want a receiver that can be transported about, yet handsome enough to match the fittings of the living room. Radiola 24 supplies the former need. Radiola 26 the latter.

Radiola 24 is enclosed in a genuine black cowhide suitcase which cannot be distinguished from an ordinary travelling bag. Take off the cover, insert the loop in the socket, and the set is ready to operate.

Radiola 26 fills the needs for a set that is adaptable to both portable and home use. It is a handsome walnut cabinet with convenient handle on top for carrying. The loop is enclosed in a walnut frame in the door, and revolves freely inside the frame. It need not be removed to operate, though it may be removed from the door and placed on the back of the set if reception is desired while the set is being carried. Here again simplicity is paramount, for to operate Radiola 26 it is necessary merely to open the door and turn the knobs.

Inasmuch as Radiola 26 is a home set as well as a portable, it is always furnished with a battery box for home use. This box is also of walnut to match the set. It provides space for full sized batteries which are somewhat more economical than the intermediate sizes carried in the

set itself. The battery box is equipped with an antenna coupler which permits the set to be connected to an indoor or outdoor antenna to secure extreme distance reception on the loud speaker.

Aside from these few differences, Radiola 24 and Radiola 26 are identical. Both employ 6 UV-199 dry cell Radiotrons. The loud-speaker units are new developments and the snake-like tubes ending in the grilled outlets in the panels produce clear, true music and speech.

Ample space is provided for A and C batteries, and intermediate size B batteries are used, which, of course, are much lighter to carry. Each set requires, for portable use, three A batteries (regular dry cells) four 22½ volt, intermediate size B batteries, and a small C battery.

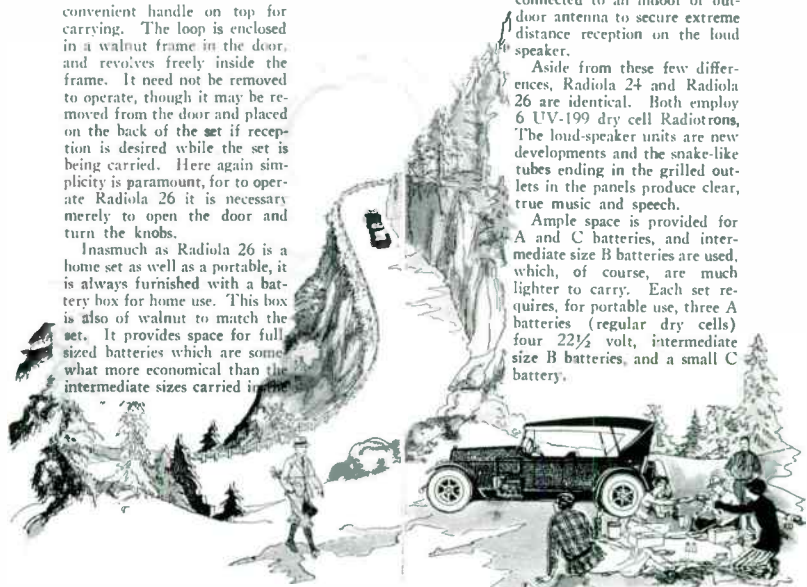

1924 -1925

RCA had no 1924-1925 season, or at least it introduced no new models in mid-1924 but kept selling the 1923-1924 sets. They had been brought out late anyway and had not had a full year's run. Besides, the superhet was still doing extremely well. RCA did, however, want to offer a portable superhet ever since Armstrong's demonstration. The AR812 semi-portable had a carrying handle on top, but . . .

Research by Arthur Van Dyck on a "radiolette" had been authorized as far back as February 15, 1923; but it was May 1, 1924, before a really compact prototype was ready. By June 4, 1924, a slightly larger sample was assembled under Van Dyck's direction at the RCA lab that, with only cosmetic changes, became the Radiola 26. While the 26 and the competing 24 might have been made in time for Christmas, 1924, RCA chose to wait until May, 1925, to introduce them. By then, the last of the AR812s and Super-VIII's had come off the production lines, and upcoming summer activities made portables more attractive.

Particularly after the record sales in 1924, RCA had a tough year in 1925, posting its first operating loss in history in the second quarter and another in the third. And it lost its position as industry sales leader to Atwater Kent, not to regain it until the late 1940's (Phileo held it for most of this period).

After theater~  
home for the best dance music!

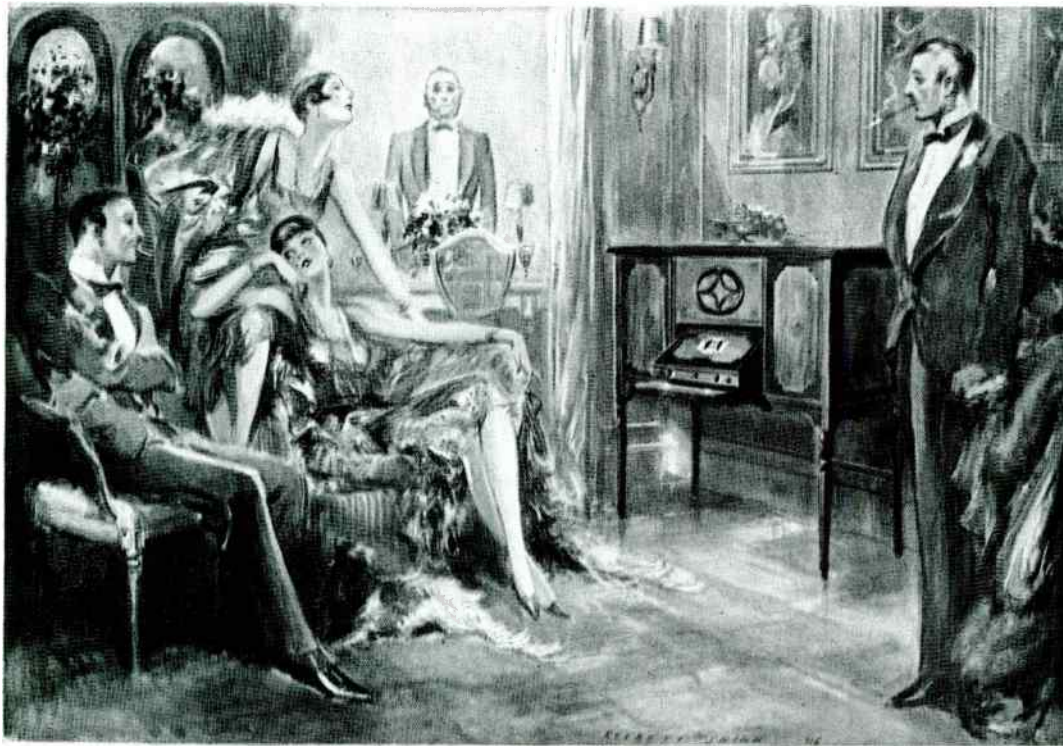

Vanity Fair (Oct. 1926)

RADIOLA 30 is "lighting socket radio"  
that is *tried · tested · perfected*

POWER reception with no batteries is the "new thing in radio" that you hear so much about. But though it is new, it has been tested and perfected, and you need not take chances on an untried purchase. RCA has been ahead of this day by nearly a year. And the Radiola 30 has had time to be thoroughly "road-tested."

It is in thousands of the finest homes. Its principles have been endorsed and adapted by Victor and Brunswick. It has power—and it's *real!* You can turn the music down

when the talk runs gaily. Or turn it up to full orchestra volume for a dance. It is natural and true to reality at any volume. It has a reserve of power—more than you will need to call on—and you'll never hear a



Radiola 30, eight-tube super-heterodyne with power speaker. Beautifully cabineted . . . and superbly *real* in tone . . . Complete, \$575  
Operates on 50-60 cycle, 110 volt A. C. lighting circuit.

crash on the grand finale of a symphony.

Radiola 30 draws its power from the house wires, and takes no more care than an electric lamp! After theater, drive *home* for the best dance music, and tune in. End the evening with a perfect bit of supper, and music right from the night clubs. Even the big bass drum comes through—even the frenzied fingering of those high piano runs. Music is music and jazz is jazz, and it's *there*—real in volume and in tone—with a Radiola 30.



RCA Radiola

MADE · BY · THE · MAKERS · OF · THE · RADIOTRON

Authorized Dealer Buy with confidence where you see this sign.



1000 N. MICHIGAN ST. NEW YORK · CHICAGO · SAN FRANCISCO

1925 -1926

The year 1925 started full of promise: an estimated 480,000 sets were to be produced compared to 275,000 in 1924. And rather than make two independent lines of competing models, GE and Westinghouse would coordinate designs, manufacturing the same sets to identical drawings. For the 1925-1926 models, Westinghouse contributed the semi-uni-control tuning and straight-line-frequency condensers. GE supplied its newly developed technology of power amplifiers, and the electrodynamic speaker of Rice and Kellogg (whose remarkable paper was read before the AIEE in April). Otherwise, the catacomb construction was similar to the previous models, except for the UX-based tubes used.

RCA displayed its new line at the National Radio Exposition on September 12-19, 1925, and advertised extensively but, unfortunately, could not make deliveries to dealers until two weeks before Christmas. And there was a glut of cut-priced merchandise already on the market, dumped by competitors in much worse financial shape. However, in the final tally, RCA did turn a substantial profit.



Rich Elskamp

Radiola 30 Sept. 1925 \$575 with tubes

The 30, though not the first AC-powered radio (the Dynergy from June 1924 had that honor, in the U.S., and Péricaud in France sold one the previous February), was the first practical one, and while it was very expensive, it did sell. 10,835 were made.

Design patent 70,286

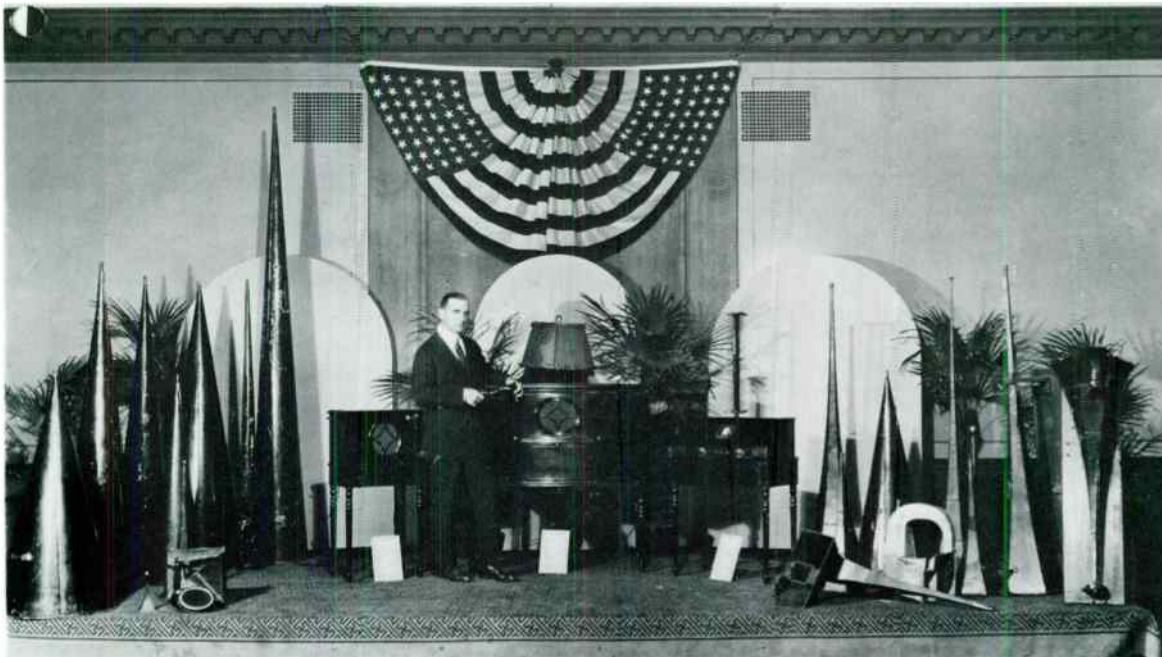

Dr. Alfred Goldsmith, head of RCA's Technical and Test Dept., lecturing on loudspeaker developments at the National Radio Exposition, Sept. 12-19, 1925. See *Wireless Age*, June - August 1925, and *Proc. I.R.E.*, 1924, pp. 423-478.

### RCA Radiola 20



**R**ADIOLA 20 is a new five-tube balanced radio frequency receiver of the uni-control type, equipped with controllable regeneration. It will surpass the performance of the average storage battery type of five-tube, tuned radio frequency receiver.

The predominating features of this set are extreme sensitivity and greater selectivity than that obtained by the usual type of five-tube circuit. Provision is made to adapt the set to aerials of various lengths.

A particularly important feature of Radiola 20 is the uni-control method of tuning, the tuning condensers for all three radio frequency circuits being mounted on the new vertical drum control dial. Provision is made for recording the call letters of the stations heard directly on the dial.

The volume obtained from Radiola 20 with dry battery operation will exceed the anticipations of the broadcast listener, for it is designed to work with Radiotron UX-120 in the last audio stage.

Radiola 20 may be connected to any Radiola Loudspeaker.

RADIOLA 20, less Radiotrons.....	\$102.50
RADIOLA 20, with Radiotrons.....	115.00
RADIOLA 20, with Radiola Loudspeaker UZ-1325.....	135.00
RADIOLA 20, with Loudspeaker Model 100.....	150.00

20 Sept. 1925 135,121 made.

Design patent 72,625.

### RCA Radiola 25



**R**ADIOLA 25 is a second-harmonic, six-tube Super-Heterodyne. This circuit has already demonstrated that it meets every demand of the broadcast listener, with respect to selectivity, range, tone and volume. Radiola 25 is equipped with the new Radiotron UX-120, dry battery, power amplifier, thus giving volume in excess of the average storage battery operated receiver.

The new RCA uni-control mechanism is employed in this Radiola, allowing sensitive tuning by means of a single control in most cases on both local and distant stations.

Radiola Loudspeaker Model UZ-1325 or Model 100 is recommended for Radiola 25 when dry battery operated. As in the case of Radiola 28, either the Model 102 or Model 104 Loudspeaker may be employed, all batteries being eliminated with the latter if "AC" Package UP-971 is used.

As in the case of all Radiola Super-Heterodynes, no antenna is required. The loop mounted directly on top of the case provides reception over extreme distances under favorable conditions.

RADIOLA 25, with Radiotrons (less batteries).....	\$165.00
RADIOLA 25, with Radiola Loudspeaker Model UZ-1325.....	183.00
RADIOLA 25, with Radiola Loudspeaker Model 100.....	200.00
RADIOLA 25, with Radiola Loudspeaker Model 102.....	305.00
RADIOLA 25, with Radiola Loudspeaker Model 104.....	410.00

25 Sept. 1925 94,815 made.

Design patent 72,627.

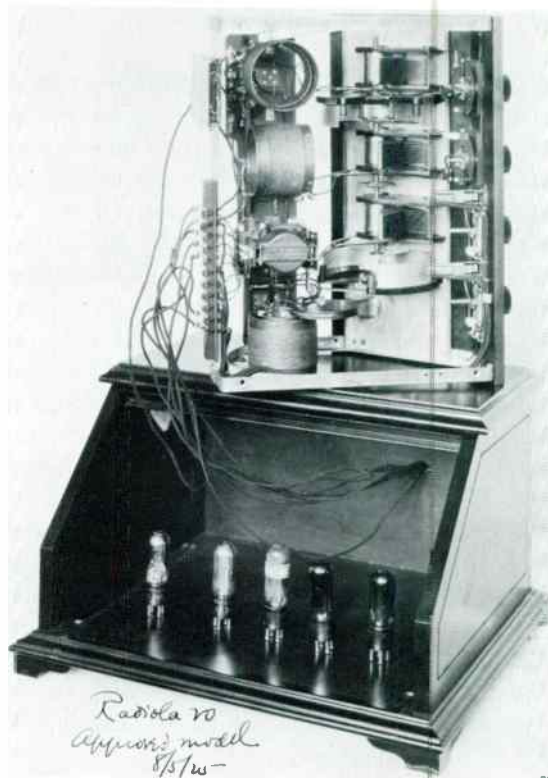

From a March 20, 1985 letter of W.L. Carlson (in charge of superhet design at GE from 1924 to 1930):

"All of the engineering and most of the manufacturing for transmitters and receivers was done in the large 4- or 5-story building #77 at the far end of the plant. Cabinets were obtained from furniture companies. Wireless Specialty assembled some of the large console models. The manufacturing organization was entirely separate from the engineering organization. Both reported to VP Edwards. The research organization was also separate; they were available for consultation.

"Adam Stein was manager of the engineering dept. until about 1927, followed by W.R.G. Baker. The engineering department was split up into a number of sections. The production design section which was the largest was headed by Ralph Langley until 1927 (he led Crosley's research after 1927 — author) and later Glenn Carpenter. My superhet section (never more than a half dozen engineers) fed information to the design section. Another section first under Howard Becker and later under Art Loughren performed a similar function for tuned RF receivers."



**RCA Radiola Loudspeaker Model 104**

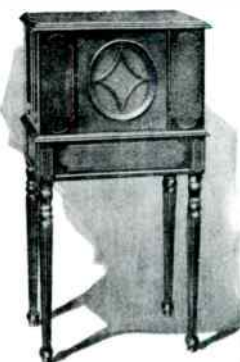

ACOUSTIC perfection has been attained in Radiola Loudspeaker Model 104. There is nothing even remotely like this loudspeaker for it provides distortionless reproduction at volume equal to that of an orchestra or band as it would be heard within the concert hall. Human speech is reproduced with a clarity unimpeachable. It is built on an entirely new principle.

Model 104 loudspeaker is equipped with a rectifier-power-amplifier unit. This employs the super-power-amplifier Radiotron Model UX-210, the output of which feeds a reproducer of new design capable of pouring forth a veritable torrent of sound. The rectifier portion of the unit in addition to supplying the necessary voltages for Radiotron UX-210, also provides plate voltage for practically any type of Radio receiver. Complete operation is obtained by merely connecting to the 110 volts, 60 cycle, alternating current circuit of the home.

RADIOLA LOUDSPEAKER MODEL 104, with all necessary Radiotrons and Rectrons . . . . . \$245.00

W. L. Carlson, in a letter of Aug. 7, 1925:

“By the summer of 1924, when it was time to decide on next year’s line, we knew that to reduce the hiss and image responses we should separate the oscillator and detector circuits and eliminate the reflex and second harmonic — that is to add two more tubes to the catacomb. But RCA Sales was reluctant to abandon the 6-tube circuit that was so successful. The coordination committee and RCA Sales decided on two models: the R25 with 6 tubes and the R28 with 8 tubes.

“Problems developed in factory quality control and engineering design. One problem that I clearly recall, because I was directly involved, was the limited tuning range of the R25. The instruction book specified a frequency range up to 1350 kc. By the 1925-26 season there were a substantial number of broadcast stations operating above 1300 kc. RCA obviously had a lot of complaints from customers who could not receive their new broadcast stations. The problems did not exist in the R28 model with separate detector and oscillator circuits.”

**RCA Radiola 28**



RADIOLA 28—a desk model of the new RCA eight-tube Super-Heterodyne, with sufficient space to accommodate all of the necessary dry batteries—is a popular priced model of the new RCA Super-Heterodyne.

The new eight tube circuit in the Radiola 28 is the same one that is employed in Radiola 30, requiring no external connections and giving an unusual degree of selectivity and sensitivity.

When Radiola 28 is dry battery operated, either Radiola Loudspeaker Model UZ-1325 or Model 100 is recommended. For those who desire increased volume, Radiola Loudspeaker Model 102 or 104 is recommended.

When Radiola 28 is used with Model 102 Loudspeaker, the set itself is dry battery operated. The Loudspeaker is operated from the 110 volt, 60 cycle, AC lighting circuit of the home. When used with Model 104 Loudspeaker, the Loudspeaker and the set itself are operated completely from the AC lighting circuit, if “AC Package” UP-972 is used. Even when operated by dry batteries, Radiola 28 gives loudspeaker volume far in excess of that obtainable from storage battery operated receivers.

RADIOLA 28, with Radiotrons (less batteries and loudspeaker) . . . . . \$260.00  
 RADIOLA 28, with Radiola Loudspeaker Model UZ-1325 . . . . . 278.00  
 RADIOLA 28, with Radiola Loudspeaker Model 100 . . . . . 295.00  
 RADIOLA 28, with Radiola Loudspeaker Model 102 . . . . . 400.00  
 RADIOLA 28, with Radiola Loudspeaker Model 104 . . . . . 505.00

28 Sept. 1925 84,978 made. Technical article in *Popular Radio*, Sept. 1926, pp. 426-429. Design patents 72,628 and 72,629.



71,657. LOUD SPEAKER. FREDERICK C. BARTON and IGOR S. BOBROVSKY, Schenectady, N. Y., assignors to General Electric Company, a Corporation of New York. Filed Nov. 14, 1925. Serial No. 15,424. Term of patent 14 years.



The ornamental design for a loud speaker as shown.

**RCA Radiola Loudspeaker Model 102**

THIS is another development of the Radio Corporation of America designed for broadcast listeners who desire improved tone quality and volume from present-day types of broadcast receivers. Model 102 possesses very fine tonal qualities with exceptional volume. The maximum volume obtainable is greatly in excess of that secured from the ordinary types of loudspeakers.



Very pleasing mellowness and clarity of tone are realized in Model 102 and it may be connected to the first audio stage of any Radiola or any other type of broadcast receiver.

Model 102 Loudspeaker is supplied with a rectifier-amplifier unit, termed "RCA Uni-Rectron Model AP-935," which operates the super-power amplifier tube, Radiotron UX-210 from 110 volts, 60 cycle, AC lighting circuits.

The use of this loudspeaker will increase the operating life of the batteries in any type of broadcast receiver.

RADIOLA LOUDSPEAKER MODEL 102, with Radiotron and Rectron . . . . . \$140.00



**RCA Duo-Rectron "B" Battery Eliminator**

DO YOU KNOW what a change there is in the performance of your radio set whenever you renew your "B" batteries. Your signals are stronger, sharper, clearer—and there is vitality and reserve power in your set that was not there before.

With an RCA Duo-Rectron you have the effect of new "B" batteries every day—but without the expense and without the bother of disconnecting and connecting.

The design of RCA Duo-Rectron takes into account the requirements of all types of broadcast receivers. It also takes into consideration the heavy current drain of experimental types of multi-tube sets which sometimes draw as much as 20 or 40 mill-

amperes in the plate circuit. This tube is provided giving plate voltages of 22½, 45, 90 and 135 volts. The maximum current obtainable is 50 milliamperes.

RCA Duo-Rectron cannot be judged by any previously existing type of battery eliminator. Regardless of the load placed upon RCA Duo-Rectron the voltage remains practically constant through the provisions of Radiotron UX-874. Any or all of the voltage taps may be used with the same fine results.

Though RCA Duo-Rectron operates from the 110 volt, 60 cycle, alternating current lighting circuit of your home, there will be no trace of alternating current hum in its operation. It has been completely eliminated through a specially designed filter system.

RCA Duo-Rectron, Model AP-937, with Radiotron UX-874 and Rectron UX-213 **\$65.00**

**RCA Uni-Rectron Power Amplifier**



BEFORE WE tell you how RCA Uni-Rectron improves the volume and quality of your radio receiver, let us explain just what it is: Uni-Rectron is a super-power amplifier that requires no batteries for its operation. It obtains its power from the 110 volt, 60 cycle, alternating current lighting circuit of your house.

Radiotron UX-210 and Rectron UX-216-B, the two tubes included with Uni-Rectron do all the work. All that is necessary is to insert the plug into one of your wall or lamp sockets and the RCA Uni-Rectron, by means of Rectron UX-216-B, changes or rectifies the current so that the correct voltage will be delivered to the super-power amplifier tube, Radiotron UX-210. The whole unit is enclosed in a metal cabinet which is small and compact and presents a good appearance. RCA Uni-Rectron may be used with any

type of dry or storage battery operated receiver. The volume of music which it is capable of delivering through the loudspeaker will equal or exceed the normal volume of the musical instruments or the singer's voice at the broadcasting studio. Now is the quality impaired. Formerly great volume could not be obtained without an equally great sacrifice of quality, but when Uni-Rectron is used every note remains clear and natural.

This super-power amplifier cannot overload. From the faintest whisper to the loudest crash of sound—RCA Uni-Rectron amplifies each note at its true value. High and low notes are all treated alike.

Not only will its volume and quality be a revelation but the cost of operating your set will be considerably less than before; for when Uni-Rectron is used the drain on the batteries which operate your receiver will be greatly reduced.

RCA Uni-Rectron, Model AP-935, with Radiotrons UX-210 and Rectron UX-216-B **\$105.00**

RCA's line at the end of 1925 included:  
old models (all overstocked):

- Super-VIII \$340 with tubes
- 26 \$225 with tubes
- AR812 \$116
- III \$ 15
- Balanced Amp \$ 18
- IIIA \$ 35

new models:

- 20 \$102.50
- 25 \$165
- 28 \$260
- 30 \$575 with tubes
- 104 \$245 with tubes

*Special Price \$75 each without tubes*



Radio Retailing (July 1927)

Radiola 30-A July 1927 \$495 17,363 made  
Design patent 76,720



Radio Retailing (July 1927)

Radiola 32 July 1927 \$895 3041 made.  
Design patent 76,721

*Radio Retailer and Jobber's* editor made this comment on the Radiola 32: "The RCA has blended the models 28 Radiola and the 104 Power Speaker into one combination . . . If one buys the 32 in the new cabinet the price is more than \$800. If the Power Speaker and set are bought separately, \$570 is the price; still no one has been taken from the Woolworth building and placed in the psychopathic ward of Bellevue Hospital for observation." (July 1927)

1926-1927

The decision having been reached early in 1926 to continue the sale of the new line of Radiolas which were introduced to the market in September, 1925, the Corporation was in a position to fill orders from its trade channels immediately upon receipt. Sales for 1926 showed a substantial increase over the prior year, not only in units but in dollar value. This statement from the 1926 Annual Report was true but incomplete: no new models were introduced for the 1926-1927 season because there was still a tremendous inventory of old ones on hand. Even after dumping 50,000 Radiola III's, 14,000 Balanced Amplifiers, and 12,000 IIIA's around September, RCA admitted to having \$13 million in obsolescent models at the end of 1926.

So RCA skipped the 1926-1927 season, aiming for a timely entry in 1927-1928 with a modern AC-powered set using the just-developed 26 and 27 tubes. The highly touted superheterodyne circuit was all but abandoned; the new Radiolas 30A and 32 were throwbacks to the old catacomb designs and far too expensive to sell in any quantity anyway.

## Introducing the new Cabinet Type Radiola 20 ~ Floor Model

List Price, \$93.50 - With Radiotrons, \$105.00

LEADING metropolitan radio dealers are finding this the quickest seller they have ever known. In fact, Radiola 20, Floor Model, is a truly exceptional value, made possible by the cooperation of the Radio Corporation of America. You will find it a short cut to profits and satisfied new customers.

The beautiful cabinets were designed by Stanley and Patterson and the Times Appliance Company. Their richness is unusual in a set so moderately priced. Each cabinet has ample battery space or room for all standard socket power devices. In tone fidelity, Radiola 20, Floor Model, is superb.

Act quickly and get your share of the brisk business this surprising buy is bringing to the trade. Your regular distributor can supply you in limited quantities. If not, write or phone us direct and we will put you in touch with a distributor near you.



RCA  
Wholesale Distributors  
**STANLEY & PATTERSON, Inc.**  
150 Varick Street, New York  
**TIMES APPLIANCE CO., Inc.**  
33 West 60th Street, New York

### Note These Selling Features

1. Beautiful, polished mahogany cabinet, greatly enhancing attractiveness of outfit—no separate table needed.
2. Ample room in compartments for all standard socket power equipment.
3. Screen tube performance, yet only five tubes are employed.
4. Special amplification circuit for long distance reception. Knurled edge of selector drum enables easy adjustment with the light pressure of a single finger.
5. Variable controls for extreme distance reception.
6. Remarkable quality of reproduction over the common musical scale.
7. One filament control for all tubes.
8. Volume control—operating independently of all other ad justments.
9. U'n-control tuning—simply mark stations on the dial.
10. Many times as effective as ordinary antenna set.
11. Projector permitting use of volume to measure filament voltage.
12. Radiola 20—designed and manufactured by world leaders, RCA, Westinghouse and General Electric.

Radio Retailing (Oct. 1927)

## RCA Radiola 16



*Sensitive  
Selective  
Compact*

Radiola 16 Sept. 1927 \$69.50  
85,320 made. Design patent 75,621



## Radiola 50

In response to a public demand for a cabinet model Radiola embodying the Radiola 17 and speaker 100-A, the Radio Corporation of America, 233 Broadway, New York City, has introduced the Radiola 50. Two doors in the front reveal the tuning control panel, with the speaker opening below. Four '26 Radiotrons are used as first audio and radio frequency amplifiers, one '27 functions as a detector, and a 171-A as the second audio amplifier. The cabinet measures 38½ in. high, 24½ in. wide and 14 in. deep, and weighs 88 lb. The intended retail price is \$285.—*Radio Retailing*, April, 1928.

Radiola 50 March 1928 \$285  
3220 made.

## RCA Radiola 17

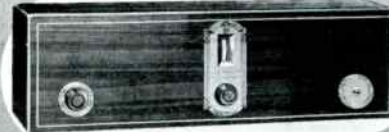

MUSIC  
*from your*  
LIGHTING  
SOCKET

Radiola 17 Sept. 1927 \$130  
179,917 made.

## The New RCA Radiola 18



LIGHTING CIRCUIT OPERATED

Radiola 18 May 1928 \$115  
More than 250,000 made.

## AC Models

After a slow start of 1,000 model 17's per day, production after November 10 was fully adequate to handle the brisk business. In April, 1928, the improved Radiola 18 replaced the 17, and since there was no need to change this well-designed model for the 1928-1929 season, it was continued. New for this season was the 60 series of superhets, engineered by W. L. Carlson's team at GE and George Beers' at Westinghouse by the summer of 1927. This was the first truly modern superhet design: one-dial tuning (using the same bathtub condenser designed for the 17 and 18), AC tubes, chassis construction, and wire antenna instead of the bulky loop.

A fundamental change came to the industry in 1927: RCA's licensing other manufacturers under its TRF and power-supply patents. Beginning with Zenith in March, then All-American and Splitdorf in April, most of the industry was licensed by the year's end.

While this increased the competition for its models (and some competitive sets were much cheaper than the Radiola 17 and 18), RCA did get a 7 1/2% royalty on every set sold. There is good reason to believe, however, that this rate was not assessed on some companies, notably Splitdorf and Atwater Kent.\*

\*See B. F. Miessner, *On the Early History of Radio Guidance* (San Francisco Press, 1964), pp. 49-52, quoted in the Splitdorf chapter. See also *Radio Retailer and Jobber*, March-September 1927, various items on Splitdorf and Atwater Kent. A little arithmetic shows that for 1928, when all important radio companies had been licensed, total industry sales were \$400 million or, roughly, \$240 million wholesale or \$200 million if RCA's own sales are deducted. Seven-and-one-half percent of \$200 million equals \$15 million in royalties that RCA should have collected. Actually, RCA reported \$6.4 million in 1928 and \$7 million in 1929.

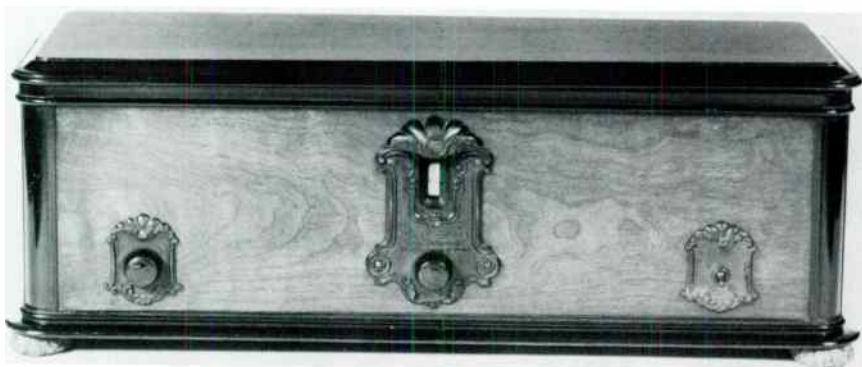

Radiola 60    Sept. 1928    \$175    135,336 made.

Technical articles (for models 62 and 64 also) in *Citizens Callbook*, vol. 11 no. 1, Jan. 1930, p. 74; *Proc. I.R.E.* vol. 17 no. 3, March 1929, pp. 501-515 and Aug. 1929, pp. 1454-1458; *Radio*, Feb. 1929, pp. 27-28.

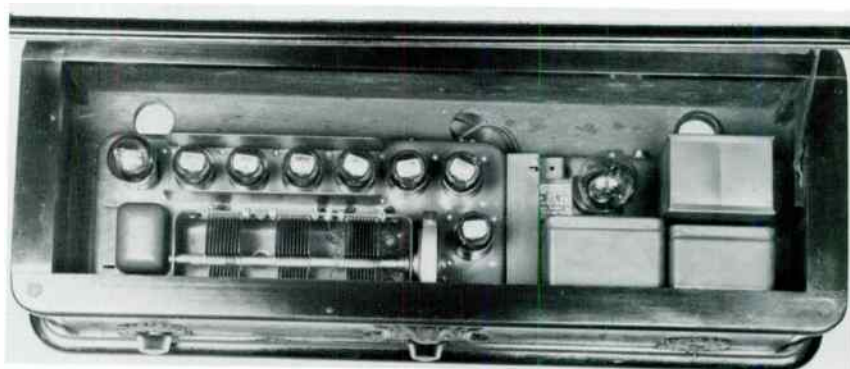



RCA RADIOLA 33—Expertly built broadcast receiver for simplified A. C. house-current operation. Very compact—no table required. Cabinet of special design. Reproduces music and voice with amazing realism. \$77.50 (less Radiotrons)

RCA LOUDSPEAKER 100B—Specially designed reproducer to match the new RCA Radiola 33. Rich, mellow tone—remarkable range and capacity. \$22

**RCA RADIOLA**

MADE BY THE MAKERS OF THE RADIOTRON

RADIO CORPORATION OF AMERICA • NEW YORK • CHICAGO • ATLANTA • DALLAS • SAN FRANCISCO



**RCA**

*Announces the new*

**RADIOLA 33**

**AND RCA LOUDSPEAKER 100 B**



Buy with confidence where you see this sign

Radiola 33 April 1929 \$77.50 236,961 made

Several Radiola models were also sold with slight cabinet variations under the Brunswick and the Graybar labels. Graybar, from Gray & Barton, founders of Western Electric in 1869, was the name of the W.E. Supply Dept. after 1926.

Reorganization

It is a tribute to David Sarnoff that he was able to hold RCA together during its first decade. RCA's arrangement with GE and Westinghouse was, at best, unwieldy. The manufacturing companies could perfectly well have handled their own merchandising as they owned or controlled many of the largest jobbers in major cities, and had plenty of experience selling electrical appliances. RCA's sales organization was staffed with former ship operators with little understanding of the business; sales manager Bucher was an

old Sarnoff crony from 1914 while advertising manager Pierre Boucheron was constantly at odds with his counterparts at the newspapers.

The second problem was more easily solved. Bucher was kicked upstairs in January 1928, to a vice presidency with RCA Photophone (movie sound systems) while in November, Boucheron was exiled to a remote regional distributorship.

Acquiring manufacturing facilities took somewhat more time and outside help. Sarnoff got an agreement from GE and Westinghouse in April, 1928, regarding formation of a manufacturing company to be owned

*Here's an*  
**RCA Radiola**  
*for every purse*  
and an  
**RCA Radiotron**  
*for every purpose*

**WE** handle RCA Radiolas, Radiotrons and Loudspeakers because — They make your radio dollar go further and buy more. They give complete satisfaction. Year after year, since the start of home reception, they have led the world in public favor. No product can win first place in public favor, and hold it continuously unless it deserves it. Performance—appearance—price! These are the three points on which RCA supremacy is based—the Big Three points of radio buying.

We have RCA Radiolas in both battery-operated and lighting circuit operated sets. We have them at every price level—each built by the master builders of radio to give buyers the greatest possible value in its class. We want you to hear them and compare the low-priced sets with the most elaborate console model. You will recognize RCA quality in every one of them.

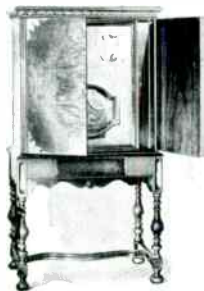

**RCA Radiola 62.**  
RCA Radiola 62 is a combination of the famous RCA Super Heterodyne and the RCA Electro-Dynamic Loudspeaker built into a beautiful and all console cabinet, with maple inlay. AC operated, employing nine powerful AC Radiotrons. Price, without Radiotrons, \$275.00.



**RCA Radiola 64.**  
RCA Radiola 64 incorporates the new RCA Super Heterodyne circuit and the new RCA Electro-Dynamic Loudspeaker, with many unusual features embodied in a walnut cabinet of distinguished design. AC operated using eleven AC Radiotrons. Price, without Radiotrons, \$580.00.



**RCA Radiola 32.**  
RCA Radiola 32 is operated direct from light socket by means of the new "AC" Radiotrons. It is easy to operate and of excellent tone quality. Its compact, beautifully finished cabinet contains all the mechanism necessary for operation. Price, without Radiotrons, \$85.00.



**RCA Radiola 80.**  
RCA Radiola 80 incorporates the new RCA Super Heterodyne circuit employing eight power, full AC Radiotrons. The entire circuit is operated by a single tuning control. Cabinet is in a two-tone Walnut finish. Complete AC operation. Price, without Radiotrons, \$247.00.



**RCA Electro-Dynamic Loudspeaker 100.**  
RCA electro-dynamic loudspeaker, Model 100, is extremely sensitive, yet will handle great volume without distortion. Cabinet is finished in walnut with panels of Vokar de Omer embroidered tulle. Operates on 105 to 125 volts, 50 to 60 cycles, A.C. Price—\$85.00



**RCA Radiola 41.**  
RCA Radiola 41 is an "all-electric" receiver incorporating the RCA tuned radio frequency circuit and the new RCA Electro-Dynamic Loudspeaker in a walnut cabinet. Price, without Radiotrons, \$215.00.



**RCA Loudspeaker 100-A.**  
RCA Loudspeaker 100-A possesses great tonal quality and handles substantial volume with remarkable clarity. Price, \$23.00.



**RCA Loudspeaker 103.**  
RCA Loudspeaker 103 is beautiful in appearance and superb in its ability to reproduce music and speech faithfully. Price, \$27.50.



**RCA Radiola 16.**  
RCA Radiola 16 is a single-control, six-tube, storage battery receiver employing the RCA tuned radio frequency circuit. Stagnosey finished cabinet. Price, complete with Radiotrons, \$83.75.



**RCA Radiola 31.**  
RCA Radiola 31 is a sensitive, tuned radio-frequency receiver and RCA loud speaker built into a handsome cabinet of beautiful walnut finish. AC operated. Price, without Radiotrons, \$175.00.



**RCA Radiola 30-A.**  
RCA Radiola 30-A is the famous eight tube Super Heterodyne equipped with a special 10-A Power Amplifier tube, and is completely socket power operated. The popular Radiola 100-A Loudspeaker is built into its handsome walnut cabinet. Price, complete with Radiotrons, \$283.00.



UX-100 Detector Amplifier Price, \$7.15	UX-110 Power Amplifier Price, \$7.50	UX-500-A Sensitive Detector Price, \$4.00	UX-500 Full-wave Rectifier Price, \$4.00	UX-700 AC Element Price, \$7.50	UX-704 Voltage Regulator Price, \$4.15	UX-501-A Detector Amplifier Price, \$1.50	UX-910 Power Amplifier Price, \$8.00	UX-113-A Power Amplifier Price, \$8.00	UX-816-004 Current Regulator Price, \$6.50	UX-711 AC Element Detector Price, \$3.00	UX-501 Half-wave Rectifier Price, \$7.50	UX-112-A Detector Amplifier Price, \$2.00	UX-500 Power Amplifier Price, \$12.00	WX-12 Detector Amplifier Price, \$2.50	UX-722 Screen-grid Amplifier Price, \$6.00	UX-500 High-Mu Amplifier Price, \$2.00	WD-41 Detector Amplifier Price, \$2.50	UX-100 Detector Amplifier Price, \$2.50
--	---	--	---	---------------------------------------	---	--	---	---	---	---	---	--	--	---	---	---	---	--

Radiotrons are your best insurance against tube troubles.

Ask for a copy of the book which describes their uses in detail.

41	Nov. 1928	\$215	
51	June 1928	\$195	6188 made.
62	Sept. 1928	\$375	19,972 made. Design patent 80,940.
64	Sept. 1928	\$550	7406 made.
100A	design patent 73,030; 103 design patent 78,973, both to Joseph Gosling, a GE lamp designer.		

# VICTOR RADIO

MICRO - SYNCHRONOUS

## the gift that keeps on giving!



Victor Radio-Electrola RE-45. The modern complete musical instrument. Same radio equipment as R-32. All-electric radio and Victor Record reproduction. Automatic record brake. Marvelous power and quality. List price \$275. Less Radiotrons.



Victor-Radio Console R-32. Exclusive modernized circuit; unique sensitivity and selectivity. 10 Radiotrons; exclusive new Victor speakers; instantaneous tuning; matchless tone quality. List price \$155. Less Radiotrons.

This Christmas, for your home, for those who are dear to you, for yourself, you will naturally seek the supreme gift, a gift beyond price...the gift of happiness.

Victor micro-synchronous Radio, with Electrola, (playing Victor Records electrically) or the radio alone in its lovely Console, will provide more happiness, and *more lasting* happiness than any other gift at any price. Victor-Radio with Electrola is unique: the entertainment it provides is as varied as human desires. It is perhaps *the only thing in the world that can please everyone, all the time!*

Victor-Radio performance is accepted as the standard by which other instruments are judged...and of which they must inevitably fall short. For no other radio is micro-synchronous; no other radio is backed by acoustical experience comparable with Victor's; and no other radio bears the name "Victor" and the famous Victor trademark.

When you go to your Victor Dealer's to hear the three models of Victor-Radio, you will find them beautiful, compact and soundly built, as become Victor instruments. You will recognize them as the gift that keeps on giving...a royal gift...at a very low price! Victor Talking Machine Division, Radio-Victor Corporation of America, Camden, N. J., U. S. A.

*Make this Christmas memorable with Victor-Radio!*

# Victor-Radio

with Electrola



Victor-Radio de luxe R-52. Wall cabinet of classical design in finest walnut veneer. Radio equipment identical with that of R-32. Inlaid door medallions of matched butt walnut. Blended finish. A luxurious cabinet housing a marvelous radio set. List price \$215. Less Radiotrons.



Victor Super-automatic Station Selector. Just slide the knob to right or left...you have the station you want.

The Victor R-32 and RE-45 were first offered in June 1929, the R-52 in October, in a lavish advertising campaign. Technical articles appeared in *RADIO*, Nov. 1929, pp. 49-50 (corrected in April 1930, p. 48) and in the *Citizens Callbook*, vol. 11 no. 3, Sept. 1930, p.77. While the mechanical design of this chassis was, er, unusual, its audio quality was outstanding, far better than that of most competitive radios. Production figures: R-32 179,090 RE-45 99,783 R-52 33,681

48% by GE, 32% by Westinghouse, and 20% by RCA; but this plan was shelved almost immediately in favor of a combination with the Victor Talking Machine Company. GE and Westinghouse advanced \$32 million to buy Victor and modernize its plant in Camden, New Jersey. Two new companies were created: one to do the manufacturing and one to handle sales. The first was the Audio Vision Appliance Company, owned jointly by GE, Westinghouse, and RCA, formed in May 1929. Then the old Victor sales organization and RCA's Commercial Department combined into the Radio-Victor Corporation of America.

This setup, very similar to the old RCA arrangement, lasted only a few months until Sarnoff was successful in forming the RCA Victor Company, Inc., on December 26, 1929, to consolidate the radio activities of all the companies. RCA could now do its own manufacturing. By May 1930, when GE and Westinghouse agreed to accept RCA stock in return for their investments in RCA Victor and Sarnoff was elected president of RCA, his dream of a unified manufacturing and sales company was complete—almost.

Almost, because the Department of Justice filed an anti-trust suit that same month, demanding that GE and Westinghouse divorce themselves completely from RCA: exclusive cross-licensing agreements, stock ownership, seats on the Board of Directors, everything. The consent decree of November, 1932, made it

official: after a 2 1/2-year period, RCA's former parents would be free to compete. But also in the agreement was a substantial reduction in RCA's debts to GE and Westinghouse. So in a sense, RCA was much better off than before, free to go its own way, which it did most successfully in the years following. As Sarnoff put it, "The Department of Justice handed me a lemon and I made lemonade out of it."

68,863. LOUD SPEAKER. WILLIAM D. LA RUE, Philadelphia, Pa., assignor to Victor Talking Machine Company, a Corporation of New Jersey. Filed Sept. 29, 1925. Serial No. 14,943. Term of patent 14 years.

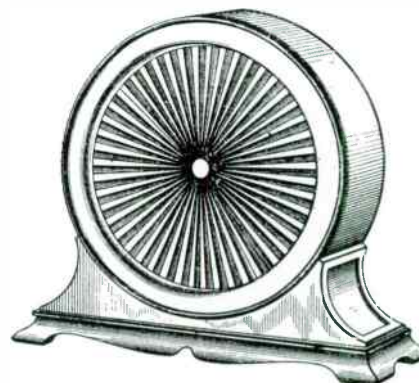

The ornamental design for a loud speaker, as shown.

The factory at Camden, N.J., where Radiolas are built by the most modern methods of straight-line production.



Radio-Music Merchant (Aug. 1930) p. 13





**RCA  
RADIOLA  
67**



**Model 105**



**RCA  
RADIOLA  
21**

So that families living in territories not served by electrical power lines may have the advantages of new developments in radio, RCA has designed two new battery-operated, screen-grid Radiolas. Radiola 21 is a table model of the new circuit, employing five Radiotrons, two of which are the battery-operated, screen-grid Radiotrons UX-222. Provision is made for the use of the power Radiotron UX-112-A or UX-171-A in the last audio stage. Radiola 21 is enclosed in a beautiful walnut veneered cabinet, is metal shielded, and is provided with the new RCA stencil-cut illuminated selector dial.

RCA Radiola 21 (less Radiotrons)..... \$69.50

Radiola 21 Sept. 1929 \$69.50



**RCA  
RADIOLA  
22**

RCA Radiola 22 is a de luxe model of the new battery-operated screen-grid Radiola. Its circuit is identical with that employed in Radiola 21, but in addition it is equipped with an RCA loudspeaker of the 103 type, already well known for its sensitivity and excellent tone quality. Its beautiful Queen Anne cabinet, constructed of several different kinds of selected wood, provides ample space for housing all batteries. Without doubt Radiola 22 is the finest of battery-operated Radio sets in appearance, as well as in sensitivity, selectivity and tone quality.

RCA Radiola 22 (less Radiotrons)..... \$135.00

Radiola 22 Sept. 1929 \$135

Description in *Radio Broadcast*, Jan. 1930, pp. 140-41. Short technical article in *Radio*, April 1930, p. 48. Performance graphs in *Radio Broadcast*, Feb. 1930, p. 223 (corrected in April 1930, p. 333).

A new—and still finer  
**RADIOLA SUPER-HETERODYNE**  
*the incomparable in advanced radio*  
*at the unprecedented price of \$ 225\*.*



RCA engineers have achieved in the new "66" Radiola Super-Heterodyne the finest cabinet radio set ever offered in this price class.

To improve the Super-Heterodyne is to gild the lily, but here is a receiver of still finer performance, with amazingly sharp selectivity and sensitivity—and even richer tone quality—the characteristics that have made it the unquestioned leader in radio design.

Coupled with it in the beautiful cabinet is an improved type of the famous RCA Electro-Dynamic speaker—the marvelous instrument that has revolutionized the art of realistic reproduction of music and the voice.

High-quality Radiolas are now priced so low that no one need deny himself the satisfaction of owning a real Radiola carrying the RCA guarantee of fine workmanship.

RCA Radiola Dealers are now displaying new Super-Heterodynes, new high-powered Screen-Grid receivers, new battery-operated sets, and new radio-phonograph combinations—the finest offering of RCA radio instruments ever announced to the public.

RCA RADIOLA 66—A new, improved RCA Super-Heterodyne with Electro-Dynamic reproducer. Built with master craftsmanship throughout. The finest Super-Heterodyne ever offered at this price. \$225\*

RCA RADIOLA 67 (Combination)—Super-Heterodyne with electric phonograph and Electro-Dynamic reproducer. \$690\*  
 RCA RADIOLA 64—Super-Heterodyne de luxe with Electro-Dynamic reproducer. . . . . \$550\*  
 RCA RADIOLA 60—Super-Heterodyne, table model. \$147\*  
 RCA RADIOLA 47 (Combination)—Screen-Grid radio, electric phonograph and Electro-Dynamic reproducer. . . . \$275\*  
 RCA RADIOLA 46—Screen-Grid radio, Electro-Dynamic speaker. . . . . \$179\*  
 RCA RADIOLA 44—Screen-Grid, table model. . . . \$110\*  
 RCA RADIOLA 33—The famous "all-electric" console type receiver . . . . . \$54\*

RCA RADIOLA 22—Screen-Grid for battery operation, with enclosed loudspeaker. . . . . \$135\*  
 RCA RADIOLA 21—Screen-Grid, table type, for battery operation. . . . . \$69.50\*  
 RCA LOUDSPEAKER 106—Electro-Dynamic. . . . . \$65  
 RCA LOUDSPEAKER 103—Magnetic type. . . . . \$30  
 RCA LOUDSPEAKER 100B—To match Radiola 33. \$17.50

\*Radiotron equipment not included in above prices. All Radiolas excepting Nos. 21 and 22 operate from house current.

RADIOLA DIVISION

RADIO-VICTOR CORPORATION OF AMERICA  
 NEW YORK · CHICAGO · ATLANTA · DALLAS · SAN FRANCISCO

Buy with confidence



where you see this sign

**RCA RADIOLA**

MADE BY THE MAKERS OF THE RADIOTRON

66 & 67 first advertised in Aug. 1929. 66 technical article in *Citizens Callbook*, vol. 11 no. 3, Sept. 1930, p. 81. 4939 model 67s were made.

# Screen-Grid RADIOLAS



RCA RADIOLA 46—Console cabinet model of the new Screen-Grid Radiola 44, with RCA Electro-Dynamic Speaker \$179 (less Radiotrons).



RCA RADIOLA 47—Combination. The newest RCA "all-electric" development in Screen-Grid radio combined with the phonograph. "Music from the air or record." \$275 (less Radiotrons).

THE SENSATION OF THE RADIO YEAR



RCA RADIOLA 44—Radio receiver utilizing Screen-Grid Radiotrons—high amplification and great selectivity. Alternating current operation from house circuit. Table cabinet of walnut veneer. \$110 (less Radiotrons).

RCA LOUDSPEAKER 103—For use with Radiola 44, \$22.50.

In addition to Screen-Grid Radiolas there are eight other models of Radiolas and Radiola Phonograph combinations ranging in price from \$54.00 to \$690.00. Any of these instruments may be purchased through RCA Radiola Dealers on the convenient RCA Time Payment Plan.

## RCA RADIOLA

Radiolas 44, 46, 47 first advertised in Sept. 1929. Technical article in *Radio*, Sept. 1929, pp. 29-30 44 performance graphs in *Citizens Callbook*, vol. 11 no. 2, March 1930, p. 84.

Production figures: 46 — 97,633 47 — 15,120

RCA has set a new standard of radio enjoyment in the new Screen-Grid Radiolas! Designed and built by the same RCA engineers who developed the Screen-Grid Radiotrons and Screen-Grid Circuit, they are the sensation of the radio year.

Never before have radio instruments of so few tubes offered such marvelous, well-rounded tonal beauty—such astounding volume without distortion—such balanced reproduction of both high and low notes.

Radiolas 44 and 46 utilize only five tubes—yet give you the performance of sets employing a far greater number. Three of these tubes are the amazing Screen-Grid Radiotrons—an RCA achievement. Included also is a new power amplifying Radiotron capable of tremendous volume without distortion.

In these great Screen-Grid Radiolas you get the freedom from distorting noises and electrical hum without the costly sacrifice of loss in fidelity and tone range... without that weakening of power and dulling of low and high notes which owners of ordinary radio sets must suffer when hum is reduced in defiance of electrical research and experience.

Radiola 44 (table model) is in a compact, two-tone walnut veneer cabinet of charming and graceful design. The console model, Radiola 46, makes use of the finest of all reproducers, the famous RCA Electro-Dynamic Speaker, an integral part of the assembly.

Radiola 47 offers the outstanding combination of Screen-Grid Radiola and Electro-Dynamic Speaker, and newest type of phonograph for the electrical reproduction of records! "Music from the air or record."

Visit your RCA dealer today. See and hear these marvelous Screen-Grid Radiolas—designed and built by the creators of the Screen-Grid Radiotron and the Screen-Grid Circuit.



RADIOLA DIVISION

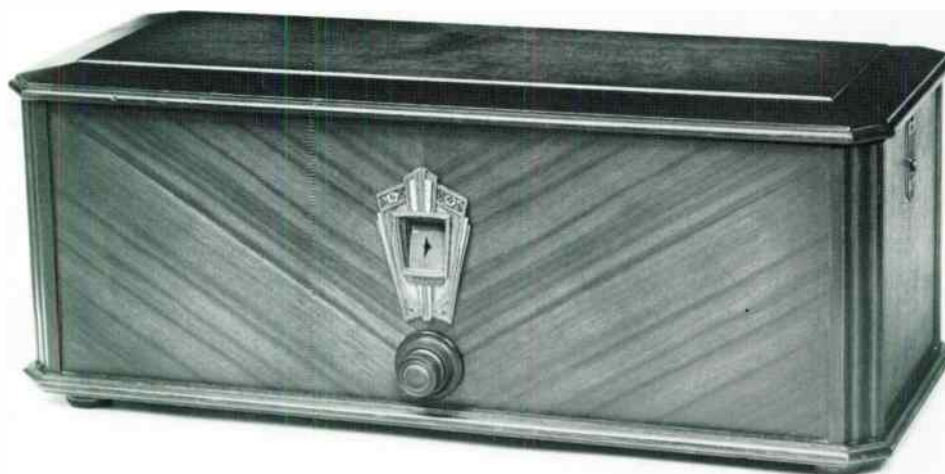

1,816,718. SHIELDED RADIO RECEIVING APPARATUS AND THE LIKE. WILLIAM L. BOND, Schenectady, N. Y., assignor to General Electric Company, a Corporation of New York. Filed Feb. 19, 1930. Serial No. 429,757. 15 Claims. (Cl. 250-16.)

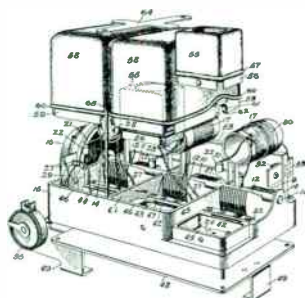

1. A shield for radio receiving apparatus and the like including in combination, an open metallic frame having integral transverse and longitudinal partitions dividing it into sections, a well in one of said sections communicating with an adjacent section of said frame, a removable shield mounted in said well, a second removable shield mounted on said frame and providing a closure means for said adjacent section, and an enclosing means for one of said shields.

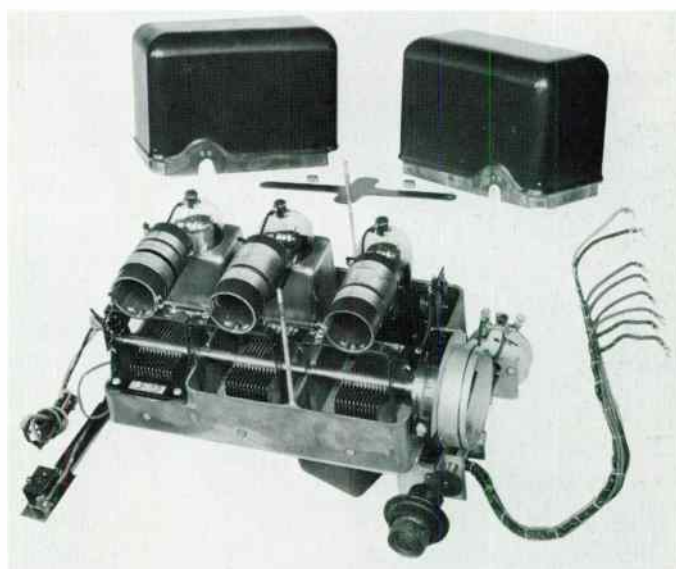

**GROSS SALES** (compiled from Annual Reports to Stockholders):

1921	\$ 1,468,920
1922	11,286,489
1923	22,465,091
1924	50,747,202
1925	46,251,786
1926	56,009,608
1927	56,651,658
1928	86,900,153

**TOTAL INCOME** (includes gross sales, marine, transoceanic, royalties, and real estate. RCA stopped publishing the detailed figures in 1929):

1928	\$ 99,626,543
1929	182,137,739
1930	137,037,596
1931	102,645,420
1932	67,361,142

## RADIO MANUFACTURERS OF THE 1920's

Model	Date	Price	No. Made	Notes
2-1	1925-26		11	
5-1	1925-26		7	
7-1Δ (Alhambra I)	1925-26	\$ 350		Radiola 20
7-2 (Alhambra II)	1925-26	425	992	Radiola 25
7-3	Sept. 1926	375	9178	Radiola 20
7-3 Electric	Sept. 1926	410°	4020	Radiola 20
7-10	Oct. 1927	275	5402	Radiola 16
7-10 Electric	Oct. 1927	310°	724	Radiola 16
7-11	June 1928	250	12109	Radiola 18
7-11 Electric	June 1928	285	14322	Radiola 18
7-25	1927-28	385	4072	Radiola 17
7-25 Electric	1927-28	420	4049	Radiola 17
7-26	June 1928	425	15001°°	Radiola 18
7-26 Electric	June 1928		1445	Radiola 18
7-26A	Nov. 1928	475		Radiola 18, dynamic speaker
7-30	Jan. 1927	375	3871	Radiola 20, similar to 7-3
7-30 Electric	Jan. 1927	410°		Included in 7-30 production figure
8-2	1925-26	310	18570	8-1 with electric motor
9-1 (Florenza)	Jan. 1926	550	3910	Radiola 25, Later \$475
9-1Δ Electric	Jan. 1926	585		Included in 9-1 production figure
9-2Δ (Borgia II)	1925-26	1000		
9-3 (Borgia I)		675	1455	Radiola 28
9-15	Late 1926	600	807	Radiola 28, Replaced Borgia I
9-15 Electric	Late 1926	635°	1746	Radiola 28
9-16	July 1928	750	2096	Radiola 18
9-16 Electric	July 1928		13	Radiola 18
9-18Δ	1928-29	925		Radiola 64
9-25	1927-28	1150	1037	Radiola 28 & 104
9-40	Oct. 1926	1000	5135	Radiola 28, Modification of 9-2
9-54	1928-29	1350	2809	Radiola 64
9-54 Electric	1928-29		2940	Radiola 64
9-55	Nov. 1927	1550	2045	Radiola 28
9-56	Dec. 1928	1750	257	Chinese Chippendale 9-54
12-1 (Cromwell)	1926-28	450	6219	Phonograph only
12-2 (Tuscany)	1926	550	1619	Phonograph only
12-15	1928	550	5966	Phonograph only
12-25	1927-28	625	2193	Phonograph only
R-twenty	Feb. 1927	135	6381	Radio only, Radiola 20

° With induction disc motor. With universal motor, \$20 more.

°° This number may include the 7-26A.

Δ Data obtained from Baumbach, *Look For the Dog*.

Information obtained from RCA, Indianapolis, by Dr. Ed Taylor.

## RADIOLA RELEASE DATES

Jan. 1922	RC	June 1927	104DC
Feb. 1922	Sr	July 27, 1927	32
Mar. 1922	Aeriola Grand	Aug. 7, 1927	30A
Sept. 1922	AC	Aug. 8, 1927	16
Dec. 1922	H	Sept. 14, 1927	30A DC
Dec. 1922	IV	Sept. 15, 1927	32DC
Dec. 1922	V	Sept. 15, 1927	17
Dec. 1922	VI	Mar. 5, 1928	AP1080
Dec. 1922	Radiola Grand	Mar. 8, 1928	105
Jan. 1923	AR	Mar. 14, 1928	50
Jan. 1923	RS	Apr. 19, 1928	18
Feb. 1923	VII	June 13, 1928	51
Feb. 1923	Special	Aug. 13, 1928	60
Mar. 1923	V-A	Aug. 17, 1928	103
Nov. 1923	IX	Sept. 14, 1928	62
Jan. 1924	VII-B	Oct. 23, 1928	64
Feb. 2, 1924	III	Nov. 26, 1928	106AC
Mar. 4, 1924	Balanced Amp.	Dec. 15, 1928	41
Mar. 4, 1924	Superheterodyne	Dec. 18, 1928	18DC
Mar. 18, 1924	Super-VIII	Dec. 18, 1928	51DC
Mar. 21, 1924	X	Mar. 1, 1929	41DC
Mar. 27, 1924	III A	Mar. 26, 1929	33
Apr. 25, 1924	Regenoflex	Mar. 26, 1929	100B
Sept. 1924	XA	Apr. 12, 1929	106DC
Feb. 15, 1925	30	May 29, 1929	44
May 12, 1925	24	May 29, 1929	46
June 23, 1925	26	July 18, 1929	66
Aug. 1925	28	July 29, 1929	33DC
Sept. 1925	104	Sept. 28, 1929	67
Sept. 10, 1925	25	Oct. 7, 1929	47
Sept. 29, 1925	28AC	Oct. 19, 1929	21
Nov. 6, 1925	20	Nov. 6, 1929	46DC
May 25, 1927	100A	Nov. 7, 1929	22

The following four pages show some General Electric and Wireless Specialty commercial models used during the 1920s.

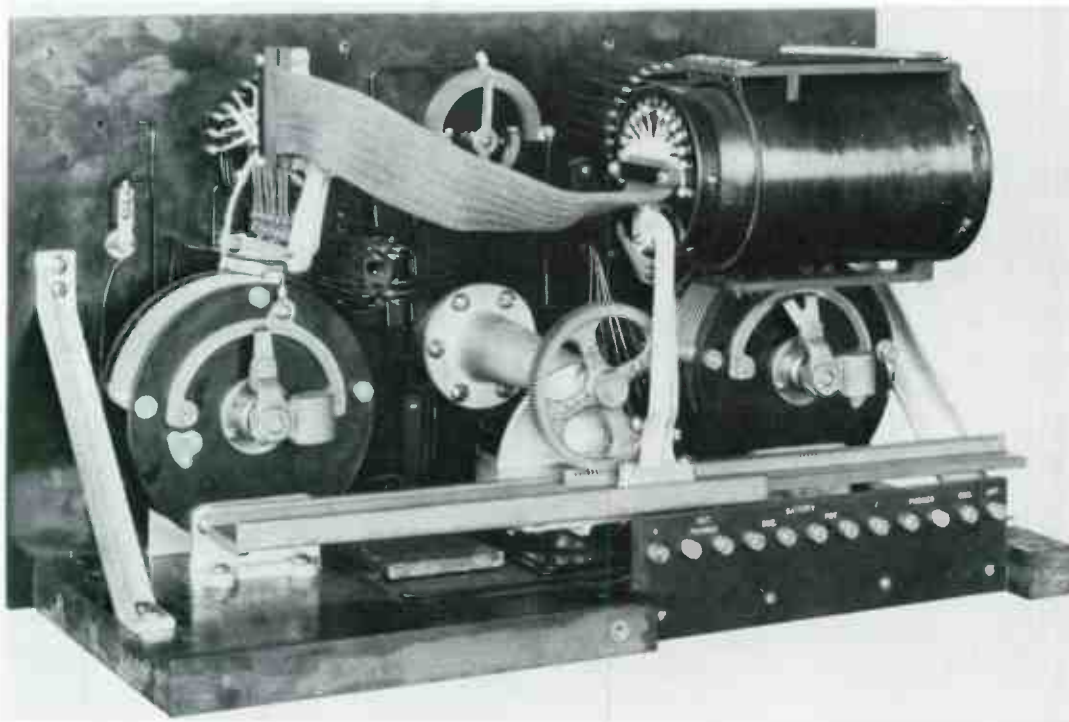

The original Marconi 106, designed by Harry Shoemaker, dated from 1915, but the sets were in wide use during the 1920s and went through many modifications. The final 106D was a regenerative model, used with an AA1400 detector-amplifier. Most of the earlier sets were converted to 106Ds. The 106C shown here was designed by Van Dyck to cover 200 to 3500 meters. These photos from the GE Publication Bureau are dated Oct. 25 and Sept. 16, 1921.

Hall of History Foundation, Schenectady

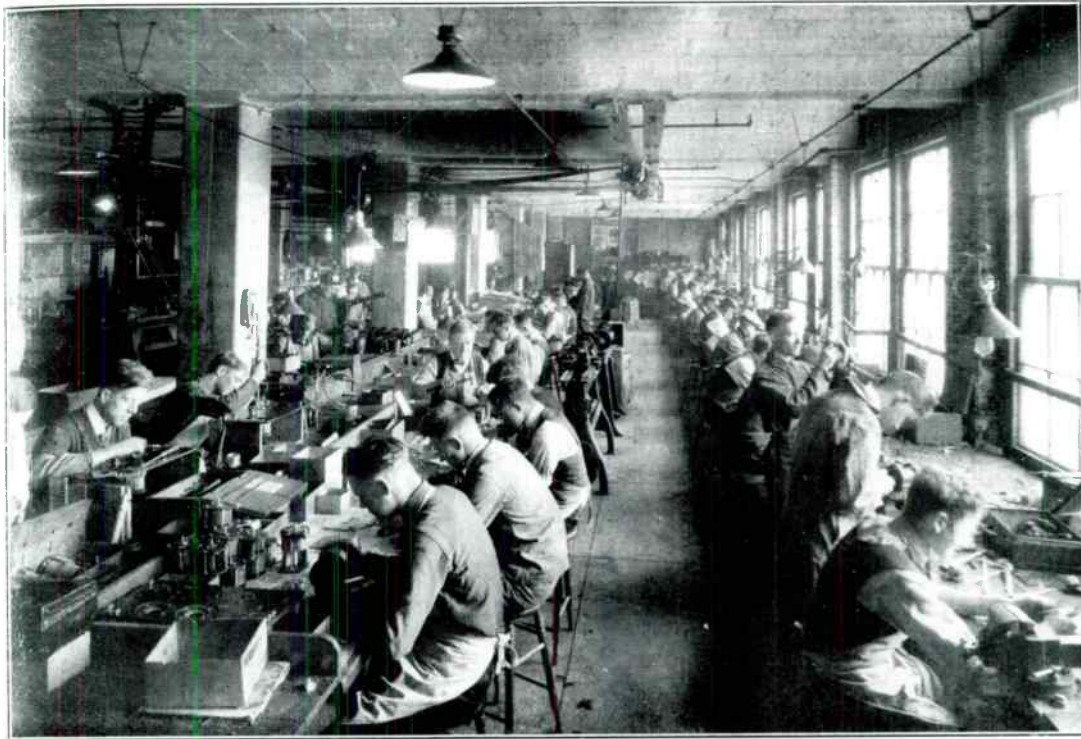

Wireless Specialty Apparatus Company, 1919 catalog, p. 69

Light-Assembly Room of Main Plant of WIRELESS SPECIALTY APPARATUS COMPANY

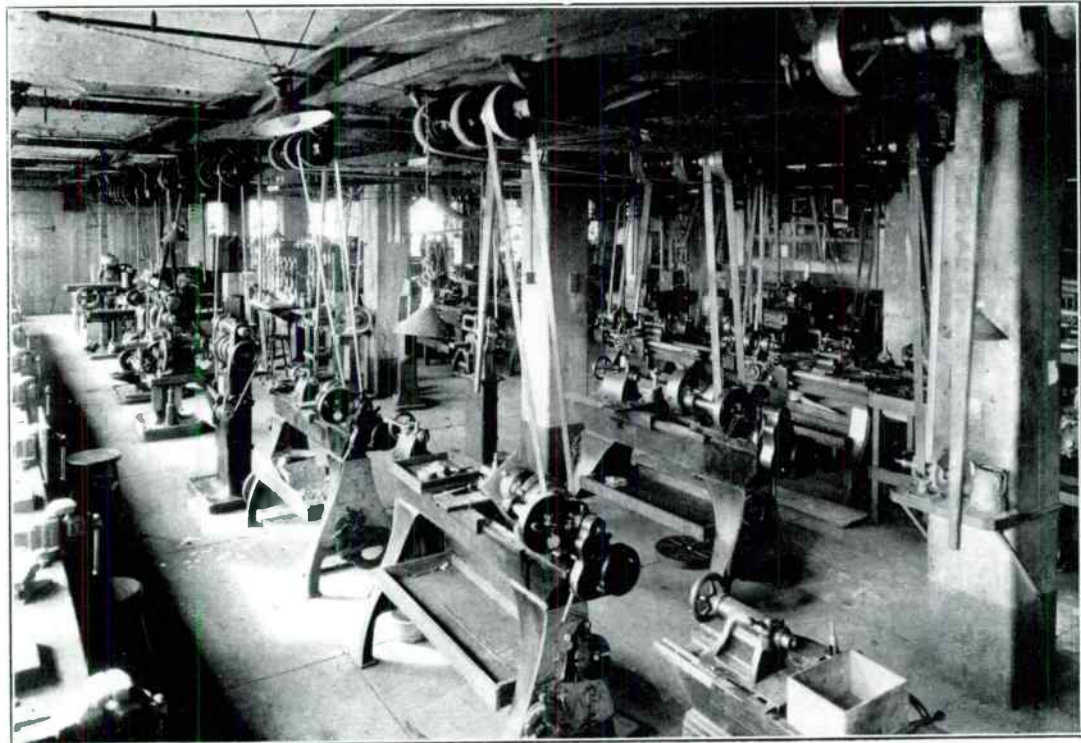

Machine Shop of Main Plant of WIRELESS SPECIALTY APPARATUS COMPANY



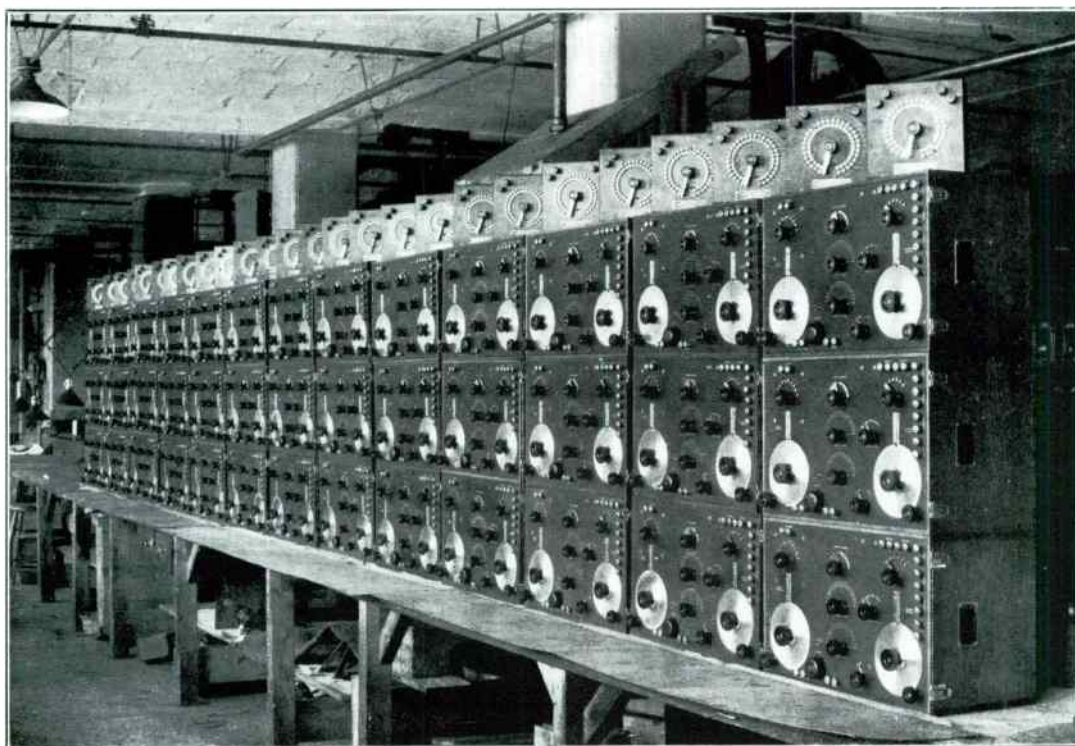

Wireless Specialty Apparatus Company, 1919 catalog, p.

Part of an order for 500 SE1220 receivers, 1918.

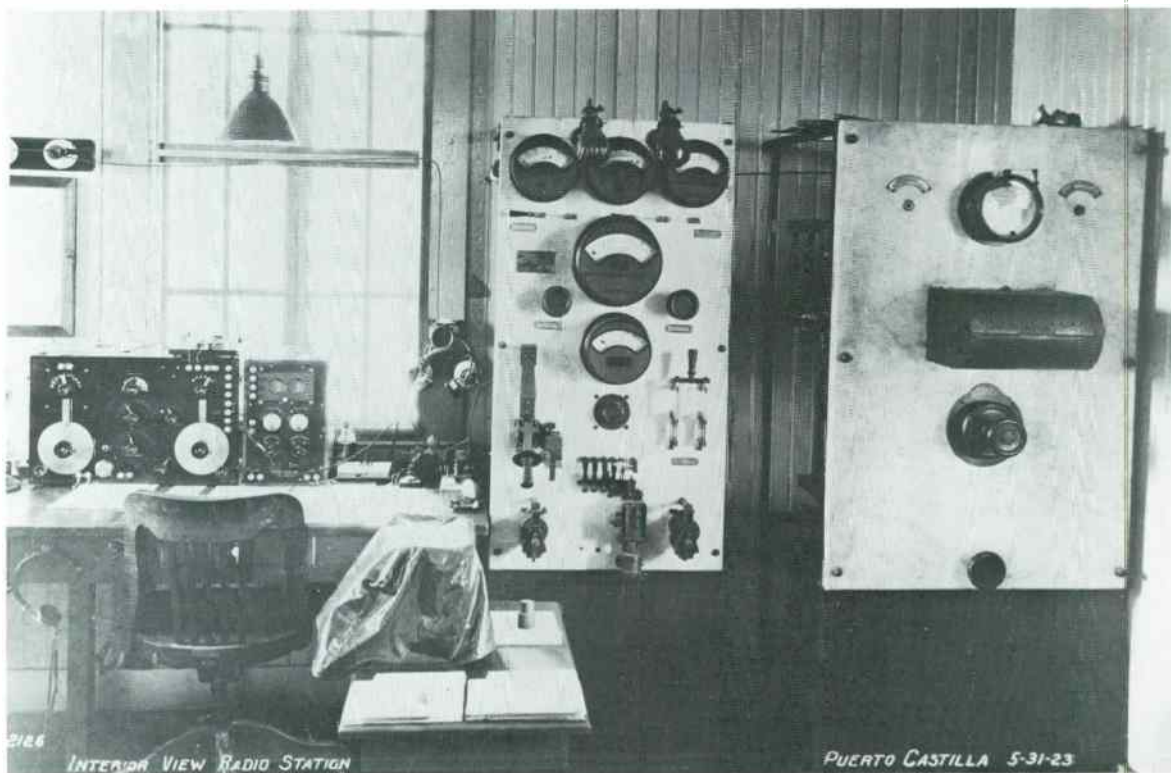

Photo by C. C. Harris.

United Fruit station at Puerto Castilla, Honduras, 1923.  
IP500 with Triode A amplifier.

The Wireless Specialty Apparatus Co. was formed in 1907 by Col. John Firth, Greenleaf W. Pickard and Pickard's patent attorney, Philip Farnsworth. Its original business was the manufacture of Pickard's silicon and Perikon detectors (Perikon was coined from PERfect plcKard cONTact). Firth was simultaneously acting as sales agent for Reginald Fessenden's National Electric Signalling Co., smoothing over Fessenden's previously stormy relations with the US Navy. WSA products were all given "IP" numbers, standing for "Interference Preventer," Fessenden's term for a tuner (but Fessenden had no connection with WSA and in fact was adamant against using any WSA equipment in his own stations, refusing even to test it). Pickard developed his loose-coupled receiver about 1908 and called it the IP76. By 1914 the IP76 had evolved into an elaborate double tuner (two separate receivers in one cabinet) and was installed in all United Fruit Co. ship and shore stations. United Fruit bought control of WSA in 1911.

After World War I WSA adopted the Navy SE143/SE1220 design and manufactured it as the IP500; the SE1420 similarly became the IP501.



IP501A Thorn Mayes

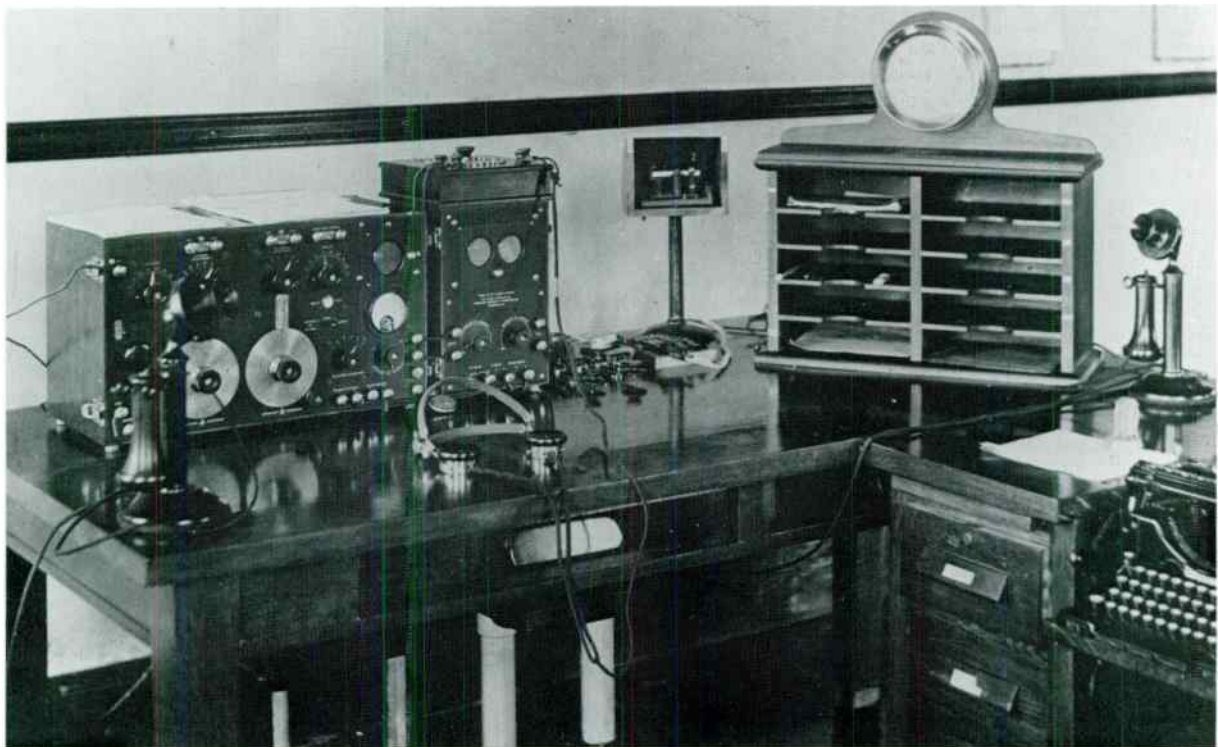

Photo by C.C. Harris.

United Fruit station at Puerto Barrios, Guatemala, 1924-25.  
IP501 with Triode B amplifier.



A. E. Bessey.

QST (May 1920)

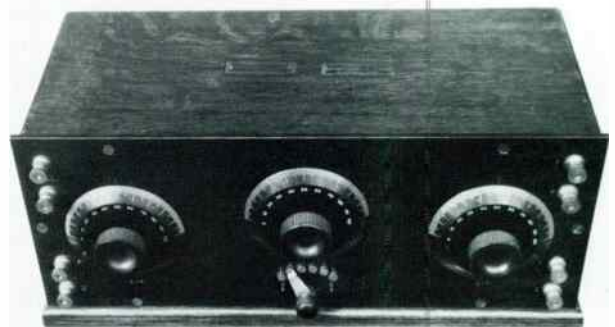
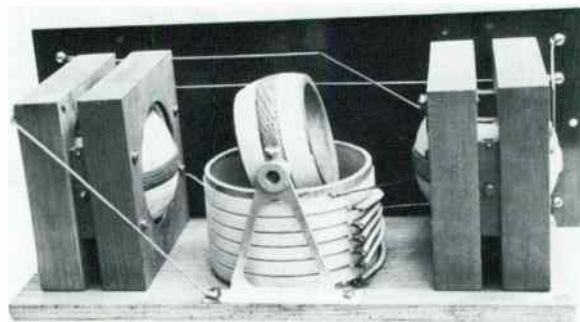

Stewart Oliver

**SPEAKING ABOUT COMBINATIONS—**

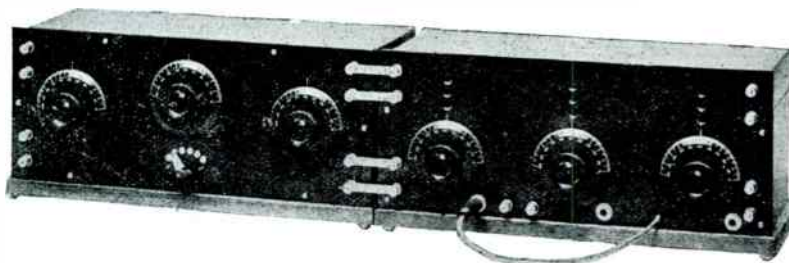

QST (Nov. 1920)

The RADIO SHOP Short Wave Regenerative Receiver combined with the latest addition to an already well established line.

**The "RADIO SHOP" Detector and Two Step Amplifier.**

A unit possessing features not found in other sets available on the market today.  
 Scientifically designed for amateur wave-lengths.  
 Magnetically screened throughout for complete elimination of "feed-back" howling.  
 Transformers of correct proportions for present day tubes.  
 Non-heating rheostats.  
 Tube sockets which take either standard V-Ts or Navy type valves.  
 Hinged cabinet top for easy access to interior for removal of valves.  
 Mica fixed condenser in detector circuit of correct capacity for regenerative circuits.  
 Separate plate battery control for detector and amplifier valves.  
 Extreme simplicity of connections. Connection strips furnished for connection to short wave receiver.  
 Furnished without valves or batteries.

Price.....\$75.00

**The "RADIO SHOP" Short Wave Regenerative Receiver.**

Now licensed under Armstrong U. S. patent No. 1,113,149. Described in detail in previous issues of "QST".

New Price.....\$45.00

Both sets sold with the distinct understanding that your money will be immediately refunded if you are not satisfied.

We will shortly have interesting literature on the above and other "RADIO SHOP" products. A stamp will put your name on our mailing list.

**THE RADIO SHOP**

Bank of Italy Bldg.,

Dept. Q,

San Jose, Calif.

# THE RADIO SHOP

## The Radio Shop / Echophone

**T**he history of The Radio Shop begins with two men: Tom Lambert and Arthur E. Bessey. Lambert had manufactured commercial wireless apparatus; was director of instruction at Marconi Institute during the war; and by January 1920 was sales manager of the Colin B. Kennedy Co. Bessey, born in 1879 in Canada, moved to the U. S. at age six; at nineteen, went into business with his father in Sunnyvale, California, making incubators; and by 1909, possessed a 5 kw spark station. Active in the ARRL as Pacific Division traffic manager, and Director from 1920 to 1922, Bessey had a ham station lavishly supplied with Kennedy equipment by 1920 (see vol. 2, p. 91) and was, no doubt, well-acquainted with Tom Lambert.

Probably it was Lambert's idea to form a new business with Bessey's financial backing (and the use of his incubator factory); Lambert was listed as manager for the next couple of years. At any rate, The Radio Shop existed by May 1920 with offices in San Jose and a plant in Sunnyvale. It made variometers at first; then, in August, it advertised a regenerative tuner using them. Bessey was the star customer—Radio Shop equipment soon replacing that of Kennedy in his station.

At the September 2-4, 1920, ARRL convention in Chicago, Bessey is said by a former employee to have acquired a license from Armstrong by buying him a few drinks. A Radio Shop ad in October stated that its sets were now licensed, although Armstrong's lawyers probably had more to do with it than Bessey's wallet.

Nothing much happened until 1922 when the radio boom reached the West Coast; but on May 5, the *Sunnyvale Standard* reported that The Radio Shop was building a new 220-foot-long plant to employ 200 people and make 150 sets per day under Tom Lambert's direction.

Late in 1922, Bessey must have associated himself more closely with the operation as he was dropped from the ARRL Board for having "gone into the radio business." And business was picking up, for in addition to its own models, The Radio Shop made sets under other names. In fact, it is nearly impossible to keep them all straight; identical models can be found

with different trade names, distributors, factory locations or model numbers engraved on the panels. Echophone was one such name, used as early as June 1922.

After the formation of the Echo Radio Corporation at St. Louis in December 1922 to handle national distribution, "The Radio Shop" name dropped from sight. The Radio Shop itself continued to exist only for legal reasons: the original Armstrong license was not transferrable.

Its last models were advertised (but probably never made) in October 1925. An Echophone company was listed in Hollywood in 1927-1928. Later, the company was bought by Western Television, Inc. (owned by Clem Wade, inventor of the Eskimo Pie), and operated in Waukegan, Illinois from 1931 to 1933. In late 1934, William J. Halligan purchased Echophone from Wade and moved it to Chicago, where it became the basis of Hallierafters.



Radio Retailing (July 1932), p. 32

### *First Ever*

Echophone will exhibit the above set at the Chicago Worlds' Fair next year, entering it as the "original midget." It was manufactured in Nov., 1928.

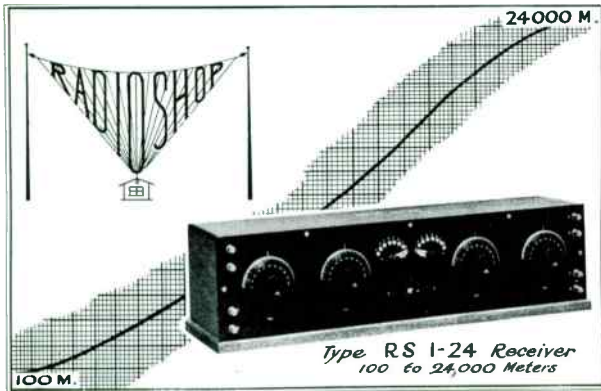

Radio News (June 1921), p. 900

### SOMETHING CONCISE:—

Concentrated essence of efficiency, the new RADIO SHOP type RS 1-24 receiver. The latest application of regenerative tuning to a range spanning every wavelength used in radio communication throughout the World.

Haven't you ever tired of the "QRM" on amateur wave-lengths and wished for a receiver that would bring in the commercial ships and long wave damped and undamped stations, without the trouble of changing wires and plugging in and out of numerous coils?

This is it! 100 to 24,000 meters, without a "dead spot," all in one cabinet! Variometer tuning applied to the entire scale with the resultant ease of control of regeneration and oscillation. Circuits so synchronized that troublesome "combinations" of tuning are entirely eliminated, making definite adjustments and reliable reception an assured thing, and the RS 1-24 the ideal receiver for all wave-lengths, with absolutely no sacrifice of efficiency on any particular wave-length. A "stand-by" arrangement is also incorporated that will broaden tuning, when so desired, for general "listening in" work. The very popular RADIO SHOP short wave receiver construction applied to wave-lengths below 1,000 meters assures maximum selectivity and efficiency for amateur and short wave commercial spark and C.W. reception. Wave-lengths from 1,000 to 24,000 meters are taken care of by an entirely new application of the variometer principle which has already been employed in the RADIO SHOP long wave receiver, described in previous advertisements. The result—SATISFACTION.

A few mechanical features that will appeal to the most exacting—Banked windings. Dials that run true. Heavy bus-bar wiring. Non-shorting variable condensers. Grained, engraved, Formica panel. Interior as well as exterior workmanship of the highest possible order. NO SEALS. We are as proud of our interior as of the outward appearance and want the purchaser to know just as much about the apparatus as we do.

The "RS 1-24" carries the same "money back if not satisfied" guarantee that applies to all RADIO SHOP products. So far we have never had to live up to this guarantee, an enviable record to say the least.

#### "THE SET THAT YOU WILL EVENTUALLY BUY"

Licensed under Armstrong's Regenerative Patent and applying this unapproachable circuit to its maximum effectiveness.

THE RADIO SHOP type RS 1-24 Receiver is the most efficient and effective radio tuning device ever built.

Price, ..... F. O. B. San Jose.....\$100.00

In ordering please specify whether Oak or Mahogany cabinet is desired.

DEALERS: We have an interesting proposition to offer you. Write us.

**THE RADIO SHOP** San Jose, California

Variometers, \$5.75 Variocouplers, \$4.75 A few still are left

## The 1922 Model Type "RS 1-24" Receiver



The New Type "RS 1-24" Receiver is the LAST word in Radio tuning devices. Although our first model was a complete success and proved absolutely satisfactory to all our purchasers, still, continued experimentation has made it possible to combine features in the new model FAR EXCEEDING anything yet developed.

While ALL features of the original model are incorporated in the improved model of the "RS 1-24," still some NEW and very ESSENTIAL qualities are added to take care of the increasing demand for a REAL C.W. AND TELEPHONE RECEIVER. For this work, a special combination of tuning is provided which makes the "RS 1-24" an absolutely "fool proof" Receiver for such work. This is accomplished through a newly developed method of regenerator which permits the vacuum tube to be kept in a CONSTANT state of oscillation, or semi-oscillation, over a wide range of wave-lengths.

The New "RS 1-24" incorporates both Inductive and Conductive tuning with two regenerators; one for use up to 3,000 meters and a second for wave-lengths up to 24,000 meters. The Inductive or "Three Coil Circuit" covers a range of from 100 to 3,000 meters and gives exceptionally sharp tuning, permitting of the elimination of practically all interference.

The Conductive Circuit is divided into two groups: 100 to 3,000 meters and 3,000 to 24,000 meters. Both circuits give PERFECT regeneration ON ALL wave-lengths covered.

The circuits are so arranged that "dead-end" effects are overcome, resulting in a remarkably efficient receiver.

A FEW PERTINENT FACTS ABOUT THE "RS 1-24" RECEIVER

There is absolutely no sacrifice of efficiency on any of the wave-lengths covered.

The RADIO SHOP Short Wave Receiver is the most efficient and most compact short wave receiver ever built. The "RS 1-24" is equally efficient on amateur wave-lengths, if not more so.

Tuning is accomplished quickly and in a simpler manner than in any other receiver ever built. There are no faulty "combinations" to be feared.

Wave-lengths are indicated on the dials. They show dots and the variometer is set on the indicated wave-length.

Wave-lengths are indicated on the dials. They show dots and the variometer is set on the indicated wave-length.

Wave-lengths are indicated on the dials. They show dots and the variometer is set on the indicated wave-length.

Wave-lengths are indicated on the dials. They show dots and the variometer is set on the indicated wave-length.

Wave-lengths are indicated on the dials. They show dots and the variometer is set on the indicated wave-length.

Wave-lengths are indicated on the dials. They show dots and the variometer is set on the indicated wave-length.

Wave-lengths are indicated on the dials. They show dots and the variometer is set on the indicated wave-length.

Wave-lengths are indicated on the dials. They show dots and the variometer is set on the indicated wave-length.

Wave-lengths are indicated on the dials. They show dots and the variometer is set on the indicated wave-length.

Wave-lengths are indicated on the dials. They show dots and the variometer is set on the indicated wave-length.

Wave-lengths are indicated on the dials. They show dots and the variometer is set on the indicated wave-length.

Wave-lengths are indicated on the dials. They show dots and the variometer is set on the indicated wave-length.

Wave-lengths are indicated on the dials. They show dots and the variometer is set on the indicated wave-length.

Wave-lengths are indicated on the dials. They show dots and the variometer is set on the indicated wave-length.

Wave-lengths are indicated on the dials. They show dots and the variometer is set on the indicated wave-length.

Wave-lengths are indicated on the dials. They show dots and the variometer is set on the indicated wave-length.

Wave-lengths are indicated on the dials. They show dots and the variometer is set on the indicated wave-length.

Wave-lengths are indicated on the dials. They show dots and the variometer is set on the indicated wave-length.

Wave-lengths are indicated on the dials. They show dots and the variometer is set on the indicated wave-length.

Wave-lengths are indicated on the dials. They show dots and the variometer is set on the indicated wave-length.

Wave-lengths are indicated on the dials. They show dots and the variometer is set on the indicated wave-length.

Wave-lengths are indicated on the dials. They show dots and the variometer is set on the indicated wave-length.

Wave-lengths are indicated on the dials. They show dots and the variometer is set on the indicated wave-length.

Wave-lengths are indicated on the dials. They show dots and the variometer is set on the indicated wave-length.

Wave-lengths are indicated on the dials. They show dots and the variometer is set on the indicated wave-length.

Wave-lengths are indicated on the dials. They show dots and the variometer is set on the indicated wave-length.

Wave-lengths are indicated on the dials. They show dots and the variometer is set on the indicated wave-length.

Wave-lengths are indicated on the dials. They show dots and the variometer is set on the indicated wave-length.

Wave-lengths are indicated on the dials. They show dots and the variometer is set on the indicated wave-length.

Wave-lengths are indicated on the dials. They show dots and the variometer is set on the indicated wave-length.

Wave-lengths are indicated on the dials. They show dots and the variometer is set on the indicated wave-length.

Wave-lengths are indicated on the dials. They show dots and the variometer is set on the indicated wave-length.

Wave-lengths are indicated on the dials. They show dots and the variometer is set on the indicated wave-length.

Wave-lengths are indicated on the dials. They show dots and the variometer is set on the indicated wave-length.

Wave-lengths are indicated on the dials. They show dots and the variometer is set on the indicated wave-length.

Wave-lengths are indicated on the dials. They show dots and the variometer is set on the indicated wave-length.

Wave-lengths are indicated on the dials. They show dots and the variometer is set on the indicated wave-length.

Wave-lengths are indicated on the dials. They show dots and the variometer is set on the indicated wave-length.

Wave-lengths are indicated on the dials. They show dots and the variometer is set on the indicated wave-length.

Wave-lengths are indicated on the dials. They show dots and the variometer is set on the indicated wave-length.

Wave-lengths are indicated on the dials. They show dots and the variometer is set on the indicated wave-length.

Wave-lengths are indicated on the dials. They show dots and the variometer is set on the indicated wave-length.

Wave-lengths are indicated on the dials. They show dots and the variometer is set on the indicated wave-length.

Wave-lengths are indicated on the dials. They show dots and the variometer is set on the indicated wave-length.

Wave-lengths are indicated on the dials. They show dots and the variometer is set on the indicated wave-length.

Wave-lengths are indicated on the dials. They show dots and the variometer is set on the indicated wave-length.

Wave-lengths are indicated on the dials. They show dots and the variometer is set on the indicated wave-length.

Wave-lengths are indicated on the dials. They show dots and the variometer is set on the indicated wave-length.

Wave-lengths are indicated on the dials. They show dots and the variometer is set on the indicated wave-length.

Wave-lengths are indicated on the dials. They show dots and the variometer is set on the indicated wave-length.

Wave-lengths are indicated on the dials. They show dots and the variometer is set on the indicated wave-length.

Wave-lengths are indicated on the dials. They show dots and the variometer is set on the indicated wave-length.

Wave-lengths are indicated on the dials. They show dots and the variometer is set on the indicated wave-length.

Wave-lengths are indicated on the dials. They show dots and the variometer is set on the indicated wave-length.

Wave-lengths are indicated on the dials. They show dots and the variometer is set on the indicated wave-length.

All Radio Shop photos not otherwise credited are by and from the collection of Stewart Oliver.

**—approved!!**

Our type H-B-1 Receiver has met with instant approval. Single tuned regenerative, enclosed in handsome mahogany cabinet. Price

**\$70.00**

Dealers' Propositions



Licensed Under "Armstrong" Patents  
Operating KVQ  
Broadcasting Station

**Hobrecht's**

1014 6th SACRAMENTO, CALIF. Phone Main 654

Tell them that you saw it in RADIO

July 1922



Jack Gray

Atlantic-Pacific Radio Supplies Co., San Francisco, advertised a type "A-P One" (not illustrated) in May, 1922, made by The Radio Shop. But A-P's July model and subsequent models were made by Oard.

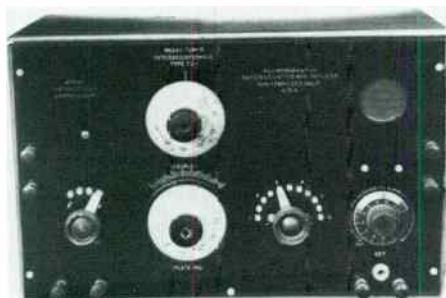

Special

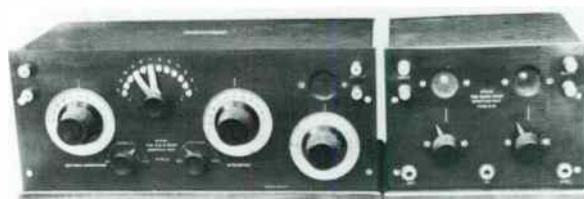
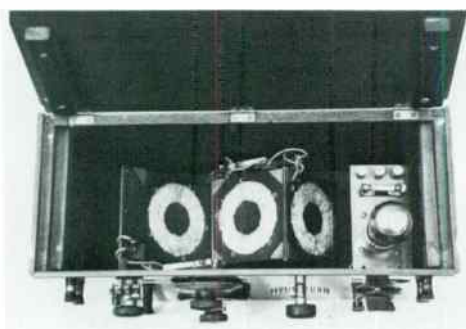

S with 2-S



Echophone TA-16

Rasac Puretone July 1922 \$85 and \$60  
Designed by Ralph M. Heintz. Distributed by Radio & Scientific Apparatus Co., San Francisco.

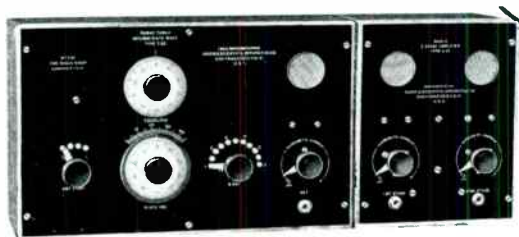

Radio (July 1922), p. 43



Radio Receiver

*Electrical Merchandising*, January, 1923

The Echo Radio Corporation, 314 International Life Building, St. Louis, Mo., is distributing several models of radio

receiving sets, all employing the Armstrong regenerative circuit. The "Echophone" type TA-16 illustrated, is a 2-stage amplifier set, with a range of from 15\* meters to 2,500 meters. Hisses, scratches and interference are said to be overcome.



Echophone Standard (Model A) September 1923 \$75  
 Echophone Special (with battery space) \$85  
 Sold in May 1923, under the name "Regenatone Model A" for \$75. An undated "Wright Radio" flyer lists the Special A (\$90) and Special B (4 tubes, \$115), and the 3- and 4-tube Grand at \$165 and \$190.

Grand



Richard Hostler

J (Junior) October 1923 \$35



3 or V3 September 1924 \$50  
Available by March 1925 as a \$75 portable or \$87.50 model with speaker. Also sold under other names such as Meteor (see next page).



**Echophone "4"**  
The last word in radio receivers. An extremely selective and powerful 4-tube regenerative. Operates on dry cells or storage batteries. Without tubes and batteries **\$125**

The model 4 was immediately discontinued.

*Radio Broadcast (Oct. 1924)*



*David Stout*

4 February 1925 \$75  
Portable, \$98



Cabinet interior lined with deep blue velour, like an old musical-instrument case. The ridges above the horn are for storing '99 tubes.



5 or F September 1924 \$110  
Model with speaker was \$165 by March 1925.



# The Marvelous 3 Tube METEOR Radio Receiver

Catalog (1924)

Only **\$15<sup>00</sup>**  
Down

Balance Easy  
Monthly  
Payments

**\$10<sup>00</sup>**  
A Month.

Licensed Under  
Armstrong Re-  
generating Pat.  
No. 1113149  
for Amate-  
ur and Experi-  
mental Use  
Only.



Receiving Set  
Complete **\$75<sup>00</sup>**  
With All Accessories  
Including Loud Speaker  
Six Months to Pay

True Reproduction and Ease of Operation.  
Low in Price. Easy Payment Plan.

**T**HIS WONDERFUL Meteor Receiving Set is a product of great engineering skill. It has a quality of tone that delights even the most critical. It will faithfully reproduce the voices of artists or the harmonies of musical instruments. It is highly selective and is capable of bringing in great distances. Ample volume is a noteworthy feature; the whole family being able to enjoy at the same time the many varied programs possible with this marvelous Meteor receiver. Dependability and trustworthy performances are assured.

Of course, such unusual results could never be obtained unless the closest attention had been given to every detail of design and manufacture.

The Meteor Receiving Set is compact, sturdy in construction and possesses an attractiveness that makes it a very desirable piece of home furniture. It is truly a set to which you can point with great pride of possession.

The circuit is especially designed for dry battery operation. It is flexible cable wired throughout, thus loose connections from jars or jolts is impossible. Panel is formica, highly polished and handsomely engraved. Cabinet is Adam brown, mahogany finish, size, 11x9x12½ inches. Battery connections are very simple. Metal tags designate proper connections to be made to ground and batteries. A perfectly balanced tuning unit, a heat resisting mica condenser of exact capacity, even specially designed transformers with scientifically measured reluctance gaps are employed. Only bakelite sockets are used. Don't be without a good radio receiving set another day. Send us \$15.00 and enjoy the endless thrills and unfold benefits the Meteor will bring you. For only \$75.00, in easy payments, this exceptional radio set is yours with nothing else to buy. Use the time payment side of the order blank enclosed.

**57A2706¼**—Meteor Radio Receiver complete with three 22½-volt batteries, three dry cells, one "C" battery, three UV199 or C299 dry cell tubes, loud speaker standing 22½ inches high, complete aerial and ground equipment, wire, insulators, lightning arrester, etc. **\$75.00**  
Nothing else to buy. \$15.00 down, \$10.00 a month. Shpg. wt., 50 lbs. Complete...  
**57A2706½**—Receiver Set only, with cabinet but without accessories, such as tubes, loud speaker, batteries, etc. \$15.00 down, \$10.00 per month. Shpg. wt., 20 lbs. **45.00**



# THE NEW LOW WAVE 1926 ECHOPHONE RECEIVERS NOW READY

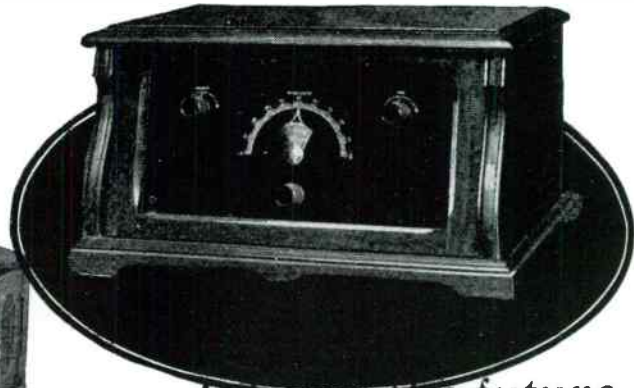

*Buy for the future*

The outstanding feature of the 1926 Echophone line is its provision for a low wave tuning range from 550 to 150 meters. The use of low waves is inevitable. Echophones give you an enormous sales advantage in that they reach stations that can't be tuned in on other sets.

### *Tone Quality, Selectivity and Beauty*

The design of our cabinets has reached a high degree of perfection. The most critical customer will be convinced upon seeing them. We seek comparison with all other sets on the market in the above three features. Tone quality and selectivity are attained with—SINGLE and DUO-DIAL CONTROL—which permits of simplicity of operation formerly not thought possible.

### *Echophone policies guarantee PROFIT—PROTECTION— PERMANENCE*

1. Profit for both distributor and dealer through liberal discounts offered.
2. Protection against price reduction and by exclusive dealer sales franchise.
3. Permanence by the good will established through extensive advertising in national publications and local newspapers.

We stand behind the dealer at all times with our SERVICE and COOPERATION.

*Write for detailed information and give us the name of your distributor; or better, order now.*

### **Echophone Radio, Inc.**

*1120 N. Ashland Ave., Chicago, Ill.*

Echophone Sales Co.  
San Francisco

Echophone Radio Shop  
Long Beach, Calif.



R-5 Console with built-in Loud Speaker

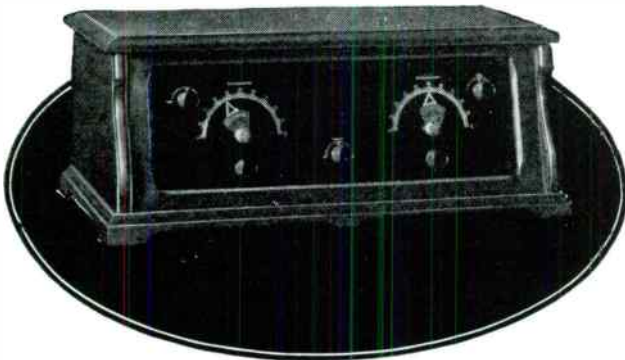

MAY 20, 1925

N.Z. WIRELESS AND BROADCASTING NEWS

9

## Au Revoir, Mr. Scott

World's Champion B.C.L.—By "ILEX."

"Au revoir, Mr. E. H. Scott." and let it be only "au revoir."

A few short months ago the writer while seated in his office at Wellington was mystified by the receipt of a wireless message sent from the R.M.S. Maunganui, due at Wellington from San Francisco within a couple of days. The missive read: "Can you meet me on arrival Maunganui, Scott." I was puzzled over the name. Scotts I knew by the score, but just which particular Scott this could be was beyond my reckoning. However, a reply in the affirmative was whisked by radio back to the mysterious Mr. Scott. It was with feelings of strong curiosity that I sought out my man when the Maunganui berthed at Wellington. He was soon located. In Mr. Scott I saw a surly round faced man with a clean-shaven happy face and merry blue eyes.

"You see, my friend, Mr. Taylor, wireless operator of this ship, gave me your name and address, and I took the liberty of sending you a radio message," was how he explained our introduction.

"I've just come down from Chicago with the wife to spend a few months holiday with her people at Tasman, Nelson District, and I've brought my portable superheterodyne to try it out in New Zealand.

"I've arranged a series of tests with some of the leading American broadcast stations, and I want to see what the conditions are like down here. They tell me the static is pretty bad, but we'll do our best."

It is now a matter of history how Mr. Scott did his best. Not only did he log the special test concerts from America but established world's records that will hold good for many a day. His receipts were proven by documentary evidence in the form of statements by independent wit-

nesses and letters and cable messages from the various broadcasting stations concerned. His greatest achievement, and one that staggers the imagination was Mr. Scott's reception of WCB'D at Zion City, Ill., 8375 miles by air-line, with good loudspeaker strength, using only an indoor loop aerial.

Something like 180 different American programmes were received by Mr. Scott from about twenty-five different Yankee stations during his few weeks' vacation in the Nelson District. In short, Mr. Scott's world's records comprise—the greatest number of American broadcasting stations heard over a distance of 6,000 miles and more; the most consistent reception of long-distance broadcasting stations; the longest distance a broadcasting station has yet been received with good loudspeaker volume by means of an indoor loop-aerial.

Mr. Scott kept a carefully compiled detailed log of each night's performance. The writer would describe it as a veritable verbatim report.

This smiling, quiet visitor came, saw and conquered, and now he has gone again. Mr. and Mrs. Scott left Auckland by the R.M. Motorship Aorangi. Before leaving Wellington, Mr. Scott said to the writer—"I'm going back to my business in Chicago, but my heart's in New Zealand, the land of my birth. I feel glad that New Zealand has now a set of broadcast listening records that will create astonishment throughout the whole radio world. It's hard to leave here, but my interests in Chicago require my attention and I must get back. Before leaving the Western States I will visit the broadcasting stations I have heard in New Zealand to check up and doubly confirm each item in my log. It has been a great holiday though I've been

busy down there in Tasman. Yet broadcast listening is a delight to me. Keeping in touch with my business in Chicago has meant some encroachment on my holiday, but nevertheless it has been a glorious change."

Mr. Scott conducts a service for supplying innumerable American newspapers with daily printed and illustrated "Radio Column," "timely tips and suggestions on the latest diagrams and hook-ups simplified" (to use the exact wording of the heading of each "release"). He also conducts a similar service for automobiling. He maintains an up-to-date laboratory and staff of radio and automobile technical experts.

The eight-valve portable superheterodyne receiving set with which Mr. Scott established his world's records while in New Zealand was designed and built by himself. The valves are UV199 mounted in shock absorbing sockets so that they conform to the ideal of a portable receiving set, requiring also only dry cells for filament and plate potential. A loudspeaker is built into the set and a folding loop aerial completes the equipment.

Every component part of the set, which when closed up would be mistaken for a suit-case, was subjected to most critical tests by Mr. Scott in his laboratories. Ultimately the parts selected were the pick of all the best on the American market. The set accordingly represents the choicest and most efficient components that money can buy. The layout, that important factor which is too often treated in a haphazard manner, next came under infinitely careful consideration. Experiment after experiment was made until finality was reached, and Mr. Scott and his technicians agreed on a common scheme which was put into effect. That the results were worthy of the

care expended leave no doubt. On his return to Chicago, Mr. Scott proposes to commercialise the set (under the name of "The Tasman") which apart from its circuit embodies many valuable factors which only untiring experimentation could obtain. I wish him all success in his future activities, and may his next visit be not long deferred. "Au Revoir."

# SCOTT

## Scott Transformer Company

**E**rnest H. Scott was born in Dunedin, New Zealand, on June 1, 1887, and spent his early years in Australia. When he was only five, he lost his father in a railroad accident and, at the age of fourteen, was orphaned when his mother died suddenly. Scott supported himself as a messenger boy and, later, as a salesman.

With the advent of World War I, Scott enlisted in the Australian-New Zealand Army Corps and served in France. During this time, he invented a device he called the "Telecator" for locating troubles in automobile engines (U.S. patent 1,193,621). The United States government purchased the rights for this invention for a sum that eventually totalled \$46,000. Telecators were used in Army machine shops and installed on tanks and tractors.

Scott made many American friends while stationed in France. When he was discharged in London at the end of the war, he decided to come to the United States, where he made Chicago his home.

During his first two years in America, he wrote a column entitled "The Care of an Automobile" that was syndicated in fifty newspapers in the United States and Canada. During this period, Scott became intensely interested in radio. In addition to his automotive columns, he was soon supplying weekly articles on the construction of radio sets. In 1922, he originated the pictorial wiring diagram which "helped thousands of nontechnical radio enthusiasts to build their first radio sets."

During the years that he wrote radio articles, Scott maintained a well-equipped laboratory where he tested hundreds of different circuits. This was necessary because he was supplying radio articles to 112 different newspapers.

After four years in America, Scott decided to visit his native New Zealand again. He was determined to take with him a radio capable of receiving U.S. broadcast stations in New Zealand. He chose a version of the Best superheterodyne using Remler components but with two tuned IF stages rather than just one.

Before leaving Chicago, he arranged for stations WGN and WQJ (now WMAQ) to send him special programs from 1:00 to 4:00 a.m. The distance from



*On The Air (Apr. 1926)*

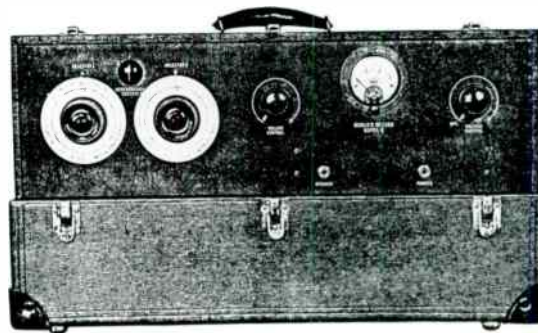
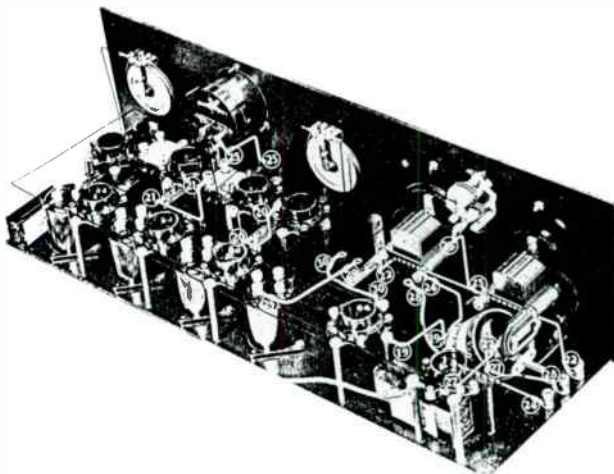

(1925) World's Record Super 9 November 1925  
\$103.26 (December), \$89 (January) kits

*J. W. F. Puett, Silver Ghosts (Dallas TX: Puett Electronics, July 1976), p. 8*

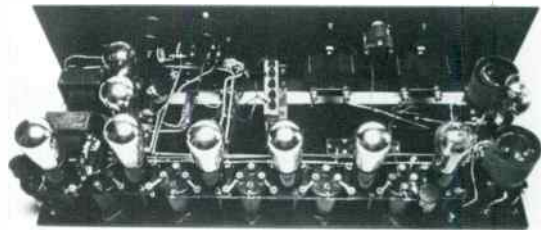
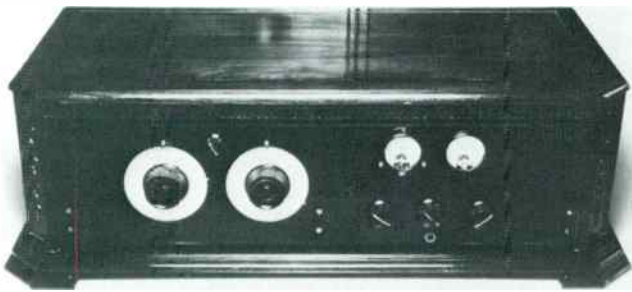

George Harris

(1926) World's Record Super 9 April 1926  
\$98.80 kit

**Improved World's Record Super 9**

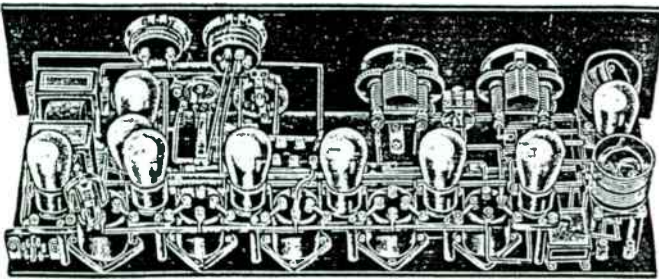

**Holds All Principal World's Records for DX Reception**

Here is the receiver for the man who wants the most powerful and sensitive set it is possible to build. Many claim to have received certain foreign stations once or twice, but the World's Record Super 9 proved its claim to record honors by bringing in stations distant 6,000 or more miles right after night. Below are the principal records made by this remarkable receiver:

1. World's Record for the greatest distance voice has been heard with a receiver using LQSP aerial only. WCHS was brought in from Tasmania, New Zealand—a air line distance of 9,375—on March 17th.
2. World's Record for the greatest number of stations heard which are distance 6,000 or more miles. A total of 19 stations were brought in.
3. World's Record for the greatest number of broadcasting stations distant 6,000 or more miles that have ever been logged on any one evening. Six foreign stations were logged in two hours and a quarter on March 28th.

During a period of three months a total of 117 programs were heard and logged all stations 6,000 miles or more distant. This proves CONSIDERABLE DX reception.

All of the above records are fully verified and a leaflet telling the story of the remarkable achievements and showing the proofs of the reception will be mailed on request.

Atlantic City on 2207 meters is brought in with local loud speaker volume. WJZ at New York is brought right in through WJZ. KTHZ at Hot Springs is brought in through WJZ.

**Natural Tone Quality**

The transformers used in the World's Record Super 9 are a laboratory product and are matched to a fraction of one per cent. It is this close matching of the transformers that is one of the secrets of the beautiful tone quality of the WR99 as well as the high amplification secured in the intermediate stages.

**Very Economical With A and B Current**

This receiver is so efficient that most of the time the filaments burn at between 2 1/2 and 3 volts and the storage current draws from the B batteries is only 10 milliamperes. For DX reception this goes up to about 15 milliamperes. The average nine tube receiver draws from 25 to 40 milliamperes, or nearly twice as much.

**Easy to Write**

The photo shows the simple layout of the WR99. The panel as supplied drilled and engraved and the baseboard of bakelite is also drilled to specifications. Detailed instructions showing the circuit, etc., have been published by the leading radio magazines. Use only the parts specified and you will have a receiver that, when completed, will not only bring in those DX stations with loud speaker volume, but will have unrivaled tone quality.

**Remarkable Selectivity**

Here is the receiver for today's conditions. In Chicago, where there are nearly 40 broadcasting stations within a radius of 38 miles, the WR99 cuts through like a knife. When WGN at Chicago is going on 323 meters, WPG at

**List of Parts Required**

3 Selectors R400 I. F. transformers.....	\$10.00
2 Helicon R400 tuned transformers.....	\$2.00
2 Hammarlund Lyric transformers.....	\$6.00
1 Variable jack filament control.....	.90
1 Interchangeable oscillator coupler.....	4.50
2 Interchangeable base.....	3.00
2 7 1/2 volt C batteries.....	1.70
1 Variable rheostat, 10 ohms.....	1.35
1 Variable rheostat, 6 ohms.....	1.35
2 Variable condensers, Hammarlund.....	\$6.00
1 Hammarlund Midret condenser.....	1.90
9 Benjamin cushion sockets.....	2.75
1 Voltmeter, Jewel, 0-7 1/2-150.....	6.50
1 Milliammeter, Jewel 0-50 milli.....	7.00
3 I.M.F. Dubilier condensers.....	2.70
1 .0025 M.F. Dubilier condenser.....	.45
1 .001 M.F. Dubilier condenser.....	.75
1 .0005 M.F. Dubilier condenser.....	.75
3 3 mec. grid leak.....	.50
1 Controlling resistance, Amersite 1A.....	1.10
1 Controlling resistance, Amersite 112.....	1.10
5 Key binding posts.....	.75
1 Red (32) fibre posts.....	2.00
1 Bakelite baseboard, 8 1/2 x 11 1/2 inches, drilled to specifications.....	4.50
1 Bakelite panel, 7x7 1/2 inches, drilled and engraved.....	6.50
1 Volume control.....	2.00
1 Tuning plug connector and nut.....	3.50
3 Mounting brackets.....	.08
2 Screws, spaggetti and bumper.....	2.00
<b>Total list value.....</b>	<b>\$123.50</b>

103H4202—These items can be selected from this catalog for a net price of **\$98.80**  
Shipping Weight 15 Pounds

**Selector R400 Intermediate Transformers**



3H4210—List, \$4.90  
Your Net Cost..... **\$4.90**  
Postage 5c Extra  
A closed iron core transformer with a peak frequency of 45 KC. The specially shaped core and high grade silicon steel laminations give a high amplification factor, while the closed core restricts the field and prevents interstage coupling. Either 199 or 201A tubes can be used. Housed in a highly polished bakelite case with all terminals plainly marked.

**Selector R400 Tuned Stage Transformers**



3H4211—List, \$4.90  
Your Net Cost..... **\$4.90**  
Postage 5c Extra  
A sharply tuned air core transformer. All of these filter transformer equipment to within a fraction of 1%. No outside condenser is required as this is sealed into case with the transformer after mounting. No perfectly are these transformers matched that two can be used in one set. This gives remarkable selectivity.

**Interchangeable Coupler**



List, \$4.50  
Your Net Cost..... **\$3.95**  
Postage 5c Extra  
3H4212—Covers from 25 to 150 meters.  
3H4213—Covers from 320 to 550 meters.  
Designed for use as an oscillating or antenna coupler. Ranges in two sizes—up to 150 meters and 220 to 550 meters. Couplers to cover wavelengths up to 6,000 meters supplied to special order. The split stator has balanced windings which give a uniform output over the wavelength range.

**Base for Interchangeable Coupler**



3H4214—List, \$1.50  
Net Price..... **\$1.29**  
Base is bakelite and jacks are brass, heavily nickel-plated. Supplied with nuts. Postage 8c Extra.

Barawik Co. catalog, Chicago (1926)

Note that Scott was continually updating his models, and there are many variations of each. For instance, the model described in *On The Air* (below), like his first model, used type '99 tubes. However, by the time the article appeared, Scott was recommending OIA's in the audio stages as shown in the accompanying schematic. Later, Scott shifted to OIA's throughout.

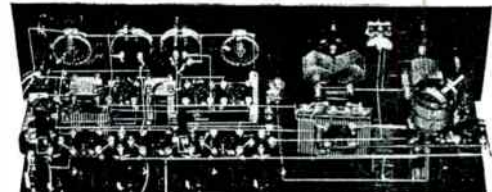
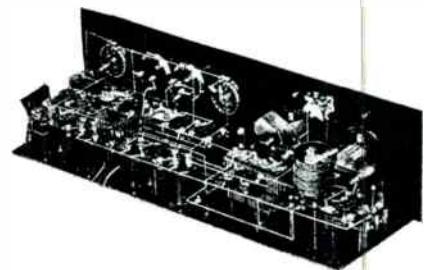

On The Air (Apr. 1926)

THE CHICAGO EVENING POST RADIO MAGAZINE, THURSDAY, OCTOBER 14, 1926.

# Ten-Tube Super Set That Picked Up Chicago Stations from New Zealand and Got London in International Tests Is Described for Post Readers; Easy to Build

Receiver Is Selective; Matched Transformers Are Used.

ANY readers of The Post will no doubt remember the reports last year of the reception of station WBBH by E. H. Scott while on a vacation at Tasman, New Zealand. During the thirteen weeks he was there, WBBH was logged on seven different nights, and the reception verified by the log here. When you consider that WBBH is over eight thousand miles distant from the spot where Mr. Scott was located, it shows that the receiver used to pick them up must be a good one.

In addition to hearing WBBH, Mr. Scott received WJZD once, WJL on four different nights, WGN twice and WICD on two different nights. In addition to these local stations, fourteen other United States stations were heard, all 6,000 miles or more distant, and most of these were heard on several different nights. When the log had been checked up, it was found that no less than four hundred records had been established for the reception of stations 6,000 miles or more distant and also these records were made eighteen months ago, they are still unbroken.

### Hears 21.0 London.

Perhaps you are wondering what this receiver has done in the reception of foreign stations from Chicago? During the first international test, 21.0 was brought in and put on the speaker with enough volume to be heard over the phone by a radio editor. During the last international test 21.0 was brought in twice on a duplicate receiver built by a Chicago physician, and the reception verified.

The World's Record Super is not only a long distance receiver but is also extremely selective and cuts thru the local barrage without difficulty. On the north side of Chicago where congestion is at its worst, KDKA at Pittsburgh or WPG at Atlantic City on 890 can be heard on the speaker right thru WGN on 363 meters, WJZ at New York on 414 can be brought on thru either WJL or WMAQ on 448 meters. It is not a difficult feat to log ten or twelve outside stations any time between 9 p. m. and 10 p. m.

The receiver used was the result of tests over a period of about two years and owes its efficiency to the fact that it was built in such a way that the shortest possible grid and plate leads are secured, yet the various transformers, oscillator, etc., are located in such positions that they are well separated from each other and have no intersecting fields.

### Uses Matched Transformers.

An inspection of the circuit diagram shows that two air core and three iron core transformers are used in the intermediate frequency stages. The particular transformers used are a laboratory product and are perfectly matched and have a high amplification factor.

It has been the experience of The Post laboratory that no super will "tune" or give real results unless the transformers are perfectly matched. Reference to the layout will show

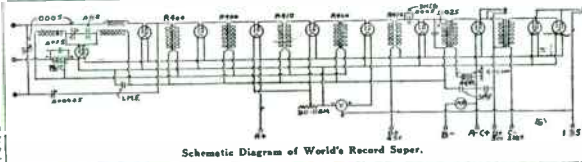

Schematic Diagram of World's Record Super.

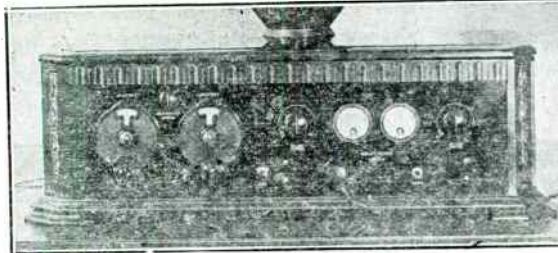

Front panel view World's Record Super.

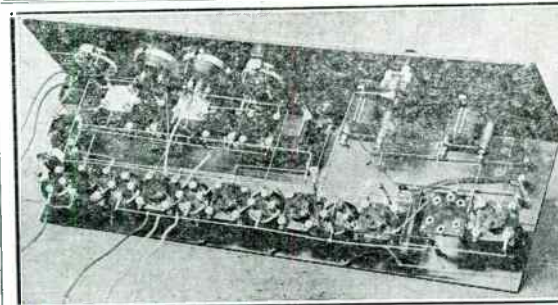

Rear and sub-panel view of World's Record Super, laboratory model.

that the construction is simple and with the aid of the photos and schematic diagram no difficulty should be experienced. Most of the leads run in a straight line, and only twelve lengths of wire are required to set the whole receiver. The sockets

are mounted on short fiber posts so that the top control level with the top of the transformers. In this way grid and plate leads of less than one inch are secured.

It might be thought that a number of special parts were used in such a remarkable receiver, and it is surprising to note that they are all standard and can be secured at any good radio dealer's.

### Putting Conveniences in Farm Home Radio Subject

Getting the conveniences of the city into the country home is not so difficult and discouraging as it seems to most farm women. Declares Miss Clara Woolworth, who for many years has been studying the problem of labor-saving devices for the rural home remote from municipal light and power service, she talks over WJL.

### Parts Used in Super

- One panel, 7 by 11
- One baseboard, 1 1/2 by 15.
- Three Selection long wavelength transformers R400.
- Two Selection long wavelength transformers R410.
- One Thor coupler (300-450 meters).
- One base for coupler.
- Ten Benjamin X sockets.
- Two Thoradon 211 transformers.
- Two Remor condensers .001.
- One Hammond Midget condenser.
- One Weston voltmeter.
- One Weston milliammeter.
- One Takley rheostat, 30 ohms.
- One Takley rheostat, 4 ohms.
- Two Takley jacks.
- One mfd. condenser.
- Two one-half mfd. condensers.
- Two Bangamo .002 condensers.
- One Bangamo .005 condenser.
- One Bangamo .004 condenser.
- One Bangamo .004 condenser.
- One grid leak, three meg.
- Three blinding posts.
- Eighteen pieces of fiber tubing.
- Four pieces of fiber tubing, 1/8" x 1/4" inch by 1/4 inch.
- Twelve lengths of bus wire.
- One Takley Midget switch.
- One condenser slip.
- Length spaghetti.
- One hundred lugs.
- Three and one-half, 1/4-inch.

### Former WJZD Announcer at Knox College Station

GALESBURG, Ill., Oct. 13.—(AP)—Knox college's radio station, WPHZ, has been rebuilt this fall and weekly programs are to be started in the near future. It is announced by college authorities, Le Roy Crider, former announcer at station WJZD, Moonstown, who enrolled at Knox this fall, will be one of the announcers.

### COLLEGE STUDIO OPENS.

Station WBB, Atlanta, Ga., is now linked with the main building of the Georgia State College of Agriculture at Athens seventy-one miles away. Educational farm talks will be broadcast from the college studio.

Static is troublesome only when its level approaches the signal volume level.



## Blue Prints

FREE Write for a complete description of the Pur of all receivers the World's Record Super 10. The receiver that holds 4 fully matched World's Record Super 10 is one of the best receivers ever built in Chicago during the past two International Conventions. Thousands of testimonials hail the World's Record Super 10 as the greatest radio receiver for free list of records and testimonials today.

### Easy to Build

You can build an exact duplicate of the original World's Record Super 10 by following our Blue Prints. Building instructions complete in every detail with each set of Blue Prints make it easy for anyone to build this remarkable receiver with perfect accuracy. Complete building instructions and Blue Prints, \$5.00. Payment with order or we will send C. O. D.

### Mail the Coupon Today!

**M-S SYNDICATE**  
 Box 2131 Cleveland, Ohio

Send me free literature and test list of the receiver made by the World's Record Super 10 for Blue Prints and Blue Prints, \$5.00. Payment with order or we will send C. O. D.

NAME .....

ADDRESS .....

## THE THOR COUPLER

is specified for the World's Record Super 10. This is an interchangeable coupler made to cover all wavelengths from 35 to 3,000 meters.

List Price of Coupler \$5  
 List Price of Base \$2

Thor Radio Mfg. Co.  
 355 Dearborn St., Chicago

## Rewards for Radio Reasoners

Booth 9, Section P  
 Chicago Radio Show

Many substantial cash awards for radio ingenuity. Visit our booth to get particulars and receive free our latest hookups on Improved Controlodyne, General Utility and Portable Receiver and other interesting circuits.

### Benjamin Cle-Ra-Tone Sockets

Used in the Hamerland-Roberts Hi-Q, Browning-Drake, L.C.-27, Karas Equamatic, Grimes Own Kit, Henry-Lyford, New Day Short-Wave, Qualitons, St. James, Infedras, Victoren, Controlodyne Wave, Qualitons, and all other leading circuits. Anti-microphonic, they stop tube noise, and add greatly to the quiet operation of the set. Tube-holding element "inserts" on four finely balanced springs. One-piece tube to terminal connection. Positive wiping contacts.

Other Benjamin super-equipment for better radio sets include the "Leakless" and 2 1/4-inch diameter Tuned Radio Frequency Cells, Straight Line Frequency and Straight Wave Length Condensers, Adjustable Panel Brochets and Battery Switches. All on display at

Booth 9, Section P  
**BENJAMIN ELECTRIC MFG. CO.**  
 New York Chicago San Francisco

## All Specified Parts For the World's Record Super 10

Call or write for free catalog of all parts needed for this wonderful receiver that has made four WORLD'S RECORDS. We stock complete parts as specified by the designer; panels drilled and engraved as per specifications.

**COMPLETE SET OF PARTS, \$85.00.**

## THOR RADIO MFG. CO.

35 South Dearborn St., Chicago, Ill.

(1926) World's Record Super 10 October 1926 \$85 kit



Jim Clark

Chicago to Tasman, New Zealand, is about 8,300 miles, and the stations were only rated at 1000 and 500 watts. Few 1924 receivers could make the grade; but Scott tuned in both special broadcasts, logging them for over an hour. During his thirteen-week stay in New Zealand, Scott logged 117 programs from 19 different stations, all 6,000 miles or more distant, establishing four world's records for consistent night-after-night reception of stations 6,000 miles or more away.

To prove that he did not have a "freak set," Scott cabled Chicago for a duplicate set of parts and built a second receiver there in New Zealand. The second set performed as well as the first, and Scott named this

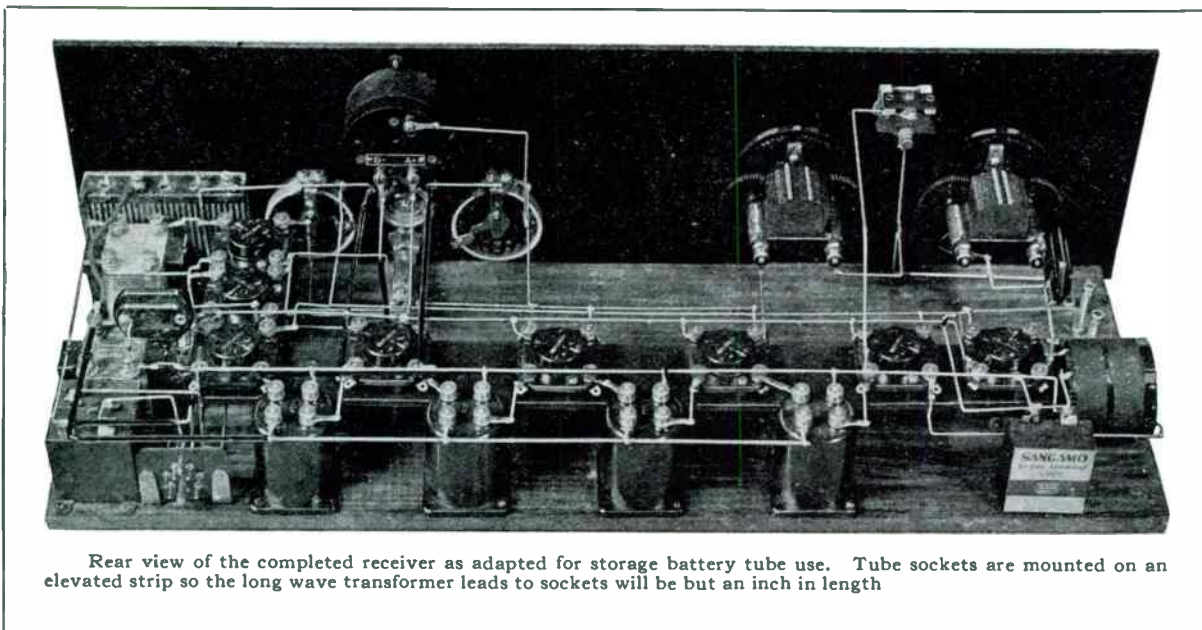

Rear view of the completed receiver as adapted for storage battery tube use. Tube sockets are mounted on an elevated strip so the long wave transformer leads to sockets will be but an inch in length

*Radio Age* (Nov. 1926), p. 39

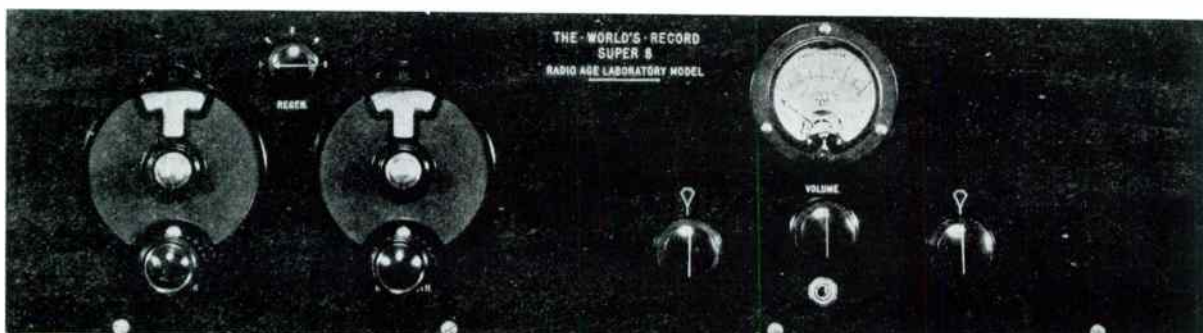

This shows the front panel view of the World's Record Super 8 as modified by Radio Age

receiver the "World's Record 9." He left the second set with his brother-in-law when he returned to America.

Scott began publicizing his "World's Record" set, selling plans by mail. In late 1926, he decided to make his own IF transformers so that he could control their characteristics more closely, at the same time changing his company's name from "Scott Radio Labs" to "Scott Transformer Company." Various World's Record designs were published in *Radio Age*, *Citizens Radio Call Book*, and *The Chicago Evening Post*, all specifying Scott's "Selectone" transformers; Scott sold complete kits for some models.

As Scott's reputation grew, he relied less on plans published in the radio magazines and more on his own models, using an ever-larger proportion of Selectone components. And as public interest in "home-brew" construction declined, he used custom-set builders to make his radios available to nontechnical buyers (without an RCA license, he could not legally make complete receivers). From his advertising, it is very difficult to tell just when Scott began selling fully assembled and wired radios — presumably not until 1930; a March 1930 ad shows the laboratory "in which all Scott receivers are hand-made to laboratory standards." A letter and brochure dated March 30, 1931, for the 1931 Allwave model, is addressed to custom set builders and offers substantial discounts for sets to be resold, but mentions "built only in comparatively small numbers by experienced laboratory workers . . . all must pass Mr. Scott's personal inspection before they leave the laboratory." Up to this point, Scott was hardly large enough to bother RCA, although the larger company sued Scott in 1932 for patent infringement. Scott accepted a license when the suit was dismissed in December.

Scott's company peaked in the late 1930's and the war years, but declined afterward as Scott was forced out by new owners. In 1951, it merged with John Meck Industries; by 1956, it was in receivership. Scott died in 1951.

H. H. Scott, who began as an audio engineer with General Radio before forming his own hi-fi manufacturing company, was no relation to E. H. Scott.

The history of Scott is covered in detail in *E. H. Scott . . . The Dean of DX* by Marvin Hobbs (Chicago: North Frontier Press, 1985, ISBN 0-933309-00-7). Hobbs was chief engineer from 1939 to 1947. Photos and advertising for many models can be found in *Silver Ghosts* by J. W. F. Puett (Dallas TX: Puett Electronics). Much of this history is taken from *Silver Ghosts* by permission.

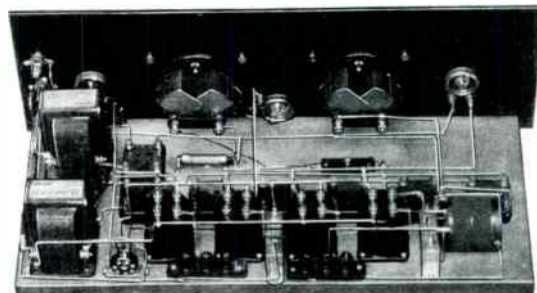

(1926) World's Record Super 8 November 1926 \$86.60 kit

(facing page) *Radio Age* model (Nov. 1926), pp. 38-40.

(above) *Citizens Call Book* 7, No. 3 model (Dec. 1926), pp. 80-85.

(not shown) *Radio Age* "Ideal" model (Mar. 1927).

(below) *Citizens Call Book* 8, No. 3 "Economy" model (Nov. 1927), pp. 154-156.



Jim Clark



Citizens Radio Call Book

195

# SELECTONE TRANSFORMERS



Designed by E. H. Scott whose famous receiver The World's Record Super established four world records for CONSISTENT reception of stations 6,000 to 8,000 miles distant.

Selectone transformers cut through the local stations with ease and their tremendous amplification bring to the distant stations with ample volume and perfect tone quality.

## Tested—Perfectly Matched—Guaranteed

TYPE R 400 Has specially designed iron core which limits stray fields and makes it possible to place transformers quite close together without danger of coupling or causing instability. Coils before sealing in case are vacuum impregnated so that all characteristics of coil remain constant. Price \$6.00.

TYPE R 410 A sharply peaked filter transformer that insures remarkable selectivity. The condenser used to tune the primary is sealed inside the case with the coils. This makes it possible to supply a filter that we KNOW is exactly tuned to the peak frequency. Price \$6.00.

## A Laboratory Product

TESTED AND MATCHED WITH PRECISION EQUIPMENT To secure maximum amplification and fine tone quality all transformers must be perfectly matched. Selectone transformers are all tested with the finest of laboratory apparatus which enables the peak frequency to be accurately determined within 1.00 of 1%.



Apparatus for Matching Transformers

ALL SELECTONE TRANSFORMERS GIVEN AIR TEST To make absolutely sure that every set of Selectone transformers are perfect in every way—high amplification, selectivity, tone quality—a special test receiver using the standard circuit is used. This is so constructed that a set of transformers can be plugged in as easily and quickly as you insert a tube in a socket.



Special Testing Receiver

Send for illustrated literature describing in detail Selectone Transformers and tests they undergo, and the story of the development of the World's Record Super, Radio's greatest DX Receiver.

DEALERS DISCOUNTS      JOBBERS      SET BUILDERS      IF YOUR DEALER CANNOT SUPPLY YOU ORDER DIRECT

## SCOTT TRANSFORMER CO.

7620 Eastlake Terrace

Chicago, Ill.

Citizens Call Book (Mar. 1927), p. 195



(1927) World's Record Super 9 March 1927 Construction article in Citizens Call Book 8, No. 1 (Mar. 1927), pp. 123-125.

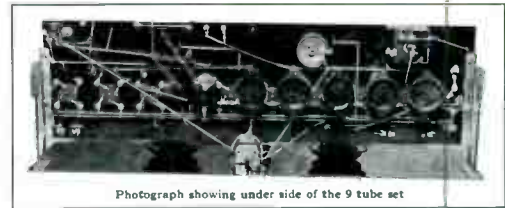

Photograph showing under side of the 9 tube set

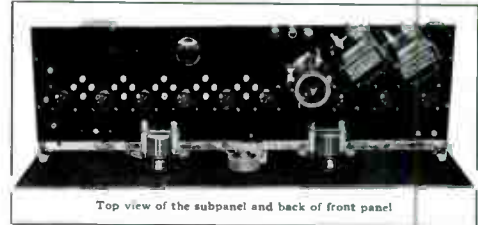

Top view of the subpanel and back of front panel



Jim Clark

Radio Age model (May-June 1927), pp. 17-23

Radio Age model (May-June 1927), pp. 17-23

## New World's Record Super 10 Most Powerful Receiver



Hold All Principal World's Long Distance Records

Tremendous Undistorted Value

Easy to Assemble

Complete list of parts and prices for the New World's Record Super 10, including transformer, coils, and other components.

## New World's Record SUPER 8



Simple to Build and Construct

Complete list of parts and prices for the New World's Record Super 8, including transformer, coils, and other components.

HAMILTON-CARR CORPORATION, CHICAGO, ILL.

31

(1927) World's Record Super 10 Sept. 1927 \$137.80 (list) kit. Construction articles in Citizens Call Book 8, No. 2 (Sept. 1927), pp. 91-95; Radio Listeners Guide & Call Book 2, No. 2 (Sept. 1927), pp. 91-93, 152; Ibid. 2, No. 4 (Spring 1928), pp. 103-107, 176-178. AC version in RLG&CB 2, No. 3 (Dec. 1927), pp. 117-119, 158, 160. Brief descriptions in Radio News (Nov. 1927), pp. 502, 512; Radio Age (Dec. 1927-Jan. 1928), pp. 8-11.

# Announcing A GREAT, NEW RECEIVER SCOTT CHALLENGES THE WHOLE WORLD OF RADIO TO ANY KIND OF COMPETITIVE TEST



E. H. SCOTT

The New Scott Shield Grid 9 was designed by E. H. Scott, designer of the World's Record Super 10, which prior to the advent of this new model held all records for radio set performance.



**More Actual Amplification • More Distance and Volume than Any Other Existing Receiver Known to Us**

This—we believe, is the most powerful, the most selective and the finest toned receiver in existence today. We draw this conclusion from having tested and scientifically measured every other receiver which might claim itself the equal of the SCOTT World's Record Shielded Grid NINE. And there is no question but that this radically new type of receiver will maintain its position of obvious superiority for years to come. For the features of circuit engineering responsible for its amazingly better performance are far ahead of any circuit developed to date.

**UNLIMITED RANGE!** Without aerial, ground or loop, the SCOTT Shielded Grid NINE brings Pacific Coast Stations to Chicago with loud speaker volume. And so tremendous is the amplification of the shielded grid long wave amplifier employed, that it is impossible to determine a range limit for this receiver when used with a short antenna and a connection to ground.

**Shielded Grid Tubes Used in an Entirely New Way**

Standard circuits commonly in use with the new shielded-grid tubes, provide actual amplification of approximately three stages. The revolutionary new circuit used exclusively in the SCOTT Shielded Grid NINE, gives a practical amplification of 140 per stage, thereby making this receiver

many times more powerful than receivers using shielded-grid tubes in a conventional manner. It is this new circuit arrangement developed and used exclusively by us which enables us to challenge the whole world of radio to any kind of competitive test with assurance that the SCOTT Shielded Grid NINE will win.

**Only One Stage of Audio Required!** The second detector output of this receiver is so heavy that concert volume and clear, undistorted cathedral tone, even on the most distant stations, is obtained with but a single stage of 2 to 1 audio frequency amplification.

**Easy to Build — Results Guaranteed** Despite the fact that the Scott Shielded Grid NINE is one of the most elaborate receiving systems ever devised — and despite the fact that it embodies many features of circuit arrangement not known to common practice, it is a very easy set to build, and when you buy the kit of parts we positively guarantee that you will get the same results we get from our laboratory model. Both panel and sub-panel are drilled to receive each part and the shield-grid amplifier units come to you fully wired and tested—ready to be connected into the circuit, just as though they were a transformer.

**Why Pay More for Less?** Why pay more than the small cost of the Scott Shielded Grid NINE when no other receiver offers you so much? Why not have a receiver which provides actual 10 kilocycle selectivity regardless of where located? Why not have a receiver with which you can listen in on all the world—no limit to its distance range. The Scott Shielded Grid NINE is, unquestionably the finest, most powerful, most advanced receiver of the day, and is, beyond all doubt, destined to hold its position of leadership, throughout the coming years. It is the ultimate. Build it—enjoy it NOW.

**FREE**  
Circuit Diagram and Particulars

Find out all particulars of the Scott Shielded Grid NINE. Examine its circuit. See for yourself why it has unlimited range—unlimited power—perfect tone. Proof of the superiority of this great new receiver is FREE to you. Also copies of 6000 and 9000 mile reception verifications and other records made by the Scott World's Record Super 9 and the Super 10, the less powerful predecessors of the new Scott Shielded Grid NINE. Get this information now. Simply clip and mail the coupon. Mail it TODAY!

**SCOTT TRANSFORMER CO.**  
7626 Eastlake Terrace v Dept. D  
CHICAGO, ILL.

**SCOTT SHIELD-GRID 9**  
WORLDS RECORD SUPER

Mail this Coupon!

Send me full particulars of the new Scott Shielded Grid NINE.

Name.....

Street.....

Town..... State.....

(1927) World's Record Shield-Grid 9 December 1927 \$138.10 kit  
Schematic and description in *Radio Engineering* (Oct. 1928), pp. 40-41.

# Ready for you now ~

# SCOTT'S World's Record SHIELD GRID NINE

# all Electric!

Radio News (Feb. 1929)

**H**ERE it is! The World's Record Scott Electrified! The finest of laboratory Shield Grid models, available now for A. C. light socket operation.

Thousands have asked us for an A. C. Electric set offering all the superb qualities of the famous Scott battery-operated set that established four authoritative world's DX records. We were not ready to offer A. C. operation until we had made several important improvements, including a newly developed "A" Eliminator, that would insure A. C. reception as good and better than with battery power.

## Unlimited Range with Superb Tone and Volume

Now we are ready to announce the ultimate in A. C. radio reception—this wonderful new A. C. World's Record Shield Grid Nine! Fully electrified—and affording all the convenience of light socket operation. No batteries to worry about; no chargers of any sort. Just plug into your A. C. light socket, and listen to a revelation of all-electric radio reception such as you have never heard before.

Rangeless distance—volume—tone—selectivity—all are yours, to a degree of flawless perfection that astounds even in this day of enormously improved radio.

## Build in Four Hours Results Guaranteed

There are no tricky adjustments to this A. C. set. You can build it in four hours, easily. Simply wire it up—plug in—and you have your receiver operating at maximum efficiency. Shielded grid amplifier unit comes fully tested and wired. Transformers are perfectly matched, with no exterior adjustments to make. Every part of this remarkable A. C. receiver is designed especially for this set, including the new perfected "A" Eliminator, and all are matched with laboratory precision.

*We guarantee that you can build the New Scott Nine and get the same results we obtain from our Laboratory models.*

## Amazing Output Insures Extreme Selectivity

The tuned R. F. and Shield Grid Long Wave R. F. of the Scott Nine give truly amazing results. The tremendous output of this set is much greater than that of the average good "super." As a result, extreme selectivity is always

obtainable. Not "fussy," uncertain selectivity; but razor-sharp sensitivity, obtainable in a stable circuit condition with tubes operating at normal voltage.

## Low Cost Operation

The New Scott A. C. Shield Grid Nine combines tremendous power with unusual operating economy. The eight tubes incorporated in the receiver draw only 29 mls. Maximum volume is obtained by the use of the Scott Power Pack and Amplifier, incorporating the ninth tube for the second stage of audio. The latest 250 power tube is used, providing tremendous power with perfect tone quality.

## SET BUILDERS! Sell in a protected market

To build up a permanent, prosperous business, you must have the kind of support that Scott gives you. Read every word of Mr. Scott's statement on pages 66 and 67. You can't afford to spend time, effort and ability building up a demand in your community only to have it supplied through "net-price" catalogs.

Get behind this fine receiver. It sells on demonstration. We help you secure and bring in prospects through our elaborate sales plan, including mailing folders, with your name imprinted, valuable Sales Manual and other selling helps. Tie up with this money-making plan. Make each day build for the future—the day when you will have a real, profitable business. Write for particulars today.

# Radio's Greatest DX Performer



## FREE! PLANS

Write at once for free circuit diagrams and full particulars about the Scott A. C. Shield Grid Nine. Also copies of authoritative 600 and 800 mile reception tests. Get all the amazing facts about this World's Record set. Also particulars about battery-operated set. Mail coupon below.

**SCOTT TRANSFORMER CO., 4448 Ravenswood Ave., CHICAGO**

Send full particulars about the Scott World's Record Shield Grid Nine, including Free Circuit Diagram, world's record test verifications, etc.

A. C. Model  
 Battery operated Model

Send also particulars about your special proposition to professional set builders.

Name..... Town.....

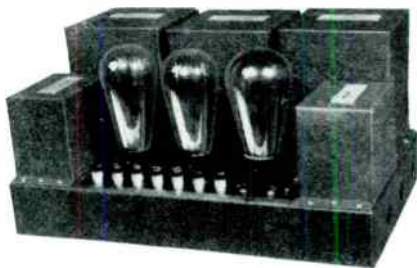

Call Book



Jim Clark

(1928) World's Record Shield-Grid 9 September 1928 \$138.10

Construction article in *Citizens Call Book* 9, No. 3 (Sept. 1928), pp. 48-51. The battery version (model 9B) is described in *Ibid.* 9, No. 4 (Nov. 1928), pp. 66-68. It has both audio tubes on the main chassis.

# SCOTT WORLD'S Announcement



**E. H. SCOTT**  
Designer of receivers holding practically all the world's records.

▲ and a policy of distribution which insures the purchaser's complete satisfaction and protects all the professional set builder's profits



## ONE DIAL Control on the New Scott A.C. Nine

The New Scott World's Record A.C. Nine which again repeats its unanswerable challenge to the whole world of radio is equal in performance in any kind of competitive test, is now improved by the embodiment of *Single Dial Control*. Now, by merely plugging into your light socket and limiting one small knob, practically any station within 10 kilometers of any other station is heard in with thunderous volume and with vigorous, life-like, full-bodied tone. A person can tune the Scott World's Record A.C. Nine over a tremendous range of frequencies with ease and speed in the matter of seconds of almost instant time. This is accomplished by means of the new *Single Dial Control* which is a complete and complete unit. It is a complete and complete unit. It is a complete and complete unit. It is a complete and complete unit.

## MAIL COUPON

Scott Receivers are designed for those who have tried other receivers and are now looking for something BETTER. They are custom built to your order and are sold only through the exclusive dealers carefully selected by the Scott Transformer Company. The order of description you see is printed with a note which has a thorough, practical knowledge of radio—the one essential that is guaranteed to compare with any other receiver available. This practical knowledge will enable you to select the receiver that will give you the most satisfaction. The price of the receiver is printed on the coupon. The price of the receiver is printed on the coupon. The price of the receiver is printed on the coupon.

**COMES to the New Scott World's Record A.C. Nine with the Single Dial Control.** The intermediate amplifier is completely shielded. This apparatus is the receiver in that of the few previous instruments which it is.

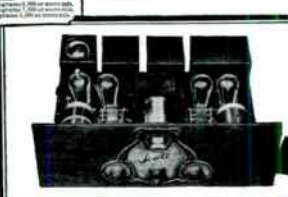

## The New Scott Symphony MODEL A.C. or D.C.

To meet the demand for a better performing custom built small receiver which is low in price but high in performance.

**The NEW A-TUBE MODEL**  
the new Scott Symphony was created. One stage of Shield-Grid Amplification is used, making it the equal to many nine tube sets and is superior in general performance. One dial control—easily tuned out the local and brings in distant stations. Eng. proved to the same quality standard as the nine tube model and back-d with the same unqualified guarantee of superior performance and complete satisfaction.

Send today since only by the new Scott World's Record A.C. Nine. One dial control—easily tuned out the local and brings in distant stations. Eng. proved to the same quality standard as the nine tube model and back-d with the same unqualified guarantee of superior performance and complete satisfaction.

**Self-contained power supply in A.C. Model**  
The A.C. Model of the Scott Symphony is equipped with built in A.C. power supply which supplies filament, plate and grid current to all A.C. tubes used and the 171 A power tube. The D.C. Model is so designed electrically that its current consumption is extremely low, thereby making it the ideal receiver for sections where A.C. current is NOT available or where it is desired to use batteries.

## SCOTT

Please say you saw it in RADIO NEWS

# RECORD RADIOS of New 1929 Models

isfaction and protects all the professional set builder's profits

## Professional Set Builders! Scott Apparatus Now Sold Only thru CUSTOM SET BUILDERS

The custom building of fine radio receivers is still a profitable profession with our plan for those who are technically qualified, because there are thousands of people who want the best there is in radio and who know that the best cannot be produced by mass production methods but only thru the custom method of hand building.

This season Scott Products will not be sold direct to consumers nor thru jobbers, but exclusively thru professional custom set builders. We have adopted this policy because we believe in you and recognize the fact that your ability to deliver a far better receiver than any mass-production factory can make, and our reputation of your market, will result in the growth of your business, and in turn, the growth of ours.

Our line this season is complete and will enable you to supply a Scott receiver in a good console from as low as \$80.00 to as high as \$1,000. It embraces the Scott World's Record Shield Grid Nine, the Scott World's Record A.C. Nine, the Scott Symphony in both A.C. and D.C. models, and a line of cabinets which enable you to out-class, at the right price, anything else in the field.

## We Help You Promote Sales

We have, ready to imprint your name thereon, illustrated advertising mailing pieces for you to use in greeting the news of your appointment as the franchised Scott Builder in your locality. Our 48 page book "How to Sell Good Custom Built Radio" tells you all about the Scott Plan and our proposition. It is the first and only complete, practical treatise ever prepared which clearly points the way to financial success for the Custom Set Builder. It is, however, sent only to those who can qualify and meet our standards as a Custom Set Builder.

## MAIL COUPON

**For Qualification Blank**  
The Scott Franchise is most especially, a valuable one. Not only because of the obvious superiority of Scott Receivers, but because after you are appointed a Scott Franchised Builder, you will have taken a step towards establishing your own REAL PROFIT A.B.L.E. business that will, with our co-operation and assistance, enable you to make more money than you ever dreamed was possible in the custom set building business.

## TRANSFORMER COMPANY

4450 Ravenswood Avenue CHICAGO, ILLINOIS

## Complete Line of CABINETS

Never before have we had a more beautiful or complete line of cabinets. They are the last word in "moderism" with sliding doors, fish-tooled walnut burr, hand rubbed finish. We show on these pages three of our ten different models and all are fine examples of the modern furniture craftsman's art. They will enable you to meet every cabinet demand from the most modest to the massive, rich, dignified hand carved console that will add distinction to the finest home. You can secure four of these models either with or without phone combinations. All are of the very highest quality and workmanship but are priced undervalueably low.



## Set Builders! MAIL THIS COUPON

Set Builders! MAIL THIS COUPON

World's Record AC 9 May 1929

Symphony May 1929 \$85 (AC), \$53 (DC)

(left) (1929) AC10 July 1929 \$175.50 with amplifier and speaker

(right) (1930) AC10 November 1929 six consoles, \$334-\$703

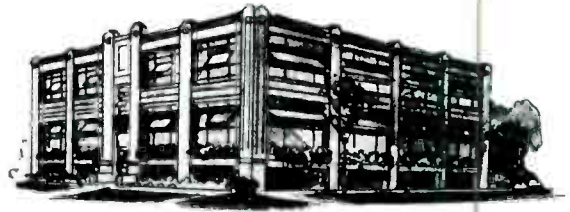

Jim Clark



Jim Clark

**T**HREE curves on the Scott A. C. Ten are shown on this page in Figures 1, 2 and 3.

The sensitivity as illustrated in Fig. 1 is merely relative as the actual sensitivity on the receiver was so far below one-half microvolt per meter that it could not be measured. The sensitivity curve shows the general outline as to the amount of relative sensitivity over the wave band, showing greatest sensitivity at 1400 kc and least at 600 kc.

The selectivity curves are illustrated in Fig. 2. It will be noticed that all three curves are nearly alike. For practical purposes they might be drawn as one curve. This feature is a very desirable one inasmuch as it indicates the selectivity is the same at any place in the broadcast band. There is very little tendency at any frequency to have very much flare.

The fidelity curves as shown in Fig. 3 are what may be expected from glancing at the selectivity curve, having a flat characteristic from 200 to 1300 cycles. The high frequency cut off is not as rapid as some receivers which have been measured in our laboratory, but the harmonics and overtones will be cut out to some extent. This type of fidelity curve is characteristic of the selectivity and cannot be bettered without a sacrifice of selectivity. The actual loss of the high frequencies will probably not be noticed by the ear as in the majority of loud speakers there is a rising characteristic at the high frequencies.

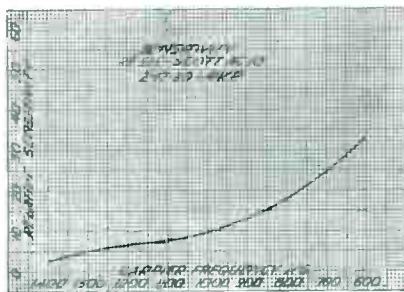

Fig. 1. Sensitivity curve

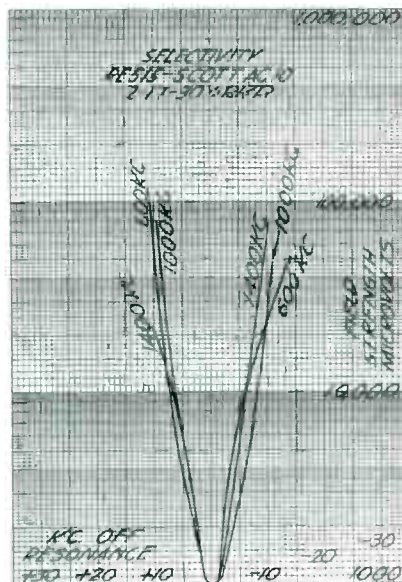

Fig. 2. Selectivity curves

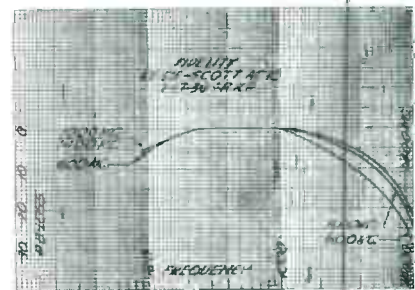
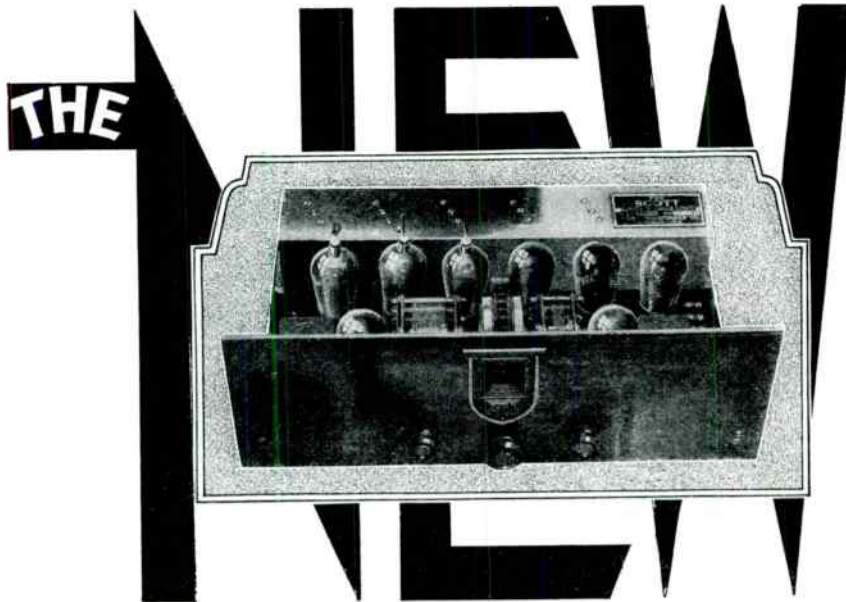

Fig. 3. Fidelity curves

Citizens Call Book 11, No. 2 (Mar. 1930), p. 120



## SCOTT A-C SCREEN GRID 10

### Screen Grid Performance Plus!

Eighteen months ago Scott announced a receiver using screen-grid tubes. This model was the result of nearly six months' work in the laboratory. The new 1930 Scott A-C Screen-Grid 10 is therefore the result of two years' actual experience with screen-grid receivers. The performance of this new model is so far in advance of any other receiver on the market today, that there is no standard with which to compare it. It uses ten tubes, three of which are screen-grid. The micro-matched Scott shielded intermediate transformers secure almost unbelievable amplification out of each screen-grid tube.

#### Unlimited Distance Range

The tremendous power of the new Scott A-C Screen-Grid 10 gives distance reception undreamed of a year ago. Stations come in with more volume than is ever desired. Every station seems like a local. Proof of this is the verification of station 2ME of Sydney, Australia, on March 12th of this year right from the center of Chicago.

#### Keen Selectivity

There is a different station on every point of the dial. By turning the single drum dial just a degree the most powerful local vanishes. Then, as you turn to the next point, some far off station perhaps a thousand, two thousand, or three thousand miles away thunders in. Another turn and it is gone. Never before has such perfect, sharp, yet easily handled selectivity been built into a receiver. Scott has outdone Scott! The possibilities of this new set actually dwarf the world's record established on the original Scott World's Record Receiver. Remember what it did—brought in 117 different programs from stations, the

closest of which was 6,000 miles to as far away as 8,375 miles, during a 13 week test period. It has challenged the entire radio industry to equal its performance—and none have answered it.

#### Absolutely Humless

The filter system used in this new Scott Custom-Built A-C Screen Grid 10 is so perfect that every trace of A. C. hum has been eliminated. Bend down, put your ear right up against the speaker, and you find it difficult to believe the receiver is switched on. The downright realism of the songs amazes you, when you hear it with every trace of A.C. hum eliminated.

SCOTT TRANSFORMER CO., 4450 Ravenswood Ave., CHICAGO., ILL.



#### Custom Set Builders and Dealers

If you are interested in selling the one receiver which has no competition, and at the same time enjoy an absolutely protected market, check the coupon and mail at once.

#### New Scott Short Wave Converter Tunes as Easily as a Broadcast Receiver

Here is a new kind of short wave converter. Gone forever, is that tricky, critical tuning, formerly required to tune a short wave receiver. A new feature we have developed in the laboratory spreads the stations in each band to what amounts to a tuning dial twenty inches in diameter. It brings in voice and code alike with perfect clarity. Listen to stations in

England, Germany, France, South Africa, Australia and New Zealand. You hear them all from 14 to 80 meters. Here is a real international receiver. Order a short wave converter when you order your Scott A-C Screen Grid 10—price \$32.50.

#### MAIL COUPON

The coupon from this announcement will bring you full particulars of the New Scott A-C Screen Grid 10—also pictures and descriptions of the many gorgeous console cabinets especially built for this receiver. Clip the coupon—mail it now—today!

-----Clip Now!

SCOTT TRANSFORMER CO.,  
 4450 Ravenswood Ave.,  
 Chicago, Ill. CRCB10  
 Send me full particulars of the New Scott A-C Shield Grid 10.  
 Send me your franchised Set Builders Proposition.  
 NAME \_\_\_\_\_  
 ADDRESS \_\_\_\_\_  
 TOWN \_\_\_\_\_ STATE \_\_\_\_\_

Tell 'Em You Saw It in the Citizens Radio Call Book Magazine and Scientific Digest

The Short Wave Converter is further described in this same issue of the *Call Book* 10, No. 4 (Nov. 1929), pp. 59-60.

# at last — the portable super-heterodyne

## PERFECTED

by McMurdo Silver, the man who designed the first Portable—described in RADIO BROADCAST, "AN ELECTRICAL MASTERPIECE" is what eminent authorities on Radio called that Portable. And the Portable Super-heterodyne here illustrated deserves even greater praise than was accorded the original.



**McMURDO SILVER**  
Well known for his startling work on the Super-heterodyne, has achieved new laurels with his easily-constructed Portable Super. His book, "THE PORTABLE SUPER-HETERODYNE" is the author's own description of his much-talked-of Portable Super. It tells in plain, non-technical language, accompanied by photographs and detail drawings, all about the Portable Super Heterodyne—how to build it, and how to secure results you never hoped to obtain outside of a laboratory. Send for your copy at once. Price...50c

\*\*\*\*\*  
that the S-M Technical Information Service is always ready to answer your questions, and help with your Super Troubles. Write us about your problems. An immediate, personal reply, by Mr. Silver will be yours without obligation.

Here is a List of Parts used by McMurdo Silver, in his Portable Super. These Parts make it possible for even a novice to build the set with only a Screw Driver, Pliers, and a Soldering Iron—that literally bring it from the Laboratory to your Kitchen Table.

2 Silver 0005 Low Loss Condensers No. 601	8 4.50 ea.
2 49 Moulded Dial—Tapered Knobs	1.00 ea.
1 Howard 6 1/2 Ohm Rheostat	1.00
1 Howard 150 Ohm Potentiometer	1.50
1 Insulated Top Binding Post	.05 ea.
1 Carter 102A Jack	.80
1 Carter 101 Jack	.70
1 Silver R. F. Transformer Unit No. 401	14.00
1 Silver Oscillator Coupler No. 101	2.50
2 Silver 199 Sockets	50 ea.
2 Jefferson Audio Transformer No. 41	4.25 ea.
1 Silver 5 Gang Panel Mounting 199 Socket No. 501	3.00
2 5 MFD By pass Condensers	.90 ea.
2 00025 Mica Condensers with Leak Clips	.45 ea.
2 002 Mica Condensers	.40 ea.
1 005 Mica Condenser	.60
1 00045 Balsam Condenser	1.00
1 5 Meg Ohm Grid Leak	.50
1 2 Meg Ohm Grid Leak	.50
1 2x1 1/2" Bikelite Panel, Drilled, Gimmal, and Engraved	6.00
1 7x4 1/2" Oak Base Board, Bus Bar, Spigetti, Screw, Nut, Solder, Flexible Lead Wire	1.25
<b>Total</b>	<b>\$57.50</b>

Shipped Prepaid Anywhere in the U. S.

### ACCESSORIES recommended by McMurdo Silver

7 U. V. 199 Tubes	8 4.00 ea.
4 Small Burgess or Eveready B Batteries	1.25
3 Red Seal Dry Cells	.35
2 Eveready or Burgess C Batteries	.60
1 Collapsible Lamp with Grease Top	6.50
1 7x18" Maltagony Cabinet	7.50

Eastern Dist. Twentieth Century Radio Corp. 102 Flatbush Ave., Brooklyn, N. Y.  
Choice territory on S-M Products now available for jobbers

**★ Silver-Marshall, inc.**  
105 S. Wabash Ave. Chicago  
Central 3744

Radio Broadcast (Nov. 1924), p. 173



"Mac" Silver could reasonably be called the first antique radio collector. He had a small "museum" (his word) arranged on shelves in his factory as early as 1933 when some of the models were only six years old. He was active in collecting early radio gear for the Henry Ford Museum where his tube collection can still be seen, and he wrote on tube collecting for *Radio News* in the 1940's.



1933 Masterpiece II brochure.

# SILVER-MARSHALL

## Silver-Marshall, Incorporated

**M**McMurdo Silver was born in Geneva, New York, on March 15, 1903, son of a professor of ancient history at Hobart College. "He was not," as Arthur Lynch related in the June 1929 *Radio News*, "a leader among the boys of the town, he did not play the most devilish of practical jokes, and he was not at the head of his class—actually, he was far from the top, most of the time." But he did have persistence, enduring a paper route for several years to earn money for wireless parts. In early 1916, his father died; and the family moved to New York City where Silver attended high school, although he never graduated.

Besides wireless, Silver's major interest was antique guns. He had a lengthy article published on this subject in 1916; and during the war years when wireless was shut down, he sold and traded firearms. He went to work for a stock-brokerage house with the intention of making it to the top in five years but left after a year-and-a-half after having advanced only to quotation-board boy. In early 1920, he joined the Westinghouse Lamp Co. at Bloomfield, New Jersey. After finding that he lacked the schooling to be an engineer, he enrolled in night courses to prepare for Cooper Union.

Soon he left Westinghouse for the Manhattan Electrical Supply Co. (MESCO) where he worked for a year-and-a-half. In early 1922, when John Griffin opened his Griffin Radio Service at 52 Vanderbilt Ave. next to Grand Central Station, Silver was his first employee. That summer, Griffin joined A. J. Haynes, who had a small store on 6th Avenue at 33rd or 35th; and the Haynes-Griffin Radio Service opened an elaborate store with a two-story sales room in an old tea room and restaurant on 43rd St. between 5th and 6th Avenues. While with Haynes-Griffin, Silver is said to have developed the superhet that A. J. Haynes publicized and sold in mid-1924.

About this time, Silver was sent to Chicago to scout for a new branch store (which opened around July);

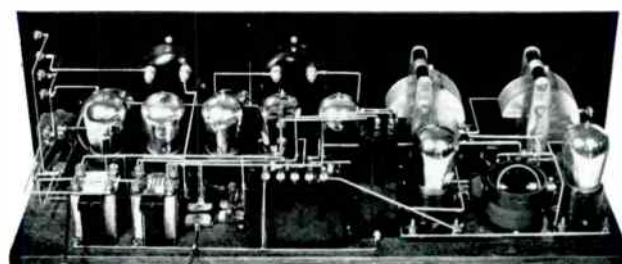

Laboratory Model December 1924 \$63.60 kit (less cabinet and meters)

Technical article in *Radio Broadcast* (Jan. 1925), pp. 498-506; construction articles in *Radio Engineering* (Dec. 1924), pp. 403-408, 424, 426; *Radio Age* (Mar. 1925), pp. 13-15, 58, 60. Illustrations from the booklet *The Portable Super-Heterodyne* (supplement).

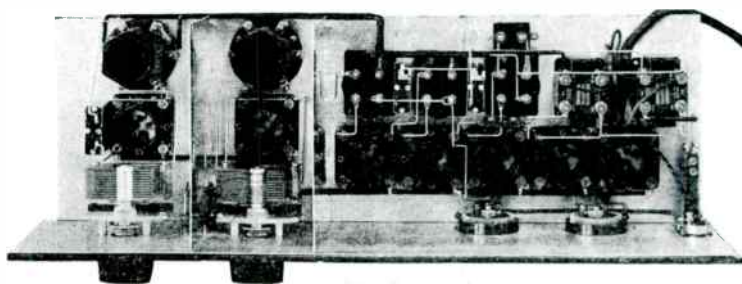

From a pamphlet *The Improved Silver Super-Heterodyne* (early 1925). An unshielded model using the same component layout was also illustrated and described in detail in *Radio News* (Jan. 1926), pp. 982-983, 1024.



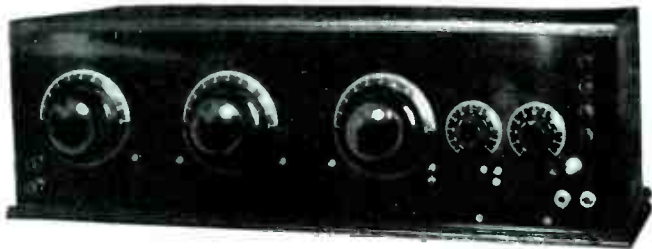

Four-Tube Knockout March 1925 \$44.40 kit

Construction articles in *Radio Broadcast* (Mar. 1925), pp. 900-906; *Radio Engineering* (May 1925), pp. 243-247; *Radio Age* (June 1925), pp. 21-22, 56.



Illustrations from *Radio Broadcast*.

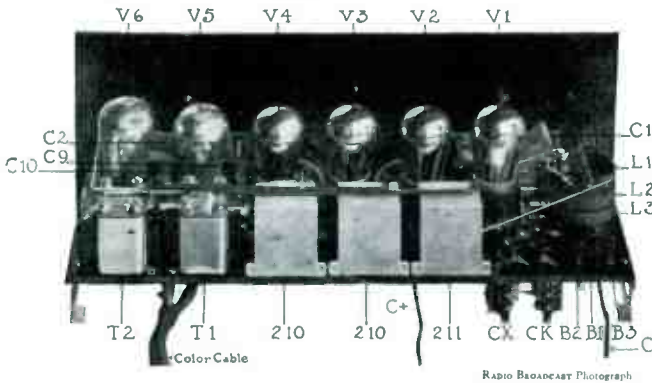

Radio Broadcast Photograph

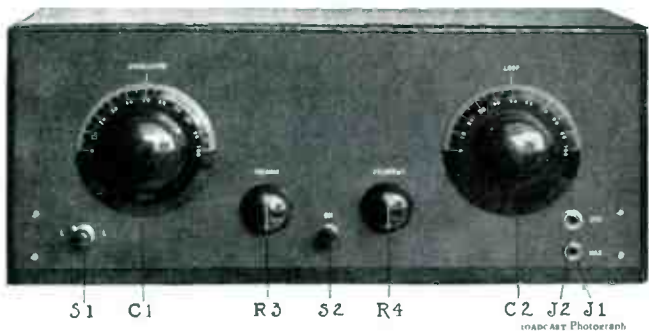

Radio Broadcast Photograph

Super-Autodyne July 1925 \$79.85 kit

Described in *Radio Broadcast* (July 1925), pp. 376-386; *Radio News* (Oct. 1925), pp. 444-445, 532, 534, 536; *Radio Engineering* (July 1925), pp. 333-340; *Radio Age* (July 1925), pp. 15-17; *Radio Review* (Sept. 1925), pp. 3-9 (from *Radio Broadcast*); *Radio Journal* (Oct. 1925), pp. 11-13, 33. Illustrations from *Radio Broadcast*.



620 S-C (Silver-Cockaday) March 1926 \$59 kit

Construction articles in *Popular Radio* (Mar. 1926), pp. 258-271; *Radio Review* (June 1926), pp. 123-128.

### McMURDO SILVER'S NEWEST RECEIVER THE SILVER "SIX"

At the Chicago Radio Show, a Silver "Six" built by Mr. C. W. Tatham won first prize in the "HOME BUILT SET CONTEST." Second prize in the same event was awarded a superheterodyne, designed by McMurdo Silver, owned and operated by Mr. Hartley. In the "MISS RADIO CONTEST" second prize was awarded to Miss Dorothy Goedecke with another of Mr. Silver's Super Designs. The Silver "Six" is Mr. Silver's latest receiver. It is a marvel. Write for the "WHY OF THE SIX," describing it in detail.

**TYPE 600 KIT**, includes all parts necessary to build the complete "SIX" \$53.00  
**TYPE 610 KIT**, essentials only, including 3 condensers, 3 inductances and 3 inductance sockets ..... \$27.75

Anyone can build the Six

<b>SM Low Loss Inductances</b> All-bakelite Low Loss interchangeable Coils for 50-550 meters. These new coils may be used as oscillators, antenna adaptors, and R.F. transformers in standard circuits. Price of all types, Each, \$2.50 Each ..... \$1.00	<b>SM 210 and 211 Transformers</b> Designed so that maximum amplification will be obtained at 50 Kilocycles. Built in bakelite housings, hermetically sealed. No. 210 is iron-core type with measured tuning condenser. Each transformer is furnished with individual laboratory curve chart. Price: Both Types, ..... \$8.00 ea.	<b>SM SLF Condensers</b> These new condensers are particularly adapted for short wave reception because of their extremely low dielectric and eddy-current losses. They are the smallest S.L.F. Condensers made. Supplied with special attachment for single control. Price: No. 311 .0005 16.00 No. 311 .00035 5.75
--	--	--

### The Improved RAYTHEON-THORDARSON B-ELIMINATOR

The SM Type 650 Kit includes Thordarson transformer, choke, Tube condensers, genuine Raytheon tube, Bradleymoys and all necessary parts. Price \$34.  
 This eliminator will deliver from 20 to 200 volts at three different, adjustable voltages with maximum current of 50 milliamperes—more than enough for the largest receiver.  
 Send for Assembly Instruction by McMurdo Silver ..... 10c  
 Circulars on SM Products mailed on request.

SEE SM PRODUCTS AT YOUR DEALER'S  
**SILVER-MARSHALL, Inc.** 116 S. WABASH AVE. CHICAGO

600 Silver Six December 1925 \$53 kit



From a photograph made for POPULAR RADIO

TESTING OUT THE FINAL MODEL

FIGURE 2: The authors are here shown putting the final model of the new receiver through its paces. They have checked up on its selectivity and tone quality as well as its distance-getting capacity and the amount of "B" battery consumption, before giving it their approval.

but he liked what he saw and decided to stay, going into business with a distant cousin, John R. Marshall. In the 1929 account by Lynch (pen name A. Henry), Silver is said to have inherited money from a step-grandfather, Frederick Courtland Penfield, ambassador to Austria, who died in June 1922. Silver-Marshall, Inc., was organized in Illinois in June 1924, opening a jobbing and retail store on S. Wabash Ave. and manufacturing on the second floor of a rented garage.

Marshall left in early 1925. Silver-Marshall's super-hot business ended abruptly in September, 1926, with a court injunction obtained by Westinghouse (as Haynes Griffin's business had ended a year before); but the timely introduction of a shielded TRF model, promoted by a flurry of newspaper and magazine articles, saved the company. The retail and jobbing business was dropped in 1927, and although the market for kits and components was decreasing by 40 percent each year, Silver-Marshall was relatively successful, steadily gaining business.

Silver-Marshall took a new turn in 1929, de-emphasizing parts and kits in favor of complete console radios. The company incorporated again in Delaware in January, acquired an RCA license in February, and constructed a new plant in March. Of course, this was precisely the wrong time to be promoting high-quality consoles, but Silver stuck with them, specializing in private-brand chassis for Lyon and Healy, Marshall Field, and others. He never did make a cheap midget set. But Silver now spent less and less time in the plant, quite unlike the old days when building his business filled every waking hour. Finally, he would arrive at 10 a.m. in his yellow Packard with one or more girl companions in tow and leave by noon.

In October 1932 the company went bankrupt and was sold at auction. Meanwhile, the old Illinois company, which had changed its name in 1929 to the Silver-Marshall Manufacturing Company, was loaned to William J. Halligan, who built Hallcrafters radios under that name for a royalty of 15 cents per nameplate. Also meanwhile (making three Silver companies operating simultaneously!), McMurdo Silver went into business under his own name and by October 1933 was actively promoting his Masterpiece II. He continued to build Masterpieces until 1938 when he again went bankrupt and was bought out by E. H. Scott, who had been his chief competitor. After working for FADA and other firms during the war, Silver organized his own company in Hartford, Connecticut, and was modestly successful making test equipment. However, as far back as 1929, Lynch noted that Silver was "of a rather mercurial temperament, given to ups and downs of feeling." He committed suicide in 1948 with one of his antique guns.



How To Build The Silver Shielded Six

630 Shielded Six October 1926 \$95 kit  
Described in *Radio Broadcast* (Oct. 1926), pp. 494-498; *QST* (Dec. 1926), pp. 27-31; *Radio Age* (Dec. 1926), pp. 25-32; *New York Herald-Tribune* (Oct. 31, 1926), pp. 2, 5 and the following week; *Radio Listeners Guide and Call Book* (Dec. 1926), pp. 86-91, 136.

Improved Shielded Six (one stage unshielded) described in *Radio Broadcast* (Nov. 1927), pp. 44-45. AC version advertised and described in *Radio News* (Nov. 1927), pp. 492-496, 522, 524, 526; *Radio Listeners Guide and Call Book* (Dec. 1927), pp. 94-100, 174-177.



# SM

## And he too was from Missouri!

ONCE upon a time—to make a long story short—a man living in Missouri didn't believe, he had to be shown. So he bought a 630-SG Shielded Six kit. The first night he listened to WEAF, New York, and KFI, Los Angeles and he had about thirty-five more—near and far. Then one morning, at about 3:50 A.M., he tuned in KOU in Honolulu, and he lived happily ever after.

That is the story of not one, but literally hundreds of owners of the new Shielded Grid Six. The set is absolutely so good that there is practically nothing like it. Coast to coast with a small loop or a 15-foot indoor antenna, under average conditions is equal performance. Japan and Australia fairly regularly on the west coast, east and west coasts, Canada, Cuba and Mexico from Illinois—these are the reports that pour in day after day. The Shielded Grid Sixes are easy to tune—only two dials—no repeat points—no wide spreads on locals—total beauty that is startling in its natural reproduction. They're the closest to the "ideal" set you'll hear for many a day to come.

Your Shielded Grid Six is ready for you in either of two models. The 630-LSG is the generally preferred loop model kit; lists at \$91.50; and the 630-SG, which is the antenna model kit, lists at \$97.00. Both unconditionally guaranteed against mechanical and electrical defects.

### 112 Kilocycle Amplifier Catacomb for Screen Grid Tubes

Now Silver-Marshall offers for immediate delivery the famous 112 K.C. time signal amplifier catacomb, improved and refined to take full advantage of the tremendous amplification possibilities of the new screen grid R.F. amplifier tubes. Every experienced fm and professional set builder knows the remarkable efficiency of the famous 6-AR 440 amplifier, with its high amplification, absolutely accurate peaking, and perfect uniformity, and the new 640-SG model of this famous unit, designed especially for screen grid tubes, is capable of providing greater amplification than any other long-wave amplifier ever marketed. The 222 type screen grid tubes are used in the three individually shielded low-loss R.F. amplifier stages, followed by a super sensitive detector (UX-200A), combined rectifier. The amplification is tremendous, the selectivity, hair-splitting, yet tone is well-labouratory tuned and calibrated to exactly 112 K.C. and either two or three R.F. stages may be used as well. It is 15 in. long, 5 in. wide, and 5 1/2 in. high, with removable cover, finished in beautifully hand-lacquered copper. It requires three 6-AR one 400-A type tubes, 6 volts at .65 amperes, 135 one 200-A type tubes, 6 volts at .65 amperes, and 4 1/2 volts of dry C battery for operation. Its current consumption is so low it may be operated on batteries, yet no finer amplifier can be had for use wherever a sharply tuned long-wave amplifier is needed.

Unconditionally guaranteed against mechanical and electrical defects, the 640-SG amplifier catacomb stands unequalled in the long-wave amplifier field. Price \$40.00, ready to use, less tubes.

**SILVER-MARSHALL, Inc.**  
846 West Jackson Blvd., Chicago, Ill.

**SILVER-MARSHALL, INC.**  
846 West Jackson Blvd., Chicago, Ill.

I enclose \$ for complete blue prints and building instructions on the Shielded Grid Six.  
Name \_\_\_\_\_  
Address \_\_\_\_\_

Radio News (Apr. 1928), p. 1167

630-SG, 630-LSG February 1928 \$97, \$91.50 kits  
Construction articles in *Radio News* (Feb. 1928), pp. 898-902, 958-960; *Radio Listeners Guide and Call Book* (Spr. 1928), pp. 83-90, 181-185.

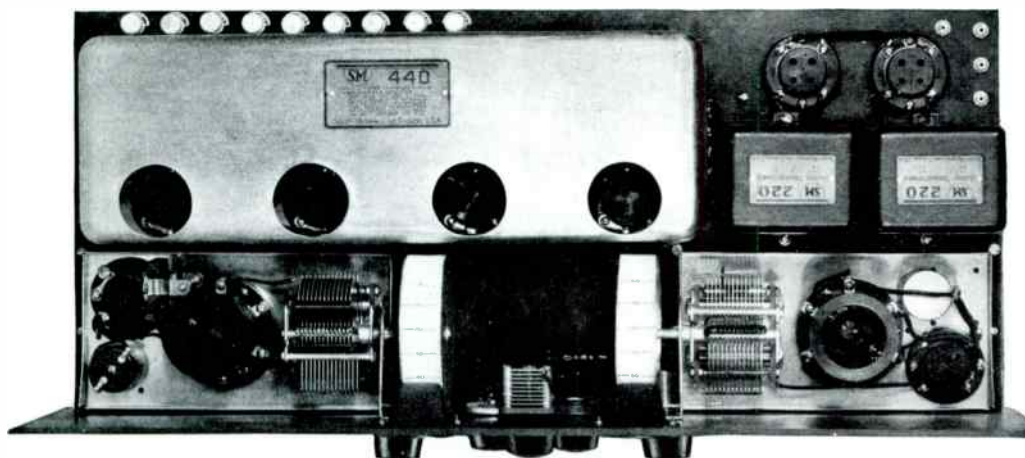

Radio Broadcast (Sept. 1927)

METAL PANEL AND CHASSIS ARE SPECIFIED ALTHOUGH THEY ARE OF BAKELITE IN THIS PHOTOGRAPH

Laboratory Superheterodyne September 1927

Designed by Ernest R. Pfaff, Silver's Chief Engineer (and Scott's after 1932). Construction articles in *Radio Broadcast* (Sept. 1927), pp. 280-282; *Radio Listeners Guide and Call Book* (Sept./Fall 1927), pp. 94-96, 122-134; *New York Telegram* (Sept. 3, 1927), p. 10.

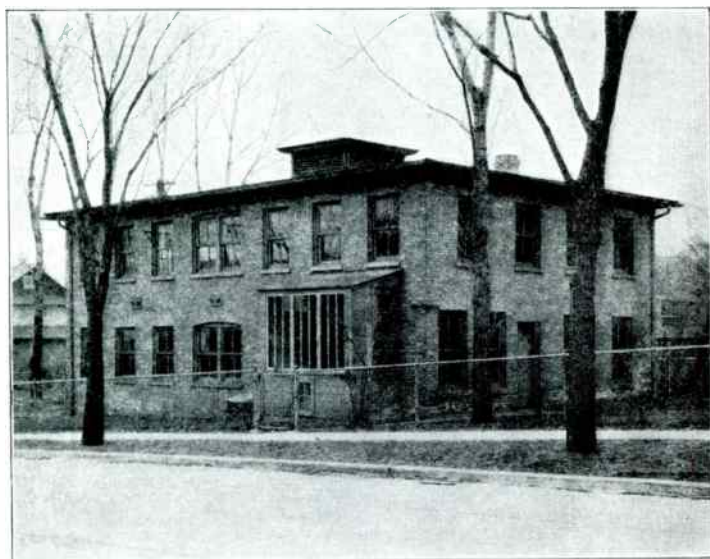

A modest start for a manufacturing industry; the second floor of a garage in a Chicago suburb was the first home of "S-M."

Radio News (June 1929), p. 1077

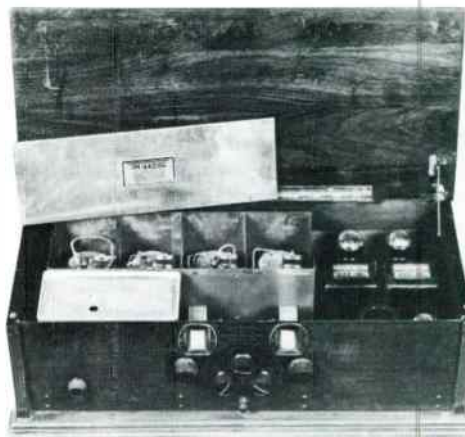

Ralph and Elinor Williams

Improved Shielded Laboratory Model February 1928  
 Parts only; not offered as a kit because of patent licensing. Described in *Radio News* (Mar. 1928), pp. 1020-1024; *New York Herald-Tribune* (Feb. 26, 1928), p. 9; *New York Telegram* (Feb. 25, 1928), pp. 3, 11. Designed by Ernest Pfaff. The right-hand shield can has been removed for the photograph.

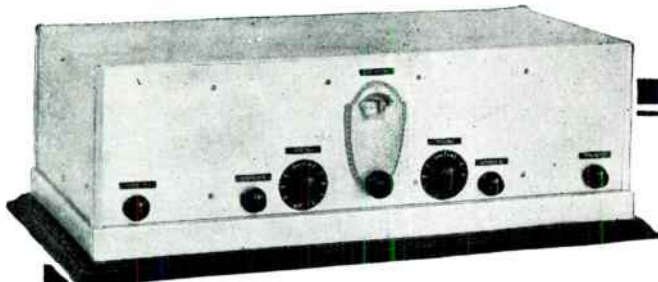

## The Season's Winner

Illustrated above is the new 7 tube SM-710 Receiver, designed by Sargent & Rayment.

A beautiful job in a heavy aluminum case, totally shielding the entire receiver. Most selective set known.

Silver-Marshall's new SM-710 will out-perform any other receiver on the market. It gives clean-cut 10 kilocycle selectivity. Uses 4 shielded grid tubes. 7 tubes in all. Individual vernier controls for each condenser unit. The new Clough system of audio amplification is also used. A totally different method of sound amplification, not surpassed by any other known system. Years ahead of the times.

**A** RECEIVER so different that it will surprise you. So simple to put together that anybody can do it. Sold either as a complete kit, including the aluminum housing, or as a completely wired ready-to-operate receiver, fully guaranteed to make good all claims advertised. More than 100 outside stations tuned-in at Chicago on a warm summer evening . . . and right through the powerful local interference. Single dial control with verniers. Enormous volume and the finest tone you have ever listened to. Undoubtedly, this receiver will outsell all others in the kit field during 1928-1929.

710 Sargent-Rayment July 1928 \$120 kit, \$150 wired

Construction articles in *Radio Broadcast* (Oct. 1928), pp. 354-356; *Radio Broadcast* (Jan. 1929), pp. 197-198; *Citizens Call Book* 9, No. 3 (Sept. 1928), pp. 78-80; *Radio Listeners Guide and Call Book* (Jan. 1929), pp. 74-76, 128.

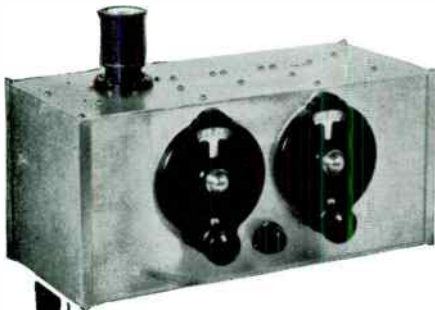

## "Round the World Four"

**A**ND now—an entirely new type of short wave receiver is ready, incorporating all of the sound engineering principles and advanced developments that have made S-M the most popular quality parts today. Heralding Silver-Marshall's definite entry into the short wave field, the new "Round the World Four" and "Round the World Adapter" introduce advanced features and an entirely new design technique. This set, the first to include screen

grid R. F. amplification with one-dial tuning for a range of 17.4 to 204 meters, is simply irresistible. Completely shielded in a thick aluminum cabinet, it can be had as a two-tube tuner to adapt any standard set to short wave reception, or as a complete 4-tube set with loud speaker range of half way round the world and back.

These new S-M short wave sets are the first to be offered designed especially for broadcast and phone reception primarily, and for code secondarily. They alone have the smooth regeneration control that provides the enormous sensitivity necessary to long distance voice and music reception—yet they are absolutely non-radiating.

If you're after the thrill of real, world-wide DX, the "Round the World Four" is the set for you. Amateur station 9VS reported loud-speaker reception from six continents in an evening. Station 9BBW, operating the set, conducted amateur two-way communication with Germany, France, England, and Italy in one evening. In daylight, east and west coast amateur stations are heard in Chicago—Nauen, Germany, and England come in like locals. Five, ten, fifteen, and fifty-watt amateur telephones all over America and Canada are regular reception on the "Round the World Four."

Type 730 "Round the World Four" kit, ready to assemble, including all parts and cabinet just as illustrated, is \$51.00. Type 731 is the two-tube "Round the World Adapter" kit, to adapt any broadcast set to long distance short wave reception, and is priced at \$36.00 complete, with identical aluminum cabinet. Price, 131T, .U, .V, and .W. coils, tuning from 17.4 to 204 meters, \$1.25 each, or \$5.75 for set of four plug-in coils with 512 socket. Type 130 winding forms cost but 50 cents each. Type 732 "Round the World" essential kit includes all above coils, coil socket, .00014 tuning condenser, .00035 tickler condenser, and three R. F. choke coils, with complete instructions, \$16.50.

730 Round the World Four June 1928 \$51 kit

Construction article in *Radio Broadcast* (Aug. 1928), pp. 203-204; *Radio Listeners Guide and Call Book* (Jan. 1929), pp. 58-60, 110; *New York Sun* (July 14, 1928), pp. 1, 3. Described in *Radio News* (Dec. 1928), pp. 538-539.

# 640 Universal All-Wave Tuners



**T**HIS series of kits provides any combination desired in the low-priced receiver field—from a simple two-tube tuner for use with headset or power amplifier, to a complete AC operated four-tube receiver with 210 type last-stage power tube. They are most ingeniously designed for progressive building if desired, the two-tube tuner occupying but 5 inches of the baseboard depth. Three inches additional baseboard depth is necessary for two audio stages—and in the remaining 4 inches of depth in standard 12" cabinet, either of two types of "power supply" (S-M 648 or 649) may be included.

Drum dials, beautifully decorated steel panel, plug-in coils (for 30 to 3000 meter range), and high grade audio transformers make these receivers up-to-the-minute in every respect. Quality is nowhere sacrificed, yet the prices are the lowest on the market. The most efficient two-tube tuner circuit known is employed (made famous by the Silver Knockout, Browning-Drake, Roberts, Lynch Aristocrat, Daily News Four, etc.).

For short wave reception, S-M 114B and 114C coils are used (see page 13) in detector stage only, with S-M 340 midget condenser added, to couple the antenna to the grid circuit of the detector tube. For reception above 600 meters, S-M 111D and 111E coils are used for RF, and S-M 114D and 114E coils for detector.

## 640 ESSENTIAL KIT (Allkit)

The essential parts for building any model Universal Tuner. Parts contained are:

2—S-M 320 Variable Condensers.....	\$ 6.50
2—S-M 515 Coil Sockets.....	2.00
1—S-M 111A Antenna Coil.....	2.50
1—S-M 114A R. F. Transformer.....	2.50
1—S-M 342 Midget Condenser.....	1.50
1—S-M 275 Radio Frequency Choke.....	.90
Blueprints and Instructions.....	.25

\$16.15

Complete factory packed kit in carton shipping weight, 4 lbs..... Price \$16.00

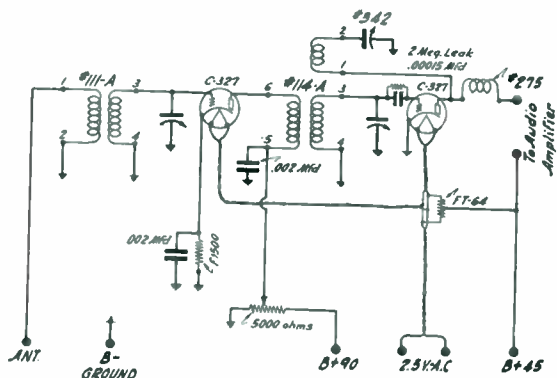

Schematic diagram of 642AC Universal All Wave Tuner

## 642 TWO TUBE TUNER KIT (TwoKit)

The 2-tube battery operated tuner for 1½, 3, or 5 volt tubes. Especially designed to precede a high quality two-stage power amplifier such as the S-M 678, 662-112, 682-210 or 682-250 Unipacs. Kit contains: S-M 640 Essential Kit, \$16.00; 1 Van Doorn 7"x18" decorated metal panel, \$3.00; 1—8" x 17" x ½" wood baseboard with hardware, \$1.50; 2—S-M 805 drum dials, \$6.00; 2—S-M 511 sockets, \$1.00; 1—Polymet .00015 condenser with clips, \$0.45; 1—Polymet .002 condenser, \$0.40; 1—Polymet 2 meg. gridleak, \$0.25; 1—Frost 6-ohm rheostat, \$0.50; 7—Fahnestock clips, \$0.35; blueprints and instructions, \$0.25. Complete (less tubes), factory packed in carton, shipping weight, 12 lbs..... Price \$29.50

## 642AC TWO-TUBE TUNER KIT (Powrkit)

The 2-tube AC Tuner using 2 UY227 (C327) tubes. With S-M two stage Unipacs it is the finest money can buy. Contains same parts as S-M 642 Kit, less 1—Frost 6-ohm rheostat and 2—S-M 511 sockets; plus 1—Frost 5000-ohm potentiometer, 2—S-M 512 sockets, 1—F1500 and 1—FT64 resistances. Complete (less tubes), factory packed in carton, shipping weight 12 lbs..... Price \$33.25

## 644 FOUR-TUBE KIT (Fourkit)

Complete 4-tube battery operated Tuner for 1½, 3, or 5volt tubes. Essentially this kit is S-M 642 Kit plus 2—S-M 511 sockets and 2—S-M 240 audio transformers. Complete (less tubes), factory packed in carton, shipping weight 16 lbs. 8 oz..... Price \$42.75

## 644AC FOUR-TUBE KIT (Folkit)

A 4-tube AC Tuner using 2—UY227 (C327) and 1—UX226 (CX326) tubes with 171 or 210-type tube in last stage, obtaining all ABC power from S-M 648 power kit (if 171 used) or S-M 649 power kit (if 210 used). Essentially this kit is the S-M 642 AC Kit plus 2—S-M 240 transformers, 1—S-M 241 transformer, 1—F1500, 1—F2000, and 2—FT64 resistors. Complete (less tubes), factory packed in carton, shipping weight 19 lbs. 8 oz..... Price \$54.00

## 644SG FOUR-TUBE SCREENED GRID KIT (Fogkit)

See next page for complete description ..... Price \$46.25

## 648 ABC POWER UNIT KIT (Lokit)

This unit fits behind any 640 series tuner in a 12" deep cabinet. Supplies 45, 90, and 220 volts DC for "B" supply and 1.5, 2.5, and 5 volts for AC tube filaments. Contains the following parts:

1—S-M 329A Power Transformer.....	\$11.00
1—S-M 331 Unichoke.....	8.00
1—S-M 511 Tube Socket.....	.50
1—S-M 659 Voltage Dividing Resistor.....	2.50
3—Parvot Series "A," 2 mf. Condensers.....	4.75
2—Parvot Series "A," 1 mf. Condensers.....	2.50
10—Fahnestock Connection Clips.....	.50
1—4"x17"x½" Wood Baseboard, with hardware.....	.75
Blueprints and Instructions.....	.25

\$32.75

Complete (less tubes), factory packed in carton, shipping weight, 14 lbs 12 oz..... Price \$32.50

## 649 ABC POWER UNIT KIT (Hikit)

Same as S-M 648 (described above) except that it supplies 450 volts for a UX210 tube in last stage, as well as A and B power for receiver if equipped with AC tubes. Contains the same parts as the 648 kit except that it uses S-M 327 power transformer at \$12.00 instead of 329A, and 3 Parvot type "B," 2 mf. condensers in place of type "A," plus one additional 659 resistor. Complete (less tubes), factory packed in carton, shipping weight 20 lbs. 6 oz..... Price \$39.75



S-M 648 ABC Power Unit

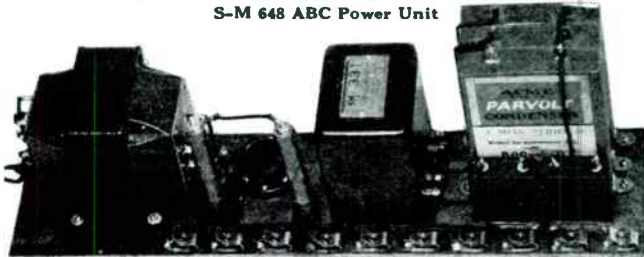

S-M 649 ABC Power Unit

Catalog (March 15, 1928)

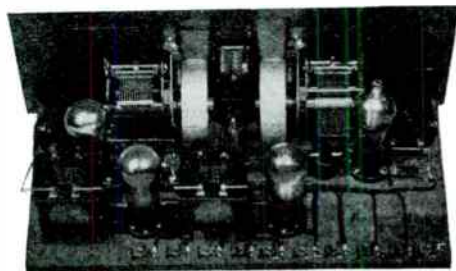

## 644SG Screen-Grid Universal All Wave Tuner

**T**HE 644SG Screen-Grid Universal All Wave Tuner is a highly efficient yet inexpensive four-tube receiver—the first screen-grid receiver to be officially approved by Radio Broadcast Magazine. It employs one screen-grid RF Amplifier tube in a one stage RF amplifier, followed by a regenerative detector and two AF amplifier stages (see schematic below).

The 644SG has a consistent range of 500 to 1500 miles on a forty foot antenna, with selectivity sufficient to permit coast to coast reception through powerful locals in the Middle West. The extremely efficient circuit, the 222-type tube, and good engineering makes the 644SG a four tube combination that excels practically any five or six tube factory-built receiver up to twice the price. As in all receivers using S-M transformers, the reproduction is more perfect than can be obtained from any other receiver in the same price class.

Not only will the 644SG tuner cover the American broadcast band, but it will, with extra S-M Coils, tune from 30-3000 meters. One S-M 111D and one S-M 114D Coils are used for 500-1500 meters, and one S-M 111E and one S-M 114E Coils for 1100-3000 meters. On short waves, below 200 meters, the RF stage is dropped and only three tubes are used, with one S-M 114B Coil for 75-200 meters, and one S-M 114C Coil for 30-75 meters, these coils being placed in the detector coil socket only, and coupled to the antenna by an extra S-M 340 midget condenser.

The parts required for constructing a 644SG Tuner, and contained in the S-M 644SG Kit (Price \$46.25) are:

2—S-M 320 Condensers.....	\$ 6.50
2—S-M 515 Coil Sockets.....	2.00
1—S-M 111A Antenna Coil.....	2.50
1—S-M 114SG R. F. Coil.....	2.50
1—S-M 342 Midget Condenser.....	1.50
2—S-M 275 R. F. Chokes.....	1.80
2—S-M 805 Drum Dials.....	6.00
4—S-M 511 Tube Sockets.....	2.00
2—S-M 240 Audio Transformers.....	12.00
1—Carter H-1 Resistance.....	.25
1—Carter H-15 Resistance.....	.25
1—Carter IR50-S Switch Rheostat.....	1.50
1—Sangamo .00015 mf. Condenser.....	.40
1—Polymet 5 meg. Grid Leak.....	.25
1—Polymet Grid Leak Mounting.....	.50
2—Fast 1 mf. Condensers.....	1.80
10—Fahnestock Connection Clips.....	.50
1—Van Doorn pierced and decorated metal Panel, 7" x 18".....	3.00
1—8" x 17" x 1/4" Wood Baseboard, with hardware.....	1.50
1—S-M 818 Carton (25 ft.) Hook-up Wire.....	.50
Blueprints and Instructions.....	.25
	<b>\$47.50</b>

### 644SG UNIVERSAL ALL WAVE TUNER KIT (Fogkit)

Complete as specified above, ready to assemble (less tubes), factory packed in carton, shipping weight, 15 lbs. 8 oz. Price \$46.25

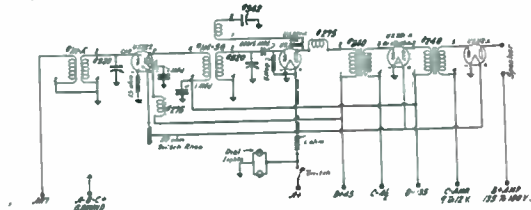

644SG March 1928 \$46.25 kit

Construction article in *Radio Broadcast* (March 1928), pp. 355-357. AC version in *Radio Broadcast* (May 1928), pp. 37-38.



## 635 Short Wave Receiver

**T**HE S-M 635 Short Wave Receiver is one of the most sensitive short wave receivers that can be built. It is designed for reception of all short wave stations, both code and broadcasting, on any wave from 18 to 150 meters (or up to 350 meters by the addition of one S-M 111A Coil).

Great prominence was given to this receiver through its being chosen by Commander Dyott for his Roosevelt Memorial Expedition to the River of Doubt, Brazil, where it performed un-failingly in keeping the expedition in touch with the outside world.

The S-M 635 Short Wave Kit contains the carefully designed and matched essentials for constructing the receiver. Using the four plug-in coils supplied, the various amateur transmitting bands fall well to the center of the tuning condenser scale and may be shifted as desired regardless of antenna length. Due to the design, "dead" spots at which the receiver will not oscillate are totally eliminated. The antenna condenser allows the antenna coupling to be adjusted to suit individual conditions of antenna and location.

When built up with a pair of S-M 220 or 240 transformers in the audio stages (see 635K kit, below), making a three tube set, excellent reception of short wave amateur and broadcast stations may be had at great distances even during the summer months. The experimenter is referred to the 32-page free booklet "How to Build the 635 Short Wave Set," which shows several circuits for the kit. A copy of this booklet accompanies each kit or is supplied free on request.

### 635 SHORT WAVE KIT

(Shorkit)

The essentials for constructing the famous S-M Short Wave Receiver, consisting of one S-M 117 Coil Set (Plug-In Type), one S-M 515 Coil Socket, one S-M 340 Midget Condenser, one S-M 275 RF Choke, and two S-M 317 Variable Condensers. Complete, factory packed in attractive display carton, shipping weight, 3 lbs. Price \$23.00

### 635K SHORT WAVE RECEIVER KIT

(Wavekit)

A complete three tube short wave receiver kit, as shown on page 10 of the booklet "How to Build the 635 Short Wave Set." Contains the following parts: 1 S-M 635 Short Wave Kit, \$23.00; 2 Marco Vernier Dials, \$5.00; 2 S-M 220 Audio Transformers, \$16.00; 2 S-M 511 Tube Sockets, \$1.00; 1 Cushioned Tube Socket, \$1.00; 2 pairs S-M 540 Sub-Panel Brackets, \$1.40; 1 Polymet .00015 mf. Condenser with clips, \$0.45; 1 Polymet 5 meg. Grid Leak, \$0.25; 1 Yaxley 6 ohm Rheostat, \$1.35; 1 Yaxley 20 ohm Rheostat, \$1.35; 1 Yaxley No. 1 Jack, \$0.50; 1 Yaxley No. 2 Jack, \$0.60; 1 Yaxley No. 10 Switch, \$0.50; 1 Belden five lead Cable, \$0.75; 2 insulated top Binding Posts \$0.30; 1 7" x 18" x 1/4" drilled and engraved Westinghouse Micarta front panel, and 1-7" x 17" x 1/4" Westinghouse Micarta Sub-Panel, \$10.50. Complete, factory packed, ready to assemble (less tubes), shipping weight 20 lbs. Price \$63.95

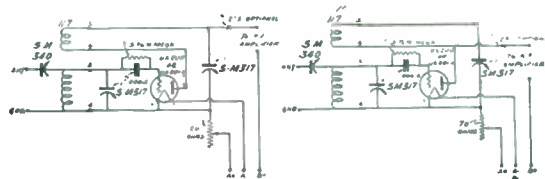

RECOMMENDED CIRCUITS FOR S-M 635 SHORT WAVE RECEIVER KIT (RANGE 18 TO 150 METERS)

635 March 1928 \$63.95 kit

A kit of coils, condensers, and socket only was first advertised in *QST* (Dec. 1926).

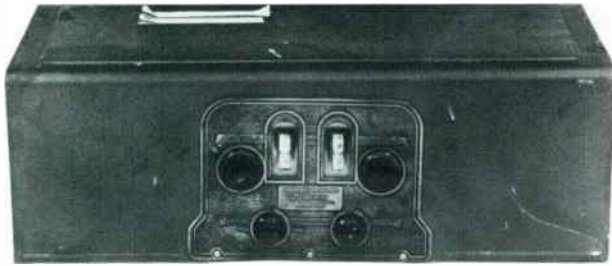

Walter Worth

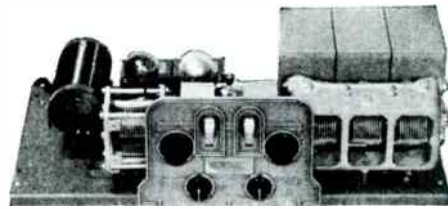
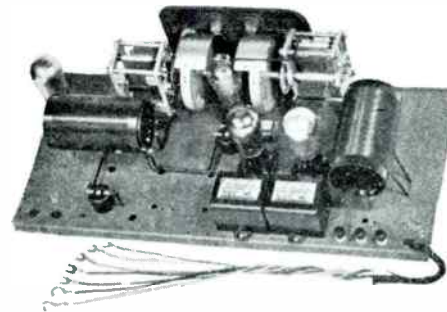
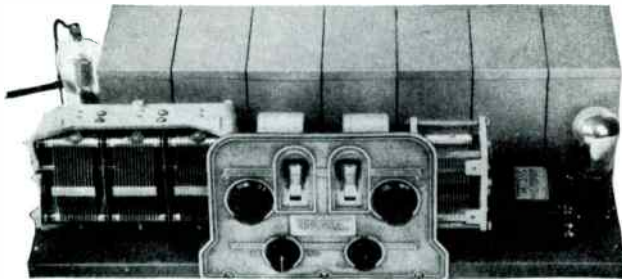

Fig. 2. The 720 Screen Grid Six with cabinet removed, but stage shields in place.

720 Screen-Grid Six July 1928 \$69.75 kit  
Construction article in *Citizens Call Book* 9, No. 3 (Sept. 1928), pp. 42-45. Description in *Radio Broadcast* (Apr. 1929), pp. 409-410.



The Radiobuilder (July 9, 1929)

1929 Laboratory Receiver August 1928  
Parts only; not offered as a kit because of patent licensing. Described in *Radio Broadcast* (Oct. 1928), pp. 334-336; *Citizens Call Book* 9, No. 3 (Sept. 1928), pp. 60-62, 108. Illustration from *Radio Broadcast*.

740 Coast to Coast Four July 1928 \$49.75 kit \$58.25 with cabinet (identical externally to 720). Construction article in *New York Telegram* (Sept. 11, 22, 29, 1928).



Model 750; eight tubes  
4-26, 1-27, 2-45, 1-80

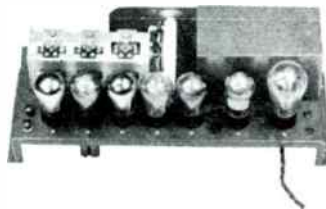

Model 760; seven tubes  
4-26, 1-27, 1-45, 1-80



Metal Table Cabinet for either 750 or 760 chassis.

Sheridan 750, 760 \$89, \$79 without cabinet

These private-brand chassis were discontinued in June, 1929. Illustrations from Silver-Marshall's house organ, *The Radiobuilder* (June 15, 1929).

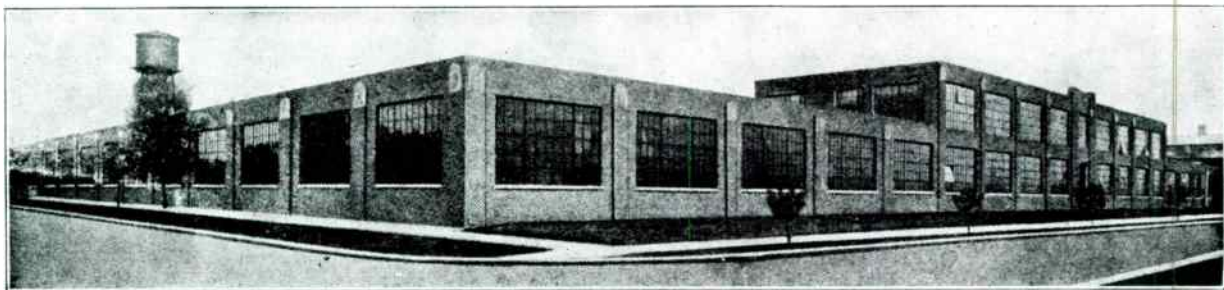

The March 1929 plant at 6401 West 65th Street, Chicago. By 1932, only the left front corner of the building was occupied by Silver-Marshall. This photo is from the Fall 1930 catalog.

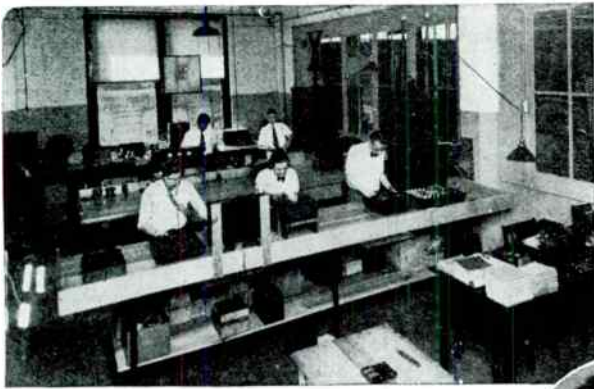

A corner of the research laboratory in the Jackson Boulevard plant which has housed Silver-Marshall since 1928. The new research laboratories alone are three times as big.

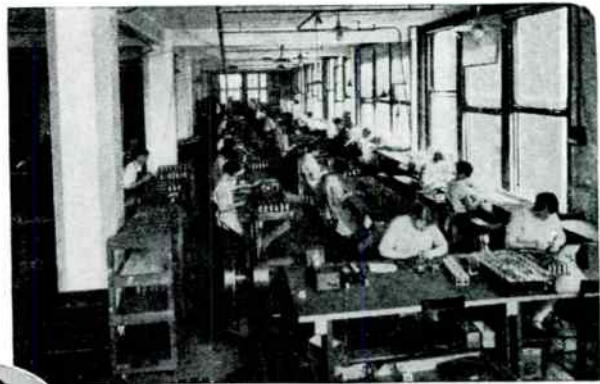

A transformer assembly department. Each transformer is given six tests, three under actual amplifier operating conditions.

Catalog (April 15, 1929)



The Silver Model 75

Silver-Marshall, Inc., Effective September 1, a new model of Silver Radio, known as the Model 75 Concert Grand, was added to the line which now consists of two models, the Sheraton Lowboy and Highboy cabinets. The



Model 75 Concert Grand houses a Model 30 Silver Radio eight-tube, screen-grid chassis exactly similar to those furnished in the Model 60 Lowboy and Model 95 Highboy. A ten-inch dynamic loud speaker is incorporated in the Model 75 cabinet.

Radio Broadcast (Nov. 1929)



The Radiobuilder (May 15, 1929)

(above)  
30 chassis May 1929 \$115  
60, 95 May 1929 \$160, \$195

Technical articles in *Radio Broadcast* (July 1929), pp. 161-163; *Radio News* (July 1929), pp. 60-62, 95; *Radio* (July 1929), pp. 53-54; *Citizens Call Book* 11, No. 1 (Jan. 1930), p. 79.

(left)  
75 October 1929 \$173

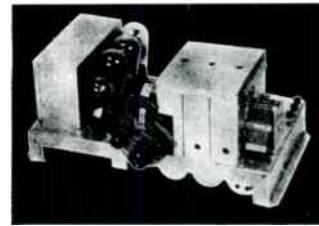

722 Bank-Selector Seven August 1929  
\$74.75 chassis only 722DC, \$57.50

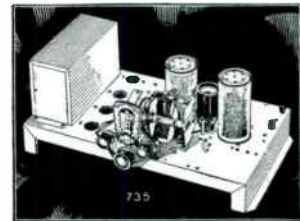

735 Round-the-World Six August 1929  
\$64.90 chassis only 735DC, \$44.80

Catalog (Sept. 1, 1929)



712 Screen-Grid AC Tuner September 1929  
\$64.90 Described in *Radio News* (Dec. 1929), pp. 518-520, 567.



# From Circuit Design



McMurdo Silver, founder and president of Silver-Marshall, Inc., one of the largest manufacturers of radio parts and custom-built superheterodynes in the world

*A pictorial trip through the factory of stock rooms, coil winding department, design  
This is another of the picture displays in  
radio plants and*

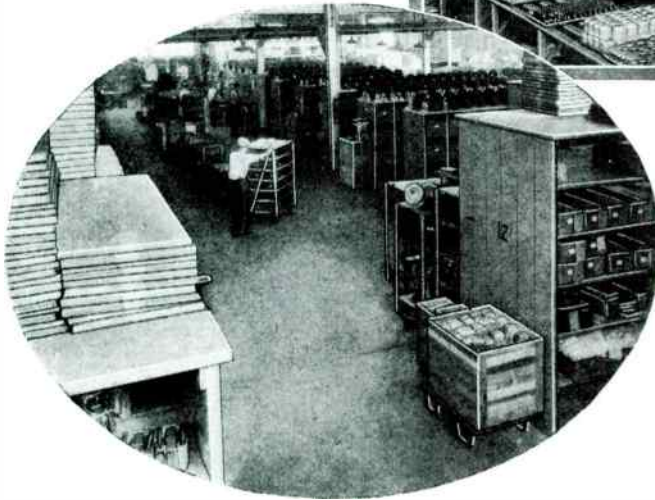

Above, the coil winding department where the enormous number of coils are made that are required daily in the construction of Silver-Marshall Superheterodyne receivers. At the left is the 12,000-foot, centrally located stock room into which all material flows and from which it is drawn as needed by the various departments. All preliminary inspections of raw materials are also made here which greatly speeds up operations in manufacturing departments

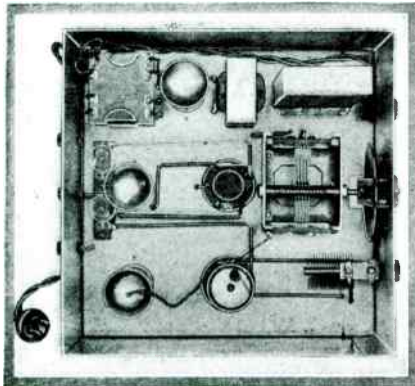

(Right)  
Because of the precision methods of manufacture required in the making of superheterodynes, all wiring in Silver-Marshall receivers is pre-formed and laced into cables by forty girls in this Cable Forming Department

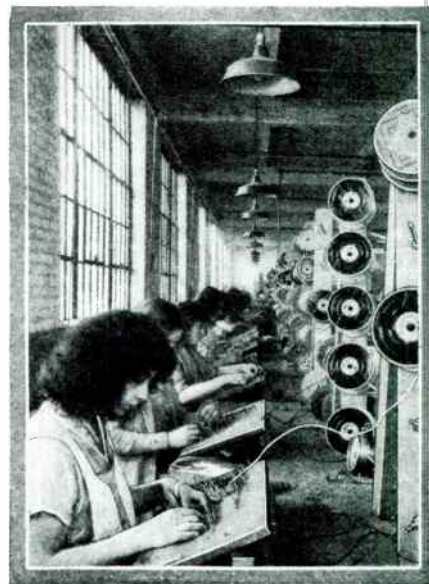

(Left)  
Top view of an S.-M. 738 Short-Wave Converter, showing the exactness with which assembly is carried out at the Silver-Marshall factory

# to Freight Car

*Silver-Marshall, Inc. showing the huge laboratory and production test positions. the RADIO NEWS series showing modern manufacturing procedure*



William J. Frisbie, for four years Factory Superintendent with Silver-Marshall, Inc. The present plant was laid out to his specifications

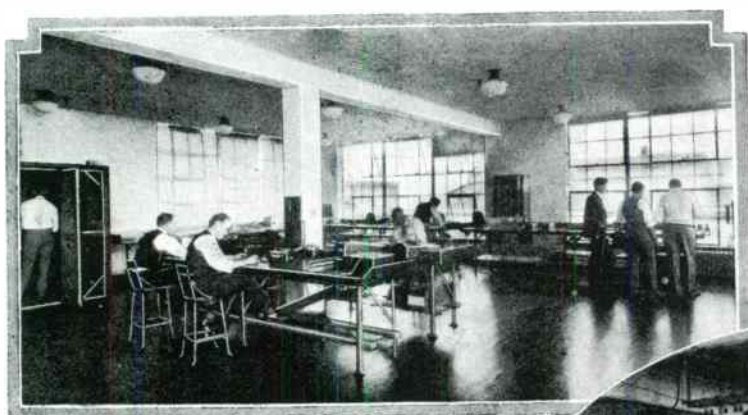

Above, part of the research laboratory at the factory, where the all-famous S.-M. circuits are developed. From here they go downstairs to the factory laboratory, where working models are designed. From the production lines, which are pictured at the right, the completed receivers go over a conveyor system through the test booths, where the tuning condensers are aligned and the receivers are tested for sensitivity

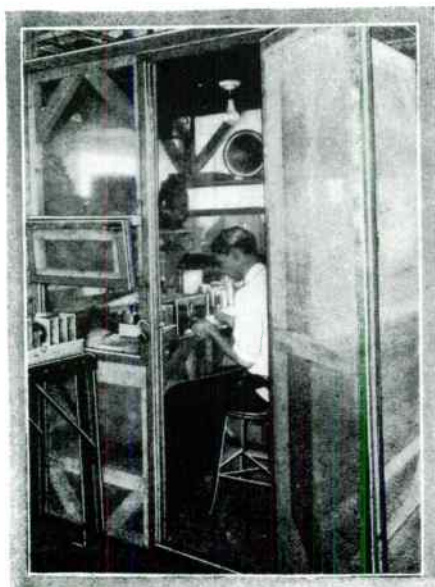

(Left)

Detailed view of one of the six testing booths at the Silver-Marshall factory. These booths are arranged strategically along the production line, the receiver chassis entering through a window, shown at the left

(Right)

The standard-gauge railway terminal in the Silver-Marshall factory, where raw material is unloaded. Freight cars are reloaded with outgoing merchandise before they leave the plant

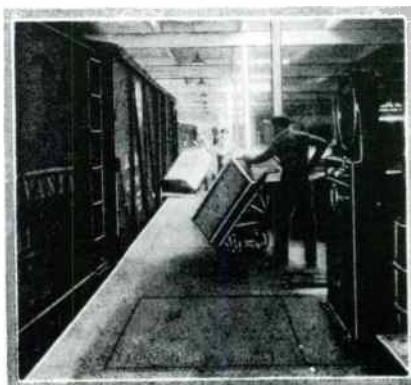

Carl Boyd joined Slagle as vice president in charge of sales in about October 1928 but almost immediately succeeded Lavern Slagle as president. He remained as head of Continental.

Paul Romey was vice president and general manager of Slagle as of October 1928.



CARL D. BOYD

JOHN T. BEATTY

PAUL K. ROMEY

Radio Retailing (Oct. 1927)

**SUPER RADIOS**

**"The Slagle Beats Them All"**

You'll hear all of our customers talking like that, without exception, because we guarantee you a finer radio for less money than you can buy anywhere. Our sets have topped them all in popularity for dependability and long range—receiving over thrilling distances—clearness of tone to the elimination of foreign noises. Write today for our FREE catalogue and prices.

**HIGH CLASS DEALERS WANTED**

**SLAGLE RADIO COMPANY**  
533 Masterson Ave. Ft. Wayne, Ind.

Radio World (June 7, 1924)

Ser. No. 217,967. (CLASS 21. ELECTRICAL APPARATUS, MACHINES, AND SUPPLIES.) LAVERN S. SLAGLE, doing business as Slagle Radio Company, Fort Wayne, Ind. Filed July 27, 1925.



The subject of the illustration is fanciful. Particular description of goods.—Radio Receiving Sets Assembled, Tubes, Loud Speakers, Batteries, and Battery Eliminators. Claims use since Apr. 25, 1925.

**Wait--'till You've Heard the Slagle!**

**Is There A Best Radio Receiver?**

Only deliberate comparison of various receivers can determine. The ideal receiver is a musical instrument—that's a Slagle! Its vast reserve of power is operated by one simple control. Go to a Slagle dealer and ask for a demonstration. It will mark the end of your quest for the best in radio achievement.

**SLAGLE RADIO COMPANY**

**Fort Wayne Indiana**

QST (Sept. 1925)

# SLAGLE

## Slagle Radio Company

**L**avern Slagle was born in Ft. Wayne, Indiana, in 1899. Licensed as 9ME in 1920, he was active enough as an amateur to be appointed ARRL Manager for his city in May 1922. While holding a regular job as assistant teller at the First National Bank, he began building radios at home; by early 1924, he had let his ham license lapse and announced to the ARRL membership that he was in the radio business. The Slagle Radio Co. continued at his home address of 530 and 437 Masterson Ave. through 1926 while he remained with the bank, indicating a limited scale of operations.

In August 1926 Slagle expanded, incorporating in Delaware. He had apparently found an angel as his ads stated "backed by a solid conservative company in business 15 years." The Ft. Wayne city directory gives new addresses: 4419 Indiana Ave. in 1927 and 1232 Maumee Ave. in 1928.

When RCA began licensing in 1927, Slagle was too small to guarantee the \$100,000 per year minimum royalty, so he and four other companies in the same situation combined to form the United States Electric Corp. in August 1927. Shortly after the merger formally took effect on January 1, 1928, one of the five (probably Workrite) collapsed; the remaining companies went into equity receivership to protect themselves, leaving Slagle once more without an RCA license. At this point, the company obtained more capital, changed its name to the Continental Radio Corp., and obtained a license from Technidyne instead of RCA. Beginning in March 1929, Continental promoted its Sky-Raider and later Star-Raider models—extremely expensive but very well-made console sets—and also made chassis for Capehart.

It was only a matter of time before the Depression caught up with such a price-no-object manufacturer. By March 1930 Continental's stock of 1,800 Star-Raiders was being sold at cut prices by a creditors' committee; by September, its assets (including an RCA license) had been sold to a group headed by Carl Boyd (formerly of Apex, one of the U. S. Electric team) and John Beatty of Sentinel. Continental Radio and Television Corp. was incorporated in Illinois in 1934 and again in Delaware in 1940, changing its name to Admiral Corporation in 1943.

Lavern Slagle attempted to get back into the radio business at least twice—in the mid-1930's and again in 1948—but went belly-up each time. He died in 1974.

## Hear the Slagle

It will end your quest  
for the  
Best in Radio Achievement



Every dealer with a sincere desire to serve his customers and make a real success in Radio, wants to sell the best receiver. Only a deliberate and careful comparison can show you which is the best Radio set.

Hear the Slagle. We feel certain that you will like its quality, its reliability and its appearance. All we ask from any dealer is an impartial test of what any Slagle Radio will do—any time, anywhere.

*Write for full details*

**Slagle Radio Company**  
Fort Wayne, Indiana

Radio Retailing (Sept. 1925)

# This "Hook-Up" Makes Money For You



Model VII. This compact little 5-tube set is the wonder of all who see it and hear it. Simple, plain cabinet, that looks well anywhere. Full 5-tube reception that brings the programs in, as well or better than many higher priced sets. Here's a quality set at the lowest price you can expect. Use it for a leader. You'll not be disappointed. List \$70 without accessories.

**GUARANTEE**  
Every Slagle Radio Receiver is positively guaranteed against all defects in material or workmanship, and to give thoroughly satisfactory service in your home or your money will be refunded without argument or red tape.

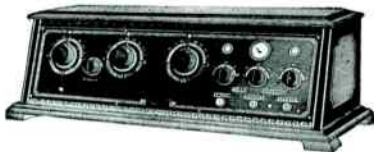

Model V. Free of noises for which sets are often responsible. Low battery consumption; extreme sensitivity to signals; sharp, clean tuning; plenty of volume; simple and complete control; full, rich tone values; and beautiful appearance are some of the points that make this set sell. It's real value. List \$150 without accessories.

There is real money in a radio store or department when properly conducted. This is the story of a "hook-up" that gives you real material to work—a common sense plan that gets results and is easy to follow.

A COMPLETE line of radio sets; designed right, built right, priced right and supported by a clean cut guarantee that means just what it says. . . . That's the beginning.

We support our trade with a powerful, hard-selling advertising campaign. It's aimed at your prospects. Through leading farm journals and newspapers it is working up business for you all the time. That's not all.

Our dealers get an attractive assortment of window streamers and easel cards for window and counter. That's not all, either.

We help you go after your prospects by mail with letters and interesting literature. We help you make sales, and we keep in touch with owners afterwards, boosting your game all the time.

The Slagle line is sold through recognized channels of distribution with liberal margins of profit. Let us tell you more of this "hook-up", what it will do for you and where you can connect with it.

**SLAGLE RADIO COMPANY**  
Fort Wayne, Indiana

A set is no better than its accessories—*Sell good ones*

# Slagle Radio

VII (later called the XII) V was first advertised in August 1925 at \$165.

# Get This Color Chart of Slagle Models

*A complete line of quality sets . . . correct price range . . . strong sales plan . . . with plenty of help for you*



**GUARANTEE**  
 Every Slagle Radio Receiver is positively guaranteed against all defects in material or workmanship, and to give thoroughly satisfactory service in your home or your money will be refunded without argument or red tape.

**T**HE full line of Slagle models is shown in our 4-color chart just off the press. Full descriptions of the sets are given together with an outline of our complete plan for helping you sell. Here is a well-balanced line of high quality sets selling from \$70 to \$350; backed by a solid, conservative company in the business 15 years; sold by a carefully organized system of cooperation that gives real results. Send for the beautiful color chart today.

**SLAGLE RADIO COMPANY**  
 Fort Wayne, Indiana

**Slagle Radio**

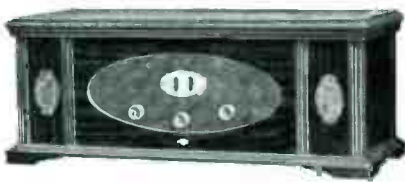

MODEL XX

Five tube radio frequency set, the latest and finest achievement of Slagle engineers, embodying complete shielding and unit construction, giving desired selectivity with perfect tone quality. The cabinet is genuine walnut, with matched burl walnut top and side panels. The instrument panel is also matched burl walnut. Extreme simplicity of control features this model. Stations are selected by turning knobs at the right and left sides of instrument panel. Dial readings appear through the window in the panel. Volume is controlled by adjusting the center knob. Model XX is equipped for the use of a power amplifier tube in the last audio stage if desired. Price \$130.00, without accessories.



MODEL XX CONSOLE  
(Open)

Quality in a radio counts above everything else and in presenting this model we are offering a set that excels in workmanship and performance. This five-tube radio frequency set is completely shielded and its unit construction gives desired selectivity with perfect tone quality. Your investment in a Model XX Console will bring the greatest possible return in satisfactory performance and beauty. Price \$185.00, without accessories.



MODEL XXV CONSOLE  
(Open)

Not only have Slagle designers built in the Model XXV, a Console of rare beauty but they have incorporated a radio frequency set that is selective and efficient. This model is regularly equipped to operate from the light socket without annoying batteries to replace, but may be supplied for battery operation. Price, with bench and socket power but without tubes, \$425.00.

Flyer

EXHIBITORS' SECTION - RMA TRADE SHOW

**New! HOT! Don't Miss It!**

No batteries at all. DRY socket unit furnishes A, B and C power  
Wonderful audio amplification system—perfect tone  
Exceptional selectivity—one-dial control  
Everything you need to make a killing



HERE'S the first news on Slagle's new improved receiver. Below is a very brief summary of a few outstanding points. Read them over carefully. Compare them with anything else you choose.

See the sets, a fine, complete line of high quality at reasonable prices. Hear 'em! We'll leave it to your eyes and ears whether or not you can make real money with 'em. Let's hear from you. The whole story is worth investigating.

SLAGLE RADIO COMPANY  
Fort Wayne, Indiana

BRIEF LIST OF OUTSTANDING SPECIFICATIONS

**Power Supply:** The entire development of complete radio receiver design is based on the principle of complete shielding and unit construction. No other radio set has ever been designed on this basis. The power supply is a dry socket unit which furnishes A, B and C power from the light socket.

**Volume Control:** The volume control is a simple, effective, one-dial control, with a range of 100 db. The volume control is a simple, effective, one-dial control, with a range of 100 db. The volume control is a simple, effective, one-dial control, with a range of 100 db.

**Station Selection:** The station selection is a simple, effective, one-dial control, with a range of 100 db. The station selection is a simple, effective, one-dial control, with a range of 100 db.

**Audio Amplification:** The audio amplification is a simple, effective, one-dial control, with a range of 100 db. The audio amplification is a simple, effective, one-dial control, with a range of 100 db.

Radio Retailing (June 1927)

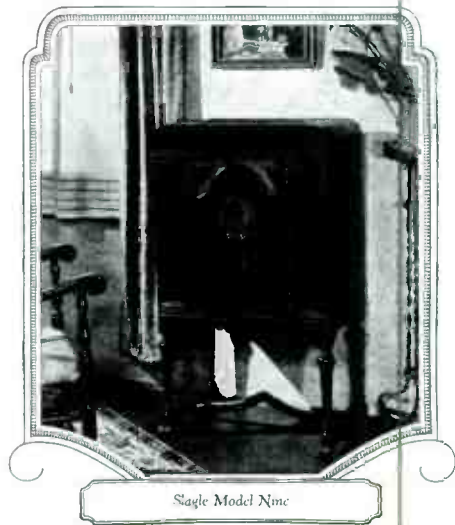

Slagle Model Nine

Radio Retailing (Aug. 1928)

Slagle Radio

9- and 10-tube models were listed beginning in September, 1927; but model numbers and prices changed nearly every month, making it impossible to keep an accurate record. An AC model appeared in November.

Schematic and service data for the model 9 are in *Citizens Call Book* 11, No. 1 (Jan. 1930), p. 71.



Flyer

Ten-29 A, B, C June 1928 \$500, \$600, \$750



Star-Raider model R-20 nine tube radio. Cabinet in Jacobean period design . . . of imported English Pollard Oak, American Burl Walnut, and American Butt Walnut. Price (less tubes) \$435.00

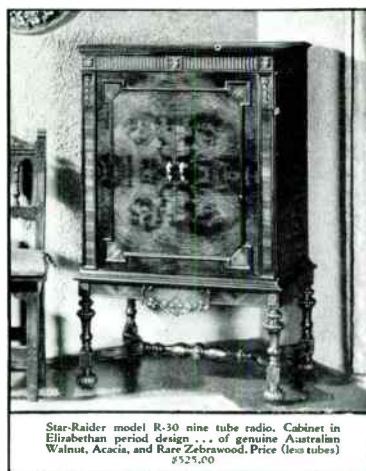

Star-Raider model R-30 nine tube radio. Cabinet in Elizabethan period design . . . of genuine Australian Walnut, Acacia, and Rare Zebra-wood. Price (less tubes) \$525.00



Star-Raider model RP-40 nine tube Radio-Phonograph combination. Cabinet of English Renaissance period of imported English Pollard Oak, Burl Walnut, and matched American Butt Walnut. Price (less tubes) \$725.00

Radio Retailing (June 1929)

Technical articles in *Citizens Call Book* 11, No. 2 (March 1930), p. 83; *Radio* (July 1929), pp. 54-55.

### A.C. Receivers

The Slagle Radio Company, Fort Wayne, Ind., a division of the U. S. Electric Corporation, is making the following A.C. console model receivers, each using the "Technidyne" circuit, a single dial illuminated control and a special volume control. Model 9-B, has nine tubes, a Newcombe-Hawley console type reproducer with a Baldwin unit, and is enclosed in a walnut cabinet, the overall dimensions of which are, 30½ in. by 18½ in. by 41½ in. high. The intended retail price complete is \$415.50.

Model 10-B, has ten tubes, a Newcombe-Hawley reproducer and comes in a walnut cabinet, price, complete, \$464. Model 10-C, has ten tubes, a Newcombe-Hawley reproducer, and is enclosed in a burl walnut console, price, complete, \$509. Model 10-CS, has ten tubes and a dynamic power speaker built especially for A.C. receivers, and is encased in a burl walnut console. It is also equipped with connection for electric phonograph pick-up. Price, complete, \$559. And, model DR, has ten tubes, a dynamic power speaker, and is also equipped with connection for electric phonograph pick-up. The cabinet is made of solid walnut and the price complete is \$634.—*Radio Retailing*, April, 1928.

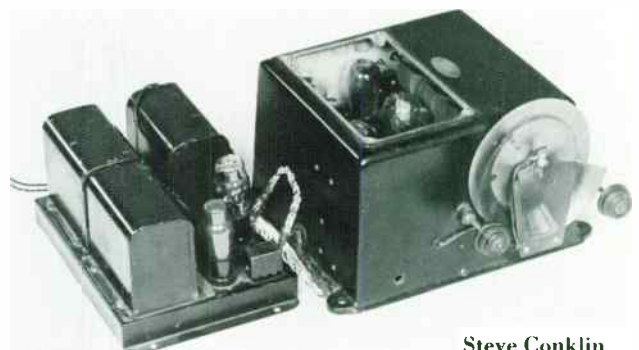

Steve Conklin

Continental model TAM tuner and power supply. This uses conventional RF stages with 484 tubes (not the Technidyne circuit) and has no audio output amplifier. It may date from 1930.





Photo by Bachrach  
MILTON B. SLEEPER

Radio Broadcast (Nov. 1922)



GORDON C. SLEEPER

Radio Dealer (April 1927)

## Of Course A Radio for Christmas BUT—

bring home a set that will be a real surprise. There's no need to give your surprise away by stringing up wires days in advance. There's no need to work with outside wires all Christmas day only to hear a few faint howls and shrieks.

If you take home a Sleeper Monotrol on Christmas eve you can hook it up in half an hour—with no outside aerial or ground connection—have it working from beneath the tree to greet your family on Christmas morning.

What better greeting could there be than Christmas carols transmitted with astonishing clarity and loudness on a loud speaker by "The Most Perfect Radio Set in America"?

# SLEEPER MONOTROL

The Sleeper Monotrol 3-tube set was the radio sensation of 1923. Now comes the new Sleeper 4-tube set—an absolute revelation in range, quality of tone and volume. It has but a single dial to tune with. Any member of your family can bring in any station any time they wish. No set has ever excelled its performance. Make sure NOW that your dealer will be able to supply a Sleeper Monotrol in time for Christmas.

*Interesting booklet  
FREE upon request.*

**SLEEPER RADIO CORPORATION**  
88 W PARK PLACE, NEW YORK, N.Y.



Radio World (Dec. 22, 1923)

Monotrol 52 December 1923 \$140

Technical articles by M. B. Sleeper in *Radio* (March 1924), pp. 15, 62, 64; *Radio and Model Engineering* (Jan. 1924), pp. 14-15.

3-tube Monotrol, August 1923 described by M. B. Sleeper in *Radio* (Dec. 1923), pp. 13-14.



Mike Feher

# SLEEPER

## Sleeper Radio Corporation

**T**wo brothers were involved with Sleeper Radio: Milton B. created it while Gordon C. ran it for most of its existence.

Milton was primarily a writer. Born in 1897, he was a contributor to *Modern Electrics* by May 1913; was an associate radio editor of *Electrical Experimenter*; and in 1919-1920, the radio editor of *Everyday Engineering*. He wrote nearly a dozen books on radio construction. In May 1921, shortly after *Everyday Engineering* folded, Milton started *Radio and Model Engineering* (later called *Radio Engineering* and, finally, *Communications*) and, over the years, a number of other publications: *Radio Mechanics*, *Radio Design*, *FM*, *High Fidelity*.

He formed the General Apparatus Co. in 1919, which changed its name to Sleeper Radio Corp. in early 1922. About this time, Gordon also became associated with the company, perhaps while Milton was visiting England during the summer; while he was gone, the company got into financial troubles. In late 1922, Milton withdrew, taking his *Radio and Model Engineering* magazine with him, leaving his company to Gordon, and disposing of all his Sleeper stock by December 1923. After this time, the brothers are said to have cordially disliked each other; Milton pointedly reminded his readers in 1926 that he had absolutely no connection with the Sleeper Radio Corporation.

In July 1923 Milton published designs for two receivers using David Grimes' Inverse Duplex scheme. By November, one of his mail-order companies was offering a kit for the three-tube Grimes set. Apparently, there was still some connection between the two brothers' enterprises as the three-tube Monotrol was advertised by Sleeper Radio in August 1923 and the four-tube version in January 1924.

Gordon had big plans. In October 1924, he moved to a 20,000-square-foot plant in Long Island City and in December, sold nearly a million dollars' worth of stock. In August 1925, he signed a contract with Music Master for 20,000 model 140s, an order large

enough to monopolize his production facilities and crowd out his own models. This proved disastrous when Music Master failed, making his "million dollar contract" worthless. A receiver was appointed on February 18 and in March, all the sets and parts on hand were sold. In July, the remnants were acquired by the newly organized Sleeper Radio and Mfg. Corp., which had the gall to offer stock and was back in business with a line of models by August. The company seems to have made few waves until March 1928 when it combined with Mu-Rad. In July, it tried to join the United States Electric combine to become RCA-licensed but failed to raise the \$28,000 needed to satisfy claims for unpaid royalties.

At this point, unable to manufacture radios, Sleeper's only hope was to ally itself with a well-heeled company that needed whatever expertise Sleeper could offer. So in November 1928 the company was bought by the speaker manufacturer Temple, formerly the radio division of the Chicago Signal Co., formed in 1925 and incorporated in May 1927 and October 1928. Having no trouble now in obtaining an RCA license, Temple planned two lines for 1929: a low-priced series under the Sleeper name and its own line of high-quality models. However, probably because of production delays, Temple liquidated the Sleeper assets on July 17 to concentrate its manufacturing in Chicago. Paul G. Andres (1890-1954) was chief engineer; after 1930, he was with Temple, Ltd., in Toronto.

For a time, once the delays had been overcome, Temple's business certainly seemed to be booming: shipments of \$712,836 were made in August and 1,000 sets per day in October for a total of \$1.1 million (at list prices) for that month shipped to jobbers. Unfortunately, as these shipments had been sent on credit, Temple was bankrupt by January 1930. When its assets were sold, both it and Sleeper ceased to exist. Gordon returned to the commercial insurance business. Milton, editor of *High Fidelity* magazine, died in 1962.



Ralph and Elinor Williams

Monotrol 54 August 1924 \$160

Technical article in *New York Evening World* (Nov. 1, 1924), pp. 17-18.

**SLEEPER 5 TUBE T. R. F. SHENENDOAH MODEL**



OUR PRICE \$18.00 EACH

Write, Wire or Phone Order—10% Deposit With Order  
**EXECUTIVE OFFICES SUPER SALES CORP.**  
 135 LIBERTY ST. NEW YORK CITY  
 Warehouse & Shipping Dept.: 624 1st Ave., New York Phone: RECTOR, 4146 - 6196 - 9487



**Five-Tube, Two-Dial Receiver**

*Radio Retailing, February, 1926*  
 The Sleeper Radio Corporation, Long Island City, N. Y., announces a five-tube set known as the "Troubadour." This set uses a tuned radio frequency circuit, with two stages of radio frequency, detector, and two stages of transformer audio amplification. It is equipped with a two-dial control, volume knob and a tuning vernier, and is designed to work with an outside aerial. It requires a storage A battery and a dry or storage B, batteries and is adapted to all standard types of storage battery bulbs. The set is housed in mahogany cabinet. The panel is inclined at an angle that permits the user to rest his hands comfortably on the dials. The outfit is 18 in. long, 16 in. deep and 9 1/2 in. high. The inclined front section is 12 in. wide. The actual instrument panel is etched brass, 7 1/2 by 15 in. Just above its top edge there is a movable little wood panel, through which the tubes are inserted. Binding posts for the aerial, ground, and various battery wires are provided on the back of the cabinet. Intended retail price, less accessories, \$65.

Troubadour (56?) February 1926 \$65

Radio Retailer & Jobber (Sept. 1926)

## The Greatest Radio Sale of the Year!

**\$39.00**  
**\$195,000 value selling for \$55,500**

**Sleeper MONOTROL**

New York and Brooklyn Stores Open Until 10 P.M. Daily  
 Phone and Mail Orders Filled as Promptly as Possible  
 Phone RECTOR 1930, 1931, 9954 and MEVINS 1022  
 Extra Salesmen on Duty During this Sale

IF THERE IS WITHOUT A DOUBT THE GREATEST RADIO SALE of the year—line of the greatest sets with the best accessories at less than wholesale cost.

**All about the set and maker**  
 The Sleeper Monotrol No. 34 is the latest Monotrol of this country. It uses the DAVENPORT SYSTEM with only four tubes does the work of seven, detector, three of Radio and three of Audio. It is a super-sensitive receiver especially designed for distance while the local stations are weak and it receives of course all remarkable. The cabinet is made of genuine African Mahogany and can well grace the best room.

**The Most Perfect Radio Set in America**  
 When this set was designed, the Sleeper Corporation spared no expense, for make it the best money affords. The single dial has warrentable cable and neatly fits the dial in the desired wave, but will operate on either loop or aerial.

**How can we do it at this price?**  
 This set without accessories lists for \$110 and even the wholesaler around the price you will pay for it complete. This sale is one of the biggest cash purchases in the Radio industry since the month of radio sets will be sold for \$55.50. This is a mere fraction of the original cost.

**A New Way to Buy Radio**  
 We offer this set "stripped." Accessories may be purchased at our regular "over the counter" low prices (see page 5). This enables you to choose your own accessories, and not have "losing" tubes and inefficient speakers thrown in with a good set to bring down the sale price.

**Remember**  
 These sets have been purchased direct from the Sleeper Co. by Mail Order, and have not consigned to help a manufacturer meet-dial stocks. Come in and listen to this set and you will appreciate the difference between a high grade standard \$110 radio set and one made to sell at price of cost.

**To Out-of-Town People**  
 Here is your opportunity to purchase a wonderful set without shipping. Simply mail us your order with a money order. We will pay express and insure package. Remember every unit fully guaranteed to operate and is brand new.

**The Guarantee**  
 Every set sold bears one year guarantee. We have made the Sleeper Guarantee: "The Monotrol is built to such absolute standards of accuracy that it carries a one year guarantee of free repair or replacement in the event of any trouble from defects in material or workmanship. Notwithstanding that where you purchase your radio at 34th St., you do not wish one of the largest radio houses in the country. Your prices are known as the lowest and our sales volume is known as among the greatest of any Radio Store.

**Why the set is Superior**  
 Our control, lightning action, no personal noise and interference, adjustable four tubes equivalent of seven. Special attention on the frequency (Bathel) component set. A limited number only. Special arrangement with the Sleeper Corporation, one of the "big five" of the industry permits you to become an owner of the latest creation in Radio, when there are no radio stores.

**NEW YORK STORE**  
 61 Cortlandt St.  
 Near Greenwich Street  
 Hours 10:30 to 9:30 Daily

**BROOKLYN STORE**  
 40 Flatbush Ave.  
 At No 10th St. South, Brooklyn, N. Y.  
 Open 10:30 to 9:30 Daily

**WALTHAM ELECTRIC CO. INC.**

New York Sun (Dec. 12, 1925)

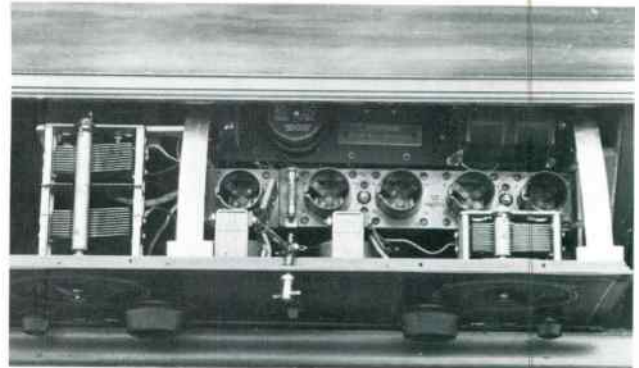

Steve Conklin

Scout 57 August 1925 \$75 (later \$90)

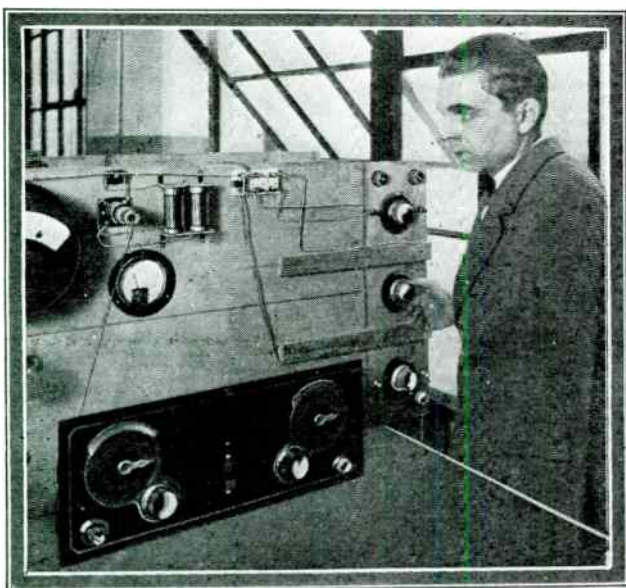

J. Louis Reynolds, chief engineer of Sleeper, described the crystal oscillator equipment used to calibrate receivers at the factory in *Radio News* (Feb. 1926), pp. 1128-1129.



Radio Dealer (Jan. 1926)

The prediction has been frequently made that radio manufacturers will soon adopt some of the factory methods of automobile makers, and that they will install the "endless belt" system of assembly. Although radio set manufacture has not quite reached this stage, a few of the more advanced plants devoted to the fabrication of radio receivers have innovated assembly methods that closely approach the automobile idea in speed of delivery and general efficiency of operation. One of these plants is the Long Island City factory of the Sleeper Radio Corporation. The shop routine corresponds to a "beltline" system except that each set is passed along manually from worker to worker instead of being actually conveyed by a continually moving carrier. The picture above shows one of the assembly benches in the Sleeper factory. The men in the foreground are completing the attachment of the tube socket and tuning coil units to the heavy curved brackets which are attached to the front panels.

Super-Symphonette 59 August 1925  
\$150 (not shown)

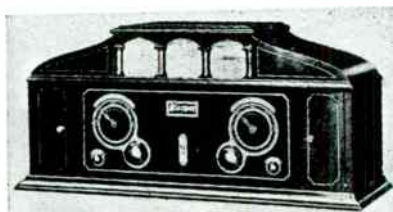

Serenader 58 August 1925 \$100 (later \$115)

**SLEEPER SERENADER**  
Type 58. Manufactured by the Sleeper Radio Corp., Long Island City, N. Y. Five tube tuned radio frequency receiving set enclosed in two color mahogany cabinet with built-in loud speaker using special Brandes unit. Overall dimensions: 34½" long, 16" high, 11" deep. 6:1 tuning knobs. Provisions made for use of UX power tube in last audio stage. List price \$115.00.

Radio Dealer (Jan. 1926)



The SCOUT  
Type 60

**SLEEPER SCOUT.**  
Manufactured by the Sleeper Radio & Mfg. Corp., 438 Washington avenue, Long Island City, N. Y. 5 tube tuned radio frequency receiving set with wave length scales, recessed in panel, calibrated from 200 to 600 meters. Compartments on each side of cabinet give space for 90 volts of "B" battery while a compartment in rear holds up to 45 volts of "C" battery as required. List price \$100.00.



The SERENADER  
Type 61

**SLEEPER SERENADER.** Manufactured by the Sleeper Radio & Mfg. Corp., 438 Washington avenue, Long Island City, N. Y. 5 tube tuned radio frequency receiving set in cabinet 35 inches long, 16 inches high and 11 inches wide with built-in loud speaker. Specially designed tone chamber with air column of 36 inches. Amplions adjustable loud speakers unit used. List price \$125.00.

Radio Dealer (Dec. 1926)

**At Your Service**  
wherever there is  
an **ELECTRIC LIGHT SOCKET**



MODEL 66  
CONSOLLETTE  
\$175

Made in Both AC and DC Types

Think of the thrill, convenience and saving in having a marvelously toned and beautiful radio that does away with all batteries and operates right from your electric light socket—that's the Sleeper Electric—the radio you've waited for. It assures you simplicity of operation, a material saving in batteries and recharging costs and dependable service day after day and month after month. Buy yourself a Sleeper Electric Radio and enjoy life. Ask any dealer for a demonstration. Write for illustrated circular giving full particulars.

Distributed by

R. H. McMann, Inc. Victory Elec. Supply Co. Bell's Elec. Supply Co.  
12 Warren St. 1707 Bedford Ave. 741 Market St.  
New York Brooklyn Newwash, N. J.

SLEEPER RADIO & MFG. CORP. Long Island City, N. Y.

**Sleeper**

New York Herald-Tribune (Nov. 6, 1927)

# Goodbye Batteries

## and all other external power accessories

Radio Retailing (June 1927)

**ABSOLUTELY ELECTRIC**—no “masked batteries” or hidden eliminators. **SLEEPER ELECTRIC RADIO** is *Electric*—not merely electrified. It has no external power units, cans or disguised troublemakers. Simple, powerful, dependable—Sell **SLEEPER ELECTRIC** sets to hundreds of families waiting for freedom from batteries.



**THE SCOUT:** Lowest priced proven dependable full-electric set available. Table model, attractive mottled walnut-finished panel, two-toned polished cabinet and knobs, Adam brown finish. Die-cast construction, 5 tube chassis, (including power tube). Superb, natural tone quality, powerful. Sells on demonstration. Size 35x11x11. List Price \$160



**THE CONSOLETTA** makes a brilliant appeal to the women who want fine furniture. Designed by America's foremost interior decorator. Polychrome, highlight finish. Built-walnut top, mottled walnut finished panel. A gem in appearance, performance and tone quality. Same superior chassis as in Scout model. Size 26x14x10. List Price \$175



**SCOUT CONSOLE.** Combining all the features of the Consolette but in a Heppelwhite design. Adds charm and distinctiveness to any room. Beautiful butt-walnut finished console of fine craftsmanship. Will satisfy the most exacting as to appearance and beauty of tone. Size 42x16x40. List Price \$235.

To proven superiority in fundamentals of tone, quality, simplicity of control, fine selectivity and long range power, Sleeper now adds electric operation from house current, doing away with all batteries.

1. No A, B or C batteries. (Complete battery elimination.)
2. Works direct from 110 volt A.C. house current.
3. Free from hum.
4. Adjustment to compensate for line voltage changes.
5. Big reserve factors—two 216-B rectifier tubes giving 50% greater capacity than needed insures long life.
6. Develops 180 volts for power tube, insuring rich full tone with big volume.
7. Hinged panel for easy access and display of interior.
8. Simple two control tuning.
9. Calibrated wave length scales.
10. Reduction vernier condenser drives
11. Non-microphonic — cushioned detector socket.
12. Non-oscillating.
13. Brilliant performer.
14. Fully guaranteed.

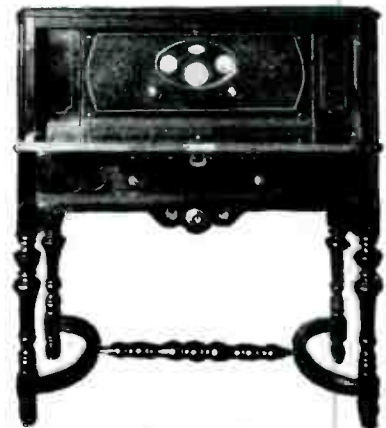

From its electric self-winding clock to its hand hammered, gold-rimmed panel the **SLEEPER ELECTRIC MONOTROL** is the ultimate in radio. Single control, six tube chassis—a set that will make a decided impression on anyone who sees or hears it. To show it is to sell it. Size 42x16x40. List Price \$350

See Mr. Sleeper at our Exhibit—Room 508 Hotel Metropole—23rd St. and Michigan Blvd., Chicago. Telephone Victory 3400.

## SLEEPER RADIO & MFG. CORPORATION

GORDON C. SLEEPER, Pres.

463 Washington Avenue Long Island City

# Sleeper Electric Radio

Scout 64 Consolette 66 Scout console 67 Monotrol 69 June 1927  
 Serenader 65 August 1927 \$175  
 Imperial 68 August 1927 \$265  
 Imperial console 70 September 1927 \$265



The Monotrol, Jr., embodies the simple tuning efficiency demanded by the public today. It has one dial to rotate the electrically illuminated wave length dial—the other knob is for volume control to allow any intensity from great concert volume down to a whisper.

Special connection is provided for supplying the exciting current required by dynamic speakers.

Two UY227, three UX226 as amplifiers, two UX171A power tubes in push-pull, and one UX280 full wave rectifier.

Radio Retailing (June 1929)

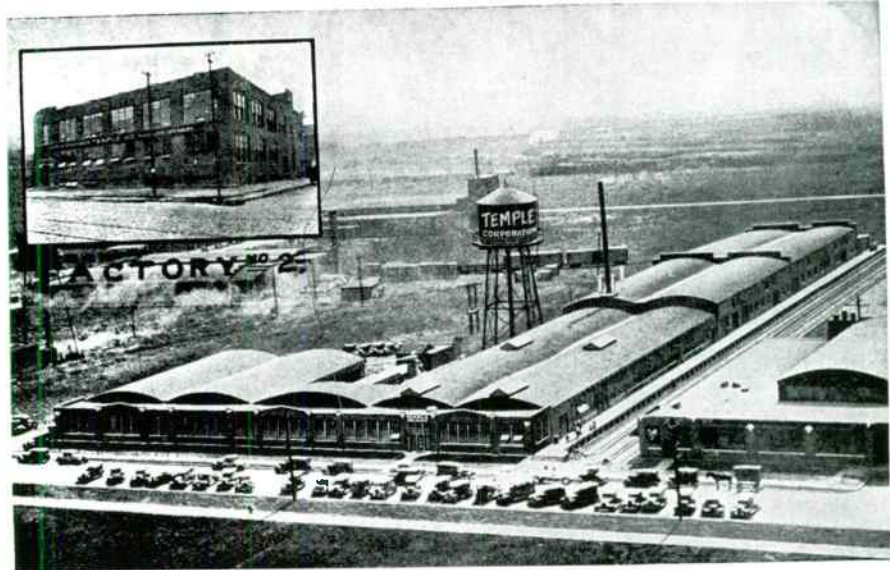

Talking Machine World (June 1929)



TYPE 71



TYPE 72

Flyer

70, 71, 72 July 1928

\$225, \$250, \$275



7-60 \$149  
8-60 \$149  
8-61 \$149



7-80 (similar) \$189  
8-80 \$189 (later \$169)  
8-81 \$189



8-90 \$289 (later \$269)  
8-91 \$289

Flyer

March 1929 (7-60, 7-80), June 1929 (8-60, 8-80, 8-90), October 1929 models



*A corner of the Receiving Inspection Division in the Temple Plant*



*A section of the Temple Radio Frequency Transformer Coil Department*



*Multiple Coil Winding in the Temple Factory*



*A corner of the Temple Transformer Assembly Department*



*Part of the Temple Machine Shop. This two-gear, high-powered press starts out the chassis base complete*

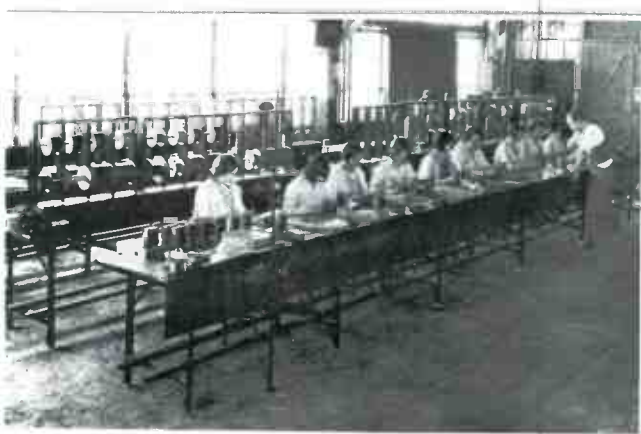

*Portion of the Temple Sub-Assembly Department (Cable forming in rear)*

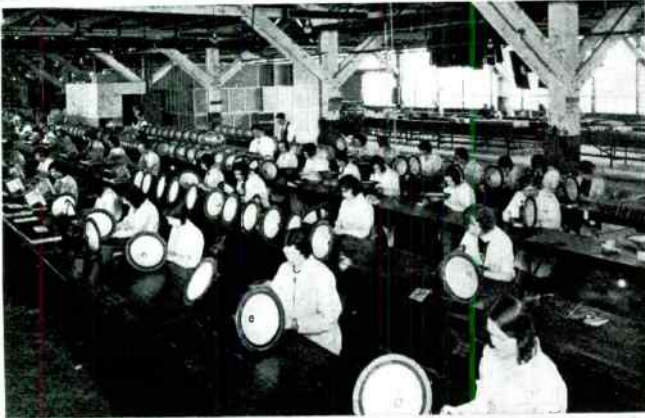

*The Temple Speaker Assembly lines*



*Section of Temple Chassis Assembly Line*

*Talking Machine World (June 1929)*

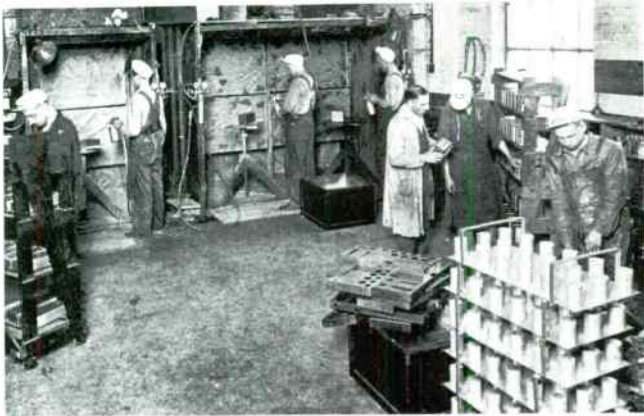

*A corner of Temple finishing department*



*The end of Temple Receiving Set Assembly Lines  
(View showing the final inspection and testing)*



*A corner in one of the Temple laboratories*

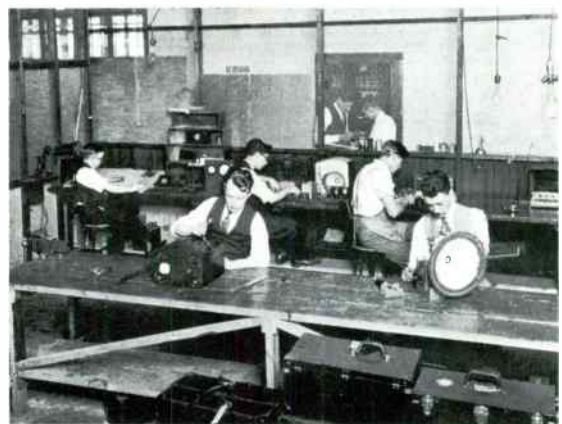

*A corner of the Temple Service Department*



# Sonoradio

CLEAR AS A BELL



**Sonora**  
Phonograph  
and Radio  
Two in One

Model 242  
\$320.00

## A Quality Combination

### Ware Three-Tube Neutrodyne and Sonora Phonograph

In the Sonoradio, Model 242, we offer a quality combination sure to appeal to music lovers and radio enthusiasts. This model consists of the famous Ware three-tube Neutrodyne in the same cabinet with a standard Sonora phonograph.

The circuit of the receiving set is a Neutrodyne Reflex, using three dry-cell tubes. Remarkable distance is secured with this set because one of the three tubes is reflexed on a new principle developed by Ware, and the equivalent of a four-tube circuit is se-

cured. Tone quality is an outstanding characteristic of both the Ware receiver and the Sonora phonograph.

In the cabinet is provided a special tray for the dry-cell batteries. In addition, there are two record albums provided.

Sounds from the radio and the phonograph pass through the same tone passage. The Sonora phonograph is in one side of the cabinet and the Ware receiving set in the other.

For complete information, address our nearest Canadian distributor

Canadian Wholesale Distributors:  
The Otto Higel Co., Ltd., King and Bathurst Sts., Toronto  
J. J. H. McLean & Co., Ltd., 329 Portage Ave., Winnipeg  
Walter F. Evans, Ltd., 657 Granville St., Vancouver  
Switzer Bros., Ltd., 310 Hastings St. West, Vancouver

242 December 1924 \$235  
Radio is a Ware Model T.



C June 1925 \$90 Highboy-\$200  
Chassis made by Splittdorf. Cabinets designed by Joseph Wolff, vice president and production manager. Patents 67,983 and 67,984 filed on May 5 and 13, 1925.



Mr. George E. Brightson

## G. E. Brightson Dies Following Accident

Founder of Sonora Phonograph Co. and President of Firm Until His Retirement Succumbs to Injuries

George Edgar Brightson, founder of the Sonora Phonograph Co. in 1912, and president of the company until his retirement some three or four years ago, died in Bellevue Hospital, New York, in May as the result of injuries received when he was knocked down by an automobile truck at Lexington avenue and Forty-fourth street. He was seventy-seven years old.

Mr. Brightson was born in Brooklyn and was prominently connected in the business world before the organization of the Sonora Co. He was prominent as a yachtsman, and was active in racing along the Sound for forty years. He made his home in New York at 140 East Forty-fifth street, and also maintained a Summer home at Harbour Point, near Oyster Bay. He is survived by his widow and two daughters, both married. Funeral services were held at St. Bartholomew's Chapel on Monday afternoon and were attended by many members of the music trade.

Phonograph Journal of Canada (Dec. 1924)

Radio Broadcast (June 1925), p. 156-d

Talking Machine World (June 1928)

70,305. RADIOCABINET. JOSEPH WOLFF, Brooklyn, N. Y., assignor to Sonora Phonograph Company, Inc., a Corporation of New York. Filed Apr. 5, 1925. Serial No. 17,182. Term of patent 7 years.

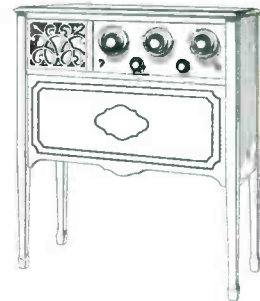

The ornamental design for a radiocabinet, substantially as shown.

# SONORA

## Sonora Phonograph Company, Incorporated

**S**onora was a large and well-established phonograph manufacturer by the 1920s. It is variously stated to have been an outgrowth of the Sonora Chime Co. in 1907 (*From Tin Foil to Stereo*) or to have been established in 1913 (*Poor's Manual of Industrials, 1924-1927*). In 1926, George E. Brighton, maker of True Blue Tubes, claimed to have founded Sonora and was, indeed, listed as board chairman in 1924.

At any rate, it was a large company with gross yearly sales of several million dollars, but it had nowhere to go if it dealt only in phonographs. So Sonora added radios to its line, although they were not made in its own plants but bought from Wireless Specialty, Ware, Splitdorf, or American Bosch.

Perhaps because the company was run by investment bankers rather than phonograph or radio people, Sonora seems to have gone through more than its share of mergers and financial deals. As early as 1917, its western distributorship became a founding part of Magnavox. In 1924, a number of other distributorships merged into one Sonora company, and again, in 1927, Sonora and some allied companies merged into the Aconstic Products Co. In mid-1928, the De Forest company was supposed to join, but somehow a large block of its stock was bought by various individuals instead of by the holding company, then resold at considerable personal profit. This affair was the subject of a lawsuit in 1931. In early 1929, Consolidated Radio Laboratories (Arborphone) was scheduled to join Sonora, and perhaps it did make the model line introduced in October 1928; but shortly afterward, Arborphone merged with United Reproducers.

On July 10, 1929, several board members resigned; almost immediately Aconstic Products bought Federal in Buffalo for \$225,000. Aconstic Products officially changed its name back to Sonora in September, 1929. But it hardly mattered as the company went into receivership in December (followed closely by United Reproducers) and its assets were auctioned in September 1930.



**Sonora**  
Phonograph and  
Radio all in one

**Sonoradio**  
CLEAR AS A BELL

*The best in Radio added to the best in Phonographs*

**T**WO great industries contribute their best to produce SONORADIO—a Sonora Phonograph combined in one convenient and beautiful cabinet with a most efficient Radio receiving set.

The Radio installation consists of a highly selective two circuit tuner with detector and radio-audio amplifier, using five UV 199 tubes; dry cell operated; its superb quality of reproduction being assured through the use of the famous Sonora "clear as a bell" amplifying tone passage.

*Sonoradio can be had of all Sonora Dealers*

**Sonora**  
RADIO SPEAKER  
With Consolidated De-Forest Horn

\$30

"Clear as a bell"

REPLACING the prominent exposed "horn" type of reproducing unit, the Sonora Radio Speaker brings to radio at last the same musical superiority that earned for Sonora Phonograph highest award for tone at the Panama Pacific Exposition.

For sale by Sonora Dealers and at good Radio stores everywhere. Make it a point to call and see them today.

Sonora Phonograph Co., Inc. New York City  
*Makers of Sonora Phonographs, Sonora Radio Speakers and Sonoradios*

New York Herald-Tribune (May 18, 1924)

241 February 1924 \$475  
The Radio is a Radiola IX.

# SONORA'S Twin Contributions

## The New Reproducing Sonora

Critics agree that this new Sonora achievement is the outstanding triumph in the new field of music reproduction. All the rich tone-color, warmth and magic of living music itself. A remarkable instrument that gives Sonora's world-famous tone full range of the entire musical register. Exquisite in design and finish.



AT \$275 · SONORA'S GREATER PHONOGRAPH · THE SYMPHONY

**C**RESCENDO of the full symphony—Limpid, flowing solo melody—Softest whispers from muted violins—Here at last is full musical justice for them all—in the New Sonora.

For a remarkable method of reproduction perfected by Sonora has added to the renowned Sonora tone new volume, range, and artistic completeness.

Hearing is believing! Ask your dealer to demonstrate the New Reproducing Sonora. And as you listen, note that Sonora cabinet craftsmen have produced new masterpieces of design and finish!



At \$95—The PRELUDE—greatest value in quality phonographs today—a genuine New Reproducing Sonora, with the perfected Sonora tone that gives new beauty to phonograph music. Cabinetwork of typical Sonora quality.



At \$125—The CONCERT—another model of the New Reproducing Sonora. Rich simplicity of design to harmonize in any setting. A real treat in the reproduction of any type of music.

**S O N O R A**  
C L E A R A S

THE SATURDAY EVENING POST

# to Lovers of Music



AT \$185 · THE "1927" STANDARD RADIO CONSOLE

WHEN Radio enthusiasm swung away from mere tuning-in and demanded clearer, truer reception, Sonora made a big contribution. The world-famous Sonora achievements in music reproduction were successfully adapted to Radio.

Now, in the new Shielded Six, Sonora presents a receiving set that puts Radio on a still higher plane of perfection.

Not only does this great set improve and combine every latest technical convenience, but it produces a rich depth and mellowness of tone never before heard in Radio music. And we honestly believe that it is the most beautiful radio you can buy today.

Your dealer shares this opinion! Ask him for a demonstration.

## The New Shielded Six Radio

Produces, we believe, a rich depth and purity of tone never before heard in Radio. A six-tube set completely shielded against interference. New improved Twin Unit Control combines single-dial convenience with double-dial distance. Typical Sonora cabinet beauty.



The new SONORA RADIO CONE SPEAKER. Attaches to any radio set—no extra batteries needed—\$25. Console model—with space for batteries—\$50. The Cone Speaker is built into the Sonora Shielded Six Console Radio shown above.



Sonora's new SHIELDED SIX RADIO is available as a straight set, at \$125, or in your choice of Console models priced up to \$225.

O R A  
A B E L L



The Shielded Six radio was first advertised in July 1926.

# Announcing THE NEW SONORA RADIOS

NOW A COMPLETE LINE IN RARE CABINETS FOR EVERY SETTING ~ AT PRICES FOR EVERY PURSE \$69.50-\$375 ~ SUPREMACY ~ ELECTIVE ~ KEENLY SENSITIVE ~ AND WITH THE TONE THAT MADE SONORA FAMOUS



E-870 ~ Six-Tube De Luxe Highboy, \$250



F-875 ~ Seven-Tube De Luxe Highboy, \$375



E-860 ~ Six-Tube Junior Highboy, \$165



E-865 ~ Six-Tube Standard Highboy, \$198



G-885 ~ Light-Six Highboy, \$135



G-880 ~ Light-Six Table Radio, \$69.50



Clock-Type Cone Speaker, \$27.50



E-850 ~ Selective Six Table Radio, \$99.50

SONORA offers a complete line of seven radio models covering a wide price range adapted to every purse. Sonora offers in its lowest priced model, at \$69.50, the tone, the reproducing quality and the supreme selectivity equal to those in its highest price sets at \$375. And Sonora stands apart as manufacturer of its own cabinets for every Sonora radio built. Sonora has a solid reputation and background of 15 years' experience in the field. Hitch your wagon to Sonora's soaring star. For this year's sales have already far surpassed last year's phenomenal record. Sonora offers you a dependable, permanent business, quick turnover, pleasant and profitable associations, a generous sales and advertising backing, and a line to handle which is acknowledged to be without rival in the industry. If you feel that you can handle Sonora adequately in your territory, we should be glad to hear from you.

SONORA PHONOGRAPH COMPANY, Incorporated  
SAGINAW, W. S.  
MICHIGAN

All models  
single dial  
control

**Sonora**  
CLEAR AS A BELL  
RADIOS-PHONOGRAPHS

E850 has the same chassis as Bosch 66.  
F875 has the same chassis as Bosch 57.

G880 has the same chassis as Bosch 46.  
AC model November 1927 \$250

Radio Retailing (Oct., 1927), p. 50

Sonora Receivers, Combinations and Phonographs

The Sonora Phonograph Company, Inc., 50 West 57th Street, New York City, announces its new line of radio receivers, radio phonograph combinations and phonograph models.

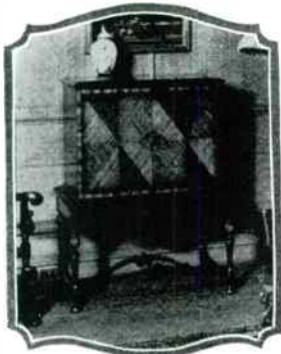

MODEL A-40

A combination model with a six-tube set which actually employs 9 tubes and operates on 110-volt; 60-cycle current and is also supplied for 25-cycle current. It has an automatic start and stop device.

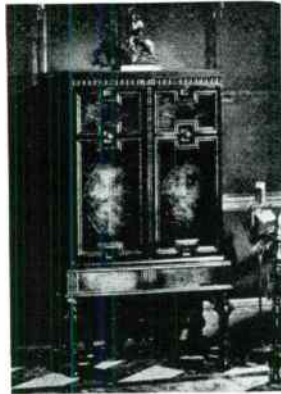

MODEL A-36

An A.C. radio receiver operating on 110-volt, 60-cycle current. It is a 7-tube set employing 11 tubes, and operates without antenna for local stations. It is of the William and Mary period and has recessed doors of crotch walnut, panelled in American walnut.



MODEL A-20

This is the new Sonora "Melodon," an electric phonograph. It operates on 110-volt, 60-cycle current. It may be also used for radio reproduction in combination with radio sets. It is equipped with automatic start and stop, non-preset device. The cabinet is of early Renaissance design; of butt walnut and crotch Australian walnut.



MODEL A-14

Models A-14 and A-12 are two phonograph models identical in character but different in cabinet design. Model A-14 is Heppelwhite, model A-12 is of conventional design. Both instruments have non-preset, full automatic stops. They have special Sonora double diaphragm reproducer and ball-bearing tone arms.



MODEL A-50 (left)

A dynamic, 10-in., cone speaker which can be employed with standard design radio sets equipped with output transformer. It requires 110 volts, 25 or 60-cycles.



MODEL A-32 (right)

This is a radio receiver with the same characteristics as model A-30, the only difference being in cabinet design.



MODEL A-30 (left)

A popular-priced, 6-tube radio set which actually employs nine tubes. It operates on 110-volt, 60 cycles. It has a self-contained speaker. The cabinet is of Australian walnut and rosewood overlay.



MODEL A-44 (right)

Another combination set, of English Renaissance in character with grained butt walnut panels and oak bull overlays. The electrical apparatus and characteristics are exactly the same as in Model A-46.

MODEL A-46

This is a radio-phonograph combination of the treasure chest type. It has Spanish grained leather canopies and bases of various designs. The radio receiver is a 7-tube set employing a full complement of 11 tubes and operates on 110-volt, 60 cycles. The phonograph automatically starts and stops all records without being preset.



A20 \$455 A30 \$190 A32 \$250 A36 \$470 A40 \$375 A44 \$695 A46 \$930

Cabinets for A20, A36, and A44 were designed by Carl Otto, patents 77,976-77,978 filed on November 13, 1928. Earlier models (not advertised) 3R, 4R, and 5R are shown in Rider and Gernsback manuals. A technical article on 5R appears in *Citizens Call Book* 10, No. 4 (Nov. 1929), p. 95.

Radio Retailing (Oct. 1928)

# THE SONORA MELODON

*in the homes of* Mrs EMILY DAVIES VANDERBILT *and*

Mr ANTHONY J. DREXEL BIDDLE Jr

**I**N the living room of Mrs. Emily Davies Vanderbilt's New York residence stands the magnificent Melodon—the new Sonora achievement that has so suddenly changed all ideas of the electrical reproduction of music.

There it yields to the ears of all its hearers a wholly new concept of the beauty which lies hidden in a phonograph record . . . superb rendition of every nuance . . . the true timbre of the human voice . . . the final purity of tone!

It is only natural that people who know the most about music are most prompt to recognize the perfection of the Sonora Melodon. In a long list of homes of well known people, the Melodon or the Melodon with Radio, is today installed.

For when these new Sonora instruments were first presented to a brilliant audience in New York, an assemblage of musicians, artists, scientists, patrons of the arts, lovers of music, men and women internationally known, their response was so immediate, their acclaim so enthusiastic, that Sonora stands today with

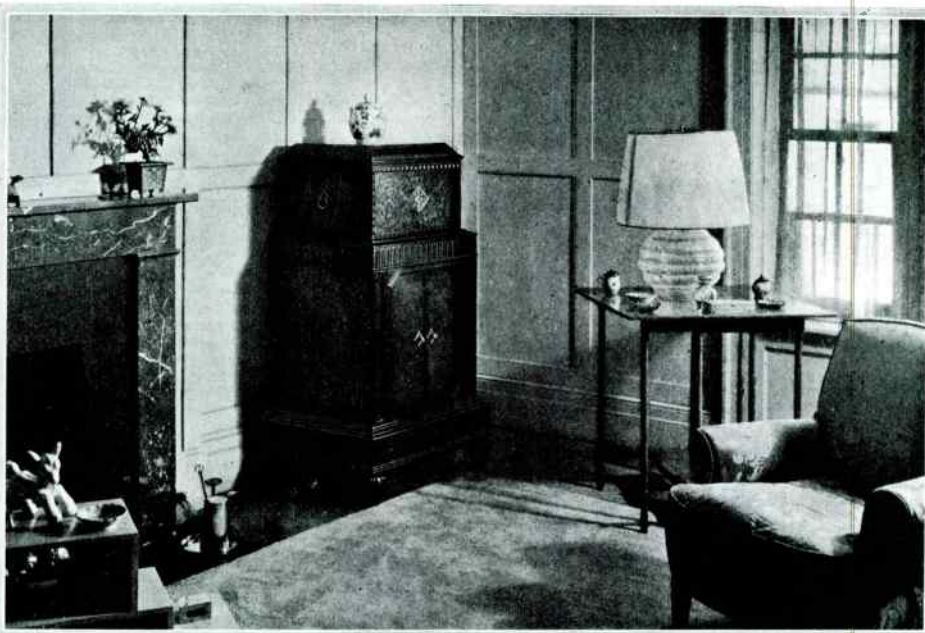

the sponsorship of many experts, for its very evident superiorities.

*The Sonora Radio  
with or without the Melodon*

You may have the Melodon alone, or in combination with Sonora Radio, as shown here in a corner of Mr. and Mrs. Anthony J. Drexel Biddle, Jr.'s, New York home. Or you may have Sonora Radio by its own perfect self.

For Sonora spans the great field of radio and recorded music and its new radios are as distinct and certain an advance as is the Melodon itself.

The Melodonic principle of reproduction permits Sonora to present a radio that may truly be termed a great musical instrument.

Gone is the consciousness of method and mechanism. You have aerial music in its purest and most lovely form.

For Sonora introduces advances easily perceived. Specifically, it employs the new Sonora



*Mrs. Emily Davies Vanderbilt's little town house at 176 East 75th Street has, in its beautifully simple living room, this A-20 model of the Sonora Melodon, where it charms the eyes as well as the ears of all.*

15-volt tubes, of long life and reserve power. This and Melodonic reproduction bring sweetness, charm, and musical virtuosity to radio music in your home.

Get in touch with your music dealer. Hear these Sonoras as soon as you can. They will be for you, as they have been for so many other music lovers, a new conception. And when you learn their cost you will be delighted that so much pleasure may be purchased for so little money!

For, once you hear these new Sonoras, no other instrument will ever seem the same!

Write for booklet to Sonora Phonograph Co., Inc., Dept. P118, Sonora Building, 50 West 57th St., New York City.

© 1928

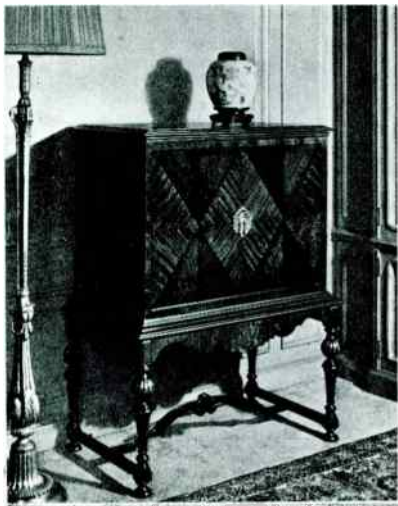

*When Mr. and Mrs. Anthony J. Drexel Biddle, Jr., of Philadelphia and New York heard the new Sonora instruments, they chose the Melodon with Radio (Model A-40, shown at left) for the library of their New York home*

**Sonora**  
CLEAR AS A BELL  
(Acoustic Products Company)

*The Saturday Evening Post, Nov. 10, 1928, p. 105.*

# ANOTHER SONORA TRIUMPH!

NEW in Conception  
NEW in Performance  
and... NEW in Price!

Designed and built entirely by SONORA

THE NEW

# SONORA RADIO

WITH  
**Synchro-tone  
Modulator  
and  
Screen Grid  
Tubes**

  
CLEAR  
AS A  
BELL



CABINET  
BY  
SONORA

**\$149<sup>50</sup>**  
less tubes

(Price slightly higher Denver west)

MODEL A-31, Lowboy. Three Screen-Grid tubes in three stages tuned R.F., Power detector, and one stage of Push-pull Audio. Synchro-tone Modulator. A pleasing cabinet of modified Gothic design paneled with rare specimens of Lace-wood and American Walnut. 110 volts, 60-cycle A. C. Available for other current supply. Dimensions: 44" High, 24" Wide, 13½" Deep.



CABINET  
BY  
SONORA

**\$179<sup>50</sup>**  
less tubes

(Price slightly higher Denver west)

MODEL A-33, Highboy. An attractive modified Colonial Period design built of such rare woods as Australian, African and American Walnut. French Chateau doors are of African Walnut. Chassis same as Model A-31. 110 volts, 60-cycle A. C. Available for other current supply. Dimensions: 48" High, 24¾" Wide, 15¼" Deep.

Also Sonora Radios and Melodion Combinations at prices ranging up to \$695.00.

**Sonora**   
CLEAR AS A BELL

A trade-mark of distinction that has been  
synonymous with fine music for 18 years.

SONORA, which has been supreme for 18 years in the manufacture of sound-reproducing instruments, now offers the sensational New Sonora Radio.

Designed especially for operation with Screen-Grid tubes and equipped with the exclusive Sonora Synchro-tone Modulator—this New Sonora Radio reproduces perfectly every musical note "clear as a bell." Never has such music come from any radio.

For the first time, you can now offer this superior Sonora instrument—the product of Sonora craftsmen and backed

by the famous Sonora reputation—at popular prices

And, further: Sonora is a complete radio line you can handle exclusively—a line that successfully meets any competition.

The New Sonora is merchandised extensively and uniquely by spectacular advertising and sales promotion campaigns that unquestionably will make Sonora the biggest sales sensation in radio.

Responsible dealers interested in the profitable Sonora franchise are invited to write immediately.

SONORA PHONOGRAPH COMPANY, INC.

Main Offices: Sonora Building, 50 West 57th Street, New York City  
Factories: Buffalo, N.Y.; Saginaw, Mich.; Bridgeburg, Ont., Canada

(Licensed under patents of Radio Corporation of America and Canadian Radio Patents, Ltd.)

World Radio History



## RADIO MANUFACTURERS OF THE 1920's

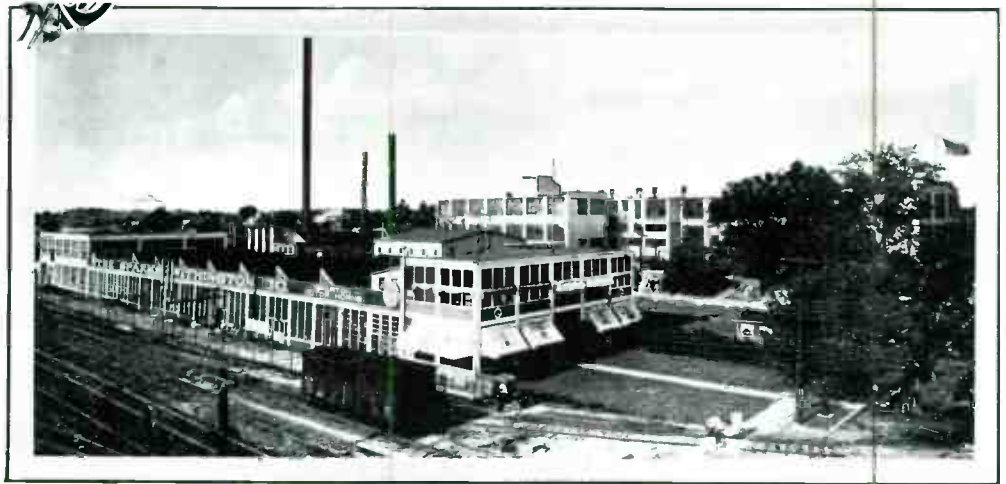

Plant No. 1 at Jackson, Mich.

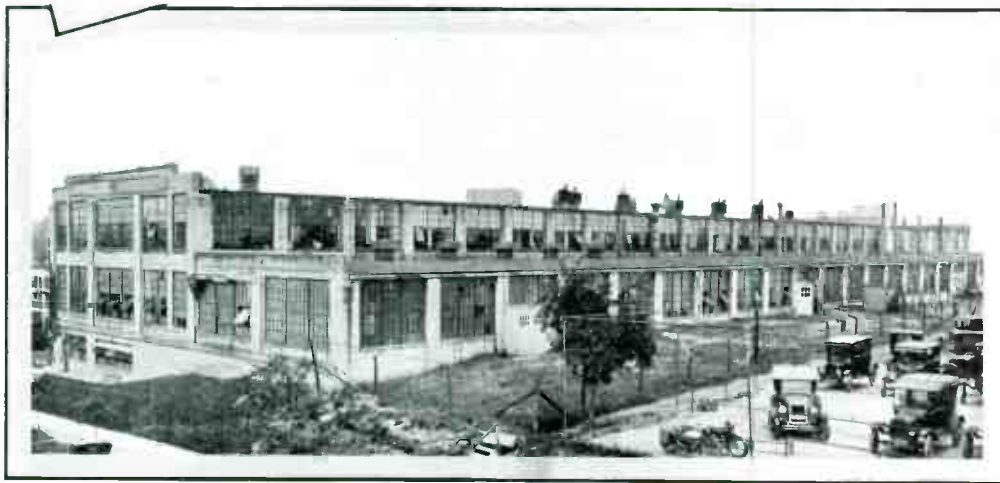

Plant No. 2 at Jackson, Mich.

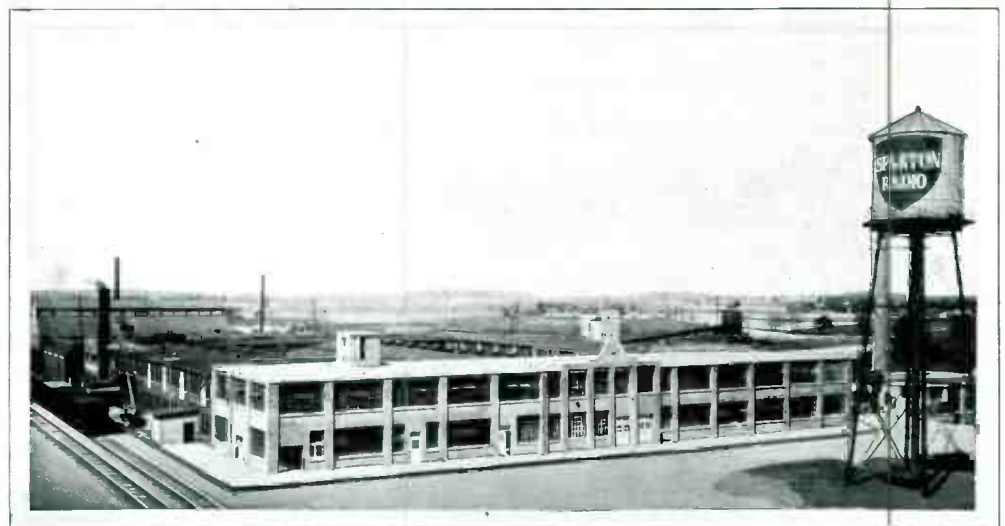

The factories in 1928 as shown in a sales promotion book.  
Plants 1 and 2 (adjoining) still exist but are no longer owned by Sparton.

# SPARTON

## The Sparks-Withington Company



Radio Retailing (Dec. 1927)

### Giving Paris the O. O.

Captain William Sparks, president of the Sparks-Withington Company, Jackson, Mich., and his Zouaves were features of the recent American Legion convention in Paris. The expression of keen delight so vividly registered on the Cap's features is undoubtedly caused by the fine showing his Zouaves made. The fact that a couple of good-looking French dames were passing by when the picture was taken had nothing whatever to do with it.

**I**n 1900, General W. H. Withington, head of a large agricultural-implement factory in Jackson, Michigan, set up his sons Philip and Winthrop in a partnership making small steel parts such as ferrules. After a few months, in need of a bookkeeper, they hired 27-year-old William Sparks, then running a grocery store, who had come to the U. S. from England with his parents at age 14. The Withingtons got much more than a bookkeeper in the bargain. Sparks quickly became the company's dynamo as it expanded into stamped steel parts for the growing automobile industry. By 1925, the company employed 500 people and was doing a substantial business in radiator fans and "Sparton" horns.

In December, 1925, Sparton began making radios (first advertised the following April) under license from Roy Weagant, former designer of the De Forest TRF models. Sparton was among the first manufacturers, with Cleartone, to embrace the Kellogg AC tube. This choice would dictate its course for many years to come; once having decided to use non-RCA tubes, Sparton needed insurance against Kellogg's capitulating to RCA and ceasing manufacture. When RCA began licensing other makers in 1927, "clause nine" in the contract required that all sets initially be equipped with RCA tubes. While this clause was successfully fought by the independent tube makers, in early 1927 Sparton was sufficiently worried to set up its own tube-production factory under the Cardon

name (after two of Sparks' grandsons: Carter, son of Clifford, and Donald, son of Harry). Now, with its own source of tubes made in sufficient numbers to be of excellent quality, there was no reason to have anything to do with RCA. In particular, there was no reason to take out a patent license and pay 7 1/2 percent of gross sales to a competitor.

As Sparton's sales continued to increase, other makers who *were* paying tribute insisted that RCA sue — which it did, in February 1928. Thereafter, Sparton switched to a circuit not covered by the Alexander TRF patent, a circuit invented by Lester Jones and available for license by his Technidyne Corp. at lower rates (a flat \$50,000) than RCA wanted. This led to the Equasonne models in mid-1928. To perform well, Jones' circuit required RF amplifier tubes with tightly controlled grid-to-plate capacitances — no problem for Sparton since it now made its own tubes — and the 484 tube was the result.

When RCA began to sue under other patents, Capt. Sparks finally signed on the dotted line in May 1929; doubtlessly, he won royalty concessions by proving that Sparton was not only willing, but quite able to carry on alone. In turn, he reportedly licensed RCA in turn under some of Sparton's patents. Now that there was no need for a Technidyne license, after offering Jones a one-time fee of \$100,000 for 1929-1930, which was refused, he simply stopped paying. Jones sued in April 1930 for \$280,000.

As the patent-license situation stabilized, there was also no need for a separate tube-making company, so Cardon Phonocraft (itself a merger of two companies from July 1, 1929) was merged into Sparks-Withington on September 23, 1930. From a peak of 4000, employment was down to 2000 by this time.

Unlike most of its competitors, Sparks-Withington made a substantial profit in 1930, but then struggled with deficits for much of the Depression. However, it did survive, making radios and televisions until 1958 when certain related assets were sold to Magnavox. The Sparton Corporation (its name changed in October 1956) still exists, stronger than ever, largely in the defense business, and still in some of the original Jackson factory buildings.

**SPARTON RADIO**  
*"The pathfinder of the air"*

*The Sparton Consolette*

Beautiful—dignified—shapely with that subdued richness so pleasing to people of good taste. In velvety two-toned walnut with ample room for all accessories.

Truly a value without precedent—and best of all—the product of SPARTON whose quarter century reputation insures the highest attainable perfection.

Combined with the SPARTON 5-26 5 tube receiver as illustrated  
 —Price \$118. Q Western and Canadian prices slightly more.

THE SPARKS-WITHINGTON COMPANY (Established 1900) JACKSON, MICHIGAN

Sparton Radio is built by the manufacturers of the world-famous Sparton horns for motor cars. Its production is a logical development of the Company's quarter-century of precision manufacture of electrical equipment.

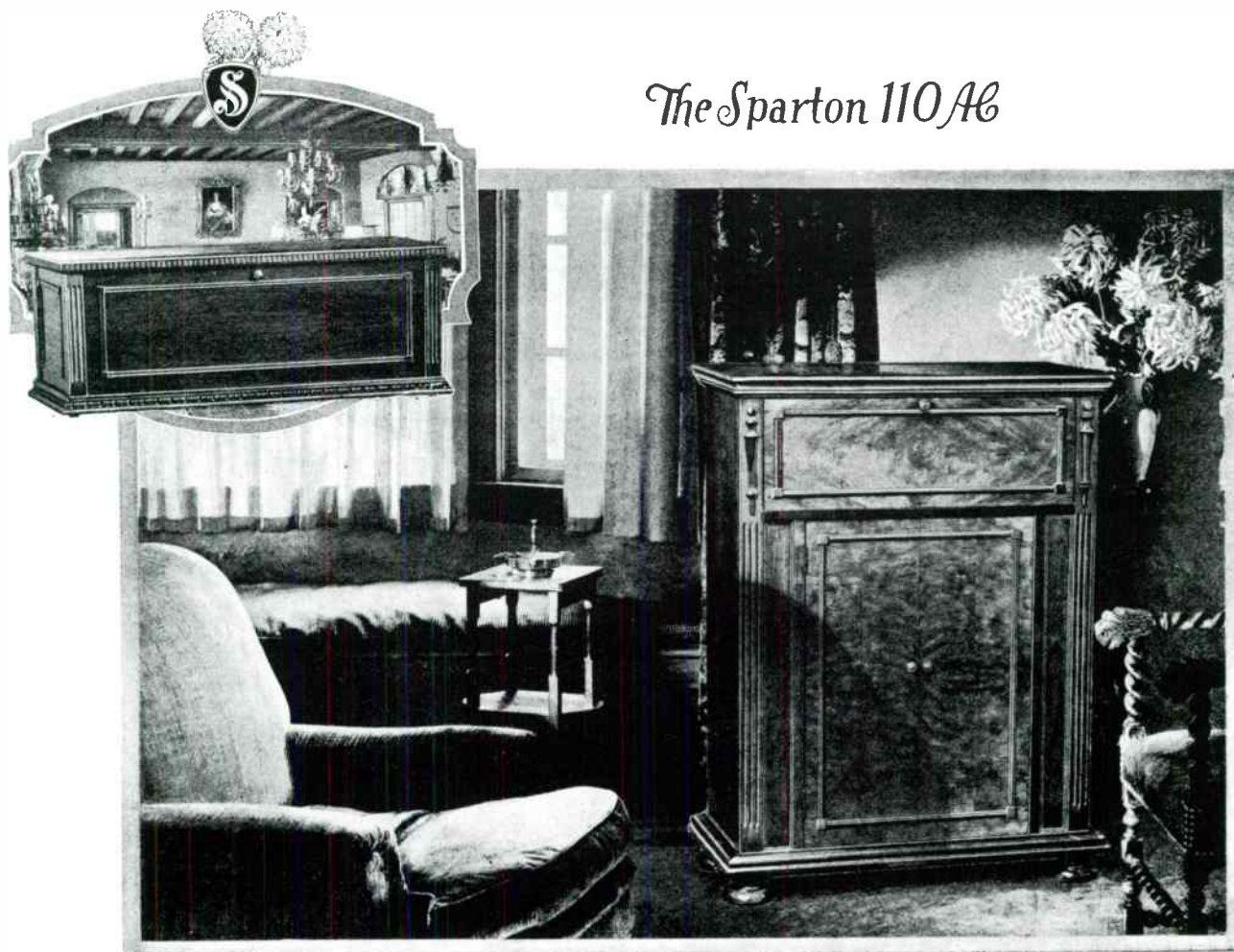

## At Last ~

NO A batteries to recharge—no B batteries to run down—no eliminators—just plug in to the regular house lighting circuit and enjoy beautiful music and splendid entertainment uninterrupted.

The Sparton 110 AC is truly the ultimate ideal that Radio lovers have been longing for. Nothing else to buy—complete with tubes all ready to enjoy.

Two beautiful two-tone walnut five tube models with the special Sparton balanced circuit and two dial control.

Tuning the Sparton is as easy as turning a page. Simply turn the right hand dial until center open-

ing shows the wave length of the station you desire. Turn the left hand dial to corresponding figure in the right hand opening and the program comes in full, rich and perfect. You can throw away the tiresome log book, as your newspapers always print exact wave lengths in their daily programs.

The new feature coupled with the special Sparton method of balancing produces the most perfect reception and tone quality of any one or multiple dial sets of which we know.

In all fairness to yourself see, hear and operate a Sparton before you buy.

AC Cabinet Model, Price \$260. AC Console, Price \$360.  
Full line of battery operated models, \$63 and upward.

*Sparton Radio is built by the manufacturers of the world-famous Sparton horns for motor cars. Its production is a logical development of the Company's quarter-century of precision manufacture of electrical equipment.*



# SPARTON RADIO

THE PATHFINDER OF THE AIR

THE SPARKS-WITHINGTON COMPANY, JACKSON, MICHIGAN

Model 6-26  
Battery Operated

Model 6-15  
Battery Operated

AC-6 Cabinet  
Electric Operation

AC-7 Cabinet  
Electric Operation

Announcing  
the  
NEW SPARTAN  
MODELS

The Sparta Radio Co. Inc.  
New York, N.Y.

6-15 July 1927 \$68

Different illustration in Sept.— see facing page.

AC 6-15 July 1927 \$188

Replaced by AC 62 (62) in October.

6-26 July 1927

Different illustration in Sept.— see facing page.

AC-6 July 1927 \$215

Replaced by AC 63 (63) (62 in drop-front cabinet, with minor chassis changes).

AC-7 July 1927 \$375



62 Flea market



**Model 6-15**  
 Battery Operated  
 This also illustrates the  
 AC 6-15 Electric Model

**Model 6-26**  
 Battery Operated

Sparton Electric AC-7  
 Console (without batteries  
 of any kind) is shown in  
 center illustration

## NOT Limited to Higher Priced Field !!

The market for Sparton Radio is not limited to the higher priced field. Sparton instruments priced as low as \$68 enable dealers to present models suited to every purse.

As the public learns that

there is no price premium on Sparton craftsmanship and Sparton tone, Sparton sales mount to even more amazing heights . . . An inquiry will bring you an eye-opening story.

THE SPARKS-WITHINGTON COMPANY

*Pioneers of Light Socket Radios without batteries of any kind*

JACKSON, MICHIGAN, U. S. A.

# SPARTON RADIO

*"The Pathfinder of the Air"*

(123)



*The EQUASONNE*  
Cabinet Set on Cabinet Speaker  
MODEL 69                      MODEL 29

Shown in the above photograph on the Sparton Equasonne Cabinet Speaker. Together they make a very handsome combination giving true Equasonne reception at a price within reach of all.

Price, complete with tubes, \$199.50



*The EQUASONNE*  
Open Console  
MODEL 79-A

An Equasonne set with every one of the patented features found in the Senior Console. The Equasonne built-in speaker is made especially for this model and is balanced perfectly to the instrument. A marvelous set at a very reasonable price.

Price, complete with tubes, \$229.50



*The EQUASONNE*  
Senior Console - MODEL 89

The magnificent Sparton Equasonne with built-in Equasonne speaker of matchless tone in a complete console of rare beauty. Light socket-operated with seven tubes and the exclusive pre-tuning and amplifying features that make Equasonne reception the marvel of modern radio.

Price, complete with tubes, \$375.00

79 August 1928 \$199.50      89 August 1928 \$375.50  
Not shown: 99 August 1928 \$875

**I**N ADDITION to the remarkable uniformity in selectivity throughout the broadcasting wave band, there is a complete elimination in this set of all balancing or neutralizing elements. The usual intermediate stage of audio amplification is also eliminated. A 25-watt power tube may be operated direct from the detector.

All the selecting is done direct from the antenna. The impulse passes through a single dial detector unit which allows a band of 10 kilocycles to pass. No tubes are employed in this new "band pass filter" selector. As radio listeners are aware, existing types of sets suffer much variation in selectivity, tuning more broadly at short wave lengths than in the long wave lengths of the upper portion of the dial. As a result, in such sets, it becomes almost impossible to receive distant stations below 250 meters without much interference and background of noise.

The new Equasonne selects so accurately that this noise and interference is eliminated as completely in the short wave lengths as in the long. It makes the set a pre-selective one, for all the tuning is done before there is any amplification at all. No impulse from adjoining channels is admitted into the amplifier or detector units with the idea

of filtering it out at a later stage of the process. The amplifier unit is as revolutionary in its operation as the selector units. With 6 tubes, one of them operating as a detector tube, it amplifies the impulse received 15,000 times instead of the usual 5,000 times. Even the most sensitive of present day sets rarely go above 8,000. This amplifier is unique in that it automatically tunes itself to the incoming frequency no matter what the wave length.

The Equasonne circuit exhibits absolutely no tendency to oscillate. The necessity for balancing or neutralizing condensers is therefore eliminated. A feature of the new detector circuit is that it can cope successfully with the relatively large voltage furnished it by the amplifier without overloading or distortion. The detector can handle up to 40 or 50 volts instead of the customary 2 or 3 and this permits working direct into the grid of a 25-watt power tube without an intermediate stage of audio amplification. This elimination of one audio stage improves the tone quality and materially reduces the background of tube noise and alternating hum. Much improvement has also been obtained in the ratio of signal to static, thereby reducing this interference,

# ↓ EQUASONNE

Best "Voice"



*The EQUASONNE*

*Console De Luxe* - MODEL 109

A complete electric console with a thrilling tone perfection that is fairly breath-taking in its exquisiteness. This model has a special built-in free edged moving piston type speaker, ultra-powered and as grippingly harmonious as a rare old cello. Encased in a carved walnut cabinet of beautiful appointment.

Price, complete with tubes, \$495.00

109 August 1928 \$495

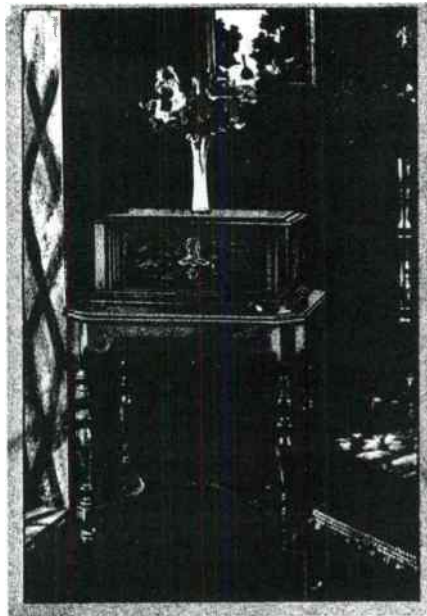

*The EQUASONNE*

*Cabinet Set*

MODEL 69

This Sparton Electric *Equasonne* cabinet set is, we believe, the greatest value in the entire radio field at anywhere near its price. A beautifully finished instrument containing the same remarkable pre-tuned *Equasonne* chassis as in the Open console.

Price, complete with tubes, \$147.00

69 August 1928 \$149.50

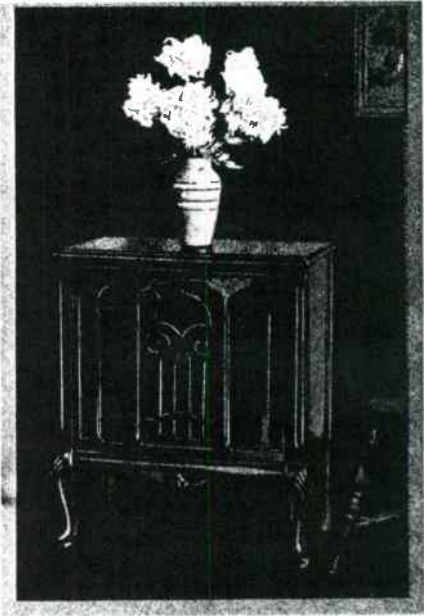

*The EQUASONNE*

*Cabinet Speaker* - MODEL 29

This perfectly balanced *Equasonne* built-in Cabinet Speaker produces a deep, resonant tone of wonderful volume. Both the high and low musical notes are delivered with absolute fidelity. Although designed particularly for the Sparton it can be purchased separately and used with any radio cabinet set.

Price, \$52.50

## SPARTON EQUASONNE

*A Revolution in Radio Circuits*

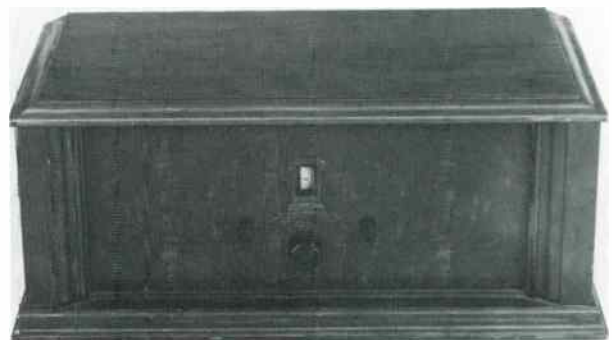
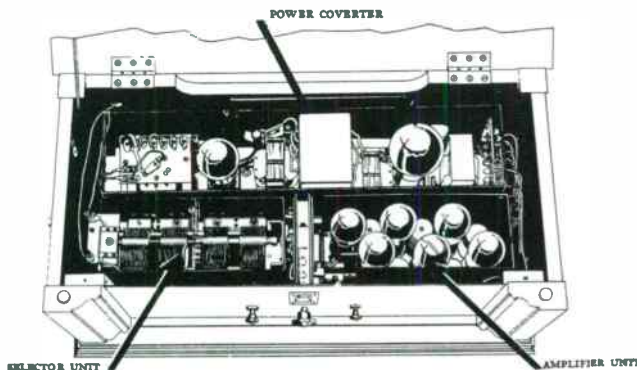

Undated flyer (probably late 1928)





**The New EQUASONNE**  
Model 301  
An exquisitely carved high-boy of pure Italian design, ultra-powered and as grippingly harmonious as a rare old cello.  
Complete with tubes... \$274.50



**The New EQUASONNE**  
Battery Model 49  
Simple... selective... powerful. With the same characteristics of the all-electric models. Has unusually low battery consumption with remarkable volume and the exquisite tone purity found only in the Equasonne instruments.  
Price... \$75.00  
Tubes Extra



**The New EQUASONNE**  
Model 930  
A remarkable Equasonne instrument of the popular low-boy style. The Equasonne dynamic built-in speaker is balanced perfectly to the circuit, producing a tone and volume that is truly marvelous at a price most reasonable.  
Complete with tubes... \$169.50

*The New*  
SPARTON  
**EQUASONNE**  
"Radio's Richest Voice"

**The New EQUASONNE**  
Model 951  
A complete new low-boy electric console with wonderful eye appeal. The face-to-face realism of this remarkable instrument will amaze you with its wonderful volume and tone fidelity.  
Complete with tubes... \$179.50

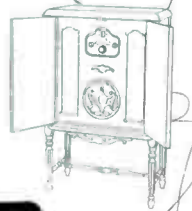

**The New EQUASONNE**  
Deluxe Model 110  
A complete electric console with a thrilling perfection that is fairly breath taking in its exquisiteness, encased in a carved walnut cabinet of beautiful appointment.  
Complete with tubes... \$395.00



**The New EQUASONNE**  
Model 89-A  
A magnificent console of matchless tone quality with all the exclusive Sparton features. Truly a marvel of modern radio.  
Complete with tubes... \$375.00



Not shown: 101 radio-phonograph \$795



October 1929 models: 931DC, 301DC; same prices as AC. 111, same chassis as 110.

Sparton claimed to be fourth in industry sales in 1928. If so, it would have been outranked only by Atwater Kent, RCA, and Crosley. Technical article on 301 appears in *Radio* (Sept. 1929), pp. 27-28.

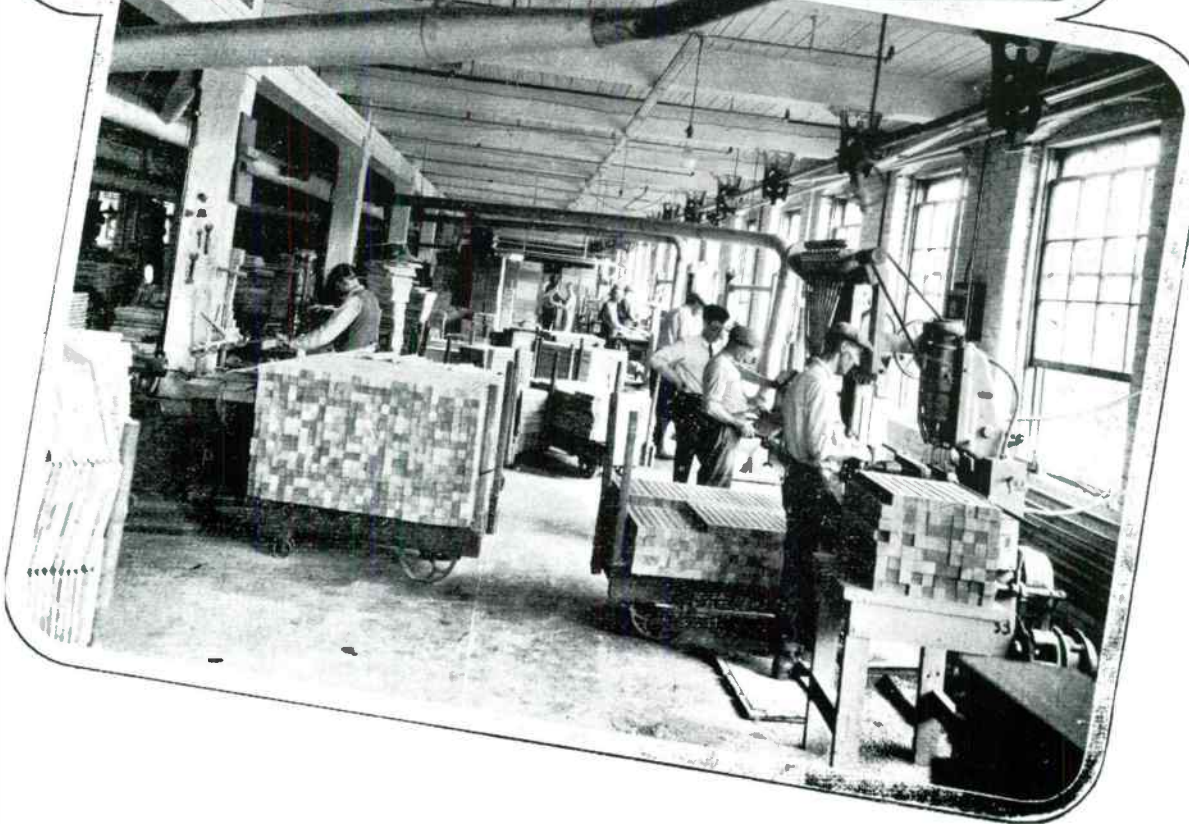

Sales book (1928)



# Splitdorf

## A FIVE TUBE SET FOR THE PRICE OF A THREE

A complete kit for building the famous SPLITDORF Five-tube Master Receiver, packed in a neat container, each assembly resting in its individual compartment. With this kit comes a complete instruction booklet. It describes every step in the construction of this marvellous circuit. It is impossible to go wrong. All holes are marked and keyed and the panel drilled. An electric soldering iron accompanies each set, also one pair Head Phones and Phone Plug.

**THE PRICE COMPLETE IS ONLY \$100.00**

This is a splendid opportunity for you to get a five-tube set for the price of a three. When you have built it, you will take pride in the ownership of one of the most talked of circuits radio engineering has produced. The name SPLITDORF is your guarantee.

Complete assembled sets (same as knocked down) but in walnut cabinet. Price \$175.00.

**The SPLITDORF ELECTRICAL CO., Limited** 490 Yonge Street  
Toronto, Ontario

Radio (Toronto) (Jan. 1925)

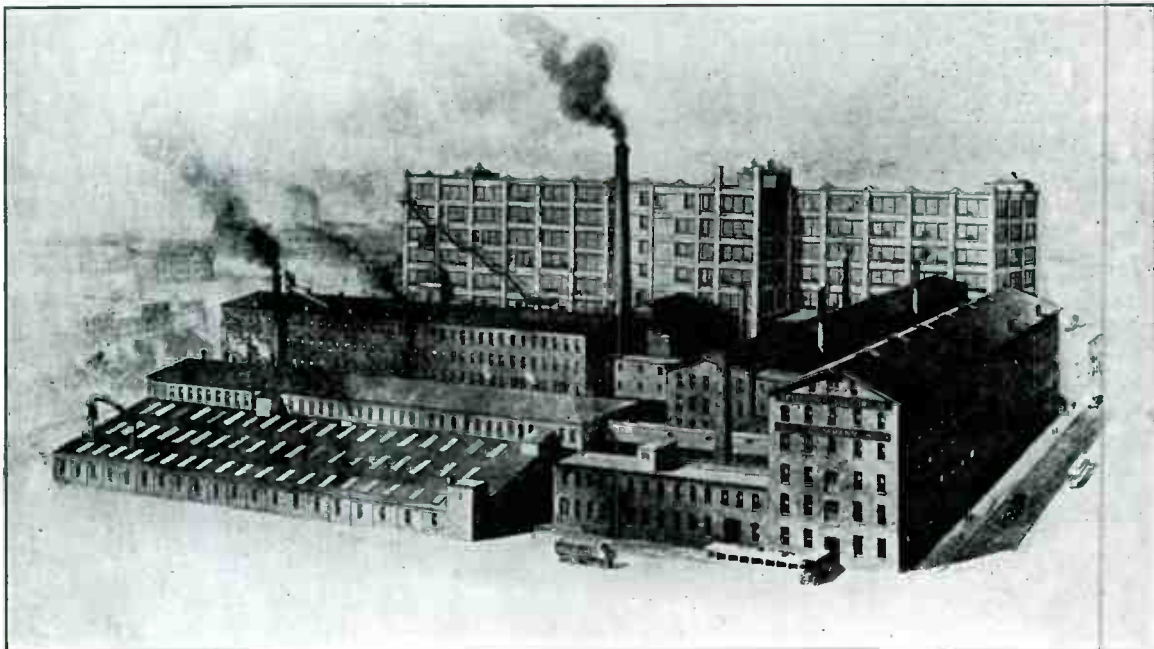

Plant of the Splitdorf-Bethlehem Electrical Company in Newark, N. J.

Radio Guide (Dec. 1925)

# SPLITDORF

## Splitdorf Radio Corporation

**S**plitdorf is notable for its effect on the rest of the radio industry more than for its own products.

It was a very old company—established in 1858—probably by Henry Splitdorf, who was an active patentee of telegraphic apparatus after 1865. By 1895, Charles F. Splitdorf was advertising induction coils and electromagnets, and within a few years,

was specializing in spark coils and ignition coils. His business was re-incorporated as the Splitdorf Electric Co. in 1912. In December 1924 it was absorbed by the Bethlehem Spark Plug Co., which changed its name shortly afterwards to the Splitdorf-Bethlehem Electrical Co.

In June 1926 Splitdorf was sued by RCA for infringement of the Alexanderson TRF patent. This



Bob Dennison

Splitdorf Crystal set. No advertising has yet been found, but this set is dated November 10, 1921 on its base in pencil. Newark's first station WDY went on the air on December 14, 1921.



CHARLES M. SCHWAB



H. V. BARTLETT

Radio Guide (April 1925) p. 16.



Model R-100

R100	Nov. 1924	\$150
R102	Nov. 1924	\$235 console

Technical article in *Radio Engineering*, Jan. 1925, pp. 24-29; *Radio Review*, July 1925, pp. 53-54, 60 (taken from *NY Telegram and Evening Mail*)

# SPLITDORF RADIO RECEPTION

## The Polonaise

Five tubes. Inherently neutralized. Encased in attractive, hinged-top cabinet, finished in the latest two-tone effect—dark walnut and light natural grain. Price, \$75. The Grande Speaker, illustrated with set, \$22.50 extra.



## What Splitdorf has made possible for you

**MUSICAL TONES**—clear, pure, mellow! Speech—sharp, distinct, understandable! Volume—when volume is desired. Distance—if that is your pleasure. And, beyond all the qualities of the reception is the absolute assurance of unflinching, dependable performance—always.

Splitdorf Receivers embody the most advanced principles of radio design. But the receiver itself is only a part of Splitdorf Radio Reception. The method by which Splitdorf Receivers are distributed assures you of more than merely a good receiver.

The merchant who sells you a Splitdorf model will make it his business to see that you get the service, the SATISFACTION, that the receiver is capable of giving.

SPLITDORF ELECTRICAL COMPANY  
Newark, New Jersey  
Subsidiary of  
Splitdorf-Bethlehem Electrical Company



### The Mikado

This creation of Japanese design includes console table and receiver. A five-tube, inherently neutralized, electric-lighted, enclosed dial, built-in speaker model. Individually decorated by hand by Japanese artists. Price, \$485.



### The Rhapsody

Five tubes. Inherently neutralized. New electric-lighted tuning controls. Desk type console of solid American Walnut. Built-in speaker. Price, \$420.



### The Geisha

A five-tube, inherently neutralized receiver. Encased in special creation of Japanese design. Individually decorated by hand in Japanese rendering. Price, \$110.



### The Grande

A large bell, swan throat speaker of exceptional tonal quality. Equipped with adjustment for controlling volume and tone. Satin black finish. Price, \$22.50.



### The Cello

A high-grade, curved throat, composition bell speaker. Large metal base. Adjustment feature permits of regulating tone and volume. Black finish. Price, \$10.



### The Nocturne

Five tubes, inherently neutralized. New electric-lighted, enclosed dial panel. Built-in speaker. American Walnut cabinet, paneled, natural finish. Price, \$150.

R500 Polonaise Aug. 1925 \$75

Oct. 1925 models: Geisha \$110, Nocturne \$150, Rhapsody \$410, Mikado \$425.

episode, which profoundly affected the future course of radio development, is best described by B. F. Miessner, whose work at John Hays Hammond's Gloucester, Mass. laboratory predated Alexander-son's. His notebook and testimony were to be the basis of Splitdorf's appeal from its original defeat in February 1927.

*"A more important encounter (though also indirect) came in 1926, in the famous suit against the Splitdorf Electrical Co. Alexanderson had taken out a patent (U.S. Patent 1,173,079; Oct. 13, 1913) on a selective tuning system that was significantly similar in its claims to the disclosures that had been made to him during his visit to Gloucester in 1912, as I have related. The patent was assigned to General Electric Co. and later cross-licensed to Westinghouse Electric and Manufacturing Co. and to Radio Corporation of America. Almost every radio manufacturer was using cascaded circuits of some sort and thus infringing on the patent held by the three major companies. As is customary in such cases, a suit was brought against one of the small manufacturers, Splitdorf Electrical Co., who had to bear the brunt of the defense; if infringement could be shown, every radio manufacturer who was using tuned, cascaded, vacuum-tube amplifier circuits for selective tuning would thereafter have to pay license fees. The suit (Equity No. 1669) was brought in the U.S. District Court, District of New Jersey, at Trenton, before Judge J. L. Bodine.*

*The RCA-G.E.-Westinghouse group won the first round of the litigation with an interlocutory decree. Splitdorf immediately set out to appeal Judge Bodine's decision. Extensive testimony was contained in the appeal, a good deal of it my own. At the beginning of the litigation, I was chief engineer of Garod Radio Corp. in Belleville, N.J., one of my first licenses for the "all-electric" radio receiver containing an AC rectifier. Splitdorf became another one of my licensees, among the first of about 20 that were based on my rapidly growing list of patents, all handled for me by Loftin. The Splitdorf brief relied heavily on my corroborated testimony and notebook records, showing prior use and disclosure to Alexanderson and to Hammond of the subject matter of the Alexanderson patent. (Prior work by the German group Schloemilch & von Bronk was also cited.) My RF-IF-AF selective system and the tuned cascaded RF vacuum-tube amplifier circuits described in my notebooks are reproduced in this brief. My corroborated testimony was never disputed by Alexanderson (who sat there throughout the proceedings), Hammond, or anyone else; in fact, Hammond never even attended the trial. Two portions of the appeal brief are reproduced in Appendix I.*

*On a Sunday afternoon in March 1927 Edwards (the Splitdorf counsel) was in Philadelphia to study the brief further and to prepare his oral presentation, which was scheduled for the next day before the U.S. Circuit Court of Appeals for the Third Circuit (No. 3561, March term, 1927). But the appeal was never presented!*

*Everyone had assumed that Splitdorf had settled out of court rather than to face an injunction; the story was that the RCA group had offered to settle the suit if Splitdorf would pay a \$150,000 down payment and a 7.5% royalty on their radio-receiver production. But there are reasons to assume that this is not what happened at all. A few years ago I stumbled on what I believe to be the answer to the mystery.*

*I was well acquainted with the members of the management team of Splitdorf. Walter Rautenstrauch (of "Technocracy" fame) had been called in by President Edward Schwab as a management consultant from Columbia University to reorganize the ailing business. I knew them both, as well as Donald Ross, Rautenstrauch's appointee as treasurer; H. B. Shearer, the radio sales manager; A. D. T. Libby, their patent attorney; Paul Ware, the chief radio engineer; Charles T. Jacobs, who later became my patent attorney; and several other officers and engineers. None of these officials would ever disclose the details of the termination of that patent suit. Schwab, Rautenstrauch, and Ross maintained a tight-lipped silence. In later years, when I became well acquainted with members of the RCA patent department during negotiations over my own patents, I tried to get the story from them and once I even asked David Sarnoff, RCA's chairman of the board, directly. None would comment.*

*Not until March 1950 during a conference with Libby (who had in the meantime started a private practice as a patent attorney and was working in that capacity for me on a group of my own patent applications) did I get an inkling of what might be the true answer. I made some notes on his comments, according to which it appears that one of Splitdorf's former executives was in Libby's office one day when I phoned him, which led them to talk about my part in the litigation and its termination. Libby was naturally interested, since he had been involved in the case himself and was in fact at home that Sunday when Edwards phoned him from Philadelphia telling him that he had better get down there that afternoon so they could go over the plans together. While he was getting ready to leave for Philadelphia, another telephone call came through from Rautenstrauch saying that the case had been settled. Neither Libby nor Edwards had the slightest suspicion that settlement negotiations were going on and they were extremely*

# Splitdorf Sets Stay Sold

THE Splitdorf line for the 1926 radio year includes two wonderfully efficient receivers, each equipped with the new Super Power Switch, and two highly developed speakers. It, also, includes a full line of up-to-the-minute radio consoles, radio tables and other specialties to meet an exacting demand.

The Splitdorf is a line that will meet the requirements of the critical, well-informed buyer who wants his radio to be a permanent investment and always give uninterrupted SATISFACTION. Write or wire for "The Nine Vital Points," showing why you can succeed with Splitdorf.

SPLITDORF ELECTRICAL COMPANY, 392 High Street, Newark, N. J.  
Subsidiary of Splitdorf-Bethlehem Electrical Company

Note: Models RV-580 and RV-695 are equipped with the Splitdorf Super Power Switch, the greatest radio development of the year. Makes receivers equally efficient on all wave lengths.



**SPLITDORF Receiver Model RV-695**

This set is a SIX tube, inherently neutralized, two control receiver having three stages of radio frequency amplification, detector and two stages of audio. The Splitdorf Super Power Switch—a feature that materially increases the efficiency and volume of the receiver at higher wave lengths—also is a part of this receiver. Wired to permit use of power tubes. Entire receiver only 22 inches long overall by 12½ inches deep by 10 inches high. Encased in a Walnut cabinet, lacquer finished in two-tone effect. Price, \$95



**SPLITDORF Receiver Model R-560**

A five tube, inherently neutralized, tuned radio frequency receiver designed to combine simplicity and ease of operation with economy both in first cost and maintenance. Large tuning dials which make accurate tuning easy. Encased in attractive, hinged-top cabinet lacquer finished in two-tone effect—dark Walnut and light natural grain. Five-terminal cable, permanently attached to rear, permits of making battery connections easily. Price, \$60



**SPLITDORF Receiver Model RV-580**

Five tubes—an inherently neutralized, tuned radio frequency receiver. Equipped with vernier tuning dials and straight line frequency variable condensers of Splitdorf design. Located at the lower center part of the panel is the Splitdorf Super Power Switch, which greatly increases volume on weak signals, especially on the higher wave lengths. Wired to permit use of power tubes. Encased in attractive piano-hinged top cabinet, lacquer finished in two-tone Walnut. Price, \$80



**SPLITDORF Console Model C-215**

Equipped with Model RV-695 Receiver  
Fitted with the Duo-dial SIX Splitdorf Receiver, this console creation represents the latest development in radio appointments for homes of refinement.

Model C-215 fitted with RV-695 Receiver  
Price, \$215



**SPLITDORF Cone Speaker**

The Splitdorf Cone type speaker is supplied with a handsomely finished base for use on table. Also equipped with silk cord for hanging. Price, \$25



**SPLITDORF Speaker Model D**

This is a smooth-finish, large horn of special rubber composition. A warm-voiced speaker of exceptional tone quality. Will handle exceptional volume without distortion. Price, \$22.50

(Prices slightly higher west of Rockies and in Canada)

# Succeed with Splitdorf

R560 Aug. 1926 \$60  
RV580 July 1926 \$80

RV695 July 1926 \$95  
C215 Aug. 1926 \$215



John Drew

surprised, upset, and even chagrined, since they felt very strongly that Splitdorf would win on appeal. What had happened, the Splitdorf executive now, many years later, explained to Libby, was that RCA indeed negotiated a \$150,000 out-of-court settlement, but only as a formality. The Splitdorf executive had access to the account books and said that the sum was never paid to RCA, nor were any subsequent royalties ever paid by Splitdorf. What had evidently happened was that RCA realized that they were licked, and rather than to lose a tremendous opportunity of licensing the entire industry, they proposed the settlement, at the same time assuring Splitdorf that they would never enforce its terms or collect any royalties. It does not take much imagination to see that RCA stock, then depressed because of the cloud of prospective litigation that hung over it, would rise tremendously on the news that Splitdorf had caved in and was taking out a license; anyone in a position to anticipate the rise by buying up all the RCA stock available before the news reached Wall Street would naturally clean up on the stock market. The Splitdorf executives were thus faced with the choice of prolonged litigation on the one hand, or a large potential personal gain, a free license, and no royalties (as royalties were never actually paid) on the other. From the viewpoint of the patent-pool group, the case would be pseudo-adjudicated, leading to a license stampede by the rest of the industry and tremendous profits from license fees in the coming years, not to speak of royalty payments. Even though the original patents have long since run out, the licenses that were taken out because of them are still running with other patents, a situation from which RCA especially has profited tremendously over the years.

That is the story; I do not vouch for its accuracy, but it is extremely plausible. If it is untrue, perhaps one of the participants will now provide documented proof to repudiate it. I have no doubt that all these events could have taken place as described without violating the letter of the law; many worse shenanigans in fact went on during those happy-go-lucky days before the Depression.

Whatever actually happened, it is a fact that the

negotiated settlement with Splitdorf, which stopped the appeal, left the first court's unappealed decree standing, which served as warning to all the other infringing radio manufacturers in the industry who were anxiously watching the trial and its outcome to rush in, hats in hand, for a license from the RCA-G.E.-Westinghouse patent pool." (From the book *On the Early History of Radio Guidance*, San Francisco Press, 1964, by permission.)

Some of these events were corroborated by *Radio Retailer and Jobber* of June and August 1927; and there seems little reason to doubt that Miessner's account is accurate, except that the minimum royalty payment was \$100,000 and not \$150,000.

Splitdorf's capitulation may have caught Atwater Kent by surprise. Kent had been following the case closely, even considering combining legal forces (it was extremely important to RCA to sign up Kent, the industry's largest manufacturer and one of the most profitable). Kent was well aware of Miessner's notebook and its damaging effect on the Alexander patent, but he eventually took out a license rather than press his court case; the implication is that he won substantial concessions from RCA, just as Splitdorf had done.

Unfortunately, Splitdorf's losses continued; it dumped \$2 million worth of unsaleable inventory about April 1928. In June, it began an association with Edison, at first manufacturing for Edison. But by January 1929 they had practically merged. By





AN EXPRESSION OF  
*BEAUTY*  
IN RADIO

The novelty of radio reception no longer excuses a complete lack of beauty in the appearance of the receiver. In new instruments of lasting charm and permanent decorative distinction, Splitdorf combines perfection of musical reproduction with furniture of rare and appealing beauty.

Built around the Splitdorf single dial six-tube receiver, noted for its superlative performance, are authentic reproductions of beautiful period furniture—made by master craftsmen and approved by world-renowned interior decorators.



The Abbey. Modeled from an Old World jewel case. Deep antique walnut. Price for battery operation \$100, for all-electric operation \$175. Tubes not included.

The Lovers (shown). In the spirit of the Italian Renaissance. Equipped with the new Splitdorf all-electric receiver, operated completely from a light socket without batteries or dynamo. Price with built-in loud-speaker, but without tubes, \$350.

Every detail of these magnificent cabinets is authentic—correctly treated and beautifully done.

Their rare beauty and excellence of workmanship make them acquisitions of unchanging worth and enduring loveliness. One of these new Splitdorf receivers in your home will remain a source of pride to you, both for its charming decorative value and its musical perfection.

Twelve models priced from \$800 to \$45. Prices apply only east of the Rockies.

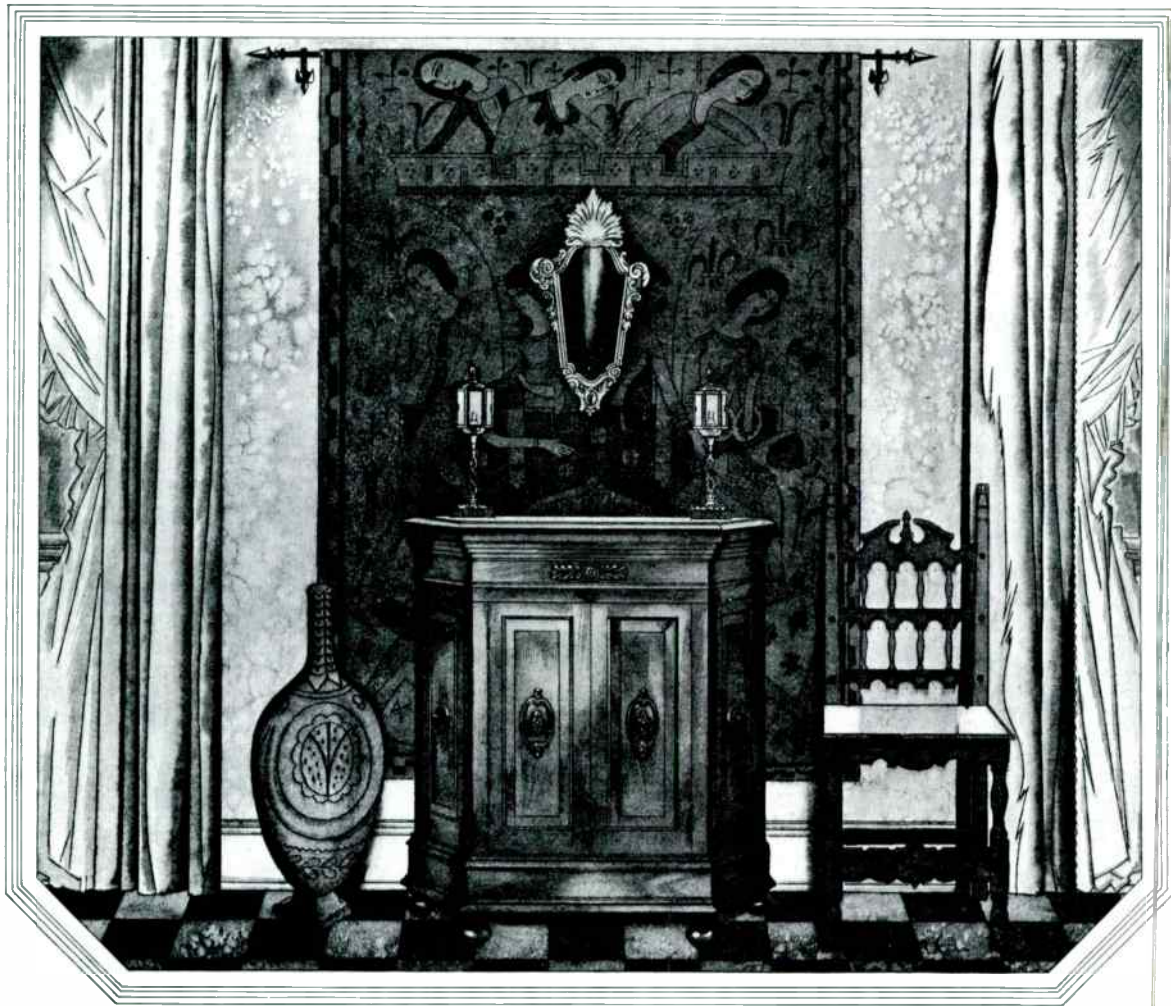

Cabinets designed under the personal direction of Mr. Noel S. Dunbar

SPLITDORF *Radio* CORPORATION



Subsidiary of Splitdorf-Bethlehem Electrical Company, NEWARK, NEW JERSEY

Other consoles:	Concerto	\$112;	Virtuoso	\$127.50;	Maistro	\$170;
	Intermezzo	\$133.50;	Warwick	\$275;	Winthrop	\$600;
	Buckingham	\$800.				

Technical article on AC Abbey appears in *Radio News* (Feb. 1928), pp. 889, 950.

Saturday Evening Post (Sept. 24, 1927)

APRIL 24, 1928

U. S. PATENT OFFICE.

74,969. RADIOCABINET. NOEL S. DUNBAR, New York, N. Y., assignor, by mesne assignments, to Splitdorf Radio Corporation, Newark, N. J. Filed Jan. 20, 1928. Serial No. 24,949. Term of patent 3 1/2 years.

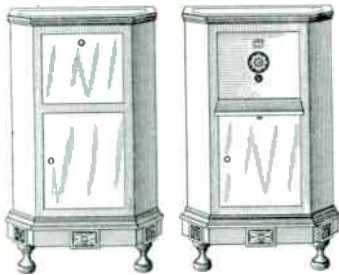

The ornamental design for a radiocabinet, as shown.

74,971. RADIOCABINET. NOEL S. DUNBAR, New York, N. Y., assignor, by mesne assignments, to Splitdorf Radio Corporation, Newark, N. J. Filed Jan. 20, 1928. Serial No. 24,951. Term of patent 3 1/2 years.



The ornamental design for a radiocabinet, as shown.

74,970. RADIOCABINET. NOEL S. DUNBAR, New York, N. Y., assignor, by mesne assignments, to Splitdorf Radio Corporation, Newark, N. J. Filed Jan. 20, 1928. Serial No. 24,950. Term of patent 3 1/2 years.



75,227. RADIOCABINET. NOEL S. DUNBAR, New York, N. Y., assignor, by mesne assignments, to Splitdorf Radio Corporation, Newark, N. J. Filed Jan. 20, 1928. Serial No. 24,948. Term of patent 3 1/2 years.



August 1928 models:	Abbey Jr., \$135	Abbey Sr., \$175	Avon, \$290
	Warwick, \$325	Lorenzo, \$390	Como, \$450
	Salem, \$575	Winthrop, \$750	Devon \$850

September 1928: Oxford

that time, the Edison company was being run by Charles, who was rather more progressive about radio than his father. Quoting a 1986 letter from George Harris:

*"The acquisition of the Splitdorf Radio Division was one of necessity in order to obtain the licenses quickly. My father was dispatched to check out the Splitdorf plants and decide whether to use the existing facilities or move the operation to the West Orange plant. He said that the Splitdorf operation was extremely crude and inadequate. The Canadian Splitdorf operation was using a heavy steel plate for a chassis with the component assembly mounted on this. All this was discarded and production moved to the Edison plant in West Orange. The first model (R1, R2, C2) was a Splitdorf design which was placed into production in order to expedite getting Edison radios into the public hands. Later models were designed at Edison with my father as product engineer since he was one of the few electrical engineers on the staff who was knowledgeable of the radio field.*

*In 1931 after the C6 and C7 had been in production for some time, a superheterodyne was designed and prototypes made, but due to the declining economy and Edison's avowed intent to save the company and the jobs of its employees, a decision was made to discontinue the radio division."*

Splitdorf (or Edison-Splitdorf after September, 1932) eventually was combined with the other Edison companies.



Abbey

David Pope



**Model R-2.** Radio with Dynamic Speaker. *Simplicity brought to a new perfection. The cabinet is in blended walnut finish, relieved with burl maple panels. A graceful piece of furniture which reflects credit on the good taste of any householder.*

Size 42½" x 22" x 16"  
List Price, including Dynamic Speaker, less tubes: \$260.



**Model R-1.** Radio with Dynamic Speaker. *Charmingly compact, it adjusts itself ideally to the modern home. . . . Blended walnut finish and panels of burl maple attest its handsome quality, with beauty enhanced by contours of inlaid maple and trimming of statuary bronze. The doors fold back flat against the sides.*

Size 46" x 22½" x 18"  
List Price, including Dynamic Speaker, less tubes: \$315.



**Model C-2.** Radio and Electric Phonograph. *Completely electrified. The cabinet of blended walnut finish, with its ornamental panels of burl maple, fits pleasingly into any interior, harmonizing with other furniture. Its doors fold inconspicuously back, flat along the sides, revealing four gold-embossed record albums.*

Size 46½" x 28½" x 18"  
List Price, including Dynamic Speaker, less tubes: \$495.



**Model C-1.** Radio and Electric Phonograph. *An exact reproduction of an Italian Credenza, handsomely carved from solid walnut, with rich polychrome motifs. Built-in record containers. Special super-power amplifier using two "250" tubes and two Dynamic Speakers. This model is the acme of sound reproduction.*

Size 48¾" x 43" x 20"  
List Price, including two Dynamic Speakers, less tubes: \$1,100.

Flyer



Charles Edison

Talking Machine World (June 1928)

**Cabinet Bargains!**

**Radio Mfgs. Close Out Sale.**  
**\$15 to \$300 Values for \$3.50 Up.**

Beautiful, high class cabinets. Made for sets selling from \$150 to \$1,000. Designed for the most palatial homes. Solidly constructed of fine woods selected for grain. All new models in perfect condition. The finest cabinets the set builder ever could buy.

Many radio owners are housing their old receivers and apparatus in one of these art cabinets. Result—radios outfits that look like five hundred or a thousand dollars. But you can see the cabinets—to appreciate their tremendous values.

Factory reorganization! All models sacrificed regardless of cost and actual value. Prices range 1-3 to 1-5 of cost to make.

Unusual designs in table models, consoles, secretaries, large and small art cabinets, and exhibition model cabinets. Cabinets for A. C. sets, for battery sets and for enclosing unsightly metal-cased radios. Cabinets that will hold radio, speaker and batteries combined.

**CALL** at the plant. Look them over. Take one away with you in your car—as many enthusiastic buyers are doing. We will ship if you prefer. If you can't call, write for illustrations and inside and outside dimensions. Open Saturdays until 10 P. M. Weekdays until 9 P. M.

**Call or Write! Open Evenings!**

**SPLITDORF RADIO CORP., Dept. W. A. 118**  
98 Warren St., near High, Newark, N. J.

New York Evening World (Jan. 12, 1929)

172

THE SATURDAY EVENING POST

March 8, 1930

## EDISON LIGHT-O-MATIC RADIO

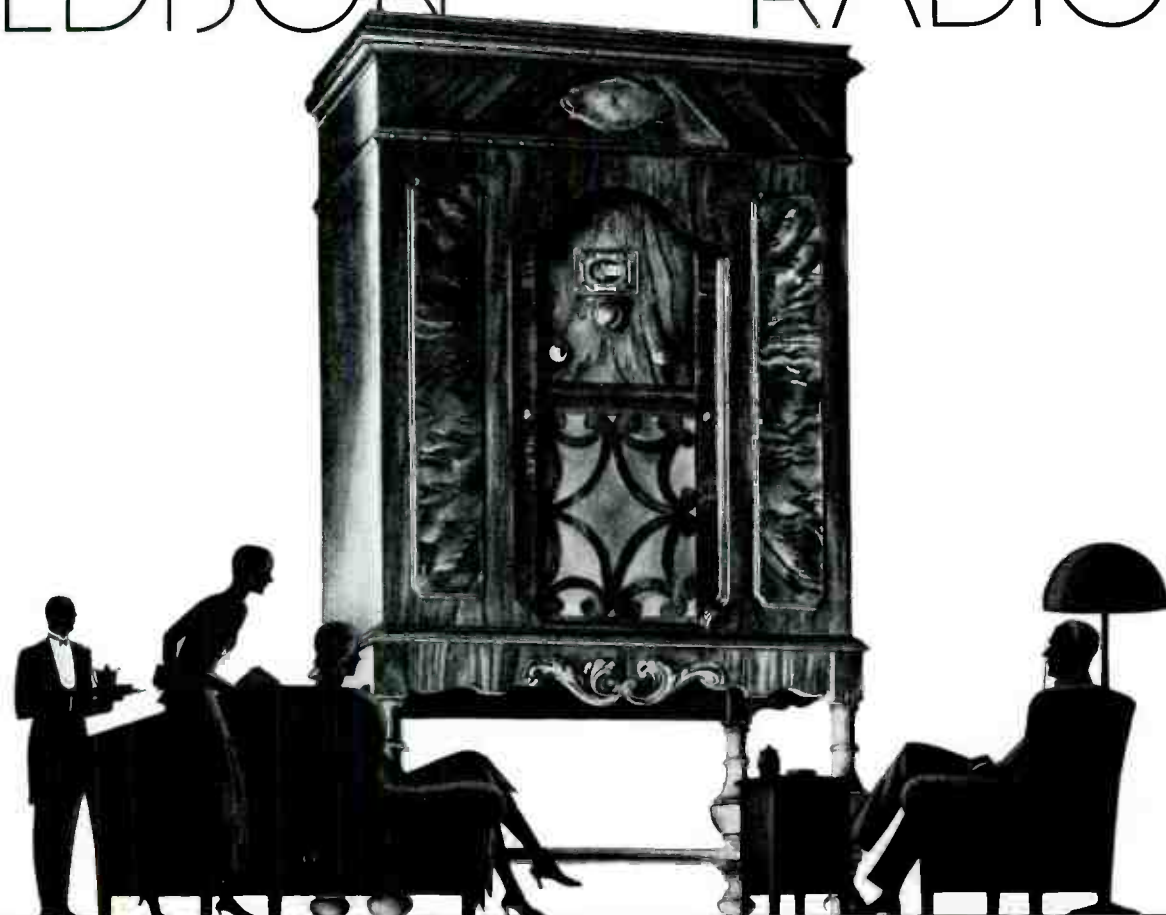

The greatest name in science  
guarantees your radio investment •

Thomas A. Edison's signature is not appended to half-way achievements. Not until a perfected radio had been developed in the Edison Laboratories could there be an Edison Radio • Now the Edison Light-O-Matic Radio is here and confidence in radio-buying has come • Choose the Edison for its faithful delivery of the artist's true performance. Choose it as an investment in better living. Choose it because of the pleasure it will give you through the years to come • Above all choose it for that pride of possession assured by the name on the panel—

*Thomas A. Edison*

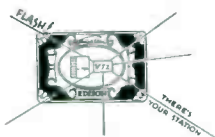

Edison Light-O-Matic Tuning instantly, easily and perfectly tunes your favorite stations, announcing each arrival with a flash of crimson light. The nuisance of log books is gone ... fussing with old-fashioned dials is done!

The model illustrated is the C-4 — the Edison Radio-Phonograph Combination. It is all-electric ... plays all makes of needle records with the same superb radio-realism that so distinguishes the Edison Radio. Its massive studio cabinet is superbly executed. Finish of blended walnut with sliding doors of matched butt walnut and front relieved with butt walnut panels. \$325, less tubes. Other models from \$175 upwards, less tubes. (Prices slightly higher in the far west.)

Write for "Edison's Part in Radio" — a fascinating booklet. Thomas A. Edison, Inc., Orange, N. J.

June 1929 models: R-5, \$167.50; R-4, \$197.50; C-4, \$295



New England Wireless & Steam Museum

**Steinite Tube Set**

1500 Mile Range Guaranteed  
Gets Stations In U. S., Canada and Cuba.  
Try it at our risk.

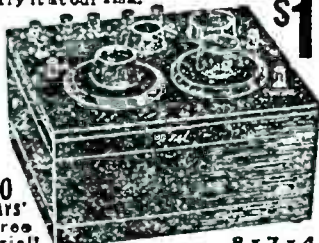

**\$12**

10  
DAYS'  
Free  
Trial!

8 x 7 x 4 In.  
**\$12**

Greatest value on the market today. Wonderful power and volume. Highly selective, sharp tuning. Solid mahogany cabinet, beautiful finish. Uses dry batteries. Cost won't exceed two cents a day.  
Try it ten days and if not delighted your money back without a word. Free descriptive literature shows users endorsements. Reference: Exchange Nat'l Bank, Atchison Savings Bank. Order today.  
**STEINITE LABORATORIES,**  
16 Radio Building, Atchison, Kansas  
Mfrs. Famous Steinite Long-Distance Crystal Sets \$6; Two Tube Amplifier \$15; 5 Tube Set \$65; De Luxe Crystal Set, complete - headphones, aerial and ground, \$10; Wave Trap \$5. Literature free. Steinite Long-Distance Crystals 60c.  
**SPECIAL OFFER**—2 Crystals, 1 Catwhisker, 5 Hook-Ups - all for \$1. **ORDER TODAY.**

New York Herald-Tribune (Dec. 21, 1924)

# Steinite Gives Distance

The Marvelous New Crystal

## On Crystal Sets!

**Underwriters Fire Patrol**

1018-21 CHERRY STREET  
KANSAS CITY MO

Steinite Laboratories  
2nd Floor, Radio Bldg.  
Atchison, Kansas.

Gentlemen:

You certainly have the greatest crystal I have ever used-- and I have used them all. Your STEINITE is the greatest for volume and distance I have ever tried.

Just for example let me tell you what I did with STEINITE last night. I picked up the St. Louis Post Dispatch. Also heard Omaha and Davenport. Now that's remarkable.

When W D A Z, The Kansas City Star is in the air, I attach a small tin horn to one receiver, shunt the other and throw the entertainment out into two large rooms. STEINITE is a REAL crystal. You can refer any doubters to me.

Since *J. A. Gardner*  
Soc'y. K. C. Fire Patrol Dept.  
Kansas City, Mo.

**RESULTS** truly amazing, like Mr. Gardner tells in his letter. Everyone astonished by STEINITE. J. A. Zeugin, Leavenworth, Kans., writes, "So far have caught Chicago, Dallas, St. Louis, Davenport and several others on my crystal set with your STEINITE crystals. Carl McGraw, Independence, Mo., says, "The first night I heard Fort Worth, Tex., Omaha, Nebr., St. Louis, Mo., and WJAZ and KYW at Chicago, Ill."

You can't doubt what you hear with your own ears. Listen in on STEINITE at my risk. Read my guarantee and offer - then act.

**Introductory Price**  
**NOW 50¢ Each**  
**SPECIAL 3 for \$1.00**

You are buying no ordinary crystal when you order STEINITE. It's an entirely new discovery. Opens up new possibilities for crystal set receivers. I make big claims for it.

**My Money-Back Guarantee**

I unreservedly guarantee STEINITE to give you better results than you ever thought possible on your crystal set, and if you are not surprised and more than pleased I will send back your money without any question. These two big Atchison banks will testify to my reliability: Exchange National Bank, Atchison Savings Bank. Don't delay the radio treat

ability: Exchange National Bank, Atchison Savings Bank. Don't delay the radio treat in store for you. Order 3 Steinite crystals today. **NOW.**

**STEINITE LABORATORIES, ATCHISON, KANSAS.**

Above:  
Crystal set February 1924 \$5  
(\$6 after December 1924)

1-tube February 1924 \$10  
(\$12 after December 1924; model 25-1)

Right:  
1-tube set and 2-tube amplifier made by the "Atchison Radio & Electric Co."

Not shown:  
5-tube December 1924 \$65  
(later, \$50)

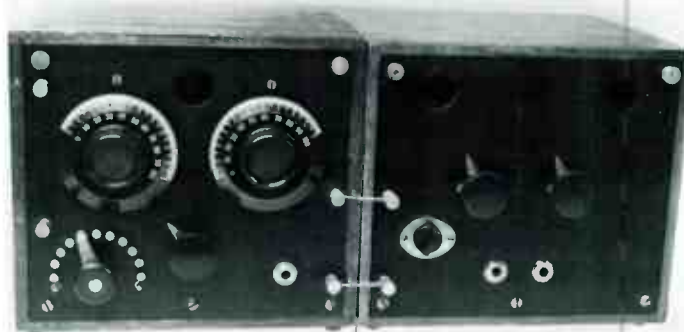

Frank and Donna White

Philadelphia Inquirer (Dec. 9, 1923)

# STEINITE

## Steinite Laboratories

**F**red W. Stein grew up in Atchison, Kansas, finishing his formal schooling with the eighth grade. After a three-year apprenticeship with the Kansas Railway Power and Light Co., he started an electrical business with a friend in 1908 and, later, an electrical contracting business on his own. He served in the Navy during the war.

In 1922, Stein formed the Atchison Radio & Electric Co. and began selling galena crystals in 1923 under the name "Steinite," claiming 1,000-mile reception; luckily, as he said years later, not too many people complained. From crystals, it was a short step to detector assemblies and complete crystal sets and even a one-tube set, all sold by mail-order from newspaper advertising.

In mid-1925, Steinite acquired the remnants of the Tri-City Radio Electric Supply Co. (Tresco), an Armstrong licensee that had fallen on hard times after a court decision prohibiting it from subcontracting manufacturing to others. Models made in this period are identified by Tri-City labels with the address of Atchison, Kansas.

In October 1926 Steinite introduced an AC set using series-string '99 tubes. This went through three versions and, by 1927, was selling so well that a Chicago sales office was opened. Its last version (the 990) even undersold the Atwater Kent "tin can."

A number of things happened in 1928, probably all related. Steinite acquired an RCA license, introduced a conventional AC set (again, underselling the \$77 Atwater Kent model 40 by \$2), and was sold to Chicago capitalists Jacob Abelson and Oscar Getz (Abelson's son-in-law). Alfred Crossley of the Naval Research Laboratory joined Steinite as chief engineer.

The manner in which Steinite got its RCA license was still legendary twenty years later. As told by Maclaurin in *Invention and Innovation in the Radio Industry* (p. 135):

*"A story is told that Senator Jim Reed of Missouri called one day at the office of Mr. Sarnoff, who was then general manager of RCA, and brought with him the president of a Missouri radio company who had been denied a license. "I am going to sit in this office until my friend here is given a license," Mr. Reed is reported to have said. Sarnoff arranged an ap-*

*pointment with General Harbord, president of RCA, and a license was granted.*

As no source is footnoted, this story might pass as apocryphal, but here is the *Radio Retailer and Jobber* (Nov. 1927):

*... Steinite ... wanted an RCA license and, report has it, got a very arrogant and belittling reception from those nincompoops that hold the rickety patent-fort down in that Woolworth Building, New York City."*

### "Jim" Reed Puts Screws On

*But the powers-that-be of that Steinite laboratory appealed forthwith to their United States Senator—none other than "Jim" Reed, that fire-eating, epithet-throwing aspirant to the Democratic nomination for the Presidency; habitat, Kansas City; fighting ground, any vacant lot.*

*Well, the "R. C. A." crowd got cold feet when "Jim" Reed began to swing at their "buttons" and came right through with a set-manufacturer's license for those Steinite laboratories.*

In October 1928 Steinite bought control of the Leslie F. Muter Co., radio parts manufacturer. To judge from the trade papers, Steinite's dealer merchandising efforts in early 1929 were something to behold with sales reaching new peaks. An additional plant was acquired in Auburn, Indiana, and a new one constructed in Ft. Wayne that was expected to more than double the company's size. At its peak in October, Steinite employed 1,185 workers and turned out a reported 2,000 sets per day. But the reign of expensive consoles was already over. Although Steinite was reorganized in January 1930, with Jim Tully (formerly of Bremer-Tully) in charge, it was in receivership with debts of \$1.3 million by April. Magnavox bought the Ft. Wayne plant in May. Steinite reorganized again in October 1930 intending to make private-brand radios and lasted another two years before disappearing.

Fred Stein, after a short-lived attempt to make radios under his own name in 1930-31, invented a device to measure moisture in grain that is still being made by Fred Stein Labs, Inc. His son took over when Stein died in November 1972 at the age of 84.

THE RADIO DEALER CATALOG OF NEW APPARATUS



STEINITE 5-TUBE SET. Manufactured by the Steinite Labs., 504 South State Street, Chicago, Ill. Five-tube tuned radio frequency receiving set enclosed in mahogany cabinet with compartments for "B" batteries. Sloping panel. List price \$60.00.

5 August 1925 \$60



Earle Drake

2 or 26-2 August 1925 \$12.50

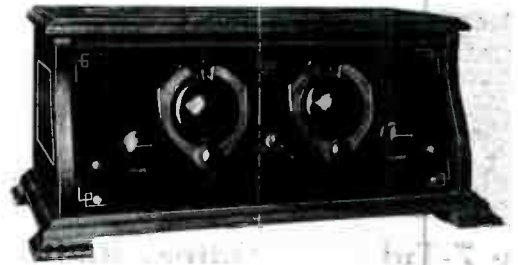

6-tube October 1926 \$45  
Console: \$79.50

Not shown:

27 July 1926 \$40  
C-27 July 1926 \$70



Frank and Donna White

2-138

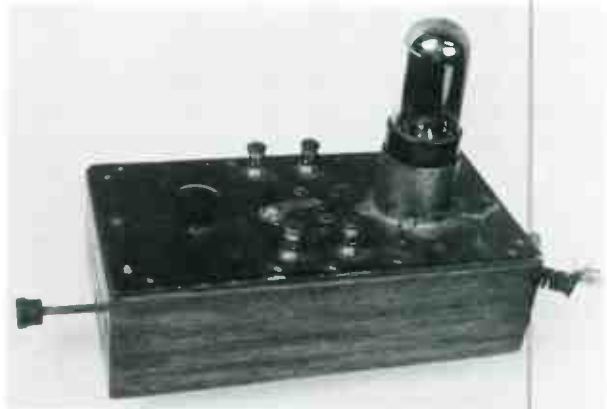

Dave McKenzie

26-1 August 1925 \$6  
(also called "Aladdin" or "Midget")

**\$125** With  
**Built-In**  
**LOUD SPEAKER**

The Radio you have  
wished for a  
thousand times



Flyer

## The New Steinite 7-Tube No-Battery Radio

Uses No Batteries of Any Kind---No Chemical Rectifiers.

You Will Marvel at Its Tone

Operates from light  
socket at cost of

1c an hour

Solid Mahogany  
Cabinets

3000 Mile Range

What may you expect in naturalness, volume, and lack of distortion? You have perhaps heard the latest type photographs that have employed some electrical and radio principles. You may expect the same truthful reproduction and fidelity of tone of this marvelous, economical 7-tube Steinite No-Battery Radio.

Think of the joy of plugging into the light socket and saying goodbye forever to batteries and more of your radio troubles. Picture to yourself a radio as musical as a Steinsway piano, and that costs \$10 an hour to operate. No wonder everyone who hears it gasps in amazement. Many say, "I can't believe it." You will hardly believe it yourself 'till you hear it. Think of the real pleasure of a radio that always brings in stations on the North American Continent, requiring no aerial for stations

five hundred miles away. For its entire range of three thousand miles you will, of course, use an outside aerial. No wonder, this is a present day radio wonder. And the price, \$125.00. The immense volume of our big new factory makes it possible. Volume! volume! volume! is responsible for the way Steinite products have swept the country. And, without tremendous volume and our low-profit policy this set should sell for \$150.00 or more.

### Radio Troubles and Expense "Now Signing Off" Plugs into Light Socket

1c  
an  
Hour  
to  
Operate

When we say "no batteries" of any kind, we mean just that, and no chemical rectifiers. Nothing to charge, no rags and friction. To run with outstrokes. No wondering as to whether it will reach out for distant stations. Absolutely nothing needed to complete the set but tubes.

Stop your Battery Expense and "lookups" and you have most of your radio troubles and expense cut out. Especially is this true in a home where there are children. This will remain the real radio achievement of 1927 and several years to come. The beauty and finish of its rich cabinet is only surpassed by its quality of tone and power. The lack of distortion and naturalness are the characteristics of the Fred W. Stein Circuit which have been amplified and improved with refinements for this particular set.

Now you can enjoy the kind of radio you have wished for a thousand times. Think not only of the pleasure of uninterrupted reception, but also of the big item of battery expense—and this is a large item with other types of radio—no matter how expert you are. This is the type of radio builders have dreamed of and worked on for several years. It has just happened that Fred W. Stein's hundreds and hundreds of experiments and trial circuits proved out first. Not luck, but hard and discouraging results were fought till success came. And now our big new factory is already into production of this wonderful radio—the only kind you will be content with, for you hear it. Not only does everyone marvel at its tone, power and beauty, but at the price above all—only \$125.00. Tremendous factory volume and year-after-year low profit policy gives you such a value. Without our nationwide low-profit plan we'd be compelled to charge you \$150.00 or more for this "New Day" Radio.



**\$150**

with Table  
Sold together or  
separately. Plugs  
into light socket.

Nothing to buy but tubes

The 7-tube Steinite No-Battery Set is guaranteed to be mechanically perfect and to require no mechanical adjusting. No expert is required to connect it. This marvelous circuit is highly selective and yet so simple a child can operate it.

#### SPECIFICATIONS

- PANEL—Solid bakelite, 7x18, machine engraved.
- SUB-PANEL—Solid bakelite; bracket suspended, cable harness wired.
- TUBES—Four 10A, one 20A, and two 316B
- SOCKETS—High grade, slip type
- DIALS—Solid bakelite Kurz-Kasch, micrometer controlled Vernier type.
- AUDIO-TRANSFORMERS—Special design, deep to w. heavy iron type.
- RADIO-TRANSFORMERS—Solid bakelite supported, high efficiency type.
- LOUD SPEAKER—Built-in. Molded wood horn, 70-inch reverse curve type. Speaker unit, full floating armature, heavy duty type.
- CABINET—Solid Mahogany, two-tone Walnut or two-tone Mahogany finishes; length, 32 1/2 inches; depth, 16 inches; height, 10 1/4 inches.



FRED W. STEIN  
Radio Builder

**Steinite Laboratories**

Factory, Atchison, Kansas

The Radio Center  
of the West

GENERAL SALES OFFICES:

504 So. State Street  
CHICAGO, ILL.



7-tube AC	October 1926	\$125
7-tube AC, no speaker	April 1927	\$100
7-tube AC console	April 1927	\$150



**Steinite Labs. Have  
Aerial Testing Tower**

Situated atop the highest hill in Atchison County, Kansas, is one of radio's latest innovations, an aerial testing laboratory. The labora-



**Steinite Aerial Testing Tower**

tory, housed in a structure twenty feet square, is 125 feet above the ground and 525 feet above the Missouri River in Atchison. The tower was recently erected by Fred W. Stein, president of the Steinite Labs., of Atchison, which maintains its general sales department in Chicago.

The tower and laboratory, it is said, were erected at a cost of more than \$50,000. It is constructed on massive steel girders, the aerial tower's lofty bungalow being reached by an electric elevator. In this laboratory, Mr. Stein, and his chief engineer, F. W. Iggberg, hope to avoid every possible earth disturbance in conducting experiments. Mr. Iggberg stated that one of the first experiments will be with a balloon-type antenna, and small captive balloons will be sent up on 1,500-foot wires, the wires designed to function as pick-ups for radio signals.

"I believe we will be able to do many things with crystal receivers," stated Mr. Iggberg, "when we complete the investigation we have in mind for this experiment." The research laboratory of the Steinite factory now is located in the building shown at the base of the tower in a large thoroughly equipped room.

The Steinite Labs. are said to employ more than 750 persons when the plant is in full operation, and the growth of the business in the twelve years which have followed its founding has forced the company to move to larger quarters four times. Plans are now in progress for the construction of a modern four-story building on the site of the present plant, and according to Guy D. Elwell, general manager, the new Steinite structure will be ready this Winter.

Talking Machine World (Aug. 1927)



- 991 Sept. 1927 \$125
- 992 with speaker \$135
- 993 console (pictured) \$165

- B-1 Oct. 1927 \$65 (battery)
- B-2 console \$105

**A BRILLIANT ACHIEVEMENT**

**NEW!**  
The **NEW**  
one unit

*The Greatest Radio!  
Sensation of 1928!*

**Steinite**  
**ELECTRIC RADIO**

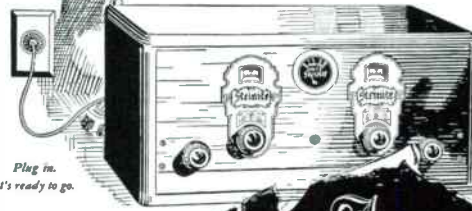

Plug in.  
It's ready to go.

**\$85**

**America's Smashing Success! Electric Radio!**

A  
Personal Message  
from **FRED W. STEIN**  
Inventor of the  
Steinite Electric

In 1921 I started in the radio business. I had the latest developments in radio, and I was the first to sell them in the United States. In 1925 I produced the first Steinite radio, and it has since become the most popular radio in the world. In 1926 Steinites were the first production radio to be sold with the introduction of the Steinite Electric.

In 1927 the Steinite Electric proved the perfection of the design, achieving the highest production of any product in the world. It is the most successful Steinite radio ever made. It is the only Steinite radio that has a standing radio value.

*Fred W. Stein*

**STEINITE RADIO CO**  
306 S. Wabash Ave., Dept. B.H.  
Chicago, Ill.

Send me full details of your new model and the Steinite proposition.

Name .....

Address .....

**Sensationally low in price—  
amazingly high in quality—  
the new STEINITE has been  
scoring heavily since its  
Introduction.**

**THIS AD—  
Running in the country's  
foremost jobbing centers—  
is making Radio history!**

Mail the coupon for details—  
**STEINITE RADIO CO.**  
306 So. Wabash Ave.  
Chicago

...ent hour. Beautiful  
...Mahogany cabi-  
...specially from cabl-  
...to the Largest  
...the West on a one-  
...the greatest

...features!  
...refinements—wood  
...aluminum subpanel,  
...of sharp tuned radio  
...mers which reproduce

...It—Buy It!  
...Today—hear the clear, pure  
...Steinite. Examine its sturdy con-  
...note the real quality and extremely  
...Then BUY—safe in the knowledge  
...you are buying the best. Licensed under  
...patents and under patent No. 1014002

**STEINITE RADIO COMPANY, Chicago**  
Atchison, Kansas

**NO Batteries - Eliminators!  
Acids - Water or Attachments!**

990 February 1928 \$85



Talking World Journal (Dec. 1928)



**THE "STANDISH" MODEL 263**

A CONSOLE SET of graceful design with built-in "Polyphonic" 2" x 4" speaker with a perfectly matched, carefully tested unit. The receiver is permanently built-in and is identical with models 261-262. Made of American Black Walnut veneer finished in genuine Duco. The beautiful grill-work backed with dull gold-finish conceals the speaker and lens'a rich touch. A value made possible because Steinite makes everything complete in its own great factories, both sets and consoles.

Price **\$115**  
Complete with tubes, \$137.50



**THE "REMBRANDT" MODEL 265**

A CONSOLE of distinction, executed in glowing American Black Walnut veneer, finished in Duco. The "Polyphonic" speaker with matched unit combines perfectly with the output of the Steinite audio system producing a powerful deep velvety tone of unusual purity and clarity. Models 261-262 are installed in this console without the use of tools. The drop-door forms a rigid desk-type arm rest. An unusual value. Price, \$85.

Price with Model 261 or 262 **\$130**  
Price with tubes \$152.50



**THE "SEVILLA" MODEL 266**

A BEAUTIFUL console in the Spanish mode with an atmosphere of grandeur which makes it the show-piece of any home! Made of American Black Walnut with burnished Walnut overlay finished in Duco. Artistic grill-work backed with dull gold-leaf covers the speaker opening. The speaker is a Steinite "Polyphonic" with a unit matched both to the speaker impedance and the output of the heavy Steinite Audio System, so in all console models shown in this folder, giving a brilliant tonal array that interprets the deepest tones of great pipe-organs as well as the highest notes of the piccolo. Models 261-262 are installed in this console without the use of tools. A striking value! Price, \$75.

Price with Model 261 or 262 **\$150**  
Complete with tubes \$172.50

261 June 1928 \$75; 263 console \$115. Console cabinets (July 1928): 265 - \$55; 266 - \$75. Dynamic speaker consoles (Oct. 1928): \$137.50, \$152, \$167, \$187.



261 Al Monroe



Architect's Conception of New Steinite Plant

## Start Erection of New Steinite Plant

New Factory at Fort Wayne, Ind., Will Treble Output of Company, Adding 210,000 Square Feet to Factory Space

A new addition to the production facilities of the Steinite Radio Co. in the form of a large factory at Fort Wayne, Ind., has been announced by Lester Abelson, Steinite production manager. The new factory, which will be built on a tract of fifteen acres, is already under construction and work is being pushed.

This increase in the production facilities of the Steinite Radio Co., together with the new factory at Auburn, Ind., will treble the output of the company, the new plant adding 210,000 square feet to the factory space.

"The tremendous rush of orders following the showing of our 1929 line to jobbers has forced us to take immediate action on our plans for expansion for this year," Mr. Abelson said. "Our factory at Fort Wayne will be a modern one-story saw-tooth building, in operation by May 1, and employing 2,000 people. Both console cabinets and sets will be manufactured there. It will be equipped with the latest of manufacturing devices and the plant will be known as Steinite factory No. 4."

At present the three factories at Atchison, Kan., and Chicago, Ill., employ 1,100 persons. Sales headquarters are located in Chicago.

Talking Machine World (March 1929)

# Sensation of the Show»

Radio Retailing (June 1929)

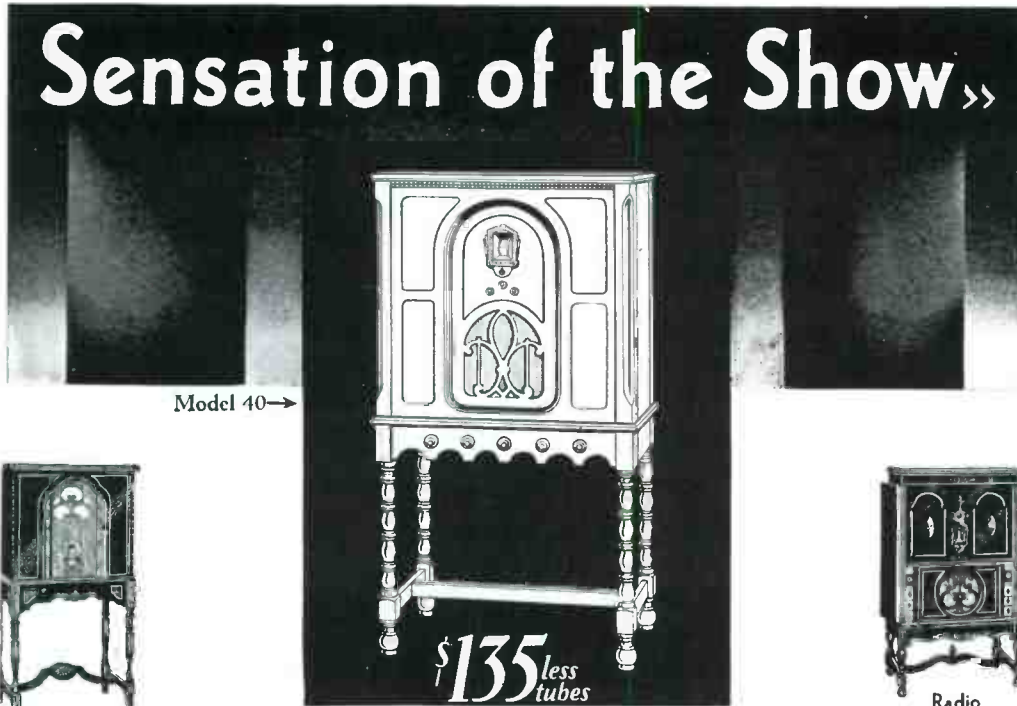

Model 40→



Model 45  
\$165 less tubes

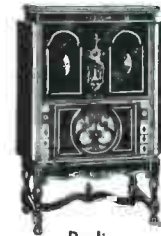

Radio  
Phonograph  
Combination  
\$250 less tubes

40	March 1929	\$135
45	June 1929	\$165
50	March 1929	\$185
60	August 1929	\$169.50
102	March 1929	\$250



Talking Machine World (Aug. 1929)

J. Abelson, president of the Steinite Radio Co., tunes in on the first radio receiver produced in the company's new ten-acre plant in Ft. Wayne, Ind., while Lester Abelson, secretary and general manager; Leslie F. Muter, president of the Leslie F. Muter Co., a Steinite subsidiary, and Oscar Getz, vice-president of Steinite, look on with interest



Alfred Crossley

Service (July 1932), front cover

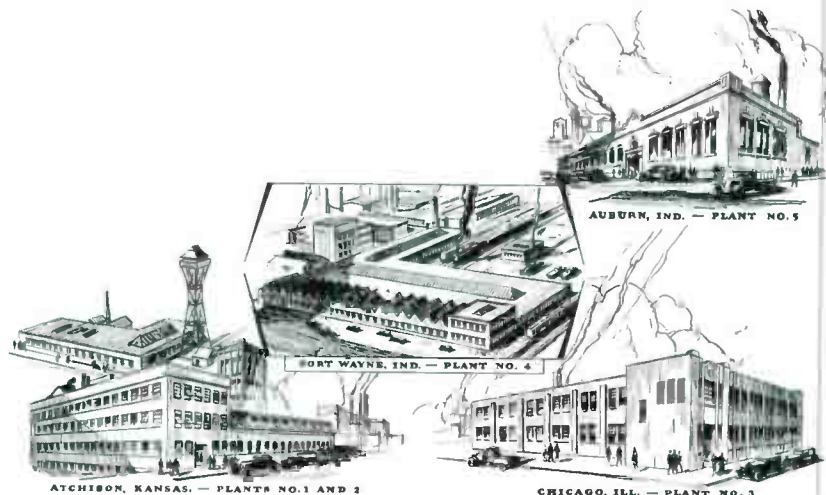

Talking Machine World (March 1929), p. 56

# AMERICA'S GREATEST VALUE

Every Steinite achievement of other years is surpassed by Steinite's new SUPER Screen-Grid Radio! And its amazingly low price makes Steinite more than ever America's Greatest Value!

Steinite's research department—years ahead of the field—has made the most effective use of the screen-grid principle. The new Steinite uses three screen-grid tubes in a SUPER screen-grid circuit. Its tone is humless—its performance thrilling! The new Steinite is an even greater contribution to radio progress than America's first low-priced electric set—produced years ago by Steinite!

Read—carefully—the features of the new Steinite. Compare them to the features offered by any radio at any price. Then you will learn that you can get no more by paying more, and that you cannot match Steinite features if you pay less.



**\$149.50** Less Tubes

A gorgeous high-boy console with the popular swinging half-doors, fitted with clever handle pulls. Rich carving, and authentic design make this console outstandingly beautiful.



Flyer

## \$118 LESS TUBES

You can get no more than these features at any price!

- |   |  |
|---|--|
| 1. Three screen-grid tubes—a total of 7 tubes.                | 5. Real humless reception.                                 |
| 2. Four condensers.   | 6. "Battleship" chassis construction, completely shielded. |
| 3. Linear power detection with automatic grid bias.           | 7. ELECTRO-Dynamic speaker.                                |
| 4. Push-pull audio power stage, using the newest "245" tubes. | 8. Glorious tone.  |
|   | 9. Magnificent consoles.                                   |

Above is shown the low-boy console, with beautifully figured butt walnut panels, in a charming design created by Steinite's own furniture specialists.

**Steinite**  
SUPER, SCREEN-GRID RADIO

October 1929 models

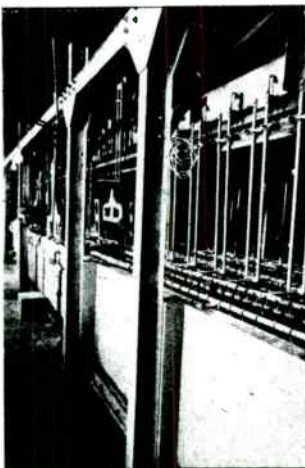

## A \$50,000.00 Cadmium Plating Machine at the Steinite Factory in Fort Wayne

Harvey Harris of the newly reorganized Steinite Mfg. Co., informs us that the factory is now one of the best equipped in the industry. Practically all parts for Steinite sets are made in the Fort Wayne plant. The cadmium plating machine, here illustrated, automatically plates the chassis in one operation.

Radio (Nov. 1930)

Actually, according to the bankruptcy petition, this plating machine cost \$20,571 and was only half paid for by May 1930.

Cadmium compounds are extremely toxic, and present-day restorers should be very careful not to breathe the dust when cleaning corroded chassis and metal parts.

82,711. RADIOCABINET. FREDERICK W. STEIN, Atchison, Kans. Filed Mar. 17, 1930. Serial No. 84,907. Term of patent 3 1/2 years.



The ornamental design for a radio cabinet, as shown



300 July 1925 \$65

Robert Russell

Ser. No. 225,207. (CLASS 21. ELECTRICAL APPARATUS, MACHINES, AND SUPPLIES.) STEWART WARNER SPEEDOMETER CORPORATION, Chicago, Ill. Filed Dec. 26, 1925.

*Stewart*

*Warner*

The mark includes the name "Stewart" in the form of facsimile signature of John K. Stewart, founder and first president of this corporation, and the name "Warner" is displayed in a style consistent with said facsimile signature.

Particular description of goods.—Detector and Amplifier Tubes for Radio Receiving Apparatus.

Claims use since Oct. 1, 1925.



325 July 1925 \$80

Henry Harder

1,938,875. RADIO CABINET. LEONARD E. PARKER, Chicago, Ill. assignor to Stewart-Warner Speedometer Corporation, Chicago, Ill., a Corporation of Virginia. Filed July 9, 1925. Serial No. 42,388. 3 Claims. (Cl. 45—52.)

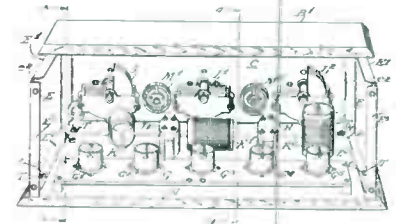

1. A structure for the purpose indicated having ends and one longitudinal side member formed integrally of a metal sheet, the end portions being folded at right angles to the middle portion, said middle portion forming said longitudinal side member, said metal sheet being flanged at all edges, the flanges at the top edges of the end portions being shortened to form gaps between the ends of said flanges and the flanges of the adjacent vertical edges of said ends; a top member secured at one longitudinal edge to the corresponding edge of the longitudinal side member opposite that which is integral with the ends, said longitudinal side being dimensioned as to thickness for entering said gaps and sliding down inside the vertical flanges of said end members to lodge said top member upon the top flanges of the ends.



305 July 1925 \$95

Ray Hill

# STEWART-WARNER

## Stewart-Warner Speedometer Corporation

**T**he name was officially Stewart-Warner Speedometer Corporation, but it made a whole line of automobile parts and accessories. It was a large company with plants totalling 21 acres of floor space, and an old one formed from two parent companies in 1912.

Since its automotive business seemed likely to decline, Stewart-Warner began looking into radio in 1923 and 1924, and was ready for production in 1925. Intending to make a complete line of radio items, it supposedly spent \$250,000 trying to manufacture tubes, of which \$106,000 went for the purchase of the O&T factory in New York City, which had previously made Silvertone tubes under de Forest license until that license was withdrawn. With O&T came its manager, Willard Twombly, at \$25,000 per year for five years. This venture turned into a disaster (Twombly went to prison in Michigan for his involvement with a young member of the opposite sex), and most Stewart-Warner tubes were actually made by Sylvania.

Stewart-Warner did somewhat better with its radio sets. Even after buying \$750,000 worth of parts from Erla, it claimed to have profited by \$1.8 million on 100,000 radios sold in 1925. In February 1926 it was said to be turning out 1,000 per day with 200,000 planned for the year.

Leonard E. Parker was responsible for the design of these first models. In July, 1926, Sylvan Harris became chief engineer; he had formerly been managing editor of Radio News and had contributed many papers to the I. R. E. Parker returned about the end of 1927 and stayed until July 1929, when C. P. Mason took over the position.

September 1926 brought a lawsuit by Westinghouse for infringement of the Armstrong regenerative patent, apparently on grounds that Stewart-Warner's sets could regenerate if their controls were misadjusted, or if higher battery voltages or higher-gain tubes were used. Stewart-Warner's response was to develop a circuit that could not possibly oscillate: the model 705. But the company also had other problems — overproduction and excess inventory. It dumped 75,000 sets at \$15 each in February 1927, according to one report, and almost unloaded 31,000 more in



Radio Dealer (Sept. 1928)

On the occasion of his joining Ozarka in July 1929, Leonard E. Parker was said to be about 39 years old, and to have been with Stewart-Warner for 15 years.

June (including 10,000 one-dial models) before deciding to sell them through its dealers instead.

Finally, in October 1927, Stewart-Warner signed an RCA license — the last major manufacturer, other than the Technidyne group, to do so. It was subsequently sued by Hazeltine, but the outcome was not reported.

Overproduction seems to have been a Stewart-Warner hallmark. Again in May 1928 it was saddled with \$1 million worth of obsolete sets that it finally unloaded directly to the public in December. Fortunately, as the *Radio Retailer and Jobber* commented, its radio losses were offset by profits from automotive products.

The trade papers carried no further news of Stewart-Warner, which is not to say the company disappeared, only that it became less conspicuous. It continued to make radios, and (later) televisions and phonographs until 1954 when it discontinued U.S. production. With diverse interests in military electronics, facsimile, furniture hardware, lubricating systems, heating, and tools, Stewart-Warner continues to grow today.



"Christmas Brings a New Companion"  
—painting by Andrew Loomis

Saturday Evening Post (Dec. 12, 1925)

## The Christmas Gift for the Entire Family

**STEWART-WARNER MATCHED-UNIT RADIO!** What Christmas present could you possibly give that would more completely satisfy everyone?  
What would you rather receive than a fine radio this Christmas?

No other gift will give such constant enjoyment every day next year, and for years after—every hour of the day of every year.

### Stewart-Warner Radio is an Investment

Most Christmas gifts are without constant value. They are set aside or disposed of shortly after Christmas. It is seldom that they have real intrinsic value—seldom that they are an investment that will give joy and entertainment to all members of the family and all your visitors as well.

Stewart-Warner Matched-Unit Radio is built by an institution whose reputation for high quality products is known the world over. You, no doubt, are using one or more of these products on your motor car right now.

Selected materials, highest class workmanship, rigid tests and inspections are not alone responsible for the remarkable success of Stewart-Warner Radio. The Matched-Unit idea made possible for us to offer you the reception you have always hoped for.

### What We Mean By Matched-Unit

By the Matched-Unit idea we simply mean that we have not only designed and perfected each individual unit, the Instrument, the Tube, the Reproducer and the Accessories—but in addition we have matched these units to function together in perfect unison.

Stewart-Warner Radios are guaranteed, as is every Stewart-Warner product, by the broadest of guarantees. Think what that means. You are absolutely protected. You take no chance.

Your authorized Stewart-Warner dealer is a qualified radio expert, selected to serve you. He is on the job to worry about your set after you buy it. He must keep you satisfied.

Now is the time to make your selection. There is a model to suit your exact desire. See your dealer today.

STEWART-WARNER SPEEDOMETER CORPORATION  
CHICAGO. — U. S. A.



**Stewart-Warner**  
**Matched-Unit Radio**  
INSTRUMENTS TUBES REPRODUCERS ACCESSORIES



COPYRIGHT 1925 BY S. W. L. CORP.

Tune in the Stewart-Warner Progr  
Friday, December 25, 1925, 8 to 9 P.M.  
*Special Selected Tone*  
Station WBBM, 226 Meters  
Kathryn Browne  
Chicago Civic Opera Contralto  
"The Voice That Cheered The Boys in France"  
Imperial Male Quartet  
Victor Record Artists

Models first advertised July 1925

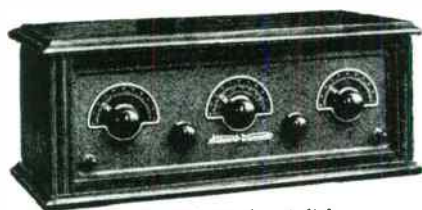

Model 325—5 tubes, 3 dials  
\$75.00



Model 501-AX—Tube  
(Can be used with set  
of any make)  
\$2.00



Model 365—5 tubes, 2 dials  
\$65.00



Model 400—Horn type  
(Can be used with set  
of any make)  
\$25.00

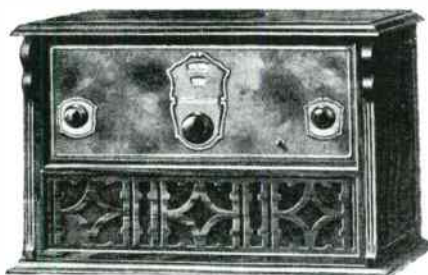

Model 350—6 tubes, 1 dial  
Built-in reproducer—\$110.00



Model 415—New type  
(Can be used with set  
of any make)  
\$30.00

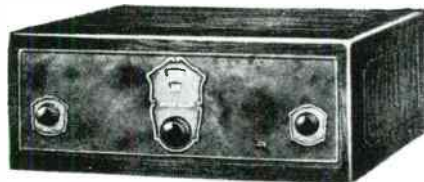

Model 345—6 tubes, 1 dial  
\$80.00



Model 375  
Console  
5 tubes, 2 dials  
\$175.00



Model 315—Console  
5 tubes, 3 dials—\$250.00



Model 360—Highboy Console  
6 tubes, 1 dial  
\$400.00



385 (no date available) \$75

Earle Drake

330	July	1926	\$65 (dry-cell 300)
335	July	1926	\$175 console
340	July	1926	\$75 (probably dry-cell version of 325)
345	July	1926	\$80
350	July	1926	\$110
355	July	1926	\$150
360	July	1926	\$400
365	Sept.	1926	\$65
375	Sept.	1926	\$175

Cabinet designs by Charles B Smith:

350	71,502	filed Aug. 23, 1926
355	71,503	filed Aug. 23, 1926
375	70,390	filed March 26, 1926

Radio Retailing (Sept. 1926)





Perfect co-ordination of units is necessary for a great band . . . And in radio, Stewart-Warner has designed and built Instruments, Tubes and Reproducer to work together in perfect unison. The result is the famous Matched-Unit Radio.



Reproducer Model 415—\$30



Radio Tube Model 501-AX \$2.00



Table Cabinet Model 325—\$75



Console Cabinet Model 375—\$175

Which model is best suited to your requirements?

There's a Stewart-Warner Matched-Unit Radio for every home—and for every purse:—

Five-tube, three-dial models (table and console types) from \$65 to \$400.

Five-tube, two-dial models (table and console types) from \$65 to \$175.

Six-tube, one-dial models (table and console types) from \$80 to \$400.

All cabinets are in walnut, beautifully finished.

Prices shown are without accessories.

All prices slightly higher west of Rockies.

## They're Knocking at Your Door!

THEY want to come into your home to entertain you. The big brass band—your favorite singer—the world-famous pianist—the most popular dance orchestra. All ready and waiting to please you. Let them in—tonight. It's Stewart-Warner Radio time!

Listen to the wonderful entertainment they offer you. Just turn the dials of a Stewart-Warner Matched-Unit Radio and let the world of finest radio enjoyment flood your home.

Listen to the marvelous tone! Full, rich, mellow, clear, beautiful. That is because Stewart-Warner has designed, built and matched every unit to work in perfect unison.

No hit-or-miss combination of set, tubes and reproducer can be expected to give such fine performance. Just as all instruments

in the brass band must be tuned and timed to blend into a perfect whole, so must all parts—all units—of a radio be *matched* to give the best and clearest reception.

When you buy your Stewart-Warner Radio, you have the satisfaction of knowing that it is made and backed by the big, reliable Stewart-Warner institution, with its twenty-year record of leadership—with its tremendous service organization, reaching from coast to coast.

Let your own ears tell you that this is the Radio you want in your home. Your nearest Blue Ribbon Dealer—a member of the national Stewart-Warner organization—is ready and anxious to demonstrate a Matched-Unit Radio for you and your family. We will gladly send you his address on request.

STEWART-WARNER SPEEDOMETER CORPORATION  
1826 DIVERSEY PARKWAY, CHICAGO, U. S. A.

# STEWART-WARNER Matched-Unit Radio

TWELVE MILLION PEOPLE ARE TODAY USING STEWART-WARNER PRODUCTS



705 June 1927 \$125

Technical articles in *Radio Broadcast* (Mar. 1928), pp. 376-378; *Radio News* (Jan. 1928), pp. 757-758.



525 June 1927 \$80

1,830,542. RADIO-FREQUENCY AMPLIFIER. SYLVAN HARRIS, Philadelphia, Pa., assignor to Stewart-Warner Corporation, Chicago, Ill., a Corporation of Virginia. Filed Nov. 4, 1927. Serial No. 230,946. 6 Claims. (Cl. 179-171.)

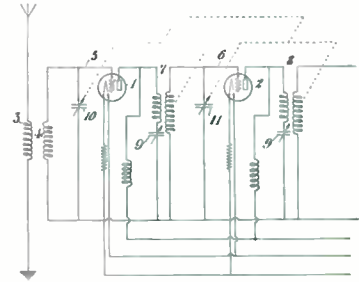

5. A multi-stage radio-frequency amplifier comprising a plurality of three electrode audions provided with tuned input circuits, each stage being coupled to the succeeding stage by a transformer with such closely coupled windings of high mutual inductance that the resonance peaks are so widely separated that only one is within the range of the receiver at any given setting, a variable capacity in series with the primary winding of each transformer for maintaining the net inductive reactance of each plate circuit at substantially zero, substantially as set forth.

DECEMBER 7, 1926

71,592. GRILLE FOR RADIOAMPLIFIER. SYDNEY E. LEE, Chicago, Ill., assignor to Stewart-Warner Speedometer Corporation, Chicago, Ill., a Corporation of Virginia. Filed Aug. 13, 1926. Serial No. 18,731. Term of patent 7 years.



The ornamental design for a grille for radioamplifier, substantially as shown.

# The New STEWART-WARNER MATCHED-UNIT RADIO

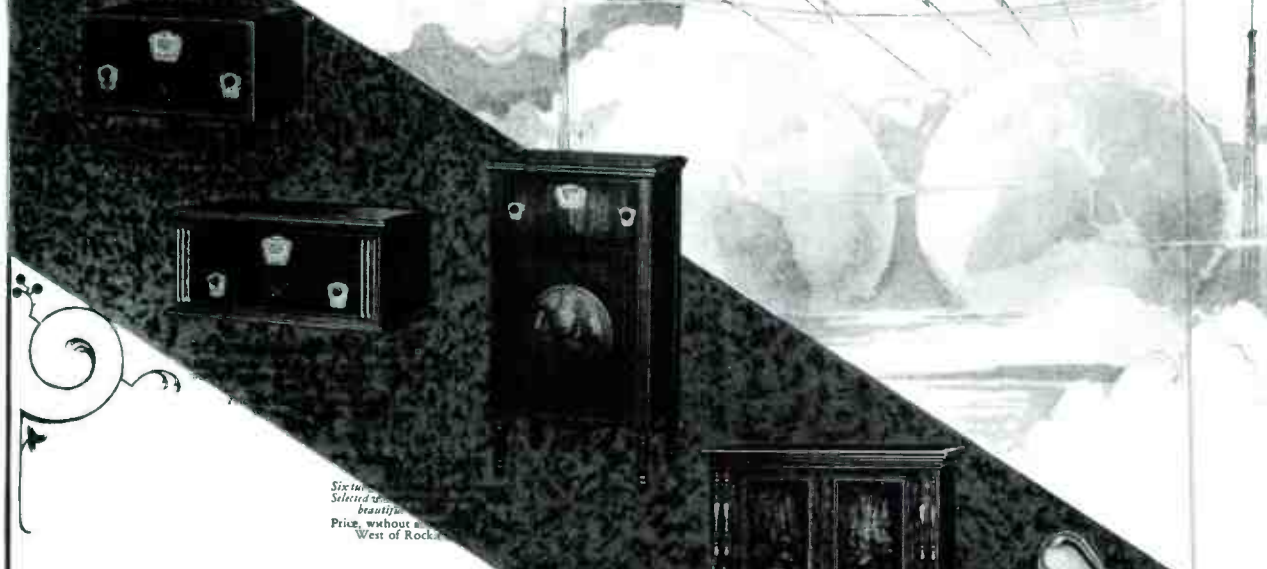

Six tube  
Selected  
beautiful  
Price, without a  
West of Rock

**I**N this wonderful new line of radio models, STEWART-WARNER has embodied all the vast knowledge and experience that the radio industry has acquired—and combined with them the craftsmanship of the most skillful cabinet makers. The chassis design and construction incorporate all the latest features that make for complete radio satisfaction; the cabinets are the last word in design and finish.

Everyone knows that today, with a good radio in your home, you have a world of entertainment at your command. Every hour of every day, there is something *good* on the air—informative, entertaining, worth-while listening to—with a great variety of appeal.

And now, with one of these new STEWART-WARNER models, you can bring in all of this entertainment with a fidelity of reproduction never before possible. We could talk to you at great length about the marvelous selectivity, wonderful tone quality, range and volume of these new models. But, today these are technical details with which you need no longer concern yourself.

Now, when buying a radio, there is really one important point for you to consider—and that's the name on the set. For in radio, as anywhere, the name means everything.

When you see "STEWART-WARNER" on a set, you can buy with perfect confidence. For over 20 years the STEWART-WARNER organization has been a leader in the manufacture of mechanical and electrical products. Sixteen million people are now satisfied users of products bearing the STEWART-WARNER name.

Step into one of our Blue Ribbon Dealer's and hear these wonderful new radios. You'll find a model and price to suit your taste; you'll find the Stewart-Warner name a guarantee of absolute satisfaction. It's the brand to demand!

STEWART-WARNER SPEEDOMETER CORPORATION  
CHICAGO, ILLINOIS, U. S. A.

### A Wonderful Opportunity for Dealers

If you have not already procured your Stewart-Warner franchise, do so at once. The Stewart-Warner policy—with its many special and protective features—offers unlimited possibilities for making money. A request will bring complete details immediately—with no obligation.



DE LUXE CONSOLE.  
Exquisite cabinet of solid walnut, selected burled walnut veneer. Six tube dial vernier control. Fully shielded chassis. Price, without accessories, \$255. West of Rockies, \$263.50

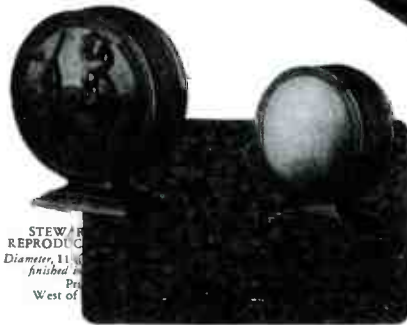

STEWART-WARNER REPRODUCERS  
Diameter, 11 1/2 inches  
finished in black  
West of Rockies

### New Stewart-Warner Reproducers

You get the best results from any set when used with one of these wonderful new Reproducers. Every musical note, from the lowest double bass to the highest piccolo, is reproduced with equal fullness and fidelity. Just turn up the volume—these Reproducers will "take it." Hear these new models at one of our Blue Ribbon Dealer's—learn how remarkably they improve the quality of radio reception.

- 520 June 1927 \$125
- 540 May 1928 \$137 (AC version of 520)
- 710 June 1927 \$225

# REALISM IN RADIO



"Fourth Down—One to Go!"



**All-Electric A. C. Combination**

(105 to 130 volts; 25 to 40 or 50 to 60 cycles)  
7 receiving tubes, with push-pull power stage

This combination of Model 801-A Series B receiver, with Model 435-A reproducer attached to the cover, is a completely self-contained radio. Built-in light-socket aerial. FOUR tuned circuits. ONE tuning control. Gold-plated illuminated dial, calibrated in wavelengths. Price of set, \$96, without tubes. Attachable reproducer, \$16. Price of combination, without tubes . . . . .

**\$112**

**REALISM in RADIO**  
THRU THE  
*Electric Ear*  
TRUE TONE BY TEST

**All-Electric A. C. Receiver, Model 801 Series B**

Same as Model 801-A Series B, but not equipped for attachable reproducer. Without tubes.

**\$96**

The same style in battery-operated set, \$69, without tubes.



**Stewart-Warner Reproducer, Model 435**

A new magnetic cone speaker, revealing a new depth and magnificence of tone.

**\$16.50**

This reproducer will improve the reception of your old set in a surprising manner.



All prices slightly higher west of the Rockies.

## STEWART-WARNER

THE VOICE OF AUTHORITY IN RADIO

### All-Electric A. C. Radio

Fourth down! One yard to go! Thirty seconds to play! What a world of drama surges around those pale goal posts in the gathering twilight!

You can hear it, feel it—almost see it, though you're miles away. The new Stewart-Warner Radio brings it to you, play by play—the blare of the band, the stamp of thousands of feet, the cheers, the spirit!

You'll marvel at the absolute Realism of reproduction made possible only by Stewart-Warner's exclusive Electric

Ear test. Fidelity of re-creation close to perfection.

This set has pick-up receptacles for playing records through the new reproducer with results equal to a new-type phonograph. Alone the reproducer will work wonders on any set.

Stewart-Warner dealers will demonstrate the set and explain the accurate tone test. Through our Nation-Wide Acceptance Plan you can buy from any Stewart-Warner dealer on easy monthly payments.



No. 1—\$42.50

No. 2—\$52.50

No. 3—\$62.50

No. 4—\$72.50

No. 5—\$87.50

Complete line of approved Console Cabinets for all sets at dealers'. Console prices include built-in Stewart-Warner Reproducers, but do not include receiving sets.

STEWART-WARNER SPEEDOMETER CORPORATION, Chicago

22 years in business—world-wide service—50 million dollars in resources—  
4th successful radio year

801 June 1928 \$94.50

Short technical article in *Radio* (Dec. 1928), p. 25.

801-A, lid drilled for speaker attachment  
802 with attached speaker, \$110.50  
811, 812 25 cycles  
806 battery model \$67.50

# "THE SET WITH THE PUNCH" STEWART-WARNER

Here's what they  
mean by  
**"PUNCH!"**

Everywhere you hear it. "The Set with the Punch"—that's what they're calling this new Stewart-Warner "Series 900" Radio.

Just what do they mean? Distance-getting ability—that's one thing. Distant stations come booming in with all the pep and punch of a "local." And power, tone, selectivity that have set an absolutely new standard of radio performance.

And sales-making ability, too. That's the "punch" that is bringing Stewart-Warner dealers a rich reward in profits. Without question here's the undisputed *Champion of the Air*—the set that is setting the pace—in profit as well as performance!

It's all made possible by the famous Stewart-Warner balanced bridge circuit; by the last word in tube assembly; by the wonderful new electro-dynamic reproducer, and other super refinements. Modern—even to plug-in for television. Thoroughbred—even to 22-carat gold plated connections.

Get the facts today about the Set with the punch, the Franchise with the punch, and the price-range with the punch! Radio's outstanding values: \$89.75 to \$170.50 (less tubes). Write or wire now.

## RADIO

*Champion of the Air!*



**\$142<sup>50</sup>\***

*Less Tubes*

Approved Jacobean Cabinet No. 35, with Model 900, of Walnut with enclosed back and hinged top. Height 38 in., width 27 in., depth 15 in. Stewart-Warner Radio comes in 60-cycle and 25 cycle AC, 100 to 130 volts, models for any current. Also battery operated models.



**\$165<sup>50</sup>\***

*Less Tubes*

Approved Sheraton Cabinet No. 58 with Model 900 Stewart-Warner Radio, illustrated above. 8 tubes, including rectifier. "Balanced Bridge" circuit. New Stewart-Warner Electro-Dynamic Reproducer. Cabinets by Louis Hanson Co., Chicago, and Burnham Phonograph Corp., Los Angeles. Walnut and lacewood with silent sliding doors; height 52½ in., width 25½ in., depth 17 in.

\* Prices slightly higher west of Rockies.

## STEWART-WARNER

THE VOICE OF AUTHORITY IN RADIO

STEWART-WARNER CORPORATION  
DIVERSEY PARKWAY, CHICAGO

901 August 1929 \$89.75  
911 \$95.25 (25 cycles)  
921 \$97.25 (110VDC)  
931 \$72.50 (battery)

951 August 1929 \$95 (screen-grid)  
Technical articles in *Radio* (March 1930),  
pp. 41-42; *Citizens Call Book* 11, No. 3  
(Sept. 1930), p. 74.

## Radio Assembly Lines Thoroughly Up-to-Date

New Lines in Chicago Plant of Stewart-Warner Corp. Said to Be Last Word in Production Equipment—Speedy Output

The radio assembly lines pictured herewith are those of the Stewart-Warner Corp.'s Chicago plant and are regarded as the last word in production equipment. Factory engineers state that the new lines not only increase efficiency of employes and speed up production but permit greater supervision and inspection of assembly work. A conveyor belt almost 200 ft. long has been installed on each of the assembly lines. Instead of having a belt passing down the center of a table, each side of the assembly bench is equipped with a slowly moving conveyor carrying the chassis in special frames and stopping them before each specialized operator. A sufficiently wide space is allowed at each stage to permit the operator

Talking Machine World (Aug. 1929)

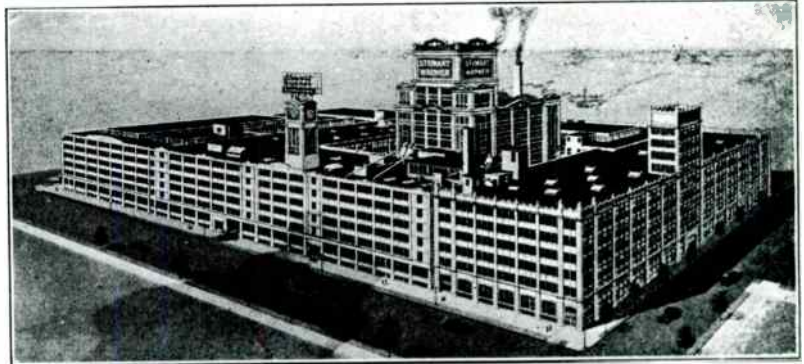

## Has Million Square Feet of Floor Space

Stewart-Warner Corp. Plant Ranks Among Largest in World—Most Modern Equipment Throughout the Factory

Containing one million square feet of floor space, and employing over 5,000 skilled workers, the gigantic Stewart-Warner Corp. factory on Diversey Parkway is one of the largest in the world. The plant is equipped with the most modern machinery known to manufacturing circles, and is operated under the most advanced methods of production. Here, in this plant, are made Stewart-Warner radio receivers and automobile accessories. The firm pioneered the automotive field twenty-three years ago, and is now in its fifth year of radio manufacture.

The tower in the center of the huge Stewart-Warner plant is its most recent addition, built in order to provide more space due to the increasing demand for manufacturing facilities.

Stewart-Warner controls as subsidiary organizations the Stewart Die Casting Corp., Bassick Alemite Corp., Alemite Mfg. Corp., the Bassick Co. and the Alemite Lubricator Co., of Canada, Ltd. In addition to radio receivers and reproducers, the Stewart-Warner Corp. produces die-castings, lubricating systems, auto accessories, auto and furniture hardware.

Talking Machine World (Apr. 1929)



Assembly Line at Chicago Plant of Stewart-Warner Corp.

to complete the portion of the assembly he or she is assigned. Two large bus bars are carried the entire length of the belt and supply the low voltage high amperage current for use in spot welding. Electric outlets are provided along the lines where soldering irons may be utilized or where sets are connected up for intermediate tests. On top of the assembly bench is a third conveyor upon which the jigs or dollies, which carry the sets during their construction, are placed at the end of the assembly line to receive another chassis in the making.



801B Steve Conklin

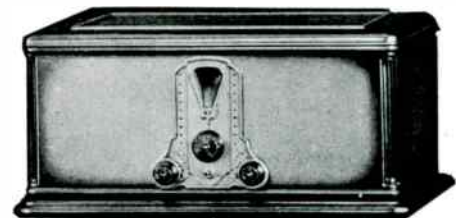

900 April 1929 \$89.75  
Consoles: \$113, \$123.25, \$142.50, \$165.50.

Short technical articles in *Citizens Call Book* 11, No. 1 (Jan. 1930), p. 78; *Radio* (July 1929), pp. 91-92.



According to John Dreyer, who worked for Hazeltine at the time, he did the electrical design while Ray Manson and Virgil Graham did the mechanical design. Later, Graham was in charge of radio engineering until 1935.

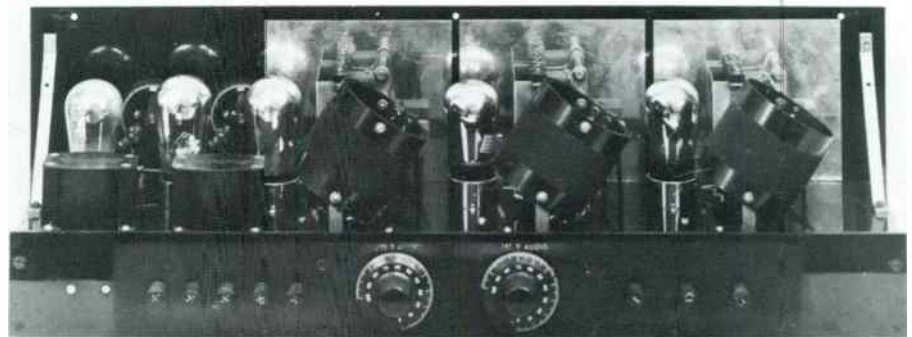

1A June 1924 \$180

**Stromberg-Carlson**  
HEAD SETS and LOUD SPEAKERS

There's an immense field of radio enjoyment in summer (the best political orators in America are on programs)—but you must have extremely sensitive reception apparatus to get good results.

have powerful magnets, the sensitivity of which gives them wide range, bringing in the fainter signals with volume and clearness.

They also have layer wound and layer insulated coils—an exclusive Stromberg-Carlson type of construction—which will stand up under the high plate voltages now used.

Ask your dealer  
Stromberg-Carlson Tel. Mfg. Co.  
1060 University Ave.  
Rochester, N. Y.

Layer Wound and Layer Insulated  
Powerful Magnets

Radio News (July 1924)

Powerful Magnets

Layer Wound and Layer Insulated

Clear Tones and Volume are essential to enjoyable radio reception

**Stromberg-Carlson**  
Head Sets and Loud Speakers

are super-sensitive and reproduce vocal and instrumental programs with naturalness and ample volume over long and short distances.

Their powerful magnets give sensitivity; the layer wound and layer insulated coils enable them to stand up under high voltages

Ask Your Dealer  
**STROMBERG-CARLSON**  
TELEPHONE MFG. CO.  
1060 University Ave., Rochester, N. Y.

No. 1-A Loud Speaker \$17.50  
No. 2-A Head Set \$5.50

Radio News (Nov. 1924)

The New  
**Stromberg-Carlson**  
No. 2-A  
**Loud Speaker**

A Triumph of Radio Engineering

Sensitive to the highest degree, this superb new Loud Speaker reproduces programs with naturalness of tone while its volume of sound is sufficient to fill the largest room on distant station reception. Graceful in design, with soft, oxidized silver finish, it is unobtrusive; so light it may be readily carried from place to place.

Requires neither extra batteries nor extra stages of amplification; simple and economical to operate.

Price \$17.50 including tax, freight and shipping.

Powerful Magnets are essential to sensitiveness, volume, and pure tone quality. The master construction and power of Stromberg-Carlson magnets give these qualities pre-eminently.

laboratory tests of the magnets used in the new No. 2-A Loud Speaker show a "pick up" of 255 pounds.

Reliable operation is further assured by use of Layer Wound and Layer Insulated Coils, which stand up under high plate voltages.

The new No. 3-A Head Set has new features you should know about.

Ask your dealer  
**STROMBERG-CARLSON TELEPHONE MFG. CO.**  
1060 University Ave., Rochester, N. Y.

No. 3-A Head Set

**Stromberg-Carlson**

Radio News (March 1925)

# STROMBERG-CARLSON

## Stromberg-Carlson Telephone Manufacturing Company

**A**lfred Stromberg was born near Stockholm, Sweden, in 1861 and came to the United States in 1884. While working for the Chicago Telephone Co., he met Androv Carlson, who was seven years older and had a similar background. With the expiration of Bell's fundamental patents in 1893 and 1894, Stromberg and Carlson, both experienced inventors and mechanics, formed a partnership in January 1894 to build telephone equipment of their design. Stromberg-Carlson prospered as a major supplier to the independent Rochester (NY) Telephone Co. Incorporated in May 1895, it was sold to a group of Rochester capitalists for \$750,000 and re-incorporated in April 1902. Stromberg returned to Chicago around 1906 and formed two new companies one of them became the Stromberg Carburetor Co., which was acquired by Bendix in 1929; the other, Stromberg Products, now makes time clocks.

Stromberg-Carlson began making wireless components in a small way in 1910; a limited number of Navy headsets in 1915; and finally, audio transformers and other radio parts. In 1916, Ray H. Manson joined the company as chief engineer. Manson was born in 1877; received his EE from the University of Maine; and had long experience with Western Electric, Kellogg, and Dean. He obtained more than 110 U.S. patents on telephone equipment, phonographs, and radio, remaining with the company until the mid-1950's.

To break into radio-receiver manufacturing, Stromberg-Carlson chose to take out a Neutrodyne license in late 1923. The company was content to make a limited number of sets—estimates ranged from 50 to 100 per day—and sell them directly to dealers through manufacturers' representatives only in New York and the surrounding states where the dealers' performances could be closely monitored. A heavy advertising budget kept Stromberg-Carlson's quality image before the public. In 1924, sales amounted to \$442,630.30 at wholesale (according to figures reported to Hazeltine), and sales through the New York representative in 1926 were reportedly



Alfred Stromberg



Androv Carlson

\$700,000. In June 1926 the company employed about 1,250 people of whom 15 percent were estimated to be building radios; in August 1928, 900; by late 1930, 2,000.

Once RCA began signing up licensees in 1927, Stromberg-Carlson lost no time in climbing on the bandwagon in the number four place right behind Splitdorf. Stromberg-Carlson had no need to fight, finding it easy to sign up for whatever licenses were available and passing along the costs to its customers. Besides the Hazeltine license, the company also used the services of RFL (Radio Frequency Laboratories), particularly in the design of the Model 501; its individually shielded RF coils in closely-fitting cans were a revelation even to the technically trained Hazeltine engineers.

The formula of high quality at a high price continued to work, even during the Depression—at least well enough to keep the company afloat. No doubt revenues from the NBC-affiliate radio station in Rochester, WHAM, acquired in 1927, did not hurt. As early as 1939, the company was involved with television and FM. Merging into General Dynamics in June, 1955, Stromberg-Carlson discontinued radio and television production in May 1956 and radio-phonographs and hi-fi components in 1961. Today, the Stromberg-Carlson Corp. makes more telephones than ever.

*Electrical World (Mar. 5, 1898), p. 223*



November, 1925

Q S T

33

## The Making of a Radio Receiver

By Virgil M. Graham\*

**T**HE first work which is done in the development of a radio receiver is the circuit experimentation. This is carried on in the laboratory under direction of the Engineering Department and is merely to determine the working characteristics and the possibilities of the proposed circuit. After this work is completed rough laboratory models are made up to test the circuit under actual working conditions. When these models are made the probable design of the finished product is kept in mind so that the rough model will give an accurate prediction of the performance of the finished receiver.

The experimental stage being completed, the engineering of the set begins, and semi-final models are made from plans drawn by Engineers. The work on these models is done in the Experimental Shop, superintended by the Engineers, to see that every detail is correct and according to their plans.

The wiring and testing of these models is done by the laboratory after the mechanical work of making and assembling is completed by the experimental or model shop. These models are used for the addition of any improvements or revisions which are neces-



ASSEMBLING THE CHASSIS OF A RADIO RECEIVER

sary until they represent what seems to be the final model.

The Drafting Department proceeds to make drawings from these revised models. When these drawings are completed or while they are being prepared the Experimental Shop makes up the finished models according to the drawings in order to check them before they are sent to the factory. The finished models are used to

\* Engineer of the Stromberg, Carlson Telephone Mfg. Co.

make the final check of the operating characteristics of the set under various conditions and also for the completion or the revision of the drawings.

After the Engineering Department is thoroughly satisfied with the operation and construction of the models the drawings are sent to the factory for preparation of stock

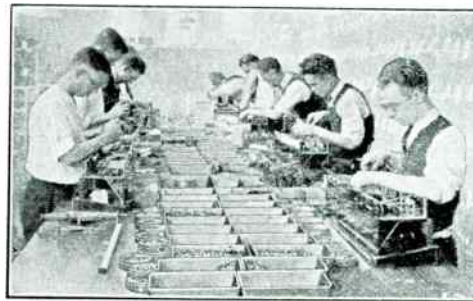

WIRING RADIO RECEIVERS

and construction of the necessary tools. The Engineering Department cooperates in all possible ways with the factory in determining methods of manufacture.

Now we come to the manufacturing stage of the radio receiver. The first work that the factory does is to make tools for the manufacturing of various parts used in the set. While the tools are being made and tested the Purchasing Department takes care of the buying of the raw materials and also of the parts such as meters, knobs, etc., which are purchased complete. As soon as the tools are ready, the various departments in the factory make up quantities sufficient to supply the first "Factory Order" for sets and the Assembly Department begins the assembly of various small parts such as balancing condensers, coil forms, etc. Not until all the materials are obtained and all the parts ready can the assembly proceed.

The chasses of the sets are assembled and taken to the wiring bench. Here the cable and bus wiring is put in and, since the sets made at this factory are neutrodyne, the angle of the radio coils adjusted very accurately. This angle is determined by the physical location of the radio-frequency apparatus in the receiver and is within a very few degrees of the angle of Professor Hazeltine's calculation.

When the sets are completely assembled and wired they are taken to the testing room where they are given a preliminary electrical test to determine if all the circuits are functioning properly and a very thorough

78,427. RADIOCABINET OR SIMILAR ARTICLE. EVERETT WORTHINGTON, Chicago, Ill., assignor to Stromberg-Carlson Telephone Manufacturing Company, Rochester, N. Y., a Corporation of New York. Filed June 25, 1928. Serial No. 27,266. Term of patent 3 1/4 years.



69,845. LOUD SPEAKER OR SIMILAR ARTICLE. RAY H. MANSON, Rochester, N. Y., assignor to The Stromberg-Carlson Telephone Manufacturing Company, Rochester, N. Y., a Corporation of New York. Filed Dec. 5, 1925. Serial No. 15,653. Term of patent 14 years.

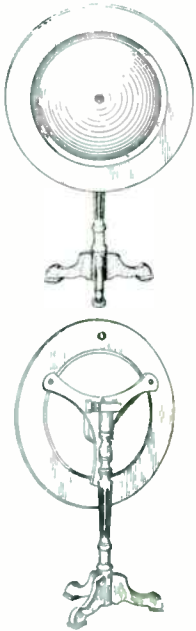

The ornamental design for a loud speaker or similar article as shown.

74,045. RADIOCABINET OR THE LIKE. JOHN M. BEACH, Grand Rapids, Mich., assignor to The Stromberg-Carlson Telephone Manufacturing Company, Rochester, N. Y., a Corporation of New York. Filed July 15, 1926. Serial No. 18,371. Term of patent 3 1/4 years.



The ornamental design for a radiocabinet or the like as shown.

- 5A speaker \$35
- 7A speaker \$30 (not shown, same but no pedestal, hangs on wall from a cord)
- 10 speaker \$40 (shown on facing page)
- 11 speaker (35 (not shown, same but no pedestal, hangs on wall from a cord)

Official Gazette of the U.S. Patent Office

(Apr. 30, 1929; Apr. 6, 1926; Dec. 13, 1927)

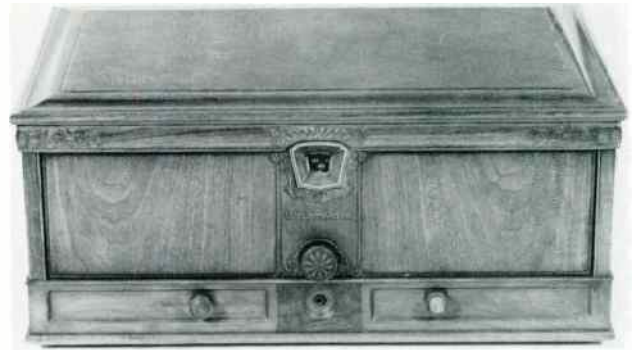

635 June 1928 \$185  
 Technical articles in *Citizens Call Book* 10, No. 4 (Nov. 1929), p. 88; *Radio Broadcast* (Sept. 1928), p. 277.

636 June 1928 \$245 console  
 638 March 1929 \$380 with dynamic speaker



501 August 1926 \$180  
 502 August 1926 \$290  
 51 table \$54.50 (61 table is similar; for 601 and 633 models, \$56)

mechanical inspection. After this test the set is balanced and again inspected and sent to the Calibrating Bench where the calibration cards are carefully made from the dial readings of the set at several wavelengths. From this bench the radio receiver is taken to the final electrical inspection where it is given a very thorough test for all operating

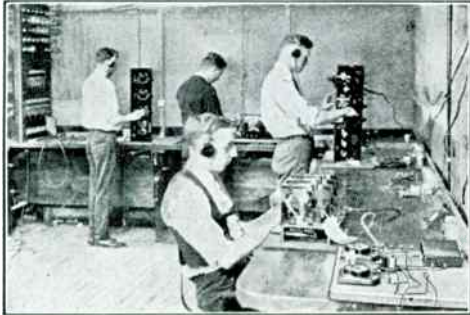

NEUTRALIZING THE RECEIVERS

characteristics. A screened room used for neutralizing the radio receivers. This screen shielding minimizes the disturbing commutator noises, etc., from the rest of the factory, so that an accurate balance can be obtained. After this test the sets are sent to where they are placed in the cabinet.

The set is placed in the cabinet and polished, it is ready for packing. The packing must be done very thoroughly and carefully as the set must stand rough handling during its journey to the future owner for whom all the detailed work has been done.



No. 2 Type Receiver, Console model — 5 tubes.

Radio Retailing (Aug. 1925)



Virgil M. Graham

Radio Broadcast (Aug. 1929)

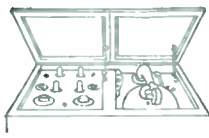

No. 3-Type Receiver, phonograph panel — 4 tubes.



## A Beautiful Receiver with a Telephonic Heritage

No. 602 Art Console (above). Finished in American Walnut; built-in Loud Speaker; space for batteries and battery charger; 6-tube; totally shielded; takes new tube base.

RADIO engineering is telephone engineering once the signal enters the receiver. In other words—how far you hear, how much you hear, how accurately you hear, depends upon the same principles as those used in the construction of the telephone.



No. 601 Table Model—6-tube; totally shielded; dual control; volt meter; takes new tube bases; operates either horn or cone type loud speaker; Solid Mahogany.

For more than 30 years Stromberg-Carlson has been making high grade telephone equipment, and the reason that this equipment has constantly met the exacting standards of public utilities, is because every worker in the Stromberg-Carlson plant has realized that his work was of vital importance; has taken pride in so performing his task that Stromberg-Carlson quality would be assured.



No. 1 Type Table Model. 5-tube; has antenna coupling switch; also key for switching from first audio to second audio frequency amplifier. Solid Mahogany.

Radio apparatus and the Telephone are so intimately related that with this experience and *esprit de corps*, Stromberg-Carlson engineers and craftsmen have been able to produce Radio Receivers that are the delight of enthusiasts everywhere.

The unexpected range of these receivers—their startling fidelity of tone—their simplicity—as well as their durability and freedom from trouble come from this telephonic heritage.

Ask your dealer to show you



the latest Stromberg-Carlson Receivers

Stromberg-Carlson Telephone Mfg. Co.  
Rochester, N. Y.

Chicago

Kansas City

Toronto

# Stromberg-Carlson

Makers of voice transmission and voice reception apparatus for more than thirty years

- 3A August 1925 \$95 for Victor 215
- 3B August 1925 \$95 for 400, 405, 410
- 2C December 1924 \$310 walnut
- 2D December 1924 \$310 mahogany

- 1B August 1925 \$180
- 602 August 1925 \$340
- 601 August 1925 \$210

Technical articles in *Radio Engineering* (July 1926), pp. 272-274; *Proc. I. R. E.* (Apr. 1926), pp. 217-247, 395-412; *Popular Radio* (Sept. 1926), pp. 465-468; *Radio News* (June 1926), p. 1647.

Design patents 69,791 and 69,792 to John M. Beach were filed on September 18, 1925.

# The Greatest Stromberg-Carlson Line

A.C. Receivers for operating direct from 60 cycle house lighting circuit; Universally Powered Receivers for operating in all other areas.



No. 633 Stromberg-Carlson A.C. Receiver. Price, with Audio-Power Unit and 9 R.C.A. Tubes—but without Cone Speaker or Loop. East of Rockies \$355; Rockies and West \$380.  
No. 601 Stromberg-Carlson, Universally Powered Receiver, similar cabinet. Price, less accessories—East of Rockies \$225; Rockies and West \$240.



No. 523 A.C. Receiver. Price, with Audio-Power Unit and 8 R.C.A. Tubes but without Cone Speaker; East of Rockies \$595; Rockies and West \$315.  
No. 501 Universally Powered Receiver, similar cabinet. Price, less accessories; East of Rockies \$180; Rockies and West \$191.50.



No. 744 A.C. Receiver Radio and Phonograph combination. Incorporates an electric phonograph having magnetic pick-up for reproducing records through audio system of Receiver and the Cone Speaker. Price, including Cone Speaker, Loop, Socket-Power Unit and 11 R.C.A. Tubes, East of Rockies \$1245; Rockies and West \$1399.



No. 514 A.C. Receiver. Price, with Audio-Power Unit and 8 R.C.A. Tubes—but without Cone Speaker. East of Rockies \$415; Rockies and West \$435.  
No. 502 Universally Powered Receiver, similar cabinet. Price, less accessories, East of Rockies \$290; Rockies and West \$315.



No. 734 A.C. Receiver. Price with Socket-Power Unit and 11 R.C.A. Tubes—but not including Cone Speaker or Envelope Loop. East of Rockies \$755; Rockies and West \$795.



No. 106 Cone Speaker. A 12-inch seamless Cone Speaker built with thin apex and thicker edge for even sound-producing qualities. Reproduces below 60-cycle fundamental tones. Designed only for highest grade Receivers. Price, East of Rockies \$40; Rockies and West \$44.

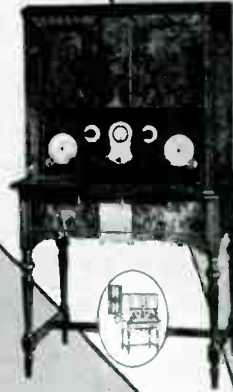

No. 614 A.C. Receiver. Price, with Audio-Power Unit and 9 R.C.A. Tubes but without Cone Speaker or Loop. East of Rockies \$595; Rockies and West \$545.  
No. 602 Universally Powered Receiver, similar cabinet. Price, less accessories, East of Rockies \$390; Rockies and West \$360.

SIX NEW A.C. STROMBERG-CARLSONS satisfy the demand for all *direct* light socket operation wherever 105-125 volt, 50-60 cycle alternating current is available. Four Universally Powered Stromberg-Carlsons give *indirect* A. C. operation with "B" eliminator and Unipower; or complete D. C. operation with batteries where house current is unavailable or unsuitable.

The Stromberg-Carlson line contains Receivers which offer loop or antenna pick-up in Treasure Chest or Console models; Receivers with single or dual station selectors; Rec-

ivers which give radio reproduction of phonograph records.

Every Stromberg-Carlson irrespective of current supply uses inexpensive, long-lived, D. C. type tubes of proved efficiency offering no limit on tone quality.

The wide range of Stromberg-Carlson prices, plus the protection and profit possible under the new Stromberg-Carlson financing plan permits more sales with safety.

Stromberg-Carlson's complete patent protection on every item of their radio installations and their guarantee not to reduce prices, assures "permanent value"

STROMBERG-CARLSON TELEPHONE MFG. CO., ROCHESTER, N. Y.

# Stromberg-Carlson

Makers of voice transmission and voice reception apparatus for more than thirty years.

Radio Retailing (Sept. 1927)



No. 641 Stromberg-Carlson Treasure Chest  
Designed for A. C. Screen Grid Tubes

In this latest Stromberg-Carlson, the enormous amplification of three of the new A. C. Screen Grid Tubes makes possible the use of linear power detection with automatic grid bias—thus perfecting tone reproduction from stations using the new 100% broadcast modulation.

The great amplification of the A. C. Screen Grid Tubes also makes an intermediate audio stage unnecessary; the output tube—the new UX-245—taking its signal directly from the detector.

Stronger, low tones, greater distance and keener selectivity are assured. Scientific Total Shielding. Single selector (illuminated). Permanent phonograph connection at back of Receiver.

The Walnut Finished Cabinet is featured by vertical and horizontal graining of exquisite beauty.

*Prices*  
No. 641-A Receiver, 60 cycle, less tubes (tubes \$21.00. See tube listings on separate page)..... \$155.00  
No. 641-B Receiver, 35-50 cycle, less tubes (tubes \$21.00. See tube listings on separate page)..... \$155.00



No. 638 Stromberg-Carlson Art Console  
With Built-In Electro-Dynamic Speaker

This magnificent new Console has all the superb tonal excellence for which Stromberg-Carlsons are celebrated, together with the rich, unlimited volume heretofore afforded by the No. 18 Stromberg-Carlson Electro-Dynamic Speaker. It is all-electric, having a chassis similar to the No. 635 Stromberg-Carlson, and using the same tubes. Natural tone quality is assured at all ranges of volume from a whisper to the loudness of the original program. A sensitive Receiver of keen selectivity. Scientific Total Shielding. Tunes with a single selector (illuminated). Permanent phonograph connection at back.

All exposed surfaces of select, beautifully grained Walnut; panels of 5-ply construction; other parts including legs and stretcher of solid Walnut. Speaker concealed by sliding panels.

*Price*  
No. 638 Receiver, 110 volt D. C., less tubes (tubes \$15.25. See tube listings on separate page)..... \$370.00

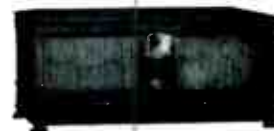

No. 635 Stromberg-Carlson Treasure Chest

In this Stromberg-Carlson both Receiver and power equipment are combined in one compact unit. Operation is direct from the house lighting circuit without batteries or liquids. The Receiver uses 9 Radiotron tubes, consisting of 5 UX-201-A and 4 UX-171-A. Employs balanced circuits, (Hazeltine patents) with Scientific Total Shielding. Its new dual circuit volume control aids materially in maintaining the Receiver's tonal excellence from bare audibility to full power. Single station selector (illuminated). Phonograph jack for record reproduction. Cabinet of beautiful two-toned Walnut.

Complete receiving and power equipment mounted on a single, sheet steel base. Wiring concealed. The various items of apparatus enclosed in compact metal casings with baked enamel finish.

*Price*  
No. 635 Receiver, 110 volt D. C., less tubes (tubes \$17.00. See tube listings on separate page)..... \$189.00

**Stromberg-Carlson**



Nos. 16 and 17 Cone Speakers

The exceptional fidelity of tone for which these Speakers are celebrated, is largely due to the construction of the cone, which is seamless and is built of acoustically correct fiber, knit together by a special process, so that it has no grain. At the center, "apex," the cone is thinner than the outside edge, for the higher frequencies are thus given better reproduction. This gradation of the thickness of the cone also does away with objectionable paper rattle. Reproducing below 60-cycle fundamental tones, these Speakers are designed especially for Stromberg-Carlson Receivers. On account of their wide musical range, they will enhance the tone quality of any high-grade receiver. Diameter of cone, 22 inches; height over-all, 34 1/2 inches.

*Prices*  
No. 16 Cone Speaker (Pedestal Type)..... \$40.00  
No. 17 Cone Speaker (Wall Type)..... \$15.00

*The Stromberg-Carlson Tube Package*

To insure the best operating results and for the greater convenience of buyers, the Stromberg-Carlson Tube Package has been created. In each package will be found properly matched tubes of the type and characteristics for which the Receiver is designed.

Purchase of a Stromberg-Carlson Tube Package with each Stromberg-Carlson Receiver insures maximum results at no extra cost.

*Prices*

The No. 845 Tube Package, for the No. 846 A. C. Receiver, includes 3 UY-224 A. C. Screen Grid Tubes, 3 UY-227, 2 UX-245, and 2 UX-280 Radiotrons..... \$32.50

The No. 640 Tube Package, for the Nos. 641 and 642 A. C. Receivers, includes 3 UY-224 A. C. Screen Grid Tubes, one UY-227, one UX-245, and one UX-280 Radiotrons..... \$21.00

The No. 620 Tube Package, for the Nos. 638 and 635 D. C. Receivers, includes 5 UX-201-A and 4 UX-171-A Radiotrons..... \$15.25

*"There is nothing finer than a Stromberg-Carlson"*

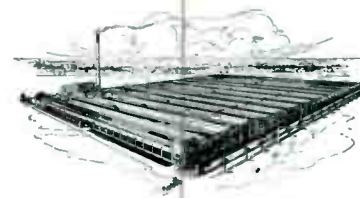

The new plant of the Stromberg-Carlson Telephone Manufacturing Company, Rochester, N. Y.

Mitchell Woodbury Corporation  
55 Franklin St. Boston, Mass.

**Stromberg-Carlson**

Circular No. 809 8-29 Fair of Rochester Printed in U. S. A.

641 June 1929 \$155

642 June 1929 \$247.50

Technical articles in *Radio Broadcast* (Aug. 1929), pp. 230-232; *Radio* (July 1929), p. 56.



*Stromberg-Carlson Magnetic Pick-up Outfits*

Two Magnetic Pick-up is readily installed in any standard phonograph. It plugs into the phonograph jack of a Stromberg-Carlson Receiver and makes possible electrical reproduction of records through the wonderful audio system of the Stromberg-Carlson Receiver, thus converting even an old phonograph to the equivalent of the most modern electrical reproducing instrument.

A specially designed control, located between the Pick-up and the Receiver, regulates the volume without muffling or distorting the music. A rich finish adds beauty to this device.

*Prices*

No. 3-B Magnetic Pick-up Outfit, (above) including No. 60 Plug and long cord. For use with Nos. 523, 533, 734, 835, 836 and 638 Stromberg-Carlson Receivers and other makes of radio receivers.....Price \$25.00

No. 3-A Magnetic Pick-up Outfit, (below) including Input Transformer, long connecting cord and No. 60 Plug. For use only with Nos. 641, 642 and 846 Stromberg-Carlson Receivers, and other makes having power detector.....Price \$30.00



*No. 25 Electro-Dynamic Speaker*

A new degree of tonal range and volume is combined with an exterior of unusual beauty in this new Stromberg-Carlson Electro-Dynamic Speaker. Uniformity of response without sacrifice of efficiency is insured by the use of a 10 inch corrugated cone, with a specially made "lively" diaphragm. *Sound volume with small power output* from the Receiver is the result of the true "moving coil" operating principle. High volume with minimum movement of the driving coil is made possible by the large diameter cone. Hum is kept down to an imperceptible degree, there being no balances to adjust or maintain. The use of a Cabinet, permitting scientific baffling, insures new beauty of true tone in the lower frequencies. Operating power for the Speaker is supplied by a UX-280 Rectifier Tube contained within the Speaker cabinet.

Switch inside of cabinet and A. C. outlet in bottom for operating with Receivers not equipped with loud speaker A. C. outlet.

The cabinet is finished in Walnut with a beautifully fashioned grille and a screen concealing the working parts. Dimensions: Height 36 inches; Width 19 inches; Depth 11 inches.

*Prices*

No. 25-A Electro-Dynamic Speaker, 60 cycle, without tube..... \$85.00  
 No. 25-B Electro-Dynamic Speaker, 25-50 cycle, without tube..... \$85.00  
 UX-280 Rectifier Tube ..... \$3.00



*Nos. 14 and 15 Cone Speakers*

A new table model Stromberg-Carlson Cone Speaker of improved design. Built to reproduce with naturalness every tone which the Receiver delivers.

The cone of this Speaker is seamless, with thin apex and thicker edge to insure evenness of sound reproduction. Short drive rods in the electrical unit make surer rendition of the high frequencies. Exceptionally rigid in construction so that there will be no rattle to mar the performance.

It has a rich brown crackle finish with a relief of dull gold. The back has a handsome metal grille with a Rayon Marquisette screen concealing the working parts. Diameter over-all 16 inches. Height over-all 18 inches.

*Prices*

No. 14 Cone Speaker, with 10 ft. Cord .....\$22.50  
 No. 15 Cone Speaker, with No. 10 Audio filter, for use with other makes of receivers ..... \$25.00



Stromberg-Carlson



*No. 846 Stromberg-Carlson Art Console*

*A. C. Screen Grid Tubes and Automatic Volume Control*

This Receiver has the exceedingly high amplification gained by Total Shielding and 3 A. C. Screen Grid Tubes.

An Automatic Volume Control with Visual Meter Tuning and Silent Key eliminates nerve-racking blasts of programs and background noises while tuning from station to station. This volume control also maintains automatically uniform volume regardless of the usual effects of the fading of incoming broadcast signals.

Three UY-224 A. C. Screen Grid Tubes are used in the radio amplifier and a UY-227 in both the Automatic Volume Control circuit and in the "Lincas" power detector. The audio amplifier employs one UY-227 in the first stage and two UX-245 tubes in "push pull" for the output. Two UX-280 Rectifier Tubes furnish power to the Receiver and Speaker. Phonograph reproduction of records provided for by permanent connection in back panel. Half-octagonal cabinet, with six legs, Walnut finished.

*Prices*

No. 846-A Receiver, 60 cycle, less tubes (tubes \$32.50. See tube listings on separate page) ..... \$147.50  
 No. 846-B Receiver, 25-50 cycle, less tubes (tubes \$32.50. See tube listings on separate page) ..... \$147.50



*No. 642 Stromberg-Carlson Art Console*

*A. C. Screen Grid Tubes and Built-in Electro-Dynamic Speaker*

A beautiful new Console model Receiver with built-in electro-dynamic speaker—designed to utilize three of the new A. C. Screen Grid Tubes which make possible *linear power detection*. This linear power detection with automatic grid bias, is necessary to obtain full value from the new 100% broadcast modulation.

The high efficiency of the new circuit, used with scientifically baffled electro-dynamic speaker, gives greatly increased volume range while maintaining clarity and quality of tone. Other features are: extreme selectivity; single dial tuning; Scientific Shielding of each radio frequency and detector stage; phonograph reproduction of records (permanent connection in back panel.)

The cabinet is finished in American Walnut with beautiful reproductions of hand carved design. Sliding doors conceal set and speaker when closed.

*Prices*

No. 642-A Receiver, 60 cycle, less tubes (tubes \$21.00. See tube listings on separate page) ..... \$247.50  
 No. 642-B Receiver, 25-50 cycle, less tubes (tubes \$21.00. See tube listings on separate page) ..... \$247.50

Talking Machine World & Radio-Music Merchant, New York, May, 1929

## Stromberg-Carlson Plant Is Completed

**Includes Twenty-eight Acres With Approximately 360,000 Square Feet of Floor Space—Is of Monitor Type Construction With Modern Equipment**

The big, new Stromberg-Carlson plant in Rochester, N. Y., where both radio receivers and telephone equipment will be manufactured, has been completed and is ready for the busiest season in the company's history. The grounds include twenty-eight acres, while the factory building measures 625 by 460 feet overall and covers approximately 360,000 square feet of floor space. The plant is a single building, one story high, divided into four units with a basement under one of them. A private siding enters the property from the adjoining New York Central main line. A shipping and receiving platform of car-door height and ten feet wide runs the full length of the building and can accommodate at one time a dozen freight cars and a fleet of trucks and vans. A

spare track over 750 feet long will take care of any extra cars. Concrete driveways lead to either end of the platform and the space between the rails of the siding is filled flush with cinders, making any part of the loading platform available to trucks.

The style of construction used on this plant is the monitor type. Fifteen monitors, like great inverted troughs, with windows on either side, run through the building from East to West, with the supporting trusses within the monitors themselves, covering spans usually of sixty feet, but of one hundred feet in one section of the plant. Such construction makes possible a wider space without supporting posts and thus increases clear space in the factory. The reduction in the number of posts makes possible the more efficient placing of machinery and benches. Another advantage of monitor type construction is that it insures perfect light to every part of the working area.

In heating, steam is led to units in the center of each monitor and equitably distributed by means of heating ducts, hung in the tops of the monitors where they do not interfere with the lighting. In the cabinet shop an ingenious filter system removes any dust made

by the cabinet machinery, which fails of being exhausted by the usual collector system, before it reaches the heating coils.

One of the outstanding features of the new Stromberg-Carlson plant is the huge radio assembly department with a continuous belt for carrying the completed chassis down to the final testing room. Throughout, whether in plating department, japan department, braider room, or cabinet shop, the latest type of equipment has been installed.

As the company manufactures both telephone and radio equipment, activities common to both fields are grouped together. Many of the machines can be used for either telephone or radio work and most of the employes can be assigned to either field. This insures both labor and machinery being used to the best advantage, for it is possible to transfer men from one field to the other as the necessity arises and thus retain an experienced force. Practically all the work connected with the manufacture of telephones, switchboards, radio receivers and loud speakers, from the making of parts to their final assembly, will be carried on entirely under the roof of this one plant.

APRIL 15, 1930

80,978. RADIO CABINET OR SIMILAR ARTICLE. EVERETT WORTHINGTON, Chicago, Ill., assignor to The Stromberg-Carlson Telephone Manufacturing Company, Rochester, N. Y., a Corporation of New York. Filed Nov. 29, 1929. Serial No. 33,575. Term of patent 3½ years.

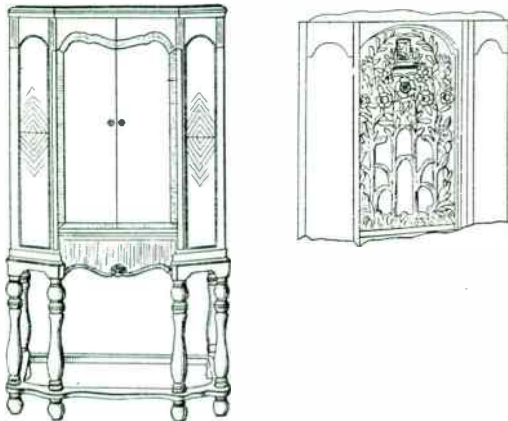

The ornamental design for a radio cabinet or similar article as shown.

846 July 1929 \$347.50

This six-legged console (illustrated on the previous page) started a whole new design trend in the industry.

Technical articles in *Citizens Call Book* 11, No. 3 (Sept. 1930), p. 75; *Radio Broadcast* (Oct. 1929), p. 355-357, 366.

Official Gazette of U.S. Patent Office



846 in a custom cabinet

Vernon Oehlke

JANUARY, 1921

27

## A Modern Telephone Manufacturer

Where and How Stromberg-Carlson Equipment  
is Made and the Personnel of the Company

**H**ELPING to give the human voice the range of a continent has been the job of the Stromberg-Carlson Telephone Manufacturing Company, of Rochester, New York, for nearly thirty years. Approximately 2,000,000 telephones have been produced by this Rochester industry, and its work in accelerating business, extending the confines of intimate neighborhood and adding a pleasing, efficient momentum to life's general activities has been one of the mightiest gifts of American industry.

The cave man with his lusty lungs could make his gibberish heard across five hundred yards of water. The megaphone of later civilization increased the range of the voice so that it was able to compass wider streams, but the human voice still was provincial until the telephone was invented in the nineteenth century. Now, by telephonic electric currents, the voice is carried across thousands of miles of space.

### LEADER AMONG INDUSTRIES

Stromberg-Carlson is a leader among the Rochester industries that are spreading the fame of this city throughout the world. Down in the diamond and gold mines of South Africa you will find its mine telephones giving underground vaults of natural wealth close communication with each other and with the offices above. Stromberg-Carlson switchboards are making swift connections in the large telephone central offices in Shanghai. By use of his Rochester-made telephone, the wealthy Argentinian senator can hold frequent conversations over a private wire with his hacienda scores of miles away in the land of pampas. In Italy, Spain, England, Mex-



ROY H. MANSON,  
Chief Engineer Stromberg-Carlson Telephone  
Manufacturing Company.

ico, Cuba, Central and South America, Africa, far-distant Australia and New Zealand—in all parts of the world—Stromberg-Carlson telephones, switchboards, magnets and other apparatus are at work.

It was back in 1892 that two young Swedes, Andrew Carlson and Alfred Stromberg, took inventory of an idea, funds at hand to capitalize it, and its hope. They were filled with vision and determination. Each had learned the telephone manufacturing business in Sweden and each had worked on this side of the Atlantic for the Western Electric Company in the production of telephones for the Bell company. With this foundation and an investment of

\$500 each, they organized the Stromberg-Carlson Telephone Manufacturing Company of Illinois.

### STARTED IN SMALL ROOM

When the company was incorporated in 1895, its plant occupied one room in a small building in Chicago. A historical note made in 1896 informs that the factory had only nine employes and was without either a punch press or a screw machine. But the two pioneers were not discouraged. They plugged on and on and when the great telephone development period came, a few years later, they were ready to reap the harvest.

Independent telephone companies sprang up in all parts of the country. Isolated farmers offered a most alluring field. Stromberg-Carlson salesmen went forth as pioneers and promoters. They were the honored guests, often the presiding officers, at the town-hall meetings called for the purpose of organizing a farmer telephone line. The salesman usually succeeded in organizing the company and, incidentally, the company so organized bought Stromberg-Carlson equipment. Knowledge of parliamentary law then was a prime requisite in a salesman.

### GAINED LARGE BUSINESS

Switchboards at telephone exchanges were crude at this period of telephone development and when the multiple board of that time with two or three sections, was introduced it was considered a marvel of size and efficiency. The Stromberg-Carlson Company continually improved its switchboards, as it did all its equipment, and gained a large business. It stepped forcefully into the central-energy telephone field which soon



Plant of the Stromberg-Carlson Telephone Manufacturing Company, Rochester, N. Y.



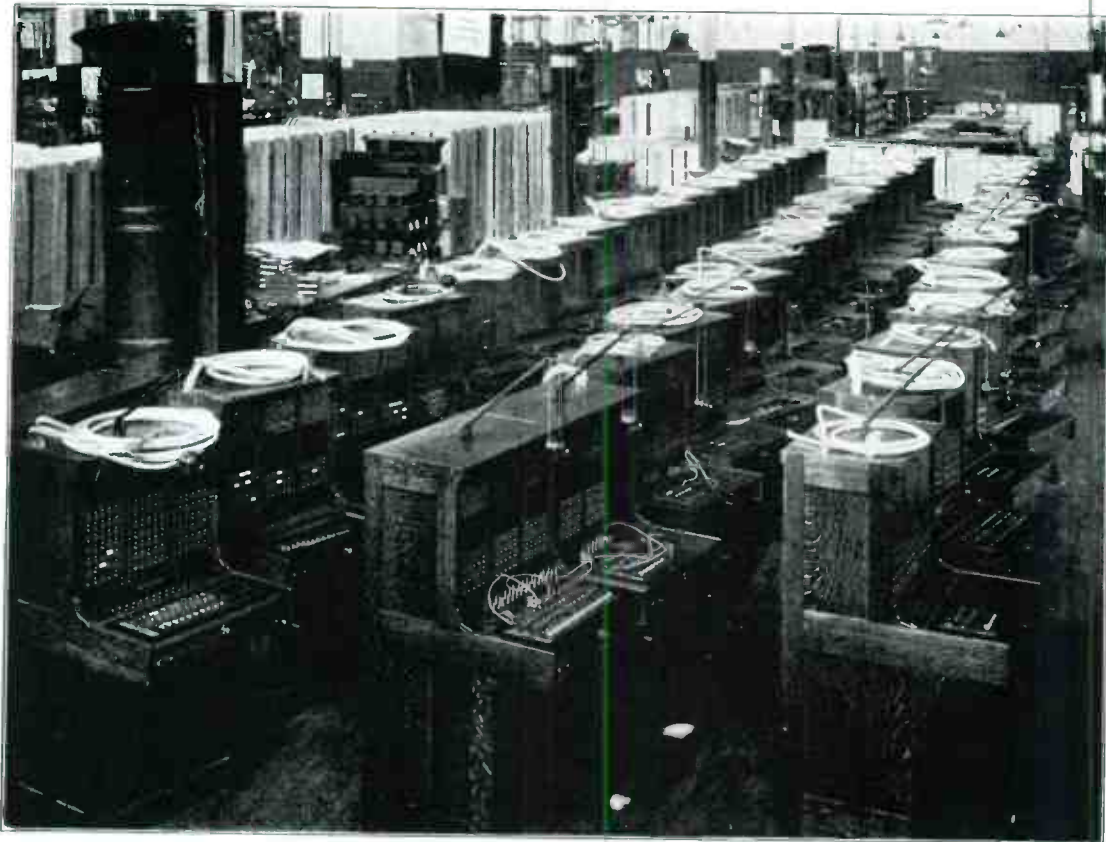

Here are many switchboards ready for packing before shipment.

covered all cities, and became a large manufacturer of city telephones for these systems.

The Rochester Telephone Company was formed in 1900 as one of the strongest of the independent companies. With a desire to insure a permanent source of equipment, the men interested in the Rochester company looked around with a view to acquiring a telephone manufacturing company. The Stromberg-Carlson Company looked promising. Negotiations for its purchase were started and in 1902 the newly organized Stromberg-Carlson Telephone Manufacturing Company of New York took over the assets of the Chicago company. The manufacture of telephone equipment was continued at the Chicago plant during the subsequent months but in 1904 the manufacturing business was brought to Rochester and placed in a new plant in University avenue, only a sales branch being left in Chicago.

#### MADE SWITCHBOARD CABLE

The new plant, which had risen out of an old cow pasture at the end of Culver Park, began industrial life here with the manufacture of switchboard cable cords and magnet wire. New buildings were erected as the company's

business grew and was transferred from the Chicago plant. The company now occupies in this plant, which is owned by the Todd Protectograph Company, a little more than half the total floor space, or about 190,000 square feet.

The plant will manufacture this year more than fifty thousand central-energy telephones, more than thirty thousand country, mine and special telephones: approximately fifty large multiple switchboards and about eight hundred smaller switchboards. It numbers among its customers telephone companies throughout the world, great mining companies, individuals, manufacturing companies, the American army and navy and ocean steamship lines.

#### LARGEST SINGLE SWITCHBOARD

Back in 1906 it built and installed in St. Louis what was the largest single switchboard in the world. This switchboard still is fulfilling all the duties of a great telephone exchange most efficiently because many of the improvements which the company has made in switchboards in later years have been added to it.

In the city of Gloversville can be found what generally is considered to be the oldest central-battery switchboard

in existence. This board appears simply to refuse to wear out. This also is true of the private branch exchange switchboard which still is giving service in the Powers Hotel in this city after long years of use.

On a visit to the plant, in University avenue, the visitor sees various products of the company in all stages of manufacture and assembly. Only the best of raw materials are used, and each part and the apparatus as a whole, is tested with great care to see that it measures up to the high standard of quality that the company has set.

Tracing the raw materials used by the company back to their places of origin means taking an extensive world tour. The visitor sees Sea island cotton being braided on to copper wires, celluloid, ivory for telephone number plates, Italian silks of various colors for switchboard cable winding, tin foil made from Straits Settlement ore, rice paper, steels of many kinds, platinum from the Urals, rubber converted from the sap of trees of Borneo, the Congo, or perhaps the Upper Amazon, lumber of oak and mahogany.

One runs into a number of interesting things in examination of raw materials

JANUARY, 1921

29

employed in telephone manufacture. There is aenoid, a substitute for celluloid in the making of key buttons. Aenoid, you learn, is made in England from cow's milk. It is a hard, black, light substance. The layman often has looked at the flat pieces of carbon found in transmitter, receiver and other parts of telephones. In a steamy room out at the Stromberg-Carlson plant, one learns how this carbon is manufactured. The process is a secret one but you are told that coal dust, molasses, sugar and "other substitutes" are mixed and baked.

## BRAIDING OF INSULATION

The various materials entering telephonic carbon are all various chemical compositions of carbon and the manufacturing process combines them into a hard carbon disc that is polished highly by two machines made especially for that purpose. The carbon disc is baked or fired nine different times in the making. After being finished into the flat disc required, the pieces are placed in slots of their particular size in the upper, circular plate of the polishing machine. A simple adjustment of the machine presses them down on the lower polishing plate. Machinery is set in motion and the carbon discs or pieces are

ground and polished in a manner similar to that employed on the finest diamonds.

Watching several hundred machines braiding insulating silk or cotton on to wire is a fascinating sight. It is the old-time May-pole dance applied as a mechanical operation in industry. The wire is the pole. The spools of silk or cotton that move with bewildering rhythm before it are the dancers paying homage in the established way. Some of the wire used by the company is exceedingly fine—it taking six miles of it to form a pound spool. Such a spool of wire occupies a machine for three weeks or more.

## WINDS 100 PAIRS OF CABLES

The winding or braiding of the switchboard cable is done by heavier machines of different mechanism. The company has one machine which winds 100 pairs of switchboard cables at a time. The cotton-covered wires used in these cables are in a variety of colors, running from plain colors to those resembling the warmth of rag carpet. It is important to have different colorings in switchboard cable so as to be able to follow any cable through the mass of cable wire in a switchboard.

The finished cord wire and cable is taken from the spools and dipped in melted beeswax. After dipping, the cable is dried slowly on revolving spools to insure an even spreading of the beeswax. The visitor also sees insulated wire being impregnated with a tarlike compound and condenser coils being impregnated with paraffin. The company has a dyeing department where cotton windings are dyed to the colors desired.

## METAL PARTS RUST-PROOF

The metal parts of telephone apparatus are all rust-proofed in the Parker process, which consists of boiling them in a compound that sinks into the surface of the metal and stands as a barrier to oxidization. Parts that will be particularly exposed to the weather afterwards are japanned or lacquered. All japanning is done by the spray method.

The making of condensers always attracts the layman, who finds it hard to believe that tin foil and thin rice paper can be wound together so tightly from spools without breaking.

The making of tinsel is another operation at the plant that holds the attention of the visitor. He sees wire finer than human hair being flattened out into



Wiring multiple jacks in the switchboard department.

30

TELEPHONE ENGINEER

a tinsel ribbon which later is wound about a fine thread to make the flexible conductor of a telephone cord. Ordinary wire in the continual bending of the cord would break, but the tinsel wire will not. The company formerly purchased the tinsel. A few years ago, merchant tailors commenced to use great amounts of tinsel on women's clothes and the company found it hard to get enough. It studied the manufacture of tinsel and installed machines to make it. Now its supply is assured and the quality greatly improved.

#### MAKES PERMANENT MAGNETS

In a similar way, the company entered the manufacture of permanent magnets. This product was largely made in Germany before 1914. When the war broke, America was shut off from the German supplies, and magnets and other manufacturers using magnets feverishly looked about for some adequate source of supply in this country. The Stromberg-Carlson Company had been making its own generator, receiver and ringer magnets for many years, and finally evolved a satisfactory process for making magneto magnets.

Today the company is the leading manufacturer of permanent magnets in this country. It supplies a large part of the magnets used by companies making magnets for automobiles, trucks, aeroplanes and other gas and electrical apparatus. It thus is having a vital part in automobile manufacture. Its production of magnets during the war was of tremendous importance to the Allies, as it supplied a heretofore German product to automobile, truck and aeroplane manufacturers.

#### WITH COMPANY FOR YEARS

The company has an unusually large number of men who have been with it for years. These older men occupy places in the plant where their trained hands and active brains will prevent costly mistakes. In the woodworking department a veteran sawyer is seen engaged in cutting up oak lumber. He swiftly, but critically, inspects his board as he draws it along to saw off proper lengths. He cuts out of the board good sized pieces for switchboards, medium sized pieces for wall telephones and small sized pieces for desk-set boxes, and has very little waste left. A poor sawyer either could waste a lot of good material or else let poor material go through. This would slow up operations and perhaps result in the rejection of a finished product. This sawyer has been with the company since 1899.

Continual improvements in production and products are being made. The engineering department works out plans. These are taken into the well-equipped laboratory where they are tested out. If

they involve new tools, the large tool department takes up the job of making them. The company now is engaged in a production that involves more than 15,000 separate pieces. Since the beginning of manufacture, more than 35,000 pieces have been used in manufacture and many of the inactive ones are still made at times to supply those desiring them for use on the older apparatus.

#### HOW LINES ARE TESTED

Great numbers of switchboards and telephones are seen in various stages of production. Young women are working along side of men in the manufacture

The testing of telephone apparatus is conducted in a most exacting way. Men testing transmitters and switchboard cable are heard monotonously singing: "Everywhere that Mary went."

#### CHINAMAN SAYS IT, TOO

These words are sung out by telephone men wherever telephone apparatus are tested. The tester in Shanghai uses it as well as the tester in New York. Over and over, he repeats it as he throws in various resistances. These were the first words that Thomas A. Edison used in speaking for phonographic record. Edison's voice was successfully recorded in his initial experi-

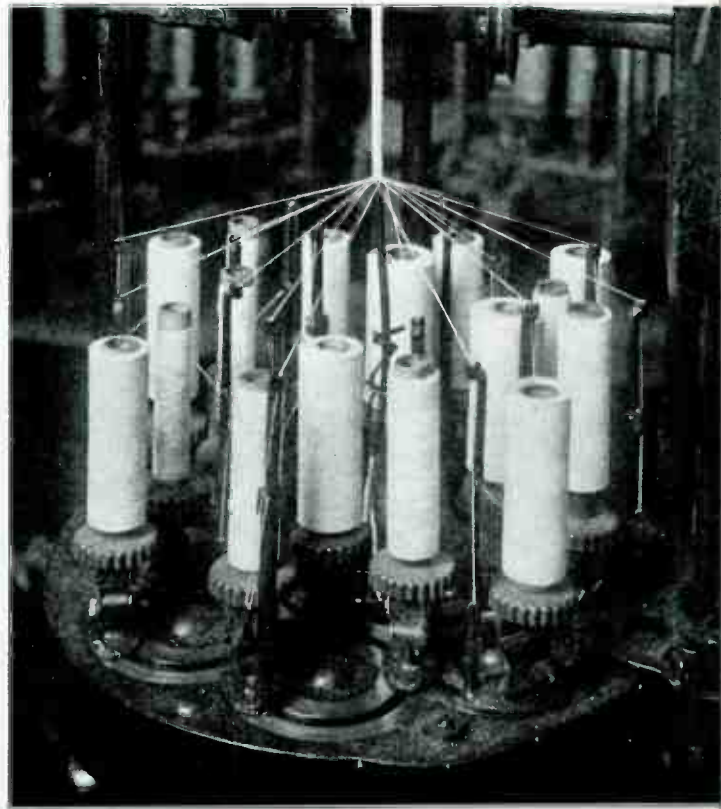

Braiding Machines in Cord Department.

and assembly of hundreds of intricate parts. They are past masters at tinkering, it seems, working swiftly and with marvelous efficiency. Wires are rapidly strung through the switchboards yet rarely is a mistake made. The cabinets of the switchboards and telephones are largely of oak, though mahogany also is used extensively. The manufacture of these cabinets keeps a large woodworking department busy. The gas ovens used in the magnet department furnaces, in the japan ovens and in doing sundry other manufacturing duties consume more than two million cubic feet of gas annually.

ment and since that time the singing phrase has been used by telephone men. In testing telephones, however, the tester usually says:

"Hello, Hello, Hello." or "One, two, three, four, five," with emphasis on the "five."

For several years, the Stromberg-Carlson Company has been manufacturing a large amount of telephone equipment for the United States Signal Corps. When General Pershing led a detachment into Mexico in 1916, he kept in touch with this side of the border by means of portable telephone and telegraph sets of Stromberg-Carlson make.

JANUARY, 1921

31

The wire over which he communicated was not erected on pole lines but was simply reeled out on the ground as the detachment traveled south and reeled up again as they returned home. Communication was successfully carried on with him over several hundred miles of fine flexible wire laid on the ground.

MADE PRODUCTS IN WAR

During the war, the company manufactured its products in much larger quantities for the army and navy. It made portable field switchboards, portable field telephones, camp switchboards, camp telephones and gunner sets for use both on land and sea that kept the lines of battle fully and quickly informed of things of moment. Other Stromberg-Carlson apparatus linked up perfect communication systems on warships. The instruments of the Rochester company figured in many historic happenings of import. They were at the elbows of the delegates to the Peace Conference in Versailles. They brought the news of the front lines back to the General Headquarters at Chaumont.

The company is almost without competition in the mine telephone field. Large numbers of mine telephones are made. They have heavy, cast-iron cabinets and their doors are fitted snug by rubber gaskets to insure against moisture entering and destroying the apparatus. These mine telephones are found in mines in all parts of the world and are doing a great work for safety.

The business of the company has quadrupled since 1914. Millions of dollars' worth of telephone apparatus is now turned out annually. It carries on hand a stock of merchandise in the form of raw materials valued at upwards of \$1,000,000.

EMPLOYEES' ASSOCIATION

A fine spirit prevails in the organization. The employes have an association that conducts a dining room, serving meals at cost. These meals at the cafeteria are remarkably low in price and consist of good, wholesome food, well served. Hundreds of employes avail themselves of the dinners daily.

An organization of employes known as the S-C club promotes athletic, social and educational activities among the employes and has given to the personnel of the plant a warm camaraderie and highly toned esprit de corp.

The officers of the company include the following: President, George W. Todd; vice-president, Fred C. Goodwin; treasurer and general manager, W. Roy McCanne; secretary, Wesley M. Angle; assistant secretary and credit manager, Edwin C. Roworth; assistant treasurer and auditor, George V. Lennon; purchasing agent, Edward A. Hanover; sales manager, George A. Scoville; export manager, C. E. Heston; advertising manager, Warren B. Eastwood; assistant sales manager, Eugena A. Reinke; chief engineer, Ray H. Manson; assistant chief engineer, E. G. Eidam; general superintendent, S. A. Beyland; assistant superintendents, J. T. McGuire and A. O. Stigberg; master mechanic, G. A. Braddock; chief inspector, W. R. Schall.

Radio News for March, 1922

859

# The Stromberg-Carlson No. 2-A Radio Head Set

These Stromberg-Carlson Radio Head Sets reproduce broadcasted, long distance, vocal or musical sounds with unequalled distinctness. Fine tonal qualities and extreme sensitiveness, are features of this high-grade piece of apparatus.

For the past eight years its makers have been recognized leaders in manufacturing professional Radio Head Sets. Back of that is twenty eight years' service in building voice transmission apparatus for telephone companies. Stromberg-Carlson Telephone Receivers and Radio Head Sets are known in every part of the world where telephones and radio stations are installed.

This wide experience has enabled us to produce a new perfected Radio Head Set, a high-grade apparatus, at a moderate figure—combining the important requirements of sensitiveness with convenience and comfort for the wearer.

The No. 2-A Radio Head Set comprises four distinct units; two receivers, head band and 5 foot cord.

## The Receivers

Receivers are equipped with a one-piece bipolar permanent magnet, of high grade magnet steel, provided with phenol fiber spool bases, slotted soft iron pole pieces, corrosion proof diaphragm, enamelled copper wire coils. All parts are encased in a receiver shell of cast non-magnetic insulating material, that is unaffected by either moisture or temperature changes. Each coil is wound to 50-ohms. The coils are connected in series. This gives a combined resistance of 2000 ohms for the 4 coils of a No. 2-A Radio Head Set.

## The Head Band

A head band is furnished of the spring wire type, covered with heavy brown webbing, correctly shaped, light in weight and comfortable to the operator. Knurled thumb screws are provided on both ends to permit locking the adjustment after it is once fitted to the head. Exposed metal parts



No. 2-A Radio Head Set,  
Complete, \$7.50

are nickel finished. Another feature of merit, in regard to the design of this head band is a provision for separating the receivers which permits two observers listening in on a circuit simultaneously with but one Stromberg-Carlson No. 2-A Head Set. This accomplishment is simple because the Head Band is provided with spring stirrups which engage the receivers, in such a manner, that either receiver may be disengaged from the head band by simply spreading the stirrups.

## The Cords

Each No. 2-A Radio Head Set is equipped with a 5-ft. brown silk, moisture proofed, receiver cord which is forked in two branches, one branch for each receiver. This forked construction permits two persons to use the head set simultaneously when desired—a feature of great convenience.

**Stromberg-Carlson Telephone Mfg. Co.**  
ROCHESTER, N. Y.

Stromberg-Carlson Telephone Mfg. Co. Rochester, N. Y.  
Send me your free bulletin 1029-R describing your No. 2-A Radio Head Set.

Name.....  
Address.....

**WE ARE SOLE DISTRIBUTORS FOR**



**SHOWN OPEN—**  
is a  
Perfect  
Table  
Lamp  
When  
Closed.

**The "ALL-WAVE" COUPLER**

**150 TO 3,000 METERS**

**GUARANTEED WAVE LENGTH**

A combination vario-coupler, and loading coil. Incorporates a superior process of combination flat and bank winding on one compact unit. Permits building the most compact receiver at a low price, as it eliminates Variometers, Vario-Couplers and Loading Coils. The Biggest Seller You Can Stock, at

**\$15.00 List**

**The RADIO PHONOLIER**

combines Lamp, and complete Radio Receiver, one step Radio, Detector, Tuner, two steps Audio, and Loud Speaker.

The "All-Wave" coupler, plus the Radio Stores Condenser, gives the Radio Phonolier a range of from 150 to 3,000 meters.

The Radio Phonolier is built of solid copper, and finished in Bronze, Silver or Gold, with lamp shades to match or contrast with interior decorations.

**List Price, \$300** And Up  
Without Tubes and Batteries

**IMMEDIATE SHIPMENTS**

**RADIO STORES CORPORATION**

Dept. W, 222 WEST 34th STREET, NEW YORK

Radio World (July 8, 1922)



John M. Williams



PATENT PENDING

THE NEW  
**"ALL WAVE"**  
COMBINATION  
FLAT AND BANK WOUND COUPLER  
Guaranteed Wave Length

**150 to 3000 Meters**

For selective long wave and  
long distance broadcast  
reception

**ELIMINATES** Use of all Variometers, Vario Couplers and Loading Coils. Permits of the Building of the Most Compact Receiver in Existence at a Considerably Lower Cost.

**PRICE \$15.00 LIST.**

Distributors, wire for rights in your territory.

Manufactured by  
**CAPITOL PHONOLIER CORPORATION**  
54 TO 60 LAFAYETTE STREET, NEW YORK CITY

Radio World (June 24, 1922)



Rich Wolven

Sheeco All-Purpose March 1924 \$21

# THERMIODYNE

## Thermiodyne Radio Corporation

**W**hen the reporter walked in, Mr. Shepard sat at a desk and looked very familiar.

“Weren’t you in business down in Lafayette Street, New York, under the name of the Callophone or Calli-something or other,” inquired the reporter?

“Yes, and we went broke with such a bang we couldn’t buy a lunch,” explained Mr. Shepard. “We headed for Plattsburgh, New York, with our tails between our legs. The only reason we went to that God-forsaken hole of abandoned training camps was because we rung an angel into the Shepard-Potter Co., who happened to own a factory there, which was vacant and seemingly not rentable at the time we occupied it.

“After we got to Plattsburgh we found certain economic advantages in our favor. The labor was far cheaper up there and there were girls in abundance who will work for very low wages.”

This conversation supposedly took place in early 1924. The Shepard-Potter Co. had been in business making novelty radios shaped like lamps; before that, Leo Potter had been associated with four different magneto manufacturers, all of which had gone bankrupt. The company’s first product after moving was the “Shepco,” a one-tube regenerative set with all components wired to front-panel posts for connection by the user in any desired circuit. Shepard-Potter might well have gone broke again.

But they had a better product to offer: the Thermiodyne one-dial set, devised by a former student of Hazeltine, Carl Trube. Potter was able to obtain enough capital from his angels (and, later, by issuing stock) to finance production and a \$150,000 advertising blitz. He also acquired the Duplex Engine Governor Co., which made the variable condensers, changing the name to Duplex Condenser and Radio Corp. (and also offering stock). Profits in December 1924



Radio Guide (April 1925)

LEO POTTER

President, Thermiodyne Radio Corporation

and January 1925 were said to be \$136,764 or \$101,230 for January alone.

No further earnings statements were released, doubtlessly for good reason. A merchandising tie-in with United Cigar Stores did not work, and what should have been a lucrative contract with Music Master for production of a model very similar to the TF-6 Thermiodyne ended in disaster when Music Master folded. “Asinine mismanagement” of the factory was charged by *Radio Retailer and Jobber* (which also printed the interview previously quoted).

*The night has a thousand voices*

## Master Control

# Thermiodyne

### Just One Turn - of One Knob - with One Hand

**We own a Radio that we want to Share with You that will put you in touch with the Voices of Life all over this Country.**

Its name is **Thermiodyne** because the Greek roots (which have always been used by Scientists in naming things) **therm** and **ion** and **dyne** represent Heat and Electron and Power. (thermos, ion, dynamo)

**Thermiodyne** gathers sound-waves from the air and delivers them to your ear with marvelous faithfulness . . . . .

It is so devised that you can, by simply turning One knob, click in any broadcasting station that is on the air regardless of distance and without interference . . . . .

Variations in broadcasting do not affect **Thermiodyne** inasmuch as the additional adjustments are provided to insure perfect reception . . . . .

As you learn to tune your **Thermiodyne** you will have added pleasure in reaching out for distant stations . . . . .

There are six tubes, three stages of thermionic frequency, detector, and two stages of audio-frequency, that bring in local or distant stations with loud-speaker volume . . . . .

Price \$140<sup>00</sup>  
without accessories  
Unconditionally  
Guaranteed  
Ask us for the complete  
Thermiodyne story

**Thermiodyne Radio Corporation**  
Plattsburgh, N.Y.

MAGNUS NORTAL



Part of our Automatic Department

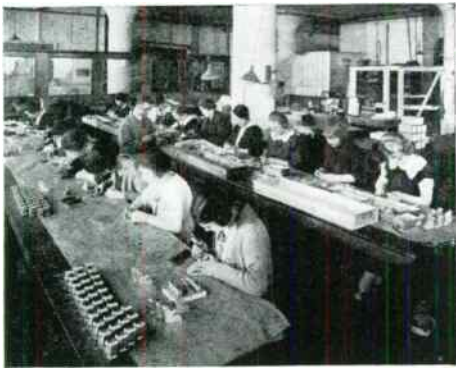

Condenser Assembly



Parts Inspection

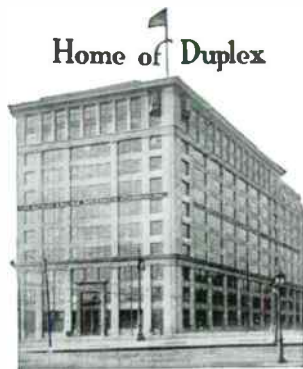

Home of Duplex

DISTRIBUTED BY

By the end of 1925, Thermiodyne's factory floors were groaning under the weight of 20,000 unwanted receivers that had to be dumped to New York gyms at \$35 to \$40. Bankruptcy was declared on April 17, 1926.

Of course, this was nothing new to Leo Potter; he sallied forth once again, this time reorganizing the Algonquin Electric Co., which had also been on the wrong end of a Music Master contract (it was still owed \$38,000). He re-incorporated Algonquin in January 1927, and having purchased the Thermiodyne trademark when the company's assets were auctioned, introduced a Thermiodyne Treasure Chest Model, later adding a remote control. But Potter got into a fight with his backer and manufacturing manager, W. E. Steinbach, and threw him out. Thereupon, Steinbach filed a bankruptcy petition against Algonquin and apparently made it stick. The company's affairs were finally wound up in 1933.

Manufacturing dates and circuitry for the various TF6 models are given in Wheeler and MacDonald, "Theory and Operation of Tuned Radio-Frequency Coupling Systems," *Proc. I. R. E.* 19 (May 1931), pp. 738-805.

In all, 50,000 Thermiodynes are said to have been produced.

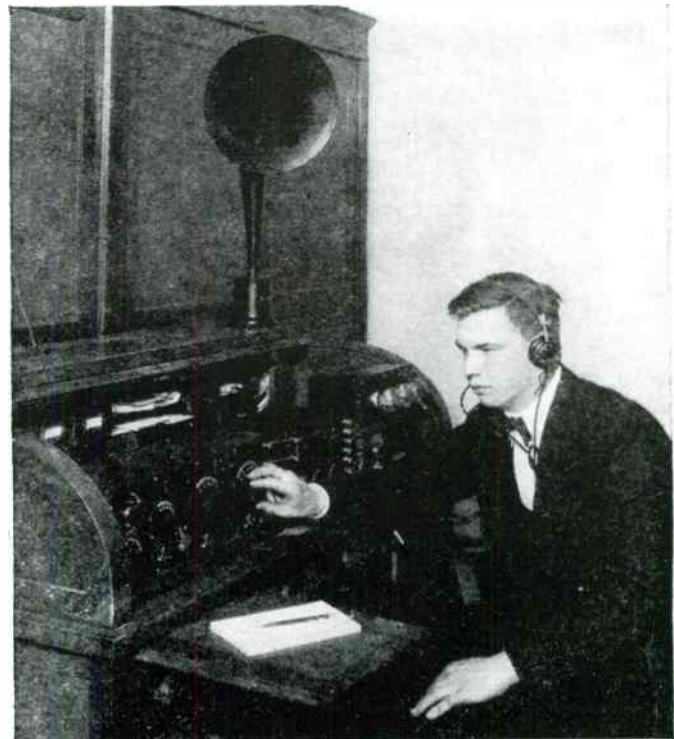

Popular Radio (March 1923)

From a photograph made for POPULAR RADIO

ONE OF THE OLD-TIME "SPARK HOUNDS"

Carl Trube died in an accident in 1927.





**As Easy as Turning a Page**  
*Stations Click in With Certainty and Simplicity*

**H**EAR the beautiful harmony of a Christmas Carol sung in Washington or the silvery chimes of old Quebec. And they come in quickly and positively—no fishing—no fussing—no logging—no uncertainty—if it's in the air Thermiodyne will get it regardless of distance.

**Price \$140**  
*Without Accessories*

With six tubes that bring in loud-speaker volume and only one master control. Think of it! With one hand you can get any distant station you want. They click in

quickly and accurately and always at the same place. Local stations and distant stations cannot interfere with each other and the four refineries are provided to stabilize the variations in broadcasting and to regulate volume.

Ask your dealer to demonstrate Thermiodyne—he will be glad to do so. If you've never listened in with a Thermiodyne you've never really heard radio.

*Every set is backed by our ironbound guarantee*

**DEALERS and JOBBERS**

Write for full particulars regarding franchise for selling the most remarkable receiving set on the market. A few territories are still available, but act quickly.

THERMIODYNE RADIO CORPORATION - PLATTSBURGH, N. Y.

*Thermiodyne*  
 Reg. U. S. Pat. Off. [Ther-MY-odyne] **TF6**

TF7 early 1926  
Same as TF6 except that it  
uses seven tubes with resis-  
tance-coupled audio. In fact,  
the panel is marked "TF6."

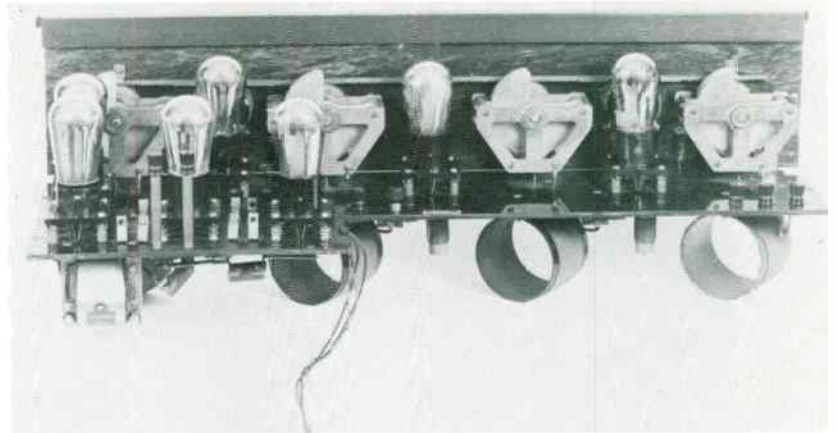

John Wolkonowicz

TF5 August 1925 \$100  
Manufactured in April 1925.

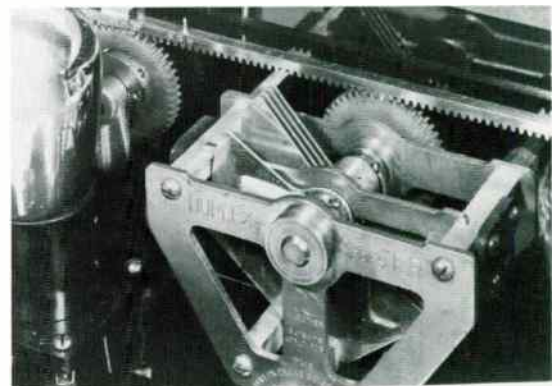

**Thermiodyne—Model 776 on Jewelers Table**  
The Jewelers Table shown in the photograph has a built-in Jewelers Table, complete in every detail, and is available in the Thermiodyne Radio Co. Price of Jewelers Table and Case \$250.  
Radio Manufacturer and Case \$250



## Thermiodyne's Master Control Brings You Everything That Radio Can Give

THE less you know about radio the more you will welcome the certainty—the simplicity—of Thermiodyne's Master Control. Master Control makes Thermiodyne popular with every member of the family. Turn Thermiodyne's Master Control to the wavelength of the station you want and there's nothing more for you to do but to enjoy the program it brings in. For when you set Thermiodyne's Master Control at a given wavelength, you adjust the entire mechanism of the Thermiodyne Receiver in that one operation. Thermiodyne's Master Control tunes, tones and clarifies at one and the same time.

Thermiodyne's Master Control combines the simplicity of single control (ability to tune all units at the same time, collectively) with the added advantage of Master Control (ability to tune each unit independently, one after the other) whenever atmospheric conditions make it necessary to do so.

And remember! There is no radio receiver—not even in the great radio research laboratories—that can do more than this.

Thermiodyne Master Control Receiver is the ideal Christmas gift for any family because no one has to study out how to "run it". Enjoy the great Holiday programs with Thermiodyne. A single turn of the Master Control sets in they glide, each in its proper place for the enjoyment of all who wish to listen. Ask any authorized Thermiodyne dealer to demonstrate Master Control in your home. If you own a set ask him what he will allow you for it in exchange for a Thermiodyne and inquire about our easy payment plan. Use the coupon in the corner. It will put you in quick touch with an authorized dealer. Try with confidence. Every Thermiodyne carries an iron-clad guarantee. Thermiodyne must make good.

Thermiodyne Radio Corporation  
1819 Broadway, New York City  
Canadian Sales Office: Dominion Thermiodyne Radio, Ltd.  
425 Phillip Street, Montreal, Canada. Main Post: Portsmouth, N. H.

Thermiodyne Model 776  
Complete De Luxe  
Price \$250  
Case \$250  
Total \$500

DEALERS—  
Listed in Yellow Pages  
of all cities  
Write for list  
of dealers  
Radio Manufacturer and Case \$250



**Thermiodyne—Model 776—FIVE TUBE**  
Master Control Receiver built on same mechanical principle as 776. Price of Receiver and Case \$180.  
Radio Manufacturer and Case \$180



**Thermiodyne—Model 776—SIX TUBES**  
Special design, complete with five tubes. Price of Receiver and Case \$200.  
Radio Manufacturer and Case \$200

# Thermiodyne

Reg. U. S. Pat. Off. [Ther-MY-odyne] Licensed under Patent of other patent proprietors

Get out the Longman Mail **TODAY!**  
Thermiodyne Radio Corporation  
1819 Broadway, New York City  
Write for list of dealers  
Radio Manufacturer and Case \$250



Radio Dealer (Aug. 1927)

### Seven-Tube Receiver in All-Metal Cabinet

*Radio Retailing, December, 1926*  
The new Thermiodyne "Treasure Chest" 7-Tube receiver, as illustrated, is being made by the Algonquin Electric Company of Poughkeepsie, N. Y. This is enclosed in a hammered, all-metal cabinet and will cover a waveband of from 190 to 550 meters. The circuit incorporates three stages of tuned radio frequency, detector, and three stages of audio frequency amplification (one transformer coupled and two resistances coupled). The set is equipped with vernier controls for fine tuning. The receiver has an intended retail price of \$180 and the table shown, \$40. This set is also being put out in red plush to retail for \$200, and the table for \$55. A cone-type loud speaker is also being made which has an intended retail price of \$40 and is finished to go with the set just described. This same speaker in ordinary finish will have an intended retail price of \$30.



Pat. 2,318 RADIO RECEIVING SET. Leo LOTTER, Malba, N. Y., assignor, by mesne assignments, to Algonquin Electric Company, Inc., New York, N. Y., a Corporation of Delaware. Filed Nov. 4, 1926. Serial No. 19,607. Term of patent 3 1/2 years.



The ornamental design for a radio receiving set as shown.

Treasure Chest November 1926 \$180

# REMOTE CONTROL—a Radio Revolution

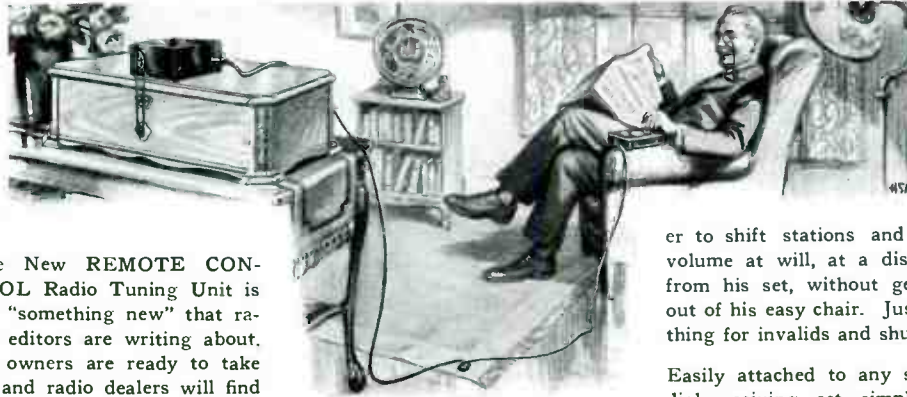

The New REMOTE CONTROL Radio Tuning Unit is the "something new" that radio editors are writing about, set owners are ready to take on and radio dealers will find among this year's fast selling items. At the Chicago Trade Show it was referred to as the "Lazy Man's Tuning Device," or as the "Radio Long Arm Reach."

The New Thermiodyne REMOTE CONTROL Radio Tuning Unit enables the own-

er to shift stations and tune volume at will, at a distance from his set, without getting out of his easy chair. Just the thing for invalids and shut-ins.

Easily attached to any single dial receiving set, simply by removing the dial and attaching adapter plate as furnished with unit and hooking up connection with set terminal.

First and Only Successful Practical Device Ever Invented to Control Radio Reception at a Distance.



Mechanical Remote Control Unit ..\$18  
Electrical Remote Control Unit (shown on set) .....\$60

LONG DISTANCE  
**Thermiodyne**  
Trade Mark Reg. U.S. Pat. Off. [Ther-Miodyne] WT 7

Hard pan radio value. No furniture or cabinet features, but sturdy, high power, go-getting radio reception. Without doubt the best set value on the market today. Same hook-up in every detail as TA7.  
Price .....\$150



Thermiodyne TA 7

Improved construction and refinement of characteristics make this the overtopping example of Power and Quality in today's radio reception.

XV Century all-metal Spanish Treasure Chest cabinet, individually, doubly and totally shielded. Polychrome gold and pastel stipple finish. Price .....\$180

Wrought Iron Console to match cabinet. Price .....\$40

Thermiodyne Speaker. The finest reproducer we have ever turned out. Price .....\$30

Complete Assembly .....\$250  
All Prices quoted List, f.o.b. Factory, Poughkeepsie, N. Y. Tubes and Accessories excepted unless Otherwise Quoted....



Pat. App. For

## Algonquin

Trade Mark Reg. U. S. Pat. Off.

High quality and popular priced. Sells itself on demonstration. Nothing like it in its class. Exceptionally fine electro-magnetic reproducing unit. Extremely sensitive throughout entire vocal and instrumental register. Full floating 18" cone of moisture proof fabric—NOT PAPER. Art metal frame with ornamental scroll and ship model design, in polychrome gold stipple finish.



Pat. App. For

List Price ....\$15  
(West of Rockies \$18)

Algonquin Radio Products will be backed up by Extensive Advertising this 1927-28 Radio Season. Liberal Discounts, Acceptable Terms and Exclusive Territory to Radio Merchants of High Standing and Responsible Rating.

**ALGONQUIN ELECTRIC COMPANY, Inc.**  
LEO POTTER, PRESIDENT

Makers of Algonquin Speakers and New Thermiodyne Receivers  
245 FIFTH AVENUE, NEW YORK CITY



## A Two-Stage Amplifier

*This Instrument, From the Wireless Improvement Company, Illustrates Some Features of Standard Navy Practice*

**A**LTHOUGH, from the point of view of the experimenter, construction following what has become known as standard Navy design is expensive, it gives to purchased or home-made equipment a dependability which inspires a consistent faith and pride in the instruments.

The amplifier illustrated here is carried in a case  $9\frac{1}{2}$  ins. high,  $4\frac{1}{2}$  ins. deep, and  $6\frac{1}{2}$  ins. wide. All the instruments are carried on the removable panel.

At the front are the tube observation windows, closed to dust by a fine mesh screen, filament rheostats, telephone jacks, and binding posts. Connections from the detector are run to the posts marked INPUT. When signals are of such strength that no amplification is required, the telephone plug is simply inserted at the jack marked DETECTOR.

For one or two stages, the filaments are lighted by turning up the rheostats, and the phone plug put in the one- or two-stage jacks.

The rear views, with the panel removed from the case, show the very compact arrangement of the apparatus.

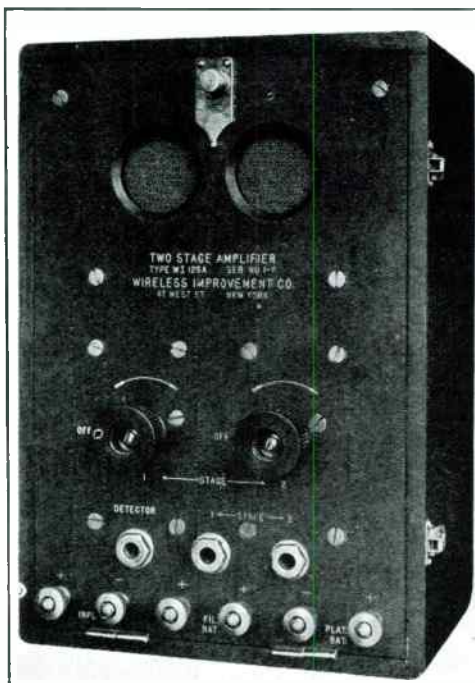

Four U-shaped brackets hold the transformers and tube sockets. This type of mounting has not been used extensively

by experimenters, although it is readily adaptable to the compact design of all kinds of instruments. A bakelite plate on the upper legs of the brackets carry the sockets.

Between the upright parts are two Navy type rheostats, just visible in the side view. A dead point is left on each rheostat so that the corresponding tube circuit can be opened. This is accomplished by connecting the tubes in parallel, with a rheostat in series with each tube.

Small biasing resistances, to give negative grid potentials, are mounted just above the socket plate.

The phone jacks are clearly shown. The first is of the open circuit type. Therefore, as long as the plug is not inserted, the plate circuit of the detector goes directly to the grid or input circuit of the first stage. The second and third, however, are of the closed circuit type. The plate circuits are closed through the jacks, when the plug is removed, or the telephones placed in series with the plate when the jack is inserted.

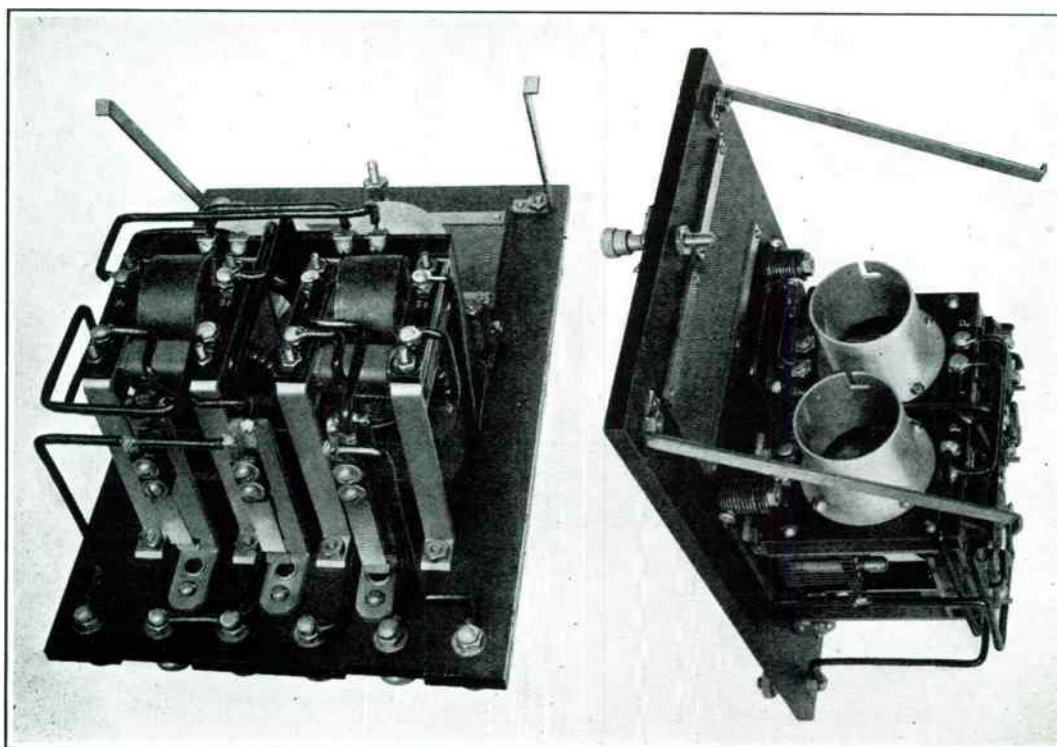

*A close examination of these illustrations will reveal a number of ideas which experimenters can incorporate in their own equipment*

# R. E. THOMPSON

## R. E. Thompson Manufacturing Company

**R**oy E. Thompson, born in Texas in 1887, worked for De Forest and United Wireless from 1906 to 1912, then became a Radio Inspector for the Commerce Department, spending one year in Chicago and another in Seattle. Having landed a Navy contract for 100 wavemeters through some Eastern connections for Seattle's Kilbourne & Clark in May 1914, he shortly convinced K&C to build transmitters to his designs (dating back to a quenched-gap model he had built in 1910). Thompson left the Commerce Department in December 1914 to join K&C as sales manager and vice president. The first of his transmitters was sold in November 1914, and by August 16, 1915, about half of the production run of forty sets had been sold to commercial users in the Seattle area. Unfortunately, Oliver Lodge's U.S. patent was still in force until that date, and two days before it expired, Marconi filed an infringement suit against K&C. The suit cost the company a lot of money in legal fees and, eventually, back royalties to Marconi, and earned ill-will among its customers. Thompson fled Kilbourne & Clark and the West Coast around September, 1915.

By mid-1917, Thompson had bought the Wireless Improvement Co. from Col. John Firth, who founded it in 1912 to make transmitters and shelved it in 1915 when he began selling Wireless Specialty models. Thompson obtained a Navy contract for quenched-gap transmitters designed by Emil Simon (a second source because Simon's own organization was taxed to capacity). He built a uni-control receiver and after a war-imposed delay, read a paper to the I. R. E. describing it.

Thompson intended to build commercial equipment; but since the postwar market had evaporated, he was forced to seek amateur business along with other companies. He began advertising a line of com-



R. E. THOMPSON  
President

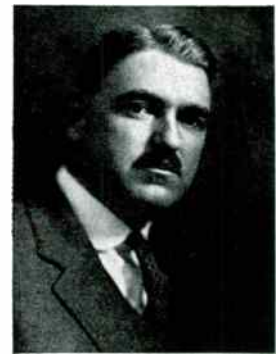

DR. L. F. FULLER  
Vice-President  
Chief Engineer

Catalog

mercial components in August 1919. For about a year, a procession of parts and equipment paraded through the advertising pages of *Wireless Age*. In November 1920, a move from 47 West St., New York City, to a four-story brick building at 66-68 & 70 York St., Jersey City, was announced. On June 3, 1922, the company was incorporated with \$3,000 capital. Since there were two Wireless Improvement companies in 1926, one incorporated and the other not, one was probably a holding company for the other, which in turn held the 1920 Armstrong regenerative license. The R. E. Thompson Mfg. Co., which held the 1923 Hazeltine Neutrodyne license, was likewise controlled by the R. E. Thompson Radio Corp. organized in May 1924 (which also held Wireless Improvement). As most of the W. I. plant and equipment was leased to the R. E. Thompson Mfg. Co., all these legal entities were essentially one and the same company.

The Best in Radio Equipment

# The Thompson **MAGNAPHONE**

**What THOMPSON Means**

After 14 years experience "Thompson" means a great deal in commercial and governmental Radio Apparatus. It will mean even more in Radio for the home.

*Conceived, designed and constructed to remedy the faults inherent to the ordinary loud speaker*

The radio reproducer that permits your receiving set to perform at the best. It is ALL THERE—the volume, the quality, the control, that you've been seeking and that you haven't been able to find elsewhere—you'll notice the difference instantly, when you plug in a Magnaphone.

Cone shaped bakelized fibre diaphragm, vibrating equally over its whole area,—two-to-one driving armature, reducing the permissible air gap 50 per cent.—laminated magnetic pole pieces,—individually and together forming a structure giving results so incomparably superior as to make the Magnaphone the choice of those who demand the best.

**Price \$35.00**

## The Thompson "Neutrodyne"

The "Neutrodyne" as a type is admittedly the last word in radio receivers. The Thompson "Neutrodyne" has all the advantages of the type plus the engineering skill and experience of one of the oldest radio organizations, one which has produced a majority of the high-grade commercial and government types of radio apparatus. To hear it is to realize the great difference even in various "Neutrodyne" sets—yet the price is only \$150.00

*At Good Dealers Generally*

**R. E. Thompson Manufacturing Co.**  
150 Nassau St., New York      Jersey City, N. J.



Popular Radio (March 1924)

Please refer to POPULAR RADIO when answering advertisements.

5A March 1924 \$150

The Thompson firm did make one regenerative model but advertised it for a very short time; nearly all of its models were neutrodyne. The first model was almost a Chinese copy of the Freed-Eisemann NR-5, even to the word-for-word reproduction of the instruction card in the lid. Freed-Eisemann was not amused; when a gentlemen's agreement to stop the copying did not seem to be taking effect, it secured a court injunction by August 1924 to halt the practice. Thompson was also "requested" by Magnavox to discontinue use of the name "Magnaphone" on its horn. Still, business was good: 1924 gross sales were \$1,089,263 (wholesale \$543,304.71 reported to Hazeltine) with a net profit of \$212,453.

Running into stiff competition, Thompson's 1925 models did not sell as planned. Why pay \$125 to \$150

for a radio when a Freshman three-dial TRF for \$60 could be purchased that, frankly, worked just as well? Atwater Kent's model 20 also appeared now, backed by extensive advertising, solid reputation, and a dealer network, for only \$100. On February 7, 270 employees were discharged; by April 1925 Thompson's factory was four floors deep in unsold inventory.

Desperate to create something different, Thompson devised a combination cone speaker and radio in 1925. The extra space behind the cone increased its bass output, and Thompson even got a patent (1,710,035) on the arrangement. The Minuet, as it was christened, was a clever design; but clever designs did not sell radios. A year-and-a-half later, 7,300 of them were still in stock.

The Minuet was Thompson's last model, although the company kept making news up to 1928. It leased space in two other buildings in November 1925 (to store unsold inventory?); bought the huge Fiat automobile plant in Poughkeepsie, NY by June 1926; went into receivership in July; welcomed engineer Paul Ware and associated executives around November; sold the Poughkeepsie plant (which was never occupied); was ordered to liquidate in May 1927; was auctioned in September; and re-organized by November 1927. It totally disappeared after that.

A PLEDGE OF *Thompson* SUPERIORITY

## The *MAGNAPHONE*

The Ultimate Radio Reproducer



A perfected instrument that, under all conditions, will give you volume without harshness, softness without muffling, purity of tone without mechanical distortion.

Clarity of Tone plus Volume of Sound  
No Sacrifice of One to Secure the Other  
A Full-Size Instrument—not a Junior Model

And so sensitive that, with a 3-tube set, it gives results otherwise to be had only with 4-tube receivers.

Ideal for Push-Pull or Other Power Amplification  
Price \$35.00

### The *Thompson* RADIO MODEL A-3

### 3 Tube REGENERATIVE RECEIVER

With Built-in MAGNAPHONE and Battery Compartment

A compact, self-contained set covering the entire broadcasting wave length range, operating from any form of indoor or outdoor aerial. Extremely sensitive, highly selective, clear, strong reproduction. Uses either dry cell or storage battery tubes.

Price \$185.00

Without Tubes or Batteries



Distributed by STEELMAN, Inc., 24-26 Murray Street, New York City.

**R. E. Thompson Mfg. Co.**  
Jersey City, N. J., U.S.A.  
Gen'l Sales Office 150 Nassau St., New York

New York Sun (Dec. 15, 1923)

Now—the matchless

## LAFAYETTE NEUTRODYNE

A set scientifically constructed to bring out the full value of the famous Hazeltine Patent



DEALERS and radio fans alike are taking great interest in this new cabinet set. It is made by a company with over ten years' experience in building radio apparatus for the American and foreign governments. It is a five tube set. This means maximum results.

No squeals or noises. No re-radiation. Maximum selectivity—absence of interference. Tremendous amplification. Gets the desired station every time on the same dial setting.

Prompt deliveries. Write for booklet and details to The Liberty Radio Corp., 151 E. 55th St., New York

THE Lafayette NEUTRODYNE

Licensed under Hazeltine Pat. No. 145088  
Made by R. E. Thompson Mfg. Co.  
Jersey City, N. J.

New York Sun (March 22, 1924)

A3 December 1923 \$195

Lafayette March 1924 \$150  
Trademark registered August 12, 1924;  
claimed use since February 7, 1924.



# Wherever there is radio, there is Thompson

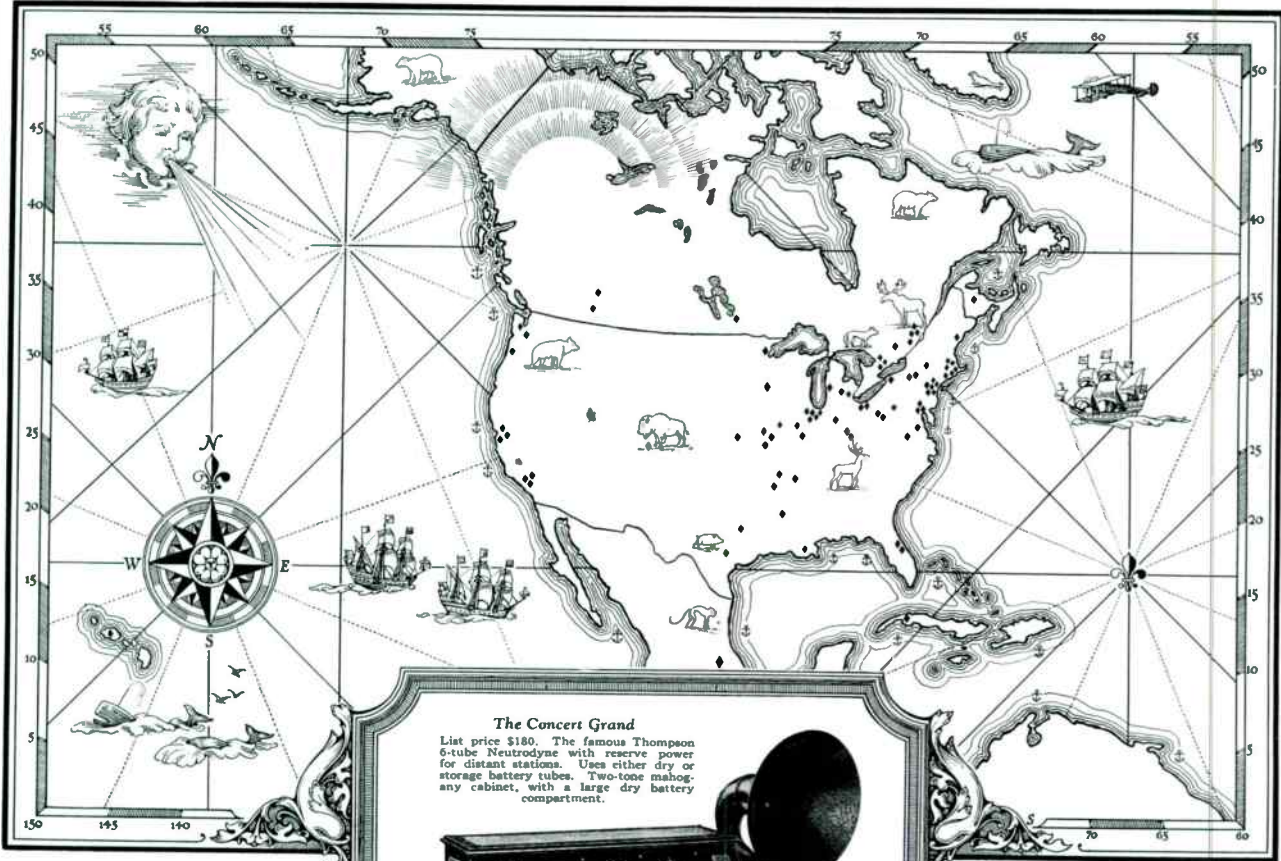

**The Concert Grand**  
List price \$180. The famous Thompson 6-tube Neutrodyne with reserve power for distant stations. Use either dry or storage battery tubes. Two-tone mahogany cabinet, with a large dry battery compartment.



**The Thompson Speaker**  
List price \$28. The standard by which all other speakers are still judged. Employs a special cone-shaped diaphragm with large composite horn. Six other special features.

IN THE fifteen years since the name Thompson first became known in radio, it has spread to all quarters of the globe. First through ship apparatus, carried into the globe's ports. Then through commercial machines, installed on shore. During the war, when armies and navies fought against time to outfit their forces, Thompson supplied quantities of radio material of a previously unknown and unheard-of kind.

From the performance of Thompson apparatus sprang an international reputation for exceeding the expectations of buyers. Nations learned to trust Thompson for results where before only steamship lines and commercial

companies knew how perfectly the promise was performed when Thompson undertook fulfilment.

Today Thompson fame shines with new lustre. Country wide, Thompson Radio Receivers are brightening the homes of America. They bring broadcasting in all its beauty and perfection to Thompson users.

For Thompson Radio fulfils the promise of pure, unalloyed radio enjoyment. Thompson

reproduces broadcasting faithfully and naturally. Distance, too, may be yours. One Thompson user in Philadelphia has received every Class B (high powered) station in the United States. This is unusual, but the fact that it has been done is proof that Thompson reception is limited only by natural, ungovernable conditions. The better dealers in your locality will be glad to demonstrate the superiorities of Thompson Receivers and Speakers. Thompson Receivers are priced from \$125 to \$360, slightly higher west of the Rockies and in Canada. R. E. Thompson Manufacturing Co., 30 Church St., New York City.



# THOMPSON RADIO



John Wolkonowicz

THE THOMPSON CONCERT GRAND—MODEL S-70  
*The Only Six Tube Neutrodyne. List Price \$180*

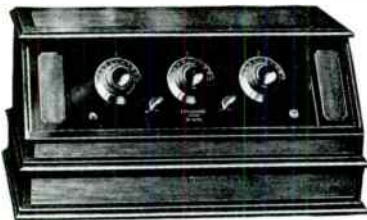

A DeLuxe instrument providing the ultimate in distance, volume and clarity. Seldom used at full power, yet when called upon it will fill a ballroom, concert hall or other large gathering place with speech or music of a quality never heretofore attained in the Radio art, in other than Thompson apparatus. The handsome two-tone mahogany cabinet with special compartment for all dry

batteries is an outstanding example of the cabinet maker's craft. Six tubes provide two stages of radio frequency, detector and three stages of new quality audio frequency amplification, arranged for either dry or storage battery operation. Length, 29 inches Height, 14 inches. Depth, 13 1/4 inches. Net weight, 29 pounds.

THE THOMPSON PARLOR GRAND—MODEL S-60  
*Five Tube Neutrodyne. List Price \$145*

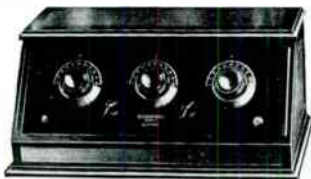

Distant stations are heard with marvelous volume. The tone is clear and natural, of a quality anyone will be proud to have his friends listen to. Stations are heard each time at the same dial settings. The cabinet with handsome sloping panel is finished in two-tone mahogany—

designed to be an ornament to any living room. Five tubes provide two stages of radio frequency, detector and two stages of audio frequency amplification. Length, 22 1/2 inches. Height, 10 inches. Depth, 13 inches. Net weight, 21 1/2 pounds.

THE THOMPSON GRANDETTE—MODEL V-50  
*Five Tube Neutrodyne. List Price \$125*



Encased in beautiful mahogany finished cabinet of simple and attractive design. Designed for five tubes which yield the maximum five tube results in distance, volume and tone clearness. It is easy to handle. Each member of the family can readily select his individual program. The exceptionally low price, the mar-

velous clearness, the volume and ability to secure distant stations combine to make the Grandette the most popular and dependable Radio Receiver available in its price range. Length, 22 1/2 inches. Height, 9 1/4 inches. Depth, 10 3/4 inches. Net weight, 19 1/2 pounds.

THE THOMPSON NEUTRODYNE PHONOGRAPH PANEL  
*Model P-11-215. List Price \$125*

The desire to give to phonograph owners the same satisfactory quality of Radio reception that is possible only with a five tube Neutrodyne has resulted in a Thompson Phonograph Radio Panel of unusual performance.

Thompson Panels contain the same essential units that have made Thompson Neutrodyne Radio Receivers famous for simplicity of operation, clarity and naturalness of tone, and a greater capacity for volume.

This panel to be inserted by a Thompson dealer in a Standard Phonograph Console Cabinet at the time the phonograph is purchased.



Built for Victor Console

Type . . . . . VV-S-215  
Length . . . . . 17 1/2"  
Width . . . . . 14 1/2"  
Depth . . . . . 6 3/8"  
Circuit . . . 2 Radio, 1 Detector, 2 Audio  
Kind . . . . . Licensed Neutrodyne  
Style . . . . . Thompson  
Dials . . . . . Three

S70 October 1924 \$180  
S60 October 1924 \$145

V50 October 1924 \$125  
P11-215 August 1925 \$125

Catalog

**SUPER-THOMPSON DUO-TONE CONSOLE**  
**MODEL C-61 NEUTRODYNE RECEIVER**

*No Recharging or Replacing of Batteries*

**T**HIS instrument is especially designed to delight the ear of the most discriminating patrons of music, and as such, to fittingly grace the music rooms of well appointed homes.

The high C of the coloratura soprano, and the low F of the basso profundo, ring true now in their tonal reproduction. Each orchestral choir, be it the soaring melody of the strings, the trill of the wood-winds, the sonorous call of the brasses or the arresting beat of the percussions, sounds out with a clarity and precision possible only with the Duo-tone system of sound reproduction, available in this model.

The secret, or rather the reason, is two-fold: first, by months of patient laboratory research, improvements have been perfected in the application of existing principles of both radio and audio amplification. In addition, at one stroke, a hitherto marked limitation in tone reproduction has been overcome by designing the Thompson Duo-tone.



**SUPER-THOMPSON DUO-TONE CONSOLE**

*Model C-61 Neutrodyne Receiver*

List Price \$360

(Including Duo-Tone Receiver System but not including tubes or power supply unit.)

This system of tone reproduction provides two especially constructed separate Speaker units, each with its own especially designed horn—one being designed to favor the low deep tones and the other the higher frequencies—the result being a complete coverage of all tones. These Speakers, being separated physically a few feet from each other, produce what might be termed sound perspective. A duet, quartet, or orchestral selection seems to have the voices or instruments properly placed relative to each other instead of coming from one mouth or instrument. The result is a delightful contrast to Radio reproduction as heretofore experienced.



*View of the Control Panel of the Super-Thompson Duo-Tone Console*

The tuning is by a single master control with compensators for the tuned circuits when compensating is necessary, which is only when the most distant stations are sought. New and special transformers have been designed to bring out all tones in their greatest purity together with volume as loud as desired by the user who has this volume always under control through a simple volume regulator.

A power supply unit is now available which is unique in that the only operation involved on the part of the owner is to push a switch as though turning on an ordinary electric light. Once a year a small amount of water is added to the container inside. The trouble of recharging or replacing batteries is entirely eliminated.

This instrument is fully self-contained in an artistic console cabinet of the Queen Anne Period, standing 42 1/2 inches high, 41 1/2 inches long and 23 inches deep. It operates on five standard UV-201 A tubes, and power tubes may be used in the output stage if desired. The Super-Thompson Duo-Tone Console Receiver is the greatest accomplishment which has come from the laboratories of the famous Thompson engineers.

**C61 August 1925 \$360**



**THOMPSON MINUET RECEIVER—MODEL R-81**

*"Unlike Any Model On the Market"*

**T**HE Minuet pioneers along original lines of development. It is designed purposely to serve the requirements of people who want broadcasting entertainment with the least exertion, in the simplest manner.

The unit (which is a five-tube dry battery Receiver) is built into a cylindrical cabinet 18 1/2 inches in diameter, the front part of this cylinder containing the cone and a cone-type Speaker. Around the periphery or circumference of the cone is a large scale which indicates the tuning positions and also movable around the periphery of the cone and inside of the adjacent circular scale is a knob, or handle, which, when moved, tunes all the circuits of the Receiver simultaneously. In the lower half of the cylinder is a battery compartment, entered from the back, which holds all the necessary batteries for operating the Set.

*It is thus seen that the set is completely self-contained, including receiver, dry batteries, and cone-type Speaker—all in one unit—with a single tuning control.*

In addition to the single large tuning control are two small compensator knobs for adjusting two of the tuned circuits accurately

to the third, when required. Thus, the advantage of individual stage tuning is retained together with the added advantage of the master control.

A push-pull battery switch is located in the base supporting the cylinder, while in the right and left corners of the base are the compensators and volume and filament control knobs, purposely made small and inconspicuous.

The set is highly selective—has the famous Thompson Tone, never before found in a dry battery Set; has the sensitivity and volume heretofore expected only from the best storage battery tube Sets—all in all an instrument which is an ornament to the most artistic home.

Finished in beautiful dark brown mahogany: Dimensions, 21 5/8 inches high; 18 1/2 inches wide and 10 1/2 inches deep. List price \$150, including cone Speaker unit but not including tubes or batteries. Weight, without batteries, approximately 25 pounds; with batteries, approximately 40 pounds.

*(When desired this model can be provided at slight additional cost with carrying case, and thus equipped provides an ideal portable Receiver.)*

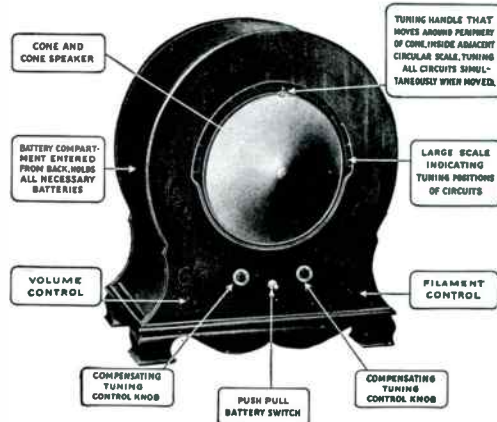

**R81 Minuet August 1925 \$150**

Described in *Popular Radio* (Mar. 1926), pp. 243-254; *Radio News* (Jan. 1926), pp. 960-961.

## Thompson Radio Corporation Adds to Plants

**This Company, and Its Predecessors, Has Fifteen Year Period of Sturdy Growth—Additional Factory Space Leased to Care for Normal Expansion of Business—Capital Increased—New Models to Be Announced.**

Fifteen years ago and more, the Wireless Improvement Company was engaged in the production of wireless apparatus. The experience thus gained, particularly in the making of precision instruments so vital to wireless, was particularly valuable when the radio industry emerged from its comparative obscurity, and, with the advent of broadcasting, and the development of radio receiving apparatus, blossomed forth almost over night into a full-fledged industry.

The R. E. Thompson Radio Corporation is a holding corporation, controlling the Wireless Improvement Company, and the R. E. Thompson Manufacturing Company, the latter the operating company. The Wireless Improvement Company controls patents covering numerous radio devices, under which Thompson radio products are manufactured.

Thompson Radio is one of the licensees under the Hazeltine Neutrodyne patents, and is also licensed under Armstrong patents—the only company licensed under patents for both neutrodyne and regenerative patents.

### Adequate Plant Facilities

The company does not stress pretentiousness in regard to its plants, but rather strives for utility, and for plant arrangements facilitating economic production. The main plant, a four story factory building, is located in close proximity to the ferry and tube terminals in Jersey City. Three floors in an adjoining building have been leased, to provide additional space necessary for the production requirements of the company's augmented line of radio receiving sets and loud speakers.

Plants are adequately equipped with machinery, tools, etc., and one of the most complete research laboratories, under the control of Dr. Leonard F. Fuller, is provided.

The available floor space in present plants is estimated at approximately 100,000 square feet, and plants now have a capacity of up to 2,000 receiving sets per week, in addition to very substantial production of loud speakers, and other products. Provision is being made for the extension of manufacturing facilities to provide for production of up to 2,000 receiving sets per day. It is not expected that this rate of production will be immediately attained, but such extension of activities is provided for should the need arise, through indicated growth of sales.

### Policies Sound

Thompson Radio Corporation has always adhered to what it considered the most ethical policies, as to production, price, and distribution of its products. The company took a firm stand in opposition to the "dumping" tactics employed to a considerable extent by some manufacturers; has endeavored to co-operate in every

essential with dealers and distributors, as to price maintenance, and protection against unfair competition. The production policy has been to maintain the highest possible type of product, and not to sacrifice quality for the sake of quantity.

### Has Several Products

The company is about to announce its line of receiving set and loud speaker models for the current season. The five tube Neutrodyne Parlor Grand model, with sloping panel, and space provided in cabinet for batteries, will be a central feature, as well as a regular square type cabinet for the same five tube circuit. A six tube Neutrodyne circuit set—the Concert Grand—will also be produced.

The regular type Thompson loud speaker, which attained such popularity last year, will be a mainstay of the line this year, and will be augmented by a newly developed cabinet model loudspeaker, with an especially designed built-in horn.

The most novel addition to the Thompson line, however, and of which details have not been received in full, is an entirely different radio receiving set and loud speaker, contained in one unit, with space provided for batteries, and housed in a tambour type cabinet. A cone diaphragm is set in the center, and is surrounded



One of the assembly rooms where the various components of the Thompson Corporation's set are rigidly fastened to the instrument panel.



A faulty variable condenser means faulty performance. These men are inspecting every variable condenser used in Thompson Neutrodynes for mechanical defects.

with a disk on which are imprinted numerals. A sliding pointer controls the tuning, and auxiliary tuning knobs are located at either corner of the base. The set is operated by dry batteries, and is self-contained, compact, and thoroughly unique in design and construction.

Another new feature is an escritoire model, with dual, built in loud-speaker, and uni-control tuning. Two spacious compartments to hold batteries are provided, and the entire ensemble is highly attractive, and an enviable addition to the furnishing of any home.

### Increasing Capital

By action of the stockholders of R. E. Thompson Radio Corporation at a special meeting held on June 24, 1925, the charter of the Company was amended increasing the authorized capital from 140,000 shares to 175,000 shares no par value common capital stock, and July 27, 1925, was fixed as the expiration date of the period within which the stockholders would have the right to subscribe for their pro rata shares of said increased stock.

The Company is arranging, as to any and all shares of stock which may not be subscribed and paid for by the stockholders, to purchase or acquire of R. E. Thompson Manufacturing Company not exceeding \$280,000 of the 7 per cent notes of that Company to be endorsed or guaranteed by this Company and to be sold or transferred by this Company, at an amount which will net the Company 90 and accrued interest. If this plan (the details of which are as yet not fully determined), is carried through, these notes will be exchangeable for common stock of this Company at not less than \$8.1967 per share. Mr. Thompson, the President of R. E. Thompson Radio Corporation, will participate in the purchase of said notes.

Because of its pioneer and subsequent experience in the "wireless" field, covering so many years the Thompson company is well qualified to make radio apparatus that will pass all tests and meet all the requirements of users, professional as well as amateurs.

From the outset of radio receiving set making, the R. E. Thompson Radio Corporation has occupied an enviable position, as it held license under both Armstrong and Hazeltine patents and was also at liberty to employ the tuned radio frequency principle. Some of its models within the last two years have been happy combinations of these circuits.

With its improved line of products, sound policies, and capable administration, Thompson Radio should continue to enhance its position, and contribute largely to the stabilization and solidarity of the radio industry as a whole.



There are many inspections in the Thompson manufacturing process. This particular test operation is a check-up on the smooth operation of every dial and control and is performed after the instrument panel is fully completed.



Sets en route to the neutralization laboratory. Work and inspection tags identify the man who has performed each operation on every set.



# ANNOUNCEMENT

This is of interest to opera-goers, to lecture and symphony patrons as well as to the dancing set, and to those scientifically interested.

Artistic radio has come with Thorola Islodyne, embodying the *Isolated Power* principle made possible only by Thorola Low-Loss Doughnut Coils. They conquer "pick-up" of unwanted stations, waste of power, uncontrollable "oscillation," complicated wiring, uncertain operation. Radio experimenters know what all this means. Radio listeners no longer need to know!

With Islodyne action any one station wanted is cleanly selected, even in broadcasting centers. Utmost power is *isolated—focused*—on this one set of signals only. The delicate radio impulses do not conflict, neutralize, offset each other. Full tone, unmodified—full volume, full distance at last are possible, at all wave lengths.

With temperamental factors banished, Thorola Islodyne achieves uniform reception. The same stations keep coming in the same. The set your dealer demonstrates tells what your set will do.

Radio reception is unmistakably elevated. Complete Thorola receivers lead their field by far, just as Thorola excels in loudspeakers and apparatus.

The Thorola name is surety of radio development not to be eclipsed. The intense interest in the 5-tube Thorola Islodyne at every radio store will tell you where expert opinion centers today. Go and listen.

REICHMANN COMPANY, CHICAGO



In smart Thorocco Cabinet the 5-tube Thorola Islodyne is..... \$85

In stunning Burled Walnut Cabinet with Circassian top the 5-tube Thorola Islodyne is..... \$115

Thorola Loud Speakers with new burnished Bakelite horn and gold throat-band are even better in appearance and performance.

Thorola 4..... \$25  
Thorola Jr..... \$15

Thorola Low-Loss Doughnut Coils installed in your present set will give you many of the greatest Thorola advantages.  
Complete set (3)... \$12  
Per coil..... \$4

National Geographic Magazine (Oct. 1925)

50 June 1925 \$ 85  
55 June 1925 \$115

# THOROLA

Reichmann Company

**O**ther than the horns and radios it made, Thorola left few clues to its history. It began as the Winkler-Reichmann Co., builders of loud-speaking telephones for paging in hotels, railway stations, etc., and for the U.S. Navy. The "Thorphone" horn for radio work was first advertised in June 1922.

The Reichmann Co. (its name changed in about August 1924) registered all sorts of names for its new line of radios: Thor, Thor-O-dyne, Thoradio, and many more before settling on Thorola and Islodyne (for "isolated power"). But it was a rough time to be entering the radio market; only 1,750,000 radios were sold in 1926, down from 2,000,000 the year before. In 1927, even fewer were sold: 1,350,000. Thorola met the same fate as hundreds of other small manufacturers. It filed for bankruptcy on July 27, 1927, and went into an operating receivership, disappearing shortly afterward.

## Prominent in Trade



Radio World (Sept. 4, 1926)

**FRANK REICHMANN**, president of the Reichmann Company of Chicago and accoustical engineer. Mr. Reichmann is famous for the many inventions he has contributed to the loud speaker field. He is prominent in radio trade circles and a member of the Mayor's Radio Commission of Chicago.



Model 601 Thorphone with Victrola Attachment.  
Price.....\$20.40

## THOROPHONE

(THUNDERPHONE)  
TRADE MARK REG. U.S. PAT. OFFICE

### GREAT RADIO VOICE

The Thorphone Real Loud Speaker. Beautiful Tone and Great Volume. Ornamental Concert Horn. Scientifically constructed with Controlled Mica Diaphragm.

Manufactured by  
**WINKLER-REICHMANN COMPANY**  
4801 S. Morgan St. Chicago, Ill.

Oldest manufacturers of loud-speaking telephones in America. Only successful makers of large paging systems. Our loud speakers are used for paging in the great hospitals, hotels, clubs, railway stations, baseball parks and for giving general orders in the U. S. Navy.

Mail Orders attended to promptly. Send money order, check or draft for purchase price. Thorphone will be sent by express or insured parcel post; charges collect. Production of Radio type just coming through. These are not yet in the hands of dealers. Mail orders will be filled first and in the order of receipt. If shipment can't be made within one week, best delivery date will be advised and your money returned if desired. If you wish to return the Thorphone for any reason whatsoever, do so within ten days and your money will be immediately refunded.

Dealers, write for proposition—one outfit only sent to dealers on trial, money-back basis.



Model 501 Thorphone Complete with Concert Horn.  
Price.....\$35.00

Radio News (July 1922)



Bill Smith

70,085. **RADIOCABINET.** FRANK J. REICHMANN, Chicago, Ill. Filed July 22, 1925. Serial No. 14,176. Term of patent 14 years.

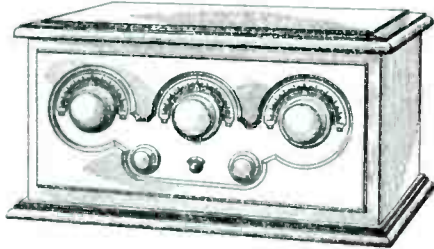

The ornamental design for a radio cabinet as shown.

0,980. **LOUD SPEAKER.** FRANK J. REICHMANN, Chicago, Ill. Filed June 3, 1926. Serial No. 17,929. Term of patent 14 years.

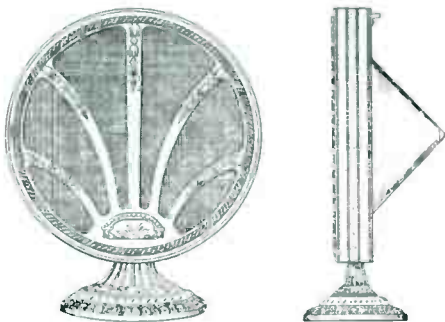

The ornamental design for loud speaker as shown.

0,981. **RADIO CONSOLE CABINET.** FRANK J. REICHMANN, Chicago, Ill. Filed June 12, 1926. Serial No. 18,014. Term of patent 14 years.



New Model 51, Genuine Mahogany Cabinet . . . . . \$85  
Console Model . . . . . \$225

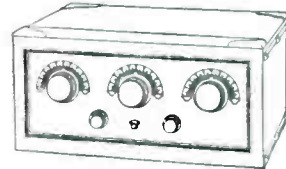

5-tube Thorola Isodyne in smart Thorocco Finish . . . . . \$85

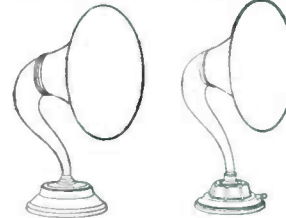

Thorola 4 Speaker \$25

Thorola Jr. Speaker \$15



Set of 3 Coils . \$12

Per Coil \$4

Isodyne action is based on Thorola Low-Loss Doughnut Coils. They bring many Thorola advantages to other receivers

Thorola Low-Loss Straight Line Frequency Condensers can also be bought separately \$5.50 and \$6

Thorola Golden Audio Reproducing Transformer . . . . . \$4.50

51 December 1925 \$ 85  
52 December 1925 \$225



Thorola Console with Two Orthophonic Horns

Thorola . . . . .	5	\$65.00	No. 65 . . . . .	Battery . . . . .	R. F. I.
2-Dial . . . . .					
" . . . . .	5	125.00	No. 66 . . . . .	" . . . . .	"
Thorola . . . . .	7	90.00	No. 60 . . . . .	" . . . . .	"
1-Dial . . . . .					
" . . . . .	7	160.00	Highboy . . . . .	" . . . . .	"
" . . . . .	7	80.00	Chassis . . . . .	" . . . . .	"
" . . . . .	6	70.00	" . . . . .	" . . . . .	"
" . . . . .	6	80.00	Model for Private Label . . . . .	" . . . . .	"
Thorola . . . . .	7	90.00	Model 60 Battery or Table Set . . . . .	Socket Pwr. . . . .	"

Radio Dealer (Dec. 1925)

Radio (July 1927)

# Your Business Protected on This New Line



**THOROLA MODEL 57**

A five-tube receiver with famous doughnut coils and positive two-dial vernier control, in a beautiful genuine walnut cabinet—arranged to take power tube in last stage—distinctive in appearance—the newest thing in performance. Price \$60.

**THOROLA 4 SPEAKER**



The standard of loud speaker reproduction. Controlled Mica diaphragm and powerful magnet builds the faintest radio impulse into giant sound with all the true tone qualities of the broadcasting station itself. Price . . . . . \$25



**THOROLA MODEL 58**

It embodies the same super-excellent circuit as Model 57. With built-in Thorola Speaker and tone chamber. An exquisite compact console, beautifully finished in rich walnut following closely the Tudor design. Price . . . . . \$125

Thorola dealers will plunge into next season's business armed and protected by exclusive dealer franchises. If you have a Thorola franchise all the Thorola business in your territory is *yours*—and there will be a lot of it with the new Thorola line.

The famous Thorola Circuit is now embodied in three new beautiful models that challenge comparison with any radio made. They represent values that radio buyers cannot and will not overlook. And your profits are protected by an unflinching dealer policy.

Let us write you the full details of our new plan and of our new line of receivers and speakers. Thorola will be distributed through selected jobbers, located conveniently to give you service and immediate delivery. If your territory is still open we honestly believe that there is an opportunity to make the real money that you have always wanted to make in radio. Write or wire today. We will answer just as promptly.

**REICHMANN COMPANY**  
Address Dept. C, 1725-39 W. 74th Street, CHICAGO



**THOROLA JUNIOR 12**

It is extremely sensitive to faint signals, and the unique method of control is responsible for the Junior Model's excellent tone quality, making it ideal for smaller apartments. Price \$15.

Prices slightly higher west of the Rockies



**THOROLA CONE No. 9**

The dual diaphragm construction exactly reproduces every note with glorious musical timbre. It has plenty of reserve volume. In artistic beauty of line the Thorola Cone stands apart. It is a beautiful work of art, harmonious with any furnishing. Price \$20.



**THOROLA MODEL 59**

In addition to the regular Thorola circuit this model is cunningly designed with two spacious tone chambers containing the Thorola 4 Speaker and the Thorola Cone No. 9. A beautiful compact console of Tudor design, finished in fine walnut. An ideal radio receiver for the small city apartment or the spacious country house. Price \$185.

# Thorola

- 57 May 1926 \$ 60 (called model 60 in one ad)
- 58 June 1926 \$125
- 59 June 1926 \$185



**A. S. 3000 M. ARLINGTON TUNER**

HS—TYPE 20,000 METER LONG WAVE COUPLER. A revolutionary design. Equally efficient on LOOP aerials, Rogers underground or overhead. No tickler coils are used and none needed as a comparative test will show. Coils are machine wound on the involute curve principle and beat the honey comb coils a thousand ways. Five steps on primary and secondary. No capacity effects. Coils are set in a special compound and will work thru the heaviest static. Not good for spark stations below 3,500 meters. XDA comes in on first tap and NSS on fourth. We don't claim that you will receive European stations without using a two step amplifier. You can get all in this hemisphere and get it good. No fine adjustments to make, turn the switch and the tuner is working. Tuner is four and three-quarter inch square by two and one-half inches deep. Formica top with nickel plated switch and points and with hard rubber posts. The wiring diagram for this tuner is on the bottom, and you can't lose it.

Price \$15.00 Delivered to You

CS—TYPE—200 METER REGENERATIVE TUNER, with primary, secondary, and tickler coil. P and S, ten taps each. No coupling is needed as the tickler coil sets at an angle determined as the most efficient. Coils machine wound involute then are waxed in and air-foot proof and damage proof.

You can use straight audion or our hook up which is glued to the bottom of the tuner. The weight of each of these tuners does not exceed two pounds. Carry them with you wherever you go.

Use any kind of an aerial you want and you will find that the results with these tuners beat anything that you have ever tried. For wireless phone work these tuners can't be beat as the wave length ranges from 175 to 450 with the amateur aerials. With a slight change in the hookup you can also use your audion to generate undamped waves and send or talk over short distances.

Price \$15.00 Delivered to You

AS—TYPE—200 METER TUNER was designed for those that wish to have a complete set of tuners for all the used wave lengths. It is the same size as each of the above only the windings are different, and has the same number of taps as the type CS. It is not efficient below 200 meters and was not designed to be. With these three tuners you can get all that is in the air. All tuners have highly polished wood bases that may be removed if you want to set them in a panel set. Rubber feet are included.

Price \$15.00 Delivered to You

VARIABLE CONDENSERS. Shipped knocked down and you assemble and save money. Polished aluminum plates .015 thick. Looks like cut when assembled. Wire made for panel sets only and have no outside cover. Top is of fibre size about 2x1x3/16. Fine knob and pointer and a graduated brass scale, 0-180 degrees. The 11 plate is to be used in the grid circuit. This is a new size as you have all been using the small fixed and wondering why you did not get the results. Connections must be soldered to the condensers which is a good point. Ask Dr Radio about this.

- 14 plate knocked down, capacity .001 M. F. delivered to you \$2.50
- 21 plate knocked down, capacity .0005 M. F. delivered to you \$2.25
- 11 plate knocked down, capacity .00025 M. F. delivered to you \$1.75

Packed in a neat strong box with full instructions.

All the above made by the Perfection Radio Laboratories, Clinton, Ia.

Sold by **TRESCO SALES AGENCY**  
Davenport, Iowa, Box 148



**B. S. LONG WAVE 20000 METER TUNER**

**C. S. 200 METER RELAY REGENERATIVE TUNER**



**KNOCK DOWN VARIABLES**

Flyer

**Perfection Panel Mounting Rheostat**

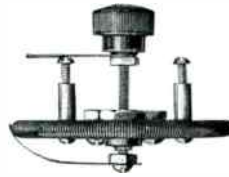

**Perfection Tuner Cabinet**

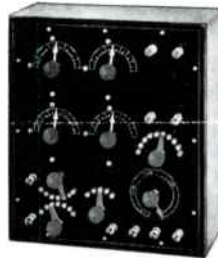

**Perfection Binding Post**



FULL SIZE

Hard Rubber Top, Nickel Plate Base.  
Order nickel or brass finish—no difference in price.

6 for 75c, 12 for \$1.25  
Add parcel post

**Perfection Universal Receiving Cabinet**



SOLD BY  
**TRESCO**  
DAVENPORT  
IOWA

Tuners first advertised in November, 1919, in both round and square cases. Style with three switches advertised in *Radio News* (June 1920).

**NOTE—When using with variometer in plate circuit, insert variometer at points P and B and connect G and W leads to P and B as below:**

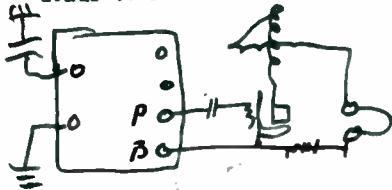

To add grid variometer simply insert it at P

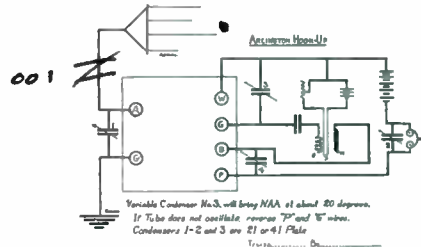

**Directions for Operating Arlington Tuner**

The Arlington Tuner, when properly operated, is the greatest all round tuner on the market. The hookup herewith should be followed closely. It is a simple audion hookup with the tickler coil inserted between the plate and phones. No coupling variation is provided as same is not necessary on any wave length with the celebrated involute coils. Every condenser shown must be used for good results. It is impossible to get NAA without about 20 degrees of the secondary condenser. NAA generally comes in about the middle tap of both Primary and Secondary on the average amateur aerial—not over 125 feet from ground to extreme limit of aerial. This tuner works perfectly on a longer aerial, but was designed for size above mentioned.

To get undamped stations up to about 10,000 meters, put in all your inductance and swing in the primary, secondary and tickler condensers.

If your signals are distorted or hiss, tune to natural tone with your condensers, and if this does not do it, back up on your filament rheostat until it clears up.

For wave lengths below 1,500 meters, put a variable condenser in series with the aerial.

**THE FIRST THING TO DO** is to put both switches on about the center tap and get the tube to oscillating, then tune for signals.

**TRESCO**  
DAVENPORT AND CLINTON, IOWA

Flyer (Feb. 1920)

# TRI-CITY

## Tri-City Radio Electric Supply Company (TRESKO)

**T**ri-City” refers to the three cities of Davenport, Iowa, and Rock Island and Moline, Illinois; the company later had a connection with Clinton, Iowa, which was not far away. It began, like virtually all other companies of this sort, with a couple of ham radio operators who liked to design and build radio apparatus, and then began selling it to other hams. The name “Tri-City Radio Laboratory” first appeared in print in June 1916, although it was later claimed to date from 1914. The address was a ham station 9XR of Robert Karlowa in the Best Building (which seems to have been a department store) in Rock Island. His partner was probably William H. Kirwan of Davenport, 9XE, whose ham activities are described in *Electrical Experimenter* (Jan. 1917), particularly his organizing a “presidential relay” on October 27. One of the prizes in this relay went to 9RD in Clinton, the father-and-son team of Frank M. and Don I. Bailey; from the published comments at the time, all involved were well acquainted.

After the war, Tri-City began advertising a series of small tuner boxes and some complete receivers. After December 1919 the ads are signed “Tresko Sales Agency, Davenport” while the flyers give Clinton as the location of the “Perfection Radio Laboratory” or, later, the “Manufacturing Dept.” Since one illustration in a flyer is marked “drawn by D. I. Bailey,” it is logical to assume that he became a partner in Tresko at the end of 1919. Meanwhile, Karlowa was head of the radio department of Young & McCombs, the department store in the Best Building in Rock Island, where he set up a broadcast station on the site of his old ham station. Young & McCombs advertised in *QST* and sent out sizeable catalogs featuring a great deal of Tresko equipment. In February 1921 Karlowa bought out the radio department, issuing similar catalogs in his own name. At some point before the end of 1920, Tresko acquired a regenerative license — as every other advertiser of such sets in mid-1920 was strong-armed into doing.

In June 1922 Tresko ads took on a new look with the “Sectional Universal” receiver and were signed

“J. Matheson Bell, Sales Manager.” Bell, later to found Ozarka, worked his way up in Montgomery Ward to become Merchandise Manager. In a later autobiographical sketch (for the benefit of potential Ozarka salesmen), he said he left Ward to found his own company with no mention of Tresko; whether he worked simultaneously for the two is unclear. A sketch of his “first Ozarka” in the later salesmen’s manual looks exactly like the Sectional Universal Tresko. His name appeared in Tresko ads until June 1923.

Considering Bell’s connections with Montgomery Ward, it is not surprising that Tri-City manufactured some of its sets. Ward had been selling many different brands such as Westinghouse, Tuska, and Klitzen in early 1922 but, in October, began featuring a Tri-City model in its ads and catalog. Demand outstripped production capacity; so for the following year, arrangements were made with Briggs & Stratton in Milwaukee to manufacture sets for Tri-City, working from designs by Pfanstiehl Radio Service Co. and shipping directly to Ward. Testimony in one patent suit (Westinghouse vs. Grebe, quoted in Maclaurin, *Invention and Innovation in the Radio Industry* [Macmillan 1949], p. 126), reveals what happened:

*“In the beginning, Montgomery Ward paid this (Davenport, Iowa) office direct for sets manufactured by Briggs & Stratton. They sent down thousands of dollars for sets that had been shipped. They followed that up with hundreds of dollars of credit, red slips for sets that had been refused and sent back, and in about three weeks I was in a maze that no one in the world could ever have crawled out of. I went to Chicago and saw the vice-president and told him it was absolutely imperative to make some other arrangements for payment as I was lost entirely, and we did make arrangements for Montgomery Ward to relieve me of the bookkeeping and send such payments as were due the factory on order direct to them with the statement and such payments as were due me direct . . .*

*I didn’t know how to keep a book. I never was a bookkeeper.”*

# LISTEN TO THE WORLD

With *TRESCO DeLuxe Type RS Tuner*

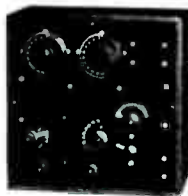

This is the Tuner that half the world is using today to hear the Grand Opera, Stock Reports, and Government Broadcasting. We guarantee that with this tuner and a suitable aerial that you will receive all broadcasting sent from anywhere that arrives at your aerial.

The tuner is extremely simple in operation, consisting of a TreSCO Involute Coil of the same design that has been used in our tuners for years. Two variable condensers assist in the tuning and it is so simple that a child can operate it. There are two posts on the left-hand side, the top one goes direct to the aerial, while the bottom one goes direct to the ground. On the right side are four posts, the two upper connecting direct to your phone, and the two lower direct to a six-volt

storage battery. It is important that the bottom post, be connected to the minus side of the storage battery, the second post from the bottom, right-hand side, being connected to the plus side of the storage battery. This is really all the connections you are obliged to make.

The tuner proper is worked by three switches shown with the switch-board in the center of the tuner. The general broad-casting wave being easily located by placing all three switches about on the center point, then turn slightly the two condensers at the top. The Rheostat, shown in the lower right-hand corner, controls the filament of the bulb, and bear in mind that the adjustment of the filament current is very critical for proper signals. When the tuner arrives it is possible that some of the hard knocks may have caused the condenser plates to touch, in which event remove the front panel entirely by taking out the screws and laying the panel down flat. If you put a piece of white paper in back of the condenser and slowly turn it, you can see if any of the plates touch, and a small pen knife pressed against the touching plate will relieve you of this trouble. The tuner will not work if these plates touch. By removing the back you can place inside of the cabinet the 22½ volt "B" Battery which we send with each set, can be connected up direct to the two small coiled wires in the bottom of the cabinet. The red wire is fastened to the plus side of the "B" Battery; the yellow wire must be tried on each and every point to find the voltage most suitable for the particular bulb you use. We find that all bulbs have different characteristics, and the best results are had by locating in the beginning the proper voltage at which it works most efficiently.

The bulb should be inserted in the socket inside of the cabinet and given a small twist to the right in order to seat it properly in the socket. You are now ready to go ahead and receive broadcasting.

We should say at this time that you cannot receive wireless at all times, there being times when there is lots of static in the air just preceding or following any kind of rapid change in temperature. After a few days' use of the tuner you will know more about it than we would ever be able to write you. The price of this tuner is set to actually take care of the manufacturing cost and royalty plus a reasonable profit on our investment. We want to be frank with you, because this tuner is priced higher than some others which may be obtained.

This tuner is licensed under Armstrong Patent United States No. 113149, and is to be used only in amateur stations or technical schools or private homes. It is not to be used for commercial service at all. The tuner is so marked and you hold yourself liable to a suit for infringement if you attempt to use it for any other purpose than that specified in the tag accompanying each tuner.

## TRESCO TYPE RS TUNER



This tuner incorporates the coil and three switches, together with binding posts of the RS De Luxe Tuner explained before, the price of it being also based on actual cost, royalty, and reasonable profit. It is also licensed under Armstrong Patent U. S. No. 113149, and is to be used only in the manner set forth, previously explained.



K. D. Condensers

## ACCESSORIES NEEDED WITH OUR TUNER

Two Condensers, preferably 17 plate and an audion cabinet of any make. The wiring diagram of this tuner is placed on the bottom, and if you follow it, it will give wonderful results. The range of this tuner, with suitable equipment, is equal to that of the RS De Luxe type of which really it is a small counterpart.

Price of Tuner, \$15.00, F. O. B. Factory.

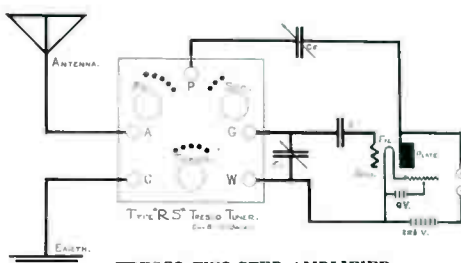

## TRESCO TWO-STEP AMPLIFIER

We designed this instrument to be of the same size as our RS De Luxe type and super-universal De Luxe type. The binding post on it matching the binding post on the two tuners mentioned. It is sent complete with 45 volts of "B" Battery, all the transformers, rheostat, sockets, necessary to properly amplify broadcasting about 100 times. Two posts are on the right-hand side of this amplifier to which may be attached any make of amplifier or loud speaker you may decide to use. No bulbs are sent as you can buy them locally and make your replacements necessary just as readily. When ordering bulbs, specify amplifier bulb. There is only one rheostat on this amplifier controlling both bulbs and the operation is so simple that it does not need much explanation. Do not burn the filament however, too bright, because you will find from experience that there is a critical point at which the signals are loud. The same battery that operates your tuner bulb will operate the amplifier very readily.



The price of this Amplifier is \$35.00, F. O. B. Factory.

# LISTENING TO THE WORLD'S GRAND OPERA

With **TRESCO TUNERS**—“They made their way by the way they're made for city or country home, cheaper than a phonograph”

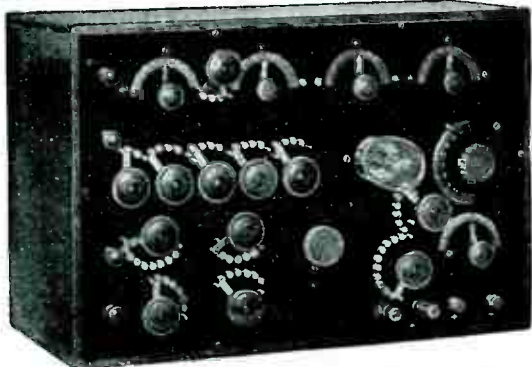

COMPLETE TUNERS FOR MUSIC—ONLY \$60.00.

## TRESCO SUPER-UNIVERSAL TUNER

Cabinet 12 x 17½ inches, Formica or Hard Rubber Panel, Weight 15 lbs.; shipping 25 lbs.; Wave length range, 150-25,000 M. Tuners inside—three, A, B, C, K.

Recommended by users of the Bureau of Market Reports and guaranteed to get all the wireless signals, either CW, spark, or telephone within the range of the sending station. This is the only tuner in the world that has this range of wave lengths and gets the signals on the smallest possible single wire aerial. Arlington time, Annapolis, San Diego signals clearly read through even a violent thunder storm. Nearly all stations in the United States of the Bureau of Markets come in on this tuner in the center of the United States, and no point in the country would prevent the reception of these signals. It is recommended for the Farmer, Bureau of Markets, Schools, Colleges, etc. There is nothing about it to get out of order or need replacing, except the high voltage batteries, a replacement of which costs only a few dollars. We ship only by express. We do not ship without testing and calibrating with your bulb, and each one is absolutely guaranteed to do just as we claim or we will refund your money. You do not need to know anything about wireless to operate this tuner or to get the signals and telephone reports. Cabinet is highly polished and all parts nickel finish. If you wish extra loud signals you may use one or two-step amplifier, as posts are provided on the tuner for this purpose. We recommend Bellini or Brown phones. We only sell this tuner assembled and calibrated to your bulb ordered with the set. It is complete with all that is needed except a pair of phones and a few dry cells to light the filament of the Audion. Ready to use when it arrives with full directions so that a child can operate it. Priced at \$100.00, F. O. B. factory.

Licensed under Armstrong Patent No. 113149.

10c brings Our Catalog.

**TRESCO — DAVENPORT — IOWA**

Flyer March 1922)

Radio News (March 1922)

Ward had paid Westinghouse \$14,000 in royalties by the end of 1923, indicating total sales of \$280,000, while Tri-City sold \$90,000 in the first quarter of 1924.

Tri-City also lent its Armstrong license to a number of other makers: Crosley, Telmac (Telephone Maintenance Co., a Chicago manufacturer and dealer), Remco (probably Radio Equipment Mfg. Co., a one-man, cellar operation on E. 2nd St. in Davenport), and Trego (owned and run by Mrs. Nellie Trego in Kansas City). Westinghouse filed suit, probably in 1923, to put a stop to this subcontracting business; after a reversal in the district court, eventually it was declared illegal. As Tri-City's fortunes declined, its Davenport business became Tresco Sales, Inc. After July 1924 the Tri-City name and Armstrong license were sold to Steinite. Steinite soon began advertising Armstrong regenerative models by the "Tri-City Radio Electric Supply Co., Atchison, Kansas." By mid-1926, when Steinite had dropped regenerative models and had no further need for the license, the Tri-City name had disappeared.

TRESKO APPARATUS

17

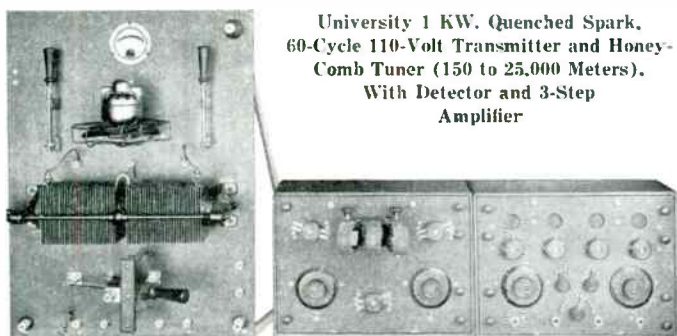

University 1 KW. Quenched Spark, 60-Cycle 110-Volt Transmitter and Honey-Comb Tuner (150 to 25,000 Meters). With Detector and 3-Step Amplifier

Transmitter—\$250.00  
CATALOG NO. 31  
Weight, 100 lbs.

Tuner—\$80.00  
CATALOG NO. 32  
Weight, 25 lbs.

Detector-Amplifier—\$125.00  
CATALOG NO. 33  
Weight, 30 lbs.

The University 1 KW. Quenched or Rotary Spark Discharger is built especially for the particular experimenter who demands a receiver and transmitter of the highest efficiency and quality. Assembled from standard units, it offers a saving of at least 50% from the prices asked for similar equipment now offered by other manufacturers. The transmitter can be supplied either with the standard quenched gap or the K-20 Rotary Gap of our manufacture.

The receiver is furnished complete, with bulbs and a complete set of coils for 150 to 25,000 meters wave-length.

Special features of the transmitter are the antenna switch, cooling fan, separate AC cut-out. The complete transmitter consists of 1 KW transformer, condenser, adjustable primary resistance, ammeter, protective device, antenna switch, quenched or rotary gap, AC cut-out switch, meter switch, and necessary binding posts.

TRESKO TYPE D-S RESONANCE TUNER  
CATALOG NO. 31



Conductively wound with Involute coils, range 150 to 250 meters. Most efficient with audion hook-up No. 3, our catalog. A 41 Pl. Var. Cond. must be used in series with ground wire for any results. Can be used with crystal if you wish local signals and music only.

Weight, 2 Pounds. Price, \$5.00





### Hook 'Er To Yer Bulb 200M-P. R. L. TUNER

Something new, using a vario-coupler wound with 1/4" copper strip. Very efficient and selective, also including our special variometer. Just as efficient as any Paragon. Weight 5 lbs. Price, \$25.00—add P.P.

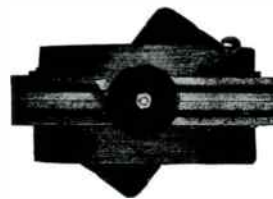

#### KNOCKED DOWN PANEL

Set it up, save money. Consists of Formica Panel—drilled ready for parts, 1 Rheostat—one 11 Plate condenser, H.V. switches, points, base and necessary binding Posts. V.T. socket \$1.00 extra. Shipping weight, 4 lbs. Price, \$8.00. Add Parcel Post.

#### RHEOSTAT

Smoothest running that's made for panels. Auto stop that prevents burning out filament. Weight 1 lb. Price, \$1.75. Add parcel post.

#### KNOCKED DOWN CONDENSERS

Assemble and save money.

11 Plate .....	\$1.80	
21 Plate .....	2.25	
41 Plate .....	3.20	Add P.P.

20,000 METER TUNERS. Arlington 5,000 Meter Tuners. Weight 3 lbs. Price, \$10.00. Get all the Arc signals going. Add P.P.

10 cents brings complete catalog full of dope.

## TRESKO, Davenport, Iowa

Radio News (Jan. 1921)

Catalog (March 1921)

22

TRESKO APPARATUS

INVOLUTE C. W. TUNER, TRESKO MODEL, LATEST DESIGN  
CATALOG NO. 38



Do you believe it possible that C. W. can be tuned in much easier than spark? Accustomed as you are to the modern regenerative with its multi-controls, where the plate circuit has to be carefully tuned to the grid circuit and then returned each time the grid circuit is varied, to say nothing of critical adjustments of antenna circuit and coupling, no doubt it sounds improbable, and indeed it is a hard job on our regenerators.

The initial adjustments of the set are a little tricky. The negative terminal of the B battery must be connected to the positive terminal of the A battery, and this point grounded. When an amplifier is used the grid circuits of same should connect with the negative side of the A battery. The polarity of the two tickler coils must be right—they will work in one direction and not in the other.

On an average amateur aerial the set will tune from 150 to 450 meters and will regenerate or oscillate over the entire range. Use a key in ground circuit and send I. C. W. same hook-up.

Includes cabinet, formica panel, 2 condensers, primary coil, 2 ticklers, switches, etc. Not just as good but better than the best.

Weight 10 lbs. Priced at \$30.00

TRESCO APPARATUS

SHORT WAVE REGENERATOR  
CATALOG NO. 2

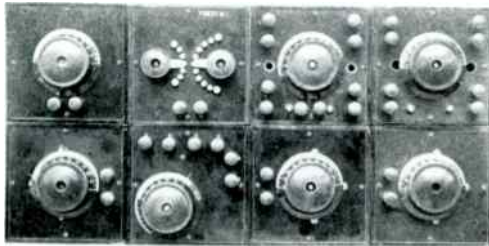

This combination includes one step amplifier, variometers, high voltage control, enclosed audion or VT, condensers, etc., ready for your aerial, phones, H. V. battery and filament battery. Wave lengths, 200 meters to 600 meters.  
Shipping Weight, 10 lbs. Price on Request.

SHORT WAVE COUPLER  
CATALOG NO. 3



Has a conductive wound primary and secondary coil and tinker coil with manual coupling. Can be used with either crystal or audion for wireless phone reception or radio signals from 200 meters to 600 meters. The best coupler we know of. It can't be equalled at this price.  
Weight, 4 lbs. Price, \$15.00



COUPLER SET  
Priced at \$43.00

SHORT WAVE

Shipping Weight, 15 lbs.



CATALOG NO. 4

Short Wave Coupler with two variometers, and the equal of any set, made of Paragon or regenerative type. Great for C. W. and I. C. W. Phone and music easily heard.

TRESCO APPARATUS

TRESCO MOUNTED VARIOMETER  
CATALOG NO. 5

Enclosing Variometer Unit shown below, with engraved dial, Formica panel, TRESCO H. R. binding posts, polished hardwood case. Front panel flush mounted.



Weight, 4 pounds  
Price, \$14.00

VARIOMETER UNIT  
CATALOG NO. 6

Size 3" Diameter by 4" Long.

Price, with dial, \$9.00  
Price without dial, \$8.00

Weight 2 lbs. Same as Used in Catalog No. 5



TRESCO ARLINGTON TUNER  
CATALOG NO. 7

Our regular A-S Type, mounted in a cabinet. Using our world famous Involute Coils. Designed for time signals from NAA. Wave length range 700 meters to 5,000 meters. The only tuner made that gets NAA without any manual coupling. Static does not affect this tuner. Not efficient on low wave lengths. Read our testimonials and be convinced. Use only our diagram. No variations. Also receives all arc signals and I'W on above wave lengths. Any single wire aerial 25 feet by 40 feet will give good results. All are tested on this size aerial, 1,300 miles from NAA. Receives phone concerts on above waves. Not efficient with crystal.



Weight, 5 lbs. Price, \$15.00

MAGNAVOX

Loud Speaker—\$15.00. Weight, 10 pounds.

Catalog (March 1921)

"Above them all" TRESCO

"Above them all" TRESCO

"Corn is up a cent"

Lic. Under Armstrong U.S. Pat. 1,131,490

Used All Over The World

**TRESCO RADIO**

J. Matheson Bell Sales Mgr.

Davenport, Iowa, U.S.A.

Radio News (Nov. 1922)

# Ready for Immediate Delivery

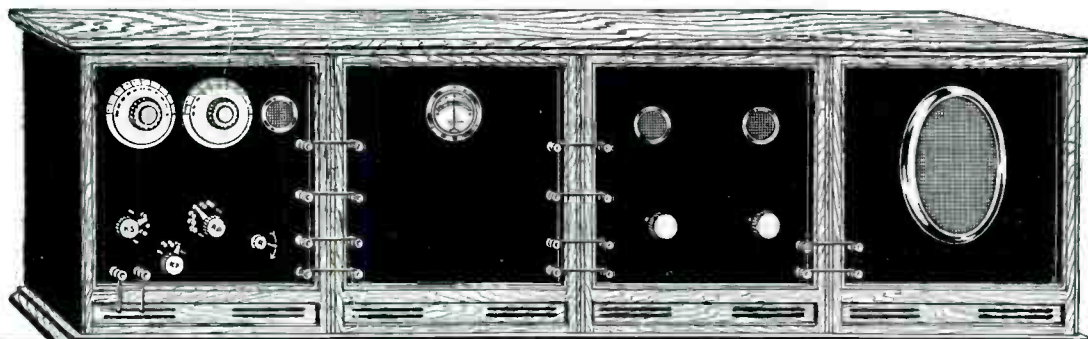

Tuner and Detector

"A" Storage Battery

Two Step Amplifier

Vocorala Loud Speaker

## THE NEW TRESKO SECTIONAL UNIVERSAL

Licensed under the Armstrong Patent No. 1,113,149

**T**HE TRESKO SECTIONAL UNIVERSAL is an entirely new idea in a regenerative radio receiving set. This receiver consists of four separate, distinct parts:

1. Tuner and Detector
2. Two Step Amplifier
3. Case for "A" Storage Battery
4. Case to fit the VOCORALA Loud Speaker

Each one is a separate unit and yet when put together with base and top, which is furnished, form a complete radio receiving set with all of the appearances of one case.

If you desire you can start with the tuner and detector unit only and later on add any one of the other three units. Instead of having different sized or different shaped boxes with a lot of ugly wires and batteries showing, the TRESKO SECTIONAL UNIVERSAL gives you the opportunity to secure a high-grade radio receiving set with no wires or batteries exposed. All of the units are made of oak, finished in French Gray, making an extremely attractive piece of furniture—something you would be proud to have in your home.

TRESKO TUNERS are not new. They were one of the first tuners ever made under the Armstrong patent. Up to the present time our production has been very small, but nevertheless TRESKO TUNERS are today in use in every country in the world and especially where requirements call for long distances. TRESKO SECTIONAL UNIVERSAL is exactly the same type tuner and two step amplifier that we have been selling for many years—the only difference is the case. We believe that the time has come when the radio receiving set should be something more than an ordinary series of cracker-boxes connected with a lot of wires and batteries on the floor.

TRESKO REGENERATIVE TUNERS are made as extremely simple as possible. They are especially adapted for those who know nothing whatever about operating a radio receiver. The involute coil which is used in these tuners has been successfully used by us for the past seven years and it will successfully receive code, voice or music from 160 to 600 meters and do so with the very smallest number of adjustments.

**W**E are now in a position to take care of any size order on the TRESKO SECTIONAL UNIVERSAL, either for separate units or the four units complete together with base and top. Tell us your requirements and we will tell you exactly what date we will make shipment.

### PRICES

Tuner and Detector unit without vacuum tubes or "B" batteries.....	\$50.00
Two Step Amplifier unit without vacuum tubes or "B" batteries.....	35.00
"A" Battery unit without batteries.....	9.50
Loud Speaker unit made to fit Westinghouse Vocorala, but furnished without Vocorala itself.....	7.50
Top and Bottom unit which when added to the four other units makes complete case all in one. Each.....	5.00
<b>Total cost of entire six units outlined above.....</b>	<b>112.00</b>

The four units when placed side by side are 50" long, 14" high and 10" deep.

TRESKO SECTIONAL UNIVERSALS are being supplied to the dealers and jobbers just as fast as possible. Order from your local dealer. If he cannot supply you we will gladly fill your order upon receipt of prices as given.

Dealers and jobbers are rapidly finding out that TRESKO is today one of the very few manufacturers who is actually in position to take care of large volume orders for immediate shipment. Liberal discounts are given to jobbers and dealers for quantity orders. We do not furnish vacuum tubes, batteries or loud speakers.

We are also desirous of securing well established salesmen who can represent us everywhere; also practical radio men for service stations.

LITERATURE FREE

## TRESKO

DAVENPORT

J. MATHESON BELL, Sales Manager

IOWA

**\$49.50**  
Special! Complete Outfit

### The Airline Special

**W**E are sure you will be pleased with the results you can get with the Airline Special. Comparative tests with many higher priced instruments have shown it to be one of the best sets obtainable today. Try the outfit every day for ten days. If at the end of that time you are not perfectly satisfied with the results, send it back to us and we will return to you the purchase price plus the transportation charges you have paid. Any one can easily set up this outfit with the aid of the simple instructions we include. These instructions show a picture of each part exactly as it looks with the different wires leading to the proper connections. You have an actual picture of the complete set just as it should be installed. The instructions are clear and simple. Each part is plainly marked and numbered. The operating instructions are equally plain and simple. How to "tune in" is described in such a way that you are assured of successful results the first time. With very little practice you will become expert in handling the outfit. Any member of the family may use the set and be sure of good results.

This receiving outfit will equal in results any of its type regardless of cost. Everything is complete—nothing extra to buy. You can take the materials we send you, put up the aerial wire, connect the instrument, which is easy to do, and in less than an hour you can be receiving signals, radio music, lectures, stock reports, market reports, or any other radio program being sent out within your range. This set is capable of receiving radio telephone messages for distances of 50 to 500 miles, depending on conditions.

**Montgomery Ward & Co.**  
Chicago Fort Worth  
Kansas City  
Portland, Ore., Saint Paul

# In the Air—Waiting for You— Entertainment, News, Education Yours the Day You Install the **Airline Special**

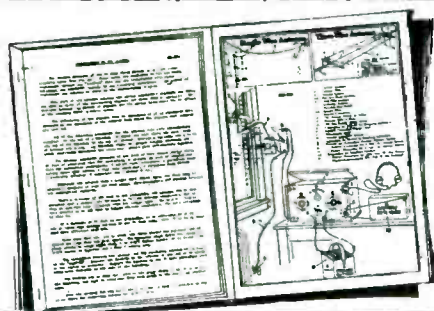

**Complete  
Directions  
for  
Installation  
and Operation  
Included**

## An Efficient Outfit—Proved By Tests



Many thorough tests were made with this outfit in the vicinity of Chicago. Concerts and messages being broadcasted from the sending stations in Detroit, Madison, Milwaukee and St. Louis, were heard regularly. Under favorable conditions more distant stations—Pittsburgh, Schenectady, Newark, Kansas City and Denver, were heard. We cite these instances to show what has been done with this set. Naturally, these performances cannot be duplicated at all times. The effective receiving range of any set depends on atmospheric conditions, geographical location, the time of the day, season of the year, and the power of the transmitting stations. When conditions are unfavorable, even the most powerful and most sensitive receiving set will have only a very limited range, and under extreme conditions may be incapable of receiving signals entirely for a time.

This set is licensed under Armstrong Patent No. 1,113,149 for amateur and experimental use.

### The Tuner and Detector

This is a single circuit type regenerative tuner requiring only very simple adjustments. The tuning circuit is directly connected to the detector and consists of a high grade condenser in series with an inductance having four taps and controlled by a switch lever. This arrangement permits very fine tuning and usually will enable the operator to tune out interfering stations. Regeneration is obtained by means of a tickler coil mounted inside of the antenna in-

ductance and wired in the plate circuit. Both condenser and tickler coil are controlled by dials mounted on a panel which makes tuning simple and rapid. Grid condenser in detector circuit. Tube socket mounted on bakelite base. Finely graduated rheostat controls filament current. Genuine bakelite panel, 6½ by 10 inches. Highly polished, mahogany finish cabinet with hinged top, 12 by 8½ by 6¾ inches. Plainly marked binding posts for all connections.

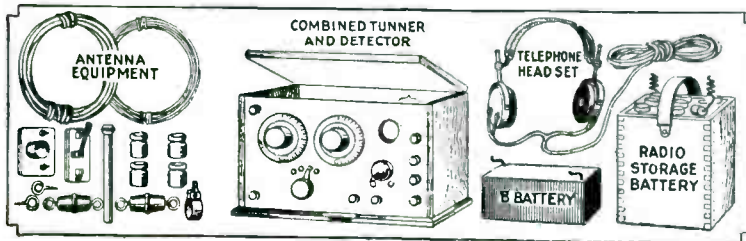

### The Complete Set Includes

Airline Special Combined Tuner and Detector, which is so simple in operation that a child can handle it.

Telephone headset, reproduces messages loud and clear (see Page 19 for description).

Radio storage battery, 6 volt, 40 ampere (see Page 33 for complete description).

663 J 639—Complete set. Not mailable. \$49.50  
663 J 640—Tuner Detector only, without accessories. Ship. weight, 6 pounds. 28.50

One detector tube (see Page 21).  
One "B" battery (see Page 33).

Antenna equipment including 150 feet of bare copper wire, 25 feet insulated wire, porcelain base double-throw switch, lightning protector ground plate, two screw-eyes and 25 feet of wire for connecting instruments.

Shipping weight, complete outfit, 40 pounds.

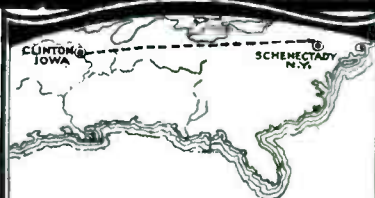

### Iowa "Listens In" On New York with Our Special Air-line Receiving Set

How would you like to live in Clinton, Iowa, and be on "listening terms" with Schenectady, New York?

Just to see for ourselves what our Complete Receiving Outfit, Number 663 J 639, could do, we took it out to a point on the Mississippi River near Clinton, Iowa, one clear night, strung a temporary aerial up on a country schoolhouse flag pole, hitched the ground wire to the pump, set the receiving instrument on the schoolhouse steps and tuned in. We heard distinctly stations in Schenectady, New York, Detroit, Chicago, Milwaukee, Madison, Wis., Kansas City and Minneapolis.

On another clear night, with our aerial strung up on a windmill near Battle Creek, Michigan, we picked up all the stations heard from Clinton and in addition Atlanta, Ga., the Naval Air Station at Washington, D. C., and amateur telegraph stations along the New England coast.

In tests made during the daytime both in Michigan and Iowa, and from our own testing station on the roof of our Chicago building, this receiving outfit has picked up messages from stations within a radius of 140 miles. These tests were made with a vacuum tube detector, but similar tests made with a detector and two stage amplifier amplified the messages a hundred times and brought them out so clear and distinct that with the aid of a loud speaker they could be heard many feet from the instrument.

These tests were made under ordinary summer weather conditions, with the outfit just as it comes to you, and under the same conditions as you will use them. With this outfit you can equal, if not surpass, every one of these receiving records.

In spite of the fact that this set costs you less than \$50, when tested side by side with much more expensive instruments it has bettered them in results again and again. You will have difficulty in finding another outfit at this price with an equal receiving range.



Montgomery Ward & Co.

All merchandise in this catalogue shipped from Northern Illinois



# The Receiver

which has met with  
Universal Favor

## Telmaco

### Type B-R Receiver



Manufactured exclusively for us by the Tri-City Radio Electric Supply Co., licensed under Armstrong U. S. Patent No. 1113149, Oct. 6th, 1914, for use in amateur stations and for radio experimental work.

A careful analysis of the past two revolutionary years in Radio shows un-

questionably that the receiver of the future must have the following qualifications:

**EASE OF OPERATION:** enabling the novice to secure satisfactory results. **HIGHEST QUALITY OF WORKMANSHIP AND MATERIALS.** The time when inferior radio products can be successfully merchandised is past. **PRICE** within the reach of everybody. All these qualifications are combined in the **TELMACO Type B-R Receiver.**

### Specifications:

Panel—Formica, grained and machine engraved. Varico-Coupler—TELMACO special silk wound with loading inductance in series with primary. Condenser—Special 13-plate with Bakelite ends. Rheostat—Single knob control. Sockets—Highly nickeled shell, Bakelite base. Dials—are polished, presenting pleasing contrast with dull panel. Workmanship—manufactured according to TELMACO'S rigid specifications. This guarantees your satisfaction. Either 6 volt or 1½ volt tube may be used.

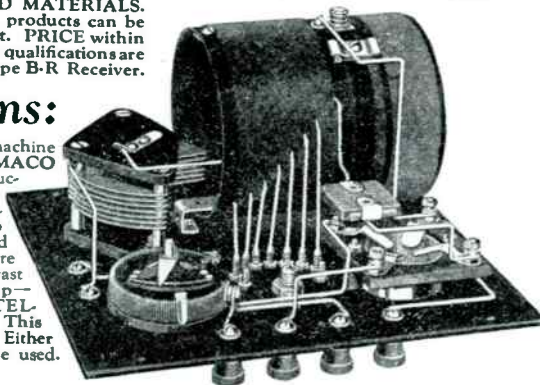

**Price \$25**

The ultimate in value.

### Telmaco Type B-A Two Stage A. F. Amplifier

Matches the above in size and construction. The greatest Amplifier value on the market. Price \$20.00.

RADIO DIVISION

TELEPHONE MAINTENANCE CO.

20 S. Wells Street

Dept. D

::

Chicago, Illinois



*Quality Radio Exclusively*

*Bona Fide Jobbers*—If our salesmen have not reached you with our proposition, write or wire for it today.

Telmaco B-R March 1923 \$25

# Young Woman Heads Large Radio Company

Started on Credit—Business Now Said To Be Million Dollars Annually.

KANSAS CITY, Aug. 20.—Twelve years ago Mrs. Nellie Trego, in her twenties and frail of figure, was left a widow when her husband, a hardware dealer, died in Humboldt, Kan. The young widow, with a daughter to support, bundled up her few belongings and went to Kansas City, the nearest metropolis. She had enough money to give her a few weeks in a business college and then she obtained employment as a stenographer in the office of A. J. Stephens, manufacturer of automobile tires.

The Stephens business grew rapidly and Mrs. Trego advanced in her work and in salary. She bought stock in the company and was on the road to wealth when collapse of the rubber market left the concern in a bankrupt condition.

But the little widow was not to be discouraged.

### Ads First Expense.

She had saved a small home from the crash and she placed a \$3,000 mortgage on it.

With \$2,500 of that sum she bought advertising space in newspapers and with the \$500 she bought, mostly on credit, some equipment and material and began the manufacture of radio sets with only a few helpers—men who had worked under her direction in the tire factory.

Orders began to roll in. Now the business of the Trego Radio Company amounts to more than a million dollars a year and Mrs. Trego is recognized as one of the business leaders of her city.

In her early thirties she is independently wealthy and happy in her work.

Success, however, has not caused her to drop any of her habits of industry and she is at her desk at 8 every morning.

### Marry? Not She.

In a recent mail containing 300 letters were many proposals of marriage, but those go into the waste basket as soon as a secretary can determine that they do not contain real business correspondence.

Mrs. Trego weighs 110 pounds. "It is not necessary that one be a physical giant to make a success in business," she says. "One merely must be able to look ahead and willing to risk his or her own judgment. That was what I did when I foresaw the future of the radio business."

Mrs. Trego's plant covers an entire block. She has more than 100 employes.

In addition to her business interests Mrs. Trego is a member of several women's organizations, including the Women's Chamber of Commerce of Kansas City.



Mrs. Nellie Trego, of the Trego Radio Company.

New York Telegram (Aug. 20, 1927)

**Tune in on All of Them With a TREGO!**

**1000 to 2000 Mile Range**

Here is the Trego Long Distance Receiver. Map shows stations actually being received daily. 1,000 to 2,000 mile range guaranteed. Polished Walnut Cabinet—Bakelite Panel—Standard parts built in complete. Operates on single W. D. 11 Tube and ordinary dry cells. Sold under rigid factory guarantee.

**FACTORY PRICE**  
**\$33.75** Regular \$45.00

**READ WHAT TREGO USERS HAVE TO SAY**

"Listened in on Havana, Cuba." E. T. DeForest, Woodhall, Ill.  
 "Heard New York, Chicago, Cleveland and Dallas." J. W. Lenz, Omega, Ga.  
 "Heard Havana, Cuba, clearly." Dr. J. K. Hill, Bonner Springs, Kansas.  
 "One St. Louis, Chicago, Louisville, Davenport, Atlanta, Pittsburgh, Schenectady and New York." A. G. Williams, Eldorado, Kansas.  
 "Heard Regina, Sask, Canada, and Los Angeles." A. C. Johnson, Delhart, Texas.

A postcard will verify any of above statements.

**Express Prepaid** We will prepay express charges any place in U. S. if remittance accompanies order. Ask for price list on complete instruments or parts.

**TREGO RADIO MANUFACTURING CO., Dept. N, Kansas City, Mo.**

Radio News (Apr. 1923)

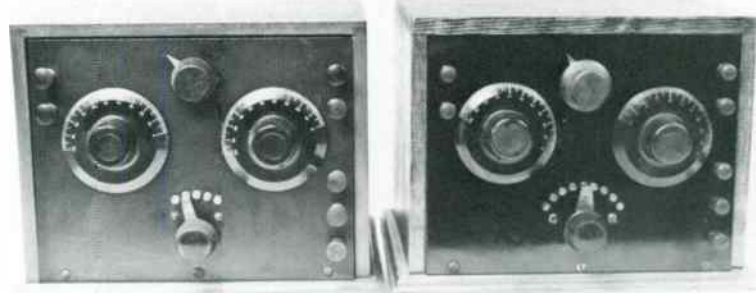

Trego models

Frank White



John Drew

**WOC—TRESKO**

Licensed Armstrong U. S. Patent No. 1118149

Two things that made Davenport famous. A complete 2000 mile Armstrong regenerative tuner for \$25.00. Use it with any make bulb W.D.11 or 12, or dry battery operation as well as storage battery. Portable set to use at camp or in your machine. Complete with bulb, batteries and phones, etc., \$37.50. Circulars free. This set received the Chicago American Regional Prize of \$350.00.

**TRESKO**

Tri City Radio Electric Supply Co.  
Box 148, Davenport, Iowa

X July 1923 \$25

## The Ultra Airline One-Tube Set

**\$19.95** Complete Nothing Extra to Buy

**No Experience Needed—Anyone Can Use It**

THE Ultra Airline is a high grade vacuum tube receiving set perfected until it is so simple that anyone can set up and use it successfully anywhere. No previous radio experience is needed. This set complete at this low price includes tube, batteries, head set and all antenna equipment; nothing extra to buy. You can set it up and be hearing programs an hour or two after you receive the set. The range of the Ultra Airline is remarkable. On cold nights, under favorable conditions, you will be able to enjoy programs regularly from stations up to 1000 miles distant, and much greater distances have been covered. It will give good service the year round.

**The World's Best Entertainers Right in Your Own Home**

Simply turn the dial and from far off cities come voices singing, bands playing, people speaking, a church organ playing, and religious services. You hear them with startling clearness. A simple pressure of the fingers on the dial brings in another, and still another station; and you choose your own entertainment. You can hear the weather forecasts, the market reports, educational lectures, the correct time. You need never be lonely with an Ultra Airline in your home. Every evening is filled with pleasant entertainment which you and your friends will enjoy.

**The Ultra Airline Is Reliable and Economical**

Reliable reception, ease of control and economy in operation are features of the Ultra Airline. The only parts to wear out are the batteries. The "B" battery with ordinary use will last several months. The "A" battery should last six weeks or more, according to its use, and is not expensive to replace. The set is small and self contained. You can take it on camping or touring trips. By adding more head sets served can listen in at the same time. The addition of the two-stage amplifier unit shown on the next page will convert the Ultra Airline into a set that can be used with a loud speaker on stations several hundred miles away, and greatly increase the range and volume of the distant stations on the band here.

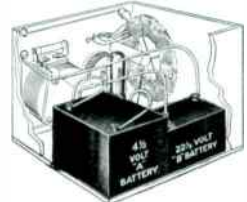

**View Showing Interior of Ultra Airline**  
The above view shows the compact interior arrangement of the Ultra Airline. Note that the batteries are contained in the cabinet, hiding all except the antenna and ground wires. This improves the appearance of the set and makes it adaptable for a portable set.



Complete Antenna Equipment is included. Nothing extra to buy.

Sensitive Head Sets with easily adjustable head bands. Page 42

## Ward's Best Radio Value

Simple—Practical Efficient  
Wonderful Long Range Records  
Owners Enthusiastic

These two letters, selected from hundreds of similar enthusiastic messages from owners of the Ultra Airline Set, will give you an idea of what it will do for you.

It is Easy to Install  
Your Ultra Airline comes to you complete in every detail. Every set before being shipped is carefully tested. The vacuum tube is inspected and thoroughly tried out to insure that it is sensitive and high quality in every way. With our set you receive a book of simple instructions with plain diagrams, which makes it so easy to install the set that absolutely no previous knowledge of radio or mechanics is necessary.

You'll Never Tire of Radio There's Always Something New

**A Practical and Efficient Receiving Set at a Very Low Price**

The Ultra Airline is a great radio set for any home. It brings in the best music, news, and sports. It is so simple to use that anyone can enjoy it. The set is compact and portable, making it perfect for travel. The price is just what you need for a high quality radio.



**Ward's Two-Stage Amplifier \$15.00**

NOTHER achievement of Ward's. A fine quality two-stage amplifier at an unusually low price. Made especially to use with Ward's Ultra Airline or Airline Special sets, which it matches in size and finish. Can be used, however, with any good one-tube set, or even with a crystal detector set.

**Volume Enough for Loud Speaker**

With this amplifier connected to your Ultra Airline you can have all the advantage of a 3-tube set. This amplifier not only makes it possible to use a loud speaker that greatly increases the range of your set. Very few distant stations that are ordinarily too faint for clear band reception on vacuum tube sets heard with amazing clearness and volume when the amplifier and a loud set are used. This amplifier can be used in connection with a crystal set and supplies the clear, sweet tone of the crystal receiving set with wonderful effect.



**Can Be Used with Dry Cells or Storage Battery**

The amplifier is mounted in a handsome cabinet finished in Adam Brown imitation Mahogany to match the Ultra Airline. The amplifier is provided with a control knob for adjusting the volume and a switch for selecting between dry cells or storage battery. The amplifier is compact and portable, making it perfect for travel. The price is just what you need for a high quality amplifier.

**Order Now—Don't Miss the Programs**

Within 24 hours after receipt of your order, your Ultra Airline Set will be on the way; and soon you, too, will be enjoying the progressive information into many hundred thousands of homes throughout the country. Buying a radio set is a purchase that will bring happiness to the entire family, and one that you will never regret.

**Complete Equipment Is Included**

The Ultra Airline Radio Receiving set comes to you complete—you have nothing extra to buy. The following is a list of everything you will receive with your set: One vacuum tube, 210 or 175-195 tubes; 25-volt "B" battery, 45-volt "A" battery and antenna equipment; head set with adjustable head bands; complete instruction book; and complete instructions.

Postage, 44c extra. **\$19.95**  
\$23 R 618—Ultra Airline with tubes, batteries or other equipment. \$31.95 Postage, 14c extra.

Ward's guarantee insures your complete satisfaction. See Page 2

W-1 mid-1923 \$23.50 complete



W-5 mid-1923 \$34.50 201A tubes  
W-6 mid-1923 \$34.50 199 tubes



W-4 mid-1923 \$19.90 201A tube  
W-2 mid-1923 \$19.90 199 tube

# Airline Special

Will Give Fine Results Anywhere

An Ideal Home Set At a Very Low Price



Designed for Close Tuning and Clear Reception

This receiving set differs from all the ordinary ones by receiving sets in that it is built for sharper tuning, which means clearer reception when broadcasting stations using similar wave lengths are on the air at the same time. This refinement is accomplished by using a type of regenerative circuit that has proved itself capable of setting out the standard stations. In addition, additional controls, but enables you to separate stations using programs with greater ease and make adjustments to suit your own tastes. For those who wish to hear as many stations as possible all at once, the Airline Special is sure to prove satisfactory. Our low price includes everything. You have no extra to buy.

With Dry Cell Equipment Complete Only \$27.50

With Storage Battery Complete Equipment Only \$37.75



The complete with the radio apparatus as the dry cell set, except the power in a 2000-ohm storage battery, each especially for the Airline Special. The set is complete with a 2000-ohm storage battery, each especially for the Airline Special. The set is complete with a 2000-ohm storage battery, each especially for the Airline Special.

# Ward's Best One-Tube Receiving Set

The Airline Special is one of the most practical and efficient single-tube receiving sets we have ever seen. It has all the advantages of fine material and workmanship at a low price. The regenerative circuit used in the Airline Special is recognized by radio engineers as one of the most practical and desirable arrangements for a radio set for ordinary reception. The value of this well known circuit has been greatly increased by its scientific application and the use of fine quality parts.

"I bought an Airline Special Receiving Set from you last January. I have the best of satisfaction in a machine of 1200 miles. We are glad to hear that you have sold many more sets than we have. It is a great relief to hear that you have sold many more sets than we have. It is a great relief to hear that you have sold many more sets than we have."

J. P. Johnson, Elmwood, Del.

Interior of Airline Special Set

Users Are Enthusiastic About The Airline Special - It Fills a Long Felt Want

The demand for an efficient one-tube set, our customers' letters printed on this page tell just what the Airline Special is doing today in homes all over the country. We do not make extravagant claims as to the receiving range of any of our other receiving sets. The customers whose letters you see here were inexperienced radio set buyers who have purchased their sets from us and are now enjoying the results of their purchases.

# You Won't Find a Better Radio Value Anywhere

The Prices Quoted Include Everything Needed - No Extras to Buy

## The Dry Cell Set

Picture on Opposite Page

These Letters Are Printed By Permission

"I received the Airline Special from you last January. I have the best of satisfaction in a machine of 1200 miles. We are glad to hear that you have sold many more sets than we have. It is a great relief to hear that you have sold many more sets than we have."

J. P. Johnson, Elmwood, Del.

## Storage Battery Set

Picture on Opposite Page

The complete with the radio apparatus as the dry cell set, except the power in a 2000-ohm storage battery, each especially for the Airline Special. The set is complete with a 2000-ohm storage battery, each especially for the Airline Special.

Distant stations come in loud and clear with an Airline De Luxe. Page 12

Jacks and Plugs correctly designed to prevent leaks. Page 53

# Airline De Luxe with Loud Speaker

## 3-Tube Receiving Set



For Dry Cell or Storage Battery Use

An extremely sensitive 3-tube Receiving Set of the well known regenerative type, furnished in either storage battery or dry cell type to meet your needs. Beautifully constructed and highly efficient. Equipped with high grade loud speaker; 2000-ohm Airline head set and all necessary equipment. No extra to buy.

High Grade Loud Speaker

The loud speaker we include in this outfit is the high grade Airline Jr. described in detail on Page 40.

# Entertains Family and Friends

The De Luxe Receiving Set uses the well known Armstrong regenerative circuit which gives it a signal strength never yet exceeded for general reliability and dependable signal strength. It employs two stages of audio frequency amplification, which increases the volume enormously and gives splendid loud speaker reproduction on programs from powerful stations up to 600 or 800 miles distant under favorable conditions. With head sets it will easily cover more than double the loud speaker range. The simplicity of operation commends the De Luxe to those who want quick, satisfactory results with the least complications. Tuning is done with one dial, which has a vernier attachment for very close tuning. This set has proved highly satisfactory to the thousands who are now using it.

View Showing Interior Construction

The Airline De Luxe is carefully designed to stand the most severe tests.

The De Luxe construction permits inspection of the interior at any time, which adds to the efficiency of the set. Well constructed in every way.

With Storage Battery \$77.50

With Dry Cell Batteries \$66.50

Standard Equipment with Each Set

Equipment included consists of a 2000-ohm Airline head set with coil and glass box, of instructions and the following standard accessories: 150 feet bare copper wire, 25 feet lead-in wire, 15 feet insulated wire, two-piece metal insulators with screws, four porcelain knobs with screws, lightning arrester and ground clamp.

# Two Types to Choose From

## Airline De Luxe Complete Receiving Set With Storage Battery \$77.50

## Airline De Luxe Complete Receiving Set With Dry Cell Battery \$66.50

Where the facilities are at hand for charging a storage battery, the operation of a set with storage battery is always more satisfactory than that of a set with dry cell. The battery set is described in detail on Page 38. The loud speaker requires no battery current. It is a high grade speaker, which gives splendid results. The set is described in detail on Page 40 and gives splendid loud speaker reproduction on programs from powerful stations up to 600 or 800 miles distant under favorable conditions.

Complete Ready to Install

The De Luxe is shipped to you complete with everything needed. There is no extra to buy. The instruction booklet with each set tells you how to put up the aerial and connect the battery and gives clear instructions for the use of the set in getting best results. It is exceedingly simple to operate, and the up-to-date set is trifling.

Equipment Included with Storage Battery Type

The Airline De Luxe with storage battery equipment includes three Cunningham or Radiotron tubes, a 2000-ohm Airline head set, a 2000-ohm storage battery, 90 volts of "B" battery, loud speaker, and all other accessories as described. Shipping weight, 10 pounds. Net weight, 8 pounds.

Equipment Included with Dry Cell Type

The Airline De Luxe with dry cell equipment includes three Cunningham or Radiotron tubes, a 2000-ohm Airline head set, 90 volts of "B" battery, one "C" battery and loud speaker as described. Shipping weight, 10 pounds. Net weight, 8 pounds.

Attractive Radio Cabinets are moderately priced on Pages 66 and 67

More than 500 broadcasting stations are listed on Pages 34 and 35

Catalog (1924)



# 2-Tube \$33<sup>50</sup> Airline Receiving Set

## Long Distance Receiver Dry Cell Type

Small and compact, yet reliable and sensitive enough to bring in the distant stations with clearness and good volume. The Airline 2-Tube Receiving Set is low priced too, and it will give you pleasure all out of proportion to its small cost. Very satisfactory for receiving weather and market reports, as well as musical programs, news bulletins, speeches and time signals which are sent out through the air every day. The range of this set, under favorable conditions on winter nights, is about 1000 miles with head sets and 300 miles with a loud speaker, although much better records have been made.



## The Approved Circuit Used Makes the 2-Tube Airline Very Easy to Operate

The circuit used in the Airline 2-Tube Receiving Set is one that has proved most satisfactory. It will bring in distant stations and is recognized as one of the most practical circuits to insure good results under all ordinary conditions. One great advantage of this Airline Set is that it is very easy to tune in.



You Can Use a Loud Speaker on Local Stations See Our Loud Speakers on Pages 40 and 41

## Will Operate Loud Speaker on Nearby Stations

Because of the type of circuit used in this set it will bring in programs from great distances—more than a thousand miles under favorable conditions. The second tube furnishes a stage of audio frequency amplification which increases the volume. Under favorable conditions programs from nearby stations will come in loud enough so you can use a loud speaker with this set.

## All Batteries Inside the Cabinet

The Airline 2-Tube Receiving Set is mounted on a panel 8½ by 9 inches. The panel fits into a cabinet 7½ inches deep, which also holds both the "A" and "B" batteries. The cabinet is Adam Brown Imitation Mahogany finish.

Since the small dry cell batteries are inside the cabinet, this set is so compact and convenient that you can easily move it from room to room, or even take it with you on trips and outings.

## Equipment Is Complete

With the Airline 2-Tube Receiving Set we furnish two U-V-199 or C-299 vacuum tubes, dry cell "A" battery and 45 volts of "B" battery, Airline 2000-ohm head set with cord and plug, complete parts for efficient antenna, and ground wire and clamp. Everything you need is included. You are ready to listen in as soon as the antenna, ground and batteries are connected.

563 R 594—Airline complete..... \$33.50  
Postage, 41c extra  
563 R 595—Airline without tubes, batteries or other accessories included..... \$17.95  
Postage, 26c extra

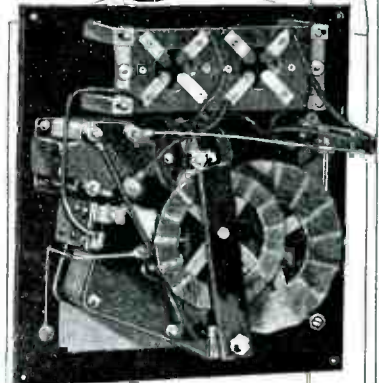

This shows how all the instruments are arranged on the under side of the panel. An example of the careful workmanship found on all of Ward's radio sets.



Montgomery Ward & Co

Light weight, substantial Head Sets are shown on Page 42

RADIOFAX, Philadelphia, June, 1924 5



**SIMPLE SIMON**

A new regenerative tuner using no switches and only one control. Three thousand miles has been conservative range during winter. This set works on a loop up to hundreds of miles, or with a ground wire only, without either aerial or loop. Just the thing to stop re-radiation. Priced at \$15.00. Add P.P. on 9 pounds. SS tuner with one-step amplifier...\$18.50 This set works without any "B" battery.

**3000 MILE RADIO TRESKO TYPE X REGENERATIVE RECEIVER**

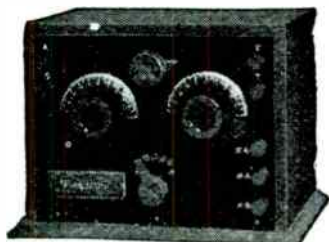

Licensed under Armstrong U. S. Patent No. 1113149. For resale to amateurs only. Thirty customers report receiving Scotland during Radio Week. A complete 3,000-mile Armstrong Regenerative tuner for \$25. Use it with any make bulb WD11 or 12, or dry battery operation as well as storage battery. Com-

plete with bulb, batteries, phones, etc.....\$37.50 Circular for 2 cents. This set received "Chicago American" Regional prize of \$350.



**500 to 1000 MILE Regenerative Tuner**

Two controls at \$12.50 only. Add P.P. on 9 pounds. This set is portable and uses any type tube.

Send Stamp for Circular

**TRESKO, DAVENPORT, IOWA**

SS Simple Simon	May 1924	\$18
Regen. Tuner	May 1924	\$12.50
Trescola	September 1924	\$22.50

Models from August 1925 (not shown):

Trescola 1	\$22.50
Trescola 2	\$22.50
Trescola 3	\$50
Trescola 4	\$60

Radio News (June 1924)

**FREE—Receiving Set and Special Parts**



Tresko Reg. Licensed Armstrong U.S. Patent No. 1,113,149

Our course of practical instruction includes not only several of our own special patented instruments, but in addition we furnish material and diagrams for building receiving sets, and finally this complete receiving set—all without additional cost!

Scores of young men who have taken our course are already earning from \$75 to over \$200 a week. Merle Wetzel, of Chicago Heights, Ill., advanced from lineman to Radio Engineer, increasing his salary 100% even while taking our course! Emmett Welsh, right after finishing his training started earning \$300 a month and expenses. Another graduate is now an operator of a broadcasting station, PWX of Havana, Cuba, and earns \$250 a month. Still another graduate, only 16 years old, is averaging \$70 a week in a radio store.

**Send for FREE BOOK**

There's more money for YOU in Radio. Find out what this field has meant to hundreds of our graduates, and how you, too, can profit in it. "Rich Rewards in Radio" has just been printed. It is filled with the latest Radio facts, figures and illustrations of tremendous interest to you. Right now—if you are at all ambitious—send for this valuable free book. Fill out the coupon—and mail it now!



NATIONAL RADIO INSTITUTE  
Dept. 60 FA  
WASHINGTON, D. C.

National Radio Institute, Dept. 60 FA  
Washington, D. C.

Without obligation, send me your book, "Rich Rewards in Radio," which tells all about the opportunities in Radio, how spare time study at home will qualify me quickly as a Certified Radiotechnician so I can get one of these splendid positions, and how your Employment Service helps me to secure a big-pay job.

Name.....AGE.....  
Street.....Occupation.....  
City.....State.....

**TRESCOLA**

**Coast to Coast Radio**

Received the Chicago Evening American, regional prize of \$350.00, 3,000 miles range,

**Price \$22.50**

Regenerative, Licensed under Armstrongs, U. S. Pat. No. 1,113,149

**OUR AMAZING OFFER**

for a short time only, send us your old crystal set and we will send you one of these beautiful tube sets for the small sum of \$12.50; add P. P. on 10 pounds.

Tubes batteries, phones, etc. extra.

**TRESKO SALES Inc, Davenport, Iowa**  
P. O. Box 148

Radio News (Sept. 1924)



## Have You Kept Pace With The Times?

Are you still operating the old style non-sensitive, poorly designed receiving apparatus? Or are you equipped with one of the new complete Gilbert Radio Outfits designed by an expert who was a Radio Officer in the U. S. Army during the war and who has incorporated all of the latest Army improvements in these new outfits.

Gilbert Radio Outfits are complete in every respect for transmitting, receiving or both. They are without doubt the latest and most scientific outfits. Each piece of apparatus is designed to operate in close harmony with every other part of the set.

The Loose Coupler used in the receiving sets is not the old Obsolete type that pulls out of the box but the new enclosed panel type. A highly sensitive instrument designed particularly to minimize distributed capacity and to eliminate dead-end losses. It is a very compact instrument in a quartered oak cabinet and is included in all Gilbert Radio Receiving Outfits.



These outfits can be purchased complete or each part separately. Our new Radio catalog No. 50 describes each one in detail. Write for it today.

## THE A. C. GILBERT COMPANY

317 Blatchley Ave.,

New Haven, Conn.

IN CANADA

THE A. C. GILBERT-MENZIES CO., Limited  
Toronto

2

ALWAYS MENTION QST WHEN WRITING TO ADVERTISERS

Designed by Tuska, these sets were also shown in his first catalog.

QST (Feb. 1920)



QST (Aug. 1916)

## Tuska Tickler



### Type 161

A new device to make a regenerative receiver out of your loose coupler. Any ordinary receiver with any type of audion can be made the equal of any regenerative set you ever saw, by the use of THE TUSKA TICKLER.

That's all—not a wire in either tuner or audion has to be changed. Gives wonderful regenerative amplification of damped signals. Can also be used as an oscillator for the undamped.

Good looking—efficient, and a real performer. In two styles, panel or flat. Illustration shows panel type. Postpaid for \$10.00. Order now and make a real set of your old tuner and audion.

Send six cents for catalogue R.

**THE C. D. TUSKA CO.**  
Hartford, Conn.

QST (May 1920)

A horizontal model was advertised in June

# C. D. TUSKA

## The C. D. Tuska Company

**C**larance D. Tuska was born in New York City in 1896; his family moved to Hartford, Connecticut, in about 1910. Here he made the acquaintance of Hiram P. Maxim (inventor of the Maxim Silencer; his father and uncle were also noted inventors of firearms and explosives) through Maxim's trial of a simple wireless set that Tuska built and consigned to a local toy store. This meeting, recounted in "A Memorable Evening" in *QST* (Jan. 1964), led to the formation of the American Radio Relay League and, later, the publication of *QST*, which Tuska edited before the war.

Tuska tells of his own company's beginnings:

*"About 1916 or 1917, Mr. H. P. Maxim acted as a judge in an A. C. Gilbert [Gilbert became famous as the maker of Erector sets and, later, American Flyer toy trains.— author] contest for boys. Maxim talked to Gilbert about the great future for amateur radio. Gilbert asked him if he would become a consultant if Gilbert went into the amateur radio field. Maxim said he did not have the time, but knew a young man who could fill the bill. Maxim told me of the conversation and suggested that I go to New Haven, see Mr. Gilbert and make any arrangement I wished, and threw in some fatherly advice. At the time (1916-17), I was working my way through Trinity College in Hartford and any income-producing job looked good. By running from my last class, I was able to make a trolley car that took me to the RR station and, by some more running, made a train to New Haven. Then another trolley to the Gilbert factory in North Haven. This was routine one day a week.*

*World War I had started and I decided to join in. Just before leaving, I worked on a trench radio transmitter for Gilbert. I left him with the understanding that I would see him when I returned. I did so, but after a few weeks Gilbert and I disagreed. He was applying toy manufacturing practice to an amateur radio receiver, and I was not able to convince him he was wrong. Finally, I told him he was wasting his money paying me for advice he would not use. He told me he was the best judge of wasting money. Yes, but I can not afford to waste my time.*

*I came home from the war with the idea of making very inexpensive sets for boys to make rather rough measurements of electrical effects, but sufficient to teach fundamentals [similar to kits Gilbert was selling for signalling, light, and magnetism — author]. I talked this over with Maxim. We organized the C. D. Tuska Co., and he let me use a vacant room over his office (that is until I had a couple of helpers and we were just too noisy overhead. Remember he was the Silencer man!). The kits were not successful, but some of the components had radio uses. I developed a differential capacitor called the Tuska Tickler. It had two sets of fixed plates and one interacting variable set. Regeneration was just coming in. This tickler could be added to existing loose-couplers and audions, (producing) capacitive feedback and regeneration. Armstrong and his attorney picked it up in an ad and convinced me that the Tickler infringed the Armstrong patent. So I became the owner of an Armstrong license." (Letter to Dexter Deeley, Antique Wireless Assoc., Sept. 1979).*

While Tuska was a consultant to Gilbert until 1923 and featured several Gilbert sets in his own Catalog No. 1 along with his own electrical instruments, there was no business connection between the two companies. Gilbert eventually dropped radio from his line.

Tuska remained in the attic at Homestead Avenue until May 1921 when his organization of three men and two boys moved to a 1200-square-foot loft in a downtown Hartford building. Increased orders forced Tuska to move again in November to a 3000-square-foot factory building on Hoadley Place. As of January 1922, eight men, three boys, and two stenographers were employed. Very soon, in response to the ongoing radio boom, a second, much larger factory was opened on Allyn St. with eighty men. Evidently, Tuska, like every other manufacturer, overreacted to the boom and produced too many sets; its Catalog No. 4, issued in late 1922 for the 1922-1923 season, showed not a single new model. By June 1923 a New York dealer had purchased and was offering for sale "five tons" of Tuska sets and parts.





Merrill Bancroft



Les Rayner



Tuska and his engineers were already at work on something new. A friend and fellow ham, Robert Miner, proposed stabilizing an RF amplifier by negative magnetic feedback (as contrasted to Hazeltine's capacitive feedback, although Hartley had patented the principle in 1918). In a series of cut-and-try experiments from March 1923, design of the "Superdyne" was worked out. (To paraphrase another engineer's comment on early-1920s practice, "A radio was not designed. You put it together and hoped it worked!")

The Superdyne did work, lasting for a year-and-a-half in the model lineup. But by mid-1925, Tuska decided to call it quits. Westinghouse sued, claiming Tuska had overstepped its license conditions by selling to jobbers and retailers. Obtaining releases from

creditors and the 24 stockholders, Tuska had sold his company to A. Atwater Kent by March 1926. Westinghouse was beginning to sue even makers of TRF radios for infringement of the Armstrong patent on grounds that their sets *could* regenerate by misadjustment of controls or by use of higher B-plus voltages; Kent probably felt it was worth having an Armstrong license in case Westinghouse won its point. Tuska joined the Atwater Kent firm as a patent attorney, assistant to Jim Schwank (nominally in charge of patents but, in fact, Kent's hatchet man), remaining until 1935 when he moved to RCA in a similar capacity. From 1947 to his retirement, Tuska was Director of Patent Operations at RCA Laboratories. He died in July 1985.

**NEW YORK**  
161 Greenwich St.  
At Liberty St.

# mikes

KRANZ BROS.

## RADIO SHOP

**BROOKLYN**  
9 Willoughby St.  
At Fulton St.,  
Borough Hall

---



**Murdock Loud Speaker**  
**\$2.95**



**A. C. Gilbert's Regenerative Tube Set with Gilbert Phones,**  
**\$12.50**

---

**New Wave Lengths Will Not Worry You—**  
WAY BELOW COST!—We are Not Giving Them Away  
BUT—We Are Selling Them for Next to Nothing!

**A. C. Gilbert Regenerative Set, including Gilbert Phones.**  
The set consists of:  
2 Marconi Condensers—Can't short circuit.  
A Silk-wired 600-meter Coupler.  
A dependable Rheostat.  
A Socket with flexible prongs.  
Mounted Neatly on a Mahogany Base, with Rubber Stands.  
Fahnstock Clip Connections—which make experimentation of new circuits an easy and convenient affair.  
The sharpest tuning set you ever saw—come and hear it demonstrated at our new Brooklyn Store—9 Willoughby Street, Near Borough Hall.

**GILBERT SET AND PHONES,**  
**\$12.50**

---

<b>BRISTOL AUDIOPHONE, LARGE TYPE</b> .....		<b>\$24.00</b>
<b>WESTINGHOUSE AERIOLA, JR., NOW</b> .....		<b>\$6.45</b>
<b>PHONES</b>		
Baldwin Type "C" .....	National Ultraphone .....	\$7.25    \$3.45
Brandes Superior .....	Signal Corps .....	5.25    3.15
Berwick Supreme .....		2.95
<b>SPECIALS</b>		
Tuska Couplers .....		\$2.50
W. D. 12 Transformers (10-1) .....		3.25
Radar Grid Leaks .....		.65
Mail Orders Solicited.		

New York Globe (May 5, 1923)

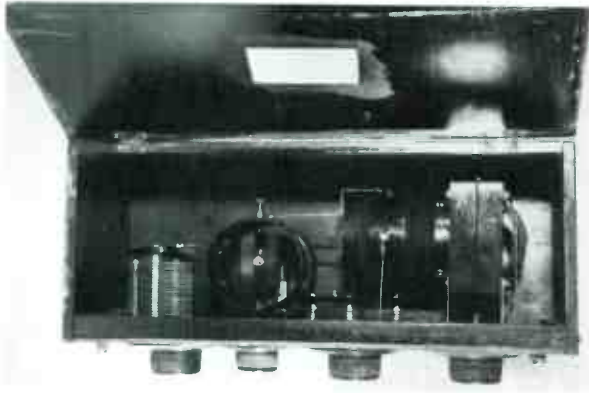

Lauren Peckham

220 May 1922 \$75

221 (not shown): detector, two-step amplifier, and horn in a single cabinet; listed in Catalog No. 4 in late 1922.



Merrill Bancroft

222 April 1922 \$75

**Buy This \$27.50**



TYPE 223

2 Tuska Variometers .....\$12.50

2 Tuska Dials..... 3.00

1 Tuska Variocoupler..... 7.50

1 Drilled and Engraved Panel ..... 5.00

**Make This \$27.50**

2 Pair Variometer Brackets 0.70

1 Switch..... .35

6 Switch Points..... .35

6 Binding Posts..... .72

10 Feet Connecting Wire... .08

**Total .....\$30.20**



TYPE 223

**The C. D. Tuska Company,**  
Hartford, Connecticut

223 kit October 1921 \$27.50

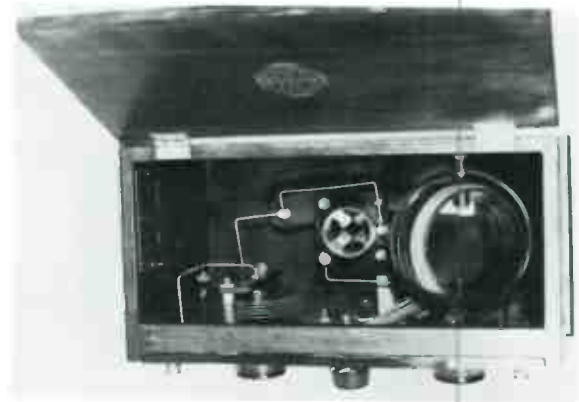

Lauren Peckham

224 March 1922 \$35

QST (Oct. 1921)

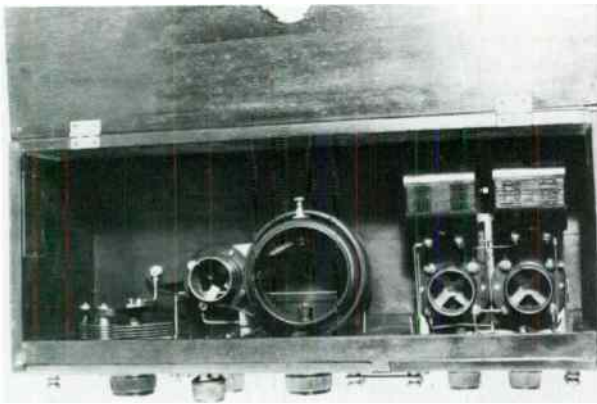

Lauren Peckham

225 (224 and 226) May 1922 \$75

*cloudel Yates*

**The SANDMAN'S STORY**

On a Tuska Radio Receiver, every evening you can hear "The Sandman's Story". This delights the children. Later comes entertaining Radio Broadcasting for grown-ups.

Tuska Radio will bring dependable broadcasting into your home. A Tuska Radio Receiver makes a wonderful Christmas Present.

Tuska Radio is substantial, reliable, dependable and recognized. Inspect today at your dealer's.

**THE C. D. TUSKA COMPANY**  
 34 Bartholomew Ave. Hartford, Conn.  
 Pacific Coast Office, 711 Mission Street, San Francisco, Calif.

**TUSKA RADIO**  
 Established 1911

Catalog Number Four contains valuable article on tuning. Receiving sets 10 cents brings if you like

Radio Broadcast (Dec. 1922)

Tuska No. 227—The model used by Station 1RU when he heard across the sea.

**Tuska Radio—  
 First to reach across the sea**

A Tuska set was used by the amateur officially credited with first receiving British amateurs in the trans-Atlantic tests. Station 1RU, Hartford, Conn. received a British operator on a Tuska as reported on page 15, February issue of this magazine.

And in France, Leon Deloy with a Tuska using only one stage of audio frequency amplification, heard a number of American stations.

Yes, truly, she's "some set." Will do anything any other set will do, and a whole lot more besides.

Perhaps you'd like to see a catalog showing all the models we build. Write for Catalog No. 18-A.

**The C. D. Tuska Co.,  
 Hartford, Conn.**

**TUSKA RADIO**

QST (May 1923)

227 May 1923 \$155

First offered in an insert to Catalog No. 4; deliveries promised on February 10, 1923.

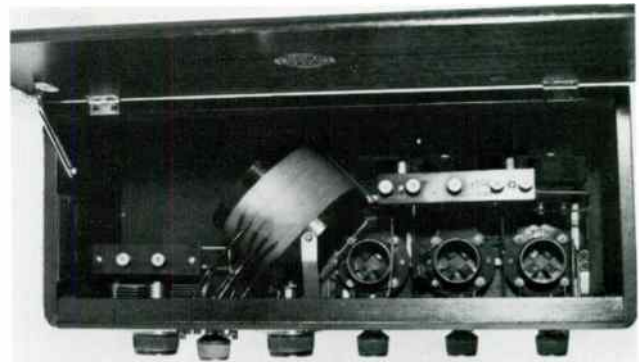

Lauren Peckham

225 (single panel) September 1923 \$75



Literary Digest (Oct. 13, 1923)

*Let the day's troubles sink with the sun*

THEN turn to your Tuska Radio, and be whisked around the world. In those precious hours between work and sleep, you live in Radio Fairyland, where you are master of distance and ruler of a host of entertainers.

Will you give your family the pleasures of Tuska Radio, which educates, soothes, amuses and takes you traveling inexpensively? Here is the receiver that annihilates miles, bringing in music and voices sweetly, clearly and undistorted. It is the ideal set for people who want the thrills of radio without tinkering.

For twelve years, Tuska Radio has been famous for advanced design and painstaking New England workmanship. The Tuska receiving set of to-day is not only up to date; it will still be serviceable in five years.

**The set illustrated above is**

Tuska Popular No. 225 3-bulb Regenerative Receiving Set. Piano finish mahogany cabinet. Amplifier switch. Concealed binding posts. Armstrong circuit, licensed under Patent No. 1,113,149. Price \$75, without bulb, batteries or loud speaker. Ask for special circular No. 21A, describing this set.

**THE C. D. TUSKA CO.**  
Hartford, Conn.

"I traveled 20,000 miles in one evening!"

Mr. M. J. Doherty, of Oak Park, Ill., writes: "Many nights I hear Station KHJ (Los Angeles), CFCN (Calgary, Canada), WEAF (New York) and others as far away. In one evening I heard 30 stations, a total distance of 20,575 miles from my home."

**TUSKA  
RADIO**



Radio Dealer (Dec. 1924)

Parts for set building are more likely to appeal to the prospective patron when attractively packed than in any other way. The C. D. Tuska Co., Hartford, Conn., features this container among its dealers.

228 Superdyne November 1923 \$125  
Technical article in QST (Nov. 1923), pp. 7-12.

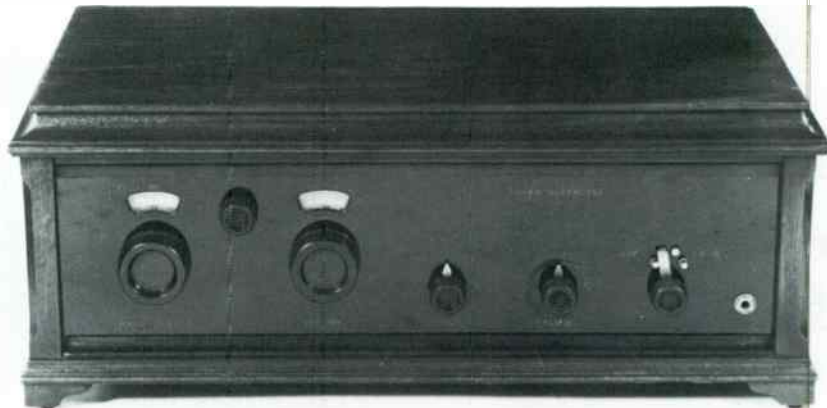
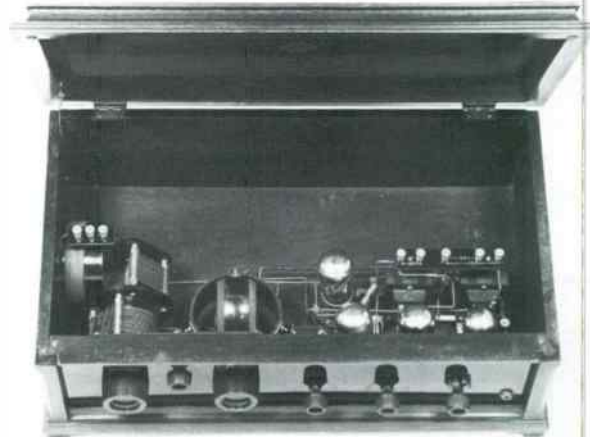

305 Superdyne September 1924 \$150

Consoles. \$275 and \$350

Tuska "Popular" Receiver

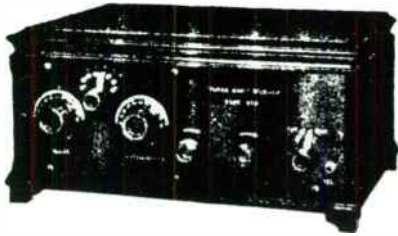

300 1924 \$85

Listed in Catalog No. 5.

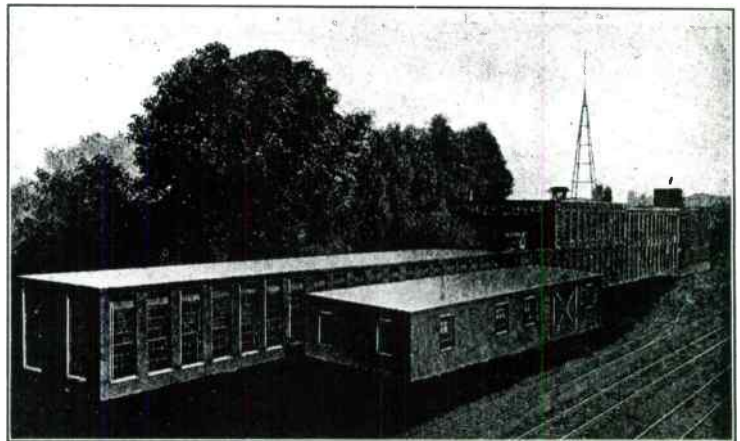

FACTORY OF C. D. TUSKA CO. IN HARTFORD, CONN.

Radio Guide (July 1925)

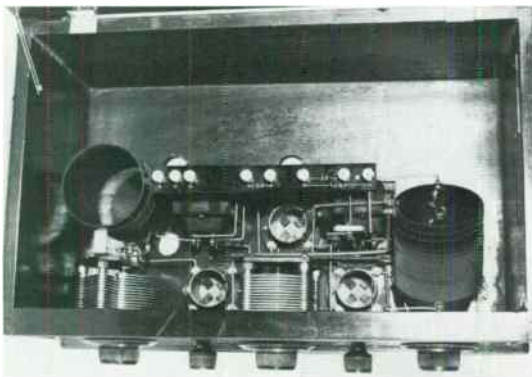

Lauren Peckham

301 Superdyne Jr. March 1925 \$85

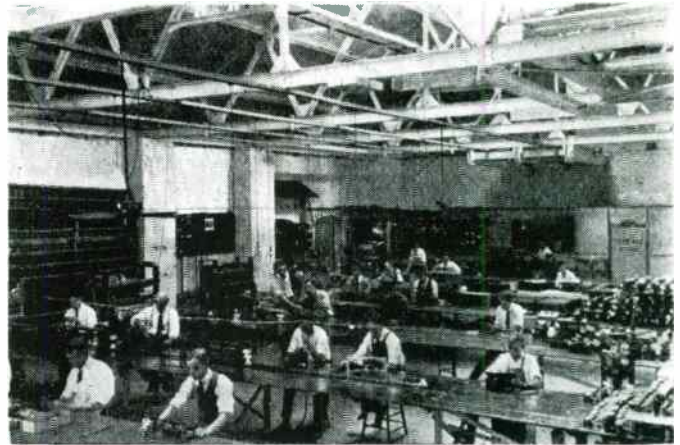

Radio World (July 21, 1923)

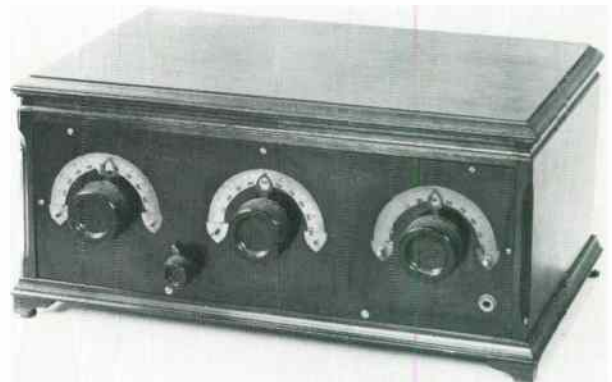

Merrill Bancroft

401 (no other data available)

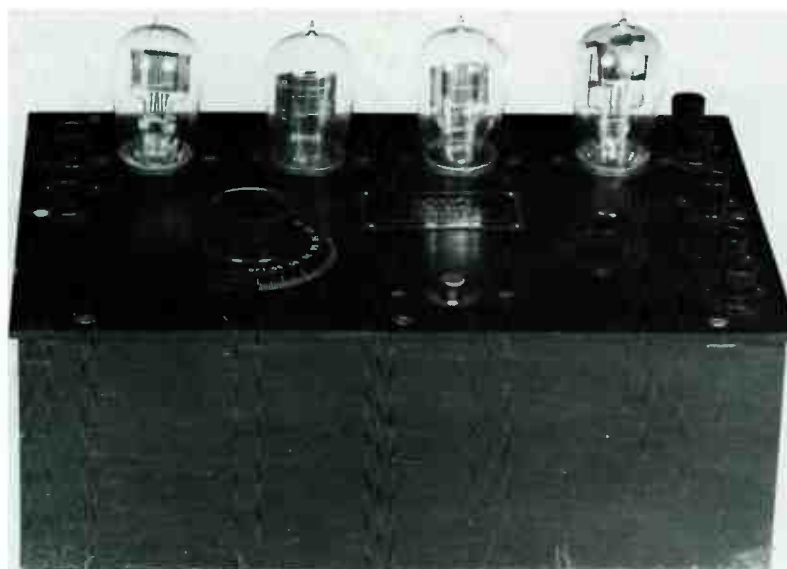

AD2 November 1922 \$110

John Drake

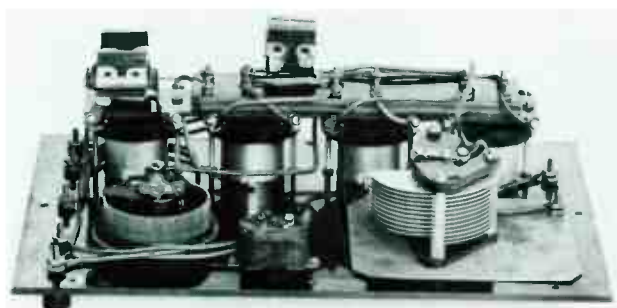

1,713,462. COUPLING RADIO FREQUENCY AMPLIFIER. ALBERT S. BLATTERMAN, Asbury Park, N. J., assignor, by mesne assignments, to B. M. C. Patent Company, Trenton, N. J., a Corporation of New Jersey. Filed June 13, 1922, Serial No. 567,964. Renewed Dec. 3, 1928. 1 Claim. (Cl. 175-359.)



A coupling transformer for radio frequency amplification comprising a bobbin formed solely of non-magnetic material having relatively narrow slots not to exceed one-eighth of an inch in width and primary and secondary coils wound in said slots the coils being wound in sections, the sections of one coil being arranged in alternate relation with the sections of the other coil.

SENSITIVE  
Tuning Range  
200-600 Meters



An  
**Epoch-Making Achievement**

This remarkable 3-Step *Radio Frequency* Amplifier-Detector Set is Now Perfected and Ready for Use.

Embodying **NEW** inventions affording higher degree of amplification and wider tuning range than heretofore obtainable. Destined to become the most widely used Receiver on the market.

*Ware*  
**TYPE AD2**  
**R-F AMPLIFIER-DETECTOR**  
**RECEIVER**

**Price \$110.00, without tubes**

With Clear, Crisp and Perfect Tone Reproduction, the AD2 Receiver—Will readily bring in the broadcasted programs up to 100 miles on 1 foot indoor coil aerial.

For long distance reception the AD2 Receiver, loose coupled to an outdoor aerial, has yet to be equaled.

An attractive and entirely reliable instrument—simple to operate—the result of over 5 years' continuous experiment and development by our engineers.

*Dealers Correspondence Invited—Descriptive Folder on Request.*

**WARE RADIO CORP'N**  
160-162 Duane Street New York City

Radio News (Nov. 1922)

# WARE

## Ware Radio Corporation

**P**aul Ware's involvement with radio began early and lasted all of his life. Born in East Orange, New Jersey, in 1893, he was an amateur by 1904 and a seagoing operator for De Forest, United Wireless, and Marconi from 1907 to 1912. After graduating from Stevens Institute with an ME in 1917, he spent the summer working with his teacher, Professor Hazeltine, on a short-range transmitter-receiver system. Enlisting in the Army in the fall of 1917, he subsequently developed this system at Camp Alfred Vail, New Jersey, into the SCR77 (BC9), which was used during the 1920's and 1930's.

In April 1922 Ware incorporated his own radio company, engaging Professor Hazeltine to design a receiver using untuned RF amplifier stages. Albert Blatterman of Mu-Rad, also at Camp Alfred Vail, designed and patented the RF transformers. While working on this Ware model AD2, Hazeltine applied his previous experience with neutralization (the SE1420, 1918) to RF amplifiers, creating the Neutrodyne.

As broadcasting stations were assigned to different frequencies in early 1923 (they had all been on 360 and 400 meters), the AD2 became obsolete and was soon outperformed by the Neutrodynes. Finally, Ware took out a Neutrodyne license — the next-to-last company to do so — in December 1923.

Ware did rather well in 1924 with gross sales of \$1,616,669 (\$1,092,152.25 at wholesale, reported to Hazeltine) and \$331,888 net profits. Before-tax profits in the last quarter alone were \$320,000. The company did so well that it attracted the attention of Wall Street financiers, notably Hugh K. Prichitt, who with his brothers-in-law the Howards, controlled Dubilier Condenser and were about to buy into Freed-Eisemann. Prichitt was a boy wonder who owned a Stock Exchange seat and controlled or had a hand in such diverse enterprises as Caddo Oil, Ajax Rubber, and even Duz soap flakes. He later overextended himself, lost his money, and suffered a mental breakdown. No sooner had he recovered and started over, than he died in 1928 at age 44.

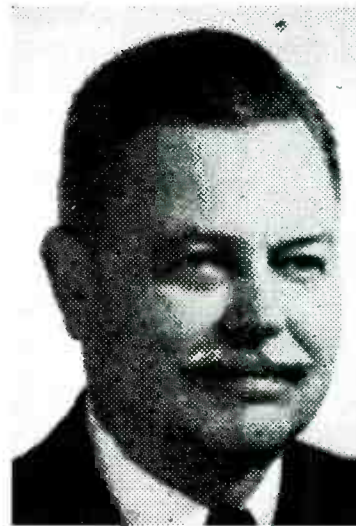

Electronics (May 1949)

Ware's performance was one cause of Prichitt's breakdown. By early 1925, shortly after Prichitt bought in, Ware could "hardly give away its sets." Components piled up, still shipped in by outside suppliers, and had to be paid for. The solution was a contract with Music Master to make 40,000 of a \$50 model very much like the old Ware model T. Other obsolete stock was job-lotted out to Landays in June: a million dollars' worth at list prices. Music Master arranged a \$450,000 loan, and Ware was saved—for a while. Paul Ware and engineer Harry Dreyer went to work on a magnificent seven-tube shielded Neutrodyne: the Music Master 250.

But nothing went right. RCA sued Ware over the Rice and Hartley neutralization patents, Ware could not make the contracted delivery dates to Music Master, and the seven-tube set did not work. This model 250 was finally approved for production in August after three weeks of fifteen-hour days for the engineers. The factory was said to be making 400 model 50s per day by that time. But according to later reports, Music Master received only 100 sets in August; 1,000 in September; and a total of 4,900 up to November 10, many of which were defective.





*Ware*  
**NEUTRODYNE**  
Type W Receiver

**Before You Buy a Radio Set  
Be Sure to See and Hear the Ware.**

Its Purity and Clarity of Tone, its ability to Select the Desired Station and cut out the others (even those in close proximity), make it a source of delight to the novice and deep satisfaction to the expert.

Its operation is simplicity itself. You turn the dials to a known combination, and there is your station, whether nearby or thousands of miles distant.

Beautiful piano-finished Cabinet of Walnut; using five vacuum tubes—2 Radio, Detector, 2 Audio—Indoor or Outdoor Aerial. Batteries self-contained. For extreme distance, storage battery is used outside of cabinet.

**Compare with Ware and avoid regret.**  
*If your dealer does not carry the Ware Neutrodyne, we will tell you where you can see it, and send descriptive booklet.*

Price \$160, without accessories.

*Ware*  
**RADIO CORPORATION**  
160-162 DUANE ST.  
NEW YORK

Licensed by the Independent Radio Manufacturers, Inc. under Haseltine Patent No. 1,450,640 and patents pending, and the trade mark "Neutrodyne," registered in the U. S. Patent Office, certificate No. 173,137

New York Sun (Feb. 9, 1924)

- W January 1924 \$160
- X October 1924 \$150
- L September 1925 (not shown)



Rich Elskamp

T August 1924 \$65  
Described in *Radio Engineering* (Sept. 1924), pp. 234-235; *New York Evening World* (Aug. 23, 1924), pp. 3, 8.

At that point, Music Master had had enough, cancelled its contract, and stopped paying Ware, which promptly caused the company to collapse. Ware dumped 15,000 model 50s to Gimbels and shut down completely on December 12, 1925, throwing 1,000 people out of work. Ware was petitioned into receivership and re-opened with a 35-man skeleton force assembling sets from parts already on hand. Of these model 250s, sold by Wanamakers in April, two out of three were said to be defective. Meanwhile, Music Master was stuck with 4,000 model 50s, and 5,000 250s and (Thermiodyne) 175s. Ware's assets were auctioned in September 1926.

Paul Ware went with Grimes in June, then to Thompson in October, where he was supposed to electrify 7,300 unsaleable Minuets in inventory. In May 1927, when Thompson's assets were auctioned, *Radio Retailer and Jobber* commented:

*Paul was going to put out an electrified radio set, an A and B eliminator, and a lot of other things, but Paul seems to have [met with] his customary and perhaps pre-destined grief. Well, Paul was always a costly experimenter in the laboratory — so was "Bill" Priess, but that's another story.*

Splittorf employed him next; and in 1929, he was back with his own company making Vreeland Band-Selector models and, later, cathedrals. Again his company failed, and he became chief engineer of Emerson, designing the model 19 in 1934 (Electronics, January 1935). Moving to P. R. Mallory, he designed the Inductuner, which was used in DuMont and Andrea televisions after the war (he joined DuMont in 1939). In about 1955, he formed Ware Marine Products and made autopilot systems until his death in November 1970.



Music Master 50

Rich Elskamp

# Ware

## NEUTRODYNE Receivers

*"To make a happy fireside clime  
To weans and wife,  
That's the true pathos and sublime  
Of human life."*  
—Burns

AS a Christmas Gift, there are few things other than radio that can contribute so much of all that is worth while to the varied interests of family life. For the young folks, sprightly dance music, news of all the big events in outdoor sports; for their elders, enlightening talks on current events, educational courses, political news, musical programs of the finest character; and for the old and the "shut-ins" a contact with the world outside that brightens their lives beyond measure.

Folks listen in delighted amazement at the naturalness and tonal beauty of every selection heard on the Ware Neutrodyne. So natural is the reproduction, in fact, that the singer or instrumentalist seems to stand in flesh and blood before you—a playing, singing, living presence. And the youngsters with a tingle in their toes say that they never heard such dance music as their Ware brings them. Purity of tone, simplicity of tuning, ability to get the station desired, and to exclude others, give the owner of the Ware Neutrodyne the deepest satisfaction.

There are three types of Ware Neutrodyne receivers—the T with three tubes, one reflexed;

the X with four tubes, one reflexed—both operating on dry cell batteries; and the W with five tubes, not reflexed, operating on a six volt storage battery. The reflexing of the T and X is worked out on a new principle applied only to Ware Neutrodyne Receivers, giving the full equivalent of an additional tube. Models TU, XU, and WU, with the same circuits, respectively, as T, X and W, are standing cabinet models with inbuilt loud speakers.

Regardless of the price, all Ware Neutrodyne Receivers have the same beautiful tone quality; the difference between them being a matter of range and power.

To appreciate the Ware you must see and hear it, which you can do at the leading phonograph or radio dealers'. We will gladly tell you who carries it in your neighborhood. Catalogue with full descriptions will be sent on request.

**Type T**—10 1/2" high, 14" wide, 13 1/2" deep. One stage radio frequency amplification, detector, and two stages of audio frequency amplification. Operates loud speaker. Without accessories, \$65.

**Type X**—8 1/2" high, 21 1/2" wide, 10 1/2" deep. Two stages radio frequency amplification, detector and two stages audio frequency amplification. A double scaled volt-meter indicates voltages of both A and B batteries. Operates loud speaker. Without accessories, \$150.

**Type W**—8 1/2" high, 21 1/2" wide, 10 1/2" deep. Two stages radio frequency amplification, detector and two stages audio frequency amplification. A double scaled volt-meter indicates voltages of A and B batteries. Operates loud speaker. Without accessories, \$175.

**Type TU**—Same circuit as Type T, in brown mahogany or walnut standing cabinet, 34 1/2" high, 18 1/2" wide, 18 1/2" deep. Loud speaker built into the cabinet. Without accessories, \$150.

**Type XU**—Same circuit as Type X, in brown mahogany or walnut cabinet, 44" high, 27 1/2" wide, 18 1/2" deep. Loud speaker built into the cabinet. Without accessories, \$275.

**Type WU**—Same circuit as Type W, in brown mahogany or walnut cabinet, 44" high, 27 1/2" wide, 18 1/2" deep. Loud speaker built into the cabinet. Without accessories, \$300.

MAKE IT A WARE THIS CHRISTMAS

*Ware*  
**RADIO CORPORATION**  
529-549 WEST 42<sup>nd</sup> STREET  
NEW YORK

Licensed by the Independent Radio Manufacturers, Inc., under Hazeltine Patents No. 1,640,000 and No. 1,489,229, and patents pending, and the trademark "Neutrodyne" registered in the United States Patent Office, Certificate No. 172,137.

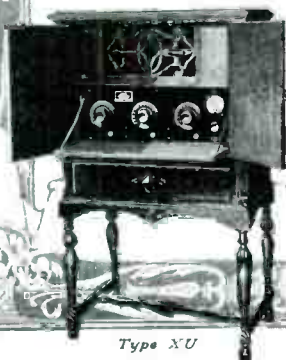

Type XU



Type W

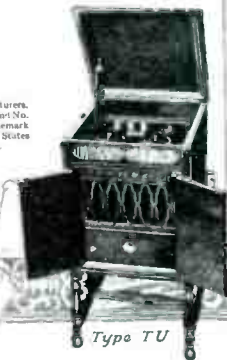

Type TU

Saturday Evening Post (Dec. 6, 1924)

# How to Modernize the Big Ware Set

This Powerful Loop Operated Receiver, Many of Which Are Still in Existence, May Be Brought Up-to-Date by Simple Alterations.

By R. D. WHITMORE.

Copyright, 1927. All Rights Reserved.  
**"KEEP** your grid and plate leads as short as possible." A dollar for each time we have read that admonition would buy the set that we happen to want. But the plate lead on the big Ware set is fourteen inches long. More than that, it is cabled together with the neutrodon lead, the plus A and the 90 B leads. As the diagram shows, these cabled leads pass down through a hole in the bottom of one shielding can, along a trough formed in the steel chassis and up through a hole into the next can. These are only a few of the unorthodox details on this interesting receiver.

It was the first and is still one of the best of the big fully shielded sets. Copying a good set is an easy way to avoid expense, but starting out boldly to develop a new style of receiver takes lots of nerve and piles of money. The Ware engineers had both and the results justified them. Pages of calculations were devoted to finding the best values for the mullas and then set after set was built to try them out. The log books of the experimenters grew thicker and thicker while the limited time for experiment grew shorter and shorter. The ordinary set is easy to build and easy to change, but the Ware had to be right from the start because it was built like a battleship. A single die to punch over eighty holes in the heavy steel chassis cost over a thousand dollars and took about two months to build. Some dies had to be made in two or three sizes because it was necessary to start them before the engineers had had time to decide just what size of unit would be best to use.

One of the best features of the set was the cause of most of the trouble. In order to make the set self-contained the ordinary clumsy loop was replaced by a little loop that you could hide under your hat and that seemed lost down behind the set in the back of the cabinet. The very weak pickup of this tiny loop required four steps of radio frequency amplification, and this meant five tuning condensers to line up and operate from a single control. Condensers may look alike, but for use like this they must read alike all the way from low to high. So, made as carefully as they were, the condensers were matched in sets of five and graded for use with the corresponding dial. This had to be done because the dial read directly in wave lengths and even 1 per cent difference in capacity would move the stations out of place on the scale.

In order to save space in the cans the ordinary three-inch neutroformers were replaced by coils only an inch and a quarter in diameter. The ordinary bakelite tubes were found to vary too much in diameter and so they were replaced by hard rubber tubes ground accurately to size under water. When the coils had been wound and lacquered to protect them from moisture changes they, too, were graded in sets of four to match the condensers. When the tube sockets and the neutroformers had been mounted on top of the condensers and wired the tuning units were tested again to be sure that they still matched. If they did they were ready to be mounted on end on the chassis with their shafts slipping down through holes in the steel frame. The four long leads were pushed down through the hole in one can base and pulled up into the next. To avoid mistakes by the solderers all the wiring of the set was done according to a color code. Plus A was red and minus A black, loop leads and 135 B were green and so on.

It has been interesting to check up on them to see what a year and a half have shown to be the facts about the big Ware set. It was so far in advance of the rest of the field when introduced that it is still a current design. The only change that has been made in it during the last year has been to add a phone jack in the plate circuit of the first audio tube and a separate filament resistance for the sec-

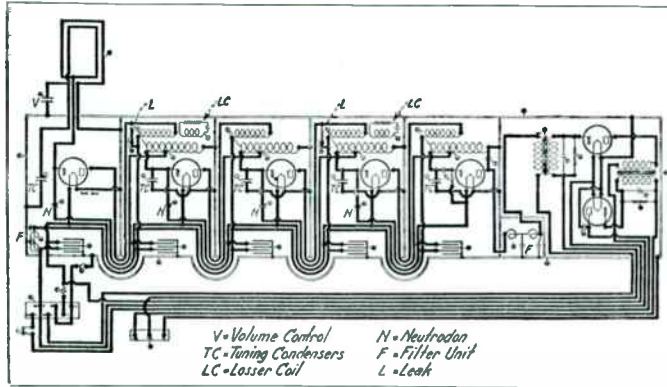

Complete wiring diagram of the seven-tube loop operated Ware.

ond audio tube. This makes it possible to operate the set on six tubes with a head set when fishing for distance. This change can be made on any of the sets at small expense by the Ware radio service for those who still have the DX fever.

Those who want greater volume and more distance than they may have been getting from the set can easily add an antenna pickup coil. Take a bakelite tube 2 1/2 inches in diameter and 1 1/4 inches long and wind twenty-one turns of No. 24 or No. 28 double silk covered wire on the middle of it. Run the ends of the wire through the double holes in the tube to hold them in place. Mount the coil flat against the left end of the cabinet behind the first can with a small single bracket. It does not matter which end of the coil is attached to antenna or ground. This coil will help on distant stations,

but it does not work well here in New York. The tuning is broadened so that stations overlap and the vernier is useless so that there is no volume control.

If the volume from the set is not satisfactory the trouble is very likely in the tubes. For some reason the set is unusually dependent upon good tubes, so that a single poor tube will completely kill the volume. The set was built to use Radiotrons 201-A or Cunningham 301-A, and it is well to stick to them. A 112 tube can be used in the last audio stage if the 4 1/2 C is increased to 9 C voltage. A 171 tube requires even more C voltage, but the results do not warrant its use. It will be necessary to leave off the last tube cover, but that makes no difference. The tube covers on the radio stages must be kept on or there will be enough feedback to the loop to make the

set run wild. The circuit diagram shows a condenser and leak across the secondary of each transformer. These are selected to match the characteristics of the 91-A tubes and results are best when they are used.

Once in a while a set will bring in only the high wave length stations or else only the low wave length stations. Or perhaps the stations are weak and out of place on the dial. Either condition means usually that a tuning condenser has slipped. It is an easy thing for the Ware service to pull the set out of the cabinet and readjust the condenser, but a mighty hard to do at home. The big Ware is perhaps the only set that needs to be oiled regularly to make it work properly. The gear train which stands between the fourth audio can and the detector should be oiled occasionally to avoid the danger of the shafts slipping in the bearings of the dearest frame. If the tuning knob is hard to turn the trouble is probably here. A little oil may save a stripped gear.

A crackling noise as the loop is turned is very likely caused by a broken loop lead. It sounds much like a bad C battery noise. The diagram shows leaks across the first and third neutroformer primaries. Not all sets have these leaks, although the mountings are there on the socket for them. It is a matter of the individual adjustment of each set that determines what value if any is required at these points. Practically all the sets have louser coils mounted in the upper end of the first and third neutroformer tubes. The amplification per stage is so great that these louser units, made up of a coil of resistance wire short-circuited through a fixed condenser, are necessary to prevent the set from "spilling over."

There are two more points in regard to the tubes worth mentioning. All the returns on the set are grounded on the steel chassis, as well as minus A and minus B. If the filament switch gets loose and turns a bit, it may become grounded on the frame so that the tubes will continue to burn although the switch is off. An easy way to burn out the tubes is to be careless with the loud speaker plug. If it is allowed to touch the terminal on the stator of the vernier condenser and the loud speaker jack at the same time, some one is going to buy a new set of tubes.

Can the big Ware be operated on a B eliminator? It can be, but your chances are four out of five that it will work better on good batteries. The average set uses the following B current; each of the four radio frequency stages, 5 milliamperes; detector, 2 milliamperes; first audio, 5; second audio, 8; a total of 35 milliamperes. Since the heavy load is on the 90 volts, it is most economical to use two heavy duty 45 volt batteries with a medium size 45 volt unit to make up the 135 volts. Very few of the eliminators that have been tried have given as good results as batteries. The only way to be sure is to shift from one to the other, but usually the batteries give a better volume.



Music Master 250. See Vol. II, p. 200, for front view.



New York Sun (June 18, 1927)

1,598,226. DUPLEX CUT-IN SYSTEM OF RADIOTELEGRAPHY. PAUL WARE, New York, N. Y., assignor to Ware Radio, Inc., New York, N. Y., a Corporation of Delaware. Original application filed Feb. 8, 1918. Serial No. 215,996, Patent No. 1,379,144. Divided and this application filed Apr. 14, 1921. Serial No. 461,436. 16 Claims. (Cl. 250—9.)

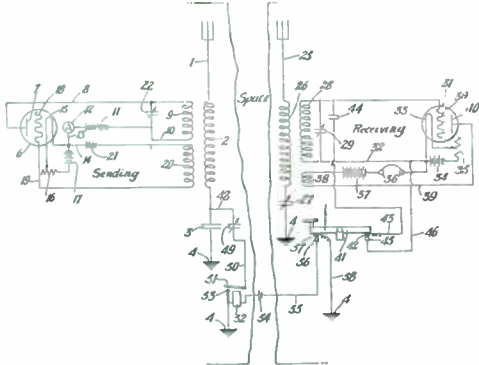

1. In a radiotelegraph system, two stations each having means for producing, radiating and receiving oscillations of such difference in frequency as to simultaneously produce a signal current at each station, detecting means at each station for the signal current, the radiating and receiving means at at least one of said stations being separated, and a key at each station for varying both signal currents.

July 1929 models (not shown): table \$195, consoles \$280 and \$425.



Vreeland band-selector model made for the American Piano Co. (Ampico).

Technical articles in *Proc. I. R. E.* (March 1928), pp. 255-280, 494, 848, 1422; *Radio* (July 1929), p. 58.



Later model (1929) BC-9 and the BC-148 that superseded it in 1935. Not shown: the one-turn loop antennas that attach to the backs of the sets.

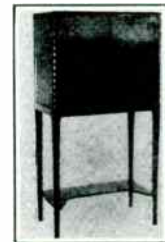

**Ware Receivers**

The screen-grid receiver recently brought out by the Ware Manufacturing Corporation, Trenton, N. J., is available in four console cabinets as well as in a table cabinet. Two 224 tubes, two 227's, one 245 and a 280 rectifier are employed in the Vreeland band selector tuning system. A dynamic speaker is standard equipment, as well as a phonograph pick-up.

The illustrated "Trianon" is modernistic in design. Price, \$725.

The "Byron" is made to harmonize with either Spanish or Italian type interiors. Price, \$400.

The "Number Ten" is of the highboy type. Price, \$235.

The "Metropolitan", a five-tube set in a highboy cabinet with diagonally matched veneer doors, is \$150. The table set is \$135.—*Radio Retailing*, October, 1929.

# Hear Every Call Clear and Distinct

THE REAL pleasure of Radio receiving comes only when your set is one that can be "tuned up" quickly to receive from far stations with clearness and distinctness. Your selection of programs need not be limited by distance. You can bring in every call clear and distinct

## With the LEWIS Receiver

With the LEWIS Three-Stage Receiver non-regenerative set all you need is an antenna and a storage battery with a few simple connections and you are ready to tune in any broadcasting station within 1000 miles or more under favorable weather conditions. A complete and fine appearing set.

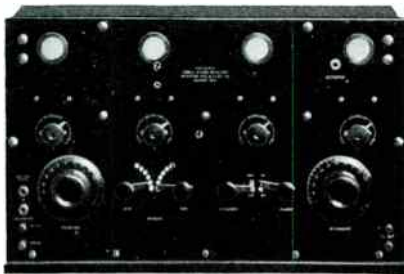

Lewis 3-Stage Receiver

All connections have been made as simple and as durable as possible. The plate is 3/16" bakelite, highly polished. All exposed parts are nickel plated. The case is solid mahogany. All adjustments and binding posts are shown on plate by white composition inlaid engraving. An opaque glass bull's eye in front of each vacuum tube prevents the eyestrain and glare usual with the average set. PRICE—\$275.00.

The wave length of the WC-4 is 195 to 620 meters, taking in the wave lengths used by the most interesting broadcasting stations. The best record was made when it received radiophone music 256 miles in midsummer at noon.



WC-4 One Step Receiver

The case is solid mahogany. Front Panel is triple X bakelite. On panel are mounted two 4" dials for adjustment of coupling and secondary wave length. Wiring is done with No. 12 copper wire, heavily tinned. Variometer and variocoupler are of latest design insuring maximum range, low distributed capacity, ease of control and sharpness of tuning. PRICE—\$93.50.

Write for folders describing Lewis Receiving Sets

**WESTERN COIL & ELECTRICAL CO.**  
Dept. B RACINE WISCONSIN

Lewis September 1922 \$275

WC4 November 1922 \$93.50

# WESTERN COIL

## Western Coil & Electrical Company

**W**hen William Turnor Lewis and his son William Mitchell Lewis began manufacturing bicycles in Racine in 1896, the father had already served 32 years with the Mitchell Wagon Co., Wisconsin's largest such manufacturer. Bicycles gave way to automobiles; and by 1922 when the two companies combined, William Mitchell Lewis employed 2,000-3,000 workers. His son William Turnor Lewis grew up in this environment. Interested in radio since 1908, Turnor Lewis had a kilowatt amateur station (call signs NF, 9JC) and a 125-foot tower by 1913. When his grandfather died in 1915, Turnor Lewis and his father incorporated the Western Coil and Electrical



William Lewis/Eric Sanders

Company. In an imposing building at 300 Fifth St. in Racine, they built "Vi-Ray-O" electrotherapeutic and X-ray equipment. After a hitch in the Navy during the war, Lewis returned to ham radio (9TL) and to Western Coil, building crystal sets in 1920 and vacuum-tube radios by 1922. He claimed to have rejected a buyout offer from Crosley about that time, and Western Coil rode the crest of the wave for a few years. The company relocated to 1-7 South Main St. in 1928 and then to 215 State St. in 1932. Lewis and his colleagues continued to file patent applications until 1930 and made a few radios until 1932. But after that time, Western Coil put its name on radios made by Wells-Gardner while making only electrical devices, television towers, and, particularly, plastic toys. The company was sold in 1978, renamed Plastic Specialties, and eventually moved to Milwaukee. Turnor Lewis (born in 1896) passed away in late 1979 or early 1980.



PATENT APPLIED FOR

*No Aerial  
Immense  
Range  
Maximum  
Volume*

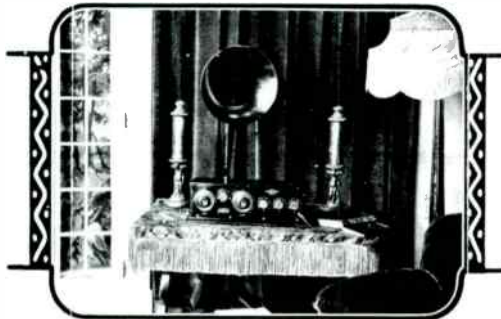

*No Loop  
Utmost  
Selective  
Easy  
Tuning*



**Loud Speaking  
Cabinet Radiodyne WC-10**  
Retail Price, complete with Tubes and Batteries (Dry) **\$298.00**  
*For Standard Equipment see other side*  
This is the Radiodyne in its most finished form, a ready setler to the well furnished home. Solid mahogany cabinet, 24 inches high, 31 inches wide, 23 inches deep. Western Electric Loud speaker, automatic volume amplifier, 100% efficiency, 250 watt speaker are contained in case, including single size B batteries. No aerial or loop needed. An easy demonstrator is quick seller.



**WC-5. The Voice of the Nation**  
*operates with aerial*  
Retail Price, complete with Tubes, Batteries, Phone, Storage Battery **\$135.00**  
Dry Batteries **\$120.00**  
*For equipment see other side*  
A four tube set as described on the other side of this circular. It meets fully the demand for a popular priced set. Your stock is complete without this set. There is nothing on the market to equal it at the price.



**WC-6**  
Retail Price, complete with Dry Battery, Tubes, Batteries and Phones **\$63.00**  
*For equipment see other side*  
**The WC-5 Without Audio Frequency Amplifier**  
This is a remarkably efficient set to get the beginner interested in radio. It is traded in later for a Radiodyne. Volume and range equal to a single tube representative, but no distortion and no radiating interference.

Some Features of  
**The RADIODYNE**  
THE ULTIMATE IN RECEIVERS

THE RADIODYNE secures the utmost results in radio frequency amplification in a form that the layman can handle with ease. This is a strong statement, but true. Its range is not limited by distance—only by static-to-signal ratio. It will receive signals from any distance if the signals are enough stronger than the atmospheric disturbances to be heard—no receiver can do more than that.

No outside antenna or loop is needed—simply twenty or thirty feet of wire for balancing purposes, which may be strung along the baseboard or hidden behind the picture moulding.

It can be made as selective or as broad-tuning as desired. Has successfully brought in Schenectady, Pittsburg, Chicago and other stations at St. Louis within six blocks of the KSD 1000 watt station in operation.

Any of the standard amplifying vacuum tubes can be used, in any combination, and no change is noted in performance when types of tubes are interchanged. Tubes and batteries will last longer in a RADIODYNE than in any receiver or combination developing equal signal volume.

It receives all distances at loud speaker intensity—with only two dials to tune. There is always power enough and to spare.

All sets have beautiful cases of solid mahogany, piano rubbed finish, with split lid. Panels are of polished black bakelite.

Place your orders at once as the factory is now almost loaded to capacity. We predict a phenomenal sale of the RADIODYNE. It is the receiver you have been waiting for.

Manufactured by the

**Western Coil & Electrical Co.**  
Racine, Wisconsin

**READ WHAT THEY SAY**

In regard to the WC 10 which we had on approval will say it arrived this afternoon and I may say that after trying out the machine tonight for one hour on a forty foot antenna strung on the floor, the WC 10 is no longer on approval. The WC 10 worked along side of five machines, all on an ideal outdoor antenna. Selectivity, volume, clearness, everything desired are in your machine and you are certainly to be congratulated.  
K. W. Thomas,  
Kepler Company,  
Eau Claire, Wis.

Referring to your letter of September 2nd, wish to advise that we received the WC-10 Radiodyne. I have had use of these sets at home for the last week and can truthfully say that it is the best set that I have ever operated and I believe that the Western Coil Company should be congratulated upon bringing such a set on the market.  
C. E. Olsson,  
Westers Motor Supply Co.,  
Minneapolis, Minn.

I have been using that WC 10 set for the last two weeks and I find that nothing can compare with it. I have heard WJAZ without antenna or ground. Every opportunity that I have, I will push this WC-10 for I can say that a person is well repaid for the amount of money he expends in purchasing this instrument.  
A. F. Herlevich,  
Milwaukee, Wis.

I don't believe they make any better sets than your WC-5 and I am going to be a strong booster for it. Picked up Omaha last Sunday morning at 10:00 o'clock when the temperature was 95 in the shade and the sun shining bright. Very few sets will do that, so here is lots of good luck.  
Frank Williams,  
Winona, Minn.

Just received the WC 5 radio set and find it to be one of the finest sets in my locality. Had a number of friends to listen in and one of them mentioned that we reached nearly every point in the country. You deserve a great deal of credit for putting out an instrument of this nature and should be appreciated by all radio fans.  
D. V. Greshammer,  
Detroit, Mich.

I have a WC 5 Radio set. I have been under the impression that summer radio was not worth while but I am very much mistaken. During the past few weeks I have heard different stations such as WDAP-WGY-WHAZ and many others on the speaker so loud and clear that it was possible to hear distinctly music and even the announcements for almost two city blocks.  
Yours for greater success,  
A. C. Hansen,  
Marquette, Mich.

*The Ultimate in Receivers*

READ HERE AND USE FOR WINDOW HANGER  
**RADIODYNE WC-10**

Can you sell such an outfit?  
Can you afford to overlook it, when every sale nets you \$70.00 to \$100.00?

Retail Price, Complete with Tubes and Batteries (Dry) **\$205.00**  
With Storage Battery \$215.00  
Dealer's Price, Less Tubes and Batteries . . . . . **\$150.00**  
LESS 33 1/3%

Discounts on the entire WC line are 33 1/3% from "Dealers List Prices." Receivers are furnished to the dealers without tubes, batteries or phones.



WC5 May 1923 \$80

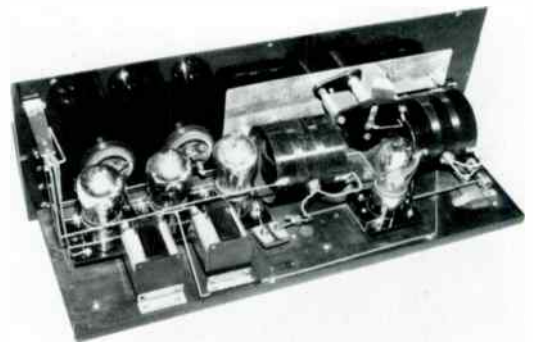

Eric Sanders



**TUNE IN ON THE SHORT WAVE  
TRANSATLANTIC MESSAGES**

If you are having trouble getting the short wave trans-atlantic signals you should have a WC-5-SW receiving set. It is the most practical set for low-wave specialists. Built by short wave experts the WC-5-SW eliminates the trouble which transmitting amateurs are having with ordinary receiving sets. If you are interested in getting better low wave results it will be to your advantage to investigate the WC-5-SW. Enthusiastic operators from all parts of the country write us praising its efficiency.

**WC-5-SW**

Built especially for Transmitting Amateurs

The WC-5-SW is a 4 tube set. One stage of tuned Radio Frequency amplification is employed ahead of the detector to make it super-sensitive. Two stages of audio frequency are used to bring up the signal strength. Uses any type of tubes. Gives perfect control of audibility. Detector rectifies only. Uses antenna compensating condenser. Only two control adjustments. Pure negative biasing on all tubes, thus marked swing on B Battery cur-

rent. Tuned Radio Frequency sharp-est known and most selective principle ever adopted. Plate potential non-critical. Mono-block tube socket. No grid plate leads on audio amplifiers. Audio amplification absolutely necessary when using low efficiency receiving antenna, i.e., underground or indoor. Mahogany cabinet, piano rub-ber finish. Rabbited-in panel. Split lid-cover. The price is only \$88.00.

Write for complete description and illustrated folder on this practical set for low wave specialists. All transmitting amateurs will be interested in this literature.

**OTT RADIO, Inc.**

224 Main Street

La Crosse, Wis.

WC5SW December 1923 \$85

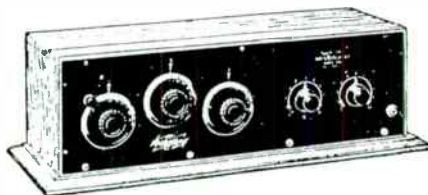

WC5B November 1924 \$80

QST (Apr. 1924)

QST (May 1923)

**Better Results  
With Less Parts**



**The W. C. 5**

is a 4 tube set. One stage of tuned radio frequency amplification is employed ahead of the detector to make it supersensitive. Two powerful stages of audio frequency are used to bring up the volume of signal strength. Simplicity of construction and the elimination of unnecessary parts make this set easy to operate and effective for receiving from long distances without high or expensive antenna.

**1,000 to 2,000 MILES  
On Loud Speaker**

The WC-5 will receive signals from stations within a radius of from 1,000 to 2,000 miles. Here is what one WC-5 owner says:

"On several occasions two different stations in Los Angeles have come in clear and strong over the loud speaker on my WC-5 set. I consider this to be remarkable when you consider that the powerful Drake Hotel station was broadcasting."

D. R. Davies, Chief Engineer,  
J. I. Case T. M. Co., Racine, Wis.

The WC-5 tunes wonderfully sharp on all popular telephone broadcasting wave lengths.

**Price \$80.00**

Wave length 160 to 750 meters

Efficient construction, fewer parts and quantity production enable us to sell this high quality set at a remarkably low price. The WC-5 is made from the best materials. The panel is solid bakelite—the case natural mahogany.

Write us for complete description of the WC-5. See it at your dealers or at one of the distributors below:

- Iulus Andrae & Sons Co., Milwaukee, Wis.
- Western Motor Supply, Minneapolis, Minn.
- Morton Electric Co., St. Louis, Mo.
- Funsten Electric Co., Kansas City, Mo.
- International Electric Supply Co., 29 Broadway, New York City
- Continental Radio Co., 120 North Wells St., Chicago, Illinois

**WESTERN COIL & ELECTRICAL CO.**  
301—5th St. Racine, Wisconsin





WC10 Radiodyne November 1923 \$150

John Drew

**"B" Battery  
Lasts Twice  
as Long  
in the  
New**

**RADIODYNE**

Chicago Tribune (Nov. 22, 1925)

Price  
~~\$39.50~~  
to  
\$215

Again, A Year Ahead

The average 5 Tube Set consumes from 20 to 25 milliamperes of "B" battery current. The New Radiodyne uses only 9 to 10 milliamperes of 90 volts—less than half—that's real economy.



WC-15 A Five Tube 2 Dial Set in Beautiful Cabinet

**Beautiful Cabinets**

Every one of the New Radiodynes have beautiful cabinets that are an ornament to any home whether the model you choose is the WC-15 at \$39.50 or the Minigogy Console at \$215.

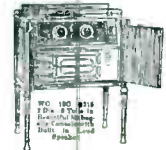

Radiodynes are manufactured by one of America's oldest and most reliable set builders and distributed only by reliable, authorized dealers.

See and hear the Radiodyne before you buy a Set at any Price.

Western Coil & Electrical Co.  
RACINE - WISCONSIN

- Distributed by
- Radio Distributing Co.
  - 541 W. 14th Street, Chicago
  - Victrolor Distributors Co.
  - 700 N. 14th St., Chicago
  - FRANKLIN, ILLINOIS
  - National B. & A. Supply Co.
  - DEVEREUX, ILLINOIS
  - Shore & Wacker Co.
  - SEA WISCONSIN, IOWA
  - Shaw-Walker-Victrol Co.
  - ST. LOUIS, MISSOURI
  - General Hardware Co.
  - BRANDT, ILLINOIS
  - John J. Taylor & Sons Co.
  - WILMINGTON, MISSOURI
  - Radio Supply & Sales Co.
  - ANN ARBOR, MICHIGAN
  - Radio-Cashmere Co., Incorporated

**When Other Types  
Are Useless**



**RADIODYNE**

**"The Voice of the Nation"**

When interference, strays, static, etc., make other types of reception utterly useless the RADIODYNE picks up broadcast programs clear and distinct.

Stations within a radius of 2000 miles can be picked up on the loud speaker; any wavelength from 200 to 700 meters.

**Price \$150.00**

For use in apartments, boats, automobiles, railroad trains, etc., the RADIODYNE is enjoyable where other types of receiving sets would not be practical.

The RADIODYNE is operated by simply grounding to a water pipe or radiator, and throwing a few feet of wire on the floor. No outside antenna, or loops are necessary.

**TO THE A.R.R.L.**

We appreciate your efforts in boosting W. C. sets and are always pleased to furnish full information about them to members who have not yet had the opportunity to operate a W. C. 5. We want every member to know the merits of this efficient outfit. If you are interested we will gladly send you a complete description of the W. C. 5 together with information as to where you can see one in operation.

Just drop us a line and we will see that your enquiry gets prompt attention

**WESTERN COIL AND ELECTRICAL CO.**  
305 Fifth St., Racine, Wis.

QST (Apr. 1924)

QST (Dec. 1923)



**RADIODYNE**

*"The Voice of the Nation"*

**No Loops—No Aerial**

The air is your theatre, college, church and newspaper if you own a Radiodyne. New York, Cuba, San Francisco and Honolulu can be picked up clear and distinct without interference from nearby stations.

The RADIODYNE is ready for operation by simply grounding to a water pipe or radiator, and throwing a few feet of wire on the floor. Uses any standard tubes—dry cell or storage battery. Extremely selective. Simple to operate—Only two controls—You can tune in on any program you select—any wavelength from 200 to 700 meters.

For use in apartments, boats, automobiles, railroad trains, etc., the RADIODYNE is enjoyable where other receiving sets would not be practical.

**Price \$150.00**

Write for illustrated folder which describes the RADIODYNE in detail. Every radio fan will be interested in this new type (antennalless) receiving set.

Just drop us a line and we will see that your inquiry gets prompt attention

**Western Coil & Electrical Company**  
305 5th St., Racine, Wisconsin



Racine Historical Society



"I have proof of bringing in San Juan, Honolulu, Havana, a station in every state in the U. S., and several stations in Canada and Mexico. One night my Radiodyne picked up Berlin, Germany, and Paris, France. A few nights previous I distinctly heard London, England. I have over 200 stations logged." E. B. HORNE, Arkadelphia, Ark.

**Radiodyne**  
The Voice of the Nation

**Some RADIODYNE**  
Type W-12  
**Features**  
Has an Amazing Degree of Selectivity  
Uses 6 Dry Cell Tubes  
Receives from Great Distances  
Has Wonderful Volume  
Exceptional Clarity  
Self Enclosed in Beautiful Two-Tone Mahogany Cabinet  
Models are Priced from \$65.00 to \$250.00  
*Write for Our Free Booklet*  
**WESTERN COIL & ELECTRICAL CO.**  
302 Fifth Street  
Racine, Wisconsin

Literary Digest (Jan. 10, 1925)

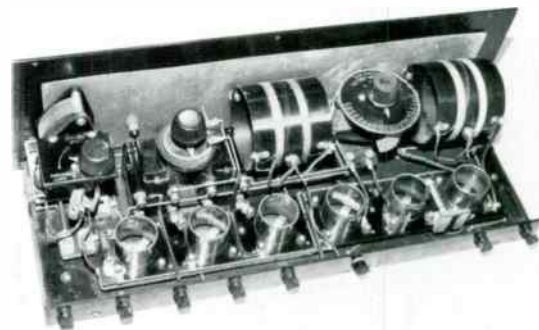

Right: WC11B September 1924 \$150  
WC11 console September 1924 \$250

Eric Sanders



Eric Sanders

WC12B November 1924 \$150 (later, \$100)  
 WC12 console \$250 (later, \$200)  
 Technical article in *QST* (June 1925), pp. 21-22.

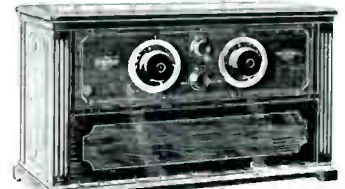

WC 18B \$100  
 2 Dial, 5 Tube in  
 Double decked, Mahogany Finished Cabinet

Announcing the  
 New Two Dial  
**Radiodyne**  
 AGAIN A YEAR AHEAD  
 Priced \$39<sup>50</sup> to \$215

Again Radiodyne is a year ahead with Two Dial, Five Tube sets that represent the utmost in simplicity of tuning, low battery consumption, tone clarity, volume and selectivity.

Two dial control represents a marked advancement in ease of tuning. Being of non-critical type you simply set approximately the volume control and then tune in with perfect ease the desired stations one after another by simply moving the Two tuning dials.

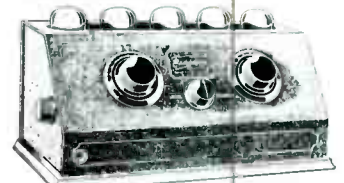

WC 15 \$39.50  
 2 Dial, 5 Tube in Black Crystalline Finish Cabinet

All of these sets are extremely economical of "B" battery current, consuming half the current used by the average 5 Tube set. All Radiodynes have one tone quality without any sacrifice of distance, are non radiating and operate on outside aerial, inside wire or lamp socket. If you prefer a Dry Cell Set make sure you hear the 6 Tube Radiodyne.

Sold by authorized dealers selected because of their desire to truthfully represent, and ability to properly install and service, if necessary, all Radiodyne Sets. If you don't know the nearest one write us for his name and free illustrated literature.

Western Coil & Electrical Co.  
 302 5th Street, Racine, Wisconsin

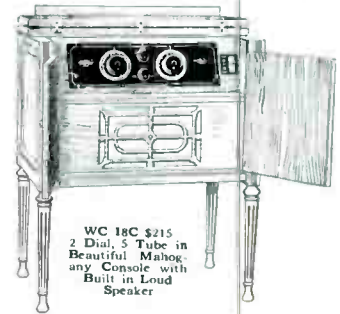

WC 18C \$215  
 2 Dial, 5 Tube in  
 Beautiful Mahog-  
 any Console with  
 Built in Loud  
 Speaker

Flyer

WC-15 With Cover in Place

**The Most Compact Five Tube Set Made**

The Radiodyne Type WC-15 is a Super-Receiver of the Compound Circuit Type

<p><b>SPECIFICATIONS</b></p> <p>Wave length—Broadcast band.              Amperes—filament—1½ with UX-201A tubes.              Tone—Excellent.              Plate current—approximately 9 to 10 milliamperes at 90 volts.              Antenna—inside wire, outside aerial, or lamp socket.              Selectivity—Excellent.              Range—Worse conditions 100 miles—Best conditions 4000 to 5000 miles.              Tubes—five: 2 radio—detector—2 audio.              Finish—(regular) Black irregular crystalline with gold stripes and engraving. Special</p>	<p>Finishes—walnut, dark red mahogany, oil hony, or blue—\$5.00 additional.              Dimensions: 15x8½x8.              Weight: 12 lbs. net; Packed 16 lbs.              Price less tubes, batteries etc.—\$49.50.              Code word Stunt.</p> <p><b>RADIODYNE MODEL "D" CONSOLE ONLY.</b>              Height—10", Length—18", Depth—13"              Dimensions of battery or speaker compartment 15½" high x 16" long x 12¼" deep.              Weight—25 lbs.              Weight Packed—35 lbs.              Finish—quartered red gum, finished in two-toned walnut.              Price (less radio receiver etc.) \$35.50.</p>
--	---

WC15 August 1925 \$39.50  
 WC15Jr September 1926 \$49.50  
 WC15Jr console \$85

Literary Digest (Sept. 12, 1925)



WC14A February 1925 \$65  
WC14B February 1925 \$85 (larger cabinet)  
WC14C February 1925 \$185 console

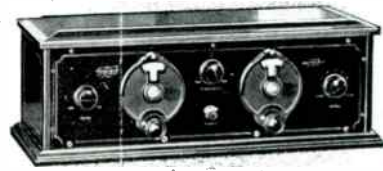

*WC19E*

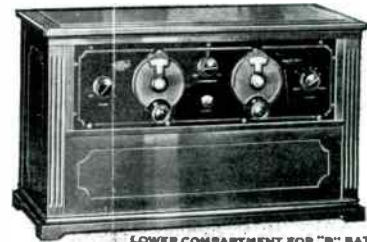

LOWER COMPARTMENT FOR "B" BATTERIES



WC17A July 1925 \$75



*WC-18C*  
A CABINET DE LUXE



WC18B August 1925 \$100  
WC18C console \$200

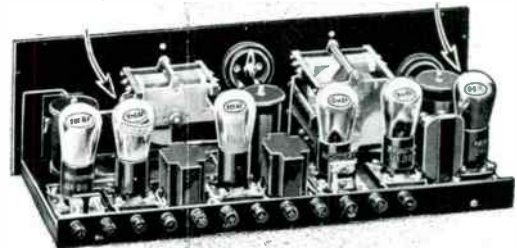

*Radio B. Chassis*  
FITS ANY RADIODYNE Cabinet



WC19E September 1926 \$110

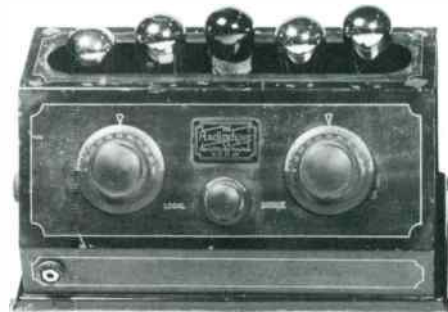

All photos by Eric Sanders

73,196. RADIO CABINET. WILLIAM TURNOR LEWIS, Racine, Wis., and MILTON MERWIN ELLS, Chicago, Ill., assignors to Western Coil & Electrical Co., Racine, Wis. Filed Sept. 20, 1926. Serial No. 19,117. Term of patent 14 years.

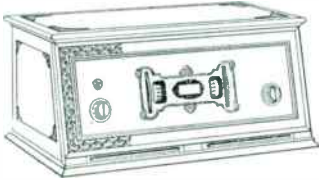

The ornamental design for a radiocabinet, as shown.

1,671,633. DIAL AND DIAL STRIP. BENJAMIN F. FLEGEL and WILLIAM TURNOR LEWIS, Racine, Wis., assignors to Western Coil & Electrical Co., Racine, Wis. Filed Sept. 20, 1926. Serial No. 136,628. 4 Claims. (Cl. 116-129.)

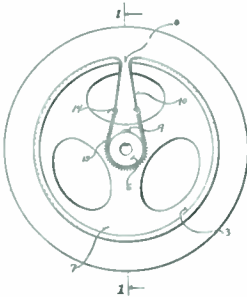

1. The combination of a dial wheel having a cylindrical portion, a dial strip surrounding said cylindrical portion, and resilient means secured to the ends of said strip for tensioning said strip and drawing such strip tightly into engagement with said cylindrical portion.

1,628,237 VARIABLE INDUCTANCE UNIT. MILTON MERWIN ELLS, Chicago, Ill., assignor to Western Coil & Electrical Co., Racine, Wis. Filed Sept. 20, 1926. Serial No. 136,627. 5 Claims. (Cl. 171-119.)

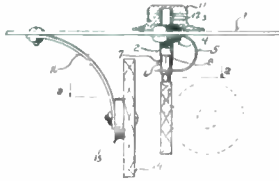

1. The combination of a panel, a stationary coil supported therefrom, a shaft mounted approximately parallel to the plane of the stationary coil and at right angles to the axis thereof, a support for said shaft, means for rotating said shaft, and a movable coil mounted tangentially with reference to said shaft, whereby said movable coil may be rocked approximately about a tangent and may thus vary its effect on the stationary coil.

1,704,570. SUSPENSION PARTS. GEORGE P. LEE, North Chicago, Ill., and WILLIAM TURNOR LEWIS, Racine, Wis., assignors to Western Coil & Electrical Co., Racine, Wis. Filed Sept. 20, 1926. Serial No. 136,515. 2 Claims. (Cl. 248-15.)

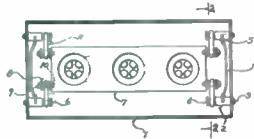

1. In a radio receiving device the combination of a casing, a plurality of posts secured to the inner side of said casing and provided with grooves at their outer ends, a socket positioned within said casing and having outwardly projecting grooved pulleys and continuous rubber bands slipped over the grooved posts and the grooved pulleys, whereby said socket is supported in a cushioned and yielding manner from said casing, whereby said pulleys will rotate to even the tension in all portions of each of said rubber bands.

1,755,982. TUNER. MILTON MERWIN ELLS, Chicago, Ill., assignor, by mesne assignments, to William Turnor Lewis, Racine, Wis. Filed Sept. 20, 1926. Serial No. 136,626. 3 Claims. (Cl. 250-40.)

1. A tuner for radio receiving sets comprising a variable condenser and an inductance coil connected together and to input terminals, a phantom circuit having a condenser and a resistance and connected to terminals, a box housing said condensers, coil, and resistance, and means on the outer side of said box for adjusting said variable con-

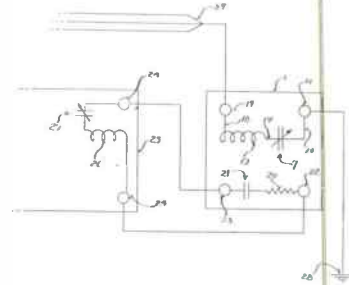

denser, one terminal of the inductance coil being a rigid support therefor and being rigidly connected to the terminal of the variable condenser.

A group of WC20G patents. Ells, born in 1895, was a research engineer with W. C. by 1925.

Other patents of Western Coil:

- #1,774,834 Lewis wireless receiving system
- #1,899,025 Ells radio receiving system
- #1,836,260 Lewis radio apparatus
- #1,841,487 Lewis television apparatus
- #1,923,155 Lewis & Woolfolk radio receiving system
- #1,964,990 Hopkins radio frequency receiving system
- #1,972,387 Lewis wireless system

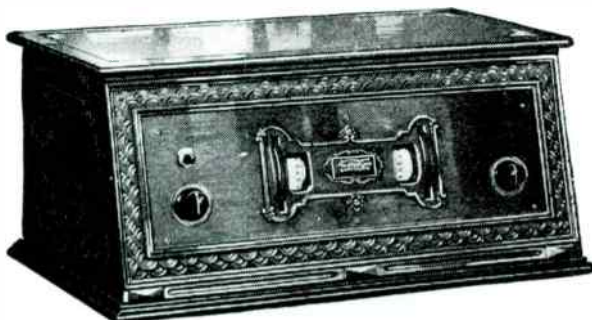

WC 20G Super Radiodyne  
9 Tube—2 Dials (3 volt tubes) \$225  
Other Models up to \$595

- WC20G September 1926 \$225
- WC20F console \$320

Radio Retailing (Sept. 1926)

Receiver

Radio Retailing, July, 1927

The Western Coil & Electrical Company, Racine, Wisconsin, has placed on the market Model WC-21G receiver. This is a 4-tube set with an illuminated dial, shielded coils and a metal chassis. It is also equipped with an output filter. It has four stages of radio frequency amplification, uses five 201-A tubes, one 171 type and one 200-a type. It is non-radiating and said by the manufacturer to be highly selective. The finish of the cabinet is walnut, highly rubbed, veined, two-toned, with inlaid carvings. The intended retail price is \$150. WC-21 chassis has an intended retail price of \$125.

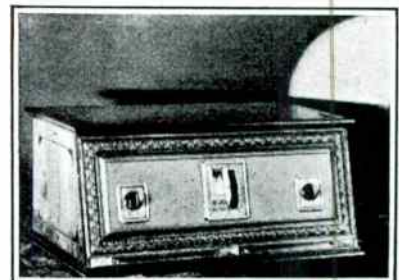

WC21G July 1927 \$150

# Facts you ought to know

OVER a period of active research and manufacturing since 1915, the Western Coil & Electrical Company at its Racine, Wisconsin plant, HAS SERVED THE PUBLIC as well as the professional world with high grade scientific apparatus including X-Ray machines and tubes, Violet Ray generators and accessories, ultra-violet and therapeutic apparatus, electrical testing machines, radio frequency apparatus and finally the famous Tri-Beam therapeutic arc and Radiodyne broadcast receivers.

The Company is one of a group of pioneers who first produced broadcast receivers for the entertainment and instruction of his majesty The American Citizen. With a corps of engineers second to none, and with years of experience in similar lines from which to draw, is it surprising that they are capable of building the best in radio sets, at prices not made exorbitant by costly mistakes of the cut and try method? The Western Coil and Electrical Company has a number of its own patents under which it manufactures its varied line of electrical apparatus. The purchase of a Radiodyne does not penalize the buyer with the burdens of exorbitant royalties on outside or foreign patents, nor does it compel him to pay part of an enormous national advertising campaign. All the value is in the Radiodyne that you purchase and it is noticeable in the quality of Radiodyne reproduction. After all, should one be called upon to pay for anything else?



## WL Radiodyne

A well built mahogany veneered cabinet with routed out paneling effect finished in two tone. Built so as to require minimum table space. Good looking and well finished.

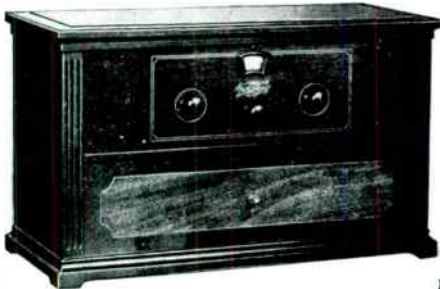

WC-22 - B

\$160.00

With 9 tubes—less speaker

SPECIFICATIONS

Length.....	24 1/2 inches
Height.....	15 inches
Depth.....	11 inches
Weight.....	40 lbs.
Weight packed	57 lbs.
Code Word—WC-22-B..	SELDY

Flyer



300 5th Street



Terminal Building (4th floor) 1928-1932



Shoop Building 215 State Street 1932-1978

photos by Eric Sanders

**A Novelty at the Boston Electric Show**

One of the features of the Boston Electric Show, which opened on September 28, was an exhibit of Western Electric loud speaking telephones.

For some time past that company's engineering department has been at work on the development of these instruments, combining the articulating qualities of a telephone receiver and the sound intensifying qualities of a megaphone. A short time ago the instrument was perfected, and ninety were accordingly installed in various parts of Mechanics Hall, where the show was held.



The Loud Speaker

The loud speaking telephones were divided into groups of ten, making nine separate circuits, which were originated in a sound-proof, glass-enclosed booth in the basement of Grand Hall. In this booth the special transmitters were located, as well as an ordinary telephone set connected to the lines of the New England Telephone and Telegraph Company.

The installation of the telephones was made to demonstrate their use as announcers—to announce interesting events about to take place, to page visitors to the show, and to furnish music from a phonograph in the transmitting booth. An equally important use to which they were put was to announce the inning-by-inning scores of the World's series baseball games, a feat made possible by the co-operation of the New England Telephone and Telegraph Company and one of the leading Boston daily papers.

It was a curious sight to see a group of people gathered around one of the telephones, either at the Western Electric exhibit in the main hall or in various

parts of the building, listening open-mouthed to the voices or music coming out of the horns, seemingly from



Telephone Engineer (Nov. 1912)

Listening to the Loud Speaking Telephone.

nowhere. That the telephones produced practical results is evidenced by the fact that a child, which had been separated from its parents in the throng, was found through their agency; and it was no unusual thing for exhibition officials to be summoned to their offices or to meetings by means of these instruments.

The efficacy of the telephones in producing music transmitted from the phonograph in the basement booth may be adduced from the fact that Creatore, the famous Italian band master, protested that they interfered with the music rendered by his band. Accordingly arrangements had to be made to use the telephones for furnishing musical selections only during the band pauses.

Sept 6<sup>th</sup> 1902

Wireless Telephony

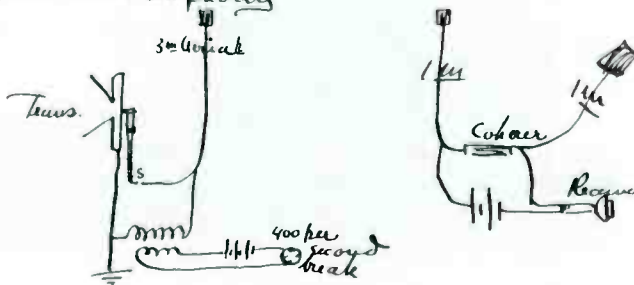

With the apparatus shown in this <sup>above</sup> sketch, tones and articulation of the voice were transmitted between rooms. Coughing "1, 2, 3 - -" was heard clearly, and at times, loudly in the receiver. A complete sentence was in one case received (How do you get me?) The undersigned have listened at the receiver, and have noted that both tone and articulation were present.

John W. Barrett H.C. Shreve  
 F. M. Durkin  
 J.M. Peck  
 Ed. W. Fay  
 E. L. Gray

A page from Greenleaf Whittier Pickard's notebook.

# WESTERN ELECTRIC

## Western Electric Company

**W**estern Electric was incorporated in 1872 to consolidate Gray & Barton (1869) and several smaller telegraph manufacturing shops dating back to 1856. It was Western Union Telegraph Company's main supplier; but when Western Union settled with the Bell interests in 1879 and abandoned the telephone business, Western Electric was left without much of its market. Jay Gould's successful takeover of Western Union in 1881 and his dismissal of General Anson Stager (Western Union's Vice President, Western Electric's President and one-third stockholder) cut Western Electric completely loose. Western Electric was already several times larger than any of the Bell-controlled makers such as Charles Williams in Boston, and Bell needed a lot more manufacturing capacity to handle its increasing business. So in 1882, Bell purchased Western Electric, merged it with the Williams and other shops, and made the combined company its sole supplier of telephone equipment.

American Telephone & Telegraph Co., originally the long-distance subsidiary of American Bell, became the parent company in an 1899 reorganization. Employees at AT&T's small engineering department in Boston experimented with radio very early. In 1892, John S. Stone unsuccessfully tried signalling to ships at sea, and G. W. Pickard transmitted speech a short distance in 1902 by mechanically modulating a spark gap with a telephone diaphragm. By 1907, AT&T was about to purchase patent rights from R. A. Fessenden, a pioneer in radiotelephony who had already broadcast for hundreds of miles from his station near Plymouth, Massachusetts. But the financial panic of 1907 threw the control of AT & T from Boston bankers to J. P. Morgan in New York. Morgan's new management retrenched by laying off 12,000 workers and merging most of AT & T's engineering staff with Western Electric's existing New York organization.

Although AT & T had temporarily lost its connection with radio, President Vail began to think about future competition from the wireless telephone. He began to build a research department that would assure a strong patent position in the new technology. Vacuum tubes, with immediate application for telephone repeaters as well as for radio,

Founders in 1869  
of Gray and Barton,  
now Graybar  
Electric Company

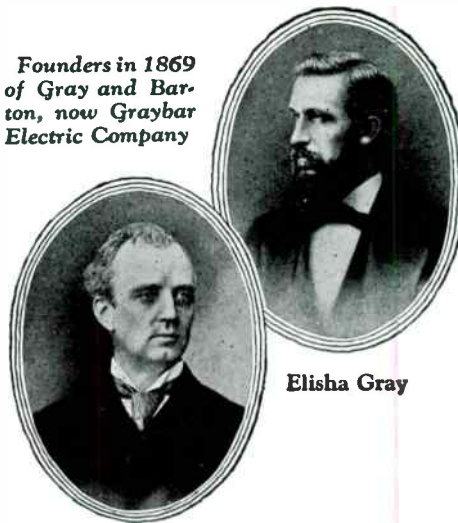

Enos M. Barton

Elisha Gray

1926-1927 catalog

received a substantial budget and new, academically trained personnel. Soon AT & T's researchers knew more about practical vacuum-tube technology than anyone else (General Electric had the edge in vacuum-tube physics). In 1915, AT & T demonstrated radiotelephone transmissions from Washington to Honolulu and Paris; and by 1918, Western Electric's expertise allowed the mass production of the reliable and efficient VT1 and VT2.\* Western Electric developed and produced large numbers of radiotelephone transmitters and receivers for the Navy and the Army Signal Corps.

During the war, the various electrical companies made radio apparatus for the military under guarantee of immunity from patent infringement, but peacetime was another matter. Aiming to exploit their newly developed technology, AT & T and GE collided head-on, each owning patents needed by the other. They were only too glad to follow a strongly worded Navy suggestion to negotiate cross-licensing agreements between themselves and with RCA and Western Electric. Radio broadcasting was, of course, not considered in

\*More than 500,000 of both types were made during the war, at a rate of 25,000 per week by November 1918. Compare the number of VT1s made with the figures for GE's equivalent VT11 (110,000) or deForest's VT21 (15,057). Each company was given a block of ten VT numbers with odd digits was assigned to



LOUD SPEAKING TELEPHONE EQUIPMENT

General

The proper design of an efficient loud speaking telephone represents one of the highest achievements in the electrical and acoustical arts as they exist today. The Western Electric Company have carried on extensive investigations upon the loud speaking telephone and loud speaking receivers with the result that they have developed the following line of apparatus which is suitable for use as an accessory to a radio receiving set.

10A Loud Speaking Telephone Outfit

This outfit consists of the following:  
1 No. 7A amplifier (2 stage with 3 No. 216A Vacuum Tubes)

1 No. 518W loud speaking receiver complete with horn.  
The No. 7A amplifier consists of a wooden cabinet, approximately 12½ x 10 x 4½ inches, supporting a panel of approved insulating material on the under side of which are secured and mounted all transformers, grid batteries, tube sockets, etc. To repair or replace any part it is only necessary to remove six screws in the cover and lift off. Upon the panel are mounted a battery switch, multi-contact switch for controlling volume of sound, and necessary binding posts.



No. 10-A

The No. 518W loud speaking receiver is of the balanced armature type, all parts of which are mounted in a metal housing. The No. 8A horn which is of molded composition is specially designed to give adequate volume and pure tone.

The No. 10A outfit requires for operation either a No. 2A current supply set, described below the following batteries:

- A—Filament battery—6 volt storage battery (approximately 120 ampere hours)
- B—Plate circuit. 120-130 volts.
- C—Grid "C" battery, 9 volts, 2 No. 751 Eveready.

Replacement Parts:

- Vacuum Tubes, No. 216A.
- Receiver Cord for No. 518W receiver, No. 767.
- Receiver horn, No. 8A.

2A Current Supply Set

This outfit is for use in place of the present "A" and "B" batteries for supplying both filament and plate current only to the No. 10A loud speaking telephone equipment where there is an alternating current lighting circuit available, whose voltage is not less than 100 or more than 120, and the frequency not less than 50 or more than 70 cycles. It cannot be used on a direct current lighting circuit.

The set, which with the exception of the tubes, is enclosed within a cast-iron case, weighs approximately 19 pounds. It consists of the necessary transformers to supply proper voltage, together with two No. 217A rectifier tubes which rectify the alternating current to direct current for the plate circuit. Two cords, one equipped with an attachment plug for connecting to the lighting circuit and the other for attaching to the No. 10A loud speaking telephone outfit, complete the equipment.



Type 2A Current Supply Set

10A June 1922 \$161  
2A 1923 \$71

LOUD SPEAKING TELEPHONE EQUIPMENT



10-D



Type 522-W

10-D Loud Speaking Telephone Outfit

The No. 10D Loud Speaking Telephone Outfit is designed to operate directly from a radio receiver set which in itself provides a sufficient amount of amplification without the assistance of a separate power amplifier. It does not require any battery for energizing the magnetic circuit.

This outfit consists of a No. 518W receiver with the addition of a No. 112A transformer mounted to the base. It is approximately 2½ ft. high and the mouth of the horn is 14 inches in diameter.

The No. 112A transformer serves the purpose of giving the proper impedance ratio between the plate circuit of the radio receiving set and the No. 518W receiver and prevents the flow of any plate current through the receiver windings.

Replacement Parts:

- Horn—No. 8A
- Cord, No. 767
- Transformer, No. 112A.

No. 522W Loud Speaking Telephone Receiver

This loud speaking telephone receiver has been developed to meet the demand of those who own phonographs, and who wish to use them in connection with their radio receiving sets.

The coils and windings of this receiver are the same as those used on our telephone head set, but the diaphragm is much larger and heavier and is so clamped as to give volume without distortion.

The construction is such that it is only necessary to remove the reproducer from the tone arm of the phonograph and slip in this receiver. The support attached to the receiver relieves any strain from the tone arm. The outfit is approximately 4 in. high, weighs about one-half pound and is equipped with a No. 782 cord for attaching direct to the receiving set.

Sufficient volume to fill the average size living room will be obtained with this receiver when used with one or two stages of amplification on an efficient vacuum tube radio receiving set within a radius of twenty miles of the broadcasting station.

The sound output from this receiver, when attached to a good receiving set, is very pleasing although not as loud as the No. 10-D.

Replacement Part:  
Cord, No. 762.

10D \$55 522W \$12



521W 1923 \$21



521CW 1924 \$23  
543W 1925

1920; but RCA and GE were given the right to sell receivers to the amateur market while Western Electric could sell transmitters.

It did not take long for the agreement to come unraveled when broadcasting caught on in late 1921 and early 1922. By April 1922 Western Electric had supplied 16 transmitters and had quotations outstanding for nearly 50 more. Now at a price of \$8,500 to \$10,500 (100- or 500-watt model), this could have been a fairly profitable business in the short term; but since in early 1922 all stations were licensed to use a single wavelength of 360 meters, it was obvious that only a limited number of them would be able to share time slots. AT & T management's solution was to set up one high-quality station in each city, keep it on the air continuously, and offer broadcast time to any organization wishing to buy it. Duplicate facilities would be avoided, and AT & T would just happen to be in the position to offer a potentially lucrative service. WEAf opened for business in New York City in July 1922 (Banning, *Commercial Broadcasting Pioneer. The WEAf Experiment 1922-1926*. Cambridge, 1946). While WEAf itself prospered — it was generally regarded as the country's finest station in spite of its paid advertising — the overall plan of an AT & T monopoly of broadcasting was too late to be acceptable to existing broadcasters or to listeners. It was quietly dropped after the broadcast band was enlarged in May 1923.

All indications are that AT & T also wanted a share of the broadcast-receiver market. RCA's income jumped from \$1.5 million in 1921 to \$11 million in 1922, not to mention what the bootleggers (all other manufacturers, in the Radio Group's view) were raking in. Johnny-come-lately Westinghouse had been handed a 40 percent share of RCA's manufacturing business while AT & T had nothing. Western Electric made excellent receivers but only for

monitoring at the broadcast stations it equipped (all stations had to monitor the 600-meter marine distress/calling channel and shut down in event of an SOS; the receivers were also needed to check the station's own transmission quality — and frequency).

Western Electric began its market assault with audio amplifiers and loudspeakers. By strict interpretation of the 1920 cross-licensing agreements, Western Electric had no rights to sell these for other than wire-telephony purposes; but in June 1922 the "Loud-Speaking Telephone Outfit" made its appearance and proved very popular as a radio attachment. At first, RCA did not protest — perhaps because it offered nothing remotely similar, perhaps because the agreements were somewhat vague on this point. But sales of receivers were specifically forbidden. Nevertheless, Western Electric developed a four-tube model 3A that was not used as a monitor and, at least occasionally, was sold for private use. And AT & T installed a 4B superheterodyne in the White House in early 1924. This act created consternation when the 4B beat the top-of-the-line Super-VIII in competitive tests; but since it was a government sale, RCA was powerless to stop it.

By this time, RCA had invoked the arbitration clause of the 1920 agreement to stop AT&T's encroachment. This story has been told in exhaustive detail by Gleason Archer (*Big Business and Radio*, New York, 1939). After months of private testimony and deliberation, the arbitrator found for RCA on nearly every disputed point. Thereupon, AT&T tried to claim that the 1920 contract itself was illegal under the Sherman anti-trust act since it was an agreement not to compete in certain areas; this would have left Western Electric free to sell broadcast receivers. However, the whole affair was settled by AT&T's withdrawal from broadcasting and its sale of WEAf to RCA in July, 1926. The anti-trust wolves were howling a bit too menacingly — RCA itself was sued by the Justice Department in 1930 — and AT&T was understandably touchy about public perception of the "telephone monopoly." It is also worth noting that the radio business in 1926 was actually shrinking, that RCA had lost its leadership in sales (to Atwater Kent), and that the industry was much more competitive than it had been five years before. Western Electric had sold its wholesale supply business to its employees in December 1925, who reorganized the division under the name of Graybar (from Gray and Barton). Its international interests went to IT & T in September of the same year. Western Electric kept only its manufacture of broadcast transmitters and audio equipment, theater sound systems, and commercial radio.

---

receiving tubes and even digits to transmitting tubes. The VT1 and VT2 worked so well that they were never changed. The GE VT11, on the other hand, was superseded by the VT13; the VT12 (equivalent to the five-watt transmitter VT2) became the VT14 and, finally, the VT16. Details can be found in Tyne's *Saga of the Vacuum Tube*. AT & T policy before about 1920 prevented publication of research work (and even verbal communication at IRE meetings!). The best sources of information on this period are: Fagen, M. D., ed. *A History of Engineering and Science in the Bell System, Vol. 1: The Early Years (1875-1925)*. (Bell Telephone Laboratories, 1975.) Reich, Leonard S. *The Making of American Industrial Research. Science and Business at GE and Bell, 1876-1926*. (Cambridge, 1985.) *Radio Electronics and the Development of Industrial Research in the Bell System*. (Ph.D. dissertation, The Johns Hopkins University, 1977.)

The Literary Digest for December 1, 1928 49

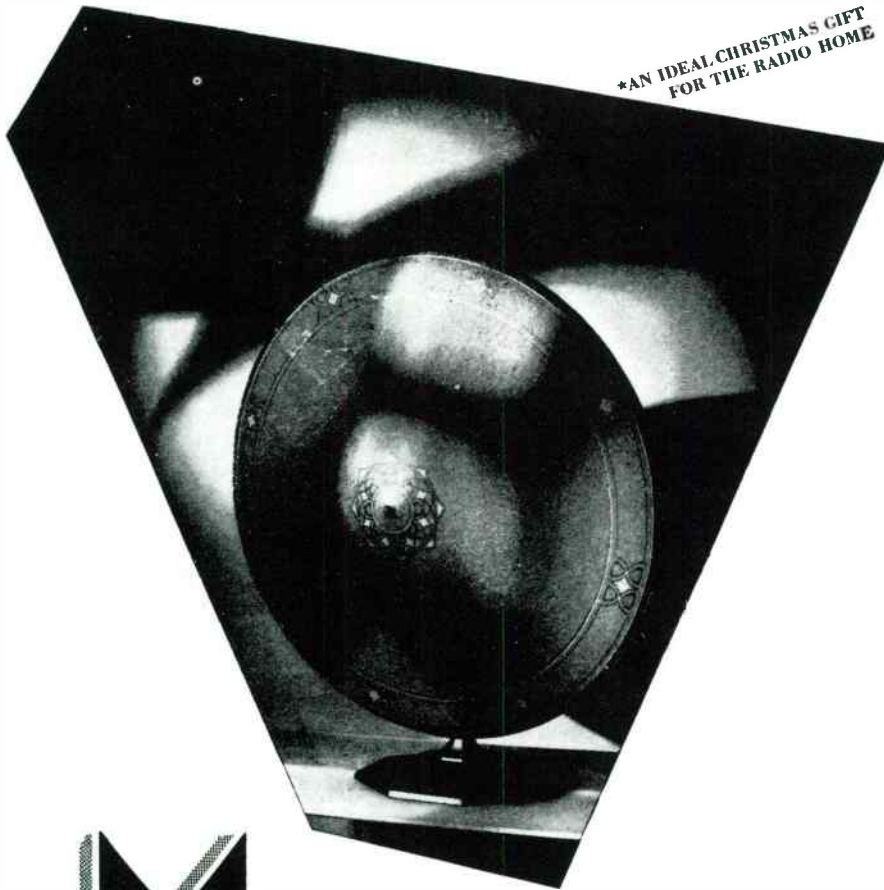
\*AN IDEAL CHRISTMAS GIFT  
FOR THE RADIO HOME

# Made by Western Electric for discriminating ears

The Western Electric 560-AW Loudspeaker, designed by Bell System engineers, is made by the makers of the nation's telephones. With it you can give your radio receiver a richer voice. With it you can gain a new appreciation of real quality in radio reception.



Broadcasting via  
Western Electric  
equipment.



Receiving via a  
Western Electric  
Loudspeaker.

## Western Electric

### LOUDSPEAKER

Distributed by GRAYBAR Electric Company  
through authorized dealers everywhere

Open All Day Saturday  
**HAYNES-GRIFFIN** Telephone Murray Hill 5650  
 RADIO SERVICE INC. 41 WEST 43<sup>RD</sup> STREET  
 BETWEEN FIFTH & SIXTH AVENUES  
 NEW YORK'S LARGEST RADIO STORE



Maj. J. Andrew White, Vice-President, Haynes-Griffin Radio Service, Inc.

Let "America's Favorite Broadcaster" Help You Get Ready.

Maj. J. Andrew White is always at your service in this store except when he is describing important sport events for WJZ's listeners. Since he has been in charge of our Complete Set Department he has helped thousands of people to select radio sets which are giving them the best possible results.

His 12 years' knowledge of all branches of radio makes his advice of the greatest help. Come in and talk over your requirements with him.

"Get Ready" Sale  
**Western Electric**

No. 14-A  
**Loud Speaker**  
 Formerly \$175.00  
**\$112.00**

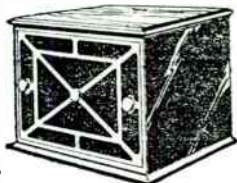

At Haynes-Griffin Now

Here is the finest loud speaker that money can buy. Made by the Western Electric Company, it is in a class by itself. Ideal for use in clubs or hotels, or when volume enough to entertain a large number of persons is required.

Unequaled for clarity and quality of tone reproduction. Comes complete with 3 Western Electric 216-A power tubes, furnishing two additional stages of amplification (one push-pull).

Ready now at the new low price in time for the Polo games, the Willa-Firpo bout, and other big broadcasting events.

**We Have Them**

Many fans have had trouble in buying a complete set of speakers for the "Kum-Bout" sets described in Radio Broadcast. We have them. Price, complete with \$8.00 mounting .....

New York Herald-Tribune (Sept. 7, 1924)

A  
**Western Electric Achievement**

The new 540A-W  
 Hornless Loudspeaker  
**\$35.00**

This supreme loudspeaker gives the radio public what they have been waiting for for the last three years—a new type of speaker that does away with tinny horns and units. The 18-inch non-metallic cone reproduces programs so far superior to any other type of speaker that it cannot be compared with them.



Have your dealer demonstrate one in your home and you will realize why the 540 AW Western Electric speaker is taking the country by storm.

WE HAVE THEM NOW

**The BRAUN Corporation**

Wholesale Only  
 Los Angeles—Oakland

Radio Doings (Oct. 4, 1924)

"Get Ready" Sale  
**Rectigon Battery Charger**

List Price, \$18.00  
**\$12.95**



The main drawback to using standard 6-volt tubes is the inconvenience and expense of charging the storage battery. The Westinghouse Rectigon Charger eliminates all this. It operates from any alternating current lamp socket and supplies your battery with a steady source of power. Turn it on at night, and in the morning the battery is charged—at a few cents cost. It is noiseless and creates no fire hazard. It has no mechanism to rust or get out of order. And its use makes certain that your storage battery is always in good shape—brimful of life—ready to light your tubes at their proper voltage.

"Get Ready" Sale  
**Exide 6 Volt Storage "A" Battery**

100-Ampere Type. List Price, \$24.40  
**\$14.75**

The use of standard 6-volt tubes in any radio set as a rule gives greater volume and more complete satisfaction. The remarkably low price at which we are selling genuine Exide 6-volt, 100 ampere-hour batteries enables you to obtain best results at a very considerable saving.

The large plate surface of the Exide gives full power, and the sturdy construction insures longest life. Buy an Exide now and make your set speak up loud enough for the whole family to hear coming broadcast events.



Store Open 8:30 A. M. to 5:30 P. M. Every Day

14A February 1924 \$140

540AW October 1924 \$35

Design patent #74,114 to George Lum, filed August 5, 1924. As of March 1926, 1,000 per day were being produced.

25B amplifier 1925

Battery box for 4D superhet.



THE IMMACULATE OPERATING ROOM AT PWX, HAVANA, CUBA

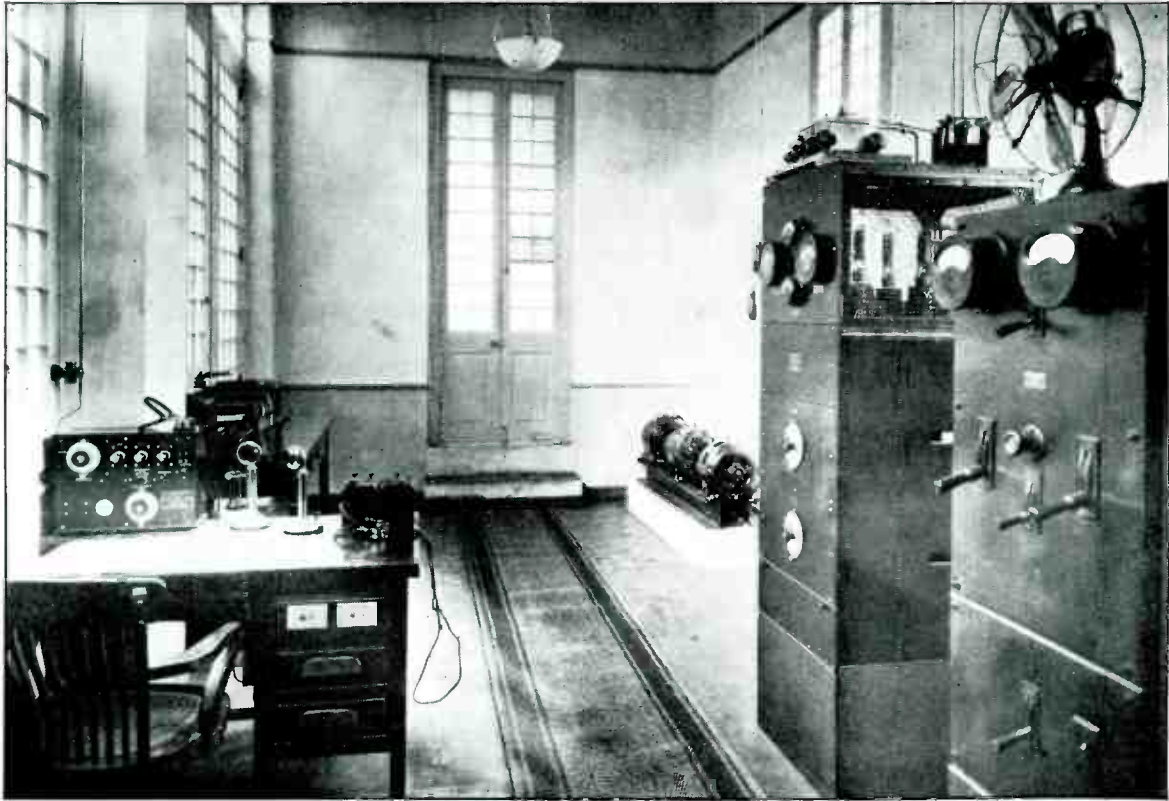

Radio Broadcast (Feb. 1923)

1A receiver September 1922



2A August 1922 (not shown)  
2C November 1922

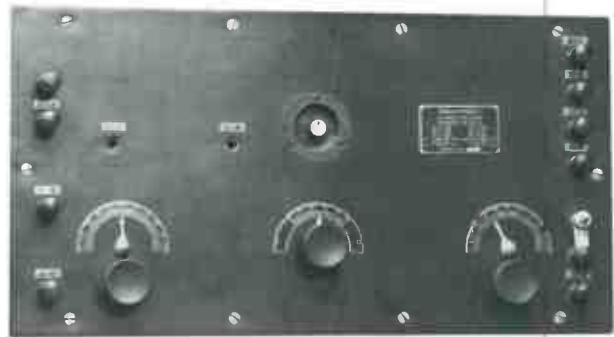

Ralph Muchow

3A August 1922

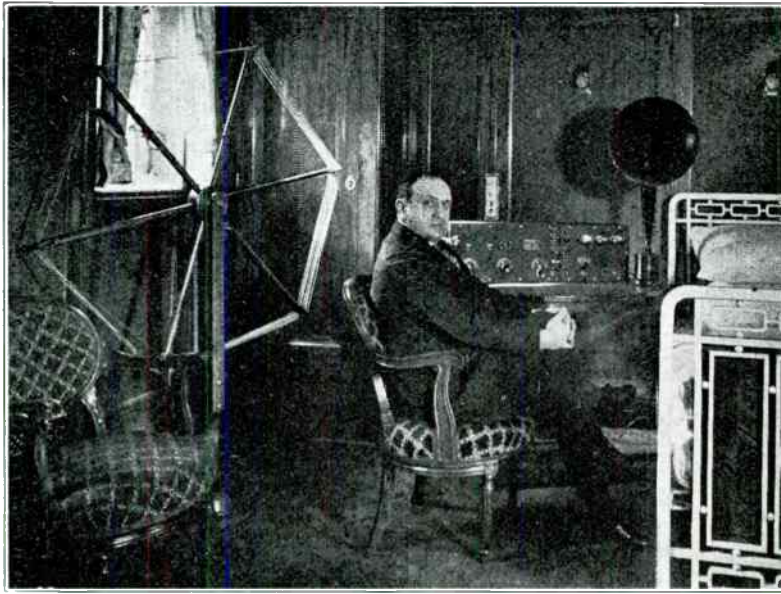

Radio Topics (March 1923)

S. L. Rothafel, director of the Capitol Theater, New York, had a complete radio receiving set installed in his stateroom on board the "Berengaria" when he sailed for Europe recently. He will occupy the same stateroom on his return and keep in close touch with Station WEAJ, from which point the Capitol Theater musical program is broadcasted.

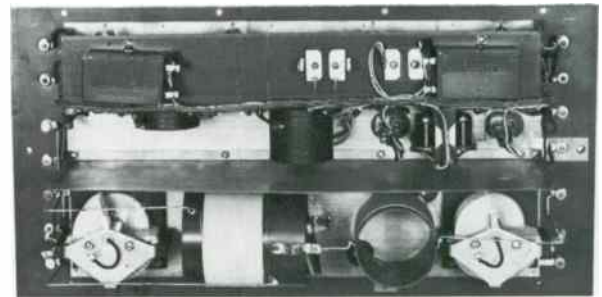

3B June 1923

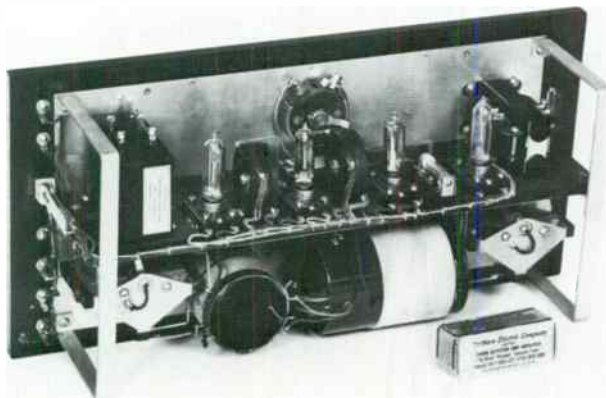

Northern Electric (Canada) R3

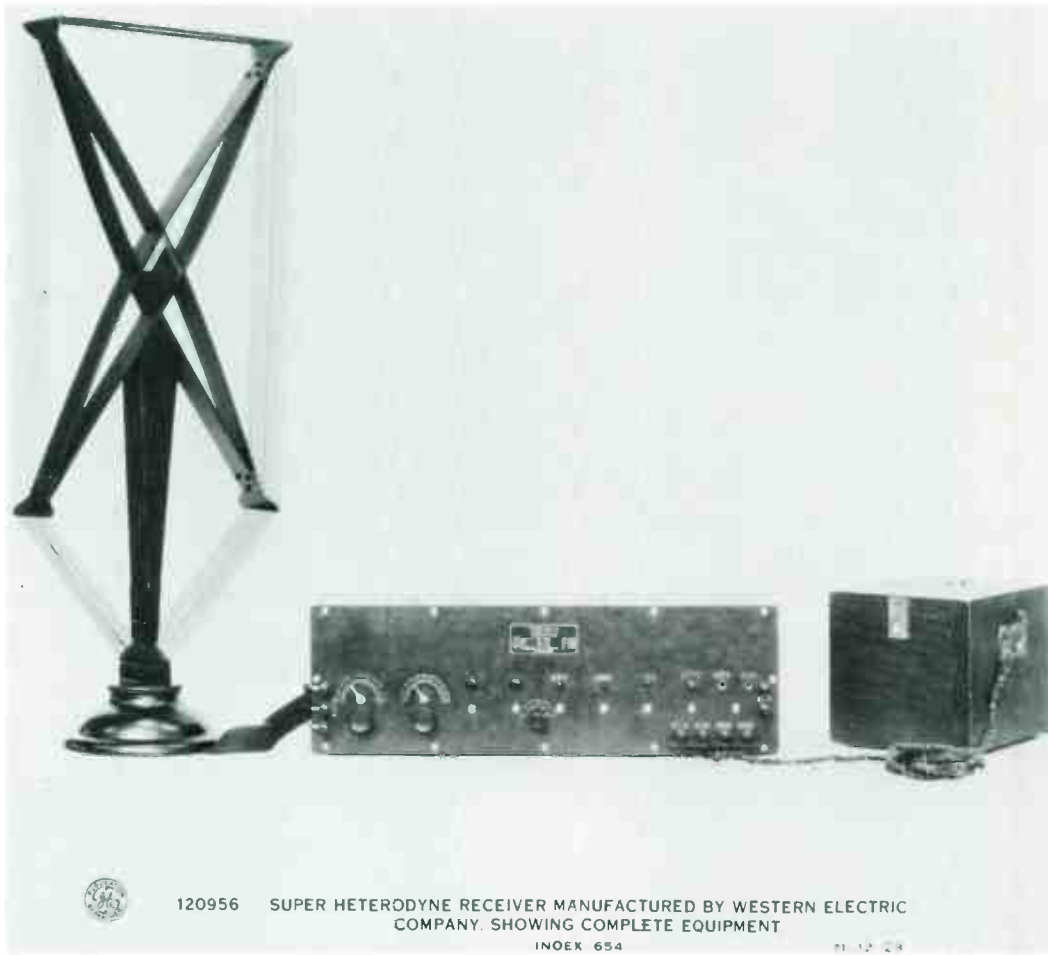

4A October 1922  
Loop design patent #69,313 to Carl Englund and Arthur Haddock, filed May 26, 1923

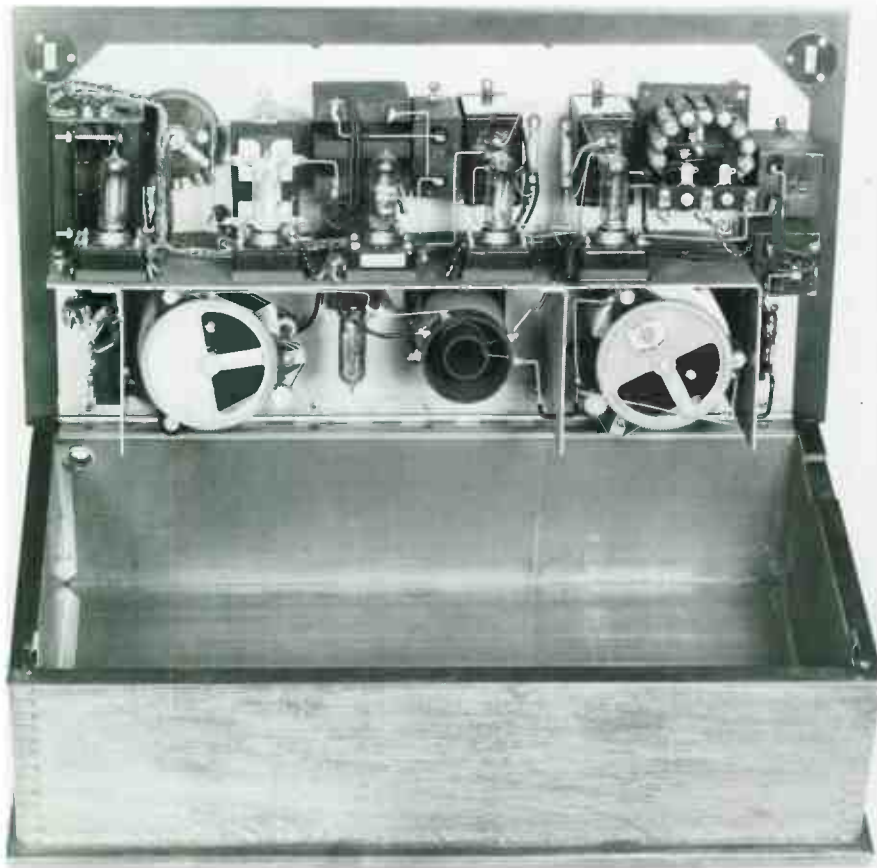

This is a standard 4D (except for the rheostat), although it never had a nameplate since it was owned by George Morris, an Inspection Dept. chief. Western Electric employees were allowed to buy surplus or damaged equipment until the privilege was abused and subsequently revoked. The 4B and 4C were similar in appearance with test jacks on the front panel. The 4B (in service by January 1924) came with a loop antenna and a battery box while the 4C was supplied with a tuner and filter for use as a broadcast monitor with the 101-B station equipment.



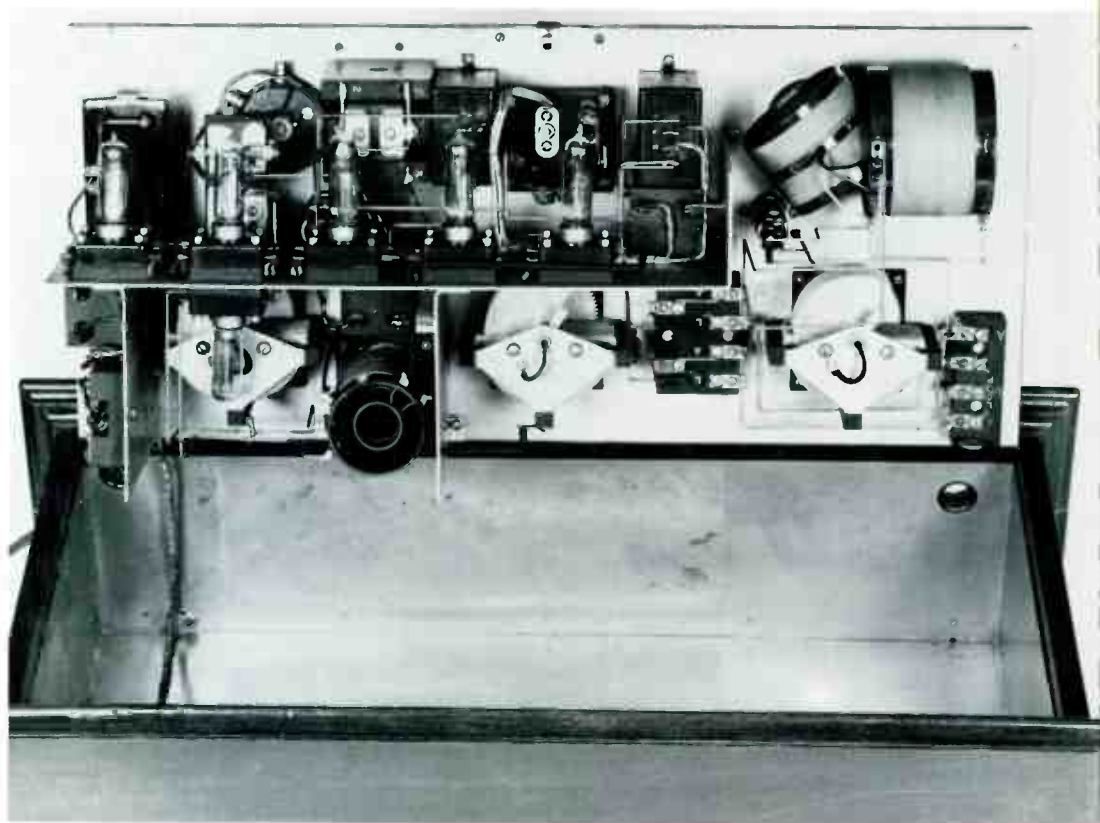

Northern Electric (Canada) R4. Unlike Western Electric, Northern was licensed to sell home receivers.

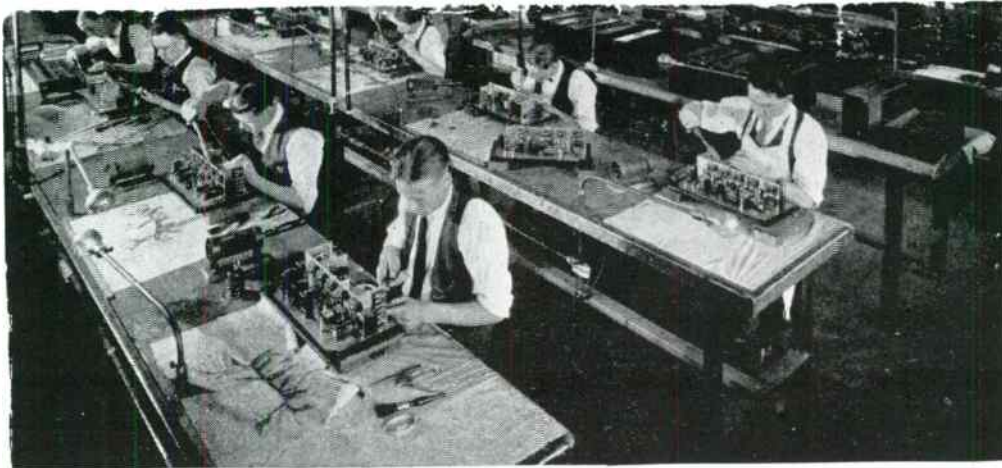

Keamygram

The Instrument Assembling and Wiring Department is on the third floor

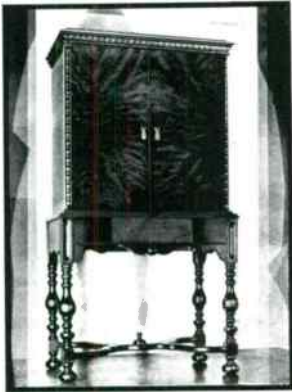

GRAYBAR 340—The long-awaited single control A. C. Super-Heterodyne, Eight-tube set. Built-in dynamic speaker. Artistic 5-ply walnut veneer cabinet. Three-quarter revolving doors. Illuminated dial. List, less Radiotrons . . . . . \$375.00

# Gray bar (RAD IO)

Its reputation is deeply rooted in electrical history

The oldest name in the electrical industry will now appear on a complete line of radio receiving sets. Associated with these receiving sets is a history that goes back 59 years—first to the days of Gray and Barton, then through the period of this company's organization as the Western Electric Supply Department and finally to its present corporate form as the Graybar Electric Company. Coupled with this history is an unparalleled

experience in electrical merchandising. It began with the selling of some of the earliest known commercial electrical material. It included, in recent years, the nation-wide merchandising of a complete line of household appliances, the furnishing of Western Electric equipment for 113 of the country's leading broadcasting stations, and the distribution of Western Electric loudspeakers.

It culminates now in as profitable and as complete a line of radio equipment as dealers have ever been offered—including not only Graybar Radio but also the famous Western Electric loudspeakers and amplifier, Radiotrons and Eveready batteries.



GRAYBAR 300—Single control, six-tube storage battery set, tuned radio frequency circuit. Mahogany finish cabinet. List, less Radiotrons, \$82.75



GRAYBAR 320—Single control, tuned radio frequency circuit, six-tube A.C. receiver. Illuminated dial. Built-in magnetic speaker. 5-ply walnut veneer cabinet, high-lighted finish. Three-quarter revolving doors. List, less Radiotrons . . . \$195.00



GRAYBAR 310—Leader among A. C. receivers. Single control, illuminated dial, six-tube, tuned radio frequency circuit. 5-ply walnut veneer cabinet. List, less Radiotrons . . . . . \$115.00



GRAYBAR 330—Single control V. L. Super-Heterodyne. 5-ply walnut veneer cabinet. Illuminated dial. Eight-tube set. List, less Radiotrons . . . \$175.00

Radio Retailing (Sept. 1928)

British models:

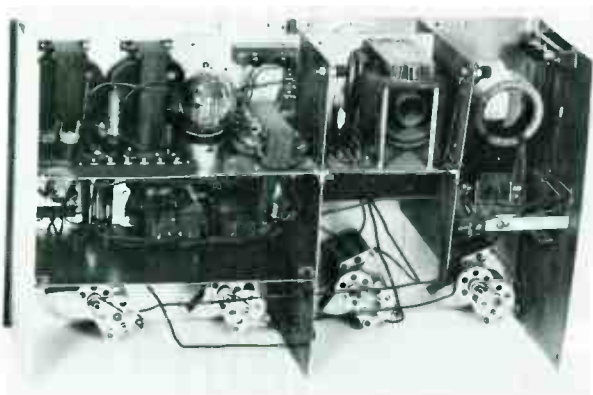

Western Electric Co., Ltd., model 4004 (1925?). An essentially identical model 44004 was sold by STC (Standard Telephones & Cables, Western Electric's successor as of October 1925) in a wooden cabinet for home use. This 4004, however, is said to have come from a government station and never had a cabinet.

W. E., Ltd., also made a superhet based on the (U.S.) W. E. model 4A, the 41002 (1924).



Western Electric Co., Ltd., 44001 based on the Westinghouse Acriola Jr.

## A Picture from Philadelphia

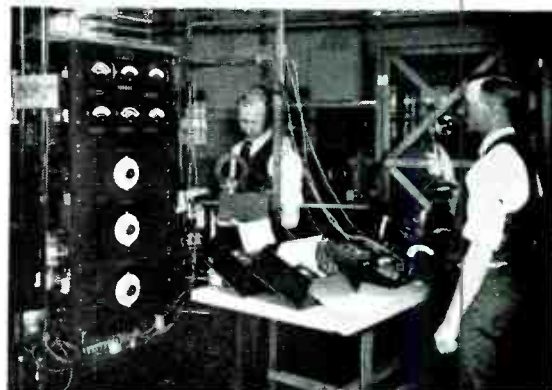

Kearnygram (May 29, 1924)

This illustration shows a Western Electric Company 500 Watt Radio Broadcasting Transmitter receiving its final electrical tests at the Philadelphia Instrument Shop. G. M. Morris is noting the effect of modulation on the antenna current and the oscillator plate current of the set. M. B. Stearns is listening to the modulation to check its quality of reproduction, and also checking the wave length setting. In the testing of these Radio Transmitters, it is not necessary to use the regulation outdoor antenna, which would cause considerable interference in the locality. A dummy antenna is used with the required capacity and resistance, which produces an artificial load on the radio frequency output, absorbing the energy that is normally put into the antenna system. The tests are very exacting. The Philadelphia Instrument Shop has produced a large number of Radio Transmitters of this type, and has supplied many of the well-known, high-quality, powerful stations.



Philadelphia Instrument Shop

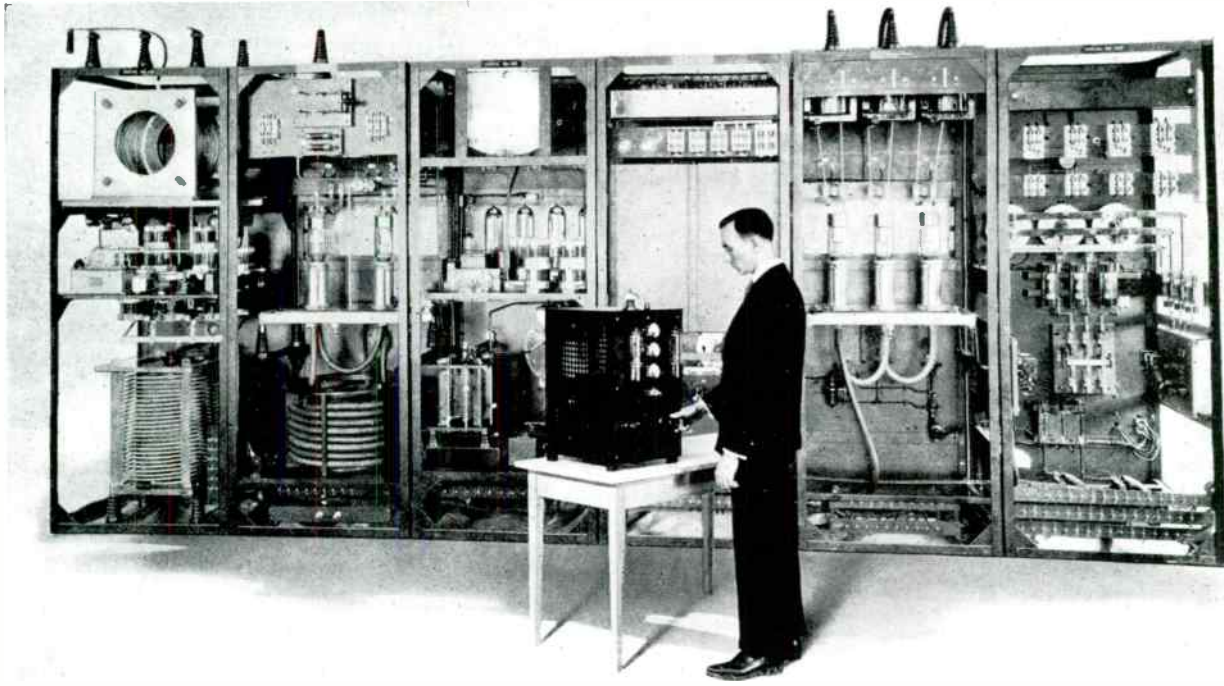

Keurnygram

George Morris inspects the smallest and the largest broadcasting sets manufactured in the Instrument Shop

### Radio Telephone Broadcasting Equipment

Few inventions have attained in so short a time either in national interest or importance the position reached by radio broadcasting. This is due in a large measure to the rapidly improving efficiency of radio apparatus.

Since the first 500-watt Western Electric Radio Telephone Broadcasting Equipment, (with which more than fifty of the best known broadcasting stations in the United States have been equipped), was designed and placed before the public, the engineers and scientists of the Bell Telephone Laboratories of the American Telephone and Telegraph Company and Western Electric Company have been studying the problems of the art with a view of improving the apparatus.

This research work has brought out three classes of equipment, known as the 103-C (50 watt); the 106-A (1000 watt) and the 104-A (5000 watt). Improved speech circuits, the reduction of harmonics, a quieter carrier wave and better facilities for monitoring and control make it capable of even higher quality transmission than that of the former equipment which has built up an enviable reputation for the stations that are now using it in the United States and other countries.



No. 6-A (1000 Watt) Radio Transmitter



No. 3-A (50 Watt) Radio Transmitter



(5000 Watt) Radio Transmitter

### Partial List of Stations Equipped with Western Electric Apparatus

#### 5000 Watt Stations

- American Tel. & Tel. Co., N. Y. .... WEAF-2XB
- U. S. Playing Card Co., Cincinnati, Ohio ..... WSAI
- Eale C. Anthony, Inc., Los Angeles, Cal. .... KFI
- The Crosley Radio Co., Cincinnati, Ohio ..... WLW
- The Palmer School of Chiropractic, Davenport, Iowa ..... WOC
- Zion Institution and Industries, (Wilbur Glenn Voliva) Zion, Ill. .... WCBD
- Peoples Pulpit Assn., Batavia, Ill. .... WORD
- Washburn & Crosby Co., Minneapolis, Minn. .... WCCO
- Radiophone Broadcasting Corp., Chicago, Ill. .... WHT
- Scars Roebuck & Co., Chicago, Ill. .... WLS
- Paulist Fathers, New York, N. Y. .... WLWL
- Jewett Radio & Phono. Co., Detroit, Mich. .... WJR
- Bankers Life Insurance Co., Des Moines, Iowa .... WHO
- Consolidated Gas, Electric Light & Power Company, Baltimore, Md. .... WBAL

#### 1000 Watt Stations

- Detroit (Mich.) News ..... WJW
- The Atlanta (Ga.) Journal ..... WSB
- Round Hills Radio Corp., So. Dartmouth, Mass. .... WMAF
- All American Radio Corp., Chicago, Ill. .... WENR
- Tenth Ave., Baptist Church, Oakland, Cal. .... KTAB
- Hale Brothers, San Francisco, Cal. .... KFO
- The National Life & Accident Ins. Co., Inc., Nashville, Tenn. .... WSM
- Larus & Bro. Company, Richmond, Va. .... WRVA
- Unity School of Christianity, Kansas City, Mo. .... WOQ
- Pasadena Star News, Pasadena, Cal. .... WHAP
- Wm. H. Taylor Finance Corporation, New York City ..... WIOD
- Miami Beach Bayshore Co., Miami Beach, Fla. .... WDAF
- City of Jacksonville, Jacksonville, Fla. .... KFQB
- Kansas City Star, Kansas City, Mo. .... WMAQ
- The Searchlight Publishing Co., Fort Worth, Texas
- Chicago Daily News, Chicago, Ill.
- M. M. Johnson Company, Clay Center, Neb.
- Shoreland Company, Miami, Florida

#### 500 Watt Stations

- Detroit (Mich.) Free Press ..... WCX
- Kansas City (Mo.) Star (Wm. R. Nelson Estate) ..... WDAF
- St. Louis (Mo.) Post Dispatch ..... KSD
- Louisville (Ky.) Courier-Journal Co. .... WHAS
- L. Bamberger & Company, Newark, N. J. .... WOR
- John Wanamaker, Philadelphia, Pa. .... WOP
- Sweeney Automobile School, Kansas City, Mo. .... WHB
- Missouri State Marketing Bureau, Jefferson City, Mo. .... WOS
- Rensselaer Polytechnic Institute, Troy, N. Y. .... WHAZ-2XAY
- Fort Worth (Tex.) Star Telegram (Fort Worth Pub. Co.) ..... WBAP
- The Chicago Daily News ..... WMAQ
- Dallas (Tex.) News (A. H. Belo & Co.) ..... WFAA
- Gimbel Brothers, Inc., Philadelphia, Pa. .... WIP
- Times Mirror Co., Los Angeles, Cal. .... KHJ
- City of Detroit (Mich.) Police Dept. .... KOP
- Oregonian Publishing Co., Portland, Ore. .... KGW
- Kaufman & Baer Co., and Pittsburgh Press ..... WCAE
- Memphis (Tenn.) Commercial-Appeal ..... WMC
- Sovereign Camp, Woodmen of the World, Omaha, Neb. .... WOAW
- Lit Brothers, Philadelphia, Pa. .... WLIT
- Chesapeake & Potomac Tel., Washington, D. C. .... WCAP
- The Outlook Co., (J. Samuels & Bro., Inc.) Providence, R. I. .... WJAR

#### 500 Watt Stations—Continued

- The Tribune Publishing Co., Oakland, Cal. .... KLX
- Echo Park Evangelistic Association, Echo Park, Los Angeles, Cal. .... KFSG
- The State University of Iowa, Iowa City, Ia. .... WSUI
- C. T. Sherer & Co., Worcester, Mass. .... WCTS
- Calumet Baking Powder Co., Chicago, Ill. .... WOJ
- D. W. Flint, Providence, R. I. .... WDWL
- Magnolia Petroleum Co., Beaumont, Texas .... KFDM
- Straubridge & Clothier, Philadelphia, Pa. .... WFI
- Reo Motor Car Co., Lansing, Mich. .... WREO
- The Edison Electric Illuminating Co., Boston, Mass. .... WEEI
- A. H. Grebe & Co., Richmond Hill, N. Y. .... WAHG
- Gimbel Bros., Inc., New York, N. Y. .... WGBS
- Express Publishing Co., Los Angeles, Cal. .... KNX
- City of Atlanta City, Atlanta City, N. J. .... WPG
- Concordia Seminary, St. Louis, Mo. .... KFQO
- Supreme Lodge of the World (Loyal Order of Moose), Mooseheart, Ill. .... WIJD
- The Travelers' Insurance Co., Hartford, Conn. .... WTHC
- University of Kansas, Lawrence, Kan. .... KFBU
- Woodlawn Theatre, Chicago, Ill. .... WMBB
- Hotel Arlington, Hot Springs, Ark. .... KTHS
- Kansas State Agricultural College, Manhattan, Kan. .... WTG
- Foster & McDonnell, Chicago, Ill. .... WBCN
- The Shepherd Stores, Boston, Mass. .... WNAC
- Peoples Pulpit Assn., Rossville, N. Y. .... WBR
- Stephens College, Columbia, Mo. .... KFBU
- Stanger Amusement Co., New Orleans, La. .... WMBM
- Fleetwood Hotel, Miami, Fla. .... WMBF
- Goodyear Tire & Rubber Co., Cleveland, Ohio .... WEAR
- Universal Broadcasting Co., Philadelphia, Pa. .... WCAU
- Monarch Mfg. Co., Council Bluffs, Iowa .... KOIL
- Florida Cities Finance Co., Miami, Fla. .... WGBU
- Vaughan School of Engineering, Milwaukee, Wis. .... WSOE
- Vanner Bros., Los Angeles, Cal. .... KFNB
- Experimenter Pub. Co., New York
- Congress Square Hotel, Portland, Me.
- May Seed and Nursery Co., Shenandoah, Iowa
- Moody Bible Institute, Chicago, Ill. .... WCHS
- Berry Seed and Nursery Company, Clarinda, Iowa
- First Baptist Church, San Jose, Cal. .... KMA
- Nicholas and Warriner, Long Beach, Cal. .... KFON
- Dallas Police and Fire Alarm Department, Dallas, Texas ..... WRR
- Hotel Lassen, Wichita, Kansas ..... WEAH
- G. H. Bowles, Clearwater, Fla. .... WDBD
- Chattanooga Radio Co., Chattanooga, Tenn. .... WDDO

#### 100 Watt Stations

- Rochester (N. Y.) Democrat and Chronicle and Eastman School of Music, Rochester, N. Y. .... WHAM
- Round Hills Radio Corp., So. Dartmouth, Mass. .... WSAQ
- Edison Electric Illuminating Co., Boston, Mass. .... WTAT
- Tremont Temple Baptist Church, Boston, Mass. .... WDBR
- Wm. F. Gabl. Co., Altoona, Pa. .... WFBG

#### 50 Watt Stations

- The Principia, St. Louis, Mo. .... WFQA
- Paris Dept. Store, San Francisco, Cal. .... KFRC
- First Baptist Church, Columbus, Ohio .... WMAN
- Dr. Louis L. Sherman, San Francisco, Cal. .... KFUS
- Pasadena (Cal.) Presbyterian Church .... KFPC
- Baxter Laundry, Grand Rapids, Mich. .... WBBG
- St. Paul's P. E. Church, Philadelphia, Pa. .... WIBG
- Glad Tidings Tabernacle, San Francisco, Cal. .... WJBR
- Brown Radio Shop, Portland, Ore. .... WJBR

1926-1927 catalog

# NEUTRODYNE

## Receiving Set

Manufactured under Hazeltine License, Patent No. 1450080

It is  
**SIMPLE**  
to  
**Operate**



Buy a  
**TRUE**  
Neutrodyne

We are pleased to announce that after eight months continuous research work we have perfected our WorkRite Neutrodyne set. Prof. Hazeltine, inventor of the Neutrodyne circuit, personally assisted us in our factory in Cleveland in attaining this result.

Our branch factory in Los Angeles, under the management of Mr. Kruger, is equipped in every way to produce mechanically perfect sets which at the same time provides an expert service available at any time to all purchasers of WorkRite Neutrodyne sets.

We are now producing our Neutrodynes in three styles:

Type B201A	\$140.00
Type B201B	160.00
Type B201C	175.00
Type B201D	300.00
Without accessories.	

We solicit inquiries from jobbers and dealers. Exclusive territory now available.

Neutrodyne marks the dawn of a new era in the science of Radio reception. It is the most wonderful and far reaching, fundamental discovery in Radio during the last ten years for obtaining—

**DISTANCE—SELECTIVITY—CLARITY—VOLUME** and complete elimination of tube and other extraneous noises. Local stations come in on the loud speaker without antenna or ground. Distant stations come in with antenna and ground on the loud speaker while the local stations are broadcasting, without the slightest interference.

New York City, Chicago, Denver, Honolulu, Fort Worth, Omaha, Hastings, Cincinnati are being brought in daily on the loud speaker, while the local stations are on the air. Stations in Oakland and San Francisco come in with almost the same strength and clarity as local stations.

**WARNING: Do not purchase any Neutrodyne set unless it is made under the Hazeltine license; otherwise they are not Neutrodynes and will prove unsatisfactory.**

### B. KRUGER & CO.

315-317 Stimson Building, Third and Spring Sts., Los Angeles, Cal.  
Distributors Pacific Coast and Western States

WESTERN BRANCH FACTORY OF THE WORKRITE MANUFACTURING CO., CLEVELAND, O.  
WE EXTEND AN INVITATION TO ALL READERS OF "RADIO JOURNAL" TO VISIT OUR BOOTHS  
NO. 26 AT THE RADIO EXPOSITION, WHERE OUR LATEST MODELS WILL BE  
FIRST OFFICIALLY SHOWN

Radio Journal (Jan. 1924)

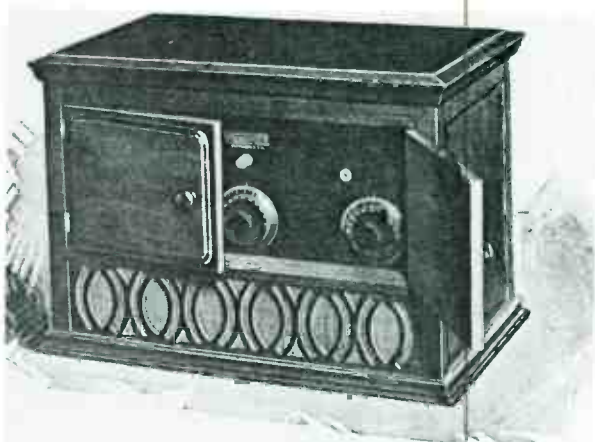

Kit instruction booklet

**WorkRite Neutro-Grand, Sr.**  
With built-in Loud Speaker. Price \$200.00

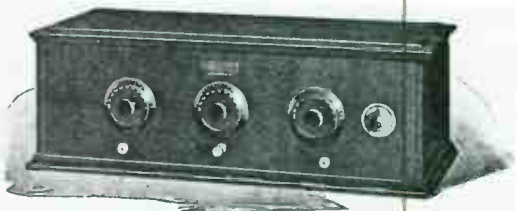

**WorkRite Neutro-Grand, Jr.**  
Price \$140.00

# Neutrodyne at the Radio Show

(Licensed) under Hazeltine Patent No. 1450080

Distance and Selectivity Guaranteed

See Us At  
Booth 34  
Hotel Biltmore



**WorkRite**  
**Neutrodyne**  
**Model 201A**  
  
Price Complete  
**\$175.00**

—and we  
mean complete.

Geo. W. Perkins, 2220 W. 31st Street, Los Angeles, hears K S D (St. Louis), K Y W (Chicago) and W O R (Newark, N. J.) on the loud speaker while local stations are on.

- A complete receiver comprises the following:
- 1 Neutrodyne Set, in genuine walnut cabinet, size 10x16x10.
  - 5 Cunningham 301-A Tubes.
  - 1 Hobbs Battery or Willard Battery and Charger.
  - 1 Trutone Loud Speaker.
  - 1 Speaker Plug.
  - 4 Large 22½-volt Ever-ready B Batteries.

NOTE—These sets are made especially for us to our specifications by Kruger & Company Western Factory Branch of Workrite Mfg. Co., Cleveland.

Please do not confuse it with the long, unsightly assemblies thrown together by the amateur. It is factory built and to very rigid specifications. Come and see for yourself!

### Patterson Electric Company

239 South Los Angeles Street  
Telephones 828-139; Main 5884 Los Angeles, California

**WELLMAN-FYRESM CO.**  
624 E. 63rd Street  
Chicago, Ill.

January 28, 1924.

Patterson Electric Co.,  
239 So. Los Angeles St.  
Los Angeles, Cal.

Dear Sirs:

I want to thank you on behalf of Mrs. Wellman and myself for the courtesy shown us last Friday evening, January 25th, when our son, Charlie Wellman, sang to us from K Y W Westinghouse Radio Station in Chicago and was received on the loud speaker in your studio.

We were doubtful whether we could receive a guarantee that we would be able to hear him on a certain date. In fact we had been trying for months to find a receiving set that would receive Chicago. As you will remember we came into your office Tuesday, January 22nd and asked if we could hear our son, Charlie Wellman, sing from Radio K Y W Chicago over your set. Without hesitation you said yes, and made the appointment for the Friday evening following.

We want to say that we were more than pleased with the reception and you can rest assured that we will give you the best recommendation possible.

Very truly yours,  
(Signed) A. L. WELLMAN,  
1775 Los Palmas Ave.,  
Hollywood, Cal.

(This letter is on file at our office)

Radio Doings (Feb. 2, 1924)

# WORKRITE

## The Workrite Manufacturing Company

**W**orkrite began as the National Motor Supply Co. in 1909, making automotive accessories and air compressors. Vernon H. Meyer (1883-1959) switched his company's production to horns and radio components in 1921, advertising nationally in September 1922. Sometime before the end of 1923, Workrite joined the Independent Radio Manufacturers, Inc., and acquired a Hazeltine Neutrodyne license. Workrite offered a knock-down (kit) model while its "West Coast Branch" factory of Kruger & Co. advertised completely wired sets in a variety of cabinets in December 1923 and January 1924. Workrite's own factory-wired models came out in March 1924: the Neutro-Grand Junior and Senior.

In May 1924 the company moved from 5518 Euclid Avenue in Cleveland to a new plant at 1812 E. 13th Street and soon came out with a new lineup of models, the first to look factory-made rather than kit-built. In September 1924 the new line was supposedly selling so well that Workrite opened a third factory in Chicago; by November, it had doubled its floor space in the Cleveland plant. Another factory was later operated in Brantford, Ontario. Sales in 1924 were \$227,143.04 (wholesale) as reported to Hazeltine. The company estimated that 160,000 Workrite sets were still in use in 1929.

In January 1925 however, Workrite found it necessary to cut its prices, and a Cleveland dealer was quoted in a trade magazine:

"The reporter's question: "How is the Neutrodyne set going in your section?"

"Why, it wasn't going at all, until Workrite cut prices on their products. We are getting some life on the Workrite now, but if we had all the Freshman sets that we wanted, and have ordered, we would not do such a marked business on the Workrite line."

Obviously, Workrite faced stiff price competition. The 1926 models, which were introduced in October 1925, appeared to be rearrangements of previous models; not until July 1926 was anything really different offered.

In August 1927, Workrite combined with Apex, Case, Sentinel, and Slagle to form the United States



V. H. MEYER

Radio Retailing (Oct. 1927)

Electric Corp. in order to obtain an RCA patent license. None of the companies individually was large enough to guarantee RCA the necessary \$100,000 per year in 7 1/2 percent royalty payments. This merger was supposed to become effective on January 1, 1928, but one of the companies (probably Workrite) failed and forced the others into receivership to protect themselves. Workrite pulled out and tried to get along without RCA, relying on its Neutrodyne license alone. Its last model series appeared in August, 1928, although so far as is known, it was never advertised. Sometime between 1926 and 1928, the Akrodyne Radio Manufacturing Co. of Cleveland built one three-dial model under Workrite's Neutrodyne license (Akrodynes were formerly made by Sunbeam in New York City).

Workrite was sold to George W. Walker and reorganized in August 1929. Meyer moved to Glendale, California, where for many years he made toys, automotive components, and electronic devices under the name of Workrite Products Company. Walker's "Workrite Radio Corp." remained in Cleveland and advertised "Walker Flexi-Units" and short-wave converters in 1930 but vanished afterward.



“Daddy, let’s get Los Angeles!”

“All right, son, that’s easy. We’ll turn the dials to 55 and get it sure, if it’s on the air.”

That’s one of the delightful things about WorkRite Super Neutrodyne Receivers. The first time you pick up a station just jot down the dial settings. After that, simply refer to your “log” and set the dials at the positions it indicates. Immediately, the station you want comes drifting in sweet and clear—and entirely free from disturbing howls or whistles.

Under favorable conditions WorkRite will go clear across the continent for you. It will bring in far-off stations regularly and distinctly on the loud speaker. Broadcasting from points 500 or 600 miles distant comes in almost as strong as that of your own home town stations.

And think of this! You can tune out powerful local stations with the utmost ease, and bring in others, using practically the same wave length, without the slightest interference. For WorkRite selectivity is simply amazing.

Experts endorse WorkRite, of course, but even tho you have never operated a radio receiver, you’ll get the real thrill and joy of radio the first time you try one of these

remarkable sets. Years of experience in radio manufacture, the finest of materials, and the most skillful workmanship, all combine to make WorkRite wonderfully easy to use.

WorkRite Receivers are as distinguished in appearance as they are in performance. Read the individual descriptions of the beautiful, artistic models shown on this page.

Remember, too, that WorkRite Receivers are absolutely new. Your dealer may not be fully informed as to their advantages. But don’t make your radio investment until you know all about the WorkRite models. Any of them will put in your home a source of ever-changing amusement and pleasure. If your dealer is unable to demonstrate WorkRite for you, write us for the name of the nearest WorkRite dealer. Beautifully illustrated folder with full information on all models will be sent you on request.

THE WORKRITE MANUFACTURING COMPANY  
 1812 EAST 30TH STREET CLEVELAND, OHIO  
 Branches: Chicago, 516 Lake Shore Drive, Los Angeles, 239 South 1st Angeles Street

DEALERS—If you don’t know about WorkRite Super Neutrodyne Receivers, by all means write us immediately for full particulars.

# WORKRITE

## SUPER NEUTRODYNE RADIO SETS

First advertised in July, 1924. Prices after January, 1925: \$120, \$170, and \$350.



WORKRITE AIR MASTER

Like all WorkRite models, this is a 5 tube set, encased in genuine crown mahogany cabinet with graceful sloping panel. Almost identical with WorkRite Radio King, shown in main illustration, except the latter has a loud speaker built into cabinet behind a handsome grille. Both furnished with plug and special cable carrying all battery wires.

Price, Air Master, without accessories, \$160  
 Price, Radio King, without accessories, \$220



WORKRITE ARISTOCRAT

In this beautiful mahogany console, the loud speaker with special horn and reproducing unit is placed on one side and compartment for A and B batteries on other side. All connections made inside with cable and plug. Front drops, forming arm-rest for tuning or writing. Drawer beneath drop is provided for log sheets, etc. A set unsurpassed in any respect.

Price, Aristocrat, without accessories, \$350

# WORKRITE

SUPER NEUTRODYNE RADIO SETS



## Announcing the Wonderful CHUM

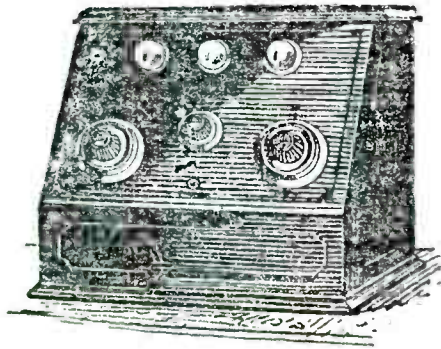

A 3-Tube Neutrodyne  
That Out-Performs  
Most 4-Tube Sets

\$65

**H**ERE'S a brand new 3-tube reflexed Neutrodyne—one that sells for a remarkably low price. You have never seen a 4-tube set—even one that costs many dollars more—that could beat it.

The WorkRite Chum has a remarkable range. Distant stations—fully a thousand miles away—come in clearly and distinctly on the loud speaker. Under favorable conditions the Chum will cover a much larger area—and without whistles, howls or distortion to spoil your fun.

It has selectivity, too. Tunes out local stations and brings in others clearly and sweetly as can be.

This beautifully built set is self-contained. There is space in the handsome dark mahogany cabinet for both A and B dry batteries. It works with any kind of an aerial—outdoor or indoor—and is always ready for instant use—any time or any place.

You must hear the Chum or any of the other famous WorkRite sets to appreciate real radio reception. Sit at the dials yourself. Get the real thrill of radio from WorkRite. We will gladly demonstrate for you.



### WORKRITE AIR MASTER

*A 5-tube Neutrodyne Set*

Encased in brown mahogany cabinet with graceful sloping panel. Almost identical with WorkRite Radio King, except the latter has a loud speaker built into cabinet.

*Air Master, without accessories \$120*

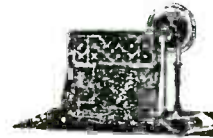

### WORKRITE RADIO KING

*A 5-tube Neutrodyne Set*

Identical to Air Master except it has remarkably fine distortionless loud speaker built into cabinet.

*Radio King, without accessories \$170*

### WORKRITE ARISTOCRAT

*A 5-tube Neutrodyne Set*

*Without accessories ..... \$350*

*Wholesale Distributors*

## Blackman Talking Machine Co., Inc.

28 West 23rd Street, New York City

Musical Products Distributing Co., Inc.

22 West 19th Street  
New York City

Wholesale Radio Equipment Co.

115 Leonard Street, New York City  
37 William Street, Newark, N. J.

Six-tube models (Oct. 1925): Air Master \$125, Radio King \$170, Aristocrat \$275.

New York Herald-Tribune (Dec. 21, 1921)





Radio Guide (July 1925)

WHERE WORKRITE NEUTRODYNES ARE MADE IN CLEVELAND, OHIO



John Wolkonowicz

Chum December 1924 \$65



Gary Schneider

Winner Five October 1925 \$80  
 Winner Six October 1925 \$90

# Line up with WORKRITE The Sensation of the Season



**WorkRite Model 16**  
A six-tube transformer and resistance coupled neutrodyne receiver. Two-dial control. Beautiful walnut cabinet. List Price \$80.00



**WorkRite Model 26**  
The same circuit and control as the Model 16 mounted in a handsome walnut console cabinet with built-in cover speaker. 22 in. wide. List Price \$145.00

**WorkRite Model 36**  
(Larger illustration in center)

The supreme accomplishment of the season. Six-tube transformer resistance coupled neutrodyne circuit. Three way switch—"Off," "Soft," "Loud"—gives wonderful volume control. Two-in-one dial operates all three condensers from one control, large built-in cover speaker, 25 in. wide. Price \$210.00.

## WORKRITE Radios WORKRITE

**P**RACTICAL refinements in control and circuit together with more attractive cabinets and fittings make the new WorkRite Super Neutrodyne Radio Sets the sensation of the season. This is bound to be a big Neutrodyne year.

A conservative well financed company with five years of radio experience is manufacturing WorkRite radio sets. The WorkRite line is established and will be on the market year after year.

Your greatest radio profits will be made in lining up with this progressive company and doing with them an ever increasing volume of profitable business.

WorkRite dealers have exclusive franchises. Write or wire at once. Your territory may be open.

**THE WORKRITE MANUFACTURING CO.**  
1819 East 30th St., Cleveland, Ohio

First advertised in July 1926.

# Which franchise would You prefer?



10 Sales per Season



50 Sales per Season



As a price proposition the answer is obvious  
/ / / / / so let's talk quality!

QUALITY is self-evident in the WorkRite 37. In fact people expect it to cost much more than it does. And naturally so. Where can they get a one dial 8-tube super-circuit with all copper-shielding, ball bearing, positive-control tuning and all-metal chassis for \$160.00? Where can such a magnificent craftsman-designed cabinet be obtained, for anywhere near this price? And above all where such truly fine radio reception?

Because of its copper-shielded fea-

*The WorkRite franchise is available to enterprising dealers in every locality. Our Sales Department will be pleased to give you the necessary information.*

ture WorkRite 37 is one of the few sets at any price that you can sell with confidence even to those who are troubled by interference from street cars, electric railways, oil burners, flashing signs, nearby power houses and the like.

This very same quality enables you to demonstrate your set in your downtown showroom.

From beginning to end WorkRite 37 is a set of quality in design and construction. Its tone quality will delight you.



### WorkRite Model 17

A single illuminated dial control 6-tube radio receiver housed in a beautiful walnut cabinet.

Price . . . . . \$95.00

### WorkRite Model 26

A 6-tube radio receiver housed in a pleasing walnut console having built-in cone speaker and ample space for batteries or power units.

Price . . . . . \$160.00

### WorkRite Cone Speaker Something New!

Send for Folder



Manufactured by  
THE WORKRITE MFG. CO.  
1812 East 30th Street  
Cleveland, Ohio

In Canada: WORKRITE RADIOS, Ltd.,  
Brantford, Ontario

Sales Department  
THE ZINKE COMPANY  
1323 So. Michigan Blvd.  
Chicago, Ill.

Model 37 was first advertised in June.

### Eight-Tube Console

The United States Electric Corporation, WorkRite Division, Cleveland, Ohio, is placing on the market the illustrated 8-tube console model receiving set with an all-electric chassis, complete copper shielding, and a single drum type illuminated control with double ball-bearing friction drive. The cabinet is made of walnut with a built-in speaker and A, B, C-power unit. The intended retail price, including chassis, speaker, power unit and cabinet, is \$310. This company also builds a 6-tube console, with specifications same as the above 8-tube model, with an intended retail price of \$225, which includes chassis, speaker, power unit and cabinet.—*Radio Retailing*, January, 1928.

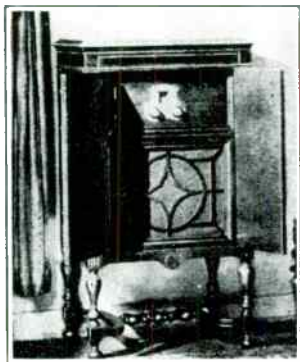

August 1928 models (not shown):

- 18 \$128 table
- 28 \$195 console
- 58 \$75 chassis only
- 38 \$160 table
- 48 \$250 console

## GEORGE W. WALKER FLEXI-UNIT



Showing No. '01 Adapter Plug

**FLEXI-UNIT**  
Exclusive Features  
(Possessed by No Other Device on the Market)

Efficient reception of the entire wave band of 15 to 550 meters with four silk insulated plug-in coils. An attractive Aluminum Cast Shield of 3/4" thickness to insure against body or hand capacity. Unit may be used with either A, C, or Battery receivers, or as an individual single tube receiver for short or long waves. Unique antenna connection arrangement insures freedom of oscillation at all frequencies without dead spots. Serves many purposes. Indestructible! Simple to operate—and inexpensive!

Write for Free Literature

One of America's Pioneer Radio Manufacturers  
**THE WORKRITE RADIO CORP.** Cleveland, Ohio

A Flexible Radio Device of Unlimited Application

- Short Wave Receiver
  - Short Wave Adapter
  - Regular Broadcast Tuner
  - R. F. Pre-Amplifier (Booster)
  - Radio "Experimental" Unit
  - Oscillator Wavetrap
- USE THIS UNIT AHEAD OF YOUR SHORT WAVE TUNER AS A R. F. BOOSTER**

Should your dealer be unable to serve you promptly—Mail your order direct to factory.

No. '01 Adapter Plug (Battery) \$2.00  
No. '27 Detector Plug (A.C. Set) 2.50  
No. '27 R.F. Adapter Plug (A.C. Set) 3.00

List Price \$16.00

Citizens Call Book (Sept. 1930)

## GEO. W. WALKER "MULTI-UNIT"

Well Deserves Its Popularity

Use Same Multi-Unit with Either A-C or Battery Type Receiver The Only Device of Its Kind in the Radio Market—Anywhere

### A RADIO RECEIVER IN ITSELF



SHORT WAVE RECEIVER  
SHORT WAVE ADAPTER

Regular Broadcast Receiver—Screen Grid Pre-Amplifier—Radio Frequency Oscillator—Extra Stage Tuned R. F.—Radio Frequency Booster—Radio "Experimental" Unit—Wavemeter—Wavetrap—etc.

One of the most unusual radio instruments ever devised. Will perform any individual function of a complete receiver, and in addition, may be used for calibrating, testing or checking. Makes a wonderful broadcast receiver, short wave receiver or transmitter. Oscillates violently over the entire scale range from 550 meters down to 15. Uses all tubes 199 to 210 and all voltages, A.C., D.C., or rectified.

Nothing like it ever placed on the market before. Serves as either an extra stage of tuned radio frequency or short wave adapter, by merely plugging into one of the tube sockets of the receiver. Tools or radio knowledge not necessary. The complete unit including four-lead plug-in adapter, plug-in coils, screen grid cap clip, etc., is housed in an attractive case, neatly finished. Complete non-technical instructions furnished. Box measures 7 1/2 x 5 x 3 1/4 in.

Ask Your Favorite

Radio Magazine Editor

About the Multi-Unit

Read What Enthusiastic Multi-Unit Fans Say—

"Using my Walker Multi-Unit for about 5 hours today, and among others picked up was one Short Wave station at Paris, France."—Geo. H. Keller, 267 Delaware Ave., Albany, N. Y.

"Purchased one of your Multi-Units and am very pleased—using it as an Extra Stage of R.F. at present. I have found it to be a very good Short Wave Unit."—R. L. Colosky, 1032 Chickamas St., Portland, Ore.

"I bought a Multi-Unit and it's great. I am getting stations I never got before—it cuts down static."—James Woodrow, 2132 Lloyd St., Milwaukee.

"I have one of your Multi-Units. It worked fine. I got your town, Dallas, Chicago, Salt Lake City, Winnipeg."—Frank Becker, Box 30, Russel, N. Dak.

"Your Unit is wonderful. Lots of pleasure picking up Short Wave Broadcasting with unit applied to an old 6-tube Freshman."—Ed. H. Ehrham, 4740 Greenwood Ave., Chicago, Ill.

"I got a Walker Multi-Unit from you some time ago. I am very well pleased."—A. I. Deniers, 2017 Ahlen Drive, Montrose, Calif.

"Have one of your very remarkable Multi-Units, and I wish to say that it has performed wonderfully. It works exceptionally well on Short Waves."—C. Heidon Baxter, 638 Marine St., Mobile, Ala.

"As a Radio Frequency Amplifier with a 199 tube, it certainly performed beautifully and added a lot of power to the Radiola 20."—Robert S. Alter, Cincinnati, Ohio.

"Have received Amateur Phone Stations, also Short Wave Broadcasts from KDKA, WLS, 2XZ (WABC), and 2XAL. Also heard WOO on board the 'Leviathan' talking to WSPX. Received this with sufficient volume on loud speaker to be heard in next room. Absolutely clear, no squeals, or loud capacity. I am more than pleased with the Unit."—A. F. Colton, 622 Evergreen St., Ashland, Ohio.

"Received several Short Wave stations right off the reel. I expect to receive Europe."—Patrick Curry, 203 14th St., Jersey City, N. J.

"I have been using your Multi-Unit as a one-tube receiver, employing a 201-A tube with very good results."—Nathan Edwards, 3433 Indiana Ave., Chicago.

"Your Walker Multi-Unit is a wonder in Radio achievement. I wouldn't take \$25.00 for mine if I could not get another."—Win. Houserman, Route 6, Kingfisher, Okla.

"I use the Unit as an R.F. Booster and the results are wonderful. Distance comes in like locals."—S. F. Kisco, 7511 Ridgeland Ave., Chicago, Ill.

"I have one of your Multi-Units and it has done everything as you have stated. I have also used it as a Modulator Oscillator and it has done as good as higher priced equipment. As a Short Wave with my Atwater Kent it reminded me of old times. The Radio Public don't know what they miss."—James M. Griffin, 2426 Fairview Ave., Wichita, Kansas.

"The 'Booster' works fine. I have been able to get a lot of stations in the daytime that I could not get before. Tried the one tube arrangement and can get WLW and WENR (Chicago)."—Edw. A. Schneider, 416 Capitol Bldg., Harrisburgh, Pa.

Should Your Dealer Be Unable to Serve You—Mail Your Remittance Directly to Factory  
**\$16.00—NOW IS THE TIME TO BUY!—\$16.00**  
FREE MULTI-UNIT FOLDER MAILED UPON REQUEST

One of America's Pioneer Radio Manufacturers

**THE WORKRITE RADIO CORP.**  
1835 East 30th Street Cleveland, Ohio

Citizens Call Book (Jan. 1930)

# Long-Distance Radio Talk With Small Power

*One-Third Kilowatt Set Talks from New York to Topeka, Fifteen Hundred Miles*

By MERLIN MOORE TAYLOR

**G**UGLIELMO MARCONI, the wireless expert, said in a moment of enthusiasm the other day that "within the year wireless telephones will supplant the present clumsy system with great economic advantage." This is taken to indicate that Mr. Marconi thinks that the wire plant, as part of a system of telephone communication, is soon to become a thing of the past. But is it?

"Central" need not worry over the possible loss of her job in the near future. She will be needed for a long time to come, even if the radio telephone does become the commercial possibility that recent experiments would indicate. Right now it would be possible to put the wireless telephone into practical use for long distance work in such cities as Chicago and New York, were it not for the expense of generating power. Even that is being overcome by nightly tests which have proved that it is possible to send the human voice through space as far as 1,500 miles with a generator that boasts only one-third of a kilowatt of power.

The De Forest Radio Company of New York has enlisted the aid of the half-million members of the American Radio Relay League in its experiments. Almost nightly tests are arranged whereby at specified

clamped to their ears, straining to hear the music of a phonograph being played in New York or the voice of a New York operator trying to reach them. Only one or

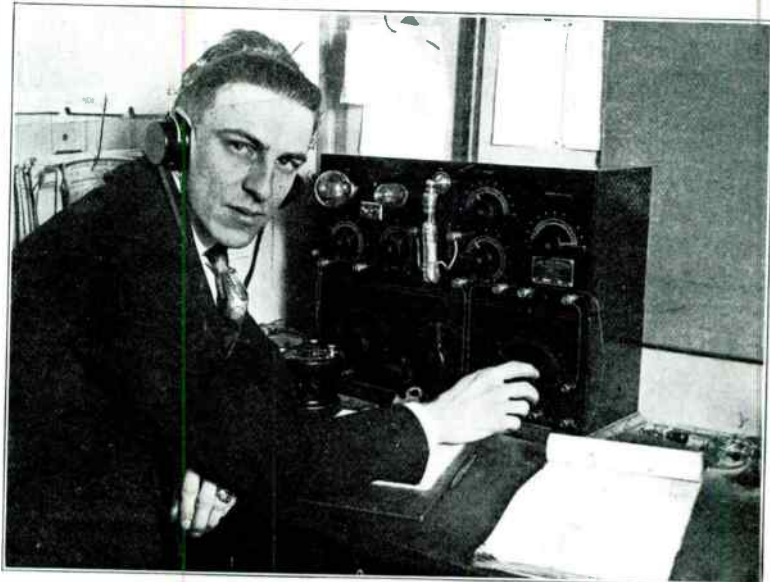

*R. H. G. Mathews, of Chicago Radio Laboratory, who has a conversation with Robert F. Gowen, inventor, of New York City, practically every night between 10 and 11 P. M. Mr. Gowen generally gives current New York news and follows this with music from his Victrola. Mathews hears signals at stations on both coasts, and from ships on the ocean and gulf as well as lakes. At times he can hear French and German stations.*

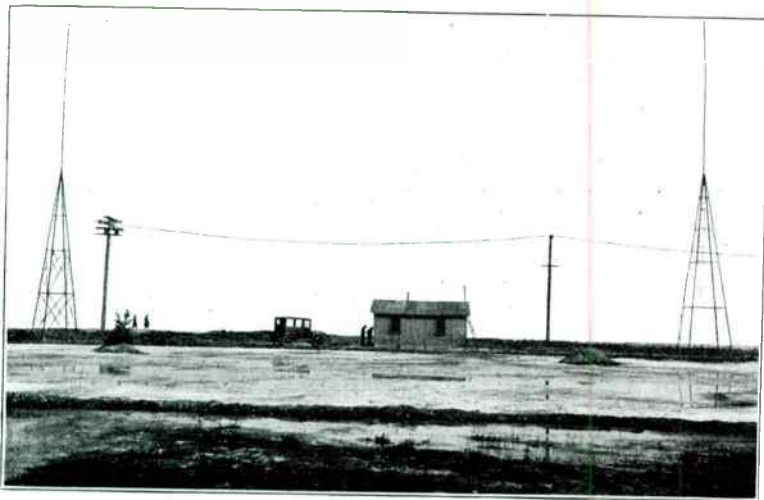

Photos by International Film Service.

*The Chicago Radio Laboratories at 5525 Sheridan Road, on the shore of Lake Michigan, where the wireless telephone waves sent out from the New York Station were first detected.*

two stations are equipped with the vacuum tubes which make it possible to send the human voice, so the results of the tests are reported by wireless telegraph, and later confirmed by mail.

The tests began in February with Robert F. Gowen, engineer of the De Forest Company, on the New York end, and R. H. G. Mathews of Chicago, former United States navy instructor and vice-president of the American Radio Relay League, at the receivers in his laboratory on the banks of Lake Michigan in Chicago. Night after night, from ten o'clock until midnight, they worked in an effort to get in communication. Mathews meanwhile had notified his fellow members of what was being done and asked them to be on the alert. Various arrangements of amplifiers and coils were tried until finally, one night, Mathews caught Gowen's voice, low and hazy, but plain enough to distinguish the words.

Telephone Engineer (Apr. 1920)

Continued on page 248.

# ZENITH

## Zenith Radio Corporation

**T**he story of Zenith revolves around four men: R. H. G. Mathews and Karl Hassel founded it while E. F. McDonald and Hugh Robertson set its course for fifty years.

R. H. G. Mathews was born on January 16, 1897, and moved from Springfield, Ohio, to Chicago in 1910. He operated amateur radio stations RM; 9IK; and, finally in 1916, 9ZN — probably the best-known and most active station in the Midwest. He enlisted in the Navy in April, 1917, persuading a number of his amateur friends to sign up, too — among them was Karl Hassel. Hassel was born in Sharon, Pennsylvania, on January 25, 1896, and had known Mathews from operating the University of Pittsburgh radio station.

### Chicago Radio Laboratory

Shortly after Mathews' release from active duty at the war's end, the two built and operated a long-wave receiving station for the *Chicago Tribune* to get news from the Versailles Peace Conference. In anticipation of amateur privileges being restored, Mathews and Hassel formed the Chicago Radio Laboratory on July 1, 1919, designing and building amplifiers to be used with the Adams-Morgan Paragon RA-6. Originally, these were built in Mathews' Carmen Avenue apartment on his mother's kitchen table until the pair erected a knock-down, two-car garage on an empty lot owned by the Edgewater Beach Hotel. They scrounged old windmill towers for antenna supports. This 14 x 18-foot building provided space for 9ZN and for the "factory" with a production of one set per week.

While they advertised a "motor boat" receiver and a "jeweler's time" set, their main business was with the hams. At first, they were limited to selling Adams-Morgan Paragons; but as soon as Mathews could negotiate with Armstrong for a regenerative-circuit license (May 15, 1920), they began turning out



COMMANDER E. F. McDONALD  
President, Zenith Radio Corporation

Radio Guide (Apr. 1925)

their own Paragons, differing mainly in binding-post placement (for connection to their detector-amplifiers, or Amplifigons). Naturally, this did not sit too well with the Adams-Morgan Co., even though it had abandoned the old RA-6 by October 1920 in favor of the much-improved RA-10. In the following February, Adams-Morgan enforced its copyright on the Paragon name, making CRL change to "ZNith Regenerator."

In March 1921 CRL moved to the third floor of a factory building on Ravenswood Avenue with a motor-driven drill press and a payroll of six employees, booming production to ten sets per week. Here CRL might have remained: a small company, run by young men with no business experience, supplying a limited market of radio hams with a hand-made product. But one man changed that: Eugene F. McDonald, Jr.

tapped out on his radio key and Gowen sent back instructions for a change in the modulation. Mathews made them and listened again. Suddenly he got the right combination and others, standing around his instrument board, could plainly hear Gowen without the aid of receivers. Then the New York man put on a jazz record in a talking machine, and had the Chicago station been large enough, a dance could have been held, so plain was the music.

The greatest surprise was yet to come. Gowen, elated over having made his voice heard in Chicago, 750 miles away, with a low power generator, got letters proving that operators in Topeka, Kan., 1,200 miles away, Valley City, N. D.; Battle Creek, Mich., and Gaffney, S. C., also had heard him. They repeated the remarks he had made and named the tune he had played. Not only had he accomplished what he was trying to do, make himself heard 750 miles away, but he had sent his voice twice that far!

Wireless telephones as a success are not new. The navy used them during the war, the Department of the Interior has equipped its rangers in the forests of the west with small sets with a small range, in China the radio telephone is being used for communication between the cities and rural districts, and London and Rome have been holding successful communication. But to make the voice audible for hundreds of miles with only a small power generator is absolutely new and it is upon that success of the wireless telephone

when a year ago United States navy operators, with President Wilson, Secretary Daniels and other notables as guests, sent the human voice around the world, a generator of 300 kilowatt power was used, a long wave length (something like 3,000 meters) was used, and it cost several thousand dollars to talk for only a few brief moments. With the low power generator in use, one of a third to a half kilowatt power, and a wave length of around 360 meters the radio telephone becomes something within the reach of almost anyone interested in wireless.

Now as to what it means to the telephone companies. Use of the telephone for long-distance communication is more and more replacing the mails and the telegraph in business transactions. The number of trunk lines between cities necessarily is limited, and it is no unusual thing for a patron to be asked to wait two or more hours before his connection can be made, because there are so many calls ahead of him. With the radiophone there is no limit to the number of trunk lines, for the air is boundless.

When the telephone companies accept the wireless telephone with low power generators as a substitute for the wire system, it will be only the work of a few minutes to set up a long distance connection. This does not mean that it is possible, or probable, that residences or business houses will at any time in the near future discard the present telephone for radio but it does mean that the telephone "central" can also be done

on an air transmission system to go ahead and talk without waiting for one of the wires to become idle.

And the patron? He won't know, unless he is in touch with scientific developments, that his voice is being carried through the air instead of over a copper wire. He may notice that the voice of the man he is talking to is more clear and distinct than in the usual telephone conversation, and he may be aware of the fact that the clash and clatter in his ears are missing, but that is all.

An interesting experiment to prove that this is possible was staged at a convention of automotive engineers, who spent a day in Michigan, across the lake from Chicago. A motorboat, equipped with the wireless telephone, was sent out on the lake several miles. Then the operator got into communication with a radio switchboard set up for the benefit of the engineers in Michigan, was connected with a regular telephone, and the rest of the conversation was finished over the wires in a telephone in Chicago.

Interesting as all this is, the operator need not worry. The radiophone will not supplant the wire telephone during her lifetime. It will supplement it, just as the wireless telegraph is supplementary to the cable lines.

Just now a pocket size wireless telephone is being made which will be able to establish communication with its companion apparatus at any time. Thus a business man can talk to his home or his office from any point he may happen to be, within the radius of his pocket instrument, if the notion seizes him.



C. R. I. GENERAL OFFICES AND FACTORY  
6433 RAVENSWOOD AVENUE

*Radio Topics* (Apr. 1921)

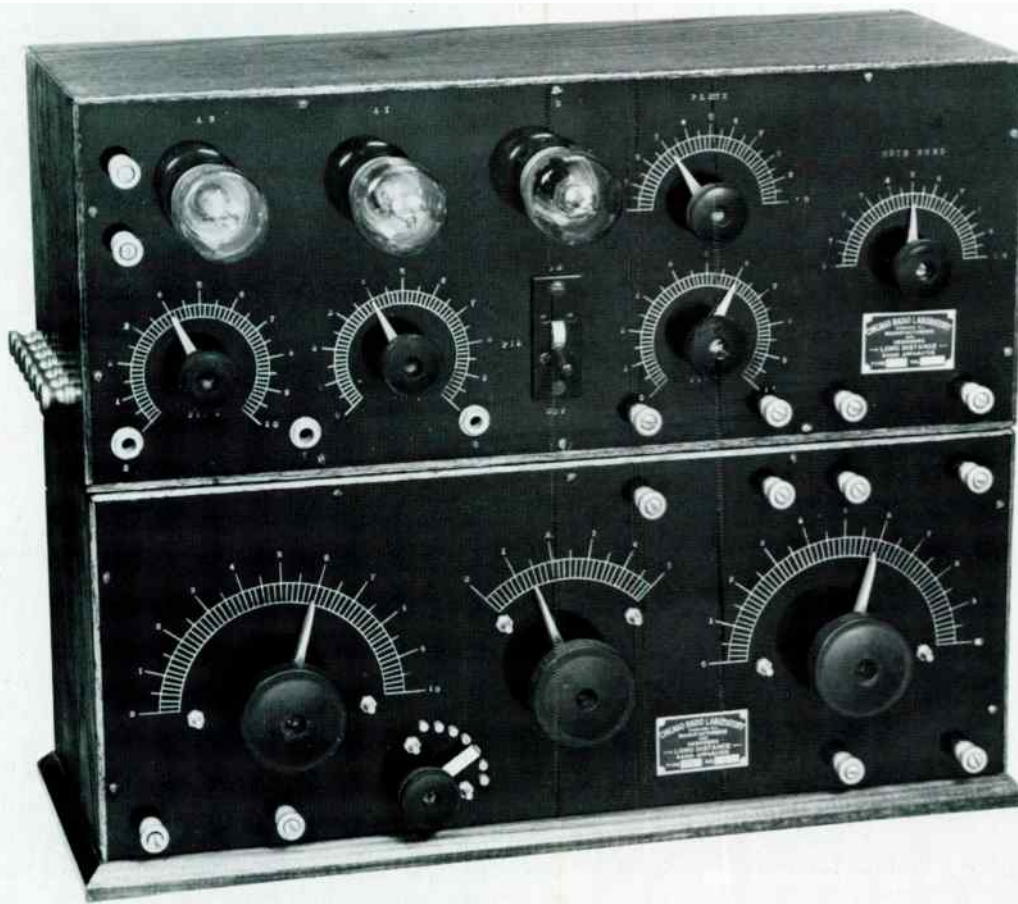

Paragon & AGN2 May 1920 \$55, \$90

According to Mathews, these sets were built twelve at a time by three workmen, taking two or three weeks per run. Later, they made twenty of them at a time. From a study of serial numbers, it appears that about 300 Paragons were made, and about 150 to 200 Amplifigons.



### A Necessity in Using the New Underground Antennae

Static elimination by the use of the Rogers underground antennae is perhaps the most striking and far reaching discovery made during the war. By this system "Static" is absolutely eliminated, the only atmospheric interference remaining being due to ground strays. In cutting out the static, however, the signal strength on 200 meters is also reduced to about one-eighth the value of the same signal on an ordinary antenna. In order to render ordinary signals, readable on the underground antenna it is therefore necessary to use one or more steps of amplification.

Our Amplifier, type AMP-1, illustrated above is especially valuable in such work owing to the high degree of amplification secured by its use. Its mechanical construction is as perfect as it can be made. The cabinet is finished in golden oak, with polished Bakelite front. All scales are engraved into the panel, and all parts are submounted, with no supporting screws on the panel front.

The amplifier coil used is the same special static-coupled type as is used in our "Amplifon" and comparative tests have shown it to be greatly superior to any other coil now on the market. We ask you to compare our price for this cabinet with the prices of others whose quality does not approach ours.

- One step Amplifier, type AMP-1 (without bulb or battery) \$ 7.00
- Two step Amplifier, type AMP-2 (without bulb or battery) \$13.00
- Static-coupled Amplifier-coil only, mounted on base \$10.00

**Chicago Radio Laboratory**

1316 CARMEN AVE.  
CHICAGO, - ILL.

### Commander McDonald

Born in 1886 in Syracuse, New York, where his father ran a store, McDonald worked in the Franklin automobile factory and then sold cars. In the years before World War I, he made a fortune in time payments on commercial autos, then sold his business in 1917, and joined Navy Intelligence with the rank of Lieutenant Commander. Looking for a business to enter after the war, he saw his first radio on New Year's Eve, 1920, while picking up his Packard at a garage. Ordering one from the Chicago Radio Laboratory, he found that this company possessed an Armstrong license and could build excellent equipment, but needed financing and direction. The Commander proposed to supply both.

QST (Aug. 1919)



Zenith/Dale Goodwin

R. H. G. Mathews (left) and an unidentified man at the ARRL Convention in Chicago, August 31-September 3, 1921.





This is the largest factory in the world devoted exclusively to the manufacture of music rolls for player pianos, and Q R S Quality built it.

QRS (1920 catalog)



Thomas M. Pletcher (1871-1950)

QRS Music Rolls, Inc.

### Montana Listens to Pittsburgh 1,500 Miles Away

Stevensville, Montana, is in the heart of the Rockies—yet through 1500 miles of intervening space and directly through the high mountains that surround the town came the "voices of the air"—from KDKA, Pittsburgh—clearly heard by

*The Ear of the World*

The following unsolicited letter from Ashley C Dixon, Stevensville, Montana, tells the story—



**Long Distance Radio**  
Improved Broadcast only program  
1750-1800 K.C. 200 200

**Model 1-R**  
A completely three-steroid regenerative five feed-back tuner, using the "Resonating Resonant" circuit, combined with an exclusive double shielded iron core transformer. Specially designed in construction and assembled in the following manner:

Total elimination of all body capacity by proper concentration of the electrostatic and electro-magnetic fields within the use of metal shields or screens.  
Reduction of high frequency resistance to an absolute minimum, and consequent increase in signal strength and efficiency.  
Usual selectivity and extreme distance range—achieved by radical departure from customary methods of construction. Aerial capacity and selectivity as well as efficiency are outstanding features of the ZENITH.

**Price \$75.00**  
Sold Through  
Music Dealers Exclusively

Zenith Long Distance Radio Receivers are equipped in a way to permit the complete elimination of interference from all unwanted stations—this feature perfected to a degree not to be found in any other machine on the market. Send for catalog and full particulars.

See Our Exhibit—Main Colonnade—Booth 44—at the Chicago Radio Show

**Chicago Radio Laboratory**  
McCormick Building Chicago, Illinois

Radio Topics (Nov. 1922)

Chicago Radio Laboratory,  
Chicago,  
Illinois.

9/21/1922.

Gentlemen:

I believe I am going to give you some facts that will astonish even the authors of the very wonderful L.R. BENTON - and please remember that this station is in the River Run Valley, completely surrounded by high mountains.

With my Zenith equipment I have since placed up KDKA, Pittsburgh, 1200 miles on the over hills. Receptions occurred between 7:00 and 12:00 P. M. on the evening of September 18th:

- WJW Colorado Springs, Colo., Denver
- WJW Portland, Oregon
- WJW Portland, Oregon
- WJW Seattle, Wash.
- WJW St. Louis Post-Dispatch
- WJW Calgary, Canada
- WJW Denver, Colo.
- WJW Salt Lake City
- WJW Long Beach, Calif.
- WJW Tacoma, Washington
- WJW Portland, Oregon
- WJW Billings, Wyo.
- WJW Seattle Post-Intelligencer

These results were obtained on my 30-foot aerial. I used two stages of amplification and sending the music through the Victrola with Zenith phonograph adapter. It was as loud and clear as a good red-wax record.

Using a loop (which you do not recommend) five feet in diameter, with 8 turns of No. 22 wire, I was able to get the following results:

Amber, located on the Graham Island in the Pacific Ocean, could be easily heard at a distance of 80 to 100 feet from the South, using two stages of amplification. KDKA of Salt Lake City was of pleasing volume in the phone with one stage. KDKA of San Francisco was good in the phone with two stages. The Seattle Post-Intelligencer News Broadcast could be readily heard through the Zenith Topics advertisement, using two stages.

These facts were made in the presence of three persons. I can substantiate the above and explain the facts before any number of reliable witnesses.

Ashley C. Dixon



Model 2-R Zenith Long Distance Receiver

The 2R had a 180-degree coupler.

Radio Merchandising (Aug. 1, 1922)

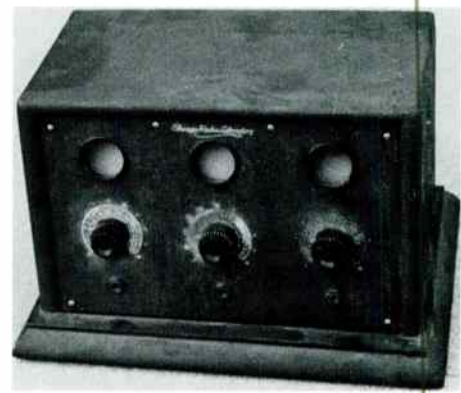

3M Walt Sanders

Ashley Dixon related his radio experiences in *Radio Broadcast* (Jan. 1924), pp. 192-195.

### The QRS Connection

The QRS Music Co. was the world's largest manufacturer of player-piano rolls with gross sales of \$3.6 million in 1921. Its president, Thomas M. Pletcher, built the company from scratch, but he knew that piano-roll sales could not increase indefinitely and that he must diversify. With a large modern factory building standing partially empty and a network of 8,000 music dealers, QRS was in an ideal position to take on radio. McDonald was the go-between: CRL would move into the QRS factory at 48th and Kedzie with QRS becoming its manufacturing and sales agent (CRL had to continue in existence as a legal entity because the Armstrong license was not transferable). QRS announced the arrangement in December 1921, sending out letters to its dealers in April soliciting orders for a new one-tube model similar in appearance to the old Paragon. By September, model 1R's were being shipped out.

### McDonald Takes Charge

For some reason, the arrangement did not continue. As early as August 3, 1922, the RCA patent policy committee recommended that suits be brought against one or more Armstrong licensees on grounds that they were overstepping their license conditions by selling to other than amateurs; and Pletcher may have been worried about risking his entire business by associating too closely with CRL. At any rate, in July 1923 the Zenith Radio Corp. was formed to replace QRS as sales agent for CRL. Although CRL remained in the QRS factory, there was now no legal

connection between the companies. In compensation, Pletcher was made a vice president of Zenith (a position he held until 1928), and at least one other QRS stockholder was made a director. But McDonald was now firmly in control. Until he died in 1958, he ran Zenith the way a captain runs his ship. Indeed, the Commander (as he was addressed by everyone except a few close friends) lived onboard a ship — the 185-foot *Mizpah*. "Except to make a living," he often remarked, "land is merely a place to tie a boat to." In June 1945 *Fortune* magazine characterized him in a highly complimentary story as having "colossal self-assurance" while Fred Cassens, who worked for him for twenty years until 1945, put it more bluntly in 1980: "He was first a genius, second a 'bastard,' absolutely ruthless. He cut up men, and other businesses, like a paper shredder."

In 1924, Zenith moved its factory operation to 3620 South Iron St., and late in that year, its executive offices to the new Straus Building. Karl Hassel's Super-Zenith models went into production just in time, for Westinghouse filed suit in September after Zenith would not agree to a 16-18 percent royalty and a limit on sales. The suit, however, was never tried and, apparently, dropped in 1927. So Zenith continued to sell its regenerative models. It also absorbed CRL, becoming a manufacturer in its own right — perhaps now that the other shoe had dropped, there was no reason for this legal fiction. Hassel did little engineering work after the Super-Zenith models, only consulting on audio problems such as the design of the 1935 Stratosphere. He retired in 1966 and died in 1975.



1R July 1922 \$75

The prototype 1R, announced in *Piano Trade Magazine* for May 1922, had essentially the same panel layout in a cabinet like the Paragon. A 3R was also announced but never made. The 1R was designed by Karl Hassel, M. B. West, and Robert Kruse. At left: 2M amplifier.



THE AMERICAN RADIO RELAY LEAGUE  
 MARYFORD, COGNOL  
**RADIOGRAM**

TO: \_\_\_\_\_  
 FROM: \_\_\_\_\_  
 DATE: \_\_\_\_\_

ALL THIS MESSAGE IS YOUR COMPLETE MESSAGE SUBJECT MATTER OF IT HAS  
 ELIMINATED UNNECESSARY REPEATING OF THE MESSAGE - THE MESSAGE IS NOT REPEATED BECAUSE  
 FROM ALL OVER THE GLOBE BEING RECEIVED

# ZENITH

Licensed under  
 Armstrong  
 U. S. Patent  
 No. 1,113,149

## AT THE NORTH POLE



**Model 4R**—The new Zenith 4R "Long-Distance" Receiver-Amplifier comprises a complete three-circuit regenerative receiver of the feed-back type. It employs the Zenith regenerative circuit in combination with an *audion detector* and *three-stage audio-frequency amplifier*, all in one cabinet. Because of the unique Zenith "selector," unusual selectivity is accomplished without complication of adjustment. The Zenith 4R may be connected directly to any loud-speaker *without* the use of other amplification for full phonograph volume, and reception may be satisfactorily accomplished over distances of more than 2,000 miles **\$85**



**Model 3R**—The new Zenith 3R "Long-Distance" Receiver-Amplifier combines a specially designed distortionless three-stage amplifier with the super-efficient Zenith three-circuit regenerative tuner. Fine vernier adjustments—in connection with the unique Zenith aperiodic or non-resonant "selector" primary circuit—make possible extreme selectivity. **2,000 to 3,000 Miles with Any Loud-Speaker** The new Zenith 3R has broken all records, even those set by its famous predecessors of the Zenith line. Satisfactory reception over distances of 2,000 to 3,000 miles, and over, is readily accomplished in full volume, using *any ordinary loud-speaker*. No special skill is required. The Zenith is the only set built which is capable of being used with all present-day tubes as well as with any tubes that may be brought out in the future. The Model 3R is compact, graceful in line, and built in a highly finished mahogany cabinet **\$160**

Inside the Arctic Circle, nine degrees from the North Pole, a little 89-foot schooner is frozen fast in the ice of Smith Sound. Aboard this schooner a group of brave men are enduring, as best they can, the desperate cold of the Arctic—cold that often drops to 60 degrees below zero. Human atoms in a boundless field of ice!

Cold is hard to endure, but far more terrible is the Arctic solitude—unbelievably oppressive. Radio, at length, has broken this spell forever!

### Concerts from Honolulu!

Daily, by means of powerful sending and receiving apparatus, the crew of the "Bowdoin" are in communication with relatives and friends in the far-off States. Daily they listen to concerts as far away as Chicago, Dallas, and Honolulu!

When the sanity, the very lives of one's shipmates may depend upon contact with the outside world, none but the *best* is good enough.

### Dr. MacMillan's Choice—the Zenith

Out of all the radio sets on the market, Dr. MacMillan selected the Zenith exclusively—because of its flawless construction, its unusual selectivity, its dependability and its tremendous reach.

Already his operator, on board the "Bowdoin" in Northern Greenland, has tuned in several hundred stations. You along the Atlantic who brag a little when you tune in Catalina Island—what would you say if you tuned in Hawaii from the Arctic Circle?

The set that Dr. MacMillan has is a standard Zenith receiving set. And you can do all that MacMillan does, and more, with either of the two new models shown at the right. Their moderate price brings them easily within your reach. Write today for full particulars.

**Zenith  
 Radio Corporation**  
 Dept. Y  
 McCormick Building  
 CHICAGO

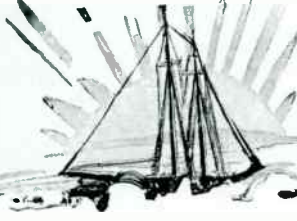

3R (early) November 1923 \$160  
 Construction article in *NY Evening World*  
 (May 3, 1924), pp. 3-4.

MacMillan's 1923-1924 expedition was written up in the *National Geographic Magazine* for June 1925; the 1925 expedition, in the November issue.

Radio Age (Jan. 1924)



Snapshots by Donald Whittier, Readfield Depot, Maine.

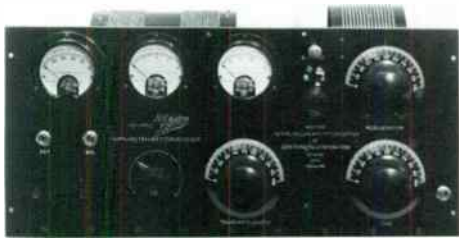

40 meter transmitter-receiver



One of the three Navy planes and McDonald's ship Peary.

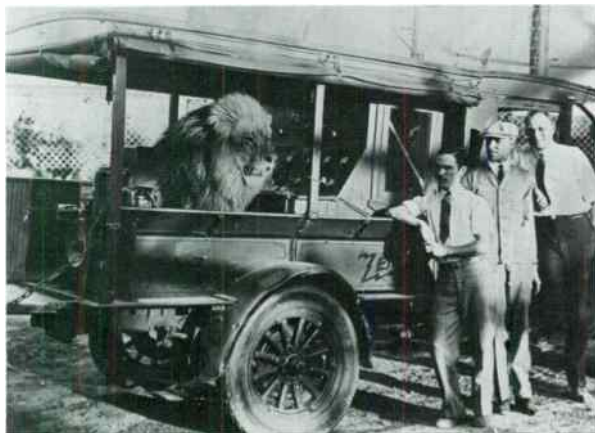

Zenith/Dale Goodwin

Nat'l Geographic Magazine (Nov. 1925)

## Arctic Exploration

Zenith was quiet in 1925. It did introduce its Super-Deluxe models, designed by Henry C. Forbes, chief engineer from 1924 to 1926; but these were mostly prestige-builders that were far too expensive to sell in quantity. McDonald, however, was as active as ever. He furnished Arctic explorer Donald B. MacMillan with radio equipment for his 1923-1924 expedition and now, in 1925, not only built short-wave transmitters and receivers, but went along as captain of the second ship. The advertising value of all this activity was worth ten times its cost. The Commander may have been a tough man to work under, but in sales promotion, he had no peer.

Zenith's other major activity was broadcasting. It had built WJAZ on the site of Mathews' old ham station 9ZN with an elegant glass-enclosed studio that opened on May 1, 1923, in the Edgewater Beach Hotel. In September 1924 Mathews and another engineer began a trip with portable broadcasting station WSAX installed in a Federal truck, broadcasting from Pike's Peak, Jack Dempsey's training camp, Gay's Lion Farm, and every small town along the way — naturally generating a string of press notices.



Radio Age (June 1925)

Above is shown the "Bowdoin," the ship which carried MacMillan to the Arctic last year. It is seen frozen in, near the Pole. Commander MacMillan is shown in the inset. The lower photo shows H. C. Forbes, John L. Reinartz and Karl Hassel, designers of the Zenith-Reinartz transmitter to be used in the 1925 expedition.



*Interior view of Spanish Sunken Garden Zenith Broadcast Studio WJAZ on the 23rd floor in the Tower of the Straus Bldg.*

**Factory**

Broadcasting Station WJAZ

**Office and Studio**

Talking Machine World (Oct. 1925)



John Terrey

Portable May 1924 \$190

Apparently, McDonald got the idea from Operadio's portable, but this turkey never flew. Fred Cassens, who worked there at the time, recalls that 1,000 were made — 600 of them came back as unsatisfactory.

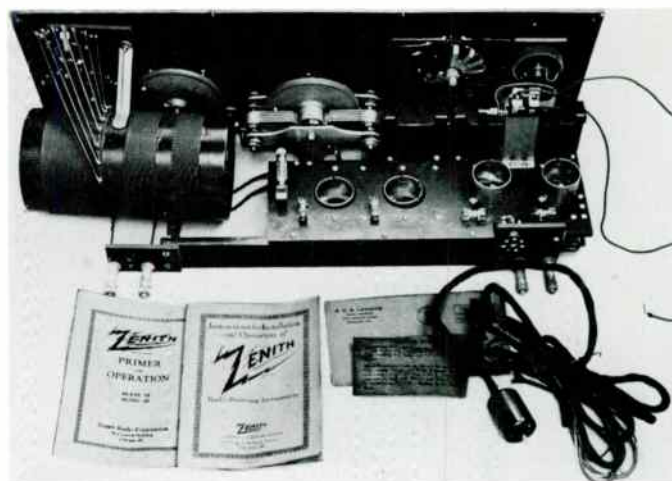

John Wolkonowicz



3R (late) \$160

3R phono panel November 1924 \$150  
(photo on p. 273)

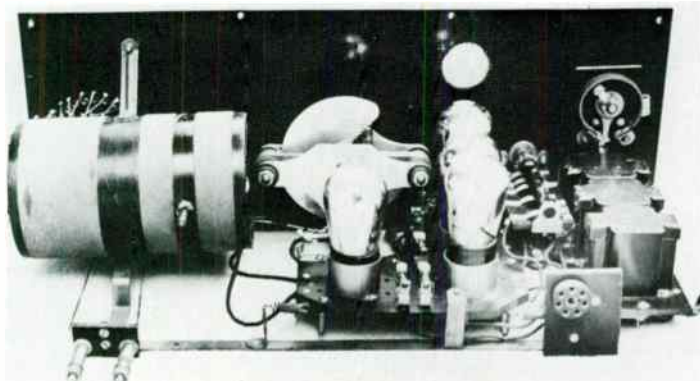

John Wolkonowicz

4R (early) November 1923 \$85



4R (late) \$95

Herb Parsons



**Super-Zenith X**  
New and exclusive Zenith features make this model supreme in the field of Radio. See Super-Zenith X at the Radio World's Fair, Madison Square Garden, New York, September 22nd to 28th.  
Price (exclusive of tubes) \$550



**Super-Zenith VII**  
(Not regenerative)—6 tubes—2 stages tuned frequency amplification—detector and 3 stages audio frequency amplification. Installed in a beautifully finished cabinet of solid mahogany—44½ inches long, 16½ inches wide, 10½ inches high. Door panels inlaid. Slanting panel of sheet bronze, mahogany finish, with scales and indicators in metallic relief. Gold plated pointers, to prevent tarnish. Compartments at either end for dry batteries. Can be operated on either wet or dry batteries. Either inside or outside antenna.  
Price (exclusive of tubes and batteries) \$230

**Super-Zenith VIII**  
Same as VII except—built with mahogany legs of well-proportioned appropriate design, converting model into console type.  
Price (exclusive of tubes and batteries) \$250

**Super-Zenith IX**  
Same as VII except—built with legs and additional compartments containing built-in Zenith loud speaker on the one side and generous storage battery space on the other.  
Price (exclusive of tubes and batteries) \$300

## It Tunes Through *Everything* The New **SUPER-ZENITH**

The new Super-Zenith is NOT regenerative. It is a six-tube set in four different models ranging from \$230 to \$550, with a new, unique and really different patented circuit controlled exclusively by the Zenith Radio Corporation. Amplification is always at a maximum in each stage for any wavelength. *The Super-Zenith line is not affected by moisture.* For the first time, you have here a set that—

- 1—tunes through *everything* and selects the station you really want.
- 2—requires only two hands—not three—to operate.
- 3—brings in each station at *only one point* on the dial.
- 4—affords such mathematical precision and simplicity that you can run over the entire dial in 1½ minutes and pick up *more* stations with greater clarity and volume than any other set on the market. Direct comparisons invited. The new Super-Zenith was perfected in Zenith's laboratories in the center of the eleven powerful Chicago broadcasting stations. Even under these extremely adverse conditions the new Super-Zenith tunes through *everything* and "gets the outside" on loop, inside, or outside antenna.
- 5—produces not only the seemingly impossible in perfect selectivity, but also possesses such artistry of design, such finished craftsmanship, that it lends distinction and exclusiveness to any living-room or library.

Write for the name of the nearest dealer from whom you can obtain a demonstration of this outstanding marvel of the radio world.

Dealers and Jobbers: Write or wire for our exclusive territorial franchise.

**ZENITH RADIO CORPORATION**  
332 South Michigan Avenue, CHICAGO 1269 Broadway, NEW YORK



**Super-Zenith X  
Exclusive Features**

Contains two new features superseding all receivers. 1st—Built-in, patented, Super-Zenith Duo-Loud Speakers (harmonically synchronized twin speakers and horns) designed to reproduce both high and low pitch tones otherwise impossible with single-unit speakers. 2nd—Zenith Battery Eliminator, distinctly a Zenith achievement. Requires no A or B batteries or charge.

Zenith Radio Corporation  
Dept. 10-C  
332 S. Michigan Ave., Chicago, Ill.  
Gentlemen: Please send me illustrated literature giving full details of the Super-Zenith.

Name.....

Address.....

ZENITH—the exclusive choice of MacMillan for his North Pole Expedition. Holder of the Berengaria record.

Models VII, VIII, IX, and X were first advertised in September, 1924. Early models had a four-position stage-change switch at the upper left of the panel; later models (blueprint dated March 1925) used a rheostat there. While the X was first advertised as an AC model, factory service literature indicates almost certainly that it always ran from batteries. Interior view of Super-Zenith VII is shown on p. 273.

The Literary Digest for November 14, 1925 65



**Super-Zenith  
Model VIII**

Same as VII except—built with mahogany legs of well proportioned, appropriate design, converting model into console type.

**Super-Zenith  
Model IX**

Same as VII except—built with legs and additional compartments containing built-in Zenith loud speaker on the one side and generous storage battery space on the other.

**New Zenith  
De Luxe  
Chinese Model**

Equipped with two built-in loud speakers, Bates Rotary Log, illuminated dial, single control specially constructed Zenith Radio Circuit.

# Why Zenith is Here to Stay—

If you own a Super-Zenith it is not necessary to tell you why the instrument is here to stay.

If you are contemplating the purchase of a radio and want one that will be thoroly satisfactory years from today—this message is for you.

In the beginning we confronted a grave question—the choice of one or the other of two business policies.

One way open was to make radios “at a price” in large quantities.

This plan we discarded and chose the other road—the road of business soundness—customer satisfaction and absolute permanence.

We designed and manufactured a superior instrument—the finest radio of its kind humanly possible to produce.

We chose this policy—not because we felt it would be the most profitable immediately, but because we knew it would be best in the long run.

As the result of that decision, Zenith has maintained a steady and ever-growing volume and owner endorsement.

Every Super-Zenith is a perfectly balanced radio instrument—simple yet responsive and highly sensitive—giving distance with ease—yet preserving clear, wonderfully true tones.

Literature gladly sent on request.

Again Commander Donald B. MacMillan chooses Zenith for his Arctic Expedition. When human lives may depend upon the reliability of radio performance, only one reason can explain his choice: Zenith has proved to be the best obtainable at any price.

Zenith Radio Corporation, Straus Bldg., Chicago

# ZENITH

TRADE MARK REG.

## LONG DISTANCE RADIO

It Costs more—but it Does more

Super-Zeniths priced from \$240 to \$355  
De Luxe Art Model Cabinets from \$500 to \$2,000  
Other Zenith Sets \$100 and \$175



69,370. RADIOCABINET. EVERETT WORTHINGTON, Chicago, Ill., assignor to Zenith Radio Corporation, Chicago, Ill., a Corporation of Illinois. Filed Dec. 7 1925. Serial No. 15,654. Term of patent 14 years



The ornamental design for a radiocabinet, as shown



Italian \$1,100



English \$750

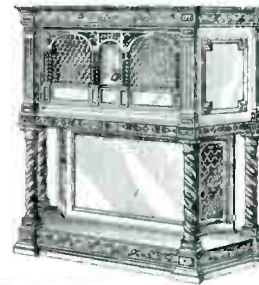

Spanish \$2,000

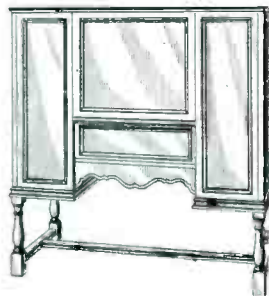
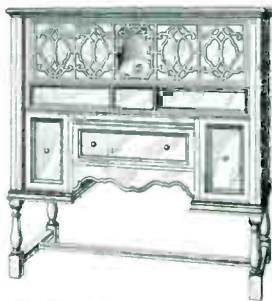

Colonial \$500



Chinese \$1,500

Super-Deluxe models September 1925

AC models September 1927

Designed by Henry Forbes (1899-1953). Forbes was assistant to the chief engineer of Cutting & Washington and Colonial in 1923-1924 before joining Zenith. In 1929, he was with Westinghouse.

Technical article (by Forbes) in *Radio Engineering* (Aug. 1926), pp. 306-308; *Radio Age* (Apr. 1926), pp. 10-11.

## Piracy

Zenith got a lot more publicity — mostly unfavorable — when McDonald decided that WJAZ should not have to share time with other stations on its assigned 930 kc channel when 910 was unoccupied (it was reserved for Canada). Refused permission by the Commerce Department to change its wavelength, WJAZ moved anyway and was promptly branded a “pirate.” McDonald characteristically distributed photos of the WJAZ crew in costume, brandishing cutlasses in the control room. He was vindicated by the courts, which decided that the Commerce Department had no legal power to assign wavelengths or to refuse licenses, but he won no friends as this decision precipitated a period of chaos until Congress created the Federal Radio Commission.

## Zenith Nearly Goes Under

In 1926, Zenith’s luck ran out. Business generally was not good, especially for a company with nothing under \$240 in its line to offer nor anything new. Zenith had large stocks of materials on hand and had borrowed so much from the First National Bank of Chicago that it could not meet the payments. Branch offices in other cities were closed; and at the bank’s insistence, treasurer S. I. Marks resigned and was replaced by Hugh Robertson, who had joined the company in 1924 as office manager and who had known McDonald since 1910. Robertson, born in Glasgow, Scotland, in 1887, was as much responsible for Zenith’s later success as McDonald, although he preferred to stay out of the limelight. He retired as board chairman in 1964 and died in 1979. He told of going to the post office in those difficult months of 1926 and getting checks from Zenith distributors out of the mail, then cashing them at a bank in Oak Park to meet the payroll.

The Model 27 pulled Zenith through this crisis. Using most of the same components as the older Super-Zeniths, it provided something new to sell: an AC-operated model. By the following February, half of the company’s indebtedness had been discharged.

## RCA License

On March 11, 1927, Zenith was first in the industry to sign up for an RCA patent license. While it claimed to have paid “up to \$500,000” in back royalties, few people in the industry seriously believed it. RCA would gladly have made that concession to get its bandwagon rolling while it had the advantage of a more-than-favorable court decision on the Alexander TRF patent. (Judge Bodine had interpreted this patent very broadly; if his decision were not appealed, it would stand as a landmark. See Splitdorf.)

McDonald did lose control of Zenith briefly in 1928 when he incautiously played the market with his Zenith stock. While he was selling, Tom Pletcher was quietly buying — 72 per cent of outstanding shares. McDonald was saved only by buying the stock option that R. H. G. Mathews had received for his half of the CRL partnership. Pletcher and a fellow QRS director sold their stock in September 1928 and retired from Zenith entirely.

After 1927, Zenith’s models were similar to those of other manufacturers; but McDonald was a master of product differentiation through advertising. With such slogans such as “The quality goes in before the name goes on” (used first in 1923 by Crosley!) and “They cost more, but they do more,” Zenith held its own among the half-dozen industry leaders until the Depression. Then it added low-cost models to its line and, by aggressive sales tactics emulating Philco, reached the number two spot by the end of the 1930s. It has remained successful to this day by continuing the same policies long after Philco foundered by abandoning them, diversifying, and trying to become something it was not.

After leaving Zenith in the mid-1920s, Mathews followed a very successful career in sales promotion with a number of companies, including his own. He died in 1982.



Radio Guide (May 1926)

## Is the Zenith Worth its Price?



Super-Zeniths are priced at from \$240 to \$2,000. Each instrument sold under a quality guarantee. Above is shown the Italian De Luxe Model, with full-length disappearing doors opened.

### Why Did Commander MacMillan Take Zenith to the Arctic?

As a result of his experience with Zenith radio in the Arctic, Commander Donald B. MacMillan has again chosen Zenith for his latest Arctic Expedition.

THAT'S a natural question—and a fair one. If everyone in America could hear the Super-Zenith, words wouldn't be necessary. Performance—quality of tone—selectivity—tell their own story—tell it distinctly—clearly—without the possibility of question. Many people who have not heard the Super-Zenith regard it as a high-priced instrument. It isn't cheap—that's true. And there's a real reason for its price. ❖ ❖ ❖

The Super-Zenith is priced on a basis of cost to make—not made to fit a price.

A watch costing one thousand dollars is far more accurate and beautiful and satisfactory than one costing a few dollars. A Super-Zenith—for the same reasons—is far superior to the ordinary radio instrument.

There are no more ounces of rubber or metal—no more feet of lumber in the Super-Zenith than in many instruments obtainable at half the price.

No argument there—we freely admit it.

For that matter there's no more raw metal in a pound of horseshoes than in an equal amount of platinum jewelry. But there is a mighty difference in cost—and value. ❖ ❖ ❖

We simply can't make the Zenith for less and give you the quality of tone, the selectivity, the certainty of satisfaction.

It's the wonderful balance of the instrument—the care and skill and perfection in make and material. It costs us more, and naturally you pay more. But it's well worth the price. Literature and dealer's name sent on request.

ZENITH RADIO CORPORATION  
310 South Michigan Avenue, Chicago, Ill.

**ZENITH**  
LONG DISTANCE  
RADIO

*It Costs more - but it Does more*

Radio News for January, 1927

87



John Wolkonowicz

- 27 October 1926 \$280
- 28 October 1926 \$300
- 29 October 1926 \$395

A factory blueprint is dated June 1926. The 27 was a modified VII using series-wired '99s in adapters. As Zenith's first AC set, the 27 had more than its share of service problems. In the St. Louis area, for instance, it could not cope with the poor line-voltage regulation and was considered a total failure by the Zenith distributor. Shown above the 27 is an early VII.

**NO BATTERIES  
NO CHARGERS  
NO WORRY  
NO ACIDS**



Super Zenith mounted on spinet base.

Zenith has again demonstrated its superiority in radio; this time you are relieved of constant worry and attention required by storage battery radio sets. The new super Zenith plugs into your light socket, there are no small storage batteries, water, acids nor chargers. Always full power. Amazing selectivity and tone quality.

Super Zeniths in three distinct models—\$280.00—\$300.00—\$395.00.

Write for literature and demonstration appointment.

**ZENITH RADIO CORPORATION, 3620 Iron St., Chicago**

MANUFACTURERS OF	\$650.00 to \$2500.00
Zenith ten tube Deluxe models (no aerial or loop) .....	\$60.00
Zenith "B" eliminator, a durable, dependable eliminator .....	\$240.00, \$260.00, \$355.00
Battery operated super Zeniths (where no electric current is available) .....	

Radio News (Jan. 1927)

**The NEW 1927 RADIO**  
*-is here-*

- No Batteries
- "
- No Acids
- "
- No Chargers
- "
- No Water
- "
- No Worry
- "
- No Attention



- Supreme in Tone
- "
- Single Control
- "
- Doubly Shielded
- "
- Selective
- "
- Powerful
- "
- Light Socket Operated

Radio News (May 1927)



Zenith makes the first and most important announcement in radio for 1927—The New Zenith, Model 17. Not a camouflaged, so called "Light Socket" Radio Set, but a truly custom built radio, designed to operate without set or dry batteries, chargers, acids or water. Just plug in to the light socket—that is all. No attachments to worry over. Always full power—this new model is adapted for use with 201A and 301A tubes. The tone is incomparable. Send for descriptive literature

**ZENITH RADIO CORPORATION, 3620 IRON STREET CHICAGO, ILL.**



Walt Sanders

17 May 1927 \$350  
A spinet base was \$20 extra.



# Your Home Deserves Zenith Radio

**G**OOD music deserves good musical reproduction. Zenith radio will bring fine broadcast programs in the manner they should be brought—with tonal delicacy, with clear undistorted rendition of every voice or instrument. For the Zenith receiver is a high grade musical instrument, made with exacting care and scientific devotion to the highest standards of performance.

Zenith design ranges from the six-tube, battery or electrically operated set to the De Luxe, fully electrical ten-tube type. Every model embodies more than twenty-five Zenith improvements

that have led the way in radio development. The Zenith price begins at one hundred dollars because Zenith quality cannot be built into a receiver of lower price. Whichever one of the sixteen Zenith models you select will bring those fine qualities of tone, selectivity, volume and clarity that your home deserves.

Make it a point to hear a Zenith demonstration before you buy radio. You will then have a standard of judgment—the *Zenith standard*. Both as musical instrument and as exquisite cabinet furniture Zenith radio is worthy of a place in the truly modern home.

DE LUXE ENGLISH  
ELECTRIC MODEL  
10 Tubes

The first 10-tube completely  
Electric Radio using power  
speaker.



World's largest manufacturers of high grade radio  
—16 models—3 different  
circuits—6, 8 and 10 tubes,  
battery or electric—antenna  
or loop—\$100 to \$2500

Western United States prices slightly higher  
Licensed only for Radio amateur, experimental and broadcast reception

# ZENITH

TRADE MARK REG.

## ←LONG DISTANCE←RADIO

TRADE MARK REG.

3620 IRON STREET, CHICAGO

**Model 12**

The Model 12 is a bona-fide 6-tube receiver with every tube a working tube. Many 6-tube receivers have only 5 effective working tubes, one being used for antenna coupling. The Model 12 has Zenith's own tubeless method of antenna coupling. Judged by the standards of many 6-tube sets, the Model 12 is the equivalent of 7 tubes. Single control electric lighted dial. Calibrated in both kilocycles and meters. 4 Zenith condensers permanently balanced on one shaft. Most 6-tube sets have 3 condensers. Battery operated, and economical in the use of batteries. Wired for power tube. Cabinet in beautiful brown mahogany veneer.

Price  
**\$100**

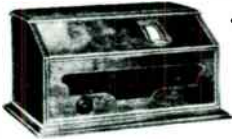

12 May 1927 \$100

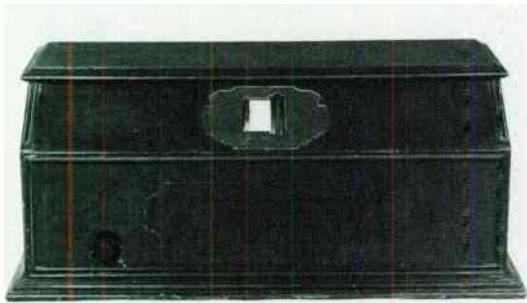

Ralph & Elinor Williams

- 11 September 1927 \$110
- 11E September 1927 \$175
- 14 September 1927 \$180
- 14E September 1927 \$255

**Model 15**

8-tube loop set. The loop folds in cabinet. Single control, electrically lighted dial showing both meters and kilocycles. Five Zenith condensers permanently balanced on one shaft; doubly shielded.

This loop receiver is especially adapted for use in places where an antenna cannot be erected. It is a long distance receiver of great range and its simplicity of operation will be a delight to those who have heretofore experienced the complex tuning systems of loop sets. Cabinet of selected walnut veneer. Front panel beautiful combination of maple and matched butt walnut veneer. Battery operated. Price... **\$185**



Flyer



- 15 September 1927 \$185
- 15E September 1927 \$285
- 15EP April 1928 \$375

# YORKVILLE RADIO COMPANY

*"If It's Not Right—Bring It Back"*

147 East 86th St., Cor. Lexington Ave. NEXT TO UNITED CIGAR STORE  
OPEN DAILY FROM 8:30 A. M. TO 11:30 P. M.—PHONE LENOX 1100.



THE QUALITY GOES IN BEFORE THE NAME GOES ON  
Zenith Radios have always been noted for their long distance and lifelike reproduction. We show here two popular models. Both sold with a small down payment, with easy weekly terms and liberal allowance on your old set.



**\$180**



TABLE MODEL \$ **110**  
ZENITH

If you want to make only a moderate investment in a good radio receiver, we recommend this table model Zenith. It will deliver more radio satisfaction than many other receivers selling for much more money. Single control makes operation easy, and stations roll in one after the other just as you want them. Encased in handsome, two-toned genuine walnut cabinet that adds beauty to any room.

**ZENITH CONSOLE**

To the left is shown the beautiful self-contained Zenith Console. It is also encased in a genuine walnut console cabinet with loud speaker of marvelous tone and ample compartment for batteries, etc. A perfect radio and strikingly handsome piece of furniture for only \$180.

**SEND THIS COUPON**

Let us know when it will be convenient and one of our representatives will call to arrange for a FREE DEMONSTRATION IN YOUR OWN HOME WITHOUT ANY OBLIGATIONS ON YOUR PART.

NAME.....

ADDRESS.....

HAVE REPRESENTATIVE CALL.....

New York Telegram (Sept. 17, 1927)

# Zenith was first

at the Arctic  
to build DeLuxe Radio  
holder of  
world's long  
distance record

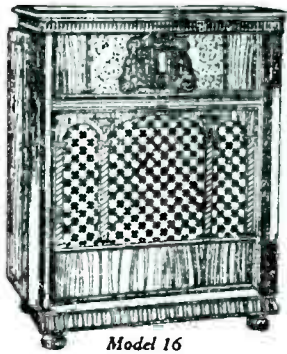

Model 16

## Zenith is First

In that shining circle of great things men have made, Zenith has built its home. It is first in radio. You need but to hear Zenith to acknowledge its worth. Beautiful tonal reproduction, faithful to the tiniest overtones as well as to the massed volume of symphonic music. Selectivity and power that ranges the whole world for joys that are hidden to other sets. The utmost in scientific reception. These are the delights Zenith will bring you—for years. Cabinet artistry, too, that graces the finest room. Hear and see Zenith. Ear and eye will agree—best.

*Model 16—The Zenith 8-Tube chassis with concealed loop and improved cone speaker. Beautiful Spanish Renaissance Cabinet—Fine lacquer finish. Battery operated, \$300. Completely Electrical, \$400 (with power speaker, \$450)*

16 Zenith models—3 different circuits—6, 8 and 10 tubes—loop, antenna or antennaloss—battery or electric—\$100 to \$2500

*Licensed only for Radio amateur, experimental and broadcast reception*



16	September 1927	\$300
16E	September 1927	\$400
16EP	September 1927	\$450

New York Herald-Tribune (Oct. 9, 1927)

Radio Retailing (February 1928)

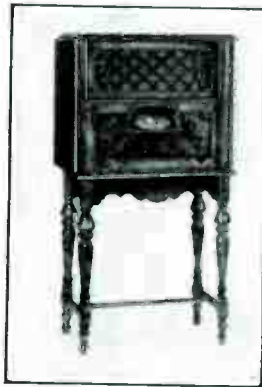

18E February 1928 \$272



# New Set Tunes in Stations with Switches



(Acme)

HARRY N. MARVIN, INVENTOR OF THE AUTOMATIC RADIO RECEIVER, OPERATING HIS RECEIVER. NOTE THE BUTTONS AND KEYS ON THE RECEIVER.

Harry N. Marvin, a former associate of Thomas A. Edison, recently demonstrated an automatic radio receiver in his home at Rye, N. Y. On this receiver stations are not tuned in by means of dials, but they are brought in by pressing buttons or turning levers. Thus WEAJ is brought in by throwing one switch, WJZ by manipulating a second, WDR by a third, and so on. Provision has been made for ten different stations so that the operator of the receiver has the choice of any one of this number. Mr. Marvin contends that the average fan does not regularly listen to more stations.

But the receiver is not actually limited to ten local stations. By using the controls in the customary manner it is possible to tune in distant stations as well as local stations. It is only the automatic feature which is limited to ten.

While the new receiver was demonstrated in the inventor's home, it will not be demonstrated publicly until the Radio World's Fair, Madison Square Garden, September, 1928.

Mr. Marvin has been working for five years to perfect this invention. He declined to reveal the technical details to reporters.

Electrical Record (Dec. 1928)

### Radio Phonographs:

37A	December 1928	\$625
40A	December 1928	\$850

Zenith aimed to monopolize the automatic-tuner field by buying patents from a number of inventors, particularly Harry N. Marvin. Most console models were available with the tuner ("A" suffix) for \$55 extra.

Radio World (Mar. 24, 1928)

# Smashes All Previous Standards The New Zenith Radio



Model 31 The 8-tube Zenith Chassis in a beautiful "Low-Boy" Console with Cone Speaker. Completely Electric. Speaker mounted behind attractive grille. Cabinet of figured walnut veneer in dark dull rubbed finish, beautifully shaded and bleached. Price—Low tube—\$100.

Model 32 The "Low-Boy" console model for battery operation. Price—Low tube—\$100.

15 Models—3 different circuits—6, 8 and 10 Tubes including Deluxe Models—with or without loop or antenna—battery or fully electric—\$100 to \$2,500. Western U. S. prices slightly higher—Licensed only for radio amateur, experimental and broadcast reception.

WE ARE proud to present the new line of Zenith Radio to the industry and to the public. It's the best job of radio building that Zenith has ever done. When Zenith distributors saw the 1928-29 line at the recent convention they placed orders for more than double the entire Zenith business of last year. The outlook is bright. Zenith dealers have made money consistently for the past seven years. This year, with a product that is worthy of Zenith's position as the world's largest manufacturer of high grade radio, the profit possibilities are greater than ever.



Model 33 Zenith 8-tube set in table cabinet. Completely Electric. Single dial control with effectively shaded all-metal chassis. Transparent dial illuminated from underneath, making figured scale stand out with brilliant clarity. Cabinet of matched walnut veneer with dial and meterboard placed in attractive circular recess at top. Price—Low tube—\$120.

Model 34 The 8-tube table model for battery operation. Price—Low tube—\$100.



Model 35 The Zenith 8-tube circuit in a "High-Boy" Console—All Electric with Cone Speaker. Power unit completely contained at left of cabinet. Cabinet of English design in figured walnut veneer. Solid walnut legs and stretchers. Price—Low tube—\$270. With Power Speaker—\$330.



Model 39 Zenith 8-tube circuit with loop and power speaker built integrally in cabinet. Completely Electric in operation. The famous Zenith power speaker embedded in the wood in a wonderful performance under all broadcast conditions. Artistic cabinet of walnut veneer, attractively carved. Power speaker installed directly behind ornamental grille. Price—Low tube—\$330.

See the Zenith Automatic at the Show!

Watch for this tremendous sensation at the radio show. The biggest thing since All-Electric radio—Zenith is first again with an idea that will sweep the country.

ZENITH RADIO CORPORATION  
3620 Iron Street, Chicago, U. S. A.

See ZENITH at the Radio Manufacturers' Trade Show  
Booth No. 89—Demonstration in Suite 505A

31	June	1928	\$100
32	June	1928	\$180
33	June	1928	\$150
33X	March	1929	\$150

34	June	1928	\$230
34P	March	1929	\$250
35	June	1928	\$270

35P	June	1928	\$330
35PX	March	1929	\$330
35APX	March	1929	\$385

P = power (electrodynamic) speaker  
X = probably "extra" (7 tubes instead of 6)  
A = automatic tuner

According to Fred Cassens, the 1927-1928 models used Majestic power packs furnished with sub-standard paper condensers that blew during hot summer weather, just as Majestic's own radios (with better condensers) appeared. Zenith was forced to have Kellogg make replacements on a crash basis and to install them at no charge. McDonald hated Majestic intensely and this would have been sufficient reason.



39	June	1928	\$450
39A	March	1929	\$510

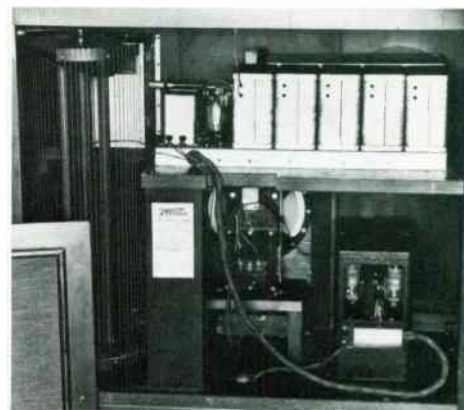

Radio Retailing (June 1928)





42 June 1929 \$175



Scott Crossman



Model 52

The cabinet housing the finest of radio receivers is this charming low-boy which combines the dignified severity of early American design with the classic Gothic motif. Front is of matched butt Walnut, top and sides of Walnut and the overlays of English satin oak. This Zenith built cabinet is acoustically correct, having been selected from among thirty-five other hand made cabinets. Includes, of course, genuine Automatic Tuning, two stages of push-pull, a genuine screen grid circuit, 12-inch Syntonic dynamic type speaker, and many other refinements and improvements all contributing to the greatest achievement of all—pure, flawless, Humanized tone.

Model 52 (for 60 cycle, 110 volt, A. C. operation) employs nine tubes with rectifier including 3-UY 224 screen grid, 3-UY 227, 2-UX 245 and 1-UX 280 (rectifier). Cabinet dimensions fourteen inches deep, twenty-nine inches long and thirty-nine inches high. Less Tubes . . . . . **\$175**  
 Model 522 same as above except for 25 cycle, 110 volt A. C. operation. Less Tubes . . . . . **\$185**  
 (Western United States prices slightly higher.)

- 52 August 1929 \$175
- 53 August 1929 \$275
- 54 August 1929 \$395
- 55 August 1929 \$700

Technical article in *Citizens Call Book* (March 1930), p. 80.



41 June 1929 \$100



Model 53



Model 54



Model 55

Artistry of this Zenith cabinet shares with Zenith engineering skill in producing this extraordinary radio receiver. For beneath the exquisite exterior of Jacobean beauty, developed of finest Walnut Veneers, is progress in radio performing ability beyond anything that has come before. Here is not only genuine Automatic Tuning, but a genuine screen-grid circuit, DOUBLE Push-Pull audio amplification, Automatic Volume Control, Automatic Station Indicator, Automatic Silencer between stations, the 12-inch Syntonic Dynamic type of speaker . . . and many other definitely NEW features. A remarkable value!

Model 53 employs nine tubes, including rectifier, as follows: 3-UY 224 screen-grid, 3-UY 227, 2-UX 245 and 1-UX 280 (rectifier) tube. Cabinet measures 21" deep, 32 1/2" wide and 45 1/4" high. Prices less Tubes . . . . . **\$275**  
 Model 532 same as above except for 25 cycle, 110 volt, A. C. operation, less tubes. . . . . **\$275**  
 (Western United States prices slightly higher.)

First to perfect a successful loop operated set, Zenith now brings to this ingenious type of radio, all the improvements and advantages of its sensationaly new specially designed screen grid circuit. Model 54 has genuine automatic tuning, automatic volume control, automatic station indicator, automatic "between station" silencer, 12" Syntonic Dynamic type speaker, as well as the many new improvements shown in the chassis description in this folder. Encased in a console of extraordinary beauty, designed in the Charles II motif. Matched butt and striped Walnuts are used on top and sides while the rich carvings and lower structure are solid walnut. Instrument panel of beautiful Carpathian elm burl.

Model 54 (for 60 cycle, 110 volt, A. C. operation) employs nine tubes with rectifier including 3-UY 224 screen grid, 3-UY 227, 2-UX 245 and 1-UX 280 (rectifier) tubes. Dimensions of cabinet, 18 1/2" deep, 31 1/2" wide and 51 1/4" high. Price . . . . . **\$395**  
 Model 542 same as above, except for 25 cycle, 110 volt, A. C. operation, less tubes. . . . . **\$395**  
 (Western United States prices slightly higher.)

Here is not merely the last word but the future word in radio—Zenith REMOTE AUTOMATIC CONTROL. The remote automatic tuner enables you to automatically tune in the desired station from any point in the house—and at any volume desired. Simple in operation—proven by unceasing tests. And in addition Model 55 gives you ALL of the new Zenith features. The magnificent cabinet is of Italian Renaissance design so desirable in the homes of lovers of beautiful furniture. Acoustically correct and constructed of the finest quality and individually selected butt matched walnut veneers, selected striped walnut and solid walnut. The instrument panel is of rich Carpathian elm burl. Model 55 (for 60 cycles, 110 volt, A. C.) employs nine tubes including rectifier as follows: 3-UY 224 screen grid, 3-UY 227, 2-UX 245 and 1-UX 280 (rectifier) tubes. Cabinet measures 18 1/2" deep, 39 inches wide and 50 inches high. Price, less tubes. . . . . **\$700**  
 Model 552 same as above except for 25 cycle, 110 volt, A. C. operation. Price, less tubes . . . . . **\$700**  
 (Western United States prices slightly higher.)

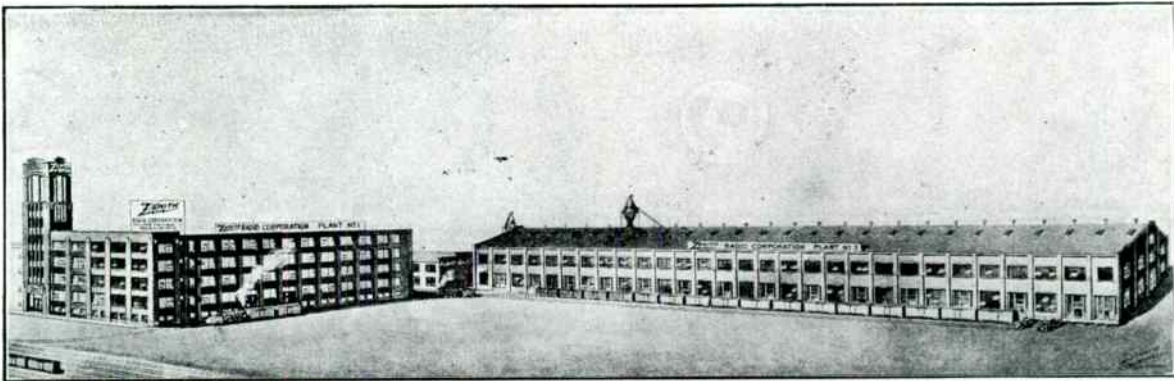

Plant No. 3 of the Zenith Radio Corp., to Be Used as a Cabinet Factory on Right in Photo

## E. F. McDonald, Jr., Buys Yacht "Mizpah"

President of Zenith Radio Corp. May Use  
Palatial Craft in Arctic Expedition—Has  
Owned Twenty-two Boats

Another splendid craft is added to the already large fleet of the Chicago Yacht Club, with the recent purchase by Commander E. F. McDonald, Jr., president of the Zenith Radio Corp., of the palatial yacht "Mizpah," which was purchased by the Commander from the estate of James Elverson, Jr., former owner of the Philadelphia Inquirer. Commander McDonald purchased the yacht in Miami, Fla.,

where he turned the ship over to Congressman Fred A. Britton for a short while, the Commander returning to Chicago. Leaving Washington recently, Commander McDonald left for New York, where he will keep his yacht for the Summer, bringing it later to Chicago, via Halifax and the St. Lawrence River.

The Commander is no newcomer in this business of yachts, having owned twenty-two previous boats. The later ones being the "Zenith," which he sold to State Representative Charles E. Weber, and the "Narro," which he owned last year and still retains.

McDonald turned over the *Mizpah* to the Navy in 1942. After the war, it carried bananas until a broken crankshaft forced its abandonment. At Zenith's request, the Interior Dept. scuttled the *Mizpah* in 1968 off Palm Beach, Florida, as an artificial reef.

Talking Machine World (June 1929)

## Zenith Triples Its Production

New Plant No. 3 Contains Over 250,000  
Square Feet of Space—Used as Cabinet  
Factory for Zenith Radio Receivers

The Zenith Radio Corp., Chicago, manufacturer of radio receivers, has tripled production this season with the addition of plant No. 3 shown on the right in the accompanying picture. This plant, which contains over 250,000 square feet of floor space, houses Zenith's new cabinet factory, in which modern wood-working machinery valued at more than a quarter of a million dollars has been installed. Original plant No. 1 is devoted to the manufacture of chassis, automatic and remote controlled tuning devices. The general offices have been enlarged and now occupy the greater part of the main floor. Plant No. 2 contains the repair, parts and employment departments. The plants are located in the heart of the central manufacturing district of Chicago at Thirty-fifth and Iron streets.

Talking Machine World (Aug. 1929)

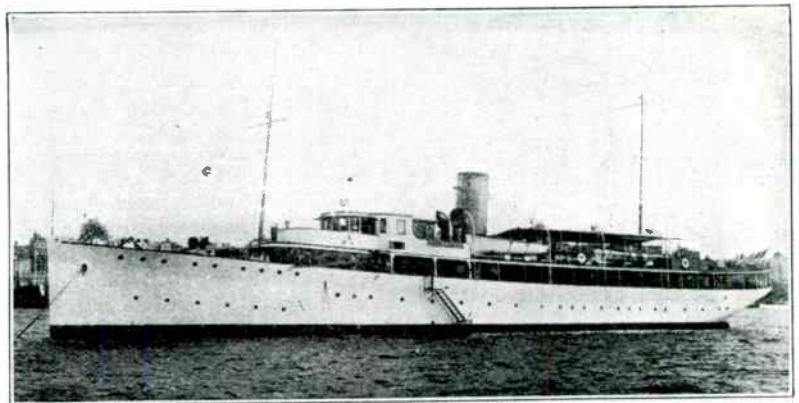

Yacht "Mizpah" Recently Purchased by E. F. McDonald, Jr.



## PARENT COMPANY PLANTS

Plant Number One  
6001 West Dickens Avenue, Chicago  
General Offices, Engineering,  
Research and Manufacturing

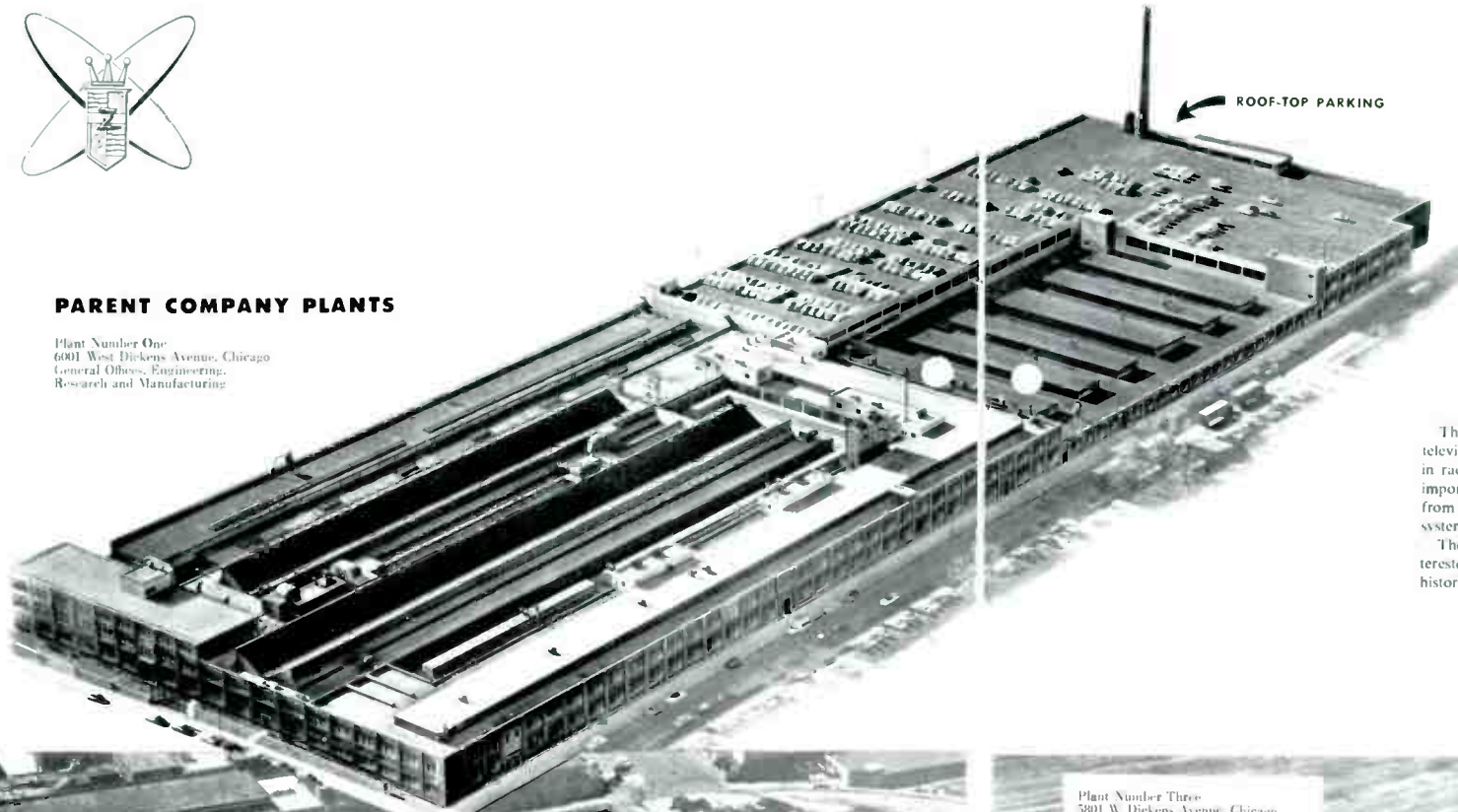

## *The Zenith Story*

The history of Zenith is to a considerable degree a history of the radio-television industry. This is so because Zenith has been a pioneer and leader in radionics since before there was a radio industry, and has played an important role in almost every important development during radio growth from an amateur toy to the most significant, widespread, and effective system of communications in history.

The Zenith story has been written because we believe you will be interested in this exciting field of radionics whether you be student, writer, historian, or a normally curious person who appreciates factual drama.

Copyright 1955 by Zenith Radio Corporation. Any portion may be reprinted upon permission. Write Director of Public Relations, Zenith Radio Corporation, 6001 W. Dickens Avenue, Chicago 39, Illinois.

Plant Number Three  
5801 W. Dickens Avenue, Chicago  
Zenith Parts and Service Division  
General Offices of Hearing Aid Division

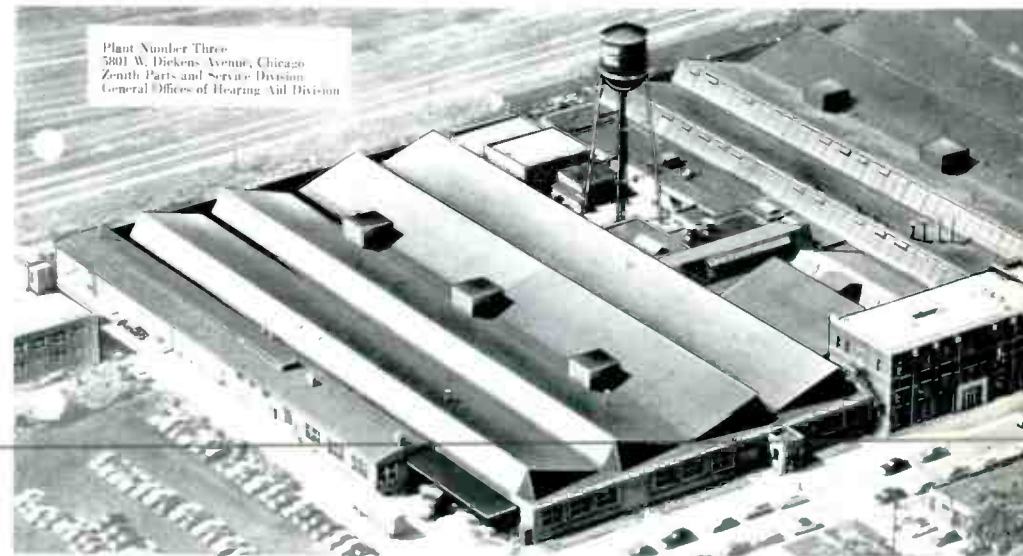

Plant Number Two  
1500 N. Kostner Avenue, Chicago  
Manufacturing



The Dickens Avenue plants, occupied by Zenith in early 1937, were originally occupied by Majestic. Belmont bought the adjoining factory.

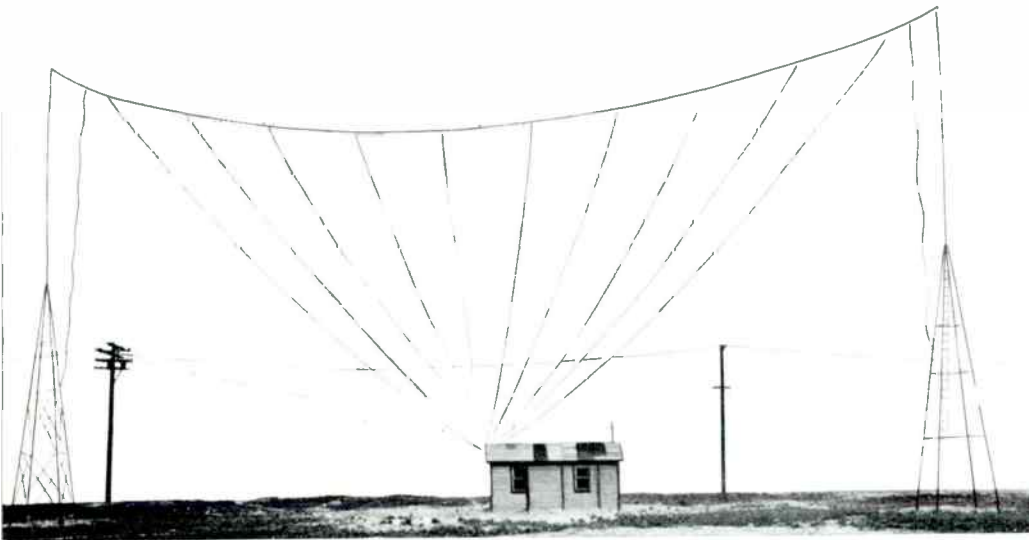

In 1919, this shack on Chicago's North Side housed station 9ZN and a factory for Z-Nith radio products.

## THE ZENITH STORY

On December 14, 1901, Guglielmo Marconi flashed the letter "S" across the Atlantic Ocean by wireless telegraph, and thereby launched a revolution in communications that was destined to bring profound changes in the pattern of civilization.

Marconi's tremendous achievement brought only passing attention from the adult public, but it kindled the imagination of eager youngsters everywhere. In the decade that followed many of these youngsters dismayed their parents by devoting more time and effort to "Marconi's toy" than to preparing themselves for a future in "something practical".

### BEGINNINGS

Two of these "wireless doodlers" lived hundreds of miles apart, and were to meet only by sheer chance. R. H. G. Mathews of Chicago pursued the hobby and qualified as an amateur radio operator in 1912. In 1915 he began building and selling wireless equipment to other amateurs. Karl Hassel of Sharpsville, Pa., won his amateur license in 1915, and then matriculated at the University of Pittsburgh. Here he discovered that he was the only person on the campus, student or faculty, who knew how to operate the University's newly constructed wireless station.

Came World War I, and both boys enlisted in the Navy. They met at Great Lakes Naval Training Station, and worked together on radio until 1919. They then set up a continuation of Mathews' business as Chicago Radio Laboratory, building and selling radio sets.

Their first factory was a table in Mathews' kitchen. Their tools were pliers, screwdrivers, a hand drill, and a soldering iron that had to be heated over the burner of a gas stove. From this kitchen table workshop grew the business that was to become Zenith Radio Corporation.

Early in their business life Mathews and Hassel began the long series of radio "firsts" that has become a Zenith tradition. One of their first ventures was construction of a long wave radio receiver for the *Chicago Tribune*, which was used to pick up news dispatches about the Versailles Peace Conference from a long wave station in France. This short circuiting of the congested trans-Atlantic cable enabled the *Tribune* to beat competitors by 12 to 24 hours on conference stories.

The varnish had scarcely dried on the kitchen table workbench before the fledgling business needed larger quarters. The boys built a new factory near the Edgewater Beach Hotel. It was a shanty-like structure that gave them a working space of fourteen by eighteen feet, with a cubby hole for their amateur radio station, 9ZN. At about the same time they published their first catalogue. A few months later they coined the trade name, Z-Nith, from the call letters of their radio station. This was the origin of the trade mark, *Zenith*.

The next Z-Nith first was construction and installation of a wireless system that made the N. C. & St. L. the first railroad in the world to successfully dispatch trains by wireless telegraph. Transmitters and receivers were set up in Tullahoma, Tennessee and Guntersville, Alabama to handle traffic over the rough country between.



Zenith long-wave equipment put the *Chicago Tribune* 12 to 24 hours ahead on news of the Versailles Peace Conference.

Initial difficulties included such things as setting off a bank's burglar alarm during a directors' meeting; adding a high voltage shock to the pain of a dentist's drill while he was working on a touchy patient; and putting nearby telephones out of service. These problems were ironed out. The system went into service, and operated successfully for several years.

By the end of 1919, the Z-Nith partnership was thriving, with production exceeding one complete set a week. In May, 1920, the boys acquired their most important asset, a license to use the basic regenerative circuit patent of radio's greatest inventive genius, the late Major Edwin H. Armstrong.

Until the latter part of 1920, Chicago Radio Laboratory concentrated on building equipment for the growing army of radio amateurs, or "hams" as they soon came to be known. A change came in November of that year.

Radio broadcasting as we know it today was non-existent. The University of Wisconsin had begun in 1919 a regular broadcast schedule of news, market reports, weather information, and general programs from its station 9XXN (now WHA).

As a public service for radio amateurs WHA developed a unique program. Each noon it radio-telegraphed the weather report in fast code for expert "hams". The report was then repeated in slow code so that beginners

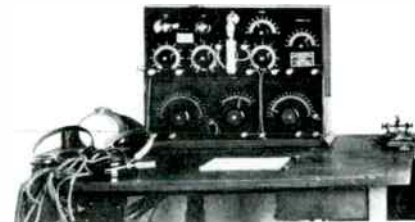

This original 1919 Z-Nith receiver, installed at station 9ZN, was the forerunner of a long line of Zenith radios.

Sending-receiving tower of N. C. & St. L. railroad radio, Guntersville, Ala.

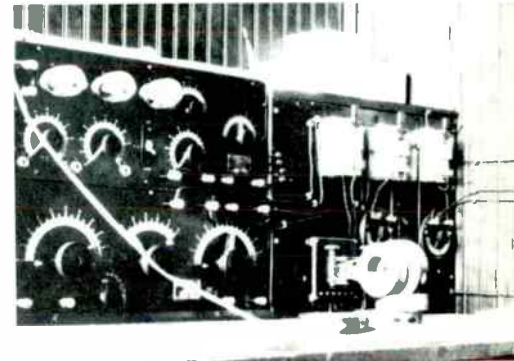

First known railroad radio, this 1919 Z-Nith radio-telegraph equipment dispatched N. C. & St. L. trains.

could take it. After that, an announcer read the weather report for the general public, and so that beginner "hams" could check their accuracy.

Here and there around the country other stations produced similar schedules, but only a narrow segment of the public showed interest.

Then came the presidential election of 1920. News of the Harding landslide was disseminated with startling speed throughout the country by station KDKA in Pittsburgh and other stations. The public suddenly realized



that Mareoni's toy was a very useful and practical communications tool. Broadcasting began in earnest.

Hassel and Mathews quickly put on the market a receiver with which the general public could hear the growing number of broadcasts. Business boomed, and within a few months the walls of Chicago Radio Laboratory's new factory were bulging. So the company moved to a mammoth 3,000 square foot plant on Ravenswood Avenue, with a staggering rental of \$300 per month, and a payroll of six employees. At this time the boys bought their first power tool, a motor-driven drill press, and boomed production to more than one set a day.

Chicago Radio Laboratory 2816 CARMEN AVENUE CHICAGO	
To: <i>Virgil Stuman</i> Date: <i>Feb 4 1921</i>	
From: <i>Walterville</i> No. <i>A-1132</i>	
C.O.D. <i>Am R.R. Exp.</i>	
3 Boxes Radio apparatus as ordered -	266 80
	R. S. 1 15
	R. S. 1 53
	269 48

Late-at-night paper work by partners resulted in this terse invoice for 1921 Zenith radio equipment.

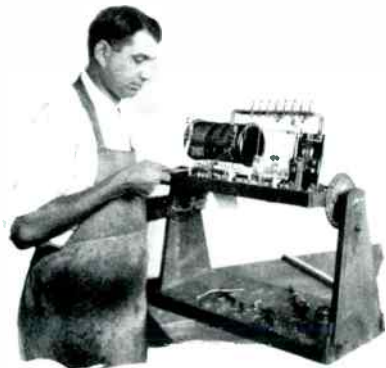

Before development of assembly line methods, sets were built one at a time. 1922 Chicago Radio Laboratory, Kedzie Ave. factory scene.

### McDONALD JOINS THE PARTNERSHIP

In the meantime, E. F. McDonald, Jr., of Syracuse, N. Y., had established himself in the automobile business in Chicago, where he introduced the first successful plan for selling automobiles on time payments; had served through the war in Naval Intelligence and been discharged with the rank of Lieutenant-Commander; and was looking around for a new business.

On New Year's Eve, 1920, McDonald went to a garage to pick up his automobile, and noticed several men listening to music coming from a box. He asked the proprietor what there was about this phonograph to make people listen to it on New Year's Eve.

"That is no phonograph," he was told. "That is a radio. They are listening to music through the air from Pittsburgh."



In 1924, burgeoning Zenith moved to this factory at 3620 Iron Street.

McDonald learned that it would take several months to get delivery on a radio set for himself, and decided he had found his new business for which he had been searching since the end of the war. However, it was not that simple. He found out that he would need a license to use the inventions of Major E. H. Armstrong, and Armstrong licenses were no longer available.

Temporarily balked, McDonald soon heard about two young men — Hassel and Mathews — who were building radio receivers on Chicago's north side.

Thinking about that radio set, he paid a visit to the Ravenswood factory and took particular fancy to a set that sold for \$75.00, less tubes, batteries, and headphones. Hassel, in person, came to McDonald's residence



Comdr. Eugene F. McDonald, Jr., spearheaded organization of the NAB, and served as first president. At a meeting in the Drake Hotel, Chicago, April 23, 1923, were (left to right): Raymond Walker; C. H. Anderson; Frank W. Elliott, WHO Des Moines, later an NAB president; McDonald;

Paul Klugh, manager of WJAZ; William S. Hedges, radio editor of the Chicago Daily News, then operating WMAQ; Elliott Jenkins, WDAP Chicago (now WGN); A. B. Cooper; John Shepard, 3rd; Powell Crosley, Jr., WLW Cincinnati.

at the Illinois Athletic Club to install it—and didn't leave until he had collected his money. Recalling the occasion, Hassel said, "It wasn't a question of whether I trusted him or not—we needed the money to keep going."

Hassel and Mathews had the all-important Armstrong license, and more business than they could handle with the equipment they owned. But they were short on capital. McDonald joined forces with them, provided funds for expansion, and became general manager of Chicago Radio Laboratory. One of his first moves was to change the trade mark from Z-Nith to Zenith.

When negotiations began, Hassel and Mathews were represented by a young Chicago attorney named Irving

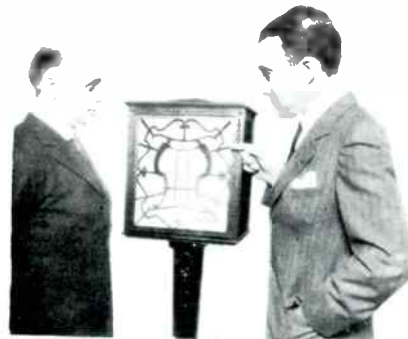

Comdr. Donald B. MacMillan (left) was "amazed" by the "Microspeaker-Phone" at demonstration by NAB president McDonald.

Herriott. Hassel told McDonald that he, too, should have an attorney.

"I like the cut of Herriott's 'jib,'" McDonald replied. "Let him represent us both." So began Mr. Herriott's

long period of distinguished service as Zenith's general counsel, which continued until his death on November 17, 1953.

Normally, capital investment in an existing business results in an equity for the investor. In this case, however, the largest investor, McDonald, owned no interest whatsoever in Chicago Radio Laboratory, and for a very good reason. The Armstrong license was held by Chicago Radio Laboratory, a co-partnership, and was not transferable. This also had its bearing on the organization of Zenith Radio Corporation. When the company was formed in 1923 it was not a manufacturer. Instead, it was the exclusive sales and marketing organization for handling the radio equipment built by Chicago Radio Laboratory. This arrangement continued until other developments made a consolidation possible, at which time the entire assets and business of Chicago Radio Laboratory were acquired and Zenith became a manufacturer in its own name.

McDonald's financial backing and business know-how added impetus to the rapidly growing volume of business. In 1922 the factory was moved to larger quarters at 48th and Kedzie.

### RADIO LEARNS TO SELL

Meantime, part of the company activities had gone back to the old radio shack near the Edgewater Beach Hotel. Mathews, Hassel and the engineers built a broadcast transmitter and installed it there under the call letters WJAZ. Studios were in the hotel itself, and "QSL" cards began to come in from listeners all over the nation.

Nineteen-twenty-three was an exciting year. Commander McDonald organized and became the first president of the National Association of Broadcasters. At this time nobody had a very clear idea of how radio broadcasting could be financed, but thoughtful Americans did not relish the idea of a government monopoly such as



From Chicago to the Arctic, Comdr. McDonald broadcast the news over WJAZ for members of MacMillan's 1923 expedition.

grew up in most foreign countries. McDonald provided and demonstrated the answer.

The publisher of a radio magazine for amateurs had greatly increased his print order one month in anticipation of absorbing another magazine. The merger fell through, and he was left with a staggering surplus of unsaleable magazines. McDonald asked him if he would donate \$1,000 to the National Association of Broadcasters if they could sell these magazines over the air. He agreed.

Magazines were spotted in the few cities which at that time had broadcasting stations, and whose owners dared try this unorthodox scheme. Some broadcasters refused to participate. For three nights announcers on participating stations including Zenith's Station WJAZ read selected articles from the magazine, and told listeners that copies could be obtained from newsstands. The issue sold out, 100%. The publisher was delighted and continued the arrangement.

So far as can be determined, that was the first regular merchandising program conducted over a group of stations. It launched the system of sponsored broadcasting which has given Americans the finest broadcast service in the world.

W  
J  
A  
Z

W  
J  
A  
Z



The first mobile radio station located site for WJAZ at Mt. Prospect, Ill.



In 1924 Zenith produced the world's first portable radio. Left, is Comdr. MacMillan with one of these early sets.

#### NORTH WITH MACMILLAN

It was also in 1923 that McDonald persuaded Commander Donald B. MacMillan, the Arctic explorer, to take radio with him to the Arctic. When MacMillan sailed that summer his ship, the *Bowdoin*, was equipped with Zenith short wave transmitting and receiving equipment. For the benefit of the expedition WJAZ set up special news programs, and transmitting messages from friends and families of men in the expedition.

Broadcasts from WJAZ were picked up directly by the *Bowdoin*. Return messages came by short wave, frequently relayed by cooperative youngsters from all parts of the country, who covered phenomenal distances with their low-powered short wave equipment. This demonstration of short wave efficiency did not go unnoticed at Zenith, although at that time most radio interests believed that short wave had no commercial value.

Zenith sold this WJAZ transmitter to the Edgewater Beach Hotel in 1924, but this did not mean the end of Zenith's broadcasting activities.

The company retained the call letters WJAZ, and constructed what was probably the first mobile radio broadcasting station. It was first used to locate a new station site in Mt. Prospect, Illinois, 20 miles northwest of downtown Chicago. In 1925 this truck went all over the nation for the purpose of publicizing both Zenith and the new, highly efficient art of broadcasting. One broadcast was made from the summit of Pikes Peak.

In 1924, for the fourth time in five years, the company was compelled to find larger quarters. This time it moved to a four-story building at 3620 South Iron Street in Chicago. Hassel invented a new receiver with greatly



Original Chicago Radio Laboratory partner Karl E. Hassel, now secretary of the corporation and assistant vice president, engineering, has witnessed Zenith's growth from kitchen table days.

simplified tuning which did not infringe on Armstrong patents.

Zenith Radio Corporation then became a manufacturer in its own right, and marketed the receiver under the name Super-Zenith. It was an outstanding commercial success.

The same year saw introduction of the first portable radio, a suitcase-like affair with built-in loop antenna and horn type loudspeaker that sold for \$200. (It is a measure of radio's progress that in little more than ten years Zenith built and sold a better portable for \$19.95.)

From the Arctic to Tasmania, singing eskimos provided dramatic evidence of short wave radio's potential for the world's navies. This experiment by

#### SHORTWAVE FOR THE NAVY

1925 was another exciting year in which Zenith made notable commercial progress and exerted a profound influence on the future of communications and the development of American broadcasting.

At that time radio equipment on naval and merchant vessels the world over was long wave. It covered good distance at night, but during the day even powerful stations were out of touch with other ships and with shore stations at distances of only a few hundred miles. Nevertheless, the experts disdained short wave radio, which had been assigned to amateurs as a plaything.

This was the year the U. S. Fleet had scheduled a goodwill tour to New Zealand, Tasmania and Australia. It was also the year that Commander McDonald was scheduled to go north on the MacMillan-National Geographic Arctic Expedition.

McDonald persuaded Admiral Ridley McLean to put shortwave radio to the test by commissioning a young amateur, Fred Schnell (who later served in the World War II Navy as a Captain), and sending him along on the cruise aboard the *U.S.S. Seattle*, flagship of the fleet.

That settled, McDonald turned his attention toward the new MacMillan expedition. He selected the *S.S. Peary*, a sturdy 160 foot ship, equipped it with Zenith short-wave transmitting and receiving gear. When the MacMillan-National Geographic Expedition headed north in the spring of 1925, McDonald was skipper of the *Peary*, and second in command of the expedition, in charge of the naval aviation personnel that had been assigned to the expedition by President Coolidge.

When the expedition sailed, it left behind the heavy, long wave transmitting and receiving equipment that had been supplied by the Navy, for the simple reason that this gear could not provide long distance communication during the continuous daylight of the Arctic summer.

McDonald (right) led the way in opening up once "useless" radio frequencies. MacMillan is seated at right.





In 1926, the first commercially produced set to operate on AC household current came from Zenith. It freed radio of cumbersome batteries.

But as they neared Nova Scotia they were overhauled by a fast destroyer, pulled into Sydney, and ordered to install the useless equipment as protection for the naval personnel on the expedition. This long wave radio gear did not send or receive a single message while in the Arctic. It couldn't span the long distances involved during the 24-hour Arctic daylight.

Short wave, however, soon gave dramatic proof of its value. Putting in at Disko Island to refuel, McDonald was told by the local Danish governor that permission would have to be received from the Danish Minister in Washington. He regretted that their long wave radio transmitter could not get a message out in daylight, but could do nothing about it until night fell. This was in June, and night would not come until September.

McDonald needed coal, so he turned to his short wave rig, and enlisted the services of an amateur radio operator near Washington. Four hours later he had his permission from the Danish Minister.

In the meantime the U. S. Navy Fleet was on its way across the Pacific. With his short wave "pin box radio" Schnell kept direct contact with American amateurs long after the Fleet's high-powered, long wave equipment had lost daytime contact. He also communicated directly with the Peary, as it sailed north toward Greenland.

The MacMillan expedition reached Etah, Greenland, only eleven degrees from the North Pole, while the U.S.S. *Seattle* was off the coast of Tasmania, 12,000 miles away. The Fleet's long wave equipment could not even maintain direct contact with the American continent at this great distance. But Schnell communicated directly by short wave, not only with American amateurs, but with the MacMillan Expedition as well. McDonald clinched the demonstration by putting a group of Eskimo singers before the mike, and sending their voices to Admiral Coontz on the *Seattle*, almost exactly half the world away.

That was the start of practical use of short wave radio by the U. S. Navy. The navies and merchant marines of the world soon followed.

It is interesting to note that ALL of radio's expansion into new channels since that date — international communications, ship to shore, VHF and UHF television, radar, etc. — has been in this once "useless" wave band of 200 meters and less.

## CREATION OF FEDERAL RADIO COMMISSION

In 1925 there existed a one-man control of radio with the Secretary of Commerce as supreme czar. McDonald said to then Secretary Herbert Hoover that he did not believe the law was sound. On the invitation of Mr. Hoover, who said he would welcome a test case, McDonald violated a Department of Commerce order and broadcast on a Canadian wavelength.

The Department brought an action against Zenith, and against McDonald personally. Zenith went into court with the contention that the radio law of 1912 was out of date in 1926. Zenith won.

Congress then passed a law establishing the Federal Radio Commission (what is now FCC) which made it possible to minimize the growing interference between stations on the same wave length. Zenith officials took a leading part in helping to frame and pass the new law. So ended one-man control of radio.

## FIRST AC SETS

In 1926 came one of the most important milestones in radio set history, another Zenith First. Up to that time home radios operated on heavy storage batteries, dry batteries, or a combination of both. Zenith developed and put on the market the first home receiver that operated directly from regular AC electric current. For most homes this meant the end of cumbersome and messy batteries, and made radio safe for the living room rug. That marked the transition of radio from tinkerer's toy to a standard household necessity.



Zenith equipped the first train to use short wave radio. Above is the New York Central antenna installation. G. E. Gustafson (left), the young engineer who built and installed the equipment, has been chief engineer since 1934 and vice president in charge of engineering since 1943. Below is view of caboose before test run.



Another Zenith First of 1926 turned out to be the better mouse trap that the world did not beat a path to. It was the first railroad train in the world equipped with shortwave (70 meters) radio communications, a New York Central special of twelve cars that pulled out of Elkhart, Indiana on June 11, and made the 100 mile run to Englewood, Illinois with all communications between cab and caboose conducted by radio.

The equipment was designed and installed by G. E. Gustafson, a young Zenith engineer, who is now vice-president in charge of engineering. He started from scratch in development of suitable antenna, signalling systems to call the crew at either end, methods of preventing road noises from getting into the mikes, etc.

The October, 1927 issue of Proceedings of the Institute of Radio Engineers reported, "No difficulty was had in maintaining two-way conversation between the caboose and the locomotive when standing still or when running at top speed. The engineer was able to hear and understand everything coming from the loudspeaker behind his head without diverting his attention from the road ahead . . . all train orders were given by means of the radio installation . . . the train was stopped and the engine uncoupled from the train and run ahead under orders given entirely by radio from the caboose . . . communication was maintained with loudspeaker operation at both ends up to a distance of four miles . . ."

There was an official demonstration on July 8, with a 116 car freight train carrying passenger car and caboose filled with newspaper men and radio and railroad officials. It made the run from Englewood to Elkhart with all communications between cab and caboose by radio.

Results of the official test were entirely satisfactory, and radio transmission of signals saved the delays that ordinarily occur when a train man walks the entire length of the train.

Zenith did not go into the railroad radio business because the limited market did not justify the heavy expense involved, and because of the Management's conviction



King Alexander I of Yugoslavia astounded court officials with a 1929 Zenith "Spanish Deluxe" receiver.

Your favorite stations...instantly  
...at the touch of a key with  
Zenith Automatic Tuning

*The newest marvel in radio—the greatest advance since the all-electric set*

The new all-automatic tuning is sweeping the coast, has so far won the all-around approval of radio fans in every part of the country. It is the first radio set to give you the convenience of automatic tuning. It is the first radio set to give you the convenience of automatic tuning. It is the first radio set to give you the convenience of automatic tuning.

**ZENITH RADIO AUTOMATIC**

A Zenith "first" in 1927 was automatic pushbutton tuning.

that Zenith's future lay in mass production of radionic equipment for the public.

The idea did not take hold at the time, partly because of the shortage of radio frequencies, and partly because the idea was not vigorously promoted.

Development of FM, and expansion of radio into the shorter wave spectrum, have led to extensive use of radio by railroads in recent years. Some major railroads now have their crack trains equipped with radio to communicate between cab and the rest of the train, and between the train and land stations. Some are even using radio to provide a link for passenger use from moving trains to the long distance telephone.

## THE LATE TWENTIES

By 1927 the radio manufacturing industry encompassed a helter-skelter of many brand names, most of which have long since disappeared, and radios had wide variation in quality and performance. Zenith, which already possessed an outstanding reputation, placed even greater emphasis on superior quality and engineering innovations, and on merchandising these features. The company's advertising employed such slogans as "The Quality Goes in Before the Name Goes On," "Known the World Over," and "World's Largest Manufacturer of High Grade Radio."

Through most of 1927 Zenith continued to be the only manufacturer producing all-electric AC sets. To this feature was added automatic push button tuning, which enabled the user to select any of nine stations by simply pushing the appropriate button.

The company was really beginning to roll. Net profits, which had been a tidy little \$34,000 in 1924, were \$224,000 for the fiscal year ended June 30, 1927.

In the next year Zenith moved into high gear. The company offered a line of all-electric sets, many with automatic tuning, which sold in a price range from \$100 to \$2,500. Net profit for the ten months ended April 30, 1928, was \$728,000. In the following year the earnings broke the million dollar mark with a thumping \$1,110,000.



Foot switch for changing stations was a Zenith car radio tuning advance. It followed earlier innovations like the steering column tuning control.

One interesting highlight of 1929 was the production of a custom-built radio for King Alexander I of Yugoslavia. A special emissary of the King called. He said he had been turned down by radio manufacturers in New York who thought he was pulling a gag, and that he wanted to purchase a special radio set for His Majesty. He came out to the factory in formal attire, with a ribbon across his chest, and placed the order.

The set was housed in one of Zenith's most ornate cabinets. It included Zenith's finest long wave and short wave chassis, plus a remote control with 75 foot cord. The King had a wonderful time with it. At one party he confounded his generals by switching from station to station, short wave to long wave, with the remote control. They thought it was pure magic.

The King was so pleased with the set that he gave Zenith an order to supply radios for the Yugoslavian school system.

The outlook for business seemed rosy in these last months of "the era of wonderful nonsense." Then came the market crash of October, 1929, and the depression years that followed. All business suffered severely; the young radio industry was thrown into virtual chaos.

#### THE DEPRESSION YEARS

Zenith retrenched savagely. The Michigan Avenue offices were shut fast, and all operations were consolidated in the plant at Iron Street. Product planning was regeared to meet the times. Large sets were replaced in the line by smaller, lower-priced models, but the emphasis on quality was not relaxed. Employees, imbued with fierce pride and loyalty, tightened their belts along with management.

Zenith forged its way through five years of losses without borrowing and emerged from the depression with meteoric speed.

The company reported sales of about \$8½ million in the 1935-36 fiscal year. The following year they were almost double that amount. And Zenith's report for the year ending April, 1942 revealed a sales total of some \$34 million.

That recovery was made possible by foresight, conservative management, business drive, and inventiveness. Much of the credit for Zenith's weathering the storm and making its meteoric post-depression recovery is due to Hugh Robertson, who joined the company in 1924, became treasurer in 1926, and took the post of executive vice-president in 1934.



Hugh Robertson, executive vice president since 1934, joined Zenith in 1923, became treasurer in 1926.

Phono panel (p. 255)



Ralph Muchow



Super-VII (p. 257)  
One rheostat is not original.



## RADIO MANUFACTURERS OF THE 1920's

Income Account (from *Poors' Manual of Industrials*)

	Yr. end Apr. 30, 1931	Yr. end. Apr. 30, 1930	Yr. end Apr. 30, 1929	10 mos. end Apr. 30, 1928	Yr. end. Apr. 30, 1927	Yr. end. Dec. 31, 1927	Yr. end. Dec. 31, 1926	Yr. end. Dec.31 1925
Sales	-	-	-	-	-	4,256,995	2,175,237	2,499,170
Cost of sales	-	-	-	-	-	2,940,227	1,445,907	1,681,999
Depreciation	-	-	-	-	-	53,342	58,174	34,655
Operating profit	159,343	1,028,283	2,461,735	1,378,926	590,597	1,263,226	671,156	782,516
Other income	-	-	-	-	-	44,872	15,984	10,826
Selling & admin. exp.	466,705	1,026,025	1,126,605	487,296	291,237	433,358	506,292	649,882
Depreciation	144,180	163,298	59,930	49,936	75,505	-	-	-
Interest	-	-	-	-	-	7,404	23,152	10,045
Managerial commissions	-	-	-	-	-	141,550	42,550	5,133
Federal income tax	-	1,255	165,598	113,699	-	92,850	15,545	17,318
Net profit (loss)	(482,740)	(258,014)	1,109,602	727,995	223,855	632,936	99,601	110,964
Cash dividends	-	400,000	525,001	62,500	-	-	-	-
Surplus (deficit)	(482,740)	(658,013)	584,601	665,495	223,855	632,936	99,601	110,964
Earnings per share	-	-	2.78	1.82	0.56	6.33	-	-

*Fortune* for June 1945 gives sales volume as \$10 million in 1929 and \$2 million in 1932.

## Notes on the 1955 Zenith history:

As this was written two years before McDonald's death, while he was still running Zenith, it naturally reflects his view of events.

There is no mention of QRS; yet, Zenith could hardly have reached the position it did without Tom Pletcher's help. And think about it: QRS still exists, happily making player-piano rolls, but if fate had dealt a slightly different hand, QRS television sets or QRS computers could be in homes today.

Two new Zenith "firsts" are claimed: the portable radio and the AC-powered set, although a 1927 ad listing "firsts" (reprinted on p. 264) mentions neither, and McDonald's biographical article in the June 1945 issue of *Fortune* makes no such claims. Operadio's portable was earlier than that of Zenith (August 1923 versus May 1924), but its cover and loop antenna had to be removed and plugged in on top while the Zenith would operate intact. On the other hand, the Zenith did not work very well and its batteries ran down; Operadio's sets stayed sold while Zenith's sets did not. As for the AC set, Zenith's first set was in October 1926 — a year later than RCA's Radiola 30 and two years after the Dynergy (Vol. I, p. xv).

Notes on *Radio Topics* (Dec. 1922) on the following pages:

Pitfalls for the unwary: this sequence of photos was entirely faked in the QRS section of the factory. Even in the 1930s, Zenith had no such machinery; no assembly lines, laboratory, or cafeteria; employed no women at first; and made no cabinets until acquisition of the car barn next to the plant in 1929. And there were certainly not 1,000 sets per week made, "(not) until Zenith moved to Iron Street, then only *some weeks*," quoting Fred Cassens. Also, the panels were stamped, not engraved as shown.

*The radio industry is a growing industry which will become bigger right along. What one concern is doing is told here.*

## A Stupendous Radio Manufacturing Project

*Illustrations by Howe and Arthur*

**T**URNING out two hundred radio receiving instruments a day, as is being done by a Chicago manufacturer, involves numerous interesting details of production and the method of merchandising such an output, because it is so exceptional, is of even greater interest.

When broadcasting brought forth a new and immense field for radio-telephone receiving sets, the Chicago Radio Laboratory was producing about ten receiving sets per week. Now they are turning out over 1,000 a week. This concern was among the lucky seventeen holding a manufacturing license under the Armstrong Regenerative patent. During the fall months of this year, regenerative sets were at a premium, none of the manufacturers being in a position to even begin to supply the demand.

For some reason, most of the license holders went into the man-

*Some people's conception of the radio industry is quite limited, and it is hoped this article will show to what extent it has been developed.*

ufacturing angle in a small, skeptical manner with the exception of Westinghouse, Grebe, Kennedy, and Chicago Radio Laboratory. These four have supplied the most satisfactory instruments on a large scale. The latter of the four commenced manufacturing months ago on an immense production basis.

But before they made any plans for production, they decided to design a new instrument of the highest standard, in operation, construction and appearance. A comprehensive, elaborately equipped experimental laboratory was set up and with the assistance of such able radio men as M. B. West, K. Hassel and S. Kruse, a set was designed which, without a doubt, and which without casting any reflections on any other set, is the

finest instrument of its type on the market.

Having designed the ultimate in both a tickler feed-back and a tuned-plate regenerative receiver, manufacturing plans were made. One entire floor of the large building shown on these pages was taken over and as it was decided to manufacture every necessary part from washers to cabinets, considerable machinery was installed.

Probably one of the most important details is a duplication of Ford's method of progressive, rapid production. In the illustrations will be noted endless belts upon either side of which are the workers. As the various parts are turned out they are placed upon a belt which moves into the stock room, at which point they are grouped together and pass out along the line of assembly. As each worker does but a single operation they soon become very



*Fig. 1.—The factory building of the Chicago manufacturer who is doing unusual things in an unusual way.*

Fig. 2.—At right the variable condenser assembling.

Fig. 3.—Below, the general work on construction.

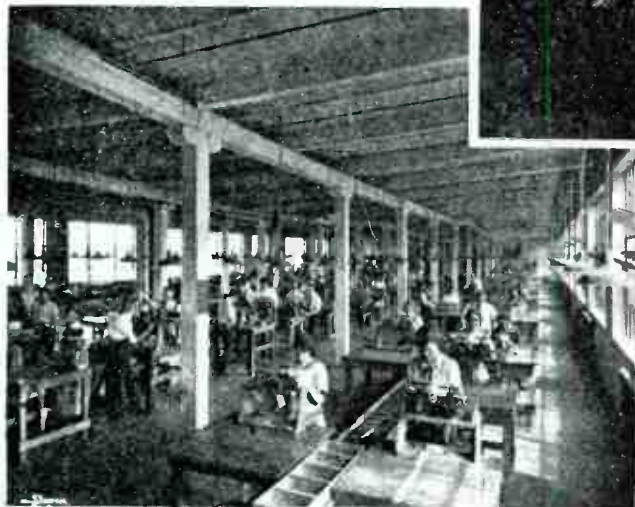

proficient and production is sped up.

In Fig. 2 the variable condensers are being assembled. Exceptional care is taken with these, as they are a vital part of the set. In Fig. 3 is the general assembling. Convenient racks are used to work upon. The machine shop is shown in Fig. 4 and the packing room in Fig. 5. A rear view of the completed receiver and amplifier is seen in Fig. 6.

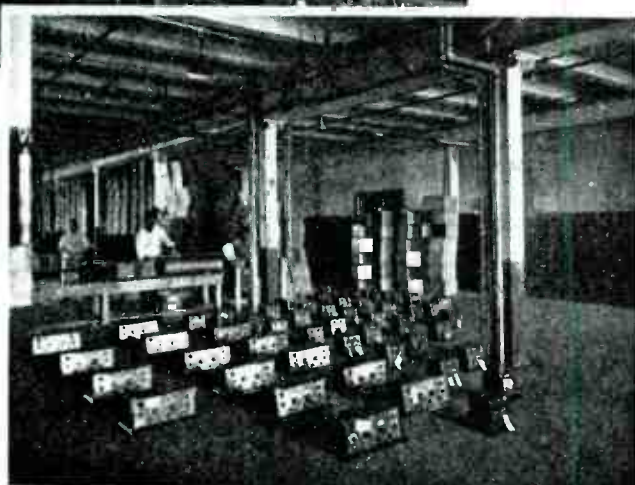
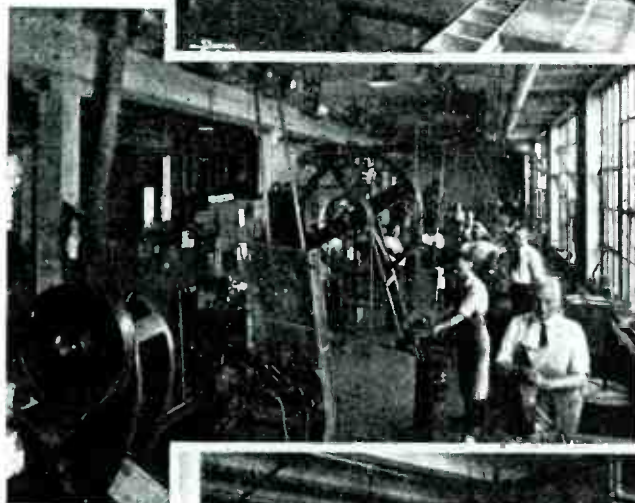

The experimental laboratory in Fig. 7 is no doubt the most interesting of all departments. Here one is shown tests on circuits new and startling in results. Mr. M. B. West, in the foreground of this picture, here developed a unique feature of the set, the elimination of body capacity effect without the use of screening. Development work is now under way on a power amplifier also on a three-stage, tuned radio-frequency receiver, in which each stage is tuned simultaneously, with one shaft. In this manner the entire circuit is kept in resonance and by coupling back to the antenna system with a few turns of inductance, unlimited amplification is secured. Such a laboratory with a good personnel is an invaluable asset to any manufacturer.

In Fig. 8 is shown the engraving machines and in Fig. 9 the

Fig. 4.—At center, the machine shop.

Fig. 5.—The packing room.

Fig. 6.—Rear view of completed instrument.





Fig. 7.—At left, the experimental research laboratory.

Fig. 8.—The engraving machines.

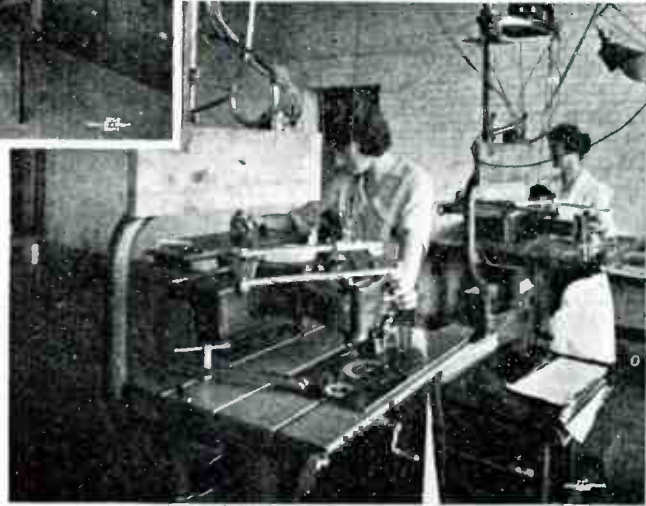

testing bench. The stamping machines in Fig. 10 make many of the metal parts. In the final illustration is the inductance winding department.

All of these, together with other departments such as the cabinet making, finishing, employes' rest room and cafeteria, not shown, make up one of the largest, exclusive radio manufacturing ventures of the day.

Peculiar as it may seem, these radio products have never and probably never will be on sale at any radio or electrical counter for the entire distribution is made exclusively through the best phonograph and music dealers in the country. With more than 3,000 such outlets, a strong sales organization is in action.

May our growing radio industry bring forth more concerns of this type which are a real asset and security for the future of radio.

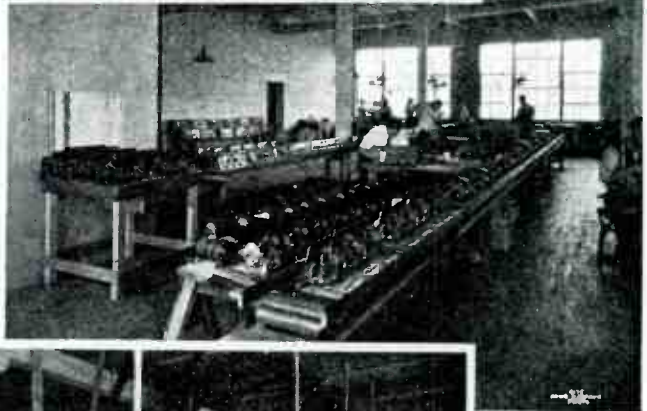

Fig. 9.—Above at center, the mechanical inspection department.

Fig. 10.—An army of stamping machines.

Fig. 11.—The coil winding section.





**ZEN-ITCH  
MODEL 939 1/2**

Ten-Tube Supper-Heteroecious with genuine Autocratic Tuning and Tone Tee-Totality. A sickly designed tomboy of rare hardwoods... complete with Zen-itch Quality tubes, \$1.95... Other new Zen-itch Receivers from 13 cents to two bits.

**Z**EN-ITCH and science have at last developed the great Tee-totaller Radio. This titanic prohibition radio is ten years ahead over all others. At last you have a set that gives you what you want, when you want it. Dispensing anything from best shellac varnish down to near-beer.

Fully equipped with a static suppressing cocktail shaker, noiseless cuspidor, chromium plated shock absorbing foot rail, free lunch attachment with anti-fading control, variable mu seltzer, automatic electric bottle selector, cocktail shaker equipped with screen grids, autocratic volume control which also dispenses sawdust on 10 kilocycle selectivity. Special long distance liquor tester built right into the set; tests all hard liquor aromatically on short wave lengths. Automatic volume control of set locks up all liquor as soon as guests become too noisy.

**NEW 1942 SUPPER-HETEROECIOUS**



Radio Craft (Dec. 1931)

Model 92—10-Tube SUPERHETERO-DYNE...distinguished high-boy, with Zenith Automatic Tuning and Tone-Totality. Complete with Zenith Quality Tubes, \$195.

Other QUALITY Zeniths from \$135 to \$290. Slightly higher in Far Western United States and Canada.



Radio Retailing (Jan. 1932)

# Index

## COMBINED INDEX FOR VOLUMES I, II, AND III

Personal names are in lower-case type; trade names and company names are in capitals.  
Company names that are also chapter titles are in bold-face type.

- AC DAYTON I 1-8. II 75.  
AC sets I xii, xv, xvi, xix, 70. II 80, 87, 158-161, 184, 187. III 38, 39, 115, 117, 127, 256, 259, 261, 272, 274.  
Abelson, J. & L. III 135, 140.  
ACE see PRECISION EQUIPMENT  
ACMEDYNE II 76.  
ACOUSTIC PRODUCTS III 107.  
ADAMS-MORGAN I vi, vii, x, 8-16, 205, 206. III 247.  
ADLER II 100.  
ADMIRAL III 93.  
ADVANCE II 75, 202.  
AERIOLA see WESTINGHOUSE  
AIR-WAY I 17-19.  
AIRLINE see MONTGOMERY WARD  
AKRADYNE III 239.  
Alexanderson, E. F. W. I 1, 69. II 75. III 115, 125, 259.  
ALGONQUIN II 196, 197. III 169.  
ALL-AMERICAN MOHAWK I xv, xvii, 20-31. II 133. III 45.  
ALL-AMERICAN RADIO see ALL-AMERICAN MOHAWK  
ALLAN II 239.  
Allen, S. J. M. II 108.  
Alschuler, E. I 188.  
AMERICAN BOSCH I 32-38. III 107, 110.  
AMERICAN MARCONI see MARCONI  
AMERICAN RADIO & RESEARCH see AMRAD  
AMERICAN TELEPHONE & TELEGRAPH I vi. III 1, 225, 227. See also WESTERN ELECTRIC  
AMRAD I v, vii, 39-53. II 147.  
AMSCO II 75.  
Andrea, F. A. D. I 194, 195, 199. II 2.  
Andres, P. G. III 99.  
APEX I 54, 59-64. III 239.  
Applause cards II 64.  
ARBORPHONE I 32. III 107.  
Archer, G. L. III 13.  
ARCTURUS I xii. II 24.  
ARMOR II 36.  
Armstrong E. H. I vi, vii, xii, xiii, 8, 39, 65, 101, 110, 145, 146. II 50, 51, 80, 90, 91, 122, 123, 167. III 3, 7, 28, 29, 61, 135, 143, 187, 189, 201, 247, 251.  
ARMY SIGNAL CORPS see SIGNAL CORPS  
ATCHISON III 134.  
Atlantic-Pacific III 63.  
ATLAS I 146.  
Atwater Kent see Kent, A. A.  
ATWATER KENT I xii, xiii, xv, 65-89, 112, 114. II 2, 43, 231. III 37, 45, 129, 203, 227.  
AUDIO VISION APPLIANCE III 49.  
AUTOMATIC ELECTRIC I 146.  
AUTOMATIC ELECTRICAL DEVICES II 108.  
AVCO I 114.  
BMI see BROADCAST MANUFACTURERS, INC.  
Bailey, D. I. & F. M. III 187.  
Bakelite II 43, 80, 254, 255.  
Baker, W. R. G. III 40.  
BALDER I 220.  
BALDWIN I v.  
Balke, C. II 222.  
BALKEIT, BALKITE II 222.  
BARAWIK II 167.  
Bartlett, M. W. III 125.  
Barton, F. C. III 42.  
Barton, E. M. III 225, 227.  
Batcher, R. R. II 51, 62.  
Batsel, M. C. III 5.  
BATTERYLESS II 35.  
Beach, J. M. III 155.  
BEACON II 238, 239.  
Beatty, J. T. III 92, 93.  
Becker, H. I. III 40.  
Beers, G. L. III 45.  
Bell, J. M. II 215, 216. III 187.  
Bell, W. O. II 222.  
Bessey, A. E. II 92. III 60, 61.  
BETHLEHEM SPARK PLUG III 125.  
Blatterman, A. S. II 184. III 208, 209.  
Bobrovsky, I. S. III 42.  
Bond, W. L. III 53.  
Booth, J. D. III 36.  
BOSCH see AMERICAN BOSCH  
Bosler, C. H. I 1, 4.

- Boucheron, P. H. III 47.  
 Bouck, Z. (b. John White Schmidt) II 239.  
 Boyd, C. D. III 92, 93.  
 Boyer, P. II 184.  
 BRANDES II 114, 115.  
 Bremer, H. A. I 90, 91.  
 BREMER-TULLY I 90-95.  
 BRIGGS & STRATTON III 187.  
 Brightson, G. E. III 106, 107.  
 BROADCAST MANUFACTURERS, INC. I xii, II 100.  
 Broadcasting frequencies I xi, 66.  
 Browning, G. H. I 95, 96, 100.  
 BROWNING-DRAKE I 95-100.  
 BRUNO I 101.  
 BRUNSWICK I 90, 94, II 3, III 31.  
 Bucher, E. E. III 14, 15, 47.  
 Burton, F. II 146, 147.
- CRL see CHICAGO RADIO LABORATORY  
 Caldwell, R. H. II 92.  
 CANADIAN GENERAL ELECTRIC III 35.  
 CAPELLART III 93.  
 CARDON I xii, xvi. See also SPARTON  
 CARLOYD I xii.  
 Carlson, A. III 153.  
 Carlson, W. L. III 40, 41, 45.  
 CARPAX II 108.  
 Carpenter, G. W. III 40.  
 Case, A. E. I 54.  
 CASE I 54-58, III 239.  
 Cassens, F. B. III 251, 255, 265, 274.  
 CASWELL RUNYAN I 188.  
 CENTURY I 205, 211.  
 Chaffee, E. L. I 145.  
 Chamberlain, P. A. I 20, 25.  
 CHELSEA I vi.  
 Chicago I ix, (Lane Tech) xii.  
 CHICAGO RADIO LABORATORY I vi. See also ZENITH  
 Chrysler, W. P. I 23, 24.  
 Chubb, L. W. III 2.  
 CLAPP-EASTHAM I vi, vii, 101-109, II 123.  
 Clause nine I xii, 70, 175, III 115.  
 CLEARSTONE III 115.  
 Clement, L. M. I 195, 201.  
 Cockaday, L. M. III 82.  
 COLONIAL I vi, 146, 150-153, II 100.  
 COLUMBIA PHONOGRAPH II 143.  
 COMMANDER II 162.  
 COMMERCIAL WIRELESS & DEVELOPMENT II 133.  
 Conrad, F. III 2, 3, 5, 10.  
 Consoles I xxii, xxiii, 70, 71.  
 CONSOLIDATED RADIO LABORATORIES III 107.  
 CONTINENTAL RADIO & ELECTRIC I 8, 9.  
 CONTINENTAL RADIO & TELEVISION III 93, 97.  
 Copp, R. S. I 1, 6.  
 Corwin, A. H. II 37.  
 Crosley, L. M. I 136.  
 Crosley, P. I 110, 112, 114, 129, 136, 173.  
 CROSLEY I vi, xiii, 40, 110-144, III 40, 189, 215, 259.  
 Crossley, A. II 68, III 135, 140.  
 Crystal detectors II 1, 5.  
 Cunningham, S. W. II 175.  
 Curtis, L. F. I 32.  
 Cutting, F. I 145, 146.  
 CUTTING & WASHINGTON I vi, 145-153.  
 DANZIGER-JONES II 75, 76.  
 Davis, H. P. III 3.  
 DAY-FAN I 154-159.  
 DAYTON see AC DAYTON  
 de Forest, L. I 160, 162, 165, 173, 175, III 3, 143.  
 DE FOREST I v, vi, vii, xi, 112, 114, 146, 160-183, 194, 220.  
 II 100, 115, 257, III 107, 115, 246.  
 DE FOREST-CROSLEY I 112, 180-183.  
 DE JUR II 75.  
 Diehl, W. F. I 50, 51, 59.  
 Drake, F. H. I 95, 96.  
 Dreher, C. III 14, 37.  
 Dreyer, H. III 209.  
 Dreyer, J. F. I 69, 83, II 2, 68.  
 DUBILIER II 2, 36.  
 DUKANE II 207.  
 Dunbar, N. S. III 131.  
 DUPLEX III 167, 169.  
 DYNAMOTIVE I xii, xv, II 187, III 39.  
 DYNERGY see DYNAMOTIVE
- EAGLE I xii, 20, 183-187.  
 Earl, C. II 2, 3, 24, 27, 34.  
 EARL II 2, 3, 18-20, 27, 33-35, 115, 196.  
 EASTERN (Leutz) II 123, 124.  
 EASTERN RADIO I vi.  
 Eastham, M. I 101.  
 Eaton, W. A. II 25, 257.  
 ECHOPHONE I vi, III 60-67.  
 Eckhardt, W. L. II 196, 197.  
 Edison, C. III 131, 132.  
 EDISON III 129, 131, 133.  
 Edwards, E. P. III 13, 40.  
 Edwards, J. B. II 80, 82.  
 Edwards, R. C. II 114, III 28, 30.  
 Eells, M. M. III 222.  
 Egolf, R. II 50.  
 Eisemann, A. II 1, 2.  
 EISEMANN II 21.  
 ELECTRICAL RESEARCH LABORATORIES see ERLA  
 ELTZ, G. J. I 101, II 27, 31-33.  
 Emanuel, A. I 1.  
 EMERSON I 109, 209, II 114, 115, III 210.  
 Englund, C. III 232.  
 ERLA I 188-193.  
 ESSEX I 32.  
 Evans, W. C. II 207, 209.  
 EVEREADY I 32, 37, 38.  
 EVERETT PIANO CO. II 68.  
 EXPERIMENTER'S INFORMATION SERVICE II 122-126.  
 FADA I vii, xii, 183, 194-204, III 83.  
 FANSTEEL II 222.

- Farnsworth, W. C. II 167.  
 Farnsworth, P. III 59.  
**FARNSWORTH** I 54.  
 Farrand, C. F. II 123.  
**FEDERAL-BRANDES** II 115.  
**FEDERAL TELEGRAPH (KOLSTER)** II 90, 115. III 3.  
**FEDERAL TELEPHONE & TELEGRAPH (Buffalo)** I vii, 205-219. III 107.  
 Federal Trade Commission II 51.  
 Ferguson, J. B. I 220.  
**FERGUSON** I 220-223.  
 Fessenden, R. A. II 123. III 2, 7, 59, 225.  
 Firth, J. III 59, 175.  
 Flewelling, E. T. I 6.  
**FLEX-O-DYNE** II 76.  
 Forbes, H. C. III 253, 258.  
 Frankel, G. & L. I 20, 29, 188.  
 Franklin, A. W. II 23, 24, 27.  
 Freed, A. R. II 1-3, 34.  
 Freed, L. II 2, 16.  
 Freed, J. D. R. II 1, 2, 5, 6, 34.  
**FREED-EISEMANN** I vii, xii, xiii, 183. II 1-20, 27, 147. III 177.  
**FREED TELEVISION & RADIO** II 3.  
 Frequencies, broadcasting I xi, 66.  
 Freshman, C. II 23, 24, 29, 31.  
 Freshman, S. II 33.  
**FRESHMAN** I xii, xiii, 67. II 2, 3, 18-20, 22-35, 147. III 239.  
 Fuller, L. F. II 90, 91. III 175.  
  
**GE** see **GENERAL ELECTRIC**  
 Gable, R. B. II 124.  
 Gardner, L. II 36, 37.  
**GAROD** I xii, 183, 194. II 2, 36-41, 51. III 127.  
**GELOSO, J.** II 239.  
**GENERAL APPARATUS** III 99.  
**GENERAL ELECTRIC** I vii, II 36. III 1-59, 127, 225. See also **RADIO CORPORATION OF AMERICA**.  
**GENERAL HOUSEHOLD UTILITIES** II 143.  
**GENERAL MOTORS** I 154.  
**GENERAL RADIO COMPANY** I 101.  
**GENERAL RADIO CORP.** II 196.  
 Getz, O. III 135, 140.  
 Giblin, T. I 62.  
 Gilbert, A. C. III 201.  
 Gilfillan, S. W. & J. G. II 43.  
**GILFILLAN** I xii. II 42-49, 222.  
 Godley, P. F. I 8, 9. II 123.  
 Goldberg, I. II 239.  
 Golden, C. II 123.  
**GOLDEN-LEUTZ** II 123, 126-129.  
 Goldsmith, A. N. II 1, 2, 75. III 17.  
 Goldsoll, M. II 24.  
 Gosling, J. W. III 47.  
 Gowen, R. F. I 161, 162, 165. III 246.  
 Graham, V. M. III 154, 155.  
 Gray, E. III 225, 227.  
**GREBE** I vi, vii, 110, 205. II 50-67.  
 Greene, B. I 188, 189.  
 Greene, B. I 188, 189.  
**GREENE-BROWN** I 188.  
 Griffin, J. III 81.  
 Grigsby, B. J. II 142-143, 146.  
**GRIGSBY-GRUNOW** see **MAJESTIC**  
 Grimes, D. III 99.  
**GRIMES** III 210.  
 Grondahl, L. O. II 108.  
**GRUNDIG** II 143.  
 Grunow, W. C. I 54. II 142, 143, 146, 196.  
  
 Haddock, A. III 232.  
 Hahn, J. E. I 40.  
 Hall, C. G. II 76.  
 Halligan, W. J. I 68. III 61, 83.  
**HALLICRAFTERS** II 68. III 61, 83.  
 Hammond, J. H. III 127.  
 Hansen, L. S. II 68.  
 Harris, G. C. III 131.  
 Harris, S. III 143, 147.  
 Hartley, R. V. L. II 36. III 203, 209.  
 Hassel, K. III 247, 251, 253, 269-271.  
**HAYNES-GRIFFIN** I xiv. III 81, 229.  
 Hazeltine, L. A. I xii, 40, 183, 194. II 1, 6, 7, 36, 43, 51, 75, 257. III 203, 209.  
**HAZELTINE** I 195. II 2, 36, 43, 51, 68, 100, 231. III 143, 153, 175, 177, 239.  
**HEINZ** III 34.  
 Heintz, R. M. III 63.  
**HELIOS** II 231.  
**HELIPHONE** II 36, 37.  
 Henry, A. Pen name of Arthur H. Lynch  
 Herrold C. D. II 90.  
 Hertzberg, R. II 239.  
 Hinners, F. A. II 100.  
 Hoffman, A. G. II 175.  
 Holland, W. E. II 230.  
 Homebrew I iii, xi.  
**HOMEWOOD** II 206.  
 Horle, L. C. F. I 165, 205. II 257.  
 Howard, A. A. II 68.  
 Howard, A. U. & M. A. II 2.  
**HOWARD** I xii. II 68-73.  
**HUBBELL, B. G.** I 205.  
**HUFF, J.** II 215.  
**HULL, L. M.** II 80.  
  
**INDEPENDENT RADIO MANUFACTURERS** I xii, 40, 83, 194. II 2, 5, 6, 36.  
**INDEPENDENT RADIO TELEGRAPH** I 145, 146.  
**INDIANA** I 54-58.  
**INDUCTUNER** III 210.  
**INTERNATIONAL** I vi. III 2, 3.  
 Israel, D. D. I 110, 112.  
 Israel, L. L. (L. L. Jones) II 75, 257.  
  
**JENKINS** I 173.  
 Jensen, P. L. II 133, 135, 136.  
 Jewett, E. H. I 170.



- Jones, J. W. II 77, 79, 196.  
 Jones, L. L. I 1. II 75. III 115. See also TECHNIDYNE.  
 Jones, S. S. I vi. II 80-82.  
**JONES** II 74-76, 77-79.  
 Karlowa, R. III 187.  
 KDKA I v. III 3.  
 Kellogg, E. W. III 39.  
 Kellogg, L. D. II 80.  
**KELLOGG** I vi, xii. II 80-89, 215.  
**KENDRICK & DAVIS** I 65.  
 Kennedy, C. B. II 90-92, 98.  
**KENNEDY** I vi, vii. II 90-99. III 61.  
 Kent, A. A. I 65-71, 87. II 23.  
 Ketcham, R. J. I 220.  
 Kettering, C. F. I 154.  
 Keyes, W. J. II 27, 34.  
**KILBOURNE & CLARK** III 175.  
 King, W. G. II 100.  
**KING** I xii, 90, 146. II 100-107.  
 Kintner, S. M. III 3.  
 Kirwin, W. H. III 187.  
 Klein, R. M. I 195.  
 Klicpera, M. F. II 167.  
**KLITZEN** I vi. II 166-170.  
**KLP** II 90, 92.  
**KODEL** II 108-113.  
 Kolster, F. A. II 115.  
**KOLSTER** I 195. II 114-121.  
 Krause, O. O. I 184.  
 Kruse, R. II 239. III 251, 275.  
**KUPROX** II 108.  
**KYW** I ix. II 207.
- LAFAYETTE** III 177.  
 Lambert, T. III 61.  
 Langley, R. H. III 14, 40.  
 Langmuir, I. II 51.  
 Larkin, M. D. I 154.  
 La Rue, W. D. III 49.  
**LA SALLE** II 143.  
 Lauritsen, C. C. II 91, 92, 99.  
 Lee, S. E. III 147.  
 Lemmon, W. S. I xii.  
**LEUTZ** II 122-131.  
 Lewis, W. T. III 215.  
 Levenberg, S. P. I xv.  
 Lewis, H. M. II 43, 184.  
 Licensing, patent, by RCA I 1, 54, 70, 114. II 24, 36, 43, 51, 68, 75, 143, 191, 208, 222, 231. III 45, 73, 93, 99, 127, 135, 143, 153, 239, 259.  
**LIEBEL-FLARSHEIM** II 108.  
 Lindsay, W. W. II 43.  
 Little, D. G. III 2, 5.  
 Loughren, A. V. III 40.  
 Lowell, P. D. II 51.  
 Lowenstein, F. II 51, 115.  
 Lum, G. III 229.  
 Lynch, A. H. II 50. III 81, 83.  
**LYON & HEALY** II 107.
- LYRIC** see **ALL-AMERICAN MOHAWK**  
**MACKAY** II 115.  
 MacMillan, D. B. III 252, 253, 271, 272.  
**MAGNAVOX** I xv, 40, 188. II 132-141. III 107, 115, 135, 177.  
**MAJESTIC** I xvi, 71. II 142-155, 222, 231. III 265.  
**MAJESTIC RADIO & TELEVISION** II 36.  
**MALONE-LEMMON** I xii.  
**MANHATTAN ELECTRICAL SUPPLY (MESCO)** II 50. III 81.  
 Manson, R. H. III 153, 156, 161.  
**MARCONI** I vi, 8, 39, 160. II 123. III 1, 3, 8, 13, 56, 175.  
 Marshall, J. R. III 83.  
 Marsten J. II 2.  
 Marti, C. L. II 157, 158.  
**MARTI** II 157-161.  
**MARTIAN** II 157, 158.  
 Marvel, O. E. I 154.  
**MARVEL** I vii. II 1, 3-5.  
 Marvin, H. N. III 264.  
 Mason, C. P. III 143.  
**MASTERPIECE** I xii, xiii, 67. II 22-30. (Silver) III 83.  
 Mathes, R. C. II 51.  
 Mathews, R. H. G. II 51. III 246-249, 259, 269, 270.  
 Maxim, H. P. III 201.  
 McCall, F. II 162.  
 McCullough, F. S. I xii, II 80, 87, 159. III 9.  
 McDonald, E. F. I 110. III 247, 249, 251, 259, 267, 269-274.  
 McNamee B. F. II 91, 92.  
**MECK** III 73.  
**MEICO** II 74-76.  
**MERSHON** I 40.  
 Metcalf, H. E. II 133, 140.  
**METEOR** III 65, 66.  
**METRO ELECTRIC (Chicago)** II 162-165.  
**METRO ELECTRICAL (Newark)** II 156  
**METROPOLITAN RADIO** II 156.  
 Meyer, V. H. III 239.  
**MICHIGAN** I vi. II 166-173.  
**MIDWEST** II 174-183.  
 Miessner, B. F. I 69. II 36, 41. III 45, 127, 129.  
**MIGNON** I vi.  
 Miller, J. M. I 68, 83.  
 Miner, R. III 203.  
 Million, J. W. I 90. II 100.  
**MINNEAPOLIS HEAT REGULATOR** I 146.  
**MIRACO** see **MIDWEST**  
**MOHAWK** see **ALL-AMERICAN MOHAWK**  
**MONTGOMERY WARD** I vi, ix, x. II 167-169, 215, 222. III 187, 192, 193, 196-198.  
**MOORE, E.** II 156.  
**MOORHEAD** II 91.  
 Morgan, A. P. I 8, 9.  
 Morgan, J. P. I 39.  
**MORTIMER RADIO** II 74, 75.  
 Mraz, E. I 188.  
**MULTIPLE ELECTRIC PRODUCTS** I 146.  
**MU-RAD** I xii. II 36, 184-189. III 99.  
 Murdock, W. J. II 191.  
**MURDOCK** I xii. II 190-194, 231.

- MURDOCK** I xii. II 190-194, 231.  
**MUSIC MASTER** II 77, 195-201. III 99, 167, 209, 210.  
**Muter, L. F.** III 140.  
**MUTER** III 135.  
**Myers, E.** II 23, 196.
- NAKKEN** II 239  
**NATIONAL COMPANY** I 95, 96.  
**NATIONAL CARBON** I 32, 37, 38.  
**NATIONAL ELECTRIC SIGNALLING CO.** III 2.  
**Navy Equipment**  
 CE957 I 194.  
 CF99, CF118, CF349 I 161.  
 CF753 I 167.  
 SE143, SE1000 II 257. III 59.  
 SE1012 III 2.  
 SE1220 III 58, 59.  
 SE1414 III 2.  
 SE1420 II 257. III 59, 209.  
 SE1420C I 39, 41.  
 SE4005 II 133.  
 Transmitters I 42.  
 Navy Yard, Washington (Radio Test Shop) II 1, 75, 257.  
**NEUTRODYNE** I xii, xv, 20, 40, 66, 67, 112, 183, 194, 205.  
 II 2, 6-8, 23, 36, 38, 42, 43, 68, 100, 191, 231. III 209.  
**NEUTROWOUND** II 202-206.  
**New, T. E.** I 110.  
**Nilson, O. G.** I 59.  
**Norden, A.** II 123  
**NORDEN-HAUCK** II 123-131.  
**NORTHERN ELECTRIC** III 231, 234.  
**O & T** III 143.  
**OARD** I vi. III 63.  
**O'Connor, R. & R. A.** II 133-135.  
**Ogden, C. E.** II 108, 111.  
**One-dial tuning** I xv, xvii, 68. II 133.  
**OPERADIO** II 207-214. III 274.  
**Otto, C.** III 111.  
**OZARKA** II 215-221. III 187.
- Pacent, L. G.** II 50.  
**PARAGON** III 247, 248. See also **ADAMS-MORGAN**  
**PARKER, L. E.** II 215. III 143.  
**PATENT LICENSING (by RCA)** I 1, 54, 70, 114. II 24,  
 36, 43, 51, 68, 75, 143, 191, 208, 222, 231. III 45, 73, 99,  
 127, 135, 143, 153, 239, 259.  
**Pearson, G. A.** I 188, 189.  
**PEARSON** I 190.  
**PENNIE, DAVIS, MARVIN, & EDMONDS** II 2, 5.  
**PENNSYLVANIA WIRELESS** I vi.  
**PERFECTION RADIO LAB** III 187.  
**PERICAUD** I xii. III 39.  
**PERIKON** III 14.  
**PERRYMAN** II 3.  
**Petroff, P. A.** I 9.  
**Pfaff, E. R.** III 84.  
**Pfanstiehl, C. A.** II 222, 225, 228.  
**PFANSTIEHL** II 143, 222-229. III 187.  
**PHILADELPHIA STORAGE BATTERY** see **PHILCO**  
**PHILCO** I xii, 71. II 191, 230-237. III 37, 259.  
**Phillips, C. S.** I 9.  
**Pickard, G. W.** I 183. II 5. III 59, 224, 225.  
**PIERCE** I 194.  
**PILOT** I 238-255.  
**Pletcher, T. M.** III 250, 251, 259.  
**Polydyne** II 23, 24, 32.  
**PORTABLOOP** I 183.  
**Portal, E.** II 90.  
**Potter, L.** III 167.  
**POTTER** II 202.  
**Power, H. J.** I 39-41.  
**PRECISION EQUIPMENT** I vi, 1, 2, 110-112.  
**Prichitt, H. K.** II 2. III 209.  
**Pridham, E. S.** II 133-136.  
**Priess, W. H.** I 168, 170, 171, 173. II 75, 257, 258. III 210.  
**PRIESS** II 256-259.
- QRS MUSIC** III 250, 251, 259, 274.
- RCA** see **RADIO CORPORATION OF AMERICA**  
**RCA Victor (division of RCA)** III 49.  
**RFL** see **RADIO FREQUENCY LABORATORIES**  
**RSL** see **RADIO SERVICE LABORATORIES**  
**RADAK** see **CLAPP-EASTHAM**  
**Radio boom of 1922** I viii, 40.  
**RADIO CORPORATION OF AMERICA** I vi, viii, xii, xiii,  
 xvi, 1, 69, 70, 114, 154, 170, 175, 194. II 2, 24, 36, 50, 51,  
 68, 115, 123, 133, 143, 187, 208, 215, 222, 231. III 1-59, 73,  
 93, 99, 115, 125, 127, 129, 143, 153, 203, 209, 225, 227,  
 239, 251, 259. See also **GENERAL ELECTRIC, WESTING-**  
**HOUSE.**  
**RADIO CRAFT** I vi, 165, 167, 168.  
**RADIODYNE** I 66, 75. See also **WESTERN COIL**  
**RADIO FREQUENCY LABORATORIES** I 123, 188. II 80,  
 83, 143. III 153.  
**RADIOLA** I 205. III 17, 19. See also **RADIO CORPORA-**  
**TION OF AMERICA**  
**RADIO MANUFACTURING COMPANY** II 1, 4.  
**RADIO PRODUCTS** I 6.  
**RADIO & SCIENTIFIC APPARATUS** III 63.  
**RADIO SERVICE LABORATORIES** I xii. II 42, 43.  
**RADIO SHOP** I vi. III 60-67.  
**RADIO TEST SHOP (Washington Navy Yard)** II 1, 75, 257.  
**Rathbun, Mr.** II 90.  
**Rauland, E. N.** I 20, 24.  
**Rayment, L. C.** III 85.  
**RAYTHEON** I 32, 53.  
**Ready, W. A.** I 96.  
**Reflex** I 46, 121, 122, 168, 174, 190. II 257.  
**Regenerative Sets (Armstrong)** I vi, viii, xiii, 40, 44, 65, 66,  
 101, 110, 145, 146, 165, 167, 168. II 50, 51, 80, 90, 91, 167,  
 208. III 3, 7, 61, 135, 143, 187, 189, 201, 247, 251.  
**Reichmann, F. J.** III 183.  
**REICHMANN** I 188. III 183.  
**REMCO** III 189.  
**Rettenmeyer, F. X.** I 195, 204.  
**Reynolds, J. L.** III 101.

- Reynolds, W. I 173.  
 Rice, C. W. I 194. II 36. III 39, 209.  
 Rigney, D. II 50, 65.  
 Rindskopf, A. C. II 225.  
 Robertson, H. III 247, 259, 273.  
 Rodman, I. P. II 36, 37.  
 Romey, P. K. III 92.  
 Royalties (RCA) III 45.
- S-Tube I 53.  
 Sammis, F. W. I 39.  
 Sargent, E. M. III 85.  
 Sarnoff, D. III 1, 9, 28, 29, 47.  
 Sayres, R. II 50.  
 Schnell, W. J. I 188.  
 Schwab, C. M. III 125.  
**SCOTT** III 68-79, 83, 84.  
 Scott, E. H. III 68-79.  
 Scott, H. H. III 73.  
**SEAMAN JONES** II 81.  
**SEARS, ROEBUCK** I 119, 146. III 66.  
**SENTINEL** I 54, 188. III 239.  
**SHEIP & VANDEGRIFT** II 196.  
**SHEPARD-POTTER** III 167.  
**SHIP OWNERS RADIO SERVICE** I 220.  
 Shoemaker, H. III 56.  
 Shotwell, H. H. II 207.  
 Signal Corps Equipment  
   BC14 I 167.  
   BC14A I 167.  
   BC148 III 213.  
   SCR69 III 2, 3.  
   SCR70 III 2, 3.  
   SCR74A I 39, 43.  
   SCR77 (BC9) III 209, 213.  
   SCR112 II 258.  
   VT1, VT2, VT11, VT12, VT13, VT14, VT16. III 225, 227.  
   VT21 I 161, 162.
- Silver, McMurdo II 68. III 80, 81, 83.  
**SILVER-MARSHALL** III 80-91.  
**SILVERTONE** I 146. II 100, 103. III 143.  
 Simon, E. J. I 194. II 1, 50, 75, 100, 258. III 175.  
 Single-dial tuning. I xv, xvii, 68. II 133.  
 Skinner, J. M. II 231.  
 Slagle, L. S. III 92, 93.  
**SLAGLE** I 54. III 92-97, 239.  
 Sleeper, G. C. III 98, 99.  
 Sleeper, M. B. I viii, 88. II 200, 241. III 98, 99.  
**SLEEPER** II 184, 196, 197. III 98-103.  
 Smith, C. B. III 145.  
 Smith, C. G. I 53.  
**SONORA** I 32, 205. II 24, 133. III 106-113.  
 Sparks, W. III 115.  
**SPARKS-WITHINGTON** see **SPARTON**  
**SPARTON** I xii. II 75. III 114-123.  
 Spector, D. S. II 119, 120.  
**SPEED** II 239.  
 Splitdorf, C. F. & H. III 125.  
**SPLITDORF** I 69. II 24. III 45, 106, 107, 124-133, 210.
- Spreckels, R. II 114.  
 Squire, F. M. I 167, 168, 170, 175.  
 Statistics of the radio industry I xx, xxi, xxiv. II 143, 231. III 37, 122.  
**STEAM ENGINEERING, BUREAU OF** III 2.  
 Stein, A. III 40.  
 Stein, F. W. III 135.  
**STEINITE** III 134-141, 189.  
**STEWART-WARNER** II 77, 215. III 142-151.  
 Stone, J. M. II 207-209.  
 Stone, J. S. III 225.  
 Strassner, C. R. I 1, 7.  
 Stromberg, A. III 153.  
**STROMBERG-CARLSON** I xii. III 152-165.  
 Studebaker, F. I 1.  
**STUDEBAKER** II 92.  
**SUNBEAM** III 239.  
 Superheterodyne I viii, xii, xiii, xvi. II 51, 123. III 28ff, 68-79, 80-84, 227, 232-236.  
**SYLVANIA** I 146. III 143.  
**SYMPHONY** II 80-82.  
**SYNCHROPHASE** II 51, 62-67.
- TRF (Tuned Radio Frequency) I xi, xiii. II 75. III 45, 125, 127.  
 Tarzian, S. I 83.  
 Taylor, W. H. II 2.  
 Teague, W. D. I 37.  
**TECHNIDYNE** I 1, 200. II 75. III 115, 143.  
**TELMACO** III 189, 194.  
**TELOS** II 75, 76.  
**TEMPLE** III 99, 103-105.  
**THERMIODYNE** I xv, xvii. II 133, 196-198. III 166-173, 210.  
 Thompson, R. E. III 175.  
**THOMPSON** I xii. III 174-181, 210.  
**THOROLA** III 182-185.  
**TIMMONS** II 196.  
 Tracy, T. H. & P. E. I 17.  
**TRANSCONTINENTAL** II 100.  
**TRAV-LER** II 208, 214.  
**TREGO** III 189, 195.  
**TRESCO** see **TRI-CITY**  
**TRI-CITY** I vi, 100. II 215, 222. III 135, 186-199.  
**TRINITY** II 238.  
 Tripp, G. E. III 3.  
 Trube, C. E. III 167, 169.  
 Tully, J. C. I 90, 91. III 135.  
 Twombly, W. III 143.  
 Tуска, C. D. III 200, 201, 203.  
**TUSKA** I vi, vii, x. III 200-207.  
**TWIN COUPLER** II 239.  
 Tyzzer, H. J. I 40, 44.
- UNION SWITCH & SIGNAL** II 108.  
**UNITED CIGAR STORES** I 101, 107. III 167.  
**UNITED FRUIT** III 58, 59. See also **WIRELESS SPECIALTY APPARATUS**  
**UNITED REPRODUCERS** III 107.  
**U. S. RADIO & TELEVISION** II 143.

- U. S. RADIO & TELEVISION II 143.  
 VALLEY APPLIANCES I 146.  
 Van Dyck, A. F. III 9, 13-15, 17, 36, 37, 56.  
 VICTOR III 31, 48, 49, 54.  
 Vreeland, F. K. III 210, 213.  
 VIKING II 200.
- WABC, WAHG, WCBS II 51.  
 Wade, C. F. III 61.  
 WBAY/WEAF III 227.  
 WBZ III 6.  
 Wagner, R. W. II 61.  
 WAGNER II 91.  
 WALKER, GEORGE W. III 239.  
 WALLACE I 160.  
 WARD see MONTGOMERY WARD  
 Ware, P. III 177, 209, 213.  
 WARE I xii. II 2, 196-201. III 106, 107, 208-213.  
 WARNER BROS. II 3.  
 Washington, B. I 145, 146.  
 WASP II 242-247.  
 Wavelengths, broadcasting I xi, 66.  
 WCCO I 146.  
 WDY III 125.  
 Weagant, R. A. I 171, 179. III 115.  
 West, M. B. III 251, 275.  
 WESTERN COIL I 66. III 214-223.  
 WESTERN TELEVISION III 61.  
 WESTERN ELECTRIC III 23, 28, 224-237.  
 .WESTERN ELECTRIC, LTD. III 236.  
 WESTINGHOUSE I vii, ix, 66, 101, 110, 146, 165, 167. II
- 2, 51, 75, 167, 207, 208. III 1-59, 83, 203, 227, 251. See also  
 RADIO CORPORATION OF AMERICA  
 WGN III 69, 72.  
 Wheeler, H. A. II 75, 236.  
 WHA III 269.  
 WHAM III 153.  
 Wickwire, T. H. I 220.  
 WILCOX-GAY II 36, 143.  
 WINKLER-REICHMANN see THOROLA  
 WIRELESS IMPROVEMENT II 1, 100. III 175.  
 WIRELESS SPECIALTY APPARATUS I vi, 11, 40, 183,  
 194. II 1, 2, 5, 36, 257. III 1, 7, 10, 18, 23, 29, 40, 57-59,  
 107, 175. See also RADIO CORPORATION OF AMERICA  
 Withington, W. H. III 115.  
 WJAZ III 253, 259, 271.  
 WKRC II 108, 111.  
 WOK II 202.  
 Wolff, J. III 106.  
 WORKRITE I xii, 54. III 93, 238-245.  
 WORLD I xii.  
 Worthington, E. II 120. III 156, 160, 258.  
 WQJ (WMAQ) III 69, 72.  
 WSAX III 253.  
 Wunderlich, N. E. II 202.  
 WURLITZER I 20, 31, 183.
- Young, O. D. III 3, 28.  
 YOUNG & McCOMBS III 187.
- ZENITH I vi, xii, xv, 20, 110. II 143, 209. III 45, 246-278.











# Radio Manufacturers of the 1920's

Volume 3: RCA to Zenith

by Alan Douglas

The first two volumes of *Radio Manufacturers of the 1920's* have been enthusiastically received and highly praised by both readers and reviewers. Volume 1 covers A-C Dayton thru J. B. Ferguson, Inc, and Volume 2 covers Freed-Eisemann to Priess. Volume 3: RCA to Zenith finishes the series, providing well-researched, comprehensive information for collectors of vintage radios of the period.



Author Alan Douglas, when he's not researching radio information, devotes some of his leisure hours to caring for his Chevys. He is shown here with his green 1968 truck, and with his 1968 sedan which is now just a memory.

All three volumes of *Radio Manufacturers of the 1920's*, along with many other fine books on radio collecting and other hobbies, are available through bookstores, radio book dealers, and directly from the publisher. Ask us for our latest catalogue.

The Vestal Press, Ltd.  
Book Publishers and Distributors since 1961  
PO Box 97  
Vestal, NY 13851-0097



ISBN 0-911572-94-5



90945>



9 780911 572940